



TIMELINE LTD

THE MORROW PROJECT

OPERATION LONESTAR

In Texas The Last Cavalry Unit Fights On...

A Complete Game Scenario
By H.N. VOSS

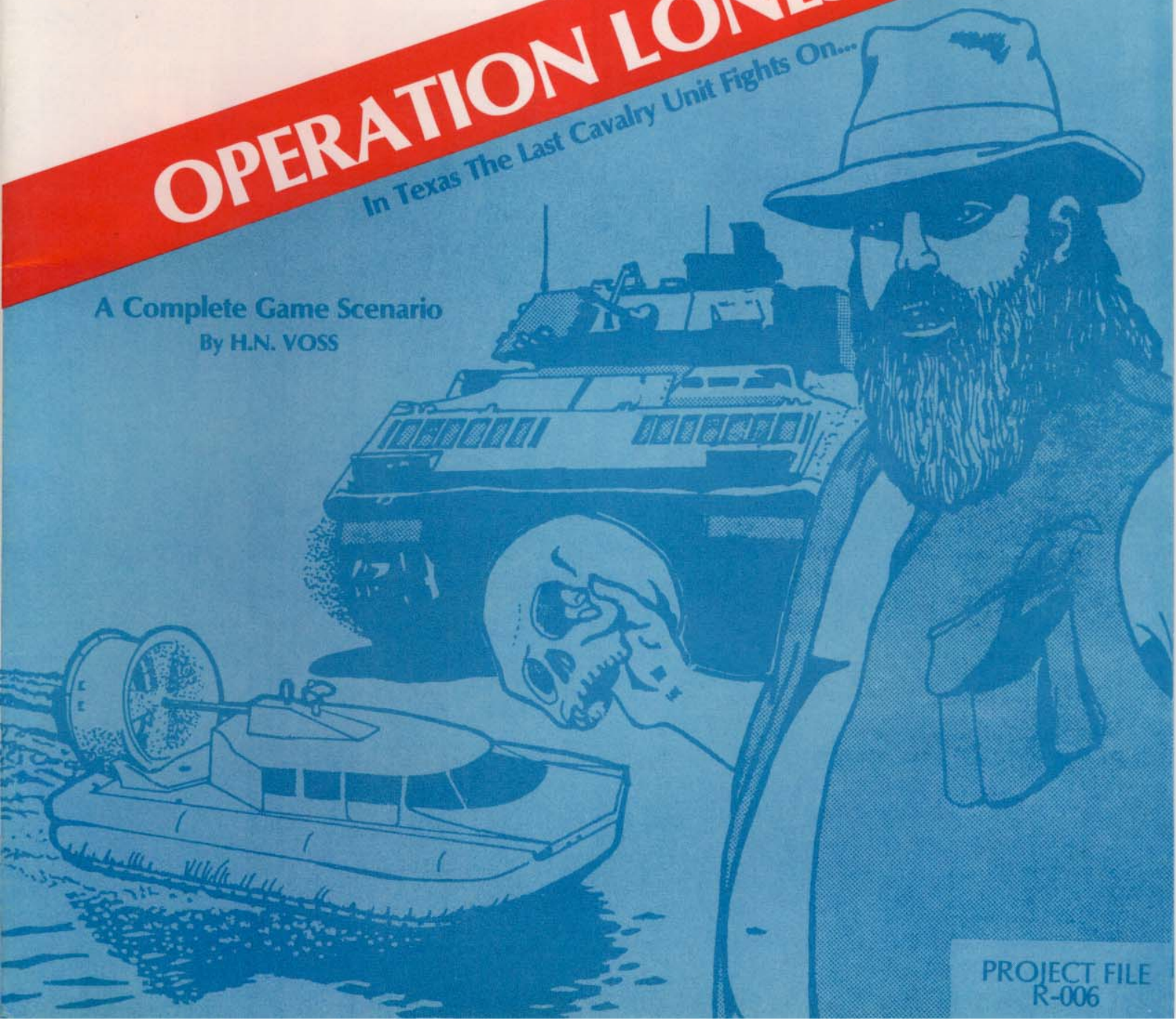

PROJECT FILE
R-006

**THE
MORROW
PROJECT**

Project File 006

OPERATION: LONESTAR



By H.N. VOSS

This document was composed and typeset on a Varsity Epics System using a Comp-Edit 6400 Digital Typesetter with the kind permission and help of both the Deucalion Resources Group and Varsity.

©Timeline Ltd. 1985

I. SITUATION: PRE WAR

The state of Texas is larger than many independent nations. Within its bounds are many types of terrain and climate: desert, swamp, forest, farmland, prairie, pasture, mountains. About the only things it lacks are rain forests and ice fields.

The people who live there are just **as diverse and earn their living** in as many ways. Farming, ranching, sheep herding, forestry, mining, oil drilling, production and refining, light and heavy industry, commercial deep sea fishing, international import and export, aircraft production, business and finance, computer design and manufacture to name only a few.

Texas has a rich history. Already a colony of the Spanish Empire **in the 1500's, it is one of the oldest areas of western habitation in the country.** With a large population of Native Americans to start with, the state eventually sheltered large numbers of people from every region of the planet. From its old adobe villages to the glittering towers of its cities, Texas is as modern and high-tech, or as sleepy and quaint, as anyone could wish.

II. SITUATION: THE WAR

Texas was smashed up pretty badly in the war. All of her major cities were destroyed; there were no providential misses. All military bases, particularly those belonging to the Air Force, were destroyed. The short term effects were as bad as any where else: radiation, fallout, water and food shortages, homeless people, and disease all swept through the state and 2/3 of the population perished.

III. SITUATION: POST WAR

In spite of the losses Texas survived. Most of the countryside remained intact, along with respectable industrial, material and human resources. With substantial aid from the surviving military some of the State began the long climb back to civilization.

South Texas did not share in the recovery; it fell into the hands of human animals. Sparsely populated west Texas, say everything north of the Big Bend in the Rio Grande and south of Odessa, fell out of step with the rest of the state. In time this land became home to a culture of nomadic hunter/herders of the old Commanche pattern; peopled by Commanches, Navajos, Latins and Anglos. The Pan Handle went off on its own, becoming an anarchic area characterized by loose associations of small towns and ranches. In both of these areas there is a lot of land but not many people; friction has been minimal.

"Near Oklahoma", (the area just **north of** the Red River) coalesced into many small "city states" and farming regions. The same thing happened in bordering areas of Arkansas and Louisiana. These areas are often rough and lawless.

The remainder of Texas thrived. Here true civilization grew again along with hope in the future. But there are a few problems...

COMBINED TEAM 13

II. GENERAL

Most teams fall into one of three broad MP categories: MARS, Science or Recon. CT 13 is unusual in that it is one of a very few Combined teams, that is, a team composed of elements from more than one specialty group. CT 13 is made up of MARS and Science personnel.

All members of the Project are volunteers, but the members of combined teams are volunteers from the ranks of the Project. CT's were frozen at various times, knowing that they would be placed and assigned specific missions at a later time, after they were frozen. Thus CT personnel do not know where they will wake up or what they are supposed to do. Of course, the Morrow Project General Orders apply: 1. Help the people. 2. Establish

contact with other Morrow teams. 3. Try to stay alive.

II. TEAM PERSONNEL

CT-13 has 8 members: 4 Science and 4 MARS. The members of each sub-team are very familiar with one another, having lived through MP training together. Each sub-team is reasonably familiar with the other as a period of mutual work and training was provided. All team members are completely familiar with standard Project equipment and its operation.

Recommended loads for this module are: SCIENCE: 7, 9, 10, 17, 18, 19, medic and **doctor**. MARS: 1, 2, 3, 4, **6,11**. No LMG loads are listed since two will be provided with the MARS vehicle. As usual, all team members can operate one another's equipment, but how well they do so may vary.

P.D. NOTE: If you are using the role playing supplement in GA-2 or in the third edition of the MP rule Book, make sure that the members of the Science sub-unit receive Backgrounds and skills in the "hard" sciences, MARS members should receive the combat skills they are entitled to and such background as the players and PD choose. You might want to leave the selection of personal loads up to the players,

III. TEAM EQUIPMENT

The team's personal gear is in perfect condition. Vehicles are also in perfect shape, along with internal stores.

THE BOLT HOLE

This module does **not make use of the standard** Morrow Project bolt hole. A map has been provided of the **bolt hole used in this module**. PD's are advised to refer to the map as necessary. The bolt hole is cylindrical and is composed of the usual concrete and steel; rather more of each than is normal. It is divided into two levels. The lower level houses the freeze tubes of the team, arranged in circular fashion, not unlike the spokes of a wheel. Pillars break up some of the open space; they support the massive weight above. The largest pillar contains the bolt hole computer. This computer is somewhat more sophisticated than the "idiot box" computers usually found in bolt holes. There is a ladder located behind the computer which leads up to **the next level**. This upper level is the "motor pool"; the vehicles are stored here. There is a large **door in one wall**. When activated, explosive charges literally blow the **door out of the bolt hole**.

Like common bolt holes, this one is usually filled with an inert gas at slight over pressure. This serves to keep out other gasses and to preserve the interior from the effects of normal atmospheric conditions (rust, etc.). When the wake up procedure is enacted, this gas is replaced by a bottled "atmosphere" mixture. As usual, the bolt hole is not designed for continuous occupancy: there are no beds, no food, no water and no latrine arrangements. It is designed to be abandoned.

Unlike other bolt holes, this one has no periscope package, no table or other amenities, and no other exits. It is even more spartan than the common bolt hole.

Team Vehicles

All of the teams vehicles in this module are new and have not appeared before. Even the team has not seen them. The Team will be able to operate them, as all controls and subsystems are similar to those found on other MP vehicles.

Three vehicles are provided. Each is an Air Cushion Vehicle (ACV) or "hovercraft" as they are more popularly known. Each is in perfect condition.

Quequod Class Flying Science Laboratory	
Crew:	4
Length:	23 ft.
Width:	12 ft.
Height (Skirt inflated):	9 ft.
Height (Skirt Static):	7 ft.
Height (Airborne):	10.5 ft.
Height (Floating):	5 ft.
Max. Gross Weight:	2,350 lbs.
Max. Cargo Weight:	1,200 lbs.
Max. Speed:	See notes
Armament:	None

The Quequod class ACV is intended to serve as a highly mobile field science laboratory. Fairly extensive scientific gear is carried but the unit remains a field system: it cannot match a static lab for space, comfort or normal scientific functions. Ideally the Quequod class should be paired with a Science 1 Vehicle or land-based lab.

The ACV operates best over calm water but can also "fly" over level ground. Its maximum speed over water is 40 mph. but normal cruising speed is best held to about 25-30 mph. Land speeds are 30 and 20 mph. respectively.

Wind conditions greatly effect ACVs. The Quequod cannot fly in winds of over 27 mph: it will not respond to controls, and it may flip over, crash, burn. In the face of a 23 mph wind the ACV is reduced to 15 mph. Side winds cause "slippage" and the ACV "skates" sideways while moving forward. Tail winds push the ACV along a little faster.

Quequod cannot negotiate water conditions where waves (sea swells) are over 1 meter tall; she will flounder and "fall out of the air." On land she cannot overcome verticle obstacles more than 2 feet tall, so even low walls will stop her. She can climb even slopes as long as the rate of rise is no more than 1:8. Quequod is not a mountain goat. She cannot cross a sheer-sided gully.

The pilot and navigator must be alert for obstacles. Moving between land and water requires calm water and a smooth piece of land. She cannot "bounce" over a boulder strewn beach. On the other hand, Quequod skims over floating logs without a qualm, something conventional boats cannot do.

ACVs do not fly. Quequod's maximum "float" height is 20 inches. You cannot "rev-up the fans" and "jump" over things. If the pilot miscalculates and flies off a low cliff or embankment, say about 4 feet high, Quequod falls and crashes. Period.

She will float. Water level when floating lies just below d&r level. As a result, the "deck" is frequently awash. Her propulsion fan will move her in the water and this will raise her in the water about a foot. Her water speed is slow: about 15 mph at top speed.

Quequod is not terribly manueverable. While hovering at a stand still she will turn on a dime; slowly. Moving at speed requires a lot of elbow room for manuevering. Her manueverability while floating is even more restricted. It is best to get close to where you want to go and then get out and paddle.

Too much weight will keep her from flying. Anything much over the cargo weight listed will keep her earth bound.

By virtue of the fusion power plant and electric engines she is all but silent in operation: you cannot hear her from more than 100 meters off. But Quequod can be seen more easily. She is big. Her fans kick up water or dust.

Still, on calm water or smooth ground whe is fast and efficient. When moving slowly she is an ideal swamp and marsh vehicle.

The cabin interior is small. All seats fold up for more room

and all have seatbelts and harnesses, save for the lab stools. There are no sleeping or latrine arrangements; Quequod is not a hotel.

The cabin, hull, skirts, fan shroud and air rudders are made from an epoxy/fiberglass/kevlar laminate which is both light weight and strong. The windows are made of ballistic plexiglass. This results in the entire vehicle exterior being proof against 7.62x39mm ammo. The Quequod is unarmed. The individual team members have their own weapons but no firing ports are provided. You can roll down the door windows and fire out that way, but physical integrity of individuals doing this is not guaranteed. In emergencies the lab windows and the front windscreen can be kicked out for escape. Replacing these will be a problem.

Quequod is not a combat unit.

Quequod has normal maritime running lights and twin halogen headlamps. These are controlled from the pilot's console. A light maritime radar is provided with a long scan range of 10 kilometers and a short, detailed range of about 2.5 km. This is operated by the navigator. The navigator also controls the autonav, but a display screen for the autonav is also provided for the pilot. A radio direction finder is also present with an effective range of 100 km. This is controlled from the lab as is the onboard computer.

Most of the basic load listed for the Quequod is stored outside of the cabin in shallow storage areas beneath the deck. (The space would have been used for fuel tanks on a conventional ACV.) Only personal gear and scientific instruments are stored in the cabin.

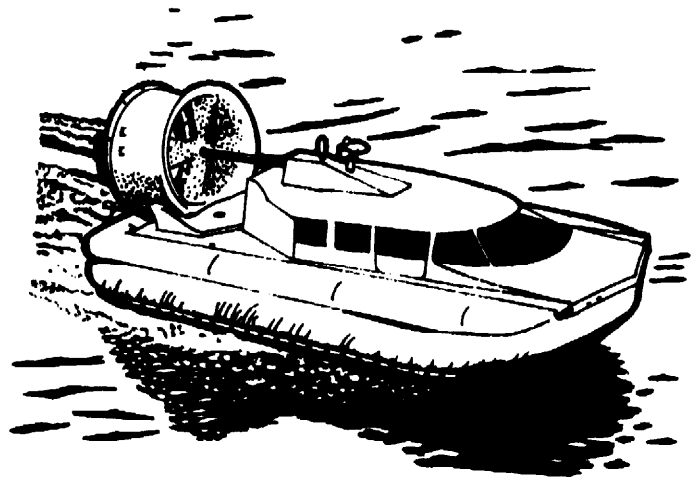

Quequod Lab Data

The lab aboard the Quequod may be inferior to a static facility, but every attempt was made to render it only just inferior. The equipment provided was the very latest and best available. In no one particular can this "flying lab" equal a static lab, but the wide range of gear carried makes the Quequod superior to any specialty shop short of one possessing the resources of a modern university.

The possible lack of full potential did not worry her designers: Quequod class ACVs were never meant to compete with better facilities. The primary purpose of Quequod was to gather data, lots of it, and pass this on to better equipped units. Thus the emphasis on all of its equipment lies in the acquisition of raw data; analysis and use were of secondary importance. The equipment carried can be broken down into several areas.

1. General Gear

A variety of labware is provided, since much of the more specific equipment will require the use of standard lab support items.

Item	Size	Quantity
Iron Lab Stands/Ring Mounts	Adjustable	4
Iron Lab Tripods	8 in.	4
Fusion bunsen burners (see note)	6 in.	4
Tube and small glassware racks	Assorted	6
Tube and flask grips	Assorted	12
Rubber "surgical" tubing	100 ft.	100 ft.
Stainless steel lab screens	Assorted	30
Rubber stoppers	Assorted	150
Tongs	6 in./1 ft. Long	2 pair each
Forceps	8 in.	8 pair
Tweezers	6 in.	10 pair
Mortar and pestle	500ml.	2 each
Scalpels/lab knives	6in.	10

Glassware

Specimen slides	2x2in.	500
Test tubes	Assorted	100
Culture (Petri) dishes	Assorted	50
Pipettes	Assorted	10
Thermometers	Assorted	10
Glass rods	Assorted	10
Tubing	Assorted	200 ft.
Florence flasks	100,250,500,750, 1000ml.	10 (2 each)
Ehrlenmeyer flasks	100,250,500,750,1000ml.	10 (2 each)
Beakers	100,250,500,750, 1000ml.	10 (2 each)
Graduated cylinders	100,250,500,750,1000ml.	5 (1 each)
Crucibles, w/lids	10,50,100ml.	30 (10 each)
Specimen jars/bottles (air tight)	Assorted	20

General Support Equipment

Refrigerator: This unit has interior dimensions amounting to 8 cubic feet, with a freezer compartment integral to the unit. Temperature controls are separate for both compartments. The unit is intended to be used for specimen storage, but in the absence of specimens it can be used to keep other things cold (like beer, if there is any...). However ice cube trays are NOT provided.

Oven: The interior dimensions of this unit are identical to those of the lab refrigerator. The oven can produce interior temperatures of up to 1000°K. Like the refrigerator, it has non-scientific applications.

Microscope: This is a good quality research scope, identical to those found in any serious biology lab in its capabilities. It has a variety of non-biological applications but it is in no way as versatile as the oven or refrigerator.

Centrifuge: A very useful tool, this one can deal with a load of up to 1kg. and can spin at 500rpm. The separation of components in solution is its main function, and it is therefore of no use mixing drinks.

Spectroscope: This is useful for determining the chemical composition of some compounds. The spectra given off by various elements can be matched against known spectra in order to determine what is in a substance. Of course, this does not give the amount of each element nor does it solve the problem of identifying all of the separate spectra in a complex compound. The spectroscope works mainly in the visible spectrum (4300 Angstroms to 6700 Angstroms) but if the computer is hooked up to it, it can give spectra in the 3000-7500 Angstrom range. The computer can also help in matching spectra but, as is usual, its programs are no substitute for human intelligence,

Autoclave/Sterilizer: The unit is used to sterilize small items, usually glassware, rendering them free of biological organisms. It usually works and will work on any run-of-the-mill bacterium. It does not wash things: if you put dirty breakfast dishes in, you will take dirty, but sterile, breakfast dishes out. Interior dimension is one cubic foot.

Test Chemical/Reagent Kit: About 5kg. of assorted multi-purpose test chemicals and reagents. When used in conjunction with the rest of the lab a great deal of data can be gathered on most organic, and many inorganic, solutions and substances.

Special Purpose Field Kits

Each of the following sets is a kit of equipment, light and portable, designed for use outside of the lab. Each kit has minimal analysis capabilities, they are designed to collect data. The data can be correlated and condensed into useful information through the resources of the lab.

In the case of those kits which can be used for simple, on-site analysis (such as the water analysis kit) and which contain chemicals, the chemicals have been provided in powdered or liquid form in sealed and pre-measured amounts. They are added to a prescribed sample size and a simple reaction (such as color change, fizzing, etc.) gives an indication of the state of the sample. Of course, the person using the kits must know what they are doing. A color change is just that unless the user knows that this indicates extreme acidity.

While the computer and its database can be helpful in describing this kind of simple analysis, it is not a teaching machine. An ignorant person will find the descriptions kept on the computer so much gibberish unless they have some experience in the area they are working in. Also, the computer cannot help a layman (as opposed to a trained specialist) do detailed analyses.

Because of this, every effort was made to give every member of a Morrow Project science team training in the simple use of the field kits. However, for more extensive analysis of samples gathered, the character must have specialized training in the field (see The Morrow Project Role-Playing Expansion in GA-2, the Basic Loads package for a list of training typical to science teams).

Geologic Sampling Kit: To the casual observer, this kit looks like a glorified rock-hound's set up. It contains the tools and other paraphernalia needed to acquire mineral samples from their native environment. In addition it has the necessary instruments for charting slope, dip, strike and the like for geologic formations. These include a Brunton compass, strike and dip measuring equipment and so on. With this equipment, the Survey Kit mentioned below, and the proper training, the team will be able to construct a geologic map of an area. Weight: 7kg.

Soil Analysis Kit This kit contains everything necessary to collect soil samples and prevent cross-contamination. There is a limited amount of analytic capability inherent to the kit, but in-depth results require the use of a lab. Included in this kit are soil boring equipment, sample containers, a few chemicals for testing soil acidity and the like and sieves for separating soil materials. Weight: 5kg.

Water Analysis Kit This kit functions in the same way as the soil kit. It can tell you immediately whether or not a sample is fit to drink. However, anything more detailed (such as why it is not) requires a lab. Included in this kit are sealed containers for keeping samples, biological contamination testing equipment, and some simple chemicals for testing the chemical purity of the water. Weight: 3kg.

Tree Boring and Bio Sampling Kit The "Tree Butcher's" rig is designed to acquire live samples and keep them fresh for reasonable periods of time. It is just about useless without lab back-up. Equipment included in this kit are tree samplers of various sizes, specimen jars for samples of wood, bugs, beetles, leaves, needles, bark, etc., and an instant developing camera to take pictures. Weight: 7kg.

Independent Field Kits

The following sets of gear have a greater inherent analytical capability than the special purpose sets. Still, they are most useful and accurate when used in conjunction with a lab.

Survey Kit This is a land surveyors outfit reduced to bare essentials. An optic scope and tripod, "range" stakes and poles, plumb lines, chart paper, solar powered calculator (with a slide rule as backup), flags, targets and markers are included, and a collapsible plane table. With this kit and a lot of time you could lay out a road, river system, dam, bridge site or what have you. With even more time you could make a fairly accurate map. The equipment is excellent but human error may interfere with the results. Weight: 20kg.

Meteorological Station Within this "kit" are instruments which can be used to determine air, land and water temperatures, to determine wind speed and direction, humidity, air pressure, rainfall amounts, and so on. To be used effectively this kit must be set up somewhere and monitored. The gear cannot predict the weather, but the information collected can be useful in formulating an "educated guess", especially with the help of the computer. As with everything else, training also helps. The station is most useful in collecting a database on which later predictions can be based.

Expanded CBR Kit This is a wizard package that would have been very handy shortly after The War. The kit itself consists of two complete environment units and a smallish, fully automated "receptor". Soil, water and other "solid" samples are fed into the receptor and, within five minutes, an amazing amount of data can be obtained from the sample.

When connected with the Quequod's computer (this can be done from outside of the vehicle), the computer will report the presence in the samples of any radioactivity and its intensity, any extraordinary chemical contamination and any unusual biological presences. It will also report the relative lethality of radiological or chemical contamination and assign a "best guess" of any biological contamination found.

In depth analysis of chemical or biological specimens by the lab crew will still be necessary to acquire precise information.

This kit is not a magic box, it is an expanded version of the standard issue CBR kit which is keyed to look for particular traces and report on certain anomalies. Without the computer and its database, it will simply provide a readout of certain percentages of various chemical, radiological and biological measurements.

Even with the computer, its "guesses" may well be wrong and they are limited to checks for expected contaminations caused by The War. It may indicate that a water sample is clean which in fact has giardia. This is because it was not looking for this infestation since it is unlikely that this usually non-fatal bacteria would be used as a bio agent. Weight: 20kg.

Complete "idiot simple" instructions for the use of all lab equipment are included in the computer. Each of the field kits also has instructions in the computer and each has a printed manual with the kit.

The Computer

The computer aboard the Quequod is vastly more advanced than the usual Morrow issue vehicular computer, while incorporating all of the functions of those simpler machines. It is built in to the lab of the Quequod and cannot be removed without extensive equipment, a hardware specialist completely familiar with the system, and a great deal of time.

The computer has a number of unusual peripherals which allow it to do several very useful things. To begin with, as mentioned above, the computer can be hooked into the Expanded CBR kit to evaluate samples for unusual contamination.

There is also a laser printer with 50kg. of paper which is capable of doing high quality printing including pictures which have been stored in the computer. The printer's resolution is 1000 dots per inch, about 1/3 the resolution of a 35mm slide but equal to the reproduction quality of an offset printing press. Indeed the printer can be used as a small press providing the team can keep it supplied in high-quality paper. The printer is approximately 18" long, 24" wide and 12" deep. Paper is fed to the machine via a cassette, much like a copying machine. If paper of insufficient quality is fed into the printer, it will jam and the printer must be opened to remove the jammed page.

There are four methods of input into the computer:

1. A standard QWERTY keyboard with an alphanumeric pad built in.
2. A headset which the operator speaks into. The computer will convert the spoken words into commands. To use the headset, the operator must first read a specified set of words into the computer in order for the computer to "learn" how the operator speaks. The voice recognition system can also be used as a lock on the computer by requiring the operator to begin a session by reciting a set passage as a password. The computer can be instructed to lock out anyone who does not follow this sequence or anyone whose voice it does not have on file.
3. To enter pictures the operator may use a modified "mouse". First made famous on Apple's Macintosh computer, it has been simplified so that it has the shape and size of a thick fountain pen and it is cordless. To use it the operator simply presses down on the on-switch located on the lower inch of the pen and begins to draw. The motions made by the operator are sent to the computer via a sonic signal and these are transformed into pen strokes which are displayed on the screen.

4. A faster way of entering picture information (if it has previously been drawn) is via the digitizing camera provided. This is a small unit which can be used to scan a picture. In its most precise usage, it is clamped into a collapsible stand and the information to be digitized is placed under it. A "snapshot" of the image is then fed into the computer. This is necessary if precisely scaled information is being fed into the system, it can however be hand held and pointed at people, trees, buildings or whatever. In the stand-held version it can be used as an optical character reader (OCR) to input printed text; provided specified examples are entered first. The system can also "read" handwritten text but due to the variation in handwriting, this is not reliable.

While these toys are both useful and powerful, the most impressive thing about this system is its software.

The real genius of the program is the ease with which it can be used. Basically the operator can sift through enormous quantities of data, asking questions about the data stored, graphing relationships and applying various programs to search, twist, and caliper the data in almost any fashion. The program will even attempt to evaluate questions which are open ended and imprecise (if the operator invokes that as an option).

The trick is that, like any other program, the user must know what to look for, the data must have been entered into the computer and the answer asked for by the operator cannot require the computer to "think". The computer is not Damocles. It is not alive, cannot think, make suppositions or originate ideas about what to test for. It can help the user make these decisions by presenting facts, summaries or statistics about an analysis, or information about a subject.

It is also not a "teaching machine", any more than a book is a teaching machine. It contains information about what gunpowder is made from. Unless step-by-step instructions on how to make gunpowder are included in its database, it cannot tell the operator how to make gunpowder. As a result, the information available is a two-edged sword. Used carefully, it is a great boon. Used idiotically it can blow your hand off.

P.D. Note: Exactly what information this computer has **in it is up to the** Project Director. However, certain guidelines can be given. It is suggested that the P.D. think about how reasonable the request for information is, and decide what, if any responses the computer can give. If the players ask for information about T-72s, either tell them that it is not in the computer's database or give them the kind of information you might find in an encyclopedia: that it is the main Soviet battle tank, that the Soviet Union has, say, 10,000 of them, that it was first deployed around 1976 and that it is also used extensively by all Warsaw Pact countries. Don't give them information about its armament, speed, weapons etc. Those are things which specialized military books have, not encyclopedias. Remember also that the computer is meant to be a piece of lab equipment and that its memory and speed is limited. Everything could not be put into it and, as a result, only the most general facts and the information most useful to the expected tasks of the team was entered.

The computer has several languages available including 'C', LISP, Smalltalk and FORTRAN. While anybody can try to program it, if they do not have training as a programmer, they will find it a difficult task. Even a capable programmer will need a great deal of time to get used to the system and to program anything complex can take months or even years. As with the information about other lab equipment, the basic information and instructions on how to operate the computer is stored on the computer **itself**.

P.D. Note: With the exception of the computer and its sub-systems, all of the lab gear is crated and packed into the lab area. It is not even possible to enter the lab area. There is no way to access the computer. The entire lab, from floor to ceiling, is full.

Mercifully, the planners attached the lab manual and contents manifest to the front of the pile. Obviously the idea was to unload and unpack the gear while the team was still in the bolt hole and thus get the lab **working** before operations commenced.

Now however, the team will have to put down somewhere else to do the job. Complete unloading will take not less than two hours. Unpacking will consume about 10 hours. Getting everything back in and properly stowed will take another 10 hours, (Fortunately there is a designated place for everything: Good planning!) Complete function checks on all equipment and a "shake down" run will require at least a week. Sadly, the MARS element will be of small help other than as unskilled labor. ("Here, carry this. Unpack there, BE CAREFUL WITH THAT!") Oh well, they can guard the mess while the science team members figure things out...

Flying Dutchman Class MARS ACV

Crew:	4
Length:	20 ft.
with RH 202:	21 ft.
Width:	12 ft.
Height (Skirt Inflated):	12 ft.
Height (Skirt Static):	10 ft.
Height (Airborne):	13.5
Height (Floating):	8 ft.
Max. Gross Weight:	900 lbs.
Max. Cargo Weight:	400 lbs.
Max. Speed:	See Notes
Armament:	1 RH 202 20mm. Cannon 2 MAG 58 LMGs

The Flying Dutchman class of ACV is a light strike **and** fire support MARS craft. It is an ideal "hit and run" vehicle, weather and terrain conditions permitting.

Its maximum speed over calm water is 60mph, 40 mph over smooth ground. Cruising speed is 45 over water, 30 over land. While floating in the water the propulsion fan can move the ACV at a rate of 15mph. The ACV can overcome 20% grades but cannot cross verticle obstacles higher than 18 inches. The ACV cannot operate in winds stronger than 30mph and its efficiency is greatly reduced when flying in winds of over 15mph.

All of the hazards and advantages of operating an ACV described for the Quequod class apply equally to the Flying Dutchman. The Flying Dutchman is armored to the same extent as the Quequod: it is proof up to 7.62 x 39mm. ammunition. There are many differences **between the vehicles**.

The Flying Dutchman is an open craft; there is no cabin and so the crew is fully exposed to the elements and rather more exposed to small arms fire. The Dutchman is significantly faster. This allows greater tactical flexibility and hopefully enhances chances of crew survival. Electronic gear is limited. An autonav is provided for the pilot but there is no radar, RDF or even headlights or running lights.

The gunner controls the RH 202 cannon (MPGB pg. 16). This weapon is sighted with a top mounted camera and the display screen is located in the center of the gunners console. A spotlight

(effective range: 1km.) is provided for targeting at night but must be mounted by the crew. This light can be used as a cycloplan headlight for the ACV but is terribly obvious. The cannon is capable of limited traverse and elevation (05° up or down, left or right), but for more radical aiming the entire ACV must be moved about. Firing the gun noticeably slows forward momentum of the craft. The RH 202 is completely stabilized and the fire control system compensates for the "rise" or "sway" of the craft caused by firing. Twin feed is provided from magazines beneath the mount. Each may hold up to 100 rounds. Reloading new belts takes a good 10 minutes.

Two wing gunners are provided with MAG 58 LMGs (pg. 15 of the MPGB). These are mounted on pintles within gun shields. The weapons move freely along a track fixed to the outer bulkhead of the firing stations. Both are limited by "idiot stops" which prevent gunners from firing into the rear fan. Aside from this limitation the guns may each fire in a 180° arc.

Despite its size, the Flying Dutchman is rather light. Its carrying capacity is severely limited. With a full issue load on board and four crew members it could at most, lift two more adults or an equivalent weight. It is not a freighter. Its small carrying capacity is the main reason for its greatly reduced basic load.

It is little more than a fast gun platform. Its sole purpose is to "run interference" for the science element.

Both ACVs have other things in common. The fusion plants aboard each can produce respectable electrical power equivalent to a 10Kw generator. Both of the aft mounted propulsion fans are separated from the forward areas by tough, close mesh metal screens to prevent solid objects from being drawn into the blades. Each has similar protection for the underside lift fans.

Both the Quequod and the Flying Dutchman will have a hard time operating in wooded areas. They're length and width and especially their height render them near useless in forests. Mountains are out of the question for these vehicles, as are steep hills.

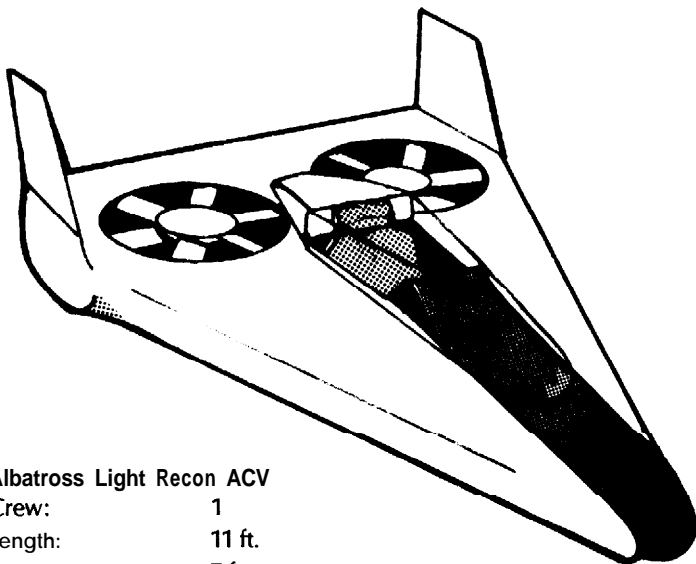

Albatross Light Recon ACV

Crew:	1
Length:	11 ft.
Width:	7 ft.
Height (Flying):	4.5 ft.
Height (Static):	4 ft.
Max. Gross Weight	350 lbs.
Max. Cargo Weight	200 lbs.
Max. Speed	See Notes
Armament	None

The Albatross is a one-man flying wedge intended solely for quiet, fast recon work. It carries very little; the 200lb. cargo limit includes the pilot.

Its maximum speed over water is about 30mph; but on level ground it can move at up to 60mph. The albatross can float but cannot use its fans while doing so. To maneuver in the water one must paddle or power up and fly. Being so small it is less effected by wind than its bigger sisters, but it still cannot fly in winds of over 25mph. Its vertical obstacle clearnace is only six inches. The Albatross is "armored" in the same way as Quequod and Flying Dutchman.

The craft has no lights and no autonav. Navigation is strictly "seat of the pants". An AN/PRC-70 radio is mounted.

The fans of all of these ACV's are protected by mesh screens from flying debris and the accidental introduction of organic matter (human hands, pelicans, etc.), but this is no protection against bullets. Therefore, the fans themselves are made from a resin/kevlar compound similar to that used in the construction of some helicopters. This makes the fans, too, proof against hits from up to 7.62x39mm.

Each of these vehicles is based on older designs which date from well before the war. The patents, designs and licenses necessary to produce the vehicles were procured by Morrow Industries and modified to suit the requirements of the Morrow Project. The ACV's were then produced by Vanderdeken Designs, a subsidiary of Morrow Industries.

Team Caches

The usual six caches were provided but most of these will be hard to access. One was near Freeport, another by Lake Jackson, two more were close to Bay City and Wharton respectively. The 5th was just north of Pasadena but this one was inundated by greater Galveston Bay and is now under about 30 feet of water and two feet of bottom sludge. The last is just south of Liberty.

Each contained small arms ammo and spare parts as well as 20mm ammo for the Rh202. A great deal of gear was provided for the use of the science element. A large store of spare parts was included for the ACVs, particularly fan blades and replacement sections for the air skirts. This left little room for the more common plows, seeds and tools usually found in caches so these are not as well represented. Exact contents should be determined by the P.D. in accordance with The Team's needs and his own ideas of the direction the game should take.

THE PEOPLE OF THE LAND

Mexico

Mexico, like most other nations, did not survive The War as a political entity. Several cities in Mexico were hit by nuclear weapons. Mexico City was foremost among these.

Mexico has never been a happy or homogenous country and it soon fell into fragmentation and a bewildering array of independent "Republicas" sprang up over night. Most of these were small and often centered around the headquarters of military districts.

During the first days of The War the most infamous of Soviet fellow travellers, Cuba, launched several small "amphibious liberation forces." While most of these came to naught, one of them concerns us in this module. This force' aiming at Tampico in Mexico was driven north and landed in the marshes not far south of Matamoros and the Texas border. Only a mixed battalion managed to land.

The battalion was quickly bogged down in the swamps and was then summarily dealt with by troops arriving from the new "Republic of Monterrey." The Cubans received no aid from home' for during their absence the island had been all but sunk by the 3rd round of U.S. nuclear strikes. As a result, the entire force was either destroyed or captured.

The Republic of Monterrey thus gained a great store of Soviet hardware. Eventually Monterrey controlled an area bounded on the north by the Rio Grande as far as Big Bend, on the west just short of Torreon, and to the south the lands north of Ciudad Victoria. It thus became one of the largest republics in what had been Mexico.

The new republic did not prosper. It was constantly threatened from without and from within. A ruling dynasty formed and made leadership of the republic hereditary. The military was not pleased.

The military was constantly called upon to defend the borders and now and then to suppress internal disorders. The dynasty more and more fell into indolence and decay. Eventually only the military prevented the dissolution of the republic. The leaders of the military were frantic for change. They accepted an offer from the "Brotherhood" to the north and were thus destroyed. The details of this can be found in the section of this module which describes the Brotherhood.

The Republic of Texas

The current Republic of Texas owes its existence solely to the presence of the 1st Cavalry Division. The politicians do not admit this.

After the war, the entire state was in danger of destruction by plague, starvation, invasion, random pillage and rapine. Here and there a small community pulled together and made it through the troubles, but in general, it was the soldiers of the 1st Cavalry that provided such order and security as existed.

The sheer size of the state helped keep things sane. Most of Texas was sparsely populated; only the cities had heavy concentrations of population and all of the largest of these were destroyed in The War. The people who were left were not in too bad a shape and were used to thinking of themselves as "Texans"; independent, proud and stiff necked. As soon as it was safe they set about rebuilding and preserving.

And failed. But in their failure they came closer to success than any other area of similar size. Texas came through The War as a recognizable product of its former self. The 1st Cav was active from the start and had, by the new year, secured both Texas A&M University and the LBJ Space Center. Teams of soldiers were in the countryside helping the survivors even sooner.

But in the beginning there was nothing but a disaster that had found a place to happen.

Gradually communities of up to 5 thousand souls formed. These eventually coalesced into county-sized units. Each was independent and each was weak. Rumours were rife about a terror in the south. Trade, transportation, communications and organization were minimal. Each area had what it takes to subsist, but few had all that was necessary to prosper. Few areas trusted one another far enough to merge.

But there was also news of the army at Fort Hood and what it was doing. The army was bringing people together and rebuilding. It sounded good. One by one the communities surrendered their autonomy for protection and progress.

The conditions set by Ft. Hood were clear and inflexible: give up self-rule and accept martial law and prosperity and security in exchange. Harsh measures for harsh times.

But the hand of the military was light. It controlled the economy of a region, true, but it brought many benefits. Law and order returned, schools were reestablished, roads and bridges were maintained or rebuilt. Troops patrolled and militias were encouraged and bandits diminished or vanished. People began to talk about a country again.

A money economy returned. Paper money was worthless but gold \$5 and \$10 pieces and silver \$1 pieces began to appear. Older, smaller coins were again worth their face value. Barter continued but was no longer the main economic activity.

And though money was scarce, prices had stabilized at newer and lower levels. A cow could be bought for a dollar and a bull for \$3. Beer was a penny or two for a pint and a bottle of whiskey was 25¢. A man could often buy an acre of land for twenty dollars.

Industry got going again. Metal could be shaped, ammunition for small arms found, wagons built, even a few of the offshore oil rigs were producing oil and gas again! Things did not get up to pre-War standards but there was hope.

Twenty years after The War there was, amid the ruins of Texas, a healthy community of free men centered around Ft. Hood. Civilization, crippled, lessened, but defiant, had survived.

All of this was engendered and controlled from Ft. Hood, and this suited just about everybody for a while. Men had complete autonomy in their home affairs as long as martial law was not violated or crowded.

Texas A&M (Agricultural and Mechanical) had been maintained, The curriculum had been shortened to two years, but then, students now received no vacations or breaks. It cost money to send students there, but much less than it once had. A community could often afford to send a bright prospect or two and usually profited on their return.

And those lads who left for the army usually came back having skills very useful to the community, both military and civil. At the least they got an education in practical problems and their solution. At the best they left with a degree from Texas A&M and/or a store of practical experience which would stand them (and their community) in good stead in the years to come.

But as the years passed and prosperity grew there was complaint. People began to feel that too much power was in the hands of the military. Couldn't some controls be loosened? Things were better then they had been and it was time for more freedom! Control was loosened and more freedom was given.

But what about free trade? Expansion? More open borders? What about civil control of the military? Historically hadn't that been the way things were done? What about Independence??!! ("Independence from what?" The Major is said to have wondered.)

Loosening of controls had led to more freedoms, but also to the engendering of a class of professional rabble-rousers. These self-styled "guardians of liberty" now called for a new country, untrammled by the superstitions and prejudices of the past, run

by the best qualified. (i.e. Themselves, but this was never so boldly stated.) They clamored for political parties and free elections and civil government. The people of Texas agreed with the saner statements and policies.

So did the military. It had governed this piece of the United States for nigh on a hundred years through necessity, not choice. It had never wanted the job and did not want it now. The then Major readily agreed, but made several provisos mandatory: The new government must accept the Constitution of the United States and the Bill of Rights as its basic articles and guiding principles; That since the government so formed would not be the government of the United States but would instead be the government of the State of Lesser Texas; That the 1st Cavalry Division (Lonestar), being an instrument of the government of the United States, would in no wise fall under the control of the State of Texas.

These conditions were agreed to.

A year was allowed during which each community would figure out what kind of government was wanted, then they would send a representative to a meeting at the University. All of the representatives would gather there and hammer something out, then take the results home for approval.

It was a nice plan. It did not work and the chaos it led to was truly magnificent! Ft. Hood quietly continued to run things while the shouting and arm-waving grew more vigorous.

It was nine years before a compromise was adopted. In that nine years the representatives, those who had sweated out the whole time, those who had not gotten fed up and quit or been bounced by disgruntled supporters, these people had learned something about running things and about getting the jobs that **needed** to be done, done. Most of them were not eager to remain in public life. Their compromise solution was fairly workable too.

This was a scaled down Federalism based on the old U.S. Government, modified to suit local conditions. There would be a president, a senate, and a judiciary. The senate would select one of its number to serve as president until communications allowed for true "national" elections. Judges would be elected locally and would be circuit judges. Eventually a Supreme Court would be formed, manned by veterans of the circuit courts. Each county would elect one senator and one judge. Local government would remain a local problem. With this done, the representatives called for general elections and went home.

Because most of the representatives to the convention flat out refused to stand for election, the majority of people who came to staff the new government were relatively inexperienced and were strangers to one another. These tyros did some weird things.

They proclaimed the Republic of Texas, rather than the state of Texas. They decreed that the capitol would not be Bryan but, for purposes of central control, would be located in Waco. (This surprised the people of Waco, who had not been consulted.) Of course, the new government was either unaware or did not care that there were no facilities for their use in Waco. To support the activities of government, an annual head tax would be levied on all citizens.

This last took everybody by surprise. Ft Hood had never taxed. (Through its land, farming, livestock and industrial interests, the 1st Cav had always been able to pay its own way.) There was discontent. Some called for the dissolving of the new government and reestablishment of military control. This was squelched when The Major refused to resume control. Things settled down but several senators found that they were no longer welcome "back home". Life went on.

The Republic was formed 51 years ago. At its greatest extent, it comprised all of the land north of the San Antonio river and south of the Red river. In the West the border roughly followed the line of old Texas highway 83. The Eastern Border was much the same as the Louisiana border had been, roughly west of the Red and the Sabine rivers. During the last push by the survivalists some 24 years ago, the land North of the San Antonio river was lost. The new border followed the course of the Guadalupe river.

One of the most constant trends of the last 50 years has been the ongoing feud between the Republic and the 1st Cav. Soon after its creation the Government tried to annex the division. This failed **due to** the division's unwillingness to accept the order and lack of popular support for the venture.

The Division countered with a request that the Republic assume financial responsibility **for the unit (pay the troops, etc.), seeing as how the 1st Cav guarded the Republic exclusively. This one took years to sort out, but in the end, the Republic wound up paying soldiers' salaries, but only that. All other expenses were borne by the unit. (Including provisions, weapons and ammo procurement, etc.)**

Perhaps in an attempt to get back some of its own, the Government then voted to tax the pay of the troops. The Division in turn, stated that the Republic could do this if the Government also paid the troops more. The Government declined the offer. The Government threatened to come and get the money by force. The Division invited them to try. Then the Republic got sneaky and informed the troops that they would be held accountable for all back taxes accrued while in service; so "save your money boys!" Upon completion of enlistment or career, the tax man

would meet you and would expect payment in full on the spot. Troopers ignored this.

Then one month some 72 men were arrested upon mustering out; **for tax evasion. The division rolled and the men were broken out of jail, with no loss of life or serious injury. the Republic did not try again.**

The Republic countered with a law forbidding soldiers the right to vote. (You don't pay taxes so you don't get a say.) The Division inquired, politely, if this meant that the troops would now be joined in the field by the Senate, or would go without defense. (If you don't fight then you don't deserve to be protected.) The new law was dropped.

Then the Government tried to disband the Division and form its own army! Everybody ignored this one and the order wasn't even repealed.

The sniping has been going on now for years. The Government, **in all of its official correspondence**, refers to the Division as "**The Army of the Republic.**" The Division refers to itself as it always has and flies the flag of the United States at all of its posts. In a country with no baseball or other spectator sports, the feud between Waco and Fort Hood is **a source of great entertainment.** The fans root heavily for the Troops and so far have not been disappointed.

Cooperation between Waco and Fort Hood, **on practical matters is generally very good. Civil administration and the military get along on all matters save those of protocol or "face." It's still fun to watch!**

The Republic Today

Even with the loss of territory in the last war, the Republic is still a big place. Population is roughly 5 million.

Still a "frontier society", farming and ranching are the main economic activities. Towns exist in profusion, but there are no cities as we know them. People are scattered pretty thinly.

Logging, fishing, mining and industry are all parts of the economy. **General technology is at a level of about 1900**, but population density and food distribution preclude large **population centers and production line assembly. Practically, transportation and communications exist at a level of about 1830.**

The level of technical knowledge is higher. Texas A & M University still maintains knowledge that was common at the time of the war. The preservation of the university has enabled much to be maintained that would otherwise have been lost. Texas A & M also houses the military academy of the 1st Cav and provides several technical courses for the military. **So while there are few radios about, there are quite a few people who understand the theory and operation of radio.**

The most important contribution of A & M has been in the training of teachers. Most of the schools in The Republic are staffed by former "aggies." Knowledge of history has been maintained, along with many other things. Levels of literary and mathematical competence are higher than they were before the war.

Most communities center around a town. Towns now regularly have stores, saloons and restaurants. Printing has not been lost and most towns have a library, but books tend to be expensive.

Towns have mayors and sheriffs. Each county usually has a Marshall, appointed by Waco. Towns and communities, especially near the borders, often have militias. Membership in the militia is voluntary, equipment is not standardized and usually consists of whatever the members bring. The Militia is usually led by the local sheriff. There is no government or military control, or support of militias. (Fort Hood will send advisors for training purposes if such are requested.)

The population is much more homogenous than it was. Distinctions between Anglos, Mexicans, Blacks and Indians are just about gone, along with pure examples of each. The pre war coastal areas sheltered a large number of Vietnamese immigrants. These people have blended in more slowly due to differing ethnic traditions.

The language commonly spoken varies from area to area. Most are English based, some are Spanish or Comanche/Navajo based; some are nearly pure Vietnamese. But except for the very young, all people can speak passable American English, for this is the language of the schools.

The government of the Republic is not taken too seriously. The idea of the Republic itself is sacred. Only the reestablishment of the U.S.A. would overshadow it.

Great respect is reserved for the "Lonestar" Division. People look to the Division and to local leaders for security and not to Waco. Judges and Marshalls are also respected, even if the Marshalls are appointed by "those fools in Waco." Waco is often mispronounced "wacko."

All things considered, the Republic of Texas is a good place to live.

The Recent State Of Emergency

The Republic was a good place to live. One month ago the invasion began. Surprise was not complete. Border patrols along the Guadalupe reported unusual activity on the far borders and a decrease in raiding. A quick check of the calendar showed that Texas was due for trouble again. The Division recommended that civilian evacuation begin. The Government demurred. The Division started moving people. The Government protested, calling the reports unfounded and the Division's activities alarmist. People started to move anyway, but not enough of them.

There had never been any formal contact between the Republic of Texas and the Republic of Monterrey. The fall of Monterrey went unnoticed.

When the invasion did come it was expected, but the size and ferocity of the attack took everyone by surprise. The details are given in the section of this module dealing with the Cavalry. Here it is enough to say that disaster is an inadequate word to describe what is happening.

But the Government, just before it dissolved, made reference to "the recent state of emergency."

The Savage lands

As has been noted, Texas is a big place with widely varying climate and terrain. Drawing an arbitrary line from El Paso through San Antonio and across to Galveston creates a "horn" of terrain south of this line. In this horn, especially south of San Antonio, the land is more barren and less populous than in most of the rest of the state. Drawing yet another line further south from Laredo to Corpus Christi makes a still smaller horn. South of this line there is very little outside of the Rio Grande Valley. The land is arid, not well suited to agriculture and sparsely inhabited.

There is also very little there worth the expenditure of a nuclear strike. This, along with the fact that prevailing winds and atmospheric conditions made this a low-risk area for fallout (assuming the wind did not change), meant that the area was an "ideal" haven for survivalists.

Survivalists had been around since the 1950's but their numbers and fanaticism grew from the mid-1970's onward. A survivalist was a person who, believing that nuclear war was either a real possibility or inevitable, planned to survive The War by being prepared for it.

In the 1950's and early 60's this usually meant digging a bomb shelter in the backyard and stocking it with food, bottled air and assorted other stuff. The idea was to hide in the hole and wait to be rescued by the Civil Defense folks when (hopefully) they arrived. This is a simple and relatively harmless attitude (however naive) and the government supported the movement with innumerable pamphlets and other information sources.

However, from the mid-60's to the mid-70's, interest waned. This was due in part to the government's not wanting to contribute to an air of hysteria and in part to the growing awareness (rarely spoken) that a hole in the backyard was not going to be nearly enough. Such a hole might get you through The War but what about Afterwards? Nobody wanted to think about that.

In the mid-70's interest was revived and not by the government. Suddenly a whole crop of writers and commentators began to speculate on what it would take to survive a nuclear war and, more importantly, what it would take to survive in the chaos that followed. "Knowledgeable" speakers appeared on TV and radio, or gave lectures to interested audiences around the country. Some magazines began running regular monthly columns on the subject. Innumerable books were printed on the topic. Advertisements sprang up for "survival goods and equipment", and many firms claimed to sell complete packages; "Everything you need to survive World War III in style!"

Much of the writing and practically all of the "goods" were useless and worse. Still, amid all of the hoo-ra there was a hard core of sound information. To survive, several things would be necessary:

1. Do not be in or near a "high-risk" area. (e.g. population centers, military posts, etc.)
2. Be as far away from these as possible ("At least a tank of gas." was the rule of thumb.)
3. Have a site chosen which is provisioned with all that you need, is ready for you, and be in it BEFORE the bombs start falling.
4. Be trained to survive at a subsistence level for the rest of your life.

While this list makes sense, there are problems with it. Few people, for whatever reason, can afford to make such preparations or are willing to do so. To be sure that you are in your sanctuary when the balloon goes up, you must live there all the time. The philosophy was all-wrong for the average man and this led to trouble in two ways.



The experts playing Cassandra pointed out (accurately) that the only way to avoid being caught in the fireball was not to be there when it formed. With this as a basic premise, all subsequent discussion focussed on how to stay alive afterwards. Much attention was given to matters of crop growing, water purification, dealing with fallout, etc. but all of the sources waxed eloquent on defense. Each pointed out, often in grim detail, just how bad things were going to be after the blow fell. It was noted that the survivors would perform inhabit a dog-eat-dog world where the "haves" (survivalists) would be forced to defend themselves and their property from the "have-nots" (i.e. non-survivalists), in order to survive. All such arguments were presented in pure Darwinian terms; survival of the fittest (the survivalists) and the Devil-take-the-hindmost! Writers pointed out that conventions of society, morals and ethics foremost, would collapse and implied that in order to survive the survivalist would be required to shuck his own morals first! Security, or defense, was to be the God of the survivalist; first, last and always.

It is beyond doubt that most of these experts were well-meaning. It is even probable that some of them were unaware of the effects that their preaching would have. Certainly they presented an accurate picture of the post-holocaust world, as far as their speculation would allow. But concentration upon the "defensive" needs of the survivalist overshadowed the equally essential "material" considerations of the survivalist; plowing, building, decontamination, etc. This was the first source of trouble which led directly to the second.

Concentration upon "defense" alienated the common man, the very person that most of the commentators claimed to be trying to reach. Instead, the "wild-eyed crazies" picked up the banner and began to fan out into the bush in order to survive. These fanatics concentrated upon defense and, specifically, arms. (Whole books were written on the subject of weapons needed for survival.) One man's defense is another man's offense. A cursory bow to other survival skills was all that was required. For the never-stated-as-such survival of the fittest doctrine meant that it was more than all right to seize what you needed, it was good, it was the will of God. This was the second problem. For all that the experts never meant it to happen, the majority of those who accepted their gospel were latter-day brigands, society's misfits who wanted an excuse to take up arms and lie in the hills to await less prosperous days. They would then descend to feed on the helpless and they could tell themselves that it was their right.

So from the mid-70's onward the crazies began to arm themselves. Small groups began to appear in remote areas. They rarely farmed or performed other useful activities for these were not the "free and independent American Pioneers" who the writers envisioned. Instead they could be found practicing military drill and small unit tactics and firing copious quantities of small arms ammo, usually poorly. Guns are glamorous, plows are not. Running around in a field with a gun is "fun", farming is hot, sweaty, dirty work and is not fun.

Many of these groups styled themselves as "warrior brotherhoods." All observed a policy of "shoot first and ask questions later", if ever.

The War did come and most of these bands survived the falling of the bombs. Of course, their stocks of freeze-dried foods, water, gasoline, spare parts, girlie magazines, toilet paper, medicine and everything else soon ran out. These people did not know how to make replacements. They had little to trade but, more importantly, were not inclined to trade. They were inclined to take.

So within months of the end of the war small parties of vicious

men, the survivalists, began to raid and plunder the homes of more honest men. This happened throughout the country and while not all survivalists were involved, the majority were. In South Texas the problem was unusually grim. The area was cut off from any other area both by terrain, language and the nuclear burst/fallout pattern to the north. Honest men had nowhere to run and no help to look forward to.

Many tried to defend themselves but only a very few succeeded. Their situation was not unlike that of a man who, though armed with a spear, is hunted by a pack of hungry wolves. There were too few people to organize against an enemy that was nearly as numerous. And honest men must work from time to time to keep body and soul together. Their enemies did not and so could strike at any time.

Within ten years of The War the lands south of Laredo and east and north of the Rio Grande were held by assorted survivalist bands. Such of the original inhabitants as remained alive lived under conditions of slavery. The area north to San Antonio was debatable as it had both a survivalist presence and free communities.

Slaving, of course, came naturally to the survivalists. They already believed in the survival of the fittest, thus, having survived, they were superior. Taking what they wanted and needed was their right. That the less able should labor on their behalf was merely natural. The warped machismo of their creed craved worship and made slaves an asset. "Lesser men" made the survivalist that much more "mighty" himself.

Finally, the majority of these "superior" men had not thought to, or more likely, had not been able to attract many women to them before The War. When the terror began the "items" most in demand were women. This naturally led to fighting of the most bitter sort that left many a husband, father, brother, son and survivalist, dead. Women gained in this way were rarely pleased. Suicide and murder in the night were rife. The male survivors of such raids could rarely be trusted to remain docile in the absence of the conquerors. Reducing the pitiful survivors to abject slavery was not only natural, it was necessary.

The survivalists themselves suffered during this time. It was inevitable that such would fight among themselves. Murder was common within bands until finally the strongest, most cunning and most ruthless in each was left in charge of the remains. This did not aid the locals.

Enmity between bands was the norm. Fighting often occurred over land, water, food, the locals and all other resources. Yet this was comparatively rare for the bands tended to ignore one another as long as there were helpless locals about to prey on. By the time the bands began to eye one another for serious conquest, most had consolidated the control of an area and were well dug in. It became more advantageous to cooperate than to fight. Still, fighting still occurred and occasionally whole groups were wiped out. This did not help the locals either. As often as not they were caught in the crossfire. Sometimes they were the cause of the fight and the center of the conflict. Some bands were known to have slaughtered whole populations in order to prevent valuable resources from falling into enemy hands.

The "society" thus formed was grim. Each band jealously guarded its territory and each raided and plundered its neighbors. Murder was the normal means of advancement within a band. Slavery was the lot of the original owners. Everything was in short supply and starvation was a constant threat because the land was arid and agriculture did not thrive,

For this reason more than any other the survivalists began to look north to more productive land.

As the years passed things grew worse. Necessary skills, since

they were only held by slaves, died out. Thus medicine, forging, husbandry, agriculture and myriad other skills either declined or disappeared. This led to still poorer living conditions and even less efficient use of the land. Education as we understand it ceased to exist and illiteracy reached 100% and stayed there.

Only those technical skills which related to small arms and ammunition maintenance and production were preserved. These were jealously guarded and handed down from Master to Apprentice creating a powerful caste of armorers who were thought of as wizards possessing magical powers.

Slavery was now endemic. Anyone who was not a warrior was a slave. Only male children could become warriors. A weak male, deformed or having poor vision, poor stamina, insufficient ruthlessness, etc, became a slave or was slain out of hand. Even twin brothers might find that one of them was a slave and the other a warrior and neither would think this odd. Male slaves were marked by having their ears cut off. Females were branded with a hot iron on both forearms.

The old or maimed of either class were slain when they were useless or helpless. Even warriors owned only what they could hold by force of arms against their peers. Slaves owned nothing and could be slain by any warrior.

Under this system the survivalists ceased to be bands and came to be clans with most of the members related by blood. This aggravated inter-clan rivalries.

The social results of the system were many but the most important resulted from the absence of the family and the breakdown of moral responsibility. In spite of the shortage of food, breeding produced alarming numbers of new mouths to feed and many of these were warriors to boot. The shortages of food and the endemic population increase spawned the open practice of cannibalism. The descendants of the survivalists found nothing strange or repugnant in the practice; meat, after all, is meat. Usually, only members of other clans, or slaves, are eaten. But captives taken in raids and the occasional slave are sometimes supplemented by slain warrior-rivals. All of this has led to clan wars on a constant basis but also to constant expansion northward.

When too many warriors were available at any one time (A condition that repeated itself about every 20 years), the clans often agreed to band together for a war of conquest in the north or occasionally south. Under one leader a horde would form and move out.

The Brotherhood

The clans exist in a matrix of mutual fear and hatred. They are decentralized and have no common goals or government. The clans cooperate only during wars of conquest, and then poorly. There is no capitol or political structure to attack.

Slaves are a majority in the system but tend to be cowed and are always closely watched. Uprisings have occurred but none have ever succeeded. Contact between slaves of different clans is impossible and so there is no "slave underground". Slaves occasionally escape. If they are found by their own clan warriors, they are tortured and killed publicly. If captured by another clan they are kept and put to work. Few have managed to escape beyond the lands controlled by the clans.

Warriors are cruel and vicious. Until recently, few had firearms. Most fought with crudely made spears, long knives and whatever else was to hand. Guns were found in the hands of a very few.

The strength of the warriors lies in their numbers. Perhaps one million souls inhabit the lands of The Brotherhood. Of these, about 100,000 are warriors. Individually, a warrior is quite a specimen. They tend to be strong, fast and are possessed of great stamina. They do not cut their hair or beards, they do not know about

combs and they do not bathe. (You can often smell a warrior long before you see him.)

Warriors are ignorant but few are stupid. They are aggressive and ruthless. They prize clothing made of woven cloth, particularly in greens, browns and blacks. This comes from the habit of the original survivalists, who decked themselves out in camouflaged clothes of various types and patterns. A few sets of original style camouflage cloth still survive and all warriors want "cammo". Of course most warriors are forced to make do with coverings of animal hide, and many go naked into battle.

The warriors observe a religion of sorts, the particulars of which vary from clan to clan. In general, this "religion" is a hopeless mish-mash of Old Norse beliefs. In brief, it is a cult of the individual. Strength and ruthlessness are praised and so are sought by each at the expense of all others. Torture and cruelty build these qualities (when they are practised upon others). The most popular form of torture-until-death came from the early days of the brotherhood's expansion. Crucifixes looted from Catholic churches led to the adoption of the practice of crucifixion among the Brotherhood as the epitome of torture. To die in battle is a guarantee of rebirth as a warrior, to die in any other way means rebirth as a slave.

There is no memory of The War as such, and no legends at all concerning the time before The War. The mythology of the brotherhood claims that the world has always been as it is. In the beginning the original "Band of Brothers" was born of death and flame. They chose to rule all others and take whatever they chose. This was good. Each clan claims descent from one or another of the mythical members of this mythical band. There are no priests or holy places. There are no gods or spirits.

Most warriors believe in magic. When confronted with that they do not understand, they often call this magic. No warrior is awed by magic. It is the desire of every warrior to possess magic, especially magic deemed to be useful in war. Far from being afraid of magic, a warrior will risk any peril and dare any deed to capture magic for his own use. Magic is power and power is good.

The Kamfyurer

Kamfyurer is a bastardized term inherited from the original survivalists, who in turn had butchered the German words for struggle and leader. Kamfyurer now means war leader. Each clan has a kamfyurer. The title "The Kamfyurer" is always assumed by the war leader of all of the clans during periods of conquest. Every warrior aspires to be The Kamfyurer. At this unhappy time The Kamfyurer is a man named Jorj.

Jorj

Jorj comes from the clan that is centered around the ruins of Laredo who call themselves "The Laredo Raiders". When Jorj was sixteen he slew his father, the then clan kamfyurer, two challengers, and then assumed clan leadership.

In another world Jorj might have been a human being. He is brilliant, a tactical genius, but he is also a product of his culture. And unlike other leaders in The Brotherhood, he is subtle and understands the strength of patience.

Partially through strength of arms but mostly through the skillful use of treachery, he has maneuvered his clan into a position of predominance in The Brotherhood and has become The Kamfyurer himself. He accomplished this five years ago.

In the first three years after he became The Kamfyurer, he began to force more cooperation among the clans than had ever been achieved before. Some clans balked at this and two clans were annihilated by Jorj. The others fell into line.

The clans had long since established themselves upon the

southern banks of the banks of the Rio Grande. Through sheer force of will Jorj began a policy of quiet infiltration of The Republic of Monterrey. Prisoners of the military of The Republic gave him valuable information before they died. Jorj quietly made contact with some of the military leaders of Monterrey and proposed a deal.

Jorj stated that his people wanted to push north, but that to do this they had to be secure in the south. Jorj therefore needed to know that Monterrey was in friendly hands before he moved. If the military would cooperate, Jorj would send his own men to affect the overthrow of the dynasty in the capitol. When he had succeeded, he would hand over everything to the generals, with the understanding that his southern flank would remain secure. He promised an end to raiding and expansion in the south.

The military should have known better; they had fought the "Northern War" for years, but the "package deal" Jorj offered was too good to turn down and they knew that they did not have to live up to their end of the bargain. They could not conceive of being overwhelmed by the northern rabble. They agreed to Jorj's plan. They were totally unaware of the infiltration of The Republic.

Jorj kept the deal up to a point. He did indeed arrange a small invasion which he personally led and which entered Monterrey by virtue of the treachery of the military. He killed every blood member of the dynastic family and many more besides. He then called the generals in to "take over".

The generals set out, each sure that he should be the new ruler, and all agreed to kill Jorj when they arrived. None reached Monterrey.

Jorj loosed his surprise first. All of the generals were ambushed and all military sites were taken by infiltrators. The Brotherhood lost many men, but that was not important. Almost all of the military equipment of The Republic was captured intact and many of the technicians required to operate and maintain it were taken alive.

The Republic of Monterrey fell to The Brotherhood at small cost and only rumour of these events ever reached north of the Rio Grande.

It was then that Jorj first displayed his full power as Kamfyurer. All of the clans were delighted with the acquisition of so much land and began to squabble over the spoils. There was no thought of further expansion.

This was not what Jorj had in mind. He was bent on the complete conquest of all of the land that he could reach, the entire world if possible. Jorj expected the next effort to destroy the ancestral enemies to the north.

It is possible that, had the clans united against Jorj, they might have been able to get rid of him. This did not happen. The northern clans, who could expect to get little of the loot from the rape of Monterrey, favored a northern war. Also, most of the young warriors of all the clans were more than willing to continue the successful wars of The Kamfyurer. Quickly, one at a time, the older leaders of the clans which were against continuing the war, died, and the war went on. This had never happened before, but there had never been a Kamfyurer like Jorj.

Jorj was patient. He had taken technicians and equipment in order to use them against the Texans. He had hoped that the prisoners taken would be able to train his own people in the operation of the new gear. This proved to be impossible as the illiterate rabble just could not absorb the technology fast enough, if at all. The Kamfyurer rearranged his plans accordingly.

The technicians were allowed to live but as slaves. Each small

group was put under a clansman. The clansman had life and death power over them, he told his "crew" what to do and if they refused, the clansman would kill them. If the crew failed in their task, they were killed. If they lied and were caught, they were killed. This system used up a fair number of "technos" but it worked. Within two years The Kamfyurer was ready for the next war.

The Current Campaign

Although The Kamfyurer is only 25 years old, he is a good tactician. He launched the recent assault about a month ago; 50,000 of the warriors of The Brotherhood attacked across the Guadalupe River one month ago and overwhelmed the defenders by their sheer numbers. These attackers were armed as usual in haphazard fashion.

In the southeast the defense had first tried to hold the line of the Lavaca River but the defense was flanked to the north and the defenders fell back to the San Bernard River.

In the north, the line of the Llano River was held for about a week but this too was overrun and the final defense of Fort Hood is now being fought on the spot. The line now being held is centered on the Lampasas River to the west and the Little River on the east.

In the last week Jorj has begun to send in his best; 20,000 young warriors supported by slaves from Monterrey. About 2,000 of these are armed with Soviet made AKM assault rifles (of Cuban extraction via Monterrey).

These fresh forces have attacked in three groups. One, of about 10,000 troops supported by 8 T-72 tanks, is driving on Ft. Hood by way of the town of Temple. The second force has pushed to and has now surrounded Bryan and College Station. This force has about 5,000 men supported by 2 T-72s and 9 BMPs. The third and last force of about 5,000 has followed the coast and is itself divided into two groups. 3,000 men supported by 3 T-72s and 5 BMPs are advancing on Texas City and Pasadena. The remaining 2,000 with the aid of two tramp steamers formerly of Cuban registration, have landed near Galveston and plan to link-up with their own forces in Texas City. And, of course, there are still about 40,000 "regular" warriors advancing on line from Brownwood to Galveston.

By order of The Kamfyurer, all warriors will continue the attack until, and if, he calls a halt. Taken territory is not to be occupied in any force. Any resistance is to be destroyed, not by-passed. Any defender taken alive is to be crucified and left for the crows. Anyone found bearing arms is to be considered a defender. Slaves will be rounded up later.

The advance is beginning to slow. The warriors, having consumed their provisions long since, are now living off the land and must forage to eat. Keeping forward units supplied with ammo, and fuel for those units with armor, is proving to be a near impossible task.

Jorj may be a brilliant tactician but he is ignorant of the art of logistics and the finer points of command and control. He has moved forward with his forces, staying well to the rear, and commands via radio in his commandeered BMP. He has been trying to coordinate the final assault from his position in Marcos. With the deterioration of radio and the slow down in the advance caused by the lack of adequate supply channels, he has become increasingly cut off from his units and has no clear idea of where they are or what is going on. He knows that this is not good and will doubtless do something about it, if he is given the time.

There can be little doubt that Jorj has been taken by surprise by the ferocity of the resistance and the sheer size of the world he set out to conquer. He is now aware of his short comings

in supply services and control. But these setbacks have only served to whet his appetite. Jorj never makes the same mistake twice. He is young, confident, and above all, patient.

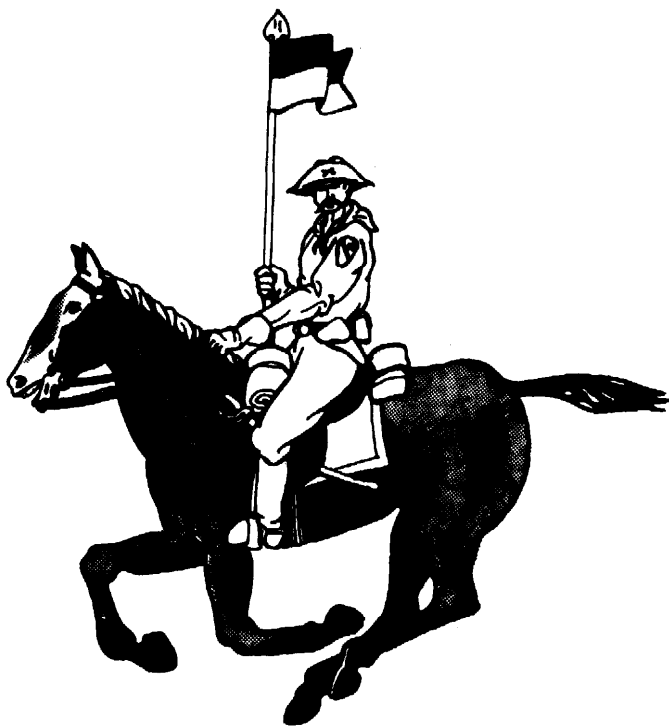

THE 1st CAVALRY DIVISION (LONESTAR)

*"I left my love, my love I left,
Crying in her sleeves.
I told her she could find me,
In the U.S. Cavalry!"*

The Captain

In the latter half of the 20th century the citizens of the United States knew that, in times long past, the U.S. Army had maintained numerous cavalry units. But most would have been surprised to learn that the Army *still* had cavalry formations.

These no longer made use of horses; the modern cavalry rode armor; tanks and APC's. The 1st Cavalry Division was stationed at Fort Hood, Texas, along with several other units. The "1st Cav", as it was commonly known, had a long and proud tradition and its morale was high.

When the war began Ft. Hood was hit in the initial strike. But Hood is big, the largest post in the U.S. Army. The place is the size of a small country; over four hundred square miles of ground. Not all of the personnel stationed there were killed.

Yet in the chaos that followed the war the majority of the surviving soldiers wandered to the four winds; there were few to stop them, fewer inclined to try. Most left on hopeless journeys to the far corners of the country, in search of homes and loved ones. A few remained; those who had no other home but the army or who recognized the futility of the search. Of these, most were gathered to one man.

Captain Robert Williams commanded a company of the 1st Cav. A shy, retiring man, he had a core of steel and the soul of a hero. He had widely been acknowledged the best captain in the division, but never in his presence. He was both Ranger and Airborne qualified, a rarity in armored units. Not a West Pointer, the captain had received his commission through ROTC. His men respected him; he was everything an army officer was supposed to be (and so few were).

His wife and children had been at Ft. Hood main post when the bombs fell. Williams found himself with no where to go and nothing to live for, except duty. Some of his men had also survived the bombs and, of course, stayed with him.

The captain collected all of the purposeless men he could find and formed them into a new company. He eventually gathered about two hundred. These became the nucleus of the First Cavalry Division, Lonestar.

The time that followed the war was bitter in many ways. The Captain salvaged some 34 M1 Abrams tanks and a like number of M2 Bradley/Devers IFV's. These were kept running with spare parts and fuel scavenged by the men of his command. Slowly, former soldiers and new recruits trickled in. A new unit began to form, stronger than the original, even if smaller and more poorly equipped. But the care and feeding of the new unit was the least of the problems facing The Captain.

By late December of the year of the war central Texas was in chaos and the United States had ceased to exist. Cpt. Williams found himself the most powerful man in his part of the world.

Other men in similar positions might have set themselves up as warlords, and some did. The Captain did not. He exerted himself on behalf of the people in the surrounding areas.

Cpt. Williams declared martial law and set about the task of rebuilding the nearby areas. His troops were constantly at work in fields, on ranches, on dams, in libraries, and countless other civil tasks.

The men moved far afield and helped. That central Texas survived at all is due solely to the efforts of Robert Williams and his men.

Were civil leaders grateful? It is to *laugh!* The captain was accused of being a martinet, a jingo, a thief, a brigand and worse. The most common complaint was two-fold: that Williams had too much control over the aid that he and his men provided and that he was not giving enough aid to us! But these were the words of politicians; the people knew better.

There was fighting. Troops of the new unit fought survivalists and occasional bands of renegade soldiers. (One such group was run by a former Lt. Col. of the 1st Cav, a man the Captain had known.) The most vicious struggle was fought against a former U.S. Senator from Waco who, declaring himself President of the United States, demanded that the 1st Cav support his claim. But neither the Captain or his troops could stomach the pseudo religious ravings of the man, his book burnings or his burnings of "heretics". When the senator proclaimed himself God the troops moved out and destroyed him.

There was also progress. In spite of the protests of all the small time politicians, many areas clamored to be brought under the protection of the 1st Cav. The university of Texas, A&M, was preserved and the Johnson Space Center was secured and placed under guard. Galveston and Texas City were brought into the community and their industrial, refining and port activities were heavily supported. Central Texas came to know peace and plenty under the benevolent stewardship of the 1st Cav. Few areas of the rest of the country were so lucky.

In time the 1st Cav grew to battalion size and there were other captains. The Captain never presumed to promote himself, but all of those under his command began to refer to him as "The Colonel", though never within his hearing.

When time finally caught up with him and Bob Williams died, the entire community mourned in earnest. He had held off the inevitable for as long as possible and regretted his death only because of the many things that were still left to be done. Yet Bob had accomplished more than any other man of his time. His memory is still revered by the people of the Republic.

Continuity

*"Halfway down the road to hell,
In a shady meadow green,
Are the souls of all dead troopers camped."*

Contrary to all reasonable expectation, the subsequent commanders of the 1st Cav were also men of integrity and vision, if less ability. These men, unwilling to usurp the title of Colonel, have all been Majors, Each holds his comision in the U.S. Army, and swears to uphold and defend the Constitution of the United States against all enemies, foreign and domestic. All have lived up to their oaths.

There have been changes. The "Division" has become nearly a division again in terms of manpower. It is no longer an armored unit. Over the years the armor has dwindled until now there are only 16 M1 tanks and 17 M2 IFV's. The other vehicles were not destroyed; they finally wore out. Parts from these are used to keep the others running. The remainder of the unit is cavalry again: horse cavalry. The Division is the only standing military force in the Republic, in order to defend this vast area the men must be mobile. Horses again provide the mobility, Armor only moves when it must. With small hope of building more, the Division hordes what remains. This is also true of main gun ammo.

Troopers again wear "army blue", Thier uniforms are made from denim-and blue dye is the-kind most commonly available. They still wear the divisional patch on their left shoulder, in black and gold, but instead of the head of a horse in the upper right half, there is now a five pointed star: the Lonestar.

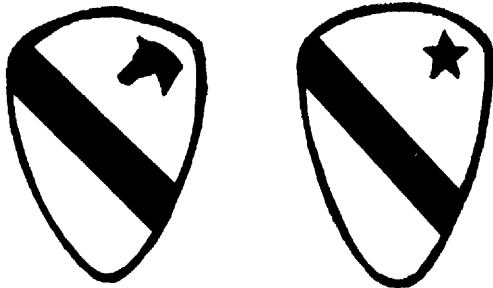

Arms are not what they used to be. The M16 rifles, never very good in the first place, wore out quickly, though there are still a few around. Troopers are now provided with .30 cal. bolt or lever action rifles of local manufacture. Cartridges are also produced locally, in quantity. Still, ammo is expensive, you can run out of it, guns will jam, and so the cavalry once again carries sabres.

A few radios remain but these are found only in vehicles or at company level and higher. For most other signalling purposes the bugle has again come into its own. Radios are used as sparingly as possible; batteries and generators are a problem and there are few spare parts.

Along with blue uniforms, horses, sabres, and bugles, the guidon has also returned. Each troop has its own, in the traditional red and white of the cavalry.

To the casual observer a unit of the 1st Cav might look like something right out of the movies. Closer inspection will dispell the illusion. While the men wear blue uniforms, wide brim white felt hats, tall boots and gauntlets, they also wear the large, bright divisional patch. Insignia of rank is not worn on the sleeve but on the collars of shirts: the black metal type of the army of the 1980's. Web gear; load carrying equipment, is the canvas issue of the old army and not traditional cavalry rig. Each horse troop usually has one M2HB .50 cal. machine gun, and extra horses to carry the weapon, its tripod and ammo. (The pre-war M60 GPMG, while more numerous, was less hardy than the older .50 Few survive in operable condition.)

The Troop is the basic unit of horse cavalry and numbers about 50 men, it is roughly analogous to the old infantry platoon in terms of size, The Troop is normally commanded by a lieutenant, assisted by a troop sergeant. There may be one or two lesser sergerants present and about a half dozen corporals. The men are all "troopers".

The Company is the next larger unit. A company is made up of three or four troops and is commanded by a captain, assisted by a first sergeant. Due to a chronic shortage of officers the Company Commander (CO) usually runs one of the Troops himself. The company usually has its own radio operator, bugler, guidon bearer, and a couple of messengers. Thus the company will number between about 150 and 200 men.

3 to 5 companies form a Regiment. This is not how it was in the "old days", but times are tough. There are eight regiments in the 1st Cav, each commanded by a major. Seven are combat units. The 8th is a cadre, headquarters and maintainance unit. Its personnel are split up between Ft. Hood and College Station. THE Major, the commanding officer of the 1st Cav, also commands the 8th directly. All supply and services are located either at regimental or divisional level.

Such armor as remains is also attached to the 8th. It rarely operates as a unit but is assigned on a piece basis to the horse companies, where it comes under the control of the company commander.

This is a "pure" cavalry division; there is no infantry, artillery, etc. It has a very austere organization. The 1st Cav is a very lean fighting unit numbering no more than 8,000 men at any given time.

The men are trained to fight on horseback, and are good at it; many enjoy it. But the horses of the division are most important because they provide mobility. The men fight on foot whenever feasible. With no infantry to support them, they must be their own. The men are equally adept at charging with sabres drawn of fighting from dug-in positions.

The roughly 7,000 men of the "line" regiments must guard many thousands of square miles of ground. Four regiments, the 1st, 3rd, 5th and 7th, guard the southern frontier. The 2nd maintains watch on the west and the 4th and 6th patrol the Red River and eastern boundaries. There are too few men to do the job.

Local militias fill the gap, especially in the south. The militias are often the first to fight, sending messages to the nearest cav post for help. It is then the turn of the cavalry to ride, in the traditional manner, to the rescue. Amazingly, they almost always arrive in time.

life in the Cavalry

**"There's a yellow rose in Texas,
That I've a mind to see..."**

"The Military" has rarely been popular in this country, but "the military" usually means the "generals", the "Pentagon", or in the case of the Republic, "Ft. Hood", But there is not a citizen of the Republic who does not stand squarely behind "our boys in blue". The army is popular with the people, Children dream of riding in the proud ranks and are encouraged by their parents.

A young man may enlist at 16. The division's standards are high and more volunteers are turned away than are accepted, even though most volunteers can already ride and shoot when they arrive. There is no draft. Accepted recruits are sent to Fort Hood for training.

At Hood most recruits receive some surprises. No **matter how tough they are, few "walk"** through the training. They are **taught how to shoot** and ride all over again, they are **taught to think, act and fight** as a part of a team. They are **sworn into the U.S. Army, not the army** of the Republic. The new trooper **quickly learns that he** belongs to The Division and not to the **Republic. They** must break and train their own horses. Recruits spend three months at Ft. Hood and **sleep soundly every night.**

After training the new trooper is sent to one of the seven line regiments. There **he receives his weapons and additional equipment** (his basic uniforms and gear he received at Ft. Hood), and is assigned to a company and troop. The Troop puts the finishing touches on his training.

Each regiment has a headquarters area with its own barracks, shops and other administrative paraphernalia. Companies are **quartered either** here or at other posts further "forward". In any company fully half of the Troops are out on patrol at **any given time. Such Troops live in** the field and are frequently involved in border skirmishes.

Even in garrison the life of a trooper is busy. **Besides the basic** chores of equipment upkeep, horse and stable **grooming, guard duty and** the other eternal military rigamarole, the men also work in the divisional fields, smithys and shops, herd livestock, and a hundred other "civilian" jobs.

The division maintains its own farm fields, beef and **horse herds, foundries and other** industries. The division is nearly self sufficient and costs the Republic much less to maintain than the **politicos are willing to admit.** Troops not in the field provide the labor to make it all possible.

Troopers work off-post too. Harvest time sees them in civilian fields. They can be found building new mills and bridges. Practically all road building and maintenance is performed by the Division. Troopers earn their pay in many ways.

Recruits earn two dollars a month, corporals three, **sergeants four**, Troop sergeants five, first sergeants ten. Lieutenants **get five**, captains ten, majors twenty. Nobody gets rich on army **pay. It's not too bad. The** army provides all of the soldiers' basic needs. \$2.00 a month is quite enough to keep the trooper in beer, tobacco and other luxuries.

Towns are usually close to posts and easily accessible to **off-duty troops. Passes** and leave time are not too hard to get. Bar fights provide additional exercise and sporting competition different from the life or death fighting found on patrol. All troopers bitch but desertions are so rare as to be a major event.

After two years in a line unit troopers may become eligible for advanced training. This is conducted either at Ft. Hood or at the university. Individual Troops provide their own smiths, cooks, handlers and other basic specialties. Advanced training produces **experts in these** areas as well as radio operators (RTO's), armor crewmen, armorers, signallers, rule-of-thumb engineers and surveyors, mechanics and a host of other skills. Trained men go back to their old units or are assigned to new ones.

An enlistment ends after **five years.** The trooper **keeps his horse and personal gear** but leaves his weapons and military equipment.

Any trooper who honorably completes his enlistment may sign on again. He will make a little more money each month and may now marry. Quarters will be provided for him and his family either on or near post.

Reinlisted troopers may "buck for officer". If selected the trooper will spend **two years** at "the academy" at the university. If he successfully completes the course the trooper becomes a lieutenant. **All officers** must serve at least one term **in the ranks before** being commissioned. This makes officers scarce, but **it helps to ensure** that these few are competent to lead as well as to command.

After thirty years of active duty the trooper may retire. He keeps his horse, gear, weapons and equipment, receives a plot of land, a plow, and a smallish cash bonus. The retiree receives a pension from the division, **not** from the Republic.

Disaster

**"Just put your pistol,
To your head,
And go to Fiddler's Green!"**

Some six weeks ago the units patrolling the southern frontier began to report unusual activity, to wit, a lack of **usual** activity: no raids, no skirmishes, no nothing. Well aware of historical trends, **the** Division prepared to meet a new invasion. The 1st, 5th, 3rd and 7th regiments were put on full alert, the 4th was ordered **to** be ready to move south on short notice. Supplies were **moved** forward to meet expected demands and civilians were encouraged to leave areas near the border.

The current Major, CO of the 1st Cav, is Robert Star. At 54 he is a veteran of 28 years with the Division and is a skillfull and conscientious commander. He ordered small spoiling forces to be strung out along the frontier with orders to inflict as much damage as possible and then fall back. The full weight of his forces were to be held in reserve until the main thrust(s) of the enemy were identified. Then the regiments would attack these concentrations and destroy them. With this in mind the Major scattered his armor among the four front line regiments, holding only two M1's and two M2's at Ft. Hood. Had this been a normal attack the plan might have worked.

Of course **this** attack was an invasion in force. The attackers outnumbered the defending cavalry and militia by at least ten to one. The spoiling forces were either destroyed or mauled. (Some comited suicide as a unit: when supporting militia that **could not** run away. Several units stayed and died rather than leave their friends and allies to be slaughtered alone.)

Within a week the forward supply areas had been overrun. By the end of the second week the survivors of the 1st, 3rd and 7th regiments **might** have made two healthy regiments between them; the 5th had ceased to exist save as a memory. The remains fought on. The 4th was thrown into the fight and the 2nd and 6th were ordered to the combat zone. Such combat units of the 8th as existed had already been committed.

A week ago the "crack" units of the Brotherhood entered the fight. The appearance of armor in the hands of the enemy more than shocked the defenders. This latest push has still not been halted, but it is being slowed down.

But everything has gone completely to hell.

Now, entering the fourth week of the war, all command and control from higher levels has vanished. **When the radios work** no one answers. Units are fighting as best they can, savagely, often cut off from help or re-supply. Before commo ceased it was learned that heavy fighting was taking place on the outskirts of Fort Hood itself. The enemy had broken the defenses near College Station and now surrounded both College Station and Bryan. There were rumors of a push on Tyler. The coast had suffered an amphibious assault and defending forces might be trapped between the ruins of Houston and the sea. And, finally, it was reported that Major Star had fallen, leading a counter attack to relieve pressure on a pocket of men from the 1st who were trapped in the ruins of Lampasas.

This news is bad. The encirclement of Bryan and the possible drive on Tyler means that the defenders are split and unable to help one another. The 2nd Regt. may be coming down from New Abilene and the 6th from Longview, but **where** they will

BASIC LOAD (VEHICULAR) STANDARD ISSUE: ACV FLYING DUTCHMAN

- 1 AN/PRC-70 Radios
- 1 Gun Camera, Rh 202, Top/Side Mount
- 2 Pr. AN/TVS-5 Night Vision Binoculars
- 1 Large Medkit
- 1 Laser Range Finder
- 1 Ration Pack
- 4 Flotation Vests
- 1 AutoNav navigation system
- 1 Searchlight, Gun, RH 202, Top/Side Mount
- 2 Fire extinguishers
- 1 Vehicle Tool Kit/Operation & Maintenance Manuals
- 4 Large Tarps, asst. Cargo tie down straps

1 Trade Pack containing:

50 Golden Double Eagles

*****_---

50 Silver Dollars

*****_--

6 1-liter bottles of Whiskey * * * * *

6 Sewing kits * * * * *

6 Comb & brush sets * * * * *

Various Toilet articles

6 250g packs of Tobacco * * * * *

4 Mirrors * * * *

6 Hunting knives * * * * *

6 Packs of candy * * * * *

6 Fishing kits * * * * *

1 M21 Rifle, 20 rd. mag, Semi-Auto, E=17,12 mags.

2 ARMBRUST 300, Single-shot, E=441, Dpw=533 (4)

**_---

M34 White Phosphorus Grenades (4)

****_---

M26A1 Fragmentation Grenades (12)

M7A3 CS Gas Grenades (8)

1 Demolition Kit containing:

1 MI83 Demolition Charge (16 M112 C4 blocks)

1 roll primercord (304m)

5 M2A1 Detonators (8 second delay)

1 MI Timers *- - -

1 M60 Fuse igniter

M18A1 Claymore mines (2)

**_---

1 case 9x19mm Ball (2880 rds)

1 case 7.62x51mm Ball (920 rds)

1 case 5.56x45mm Ball (1640 rds)

1 case 12 gauge magnum 00 buckshot (500 rds)

500 rounds, 20mm: 250 HEI, 250 API

2000 rounds, 7.62x51 Linked, for LMGs. Tracer mix: 1 in 10

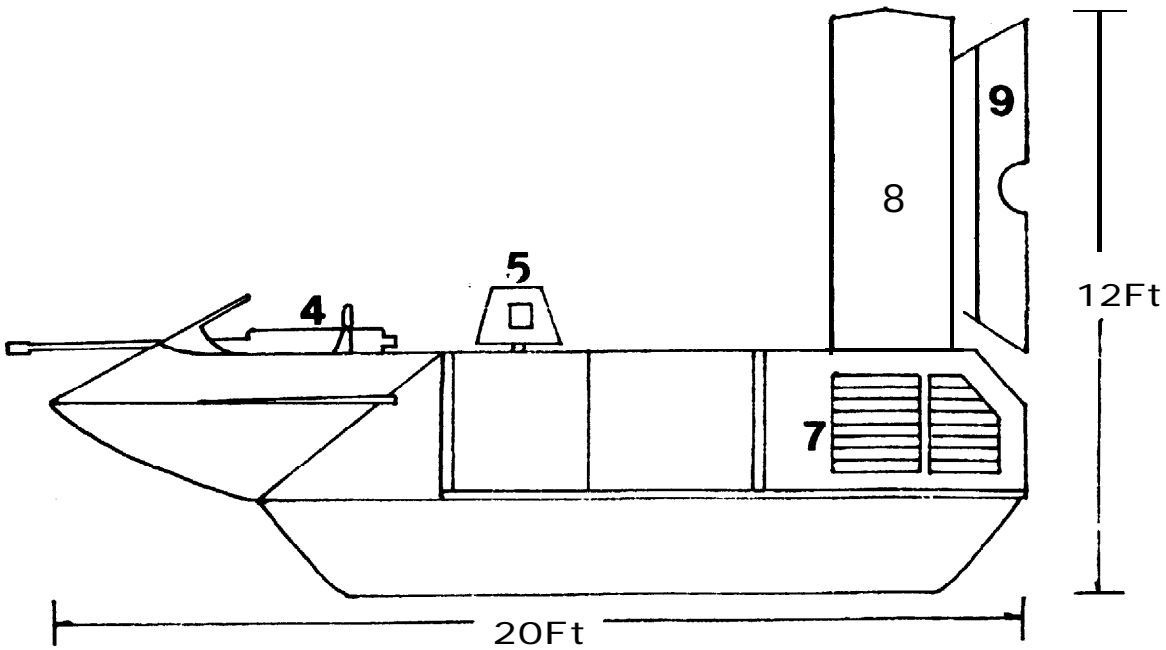
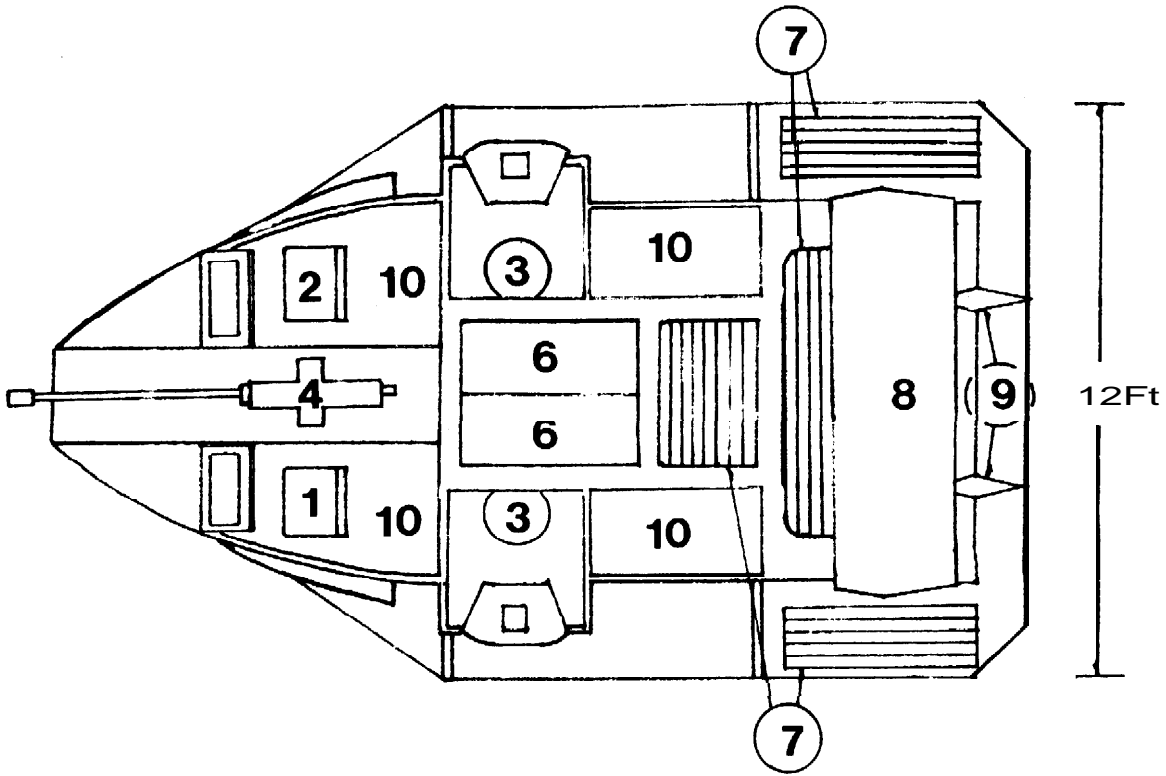

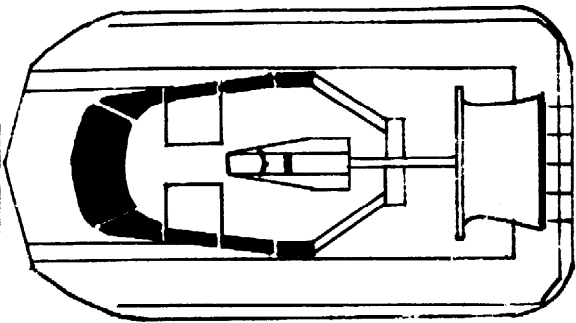

INTERIOR KEY: QUEQUOD CLASS
AIR CUSHION VEHICLE (ACV)

NO. QTY. DESCRIPTION

1	1	Pilot's Seat
2	1	Navigator's Seat
3	2	Folding Seats
4	1	Lab Area
5	2	Lab stools
6	1	Pilot's Controls
7	1	Navigator's Controls
8	1	Fusion Power Plant
9	2	Doors

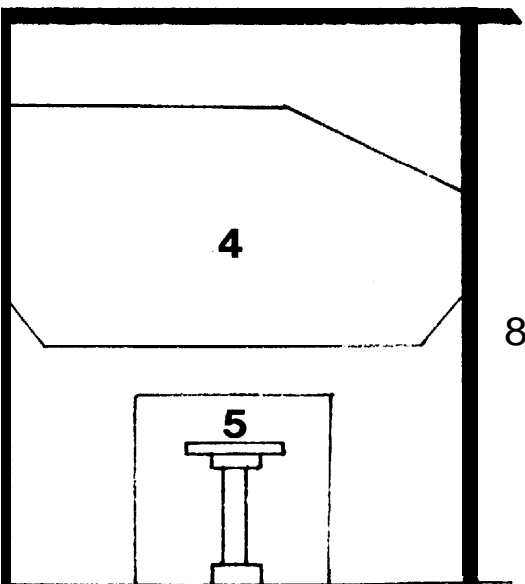

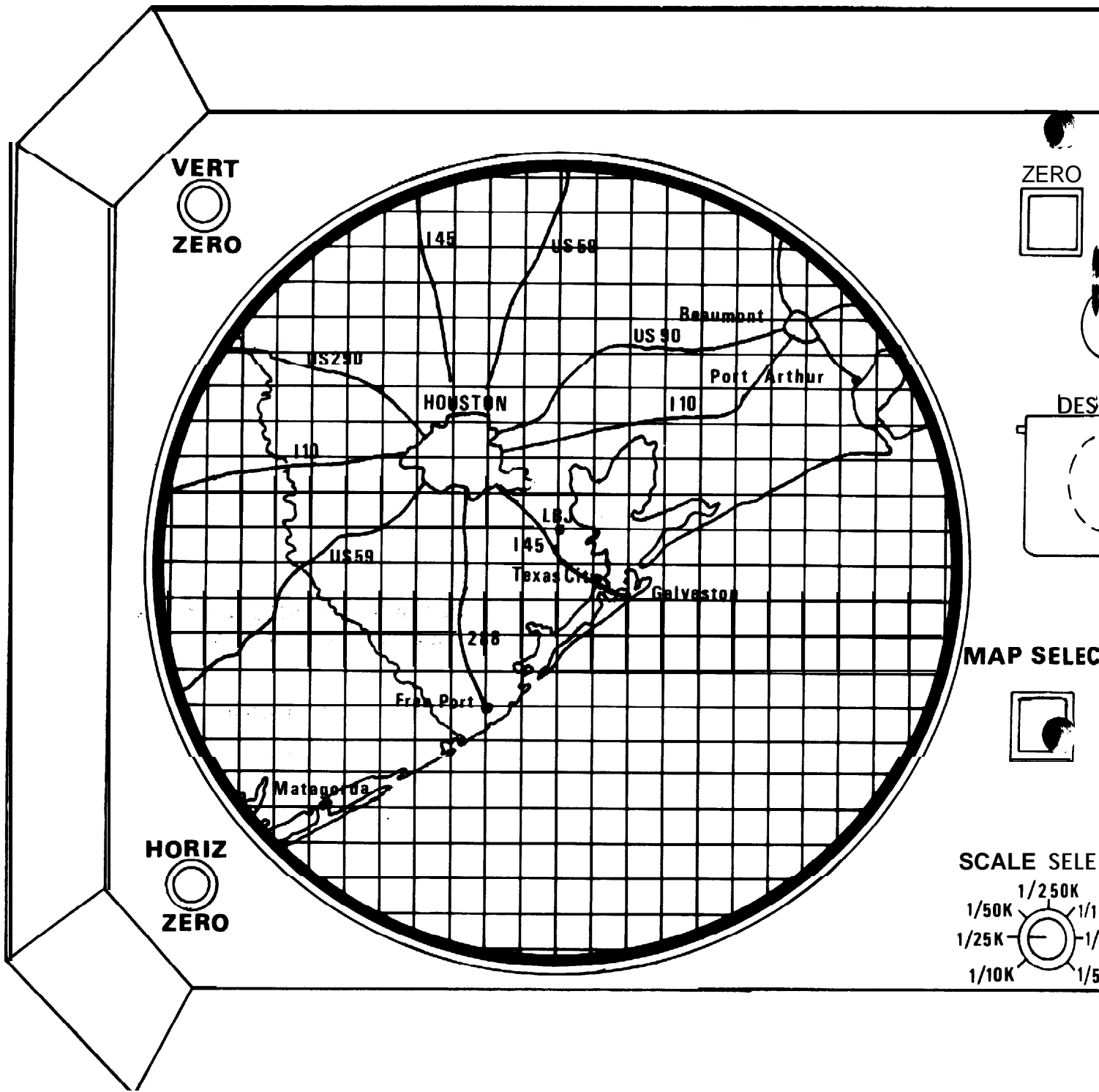

VERT ZERO; Allows adjustment of the displayed map to the unit in the vertical plan.

HORIZ ZERO; Allows adjustment of the displayed map to the unit in the horizontal plane.

ZERO; Allows the use of the Vert and Horiz adjustment dials.

DESTRUCT ARM; (covered toggle switch) Arms the destruct system causing a beeping sound once per second until fired or disarmed.

DESTRUCT; (**covered** push button) With the seal wire broken, cover lifted, and button depressed the system fires an internal thermite charge in five seconds. The charge destroys the interior of the AutoNav.

MAP SELECT; Initiates system allowing the use of the keyboard to select a specific map.

SCALE SELECT; Determines scale of map displayed.

KEYBOARD; Used to input information into system.

SENSOR SYSTEM SELECT

RDF; Allows radio direction finder (if available) on screen.

MAG; Allows magnetic sensor (if available) on display screen.

RADAR; Allows radar set (if available) on screen.

CACHE LOCATION; Shows all assigned cache locations.

LIBRARY; Reads out all available maps on the system.

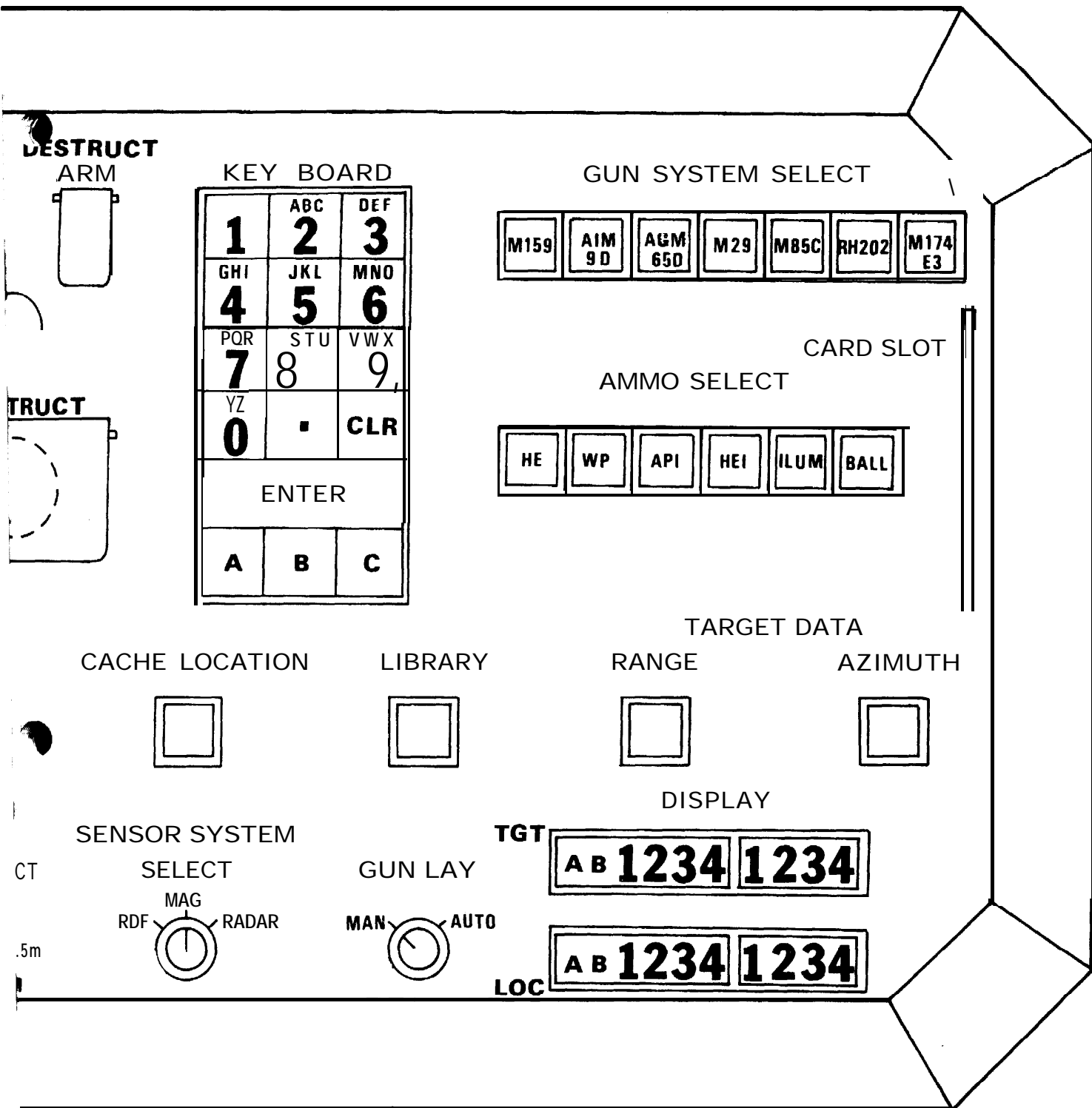

to AutoNav) to indicate direction on display
 AutoNav) to indicate location of detected
 Nav) to indicate detected targets on display

is when depressed.

play screen.

GUN LAY

MAN; Disengages Gun Lay system to allow manual laying (aiming) of gun system.
 AUTO; Engages Gun Lay system to aim weapon system according to data In AutoNav.

GUN SYSTEM SELECT; Allows AutoNav to aim indicated weapon system, if vehicle is so equipped, using Gun Lay system.

AMMO SELECT; Indicates ammunition fified in selected Gun System.

TARGET DATA

RANGE; Allows input of data for Gun Lay system.

AZIMUTH; Allows input of data for Gun Lay system.

DISPLAY; Indicates data, either Target or Location, shown on display screen or keyed into system from keyboard.

CARD SLOT; Allows insertion of Morrow I.D. card to activate AutoNav displays. AutoNav will function (track its movement) without card but will not display any information or allow any other functions.

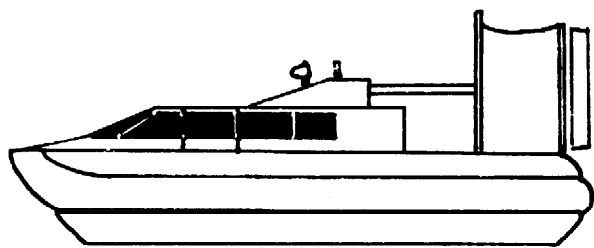

23Ft

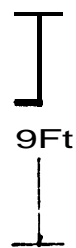

9Ft

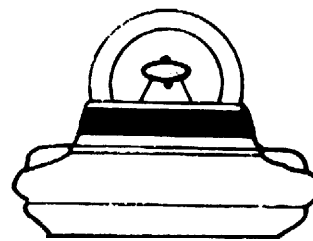

12Ft

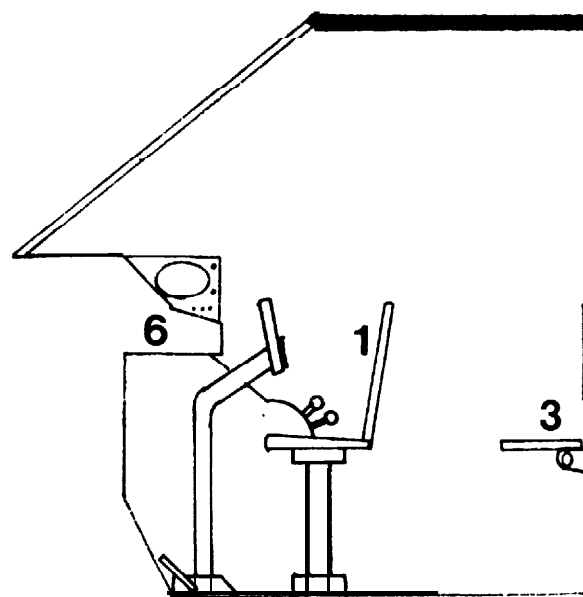
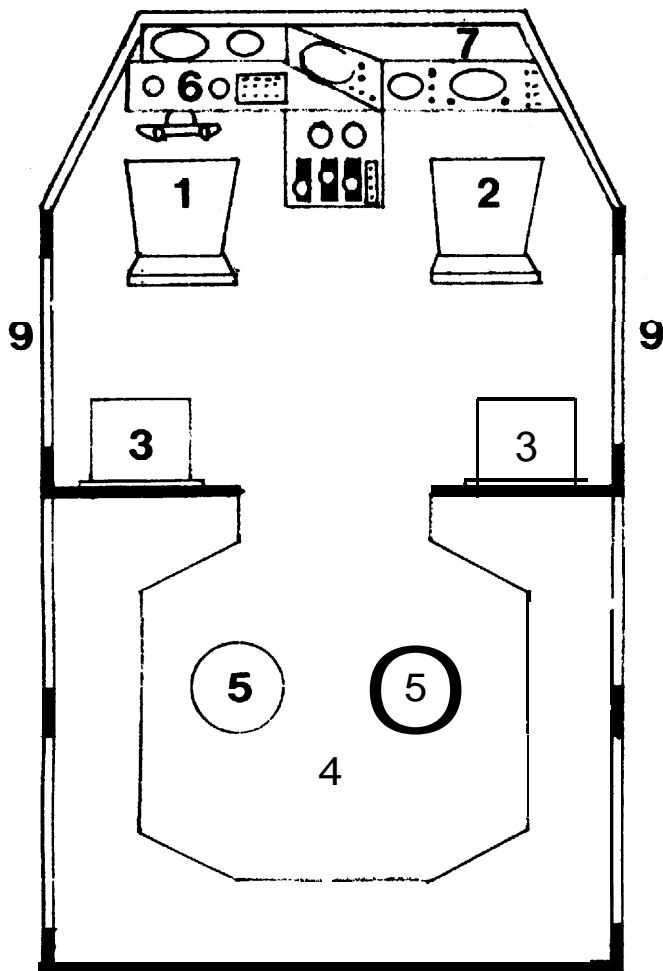

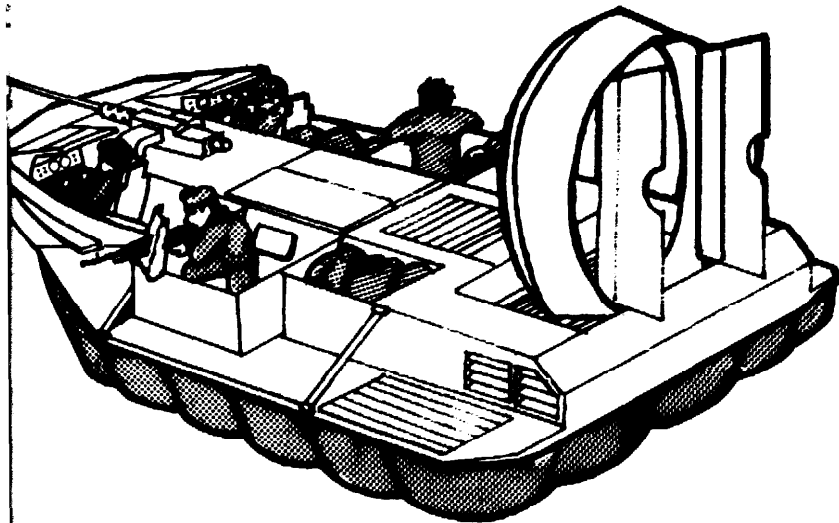

INTERIOR KEY: FLYING DUTCHMAN CLASS
AIR CUSHION VEHICLE (ACV)

NO.	QTY.	DESCRIPTION
1	1	Pilot's Seat and Controls
2	1	Gunner's Seat and Controls (RH 202)
3	2	Wing Gunner's Seats (LMGs)
4	1	RH 202 20mm Cannon and Feed System
5	2	LMG Gun Shields and Pintle Mounts
6	2	Fusion Power Plant Access Doors
7	6	Air Intake Vents
8	1	Propulsion Fan Shroud
9	2	Air Rudders
10	4	Storage Bays

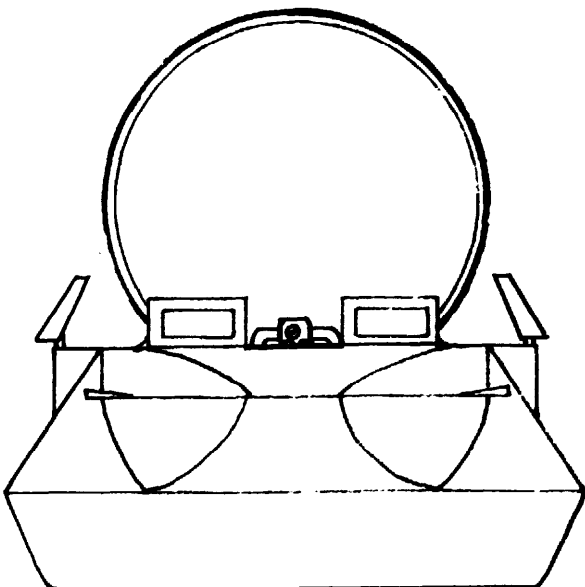

BASIC LOAD (VEHICULAR) STANDARD ISSUE: ACV QUEQUOD

1 AN/PRC-70 Radio	1 AutoNav navigation system
1 "RDF" Radio Direction Finder	1 Computer
1 AN/TVS-5 Binoculars	1 CRT and Keyboard (Computer)
2 Fire extinguishers	1 Large Medkit
1 Vehicular Tool Kit/Operations & Maintenance Manuals	1 Maritime Navigation Radar (Lt.)
1 Ration Pack	2 23m coils, 1mm nylon rope (1,700kg. test)

1 Trade Pack containing:

50 Golden Double Eagles

*****_ _ _

50 Silver Dollars

*****_ _ _

6 1-liter bottles of Whiskey * * * * *

6 Sewing kits * * * * *

6 Comb & brush sets * * * * *

Various Toilet articles

6 250g packs of Tobacco * * * * *

4 Mirrors * * * * *

6 Hunting knives * * * * *

6 Packs of candy * * * * *

6 Fishing kits * * * * *

ARMBRUST 300, Single-shot, E=l41, Dpw=533 (2)

* * _ _ _

M34 White Phosphorus Grenades (6)

* * * * * _ _ _

M26A1 Fragmentation Grenades (6)

* * * * * _ _ _

M7A3 CS Gas Grenades (6)

* * * * * _ _ _

M9A1 BZ Gas Grenades (6)

* * * * * _ _ _

M18A1 Claymore mines (2)

* * _ _ _

1 case 9x19mm Ball (2888 rds)

1 case 7.62x51mm Ball (928 rds)

1 case 5.56x45mm Ball (1640 rds)

1 case 12 gauge magnum 00 buckshot (500 rds)

Flotation Vests (4)

arrive, and whether or not they will appear in time to be of any use, is uncertain. Nobody knows who, if anybody, is now commanding the division. Nobody knows how much friendly armor is left, or where it is. There are no reserves. Food, ammo and medical supplies are all running out and there is little hope of getting more. In the midst of all of this there is a worse problem.

Before the invasion they were called evacuees. Since the invasion they are refugees; ordinary people heading north as best they can. Most are women, children and old men. Most carry a few pitiful belongings, push carts, lead animals, or fall by the wayside.

Some have been on the road since the beginning. All are tired, hungry and terrified. For the last several weeks the entire southern horizon has been shrouded in smoke; smoke from the fires started by the invaders or the fires set by retreating troops. Smoke from the burning homes and lives of men. The refugees have nowhere to go, no homes to return to. They cover all of the roads leading north.

The troopers and local civilians have been doing as much as they can to help, but the job is too big. Lately, prosperous families have given aid one day only to find themselves refugees on the next; driven out by the advance of the enemy.

The strain on supplies is already great. The Division has been forced to use men who are desperately needed elsewhere to guard the refugee columns. What has happened to unprotected columns fallen upon by the enemy is not good to think about.

The saddest thing about the refugees is that there are too few of them. There ought to be about a million, but estimates show that there are only about two to three hundred thousand. The speed of the enemy advance has prevented the escape of more.

Things are tough all over, but the worst conditions exist near the coast in what is beginning to be called the "Houston Pocket".

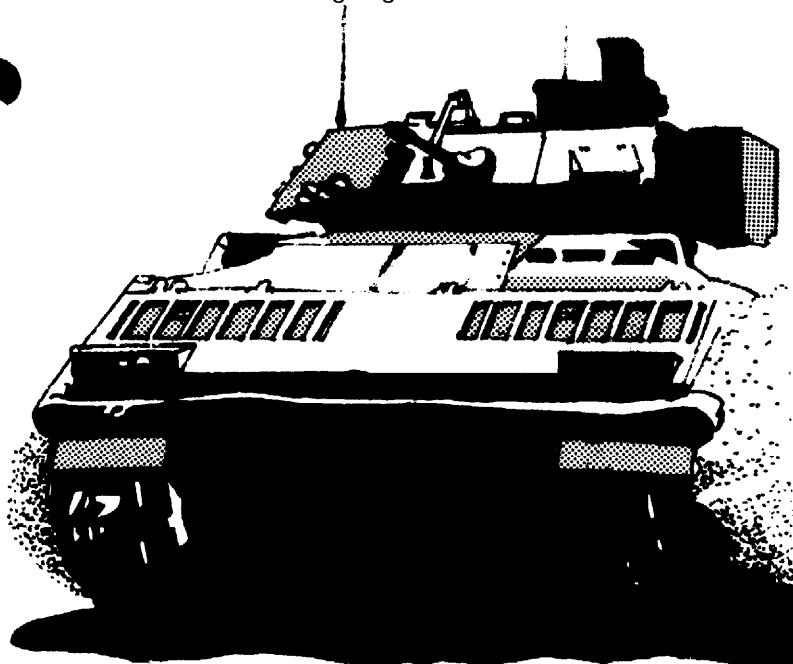

Johnson Space Center

The Johnson Space Center, or JSC as it is commonly abbreviated, will play a major part in this module. The following section provides necessary background information.

Its mission was:

"To develop the technology required for the operation of manned space flight; manage the industrial efforts in the design and fabrication of manned spacecraft; manage biomedical and scientific experiments during the manned missions; select and train astronauts; and control the NASA manned space flights from launch through landing. "

The JSC was not destroyed in The War but The War rendered it useless: it destroyed all possibility of more space flights, manned or not, for a long time. Elements of the 1st Cav arrived at the center only weeks after The War with orders to secure the site and prevent its dismemberment. Such members of the staff as remained in the area readily assisted the soldiers in the task. While of little use at the moment, the center, if preserved, might one day be valuable again.

What could be done was done. Delicate equipment was stored away as carefully as possible. Buildings were "mothballed" by making them as airtight as conditions allowed and then sealing them. Detailed lists of what was found, how and where things were stored, all of what was done and why, were written up and packed off to A&M. It took several years. When the job was done the remaining staff drifted off, most to A&M or Ft. Hood. Since that time one troop of cavalry has remained in garrison there, defending the center from treasure and souvenir hunters, people seeking unused building materials and the idly curious. Occasional A&M research groups came to study amid the dust of the empty buildings.

In the last 150 years there have been some changes. The volatile weather of the region has destroyed the Rocket Park, brought down the high tension power lines, and rendered the ground more marshy than it was. The garrison troop has always managed to keep the buildings tight against the elements but the buildings look terrible. Many are grown over with moss, vines and mildew. Many windows have been destroyed but the gaps have been efficiently boarded or bricked up. Of course, this adds to the air of deterioration.

The once park-like grounds have gone to seed. While new trees have been gotten rid of as soon as possible, nobody has cut the grass or bothered about "brush growth" for a long time. It's a big place and there is only so much that 40 odd men can do.

When civil government was reestablished, the military surrendered control of JSC to it but left the garrison troop in place. The new government soon plundered the many office buildings of The Center for furniture, rugs, paper, paper clips, staples and anything else that wasn't tied down. The military did not interfere. When the government started nosing about the technical buildings looking for "additional resources", the troops were ordered to prevent access, and to shoot if necessary. The government backed off, but this is yet another sore spot between it and The Division. The looted office buildings have been left as the government left them: gutted shells with even the windows and drain pipes carted off.

Finally, garrison troops have surrounded the perimeter with a high barbed wire fence. This is to keep out wildlife more than humans, though signs at intervals do warn interlopers not to trespass. Troopers have rarely had to shoot trespassers and have only shot those who were armed and fired on them first. All others have either been run off or taken alive.

There are no guard towers, bunkers, security posts or other vanities; they have never been necessary. There are usually one or two guards standing by the gate. An old office building serves as a barracks/mess hall.

But to a stranger the place looks awful. An exceptionally rank and long abandoned POW camp would look good by comparison. One might believe the site had once been a technological marvel, but nobody would believe it could ever be so again! But then, the insides of the preserved buildings do not show.

More will be said about the JSC in the Play of the Game Section of this module.

The Houston Pocket

The Houston Pocket will be of great importance to the P.D. since it is here that the team will do most of its work. **The "active portion"** of this module will begin here and, perhaps, end here. Thus a little history is in order.

Houston was smashed during The War. It was hit so hard and so repeatedly that the entire area, never very far above sea level, became flooded by water from nearby Galveston Bay. The water, the radiation, the ruins and the swamps make the area impassable.

Galveston and Texas City were not hit, but the economy of both were tied to Houston. Both diminished after the war. But they did not die.

This was one of the first areas annexed by the 1st Cav after the war, along with the LBJ Space Center which is also in the area. The industrial and refining centers of Texas City/Galveston, along with the extensive offshore oil drilling facilities, were deemed too important to allow to fall into ruin. All would be needed in the years to come.

They preserved everything they could. Galveston has suffered much, for with reduced population she could no longer continue to wage her war with the sea. Yet much of the heavy industry and all of the oil refining done in Texas comes from these two towns. Indeed, all of the fuel requirements of the 1st Cav are met by the oil wells and refineries of this area. While large stockpiles exist at other places, the loss or destruction of Texas City/Galveston would be a severe blow to the military capability of the Republic. (Though most of the petrol products that come from here are used by civilians for heating, cooking and in lamps.)

The "twin towns" are proud. Their inhabitants enjoy a relatively high standard of living. Electric lights in every home are common. "First in The Republic!" is the local motto.

The land in the area is low, flat and wet. There are occasional low hills and rolling ridges. Lands on the sea or Galveston bay are either swampy or sandy. This has led to extensive damage and flooding in times of storm or hurricane. But while Galveston's proud sea wall is somewhat smaller, it is still intact and has protected the town's inhabitants from the worst storms.

In the summer the weather ranges from the merely uncomfortable to the completely intolerable. Rainfall exceeds 50 inches a year, but in the summer, most of this comes in the form of torrential thunderstorms (sometimes accompanied by tornados). For people, this is difficult, but for plants it is marvelous. Vines, creepers, undergrowth and scrub trees will strangle anything that is left unattended for 5 minutes **or more**.

At first glance the winter, with a low of around 25°F. would seem to be a relief. It is not. Generally winter is accompanied by weeks of overcast, wet weather complete with a biting wind ("northers" in local parlance) and long days of constant rain varying between an unpleasant drizzle and a cold, miserable downpour.

The spring and fall seasons are actually a relief from this with temperatures in the 60s and 70s, clear skies and gentle breezes. Unfortunately, these seasons each last about a week and then pass into one of the other unfortunate periods which are laughingly called winter and summer. And then there are the hurricanes.

Every ten years or so a "tropical depression of unusual intensity" (to use the dictionary definition) hits the Texas coast. These disturbances routinely cause tides 10 feet above normal, winds of over 100 mph, rain in excess of 5 inches in a 24 hour period. When a particularly severe storm lands, there can be winds over 200 mph which will rip entire houses off of their foundations only to deluge the shells left with 20 or more inches of rain supplemented by tides over 20 feet above normal. In addition, scores of tornados have been known to spawn around these

mammoth storms, often causing more damage than the storm itself.

In the first decade of the 20th century, Galveston Island was all but sunk by one of these huge storms. The entire island was covered by ten feet of water, the cemeteries opened and the dead were carried out to sea with the tide, only to be returned the next day. Any house not built of stone was leveled and the survivors, in hopes of avoiding this disaster again, began construction of the 30 mile-long sea wall and, even more significantly, began a program to raise the level *of the entire island by 70 feet*. This program was completed within five years of the disastrous storm and the few buildings left after the typhoon are still several feet below the level of the rest of the island.

The invasion has hit the area hard. The initial crossings of the Guadalupe river did not create a panic. After all, that was over a hundred miles away. The continued advance caused some alarm, especially after the Lavaca line collapsed and refugees began pouring in. "Still," people told themselves, "the Army can hold San Bernard. And we're too important to them to let us be overrun." This was true, but it failed to take into account the sea borne assault.

The amphibious assault on Galveston coincided with a push, supported by armor, across the San Bernard. In Galveston and Texas City the militia bore the brunt of the first assault, but they were soon joined by the Army, reeling back from the defense of the San Bernard.

On both old routes I-10 and Texas 59, the bridges across the San Bernard were taken intact. The enemy is now making use of both and will soon draw nigh the ruins of Houston. Thus the formation of the "Houston Pocket."

Originally it was bounded by the San Bernard river, old 59, Houston, and the sea. In the last week the line of the San Bernard was replaced by Texas 288. Soon the line will be I-45.

Within the pocket are between 10 and 20,000 civilians, both inhabitants of the region and displaced citizens from further south. The only route of escape open to them is the long trek around the Western end of the ruins. **When the enemy arrives this will be closed. When this happens the only way out will be via boat across the bay. The only thing that stands between the refugees and death is the remains of C Company, 7th Reg 1st Cav Div.**

'C' Company

To the survivors of Charlie Company, the war seems to have begun a year ago. **C771** was one of those units originally assigned a spoiling mission. One month ago the company could boast 206 men; now less than 10% are still alive.

The unit has seen action at the fall of Victoria and Edna the burning of Wharton and the defense of the San Bernard and Lake Jackson. During the last 27 days elements of 'C' Co have fought on 22. The troops have seen the hordes attack again and again, with numbers that do not seem to lessen. They have helped the columns of struggling refugees, given them their meagre food, and fought innumerable rearguard actions. **The men are dirty, exhausted, but still very much alive. This is due wholly to the efforts of their commander.**

Captain Bartholomew (Buck) Vega's ancestors came to the U.S. after the fall of Cuba in the early 60's. Sons have served in the armed forces ever since but few have chosen to make the military a career. Buck enlisted at 16, served his time, saved his pay, got out and went to school at A & M. Spurning the technical training, he chose to concentrate on philosophy and history. Obtaining what he had come for, he then reenlisted and was soon sent to "the Academy" to become an officer. He was promoted to captain 8 years ago and took command of 'C' Co at that time.

He has now served 17 years on active duty.

Among other officers he is known as "silent Vega" because he so rarely speaks. His troops know the nickname too, but attribute it to his skill at dismounted nighttime patrols. Both are accurate. The captain has never been heard swearing at any of his men or even raising his voice. He has often been seen leading his horse on foot while a wounded trooper or refugee occupied his saddle. He almost never smiles. Captain Vega drives himself to his limits and beyond, does the same to his men — and they love him. Anyone who has ever spent any time under his command is willing to do anything for him. If a request came down for volunteers for a raid on hell, men would check out equipment, look for extra canteens and saddle up. This is just as well, since hell has come to them.

Buck Vega has done as well as he can with what he has. Only 22 men remain from his original command and this grieves him more than most know. During the long retreat he has picked up survivors from other units and now has 63 effectives but only 29 of these have horses. Also filling out the ranks of C Co. are 2 M2 Bradley IFVs (Infantry Fighting Vehicles) from other units, both of which were cut off from the north, and are now low on fuel and ammo.

When the last assault began, his major, the C.O. of the 7th, ordered Vega to take command of everything south of Texas 59 and hold it for as long as possible. Major Dark said he would take the northern side and try to link up with elements of the 3rd Regt. rumored to be near Navasota. The major is a good man and would himself have taken the more dangerous southern command but he could not get there in time. Nothing has been heard from him, or anyone else, since. It is feared that he is dead.

So, for the past few days Vega has been presiding over a rapidly crumbling situation. His troops are in retreat before an estimated 10,000 enemy (counting the forces which landed at Galveston). The militia has all but been destroyed. Galveston is lost but an understrength Troop (22 men and militia survivors) is fighting amid the ruins of Texas City trying to hold back the amphibious assault. The Captain, with the remaining troops, is falling back as slowly as possible, trying to buy time for the refugees to escape. He has organized a boat evacuation from Bacliff to Smith Point across the bay, but there are too few boats and too many refugees.

Vega will eventually abandon Texas City and try to hold the line of I-45, finally falling back on the LBJ space center for a last stand. He has small hope for himself or his men, but does hope that their efforts will allow most of the civilians to escape. He is deeply worried about the possibility of the enemy ships entering the bay and halting the evacuation but there is nothing he can do about it. Throughout all of this his right hand man has been 1st Sgt. Ho.

"Top Shirt" Ho is descended from Vietnamese refugees who came to shrimp in the Gulf of Mexico. He has been in the army for 27 years, has three times refused offers to attend The Academy, and has turned down two battlefield promotions. Ho likes being a sergeant. He has been 1st Sgt. of C/7/1 for 12 years now and he had been looking forward to retirement. He is now 48.

Ho is not like The Captain; he will laugh at any joke, talk for hours on end, and is what can only be called foul mouthed. He can mix obscenities freely in English, Spanish, Vietnamese and Commanche and he frequently does. He delights in playing the "stupid slope" and will pretend to speak only Viet with obnoxious strangers as he picks up a lot of information in this way. He is a character, boisterous and active, as militarily capable as The Captain, well liked by his troops, even if feared. The 1st Sgt. is of the opinion that "Captain Vega is the best %*\$ officer in the whole *&\$!! division!" and is devoted to him.

1st Sgt. Ho has, for the last few days, been put in charge of the evacuation and given 10 men to assist him. He is responsible for the appearance of a small fleet (5 boats) of Viet fishermen showing up for ferry duty.

The Captain and the 1st Sgt. are holding everything together as the trap closes.



Personalities

Within the Houston Pocket are a few people who are important enough to mention here since they may become important in the course of the game. Foremost among the personalities are Captain Vega and 1st Sergeant Ho but they have already been covered.

Leutenant Daniels

A small and cheerful man, the Lt. has been with the Company for three years and in the division for ten. He is a competent officer but lacks the Captain's experience. Daniels is commanding the defense of Texas City. If something happens to Vega, Daniels will be left in command. He is quite smart enough to rely on 1st Sgt. Ho in such an eventuality.

Sergeant Krans

From A/8/1, Krans is an armor man, commanding one of the 2 M2s on hand. He loves his crew and his machine, is singly proud of both, and handles both artistically.

Troop Sgt. Humber

Originally of B/7/1, he joined up with 'C' after Wharton. He is now the next senior NCO to Ho. He has learned that his wife, children and family in general did not escape from Georgetown and is out for vengeance. He is capable and vicious, but may have more than a little of the "death wish".

Corporal Maniscalco

Cpl. "Mannie" is the radio operator of 'C' company and is the best RTO any of the men have ever seen in spite of never having attended the tech school at division; he just has a "knack" for it. The Cpl. is a rarity: he bears the marks of a slave from the south. As a result nobody has questioned him about his past prior to enlisting.

This is just as well. Mannie was a slave, but he was not born one. He was born in Alabama in 1963 and was frozen near Pleasanton as a member of a Snake Eater team in 1985. His team thawed four years ago and was quickly located and destroyed by The Brotherhood. Mannie was taken alive but later escaped to The Republic. Having nothing better to do, he enlisted in the 1st Cav and, having been trained as an SF RTO, he knew the job more than well.

He will be watching any members of "The Morrow Project" very carefully but he will say and do nothing until he is sure of what kind of people he is dealing with. The Cpl. could be very useful as he is the only one who is familiar with the set up of the enemy and he knows it too well. He has even seen the Kamfyurer and so knows what he looks like. Mannie is a mine of useful information. Before being frozen he was a Sgt. in the U.S. Special Forces.

Doctor Crenshaw

"Doc" Crenshaw used to have a practice in Yoakum. Now she is running a field hospital in the cafeteria of the LBJ Space Center. Doc is 61, tired, pessimistic, cynical and dedicated. The "hospital" has 32 military patients and over 200 refugees. Most are too ill to be moved. Crenshaw is short of everything she needs and is nasty about it. If the final evacuation comes, many of the wounded will have to remain behind. Doc Crenshaw is unlikely to leave them.

Senator Lavin

Dan Lavin was the representative from the area around Bay City and was down there when the war began. Dan is a prime example of the kind of over-stuffed, pompous, self-important and impotent man who made up the majority of the legislature of The Republic. He had a reputation for opposing all military spending or government cooperation with the military but now loudly demands protection. His constituents suspected him of feathering his own nest with local money. He "wants the best for The People and is out to protect their interests" but only he is qualified to determine what is "best" or "interesting".

The good Senator has been making a nuisance of himself by claiming civil authority over the military and trying to take over. He has engaged in a good deal of rabble rousing among the refugees and claims to have great support (a bald faced lie).

If things get much worse the fool is certain to head for the enemy to "try and make a deal" (for himself, not for "his people"). They will kill him, but may extract valuable information in the process.

The Field Research Team

This is a group of four scholars from A&M who were studying the LBJ Space Center. They waited too long to run and are now stuck there. Still, each has great technical ability and may prove useful.

Ron Bradshaw, 56, leads the team. He is a medium-brilliant electronic and computer theorist, but does not have the common sense that God promised a door knob. He cooperates with Captain Vega-when he remembers to. If the attackers do overrun the Center, Bradshaw and his team will probably notice only when they are bayoneted.

PLAY OF THE GAME

Wake Up

PD Note: Be sure that your players are fully briefed, have their basic loads in hand and are ready to go before you begin the following sequence! Remember: when they begin they will not know where they are or what they are supposed to do. They are supposed to be confused and disorganized, and if you do not give them any details, they will be.

The team awakes to bright lights and the sound of a low intensity siren. Coming out of their tubes they may notice that they occupy a non-standard bolt hole; they will certainly notice that the floor is ankle deep in water. The water level is rising. The computer is flashing the Emergency Wake Up Code, signalling that the hole itself is in some sort of danger. The screen reads:

MP CT-13

CLIMATIC CONDITIONS DESTROYING THIS FACILITY

TAKE ORDERS ON CONSOLE

VEHICLES ON UPPERLEVEL

IMPREATIVE THAT YOU EVACUATE IMMEDIATELY

GOOD LUCK

Estimated time remaining before termination of functions: 7min. 32sec.

On the console in front of the screen the team will find two bulky plastic wrapped packages; presumably the aforementioned orders. The screen will already be counting down from the original time shown.

PD Note: Impress upon the team that they are now in "real time"; they've got to be out of there in seven minutes. Look at your watch and smile.

The walls already show hair-line cracks and there is a good deal of moisture on them. The entire room throbs at intervals and seems to sway ever so slightly. The lights may begin to dim and flicker periodically.

Water is pouring into the room from above through a hole in the roof behind the computer. Since there is a metal ladder set into the wall leading up through this hole, this must be the way to the "upper level" that the computer mentioned. Team members can only ascend the narrow ladder one at a time. They should have little trouble doing so, but all will be thoroughly soaked in the process.

On the upper level the conditions are somewhat better. The floor is awash, but it is only a few inches deep (Most of the water is running down into the lower level). The promised vehicles are waiting here, but the team has never seen any of them before. Entering any of them the team members will find that they can operate them; the controls are Morrow Vehicular standard. Starting them up will present no problem but, the fans will cause some of the water to turn to spray, which will fill the chamber, reduce visibility to about five feet, and make the team that much wetter. Who dives into what vehicle is hardly crucial at this time.

The door to the outside will open when the switch beside it is thrown, but this means that somebody has got to be standing by the switch; it cannot be activated from a vehicle. Somebody is going to be standing there in the water; who?

Water on the lower level is increasing at the rate of about one foot per minute. The roof of the lower chamber is seven feet from the floor. Is any body still down there?

Five minutes after the team reads the initial message on the computer, all interior lighting will flicker and then fail entirely. Does any body have their flashlight handy?

The door does not simply open; equipped with small explosive charges, it is literally "blown out" of the wall (this will cause no harm to the team) , and it will slide majestically from view. Then a wave will enter the chamber, perhaps causing confusion and mayhem. (There had better not be any personnel on the lower level!) Will the wave sweep the poor door man off of his feet and out into the night? It is night outside; pitch black night. In the scramble for the door, only one vehicle at a time may exit through the door.

PD Note: It is bad form to kill players in this first seven minutes of the game.

It will stay dark outside because it is the middle of the night. The players will be able to get an idea of their surroundings only during brief periods of light caused by intermittent flashes of lightning. It is *pouring* rain. They are surrounded by water, salt water, and a stiff wind is blowing from the south-east. Looking behind them the players may see, silhouetted by lightning, an off shore oil rig. Their bolt hole was situated in one of its massive supports. As they ride away from it, heavy seas are beginning to build.

If any one brought one or both of the sealed packets into the Science ACV, these can now be opened and read. Both packages are identical. Each contain operator and maintenance manuals for all of the ACVs. These make up the bulk of the contents of the packages, however each also contains a set of orders which, when stripped of bureaucratic language, say roughly this:

1. The senior member of the science element is in over all command of CT-13. Senior member of the MARS element is second in command.
2. The mission of CT-13 is to secure the LBJ Space Center (see auto nav). Other units will support as available.
3. CT-13 is to establish control of Morrow Project Land-Sat 01 and relay information gained to Prime Base.

PD Note: The new team will be unaware that 150 years have passed since the war. They will not know that Prime Base is out of action.

Landsat 01 is the only Morrow Project satellite. It is intended to be used for navigation and as a communications relay. This information, and detailed instructions for activating the satellite are included in the orders. Until the satellite receives the activation signal, it will remain dormant.

The ACV autonavs will be showing a Location some 200 miles from the Texas coast as the current position of the vehicles. The radar of the Quequod shows an immense storm system moving in from the south/south east; fast. Wind direction and sea conditions will force the team to run for the Texas coast. Radio watch will produce no results and commo between the vehicles will be weaker than it should be.

Only the Quequod has lights and radar, and only she has an enclosed cabin. Her passengers might get a start on drying off. The other vehicles are open to the elements and have no lights or radar. A team with any sense will keep these vehicles close to Quequod and let her pilot call the shots. Conditions in the open craft will be dismal. The only source of light is the dim glow from instrument panels. The constant rain and wind will keep everyone soaked to the skin. The temperature is about 85°F.

If anyone aboard these ACV's opens an orders packet the contents will be ruined. Sea sickness may be a problem on all of the ACV's. Each character should roll his CONx4 or less on a **D-100**. A failed roll means the character comes down with a case of the dry heaves (since they have nothing in thier stomachs). It's going to be a long, wet night.

Wind speed will remain constant and sea conditions will not worsen so long as the team moves with the wind. They will be forced to make land fall somewhere between Matagorda and Port Arthur. Galveston Bay is the rough mid point between these two extremes.

Moving at an angle to the wind is very difficult and **only partially effective (about one meter "forward" for every three meters of "slide" in the direction of the wind)**, and will require moving against the sea swell instead of with it. Moving against the wind is not possible.

When the team is within 20KM of the coast the radar will begin to pick up the **shore line, Possible landing sites can be found on the autonav.**

PD Note: It will take the team at least three hours to reach land, perhaps longer. This time can be profitably spent by an occupant of the Quequod reading pertinent sections of the manuals to the other ACV's over the radii. The time may also be used to form some plan of action. Let only one player speak at a time, thus simulating the limitations of a **discussion over a radio.**

Remember that the autonav maps are 150 years out of date. Sea coasts can change a lot in that much time. **Major differences may be shown up by the radar, if the operator is comparing radar to the autonav display. With the approach of a new ice age, the mean water level is generally less than it was. Landing sites will abound in areas of swamp and in bays.**

Contact

The team will land in one of three broad areas: south of Galveston Bay, which is now in enemy hands, north of the Bay, still in friendly hands, or in the Bay itself, where the war is still being fought.

In the south the team will eventually encounter one of two kinds of folks: refugees or warriors. Refugees will be typified by small, hunted bands, terrified and hard to find. They are very unlikely to approach the team, but if **contacted they can appraise the team of local conditions, with a heavy emphasis on panic, terror and rumor of disaster. Warriors will attack the team without hesitation.**

On the north shore the team will find local citizens who, in view of the times and news from the south, will avoid them. If contacted they can also provide news and rumor. There are no Cav patrols in the area.

But the team is most likely to run for the shelter of Galveston Bay. **To carry out their mission they will have to head for this area sooner or later.**

Radar will not show a clear image until the team is within 5KM of the shore. Detailed scan will be useless at ranges greater than 1 km. Electric lights are still burning in Galveston and their glow will be seen from 1 to 3 km out, depending on the intensity of the rain. The light of the fires raging in the city can be seen for about the same distance. Even the dimmest player is likely to suspect that there is something wrong. Within 1 km the radar will show the two Cuban steamers as distinct blips in the water, but the team will not know what they are for sure until they make visual contact. The ships are anchored well off shore because of the coming storm. Each still has its Mexican crew on board

as well as a dozen or so warriors to watch the crews. Bright players will realize that ships with any smarts would be in the bay, not out here, not with a storm blowing up.

Assuming that the team tries and that they search the frequencies until they hit something, radio traffic can now be heard. The voices are all speaking Spanish. (The Brotherhood cannot figure out how to use good commo gear, their slaves have to run it for them and translate.) The radio operators are having a hard time maintaining contact with one another, except for the two shipborne sets. Many voices are quite weak and others are breaking up in static.

PD Note: You're going to love this one! The approaching storm is interfering with all radio and the Quequod's radar. The 'approaching storm' is the mother of all hurricanes.

A normal hurricane is bad and will play hell with electronics; this one is worse. Hurricanes are tall, they stretch 'way up in the sky, up where, even this long after the war, there is plenty of metallic, radioactive dust. The hurricane pulls it down and adds more from the planet's surface. This gets mixed with water vapor. Even now all radio commo is limited to a few km's, soon it will be less. Radar too will be increasingly limited: a competent radar operator will recognize classic "jamming" conditions. By the time the storm is on top of them all radio and radar will be useless. It is up to the players to figure out what is causing the trouble. Another thing to **keep** in mind is this: If the team is using a frequency which the warriors are also using, or if they have tried to contact the RTO's on that freq., the enemy will be aware of their presence. Even if a Spanish speaking team member has been using the radio, he will be identified as a stranger: the Mexican operators all know one another.

If the team draws close enough to be seen from the ships, the warriors will fire on them. While the ships themselves are unarmed, two of the warriors on each have AKM's. The warriors so armed will spray anything that moves on the water. The bullets will not penetrate the ACV's but the two open craft may be in trouble. The ships are much taller than either of them and the warriors will be firing down into the open passenger areas. Still, visibility being as limited as it is, only an ACV with lights is likely to be spotted and fired on.

Assuming that the team survives this encounter, or ignores it completely, they will have to make for the entrance of Galveston bay. The entrance is not far north of the city, a gap between the island and Bolivar peninsula. Radar will show it clearly; it is about a mile across. The water in the gap will be rough. With the wind coming from the direction it is, the entire sea is trying to pour into the bay. The ACV's can handle this with no problem, but it *looks* dangerous. From here it is possible to hear small arms fire from Galveston/Texas City. If Quequod has her lights on, warriors will fire at her from Galveston Island.

Inside the bay the winds and seas are less violent (for the time being), Give the team an hour or so of game time to "go to ground" somewhere before conditions here begin to match those on the sea. There are many suitable landing areas since beach and marshy ground are the norm here. The western edge of the bay is the most logical side to land on, since it is closest to the objective. But where ever they land, only about 100 meters of ground will be available for maneuver before trees begin. Due to the size of Quequod and Flying Dutchman, they will have

to skirt the low lands until they find a gap in the tree line large enough to admit the vehicles to the interior. Such gaps occur only where roads come down to the shore line. If the team has landed within 5 km of Texas City there is a chance that they may be detected and attacked by roving bands of warriors.

Moving inland the team will almost certainly run across I-45, and I-45 cannot be crossed quietly. In the wind, the rain and the darkness, the approach of the team will likely go unnoticed. By the same token, the team is likely to stumble upon I-45 from very close quarters, say 100 meters or less.

I-45 is covered with refugees fleeing from Galveston, Texas City and points south. The discerning eye will note that, while moving quickly, they are moving in orderly fashion and there is no sign of panic. Even though visibility is not more than 100 meters, here and there an armed figure can be seen; moving along with the flow of humanity and expediting matters. The motionless figures standing guard among the trees *cannot be seen*.

Should team members creep close enough to the road to hear voices they will discover that English, Spanish and some oriental language (Viet) are all being spoken, often used in a rich mixture. Such team members will also be detected by the motionless guards.

The troopers here are all men who have lost their mounts. They are assisting the refugees, guarding their route, and they are commanded by 1st Sgt. Ho. They will probably be aware of the team long before the team knows about the troopers.

The soldiers will try to parley before becoming unpleasant. They will not mistake the team for warriors since warriors would have already attacked. Of course, if the team turns hostile the troopers will shoot to kill. Assuming that peaceful contact is achieved, the troopers will try to persuade the team to follow one of their number, ACV's and all, to the 1st Sgt. Should negotiations take much time, Ho will come to the scene.

Ho is "hanging out" in the vicinity of Dickinson along I-45, he has one of the M2 Bradleys there with him. Whether the team goes to him or he and the Bradley meet the team, he will tell the team to wait around until the refugees are past, which will hopefully be about dawn, and then he will lead them to his C.O. at the Space Center.

The troops will not be impressed by the ACV's; they are too tired for that. Ho will avoid a fight at any cost up to letting his job be interferred with. He is tired too and the appearance of the team *is* just one more headache to deal with. Whether the strangers want to wait or not is fine with him, but if they screw things up on the road he'll kill them. Personally if possible. At dawn he'll take them to the captain and they'll be *his* worry. Ho will go get some sleep. The rain and the wind grow stronger through the night.

For extra excitement the PD may wish to add sounds of sporadic gunfire to the south, coming closer through the remainder of the night, growing quite near and distinct around dawn. This will be the survivors of Lt. Daniels' force fighting a rear guard action for the refugees. There might even be a short, sharp fight in it for the team.

No matter where the team landed on the coast, no matter how long it takes them to get there, this is the encounter to use to bring them into the Space Center. They may blow it, but try to give them the chance anyway.

The Space Center

Captain Vega will want to see the team members and form his own opinion of their character, motives, etc. At worst he will attempt to arrest and imprison the team, and confiscate their equipment "for the duration". Less severely, Vega may be so dubious

about the team that he merely tells them to take their stuff and get lost. However, the captain is in desperate need for any and all help. He will probably try to enlist the team.

Outright enlistment in the 1st Cav, for the duration of the emergency, would best suit his needs: it will place the team and their gear under his direct control. But Vega is a reasonable man and will not insist upon this; he will happily accept the aid of the team as an autonomous unit. If the team refuses to cooperate in any fashion the captain will order them to get lost. (Being civilians so far as he is concerned, they have no place in the combat zone if they will not contribute to the war effort.)

Being an honorable man, Vega will point out to the team, before they choose options, that his unit is outnumbered to an unknown, but very large, degree. He has small hope for the survival of his command, much less of winning, but is going to hold out here for as long as he can to give the refugees as much time as possible to escape. The 7th cav, such as there is of it handy, will likely wind up doing another last stand right here. Unless they win, all the defenders will die: the lucky ones in the fight, the others in captivity. Does the team know about the savages' quaint affection for crucifixion?

Honesty will force the captain to point out that, should the team choose to bug out, they will have to run north. When things settle down the team may face awkward questions about the role they played in the war. If any of the defenders of the Space Center survive the coming battle, the team may be accused of cowardice and poltroonery. Honest men will have no truck with such. On the other hand, if the enemy wins, things will be even worse. Deals cannot be made with the savages. Besides, if the team has any real interest in the Center they cannot afford to let it be taken: the savages are burning as they come and will destroy the center if they capture it. Therefore: none of the team's options are pleasant.

The "guard troop" of the Center was long since sent into the fight. Upon his arrival there the captain found himself in command of the center itself. Under no circumstances will he allow anything to be removed from the site. Access to some buildings may be permitted if the team hangs around and if time permits. There is nothing in the buildings of any immediate military value. (This is true.)

If the team agrees to stay on and help out the captain will consult them about his plans. Having too few men to hold the entire center, he will concentrate on the main buildings, fortify them and routes between them, and arrange things so that each becomes a small fortress which supports others nearby. This defense will be centered around the cafeteria/field hospital, which will be held to the last. (The preservation of the lives of his men is more important to Vega than the fate of useless equipment in ancient buildings.) It is a good plan.

Having described the plan, he will ask the team for comment and suggestions. Vega is smart; smart enough to know that he does not know everything, smart enough to ask how the team and their equipment can be put to the best use. Any good suggestion will be considered and adopted. First Sgt Ho, Lt. Daniels and Troop Sgt. Humber may be called in to help and give opinions.

P.D. Note: Remember, Vega and his men, while familiar with having armor, have never successfully fought an opponent posing tanks of their own. Even simple anti-armor tactics will be news to them. The notion of infantry supporting armor is new to them. The idea that separating the enemy infantry from their armor will make that armor vulnerable will be of great value.

The chain guns mounted by the M2's can penetrate the armor of the BMP, but are all but useless against a T-72. The Bradley is capable of launching TOW anti-tank missiles (pg. 18 MPGB), but none have been available for over 100 years. Therefore, any anti-tank armament held by the team will be of immense value.

More important, the Rh202, two MAG 58 LMG's, grenades, demolition equipment, mines, radar and individual small arms of the team constitute a force of considerable power. If they are properly used. Vega and his men do not know how to use the stuff to best effect and so will have to rely on the expertise of the team members. It is the enemy on foot who pose the greatest threat.

The leaders of the Cav. will be willing to modify plans, deployment and tactics, within reason, on the basis of the advice of the team. This need not be completed in one day.

Preparations

As time passes the storm will worsen. Wind will increase and the rain will not stop. Leading bands of the pursuing enemy will begin to appear by dusk of the day on which the team arrives. Skirmishes on the perimeter of the center will occur, but no real battles. The rain will continue to fall.

The next day will see more enemy troops arriving. By nightfall the center will be surrounded; no further contact with the "outside" will be possible. At dawn a general attack will begin, on all sides of the center, with every available warrior.

Therefore, the night following the day on which the team arrives, as well as the following day, will be the only period during which the defenders may prepare without interruption. Twenty four hours. During the "second" day; the last half of the 24 hours, wind will increase to the point where the ACV's cannot fly. They will have to be tied down to keep them from being blown away. (If the team fails to do this, the ACV's will be destroyed when the main force of the hurricane arrives. P.D.'s should give the players ample warning for this without being specific: a bouncing, lurching 20 ft. ACV is hard to ignore.)

Once the night skirmishing begins, it will continue sporadically until the dawn attack begins. Preparations may still continue, but a full effort by all defenders is now impossible. With the center surrounded, filling sand bags, digging trenches and other such work will have to take second place to defense. To be of any use, the weapons on the Flying Dutchman will have to be dismounted and used in a ground role.

When the dawn attack begins, all preparation will be forced to cease. Units will have to fight where the attack finds them, with whatever they have on hand.

Subject to the PD's approval, the disposition of forces and equipment will look something like this: Defenders: 50-60 troopers in good shape, about 20 wounded who can fight but not move much. Everyone armed with .30 cal rifles and 80-100 rounds each. One .50 cal M2HB heavy MG with about 1300 rounds of ammo. Two M2 Bradley IFV's with an average of 200 rounds per main gun and about 500 for the 7.62 co-ax, plus the team and their gear. Enemy: 500-1000 infantry. Fifty or so armed with ARM assault rifles, but each will have only about 60 rounds. Something like 100 more armed with captured and assorted other firearms with still less ammo. The remainder armed in the traditional miserable fashion.

The enemy commander is a young warrior named Rojr, a "protege" of Jorj. He has already commanded the successful landing at Galveston. Remembering his Kamfyurer's orders, he is investing the major point of resistance and ignoring the refugee evacuation. Lacking the tactical ability of his superior and his charisma, he will try the traditional "human wave" assault so

common among the clans. Like his leader, he leads from the rear and will not expose himself to danger.

Rob will continue the assault either until he wins or until 50% of his men are killed. If the latter takes place he will order retreat, but how many warriors will accept the orders is a matter left to the P.D. to decide.

The attack at dawn will take place amidst 50 mile an hour winds and in rain so dense that visibility will never be greater than 100 meters. Just how Rojr will figure out when his casualties reach 50% is uncertain. The fighting is likely to last for several hours no matter what, and small bands of the enemy may penetrate quite far into the defense unseen. Rear areas are not necessarily safe.

Should this attack succeed, nothing more need be said.

If, on the other hand, the attack is repelled, the game will continue. Enemy withdrawal will likely be obvious. Alert troops will be able to inflict grave damage on the rout-in-progress. Yet small bands may not "get the word", or refuse the order, or find themselves in positions from which they cannot pull out. There may be wounded who are too badly hurt to escape but remain alive and dangerous. (Remember: warriors may be taken captive but they never surrender.) Surviving defenders may often be unaware of the presence of such pockets. "Mopping up" such will take time and will be dangerous, if it is possible at all.

The job may not be possible. Chances are good that the assault, no matter how damaging to the enemy, will have hurt the defenders very badly. Under the circumstances, 30-50% casualties among the defenders is not unlikely: enemy numbers will tell and odds of 10 to 1 are atrocious. Mopping up will cause additional deaths, though not on the same order.

The defenders will have that night, the next day and the following night to reorganize, although they will not know it. During that night and the following day, the storm will reach its peak. Visibility will close down to about 10 meters and occasional winds will peak at over 100 mph, if anybody cares. Persons not under cover will be in deep trouble. What glass windows remain will not be there for long.

Thus the survivors of the assault will be kept busy for the next 24 hours, eliminating resistance, caring for the wounded, shoring up defense and seeing to damage caused by the hurricane. The work that needs to be done will not be complete before exhaustion starts to drop people in their tracks.

The next night will be quiet, the storm will abate but not cease. By dawn the weather will have calmed considerably; it will be possible to get the ACV's airborne again. But by 10 am the final assault will commence.

After the defeat of his initial attack Rojr will begin to plan the next. Finding the Center a tough nut to crack, he will call for all available forces to join him in the vicinity. What with radio down, messengers must carry the word on foot.

The hurricane will, at the very least, slow things down. Enemy troops attacking the Center will suffer losses to the weather, as will most enemies anywhere near the coast. But by the following night units will start to move into the area. When the final assault kicks off it will probably be made up of every able hand on the "Southern Front"; 2-3000 infantry, about 100 armed with AKM's and another 500 or so with assorted fire arms. These will be supported by 4 T-72 tanks and 3 BMP's.

All will be short on ammo, especially the armor. All will be very tired from the march and the effects of the storm. While this is good news, it is not good enough. There will be fewer defenders than there were, and while these will be less tired than the enemy, they will still be weary. They too will be short on ammo.

By 10 am the sun will start to break through the clouds but rain will continue. Radios and radar will work again, but the radio will not be answered and radar will show enemy armor. The morning light will shine on thousands of attackers on all sides, movings toward the Center. After this brief glimpse the clouds will close down, rain will reduce visibility to 50 meters, and the final assault will begin in earnest.

To get the players out of this a deus ex machina is required and so one is provided. Wait until the team has expended the last AT round. They are perilously low on ammo, the hordes are at the doors and people are fixing bayonets. Or perhaps not quite that long. Amidst the heroic last stand a sound is heard. From the north, distorted by the rain and yet unmistakable to any veteran of early morning western movies, bugles! Cavalry Bugles! Sounding the Charge! Fainter than the bugles but more ominous is the sound of heavy tracks smashing the earth: Armor! The hoof beats of horse cavalry blend with the clank of treads and the roar of tank cannon to overwhelm the cries of fear and terror being torn from the throats of the enemy! Sabres flash in the rain as the horsemen sweep to the attack. in a few hours, perhaps after a sortie by the Flying Dutchman in support of the counter attack, the battle is over. Beside the smoking shells of destroyed buildings, illuminated by the ghastly light of burning enemy armor, under the stars of a clearing sky, the newcomers tell their tale.

Rationale

Over a week ago The Major finally figured out that the enemy, with radios of their own, were able to listen in on the plans and movements of friendly units. Horse messengers were sent to all units that could be reached informing them of the discovery and ordering all of them to gradually cease transmission, terminating entirely after bogus cries for help and reports of disaster (including the death of The Major). But the radios were left on and manned and the tables were turned: now the 1st Cav. listened to the radio traffic of the invaders!

This gave a good indication of the whereabouts of enemy forces. It also provided commanders with the news that enemy armor was short on fuel, that all units were low on ammo and food, were tired, worried about the weather and were largely in disarray.

When the weather closed in, the 1st Cav. counterattacked. Away from the coast the effects of the hurricane were less severe. In the rain, the wind and the reduced visibility, the masses of the enemy could not be used to great effect. The smaller, highly disciplined units of the Army moved among them like fleas on a dog. They destroyed many of the enemy and the remainder was fleeing south before the worst of the storm arrived. Elements of the 6th Cav., along with remnants of the 7th (supported by 4 M1 tanks), were dispatched to the aid of the Houston Pocket even though the men trapped there did not know it.

The hurricane slowed movement and then halted it, but as soon as conditions permitted, the march resumed. Meeting only scattered resistance (most warriors having answered Rojr's summons), the rescue pushed south. Receiving the radio calls for help sent that morning, the relief force know where to go. The rest is, as they say, history.

Aftermath

Surviving team members will eventually be allowed to make use of the facilities at LBJ. Assuming the mission control building survived the battles, equipment can probably be gathered that will allow the team to activate MP Landsat 01 (at the PD's discretion). Power can be supplied by "plugging into" the fusion pack of one of the bigger ACVs.

In the short term this will do the team little good, but in the

long term Landsat 01 may prove enormously useful.

Placed in a geosynchronous orbit over a point a tad west of Kansas City, this very sophisticated unit can provide several services. For those Project units who know how to contact it, the Landsat can be used to pinpoint their location on the ground: a good check for the autonav systems. It can be used to relay radio messages beyond the normal range of Project radios; teams will theoretically be able to communicate from California to Maine, from Alaska to Florida. LS-01, by virtue of its camera equipment, can transmit pictures of the Earth's surface and thus serve as an ersatz weather satellite. Perhaps most important, given time and lots of effort, the pictures sent by LS-01 will enable teams to accurately update their maps!

Of course, this will take time. In order to make use of the last two functions, the team will have to get TV screens working. None of these possibilities are written down, but all can be deduced by a capable team. It may even be possible to create a direct computer interface which will allow units in the field to let the Landsat, through vehicular computers linked to the autonav, automatically update maps in the system! But all of this is long term and presupposes that peace will return.

That is far from certain. While the counterattack of the 1st Cav. scattered the enemy and killed many, of the 70,000 invaders, probably half still survive. Most of these will have taken refuge south of the San Bernard and Llano Rivers. The "regained territory" is in bad shape with looting and burning having left most human dwellings in no condition for quick reoccupation.

It is unlikely that even Jorj will be able to stir the warriors to new efforts in the near future. With so much new land, here and in Monterrey, and so many new slaves, most effort will go to consolidating the fresh gains. Given a few years, the new lands will be under the yoke as firmly as the old, nearly as barren and the north will be in trouble again.

The 1st Cav will be disinclined to do anything about this. One-half to two-thirds of the unit has been destroyed. It will take time to rebuild. Civilian government has collapsed again and until it is reconstituted the Cav will again have to take its place. Thousands of refugees must be looked after and resettled. The damage caused by the invasion, and by the hurricane, must be repaired. The troops will be too busy to worry about more war.

Where does the MP team stand in all of this? Depending on their performance in the fight, it is a near certainty that survivors will be offered positions as NCOs or lieutenants in the division. If Captain Vega survived, he will find himself in command of the 7th as the senior surviving officer. He'll be a major as soon as somebody has the time to see to the formalities. Among the remains of units there will be a lot of promotions but very few celebrations. Even 1st Sgt. Ho will probably have to accept a commission; duty and honor require it.

Vega is a potential key to the situation. He will be very busy organizing the "new" regiment, but will be glad to assist the Team as much as he is able. A student of history, he has long held the belief that there are parallels between the situation in The Republic and conditions in early post-Roman Britain. There, once each generation, breeding on "The Saxon Shore" led to fresh invasions. While he has never spoken his theory aloud, he may now let hints drop. If any of the Team has been bright enough to notice the generational pattern, the Captain (Major) will be happy to compare notes.

For this is the root of the problem and Vega knows it: for over a hundred years the Cav has won every battle but has been losing the war. The savages will always breed more warriors and attack again and again unless the war is carried to them. This may not

be nice, it may not be properly idealistic, but the fact remains that these "people" are not humans but animals. Conquering them is the only answer. Cpl. (Sgt.) Maniscalco will agree,

So the war must be carried south. It will fall to Vega, or Vega and the team, to convince others, This will not be too hard but it will take time and time is of the essence.

Initially the team will have many responsibilities but several military options that they are uniquely qualified and equipped to seize. If the storm did not destroy them and if their crews did not sail away, or even if they did, The MARS team might want to capture or sink the two Cuban steamers. Long range recon and penetration of enemy territory, perhaps some sabotage, can also be assayed. As long as Jorj lives he is a threat to the north. A deep raid and assassination are in order here. Corporal Maniscalco, with his knowledge of the terrain and the "set up" would be of enormous value in either of the later two ventures.

As soon as the Division has healed its wounds the war should resume. If the army moves within 6 months there is a good chance of saving many of the slaves taken in the invasion.

If Jorj is still alive the renewed war will be hard fought. Even if he is not around, things will be difficult. Yet the advantage will remain with the Division; the clans are unlikely to cooperate in mutual defense, they like seeing one another butchered. This means that the new push will take the form of many short, sharp small fights instead of big, pitched battles. This will not be the case if Jorj is still in command,

The mobility of the team will make them very useful in scouting and flank security roles; even the Science team. Fighting is not the object in either mission, quite the opposite in fact.

Yet by the time the war is back up to a rolling boil it is likely that the Science team will be deep into the problem of bringing the Space Center back on line. This could not be done after The War for want of men and material; both were desperately needed elsewhere. By the time the state was wealthy enough to support non-productive research, nobody with the practical knowledge was left alive.

The arrival of the team introduces a group of people who remember the ancient technology as if it was there only yesterday; indeed, to them it was. With the members of the Science team to identify equipment and its uses, the competent theoreticians of A&M can get things working again.

It will require a team effort of both the Science team and the A&M boys. The Science team will provide memory, practical skill and material resources in the form of using the mobile lab. A&M provides the manpower, physical resources, equipment and technical data. Remember, the A&M men are very capable once they have things explained to them. Often they will be faster than the team once they get the basics.

In a few years the Center can be put back into operation. But this lies in the main stream of events; outside of that main stream there are many other activities for the team to become embroiled in.

The citizens of the Republic are not illiterate peasants, they will not be over awed by the ACV's or other gizmos possessed by the team. They may show a great deal of interest, crowds might even form, but any of the usual "Look at the white man's heap big magic!" routine will be met with quiet smiles or gales of laughter, depending upon how polite the audience is feeling. This is even more true of the do-dads in the trade pack. Of course, the gold and silver will be genuinely useful and the 150 year old whiskey will be more valuable here than in most other places. With the exception of the refugees, the locals are pretty well off. There is not much the team has that will interest them.

Aid to the refugees is really needed but there is not much

that the team can do to help: the problem is too big. The food and medicine carried by the team can only be given to a few. What the refugees most need the team cannot provide: a ride out of the war zone. The ACV's just cannot carry much. Yet there is likely to be some clamour for the team to evacuate seriously wounded or children.

Speaking of wounded, one place where the team can do a lot of good is in the field hospital at the Space Center. Another doctor or even a skilled medic will make the difference between life and death for about half of the patients, and for the wounded brought in from the "final defense". Here the medicines of the team and the large medkit can be used to best effect. They will probably be used up, but there is no better cause. PD's are encouraged to be generous with medical supplies in caches, if the team uses up thier supplies in the hospital or upon refugees.

And while we're on the subject of caches, the ones to the south can only be opened if the land is recovered or if the team tries some very risky trips. Keep in mind that the contents of an average cache will weigh about ten times as much as any of the ACV's can lift. (The team may not realize this untill it is much too late.)

The exact contents of any cache is always up to the PD, since only the PD knows the needs of the team and his own needs in terms of how he wants the game to run. Use the guidelines given in the section concerning caches, but always feel free to add or delete items. Ammo will be a big factor in this game, so you might not want to short change your players in that area, this time. You might even want to reward them; say with a portable fusion power generator. This would be very useful later on at the Space Center.

Designers Notes

Lonestar is being released over a year late. Fortunately the delay has allowed for a more finished product.

A lot of playtesting went into this one! The *Lonestar* module now offers the P.D. a variety of options and a level of realism that are not usually found in a game module.

Running *Lonestar* should be as much fun as playing in it. As the Project Director you have all of the background data you need, while at the same time you have a great deal of "elbow room" to include your own ideas and twists on the basic plot.

We recommend that you run *Lonestar* fast and hard. The team enters this one confused and off balance: keep them that way! From the emergency evacuation of the bolthole, to the midnight ride in the ACV's across the restless sea, to the war zone of Houston/Galveston, things are happening fast! You have complete control over events. if you handle things well, the team will be unable to catch their breath for a full week of game time.

Much of the module is designed to help you maintain the pressure and increase it as the game unfolds. The hurricane builds and will strike when you think the time is right. The snafu with the crated lab equipment can be used to great effect. The ever present rain and the horrible, humid heat can be used to the discomfiture of the team; those coveralls will be soaked, heavy and hot. The team should start out soaked and stay that way.

Surprises like columns of refugees, the "new" cavalry, the animal invaders, and the fact that the Space Center is the strong point for a final desperate stand, should keep the team about half numb from shock. Throw in the unexpected armor, the fact that the fancy ACV's will be useless because of the weather, the presence of civilization where there ought to be chaos, the fact that the civilization stands a fair chance of being overwhelmed by chaos, and what looks like an impossible and useless mission for the team itself, will keep the team running in circles and wishing they had never been born! Yes, in short order they ought to be wondering if everything they know is wrong.

If they ever do get the satellite working, Damocles will notice it and try to contact the team. This may lead to the creation of a Mississippi Valley Morrow Project axis of operations and communications. A huge area of the former United States may thus be tenuously linked to the mutual advantage of all concerned. Of course, this will take years to complete. But linking up with the teams in the north is a natural move. Remember: Delta Base is roughly halfway between Galveston and Damocles.

But where things go and what happens next is now up to you! Good Luck!

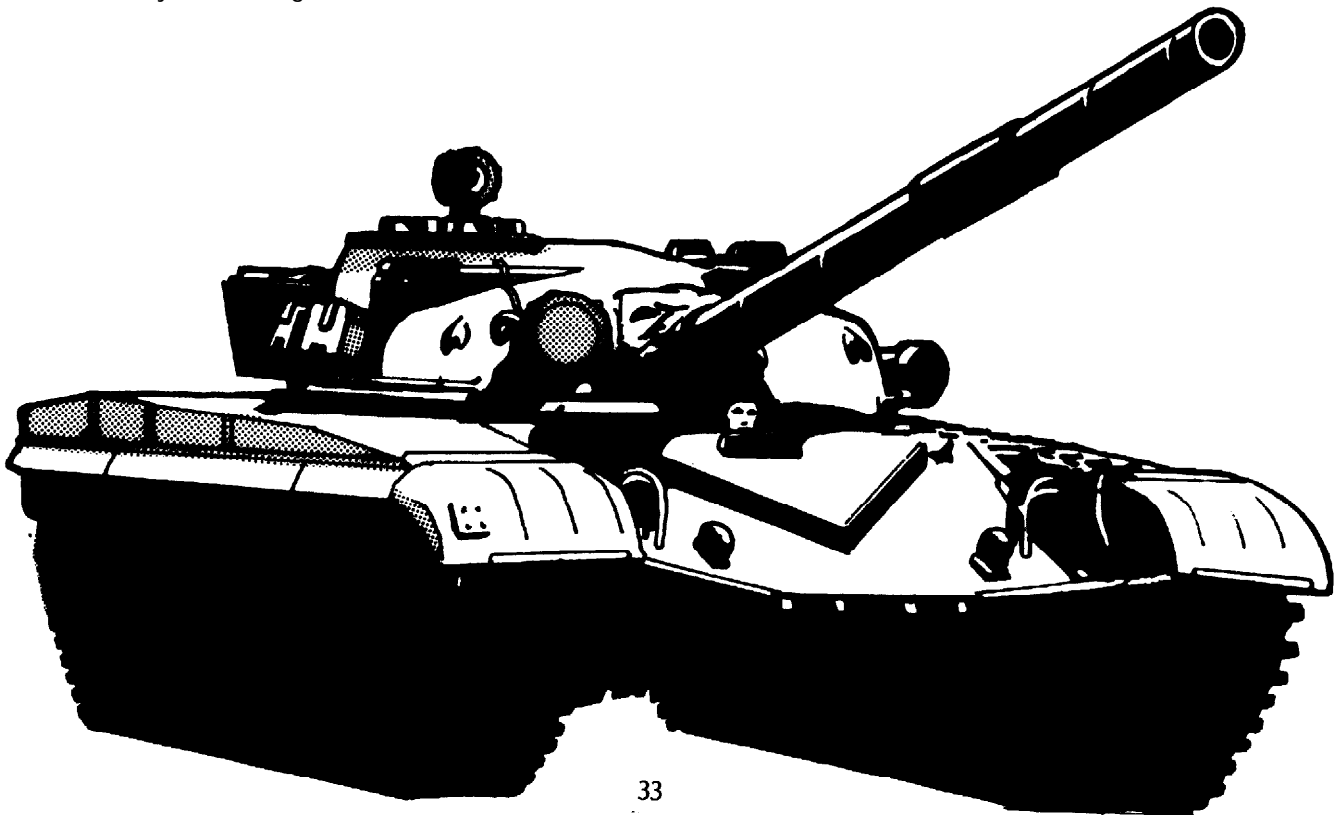

NEW EQUIPMENT

Armor

The armored vehicles presented in this module do exist. The M1 and M2 are the most modern armor in the U.S. inventory. The T-72 and BMP are both main stays of the USSR/Warsaw Pact armies. Of course, none of these vehicles are operating at full capacity after 150 years of use. All have been heavily modified and/or haphazardly repaired. For the sake of comparison, each will be provided with two sets of data: the original specs., which show the vehicles' qualities as they were originally, and the unit as it exists in Lonestar.

Notes on the Brotherhood's Use of Armor

All of the armor captured in Monterrey is still manned by Mexican troops. To put it mildly, their hearts are not in the current fight.

Each vehicle is commanded by a warrior. He tells the crew where and when to go and how fast. He tells the crew what to shoot at and when. He also tells them when to use the radio and who to call. The crew is chained into the vehicle so they cannot run away. At any hint of treachery, the warrior will kill one of the crew members.

Still, the Mexican crews do all that they can to ruin performance. The warriors are ignorant and up to a point are forced to rely on the word of their slaves. As a result, most warriors now believe that it takes two or even three main gun rounds to acquire a target at ranges that are actually quite close. They believe that radio magic is subject to failure at any time, and that there is no reliable way to tell how much fuel a vehicle has or is using.

The fact that the Mexican crews are chained to their vehicles is unknown in The Republic. If it ever becomes known, more care will be taken to save the crews if possible.

If the warrior in a vehicle is killed, the crew will stop fighting, surrender if possible, run away if they cannot. More crews have been killed by warriors than have died under "enemy" fire.

None of the vehicles retains any smoke generating capability, fancy optics or laser ranging equipment. They are very worn and tired vehicles.

The Brotherhood often covers their armor with riders who, if possible, stay on the vehicle right through a fight. The skulls of victims, as well as severed heads on their way to becoming skulls, usually decorate the main guns.

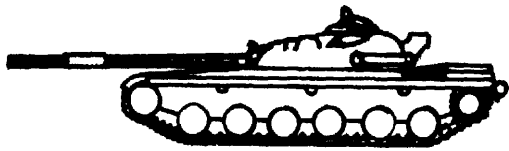

T-72 Tank	Original Specs.	Lonestar
Crew	3	3+1
Length	7m.(9.2 w/gun)	7m.(9.2 w/gun)
Width	3.5m	3.5m
Height	2.3m	2.3m
Ground Clearance	.4m	.4m
Turning Radius	10m	10m
Max. Road Speed	80kph	50kph
Cruising Speed	60kph	30kph
Water Speed	N/A	N/A
Gradient	60%	50%
Verticle Obstacle	.8m	.8m
Trench	2.8m	2.8m

Armament	1-125mm	1-125mm
	1-7.62 LMC	1-7.62 LMC
	1-12.7 HMG	-
Ammo	40 rnds. of 125mm	
	as follows:	125mm left:
	12 APFDS	2 APFDS
	6 HEAT-FS	1 HEAT-FS
	22 HE/Frag	4 HE/Frag
	2500 7.62 rnds.	200 7.62 rnds.
	500 12.7 rnds.	-

Notes on the T-72

The addition of one crew member reflects the warrior who controls the crew. Any tank can turn on a dime but the very long gun on the T-72 somewhat restricts its movements in this regard. The '72 is powered by a V-12 diesel but this engine is tremendously tired; hence the reduced speeds.

The '72, like most Soviet tanks, was originally equipped with snorkeling gear to enable it to cross water obstacles. Briefly, the way these were used is as follows: you seal up the tank, erect a tall tube to channel air, drive into the water, let it close over you, and drive along under water until you come out on the other side. This trick was never tried under combat conditions, for which the shades of Soviet tankers are still grateful. The snorkeling gear did not survive the last 150 years, so don't worry about it!

The 125mm smoothbore gun is an incredibly lethal weapon. But the crews in these latter times are not familiar with it to any degree and have had little chance to practice before the war. For purposes of this module, use the T-72 table to determine hits with the 125.

A hit on an M1 with a HEAT round will kill the tank. APFDS will not penetrate an M1 turret or front hull. HE will have no effect on an M1 save in the case of a rear hull hit or a track shot. Any 125mm hit will kill an M2.

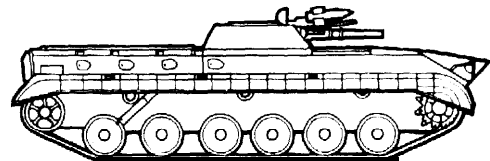

BMP APC/ICV	Original Specs	Lonestar
Crew	3+8	2+1 warrior + 8
Length	6.75mm	6.75mm
Height	3m	3m
Ground Clearance	.4m	.4m
Turning Radius	3m	3m
Max. Road Speed	55kph	40kph
Cruising Speed	40kph	30kph
Water Speed	8kph	N/A
Gradient	60%	50%
Verticle Obstacle	1m	1m
Trench	2m	2m
Armament	73mm gun	73mm gun
	7.62 LMG (Coax)	7.62 LMG (Coax)
	SAGGER ATGM	-
Ammo	40 rnds. 73mm HEAT	7 rnds. 73mm HE
	2000 7.62 rnds.	500 7.62 rnds.
	4 SAGGER ATGM	-

Notes on the BMP

The warrior now rides in the former commander's position, just behind the driver. The original BMP could swim across calm water, propelled by its tracks. Some of the BMPs in Lonestar might still be capable of this, but vehicles in the hands of the Brotherhood will not attempt to swim. No warrior believes that such a monster can float.

The 73mm smoothbore gun is a good weapon. In original condition it could hit out to 1000 meters with fair lethality. But these 150+ year old weapons are not as good; use the BMP hit table.

Only HE ammo produced in Monterrey is available for the gun. A hit from this will kill an M2. Hits on an M1 will have no effect unless a track hit is scored.

The BMP can carry 8 men as well as the crew. There are firing ports in the hull, but they were welded shut by the army in Monterrey. Passengers can fire weapons only if they expose themselves from the rear hatches.

There are four large hatches, each large enough for two men, on the rear deck. Also, two doors open at the rear of the vehicle for easier mounting and dismounting. These rear doors contain fuel tanks! The driver, gunner and commander all have their own hatches above their seats.

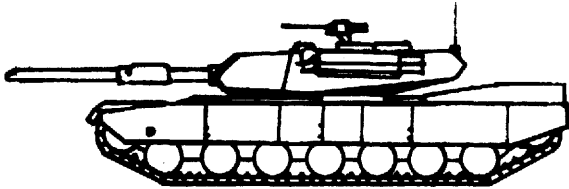

M1A1 tank	Original Specs	lonestar
Crew	4	4
Length	8m	8m
Width	3.5m	3.5m
Height	2.3m	2.3m
Ground Clearance	.5m	.5m
Turning Radius	10m	10m
Max. Road Speed	72kph	60kph
Cruising Speed	48kph	35kph
Water Speed	N/A	N/A
Gradient	60%	60%
Vertical Obstacle	1.2m	1.2m
Trench	2.8m	2.8m
Armament	1 120mm gun 1 M2HB 1 M240 7.62 coax 1 MAG 58 7.62 LMG	1 120mm gun 1 M2HB 1 M240 coax 1 MAG 58 7.62
Ammo	40 rds. 120mm 15 rds. APFSDS 5 rds. HESH 5 rds. AP 15 rds. HE 1,000 rds. .50 cal. 11,400 rds. 7.62mm	9 rds. APFSDS 4 rds. HESH 4 rds. AP 6 rds. HE 250 rds. .50 cal. 3000 rds. 7.62mm

Additional Comments:

The M1A1 tank is the first modification of the M1 Abrams. The A1 entered production in August of 1985. The A1 differs from the M1 primarily in additional applique armor applied to the turret and the replacement of the rifled 105mm gun with a German designed 120mm smooth bore gun. This change was made necessary because of the inability of the 105mm to consistently penetrate the frontal armor of the Soviet T-72/T-80.

However, over 2,000 M1s were built with the 105. While these were scheduled to be upgraded to the 120mm or a better 105, The War halted the refit program. If you wish to include the inferior M1 in this module, complete 105 gun data can be found in liberation at Riverton, PF-01.

The 120mm fires a variety of ammo and is reasonably accurate at ranges of up to 3,000m. The gun is fully stabilized and while on the move can be accurately fired at ranges of up to 1,500m.

The Lonestar M1A1, like its Soviet built opponents, is tired. All of its fancy night fighting, laser range finding, smoke launching and fire extinguishing gear is no longer working. The gun stabilization system has been carefully maintained. HE rounds are made locally, The APFSDS rounds are left over from before the war. (Having no armored targets to use them against, they were saved and maintained.)

The crews know the tank well enough that they can usually hit what they are shooting at. They are much better than the slaves manning the captured armor of the brotherhood.

The 120mm gun will penetrate the BMP at any range. Any area of the T-72 will be penetrated at ranges up to 1,000 meters. Beyond this range the front and sides of the T-72 turret are impervious to fire fro the M1A1 APFSDS. HESH rounds will penetrate at any range. HE has no effect on the T-72 unless a track hit is scored.

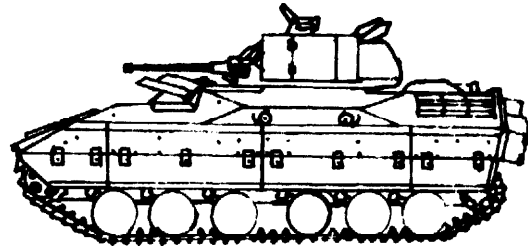

M2 Bradley/Devers	Original Specs.	Lonestar
Crew	3+7	3+7
Length	6.5m	6.5m
Width	3.2m	3.2m
Height	3m	3m
Ground Clearance	.4m	.4m
Turning Radius	6.5m	6.5m
Max Road Speed	66kph	55kph
Cruising Speed	48kph	35kph
Water Speed	7.2kph	6kph
Gradient	60%	60%
Verticle Obstacle	.9m	.9m
Trench	2.54m	2.54m
Armament	1 M242 25mm 1 M240 7.62mm 2 TOW launchers 25mm 300 APDS 600HE 2340 7.62mm 7 TOW missiles	1 M242 25mm 1 M240 7.62mm — 25mm 300 APDS 200 HE 500 7.62mm

Additional Commenk:

The M2 is too big, too tall and too expensive, but it is the best that we have. In the hands of the Cav it has been used **more** as a light tank than as an IFV. Its 25mm gun (**detailed in PF-02, Damocles**) is **very useful** in the infantry support role. No TOW rounds have survived, so the TOW launcher is **inoperable**.

Firing ports are provided for the passengers but these require specially modified M16s to work and none are left. This will limit the amount of fire an M2 can lay down.

The 25mm gun can and will destroy a BMP but will not effect a T-72. Even blowing the tracks off one of these tanks is unlikely. The M-242 has an E-Factor of 67.

Additional Comments:

This Soviet LMG is made in a variety of styles but only the **PKT concerns us here since this is the model** used as a coax on **both the BMP and the T-72**. It is based on the Kalashnikov action (AK-47, AKM), **stretched out and turned upside down**. **Do note** that this weapon cannot use any ammo save its own. Like the rest of the AK series, it is a very robust weapon.



Name:	AKM Assault Rifle
Cal.:	7.62x39mm
E-Factor:	15
Wt. (Empty):	4.3kg.
Eff. Range:	400m
Max Range:	2200m
Type of Fire:	Selective Fire
Rate of Fire:	30/100rpm
Feed Device:	30 rd. Magazine
Feed Device Wt.:	.827kg.
Basic Load :	N/A
Load Wt.:	N/A
Total Wt.:	N/A



Additional Commenk:

The AKM is the first descendent of the AK-47 and differs from the '47 in very few details. Both are amazingly robuts weapons: initial production M16s are now useless, but the significantly older first issue AK-47s are still faithfully serving their masters. You can say what you like about the AKM; that it's too heavy, kicks like a mule, is crudely made and hard to control. Yet it is a superlative combat rifle for this one salient fact: it keeps on working.

Name:	Cav Rifle
Cal.	.30 cal.
E-Factor	15
Wt. (Empty)	5.5kg.
Eff. Range	500m.
Max Range	2,123m.
Type of Fire	Single Shot
Rate of Fire	20 RPM
Feed Device	7rd/5rd Integral Magazine
Feed Device Wt.	N/A
Basic Load	200 rds.
Load Wt.	4.2kg.
Total Wt.	N/A

Additional Comments:

There are two basic cavalry rifles. One is a bolt action based on the old Krag-Jorgenson, the other is a lever action similar to the Henry and early Winchesters. Both models are easy to produce and maintain.

The lever action model has an under-the-barrel tubular magazine which holds seven rounds. The bolt action has a five round magazine which cannot be removed from the weapon. in both cases rounds are individually loaded into the magazine. Ammo is interchangeable with both weapons, but not with anything used by the Project.

The Basic Load is that issued to troopers going out on patrol.



Name:	PK/PKS/PKT Machine Gun
Cal.	7.62x54mm
E-Factor	17
Wt. Empty	9 Kg.
Eff. Range	1,000m.
Max Range	2,900m.
Type of Fire	Full Auto
Rate of Fire	650 RPM
Feed Device	100 rd. belt
Feed Device Wt.	2.5 Kg.
Basic Load	N/A
Load Wt.	N/A

Targeting, The "To Hit" Tables

T-72

Target	Range & Chance To Hit		
	100m	500m	1000m
Building	40%	70%	50%
Vehicle	70%	50%	30%
Moving Vehicle	50%	30%	10%

BMP

Target	Range & Chance To Hit		
	100m	500m	750m
Building	80%	70%	50%
Vehicle	70%	50%	20%
Moving Vehicle	50%	30%	10%

M1A1

Target	Range & Chance To Hit				
	100m	500m	1000m	1500m	2000m
Building	93%	90%	80%	60%	40%
Vehicle	90%	80%	70%	50%	30%
Moving Vehicle	80%	70%	50%	30%	10%

M2

Target	Range & Chance To Hit			
	100m	500m	1000m	1500m
Building	90%	80%	60%	40%
Vehicle	90%	80%	70%	20%
Moving Vehicle	90%	80%	60%	10%

Hit location Tables For Vehicles

T-72/M1A1/M2

Roll 1D6	Target Attitude:	Front/Rear	Side
1		Track	Track
2		Hull	Track
3		Hull	Hull
4		Hull	Hull
5		Turret	Turret
6		Turret	Turret

BMP

Roll 1D6	Target Attitude:	Front/Rear	Side
1		Track	Track
2		Hull	Track
3		Hull	Hull
4		Hull	Hull
5		Hull	Hull
6		Turret	Turret

Note; Track hits immobilize the target. Penetration of hull or turret will kill the vehicle.

Hit Location Tables For ACVs Hit By 73mm Or 125mm Fire

Quequod

Roll 1D6	Target Attitude:	Front/Rear	Side
1		Skirt	Skirt
2		Skirt	Skirt
3		Cabin	Cabin
4		Hull	Cabin
5		Hull	Hull
6		Fan	Fan

Flying Dutchman

Roll 1D6	Target Attitude:	Front/Rear	Side
1		Skirt	Skirt
2		Skirt	Skirt
3		Hull	Skirt
4		Hull	Hull
5		Fan	Hull
6		Fan	Fan

Notes: Skirt or fan hits immobilize the vehicle. If it is moving the ACV crashes. In such a case each character rolls his luck on 1D20 to survive. If the roll is failed, roll again. If the player succeeds the second time, the team member is badly injured and unconscious. If the second roll is not made, the character is dead. Cabin or hull hits: The ACV is destroyed. Each character must roll his luck or less on 1D100 in order to survive at all.

The Albatross

If the Albatross is fired on, halve the attacker's chances to hit. If a hit is still achieved, the ACV is destroyed and the pilot is killed.

The Effect of Project Weapons on Armor in Lonestar

Use the firer's accuracy and the individual weapon's data to determine whether or not a round hits. Use the included Hit Location Table to determine the point of impact. The effect of the following Project weapons is described below:

M72A1 LAW

A LAW will kill a BMP unless a track hit is rolled. It will kill a T-72 only if it hits the side or the rear hull.

Armbrust, Dragon and TOW

These weapons will kill either a BMP or a T-72 on any non-track hit.

RH 202

This weapon will penetrate a BMP out to 1000m. The weapon will not penetrate a T-72 at any range.

BOLT HOLE

A UPPER LEVEL

- 1 Door
- 2 Door Control
- 3 MARS ACV
- 4 SCIENCE ACV
- 5 RECON ACV
- 6 Access to B

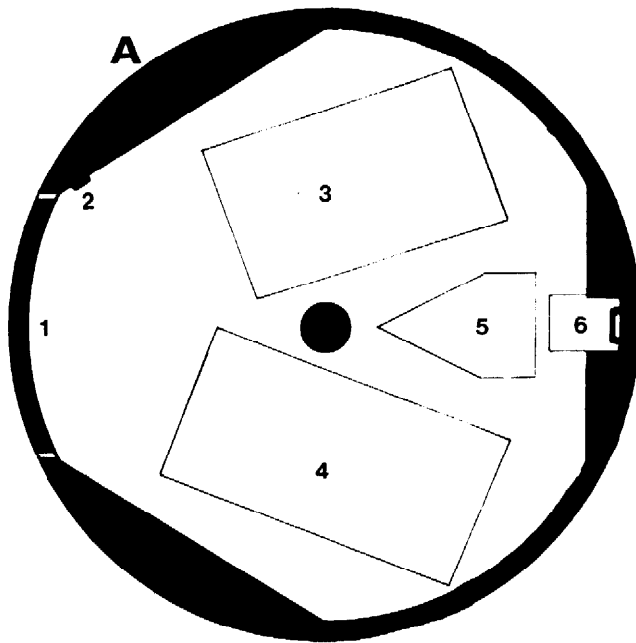

B LOWER LEVEL

- 1 Roof Supports
- 2 Computer
- 3 Access to A
- 4-11 Freeze Tubes

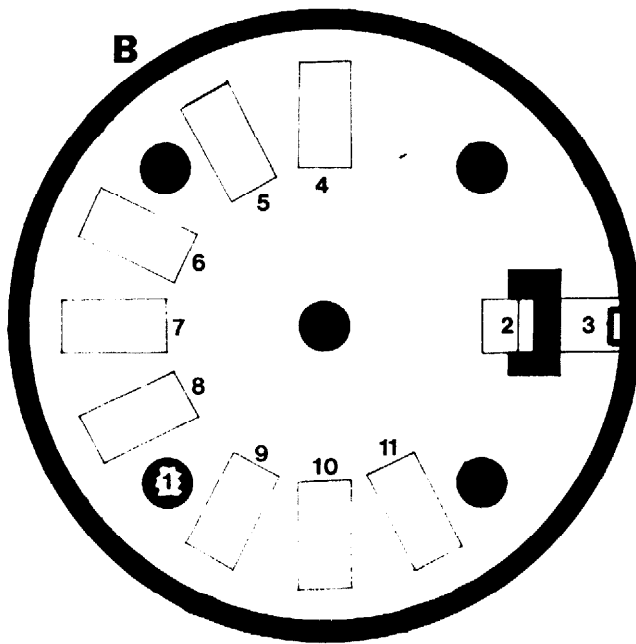



THE MORROW PROJECT LINE NOW INCLUDES:

GAME MODULES:

Liberation at Riverton	\$ 6.95
Damocles	"
Operation Lucifer	"
The Ruins of Chicago	"
The Starnaman Incident	"

GAME AIDS:

Project Director's Shield and Tables	\$5.00
Vehicular Blue Prints and Interiors	\$6.95

Coming in late 1985: Morrow
Project metal miniatures from:

CRIMSON DRAGONtm MINIATURES

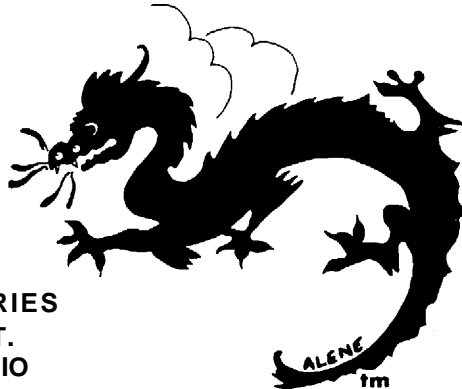

TAG INDUSTRIES
316 MAIN ST.
CASTALIA, OH IO
44824

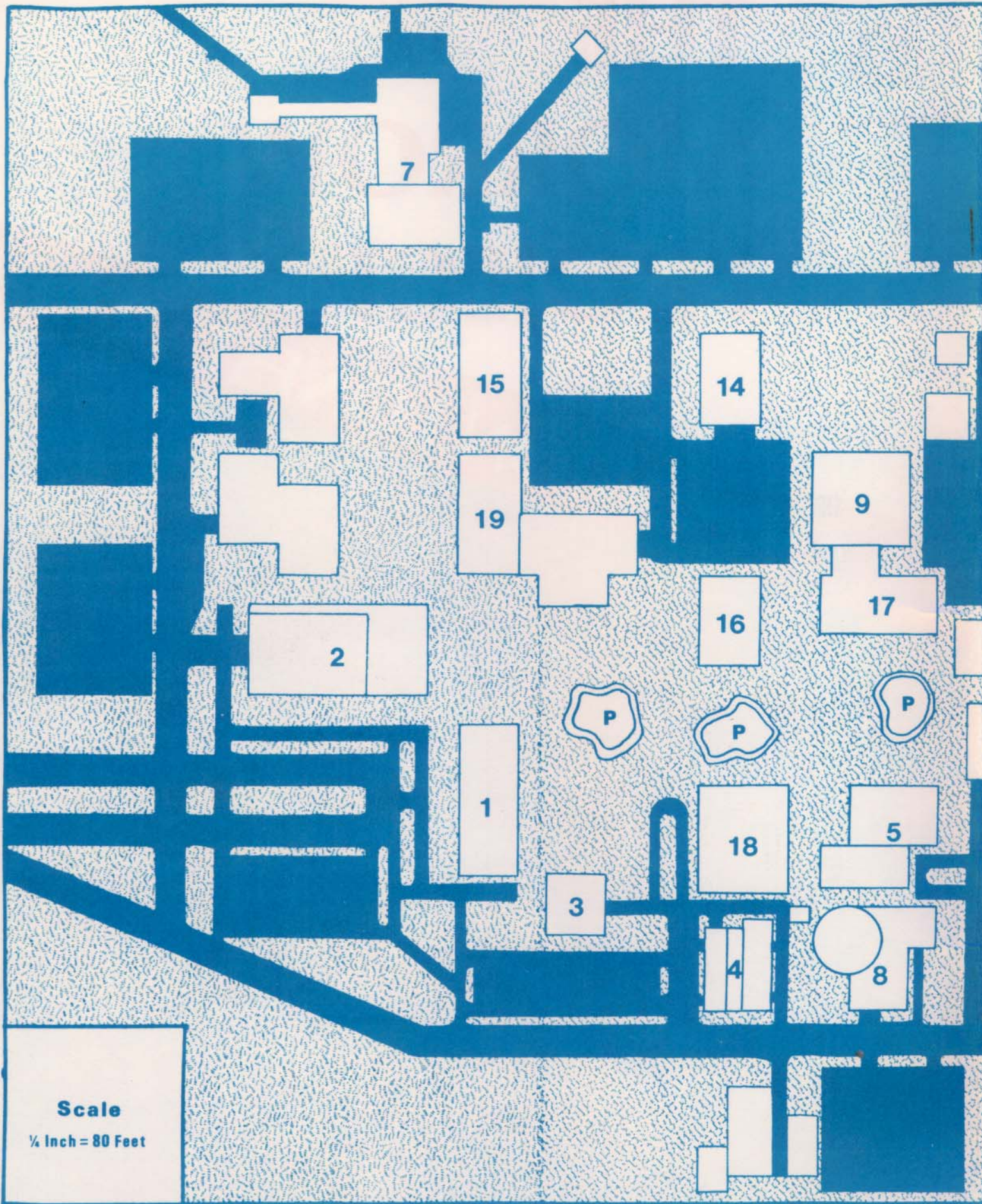

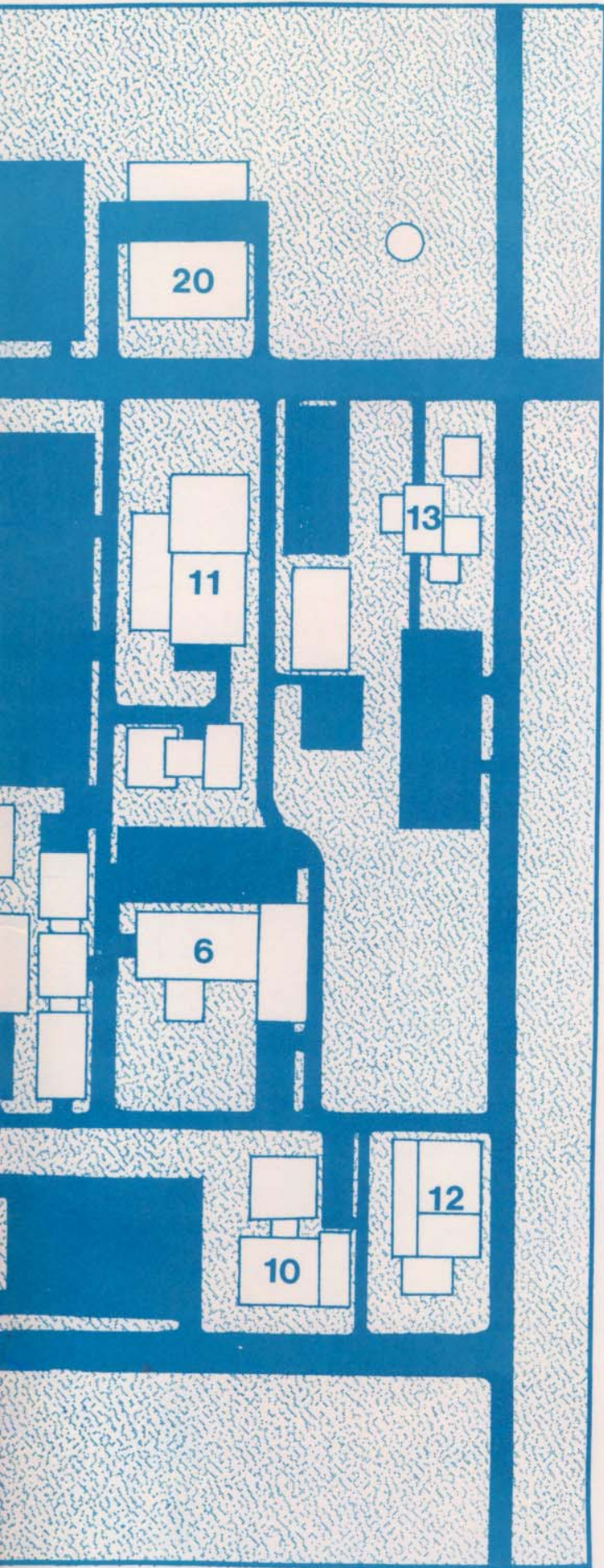

LBJ Space Center

- 1 Project Management Building
- 2 Auditorium and Visitors Center
- 3 Central Cafeteria
- 4 Mission Simulation and Training Facility
- 5 Crew Systems Laboratory
- 6 Space Shuttle Orbiter Mockup and Integration Laboratory
- 7 Anechoic Chamber Test Facility
- 8 Weightless Environment Test Facility
- 9 Mission Control Center
- 10 Lunar Sample Building
- 11 Space Environment Simulation Laboratory
- 12 Life Sciences Laboratory
- 13 Vibration and Acoustic Test Facility
- 14 Offices
- 15 "
- 16 "
- 17 "
- 18 "
- 19 "
- 20 Power and Air P Ponds

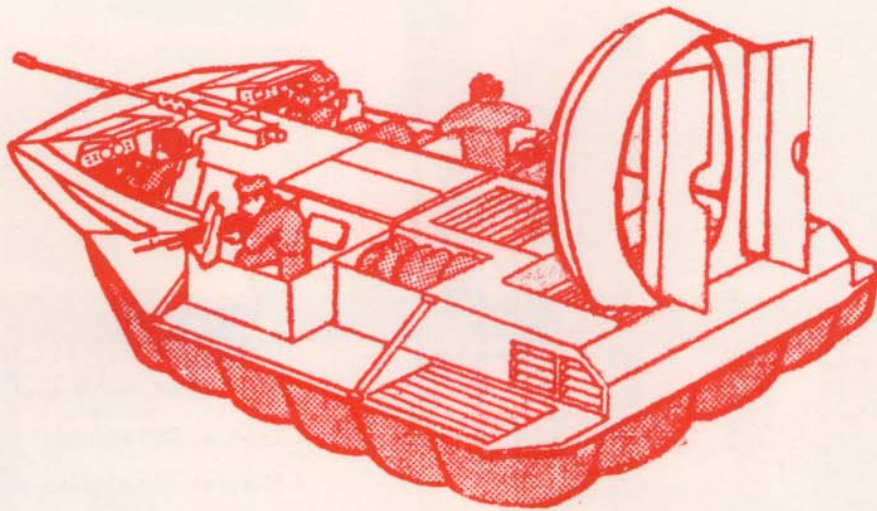

For those of you who have been wanting a **War...** The members of Combined MARS and Science Team 13 enter a world of storm and slaughter to try and accomplish an impossible mission. They find themselves in a desperate, last-ditch battle against merciless savages. Buffeted by a killer storm, in a land filled with refugees, they join the Last Cavalry Unit in the fight for survival.

This game package contains all of the information, maps and systems necessary for the Project Director to run this scenario. The package also includes information concerning new weapons, M1A1 Main Battle Tank, M2 Bradley APC, T-72 MBT, BMP APC, MARS and Science Air Cushion Vehicles, the mobile science lab and computer on board the new ACV, and more.

POSSESSION OF THE MORROW PROJECT GAME BOOK IS NECESSARY TO THE USE OF THIS GAME PACKAGE.



©Timeline Ltd. 1985

TIMELINE LTD