



TIMELINE LTD

THE MORROW PROJECT

THE STARNAMAN INCIDENT

A Complete Game Scenario
By C. STARNAMAN and H.N. VOSS

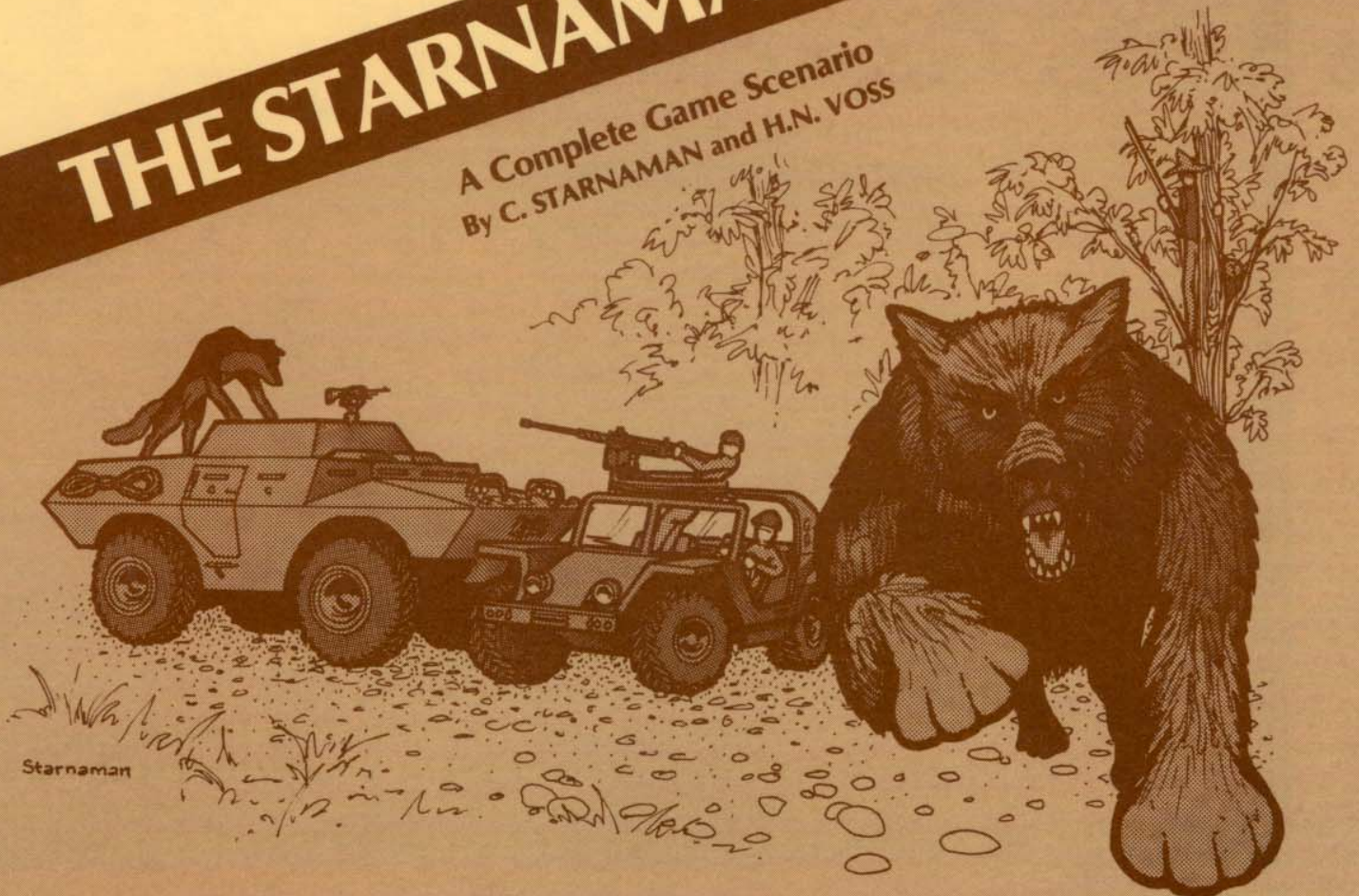

PRIOR POSSESSION OF THE MORROW PROJECT TM1-1
IS NECESSARY TO THE USE OF THIS MODULE.

PROJECT FILE
R-005

**THE
MORROW
PROJECT**

Project File 005

THE STARNAMAN INCIDENT

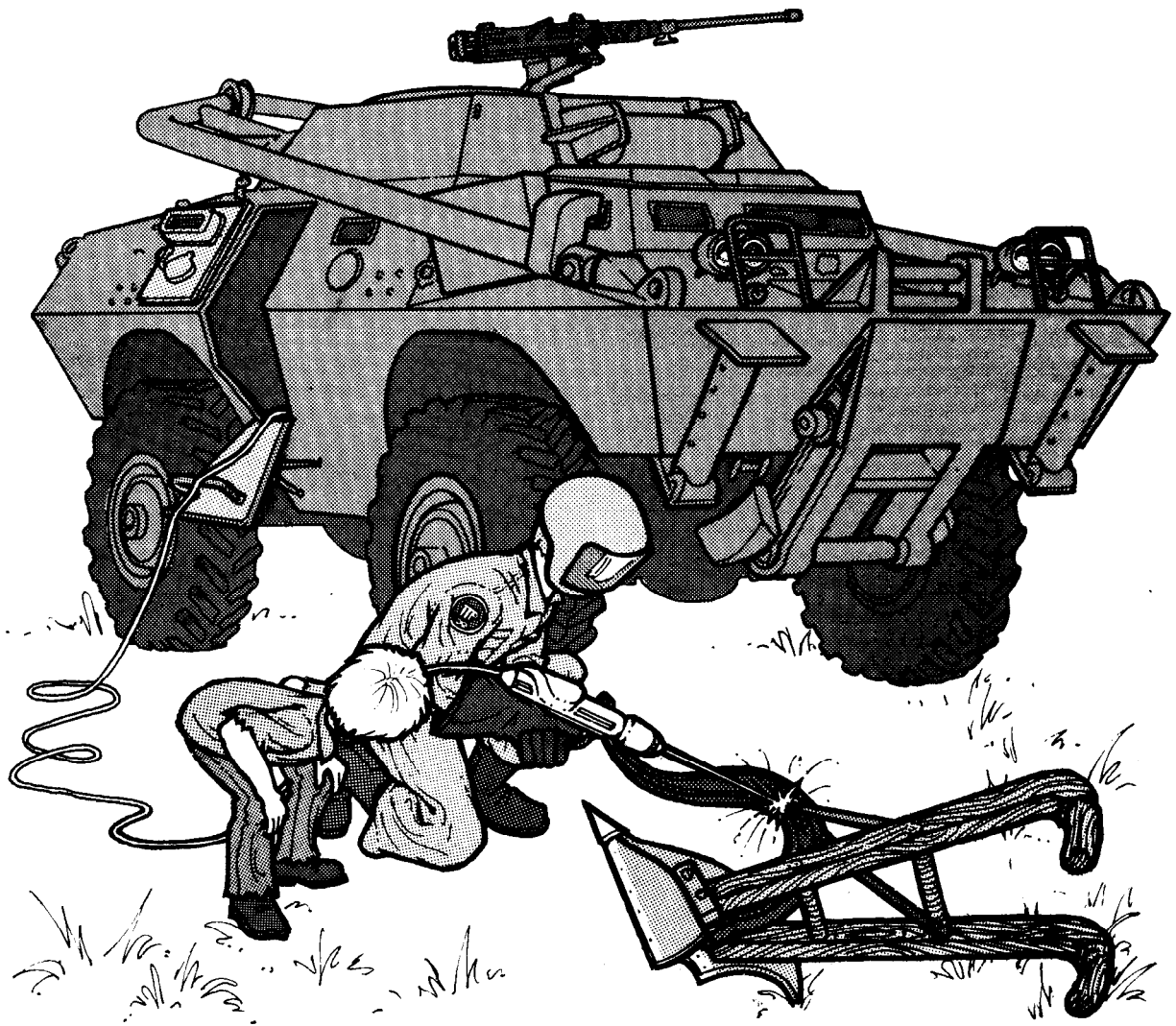

By
Illustrations

C. STARNAMAN and H.N. VOSS
C. STARNAMAN and H.N. VOSS

This document was composed and typeset on a Varityper Epics System using a Camp-Edit 5510 Phototypesetter with the kind permission and help of both the Deucalion Resources Group and Varityper.

INTRODUCTION

The War brought death and destruction to the people of the Mississippi River Valley. They were decent folk that suffered from nuclear hell, the end of their way of life, a flood of refugees, and war amid the ruins. That they survived and rebuilt a semblance of society is amazing. That they were and their descendants still are decent folks is nothing short of incredible.

The Starnaman Incident is about these people. They live in a world that is similar but not the same as ours. They live with dignity, grace, fear, hope, superstition and death. The Team must learn the subtle difference of this world or die. They must learn to be "good neighbors" or hunted enemies. Most of all, they must learn to live with the brawling lust for life required by the Morrow Project.

HANK ROOT

THE MISSISSIPPI RIVER VALLEY

I. SITUATION: PRE-WAR

The Mississippi has been the highway of the central United States since the Colonial Period. The intersection of the Mississippi and Ohio Rivers has been the site of an important settlement since settlers first moved into the Mississippi Valley.

Roads in the area generally followed the river and settlements became major centers of trade. Some of these settlements grew to cities such as St. Louis and Memphis with barge traffic passing up and down the River between them. Other, smaller settlements remained local centers of trade for the next two hundred years and were virtually untouched by modern life. Even the coming of the interstate highway did little to change these towns of less than a thousand people. There were bad times and there was The River to contend with in flood season, but there was also a sense of continuity and stability.

II. SITUATION: THE WAR

A Soviet SS-N-17 targeted on St. Louis dropped one of its MIRV warheads squarely in the Mississippi. Besides generating a glowing rain to the east, the blast sent a wall of water down the River destroying everything as far south as Chester. As the wave swept by it flooded areas usually above the high water mark of the River. The force of the waters finally diminished as it mixed with the waters of the Ohio but the last of its energy was spent along the Kentucky shore, raging through the sleepy rivertowns with destructive force.

III. SITUATION: POST-WAR

The nuclear tidal-wave did all of the damage to the area as no other missiles fell nearby. Bio weapons were targeted on the bigger population centers and, while the big wave killed many, once the surge had passed, the waters began to recede.

There was little or no water left to cause further difficulties as there so often is after a flood. But, the surge left an uneven trace of radiation behind as the water flowed back through the sluggish side-streams to the river. Today such areas are not lethal or even harmful unless one settles in a particularly contaminated area. The towns, which were on high ground, were less affected by accumulated radiation than by the force of the initial surge. Houses were swept off their foundations, sewers emptied into the streets and downed power line electrified the standing pools of water. The people in the towns died by the thousands in the first weeks after the initial attack.

The survivors had only begun to cope with the flood's damage when the first desperate bands of refugees entered the area. They were sick, starving or both and they were following the River south. Radiation victims were called "Sicklings" and most died

within a month or so. Those who came down the Ohio did not suffer as much from radiation as from fear, hunger and desperation. These people became known as "Starvings" and many died in the following months, often at the hands of other Starvings. They remained in the area until they died, or until they were accepted into the fortified hamlets. In the end, the people of the fortified communities were able to survive, and ultimately prosper.

150 years after the War, the Mississippi River is again the central highway of what was once the United States. The area is similar to what it might have been between 1760 and 1810. It is rough, but there is a patina of civilization.

Unlike the original colonial period, there is not much consciousness of "statehood". There is no manifest destiny, **no** yearning to press westward (though as the population increases, this may change). Instead, there is a feeling of fierce loyalty to family, friends and community.

Trade along the river is reasonably constant though still the province of small entrepreneurs and companies characterized by men of bravery, vision and (sometimes) extreme avarice. This trade varies from one man with a pack on his back, travelling on foot, to small trading companies operating barges and boats on the river.

The small trading communities are on the verge of developing into city-states or small regional powers. This competition has already led to some conflicts.

RECON TEAM H-9

I. GENERAL

Recon Team H-9 was frozen on **12** October **1984**. The members of the Team know they are part of a major operation consisting of a number of teams, but for security reasons they have not met these teams and do not know where the other teams were placed. They **do know** where their bolt-hole is but they are not familiar with the area.

The Team knows their mission is to help the locals in whatever way they can, link up with the other teams and make contact with Prime Base. They do not know the local terrain or people and have been told to make their way to a specific spot designated on their vehicle autonavs by a glowing red triangle. Naturally their maps are 158 years out of date.

II. TEAM PERSONNEL

The Delta teams have been trained separately, but the individual Team members have spent at least twelve months together in Morrow Project training in a large number of skills.

III. TEAM EQUIPMENT

Team equipment has been preserved in perfect working order by the bolt hole system. Team members are thoroughly familiar with their own equipment and are trained to some extent with the weapons and equipment of their teammates.

THE BOLT HOLE

This is the standard storage and freezing facility of the Morrow Project, mentioned in the gamebook. These are the same throughout the project and differ only in size. The size depends upon the number of personnel and the size of the vehicles, if any. See R-01 Riverton for the layout of a typical bolt hole.

Briefly, the "hole" consists of a buried room constructed of steel and reinforced concrete. It is designed to be air tight and reasonably blast proof, and is shielded from lethal radiation.

While the occupants are in stasis the hole is filled with an inert gas at slight overpressure. This has the dual function of keeping foreign gasses out and preserving the equipment inside the hole from the normal wear and tear of time; things do not rust in a Project bolt hole. Part of the hole's integral equipment is an "idiot box" computer. This computer is responsible for maintaining the gas pressure, monitoring the hibernating team and awakening them either upon receipt of the recall signal or in the event of an emergency. For the most part the idiot box just sits and waits.

When the "activate" signal is received, the computer evacuates the inert gas and fills the chamber with a pre-bottled atmosphere mixture. It then activates the "awake procedure" in the freeze tubes. When this procedure is complete the computer shuts down and cannot be reactivated. All team personnel are aware of these facts.

The hole itself contains the team's freeze tubes, a vehicle (if any) and a large table. It also includes the periscope package which consists of a periscope designed to view the immediate area above the hole, equipment to monitor the levels of radiation in the area and the presence of chemical or biological hazards. A radio antenna completes the periscope package. This equipment cannot be moved from the hole and the team knows it.

The hole has three exits; two for emergency use by the team and the primary exit for the team and vehicle. All are designed to be blast proof and difficult to detect by casual outside observation. The two emergency exits are cofferdammed with sand which must be removed before the exits can be used. One of the cabinets in the hole contains the tools necessary to do this. The primary exit is equipped with hydraulic rams to open the large door.

It should be noted that the bolt hole is not designed for habitation. There are no beds, no food other than the emergency supplies, no water source and no latrine arrangements. It is **designed** to be abandoned.

TEAM VEHICLES

Team H-9's vehicle is the V-150 81mm mortar carrier. It is intact, operational and stored in the Team's bolt hole. Morrow Project vehicles are fusion powered and require no external source of fuel, but they do require maintenance on a regular basis as does any piece of equipment (see TM1-1). This vehicle is equipped with the Morrow Project magnetic detection device described on page XX of the gamebook.

PD NOTE: We recommend H-9 be equipped with the V-150 mortar carrier as this unit will be of limited use to the Team and will thus help to keep them out of trouble by keeping their itchy fingers from their triggers. However, the PD may wish to substitute XR-311s.

PD NOTE: Teams entering this area from other places (such as Chicago or the UP) must be handled differently. They should arrive in the same sort of shape they were in following their most recent activities. Delta Base may well be a Godsend to them.

Such teams will, of course, have no caches in the local area, It is possible that the PD will allow that the team has some limited knowledge of a support facility somewhere in the area. Feel free to move and modify Delta to suit your campaign. If the Team is part of the Riverton-Chicago cycle, the PD may want to send the Team into the Delta area. We recommend a mission involving limited information provided by the C.O. of the Science Team on Isle Royale/Damocles. This might involve a rumor of a "command team" and/or a "base of some sort" in the Delta area. 'You're expendable, go thou forth and check it out!'

TEAM CACHES

Being so close to Delta Base, team H-9 was provided with only one cache. This cache is less than a kilometer from Starnaman. Should the Team make their way to this cache they will find it quite empty, open, and lying exposed to the elements. (It was found and plundered by the pseudo A-9 team ...)

IMMEDIATE ASSISTANCE KIT

- 2 medkits
- 12 Medkit Reloads
- 1 MI CBR Kit (Spare)
- 6 M1 Reloads
- 24 Coveralls, plastic disposable, decontamination with gloves, mask, and boot covers

The Morrow Project planners anticipated large numbers of refugees would be suffering from lingering as well as immediate physical ills. While H-9 is not a medical team, they have been equipped with the Immediate Assistance Kit containing additional medical supplies and CBR/Decontamination spares and equipment. They are not the Red Cross, but they can give some degree of immediate assistance to refugees they encounter. However, these ideas are 150 years too late.

THE AREA, TERRAIN AND ENVIRONMENT

Team H-9 receives the wake-up signal in late spring. Weather isn't a major factor in this scenario except in its overall effect on the area. The last three winters have been abnormally cold and harsh, which has driven packs of Mutant Wolves (see gamebook, pg. 61) down from their homes in the north. The cold has also had a disastrous effect on the locals and there have been more winter deaths, late and poor crops and reductions in trade and commerce. Unmelted snow farther north has brought a welcome relief from the usual spring floods, but The River level is dropping and this will soon hinder navigation on the Ohio.

With daily highs in the 50 \pm -60 \pm F. (10 \pm -15 \pm C) range, it is cooler than usual and the spring rains have not been as heavy. As a result there is less greenery than usual.

The terrain is flattest near The River, rising and becoming more contoured as it moves east toward the ridge containing Delta Base. The area is densely forested with small cleared areas for crops. The spring mud is gone and team vehicles will have no problems, though tangled undergrowth makes the local cart tracks appealing. With the snows passed, the Team could meet farmers, traders, teamsters or most likely, wolves.

MUTANT WOLVES

The harsh winter has driven packs of Mutant Wolves down from the north and they present the clearest danger to the locals and the team. The severe cold of the previous winters has reduced the average pack size to 4 or 5 and has left only the hardiest alive. Fewer of the packs contain cubs as the young often die in the deadly cold. Large, fast, powerful and most of all semi-intelligent, the Mutants have enjoyed good hunting and their attacks are no longer frenzied with hunger, but are instead cunning and deliberate. They understand about muzzleloading firearms and use the reload time to attack, usually circling and feinting until the weapon is fired and then making the actual attack. They hunt in coordinated pairs, working to confuse their prey. A pack may consist of up to three such pairs of hunters.

PD NOTE: You may choose either to create a number of packs for the area, keeping track of them and reducing the frequency of attack as they are wiped out, or you may count on the ready supply flooding down from the north and simply roll for them as a random encounter.

RANDOM WOLF PACKS

To determine the pack size and composition, roll 2D6 (1 for size, 1 for composition):

DIE NO.	OF ROLL	WOLVES	01	02	03-04	05	06
01	3	1M, 1F, 1C	1M, 1F, 1YM	1M, 1F, 1YM	1M, 2F, 1YF	2M, 1F	2M, 1F
02	4	1M, 1F, 1YF, 1C	1M, 1F, 1YF, 1YM	1M, 2F, 1YF	2M, 1F, 1YM	2M, 2F	2M, 2F
03-04	5	1M, 1F, 1C, 1YM	1M, 2F, 2YF	2M, 2F, 1YF	2M, 2F, 1YM	2M, 3F	2M, 3F
05-06	6	1M, 2F, 1C, 1YF	2M, 2F, 1YF, 1YM	2M, 3F, 1YF	3M, 2F, 1YF	3M, 3F	3M, 3F

WOLVES	Length	Weight	DX/ACC	ST/CON	SP/BP
M: Male, Adult	31/4m	250 Kg.	16	20	450
F: Female, Adult	3m	200 Kg.	15	18	400
YM: Male, Young	21/2m	150Kg.	12	16	350
YF: Female, Young	2m	100 Kg.	12	12	300
C: Cub	1m	50 Kg.	4	6	100

COMMENTS:

Mutant Wolves aren't simply big, mean neighborhood dogs. These are throwbacks to the Dire Wolf of the Ice Age, Man's enemy of the past. Each animal is nearly the size of a small bear and they are faster, nimbler and above all, smarter than wolves living today. They learn from experience and change their tactics to fit the situations, working in a group or in pairs. The jaws of a 50Kg modern dog can break bones (German Shepherds and Alsatians being good examples). The jaws of a 300Kg Mutant Wolf will sever an unprotected limb as quickly as a two ton press. While they are dexterous, agile creatures, they rely more on their sense of smell than eyesight and this reduces the effectiveness of their jaws somewhat as it often takes more than one attack to firmly seize their prey. It is not much of a liability. At close range, their attacks can come as close as two seconds apart, never more than four and all they usually need is one firm grip on their victim.

Wolves are able to run at different maximum speed according to terrain and obstacles as with all animals. For the purposes of the game, their speed from a standing start is as follows:

FOREST — 5 meters per second

TRAILS - 10 meters per second (Requires one second at 5m/sec)

OPEN GROUND — 15 meters per second (Requires one second at 10m/sec and one second at 5m/sec).

(NOTE: Cart tracks are considered trails and clearings, open ground)

The Mutant Wolves fear only firearms and then only until they have been discharged. They have no natural enemies in the area except man and they are intelligent enough to recognize this. They will always attack an individual and sometimes groups of two or three. They are not, however, killing machines. They are very family and community oriented and are often quite formal among themselves. The pack bonds are very strong and they will seldom abandon a wounded pack member and will fight suicidally to protect any cub which has survived the winter. Curiosity comes with intelligence and they have their share of both. They will often

shadow large groups across their entire hunting range with no hostile intent, simply interest. Opportunists, in such a case they would also be waiting for someone to become separated from the main group.

Mutant Wolves work well together and the moves of hunting partners become almost instinctual. Most hunting or attacking is done in pairs so the largest packs in the area will consist of three pairs of hunters. Different packs have developed different styles of attack and some pairs of hunters are more effective than others.

PD NOTE: Experiment with these wolves! If and when the Team camps for the night, people fetching water, or wandering off into the dark may be excellent targets for an attack.

In running a wolf attack the first and most important thing to remember is that it is a contact sport. A wolf traveling at high speed has only a second to use its jaws unless it can knock its prey to the ground and therefore it attacks with its mass as well as its jaws. Wolves will usually attack a limb rather than the prey's

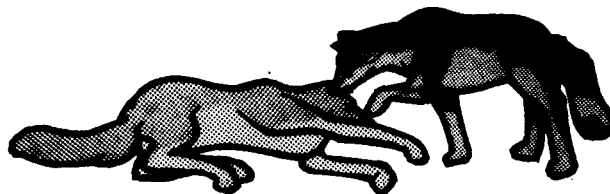

torso and attempt to drag their prey to the ground or toss it some distance.

The following chart is designed to reflect this method of attack.

WOLF ATTACK

Roll 1D100 for the wolf's target area and 1D6 for the result of the attack.

DIE ROLL	WOLF ATTACK TARGET AREA
01-05	Left Shoulder
05-10	Right Shoulder
11-15	Upper Torso
16-20	Lower Torso
21-30	Upper Left Arm
31-40	Upper Right Arm
41	Left Elbow
42	Right Elbow
43-48	Lower Left Arm
49-54	Lower Right Arm
55	Left Wrist
56	Right Wrist
57-58	Left Hand
59-60	Right Hand
61-68	Left Thigh
69-75	Right Thigh
76	Left Knee
77	Right Knee
78-81	Left Calf
82-86	Right Calf
87	Left Ankle
88	Right Ankle
89-90	Left Foot
91-92	Right Foot
93-98	Neck
99-00	Head

RESULT

DIE ROLL	EFFECT
01	Wolf misses completely, momentum carries it onward for 2 seconds
02	Wolf's jaws miss but victim is hit and knocked down, wolf continues onward.
03	Wolf's jaws catch victim's clothing, victim is down but unhurt
04-05	Wolf's jaws close on the victim. If coveralls are worn, the flesh will be crushed, otherwise causes major injury.
06	Skeletal members crushed and/or severe internal injuries; unprotected areas severed.

At the PD's discretion, if a 03-06 was rolled for the result of the wolf's attack, roll a D10 and consult the following table to determine what the wolf's follow-up will be.

DIE ROLL	WOLF'S RESPONSE
01	Confused by resistweave coverall, let's go and begins circling.
02	Wolf hangs on.
03-04	Wolf shakes victim, victim unable to react for 2 combat turns
05-07	Wolf throws victim, roll 1D6 for distance in meters and 1D8 for direction
08-10	Wolf attacks again, roll D100 and begin again.



Starnaman

THE PEOPLE OF THE LAND

Life in the western end of Kentucky has changed greatly in the 150 years that have passed. The communities of Wylie, Brackton and Oakton are gone because their reconstruction was impossible in the grim and chaotic times that followed the War. In their place a single town has sprung up. It is perhaps as large as the largest of its predecessors and it currently boasts about a thousand residents. It is the hub of the reawakening flow of trade in the area. Once called Starnaman's Hold it is now simply known as Starnaman.

STARNAMAN

I. ORIGINS

Starnaman began shortly after the Mississippi rolled over the towns of Wylie, Brackton and Oakton ending them as communities though many of their inhabitants survived. The Starnaman house was halfway between Wylie and Oakton on high ground nestled protectively in the face of a low butte and it had a good well. The survivors collected there and formed the first encampment.

They were refugees at first bent on survival and only later building structures and fighting off marauders who raided them for weapons, food and medicine. Building materials were brought from Wylie in armed convoys as long as the gasoline lasted. A low stone wall was begun around the camp and was added to constantly. The wall grew taller than a man and more than a meter in thickness. It became the symbol of the town and while it protected them against lesser dangers it couldn't stop the worst.

II. HISTORY

Four decades after the War, the chaos finally began to subside. New generations began to outgrow the wall around Starnaman's Hold as the town had come to be called. A temporary palisade helped protect the overflow but a new wall was inevitable. Starnaman's Hold was wealthy by local standards and this drew raiders and scavengers. As the new wall rose, a new round of raids signalled a second bloody period in the town's history. The wall took two decades more to finish and the gate towers took another ten years to complete.

The families which were crowded inside the old wall moved their shops into the new area, where the wealthiest got the best and largest spots.

III. STARNAMAN TODAY

The following sections describe different parts of the modern town of Starnaman. Map 1 is an overview of the town with each of the sections described below labeled appropriately.

OLD TOWN

Old Town, the area enclosed by the old wall, became the home of the gentry when the people moved and the old shops became houses. There are less than twenty families living within Old Town but they control most of the trade and power within the town. Strangers must be escorted by an Old Town resident or employee to move within the Old Town wall. Lodged against the cliff in Old Town is the Guild Hall, a two story stone building first used as the communal fortress, then a storehouse and now as the meeting place of the leaders of Starnaman's guilds.

NEW TOWN

New Town consists primarily of shops, many of which are owned by families living in Old Town. An almost equal number are family shops with the craftsmen and their families living above or in back of the workshop. New Town is the hub of commerce and industry and is inhabited by a growing middle class. Traders are allowed to enter the town only during daylight hours unless they

are guided by a local citizen. The area is primarily divided between the smithys in one section, weavers on the opposite side of the gate, and the potters in the center of the town. The remaining sections are taken up by the smaller guilds. Almost directly between the Old Town and New Town gates is a stone and mortar pedestal supporting a rusted V-150 hull that has been stripped of everything which could be removed. It is a symbol of the town's will to resist and survive against impossible odds.

TRADE CAMP

Trading meant letting strangers into the town walls and when this led to trouble, the merchants built Trade Camp, a palisaded compound outside the main gate. It has been operated by the Yates family for almost fifty years and is currently an independent enclave under Taylor Yates. It consists of a "Boarding Tavern" where traders can rent a room, stables, a display area for their goods and a place where they can meet with representatives of each of the guilds of Starnaman.

INSIDE THE FENCE

As the smithys and shops expanded and their staffs grew, the new wall was again outgrown and a new palisade has grown outside New Town near the well. A tower gate pierces the wall there and has become known as Journeyman's Gate because the area against the bluff is home to the families of clerks and journeymen of New Town. It has not acquired a name and is simply known as "Inside the Fence."

LOW TOWN

The inevitable slum grew against the palisade of Trade Camp along the short weaving wall connecting the Camp and the bluff. It is called Low Town and anybody or anything can be had there.

THE LANDING

About 2km. west of the tower on the south side of a smallish peninsula lies the landing. This is an area devoted wholly to the river trade. It is a place for boats to land near the town and it is sheltered from the current of the river. There are several longish jettys there along with boat sheds for the winter and small warehouses for perishable goods just arrived or ready to be shipped out. The area is surrounded by a wooden palisade but no one lives there.

There is considerable activity here year round during the daylight hours. There is usually at least one boat being built or repaired, cargo being handled, ropes and lines being braided and traffic coming and going along the river. Some boat crews spend the night on board their crafts though most prefer Trade Camp. The palisade is lightly guarded at night by a group of dock employees.

IV. GUILDS

The guilds in Starnaman grew from manufacturing and crafts in order to regulate trade. The Guild Council found that to do this effectively they needed to control the town itself. The system of guilds has worked well for almost fifty years and the guilds have become the center of town social life as well. As a result each guild has its own tavern in the guild hall. Decisions are often made over a beer in the tavern with the consensus of the guild members present being noted by the guildmaster and passed on by him or her to the Council.

The council is made up of the master of each guild, usually the most powerful member, who speaks for the whole guild. In addition, any master craftsman (foreman and independent shop owners) may come to any guild meeting or Council session to listen or speak on behalf of him or herself, their apprentices or workers, or their families.

The table below shows the number of master craftsmen along with the leading Old Town people in each guild. This provides the PD with a handy list of people at a guild meeting or a Council session as well as showing the overwhelming control that the inhabitants of Old Town have in the governing of Starnaman.

GUILD	NUMBER OF MEMBERS	PROMINENT MEMBERS
Blacksmiths	5	Forbes, D; Yarboro, OD; Overman, T
Gunsmiths	4	Barlow, TJ; Hackley (Forbes Mgr.)
Potters	5	Upton, J; Hobbs, RC
Weavers	5	Dobler, H; Tockman, LW; Bowes, W
Gold/Silversmiths	2	Donnelly, G; Tenklae, D
Woodworkers	3	Pickman, E
Warehousemen	3	O'Neil, D; Forbes, O
Cobblers	2	
Wheelwright	1	
Hostlers	4	

Note that the guildmasters are always listed first in the list of people who are members of the guilds.

Currently the Guild Council is wrestling with a number of problems that have no easy solution. These can provide the Team with an obvious set of tasks if they decide to pitch in and help the folks of Starnaman. They can also drag the Team into a series of political struggles that they don't want to have anything to do with. In any event a Council session is always a lively affair with many opportunities for role-playing.

PD NOTE: This list is not final! Other matters may appear during the play of the game. The PD should feel free to add or delete items from this list. These problems are here to keep the Team from thinking they've wandered into a muleloading Utopia.

GUILD COUNCIL PROBLEMS

Sickness

The most common threat to life in Starnaman, sickness and injury are often fatal. Medicine is rudimentary at best, sanitation is non-existent and the population is crowded into the town walls where disease spreads quickly from family to family.

Water

Water, or the lack of it, is a major problem in Starnaman. Old Town has one well and there is another in New Town but there is no source of fresh water Inside the Fence, in Trader Camp or in Low Town. This also affects the incidence of sickness and increases the problems in fighting fires.

Fire

With wooden buildings, wooden shingles and several smithys in town, fire is a constant danger. A shortage of water makes this a constant concern.

Security

The last major raid on Starnaman was soundly beaten two years ago but rumors have come upstream from Memphis Village of a raid being planned for the fall after the harvest. Memphis Village is usually a town of traders rather than raiders but the wealth of Starnaman's guilds has interested many people in Memphis Village. This could be a dangerous situation as it is rumored that Memphis Village has three smoothbore cannon which could breach Starnaman's town wall.

Food

Because most of Starnaman's food is bartered from the local farmers for trade goods, the town food supply is tied to the amount of surplus among local farm families. In the past few years the crops have not been good and food stores from previous years have begun to run low.

Shelter

The harsh winters have killed many people inside the Fence and in Low Town, usually because of inadequate shelter and heat.

Fear

The Guild Council is paralyzed by the fear of losing control of the town and because they depend on their position to keep their grip on the town. Because of this, they dare not look outside for help and they see threats in every complaint brought before the Council.

Rivalries

Rivalries are tearing some of the guilds apart (in particular the potters and woodworker guilds) and this is keeping the Council from making decisions about such things as taxation, shelter and questions of trade with Memphis Village.

Taxation

The Council is faced with universal resistance to taxation and has no funds with which to actually *do* anything. Trade Camp is exempt from taxes by treaty and the guilds can't agree on how to tax themselves.

Wolves

Packs of Mutant Wolves have invaded the area and the locals have never seen a wolf as big or as smart as these are. Many people are afraid to use the forest trails and this has hurt business and food production in and around Starnaman.

PEOPLE OF STARNAMAN

CUSTOMS

There are a number of things that the people of Starnaman do or don't do. Some of these are based on good common sense, some on habit and some on superstition or legend. In any event, the following is a list of customs that, in general, all the people in and around Starnaman will observe.

Drinking

This is the commonest sport in Starnaman. It is usually done with anyone handy and confers no special bond. Friendship isn't necessary; only thirst. The locals often use drinking time to assess a newcomer. If the Team sits down to a drinking and thinking match with the locals, remember that the locals are used to it and to the stuff that passes for whiskey locally. The Team members on the other hand did not have much of a chance to drink during training so that will get drunk faster.

There are two kinds of whiskey found in Starnaman: Sippin' whiskey and Trade whiskey. Sippin' whiskey is smoother, mellow and generally saved for special occasions like celebrating successful 'coon hunts or the birth of a new child in a family. Trade whiskey is strong, raw "corn squeezin's" that is the day-to-day aqua vitae of the folks of Starnaman.

The effect of drinking on the Team members is a temporary reduction in motor skills (including Dex, Agility, weapon skills and movement speed), Intelligence, Charisma and Tech skills (especially driving an MPV). Each shot of Sippin' whiskey reduces a character's skill by 5% per shot while Trade whiskey reduces skills by 10% per shot. Tavern whiskey (a watered down version of Trade whiskey) reduces skills by 7% per shot. The effects of drinking will be felt for three hours from the time of drinking. Anyone reaching 0% or less in a motor skill will pass out for at least 10 hours.

Most of the drinking in Starnaman is social rather than heavy during the early hours of the evening. Later on, serious drinking, decision making and wheeling and dealing are done.



Speech

The way something is said in Starnaman can often have more importance than what is said. The locals say exactly what they mean, mean what they say and expect other people to do the same. Lying is considered as bad as theft and an outright lie is punishable by public flogging. It is however a local art to tell the exact truth and leave a false impression.

Slighting or questioning another person's worth, word or honor is usually grounds for drawn blades and occasionally grounds for starting a feud. No one makes casual or careless remarks about someone else let alone insulting them unless they mean to fight.

Bragging is considered bad form and a person suspected of it is usually called on to prove their claims. Usually this involves careful consideration and a lot of betting. However, "Tain't brag if you can do it." Players are advised to remember that "talk is cheap, whiskey costs money".

Justice

Starnaman justice is an informal affair in most cases. Persons accused of murder or willful injury to a person will get a Council hearing and if, proved guilty, severe punishment. Flogging and execution are most usual since there is no real prison in Starnaman and since most people believe that punishment should be handed out directly and immediately.

Rape or arson will bring every able-bodied individual running and "Frontier Justice" is usually meted out on the spot.

Theft or "Slightings", when important enough for a Council hearing usually result in the guilty party being indentured to the victim to work off the punishment.

While there is little crime in Starnaman proper, Low Town is another matter. Justice there is what you make for yourself and the City Council will seldom grant a hearing about such crimes unless they involve the safety of the town as a whole or if the crime involved a child. In these cases punishment of those found guilty will usually involve execution.

Prohibitions

There are several habits or customs that are generally avoided by the people of Starnaman. Some of these are listed below.

1. Eating fish of any sort is prohibited though fish may be used by farmers for fertilizer.
2. Stealing a knife is considered bad luck. The crime of theft is one thing, but the crime of stealing a weapon is much more serious. The origin of this belief may lie in the fact that most people can readily identify their own weapons, so if the culprit is caught the "bad luck" of a flogging or indentured servitude may result..
3. Swimming is discouraged. (Perhaps because a drowning man may cause further loss of life when rescue attempts fail.)
4. Pointing out an obvious pregnancy is considered bad form and very embarrassing. If the woman loses the baby the community pretends she was never pregnant while the person who commented on her pregnancy is shunned.
5. Discharging firearms indoors is frowned on. Knives are considered acceptable for social disputes.
6. Breaking glass of any sort is said to cause seven years bad luck.
7. Spilling gunpowder is thought to precede an injury and, in a muzzle loading technology, it very often does.
8. Wearing one-piece clothing or cloth hats is strictly forbidden, and would at the very least provoke a fight.

Dress

In general the people of Starnaman wear two-piece clothing. The women never wear dresses. Instead they wear **loose** blouses, calf-length skirts, leather boots and belts and often carry a small knife. Hats or bonnets are sometimes worn and are usually made of lace, straw, thin leather or fur depending upon the season and the occasion.

The men of Starnaman usually wear a pullover shirt, often with a collar, trousers, leather boots and hats and always at least one knife on their belt. Many men wear two knives in a rig peculiar to Starnaman consisting of a side-by-side **pair of sheaths** and matched knives. A vest is worn in all but **the hottest weather**.

Children generally wear shirt and trousers until the age of ten when girls begin wearing **skirts**. **In the summer the children go barefoot** and in the winter they wear boots or **thick moccasins**.

Wool is scarce but cotton from downstream is plentiful and thus most of the clothes are made from it. In the winter, leather and furs are more common.

Families are the future of Starnaman and the people are very aware of this. Women are respected, but mothers are revered and the network of mothers exerts a very strong influence over the town. The children are the town's link to the future and are looked after by everyone. Any serious harm **done to a child is a hanging offense**. The way a stranger treats a child often has more to do with whether or not they are accepted by the locals than might be expected.

Coon Hunting

A further note should be added on a favorite pastime in the Starnaman community: 'coon huntin'. This is the practice of hunting raccoons for sport, for meat and for joy.

The raccoon is a wiley animal. A nocturnal mammal, it is renowned for **its fur, its flavor** in a stew and its seemingly human cunning. The adult raccoon can measure up to three feet in length, including the tail, and can weigh up to 50 pounds although most are smaller. They have small, sharp teeth, long claws which enable them to climb quickly and surely, a keen sense of smell and good night vision.

They can and will eat most anything, including meat, although they exhibit a fondness for raiding human stores whenever possible. They can burrow and swim, and while they cannot fly, their ability to jump from tree to tree is the next best thing.

Hunting such an animal doesn't require much. Hunting one successfully is another matter. A 'coon gets smarter as it gets older and so should a 'coon hunter.

Proper technique calls for a moonlit night, starting about 10 or 11 and continuing until either the 'coon is "treed" or dawn breaks. One man sets out with one or two dogs. The dogs cast about for scent and begin baying when they find it. In this way, **the dogs** begin the hunt and the man follows.

The hunt can mean a very long chase. A 'coon is fast and smart. It will use water, take to trees, double back and **cover many miles before light**. It will **choose** terrain likely to daunt pursuers. Anyone who wants to hunt 'coons should be in **good shape** and possessed of **uncommon stamina**. He should rest up the day before and **plan on doing nothing the following day** since the night of the hunt will be a long one.

'Coon dogs should be mentioned since they are a rare breed. Any dog can be a 'coon dog. The best seem to be of mongrel descent with nothing to recommend them save that they are disciplined, smart, loyal and aggressive. It takes time to train a 'coon dog because no two 'coons are the same. What works with one probably won't work with another. The dog must gather experience

and this is not easy. A cornered 'coon is dangerous but even a chased 'coon is not happy. 'Coons have lured dogs into folly, drowning, crippling or killing them. A 'coon, especially an old one, is mentally and physically more than a match for even the best dog. The dog must learn not to close, not to be trapped, not to be lured into water and not to be drawn too far from the human hunter. Some learn, others die.

Dogs are usually paired, one young and one old. An accomplished 'coon dog is worth a lot; as much as a Barlow rifle or more. This is solely because of his hunting skill since you can't breed a 'coon dog; they must learn from the ground up.

The old 'coon hunters are also they best. Again it is a matter of experience. They may not leap as high or run as fast as a younger man, but they rarely have to. They still keep going all night and have been routinely known to leave younger hunters far behind.

Recently the wolves have changed things. It may not be stated openly but the wolves are hated most for ruining the 'coon hunting. It is no longer safe to go out 'coon hunting, particularly not alone. Several dogs have already been taken and one or two hunters. Men still go out, but now in groups of three or four and it just ain't right. It's no longer possible for a man to take his boy out, one on one, and learn him proper.

PD NOTE: 'Coon hunting can be used as a way for the Team to "meet" locals; with dogs and men bursting through the camp in the middle of the night. If team members become friendly with the locals, they may be invited on a hunt, but they are likely be run into the ground. Their high tech goodies will be frowned on. A man goes after a coon with his wits, not with gadgets. The hunt is the thing. A sharp team can tell if they're on good terms with the locals if they are invited out on a second hunt.



TOWNSPEOPLE

DEWEY FORBES

Master Forbes, as he insists on being addressed, is the guildmaster of the blacksmiths, the most powerful of the guilds and he is the single most powerful individual in the city. His position is buttressed by ownership of the largest smithy. The recent acquisition of the largest gunsmithy (under questionable circumstances) has added to his importance. Several of the blacksmiths and the rest of the gunsmith's guild act as a counterweight by ritually opposing his every move. His manager in the gunsmithy, Orin Hackley, has done nothing to add to Master Forbes's image, but has done wonders for his purse.

At 52, Master Forbes is a bull gone to fat, but he is still imposing. He considers himself a canny businessman; he will do exactly as he promises but anything more or less is fair game. He is proud of his power and holds court from a reserved table at the Smithy's Hammer Tavern each night.

O. DAVIS YARBORO

Master Yarboro, as he is commonly called, is head of the other major smithy in Starnaman and Forbes's most bitter enemy. His smithy is located at the other end of the row from Forbes's. At 32, Davis is head of the growing Yarboro clan and master of the Yarboro Smithy. His wife Betty handles the business end while he tends to the craft.

He can also be found at the Smithy's Hammer (all taverns are considered neutral ground though they see their share of fights) which is just outside his door. While Forbes is noted for the lowest price and quality, the Yarboros are known for the best. When ordering their muskets, discriminating shooters often specify Yarboro metal for the barrel believing it to be less prone to warpage or explosion.

BETTY YARBORO (NEE FORBES)

Daughter of Master Forbes, Betty married O. Davis Yarboro, her father's worst enemy. Prudently, neither family came to the wedding. Still, shots were fired. The Yarboros have come to accept her while her father has publicly disowned her. Since she was a child, he had planned that she would marry Orin Hackley's son Jimmy. Her marriage to O. Davis ruined his plans and enraged her father.

Betty is fiercely loyal to "O.D." (which she pronounces "Odie"). She is nineteen and is pregnant with their first child. She grew up in Old Town and is known by the more influential folk to be a good match for the respected O. Davis Yarboro. The smart money is betting that Dewey won't be able to deny his grandchild as he has his daughter.

OLIVIA FORBES

Libby Forbes is Betty's fourteen year old sister. She has been forbidden to see Betty but she defiantly visits her anyway. Like her older sister she is a small wispy blonde.

Her main interest at the moment is her horse, a bay colt which she exercises outside the town walls when she can find a musket-toting adult to accompany her. She will never be found in the woods, but could be encountered anywhere in the area from the edge of the woods to the city walls, always with an adult or two as guards.

T.J. BARLOW

"Whiskey Joe" Barlow speaks for the three smaller gunsmiths of the Guild. He is the master of his own smithy which he inherited when his father was killed in the battle for Journeyman's Gate during the raid of two years ago. Sober he is the finest gunsmith for 100 km. but when he isn't working he's usually roaring drunk and chasing women. 22 years old, handsome and persuasive, he often catches them. Several are setting matrimonial snares for him.

T.J. Barlow is justly famed for his renditions of the family design, a .50 caliber rifle, as well as his line of .80 muskets and smaller .60 smoothbores. His rifles fetch the top price locally and are renowned for their uncanny accuracy. Recently, paper caps of fulminate of mercury (percussion caps), have started arriving from Memphis Village and Whiskey Joe has begun to offer his weapons with either the traditional flintlock or the new system. The local shooters can see the advantage in not having to strike a spark to a pan of open gunpowder but they are afraid to become dependent on the supply lines from Memphis Village. Still the idea is catching on slowly and because of the money he makes selling them, T.J. Barlow is pushing the new weapons with each sale.

HANNAH DOBLER

"Miz Hannah" is the head of the Weaver's Guild and matriarch of the Dobler clan. She just turned 68 and is no longer active in the family business, yet she seems to know everything that happens. She devotes most of her time to managing the Guild and as a result has complete control over it. She loves intrigue for its own sake and is widely known for her tightfist with money. The only exception is her grandchildren, who are in their twenties, with whom she is moderately indulgent. Hannah is superstitious and often makes bad business decisions based on "signs". She is exceedingly conservative in thought and action and she is as stubborn as a fence post. If the Team will have to be alert for hidden motives and double meanings when dealing with her.

JOHN UPTON

John Upton is the 32 year old head of the Potter's Guild. He is grappling unsuccessfully with the problems of a warring guild. Factions are fighting over everything from the rights to certain clay beds to the copying of designs. While he tries hard to deal with these problems, there seems to be no way to end the strife.

Part of the problem is that his temperament is not suited to either the craft or the guild management. John would be happier in the woods with a musket across his saddle than in the craft shop but he feels it is his duty to carry on his family's tradition.

He is a friendly loner that everyone knows and likes but he has no close friends in Starnaman. He is a maverick in the Guild Council; one time siding with Forbes or Dobler, the next with Whiskey Joe or Master Yarboro against them. He is related to Hannah Dobler but neither of them admits it.

EVERET PICKMAN

Everet Pickman is to shaping gunstocks what Stradivarius was to violins. He eyes and measures the prospective shooter, checking everything from length of arm to length of reflexes before starting on his work. He has created stocks for everything carried in Starnaman from working muskets to inlaid horse pistols which may never be fired. He is best known for his collaborations on rifles with T.J. Barlow, often, like the pistols, never to be fired. His reputation was made by the handful of marksmen who have carried off every local competition for years and fed their families with the Barlow-Pickman Rifle.

While Everet Pickman is an artist in wood, he is a poor excuse

for a human being. He has the ability to offend almost everyone with whom he does business and it is said that if he were only a little less talented, he would starve. People deal with Everet Pickman because they want the best and in spite of his personality.

His insults are often overlooked because every boy in Starnaman learned to whittle from Everet. There is always a small knot of youngsters clogging the doorway to his shop and, though he keeps them out of the shop itself, he always seems to find time in a busy day to spend some time sitting out on the stoop with them. Along with whittling, the kids often pick up an adult vocabulary though this is inevitable in a town such as Starnaman. Ladies never deal with Everet if they can avoid it.

HARRISON WILSON

Harrison Wilson likes to be called "Mister Sheriff" by the gentry of Old Town. Having been chosen Sheriff by the Guild Council and being the social climber he is, he attends all the right functions. He is generally thought of as a pleasant person but it is common knowledge that he can be bought. His tenure has been characterized by making as much money and as few waves as possible.

When dealing with Low Towners he has occasionally shown a slight cruel streak but never with "respectable folks". A majority of the work is done by his senior deputies while Sheriff Wilson strolls the better parts of town and stops for a drink in the taverns to "find out how things are going" and to enjoy a free whiskey or two.

CECIL HARBOLD

Cecil the Snake is the kingpin of what organization there is to crime in Low Town. He is the main dealer in Trade Whiskey which he produces and controls in a jealous monopoly. His profits from the liquor have made him the most powerful figure in Low Town and his methods have made him the most hated. He takes offense easily because getting mad and getting even are his hobbies. He regularly cheats the Traders for they have to deal with him to get their Trade Whiskey, a staple commodity in the area.

Tall, thin, age 44, he operates from his tavern, the Palace (known locally as The Snake Pit). His production still is kept in a large stone warehouse under constant guard, as it is the basis for his power. Fabulous stories are told of the "other" contents of the warehouse, but most of them are street fiction. The Snake Pit itself is at the far end of Low Town - literally as low as you can get. So, say the locals, is Cecil.

RED TOBIN (no other name known)

Red Tobin grew up on the Big River and freight barging is in his blood. So is a good portion of the Tavern Whiskey wherever **he ties up. The numerous trips he's made up and down the river combine with the booze to make him the foremost local source of bad information. He claims to have been everywhere but not in front of anyone who has been much beyond the town gate.**

His information is always erroneous as Red Tobin would rather lie if he thinks he can get away with it. If there were laws on the River, his existence would violate most of them. He can no longer land at Memphis Village and he passes quickly through several stretches of the lower Ohio River. Hamhand will no longer let him into Trader Camp and so he can be found at the Snake Pit whenever his boat, the Mudcat, is at the docks.

It has been rumored, but never proven, that Red Tobin killed a group of passengers for their gold near Memphis Village. He has been implicated in several unprovable cases of river piracy. He is **often found with one or two of his crew of four ragged riverboatmen and he is seldom seen during daylight (at least not**

around the Low Town area).

THE GARRISON BROTHERS

The four Garrison Brothers, ranging from 16 to 24, haunt the trader trails hoping to overpower lone travelers. They are small-time thieves but the influx of the Mutant Wolves has scared them enough that they have moved into Low Town and signed on with Cecil the Snake. They are just getting settled in but the Deputies on the gate are already watching them and Hamhand, knowing their reputation, refuses them entry to Trader Camp. They are belligerent, and since they are trying to establish a reputation of being tough and experienced they are being more than usually brutal.

Several of the more experienced Low Towners have suggested that Cecil is probably getting them ready for a "one-way" mission, involving a freight wagon, as he has done this sort of thing before. The Garrisons still have not figured out why Cecil won't give them credit against their wages...

TAYLOR YATES

Hamhand, as he is called by Traders, is a pleasantly ominous figure. He runs the trader camp enclave with smiling authority. He is honest and demands his employees to be so too but he reserves the right to cheat anyone who cheats him. A wrestler of some renown in his youth, he has lost none of his quickness or strength.

Hamhand is legendary both as a source of information and as a way of sending messages. He is utterly trustworthy with a message and he eventually sees everybody who lives on or near the River. Hamhand's Trader Camp enclave is outside the direct power of the Guild Council but he is wise enough not to go head-on against them. He is fiercely independent and proud of his special status and he often expresses his dissatisfaction with the way the Guild Council runs things.

Listening to Hamhand's opinions, rather than what he declares to be fact could lead the Team to some wrong conclusions about the guilds, the Council, and Starnaman in general and could lead the Team off crusading against them rather than trying to work with them. On the other hand, he is honest and he's a great ally in a tavern brawl (though it better not be in his tavern!)

JEAN BARNES

Jean heads the day shift at the Trader Camp Tavern, tending bar, waiting on tables and occasionally giving first aid. She is eighteen, overweight and has a crush on the Head of Deputies at the main gate. He has so far been able to parry her advances gallantly. She has taken to wearing a bag of special herbs to attract him. It has had no effect and is starting to smell bad. She lives at home with her parents Inside the Fence.

She is naturally fearful and covers it with a perpetual grin which leaves her looking like the Village Idiot. She's not. She can read reasonably well, print and do simple mathematics. She is slightly above average in intelligence and is always searching for something new. She is loyal to Hamhand because she has no one else to be loyal to. It must be said in her favor that she is not looking beyond her present job and expects to remain loyal as long as she takes his pay.

TRAVIS BAKER

Travis heads the night shift at the Trader Camp Tavern. He does much the same thing as Jean but in addition helps Jimmy the stableboy hoist drunken Traders into bed, boots and all. Unlike Jean, he lives in the Tavern in a back room. He is on call day and night but it must be a dire emergency before anyone will

wake him during the day. He is mean if he is woken during the day.

At 20 Travis is rangy and stronger than he looks. He usually needs a bath, seldom shaves and can neither read nor write but is adnormally good at what he calls "sums". He is a good judge of character and has Hamhand's complete trust. He has recently apprenticed his brother to Titus the Wheelwright hoping he will learn a trade. He has no other surviving relatives and is happy to be where he is.

VISITORS TO STARNAMAN

The folks described below are not citizens of Starnaman but are often found in or near the town. They are a part of the society in which the Team finds themselves and they are typical of the range of people to be found in the area. The list includes many traders and other individuals who generally go it on their own as farmers, teamsters, and riverboat men whom the Team may meet on the trail or in any number of taverns.

DOGWOOD POPE

Dogwood brings gunpowder down the Ohio River to trade for cloth, muskets and whiskey. He is an imposing figure as he stands over two meters tall and is mostly covered in poorly tanned skins.

Unlike the locals he is a talker. Pope will share his information with the Team if they give him a chance but Dogwood is a slow talker. He is a source of good information, which is even rarer than a talker, but he relishes the details of a story and will drown a willing listener in unwanted information.

He travels an unknown but regular route and he brings so much gunpowder with him that it is suspected that he has found an area where blackpowder production is a cottage industry. The average grade of the powder he trades is well below that of the powder brought from the bigger settlements to the south. But there is always a market for powder and because of his prices Dogwood seldom lacks customers.

THE BILLERS

The Biller family moves over a regular route trading pottery, jugs and small hardware from Starnaman in return for furs, beadwork and Sippin' Whiskey. The family consists of two brothers, Orin and John, their four sons, Orin's wife Anne and their orphaned niece Helen (known as "Hellion" on the Trade Trail). With a cart and a pair of draft horses they haul the goods with at least three outriders at all times. John's wife Susan and their youngest child were killed eight months ago when the little caravan was ambushed by an unknown group.

BEEBO TEAGUE

Beebo Teague regularly comes upriver from the comparative metropolis of Memphis Village to pick up "specialty items" from Starnaman. Some of these are obtained at night from the likes of Cecil Harbold and others are purchased in the taverns of New Town. He brings finely milled gunpowder, intricate jewelry for the ladies of Old Town and replacement parts for Cecil's big production still. Beebo never travels anywhere without two or three bodyguards as he is the only man in Starnaman who doesn't wear a knife. Beebo was born with a sneer on his lips and so he needs the armed bodyguards.

SNAKEOIL CHARLIE PETERSON

Snakeoil Charlie is a notable exception to the rule of truth in advertising. His claims are outrageous and his products are almost worthless but the locals treat him more as entertainment than

as a businessman. His patter will beguile even those who know what he's up to because they don't mind "paying for the show". His line of chatter revolves around the customer's near perfection and their obvious need for the finishing touch: a bottle of whatever he's selling. Snakeoil Charlie is an institution, beloved but not particularly respected.

WITLESS JOHN

John Haggerty, 72, has spent his entire life tramping the forest trails with his backpack crammed with odds and ends. His nickname derives from a story that he was released by a band of slavers who had captured him when he was in his teens because he acted deranged that they figured he was worthless. The same cunning has kept him alive over the years.

He carries two knives in a Starnaman rig and a brace of short .50 caliber rifled pistols made for him by John H. Barlow, Whiskey Joe's father. He has never carried a long gun and assures one and all his wits and pistols will get him through. If the Team should meet Witless John on the trail, they had better be sharp as John is. He will probably say little, learn as much as possible and not give away his true feelings behind his "trader face". His news and observations are listened to locally and respected.

WHITEGRASS

Every few years a party of Indians appears from the eastern forest. The last four parties have been led by a man addressed only as Whitegrass. Two trips ago he dragged in most of a late-model Cadillac and traded it piecemeal to the local blacksmiths for enough to leave loaded with treasures. The last trip yielded less the most spectacular item being an aluminum beer keg.

It is expected by the knowledgeable townspeople that Whitegrass will return soon. When he does, it will be to meet with tow representatives of the Amerind Empire from the west who have been trying to make contact with him for some time. The townspeople only know he will bring pre-war metal to trade and expect tough bargaining as usual. Whitegrass and his men volunteer no information, make their deals, load up their provisions and disappear for another couple of years. A chance meeting with Whitegrass, if handled properly would give the Team valuable information about Starnaman and the Legend.

THE LEGEND OF TEAM A-9

In 1978, a local bartender overheard comments made by workmen from the UC Nuclear Waste Plant which he passed on to some friends in organized crime. Years passed, the bartender became the owner and the world situation worsened. When UC workers resumed patronizing the bar in 1988, the barkeep was sufficiently curious to follow one of the crews to their job.

The man thus became aware of MARS team A-9's bolthole, which was then undergoing an equipment update. He did not know that what he saw was a Morrow Project bolthole. He believed he had discovered some sort of bomb shelter, probably for the use of UC senior personel, if and when. This news was also sent along syndicate channels.

Harry (the Hammer) Sturgis, head of the St. Louis organization, eventually received the barman's report. Bomb shelters did not much interest Harry, but bomb shelters often had weapons, and weapons were another matter. The Hammer eventually filed the incident under "pending" and went on with his other business.

November of 1989 found Sturgis and his guards at his rustic retreat in the Ozarks. The War caught them by surprise. The estate was stocked for partying, not survival and man does not live on alcohol and poker alone. Harry, though, remembered the report on the "bomb shelter" and decided to be a survivor. He and his men hustled into their chopper and headed for Hazelton, Kentucky.

HARLAN KING

Harlan King is seventeen and on his own. He couldn't get along with his step-father's new wife so he left the farm for the exciting life of a Trader. He has spent his life following a plow and is totally unequipped for trading. Armed with a knife and a worn out musket, he arrived in Starnaman unharmed but he lost his grubstake, a bundle of "winter weasel" pelts, before he had walked the length of Low Town. No one is going to give Harlan credit for a season or two so he is sleeping in Hamhand's stable and helping Jimmy the stableboy. He is still hoping to "team up" with a veteran trader. The odds of the happening are very low.



The chaos that Harry and his boys encountered is best left to the imagination. Suffice it to say that they were able to survive long enough to locate the failing barkeep. The men were, after all, well armed, and ruthless where their own safety was concerned. The old barman was willing enough to show Harry to the site on the condition the he, too, would share in whatever safety might be had. Of course, once he had led Sturgis and his band to their goal, he was no longer of any use. Harry killed the old man himself.

It took the thugs some time to effect an entry. They located only the vehicular access door and they managed to blast it open but in the process they destroyed the bolthole computer.

Entering the bunker, they found the team vehicles, freeze tubes and the very tough personal storage lockers. cursory inspection of the facility showed that the lockers and the vehicles could be operated only with cards. A search revealed no cards so Harry rightly assumed that the necessary cards must rest in the tubes with their owners. Further blasting was not feasible as the gang had squandered such explosives as they had had in breaching the door. They used an axe to smash their way into the first tube which exploded from the thermal exchange and killed on of the goons. After that they were more cautious and the survivors took the time to read the manual override instructions on the remaining tubes.

Working carefully, they opened each tube, murdered their occupants and stole their cards. This left them in control of the vehicles and equipment. Harry and his animals spent some time figuring out the gear, the coveralls, the vehicles and the weapons. Harry himself spent some time thinking.

Harry's thoughts went something like this: The War might or might not be over and the government might or might not reemerge. Right now there was no law, and men with arms and a purpose might move fast and live well. Whatever this "Morrow Project" was, it seemed to be non-governmental and there seemed to be a lot more to it than this hole in the ground. The whole set-up reeked of money, organization and resources. Harry was too good an organization man not to recognize it. To Harry it seemed like a good idea to hedge his bets.

The gang assumed an MP identity since Harry reasoned that if either the government or the MP showed up he and his gang could chuck the stuff and no one would be any the wiser as to who they really were. The little gang began to learn to use their new toys and wear the coveralls of slain team members and they set out to carve a small empire. Thus began a fifteen year reign of terror.

Of course, as far as the locals were concerned, Harry and his minions were the Morrow Project. They were ignorant of the events leading up to the gangs appearance and to this day they associate the Morrow Project with the gang. The people of the area fought the "Project", suffered horribly and eventually won. It is with no small pride that the men of current times recall the valiant struggle in the face of overwhelming odds. The memory of this epic fight has been kept alive in an oral tradition, a legend handed down to the young of each generation. The legend is learned by rote and the "Morrow People" have come to stand for all that is evil. It begins like this:

"The Morrow People came as a plague upon the land, born of the hellfires of Destruction. They were born full-grown, sprung from the earth and had the fires of hell in their hands. Their evil grew as they wasted the land. Our people died again and again."

The Hammer and his men marauded, killing wantonly, and eventually their stores dwindled. The pseudo-MP gang learned how to use the Auto Navs, located the A-9 cache, took its contents, used them, and then proceeded to Delta Base. The simple machine there honored the I.D. cards of the dead team and resupplied the killers. They received not only ammo, but rations. This freed them of the necessity of raiding, but they still pursued it as a sport.

Within weeks of the murderers' arrival the first Sicklings and Starvlings entered the area. Sicklings were killed outright by Harry and his boys since the murderers feared "plague". Starvlings were frequently less lucky...

Eventually the murderers found that Delta Base stopped honoring their cards, no more supplies were forthcoming and the locals would rise if the terror was not maintained. The Hammer instituted a search for other bolt holes. Over the years, two more of the Delta teams' bolt holes were located. These were Recon teams H-5 and H-10 and they were killed in the same way as the members of A-9. The sweeps the murderers made searching the countryside for the teams only increased contact with the locals and this meant more violence.

"They travelled across the land and those who resisted, died. The clothing of the Morrow Demons was proof against our weapons. They were never found without their clothes, so by their clothes they are known: of one piece they are, covering the body in the manner of shirt and trousers. Upon one shoulder is the mark of spears;

three in number. Thus is the fate of all displayed, man, woman and child. Upon the other sleeve rests the mark of the Morrow People. This MP is the mark of evil and death. Upon their head they wore soft hats of cloth, green in color. Thus are they known."

The imposters murdered and enslaved, robbed and humiliated the people of the area. Local women began carrying knives with which to kill themselves rather than risk being taken alive and this tradition is still observed today. The killers seemed to enjoy the rare sport of a child's futile resistance...

"The men of Smith's Forge said that they would endure no more and vowed to fight. They built a wall before a cave, taking themselves and their folk behind it. In this the Morrow People did not hinder them.

But when other men began to look at Smith's Forge with hope, when heads were held high with pride, the Morrow People descended upon the forge. They rode wagons of steel, powered by the devil and needing no animals to draw them. They swept away the walls of Smith's Forge with fire. When the walls fell the People took refuge in the cave, the war machines slowly crawling up to the cave mouth like snakes from Hell.

Those who had fought had nothing left to fight with. When night came the Morrow Devils built a great fire at the mouth of the cave and the smoke forced many of the Folk out into the night.

And when they came into the light of the fire and the witch-lights of the Morrows, their dooms were chosen. The men of Smith's Forge were taken, touched by destruction but left alive to watch. The women and children were destroyed outright using weapons of fire that turned the families of the men of Smith's Forge into screaming torches. The crying of the wounded men lasted long into the night before they too were killed by the laughing hellspawn."

The slaughter lasted for 15 years while the hatred of the locals and the mood of resistance slowly grew. Eventually, Delta Base issued the last of the dead teams' equipment and would issue no more.

The end of the murderers is detailed later on in the section on Delta Base as it involves events of which the locals are ignorant. For now, it will suffice to say that the locals believe that they bear the sole responsibility for the end of the Morrow People in a fight that took place at the very gates of the base.

Today there are remnants of these events in the customs and habits of the descendants of the people who fought the gang. The prohibition against one-piece clothing is an example of this. The Morrow symbol itself is automatically associated with the evil Morrow People by the locals. When drawn, it is always spat upon and then obliterated. It is never left intact. Most often when The Legend is told, the symbol is simply scratched in the dirt. It is never used as a joke or taken lightly.

The infinity symbol has become disconnected from the Morrow Project symbol and is now used to ward off evil. The gesture is usually drawn in the air with the forefinger. It is also used as a design on clothing to protect the wearer from evil. This could be important to the team because the locals may be doubtful that even the evil Morrow People could withstand the charm, which may give the team some measure of protection from lynching or an immediate attack.

The MARS symbol is specifically mentioned as being on the other sleeve of the coveralls and its absence may also be a point in the Team's favor. The locals will have no understanding of the Recon Eye but will be very curious. A transient MARS team on the other hand will have special problems...

While the locals have a deep and abiding hatred for the evil of the Morrows, they have a love for the equipment, though only small items still remain. The vehicles were destroyed as abominations, but their metal was salvaged. Dewey Forbes has inherited a fusion forge which is used only on special occasions and which was the basis of his family's fortune. Witless John Haggerty carries a Morrow Project knife/bayonet in a beaded leather sheath. it is thin with sharpening but still effective. One

of Hamhand's most prized possessions is a stainless steel ax of Morrow Project issue. These possessions are honored like gold wrested from a troll or a war memento.

The imposters were careful not to let weapons fall into local hands and the locals have not kept Henry's coveralls. The XR-311 he drove is inside the Council Hall on the ground floor (the chambers are above) with it 50 cal. M2HB intact but rusted solid. There is no ammo. Henry's sidearm, a Smith and Wesson M27-3 1/2, is used as a gavel by the Guild President and it too is out of ammunition and in poor repair.



STARNAMAN, GENERAL PLAN:

- | | | | |
|----|-------------------|----|------------------|
| 1 | Blacksmiths | 13 | V-150 Hull |
| 2 | Gunsmiths | 14 | Old Town Well |
| 3 | Weavers | 15 | New Town Well |
| 4 | Potters | 16 | Guild Trade Hall |
| 5 | Taverns | 17 | Trader's Hall |
| 6 | Stables | | |
| 7 | Sherriff | | |
| 8 | Town Gate | | |
| 9 | journeyman's Gate | | |
| 10 | Council Tower | | |
| 11 | Woodworkers | | |
| 12 | Gold/silversmiths | | |

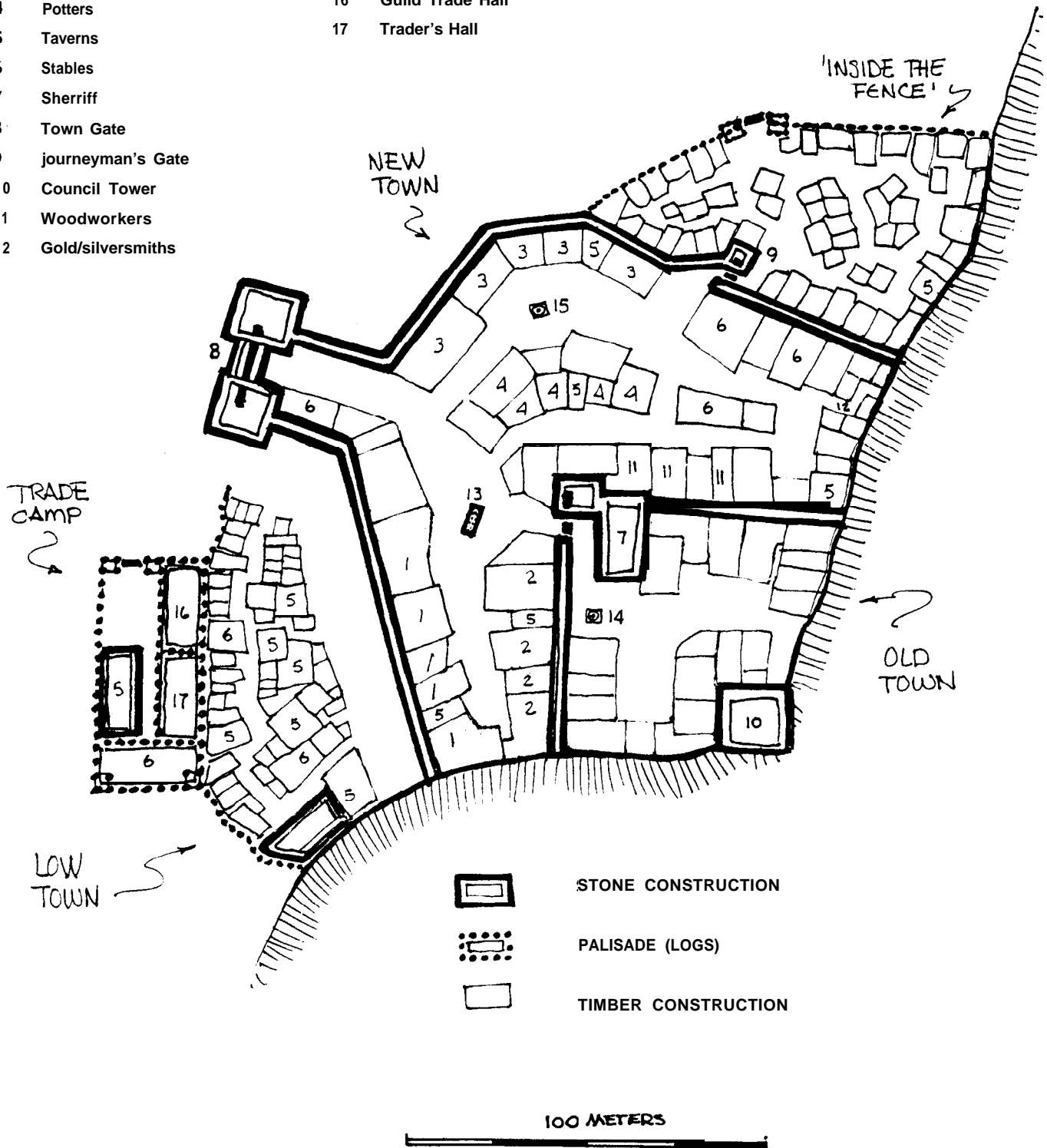

DELTA BASE

Introduction

The task of the Morrow Project, rebuilding a civilization of the size and complexity of our culture, was one of the most ambitious projects of all time. To do this in a little over twenty years was impossible. There was neither the time nor the resources to plan for all events or even the most likely ones. Because of this the Morrow Project planners decided on a more flexible approach.

The Project was divided into three active sections: Recon, MARS and Science and each was designed to deal with certain types of problems. According to the plan, all of their work was to be coordinated from a central point, Prime Base, which was meant to evaluate reports and decide where the resources of the Morrow Project could be used most effectively. Often this would amount to putting a band aid on a gaping wound but the Morrow planners were more concerned that knowledge in the form of the team's experience and training be preserved. They hoped that in this way the remnants of our civilization could be maintained until there were enough people to help it grow again.

The Recon teams were the primary source of information for Prime Base. They were the eyes and ears that allowed Prime Base to evaluate the current situation. But, in a less immediate way, they were a storehouse of knowledge and skills. They were human resources that were decentralized and capable of acting independently in a situation if and when communication broke down. In this way, even though Prime Base was destroyed, the Morrow Project has been successful; the knowledge of the 20th century has survived in the teams that are waking up and with their help it is possible that the world may avoid a new dark age.

The MARS and Science teams were originally designed for special circumstances and problems that were beyond the capabilities of the Recon teams. Military problems such as the Krell warriors or other dictators were the province of MARS teams. Similarly, problems that required special equipment or knowledge were dealt with by the Science teams.

Once the initial teams and equipment were in place, the Morrow planners began to look at more complex responses to the thousands of questions posed by a nuclear holocaust. The problems in rebuilding an area generally revolved around the need for materials, expertise and planning. While the Project could not even begin to supply all the necessary materials in all areas for building and maintaining even a small town, they could provide the tools with which the local people of an area could begin to build a better life. The teams were there to help, to teach and to lay the groundwork for a new world.

With this in mind, several areas that were expected to escape relatively unharmed were chosen as sites for special supply bases. While these bases would have some weapons and ammunition, their primary aim was to supply the locals and the teams with the equipment necessary to help improve the standard of living in the area. Forges, construction and sanitation equipment that could be used by the people were all included in these bases. Anticipating the flow of refugees to such areas, additional medicine and food were added as well as decontamination units, geiger counters and equipment for putting up emergency shelter.

Around these special bases new teams were frozen to provide the personnel to organize a massive reconstruction effort. Usually there was at least one MARS team, one Science team and no less than six Recon teams in one of these areas. They were to provide both the expertise and the organization for the work. But it was neither possible nor desirable for 100 or so Morrow personnel to do the work required to rebuild a region of no

less than 100,000 square miles. From the start the teams would need to work with the survivors, teaching them the skills and providing the planning for the job.

Nor were the teams meant to form a government other than as a stop-gap measure. Their role was meant to be similar to the National Guard when they are called out to help in times of fire, flood and disaster until civilian government can again deal with the situation.

The regional supply bases were carefully located. Each of them were put in places that were easy to reach (even by primitive means), and near areas that had a lot of people spread over a relatively small area but that were not important enough to be targets for bombs.

As with other Morrow efforts, there was not enough time to do everything. There were a small number of supply bases and they were all "camouflaged" to appear as something other than what they actually were. Some were hidden in abandoned oil refineries, or mines, others masqueraded as bogus military sites. Each was handled differently and positioned very carefully.

PD NOTE: Much of this information would be generally available to the Team. Specifics are up to the PD. The amount of information the Team actually has depends on what stage of the planning they were frozen at. The Play of the Game and Designers Notes sections have further details about the bases and their organization for the PD.

Because a supply base is too big to conceal, Delta Base (the supply base the Team was attached to) was built under the guise of an automated nuclear waste processing plant owned by the United Consolidated Corporation, a division of Morrow Industries. Construction was begun in 1974 and finished in 1979. When completed, Delta Base was a gigantic underground warehouse prepared to dispense supplies and equipment to the Morrow Teams.

The "United Consolidated" experts had been gone only months when there was an "accident" at the plant; it was quarantined and declared a total loss due to radiation contamination. The local towns went through radiation scares and the plant area was sealed by special UC teams.

In the fall of 1988, United Consolidated crews returned to clean up the contamination. After some time, they declared that the plant was a total loss, and could not be reclaimed. The plant was resealed. This hoax allowed the Morrow Project planners to update the Base equipment and inventory. Updated equipment was also placed in the nearby bolt holes under the guise of checking remote sensors for malfunction or radiation leaks. The area near the Base was then "seeded" with mildly radioactive debris to strengthen the fraud.

It was felt the fences and the warning signs, coupled with the bogus "accident", would serve to keep the idly curious away. The radioactive seeding was undertaken for the benefit of more professional but equally nosy trespassers. Everything was planned to discourage curiosity.

Approaches to Delta Base (See Map II)

From Starnaman the trail heads north, then east and from time to time shows bits of asphalt. The hills often show evidence of a former traffic but these days are mostly mud, slush or dust depending on the time of year. Larger vehicles like the V-150 will have a difficult time on the approach road but only in places will the track become narrow enough or the trees low enough to cause any real problem. Wolves, naturally, will be plentiful farther

from Starnaman.

1. Intimidation Zone

This is an area very lightly seeded with radioactive waste. A sickly yellow grass is the only thing which grows here. There is no animal habitation though there are signs that animals pass through the area.

The RAD level is less than 1 per hour which is quite enough to trigger the alarm on the MP M1CBR unit (pg. 25 MPGB). This zone extends in a rough circle for a distance of about 1 km measured from the access dome.

II. Warning Zone

Beginning about 500 meters in from the start of the Intimidation Zone, this area is more heavily irradiated. Here the ground is barren and the RAD count steadily increases from about 2 RADs per hour to 5 RADs p.h. at the rim of the bowl that shelters the base entrance.

A. Fences

Two fences lie within the warning zone. The first is 100 meters from the end of the Intimidation Zone and the second begins 100 meters farther along the track. Both fences form a circle. Each fence was made of 10 foot high cyclone wire mesh topped with concertina razor tape. The outer fence sported metal signs at 50 meter intervals bearing the message:

DANGER!
RADIATION HAZARD
DO NOT ENTER

In small letters beneath this message is:

UNITED CONSOLIDATED CO., a division of MORROW
INDUSTRIES.

Some of these signs remain in place and some are still at least partially legible but in most places the fence has either fallen or rusted out.

The second fence was once electrified but is now harmless. Close inspection of the fence will show its original nature. Here and there along the fence there are human bones; some may even be hanging in the razor tape at the top.

Both fences were cut by gates on the access road. Both gates are open and bits of chain and lock are still hanging from them.

PD NOTE: Here and there, these fences may well be down since there's been no maintenance for a long time. The human remains are those of "sicklings" from the time just after the War. These persons were already dying when they arrived. It may be that they were seeking shelter, any shelter from the winter. Their bones will show varying but high levels of radioactive contamination. Of course, the Team will have no idea as to the identities or the purposes of these people...

B. Minefield

Fifty meters inside the last fence is a continuous belt of anti-personnel mines, broken only by the approach road. These were activated by geosensor at the outset of the War. Half of them are no longer functional. They are so unstable that they occasionally explode from age. (Die roll of 02 or less on D100 will detonate a mine spontaneously.) The minefield is 50 meters deep.

Minefield Effect Table

At each ten meter interval traveled by a player through the mine field, roll a **D10** and a D6. Check the first table to see if a mine is encountered. If there is a mine and it goes off, use the D6 and the second table to see what type it is and what its effect will be.

Mine Encounter Table

DIE ROLL	ENCOUNTER
01-06	No mine encountered
07-08	A mine is triggered but is defective, no explosion
09-10	A mine is triggered and explodes

If a mine is triggered and explodes (09-10), roll 1D6 to see effect.

DIE ROLL	EFFECT AND TYPE
01-04	M25 Anti-personnel mine: burst radius .156m, E-Factor 6, DPW 20
05-06	M16A1 Anti-personnel mine: burst radius 30m, E-Factor 4, DPW 888 (Fires steel balls for 30 meters)

There are no vehicular mines in this area, but the APERS mines may damage MPV's. Consult the appropriate tables in the MPGB (pgs. 36, 38 and 45).

C. Sensors

There is a network of geosensors beyond the minefield. These are buried and are not visible. The geosensors recorded the seismic jolts of the War and activated the Delta Base defenses. The sensors will also record a 50 kilo intruder 250 meters into the trees beyond the barren area. Alerted by these geosensors, the defense system will raise all of the mushroom turrets at once.

III. The Bowl (see Map III)

The bowl is an artificially created depression scooped out of the ridge. While its man made nature will be obvious to the Team members, no local would recognize it as being anything other than a natural depression. Enough of the ridge has been left in "front" of the bowl to effectively prevent a view of the interior from the access road. The bowl itself is not shown on the Team's Auto Nav although the ridge is there. The Team will have to approach the gates or climb the ridge to the rim of the bowl in order to see into the depression. As it is very deep, most of the bowl is usually in shadow since the height of the ridge wall shuts out the sunlight for most of the day. The depression is only fully lighted for about two hours in the middle of the day.

Originally the bowl was nearly uniform and 80 meters across. With the erosion of the following 150 years, it is now about 85 meters wide at the top and 76 meters at the bottom as the slopes have eroded down. The sides can be climbed to about halfway up the slope. The walls are about 25 meters high near the gates and about 50 meters high behind the access dome.

The floor of the bowl is radioactive. At the gates, the count is about 5 RADs per hour and rises to 10 RADs p.h. at the loading dock/access dome; so there is no life in the depression or on its walls.



A. The Gate

The access road leads to a double gate which is the entry point to the bowl. The ridge here has been cut away for some 15 meters to make this entryway and in the center of this cut are two stone pillars, 10 meters apart. The pillars are connected to the ridge y sections of 12 foot high cyclone fence.

Each pillar has a stainless steel plaque on it. The one on the left reads:

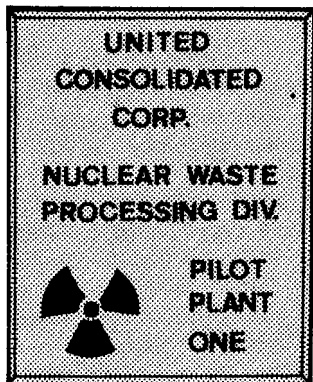

The one on the right reads:

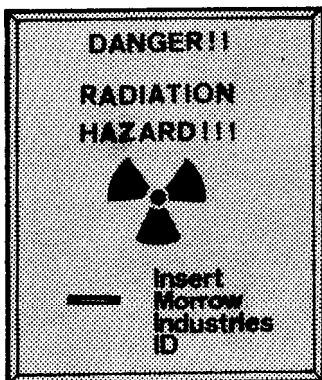

The space between the pillars is occupied by two ten foot high steel bar gates, each supported on steel rollers. The left pillar and gate were heavily damaged at some time in the past and that gate no longer works. The right hand gate will open if an MPID is inserted into the card slot in the right plaque. The gate closes automatically after two minutes.

“Mushroom” Turrets

Most of the active defense of the aboveground areas of Delta Base is handled by automated “mushroom” gun turrets connected directly to the on-site computer. There are two groups of these mushrooms; eight are in the bowl itself and twelve more are placed on the top of the rim. The use of the two groups differs and so their operation is described seperately. However, both sets of turrets look alike and work in the same manner.

All mushrooms raise as soon as the geosensors detect sufficient movement in the area, and so the Team members should **only see them** in their extended form. The only way the Team is likely to see one retracted is if a turret has taken sufficient fire to cause it to retract.

Since the weapons do not protrude from the turrets, the Team members are not likely to recognize the mushrooms as weapons’ stations. They look rather like ventilator stacks and unless a Team member spends some time observing a turret, he is not likely to notice it moving. This is because the turrets are featureless and detection of their movement is difficult - it all looks the same.

The mushrooms are 1.25 meters across at the stem and the stem rises .5 meters above the ground. The weapons are located in the stem just below the cap. This makes it even harder to detect or hit the weapons. The cap is a flat dome one meter thick at its deepest point and 2.25 meters from rim to rim. When the turret is retracted only the cap remains above ground.

The mushrooms retract into armored sockets below ground level which contain all the machinery necessary to their operation. There are only electronic control leads to the Delta Base complex. Thus the turrets and sockets provide no physical access to the base.

The turrets are cast steel, retracting cupolas controlled by the base computer and each contains an Rh202 20mm. cannon and a coax 7.62 MAG58. To accomodate the weapons in the retracting cupolas, shorter barrels than usual are fitted on the weapons. The corresponding advantages in stability and sight/sensor target-following cancel the loss in accuracy at the ranges involved.

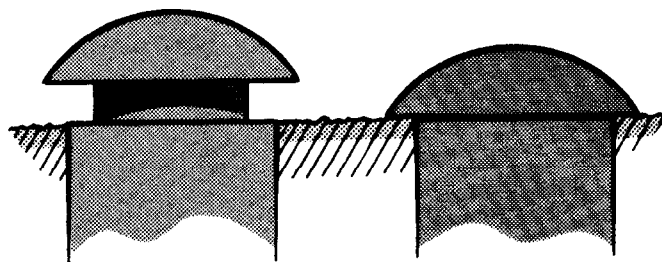

Each turret requires one full second to fully retract. Retracted, they take 2 1/2 seconds to reopen to firing position. A mushroom turret requires 20 seconds to make one full revolution of 360 degrees.

Firing

Assume the following basic accuracy for firing turrets:

TARGET	CHANCES TO HIT
Man-sized, stationary	30%
Man-size, moving	20%
Stationary Vehicle	60%
Moving Vehicle	40%

Each turret **was equipped with 1,000 rounds of 7.62mm.** ammunition and 300 rounds **of 20mm.** ammunition. **All weapons have at least ha/f of their original ammunition supply left.** Geosensor data on the weight of an intruder being tracked will determine how much firepower is used. The chart below shows the overall pattern:

TARGET WEIGHT	7.62mm ROUNDS	20mm SHELLS	COMMENTS
25-50kg.	3	-	
50-150kg.	10	-	Moving Target
	5	1	Stationary or slow target
150+kg.	3/5/10	5	Increases with target size

When firing combination bursts of 7.62 and 20mm., the computer fires the 7.62mm. burst and, on the basis of the ballistic projections from the coax sight/sensor group, fires the 20mm. only if a hit is expected. If more than half the round fired from the 7.62mm. hit the target, the **20mm. will also be fired before the last of the 7.62 rounds reach the target.** Roll ID10 (01-09 a hit) for the results of the 20mm. shell/shells.

All firing patterns available are made up of 3/5/10 round bursts from the 7.62mm. coax, followed by either a single 20mm shell or a burst of 5 shells. Ammunition conservation was a consideration in the design of the firing patterns.

The computer can simultaneously track and engage up to four targets using as many or as few turrets as the situation seems to call for. The computer will engage moving targets first and leave stationary targets for later attention. In order to conserve ammo, turrets will not fire on retreating forces which are not firing.

The turrets are uniformly effective in all weather conditions and light levels.

Engaging Mushrooms

Total destruction of a mushroom turret requires a cumulative E-factor of 400 because of the materials and ballistic properties of their shape. The recessed muzzles of the 20mm. and 7.62mm. and the sight/sensor cluster can be hit, disabling that function. If the sight/sensor is hit, reduce turret accuracy by 50% as the computer no longer has coax sighting but can track the target from sensor data from the remaining turrets. When a turret is hit, roll a D100 to see the effect:

DIE ROLL	EFFECT
01	Sensor/sight group destroyed
02	7.62mm MAG 58 disabled
03-04	20mm Rh202 disabled
05-15	Center Cap, full E-factor applied
16-30	Center Stem, full E-factor applied
31-50	Sloped Cap, 1/2 E-factor applied
51-60	Sloped Stem, 1/2 E-factor applied
61-80	Edge Cap, 1/4 E-factor applied
81-90	Edge Stem, 1/4 E-factor applied
91-00	Complete deflection, no effect

E-FACTOR	CUMULATIVE E-FACTOR RESULT
300	Turret will track but will no longer retract
380	Turret will no longer track, but can fire if target moves into the line of fire
400	Turret destroyed

The turret will be retracted every time it receives more than **100** points of damage or if area weapons (such as a mortar) are being used against it. The mushroom will be raised again, if necessary, at a later time. This can make for an unnerving "jingle-jangle" effect of appearing and disappearing mushrooms during a firefight.

Mushrooms in the Bowl

Assuming that an MPID is used to gain access to the bowl, the turrets will not fire at those who enter whether they are on foot or in vehicles. The only conditions under which these turrets will fire are: **1.** If an attempt is made to damage a turret, or **2.** If an attempt is made to force entry to the Delta subterranean complex (like blasting the door or serious tunnelling into the ridge).

In either case, only those persons or vehicles which are engaged in such activities will be fired on. Time permitting, a warning burst will precede any attempt to kill.

In any event, the turrets will always rotate to track all movement in the bowl and an attempt is made to cover the entire area. The turrets, between them, can fire anywhere along the floor of the bowl. If an I.D. card is not used to gain entry, the mushrooms will behave in the same way as those on the rim (i.e. fire automatically at any target).

Mushrooms on the Rim

The mushrooms positioned near the top of the bowl cover the clear area on the ridge. They cannot fire at targets on the flat below the ridge and they cannot fire into the bowl. They fire automatically at any target moving within the fenceline that is on the ridge. They will continue to fire until all movement stops and all return fire has ceased.

The Delta facility has no means of repairing any damage to any of the mushrooms or of replenishing their ammo store.

C. The laser

This system is intended to provide higher angle fire than the mushrooms. As time has passed, this system has been used more than in the days immediately after the War. This was done in order to conserve the ammo in the turrets.

The laser is a Mk3 (pg. 28 of MPGB) and is located in an armored box protruding from the wall of the bowl eight meters above the loading dock. Once buried in the earth, fully concealed, 150 years of erosion have left it cantilevered, sticking dangerously far out and with a one meter cube of the box exposed. The laser's balance is so precarious that a hit of E50 or more on the box or into the earth within two meters will cause it to topple onto the loading dock.

The weapon is powered from the base's fusion power source. Its fire is governed by the same conditions as that of the turrets in the bowl. When firing it uses one second bursts on live targets and 5 second bursts on vehicles. The weapon has the same chances to hit as the mushroom turrets.

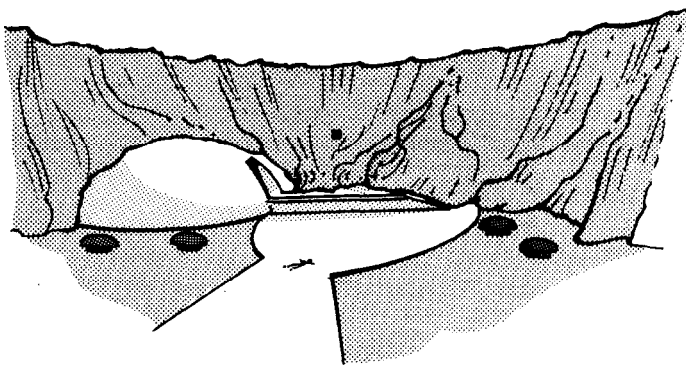

D. Other Items in the Bowl

The road crosses straight to the loading dock set in the far side of the bowl. Just inside the fence is the freshly killed carcass of a young, male Mutant Wolf, almost cut in two by the laser. Here and there for the first twenty-five meters are skeletal remains. Most are partially buried in the sterile soil. Several will show traces of lethal levels of radiation. All, **if exhumed, would show evidence of laser, machine gun or cannon fire.** Most of the remains are animal but several are recognizably human.

There are no remains closer to the loading dock than the center of the bowl except a solitary form, well over six feet in length, sprawled at the point where the road flares out to encompass **the dock.** The top of the skull appears to have been surgically removed. It is wearing Morrow Project coveralls which are badly weathered but intact. A rusted lump on the concrete could once have been an Uzi. The coverall bears the MARS patch and the name MORRISON over the breast while the MPID card in the IMPID is inserted, the door will slide open by retracting upwards into the dome. The door rises at one meter per minute and is made of .5 meter thick steel.

BASIC LOAD (VEHICULAR) STANDARD ISSUE)

1 pr. AN/TVS-5 Binoculars 1 Machete
 1 Laser Rangefinder 20m Tow chain (breaking
 1 AutoNav navigation system strength 5.25 metric tons)
 1 AN/PRC-70 3 Fire extinguishers
 1 Radio Direction Finder Tool kit
 1 Large MedKit 1 Shovel
 1 Ax 1 Tripod (M122 or .50 Cal.)
 1 Sledgehammer 2 Ration packs
 1 Mountain Kit containing:
 2-33m coils 11mm nylon rope (breaking strength 1,700kg)
 1 Folding grappling hook 1 225 gram Hammer
 20 Pitons * * * * *
 30 Snaplinks * * * * *
 6 M688 40mm Rocket shells (to launch grappling hook from M79)
 * * * * *_ _ _
 1 set Climbing spikes (for ice)
 1 Trade pack containing;
 50 Gold Double Eagles
 * * * * *
 50 Silver Dollars
 * * * * *
 6 one-liter bottles of Whiskey * * * * *
 6 Sewing kits * * * * * 4 Mirrors * * * *
 6 Comb and brush sets * * * * * 6 Hunting knives * * * * *
 6 250g packs Tobacco * * * * * 6 packs Candy * * * * *
 Various toilet articles 6 Fishing kits * * * * *

1 M21 Rifle, 20rd mag, Semi-Auto, E=17, 12 mags.
 * * * * * _
 * * * * * _
 * * * * * _
 * * * * * _
 ARMBRUST 300, Single-shot, E=441, Dpw=533 (4)
 * * * *_ _ _
 1 case M34 White Phosphorus Grenades (16)
 * * * * * *_ _ _
 1 case M26A1 Fragmentation Grenades (30)
 * * * * * *_ _ _
 1 case M7A3 CS Gas Grenades (16)
 * * * * * *_ _ _
 M183 Demolition charge (16 M112 C4 blocks)
 * * * * * _ _ _
 1 roll Primercord (152m)
 10 M2A1 Detonators (8 second delay)
 * * * * * *_ _ _
 2 M1 Timers
 *_ _ _
 2 M18A1 Claymore mines
 *_ _ _
 1 case 9x19mm Ball (2880 rds)
 1 case 7.62x51mm Ball (920 rds)
 1 case 5.56x45mm Ball (1640 rds)
 1 case 12 gauge magnum 00 buckshot (500 rds)

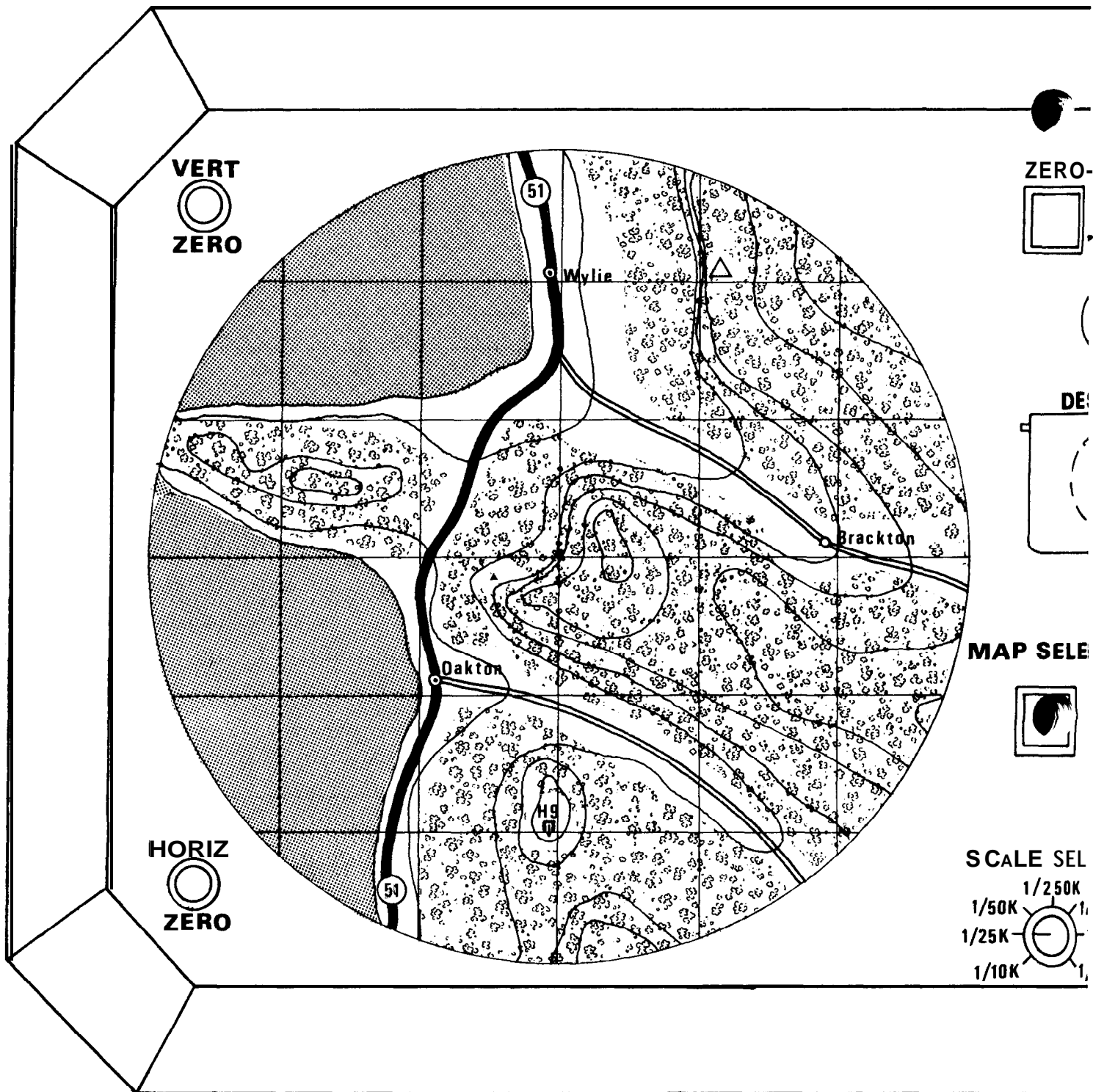

VERT ZERO; Allows adjustment of the displayed map to the unit in the vertical plan.

HORIZ ZERO; Allows adjustment of the displayed map to the unit in the horizontal plane.

ZERO; Allows the use of the Vert and Horiz adjustment dials.

DESTRUCT ARM; (covered toggle switch) Arms the destruct system causing a beeping sound once per second until fired or disarmed.

DESTRUCT; (covered push button) With the seal wire broken, cover lifted, and button depressed the system fires an internal thermite charge in five seconds. The charge destroys the Interior of the AutoNav.

MAP SELECT; Initiates system allowing the use of the keyboard to select a specific map.

SCALE SELECT; Determines scale of map displayed.

KEYBOARD: Used to input information into system.

SENSOR SYSTEM SELECT

RDF; Allows radio direction finder (if available) on screen.

MAG; Allows magnetic sensor (if available) targets on display screen.

RADAR; Allows radar set (if available) on screen.

CACHE LOCATION; Shows all assigned cache locations on screen.

LIBRARY; Reads out all available maps on screen.

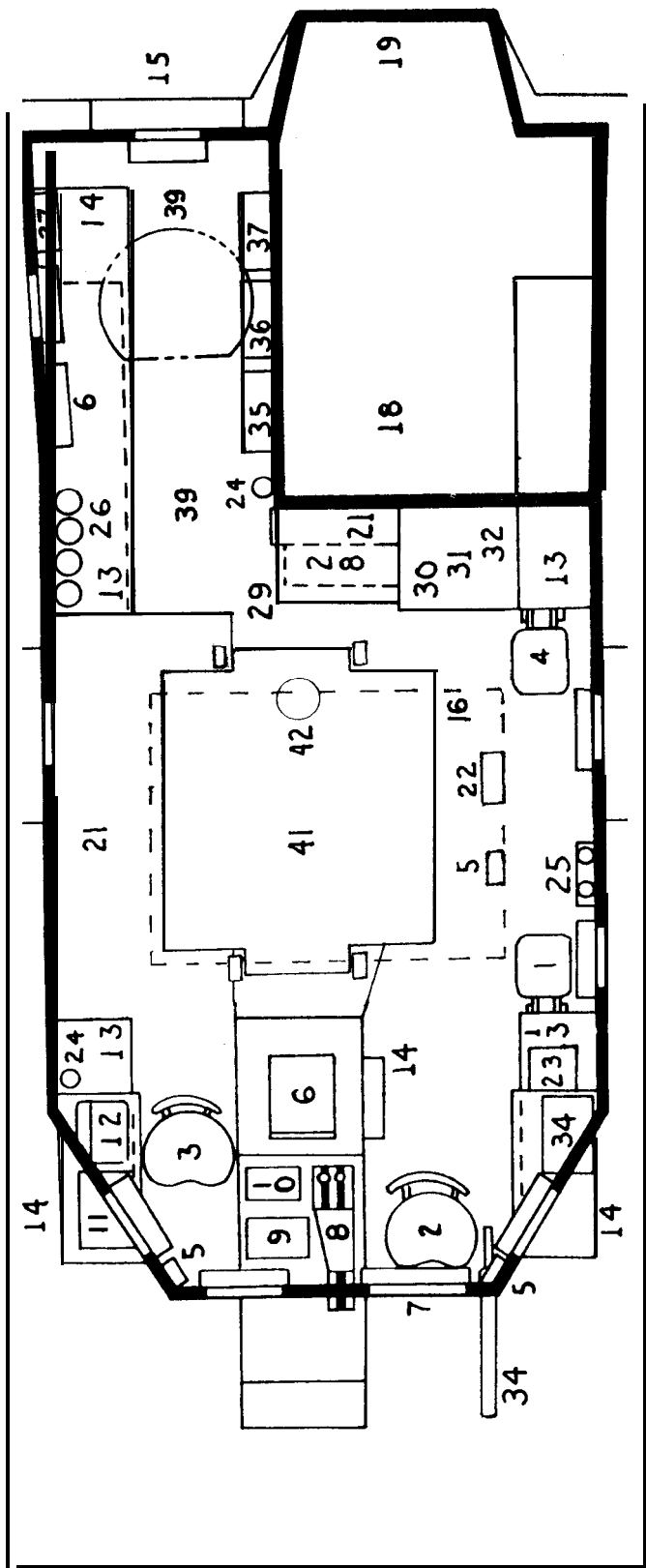



BASIC LOAD (VEHICULAR) COMMANDO V-150 ARMORED RECOVERY VEHICLE
1 M2HB Machinegun, 105rd belt, Selective fire, E=30, 20 belts,
Short burst-10rds, Medium burst=20rds, Long burst=30rds.

```
*****_*****_*****_*****_  
*****_*****_*****_*****_  
*****_*****_*****_*****_  
*****_*****_*****_*****_--
```

* = Short burst

- = Reload

- - - = Out of Ammunition

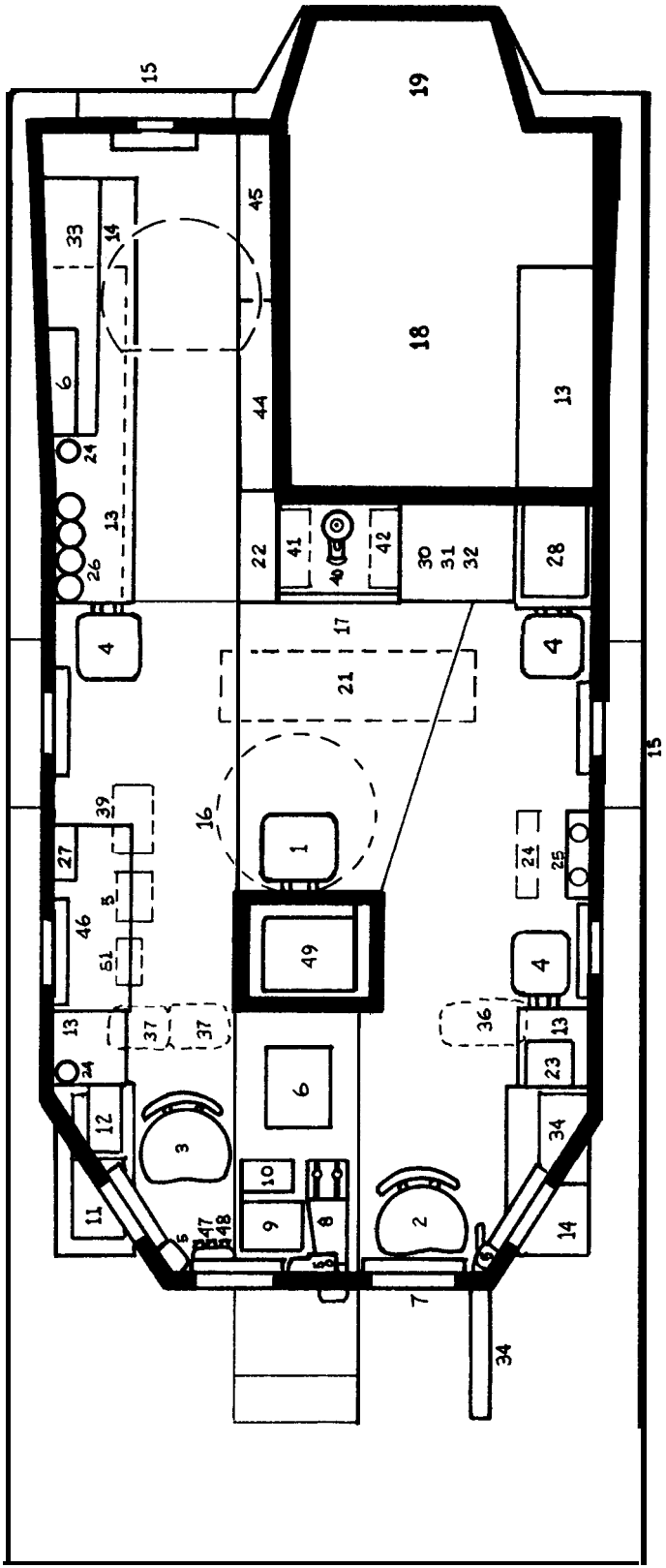

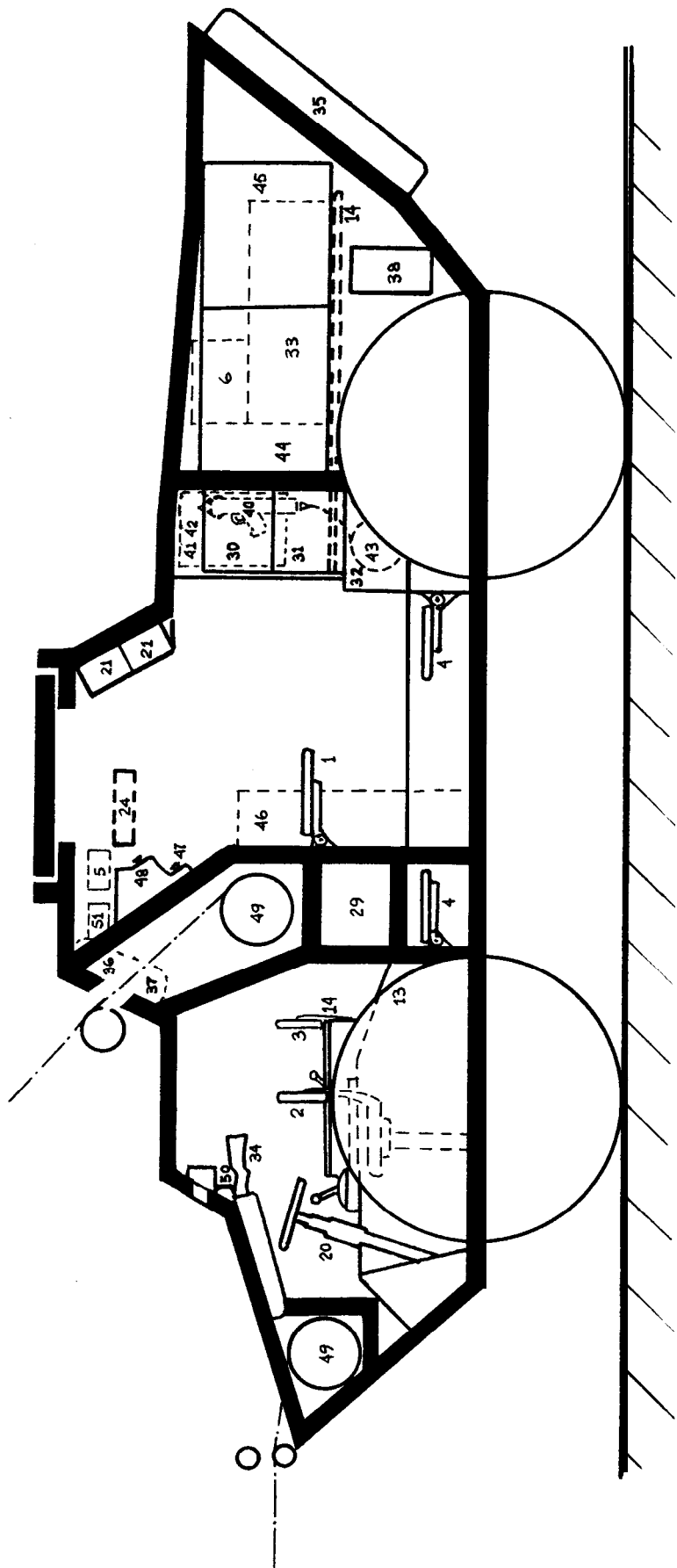

INTERIOR KEY: V-150 ARMORED RECOVERY VEHICLE

NO.	QTY.	DESCRIPTION
1	1	Commander's seat (Folding)
2	1	Driver's seat
	1	Radio Operator's seat
2		Passenger seats (Folding)
		Intercom
	2	AN/PRC 70 Radios
10		Window/vision block
;	1	Driver's controls
9	1	Auto Nav Navigation system
10	1	'RDF' Radio Direction Finder (Vehicle mounted)
11	1	Computer
12		CRT & Keyboard for Item 11
13		Wheel well
14	3	Mounting plate on wheel well
15	3	Door
16	1	Cupola Ring
17	1	Hull raised in this area to clear drivetrain
18	1	Engine compartment
19	1	Ventilation for engine compartment
20		Steering wheel
21		.50 cal. Ammo Boxes (105 rounds ea.)
22	12	.50 cal. Ammo Boxes (105 rounds ea.)
23	1	AN/TVS-5 Binoculars
24	3	Fire Extinguishers
25	1	ase each: 12 Ga. 00 Mag Buckshot, 5.56mm Ball, 7.62mm Ball, 9mm Ball
26	4	Armbrust 300
27	1	Large medkit
28	1	Tool Kit (ARV Maintenance)
29	1	Explosives locker
	1	Case, M7A3 CS Gas Grenades
	1	Case, M34 White Phosphorus Grenades
	1	Case, M26A1 Fragmentation enades
	1	1 Each: Ax, Sledge hammer, Machete, Shovel, Tripod
	1	M21 Rifle, 12 Magazines
	1	Mountain kit
	1	Trade Pack
	2	Ration Packs
	1	Case, M18A1 Claymore Mines
39	1	Laser Range Finder (mounted under vehicle roof)
	1	Mk 1 10m Cutting & Welding Laser
	1	Maintenance kit, Mk 1 Laser
42	1	Protective clothing, Mk 1 Laser (Safety mask, gloves, apron)
43	1	Take-up Reel, Mk 1 Laser power cable (vehicle mounted)
44	2	Sets, Hand Tools, Racked in cabinets
45	1	Power tools, Set, in Cabinets
46	1	Winch accessories locker
47		'A' Frame actuator (Hydraulic positioning lift)
		Winch controls
	2	Winch, 4500 Kg Capacity (vehicle mounted)
	1	Lifting Base controls (Hydraulic positioning)
	1	Portable Controller (Combines: 47; 48;& 50)

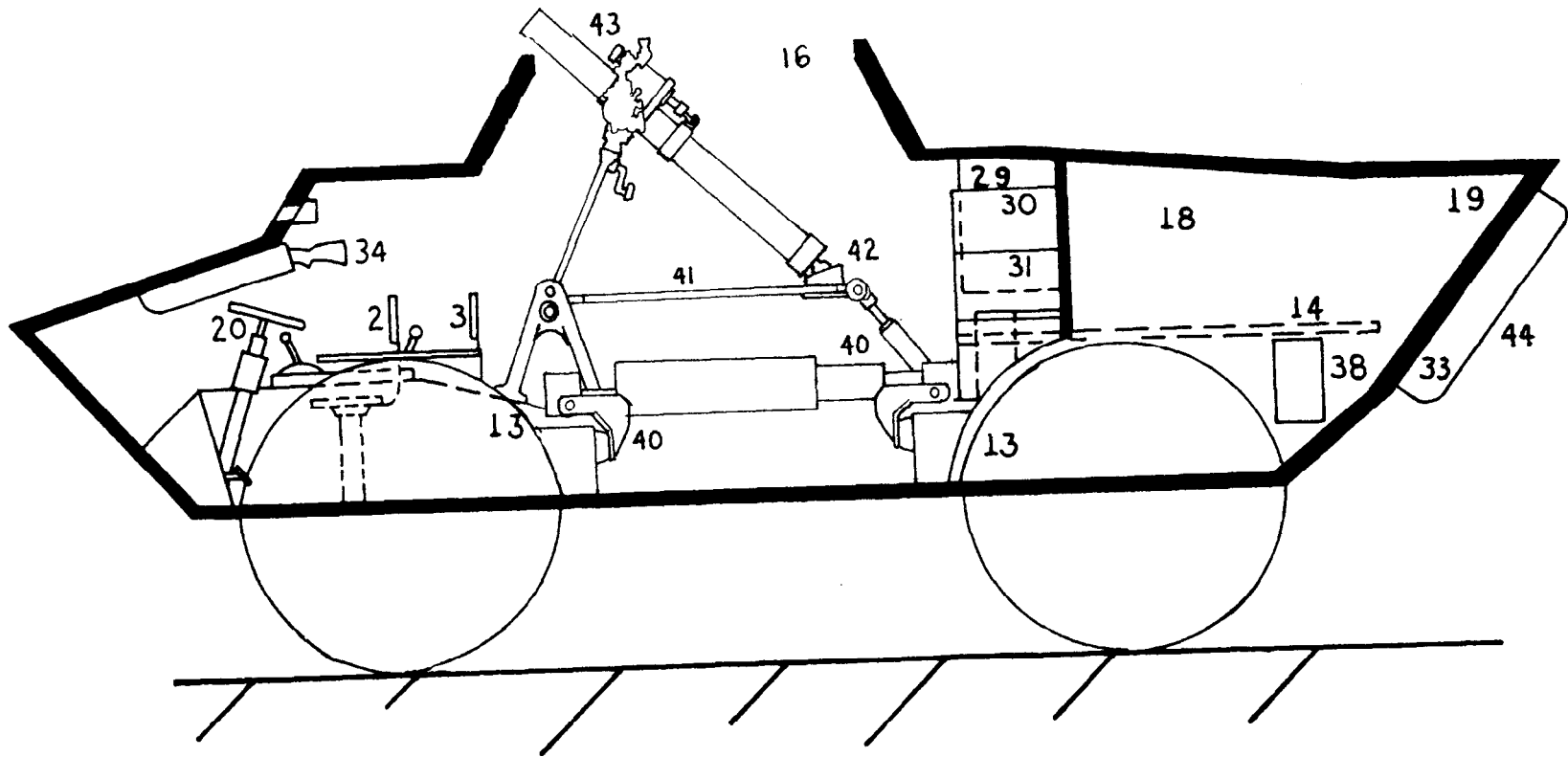

INTERIOR KEY: COMMANDO V-150 w/81mm MORTAR

NO.	QTY.	DESCRIPTION
1	1	COMMANDERS/GUNNERS SEAT
2	1	DRIVERS SEAT
3	1	RADIO OPERATORS SEAT
4	1	LOADERS SEAT
5	3	INTERCOM
6	2	AN/PRC-70 RADIO
7	10	WINDOW/VISION BLOCK
8	1	DRIVERS CONTROLS
9	1	AUTO NAV NAVIGATION SYSTEM
10	1	'RDF' RADIO DIRECTION FINDER (VEHICLE MOUNTED)
11	1	COMPUTER
12	1	CRT AND KEY BOARD FOR ITEM 11
13	4	WHEEL WELL
14	3	MOUNTING PLATE (MOUNTED ON WHEEL WELL)
15	3	DOOR
16	1	CENTRAL OPENING
17	1	HULL RAISED IN THIS AREA TO CLEAR DRIVE TRAIN
18	1	ENGINE COMPARTMENT (CONTAINS DRIVE TRAIN & FUSION REACTOR)
19	1	VENTILATION FOR ENGINE COMPARTMENT
20	1	STEERING WHEEL
21	26	READY ROUNDS FOR 81mm MORTAR (BLOCKS RIGHT HAND DOOR)
22	1	LASER RANGE FINDER (MOUNTED ON EXTENSION WALL)
23	1	AN/TVS-5 BINOCULARS
24	3	FIRE EXTINGUISHERS
25	1	1 CASE EACH 12 GAUGE MAGNUM 00 BUCKSHOT, 5.56mm BALL, 7.62mm BALL, 9mm BALL
26	4	ARMBRUST 300
27		LARGE MEDKIT
28		TOOL KIT
29		EXPLOSIVES LOCKER
30	1	CASE, M/A3 CS GAS GRENADES
31	1	CASE, M/B4 WHITE PHOSPHOROUS GRENADES
32	1	CASE, M/6A1 FRAGMENTATION GRENADES
33	1	1 EACH AX, SLEDGE HAMMER, MACHETTE, SHOVEL, TRIPOD
34	1	M21 RIFLE, 12 MAGAZINES
35		MOUNTAIN KIT
36	1	TRADE PACK
37	2	RATION PACKS
38	1	CASE, M/8A1 CLAYMORE MINES
39	1	54 ROUNDS 81mm [STACKED FLOOR TO CEILING]
40	2	RECOIL MECHANISM
41	1	GUN PLATFORM
42	1	MORTAR BASE
43	1	81mm MORTAR
44		MORTAR BASE PLATE [FOR EXTERNAL USE OF MORTAR]

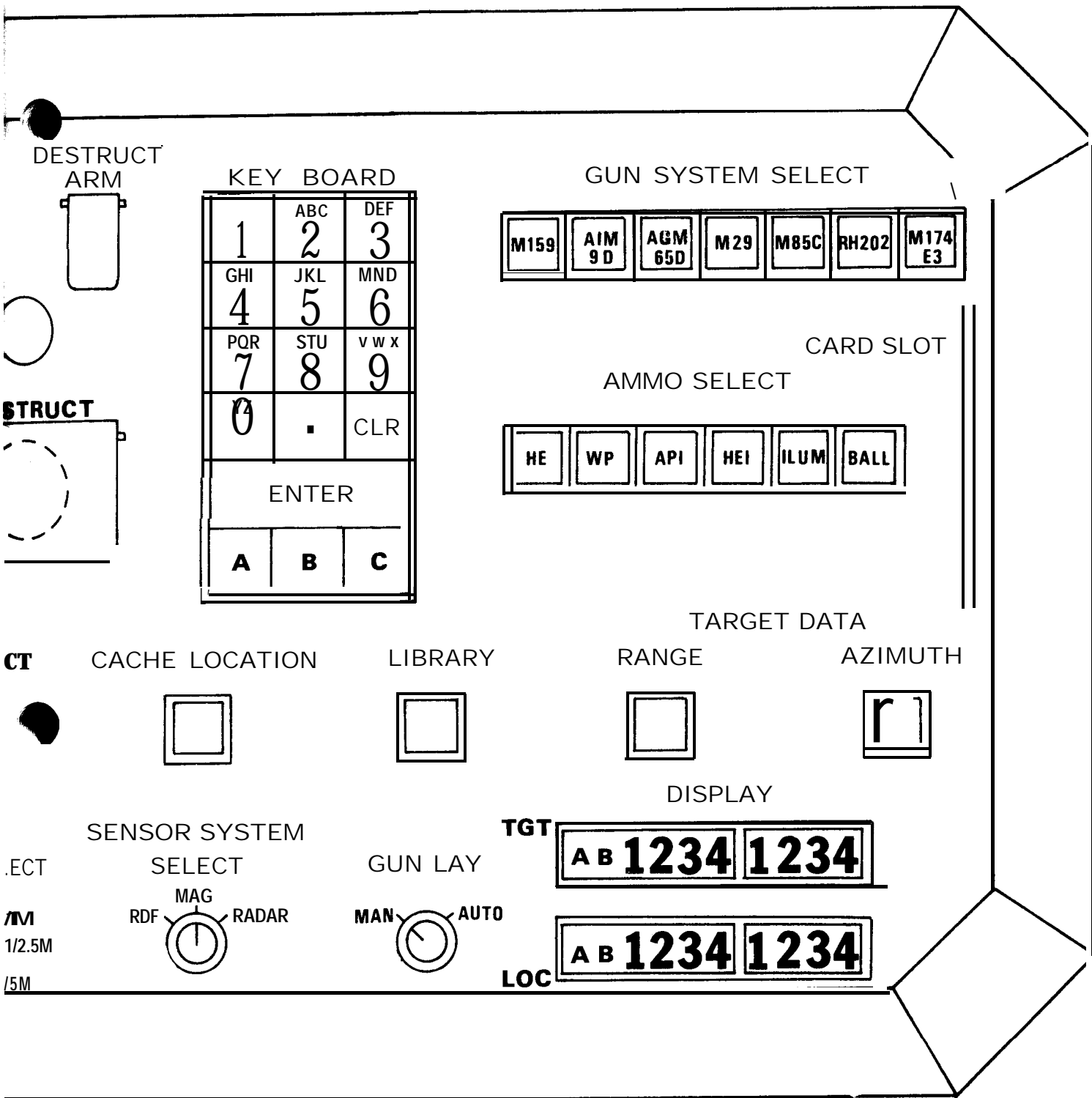

table to AutoNav) to indicate direction on display
 le to AutoNav) to indicate location of detected
 AutoNav) to indicate detected targets on display

aches when depressed.

n display screen.

GUN LAY

MAN; Disengages Gun Lay system to allow manual laying (aiming) of gun system.
 AUTO; Engages Gun Lay system to aim weapon system according to data in AutoNav.

GUN SYSTEM SELECT; Allows AutoNav to aim indicated weapon system, if vehicle is so equipped, using Gun Lay system.

AMMO SELECT; Indicates ammunition fired in selected Gun System.

TARGET DATA

RANGE; Allows input of data for Gun Lay system.
 AZIMUTH; Allows input of data for Gun Lay system.

DISPLAY; Indicates data, either Target or Location, shown on display screen or keyed Into system from keyboard.

CARD SLOT; Allows insertion of Morrow I.D. card to activate AutoNav displays. AutoNav will function (track its movement) without card but will not display any information or allow any other functions.

BASIC LOAD (VEHICULAR) STANDARD ISSUE: COMMANDO V-150 ARV

- | | |
|---|---|
| 2 AN/PRC-70 Radios | 1 AutoNav navigation system |
| 1 "RDF" Radio Direction Finder | 1 Computer |
| 1 AN/TVS-5 Binoculars | 1 CRT and Keyboard (Computer) |
| 3 Fire extinguishers | 1 Large Medkit |
| 1 Tool Kit (ARV Maintenance) | 2 Sets hand tools in cabinets |
| 1 Ax | 1 Laser rangefinder (vehicle mounted) |
| 1 Sledgehammer (6 lb.) | 1 Mk 1 10m Cutting and Welding Laser (racked) |
| 1 Sledgehammer (10 lb.) | 1 10 meter Mk 1 Laser power cable |
| 1 Shovel | 1 Mk 1 power cable take-up reel (vehicle mounted) |
| 1 Set power tools | 1 Set winch accessories and spares; hooks, block and tackle, (4) collapsible 1000kg. earth anchors, cable ends and fasteners, winch spares, winch maintenance tools |
| 1 Set protective clothing, Mk 1 laser: Safety mask, apron, gloves | 2 Ration Packs |
| 20 Boxes .50 Cal. (8 in ready pos.) | |

1 Mountain Kit containing:

- | | |
|----------------------------------|---------------------------------|
| 1 Portable winch/base controller | 1 set climbing spikes (for ice) |
| 1 Folding grappling hook | 1 225 gram hammer |

2-33m coils 11mm nylon rope (breaking strength 1,700 kg.)

2 OPitons *****

30 Snaplinks *****

6 M688 40mm Rocket shells (to launch grappling hooks from M79) * * * * *

1 Trade Pack containing:

50 Golden Double Eagles *****

50 Silver Dollars *****

6 1-liter bottles of Whiskey * * * * *

6 Sewing kits • * * * * •

6 Comb & brush sets * * * * *

Various Toilet articles

6 250g packs of Tobacco * * * * *

4 Mirrors * * * *

6 Hunting knives * * * * *

6 Packs of candy * * * * *

6 Fishing kits * * * * *

1 M21 Rifle, 20 rd. mag, Semi-Auto, E=17,12 mags.

ARMBRUST 300, Single-shot, E=441, Dpw=533 (4)

1 case M34 White Phosphorus Grenades (16)

1 case M26A1 Fragmentation Grenades (30)

1 case M7A3 CS Gas Grenades (16)

2 MI83 Demolition Charge (16 M112 C4 blocks ea.)

2 rolls primercord (304m)

10 M26A1 Detonators (8 second delay)

2 MI Timers * * - - -

1 M60 Fuse igniter

1 case M18A1 Claymore mines

1 case 9x19mm Ball (2880 rds)

1 case 7.62x51mm Ball (920 rds)

1 case 5.56x45mm Ball (1640 rds)

1 case 12 gauge magnum 00 buckshot (500 rds)

IV. DELTA BASE INTERIOR (SEE MAP IV)

A. The Loading Dock

Fully ten meters long and six meters wide, the loading dock is chipped and cracked, but intact. Enough flaking paint remains on its front face to show the words: REMAIN IN YOUR TRUCK! YOUR LOAD WILL BE REMOVED FOR YOU!, and a radiation warning trefoil. At the far right, a ramp leads from ground level

will slide open by retracting into the dome. The door rises at 1 meter per minute and is made of .5 meter thick steel.

to the dock. Originally it was wide enough to accommodate a V-150, however, due to erosion so much earth covers the dock that only an XR-311 or a Commando Scout can use the dock and reach the dome. The dock ends at a door in the dome. To the left of the door is a cardslot. The door is/was large enough to admit a V-150 with a 20mm cannon turret but it, like the dock, is partially blocked by earth. An XR-311 or Scout could still enter. **The cardslot is unmarked but** if an MPID is inserted, the door

Map IV

Each square equals 2.5 m.

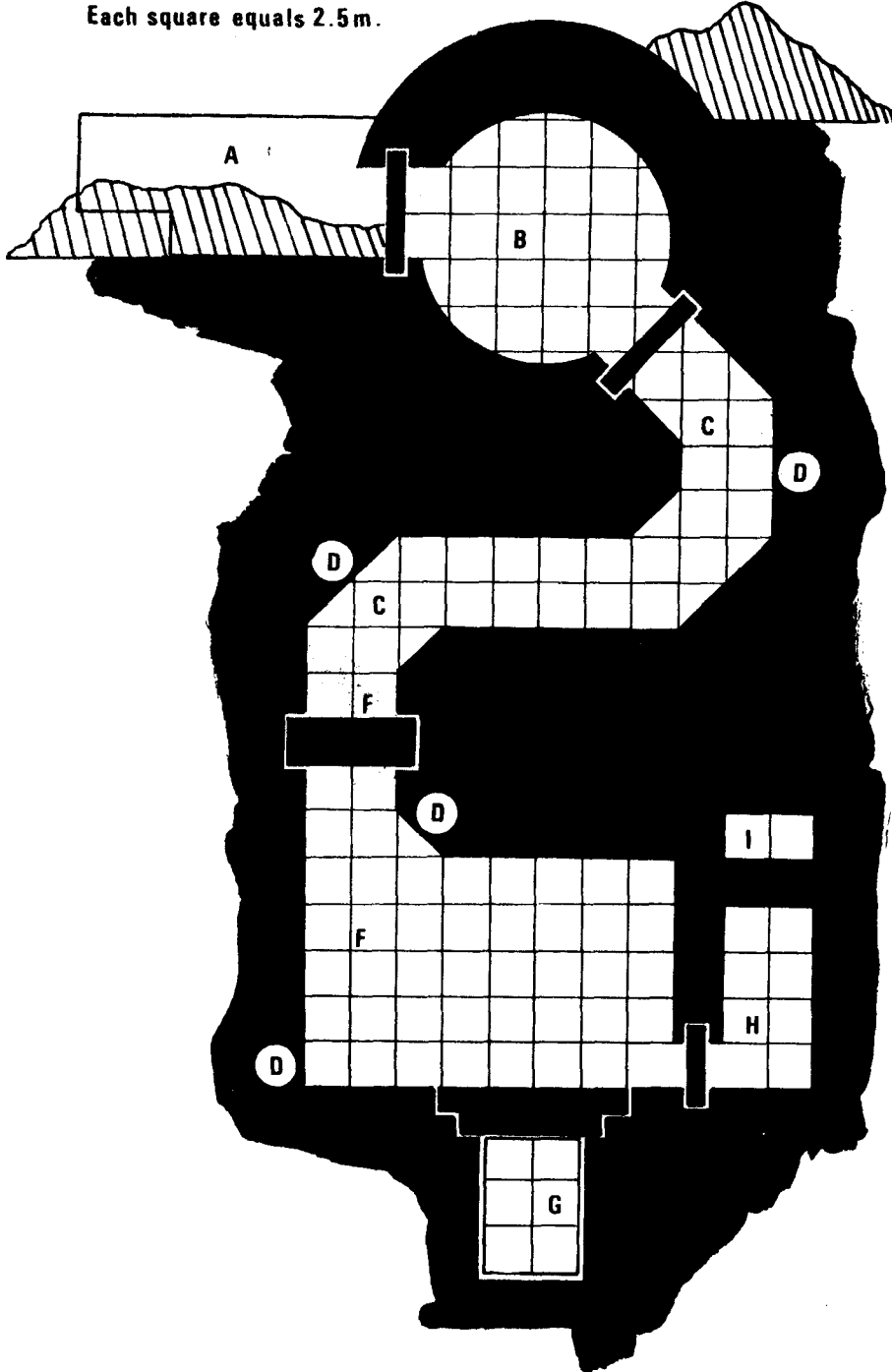

B. The Access Dome

The walls of the dome are several meters thick and the floor of the dome is some 17 meters across. The maximum interior height of the dome is about 10 meters. The floor is circular and slopes downward from the dock at a 30° angle. At the lowest point of the floor a blast door is set in the far wall of the dome. On the right side of the blast door is a card slot and the words: "INSERT MPID HERE."

The dome and its floor appears to be made of reinforced poured concrete. The dome interior is not lighted. It is quite "hot" inside with a RAD count of 20 per hour. As one approaches the blast door, the count goes up to a peak of 50 RADs per hour at the door itself. The door is 3 meters square.

Once opened, the door to the loading dock stays open for five minutes and then closes automatically. The door closes completely in 30 seconds and the player's don't want to be in its way!

PD NOTE: The floors in the dome and in the interior are very steep in order to discourage dismounted movement. Some floor areas in the dome are even steeper than 30° and only the obvious "path" from door to door is an even 30°. The blast door RAD count is intended to scare properly equipped intruders half to death. The obvious implication is that beyond the door lies a radioactive hell. The Team is not likely to be any wiser...

If an MPID is inserted at the blast door, the door will rise into the ceiling at the rate one meter per minute: the door is one meter thick. As the door rises, the RAD count will fall. Investigation will show that the corridor exposed is not at all "hot" but that the dome still is. The door closes after only two minutes and it too only takes 30 seconds to close. On the wall beyond this door is another cardslot. If a card is inserted here, both doors in the dome will rise, permitting rapid exit with minimal radiation exposure. A sign above the card slot contains this information.

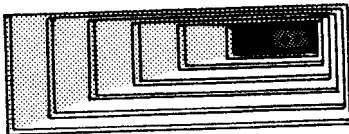

The Corridor

The corridor still slopes downward at 30° and turns sharply to the right. This bend is so sharp that V-158 vehicles entering will be forced to stop and reverse at least once to negotiate the corner since the corridor is only 5 meters wide. The ceiling is 3.5 meters above the floor and there is no source of light in the corridor.

The corridor is empty except for two skeletons slumped together in the center of the floor. These skeletons are also wearing Morrow Project coveralls, one with a MARS patch, the smaller one with a Recon symbol. A pair of M10 Ingrams lay rusted into lumps near their hands. The MARS suit bears the name tape FEDDERSEN but the ID card in the pocket is issued to ECON SCHMIDT JR. The name tape and ID of the Recon suit match. They read JORGE MONTERO. Both skeletons have been lethally hit by laser fire.

Ten meters beyond the bodies the corridor again turns sharply, this time to the left where it abruptly ends in a second, thicker blast door. Again the outer wall of the bend contains a pair of interior turrets mounted with lasers. The concrete around the mantlets is pocked by Ymm. automatic weapons fire. Like all the other turrets, these will track the Team at all times.

D. Interior Turrets

Set into the far side of the bend, opposite the center of the blast door, are a pair of recessed, mantletted turrets. Three meters above the floor is the primary weapon, an Mk3 laser. Below it, two meters above the floor, is an identical mantlet containing a 7.62mm. MAG58. Like the external mushroom turrets, the internal weapons are also equipped with shorter barrels but within the confines of the corridor the difference in accuracy is academic.

The only openings in the armored mantlets are for the recessed muzzles and the tiny armored sight/sensor group. A strike on these will disable the turret. The remainder of the mantlet is cast armor steel that moves within an armored housing set in the reinforced concrete of the walls.

Knocking out an interior turret requires a cumulative E-factor of 200. At an E-factor of 175, the turret will no longer track but it is still capable of firing its weapons should a target move into its line of fire.

The lasers draw their power from the base fusion plant and for all practical purposes have an inexhaustible supply of "ammunition". The 7.62mm. MAC 58's were entombed with 600 rounds per gun, all of which is intact. These guns have not been fired for 150 years, if at all.

When firing the 7.62mm. Mag58 interior turrets for the first time, roll a D10, 01-08 means that the weapon fires normally. 09 means that the ammunition feed is jammed and the gun won't fire. On a roll of a 10, the weapon misfires, detonates ammunition and the turret is destroyed. The blast radius from this explosion is 20 meters (frag.) and will disable the companion laser turret.

The lasers are Mk 3's the same as the lasers in the bowl. The chance to hit are the same for these weapons as for the mushroom turrets. The MAC 58's fire in 10 round bursts with the lasers firing in the same pattern as those in the bowl outside. The weapons' fire is controlled by the same rules as the ones for the mushroom turrets.

Inner Blast Door

Thicker than the first doors, the blast door is 2 1/2 meters of laminated armor steel. This door is also flanked by a small stainless steel plate with the familiar slot and the words "INSERT MPID HERE". Like the first, the inner blast door raises at a rate of one meter per minute and closes in slightly less than 2 seconds once the Team has passed. The movement of the first person through the door triggers several circuits within the areas beyond. Garage and quarter's lights come on, the door to the personnel area opens and the computer terminal activates for processing requisitions.

PD NOTE: The entry systems are designed such that only one door can be open at a time. When the Team has passed the first, it will close automatically, and the second door can be opened. If a vehicle or team member blocks the outer door, the inner one will not open.

When the door does come down, gravity slips it into place against recessed buffers with an impressive WHOOOSH-THUD.

F. The Garage

Beyond the blast door the garage opens away to the right. It is over 20 meters long and more than a dozen meters wide. Like the corridors, the ceiling is 3.5 meters above the floor but there are several flat lighting panels embedded into the ceiling and a series of small ventilation holes. In a deep notch just inside the door on the right is a third laser turret and in the far left corner,

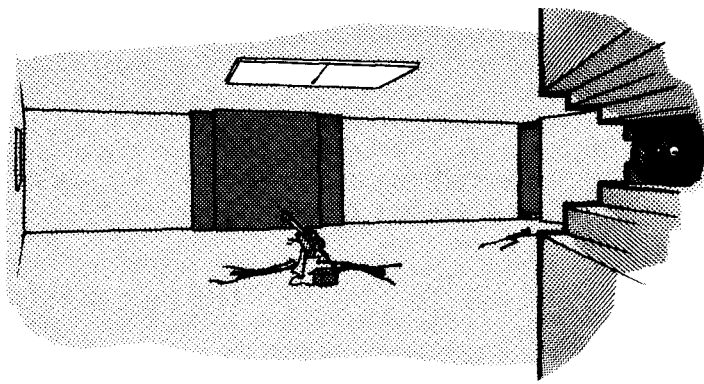

a MAC 58 turret. The unpainted concrete is damp and the air is musty.

As the lights come on, the Team will see a massive steel door and casing set into the far wall. A small, 15cm. deep hole is in the center of the far door and the cause, a Morrow Project Mk 3 laser, is still aimed at the door. The laser has been totally destroyed by fire from the laser turret near the door though the cable and fusion pack are intact. Also in the center of the room are two more skeletons, again in MP coveralls. Both have been hit by fire from the MAG58. One skeleton has a shattered skull and the other shows many broken ribs. Both are wearing MARS patches but neither of them have I.D. cards.

In the far right corner is the personnel door to the team quarters. It starts to rise at one meter per minute as soon as the Team enters the inner door. Slumped against the entryway to the quarters is a third skeleton, smaller than the two in the center and with the central torso destroyed by laser fire. The Morrow Project coveralls were little protection against the deadly fire. The name tape is gone but the coverall still bears the Recon patch and in the remainder of the left breast pocket, portions of an MPID issued to . . . AN HUGHES can be found.

Save for dust, dirt and a rusted Ingram M10 near the personnel door, the rest of the garage area is empty.

G. The Delivery lift

The connecting link with the underground warehouse, the delivery lift consists of a massive sliding block of steel in an armored shaft. The upper surface of the block acts as the floor of an elevator for items moving from the warehouse levels. The door, which is of the same construction, is controlled by the computer deep in the warehouse and not by an ID card.

Travelling at a stately one meter per minute, it reveals a massive steel box, the floor of which is a sliding block and the walls, the armored shaft. It resembles a bank vault and it is here that requisitioned supplies will appear. The block does not move until the door is completely closed, and the elevator will not descend if there is any weight remaining on it. Thus the Team will never see the block in motion. The delivery lift cycles at a maximum rate of three trips per hour.

H. The Team Quarters

The Team quarters aren't designed to be used permanently, nor are they desirable for that purpose. The quarters are a four by nine meter box, 3.5 meters in height. The end farthest from the door is slightly curved and contains a porcelain commode and a stainless steel sink, both dirty. The walls are lined with eight bunks with four bunks in two tiers against each wall. There are no mattresses, simply metal shelves on which to throw a bed roll. The computer terminal is mounted in the side wall opposite the entry. The screen is mounted flush with the wall and the keyboard protrudes from the wall for standing use.

Air Handling Equipment

Air is supplied to the team quarters, the garage and the corridor by a unit sealed in the walls of the base. With backup systems, it will continue to function for another 150 years. It draws air from small holes under the lip of the loading dock to the handler and filters and through a set of small tubes to the various rooms in the base. Ventilation is adequate but not good.

Theory, Operation and Control of Delta Base Defenses

It was never assumed that Delta Base would have to deal with a large-scale assault and with the Delta Teams in the area for support, the turrets were installed to deal with small bands of marauders or opportunists. In addition, unlike DAMOCLES, which was a military installation, the Base was forced to appear unarmed until the War started and so the cupolas were hidden below ground level and camouflaged.

The key lies in what the defenses were designed to handle. People with I.D. cards who use the obvious approaches can literally come and go as they please. Only activities which might damage the base will cause the defenses to activate. Even then, warning bursts will probably precede fire to kill.

The Fall of The Hammer

The Hammer was worried. The base in the ridge had stopped honoring the I.D. cards in his possession and he could find no more Morrow teams to plunder. Ammo was dangerously low and the locals were growing restive because his men were more hesitant to shoot. Already two of his men had disappeared. A show of terror was **in order but he was too short on hardware to be sure he could win** if a firefight broke out. Something had to be done.

The base had more stuff, it just wouldn't give it to him. But The Hammer was used to that; others had tried the same thing in the past. He smiled and started figuring how he could take what he wanted.

Pursued by the rabble from Starnaman's Hold, he and his band fled up the trail to the ridge. The armored cars were destroyed but The Hammer was sure he and his boys had enough goods to make the trip. They stopped at the fences and The Hammer gave his final orders.

"I'll keep Mitch with me and we'll stop 'em in the trees. You guys take the laser and go bust that damn thing open. Get bark here with more stuff as soon as you can."

The rest of the gang proceeded to the base, anticipating no trouble since there had never been any before. Inside they were able to set up the laser without interference but when the first burst went out, the garage turrets fired warning rounds. Alarmed but ignorant, the thugs fired again. This time the return fire was accurate and deadly.

With the laser crew dead and the weapon obviously destroyed, the three remaining murderers fled. Now alerted to the menace of the interior turrets, one man went ahead to open the doors while the other two covered. When the doors began to open, the covering men, with more guts than brains, fired on a turret. The man at the door heard their screams, the sound of their bodies falling and ran for his life, firing as he went. Once into the bowl he was cut down.

Back at the fences, Mitch and The Hammer were wondering where the others were. As time passed locals could be seen advancing from tree to tree. As darkness came The Hammer decided that he was on his own. Sounds of movement could be heard in the tall grass around them. Mitch broke. Typical of his kind, he could dish out terror but he could not face it himself. Suddenly standing, he screamed and began to fire wildly into the darkness. Pausing to change magazines, a crash of gunfire from all sides ended his life in a spray of blood.

V. Delta Plan: Control of Delta Base

The Delta Base computer is operating on contingency programs and backup systems. When the personnel of Prime Base were wiped out by a bio agent, the chain of command broke down **and** Delta Base was on its own. Designed primarily for supply inventory and handling, Delta Base is basically a vending machine and is incapable of sophisticated choices.

The original plan called for Prime Base to wake all the teams at the same time. When the local commander (HC-4) took control of the forces gathered at Delta Base he was to use his Command Access Card, call Prime Base on the computer's equipment, and report in. Upon receiving his report, Prime Base would flash back a coded signal to the computer and turn control of the base over to him. Naturally there were backups for everything from the death of the commander (HC-4) and his XO (A-9) to the destruction of Prime Base.

Unfortunately, all of these backups have been triggered. The local commander is still frozen in his bolthole. None of the remaining teams know of his existence. His XO, the MARS team leader, is dead. Prime Base does not answer.

Delta Base has excellent communication equipment but it is not being used. However, a 100 meter antenna can be raised and radio systems activated when the right conditions are met. At the moment, the gear is dormant.

The computer is still waiting with mechanical patience for the signal to turn control of the base over to someone but the coded signal must be received from another Morrow Project computer, either one at another major installation or from one aboard a MARS or Science-One vehicle brought to the local area.

The vending machine mentality of the base computer is limited to making decisions based on the only outside information it has: the Morrow Project I.D. cards and the team supply requisitions.

Requisitions are made through the computer terminal in the team quarters. This terminal is activated by an MPID. The terminal consists of a standard display screen and a very simple keyboard of unusual design. The keyboard and the screen function as a unit. When activated, the screen displays a list of materials identified as Class I items. Also present are instructions explaining how to use the keyboard to designate the desired items and quantities.

Computer Inventory Display

The inventory list is the only thing which will show on the computer screen without the use of a Command Access Card and it will be displayed whenever there are personnel inside the garage/personnel quarters area. The screen requests the entry of the team number and it will then display the message "CLASS I ITEMS AVAILABLE FOR REQUISITION" which will remain at the top of the screen. Below it is the a list of items. A cursor will be placed to the right of the first item. It will remain there until the operator enters a quantity or presses the 'NO' command key at which point the cursor will move to the next item. Holding the key down will cause the cursor to advance at the rate of one item per second. These instructions are printed above the list on the screen. The list is as follows:

CLASS 1 ITEMS

- Trailer, Utility, XR311 (250 Kilo Capacity) W/Hitch
- Trailer, Heavy, V-150 (1 Ton Capacity) W/Hitch
- Team Weapons: Replacement, Order Individually by Type (10 ea.)
- Team Weapons: Ammunition, Order by Type and Quantity (Cases)
- Vehicle Spares (Parts)
- Vehicle Tools
- Food Stocks: Morrow Project issue, Dehydrated (Ration Packs)
- Hand Tools, Farm, Carpentry, Metalworking, General: Specify Type

- Seed, 100 LB. Sacks: Specify Type
- Fertilizer, 100 LB. Sacks
- Non-MP Medical Kits
- Teaching Machine and Basic Library
- Individual Packs, MP Issue
- Individual Clothing Issue
- Coveralls, Resistweave
- Weapons, Local Issue:
 - Gun, M6 Survival, .22 Cal/.410 Ga
- Ammunition, .22 Cal Long Rifle, 100 Per Box, 10 Boxes Per Case
- Ammunition, .410 Ga Shell, 50 Per Box, 12 Boxes Per Case
 - Shot
 - Ball
 - Flare, Signal
- Coveralls, Cotton, Camouflage, Reversible, 2 Per Team Member
 - Fall/Winter
 - Spring/Summer
- Wire, Protective, Barbed
- Cans, 5 Gallon, Water/Gasoline
- Drill Rig, Vehicle Powered, 75m Depth, W/Trailer
- Drill Casing, 300m
- Hardware, General
- Fasteners: Nuts, Bolts, Screws: Order by Type and Qudntity
- Cable, Steel Braided, W/Hardware
- Cement, 10x50 LB Bags
- Glass, Window, 200 18"x24" Panes
- Kitchen, Portable, W/Trailer
 - Autoclave
 - Plates (250)
- Cups (250)
- Utensil Sets (250)
- Block and Tackle, 10 Sets W/Rope
- Bullhorns (4)
- Recharger, Battery, Solar Powered
- Water Treatment Unit, Portable, W/Trailer (Capacity: 40 Gal/
- ED**
- Sewage Treatment Unit, Permanent, W/Pipe (Capacity: 500 Persons)
- Press, Printing, Hand Operated W/100 Redms of Paper and Type
- Generator, Electrical, Multisource (Fusion/Solar/Wind)
- Chainsaws, Mulifuel
- Suits, Protective, Decontamination
- Fishing Equipment
 - Hooks and Line, Assorted
- Nets
- Plastic Sheet, 10 mil. 50 48"x500' Rolls
- Panels, Marker, Cerise, 2 Sets
- Medical Supplies and Equipment
 - Trauma
 - Decontamination (CBR)
- Maternity
- Pediatrics
- Public Health
- Medkits, Reloads (Large)
- Medkit, Reloads (Regular)
- Surgical Kits (Pack)
- Forge, Hand, Semi-Portable, Fusion-Powered
- Replacement Blades, Chainsaw
- Geiger Counters, Civilian Issue
- Civilian CBR Decontamination Kits
- Demolition Packs, MP Standard Issue
- Trauma Unit, Automated, Computerized, Portable, W/Trailer and Hitch**

The Team can receive anything on the Class I list. No indication is made of any other list though the Team may realize that "Class I" might imply other classes.

Communication with the computer is not possible. Not only will the machine not answer questions, there is no means provided to ask questions. The keyboard is composed only of command keys and a number pad. There are no alphabet keys and no voice comma.

While an MPID will uncork the flood of Cache Level/Class I items to any team entering Delta Base, the Delta Project Class II equipment will only be issued when the correct conditions are met. These conditions are described by a Stable Class I Supply Requisition Profile (a Stable Profile for short).

Stable Profile

A Stable Profile is indicated when the Team's Class I Supply Requisitions conform to the following:

1. Minimum ammunition for team weapons
2. Minimum foodstuffs
3. Medical supplies requested for community use
4. Construction supplies and equipment requested for community use.

All of these requirements must be met before Class II items will be released. The Team may make many visits to Delta Base, and can achieve a Stable Profile at any time although it probably won't happen until after at least a few visits.

When or if a Stable Profile is attained, the computer will automatically display the Class II list in addition to the Class I items.

CLASS 2 ITEMS

Vehicle, Morrow Project, V-150 Armored Recovery
 'A' Frame, Vehicle Mounted and Operated
 Winches, Dual
 Jacks, Folding, Vehicle Mounted
 Support Base, Vehicle Mounted
 Laser, Welding and Cutting, Manual, Vehicle Powered
 10m Power Cable and Take-Up Reel, Vehicle Mounted
 Lab, Chemical, Analysis and Limited Production, W/Trailer and Hitch
 Ammunition, Reloading Equipment (2 Sets)
 Press, Manual Production
 Dies, Reloading
 Cases, Cartridge
 Primers, Cartridge
 Bullets, Manufactured, By Type and Weight
 Gunpowder, By Type
 Scales and Measuring Equipment
 Magazines, Spares
 Molds, Casting
 Bullet, W/Lead (500 LBS.)
 Cartridge, W/Brass Alloy (500 LBS.)
 Library, Microfilm, Encyclopedic (4 Sets) W/1mx1mx1 1/2m Case Readers, Microfilm (1 Dozen Per Set)
 Morrow Project Vehicles: Replacements
 XR311
 Commando Scout
 Commando Ranger
 Commando V-150 APC
 Commando v-150 20mm
 Autonav, Spares
 Carotgraphic Set (Autonav Mapmaking)
 Microfilm Processor (Autonav Mapmaking)
 Dome, Geodesic, Portable, 10mx4m W/Multifuel Heater/Stove
 Scaffold Jacks
 Paint, Vehicle, Green, 100 Gallons

Workshop, Machine and Tool, W/Trailer and Vehicle PTO
 Medkits (Large)
 Medkit (Individual)
 Drug Kits (Pack)
 Wire, Protective, Concertina (Razor Tape)

From this point on the Team will be able to requisition supplies from either class.

Classes III and IV exist but have nothing to do with supply. Instead, they are items useful for MP command and control. Class III gives access to the base comms facilities. This requires an MPID and an MP Command Access card. When both are inserted in the machine, the screen will display common procedures and ranges, raise the antenna (which will come out of the ridge 60 meters from the bowl) and give instructions for attaching a vehicular computer keyboard and radio hand/headset to the base keyboard. This will allow either voice or CW (Morse) transmissions.

At no time will the Team see a radio. These modifications will not allow communications with the computer. The computer cannot communicate.

Class IV access comes with a Command Access card coupled with an order from a security rating of 5 or higher Morrow commander sent through a secure link with a MARS or Science vehicular computer. This process will give command of Delta Base to the Team concerned.

Command still does not permit comms with the computer as the computer has nothing to communicate. It does allow the Team access to the empty memory areas of the unit through their vehicular computer and this memory may be filled and used as an addition to their on-board computer. Command does not allow use of the base defense systems. Nor does it allow physical access to any other area of Delta Base. Thus command is not too big a deal. See the following table for a quick reference to the access levels and facilities available at each level.

LEVEL	DELTA BASE ACCESS LEVELS	
	REQUIREMENT	ACCESS
CLASS I	MPID	Cache level supply items and equipment. Basic level community assistance items.
CLASS II	MPID & STABLE PROFILE	Advanced equipment and critical supplies assigned to Delta Project.
CLASS III	MPID & COMMAND ACCESS CARD	Use of Base command communication equipment for contact with Prime Base
CLASS IV	MPID & EXTERNAL COMPUTER CODE	Command of Delta Base

COMMAND ACCESS CARDS:

This is a bearer card which allows the user access to the communications equipment contained in any automated installation of the Morrow Project. These cards are kept at Prime Base, and at the manned supply bases such as Isle Royale (see DAMOCLES, PF-02). They are for use by mobile command units, or special mission personnel.

EXTERNAL CODE SIGNAL

The code signal to assign command of the Base must come from a Morrow Project computer such as the main unit at Prime Base or at other major installations. It can also be delivered by the computers aboard either a MARS or Science One vehicle if they are brought into the local area. Like the Command Access Card, the code is kept at both Prime Base and at the major second echelon bases.

And what of The Hammer? After Mitch died, he tried to creep away into the darkness. He was taken alive before he reached the trees. The Hammer died neither quickly nor bravely.

His effects have been kept by the Starnaman Guild Council. They are put on display yearly to help keep the memory of evil alive. They are not much talked about so the Team would not hear about them from casual hearsay.

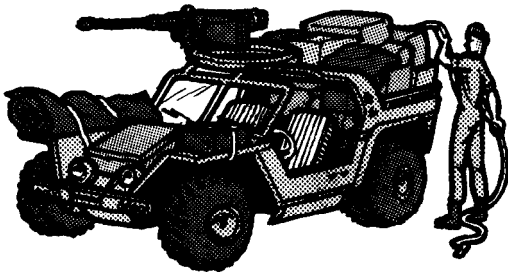

PLAY OF THE GAME

The Starnaman Incident has a lot to recommend it, but play of this module will vary greatly depending on whether the module is used as part of an existing campaign or whether Recon Team H-9 is raised. The comments which follow attempt to deal with either possibility.

When team H-9 is raised, the players will have unusual circumstances to deal with. They know that they are intended to support or be a part of a large Morrow Operation in the area, but they have no knowledge of who, what, when, where how or why. They will have to find what answers there are for themselves.

Further, the auto-nav shows only one cache instead of the usual six. Worse, the auto-nav has a blinking red triangle (Delta Base) and offers no explanations as to its identity, purpose etc. Is it the (or a) rendezvous point for the whole outfit? A warning? Or what? There is also the usual total confusion over the 150 year lapse with bad maps, no orders etc. And it gets worse.

Once out of the hole, the team must go somewhere. There are two tracks in the area that loosely parallel former roads. The towns marked on the auto-nav are ancient ruins. The river is not where it is supposed to be. The forest is thick and there are way too many wolf tracks (WOLVES?!) and it is too chilly for the apparent time of year. From the edge of the bolthole it is possible to see the smoke rising from Starnaman even if nothing, according to the map, is supposed to be over in that direction except, oh no! the CACHE!

Eventually the team will move out and will come into contact with something, either of the PD's creation or from the module. We recommend the Fergusson family.

Teams entering the area from other campaigns will also have Delta Base show up on their auto-navs as a flashing red triangle. The PD may wish for them to meet the Fergussons as well.

The Fergusson Family

The Fergussons are farmers who scratch a difficult living from the land. They are representative of the average family living outside Starnaman. They grow a variety of crops, raise animals and trade "winter crafts" to the Traders who stop by now and then. Their life is simple and harsh. The constant fight each year to grow enough to make it through the winter and be able to start again the next year is exhausting. The past two winters were close and Bailey Fergusson is driving himself harder, remembering the sparse crops of the past three harvests.

The Fergussons are ignorant (but not stupid!), superstitious and fearful of strangers not carrying trade goods. They have never been more than a few kilometers from their cabin but they are hard working, honest and decent people who have reason to be cautious living alone in the forest.

Bailey Fergusson, 28, husband and father of three, has been a farmer as long as he can remember. He knows nothing else and desires nothing more than a good harvest and an end to the Wolves. Bailey is a large man, 85 kilos or so and appears to have calluses everywhere. He will fight if threatened, drink if it's offered and remember a slight or a kindness for the rest of his life. His eldest son, David, was killed by wolves earlier in the spring and Bailey has not gotten over the loss. The remaining children stay near the cabin and only he goes to the fields, alone with their mule, hoping that he will be able to get back to the cabin before dark. He plows with two muskets slung on his shoulders and as a result has calluses in the middle of his back.

Anita Fergusson, 26, wife, mother and often defender of the home. She too is still grieving for David and is being overly protective of the remaining two children. She is a strong woman, large-boned and husky but she moves with a lightness belying her size. Of the two, she is the more suspicious of strangers, and probably would not open the cabin door to talk to a team member on foot, especially in coveralls! The Legend is Truth to Anita (as with most of the farm people in the area). Her fears are mostly for her two remaining children.

Annie Fergusson, 6, only daughter of the Fergusson's. She is bright little girl and she spends most of her time following her mother or sitting by the hearth tending her younger brother. She is curious and is inclined to try things she is almost capable of doing. She has shut David's death from her mind and simply "doesn't hear" anything said about him.

Joey Fergusson, 5, is the youngest child and is into everything. Like Annie, he is bright and curious but he is not yet old enough to be properly cautious. He understands about death; he saw a pig slaughtered once, but he does not seem to understand about David's death. He spends most of his time inside the cabin looking into the fire and saying nothing. Outside it is a full time job to keep an eye on him but he too is wary of strangers and runs for the house at the sight of anyone other than his immediate family. Inside he is a scared little boy.

Under the circumstances, the most the Team is likely to learn from the Fergussons is that there is a town, Starnaman, and it's the place where strangers generally go and that anybody they ask can tell them how to get to Starnaman.

The people in the area are not unfriendly, they just don't trust strangers. The Team can get to know these folks but it takes some time. Weeks, months, or years depending on who you are and what you do. They are decent people and if a team member showed up alone in the middle of the night and badly wounded, they'd let him in and help him to the limit of their ability. Even wearing Project coveralls. Of course he'd likely be tried and hanged once he recovered but first he'd be given a chance to say his piece.

But nobody is going to talk to anyone in a vehicle, or displaying MP patches and/or coveralls. Folks will vanish at the sight of such people. At the same time, nobody is going to start shooting unless they are directly threatened. Since people know the difference between real danger and an unfortunate misunderstanding, they don't take up arms lightly.

When they do fight they fight to win. If either an MPV or coveralls are seen, word will reach Starnaman within hours. Shortly thereafter (probably the same day or early the next) all able-bodied men for miles around will gather and a hunt will begin. Feuds will be set aside and years of 'coon hunting experience will come to the fore.

Ambush and raid become the game as the quarry (i.e. the Team) is stalked. These tough men know every inch of the land and believe that they are fighting for their lives and their families. They do not want to die, they will try to stay alive, but they will sacrifice their lives if they feel they must. They will wait and watch for the best time and place to attack.

Given the chance, they will avoid slaughter. For the world of the Morrow Project, this is a civilized time and place. If possible, the Team will be taken captive and put on trial before the Guild Masters. Justice is important to them and they have no taste for a cold-blooded lynching.

A trial is, in fact, the desired result, both to suit local feeling and for the joy of play. Being a "Morrow Person" is of course worth an automatic death sentence. There may be mitigating circumstances, services to people in the past, perhaps even saving a life. Even though the people of Starnaman look upon Morrow People as demons incarnate, they don't want to hang anybody. Unless there is proof of some evil done, they'd like to give people they're supposed to hang a chance.

Of course, mitigating circumstances can be damning as well. Manslaughter, mayhem, truce breaking etc. and the premier offenses of endangering, threatening, kidnapping or killing a child. All of these are unforgivable and will give them more than enough reason to hang the Team. We don't know how a team could talk its way out of such a situation, but perhaps it can be done. Though for child slaying, no trial might be necessary. For this, the locals might spend years and chase the perpetrators across the continent.

Children are the single most important facet of the Starnaman community. They embody the life, hopes and dreams of all of Starnaman. Everything within reason is lavished upon children. They are watched and guarded and loved by everyone within the community.

It may take a while to notice this. The people do not handicap their children by making their lives too easy. And while a child's life is free, it is liberally sprinkled with spankings, chewing outs and extra chores. The love and regard lavished upon children does not show all at once, it is too basic a part of the culture. It works both ways too. If the Team can somehow get the children on their side...

Should the Team make it to Starnaman without arousing the ire or suspicions of the local populace, other possibilities open up. The inn of Trader Camp is a good place for information as well as drink and bad company. "Hamhand" is a good source and will give good, accurate advice, particularly concerning trade and prices, if he thinks the team members are "decent folks".

Here the Team can hear The Legend of the Morrow People in full. This is especially true if they have not heard it before as everyone in the area longs for the chance to tell the tale to a virgin audience. It is the local epic and everyone will want to participate.

Assuming proper interest is shown (as is likely), the locals can even show the team the "Pit in the earth whence came the demons." This is the bolthole of A-9. It is filled with wreckage but it is a venerated site.

As for the team cache, it lies a mere 50 meters from the town walls, it has long since been plundered by "A-9". The hole has been taken over by a local farmer and is used as a root cellar; it's filled with potatoes. The locals do not associate it with the Morrow People.

In Starnaman the team will be able to buy many things. Some of them may even be worthwhile but remember that the team is fully supplied and the locals are very sharp traders. One thing is not for sale: local clothing. Usually people trade for bolts of cloth and make their own clothes. The team will have to do the same or make other arrangements. Their trade pack gold and silver will be welcome but it will not go as far as it might if the team earns a reputation as suckers.

We recommend that the PD have a good time with Starnaman and its people. While "civilized" it is still a lusty, brawling frontier town. Detours into Low Town offer myriad possibilities including knife fights, drinking bouts, sharp trading, petty theft, and feuds. Fun or not, a team will know they are alive!

And never ignore the potential of an "unmasked" team. If the Team manages to pass as something other than Morrow Project people, sooner or later the secret will come out. When the revelation is made a trial must be held. A nighttime procession with torches and the whole town in attendance worked well in playtesting.

Sooner or later, the Team is bound to go and investigate Delta Base. Make the most of the fear of the unknown. Don't make it too easy for the Team to realize the passive nature of the defenses. Use the high radiation levels for maximum effect. When opening the final door in the access dome the Team will be sure that the radiation on the far side of the door will be enough to fry their eyeballs. They will be expecting nothing less than a radioactive hell beyond the door. During playtesting, some teams never entered Delta Base proper because of this fear despite the obvious Morrow entry checks.

Once inside it's time to consider the skeletons and the turrets. The Team will not be certain under what conditions the weapons will fire. There are remains of what might be A-9 lying about. The 9mm. marks on one turret and the obvious attitude of the laser might provide clues: Delta Base shoots only in self-defense. There is certainly no one to tell them this, least of all the Delta computer.

The computer and computer console/keyboard are another fine area for adventure. This computer is non-communicative! It is not bright, just well programmed. It is not Damocles; it does not think. Attempts to reason with this machine will drive the Team to tears while in no way impressing the machine. You can't reason with it, it doesn't care. It may help to think of the computer as an automated supply clerk and guard: a vending machine with a gun.

The base will hand out any and all of the Class I items. This can cause the Team problems in that the loading dock is partially blocked. The Team can, literally, get more stuff than they can carry. Remember the 300 downslope they must pass down to get to the supply point. It is now a 300 vertical obstacle to getting the plunder out. And once items have come up on the lift, there is no way to send them back down. The garage area can begin to look like a junkyard in fairly short order.

The living quarters are no prize. There is **not even privacy when the latrine is used**. There is no shower and no climate control. It's damp, too bright and uncomfortable by design. There are no cooking arrangements. It's about as hospitable as an IRS waiting room and the Team should be made to feel the same desire to escape.

There is no practical limit to the stores of Delta **Base; one team cannot exhaust** them in any reasonable amount of time. We feel the decision of how many Delta Base goodies to **allow the Team should be** made by the individual PD. The PD must also make the final decisions concerning how much the Team knows about Class II items, The computer might display them while refusing to give them to the Team. It's not a good idea to let the Team know about the stable profile requirement. Generally speaking, the computer might refuse further requisitions after five **heavy** ammo orders.

If a stable profile is achieved, the Team might be allowed unlimited access to Class I and II items. The final decision on what and how much a team gets must rest with the PD. We **don't** want to run your **campaign**. Feel free to add or delete items. You might want to bear in mind the mission of the site: a supply depot for reconstruction, not an arsenal. The weapons and vehicles present are intended as replacements, not reinforcements.

Once the Team does achieve a stable profile, it can be as much fun as Christmas. This is particularly true if the team has given up on Class II thinking perhaps that they do not have the right cards. It's a nice surprise to walk in one day and be allowed new goodies for no apparent reason.

Class III access will allow the Team to use the base communication equipment. On a good day they can establish contact with Damocles. Regular communication with areas as far away as Chicago becomes a near certainty. Delta Base thus becomes a prime retransmission site for the central part of the continent.

The biggest advantage of Class IV access is that it will allow the Team to turn off the defenses (but not control them!). This is no mean thing.

The locals avoid the base area. Even if they are in pursuit of Morrow People they are most unlikely to enter even the intimidation zone, though if the Team has taken child hostages this **may change**. It is possible for a "human wave" assault to overrun the base defenses but the locals must be desperate to try it. The odds against the locals would be enormous. If forced to this extreme, the locals will, if they can, kill all the Morrow People. Inside the bowl they might try to burn the Team out. Piling wood and brush on the loading dock and dome and ighting it would in no way harm the base. Remember though, that the air system draws its flow from the loading dock. This would smoke the Team out; remember, gas masks do not solve a lack of oxygen! Team members within the base are also blind and deaf to what goes on outside.

Any way you look at it, it's going to take the Team years to bring up and deploy the equipment which Starnaman alone could use. Not only because of transport and manpower difficulties, but also due to local resistance. It will take time to convince people of the superiority of new-fangled ways. The locals are conservative for good reasons, mostly having to do with survival. One significant failure can effect all other projects in progress. Losing a life in the mini-med would be a real set back. However, the Team can convince the locals with long and sweaty hours of careful work. Delta Base by itself will not help. It takes thoughtful use of the goodies and a keen appreciation of what Starnaman is and how it works to fulfill the plan of the Delta Base designers.

Ideally played, there won't be much shooting in this module. The one exception to this is the wolves. Run the **wolves** smart, fast and deadly. There are a lot of them in the Starnaman area because the hunting is good. They form a fairly tight ring in the countryside and very little moves without their noticing it. So far, attacks on humans have been rare. This will change as winter comes again.

One of the best ways the Team can make an entrance into local life is as accomplished wolf hunters. The wolf problem is on everyone's mind and if the Team talks to the Fergussons, or another farmer, they will hear about it. No one will hire the Team to hunt wolves, but **a big wolf pelt** in good condition will fetch a good price in the Trade Camp. It will also do good things for the reputation of the hunter.

Remember that the whole A-9 mess will be a mystery to the Team. Did a MARS team turn renegade? How? What really happened? We are providing no answers for the Team. As in the real world some things just have no easy explanation and nobody gets all the answers they want.

If you choose, you can reveal the identity of Hammer to the Team through his personal effects which have been kept by the masters of Starnaman. He was an egomaniac and he might have kept pre-War news clippings about himself. Or a journal. A record book. It's up to you. Don't make the revelation come too **soon**, let the mystery have time to fester in the minds of the Team.

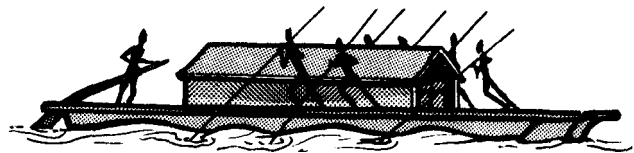

DESIGNER'S NOTES

The Starnaman Incident was designed with the needs of a campaign in mind. It has been nearly two years since Timeline published PF-01, "Riverton" and by now, four modules later there must be a lot of teams who are low on everything.

And not only in campaigns that use our modules. Project Directors using their own creations may be looking for a way to re-supply teams. Delta Base will be useful to either type of game.

The "idiot" form that the base takes is purely intentional. This is for three reasons:

1. Ease of use and modification for the PD
2. Resistance to misuse by a Team
3. "Damocles confusion"

The first point received the most attention, The base had to be easy for the PD to use either within the "Morrow Mythos" or as a "plug-in" for a home grown campaign. It had to run itself to allow the PD leisure for the important task of conducting the game as a whole. Since no two games ever run in exactly the same way, the base had to lend itself to modification. This is most true in resupply items available. Class I and Class II items can be moved about at will without affecting the base. Class III and IV are open to the whim of a PD who can decide what these classes mean. We *do* think that the PD should maintain Delta Base in its role as a support facility, primarily offering equipment to help with the task of reconstruction. No tanks, aircraft, nuclear weapons etc.

Teams will have a rough time abusing the base because it is an idiot. it can't be outsmarted because it does not think.' For those who have trouble with this idea, think of a rifle trigger: if it is **not** pulled, the weapon will not fire. If it is pulled, it will go off. Delta Base is as simple as that. Conditions dictate its actions and there are no modifiers. Teams trying to finesse this machine are not only wasting their time but may also receive a rude shock.

Teams may still try to finesse the machine and this is especially true of teams who have matched wits with Damocles. This is the Damocles confusion factor. Playtesting has shown that teams who have encountered Damocles credit Delta with the same attributes. When Delta fails to respond to team cunning and innovation, teams usually assume that Delta is even more advanced than Damocle despite the simpler, more obvious and true conclusion. (Some playtesters are learning this as they read these words for **some of** them refused to believe our honest answers to their indignant questions, preferring to await publication for "the real truth".)

Some PDs **may** find this situation a problem but we think that, handled properly, it's an asset to the game. Confusion in the face of **the** unknown is a good thing to throw in the path of a jaded and worldly team. The more so in that engaging in this frolic means that they are fighting themselves and their overactive imaginations. If nothing else, it is fun to watch.

If H-9 is going to be raised, the PD may want to deal still more jokers into the game. Try to postpone the Team's encounter with Delta Base for as long as possible. You might confuse things further by introducing another team, haggard and shop worn, perhaps from Chicago, and looking for Delta Base. This move works well when H-9 has gotten used to the idea of being on their own and on good terms with the locals and feeling a bit cocky about their skills.

The remaining Delta Teams provide a good way for the PD to replace troops lost in the course of the campaign. Up until now the PD has had to fend for himself in this matter, usually providing replacements from the ranks of the locals. While this is not all bad, it was time to allow some way for trained personnel to get back into the game.

Likewise, if the Team has come from Chicago, encountering one of the Delta teams may be quite a shock to a team used to operating on their own. And, from a campaign standpoint, the possibility of the base commander's team waking up can be used if the H-9 gets out of hand. Having to answer some embarrassing questions about their actions will often force a team to consider more carefully what they do in the future.

New Morrow Project People may have a detrimental effect on the mental attitude of the people of Starnaman. This is especially true if they know that there are lots of Morrow People somewhere else. It's one thing to get used to a few demons and admit that they might be decent folks, but if you know that all the legions of hell are just a few hundred miles away...

Keep in mind that there is an opposite side to the river. According to TM1-1, somewhere on that side is the center of Krell power. **As** the Starnaman establishment gains in notoriety, uninvited company may come to town.

The winters are getting harder and the wolves are moving south. Those who have played in Damocles will recall the extreme weather farther north. This is because an ice age is beginning.

It had been on its way for quite some time but The War has accelerated it. Nobody's noticed it yet since they didn't have the equipment or the time to look. Prime Base might have detected it if it was **still functioning and someone asked the right questions**. It will not affect games too much just yet, but keep it in mind. Ice ages do not become obvious overnight and it will be awhile before the glaciers arrive...

Good luck.

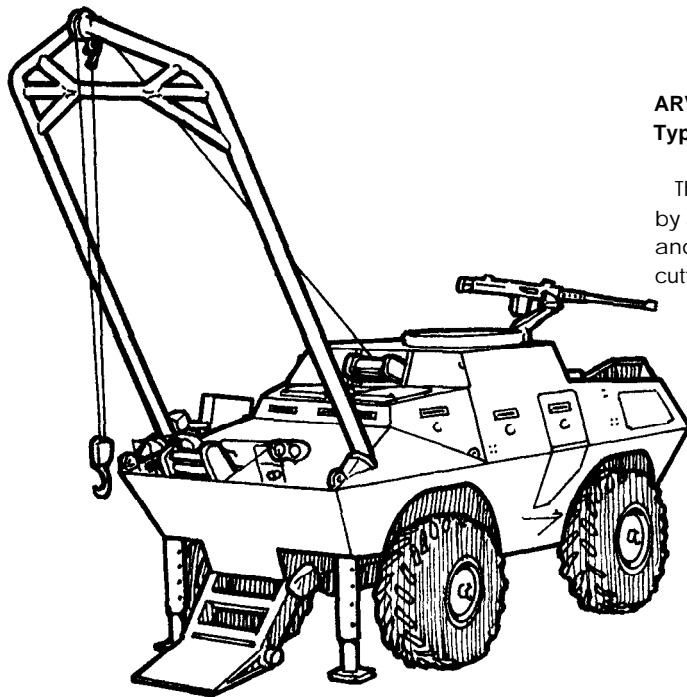

ARV Cutting and Welding Laser (Vehicle Mounted)

Type: 10m laser Wt.:5.2kg Rg.:30m E-Factor:15/sec Power: 200Kw

This is essentially a hand operated HAAM suit laser tethered by a 10 meter power cable to the vehicle-mounted take-up reel and vehicle reactor. The laser's primary use is the welding and cutting of metals. It requires two hands to operate for fine work.

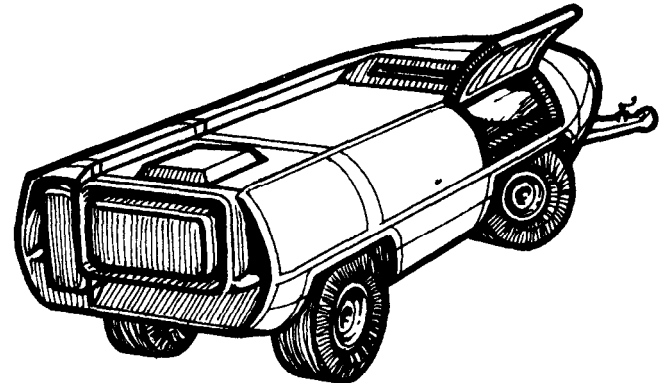

NEW EQUIPMENT

NAME: V-150 Armored Recovery Vehicle

Crew: 2 (6)
 Length: 5.71m
 Width: 2.26m
 Height:(M2HB) 3.38m
 'A' Frame Lift Wt.: 4500kg
 Ground Clearance: .381 m
 Turning Radius: 8.382m
 Road Speed (Max.): 88km/hr
 Fording Depth: Amphibious
 Water Speed (Max.): 4.7km/hr
 Gradient: 60%
 Vertical Obstacle: .914m
 Trench: .5m
 Armor Class: 100
 Armament: (1)M2HB

The V-150 Armored Recovery Vehicle is designed to recover disabled vehicles using its winches and support base as well as lifting heavy objects using the vehicle-mounted winch and 'A'frame mounted at the front of the vehicle.

Because the primary job of the ARV is the recovery of damaged vehicles, it is equipped with a Mk 1 cutting and welding laser which draws its power from the vehicle via a 10 meter power cable. Defensively the laser is almost useless as it is meant to be used on things no more than a few feet away. it's main use is to cut away damage to allow a vehicle to be move or to reweld broken components in the field in order to get a disabled vehicle operational.

To prepare the ARV for heavy lifting (2000-4500kg), the jacks at the front corners must be manually lowered and placed solidly then the front-mounted support base lowered hydraulically and positioned firmly. The 'A' frame is lifted from its traveling position to its erect (lifting) position and actuated from the central winch control. The cable is attached before lifting. Neither the vehicle nor the 'A' frame can be moved while lifting; this is not a turret crane which can move loads from side to side. The set-up time for two men is about 2 minutes when they are completely familiar with the procedure. If not, it can take hours to get it all right.

Trauma Treatment Unit, Emergency Medical, Automated, Computerized, Portable, Trailered, "Mini-Med"

This unit is closer to a prototype than a production model. It works, but... The trailer unit requires an MPV to power it while it is functioning and it ran require anywhere from five minutes to an hour per patient depending on the severity of the casualty.

It is a trauma unit designed to handle post-holocaust medical care on a production line basis. It is fully automated, seals during use and makes drastic decisions. It keeps people alive and sometimes not much else. Any team member who has seen the unit's handiwork will not enter the mini-med as long as they have the power to resist. It will save lives 90% of the time if the casualty is not on the verge of death.

The following table gives the results of the mini-med. Roll a D10 and consult:

01-04	Return of function; serious scarring but full rehabilitation
05-08	Some loss of function (roll 1D6: 10%-60% disability).
09	Amputation of extremities, minimum survival level for internal organs, patient crippled
10	Death; victim beyond mini-med capabilities

The mini-med unit contains supplies to deal with 100 average trauma injury victims. This is the unit's load and one reload. Reloads are available at Delta Base.

Height: 1 3/4m Width: 2m Length: 3.29m Crd Clr: .425m Weight: 985kg Road Speed: 30km/hr

The mini-med unit cannot be moved by an XR-311 except on smooth, flat terrain and then **only with difficulty**. However, the XR-311 will power the mini-med. **The mini-med has an armor class of 9 but is fragile, hence the low road speed. Note that 2.5km/hr is for the best road conditions.**

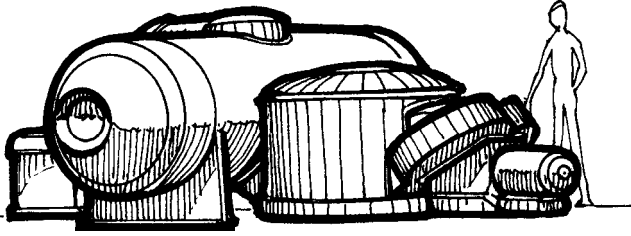

Waste Treatment Unit, Thermal Conversion

Because civilizations have never existed without waste and garbage, disease and pestilence have always been a major danger to survival. To deal with this problem, the Delta Base planners included a highly sophisticated, fusion-powered waste treatment plant for permanent installation.

It consists of two, one tonne loads, which, when erected, will process 2.5 kilos of raw sewage per person per day for a maximum of 500 people. The residue, a gray-white powder, is sterile and makes a good fertilizer, improving crop yields by twenty-five percent.

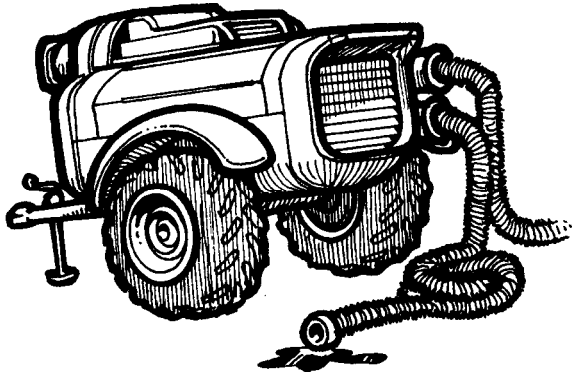

Water Treatment Unit, Portable, Trailered

The universal need for uncontaminated water led to the inclusion of this portable unit. It can process 40 gallons of water in one hour and is powered by a vehicle reactor. The unit is primarily a tank with self-contained decontamination/filtration unit. Should the filters of the feed clog, the unit shuts down.

Water quality is monitored to assure purity of output. The unit can be operated and towed by an XR-311. All inlet and outlet fittings are 5cm (2 inches) in diameter. The unit includes pump and 10 meters of inlet/outlet pipes.

Trailers:

One Tonne Flatbed, 4 Wheel, Sprung, V-150

This is a one tonne (1000kg) capacity platform trailer for use with the V-150.

Deck Ht.:	11/2m
Width:	2m
Length:	4m
Road Speed:	50km/hr
Cr. Clr.:	.396m
Off Road Speed:	2.5km/hr
Armor Class:	N/A

250kg Closed Utility, 2 Wheel, Sprung, XR-311/Ranger/Commando Scout

This is a quarter tonne (250 kg) capacity box trailer for use with smaller MPVs.

Ht.:	1.6m
Width:	1.9m
Length:	2m
Box:	1m x 1.9m x 2m
Road Speed:	50km/hr
Cr. Clr.:	.485m
Off Road Speed:	10 km/hr
Armor Class:	9

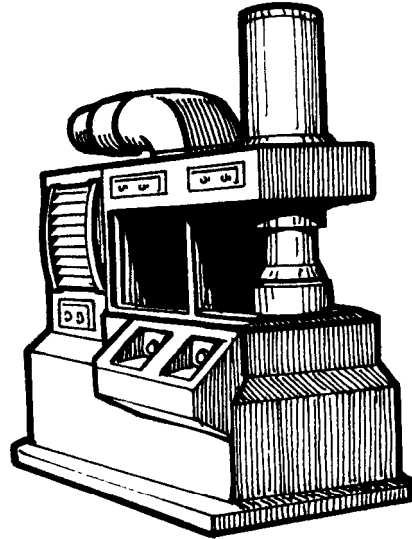

Forge, Hand, Semi-Portable, Fusion-Powered

This unit consists of a combination fusion furnace for heating and smelting ore, and a small (30kg-900kg) hand controlled power forge. It was included for reclamation of pre-War scrap metal and will recycle it to produce anything from nails to bar stock. Capable of handling high-carbon steel, it is most at home with more malleable metals. Includes dies and die-making materials

Ht. (to stack):	1.96m
(to ram):	2.6m
Width:	1m
Length:	1.86m
Weight:	228.5kg
Operator:	1 person
Transportable as two loads:	104kg, 124.5kg

All flintlock weapons are prone to delayed and mis-fires. At the PD's discretion, when firing a flintlock ignited weapon, roll ID20 and check the table below for the results:

01-10	Weapon goes off correctly
10-15	Ignition delayed by one second; reduce acc total by 10%
16-20	Weapon mis-fires and does not go

NAME:	M6 SURVIVAL GUN
Caliber:	.22 cal (Over)
	.410 Ga. (Under)
E-Factor (.22):	5
(.410):	3
Weight (empty):	1.13 Kg.
Effective Range:	200m (.22)
	20m (.410)
Maximum Range:	2400m (.22)
	40m (.410)
Type of Fire:	Single Shot
Rate of Fire:	8 rpm
Feed Device:	Break Action
Load Weight:	N/A
Total Weight:	N/A

The M6 was first issued to U.S. airmen of WWII. It fires a .22LR (long rifle) round or a .410 shot shell. The weapon has two barrels mounted one above the other (an "over and under") the top barrel for the .22 rifle, the lower for the .410 shotgun. It was intended that the rifle be used for self-defense, the shotgun to take small game; it is a true "survival" rifle.

This no-frills design makes for an extremely ugly but remarkably sturdy weapon. The sights are adequate for use within the stated effective ranges. Compartments in the stock hold 9 rounds of .22 and 4 rounds of .410. The weapon fires one round at a time, after which the fired barrel must be reloaded. The .410 and the .22 cannot be fired together.

PD NOTE: Neither round will penetrate Project coveralls. This was a factor in the selection of this weapon for issue to locals. It is an efficient game getter and it is issued with 50 rounds of .22 and 20 rounds of .410. Requesting it from Delta Base will help a team to achieve a stable profile.

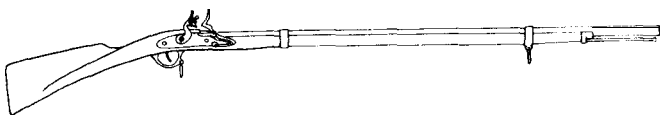

NAME:	F.J. Smalley .80 Cal. Musket
Caliber:	.80 cal.
E-Factor	13
Weight:	6.0 kg.
Effective Range:	50m
Max. Range:	180m
Type of Fire:	Single Shot
Rate of Fire:	4 rpm
Feed Device:	N/A
Feed Device Weight:	N/A
Basic Load:	50 rounds
Load Weight:	2.4 Kg.
Total Weight:	8.4 Kg.

F.J. Smalley is representative of the two middle-ranked gunsmiths in Starnaman and his .80 musket is the local Basic Standard that is most often carried by the locals. It fires a spherical lead ball eight tenths of an inch in diameter which does its damage primarily from impact. It is a short range weapon and an adversary can cover considerable ground while the shooter takes fifteen seconds to load and prime his musket for a second shot.

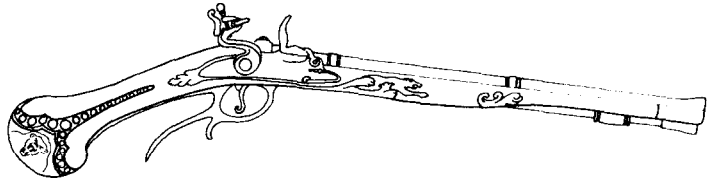

NAME:	Hackley .80 cal. Horse Pistol
Caliber:	.80 cal.
E-Factor:	8
Weight:	2.5 Kg
Effective Range:	12m
Max. Range:	90m
Type of Fire:	Single Shot
Rate of Fire:	4 rpm
Feed Device:	N/A
Feed Device Weight:	N/A
Basic Load:	Musket Load
Basic Load Weight:	N/A
Total Weight:	N/A

The Horse Pistol is nothing more than the old Dragoon Pistol. The theory is that a heavy, long-barreled pistol is easier to aim and fire from horseback. True or not, they have become a status symbol around Starnaman. Most are heavily carved, inlaid or etched and it is not uncommon for a man to have more money in his horse pistols than his musket.

People who carry them usually carry them on either side of the saddle. An interesting note: people who have to depend on their firearms usually don't waste their money on pistols. T.J. Barlow doesn't make them and the Hackley's are the worst (it is appropriate to roll for a mis-fire with every shot with a Hackley horse pistol).



NAME:	Barlow .50 Cal. Percussion Rifle
Caliber:	.50
E-Factor:	14
Weight (rifle):	4.4 Kg.
Effective Range:	320m
Max. Range:	800m
Type of Fire:	Single Shot
Rate of Fire:	1 1/2 rpm
Feed Device:	N/A
Feed Device Weight:	N/A
Basic Load:	Variable
Load Weight:	2.5 Kg.
Total Weight:	6.9 Kg.

T.J. Barlow is the best gunsmith in the local area and the .50 caliber rifle has been a family specialty for three generations. His rifles are accurate and get the most out of the poor quality black powder that is generally available. He is experimenting with fulminate of mercury (percussion) caps brought from Memphis Village and he now offers his rifles and muskets with the option of percussion ignition instead of the traditional flintlock. Shown here is the most expensive rifle in Starnaman with percussion ignition and an Everet Pickman stock built to the buyers specs.

In practical terms, the problem with any muzzleloading rifle is the time necessary to tightly wad and ram home the bullet. This reduces the usefulness of the weapon. Rifles of this type are usually owned by the wealthy as status symbols or by expert marksmen who only get one shot.

Additional technical and historical information on black powder weapons can be found in Damocles.

The three weapons listed here may be used as representatives of the basic types (rifle, musket and pistol), as well as the two ignition systems (flintlock and percussion). For those who wish to equip the locals with a wider range within each type, the chart shown below will be useful.

Mississippi River Muzzleloaders

The quality and accuracy of individual types of firearms varies from one gunsmith to another as well as from weapon to weapon. Each weapon is hand made, no two are alike and each bears the imprint of the craftsman who made it. The guns of T.J. Barlow are made to the highest standards in the area and get the most out of the low-grade powder available. Those of the Harkley & Sons gunsmithy are barely serviceable when new, they are sub-standard and not carried by knowledgeable locals. The two smaller smithys turn out solid workmanship, thus filling the middle-ground. The more expensive weapons are all made to order while cheaper ones come "off the shelf".

The following chart by no means covers all the types and variations created by the smithys of Starnaman but it is a representative sample of the more common types:

TYPE	GUNSMITH	CALIBER	E-FACTOR	WT.	EFF. RG.	MAX. RG.	ROF
MUSKET	Barlow	.80	13	5.9kg.	55m	200m	4rpm
	Smalley	.80	13	6.0kg.	50m	180m	4rpm
	Hackley	.80	13	6.0kg.	45m	160m	4rpm
	Barlow	.60	11	5.5kg.	60m	200m	3rpm
	Smalley	.60	10	5.6kg.	55m	175m	4rpm
	Barlow	.60	11	5.5kg.	60m	200m	3rpm
SHORT MUSKET (Shotgun Load)	Barlow	1.00	10	3.8kg.	35m	75m	3rpm
	Smalley	.80	8	4.0kg.	40m	100m	4rpm
	Hackley	.80	8	4.1 kg.	35m	80m	4rpm
RIFLE	Barlow	.50	14	4.4kg.	320m	800m	1.5rpm
	Smalley	.50	14	4.6kg.	285m	760m	1.5 rpm
HORSE PISTOL	Smalley	.80	9	2.5kg.	15m	120m	4rpm
	Hackley	.80	8	2.5kg.	12m	90m	4rpm
SHORT PISTOL	Smalley	.80	a	1.2kg.	10m	100m	4rpm
RIFLED PISTOL	Barlow	.50	11	.9kg.	15m	250m	1.5rpm

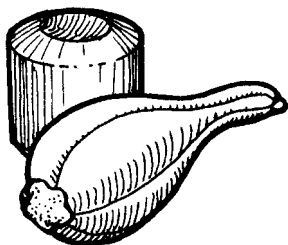

NAME: Mustard Gourd
 Weight: Variable (1/4 kilo avg.)
 Fuse Delay: N/A
 Effective Radius: 11/2m (very variable)

Comments:

Mustard gourds are the local equivalent of tear gas. A thin, brittle gourd is filled with powdered mustard seeds and the opening is capped with clay. When thrown, the gourd bursts dispersing the cloud of flour-fine mustard particles.

The effects of this irritant include tearing of the eye, gagging, sneezing, coughing and respiratory distress. The effects last for several minutes. The more official versions, carried by the Sheriff's Deputies at Town Gate for crowd control, are contained in thin pottery casings. A wide range of optional fillings are occasionally seen during feuds.

ARMOR TABLES: COMMANDO V-150 w/81mm MORTAR

TABLE A1: FRONT

DIE ROLL	AREA HIT
1-22	Wheel
23-27	Axle
28-51	Right Bow
52-77	Left Bow
78-82	Winch
83-87	Upper Hull; Right
88-95	Upper Hull; Center
96-100	Upper Hull; Left

TABLE A2: FRONT/SIDE

DIE ROLL	AREA HIT
1-18	Front Wheel
19-27	Rear Wheel
28-40	Right Bow
41-52	Left Bow
53-55	Winch
56-58	Upper Hull; Right
59-62	Upper Hull; Center
63-65	Upper Hull; Left
66-73	Side, Front
74-84	Side, Center
85-95	Side, Rear
96-100	Side Door

TABLE A3: SIDE

DIE ROLL	AREA HIT
1-15	Front Wheel
16-30	Rear Wheel
31-45	Side, Front
46-68	Side, Center
69-92	Side, Rear
93-100	Side Door

TABLE A4: SIDE/REAR

DIE ROLL	AREA HIT
1-9	Front Wheel
10-27	Rear Wheel
28-34	Side, Front
35-46	Side, Center
47-58	Side, Rear
59-62	Side Door
63-77	Right Rear
78-100	Left Rear

TABLE A5: REAR

DIE ROLL	AREA HIT
1-22	Wheel
23-26	Axle
27-55	Right Rear
56-84	Left Rear
85-100	Rear Door

TABLE B1

	WEAPON CLASS							Flame
	A	B	C	D	E	F	G	
Chance of Penetration	99%	99%	99%	99%	80%	50%	01 %	No Effect

NOTE: Penetration by an A or B class weapon on a V-150 automatically causes a "catastrophic kill." A catastrophic kill causes the total destruction of the vehicle, its contents and occupants.

TABLE B2

ARMOR TABLES: COMMANDO V-150 w/81 mm MORTAR

AREA HIT	STRUCK BY		EFFECT	
	AP	HE		
Wheels and Axles	75%	90%	Vehicle Immobilized	
Right Bow	10%	15%	Vehicle Immobilized, Drive Train Damaged	
	30%	55%	Detonate ammo stores	
	15%	25%	Computer Damaged; will not function	
	10%	20%	Auto-nav Damaged; will not track	
	10%	15%	Radio damaged; will not operate	
	60%	80%	Kill/Wound Radio Operator	
	05%	10%	Kill/Wound Driver	
Left Bow	05%	10%	Kill/Wound Passengers	
	15%	20%	Drive Train Damaged; vehicle immobilized	
	05%	10%	Detonate ammo stores	
	15%	25%	Driving controls damaged	
	10%	20%	Radio Damaged; will not operate	
	05%	10%	M21 Damaged; will not function	
	60%	80%	Kill/Wound Driver	
	05%	10%	Kill/Wound Radio Operator	
Winch	05%	10%	Kill/Wound Passengers	
	05%	20%	Destroy AN/TVS-5 binoculars	
	80%	90%	Winch Destroyed. Other Effects are the same as for Right Bow	
	Upper Hull Right	40%	60%	Detonate ammo stores
		05%	10%	Computer damaged; will not function
		10%	15%	Auto-nav damaged; will not track
		05%	10%	Radio damaged; will not operate
05%		20%	Laser Rangefinder Destroyed	
70%		90%	Kill/Wound Radio Operator	
10%		20%	Kill/Wound Driver	
Upper Hull Center	05%	10%	Kill/Wound Passengers	
	05%	15%	Detonate ammo stores	
	10%	15%	Auto-nav Damaged; will not track	
	10%	15%	RF Damaged; will not function	
	10%	15%	Radio Damaged; will not operate	
	10%	15%	Driving Controls Damaged	
	40%	60%	Kill/Wound Radio Operator	
	40%	60%	Kill/Wound Driver	
Upper Hull Left	10%	20%	Destroy Mortar	
	05%	10%	Kill/Wound Passengers	
	05%	15%	Detonate ammo stores	
	10%	15%	Auto-nav Damaged; will not track	
	05%	10%	Radio Damaged; will not operate	
	10%	20%	Driving Controls Damaged	
	05%	20%	AN/TVS-5 Binoculars Destroyed	
Right Side Front	70%	90%	Kill/Wound Driver	
	10%	20%	Kill/Wound Radio Operator	
	05%	10%	Kill/Wound Passengers	
	10%	20%	Radio Damaged; will not operate	
	10%	20%	Auto-nav Damaged; will not track	
	20%	30%	Computer Damaged; will not function	
Right Side Front	30%	40%	Vehicle Immobilized; drive train damaged	
	20%	30%	Computer Damaged; will not function	
	10%	20%	Auto-nav Damaged; will not track	
	10%	20%	Radio Damaged; will not operate	
	50%	70%	Kill/Wound Radio Operator	
05%	10%	Kill/Wound Driver		

AREA HIT	STRUCK BY		EFFECT	ARMOR TABLES: COMMANDO V-150 w/81mm MORTAR
	AP	HE		
Right Side Center	60%	80%	Detonate Ammo Stores	
	30%	50%	Destroy Mortar	
	20%	30%	Kill/Wound Radio Operator	
	20%	30%	Kill/Passengers	
	10%	40%	Laser rangefinder destroyed	
Right Side Rear	70%	90%	Detonate Armbrusts/Claymores	
	20%	30%	Vehicle Immobilized	
	40%	60%	Supply packs damaged; 50% destroyed	
	20%	60%	AN/PRC-70 Radio Destroyed	
	05%	10%	Kill/Wound Passengers	
Left Side Front	30%	40%	Drive Train Damaged; Vehicle Immobilized	
	20%	30%	Driving Controls Damaged	
	10%	20%	Radio Damaged; will not operate	
	10%	20%	M21 Rifle Damaged; will not function	
	10%	30%	AN/TVS-5 Binoculars Destroyed	
	50%	70%	KilkWound Driver	
Left Side Center	60%	80%	Detonate Ammo Stores	
	30%	50%	Destroy Mortar	
	20%	30%	Kill/Wound Driver	
	20%	30%	KilkWound Passengers	
Left Side Rear	40%	60%	Detonate Ammo Stores	
	80%	90%	Drive train damaged; Vehicle Immobilized	
	05%	10%	KilkWound Passengers	
Side Doors	85%	90%	Door Damaged; Will not open/close. Other effects as for appropriate Side/Center hit.	
Right Rear & Rear Door	70%	90%	Detonate Armbrust/Claymores/81mm Ammo	
	80%	90%	Door Damaged; Will not open/close	
	40%	60%	Supply pack damaged; 50% destroyed	
	05%	10%	KilkWound Passengers	
Left Rear	80%	90%	Vehicle Immobilized	

NOTES ON THE COMMANDO V-150 81mm MORTAR VEHICLE:

The V-150 along with its TOW mounting twin was issued only to MARS units or teams expected to directly support MARS teams. The vehicle has an awesome fire capability but its usefulness is limited. 150 years after the War, there are not many targets which require engagement by the mortar.

Using the mortar is a time consuming process. The weapon and its mount fold for travel and must be erected and locked in place prior to firing. The 81mm rounds must be individually unpacked, the charge set and only then can they be fired. The V-150 must be reasonably level and stationary. The gun must be carefully layed and perhaps realigned after each round to compensate for vehicle shift. Assuming a dead cold start with the MPV in motion, it will take not less than five minutes before the first round leaves the tube.

Usually it will take longer. Sighting a mortar for accurate fire is a real joy and no one ever knows where the thing will really hit until a round comes down. The Auto-Nav changes this. The Auto-Nav keeps track of the vehicle's position and therefore of the mortar's position as well. If the Team knows where they want to fire and can plot it on the Auto-Nav display, then the device can determine the charge, fusing, gun lay and time on target. All the team has to do is the physical work.

Assuming good target location data, a first round hit is automatic. As long as the Auto-Nav knows where it is, it will hit the point plotted on the screen. If the team is mistaken as to the target's location, the Auto-Nav cannot help.

Use in this mode requires faith on the part of the team for they may not be able to see the target when they fire. If the Auto-Nav is not used, an observer will be necessary to direct and adjust fire on the target. This is much more difficult.

The mortar can be dismounted and used away from the V-150. The Auto-Nav can still plot fire as long as all of the conditions mentioned above are met and the Auto-Nav is programmed with the precise (and accurate) location of the weapon. Adjustment will be necessary as the base plate digs itself in during firing.

The mortar, its pedestal and the recoil system can be removed from the vehicle. In this form the V-150 can become a high capacity hauler. The Morrow Planners had such use in mind as the primary use for the vehicle.

With the mortar in place and the basic load intact the interior is crowded. The right door, the back door and the rear hatch cannot be reached from within. Most of the room is taken up by ammo. If this goes off there will be nothing left, the V-150 will come apart like an overpressured beer can. Messy.

There are two pintle mounts centered fore and aft on the fighting compartment extension. 7.62mm or 5.56mm machine guns can be mounted on either but using them will require the top doors to be open and the gunners exposed. These weapon mounts are intended for close-in emergency defense: while running away.

ARMOR TABLES: COMMANDO V-150 ARMORED RECOVERY VEHICLE

TABLE A1: FRONT

DIE ROLL	AREA HIT
01-16	Wheel
17-20	Axle
21-30	Right Bow
31-40	Left Bow
41-53	Support Base/Winch
54-57	Right Jack
58-61	Left Jack
62-65	Upper Hull Right
66-72	Upper Hull Center
73-76	Upper Hull Left
77-81	Cupola, Right
82-91	Cupola, Center
92-96	Cupola, Left
97-00	'A' Frame

TABLE A2: FRONT/SIDE

DIE ROLL	AREA HIT
01-13	Front Wheel
14-20	Rear Wheel
21-24	Right Bow
25-28	Left Bow
29-34	Support Base/Winch
35-36	Right Jack
37-38	Left Jack
39-40	Upper Hull Right
41-42	Upper Hull Center
43-44	Upper Hull Left
45-50	Side Front
51-58	Side Center
59-67	Side Rear
68-71	Side Door
72-74	Cupola, Front Right
75-78	Cupola, Front Center
79-81	Cupola, Front Left
82-91	Cupola, Side
92-00	'A' Frame

TABLE A3: SIDE

DIE ROLL	AREA HIT
01-11	Front Wheel
12-22	Rear Wheel
23-33	Side Front
34-52	Side Center
53-69	Side Rear
70-75	Side Door
76-87	Cupola
88-97	'A' Frame
98-00	Base/Jacks

TABLE A4: SIDE/REAR

DIE ROLL	AREA HIT
01-07	Front Wheel
08-21	Rear Wheel
22-26	Side Front
27-34	Side Center
35-42	Side Rear
43-45	Side Door
46-57	Right Rear
58-75	Left Rear
76-83	Cupola, Side
84-91	Cupola, Rear
92-00	'A' Frame

TABLE A5: REAR

DIE ROLL	AREA HIT
01-17	Wheel
18-20	Axle
21-45	Right Rear
46-62	Left Rear
63-73	Rear Door
74-89	Cupola, Rear
90-00	'A' Frame

TABLE B1

	WEAPON CLASS							FLAME
	A	B	C	D	E	F	G	
Chance of Penetration	99%	99%	99%	99%	80%	50%	01%	NO EFFECT

NOTE: Penetration by an A or B class weapon on a V-158 automatically results in a "catastrophic kill". A catastrophic kill causes the total destruction of the vehicle, its contents and occupants.

AREA HIT	STRUCK BY		EFFECT
	AP	HE	
Wheels and Axles	75%	90%	Vehicle Immobilized
Right Bow	10%	15%	Vehicle Immobilized, Drive Train Damaged
	—	05%	Detonate ammo stores
	15%	25%	Computer Damaged, will not function
	10%	20%	Auto-nav Damaged, will not track
	10%	15%	Radio damaged, will not operate
	—	05%	Winch Locker hit, equipment damaged
	60%	80%	KilkWound Radio Operator
	30%	40%	Kill/Wound Gunner/Winch Operator
	05%	10%	KilkWound Driver
	05%	10%	KilkWound Passengers
Right Jack	60%	80%	Jack Disabled; Lifting capacity limited. Other effects are the same as Right Bow
Left Bow	15%	20%	Drive Train Damaged; Vehicle Immobilized
	05%	10%	Detonate ammo stores
	15%	25%	Driving controls damaged
	10%	20%	Radio Damaged; Will not operate
	05%	10%	M21 Damaged; Will not function
	05%	20%	AIVNS-5 Binoculars Destroyed
	60%	80%	Kill/Wound Driver
	30%	40%	Kill/Wound Gunner/Winch Operator
	05%	10%	Kill/Wound Radio Operator
	05%		Kill/Wound Passengers
Support Base & Winch	70%	80%	Base Destroyed; Lift capacity limited. Other effects are the same as Right Bow.
Left jack	60%	80%	Jack Disabled; Lift capacity limited. Other effects are the same as Left Bow.
Upper Hull Right		05%	Detonate ammo stores
	05%	10%	Computer damaged; Will not function
	10%	15%	Auto-nav damaged; Will not track
	05%	10%	Radio damaged; Will not operate
	05%	10%	Forward Winch Controls Destroyed
	70%	90%	KilkWound Radio Operator
	40%	50%	Kill/Wound Gunner/Winch Operator
	10%	20%	Kill/Wound Driver
05%	10%	Kill/Wound Passengers	
Upper Hull Center	—	05%	Detonate ammo stores
	10%	15%	Auto-nav Damaged; Will not track
	40%	60%	Forward Winch Controls Damaged
	10%	15%	RDF Damaged; Will not function
	40%	60%	Lifting Base Controls Destroyed
	10%	15%	Radio Damaged; Will not operate
	10%	15%	Driving Controls Damaged
	40%	60%	Kill/Wound Radio Operator
	05%	10%	Kill/Wound Gunner/Winch Operator
	40%	60%	Kill/Wound Driver
	05%	10%	KilkWound Passengers
Upper Hull Left	—	05%	Detonate ammo stores
	10%	15%	Auto-nav Damaged; Will not track
	05%	10%	Radio Damaged; Will not operate
	05%	10%	Lift Base Controls Damaged; Will not operate
	10%	20%	Driving Controls Damaged
	05%	20%	AN/TVS-5 Binoculars Destroyed
	70%	90%	Kill/Wound Driver
	10%	20%	Kill/Wound Radio Operator
	10%	20%	Kill/wound Gunner/Winch Operator
	05%	10%	Kill/Wound Passengers

AREA HIT	STRUCK BY		EFFECT	ARMOR TABLES: COMMANDO V-150 ARV
	AP	HE		
A' Frame	60%	80%	'A' Frame Damaged; Cannot be used	
	50%	70%	'A' Frame Hydraulic Positioning Unit Damaged	
	10%	20%	'A' Frame Hinges Jammed; Cannot be erected	
Right Side Front	30%	40%	Vehicle Immobilized; Drive train damaged	
	20%	30%	Computer Damaged; Will not function	
	10%	20%	Forward Winch Controls Disabled	
	10%	20%	Auto-nav Damaged; Will not track	
	10%	20%	Radio Damaged; Will not operate	
	05%	10%	Lift Base Controls Damaged; Will not operate	
	70%	90%	Kill/Wound Radio Operator	
Right Side Center	10%	30%	Kill/Wound Driver	
	50%	70%	Detonate Ammo Stores	
	20%	50%	Damaged Mk 1 Laser; Will not function	
	05%	10%	Laser Power Cable Reel Lammed; Will not operate	
	30%	20%	Winch Damaged; Cannot be used	
	20%	30%	Winch Controls Destroyed	
	50%	60%	Kill/Wound Gunner/Winch Operator	
Right Side Rear	20%	30%	Kill/Wound Radio Operator	
	20%	30%	Kill/Passengers	
	40%	60%	Destroyed Winch Locker & Accessories	
	50%	70%	Detonate Armbrusts/Claymores	
	40%	60%	Kill/Wound Passengers	
	20%	30%	Vehicle Immobilized	
	30%	30%	Hand Tools Destroyed	
Left Side Front	30%	50%	Power Tools Destroyed	
	30%	50%	AfVPRC-70 Radio Destroyed	
	20%	60%	Detonate .50 Cal. Ammo	
	40%	60%	Kill/Wound Passengers	
	05%	10%	Kill/Wound Passengers	
	30%	40%	Vehicle Immobilized; Drive train damaged	
	20%	30%	Driving Controls Damaged	
Left Side Center	10%	20%	Radio Damaged; Will not operate	
	10%	20%	Lift Base Controls Damaged	
	10%	20%	M21 Rifle Damaged	
	10%	30%	AN/TVS-5 Binoculars Destroyed	
	50%	70%	Kill/Wound Driver	
	05%	10%	Kill/Wound Radio Operator	
	Left Side Rear	70%	90%	Detonate Ammo Stores
20%		50%	Damage Mk 1 Laser, Will not function	
05%		10%	Laser Power Cable Reel jammed; Will not operate	
30%		20%	Winch Damaged; Cannot be used	
20%		30%	Winch Controls Destroyed	
10%		20%	Destroy Winch Locker & Accessories	
50%		60%	Kill/Wound Gunner/Winch Operator	
Side Doors	20%	30%	Kill/Wound Driver	
	20%	30%	Kill/Wound Passengers	
	10%	20%	Destroy Vehicle Maintenance Tools	
	40%	60%	Detonate Ammo Stores	
Right Rear & Rear Door	80%	90%	Vehicle immobilized; Drive train damaged	
	05%	10%	Kill/Wound Passengers	
	85%	90%	Door Damaged; Will not open/close. Other effects as for appropriate Side/Center hit.	
	40%	60%	Detonate Armbrust/Claymores	
Right Rear & Rear Door	80%	90%	Door Damaged; Will not open/close	
	30%	30%	Hand Tools Destroyed	
	30%	50%	Power Tools Destroyed	
	20%	60%	AN/PRC-70 Destroyed	
	40%	60%	Detonate .50 Cal. Ammo.	
	05%	10%	Kill/Wound Passengers	

AREA HIT	STRUCK BY		EFFECT
	AP	HE	
Left Rear	80%	90%	Vehicle Immobilized
Cupola, Right Front	60%	80%	Supply Packs (Ration) Damaged; 50% destroyed
	40%	80%	Portable Winch/Base Controller Destroyed
	20%	60%	Laser Rangefinder Destroyed
	20%	40%	Detonate .50 Cal. Ammo
	05%	20%	Winch Controls Destroyed
	40%	60%	Kill/Wound Gunner/Winch Operator
	05%	10%	Kill/Wound Passenger
Cupola, Center Front	80%	90%	Disable Winch Rollers; Winch inoperable
	20%	40%	Winch Destroyed
	40%	30%	Detonates .50 Cal. Ammo
	40%	50%	Winch Controls Destroyed
	40%	60%	Kill/Wound Gunner/Winch Operator
	10%	20%	Damage Mk 1 Laser
	05%	10%	Kill/Wound Passenger
Cupola, Left Front	60%	80%	Supply Pack (Trade) Destroyed
	40%	60%	Detonate .50 Cal. Ammo
	30%	50%	Detonate Ammo Stores
	10%	30%	Mk 1 Laser Damaged
	10%	30%	Destroy Vehicle Maintenance Tools
	40%	60%	Kill/Wound Gunner/Winch Operator
	10%	20%	Kill/Wound Passenger
Cupola, Right Side	20%	40%	Detonate .50 Cal. Ammo
	10%	40%	Portable Winch Controller Destroyed
	20%	60%	Laser Rangefinder Destroyed
	30%	50%	Winch Controls Destroyed
	05%	10%	Detonates Ammo Stores
	30%	30%	Disables Winch Tower Winch Inoperable
	20%	40%	Supply Packs (Ration) Damaged; 50% destroyed
	50%	60%	Kill/Wound Gunner/Winch Operator
	10%	20%	Kill/Wound Passenger
Cupola, Left Side	20%	40%	Detonate .50 Cal. Ammo
	05%	10%	Detonate Ammo Stores
	05%	10%	Disables Winch Tower; Winch Inoperable
	30%	50%	Winch Controls Destroyed
	20%	40%	Trade Pack Destroyed
	10%	40%	Laser Rangefinder Destroyed
	50%	60%	Kill/Wound Gunner/Winch Operator
	10%	30%	Kill/Wound Passenger
Cupola, Rear	80%	90%	Detonate .50 Cal. Ammo
	40%	60%	Winch Controls Damaged
	20%	60%	Laser Rangefinder Destroyed
	10%	50%	Portable Winch/Base Controller Destroyed
	10%	30%	Trade Pack Destroyed
	20%	40%	Supply Packs (Ration) Damaged; 50% Destroyed
	20%	10%	Winch Tower Disabled; Winch Inoperable
	50%	60%	Kill/Wound Gunner/Winch Operator
	10%	30%	Kill/Wound Passenger
	05%	10%	Kill/Wound Radio Operator
	05%	10%	Kill/Wound Driver

Map I

Each square equals 1KM.

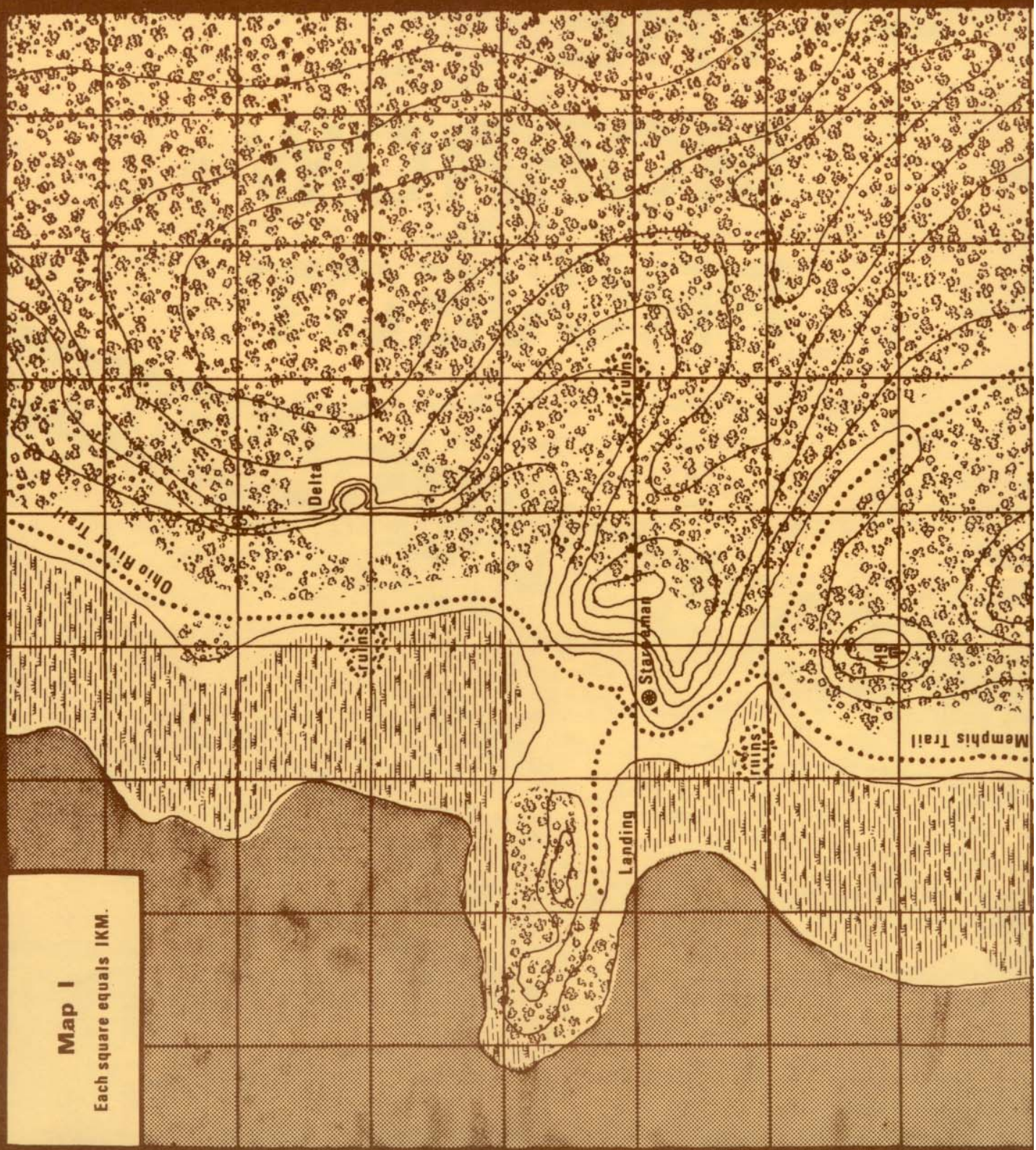

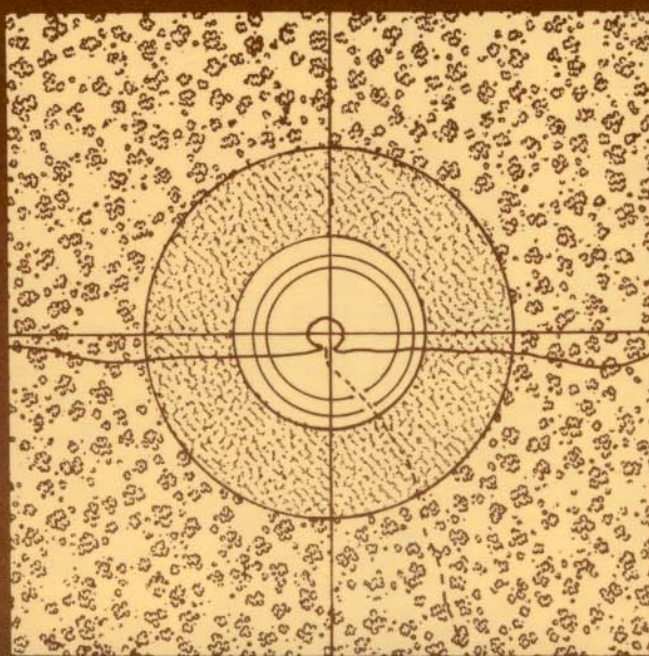
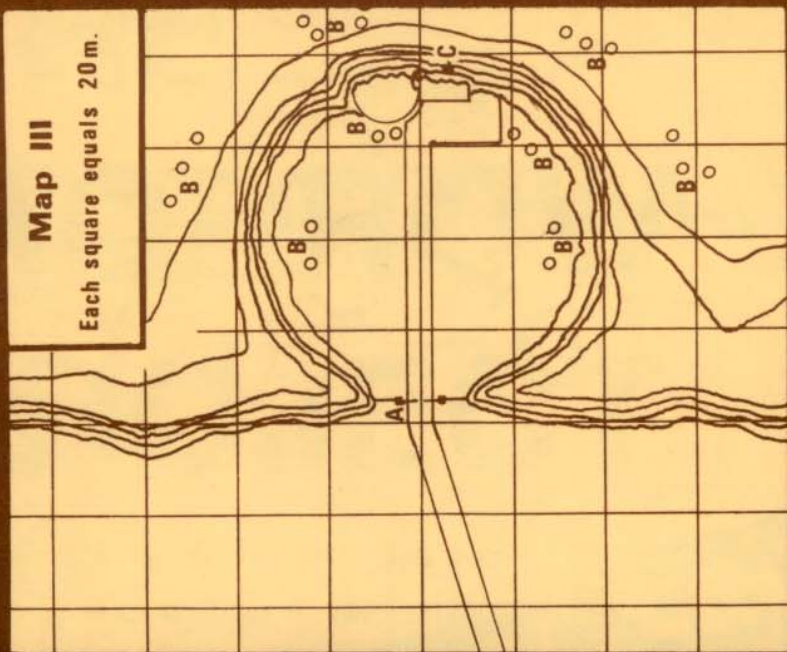
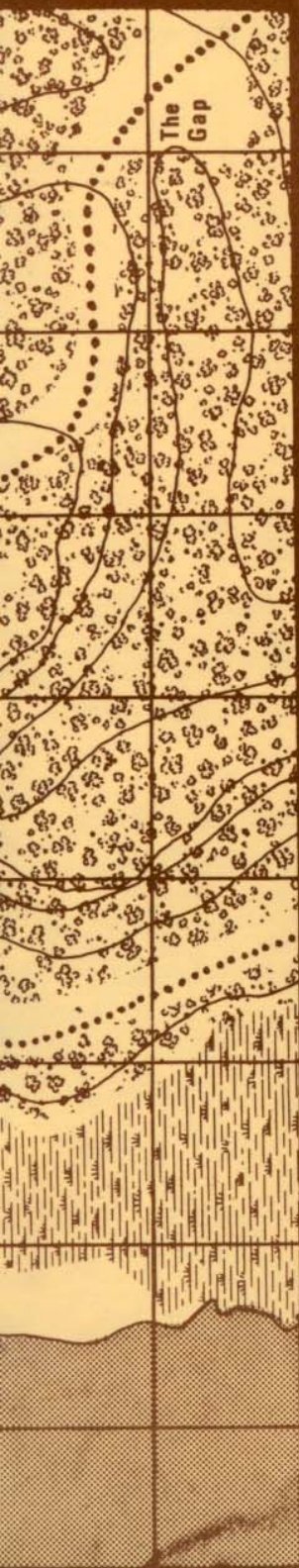

Map II
Each square equals 1KM.

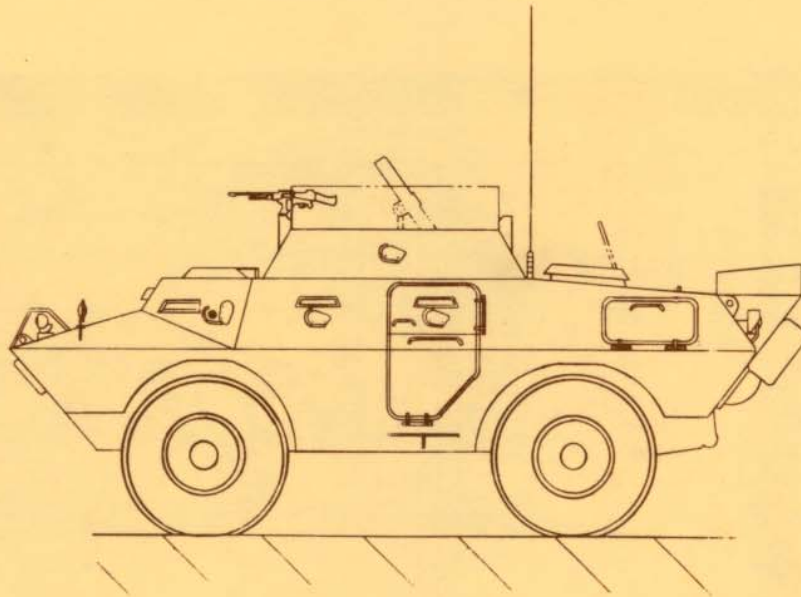

One hundred and fifty years ago the people of Starnaman fought a bloody war of liberation. For over ten years they struggled against a reign of terror. Team H-9 finds itself enmeshed in a legend of horror and hatred passed down to people that they do not know. Worst of all, neither the legend nor the evidence makes any sense...

This game package contains all of the information, maps and systems necessary for the Project Director to run this scenario. The package also includes information concerning new weapons, the interior of the Commando V-150 81mm Mortar Carrier, the new V-150 ARV and an automated Morrow Project support facility containing vehicles, tools, supplies and more.

POSSESSION OF THE MORROW PROJECT GAME BOOK IS NECESSARY TO THE USE OF THIS GAME PACKAGE.

©Timeline Ltd. 1984



TIMELINE LTD