



# S.H.I.E.L.D.™

## A MARVEL SUPER HEROES™ game supplement by William Tracy

S.H.I.E.L.D. (Supreme Headquarters International Espionage Law-Enforcement Division) is an international organization independent of all governments. Its job is to seek out and destroy those threats which endanger mankind and the Earth itself — be they terrestrial or from other worlds. S.H.I.E.L.D. was formed in the early 1960s to oppose the growing power of the organization known as HYDRA™. Nick Fury™, a CIA agent and hero of World War II, was made the agency's public director. Since its beginning, S.H.I.E.L.D. has played a major role in the world's defense, fighting villains and criminal forces, with and without the help of the other Marvel Super Heroes™.

### Casebook and history

S.H.I.E.L.D. has fought many opponents over the last two decades. Some of the most challenging cases are briefly described below — though not in chronological order.

**HYDRA:** HYDRA was a secret, highly-organized group that planned to conquer the world using advanced technology. HYDRA was created by a group of Japanese subversives, but it was taken over by the ex-Nazi Baron Wolfgang von Strucker at the end of World War II. Though von Strucker had been one of Hitler's top men, he soon had a falling out with the Fuehrer and had to flee Germany before the war's end.

Von Strucker came to Japan and became the secret leader of HYDRA by assassinating the former one. He built a small island in the Pacific, and soon HYDRA scientists were learning how to make nuclear weapons. A band of American commandos called the "Leatherneck Raiders" and a group of Japanese commandos known as the Seven Samurai joined forces and destroyed the island, but von Strucker escaped.

Over the next fifteen years, von Strucker slowly rebuilt HYDRA and set up his headquarters in America. During this time, two branches of HYDRA were

created: A.I.M. (Advanced Idea Mechanics), which created the scientific weaponry for HYDRA, and THEM, which supervised the efforts of HYDRA and other subversive organizations.

By the early 1960s, HYDRA had agents all over the world and an arsenal that was larger than that of most nations. It



NICK FURY™

was then that S.H.I.E.L.D. and Nick Fury came on the scene. Baron von Strucker and Fury were bitter enemies from the Second World War, though Fury was not aware at first that von Strucker was HYDRA's leader.

After Fury became S.H.I.E.L.D.'s director, HYDRA tried to blackmail the world with its orbiting Betatron Bomb. While Tony Stark de-activated the Bomb, Fury and his men captured HYDRA's New York office. After that defeat, A.I.M., THEM, and the Secret Empire attacked S.H.I.E.L.D., while HYDRA quietly rebuilt. Von Strucker had stayed out of the picture and assumed many false identities, including that of John Bronston, an agent of S.H.I.E.L.D. Once again he took control of HYDRA and threatened to use the Overkill Horn, which would have set off every nuclear device in the world. He was again defeated by Fury and his men.

Von Strucker then planted a Death-Spore Bomb aboard the *Helicarrier*™, but his plans were again stopped by Fury. Fury invaded HYDRA's new dome-covered island fortress and placed the Bomb there. While fighting with Fury, von Strucker accidentally ran into a nuclear reactor chamber and was incinerated. Fury escaped as HYDRA's island sank into the Pacific forever.

Since then, various splinter groups of HYDRA and its sister organizations have surfaced, but none have achieved any real success. The villainess named Viper™ took control of the New York section of HYDRA for a time, but she accomplished little.

**Scorpio:** Just after S.H.I.E.L.D. was established, Nick Fury was attacked several times by a man known only as Scorpio. Their confrontations always ended in victory for Fury but escape for Scorpio. It wasn't until many years later that Fury discovered that Scorpio was actually his brother, Jake, who had become mentally unbalanced and has since died (see *Defender's* #50).

**Mockingbird™:** One of S.H.I.E.L.D.'s

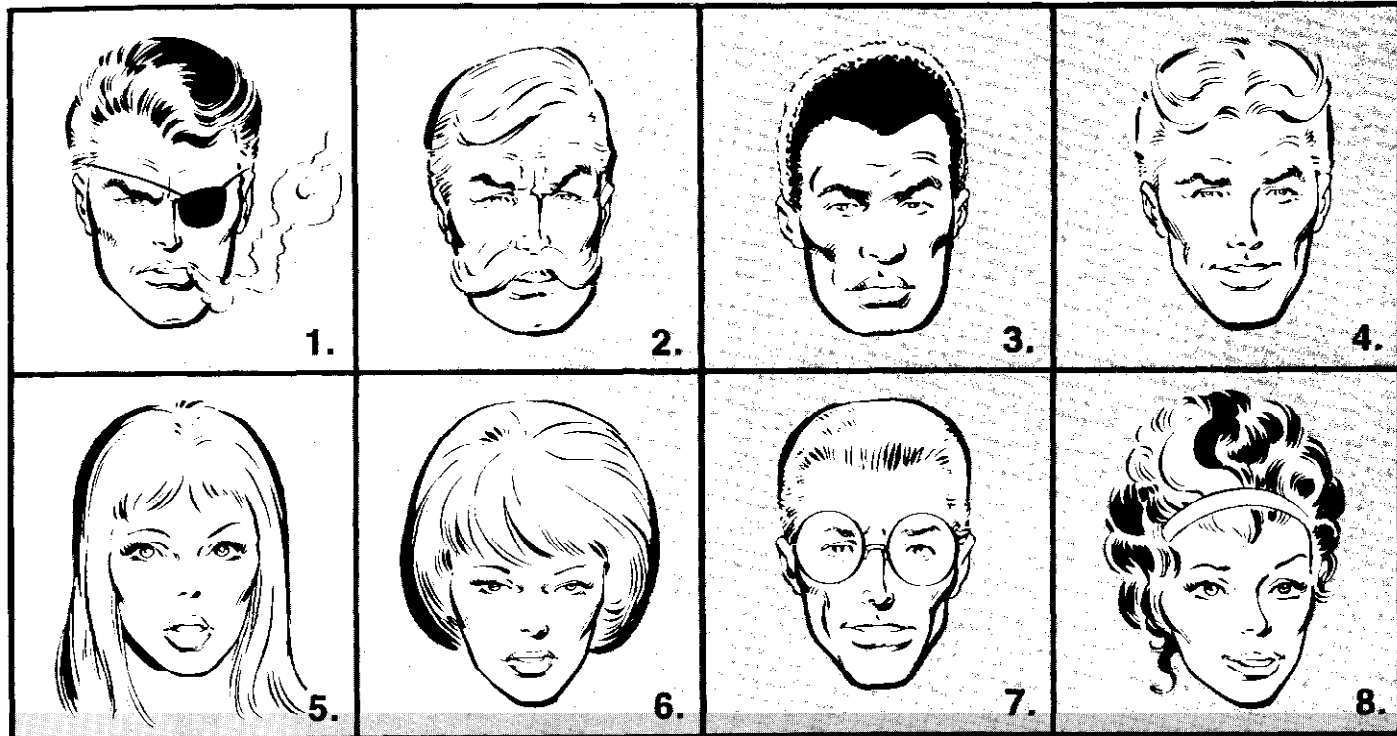

best agents, Barbara Morse, has since resigned from the agency to undertake a full-time career as an adventuress: Mockingbird™, of the West Coast Avengers™. Her struggle against traitors within S.H.I.E.L.D. was documented in the MARVEL®-Phile of DRAGON® Magazine issue #93.

*Dire Wraiths™*: Recently S.H.I.E.L.D. undertook to fight against the sorcerous, shape-changing aliens known as the Dire Wraiths. Along with the Avengers™, the

Fantastic Four™, and other Marvel Super Heroes™, the Dire Wraiths were repulsed from Earth.

S.H.I.E.L.D. has been involved directly and indirectly with many other adventures, most of them unknown to the general public. Nick Fury™ and his men have worked closely with Captain America™ and the Avengers™ in their battles for justice. Another of S.H.I.E.L.D.'s former agents, the Black Widow™, also works with the organiza-

tion at times. (Black Widow is detailed in Module MH-4, *Lone Wolves*.)

S.H.I.E.L.D. has its share of internal problems, to which some of the cases above allude. S.H.I.E.L.D. once attempted to train super agents, but the project was discontinued when two agents turned traitor. At one point, a telepath named Marvin Flumm worked with the organization's ESP unit; he later became known as the villain Mentallo™.

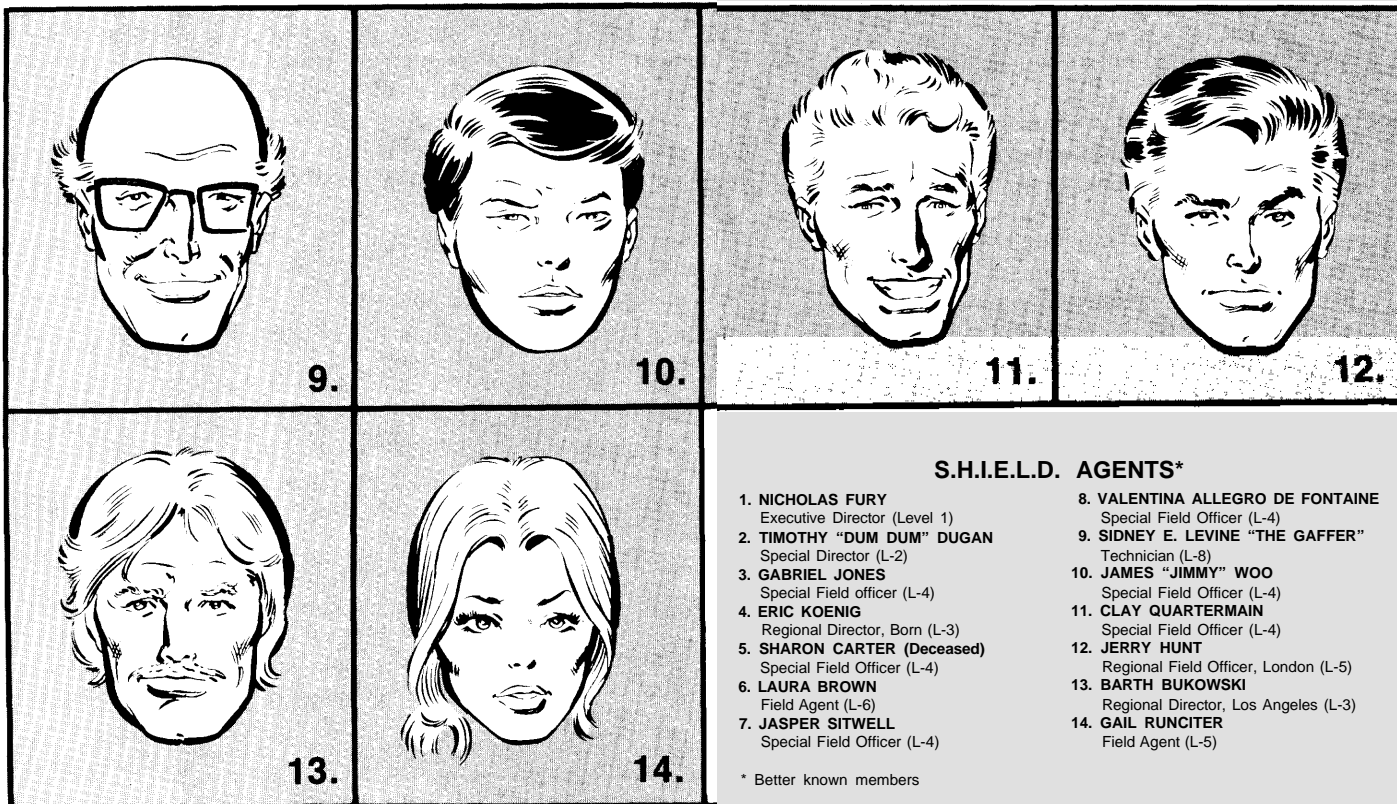

**S.H.I.E.L.D. AGENTS\***

- |  |   |
|--|---|
| 1. NICHOLAS FURY<br>Executive Director (Level 1)           | 8. VALENTINA ALLEGRO DE FONTAINE<br>Special Field Officer (L-4) |
| 2. TIMOTHY "DUM DUM" DUGAN<br>Special Director (L-2)       | 9. SIDNEY E. LEVINE "THE GAFFER"<br>Technician (L-8)            |
| 3. GABRIEL JONES<br>Special Field officer (L-4)            | 10. JAMES "JIMMY" WOO<br>Special Field Officer (L-4)            |
| 4. ERIC KOENIG<br>Regional Director, Born (L-3)            | 11. CLAY QUARTERMAIN<br>Special Field Officer (L-4)             |
| 5. SHARON CARTER (Deceased)<br>Special Field Officer (L-4) | 12. JERRY HUNT<br>Regional Field Officer, London (L-5)          |
| 6. LAURA BROWN<br>Field Agent (L-6)                        | 13. BARTH BUKOWSKI<br>Regional Director, Los Angeles (L-3)      |
| 7. JASPER SITWELL<br>Special Field Officer (L-4)           | 14. GAIL RUNCITER<br>Field Agent (L-5)                          |

\* Better known members

## Organization

The S.H.I.E.L.D. organization is based on eight different command/security levels. Only one man is on Level 1, Colonel Nicholas Fury™, the Executive Director of S.H.I.E.L.D. The duties of the other levels are given below.

Level 2: Special Directors make command decisions when Fury is not available. They also coordinate efforts to follow Fury's special orders. Currently, Timothy "Dum Dum" Dugan, Fury's best friend, is the only person on this level.

Level 3: Regional Directors head up the S.H.I.E.L.D. regional offices across the world, co-ordinating all S.H.I.E.L.D. activities in their area unless they receive special orders from Fury or Dugan.

Level 4: Special Field Officers are agents who usually work alone undercover, taking orders directly from Fury and Dugan. Their task is to gather information for S.H.I.E.L.D.

Level 5: Regional Officers help the Regional Directors co-ordinate activities, and provide leadership in their region when their Regional Directors are not available.

Level 6: Field Agents make up the main fighting force of the organization. Sometimes Field Agents will work undercover, reporting to their Regional Directors. They are the backbone of most para-military operations.

Level 7: Administrators make sure that S.H.I.E.L.D.'s activities are done according to law. They take care of the red tape and paperwork that are a part of any bureaucracy.

Level 8: Technicians keep S.H.I.E.L.D.'s machinery in good repair and constantly update the agency's old equipment while they create new equipment.

The *Helicarrier*™ also houses a small group of people who have no designated level. These are the ESPers, who are employed in special research projects and assist the organization when it is facing psychic foes. The ESPers are hooked into a Psionic Amplifying Machine, which gives them a group Psyche rank of Amazing. When hooked into the PAM, ESPers are capable of performing any of the mental powers listed in the MARVEL SUPER HEROES Campaign Book.

As mentioned above, S.H.I.E.L.D. maintains offices all over the world, including New York, Los Angeles, London, and Bonn. Some hidden bases exist in Communist countries. S.H.I.E.L.D.'s headquarters are in the gigantic *Helicarrier*. Though their operations are secret, the organization's existence is known to the general public, and S.H.I.E.L.D. maintains a few public offices.

## The *Helicarrier*™

S.H.I.E.L.D.'s headquarters are based in a gigantic, flying aircraft carrier known as the *Helicarrier*. The *Helicarrier* is an important part of the World-Wide Military Command and Control System (WWMCCS), which maintains communications in times of world crises. It is also a major link in the Defense Communications System (DCS). The *Helicarrier's* main function is the surveillance of land and space, and it houses a number of highly trained electronic intelligence personnel. Field Agents are also tested and trained aboard the *Helicarrier*.

The *Helicarrier* has three layers of armor: two layers of 5-inch hardened alloy with a 12-inch layer of fragment suppressor sandwiched between them. This gives the *Helicarrier* an Excellent Body and Monstrous Armor.

The *Helicarrier* is powered by a small thermonuclear plant and flies by means of an anti-gravity generator augmented by six large twin-bladed helicopter rotors. The *Helicarrier* has Good Control and Excellent Speed. The *Helicarrier* is rigid enough so that it may land on the ground or in water, but its radar "ball" deck must be jettisoned beforehand.

The *Helicarrier* is armed with the following weapons:

- \* ten 70mm radar-guided anti-missile electric cannons (Range: Excellent, Damage: Amazing; can be used as anti-missile defense),
- \* six 40mm radar-guided anti-missile electric cannons (Range: Good; Damage: Incredible; can be used as anti-missile defense),
- \* four armored boxed missile launchers (eight missiles each, Body: Remarkable, Control: Incredible, Speed: Remarkable, Damage: Amazing),
- \* cruise missile launch deck (30 cruise missiles, Body: Remarkable, Control: Incredible, Speed: Amazing, Damage: Unearthly); and,
- \* an anti-missile teravolt charged particle projector (Range: Amazing, Damage: Amazing).

Not only is the *Helicarrier* heavily armed, but it also serves as an aircraft carrier by the following military aircraft:

- \* thirty-two F/A-18 planes (Body: Typical, Speed: Incredible, Control: Excellent); Weapons: 4 guided missiles (regular types) and 2 machine guns (Range: Good, Damage: Remarkable),
- \* two E-2C Hawkeye early warning planes (Control: Good, Speed: Excellent, Body: Typical); Weapons: 2 guided missiles and 2 machine guns (as above); they also have a radar range of 300 miles and constantly patrol the airspace around

the *Helicarrier*; and,

- \* four mini-Sea King anti-submarine helicopters (Control: Good, Speed: Excellent, Body: Good); Weapons: 2 air-to-sea torpedoes (Body: Remarkable, Control: Excellent, Speed: Good, Damage: Amazing), 2 depth charges (Range: Good, Damage: Incredible), 2 machine guns (as above); used for submarine patrol, cargo hauling, and rescue missions.

The deck of the *Helicarrier* houses a vibration-isolated missile silo which contains an intermediate-range ballistic missile (Body: Remarkable, Speed: Remarkable, Control: Incredible, Damage: up to Class 1000). It has a range of 3500 miles and can achieve low earth orbit. It can be used as a weapon or for a variety of special missions, such as placing a satellite into orbit.

The *Helicarrier* is usually crewed by 450 men, but in emergencies it can hold up to a thousand people. It carries enough food and water to last a regular crew for 30 days. The *Helicarrier* itself can maintain flight indefinitely.

## Weapons and special equipment

S.H.I.E.L.D. will always be equipped with the most modern weapons and special equipment. This section details the items that S.H.I.E.L.D. agents regularly employ. The agents themselves are described in the *Avengers Assembled!* module.

S.H.I.E.L.D. regulation uniforms are made of nine-ply kelvar, providing Typical protection from physical attacks. The uniforms are also made of beta-cloth (type C), which can withstand temperatures up to 1700°F, providing Excellent resistance to fire.

Each S.H.I.E.L.D. agent is provided with two types of handguns. One is a plasma beam handgun (Damage: Excellent, Range: 5 areas), with a powerpack that enables it to fire 19 times before running out of power. The other regulation handgun is a .30 caliber rapid fire automatic machine pistol (Range: Good, Good Damage from single shots, Remarkable Damage from bursts). The bullets are armor-piercing, with cores of high-density spent uranium. Each ammo clip holds 60 rounds (600 bullets), and the gun has a variable rate of fire, enabling it to shoot 1-100 bullets/round.

When S.H.I.E.L.D. agents go on paramilitary operations, they each carry the following weapons and special equipment:

- \* 1 smoke bomb (see smoke grenade on p. 17 of the Campaign Book),
- \* 1 flare (does Typical damage if used as

# S.H.I.E.L.D. HELICARRIER™

NOTE: FLIGHT DECK CREWS ("TERRIERS") OBSERVATION/SAFETY PLATFORMS, WHICH RING THE FLIGHT DECK HAVE BEEN OMITTED FOR PURPOSES OF CLARITY.

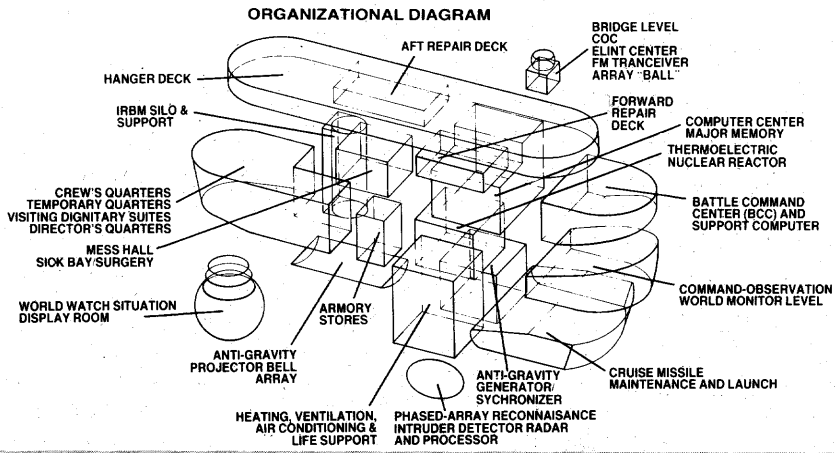
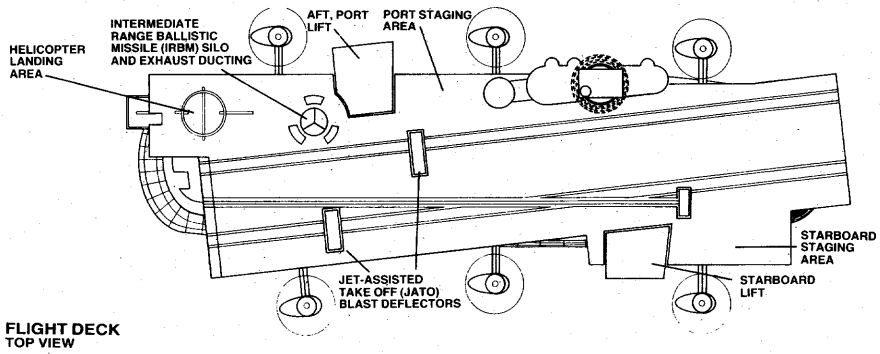
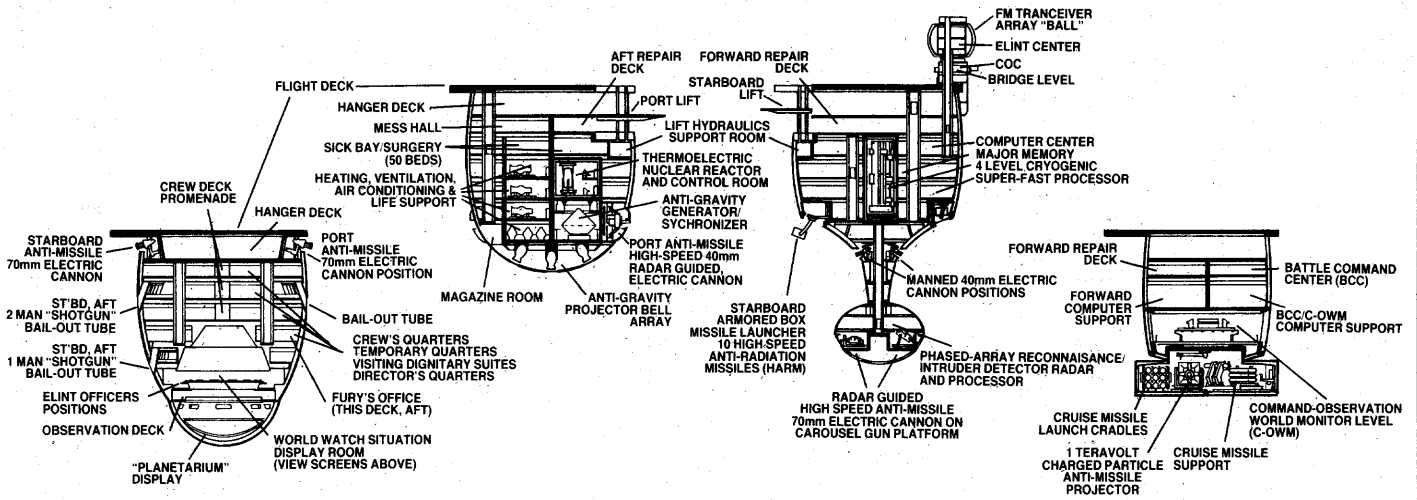
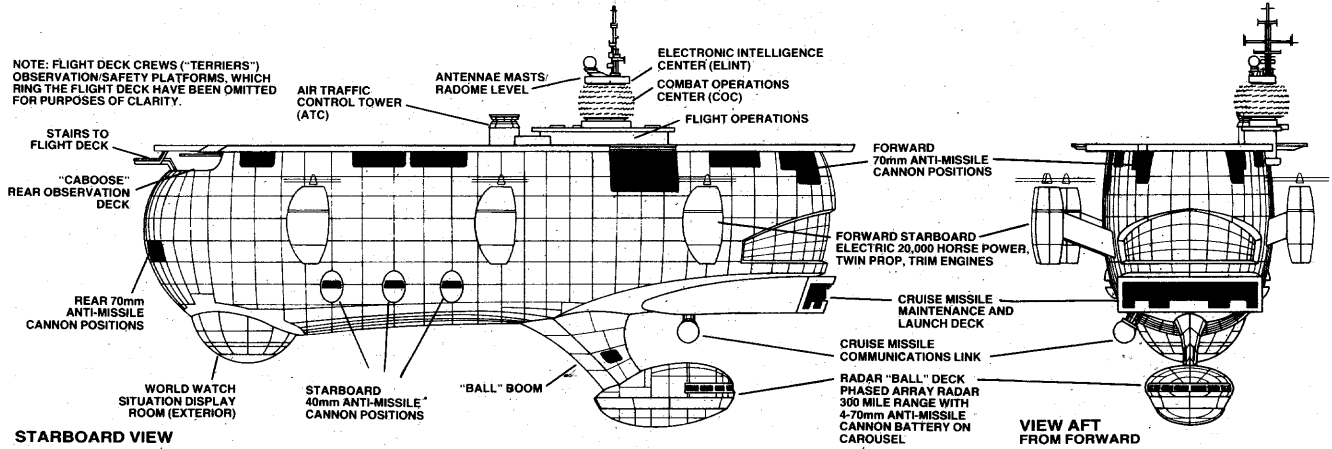



a weapon, burns for 5 rounds),  
 \* 1 thermite bomb (as explosive grenade, p. 17 of Campaign Book, except it does Incredible Damage and will do Excellent Damage every round to anyone hit due to clinging flames until the flames are extinguished),  
 \* 1 fragmentation bomb (as explosive grenade on p. 17, Campaign Book, except it does Incredible Damage),  
 \* 1 throwing knife (Excellent Damage when thrown),  
 \* 1 gas bomb (knockout gas with Incredible potency),  
 \* 1 radio link pocket computer (10 mile radio range, Remarkable complexity),  
 \* 1 flexible saw (able to saw through 1 inch of Good material in 5 rounds); and,  
 \* 1 garrote reel (must surprise opponent from behind to be used; does Excellent Damage each round; use Grappling Battle Effects Table to determine if victim can free himself; escape requires a roll in a Red area).

The main transportation for S.H.I.E.L.D. agents is the Flying Car, a modified Ferrari 330/P4 Berlinetta. The car is armored with 1" foamed alloy, and its windows are made of 1" bullet-proof Lexan, giving it Excellent protection with an Excellent Body.

The car is electrically powered by turbines. While on land the car has Remarkable Control (computer-aided steering) and Remarkable Speed. The car's four wheels are also mini-jet turbines enabling the car to fly with Remarkable Control and Incredible Speed. The car is also totally submersible with a 5-hour air supply, although it only has Typical Speed and Excellent Control underwater.

The car is armed with a 20mm electric cannon (Range: Excellent, Damage: Excellent, ammo supply of 1000 rounds), a 30mm radar-guided anti-missile electric cannon (Range: Excellent, Damage: Excellent, ammo supply of 50 rounds), and a missile launcher (4 air-to-air missiles, Body: Excellent, Control: Excellent, Speed: Excellent, Damage: Incredible). The 20mm cannon is in the front of the car; the 30mm cannon and the missile launcher are in the rear.

The car also has a variety of special equipment, including self-sealing tires, radar, a computer and communications console/scrambler, a S-band communications satellite antenna, 20 cm of radar chaff to disrupt radar signals, ejection seats, and a car parachute.

Over the years, S.H.I.E.L.D. has used the Life Module Decoy Matrix several times. This machine creates android doubles of the person placed in the

Master Matrix. Androids will have the same physical attributes as the originals, but their mental attributes are only Typical since they have no real mind. They are either pre-programmed or voice/radio controlled.

S.H.I.E.L.D. agents have also used jet cycles, an Entrope Phase Barrier Guard System (Remarkable-strength force field), an image scanner (discerns real form of items and people), mold cocoon pellets, and two-way wrist communicators. Assume that any weapon or gadget that can be invented has already been designed by S.H.I.E.L.D. technicians and has probably been built and used.

### Nick Fury™

No article on S.H.I.E.L.D. would be complete without mentioning Nick Fury, the director of the organization. Though Fury is no costumed crusader, he is a tough, die-hard fighter, especially with the man-power and technological resources of S.H.I.E.L.D. to back him up.

#### NICK FURY™

##### Director of S.H.I.E.L.D.

Fighting: EXCELLENT (20)  
 Agility: EXCELLENT (20)  
 Strength: GOOD (10)  
 Endurance: EXCELLENT (20)  
 Reason: EXCELLENT (20)  
 Intuition: EXCELLENT (20)  
 Psyche: GOOD (10)

Health: 70  
 Karma: 50  
 Resources: AMAZING  
 Popularity: 75

**Talents:** Fury has trained as a paratrooper, a ranger, a demolitions expert (including underwater demolitions), and a pilot. He can operate any vehicle made on Earth, including spacecraft and lunar landing modules.

A master of martial arts and wrestling Fury is also a marksman and weapons master. He knows much about law and law enforcement, engineering, history, first aid, and military science.

Nick Fury has access to all S.H.I.E.L.D. weapons and equipment. His personal weapon is a .15 caliber needle gun with a range of 4 areas (it does Good Damage). An ammo clip holds 300 rounds.

Nicholas Joseph Fury was the elder of two children born to an American pilot. His father died in action during World War I, and Nick grew up in the toughest section of New York City, Hell's Kitchen. In December, 1941, when America entered World War II, Fury was unemployed and decided to enlist in the U.S.

Army. Fury took basic training at Fort Dix, New Jersey.

After basic training, Fury was quickly promoted to the rank of sergeant and put in charge of an elite group of soldiers who were known as the "Howling Commandos™." This special unit became famous throughout the European theatre of operations, performing many important missions for the Allies. The group was first organized in 1942 by Captain Samuel "Happy Sam" Sawyer, the force's commanding officer. British Prime Minister Winston Churchill made the "Howling Commandos" the first American Ranger squadron to gain the rank of Commandos in His Majesty's Army. The "Howling Commandos" were made up of Nick Fury, Timothy "Dum Dum" Dugan, Gabriel Jones, Robert "Rebel" Ralston, Percival "Pinky" Pinkerton, Isadore "Izzy" Cohen, Dino Minelli, Eric Koenig, Jonathan "Junior" Juniper (killed in action in the war) and Fred Jones (disabled in combat).

During a special mission in France, Fury came under the medical care of Professor Berthold Sternburg, who inoculated Fury with the "Infinity Formula" serum. Fury takes this serum annually, and it has slowed down Fury's aging process enormously.

The "Howlers" were disbanded after the war, but Fury remained on active duty during the Korean War. During this conflict, the "Howlers" were reunited for a special mission in which they secretly crossed the 38th Parallel and destroyed an enemy MIG base. During the mission, Samuel Sawyer was killed and Fury was given a battlefield commission of Second Lieutenant. During the mid-1950s, Fury was on loan to the French government and served as an espionage agent for France during the early part of the Viet Nam War. This work earned him a promotion to Colonel.

After his Viet Nam work, Fury became an agent for the Central Intelligence Agency for a few years. In the early 1960s, he was offered the directorship of S.H.I.E.L.D., which he has retained ever since.

Anytime the player characters discover an international conspiracy or an organization that threatens mankind itself, there is a good chance that at least one S.H.I.E.L.D. agent will be encountered on the scene as well. If S.H.I.E.L.D. agents are involved, heroes such as Captain America™ may soon be on the scene, and more heroes will be coming as things get tougher.

# Return to the Viper's™ Pit

## *Expanding your MARVEL SUPER HEROES™ campaign*

by Kim Eastland

Creating a module, like many other things in this world, is a group effort. When the writer/designer has finished his manuscript, it still goes through many hands, including those of editors, artists, layout persons, and so on. This is a great system because additional creative input sharpens the product. Sometimes, of course, things get left out or aren't completely explained. This article wraps up a glitch or two in my MARVEL SUPER HEROES™ Module, *Pit of the Viper™*, and adds new material to the module as well.

A few of the creative people who helped put this module together deserve credit for their work. Dennis Kauth took my rough concepts for the fold-ups and turned them into beautiful pieces of three-dimensional machine art. Jeff Butler did the great artwork on the 3-D characters (as usual), and John Meyers put together the finished product. All three of these artists did a splendid job, and I thank them.

### **A few corrections**

The top of the Nihilist™ Complex Map page is north. This will help the Judge tie it into the larger city map from the boxed set. The smaller Warehouse Map on the same page should have a line of crates running along its west wall. Behind these crates is the pneu-tube entrance to the complex. The doorway on the south wall of the warehouse leads to the retail outlet in the front. Also, add a monitor in the southeast corner of the Flight Deck, area II.

Note that the recharging stations in the complex are used for cyborgs, electric carts, and laser weapons.

The "tented" picture of Captain America™ is actually a dartboard. Just prick it with a pin a few times so that

the characters will notice it when they enter Viper's room.

### **Additional material**

During the laying out of the cut-outs, extra room was created due to Dennis's superior organizational ability, and last-minute additions were implemented to give the most cut-outs for the money. Everyone involved felt it would be fun for us to give the creative Judges out there something to play with. Here are some suggested statistics for the new "toys" we added.

*Missiles and rockets* — Range: 20 areas; Damage: 50 (one use); Body: Excellent; Speed: Excellent. The only difference between the two is that a rocket is fired in a specific direction and will continue in a straight line until it strikes something or reaches the end of its range.

A missile is guided (Control: Remarkable) and can home in on one target. It will follow the target and explode either upon impact with it, upon impact with an obstacle that suddenly appears between it and the target, or upon reaching the end of its flight range. The addition of rockets or missiles to an Attack Sled reclassifies it as an N-3 Attack Sled. Rockets and missiles can also be used in a Danger Room, but their damage is reduced to 2.

*Laser cannon* — Range: 12; Damage: 75; 5 shots before it has to be recharged, but it can only fire every other turn because it overheats. This cannon may be used in a Danger Room, where it only does 2 points of damage and has Incredible Control, or it can be mounted on an Attack Sled. When the cannon is added to an N-3 Attack Sled, the sled is reclassified as an N-4 Attack Sled.

*Flying rings* — Range: variable (1d10 areas); Damage: 2; Speed: Remarkable;

Control: Amazing. Flying Rings are only used in Danger Rooms for training purposes. Some will expand and entrap the characters inside them if they strike. Others will lay out a smoke screen as they whiz along. The Judge can have a great time throwing these things at unsuspecting heroes who come in for a workout (just like Professor X™ does to the X-Men™).

*Tentacle pillar* — This is a nasty little trap that can be incorporated into any scenario if the party starts to take things for granted. It's a wonderful defense mechanism designed to look just like a steel girder, stone pillar, etc. In truth, it's a steel trap (Remarkable material) set to unleash its tentacles and ensnare anyone who passes within a few feet of it. It grapples with Remarkable Strength and can attack any one character with up to 4 tentacles.

*Gauthits* — A "gauthit" is any one of the numerous little jig-a-ma-whats that Dennis tossed into the cut-out sections. Some are simply gas tanks for use in the module; others are obstacles to trip over or toss into melee. Others may be potentially devastating weapons. It is completely up to you and your imagination what can be done with them.

If a Judge is looking for a theme on which to base a MARVEL SUPER HEROES™ campaign, the *Pit of the Viper* module is strongly recommended. It could be the first step in a potential resurrection of Hydra™, that most feared of Marvel's secret, evil organizations. The chilling cry of "Hail, Hydra!" might be just what you need to keep your heroes looking over their shoulders.

All Marvel characters, their likenesses, and MARVEL SUPER HEROES are trademarks of the Marvel Comics Group. © 1985 Marvel Comics Group, a division of Cadence Industries. All Rights Reserved.

# Creative Conjuring

## *A variant magic system for the MARVEL SUPER HEROES™ game*

by Eric Walker

The MARVEL SUPER HEROES™ game is a fast-paced, action-filled adventure game in which the players can do anything they want. However, like all games, it has a few bugs, particularly in the character generation system. The Campaign Book (p. 45) notes that magical training is not available as a normal talent, meaning that players cannot use Doctor Strange™ or create characters with magical powers. As the game stands now, magic is too powerful; characters can do anything with it. A sorcerer with a Psyche of Good (the minimum required for magical training) can do everything that a sorcerer with a Class 1000 Psyche could do, albeit within a very limited range. This article will attempt to solve these problems by categorizing the Marvel Universe™ magic system and limiting its powers, so that even Doctor Strange is not all-powerful. This system is based on the ADVANCED DUNGEONS & DRAGONS® magic system, and Judges may modify it as they please.

The Campaign Book states that all magic comes from three sources: Personal Energy, Universal Energy, and Dimensional Energy. A brief description of types of spells is given on pp. 10-11, and the rest of the section describes the casting of magical spells. Actually, the three spell sources can be divided into subgroups as given on the following table.

<i>Personal Energies</i>	<i>Universal Energies</i>	<i>Dimensional Energies</i>
Extended senses	Alterations	Conjurations
Illusions	Divinations	Creations
Mental powers	Evocations	Necromantics

These nine categories contain all types of magics, including raising mystical force fields, dimensional travel, and turning people into frogs. Most spell effects that a Marvel Super Hero mage would desire to cast are duplicated in the AD&D *Players Handbook* and easily classified by the above system.

A spell caster can choose a certain number of magical powers from these categories, depending upon his Psyche. For every rank of a sorcerer's Psyche above Typical, he gets to choose one magical power from the table. Thus a sorcerer with a Psyche of Good would have only one power (such as Alterations), while a magician with Class 1000 Psyche would have all nine powers. Furthermore, a wizard with Good Psyche could only choose his power from the three powers under Personal Energy, and cannot use Universal or Dimensional Energies. A sorcerer with Excellent Psyche (able to use two powers) can use Personal and Universal Energies, but not Dimensional ones. The use of Dimensional Energies requires a Psyche of Remarkable or better.

This simple system limits a magic-using character but still allows him great variety in the types of spells that he can use. All nine of the magical powers are described below.

The only way for a sorcerer to gain more magical powers is to either have his Psyche raised magically or to augment his magical powers through the use of magical items. These are enchanted objects under a sorcerer's control that allow him to practice magic outside of his normal range of spells. Magic items such as crystal balls, talismans, and wands can either be taken from enemy sorcerers (a difficult deed), or they can be enchanted by the sor-



cerer himself. To make a magical item, the sorcerer must follow the steps in Chapter 2 of the Campaign Book, in the section "Building Things" (under the category of special devices). Instead of a Reason FEAT roll, he must make a Psyche FEAT roll.

To create a magical item, though, the sorcerer must have something connected with the power he wants to enchant into the item. If he wants an item that increases Strength, he must have some part of a creature of a strength equal to the level desired, such as the ear of a bull (or even a lock of the hair of Thor™). A device to allow travel through the dimensions would likely require something from another dimension. This can lead to interesting scenarios as the character and his allies venture into another dimension in search of the required item.

### Personal energies

**Extended senses** — This is the ability of a wizard to heighten or lessen his own ability scores or powers, or those of a willing subject. It also includes the ability to see into other dimensions and to project his soul into the Astral Dimension. There are limits as to how high or low ability scores or powers can be adjusted. A sorcerer with a Psyche of Good to Remarkable can change ability

scores up to 2 ranks above or below normal; a sorcerer with Incredible to Monstrous Psyche can affect scores for up to 3 ranks; a Psyche of Unearthly and Shift X allows him to affect scores by 4 ranks, and a Class 1000 Psyche allows him to alter the scores by 5 ranks. Unlike all other spells, the effects of raising or lowering ability ranks puts such a drain on the spell caster that abilities are only affected for one day at most, and the sorcerer automatically loses 10 Health points when the spell wears off. This does not happen when the sorcerer augments his normal senses, such as sight or touch; a normal Psyche FEAT roll must be made as usual.

**Illusions** – This is not the same as the Image Generation power (under Mental Powers in the Campaign Book). The illusions that can be created are extremely varied, and include illusionary creatures and things, invisibility, and even the illusory healing of damage. If the latter illusion takes effect (meaning the affected being thinks the illusion is real), the being will be “healed” of a number of Health points equal to the caster’s Psyche. Actually, no damage has been healed, and the Judge will have to keep a running total of the being’s Health points; when they reach zero, the being is affected normally. Only then does he learn that the “healing” was an illusion.

**Mental powers** – This magical power can be treated the same as the Mental Powers super power (p. 42 in the Campaign Book), except that the Image Generation power will not work. A wizard having this power can use telepathy, launch a mental blast, generate a force field, and so forth. If the spell cast is permanent, the caster does *not* gain mental powers as a super power. Because it is a magical power, this power can be detected and dispelled normally. (Dispelling magic is detailed under Evocation.)

### Universal energies

**Alteration** – This is a sorcerer’s ability to physically change things. With this power, a boulder can be changed into a statue, weather can be summoned and controlled, people can be changed into animals (and vice versa), and so on. Anything affected by this spell will radiate magic for the spell’s duration; this is a tell-tale mark of a sorcerer’s work. Note that if the spell caster has never seen a particular thing (for

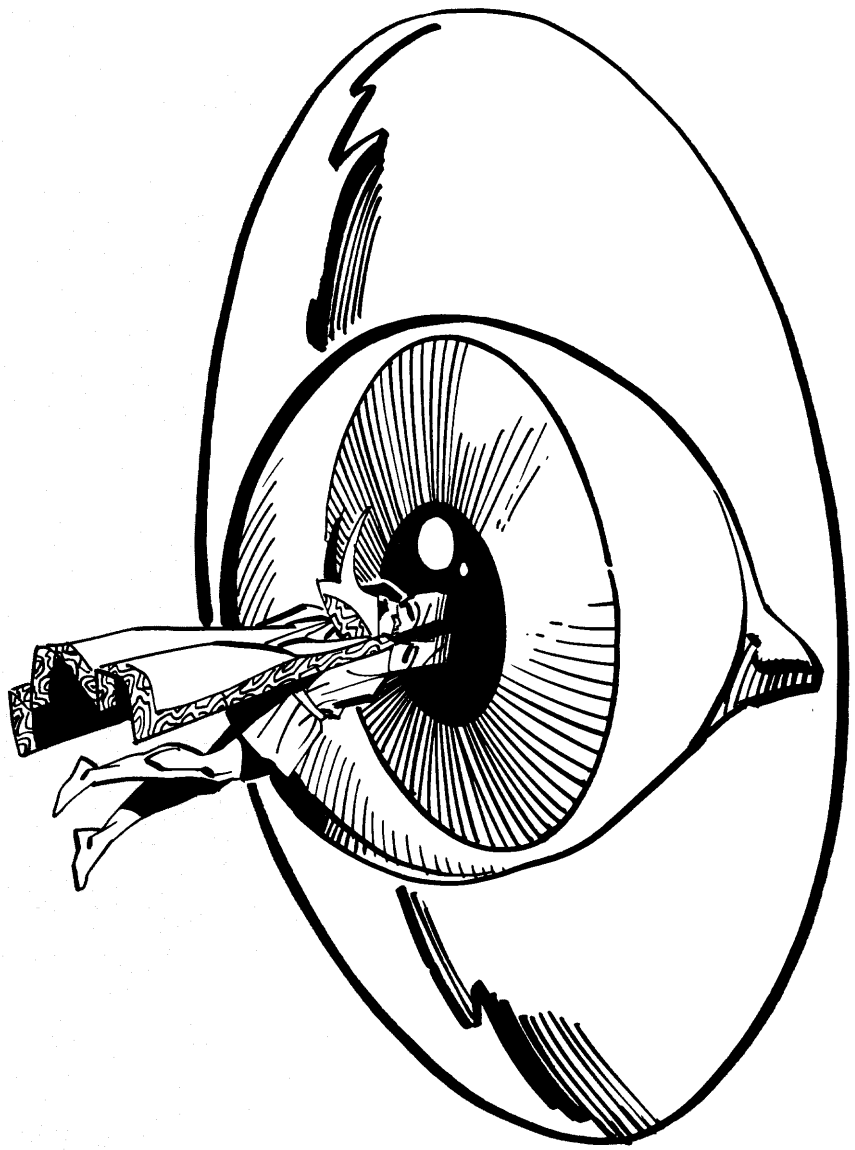

example, a Skrull™), he cannot turn any person or object into that thing.

**Divination** – This is the ability to uncover information. With this power, the sorcerer can detect sources of magic (such as other sorcerers), locate physical objects (such as a key or hidden weapon), or contact other beings (such as the rulers of other dimensions) and seek advice from them. If he attempts to do this, he must make a Personality FEAT roll. White means that the being is angered by the sorcerer’s interference, and he might send one of his minions to attack the sorcerer. A green result means that no information is received (“Sorry, all lines are busy now. . .”). Yellow means that the sorcerer receives a vague message or vision that must be deciphered. Red means that the sorcerer receives exactly the information he wanted to get.

**Evocation** – This is the sorcerer’s ability to harness magical energy and channel it in certain ways. This power

governs the casting of magical bolts of power, the raising of mystical shields, the power to reflect a spell completely (requiring both a red Psyche FEAT roll and the player’s prior declaration that this is being attempted), or the casting of a special spell called *dispel magic*.

**Dispel magic** allows a sorcerer to completely erase or neutralize a magical effect. To accomplish this, the caster must make a Psyche FEAT roll as normal, but if his Psyche is less than the Psyche of the wizard who cast the spell that he is trying to negate, he must make a red FEAT roll to successfully dispel the magic. If his Psyche is equal to the opposing spell caster, he needs a yellow FEAT to succeed; if his Psyche is greater, a green FEAT will successfully dispel the magic. If the FEAT fails, nothing happens, and the sorcerer will not have another chance to dispel the magical effect. Note that he may automatically dispel his own magic, whether he has the power of Evocation or not.



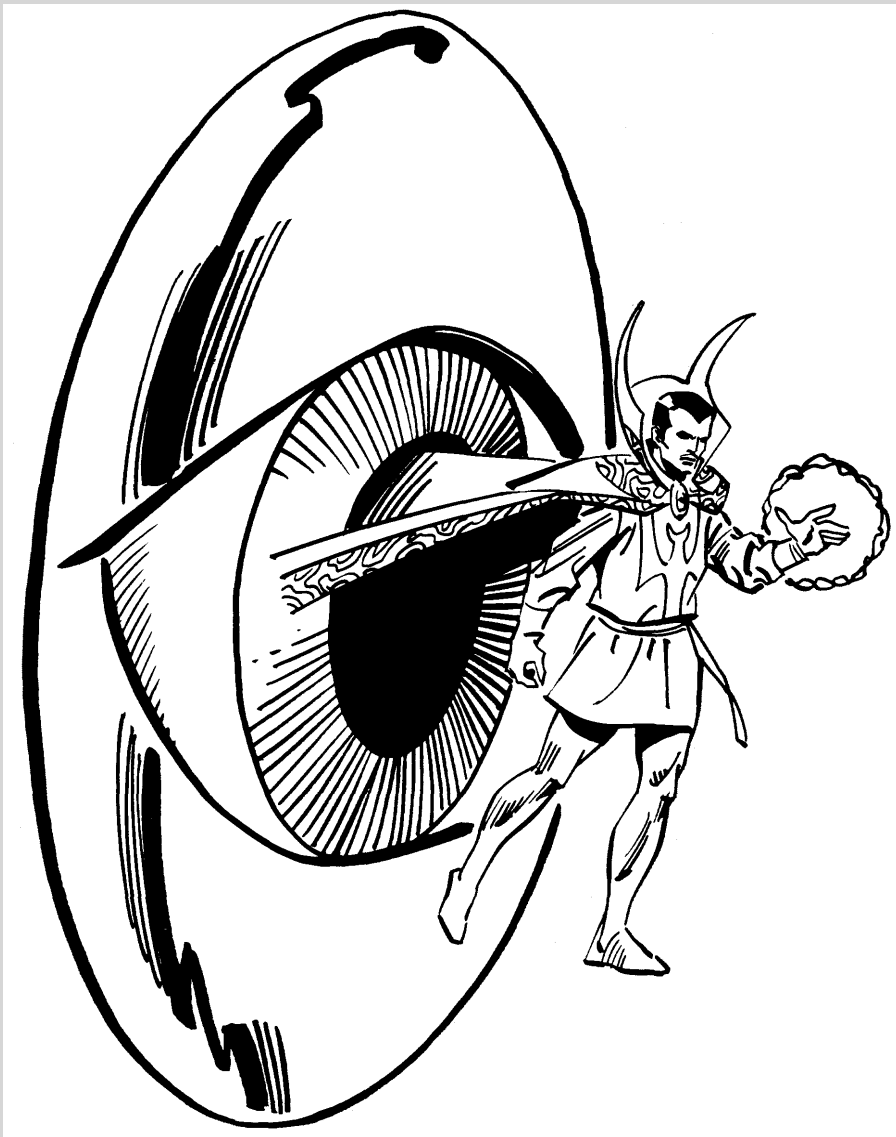

AH Marvel characters, their likenesses, and MARVEL SUPER HEROES are trademarks of the Marvel Comics Group.  
 © 1985 Marvel Comics Group, a division of Cadence Industries All Rights Reserved.

### Dimensional energies

**Conjuration** — This is the power to summon creatures or things from other dimensions. (Teleportation is a power found under Evocation.) With conjuration, the sorcerer can steal a piece of rock from the Negative Zone (though this is extremely dangerous), or he could summon one of the creatures from the mystic dimensions — i.e., demons. Demons are very powerful monsters that most characters should avoid, as they have certain magical abilities of their own. Unless the sorcerer has some way to control the demon he summons, there is nothing to stop it from attacking as soon as it appears. However, demons are repelled by the holy symbols of various religions, and a pentagram will serve to successfully “contain” a demon: the creature cannot cross the

boundaries of the star, nor can it cast spells across the barrier. A typical incantation to summon a demon might be versed as follows:

*“(Hear me, Dormammu™ the Dark!  
 A boon I dare to ask of thee:  
 I call upon the Black Hellspawn —  
 Awake! And harken unto me.”*

Note that the power of Conjuration can be reversed, so as to banish a being from this dimension to a dimension of the sorcerer’s choice.

**Creation** — This is simply the creation of things. With this power, the sorcerer can create a physical object out of thin air; its dimensions are the size of one area square per rank of the spell caster’s Psyche above Excellent. Thus, a sorcerer with Remarkable Psyche could create an object of one-area size, such as a small wall, while a wizard of Class 1000 can create a seven-area object. The object can only

be roughly shaped; for fine detail, the Universal power of Alteration will have to be used by the sorcerer. “Rough shape” means the object can be given no more than a humanoid form or the general outline of an automobile, for instance.

**Necromancy** — This is the most dangerous of all magical powers, as it involves intrusions into the domain of the being known as Death. This is the sorcerer’s ability to bring the dead back to life. **Only a red FEAT** will bring the dead back to life, and, whether the caster succeeds or not, Death will become aware of the spell caster’s existence. Death may ask a service of the wizard in exchange for the dead soul, or he may just shorten the sorcerer’s life span by an appropriate amount. The Judge has complete authority when dealing with the sorcerer on this matter; if he thinks that the dead being should not be brought back to life, he can rule that Death does not want this soul to return to the land of the living, thus wasting the spell (and getting the sorcerer into terrible trouble).

Other forms of Necromancy that are much less dangerous include the healing of damage (equal to the spell caster’s Psyche), the ability to fake death (stop heartbeat and brain patterns, etc., but still live), and to steal the soul of another being and place it in a container (called **magic jarring** — a variation of this spell was used on Ghost Rider™ once). The chance for the spell caster to steal a soul is the same as the sorcerer’s chance to **dispel magic** based on the victim’s Psyche. Note that the stealing of souls is an extremely evil act, and it is sure to affect the Popularity of the sorcerer.

Doctor Strange’s personal abilities are given in the Campaign Book, on pp. 4-7. Under this revised system, Doctor Strange’s magical abilities are not as ultimately powerful as they were under the original MARVEL SUPER HEROES system. Nonetheless, this system should give wizards in the game a fighting chance, and it will still keep a sorcerer from upsetting the all-important game balance. It should also be said that though this system limits the powers of wizards, magic-users should be very rare (at best) in the Marvel Universe. I would suggest that there should be only one wizard in every group of player characters. Otherwise, why would the game need beings like the X-Men™?

# Aies™

## SCIENCE-FICTION GAMING SECTION

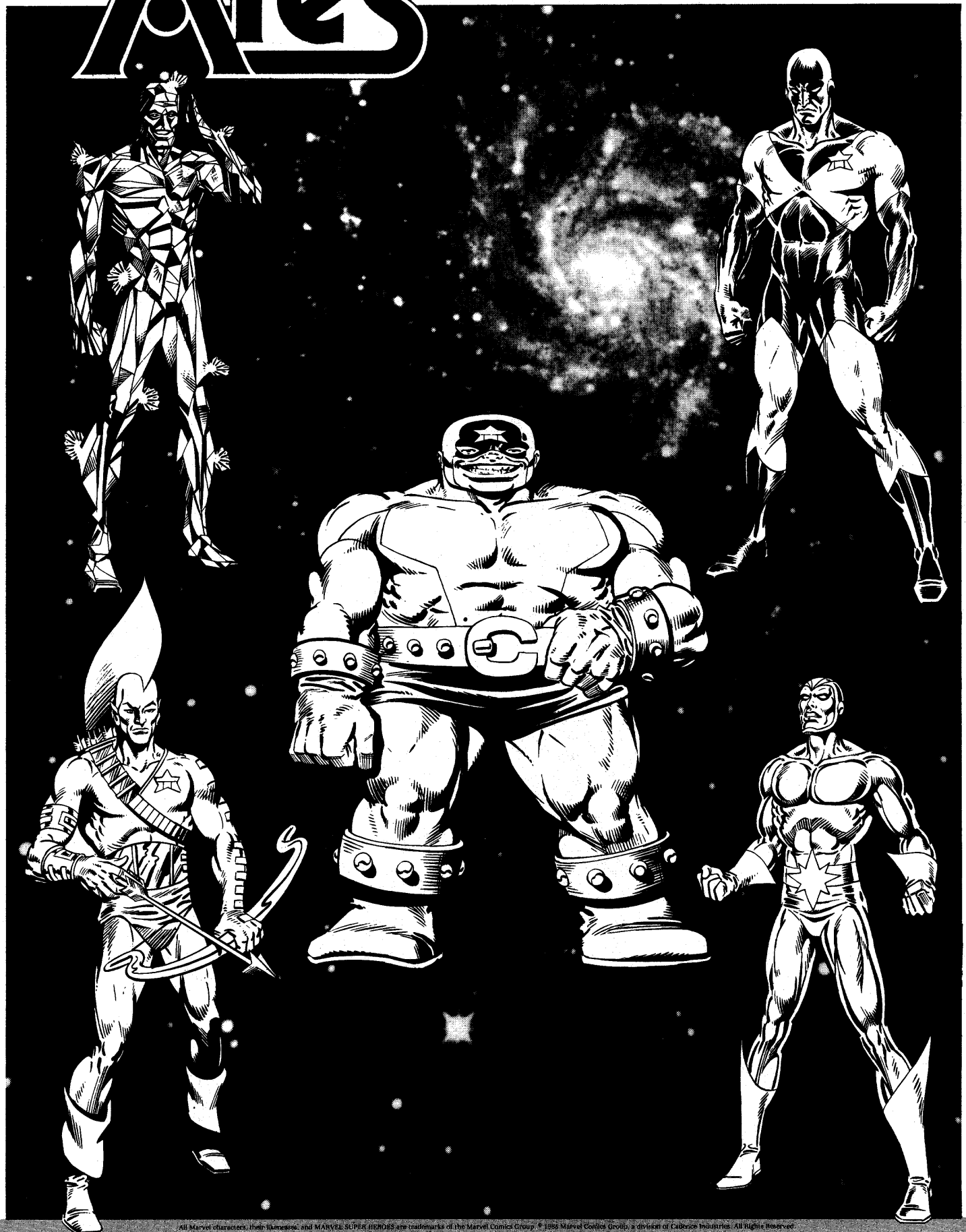

All Marvel Characters, their likenesses, and MARVEL SUPER HEROES are trademarks of the Marvel Comics Group. © 1986 Marvel Comics Group, a division of Citicorp Industries. All Rights Reserved.

Photo courtesy of Yerkes Observatory



# DEFENDERS OF THE FUTURE

*Marvel's Guardians of the Galaxy™*



All Marvel characters, their likenesses, and MARVEL SUPER HEROES are trademarks of the Marvel Comics Group. © 1985 Marvel Comics Group, a division of Cadence Industries. AU Rights Reserved.

by **William Tracy**

Over the years, the Marvel Universe™ has expanded to include various dimensions and alternate universes. The Guardians of the Galaxy™ come from an alternate future of the Marvel Universe, albeit one that diverged in the mid-

Twentieth Century, when a Guardian affected the life of his past counterpart.

In this alternate future, the Earth is successfully invaded and taken over by an alien race, the Badoon™, in the thirty-first century. The Badoon empire con-

trolled the Solar System for several years until a band of super-powered beings rallied the remaining humans and successfully pushed the aliens off Earth. Several more years were spent in attacking Badoon posts still in the system; then, the Guardians, with the aid of the time-traveling Defenders™, were able to drive the Badoon completely out of solar space.

After ensuring that Earth was safe, the Guardians set off to give aid to any in the Milky Way Galaxy who needed it, using their starship *Freedom's Lady*. Since then, the Guardians have made two trips to our current time, one of which caused the divergence of the time streams mentioned above.

Two separate Popularity scores are given. The first is the characters' Popularity in twentieth-century Earth, and the second is their Popularity in their future alternate universe. *[Statistics for the alien Badoon will be given in a future article. —Editor]*

## VANCE ASTRO™

Vance Astrovik, Major U.S.A.F.  
Ex-astronaut, now adventurer

Fighting: EXCELLENT (20)  
Agility: EXCELLENT (20)  
Strength: TYPICAL (6)  
Endurance: GOOD (10)  
Reason: EXCELLENT (20)  
Intuition: GOOD (10)  
Psyche: GOOD (10)

Health: 56  
Karma: 40  
Resources: EXCELLENT  
Popularity: 5/100

## Powers:

**TELEKINESIS.** Vance has a limited telekinetic ability that allows him to project beams of force. His power is only able to affect those within the area he occupies. The force beams can do up to Incredible damage if focused on one target, or can do Excellent damage to everyone around him. Vance is not able to produce other telekinetic powers. This power has an Incredible rating.

**SPECIAL BODY SUIT.** Vance was given a special body suit to keep him alive on his first interstellar voyage. It is made of a Remarkable material. If the suit is hit with any one attack that does more than 30 points of damage, the suit will tear and Vance's body will be instantly destroyed.

**Talents:** Vance Astro is able to fly any space vehicle and can pilot or drive

almost any other type of vehicle. Being an astronaut, Vance was also trained in physics, astronomy, electronics, engineering, and chemistry; his Reason is Remarkable in those areas. Vance was trained in martial arts in the Air Force.

**Background:** Vance Astrovik was the only son of a small-town butcher, and he joined the Air Force at the age of 18. Three years later, Vance became the youngest person to ever join the U.S. astronaut-training program. In 1988, Vance volunteered for the first U.S. manned interstellar mission to the Alpha Centauri system. His ship, *Odysseus I*, was not able to travel faster than light, so he was provided with a special bodysuit, described above, to preserve his body for the thousand-year trip. During the journey, he was placed in suspended animation; as a result, his latent psionic abilities surfaced.

Upon reaching the Centauri system, he discovered that Earth ships had reached the system 200 years earlier, thanks to the invention of a faster-than-light drive. Humans had been unable to intercept Vance's flight path. Upon reaching Centauri IV, Vance was given a hero's welcome.

A few days later, Centauri IV, along with other interstellar Earth colonies and the Earth itself, was invaded by the Badoon. Vance joined with several other heroes to drive the Badoon from Earth, and he went on to become the leader of the Guardians of the Galaxy.

While visiting the twentieth century on a time-traveling mission, Vance sought out his teenage self and tried to convince him not to become an astronaut, so that he would not have to experience his own future. The meeting of these two minds caused psychic feedback which brought the younger Astro's psionic abilities to the surface years before they were supposed to arise. This caused a divergence of the timestream, so the future of the original Vance Astro is not that of the current Marvel Universe.

#### **CHARLIE-27™**

##### **Charlie-27**

##### **Ex-space soldier, now adventurer**

Fighting: EXCELLENT (20)  
Agility: GOOD (10)  
Strength: REMARKABLE (30)  
Endurance: REMARKABLE (30)  
Reason: GOOD (10)  
Intuition: TYPICAL (6)  
Psyche: TYPICAL (6)

Health: 90  
Karma: 22  
Resources: EXCELLENT  
Popularity: 0/100

##### **Powers:**

**BODY ARMOR.** Charlie-27's dense skin gives him Typical protection against physical attacks.

**Talents:** Charlie-27 was a space soldier, trained with guns, blunt and sharp weapons, wrestling, first aid, and related military matters.

**Background:** Charlie-27 was born on Jupiter in A.D. 2981, the son of two mine workers. Like all Earth colonists on Jupiter, Charlie-27 was bio-engineered to withstand the high gravity of the planet. The process made his body massive compared to the human norm.

At age 16, Charlie enlisted in the space militia of the United Lands of Earth. In A.D. 3007, when the Badoon invaded, Charlie became the only survivor of the Jupiter colony. He went on to become a member of the Guardians of the Galaxy.

#### **MARTINEX™**

##### **Martinex**

##### **Former space technician, now adventurer**

Fighting: GOOD (10)  
Agility: GOOD (10)  
Strength: REMARKABLE (30)  
Endurance: GOOD (10)  
Reason: EXCELLENT (20)  
Intuition: TYPICAL (6)  
Psyche: TYPICAL (6)

Health: 60  
Karma: 32  
Resources: EXCELLENT  
Popularity: 0/100

##### **Powers:**

**COLD AND HEAT PROJECTION.** Martinex is able to generate beams of intense heat from his right hand and beams of frigid cold from his left hand. These beams can do up to Shift X damage, but he can only use them four times each per day, due to the fact that the energy for the beams is taken from his body. Martinex can project the beams with Excellent Agility within a one-area range. This power is Unearthly.

**BODY ARMOR.** Most of Martinex's body is composed of silicon, providing him with Unearthly protection against fire-based and cold-based attacks.

**Talents:** Martinex went to the Pluvian Technical Institute and was trained in

engineering, physics, and electronics. His Reason is Remarkable in these areas.

**Background:** Martinex was born in A.D. 2986, the son of two professional technicians on the Earth colony on Pluto. Like all colonists of Pluto, Martinex was bio-engineered to withstand the local low temperatures and poisonous atmosphere. When the Badoon invaded, the planet was evacuated while Martinex stayed behind to destroy Pluto's advanced industrial complexes. Martinex was rescued by Charlie-27 and eventually became a member of the Guardians of the Galaxy.

#### **YONDU™**

##### **Yondu Udonta Adventurer**

Fighting: GOOD (10)  
Agility: GOOD (10)  
Strength: GOOD (10)  
Endurance: GOOD (10)  
Reason: TYPICAL (6)  
Intuition: INCREDIBLE (40)  
Psyche: REMARKABLE (30)

Health: 40  
Karma: 76  
Resources: EXCELLENT  
Popularity: 0/100

##### **Powers:**

**MYSTIC EMPATHY.** Yondu is a mystic who is able to sense and form a rapport with local animals and plant life. Using this ability in the wilderness, he is able to sense objects and life forms that are not a part of the natural ecology of the area. He is also able to find specific elements within the area, such as a specific plant or animal. Yondu is able to sense and pinpoint mystical, psychic, and magical forces and beings, and he can sense their presence and activities automatically. These powers are Unearthly in nature and range.

**UNIQUE WEAPON.** Yondu uses a bow and a quiver of arrows, the arrows being made of *yaka*, a sound-sensitive metal only found on Yondu's planet, Centauri IV. By whistling, Yondu is able to control the direction of the arrow's flight after he has shot it. Unless Yondu is unable to whistle, each arrow has an Incredible Control rank and can even be made to return to him.

**Talents:** Yondu is a trained woodsman and is an expert with bows.

**Background:** Yondu's people were characterized by blue skin and a red dorsal fin on their heads. Yondu was in

the wilderness, undergoing his ritual of manhood ordeal, when the Badoon destroyed the Earth colony on the planet and then destroyed all other natives. Yondu was able to escape with the aid of Vance Astro, and he became one of the Guardians of the Galaxy after liberating Earth.

### STARHAWK™

#### Stakar and Aleta Adventurer

Fighting: GOOD (10)  
Agility: GOOD (10)  
Strength: REMARKABLE (30)  
Endurance: REMARKABLE (30)  
Reason: AMAZING (50)  
Intuition: UNEARTHLY (100)  
Psyche: MONSTROUS (75)

Health: 80  
Karma: 225  
Resources: EXCELLENT  
Popularity: 0/100

#### Powers:

**RESISTANCE TO POISON.** Starhawk has Monstrous immunity to most diseases, poisons, and illnesses caused by radiation.

**LIGHT CONTROL.** Starhawk is able to manipulate light energy from any source, changing it into energy that he/she can use to perform superhuman feats. He/she can project beams of heat or force, create temporary bridges of solid light, and penetrate energy fields by jamming their wavelengths. This power is Unearthly in nature, though the strength of particular powers used is directly proportional to the ambient light energy within Starhawk's area. Thus, a Good-intensity light (normal daylight) would allow Starhawk to shoot force bolts at Good range doing Good damage, create light bridges lasting 10 minutes, or penetrate Good-intensity energy fields.

**FLIGHT.** Starhawk is able to fly using his/her light control ability, reaching Unearthly speeds in space and Monstrous speeds in a planet's atmosphere. Starhawk's suit contains a life-support system that can work indefinitely, and it will deploy winglike structures to catch and use the solar wind. Starhawk's Agility increases to levels equal to his speed when he flies, with a minimum Agility rating of Good.

**MENTAL POWER.** Starhawk is able to sense abnormal concentrations and expenditures of energy and disruptions in the space-time continuum. This

power is Class 1000 in nature and range.

**Talents:** Starhawk is an expert in almost all sciences and is a scholar.

**Background:** In the early twentieth century, a great war began on the planet Arcturus IV between two factions, one wanting natural childbirth and the other believing that babies should be bio-engineered in the laboratory. The war ended in a nuclear catastrophe.

More of the laboratory-bred natives survived than the natural Arcturians. The laboratory-bred ones mutated into horrible creatures, and the surviving natural Arcturians formed bands called Reavers, whose main task was to destroy the mutants. On the raid in which the last of the mutants were destroyed, a Reaver named Ogord™ found a baby male mutant who looked normal. Ogord received permission to raise the baby as his own; the child, whom Ogord named Stakar, grew close to his step-sister Aleta as the years passed.

In time, Stakar and Aleta entered some ancient ruins and discovered a learning helmet. They both struggled for the helmet and it malfunctioned, converting Aleta into energy. She entered into a religious idol of a hawk-god, animated it, and began attacking the bands of Reavers looking for her and her brother. Stakar used the helmet to form a telepathic link with her and then somehow merged his being with hers. The resulting being left the world and roamed the universe. After several centuries, Starhawk met the Guardians of the Galaxy and helped them chase the Badoon from Earth's solar system.

### NIKKI™

#### Nikki Adventurer

Fighting: GOOD (10)  
Agility: EXCELLENT (20)  
Strength: TYPICAL (6)  
Endurance: GOOD (10)  
Reason: GOOD (10)  
Intuition: GOOD (10)  
Psyche: TYPICAL (6)

Health: 46  
Karma: 26  
Resources: EXCELLENT  
Popularity: 0/100

#### Powers:

**SPECIAL RESISTANCE.** Nikki's skin contains a large amount of a specially mutated form of melanin. This and several other mutations give Nikki

Unearthly protection against attacks using ultraviolet radiation and Monstrous protection against heat-based and infrared-energy attacks.

**PROTECTED SENSES.** Nikki's eyes have been altered so that they have Incredible protection from blinding light.

**Talents:** Nikki is a marksman and weapons master. She is trained to be an expert with guns, thrown weapons, and blunt and sharp-edged weapons. She is also skilled in martial arts.

**Weapons:** Nikki usually carries two weapons: a neuronics-frequency stunner and a pulsed, high-powered, green laser pistol. The laser pistol does Remarkable damage and has Typical range. Its power clip contains enough energy for 10 shots. Anyone hit by the stunner must make an Endurance FEAT roll in the yellow area of the column. If they fail the roll, they will be paralyzed and stunned for 100 rounds minus their Endurance rank number. The stunner has Typical range and has a power clip that has enough energy for 10 shots.

**Background:** Nikki was the only daughter of two administrators of the mining colony on the planet Mercury, and was born in A.D. 2997. Like all colonists on Mercury, Nikki was bio-engineered to withstand high temperatures and ultraviolet radiation. The process gave her very dark skin and specialized eyes. When Nikki was a child, the Badoon invaded the Solar System and killed all other Mercury colonists. Nikki managed to escape in a spaceship, but she soon ran out of food. Luckily, she discovered an abandoned cargo ship and boarded it. For the next seven years, she lived alone on the cargo ship, whose life-support system worked but whose communicators and engines did not. She was rescued by the Guardians of the Galaxy, who had driven the Badoon out of the Solar System, and she has stayed on as a team member.

### Freedom's Lady

Freedom's Lady is an Annihilator-class Earth battleship, owned and operated by the Guardians of the Galaxy. The ship has Unearthly speed, Amazing control, and a Remarkable body. It is protected by an almost invulnerable defense shield, that provides the ship with Shift X protection. The ship has five laser cannons (Damage: Incredible, Range: Monstrous) and two torpedo launchers (Body: Good, Control: Incredible, Speed: Incredible, Damage: Monstrous).



An Ares™ Section Special

# SUDDEN DAWN

A MARVEL SUPER HEROES™ Module

Designed by William Tracy





Many believe that the Marvel Universe™ began in the 1960s with the birth of the Fantastic Four™, the Hulk™, and Spider-Man™. In actuality, comic-book heroes have been around for much longer than that. During World War II, costumed heroes were quite famous, fighting in Europe or on the home front against the Axis powers.

According to the history of the Marvel Universe, the most famous of these heroes joined together to form the super-team known as the Invaders™: Captain America™, Bucky™, the Human Torch™, Toro™, and the Sub-Mariner™. In early 1942, the evil Nazi genius known as the Red Skull™ was able to gain hypnotic control over all of the Invaders except for Bucky. Bucky broadcast a radio appeal for help and was answered by a number of costumed heroes; this new group was christened the Liberty Legion™. The Liberty Legion prevented the mind-controlled Invaders from performing acts of sabotage, and during a climactic battle between the two groups, Toro flew into the Red Skull's airship and destroyed both it and the hypnotic-control device.

The Liberty Legion members elected to stay together to stop Nazi sabotage in America, while the Invaders went back

to fight overseas. One of the most important missions the Legion ever tackled came in 1944, but little was ever heard about it because of the nature of the mission. Only now can the full story be told. . . .

This adventure is designed for a Judge and eight players. It is possible for fewer players to participate, if several players wish to run multiple characters. More may play, using characters from the Invaders. Captain America appears in the boxed MARVEL SUPER HEROES™ game, the Sub-Mariner was listed in DRAGON® issue #89, and Bucky appears in the MARVEL®-Phile of this issue. Compared to the Liberty Legion members, however, Captain America and the Sub-Mariner are exceptionally powerful. As an alternative, time-traveling heroes from the modern world might voyage back to help out, or super-soldiers such as Nick Fury™ might be added to the adventure. If more heroes are used, the Judge should increase the power of the opposition by 3-4 more soldiers per hero per scenario, or he should increase the Karma of the Marvel Super Villains™ by 100 points apiece. Players may, of course, use original characters.

**Note:** If the Sub-Mariner is used, he should be granted Excellent body armor from his dense skin.

Though the founding member of the Liberty Legion, Bucky, has gone to Europe, the group is carrying on as usual. The Spirit of '76™, a hero from a British hero group (the Crusaders™), has returned home, however. He will be recruited into the adventure in the first chapter as a player character.

The Judge should read through this entire adventure carefully and should be especially familiar with the powers of Baron Blood™, the mastermind behind Project: Sudden Dawn. A Marvel vampire is a terrible opponent, and Baron Blood was one of the worst next to Dracula™ himself!

At all times, the villains should act with reason and forethought, and they should be played so that they act as nasty and as rude as they do in comic books. Common soldiers and spies obey their masters implicitly, but villains (especially the ones in the Super-Axis™) are often consumed with hatred for one another as well as for their heroic foes. Though the Super-Axis villains claimed to fight for Hitler, in truth they selfishly fought for their own individual fame and power.

---

## PLAYING NOTES

The referee may set up the game by removing the player character cards stapled in the center of this magazine, cutting them apart, and passing them out to the players. The players may then choose which heroes they wish to use.

A brief glance over the heroes for this adventure reveals that they are much weaker than most costumed crimefighters in later eras. Care will have to be used to complete the adventure if the heroes are to remain in one piece! Players should be given time before the adventure starts to discuss possible strategies for making it through dangerous situations.

The use of a Karma pool is suggested, particularly if the players work well together. Be aware that killing an opponent will destroy the entire Karma pool. If each hero donates half of his or her Karma to the pool, the Liberty Legion and Spirit of '76 will have 98 Karma points to share.

The maps required for this adventure are those provided with the various module packs and with the boxed MARVEL SUPER HEROES game set, save for the ones in Chapters 2 and 4. Each chapter lists the maps required. Judges should ensure that they have the proper

maps before the game gets under way, or else they should generate their own maps. Counters for all the heroes and villains in this scenario will have to be created by the Judge and players. Counters for vehicles, crowds, soldiers, spies, etc., should also be generated.

If a hero is injured severely enough to require hospitalization, a new player character may be substituted in later scenarios. The Judge may declare that heroes who would be killed in this adventure are sent instead to the hospital for several months, requiring substitution of a new player character. New heroes may be chosen as noted above; Bucky is strongly recommended.

In role-playing the heroes, the main characteristics they all share are patriotism, moral integrity, and a hatred for the Axis. Patriot™ emulates Captain America in personality and is one of the more even-tempered of the heroes. Blue Diamond™ is rather hot-headed and impulsive. Jack Frost™ is aloof, being a nonhuman, but friendly. Whizzer™ and Miss America™ are quite attracted to each other. Thin Man™ and Red Raven™ are excellent friends. Bucky (if used in this scenario) is fervently patriotic and active, but may act before he thinks.

Spirit of '76 is also highly patriotic, and often insists that his fists can solve any problem a villain gives him.

**Heroes and bullets:** One important consideration concerns protection from flying bullets, which the Nazis in this adventure fire by the thousands. Heroes with no armor protection should use stealth and their wits to defeat armed foes. Villains in the same area as a hero attack only with fists, knives, clubs, and the like.

Blue Diamond has little to worry about, even from artillery fire. Red Raven and Spirit of '76 have some protection from bullets from their costumes. Jack Frost can make ice shields, and Thin Man can either absorb or dodge some bullet hits by thinning.

It must be noted that none of the heroes like using guns or rifles, and Spirit of '76 is particularly adamant about using only his fists to stop crimes. Each time a hero uses a gun, this should cause a Karma loss of -10 (-20 for Spirit of '76) for that hero. The only time this Karma loss can be avoided is if the heroes are confronting Baron Blood, when special weapons must be used. There is **no** Karma loss for killing Baron Blood, since he is already dead!

# Chapter 1: THE BLITZ BEGINS!

## CAMPAIGN

Read the following to the Liberty Legion players.

It's May, 1944. Rumors circulate daily throughout the streets of New York City of a possible Allied invasion of Europe, coming within months, weeks, or even days. If the Allies can gain a toehold on Fortress Europe, the days of Nazi Germany are numbered.

The end of the war would come none too soon. So far, America has been spared the devastation visited across the rest of the world. Your worst fears are that Adolf Hitler and his Super-Axis allies will find a way to bring the war to your own shores. U-boats already patrol the Eastern seaboard and torpedo ships which leave the harbor. cont . . .

## JUDGE'S INFORMATION

The heart of this adventure concerns both the attempted theft of the Manhattan Project's atomic secrets by agents of the Super-Axis and the subsequent attempt at atomic extortion. Under the direction of the red Skull in Berlin, Baron Blood has assembled a force of soldiers, agents, and super-powered characters to steal information on the Manhattan Project from the U.S. Army. The relative success of the heroes in stopping this plan in early stages of the adventure has a direct bearing on the power of the primitive nuclear device constructed in chapter 4. If the heroes are alert, the bomb will be relatively weak and have little effect. If they slip up, however, things could be quite dangerous later on. . . .



Lately spy and sabotage activities have been at a low. You sense that the enemy may be preparing to strike at America's war industry, and each of you has tried to discover such plans without success.

Now it's Friday afternoon. You are gathered at a local radio station, enjoying a break. Patriot has just finished his weekly broadcast about the war effort, and you are discussing your plans for the coming week. Abruptly, one of the sound engineers breaks into your discussion. Some sort of disturbance is going on down the street, and the police are calling for assistance — meaning you!

The referee should use the city map from the boxed MARVEL SUPER HEROES game set. The radio station where the Liberty Legion begins play is on the first floor of the Krupp Building; they may leave the building at the start of the scenario. The sounds of gunfire may be heard from the western end of town, around 7th Avenue.

Read the following to the Spirit of '76 player.

You've only been off the plane an hour now, but already you feel as if you've never left America. If it weren't for your special assignment, you'd be tempted just to wander the streets of New York and enjoy yourself.

But for now, you've other things on your mind. British intelligence services intercepted a special message. Some of Nazi Germany's most dangerous super-powered agents have come to America, and you know it can't mean anything but trouble for the Allied cause. You've got to stop them any way you can. You didn't have time to warn the proper authorities or get authorization for military backup, so you've come alone to do what you can. The Globe Press building is going to be the first target of Axis sabotage — but why? You aim to find out!

Spirit of '76 may start the scenario anywhere around the block where Globe Press, Minski's Foods, and Ace Handling are located. He is wearing a trench coat, but is ready to throw it off at a moment's notice and attack.

Unknown to the Liberty Legion, a force of criminals has been secretly hired by Agent Axis™, a top enemy spy, to rob the jeweler's store and keep the local police and heroes busy. The important action is about to happen over at the Globe Press building. There, Agent Axis and a force of disguised German soldiers are going to attack the offices of Globe Press. A Nazi agent discovered that the U.S. Army was using Globe Press as a secret research center for work on the Manhattan Project, the project to build the first atomic bomb. Agent Axis intends to steal as many of the notebooks and diagrams in the building as he can find. This is the first step in Baron Blood's master plan.

## BATTLE

The initial action revolves around Rosenstein's Fine Jewels. The Judge should set up four thugs (as per the Campaign Book, p. 27), armed with handguns, in and around the jewelry store. A police car is parked at the corner of Garfield Street and 7th Avenue, and two police officers (as per the Campaign Book, p. 27) are exchanging gunfire with the robbers in front of Rosenstein's. All nearby pedestrians have fled, except for a young boy outside of Crystal's department store (corner of Arthur Street and 7th Avenue). The boy is too frightened to either run or to seek cover.

The gunfire continues for four rounds. In the third round, one of the officers is wounded and knocked down. In the fifth round, the robbers head for the alley behind Rosenstein's to jump into a waiting getaway car. (The driver is a pistol-armed thug.) In this same round, unless the heroes have moved him, a stray bullet hits the boy in front of Crystal's, seriously wounding him. The getaway car starts to leave the alleyway in the sixth round, heading south on Garfield Street at top speed (to draw police and heroes away from Globe Press). If the getaway car leaves the game map, the robbers have escaped.

If at any time it is possible for the thugs to capture a hero, they will do so

and hold him (or her) as a hostage to ensure their escape. They will later demand a ransom; the Judge should handle this as seen fit.

In round seven, the entire side of the Overton Storage warehouse facing Garfield Street explodes, doing Excellent damage to anyone in the two Garfield Street areas beside the building. (The building was secretly taken over by Nazi agents and has been used as a staging area for the assault on Globe Press.) A large tank with a flamethrower mounted in place of a tank gun then rolls out of the building over the rubble and takes up a position facing south along Garfield Street.

The experimental Nazi flame-tank has Excellent control, Poor Speed, and a Remarkable-strength body. The flamethrower mounted on the tank's turret has a range of 2 areas and does Remarkable damage to all that it hits. Anyone hit by the flames may attempt to make a Red FEAT roll for Agility in order to escape most of the flames and take only Good damage. Each time the tank fires, make a FEAT roll in the Remarkable column. A Red result means the tank's flamethrower jams for that round, though it may try to fire normally in the next round. A roll of 00 indicates that the tank flamethrower has broken down; the vehicle is able to move, but the weapon is permanently jammed. A roll of 01 indicates that the tank's drive system has jammed; the tank stops, though its flamethrower still works. The tank is crewed by two German soldiers armed with pistols.

On the round after the tank rolls out into the street, ten black-hooded and heavily armed men (Nazi soldiers, as per the NPC capsules at the end of this module) charge out, led by Agent Axis (wearing a black suit and a black slouch hat). The soldiers are armed with six pistols, two rifles, and two submachine guns. One soldier armed with a pistol also carries two hand grenades, one of which he will use to blast his way into the front door of the Globe Press building. The extra grenade is for meddling hero-types. Agent Axis carries a submachine gun and two pistols. Grenades are treated as per the Campaign Book, p. 17.

The Globe Press building is unoccupied except for two American soldiers (as per the Campaign Book) with one pistol and one rifle each. Both will be incapacitated when the grenade-using Nazi blows up the front door, where they were standing. The plans and notebooks that Agent Axis wants are locked in a file drawer near the center of the

building. If he spends two complete rounds in the building without performing any other actions, Agent Axis will discover the notebooks and steal them.

Agent Axis wishes to avoid capture at all costs. His henchmen will do everything they can to help him escape, even at risk of their own lives. Three getaway cars are parked on Garfield Street in front of the Midtown Utilities Building; Agent Axis and his fellows head for them as soon as the notebooks are recovered. The drivers of all three cars start their engines as soon as the attack on the Globe Press building begins; drivers are treated as thugs (as per the Campaign Book) and are armed with pistols. The cars split up and attempt to leave the game map, heading in the direction of Rathbone Park at high speed. If any car leaves the eastern edge of the game map, the occupants are assumed to have escaped. When Agent Axis and the soldiers head for the getaway cars, the tank crew will abandon their vehicle and leave with the rest.

The Judge should locate a few other parked cars around the area, to avoid casting suspicion on the getaway cars. However, a hero making a Yellow Intuition FEAT roll within one area of the parked cars notices that the drivers are acting suspiciously (checking watches, looking up the street, not fleeing when everyone else has, etc.).

As above, if it is possible for Agent Axis or his men to capture a hero, they will use the hero as a hostage to ensure their escape. The hero will not be ransomed. Instead, the Nazis will attempt to ship the hero back to Nazi Germany, where horrible experiments, torture, and brainwashing may await him.

If Agent Axis sees that the experimental flame-tank is in danger of being captured, he will pull out a small, hand-held radio control device and push the red button on it. This will cause the tank to explode. Anyone inside the tank will take Amazing damage; those outside the tank in the same area will take Incredible damage, and anyone one area away from the tank will take Good damage. Agent Axis won't mind killing the tank crew if he feels it necessary. He will definitely blow up the tank once he and his men are leaving, before he exits the game map. Only grappling with Agent Axis, shooting the transmitter box, or freezing his hand (using Jack Frost's powers) will stop him from accomplishing this. Assume it takes one round for him to pull the radio-control device out and another round to push the button, allowing the heroes time to react.

The Judge may add extra NPCs to this scenario, such as newly arrived police cars, crowds of curious onlookers, and well-meaning citizens who try to stop the bad guys from doing whatever they're doing. Appropriate Karma bonuses and penalties should be awarded to the heroes for saving innocents, assisting with rescues, and so forth. Note the section on crowd reactions in the Campaign Book, p. 28.

## AFTERMATH

If Agent Axis is captured, he will refuse to talk, and he will be held for trial on espionage, sabotage, and other other crimes. It is highly likely that rescue attempts will be made by other Super-Axis agents later on.

If the soldiers with Agent Axis are captured, they will initially confess very little. They were assigned to this mission by Agent Axis, but have no idea of what they were to steal or who is in charge of this project. They only know their mission was of critical importance to the Axis cause. Some men will be openly contemptuous of the heroes, particularly the most popular heroes. Any hero who manages to get a Nazi soldier or spy to talk (Campaign Book, p. 28) will learn that the men are fearful of punishment from their superiors for having failed to accomplish the mission.

Anyone reading the papers that Agent Axis was attempting to steal discovers (after a Yellow Reason FEAT roll) that they are covered with complex mathematical and physics formulas on radiation. Nothing else of value can be discerned from them, except by Red Raven or Thin Man. Either of these characters are capable of discerning that these papers could be describing the effects of splitting the atom. Loose talk about these papers or the Manhattan Project will anger the Army, and possibly cause the hero to be detained and interrogated himself temporarily.

After the battle, the Liberty Legion and Spirit of '76 are contacted by high-ranking officers in the U.S. Army. They are sworn to secrecy, and made to understand that what they are about to learn is classified material of the highest importance.

The research being conducted at the Globe Press offices is only one small part of an important American project to create a weapon that will hopefully end the war. To maintain the project's secrecy, the Manhattan Project has been split into several departments which know nothing about each other. Each department is working on a different

aspect of the weapon's design and development. Nothing more can be said about the weapon itself, except that it will be of unheard of power and destructiveness. The Army officers treat the project with grim seriousness. They never use the words "atomic bomb," "fallout," "nuclear weapon," or the like. They want the project to stay secret, even from heroes. After all, if the Red Skull could brain-wash the Invaders . . .

Unfortunately, Hitler is believed to have learned of the project, and a similar weapons program is in progress in Nazi Germany. Though Hitler is skeptical of the weapon's power, he has allowed funding for the project. So far, limited success has been achieved, but with no working prototype.

Thus, Hitler has decided to have information on the American project stolen by his agents. Possession of this material would hopefully fill in the gaps in their knowledge. British agents learned that the assault on the Globe Press building was the first phase of this plan. Though Spirit of '76 was flown back to the United States in order to warn the authorities there, he wasn't able to reach them in time, so he went ahead to the site of the first attack.

The Army now wishes the Liberty Legion to defend two other important sites from possible Nazi aggression. Intelligence sources have learned that these places are the ones most likely to be attacked, and the Legion has to move immediately to defend the next target

on the list. If desired, extra help can be received from the Army and from the Office of Strategic Services (the wartime intelligence service that later became the CIA) to replace lost manpower.

Heroes may heal up to twice their Endurance before the next chapter.

### *The Blitz Begins KARMA*

Prevent boy (or other innocents) from being wounded	+30
Capturing Agent Axis	+20
Stopping theft of notebooks	+20
Each wounded policeman and soldier assisted	+15
Capturing tank intact	+15
Each thug, enemy soldier, or spy captured	+10
Each getaway car prevented from leaving map	+10
Each thug or enemy agent (including car drivers) escaping the map	-10
Each hero captured/incapacitated	-20
Agent Axis escapes without notebooks	-20
Loose talk about Manhattan Project	-20
Agent Axis escapes with the notebooks	-40
Killing any enemy, including Agent Axis	-All

Other Karma awards and penalties may be given out as the Judge sees fit, as per the Campaign Book.

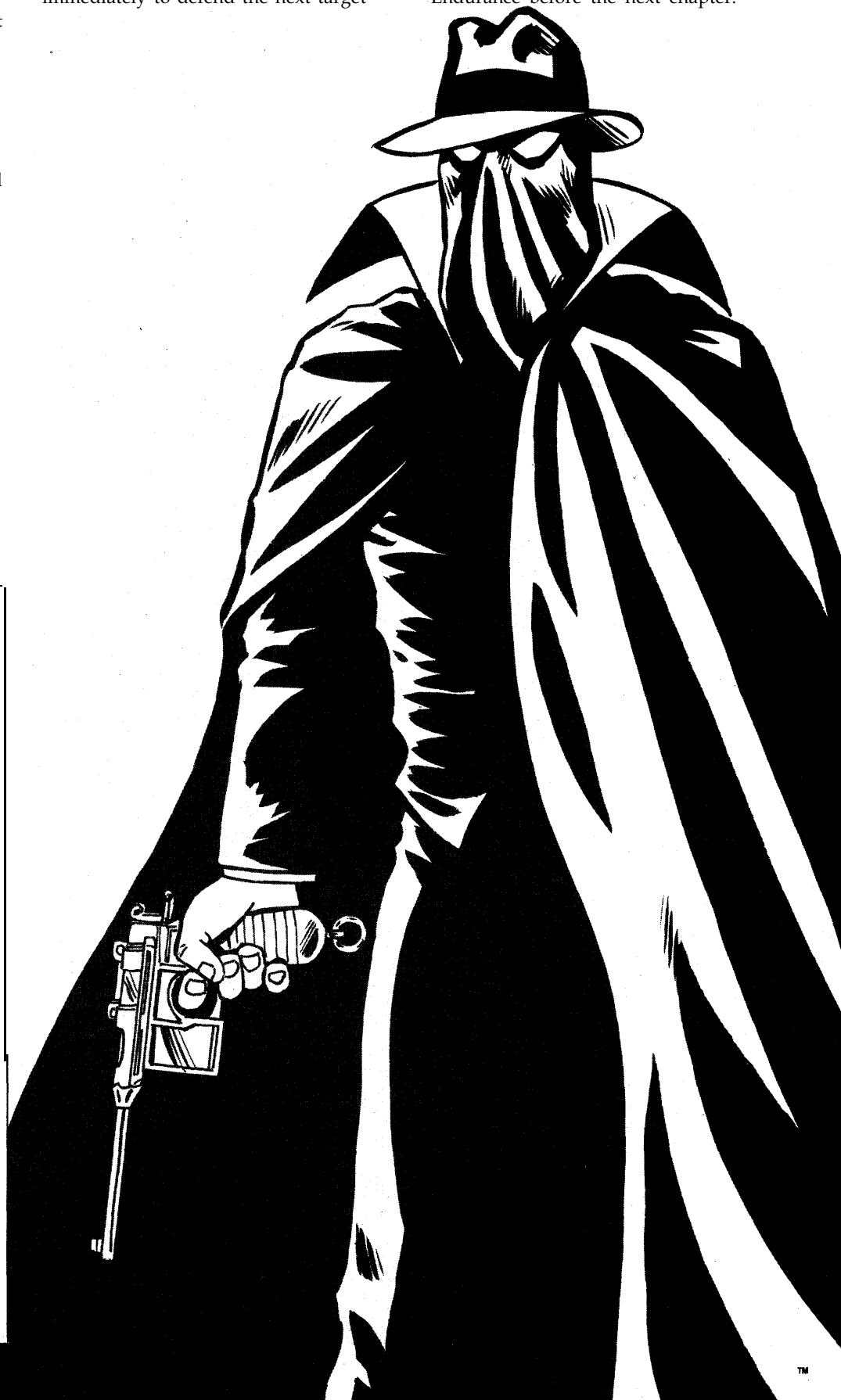



## Chapter 2: THE LIBERTY LEGION BOWL

### CAMPAIGN

The Thin Man will be asked to fly his special aircraft to the place where the U.S. Army believes the Nazi agents are ready to strike next. The Liberty Legion plane is described on the Thin Man's character card. The plane can hold the entire Legion, plus the Spirit of '76, though it may be a tight fit. If Thin Man is incapacitated or not used, the group will be flown to their destination, but will have no time to prepare for the encounter and will not have the use of any aircraft.

Thin Man's plane is especially constructed to take his elastic and far-reaching arms into account. Anyone else using the plane must make a Green Agility FEAT every two rounds when flying the plane to avoid crashing, as well as making a Yellow Reason FEAT at first to understand the plane's control situation.

The Legion is instructed to fly to the University of Chicago, to the Stagg Football Field. The Army grants the Legion permission to land in the field parking lot, which is easy to do since the current college dean hates football and the lot is empty. The Legion arrives before dusk.

Before leaving for Chicago, Patriot is given a special message from an Army general associated with the Manhattan Project. He is informed that a research center has been set up beneath Stagg Field, and the center is to be defended at all costs. The work going on there is critical to the success of the project. Dangerous materials are stored there as well. A special telephone was secretly installed in the stadium of the field for the heroes to use to summon help; military units are standing by, but at a distance (so as not to scare the villains away, if they come).

If the characters arrive on the Liberty Legion plane, they will have two hours to plan their strategy for the next encounter. The Liberty Legion plane may be moved aside and covered by tarps. If they arrived on another plane, they will get to the field in a regular automobile only one round before the Nazis arrive.

The map required for this chapter should be generated by the Judge. A small-scale version of the map, which is easy to reproduce and uses staggered square blocks, appears at right. It

essentially depicts Stagg Field, the bleachers around it, and other relevant scenery. The map squares should be about 1" to 1½" wide, each one representing an area about 20 yards across. The map is not meant to be an exact replica of the real Stagg Field; it is only the way it looked in the 1940s of the Marvel Universe.

The materials used in the stadium at Stagg Field are as follows: goalposts – Good; walls between field and benches – Excellent (5' high); benches – Poor; railings in stands – Excellent; doors to underground complex – Incredible.

Note the location of the secret telephone. A military operator located near the stadium will answer the phone if the receiver is picked up. He can summon any reasonable assistance, including police, fire, medical, and military aid. (Military aid, for obvious reasons, will arrive first.)

Just after darkness falls (which is when the PCs arrive if they are transported by the Army Air Force), the group hears the sound of a propellor-driven plane approaching the field from the east. After a minute, a strange-looking aircraft appears, moving slowly over the stadium stands and heading for the center of the football field. The aircraft appears to be an airplane standing up on its tail, with several fins and smaller propellers projecting from its sides. The plane is painted with a camouflage style that anyone making a Yellow Reason FEAT roll will recognize as a typical German design.

The aircraft is an experimental model of a VTOL (Vertical Take-Off and Land-

ing) vehicle. The plane has Excellent control, Good speed, and a Good body. It is armed with two machine guns mounted on its sides which do Remarkable damage at a range of 10 areas; the guns fire with Good Agility.

Unless it encounters heavy ground fire or is made to crash, the plane lands in the center of the football field. Two rounds later, as the main propellor is winding down, two costumed beings and eight submachine-gun armed Nazi soldiers (wearing normal American clothing) leave the plane by a folding stairway at the bottom. After one round of hasty conversation, one of the costumed beings (a giant woman) leads the soldiers across the field to the large doors leading to the complex beneath the field. The costumed man will fly into the air and slowly circle the field, looking for costumed heroes, police, or military people to attack.

The military forces near Stagg Field have heard and seen the VTOL's approach. They arrive shortly after it appears over the field, as noted below.

### BATTLE

The costumed man and woman are two super-powered Nazis: Master Man™ and Warrior Woman™. Warrior Woman is in charge of the mission to break into the underground complex, steal as much as possible, and destroy everything else.

If not interrupted, Master Man continues to fly in a circle around the field until the U.S. Army arrives in force. Meanwhile, Warrior Woman reaches the

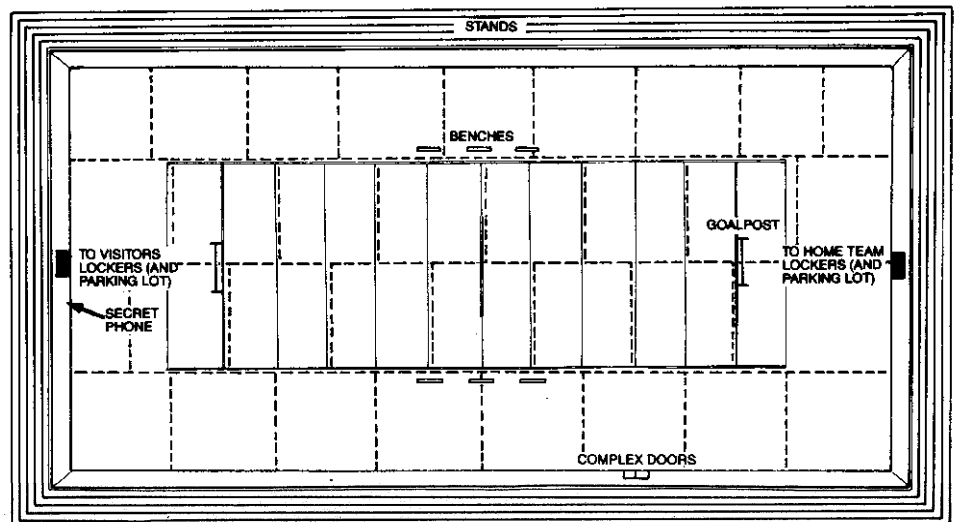

doors leading to the underground complex, destroys them in one round, and charges inside with her henchmen. After six rounds underground, Warrior Woman and five of her soldiers emerge (the other soldiers were killed or wounded in the raid), bearing numerous papers and pieces of equipment. They head for the VTOL plane, board it in two rounds, summon Master Man, and take off. It takes three rounds for the VTOL to warm up to the point that it can fly again, once the pilot sees people returning to the plane. One Luftwaffe pilot (unarmed, with Typical stats) and two soldiers armed with submachine guns remain aboard the ship at all times.

If any heroes appear, Warrior Woman direct her soldiers to spray them with submachine-gun fire. She then has Master Man attack and joins in the battle herself. She attempts to subdue and capture any heroes she can, taking them aboard the VTOL plane. If any of her men are wounded, she will direct others to pick them up and bring them aboard the VTOL if possible. If Master Man is put out of action, Warrior Woman will abandon him and attempt to escape. If Warrior Woman is knocked out, Master Man will attack until he is defeated or he defeats the heroes; the soldiers will flee in the meantime. Neither super-character will flee otherwise.

If any of the enemy forces escape in the VTOL, the Liberty Legion may attempt to pursue them using Thin Man's special aircraft. The chase occurs at night, of course, and the Judge may add additional problems to the fight — such as civil defense forces mistaking the dogfighting planes for an enemy raid, which will soon produce an attack by Army Air Force fighters. If the Liberty Legion has no plane, the Nazis escape and make their way back to a hidden base in upper New York state.

If the VTOL takes a Red "Kill" roll from any missile weapon, the main propellor on the craft has been hit. The VTOL immediately drops from the sky and crashes, doing Remarkable damage to all occupants. If the ship takes more than Good damage from any attack, a "Bull's-Eye" result means that a passenger has been injured. Select a passenger at random inside the VTOL and apply the results of the attack damage (minus the Good body armor of the VTOL) to him. If the pilot is hit, the plane will crash at once, as noted above.

Warrior Woman and Master Man, if they survive the crash of the VTOL, will stay and fight until overwhelmed or until they destroy all opposition and can

flee. They will then try to make their way to an emergency hideout, run by Nazi spies on the outskirts of Chicago.

Six rounds after the villains manage to break into the underground complex (if allowed to do so), the Army arrives. Four large trucks, each containing eight soldiers (armed with rifles, all as per the Campaign and Battle Books), a driver, and an officer (the latter two with pistols) pull up outside the field and unload. If any of the four officers fails to make a Green Intuition FEAT roll, he assumes that the heroes are also Nazi saboteurs, and orders his men to open fire on them as well as on the real Nazis.

### AFTERMATH

Neither Warrior Woman (out of pride) nor Master Man (out of stupidity) are willing to surrender to Allied heroes; both fight until they are unconscious or flee (as outlined above). The soldiers with these characters surrender immediately when both of the super-Nazis are taken out of action.

Warrior Woman and Master Man are similarly hard to interrogate when captured, though Master Man may accidentally let information slip out under questioning if he makes a White (only) Reason FEAT roll during an interrogation session. Warrior Woman cannot be intimidated and refuses to talk at all if caught. The soldiers may be interrogated as per the Campaign Book, p. 28.

The soldiers only know that they arrived in the U.S. by U-boat and that they have been staying at a hidden encampment in New York state. There, they were assigned to work with the two super-Nazis in stealing some plans from Stagg Field's laboratory. They aren't sure what the plans were for, but several guess that the Americans are working on a poison gas bomb.

Master Man, if he slips, becomes angry and tells the heroes that they'll regret their deeds "vonce der Baron hears of zis!" He clumsily tries to cover his slip by denying that he said anything at all about a baron; he meant "der Führer" (i.e., Adolph Hitler). This clue is still confusing, as it could refer to either Baron Blood, Baron Zemo, or Baron Strucker, all of whom are major Nazi figures well-known to most American heroes. It could also mean some other baron, or it could be a code-name for the Red Skull.

The information on the papers that the Nazis are trying to steal deals with setting up an controlled atomic chain reaction, which is the nature of the

research going on beneath the football field. Some of the papers also deal with the process of creating an uncontrolled atomic reaction, which would release immense amounts of energy. Anyone making a Yellow Reason FEAT roll recognizes these facts after a short scan of the papers. The equipment represents samples of dampening rods used in maintaining a stable atomic pile. None of the equipment is radioactive.

When the battle ends, the military drops a security net over the entire operation, keeping out reporters and unauthorized civilians. Any hero who talks indiscriminately about what he or she has read in the stolen papers risks being arrested and temporarily confined by the military police.

The Army won't discuss the project going on at Stagg Field. Once the battle is over, the heroes are asked to head for the next high-security facility that may come under attack. Again, transportation is provided, granted that the Liberty Legion is not able to use Thin Man's plane. All heroes may recover two Endurance ranks of Health on the way to their next job. Injured or captured heroes may be replaced, as noted above.

### *The Liberty Legion Bowl* KARMA

Stop Nazis from entering the underground complex	+50
Capture Master Man	+40
Capture Warrior Woman	+40
VTOL captured intact	+20
Each Nazi soldier captured	+10
Each Nazi soldier who escapes	-10
VTOL destroyed	-15
Each American soldier injured by heroes	-15
Loose talk about Manhattan Project	-20
Each hero captured/incapacitated by enemy	-20
Nazis enter underground complex	-40
Master Man/Warrior Woman escapes	-40 each
Plans and equipment taken away by Nazis	-40
Enemy or friendly person killed by hero	-All

Other Karma awards and penalties may be given out as the Judge sees fit, as per the Campaign Book.

---

## Chapter 3: U-DAY!

### CAMPAIGN

Read the following to the players.

Before leaving for the next assignment, you are given a brief — ing by an Army general. He tells you that the next point of Nazi sabotage has been discovered to be the Barclay Research Center, along a river near the New York coast. Your Legion is to land at a private airfield only five miles from the facility, two hours before dawn. Two jeeps and several Army officers will meet you there to take you on to the center.

The buildings at the research center have been evacuated. Unfortunately, much of the larger equipment cannot be moved. Rather than destroying it, the Army wishes the Liberty Legion to defend the equipment. The equipment is stored in one particular building. Other structures are the mess hall, barracks for workers and scientists, warehouses, and so forth. Your force must be stationed in the facility as best you can before the enemy assault begins.

Barclay Research Center is not a historical location, but existed in the Marvel Universe of World War II. The map used for the Barclay Center is the riverfront city map found with the MH AC 6, *New York, New York* game accessory. All of the labels for the buildings should be ignored for the purposes of this scenario, and should be replaced by the following:

The Dobson/Spartan/Le Grand block is now the main research building, where the most important machinery is stored. The Hayes Street Library/Museum block is the auxiliary research building, with other equipment. The Keeler-and-Thompson/DocTech block is now the research center's main office area, with lots of communications gear kept in the DocTech Labs area. The Arthur Street Bridge extends no farther than the edge of the map, becoming another pier (and all piers are owned by the research center). The three blocks near the river (Aiken's, Brand Corp. warehouses, and

the legend block) are normal warehouses, filled with assorted minor materials like clothing, foods, regular tools, etc. The Sutherland/Manchester/Highley block has become the rec center, gym, and mess hall. The triangular blocks in the lower left side of the map are entry gate buildings to the research center. All other buildings west of Harrison Street are barracks buildings (now empty), and all others east of Harrison Street are abandoned and empty. Ignore the private pier's fence.

The main and auxiliary research buildings are constructed of Excellent material (concrete). All other buildings are Typical in material strength (reinforced wood). The machinery in the two research buildings is made of Good-strength material, and the furniture found anywhere in the complex is of Poor material strength (wood). Piers and wharfs are of Typical material. All doors in the complex are of Good strength, except for the doors on the research buildings, which are of Excellent strength. The two research buildings have no windows.

---

### BATTLE

The heroes encounter nothing except a stray dog (the camp's mascot) as they wait through the night. The dog is a carefree mutt that barks loudly and long at any costumed being he sees (FASE = all Typical, Health = 24, bites for Good damage). If the dog is harmed, then the scientists who normally live at the research center will be angered. The dog won't bite unless attacked first.

As the first rays of the sun cross the sky, a wake appears in the river and approaches the shore. Three rounds later, a conning tower from a U-boat surfaces across from the Keeler-and-Thompson building. The sub covers three areas, with the average width of a street. The conning tower appears in the center area of the three sub areas. The interior of the sub may be detailed by the Judge if desired, though it may not be necessary for the adventure.

The body and hatches of the submarine are of Remarkable material. The sub has Good control and speed.

On the round after the sub surfaces, a hatch opens and twelve Nazi sailors

The entire complex is surrounded (at map's edge, with the three areas in the lower left corner being excluded) by an electrified wire fence made from Typical material (Good damage if touched). No fence extends along the shoreline.

No building is higher than one story in this complex. All weapons and ammunition have been removed from the area.

All of the above information on building identifications should be passed on to the players before the heroes hide themselves in the area. The defense of the two research buildings is of greatest importance.

**Special note:** The Army has managed, at the last minute, to drop off numerous books and papers in the two research buildings that are filled with false information. Anyone who reads this material believes it to be no different in nature from any of the other secret material seen in the previous two chapters. However, the information does them no good if they decide to use it for building any nuclear devices. The Army will not tell the heroes at any time that the information is false.

---

(treat as soldiers in all respects) climb out. Ten, equipped with one submachine gun and one special grenade each, head for the research complex by climbing onto the Arthur Street pier from the bow of the submarine. Two other men remain on the sub, readying the deck gun mounted in front of the conning tower. Two rounds later, the gun will be ready to fire (as light artillery in the Campaign Book, p. 17).

One round after the U-boat surfaces, a costumed figure leap from the water onto the middle pier. Any hero seeing this person recognizes him as U-Man™, a renegade Atlantean working for the Nazi cause. U-Man is carrying a small pouch of waterproof equipment, containing a miniature camera and several waterproof bags (empty). His mission is to reach the two research buildings, break inside, take pictures of any interesting equipment, snatch all valuable-looking documents, and destroy all remaining equipment. It takes one round to break into a building, three rounds to take pictures, two rounds to snatch papers, and three rounds to destroy equipment in each research building.



The ten sailors entering the complex cautiously proceed into the heart of the research center, searching for hated Americans to kill. They continue to patrol the streets until such time as U-Man finishes his tasks. When his tasks are completed, U-Man runs for the Arthur Street pier, dives into the water, and leaves the scenario. The U-boat fires one warning shot from its gun over the water; the sailors then hurl their grenades into as many buildings as they can to destroy them. The grenades are incendiary in nature, setting fire to all materials within the area they detonate (Remarkable damage, followed by two rounds of Good damage from flames). Once this is done, the sailors flee to the

U-boat, where the U-boat's gun opens fire on the riverside offices and communications center, destroying them completely in three rounds. As the U-boat leaves, it continues to fire shells into the complex for six rounds, blasting all shoreline buildings into rubble.

The submarine contains eight more sailors, each armed with a pistol and having soldier statistics. If the submarine's armor is penetrated, the sub will sink in five rounds. Each man aboard the sub must make a Yellow Endurance FEAT in order to escape drowning and make it to shore. The sub captain is also aboard; treat him as a mercenary, as per the Campaign Book, p. 27.

U-Man fights any costumed hero without a moment's hesitation, hoping to gain status in the eyes of the Reich. He wants to capture a few heroes and bring them alive to the submarine, where they can then be taken to a German destroyer in the Atlantic and transferred to Germany. He will not retreat unless he has less than one-quarter of his Health points left; then he dives into the water and swims to the bottom, out of reach of the heroes.

The sailors in the complex split up into groups of two as they patrol the streets, wondering where the Americans went. They tend to avoid closing with costumed heroes, firing their sub-machine guns and throwing grenades instead. If one member of a team is knocked down, the other man will not leave him. Small groups will quickly reform into larger groups once danger threatens, and the men have been trained to set up ambushes and crossfires whenever possible. They, too, try to capture heroes, as they stand to gain medals and promotions for doing so. If the sailors see U-Man knocked out of the fight, they will flee for their U-boat without trying to rescue him.

#### AFTERMATH

U-Man, like other previously captured Nazi villains, at first refuses to talk. However, if shown that other super-Nazis have been caught, he might be made to talk according to the rules in the Campaign Book (p. 28).

U-Man claims that he was hired by Baron Blood for this mission. He has no idea of what he's supposed to be looking for and cares nothing about the Manhattan Project. He only wants to become the ruler of Atlantis, supported by his Nazi buddies. He pretends to be as cooperative as possible, but will escape at the first opportunity.

The sailors with U-Man know less than he does. They were to raid the research base and destroy as much of it as possible. They cannot offer more than that.

After the battle, the characters are met by a grim Army general. The entire raid against the Barclay Research Center was only a feint. American intelligence now believes that the Nazis meant for the Americans to discover the leads to the Barclay raid, as a second raid went uninterrupted on the New Jersey coast. An important scientist was kidnapped by other Nazi raiders, and an experimental prototype of the project's weapon was picked up.

Early reports from the area say that a dense fog rolled in and hampered security efforts. Several guards were discovered in a dazed condition, two of them with unusual neck wounds and severe anemia. Both soldiers are being hospitalized, but should recover. (They will not turn into vampires later.)

The Liberty Legion and Spirit of '76 are given two days off to rest. Each hero may regain up to twice his or her Endurance rank in Health (or double this rate for each day spent in bed).

#### U-Day KARMA

Capture U-Man	+40
Prevent U-Man from entering research buildings	+40
Prevent sailors from bombing any buildings	+30
Capture U-boat intact	+20
Each enemy sailor captured	+10
U-boat destroyed	No loss
Each enemy sailor that escapes	-10
Dog in Barclay Center harmed	-10
Each hero captured/incapacitated	-20
Loose talk about Manhattan Project	-20
Planted notebooks taken by Nazis	-20
U-Man's camera (with pictures taken by Nazis)	-20
U-Man destroys any equipment	-20
U-Man escapes	-40
Any enemy killed	-All

Other Karma awards and penalties may be given out as the Judge sees fit, as per the Campaign Book. Though the planted notebooks are useless to the Nazis, Karma is still lost for their theft, as the heroes were to prevent such an action anyway.

## Chapter 4: THE FINAL COUNTDOWN

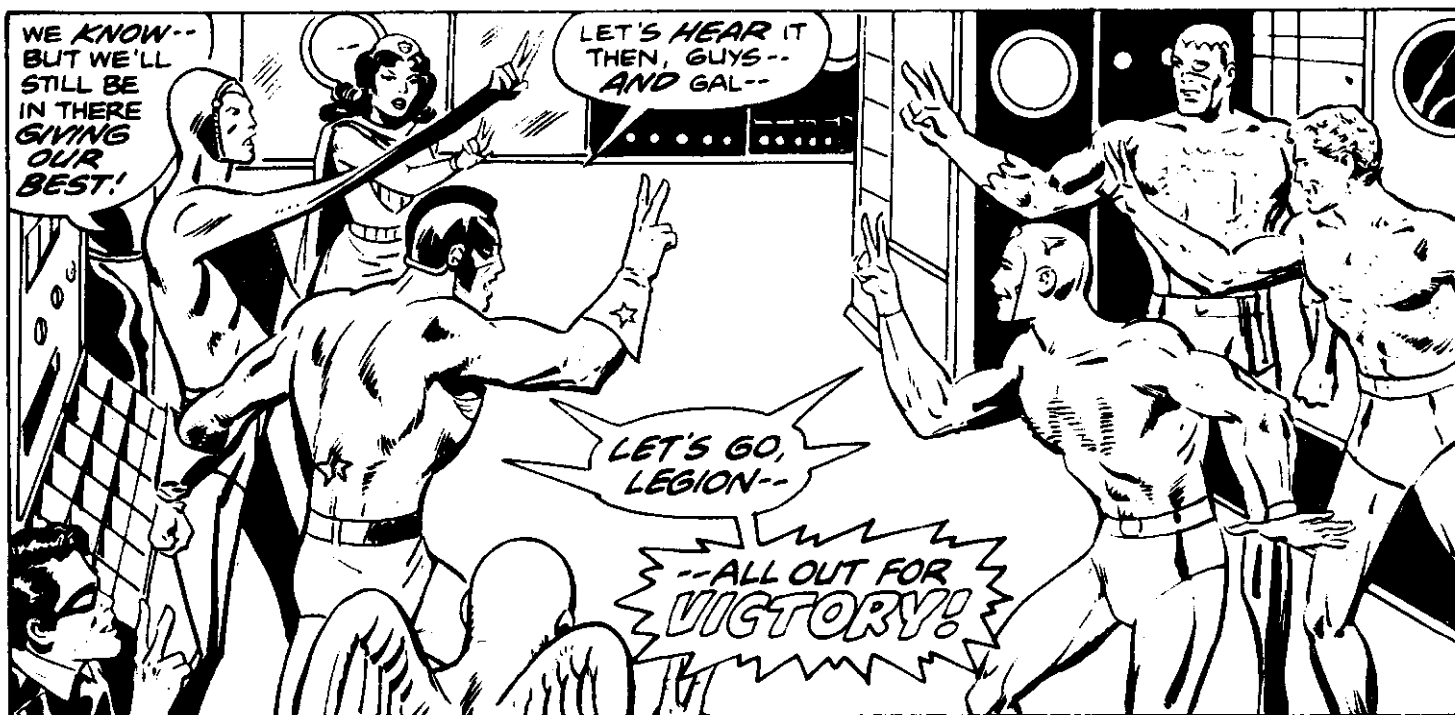

### CAMPAIGN

Read the following to the players.

Two days have passed since the fight at the Barclay Research Center. You are now back in New York City, and are broadcasting a special radio show featuring a conversation with Spirit of '76. "Six" is retelling his experiences with the Crusaders in fighting Axis aggression in Europe. Suddenly, the broadcast is jammed by a more powerful transmitter. As the static clears, a dreadful, hissing voice comes from the speakers.

"Your petty broadcast has been temporarily cancelled so that I may issue the following ultimatum. At this moment, I, Baron Blood, have taken control of the top story of the Empire State Hotel, in downtown Manhattan. We have in our possession a new type of powerful bomb, which we acquired from your own corrupt and incompetent military.

"The bomb has been armed, and it is set to go off in exactly 24 hours. Only I am able to stop the

bomb from exploding. I will gladly do so if I receive news that American troops are going to be withdrawn from Britain and Africa, and that the American government will negotiate peace with the Axis powers.

"Do not attempt to attack me! I am able to cause the bomb to explode at any time. The blast alone would reduce all of the Lower East Side of Manhattan to smoldering rubble. If you don't believe me, ask your military scientists. That is all. Sieg Heil!"

The Liberty Legion is aware that Baron Blood is a vampire and that the only way to stop him is to destroy him. Anyone making a Green Reason FEAT may remember the sorts of devices that slay a vampire, as listed under Baron Blood's capsule description at the end of this module. Obtaining these devices in a hurry may prove difficult, however.

Dark storm clouds fill the sky outside over New York City. Upon reaching the 35-story Empire State Hotel (down the street from the Empire State Building), the heroes find the area jammed with spectators. Military police and New York

City cops are just now starting to arrive and are trying to cordon off the building and evacuate everyone from a one-block area around the hotel. (Remember, no one in 1944 has any idea of what sort of bomb the Army has been working on, or what kind of power atomic weapons have.) As soon as they see any costumed heroes, the police and military men will escort them to a command post set up across the street from the hotel.

The colonel in charge of the military forces there is on a radio linkup to the governor of New York state, the mayor of the city, and President Roosevelt. After many "Yes, sirs" and "No, sirs," the harassed colonel hangs up and tells the heroes that they've got their work cut out for them. The President, the governor, and the mayor all agree that the American government cannot give in to the demands of the Nazis. The heroes must try to disarm the bomb and bring Baron Blood and his henchmen to justice. The assault on the building must begin as soon as possible. It is now 2 P.M.

The only map required for this adventure is the one appearing in the game accessory MH AC 6, *New York, New York*, on the inside cover of the module. Use the Manchester Hotel's Penthouse Suite Level for the top floor of the Empire State Hotel, only changing the room numbers to 3501-3504. The Judge



may detail the floor further to show the location of furniture, potted plants, lights, electrical outlets, and so forth. The storage area is filled with cleaning supplies, linens, spare furniture, tools, extra carpeting, wastecans, extra light bulbs, and mops and brooms. The stairs going up lead to the roof.

The outside walls of the hotel are of Remarkable-strength material (reinforced concrete). The floors and ceilings are also of Remarkable strength. The interior walls are of Typical material, and the doors are also Typical strength. Furniture is of Poor strength. Windows are Feeble strength. The elevator doors are of Good strength; the elevator car has Typical armor (partially shielding those inside from grenade blasts), and the elevator cables are Excellent strength.

## BATTLE

Baron Blood, his men, and the bomb were landed on the roof of the hotel the night before by VTOL. Since then, the Baron has been using hypnosis to control hotel employees and set up his base of operations on the 35th floor.

Any costumed figure entering the building during daylight (unless disguised or hidden) has a 95% chance of being spotted by the Baron's men. Any flying figure is automatically seen and reported. The Baron will then turn on his radio and announce that any interference by so-called heroes will cause him to detonate the bomb in his possession (see below). He avoids carrying out this threat unless the heroes actually break into the 35th floor and enter combat with the Nazis there.

The Baron's men have jammed the elevator circuitry. Anyone with electrical or mechanical skill (or an appropriate super-power) may repair the elevators and use them to head for the 35th floor. However, the guards outside the elevators on the top floor will immediately notice the elevator's movement and will report it. In addition, they will force the elevator doors open and will drop hand grenades down upon the elevator's roof. Forcing the elevator doors open requires a Red Strength FEAT roll for one man, a Yellow FEAT roll for two or three men, and a Green FEAT roll for four or more men. One attempt takes one round.

The heroes may climb the stairs, though this will be exhausting. Heroes with an Endurance of Excellent or better may run up the stairs without rest-

ing before battle. Those with Good Endurance have to rest one round at the top of the stairs before fighting (unless an Endurance FEAT is made). Those with less than Good Endurance require frequent rests on the way up, unless walking. Those with Poor or worse Endurance have to rest while walking upstairs.

A number of people may be found on the 35th floor. Four soldiers armed with two grenades, a dagger, and a submachine gun apiece (in full SS combat uniform) patrol the corridor outside the elevators. Three similarly equipped soldiers stand at the top of the staircase by the storage room door; two other soldiers are on the building's roof (which is flat and has two air ducts, without elevator access), looking over the edge of the building with binoculars. In addition, the super-powered Iron Cross™ is also on the roof, watching for aircraft. A VTOL similar to the one used in Chapter 2 is parked on the roof beside an air duct. No military aircraft have flown over the building yet, so the VTOL hasn't been spotted. The VTOL pilot is resting inside the plane, which also contains the radio transmitter.

Suite 3501 has been turned into a temporary cell for captured hotel employees and guests. Two bellboys, two married couples, a businessman, and a

maid are being kept here under guard by two other soldiers, equipped as above. The guards are not prone to use their weapons to kill their prisoners, preferring to use them on any heroes they see. If any heroes attempt to break into the room, the businessman (an ex-NYC cop, using police statistics in the Campaign Book) will join the fight.

Suite 3502 contains the bomb, a primitive fission device looking like a large, wired-up crate (weighing 400 lbs.). It's guarded by three soldiers and Baron Blood. In addition, the scientist captured in Chapter 3, Dr. Horatio Martin, is present. He is the only man who can defuse the bomb, a process that takes only two rounds unless Baron Blood has pushed the red button on top of the bomb. If this happens, the bomb will explode in twenty rounds. (Defusing it then takes four rounds.) Baron Blood will then order all Nazi soldiers and super-characters to the roof, where they will board the VTOL and escape. However, Baron Blood will drop Dr. Martin off the roof before he goes, so that no one will be able to stop the explosion. A hero with knowledge of electrical workings can disarm the bomb after six rounds of work on a Yellow Reason FEAT roll. Certain mutations or powers might also be helpful.

The power of the bomb is determined



by the relative success or failure of the heroes in the previous chapters. The bomb is not well designed and would not normally produce the enormous fireball that we are accustomed to seeing. The bomb is powerful enough to generate partial fission if the Axis super-agents have gathered enough information from the Americans beforehand.

The bomb has a basic destructive power that is augmented as outlined below. At present, the bomb cannot generate a nuclear blast, but the explosive casing around the bomb can scatter radioactive material across the 35th floor and out through the windows into the streets below. The blast causes Incredible damage to anyone in the same area with the bomb, Remarkable damage to all one area away, and Good damage to anything two or three areas away. The radioactive material does Feeble damage to anyone within the area where the bomb explodes and all areas immediately adjacent to it; this damage is taken every round until the affected characters leave the area and clean themselves off. The blast also smashes the roof and floor of the room.

The theft of the notebooks in Chapter 1, the theft of material from the Stag Field station in Chapter 2, and the pictures taken by U-Man in Chapter 3 each contribute to the power of the bomb. If only one of the above incidents occurs, the bomb will function as above, but the radioactive material spread around the area will do Poor damage every round (as it has been better refined). If only two of the above incidents occur, the blast will do Amazing damage to the area in which it rests, Incredible damage to all things one or two areas away, Excellent damage to all out to four areas, and Typical damage out to six areas. The radioactive material from the bomb's core will do Poor damage every round as above, to anyone who enters the blast zone.

If all three incidents occur, the bomb will be capable of partial fission. The fireball will destroy the upper five floors of the hotel, showering a wide area of Manhattan with radioactive debris and broken concrete. Dozens of people will be killed, hundreds will be injured, and military authorities will take days to clean the area up. The incident will spur America's war effort, greatly angering the people and the government, and will turn an already terrible war into one of great savagery. Moves will be made to speed development of the atomic bomb, with the intent of using the first one against Berlin in late 1944. The Judge

should handle these developments as he or she sees fit.

The blast does Unearthly damage to anyone within five areas of the center of the explosion. The damage decreases over area until it reaches Poor levels at twenty areas away. The fallout from the blast does Poor damage every round to anyone in the building, and does Feeble damage to anyone within the area of the blast across Manhattan every hour, until cleaned up. Baron Blood and all who escaped in the VTOL are not affected.

However, if the misleading documents in Chapter 3 are stolen by U-Man or others, the power of the bomb is dropped by one level. The base power of the bomb cannot be reduced beyond the lowest level mentioned above.

At present, Dr. Martin is under Baron Blood's hypnotic control. He has been putting the finishing touches on the bomb, using the materials that the Baron has had stolen by others. He will not fight any costumed heroes, as he is too aware of his poor physical condition (FASE scores are all Poor; Reason is Remarkable in nuclear physics and Excellent otherwise; IP scores are each Good).

Suite 3503 has been converted into a temporary barracks for Nazi soldiers. Two soldiers are present, resting from their tour of guard duty. Their equipment and weapons lie by their beds. A backpack beneath one bed contains \$52,000 in cash, jewelry, and other valuables stolen from the people on this floor. Suite 3504 is not in use, though it has been searched for valuables.

Baron Blood can use the storm to attack heroes with lightning bolts (requiring a Green Agility FEAT roll) or wind storms. He makes maximum use of all of his powers in a conflict, always acting with cunning and malign intent.

### AFTERMATH

The aftereffects of the bomb explosion are detailed above. Once the heroes have managed to prevent the explosion, the Army will be pleased, but will pressure the heroes to say as little as possible about the incident, for reasons of national security. Presidential citations will come, though the citations will be carefully worded to avoid mentioning the incident directly.

A news blackout is imposed on the whole adventure, with the Army simply refusing to discuss any details of the episode. The heroes have to play along, never discussing the fact that they foiled the first nuclear ransom.

Iron Cross, if defeated and captured,

talks as outlined in the Campaign Book (p. 28). He knows only that he was to guard the bomb, about which he knows nothing, and assist Baron Blood in any manner that he could.

Baron Blood never reveals the details of his mission. He will not stand to be captured, and will fight until slain or until he escapes. He has no interest in capturing a hero — he only wishes to drain them of blood and turn them into vampires for the cause of the Axis powers! Because she can fly and is rather attractive, he has his eyes set on Miss America in particular for a role as his vampiric assistant.

The soldiers know nothing about the bomb. They were brought along only to assist the Baron in any ways they could.

Dr. Martin remembers little about his captivity, except that he is ashamed that he served Baron Blood so willingly (even if he didn't mean to do so).

Once the adventure ends, Spirit of '76 will return to Britain and the Crusaders. The Liberty Legion members will be given a rest for a few days — but they have a war bond rally at Yankee Stadium coming up. . . .

### *The Final Countdown* KARMA

Prevent bomb from exploding	+ 100
Iron Cross captured	+40
Doctor Martin rescued	+30
VTOL captured intact	+20
Each captive rescued from Nazis	+10
Each Nazi soldier captured	+10
Baron Blood slain	No loss
Each Nazi soldier escaping	-10
VTOL destroyed	-15
Each hero captured, incapacitated, or controlled (by Baron Blood)	-20
Loose talk about the adventure	-25
Dr. Martin killed by Baron Blood	-30
Dr. Martin injured by heroes	-30
Iron Cross escapes	-40
Bomb explodes (non-nuclear)	-50
Baron Blood escapes	-50
Enemy or friendly person killed by heroes	-All (for killer)
Bomb explodes (nuclear)	-All (for entire group)

Other Karma awards and penalties may be given out as the Judge sees fit, as per the Campaign Book.

## SUDDEN DAWN'S VILLAINS

### BARON BLOOD™

Lord John Falsworth

Agent of the Super-Axis

Fighting: EXCELLENT (20)

Agility: REMARKABLE (30)

Strength: REMARKABLE (30)

Endurance: INCREDIBLE (40)

Reason: GOOD (10)

Intuition: EXCELLENT (20)

Psyche: REMARKABLE (30)

Health: 120

Karma: 60

Resources: EXCELLENT

(backed by Nazi Germany)

Popularity: -30 (in U.S.A.)

#### Powers:

**ANIMAL CONTROL.** Baron Blood is able to summon and completely control bats, rats, mice, and wolves. This power is Incredible in nature. A swarm of bats, rats, or mice arrives on the round following the start of his summons, and attacks any one area the Baron desires within four areas of himself. The swarm has the following statistics:

F	A	S	E
Good	Typi	Feeb	Exce

If a hero inflicts 38 points of damage on the swarm of creatures, it disperses and is gone. A swarm only attacks those in the area the Baron designates, and does Typical damage to everyone in that area every round. The swarm always gains initiative. Those leaving the area continue to be attacked (rats have Feeble and bats Typical Speed).

If wolves are available, use the statistics for Guard Dogs in the Campaign Book, p. 30. Wolves, as above, only attack those within a particular area the Baron designates within a four-area radius of himself.

**FLIGHT.** Baron Blood is able to fly without transforming himself into a bat. He can move 6 areas per round in this manner, which may be a form of psionic levitation.

**HYPNOTISM.** Anyone looking at Baron Blood for longer than one round must make a Psyche FEAT roll to avoid being hypnotized by him and falling under his complete control. A Red FEAT is required if one's Psyche is less than Remarkable; a Yellow FEAT is needed if one's Psyche is Remarkable, and a Green FEAT if one has a Psyche of Incredible or better. Hypnosis lasts six rounds, but the Baron must not fight.

**POISON RESISTANCE.** Any toxic substance eaten or injected into Baron Blood's system affects him normally, but is not capable of causing his death. Assume that he always has at least 8 Health points left, no matter how large a dose of poison is given him.

**REGENERATION.** Baron Blood's regenerative powers are Unearthly in nature, allowing him to recover up to 100 Health points at the beginning of each round. He loses this power in direct sunlight. This power does not operate against certain attack forms described below and cannot be used to regenerate lost limbs.



**VAMPIRIC BITE:** If Baron Blood is able to make a Red FEAT roll on the Grappling table, he can bite his held victim and drain him or her of blood. The bite inflicts Typical damage every round, but if the hold isn't broken before the victim dies, the victim's body will arise in three days as a vampire. Anyone who suffers a loss of over half his or her Health to a vampire's bite will develop into a vampire in 2-20 weeks, being under the complete influence of the attacking vampire until then. The lost Health cannot be recovered, and the medical science of the 1940s cannot stop the onset of vampir-

ism. Note that aliens, robots, androids, and nonhumans (including Jack Frost) cannot become vampires and cannot be drained of blood in this manner.

**WEATHER CONTROL.** Baron Blood can control weather with Remarkable ability; he can be assumed to control all the weather upon any particular campaign map that he occupies. Fog reduces visibility to a one-area radius around a character. Heat waves and cold snaps would cause Feeble damage to everyone with an Endurance of Typical or less. Baron Blood can summon lightning once per three turns (Remarkable damage), cause winds of Remarkable strength (forcing heroes with Excellent flight or less to land or crash), or produce rain, hail, or snow for five rounds.

**VULNERABILITIES.** Though he is an exceptionally powerful vampire, Baron Blood has certain vulnerabilities that are common to all such creatures. He can tolerate brief periods of sunlight (up to half an hour) without harm, due to cosmetic surgery performed upon him by Nazi scientists. If he remains in sunlight beyond this period, his FASE scores suffer a loss of one rank each for every two rounds he continues to stay in direct sunlight (to a minimum of Poor). When all of his scores reach the minimum of Poor (Health = 8), he disintegrates in the following round and turns into dust. Unless the dust is scattered (which will permanently destroy Baron Blood), the dust will mystically reform into the Baron in five rounds, once placed in darkness.

Baron Blood must satisfy his craving for fresh blood at least once every other day. It is assumed that the Nazis are supplying him with fresh blood during the course of this adventure, though he might not be adverse to taking some from a hero.

Though most vampires become comatose in daylight, Baron Blood is able to operate normally during the day. He must spend some time asleep, however, in a coffin filled with soil from England. Unlike other vampires, Baron Blood cannot shapechange due to his operation.

Baron Blood will not come closer than one area to anyone who wears garlic or holds aloft a religious symbol in which the bearer has faith. The touch of a holy symbol wielded by a true believer causes damage equal to the attacker's Psyche rank. Baron Blood avoids mirrors, though they cause him no harm, because he casts no reflection in them. His image cannot be captured on photographic film.

Weapons made of silver or wood cause Baron Blood great pain, and he actively avoids combat with anyone using such devices — even fleeing if necessary. Running a wooden stake or silver blade into his heart (a Red FEAT on the Hack-&-Slash chart) instantly slays the Baron, but removing the weapon from his body causes him to come to life again, even if his body has fallen into dust. This process takes only five rounds. Baron Blood cannot regenerate damage from a heart strike until the weapon is removed. Beheading the Baron (requiring a Red FEAT roll with a large bladed weapon and at least Excellent Strength, using the Hack-&-Slash chart) also kills him.

Baron Blood was not permanently destroyed until long after the end of the Second World War, when Captain America finished his career. For the purposes of this module, killing the Baron in one of the above ways should be suitable, so his death will not be permanent. His family will wish his remains returned for burial in England.

**Talents:** Baron Blood has Excellent Reason in matters of the occult.

**Background:** Baron Blood was a member of the British aristocracy, a young nobleman who sought the tomb of Dracula in hopes of reviving and controlling him. Unfortunately, Dracula bit and killed Lord Falsworth, turning him into a vampire. Lord Falsworth was sent to Britain before World War I to wreak havoc, and he became an assassin for the Germans, killing many high-ranking British leaders. Wounded by the first Union Jack™, Baron Blood (as he was code-named by the Germans) fled. He made contact with the Nazis during their rise to power, was operated on to gain special powers at the cost of his other abilities, and returned to England. He again started a reign of terror, which was ended by the Invaders and Union Jack. He was resurrected, however, and joined the Super-Axis cause.

Baron Blood has no compunctions about killing and is an inhumanly evil foe. He hates British figures, especially those of the aristocracy.

### AGENT AXIS™

**Real name unknown**

**Super-Axis spy**

Fighting: REMARKABLE (30)	Health: 100
Agility: REMARKABLE (30)	Karma: 46
Strength: EXCELLENT (20)	Resources: EXCELLENT (backed by Axis powers)
Endurance: EXCELLENT (20)	Popularity: -5 (in U.S.A.)
Reason: GOOD (10)	
Intuition: REMARKABLE (30)	
Psyche: TYPICAL (6)	

**Powers:** No special powers

**Talents:** Agent Axis is an expert with all forms of firearms and sharp weapons. He is also a marksman and excels in martial arts and wrestling. His Reason in military matters is Excellent, and he has Incredible Reason in espionage.

**Background:** Agent Axis was the product of the accidental merging of three master spies (one German, one Italian, and one Japanese) into one body. He is now employed by the intelligence services of all three Axis powers.

### MASTER MAN™

**Wilhelm Lohmer**

**Agent of the Super-Axis**

Fighting: INCREDIBLE (40)	Health: 120
Agility: GOOD (10)	Karma: 12
Strength: REMARKABLE (30)	Resources: GOOD (backed by Nazi Germany)
Endurance: INCREDIBLE (40)	Popularity: -5 (in U.S.A.)
Reason: POOR (4)	
Intuition: POOR (4)	
Psyche: POOR (4)	

**Powers:**

**FLIGHT.** Master Man can fly at 6 areas per round with Typical control and agility in the air.

**Talents:** None

**Background:** Wilhelm Lohmer was injected with a Nazi-produced variant of the Super-Soldier formula that gave Captain America his powers. The formula gave him the power of flight in addition to increasing his physical abilities. Master Man is prone to take orders from any (Nazi) authority figure and is not very intelligent. An arrogant fighter, he hates the Liberty Legion with a passion.



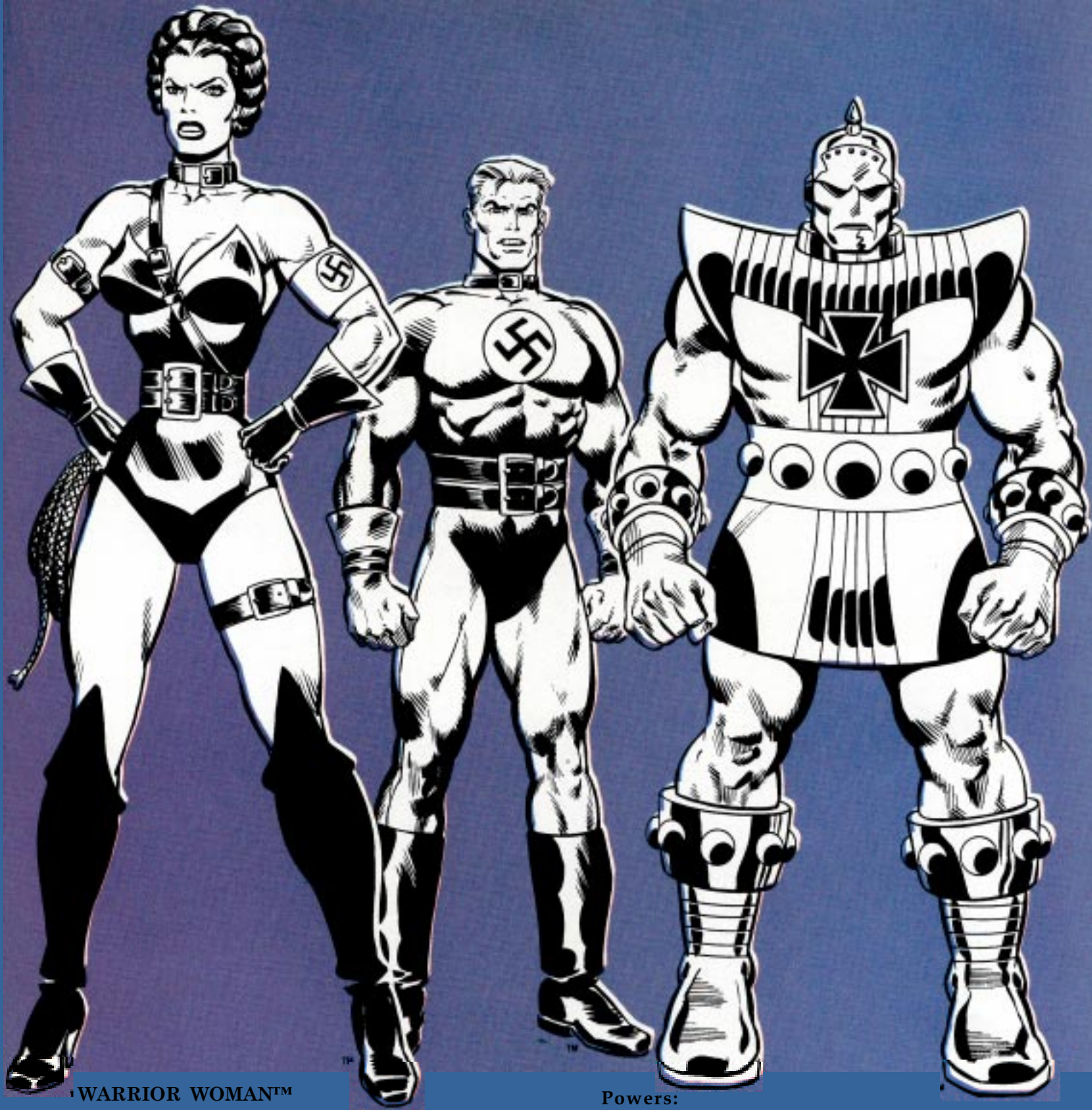

## WARRIOR WOMAN™

**Frieda Ratsel**  
**Agent of the Super-Axis**

Fighting: EXCELLENT (20)  
Agility: GOOD (10)  
Strength: INCREDIBLE (40)  
Endurance: INCREDIBLE (40)  
Reason: GOOD (10)  
Intuition: GOOD (10)  
Psyche: TYPICAL (6)

Health: 110

Karma: 26

Resources: GOOD

(backed by Nazi Germany)

Popularity: -5 (in U.S.A.)

### Powers:

**HYPNOTISM.** Frau Ratsel is highly skilled at hypnotism. If she can work with a captured or willing subject, she can force the victim to tell her any information he knows, unless the victim makes a Yellow Psyche FEAT roll. Only one roll is made per victim per day.

**Talents:** Frau Ratsel has Excellent knowledge of espionage, having been a spy before she gained super-powers.

**Background:** Frau Ratsel received another variation on the Super-Soldier formula, growing to 10' in height as a result of a laboratory accident. She hates all men except for the Fuhrer, and is sadistic in nature. Warrior Woman sometimes uses a whip (range: one area; Typical material; Incredible damage; can entangle foes on a Bull's-Eye).

## U-MAN™

### Meranno Citizen of Atlantis

Fighting: REMARKABLE (30)      Health: 130  
Agility: EXCELLENT (20)      Karma: 18  
Strength: AMAZING (50)      Resources: GOOD  
Endurance: REMARKABLE (30)      (backed by Nazi Germany)  
Reason: TYPICAL (6)      Popularity: -5 (in U.S.A.)  
Intuition: TYPICAL (6)  
Psyche: TYPICAL (6)

#### Powers:

ATLANTEAN POWERS. Meranno is an Atlantean, and as such he can breathe underwater indefinitely through his gills and swim at 5 areas per round. He can move around on land in the open air, but takes 1 point of damage every round for the first 20 rounds (10 minutes) that he is on the surface. After that, he takes 10 points of damage per round from suffocation until he can get to the water again. In addition, his FASERIP abilities shift down one rank every two rounds; again, this occurs only after the first 10 minutes out of water, and will reverse itself once he is in water again.

Meranno's vision is sensitive to green light, allowing him to see well underwater.

DENSE FLESH. Meranno has Excellent body armor from his thick skin, and has Excellent resistance to cold.

**Talents:** None

**Background:** Meranno managed to artificially heighten his strength. In exchange for his work in defeating the Allies, he was to be made ruler of Atlantis by the Nazis, in place of his hated enemy, the Sub-Mariner.

## IRON CROSS™

### Helmut Gruler Agent of the Super-Axis

Fighting: EXCELLENT (20)      Health: 44/94  
Agility: POOR (4)      Karma: 16  
Strength: GOOD (10)/  
INCREDIBLE (40)      Resources: GOOD  
Endurance: GOOD (10)/  
REMARKABLE (30)      (backed by Nazi Germany)  
Reason: TYPICAL (6)      Popularity: -5 (in U.S.A.)  
Intuition: POOR (4)  
Psyche: TYPICAL (6)

Resources: GOOD (backed by Nazi Germany)  
Popularity: -5 (in U.S.A.)

#### Powers:

BATTLE SUIT. All of Iron Cross's powers come from his armored battle suit, which enhances his Strength, Endurance, and Health. The suit allows Iron Cross to fly at 6 areas per round with Typical control, and grants him Remarkable protection against physical attacks and Good protection from energy attacks. Furthermore, the gauntlets of the suit fire either electrical bolts or beams of intense cold. These do Remarkable damage at a 3-area range. The suit can discharge sleeping gas to cover the area in which he is standing (Yellow Endurance FEAT required to withstand the effects) and has fire extinguishers of Excellent power.

If his armor takes damage from heat or fire, it must make a yellow FEAT roll (on the Good column) or else the circuits will fuse, rendering the armor immobile and nonfunctional.

**Talents:** None

**Background:** Helmut Gruler is a German champion who wears a suit of armor created by Professor Franz Schneider. He is fanatically loyal to the German cause and despises all Allied heroes.

## Average Nazi soldier

Fighting: GOOD (10)      Health: 32  
Agility: TYPICAL (6)      Karma: 16  
Strength: TYPICAL (6)      Resources: TYPICAL  
Endurance: GOOD (10)      Popularity: -1 (in U.S.A.)  
Reason: TYPICAL (6)  
Intuition: TYPICAL (6)  
Psyche: POOR (4)

**Talents:** Military skill; also, shift to right one column when using knives, handguns, rifles, or submachine guns. See the Battle Book (p. 14) and the Campaign Book (p. 17) for more information on weaponry available to soldiers. The Judge may have selected soldiers with other talents, such as Marksman, Weapon Master, Martial Arts, Wrestling, Thrown Weapons, Blunt Weapons, and so forth.

## Average Nazi secret agent

Fighting: GOOD (10)      Health: 28  
Agility: TYPICAL (6)      Karma: 26  
Strength: TYPICAL (6)      Resources: TYPICAL  
Endurance: GOOD (6)      Popularity: -3 (in U.S.A.)  
Reason: GOOD (10)  
Intuition: GOOD (10)  
Psyche: TYPICAL (6)

**Talents:** Each agent has one or two weapons (usually a handgun or knife) with which he shifts one column to the right. Agents also have Excellent knowledge of espionage matters. See the Battle Book (p. 14) and the Campaign Book (p. 17) for more information on weaponry.

## A Selected Bibliography

The full story of the creation of the Liberty Legion may be found in the following magazines: *Marvel Premiere*™ #29 (April 1976), *The Invaders*™ #6 (May 1976), and *Marvel Premiere* #30 (June 1976). Spirit of '76 and his allies in the Crusaders made their first appearance in *The Invaders* #14 (March 1977). Various issues of *The Invaders* comics detailed other Allied and Axis characters who fought on the battlefields of World War II.

## Credits

Designed by Wild William Tracy  
Edited and developed by Rickety Roger Moore, with proofreading assistance by Pugnacious Pat Price.  
Illustrations by the Mighty Marvel Bullpen and Jumbo Jeff Butler  
Production work by Rapid Roger Raupp and Kwik Kim Lindau  
Special assistance from "Indiana Harold" Johnson and Delightful Deborah Highley.



**PATRIOT™**



**MISS AMERICA™**



**SPIRIT OF '76™**



**WHIZZER™**



## MISS AMERICA™

**Madeline Joyce, adventuress**  
**(identity known to U.S. government)**

Fighting: GOOD (10)      Health: 56  
Agility: EXCELLENT (20)      Karma: 22  
Strength: TYPICAL (6)      Resources: EXCELLENT  
Endurance: EXCELLENT (20)      (supported by U.S. government)  
Reason: TYPICAL (6)      Popularity: 40  
Intuition: GOOD (10)  
Psyche: TYPICAL (6)

### Powers

**LEVITATION:** Miss America has the power to levitate by her mental powers, allowing her to rise into the air as high as normal breathing would allow (20,000 feet) and to hover in place, staying aloft up to 2 hours. By careful jumps, she can fly at 4 areas per round with Excellent control, though she has to land and kick off again to keep going.

**Talents:** None.

**Background:** Madeline Joyce was visiting a lighthouse used for electrical experiments when a lightning bolt from the equipment and an electrical storm struck her. When she recovered from her coma, she found her latent mutant powers had surfaced. She became a costumed crimefighter, and while fighting a Nazi spy ring in New York, she met the Whizzer™. They joined forces to crush the spies and free the Invaders™ from the Red Skull™.

MISS AMERICA and the distinctive likeness thereof are trademarks of the Marvel Comics Group. Copyright ©1985 Marvel Comics Group. All Rights Reserved.

## WHIZZER™

**Robert L. Frank, adventurer**  
**(identity known to U.S. government)**

Fighting: EXCELLENT (20)      Health: 86  
Agility: INCREDIBLE (40)      Karma: 26  
Strength: TYPICAL (6)      Resources: EXCELLENT  
Endurance: EXCELLENT (20)      (supported by U.S. government)  
Reason: GOOD (10)      Popularity: 40  
Intuition: GOOD (10)  
Psyche: TYPICAL (6)

### Powers

**LIGHTNING SPEED:** The Whizzer can move up to 10 areas per round because of his superhuman metabolism. He has also developed his fighting skills to compliment his speed, and his Fighting rises to Incredible when he is in motion.

**Talents:** He can use a special martial arts talent while he is in motion, slamming and stunning larger opponents.

**Background:** While in Africa with his scientist father, young Robert was bitten by a cobra. A mongoose killed the cobra, and Dr. Frank injected some of the mongoose's blood into Robert. Dr. Frank died of a heart attack, but Robert survived and developed superhuman speed. When he grew up, Robert returned to the U.S. as a costumed crimefighter. He was fighting a Nazi spy ring in upstate New York when contacted by Bucky Barnes™ to help free the Invaders™ from the Red Skull™. On this mission, he met Miss America™, and they were engaged to be married in later years.

WHIZZER and the distinctive likeness thereof are trademarks of the Marvel Comb Group. Copyright ©1985 Marvel Comics Group. All Rights Reserved.

## PATRIOT™

**Jeffrey Mace, reporter and adventurer**  
**(secret identity)**

Fighting: REMARKABLE (30)      Health: 66  
Agility: GOOD (10)      Karma: 26  
Strength: TYPICAL (6)      Resources: EXCELLENT  
Endurance: EXCELLENT (20)      (supported by U.S. government)  
Reason: GOOD (10)      Popularity: 40  
Intuition: GOOD (10)  
Psyche: TYPICAL (6)

### Powers

Patriot has no super powers.

**Talents:** Patriot is skilled in journalism and martial arts.

**Background:** Jeffrey Mace left his career as a reporter for the New York Daily Bugle at the start of World War II to fight crime and Nazi espionage in America as a costumed hero. He still makes regular patriotic radio broadcasts from New York City. When the Invaders™ were captured by the Red Skull™, Patriot joined Bucky Barnes and other heroes to free them, becoming a founding member of the Liberty Legion.

PATRIOT and the distinctive likeness thereof are trademarks of the Marvel Comics Group. Copyright ©1985 Marvel Comics Group. All Rights Reserved.

## SPIRIT OF '76"

**William Nasland, adventurer**  
**(secret identity)**

Fighting: EXCELLENT (20)      Health: 70  
Agility: EXCELLENT (20)      Karma: 22  
Strength: GOOD (10)      Resources: Good  
Endurance: EXCELLENT (20)      Popularity: 25  
Reason: TYPICAL (6)  
Intuition: GOOD (10)  
Psyche: TYPICAL (6)

### Powers

**CAPE:** Spirit of '76 has no superhuman powers. His cape is made of a bullet-proof material that provides Typical protection against physical attacks made against him from behind. He may draw the cape around to protect his front as well.

**Talents:** None

**Background:** Spirit of '76 first appeared at the beginning of World War II as a costumed agent of the U.S. government, fighting Nazi espionage at home. In 1942 he moved to Great Britain and joined a group of British super heroes called the Crusaders™. This group discovered that they had been organized as part of a Nazi plot, but they conquered their backers. Spirit of '76 returned to America on occasions to work with the Liberty Legion during the war.

SPIRIT OF '76 and the distinctive likeness thereof are trademarks of the Marvel Comics Group. Copyright ©1985 Marvel Comics Group. All Rights Reserved.

## RED RAVEN™

**Real name unknown, adventurer**

Fighting: GOOD (10)      Health: 56  
Agility: EXCELLENT (20)      Karma: 22  
Strength: TYPICAL (6)      Resources: EXCELLENT  
Endurance: EXCELLENT (20)      (supported by U.S. government)  
Reason: GOOD (10)      Popularity: 40  
Intuition: TYPICAL (6)  
Psyche: TYPICAL (6)

### Powers

**WINGS:** Red Raven wears an anti-gravity suit fitted with a large pair of birdlike wings. This suit allows him to fly at Typical speed (up to 140 mph) with Excellent control. If he makes a successful Agility FEAT, Red Raven can use his wings as a shield to provide Excellent protection from physical attacks and Incredible protection from heat-based attacks. If he makes a successful flight-control FEAT roll, he is also able to swing his wings with enough force to cause Excellent damage. The wings also contain a built-in blaster which does Remarkable damage at a range of 6 areas.

**Talents:** Red Raven has some knowledge of electronics and engineering, and his Reason is Excellent in those areas.

**Background:** Red Raven's parents were killed when their plane crashed into a floating city which belonged to a winged race of Inhumans™. The child was raised by the Inhumans (the Bird-People) and was given his winged costume. Red Raven later went to America to join the Liberty Legion™, to fight Nazi aggression in World War II.

RED RAVEN and the distinctive likeness thereof are trademarks of the Marvel Comics Group. Copyright ©1985 Marvel Comics Group. All Rights Reserved.

## BLUE DIAMOND™

**Elton T. Morrow, scientist and adventurer  
(secret identity)**

Fighting: GOOD (10)      Health: 70  
Agility: GOOD (10)      Karma: 26  
Strength: INCREDIBLE (40)      Resources: EXCELLENT  
Endurance: GOOD (10)      (supported by U.S. government)  
Reason: GOOD (10)      Popularity: 40  
Intuition: GOOD (10)  
Psyche: TYPICAL (6)

### Powers

**BODY ARMOR:** Blue Diamond's skin is hard enough to provide him with Amazing protection against physical attacks and Remarkable protection from energy attacks.

**Talents:** He has Excellent Reason in Anthropology.

**Background:** Elton Morrow was standing near a large diamond when it exploded, imbedding millions of diamond particles in his skin. This granted him superhuman strength and invulnerability.

BLUE DIAMOND and the distinctive likeness thereof are trademarks of the Marvel Comics Group. Red Skull, Bucky Barnes, the Inhumans, the Invaders, and the Crusaders are trademarks of the Marvel Comics Group. Copyright © 1985 Marvel Comics Group. All Rights Reserved.

## THIN MAN™

**Bruce Dickson, scientist and adventurer  
(public identity)**

Fighting: GOOD (10)      Health: 42  
Agility: TYPICAL (6)      Karma: 26  
Strength: TYPICAL (6)      Resources: EXCELLENT  
Endurance: EXCELLENT (20)      (supported by U.S. government)  
Reason: GOOD (10)      Popularity: 40  
Intuition: GOOD (10)  
Psyche: TYPICAL (6)

### Powers

**BODY PLASTICITY:** Thin Man is able to alter and stretch his body to become paper thin or to reach long distances. This power is Feeble and can only be used defensively. Anyone trying to hit Thin Man with a fist or weapon must make a two-column shift to the left as Thin Man's body will absorb most of the blow. Thin Man can attack while thinned.

**Talents:** Thin Man has an Excellent Reason in chemistry, electronics, aeronautics, piloting, and engineering.

**Background:** Bruce Dickson discovered Kalahia, a lost city (in the Himalayas), populated by beings who could flatten themselves as thin as paper. The people of Kalahia injected him with a chemical that gave him his powers. The Thin Man has a special aircraft that can only be safely piloted by him. (All others must make a Reason FEAT to do so, as well as Agility FEATS to avoid crashing.) The plane is a modified fighter with Good Control, Excellent Speed, and a Typical Body. The two wing-mounted machine guns will do Remarkable Damage to a range of 40 areas.

THIN MAN and the distinctive likeness thereof are trademarks of the Marvel Comics Group. Copyright ©1985 Marvel Comics Group. All Rights Reserved.

## JACK FROST™

**Real name unknown, adventurer**

Fighting: GOOD (10)      Health: 76  
Agility: EXCELLENT (20)      Karma: 26  
Strength: TYPICAL (6)      Resources: EXCELLENT  
Endurance: INCREDIBLE (40)      (supported by U.S. government)  
Reason: TYPICAL (6)      Popularity: 20  
Intuition: GOOD (10)  
Psyche: GOOD (10)

### Powers

**COLD POWER:** Jack Frost is able to project rays of intense cold; anyone struck by such a ray must make an Endurance FEAT roll and check the stun column of the Battle Effects Table. The victim will be frozen in a sheath of ice (Good material) if the FEAT roll fails. One such ray may be fired per round to a maximum range of 6 areas. This power is considered Amazing.

Jack Frost is also able to manipulate ice and shape it into crude shields, which will provide Excellent protection. Jack Frost has Unearthly resistance to cold attacks, but heat-based attacks gain an UP TWO shift in damage against him.

**Talents:** None

**Background:** Jack Frost's personal history is unknown at this time to anyone.

JACK FROST and the distinctive likeness thereof are trademarks of the Marvel Comics Group. Copyright ©1985 Marvel Comics Group. All Rights Reserved.

**THIN MAN™**



**RED RAVEN™**



**JACK FROST™**



**BLUE DIAMOND™**





# The Big Guns

*The armed forces in the  
MARVEL SUPER HEROES™ game*

If a gigantic reptile is chomping on the docks of Seattle or an alien saucer is dropping stink bombs on Kansas City, costumed heroes won't be the only ones going against the enemy. Aliens, giant reptiles, and Marvel Super Villains™ are going to have to take on the regular Army, Navy, and Air Force — and they are *tough!*. This article gives a few suggestions on using some of the weapons of the U.S. military in your campaigns, and describes five military vehicles in MARVEL SUPER HEROES terms. First, a few definitions.

**Crew** — Most of the larger vehicles and weapons require a minimum crew to operate efficiently. Each soldier, sailor, or pilot may be considered a typical soldier as described in the Campaign Book. Each shifts his Agility one column to the right when using the weapon or when piloting the vehicle with which he has been trained. Untrained persons trying to fire a heavy weapon must first make a Reason FEAT roll to be able to get it to work. They must also shift their Agility one column to the left to simulate the expected loss in accuracy.

**Sensors** — Radar uses radio waves to detect objects, bouncing them off a vehicle or object and measuring the time it takes them to return in order to gauge distance. Some aircraft are able to fly and land without visibility, using radar alone. Radar waves can be controlled by certain individuals with magnetic or electrical control (such as Magneto™ or Electra™). With a successful FEAT roll, the radar waves may be redirected to make any one object the controlling person chooses invisible.

For example, a villain with Monstrous electromagnetic control approaches an air base protected by radar with a 200-mile range. The Judge decides that a Green FEAT will be sufficient to deflect the radar. When the villain enters the radar field, the judge rolls for him and gets a Yellow FEAT result. The villain is then invisible to the radar unless his power is reduced or his attention distracted. If he is attacked, the Judge may require a second FEAT roll to make sure he has not been distracted and allowed the radar to detect him.

Sonar uses sound waves to detect objects under water. Almost all naval craft are equipped with some form of sonar.



Characters with sound control can make themselves invisible to sonar with a successful FEAT roll.

**Guided missiles and torpedoes** — Guided missiles and torpedoes have either active or passive control systems. Active control allows the missile to be guided by the person who fired it. With passive control, the missile has homing abilities using heat, sound, or some other target-finding system. The Control rank of a missile or torpedo represents the accuracy of the tracking system. With a passive system, the person firing the missile rolls on the control system's rank rather than on the character's Agility.

Each missile is designed for one attack mode: air-to-air, air-to-ground, ship-to-ship, etc. If a missile designed for one purpose is used for another, its Control rank moves one column to the left (if it can be used at all). Only missiles designed to go underwater will be able to penetrate the surface of an ocean or lake; all others will explode the instant they strike the surface of the water.

For example, a hypothetical villain named Buzzard Man zooms toward a military jet. The jet fires a passive heat-seeking air-to-air missile at him. The missile has Remarkable con-





The accuracy of bombing is determined by rolling on the Shooting-&-Throwing column, using the Agility of the pilot who dropped the bomb. If the pilot misses, count the number of columns by which he missed; that will be the number of areas away from the target where the bomb strikes the ground, in a direct line from the approach of the aircraft. (There is an equal chance that the bomb will either fall short or long.) Anyone in the blast area must roll for damage. Large bombs have broader areas of effect.

The accuracy of a napalm drop is determined by the same method as a high-explosive bomb. However, everyone in the target area will be exposed to flame and heat of Incredible power. This may only be dodged by ultra-high speed or teleportation which allows one to leave the area almost instantly. The judge must decide if the surrounding buildings, forest, etc., catch fire and, if so, how long they burn.

Strafing occurs when a plane flies over an area and fires at it with machine guns and cannons. The accuracy of the attack is determined by rolling on the Shooting-&-Throwing column with the pilot's Agility. Some judges may choose to reduce the pilot's rank one to the left when flying jets on strafing runs, since jets have such high minimum speeds.

*Bull's-Eye and Kill results* — To simulate the firing of precision weapons against armored vehicles, I suggest certain unarmored parts be available as targets for Bull's-Eye slots. For example, someone shooting at a tank may not be able to penetrate the armor, but he may try to shoot off the radio antenna, the spotlight, or even the machine gun.

With a Kill result, the vehicle should receive some serious damage. On a tank, the attacker may have jammed the treads or damaged the engine, if he or she can penetrate the tank's armor. Similar results may be devised for other vehicles.

### M-60 Main Battle Tank

This vehicle is used by the U.S. Army and Marine Corps, Israel, Iran, Italy, Saudi Arabia, South Korea, and Turkey. It has a Remarkable Body, Poor Speed, Excellent Control, and a crew of four.

**Body** — The M-60 has .5" to 4.8" of cast armor and weighs 54 tons. The crew receives Excellent protection (due to the tank's air conditioning) from all chemical weapons. The electrical systems, including the ignition and radio,

have Excellent protection from energy attacks.

On the M-60 series, Bull's Eye targets include the radio antenna and headlights (Typical material strength) and the external machine guns (Good material strength). On a Kill shot, the Judge may decide to jam one of the treads, freezing the tank in place until it is repaired.

**Performance** — The M-60 has a 12-cylinder diesel engine capable of 30 mph in flat terrain. The tank can climb a slope of 60°, climb over vertical obstacles 3' high, and ford water up to 3' deep without modifications.

**Armament** — The M-60 carries a 105mm cannon (Incredible damage, 20-area range) and a 7.62mm machine gun (Remarkable damage, 10-area range) on its turret. These guns can only fire in the direction the turret is facing, but the turret can turn 360°. On top of the turret is a 5" anti-aircraft machine gun (Remarkable damage, 15-area range) which can turn independently of the turret for 360°. One model of the M-60 tank replaces the 105mm cannon with a flame thrower (Incredible damage, 2-area range).

The M-60 can ram for Remarkable damage. If it rams and rolls a Red result on the Remarkable column, it will run over the target and do Incredible damage, supposing the target is of the appropriate size.

### F-16 Fighter-Bomber

The General Dynamics F-16 multi-role jet fighter-bomber is used by the U.S. Air Force, Belgium, Denmark, Netherlands, and Norway. It has a Excellent body, Amazing speed, Remarkable control, and one crewman (the pilot).

**Body** — The F-16's body is considered Excellent, but the control and communications systems have only Good protection against magnetic and electrical attacks. The pilot is protected against all chemical and biological weapons while his cockpit is sealed. The plane weighs 21 tons with a full load of weapons and fuel.

A Bulls-Eye result may damage the control surfaces of the plane. If this happens, the jet must land as soon as possible. A Kill result damages the single engine and causes the plane to crash. The pilot may only be struck by an attack that can penetrate the plane's armor.

**Performance** — The F-16 has one 23,845-lb. thrust afterburner turbo-fan engine. Its maximum speed is 915 mph fully loaded, but its minimum speed is

control and makes a Green FEAT roll, meaning the missile has been able to follow the heat of Buzzard Man's jet thrusters. The missile will clip his tail feathers, perhaps permanently.

Some characters will use fireballs, fog, or other things to distract a missile. The judge must decide how difficult it will be for the missile to find its true target under these circumstances. Dodging is rolled in the usual way, if a character wishes to avoid being struck by a projectile or missile.

*Bombing and strafing* — We need consider only two types of bombs: explosives and napalm. An explosive bomb is treated like a large hand grenade. Everyone in the area where the bomb explodes must roll on the Hack-&Slash column of the Battle Effects Table to determine if they take damage.



uncertain. It requires 25 areas to take off or land safely, requiring a perfectly smooth, straight surface such as an airport runway.

**Armament** — The U.S. Air Force usually equips the F-16 with one 20mm multi-barrel cannon with 500 rounds (Excellent damage, 10-area range) and carries two Sidewinder missiles, one on each wing tip. Under the wings and body of the plane are four more hard points which can carry cluster bombs, Sidewinder missiles, or Sparrow missiles. In the center of the body of the plane is a rack able to carry a 2,200-lb. bomb.

The Sidewinder is a heat-seeking anti-aircraft missile (Remarkable damage, 11-mile range, Typical body, Unearthly speed, Typical control). The Sparrow is a radar-guided missile which comes in three types: air-to-air, air-to-ship (the Sea Sparrow), and air-to-surface (the Land Sparrow) (Remarkable damage, 28-mile range, Typical body, Unearthly speed, Good control). Cluster bombs (Incredible damage) and the single large bomb (Amazing damage) may be used free falling or laser-directed. If free-falling, their accuracy is dependent on the pilot's Agility rank. Laser-directed bombs are guided toward targets (but not propelled) by air-control surfaces. This control system simply adds one rank to the pilot's Agility.

If the F-16 rams anything, it does Incredible damage. However, if either the plane's body or control rank falls to Feeble, it blows up. It must also make an

immediate control check (Yellow FEAT) in order to avoid going out of control when it strikes something (or vice versa). The pilot may successfully eject if he makes a FEAT roll against his Agility.

### AV-8 Harrier Jet Fighter

The Harrier VTOL jet fighter is used by U.S. Marine Corps, Spanish Navy, and British Air Force. It has an Excellent body, Incredible speed, Remarkable control, and a crew of one pilot.

**Body** — The plane's body is considered Excellent armor, but the control and communication systems have only Good protection against magnetic and electrical attacks. The pilot is protected from all chemical weapons when his cockpit is sealed.

A Bull's-Eye result may damage the plane's control surfaces, requiring it to land immediately. A Kill result means that the engine is knocked out and the plane will crash.

**Performance** — The Harrier has one 21,500 lb. thrust turbo-fan engine and travels 740 mph maximum. It can go a minimum of 58 mph (Typical speed) using its VTOL powers. It is able to take off and land in a single area. Since it weighs 12.5 tons with weapons and fuel, it cannot land on rooftops or other structures not designed to hold such weight (requiring Amazing strength or better).

**Armament** — The AV-8 normally carries two 30mm machine guns

(Remarkable damage, 10-area range) and two Sidewinder air-to-air heat-seeking missiles (Remarkable damage, 11-mile range, Typical body, Unearthly speed, Typical control). The AV-8 can carry three 1000-lb. bombs, one under the body and the other two in the wings (Incredible damage).

The Harrier can ram for Remarkable damage, but if either its Body or Control Rank drop below Feeble, it blows up. Due to its VTOL features, it can blast the area directly below it with flames of Excellent power. This happens whenever it lands or takes off. If the plane is damaged, the pilot may eject to safety if he makes a Green FEAT Roll on his Agility.

### Ohio-Class Submarine

The Ohio-class ballistic-missile submarine is used only by the U.S. Navy. It has a Remarkable Body, Good Speed, Good Control, and a crew of 133.

**Body** — The submarine's body consists of a very heavy, pressure-resistant hull. The hull is compartmentalized, so if one chamber is breached, it is sealed to protect the others. Each time a chamber is flooded, the submarine loses one rank in both speed and control. If either rank reaches Feeble, the submarine sinks helplessly to the ocean bottom. The electrical system has Remarkable shielding, and the crew is protected from all chemical weapons when the hatches are sealed.

Bull's-Eyes may be scored against the periscope or the radar antenna disc. Destroying the disc (Good material strength) destroys the ship's radar capabilities. Damaging the periscope (Typical material strength) renders the ship blind (except for its sonar) when submerged. A Kill roll allows the attacker to disable the sub's single propeller (Excellent material strength).

**Performance** — The exact top speed of the Ohio-class submarine is secret, but may be assumed to be over 100 mph (Good speed). The sub's depth limit is 985 ft.; to go below this level requires a FEAT roll using the hull's strength. A white or green result means it survives, a Yellow roll means the sub drops one rank in every class, and on a Red roll, the hull is crushed and the sub destroyed.

The submarine requires 36 ft. of water to maneuver on the surface. In shallower waters, the sub runs aground. Escape will require a Green FEAT roll on the Typical column. The ship may only try and escape once every 10 turns.





**Armament** — The Ohio class is equipped with four 21-inch torpedo tubes firing acoustic homing torpedoes which follow the sounds made by a ship (Incredible damage, Typical body, Excellent speed, Remarkable control).

It also has 24 tubes for Trident Intercontinental Ballistic Missiles (Class 1000 damage, 4,400-mile range, Good body, Uneearthly speed, Excellent control). An ICBM's target must be a fixed position on the earth's surface. The missile may be equipped with explosives of any power, and it may also contain chemical weapons.

As a final resort against intruders, the crew may release radiation from the sub's power plant. This will cause Monstrous radiation damage to everything alive in a 10-area radius around the sub.

**Special equipment** — Each ICBM-carrying submarine has ten different communication systems on board, linking it to the world's satellite system as well as allowing direct transmissions. All Ohio-class subs are equipped with sonar and may use both air and surface radar when surfaced. The radar has a range of 200 miles and the sonar 25 miles.

### Kidd-Class Destroyer

The Kidd-class destroyer is used only by the U.S. Navy. It has a Remarkable body, Good speed, Good control, and a crew of 200.

**Body** — The Kidd-class destroyer is designed for fleet escort duty, and it carries armor that will not reduce its speed. The hull of a destroyer will not protect crew members from chemical weapons, as it is not sealable. Destroyers are compartmentalized to protect them from flooding. When the outer hull is breached, only one chamber floods; the entire ship loses one rank in both Body and Control whenever this occurs. If

either of these ranks reach Feeble, the ship sinks.

Possible Bull's-Eye targets are the radar discs, radio antenna, and any crewmembers standing on the deck or bridge. The discs and antenna each have a material strength of Good.

A Kill result means one of the propeller shafts (Excellent material strength) has been damaged or fouled. This reduces the destroyer's Control and Speed by half.

**Performance** — The best speed of the Kidd-class destroyer is over 100 mph. It uses four gas turbines with two propeller shafts.

The destroyer cannot move into water less than 60' deep, or it will run aground. Escape will require a Typical FEAT roll, and an escape attempt may be made once every 10 turns.

**Armament** — The ship carries front and rear MK-26 twin missile launchers, each able to fire two missiles in the same round in 180(o) fields of fire. Three kinds of missiles may be used. The MR anti-aircraft missiles have active guidance (Incredible damage, 6-mile range, Typical body, Excellent speed). The Harpoon anti-ship missiles also have active guidance (Good damage, 60-mile range, Typical body, Good speed). The

ASROC anti-submarine missiles carried on the destroyer become acoustic homing torpedoes after they strike the water (Incredible damage, 6-mile range, Typical body, Good speed, Remarkable control).

In addition, each destroyer has two 5" MK-45 cannon, one each mounted on the bow and stern (Excellent damage, 30-area range). They also have six MK-32 torpedo tubes, firing MK-46 torpedoes with acoustic homing (Incredible damage, 2-mile range, Typical body, Excellent speed, Remarkable control).

The Kidd-class destroyer also carries two LAMPS (Light Airborne Multi-Purpose Systems) anti-submarine helicopters. These helicopters are equipped with radar, sonar buoys, and a magnetic system for detecting submarines from the air (nicknamed MAD). They can direct Harpoon missiles fired from the ship after the missiles have crossed the ship's visual horizon. A LAMPS helicopter has a Good body, Good speed, Good control, and a crew of four.

Kidd-class destroyers are able to ram surface targets for Amazing damage without harm to themselves, since their bows were designed for ramming. This attack only affects surface craft and beings.

# FLASHING BLADES™



A complete role-playing game of swashbuckling adventure set in the era of the Three Musketeers.

Basic rules covering:

- Character Generation
- Advantages & Secrets
- Skills
- Careers & Professions
- Combat
- Detailed Background

FLASHING BLADES comes with the complete rules of play, introductory adventure book with three adventures to get your campaign going, a master character sheet (suitable for photocopying), and a gamemaster's screen of the important charts and tables for easy reference. This is all you need to begin a campaign in a time when the rivalry between King and Cardinal changed the course of history across France and all of Europe. \$12.00.

Also Available: PARISIAN ADVENTURES for use with FLASHING BLADES. Including 4 adventures, a guide to 17th Century Paris, and exotic items . . . \$5

Available from better shops worldwide or direct from us at:  
P.O. Box 162, Roslyn, N.Y. 11576 (USA).  
Please add \$2 for post and handling. NY residents please add sales tax.



# Phoenix Phoenix Phoenix Phoenix

*The outer limits of the  
MARVEL SUPER HEROES™ game*

by Roger E. Moore

Who is the most powerful hero that one can play in the MARVEL SUPER HEROES™ game? One thinks of characters like Thor™, the Hulk™, and Doctor Strange™, yet there are a few who transcend even these beings in sheer power and ability. Are these beings playable in the game? If

so, how can they be managed?

Without question, one of the most powerful heroes in the Marvel Universe™ was the being known as Phoenix™. In her short career, she both saved and nearly destroyed the known universe with her powers. This article focuses on Phoenix (and Dark Phoenix™) in the MARVEL SUPER HEROES game and on ways in which she and others like her may appear.



Phoenix would appear around her in the shape of a huge, flaming bird of prey. This flaming bird was composed of cosmic flame, which could cover a variable area from 1-100 areas, depending upon her desires and the amount of power she was using. Though the "bird" was not known to touch anyone, it could do Unearthly flame damage if used as a weapon.

The various aspects of her phoenix-force powers are described below; these scores are for her *maximum possible safe output*, the limits beyond which she cannot go without risk of loss of self-control (and playability).

Note: Any action requiring a Green Psyche FEAT roll to keep from changing into Dark Phoenix (see limitations) also results in the loss of 100 Karma points. Yellow FEAT rolls involve the loss of half of all existing Karma or 100 Karma points, whichever is greater, and Red FEAT rolls are accompanied by the loss of all Karma. No Karma may be added to any Dark Phoenix check.

*Telekinesis:* Phoenix could telekinetically lift weights as if she had Unearthly Strength, affecting objects at Unearthly range in her line of sight. A group of objects in one area was carried as one object.

Using telekinetic control over molecular structures, Phoenix could fire concussive force bolts from her hands with Unearthly

## PHOENIX™

"Jean Grey™" (no real name)  
Unknown energy being

Fighting:	GOOD	(10)
Agility:	GOOD	(10)
Strength:	TYPICAL	(6)
Endurance:	UNEARTHLY	(100)
Reason:	GOOD	(10)
Intuition:	EXCELLENT	(20)
Psyche:	CLASS 1000	(1000)
Health:	126	
Karma:	1030	
Resources:	Class 1000	
Popularity:	50 (Phoenix)	
	-100 (Dark Phoenix)	

## Known powers:

PHOENIX FORCE: Phoenix had access to incredible power on a cosmic scale. In effect, the normal mutant abilities of Jean Grey as Marvel Girl™ — telekinesis and telepathy — were magnified a thousand-fold in the phoenix-being. However, depending on her emotional state, imagination, experience, and mental restraints, Phoenix often functioned at levels far below her maximum capability. Phoenix could use three of her powers at once without effort, and more powers if she made a Yellow FEAT roll for each extra power used.

When Phoenix used her powers, the



power and Class 1000 range, and could produce a personal force field capable of absorbing Class 1000 amounts of any damage (save from mental, psionic, or magical attacks). Because of her control over molecules (similar in many ways to that now used by the Molecule Man™), Phoenix could fire blasts of Unearthly heat or cold as well as telekinetic force bolts. She could also cause objects to freeze or burn spontaneously by mental command if they were within Unearthly range, inflicting up to Unearthly damage each turn.

Phoenix was also capable of telekinetic flight, propelling herself at up to Class 1000 speeds in space. If flying in an atmosphere or carrying passengers with her telekinetic powers, however, she kept her maximum speed at Unearthly levels and protected the passengers with Unearthly-class force fields. Phoenix was able to combine her speed and use of a force field to turn herself into an unstoppable ram, punching through starship hulls with ease.

By altering her own internal molecular structure, Phoenix was able to completely regenerate all of her wounds in one turn. She could ignore the extremes of heat and cold with Class 1000 ability so long as she was conscious, and could withstand arctic cold or the furnace at the heart of a star. She could make herself immune to all corrosive atmospheres and substances, and could exist in any environment.

Her molecular control allowed her to control weather as well, and she could summon or create any form of atmospheric phenomenon (windstorms, tornadoes, lightning, rain, etc.) within Unearthly range, and having up to Unearthly effects.

Use of her telekinetic powers to slay another being brings about an immediate Red Psyche FEAT roll to avoid turning into Dark Phoenix, if the killing was combat-related but entirely accidental. This roll may be reduced to a Yellow FEAT if the slaying was not combat related and was by accident, but the resulting emotional upheaval Phoenix experiences will be strong in any event. Premeditated murder brings an automatic change to Dark Phoenix.

*Atomic transformation:* At first believed to be an advanced form of her telekinesis power, this Unearthly ability allowed Phoenix to transform any one substance into another. She could even transform living substances into nonliving materials (such as turning a tree into gold, or a houseplant into solid crystal), and was able to turn the solid-steel body of Colossus™ back into flesh against his will – and keep it that way. On a mundane level, Phoenix used this power to alter her clothing and costume (and those of everyone within line-of-sight range). Assumedly, Phoenix could create corrosives and poisons – but doing so against a living opponent would cause her to make a Yellow Psyche FEAT roll to keep from changing into Dark

Phoenix, with a Red FEAT roll following if her opponent died (with automatic failure if murder was intended).

If Phoenix uses this atomic transformation power on a living being, she must make a Psyche FEAT roll to prevent reversion to Dark Phoenix. Using it on unintelligent life like plants produces a Green FEAT roll; if used on living creatures (reptiles, mammals, etc.) that are not considered to have human-level intelligence or be capable of developing a civilization, she must make a Yellow FEAT roll. Using this power on an intelligent, thinking being of any sort (which Phoenix would be able to identify at once by telepathy) causes a Red FEAT roll. At the worst, using this power to purposefully kill an intelligent, living being causes automatic reversion to Dark Phoenix form.

*Power absorption:* Phoenix was able to increase her Health by absorbing raw energy in the area around her. She could draw in Class 1000 amounts of power in a single turn, but could take no other action in that turn. However, drawing in power induced a craving for more power and threatened to bring out the Dark Phoenix within her. If absorbing energy of up to Excellent levels, Phoenix must make a Green Psyche FEAT roll or revert to her Dark Phoenix form. If taking in energy up to Amazing levels, a Yellow Psyche FEAT roll is required. Energy absorption of up to Shift X power requires a Red FEAT roll, and absorption of Class 1000 power automatically causes a reversion to Dark Phoenix.

*Telepathy:* Phoenix was capable of reading thoughts at Unearthly distances with Unearthly power. She could fire bolts of Unearthly mental power at the same range, doing Unearthly damage or stunning victims for 10-100 turns. Because her telepathic ability was uncontrolled to a certain extent, she commonly read the thoughts of everyone within three areas of her and suffered no Karma loss for mind-reading.

Phoenix was easily capable of altering the thoughts and personality of an opponent in the manner of Professor X™, though she did so in desperation. She drove Mastermind™ insane, but did so in order to save her personality. An attempt to alter someone's thoughts, personality, or sanity produces a loss of all Karma and a Green Psyche FEAT roll to avoid turning into Dark Phoenix. Phoenix need only make a Psyche FEAT roll to accomplish the above, shifting to the left one column for every rank of Psyche over Typical possessed by her opponent.

*Space-warp creation:* As an outgrowth of her abilities to rearrange matter and energy, Phoenix could create space warps through which she would travel across the universe at hyper-light speeds. This power functions as a sort of teleportation ability at the Class 1000 level, reaching intergalactic distances with ease.

Note: Phoenix could increase any of the above-mentioned Unearthly limits on her powers, but doing so risked bringing on her Dark Phoenix form. A shift X power usage means a Green Psyche FEAT roll to prevent the reversion, while Class 1000 use means a Red FEAT roll.

**Talents:** Fashion modeling (Good ability)

**Personality:** Phoenix duplicated the majority of Jean Grey's behavior and attitudes. She tended to be absorbed in her own problems, but she possessed a strong moral character and desired to do good. She was proud of her "mutant" heritage (still believing herself to be the original Jean Grey) and would go to great lengths to help her fellow X-Men™.

Phoenix had extremely close ties with numerous mutant heroes. Cyclops™ was her lover and was closest to her. Storm and Colossus were like sister and brother to her, and Moira MacTaggart™ thought of Phoenix as her daughter. Wolverine™ bore a secret love for Phoenix, and Professor X was her mentor (and a distant fatherly figure as well). Of course, the events of the Dark Phoenix period and Marvel Girl's reappearance may have altered these conditions.

Because of her past dealings with Sentinels™, Magneto™, the Hellfire Club™, the Shi'ar™, and Mastermind, a reborn Phoenix may harbor considerable dislike for these beings. She would try to handle it appropriately, but may find herself seriously considering a more lasting revenge against them. If she fails a Green Karma FEAT roll upon encountering these beings, she may take steps to ensure that they never have the chance to harm her or her friends again (player's choice as to the handling of this matter, but the Judge should keep Karma losses and chances for Dark Phoenix appearance in mind).

**Limitations:** Phoenix was essentially an energy being who adopted Marvel Girl's human form and personality, but was not able to eliminate or control its original nature. The phoenix-force represents the emotional principle of rebirth through destruction, and this conflicted with Jean Grey's personality, which sought to use reason, create, and do good. So long as "Jean Grey" was in control of Phoenix, she behaved in a responsible and self-sacrificing manner.

However, the Jean Grey persona was continually tempted by the lure of her own powers and rattled by mental assaults from criminal forces, particularly Mastermind, which eroded her self-control. It is possible that Phoenix was driven insane by her own dual nature and conflicting desires to do good and to destroy. Any action that led to the death of another being, the altering of its essential nature or personality, the absorption of high levels of power (feeding her passion and



bringing out her darker side), or the loss of her self-control (if she is mind-controlled by another being, for instance) would push Phoenix toward reversion into Dark Phoenix, her destructive counterpart.

If mentally attacked by another being, Phoenix is considered to have a Psyche of merely Excellent, reflecting her internal conflicts that make her susceptible to mental control. She may make a Red Psyche FEAT roll every 1-10 turns in order to throw off someone else's domination of her free will. If she loses control of herself by another being's actions, she must make a Yellow Psyche FEAT roll upon her recovery or else revert to Dark Phoenix form in 1-10 turns. She can give warning of her loss of mental control to her allies. Any form of immediate comfort offered her will alter the roll to a Green one.

Dark Phoenix is essentially an insane and destructive goddess who will do all in her power to gain even more power, without regard to the effects on anyone else. Dark Phoenix may briefly retain certain moral inhibitions (such as those preventing her from killing heroes who were closest to Phoenix), but otherwise she cares nothing for anyone but herself. The murder of billions of innocents would not even make her blink, and she takes great pleasure in toying with her prospective victims. The green areas of Phoenix's costume turn red when this reversion occurs.

As noted above, certain actions may cause Phoenix to revert to Dark Phoenix form. Once this happens, the Dark Phoenix persona remains in control for 10-100 turns (and is controlled by the Judge). After this, a new Red Psyche FEAT roll may be made; success indicates that the good Jean Grey personality (the player) comes into control. Reversion to Dark Phoenix means an automatic loss of all Karma. Pleas from Jean Grey's closest friends may also bring about a change from Dark Phoenix to Phoenix. Cyclops can induce a Red Psyche FEAT roll to stop Dark Phoenix, because of Jean Grey's love for him and because of their telepathic communion. Storm™, Moira MacTaggart™, Wolverine™, and Colossus each have one chance in 100 (roll 00) of stopping Dark Phoenix with their appeals. Professor X may attempt to draw out the Jean Grey persona by using his telepathic powers, though it will take a Psyche FEAT roll on the Feeble column for him to do so. Few other beings even have a chance to cause a Dark Phoenix-to-Phoenix reversion.

As a final limitation, Phoenix's Karma cannot be pooled with any other being or group. She is a breed apart and cannot share herself fully with others.

**Background:** The story of Phoenix begins with Marvel Girl, who piloted a space shuttle through re-entry in Earth's atmosphere after a space-station battle

between the X-Men and renegade forces of Project Wideawake™. During the re-entry, radiation bombarded the shuttle, and Jean Grey was believed to have died from exposure to it — only to be reborn as Phoenix after the shuttle crashed in Jamaica Bay.

Phoenix claimed that she was in reality Jean Grey and had been restored to life by the power of the phoenix-force, a primal energy being associated with the living force in the universe. In later years it was learned that Jean Grey had actually been approached by the phoenix-force and offered the chance to save her friends aboard the shuttle, in exchange for giving up her identity to the force and letting her own body lie undiscovered at the bottom of the sea while it healed from its radiation-induced injuries. The being known as Phoenix fully believed, to the very end, that it was truly Jean Grey.

Shortly after her "rebirth," Phoenix literally saved the universe from the mad Emperor D'ken in the Shi'ar Galaxy. Using her powers to their fullest, she entered the M'krann Crystal, a device holding a neutron galaxy in check with stasis fields, and single-handedly knit the stasis fields around the galaxy together again, a feat that no living being could imagine happening. Afterwards, she appeared to have burnt out her powers, and possessed Marvel Girl's powers in all respects.

However, Phoenix had merely imposed unconscious limits on her own powers. As time went on, it became apparent that Phoenix's powers were gradually increasing again, with no upper limits in sight. Tests run by Moira MacTaggart indicated that Phoenix would soon operate on god-like levels. Her teammates in the X-Men became concerned over Phoenix's rise, and Jean Grey's lover, Cyclops, was especially disturbed.

The crisis came to a head when Mastermind manipulated Phoenix's mind in order to make her a pawn of the Hellfire Club™. He succeeded in turning Phoenix to evil as the Black Queen, but Phoenix broke free of his control long enough to drive Mastermind insane. Her mental control shot, she suddenly reverted to Dark Phoenix form and attacked her fellow X-Men.

Dark Phoenix defeated the X-Men with ridiculous ease, then gated herself across the universe to the Shi'ar Galaxy, where she caused a sun to go nova to feed her craving for power. The nova incinerated five billion aliens on a neighboring world, and a Shi'ar warship that fired on her was promptly destroyed, too — but not before its captain warned Empress Lilandra™ of Phoenix's appearance. The armed might of the Shi'ar Empire then gave chase.

Dark Phoenix returned to Earth with murder on her mind, but was successfully exorcised of her madness by Cyclops and Professor X. However, the avenging Shi'ar teleported Phoenix and the X-Men aboard one of their starships and revealed the

extent of Dark Phoenix's rampage. To prevent Phoenix's immediate execution, the X-Men fought the Imperial Guard™ in a trial by combat, believing that she should not have to pay for her deeds when she was insane. The X-Men lost, but Phoenix (realizing she couldn't control her destructive urges any longer) activated an ancient war machine by telekinesis and killed herself.

In later years, another heroine named Phoenix appeared from an alternate universe. This Phoenix was the daughter of Jean Grey and Cyclops, but Jean Grey had lost all of her Phoenix powers. This new Phoenix is described in MHSP 2, *Secret Wars™ II*, and she has little of her mother's phoenix-force powers (save for what the Beyonder™ gave her for a time).

### The Phoenix arises again

Though she is believed to be dead at present, it is entirely possible that Phoenix could reappear in the Marvel Universe. The Phoenix of legend was able to arise from its own ashes, and Marvel Girl (or another telepathic/psionic hero) might accidentally summon Phoenix *in extremis*. A Phoenix from an alternate or divergent universe (such as the one who survived the annihilation of her own universe at the hands of Korvac™ and went off looking for a new universe to call home in the WHAT IF?™ series) might find her way to the campaign world.

Should Phoenix reappear, her first task will be to stay alive. All super-hero forces on the planet (and many elsewhere in the universe) regards Phoenix as an evil, insanely destructive entity, and will attack her on sight with all the ferocity that the heroes showed the first Phoenix and later the Beyonder. The Avengers™, the Fantastic Four™, the Shi'ar Imperial Guard, and even criminal groups such as the Hellfire Club (which felt her power once before) would spare no expense and take no quarter in trying to destroy her. In addition, she is regarded as a threat by the Shi'ar, Skrull™, and Kree™ empires, and all three would lay aside their in-fighting in order to hunt Phoenix down and annihilate her. If Phoenix is still having internal conflicts over her good and evil sides, this certainly isn't going to help her.

Of all those who knew Phoenix, only a few might have a chance of overcoming their urge to destroy her. Cyclops and the others mentioned above who were closest to her would be most likely to try to come to terms with her, but this cannot be guaranteed. (After all, the *real* Jean Grey is alive and well now!) Hiding her presence would be hard for Phoenix, who liked showy displays of power. Her power usage could be detected by Spider-Man™'s spider sense, the Silver Surfer™, Doctor Strange, Professor X, complex monitoring equipment maintained by the Fantastic Four

and other organizations, and by Cyclops's telepathic awareness that he gained from close contact with Jean Grey.

### Class 1000 adventures

If her existence could be hidden from the interstellar empires and Earth's heroes at large, Phoenix might find adventure interacting with other equally powerful beings — among them Molecule Man, Odin™, Zeus™, the Celestials™, Death™, Eternity™, the In-Betweener™, Korvac, Mephisto™, the Elders of the Universe™, Ego™, Thanos™, and Galactus™. Note that several of these beings are supposed to be dead — but this, of course, could be altered.

The MARVEL SUPER HEROES game begins to lose its balance as a character's abilities enter the Class 1000 level, but with the proper restrictions even the mightiest characters can be played. In the case of Phoenix, most of her powers are balanced by the danger of turning into Dark Phoenix (and being turned into an NPC run by the Judge). The player who uses Phoenix should be finely aware of the responsibility that comes with endless power; indeed, Phoenix herself was in the habit of applying an upper limit to her power use (assumed here to be on the Unearthly level).

It is conceivable that a group of players may wish to use several Class 1000 heroes on an adventure. Imagine trying to come up with a scenario to challenge Phoenix, Molecule Man, Galactus, and Zeus! It can be done, however (though it will take a little time). Note, for example, that several of the Class 1000 beings above are (or were) villains. Some, like the Celestials, seem to surpass all but the Beyonder in power. A Class 1000 being can be challenged by a fleet of starships, an invasion of Unearthly-class demons from Mephisto, a reanimated suit of Destroyer™ armor, and so forth. Masses of low-level sorts can be as effective as tougher ones (just as a swarm of wasps can be as bad as a single wolf).

Then, too, one must consider the personality of the characters involved. Phoenix is an adventurer at heart, true enough — but Molecule Man wants to be left alone to live with his girlfriend Volcana™, Zeus usually has governmental matters on his mind, and Galactus is basically interested in raiding the stellar ice-box all day to feed his hunger. It might be better to arrange for adventures in which Phoenix is played with an assortment of Unearthly-class heroes, such as Hercules™, Thor, and the rest — but then you run into the old problem of convincing the good guys that Phoenix is a good guy, too. The chances of that happening might be very, very slim. Perhaps the easy-going Molecule Man (who tutored the Beyonder, after all) would help out, and the Silver Surfer would be a good bet to befriend her. Beyond that . . . ?

When designing ultra-tough adventures for Unearthly-class characters (and above), the following points should be kept in mind:

1. Avoid always threatening the existence of the Earth or the universe. Secret Wars II did a nice job of threatening everything there was, and saving the Earth becomes an old theme after a time. But outer space is full of places that could challenge the abilities of any hero or villain. Aliens could come to Earth and request aid to save their people from extinction or conquest. A mammoth starship could enter the solar system on an unknown mission. An alien life-force could have invaded Galactus's world-ship and placed him in suspended animation, and his Herald Nova™ might need help in removing it. Then, there is always the Secret Wars I model (kidnapped heroes fight kidnapped villains in cosmic arena). This can be overdone, of course, though the Grandmaster™, the Collector™, and Kang™ seem to enjoy this.

2. Use a wide assortment of foes. If high-strength heroes fight only other high-strength heroes, the Judge will see yawns from the players before long. Use variety when choosing villains: magic-using foes, mentalist foes, multipowered enemies, etc. If a hero has a weak spot, hit it now and then (though this could prove fatal to everyone in Phoenix's case; use good judgement here).

3. Vary the damage done by attacks. The reason for this becomes obvious when an Unearthly-class attack is pitted against Unearthly armor, or any other such situation. It stands to reason that some damage must get through sometime. One solution to this is to vary damage done by attacks, while keeping armor values constant. One table that varies attack damage within a range of 20% higher or lower appears below. Damage values below Good are too low to bother with; those at Class 1000 level are too high.

Attack power	Base rating	Variable rating
Good	10	2d4 + 5
Excellent	20	2d4 + 15
Remarkable	30	2d6 + 23
Incredible	40	2d8 + 31
Amazing	50	2d10 + 39
Monstrous	75	3d10 + 59
Unearthly	100	2d20 + 79
Shift X	150	3d20 + 119

4. Spell out a powerful character's powers as completely as possible, and allow only one character per player. If the characters powers are specific (as well as its limitations), then the player will have a clearer idea of what sorts of things he or she can try, and the player will have his hands full anyway figuring out what to do next.

5. Use mystery and problem-solving in addition to straightforward punch-'em-out fights. If Phoenix cannot hit a foe with a force-bolt, maybe she could talk him out of his crime — or even apply a gentle, friendly threat that harms no one. Problem-solving adventures, involving careful planning, strategy, and creative thought, are always good ways to keep even Phoenix and Molecule Man busy.

6. Finally, apply limitations to Class 1000 abilities that could threaten game balance. Phoenix, as given above, can reach Class 1000 power in almost any area — but doing so is very risky for her, and she should set her limits lower than that. Applying fixed limits beyond which certain penalties come into play is a good method of controlling the character's actions, and on-the-spot judgements on Karma losses and so forth are also helpful. Any Karma loss should be considerable for powerful characters, particularly since the PCs have a greater responsibility to check their powers. Acting out of character may also cause a substantial Karma loss (100 points minimum). Another limitation for any Class 1000 character is to prohibit the use of Karma pools; otherwise, game balance takes a walk.

### The NPC Phoenix

Much of the above information should be useful in figuring out adventures for an NPC Phoenix controlled by the Judge — which in the long run might be the best way to handle her in most campaigns. Phoenix (even at the somewhat scaled-down levels above) may prove too overwhelming to use, though it could prove to be interesting in the sorts of player-to-player interaction it produces.

Should Phoenix ever turn to Dark Phoenix, the Judge should play her to be as savage, vicious, vindictive, ruthless, and destructive as possible. If you don't want to kill heroes, be sure to scare them! Undoubtedly, this might be a good time to trot out Molecule Man to clean up after her, and a contest of wills between the two would be an interesting problem. Perhaps the players could take the roles of several Class 1000 beings who are trying to hunt down Phoenix and destroy her, if the Judge feels up to it. Otherwise, the players will be concerned with staying out of the way as Phoenix mixes it up with the other Class 1000 types.

Finally, a series of scenarios could be played out in which an NPC Phoenix returns and the heroes have to decide how to handle her. Since she might not initially be in Dark Phoenix form, it would be wise to handle her carefully (as with the Beyonder). In time, she might be convinced to leave for parts unknown, rejoin the phoenix-force, or turn fully human (and become completely normal). The possibilities are endless.

# Dire Invasion

*Rom™ and the Spaceknights™ of Galador*

by William Tracy

In another area of the Milky Way galaxy, far from Earth, flourished the civilization of Galador. The inhabitants of Galador were a highly advanced and peaceful race, and spread their philosophy across the stars. About 200 Terran years ago, the Galadorian exploration fleet entered an area known as the Dark Nebula and encountered the nebula's inhabitants, an alien race known as the Dire Wraiths™. These hostile shape-changers were experts in technology and sorcery. Summoning a birdlike monster known as Deathwing, the Dire Wraiths ambushed and destroyed the Galadorian space fleet.

The Prime Director of Galador, after receiving the last message from the doomed fleet, asked for volunteers from the populace to participate in a special program. The volunteers' bodies would be placed in suspended animation while their brains and nervous systems would be grafted into a special suit of cybernetic armor. The mission of these volunteers, who were known as Spaceknights, was to defeat the Dire Wraiths before their evil could reach other civilizations. Rom™ was the first volunteer for this program.

The Spaceknights were provided with special weapons, space flight capability, and superhuman strength. Though the Spaceknights destroyed most of the Dire Wraith space fleet and the demon Deathwing, many Dire Wraiths escaped, and their forts were believed to exist in other sections of the galaxy. The location of the Wraith homeworld was unknown as well. The Spaceknights

swore to battle the Dire Wraiths anywhere in the galaxy until the last of them had been hurled into Limbo with the neutralizer guns of the Galadorians.

A special Galadorian space probe eventually detected Wraith activity on Earth and relayed the information back to Galador. Rom volunteered to go to Earth, and upon his arrival he learned that Earth's society had already been infiltrated by the shape-changing aliens. The Wraiths usually took over a world by killing and assuming the identities of their victims, who were often important members of society.

At first, Rom was hunted by the legal authorities for murder. When Rom used his neutralizer on the disguised Dire Wraiths to cast them into Limbo, it looked like he was killing human beings. Eventually, the population of Clairton, West Virginia, discovered that Rom's story was true after being shown the powers of the Dire Wraiths. Clairton then aided Rom whenever possible, even protecting him from federal authorities after he used his neutralizer on some high officials of the Pentagon who were actually Dire Wraiths.

While in Clairton, Rom met and fell in love with a human woman named Brandy Clark™, who in turn fell in love with the dedicated alien. Rom was soon joined by a fellow Spaceknight, his Galadorian fiance Starshine™. When Starshine was killed by the Dire Wraiths and removed from her armor, Brandy Clark was placed in Starshine's armor by magical means as part of a scheme to destroy Rom. The plot failed and Brandy fought alongside Rom in Starshine armor. Much later, Brandy was removed from the





armor by the evil sorcery of Hybrid", the offspring of a human and a Dire Wraith.

When Rom was away from Clairton, it was protected by Brock Jones, the Torpedo™. Brock had come upon the original builder and wearer of the Torpedo armor suit, who had been critically injured in an unplanned battle with Daredevil™. The man told Brock that his name was Michael Stivak. Before Michael died, he told Brock about his suit and background. Michael was a Yugoslavian scientist who had been brought to America by his uncle, Senator Eugene Stivak. The Senator hired Michael to build and design a battle-suit for the American government, but Michael later found out that his uncle was working for some unknown and unfriendly organization.

Michael was trying to destroy the plans for the battle-suit when he had his accidental fight with Daredevil. Before Michael died, he made Brock promise to destroy the plans; Brock donned the suit and quickly did so. For the next few months, he acted as a part-time super hero, fighting a group called the Rocketeers™ several times. These men, hired by Senator Stivak, wore weaker prototypes of Torpedo's battle-suit.

The Rocketeers soon discovered Brock's secret identity, forcing him to move his family to another city, which happened to be Clairton. There he met Rom and became his ally. Later they found that Torpedo's battle-suit had actually been financed by the Dire Wraiths, who had been looking for a new weapon to use against Rom. Rom made Torpedo a special pair of goggles that enabled him to see Dire Wraiths, no matter what form they were in.

Meanwhile, a shake-up in the Dire Wraith chain of command had occurred. So far, the Dire Wraiths on Earth had consisted of the males, who were experts in technology. The female Wraiths were experts in sorcery and were the leaders of the race. The females decided that the males weren't doing a very good job of world-conquering, so they took over all Earth operations and killed all the males present.

Then, while Rom was away from Clairton, the female Wraiths took over the town while magically clouding Torpedo's mind so that he wouldn't notice anything. Eventually, everybody in Clairton was dead and had been replaced by Wraiths. Torpedo died fighting Wraiths in his burning house. The Torpedo battle-suit was apparently destroyed in the fire. Rom and Starshine II swore to avenge the people of Clairton and the courageous Torpedo.

By this time, the government had discovered that Rom was not a homicidal alien, but a benevolent being trying to save Earth from the Dire Wraiths. The government placed S.H.I.E.L.D.™ and its psionic division in control of Wraith-destroying missions and enlisted the help of various super heroes, including the X-Men™ and Alpha Flight™. Eventually, a special branch of S.H.I.E.L.D. known as the Wraith-Hunter Rangers was formed to deal with the problem.

Rom soon gained two new allies: Rick Jones™ and a little girl named Cindy Adams™. Rick Jones, who has been involved with many super heroes, became one of Rom's closest friends and allies even though he was in love with Brandy Clark. Rick discovered that he was dying of an incurable form of cancer, the same cancer that killed Captain Marvel™ some time before. Cindy Adams was a normal child until she was attacked by a Dire Wraith. The Wraith was killed just as it had begun to absorb her memories. Because of this, a part of the Wraith's consciousness was lodged in her mind, and at times Cindy could guess what the Wraiths were planning.

Unfortunately, a government agent named Peter Gyrich™ was assigned to the Dire Wraith branch. Gyrich, who had worked with super heroes before, was apparently paranoid when it came to super beings. He caused many problems for Rom and his newest ally, the mutant known as Forge™.

After fighting a losing battle on Earth, the Wraiths decided on one final plan. They prepared to use their magic to teleport their homeworld to Earth's solar system, destroying the Earth and putting the homeworld in the Earth's orbit. Luckily, Forge was able to build a larger prototype of Rom's neutralizer and have it placed in orbit around the Earth. Powered by Rom's neutralizer, it was aimed and fired at the Wraithworld, destroying the planet

and a great portion of the Wraiths' power, since it was the source of their sorcerous energy. With the power of the Wraiths broken, mopping-up operations finished off the remainder of the alien invaders.

In time, Rom left Earth to return to Galador, accompanied by several of his fellow Spaceknights. They discovered that Galador, which had been transferred to a new galaxy by Galactus™, had been ravaged by second-generation Spaceknights who were to have defended the world. All the Galadorians were soon slain by the rouge Spaceknights, who were in turn defeated by Rom and his allies. Brandy Clark, who had been sent to Galador by the Beyonder™, helped the remaining Spaceknights find the means to turn Rom back into his original human form. His mission completed, Rom retired with Brandy to spend their days on Galador and rebuild its civilization, protected by the surviving Spaceknights.

Several characters described in the Rom saga have already appeared in modules and supplements published by TSR, Inc. The Torpedo armor was described in MHAC-8, Weapons Locker, and Peter Gyrich and Forge were described in MHAC-5, *Project: Widesawake*™. S.H.I.E.L.D. appeared in MHAC-2, *Avengers™ Assembled!*, as did Rick Jones™. The other important heroes and villains of this saga are given below.

## ROM™

### Spaceknight of Galador (Inactive)

Fighting: INCREDIBLE (40)  
Agility: EXCELLENT (20)  
Strength: INCREDIBLE (40)  
Endurance: MONSTROUS (75)  
Reason: EXCELLENT (20)  
Intuition: EXCELLENT (20)  
Psyche: GOOD (10)

Health: 175

Karma: 50

Resources: Amazing (government backed)

Popularity: 20

**Talents:** Rom had no special talents.

### Known Powers:

**FLIGHT.** Rom's armor was provided with twin rocket pods (electrically powered, low-density plasma engines) which enabled him to fly at Unearthly speed in the vacuum of space or at Monstrous speeds in an atmosphere. Rom also possessed special sensors that enable him to locate space warps with Monstrous ability and range, allowing "shortcuts" through space with Class 1000 range.

**BODY ARMOR.** Rom's suit of armor provided him with Incredible protection against all physical, radiation, heat-based, and cold-based attacks. He could survive in deep space indefinitely.

**REGENERATION.** Rom's armor had built-in microfactories able to repair damaged circuitry, providing him with Good regeneration.

**Equipment Weapons:** The following equipment was kept in a fold in hyperspace and could be mentally summoned and used in one turn.

**ENERGY ANALYZER.** This item's main function was to emit ultra-high frequency waves that scanned a being's molecular structure. The waves caused certain rare earth elements in the Dire Wraiths' bodies to emit special radio waves which were visible to Rom's visor sensors, enabling him to see the Dire Wraiths as they truly were, no matter what form they took. The analyzer could also scan other items and beings, and inform Rom of the object's or being's power potential. The analyzer could trace the energy trails of powerful beings or objects. The analyzer had no attack abilities, though it bathed the subject in a red energy field that could frighten the victim.

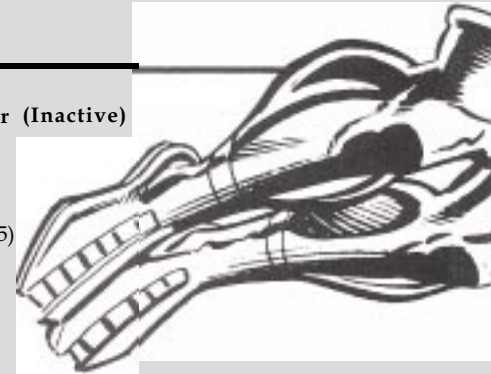



All Marvel characters, MARVEL SUPER HEROES, and the distinctive likenesses thereof are trademarks of the Marvel Comics Group. Copyright ©1986 Marvel Comics Group, a division of Cadence Industries Corporation. All Rights Reserved. ROM is a trademark of Parker Brothers. Copyright ©1986 Parker Brothers.

## STARSHINE™ I and II Landra (I) and Brandy Clark (II) Spaceknights of Galador

	I (Deceased)	II (Inactive)
Fighting:	REMARKABLE (30)	EXCELLENT (20)
Agility:	INCREDIBLE (40)	INCREDIBLE (40)
Strength:	INCREDIBLE (40)	INCREDIBLE (40)
Endurance:	MONSTROUS (75)	MONSTROUS (75)
Reason:	EXCELLENT (20)	TYPICAL (6)
Intuition:	GOOD (10)	TYPICAL (6)
Psyche:	GOOD (10)	TYPICAL (6)
Health:	185	175
Karma:	40	18
Resources:	AMAZING	AMAZING
Popularity:	10	10

**Talents:** Starshine (II or I) had no special talents.

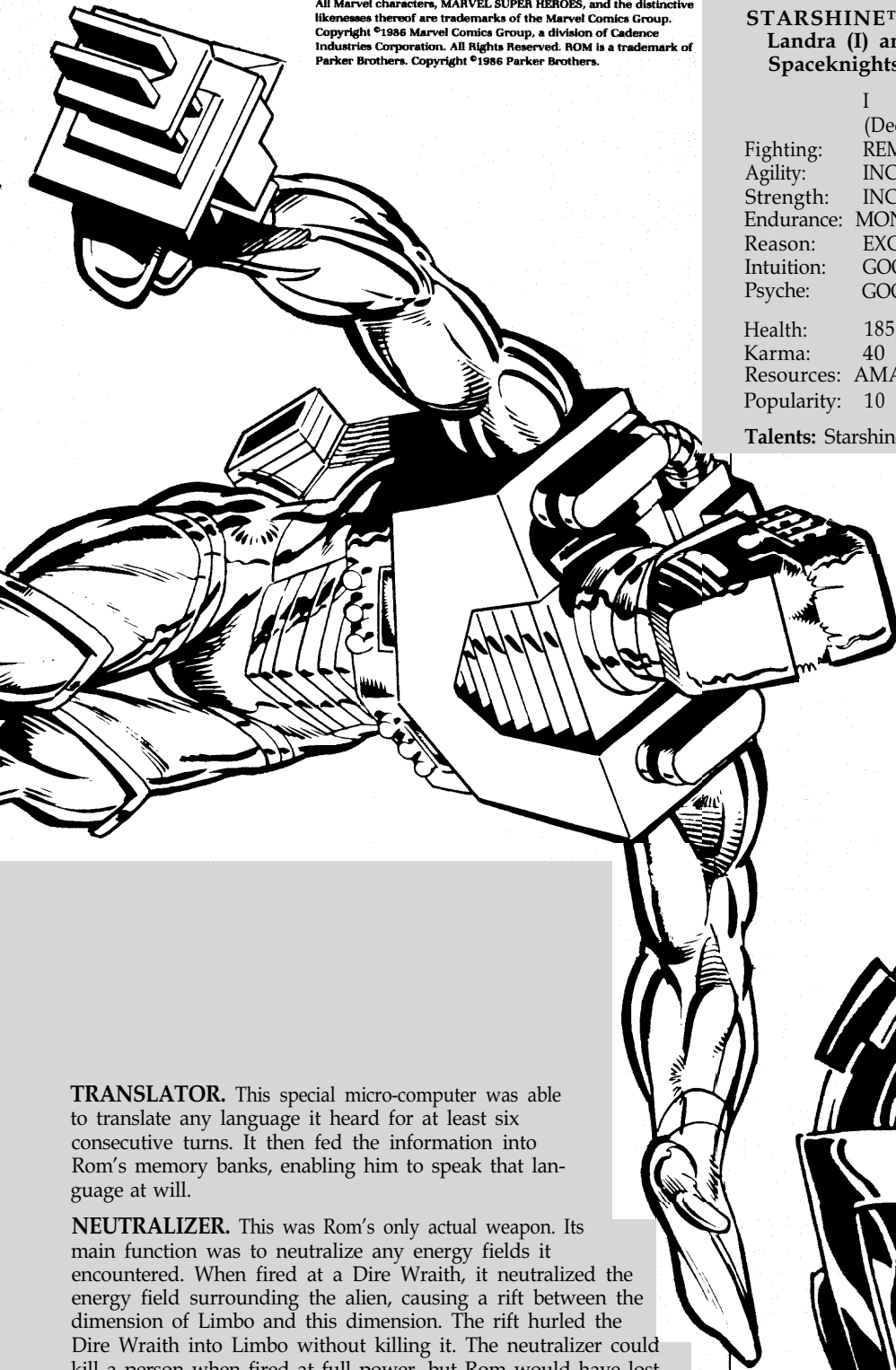

**TRANSLATOR.** This special micro-computer was able to translate any language it heard for at least six consecutive turns. It then fed the information into Rom's memory banks, enabling him to speak that language at will.

**NEUTRALIZER.** This was Rom's only actual weapon. Its main function was to neutralize any energy fields it encountered. When fired at a Dire Wraith, it neutralized the energy field surrounding the alien, causing a rift between the dimension of Limbo and this dimension. The rift hurled the Dire Wraith into Limbo without killing it. The neutralizer could kill a person when fired at full power, but Rom would have lost all Karma points for killing anyone, even Dire Wraiths. Rom could automatically determine the power level of the weapon. Dire Wraiths taken to Limbo were unable to escape from it.

At its lowest setting, the neutralizer could neutralize radiation poisoning in organic beings. At its highest setting, it neutralized the life-force of a being, killing it instantly. A human could not be transported into Limbo because a human could not survive the trip or a direct hit from the neutralizer set at that power level.

Anyone trying to use the neutralizer, except Rom, took Monstrous damage; no damage was taken by just touching the weapon. Brandy Clark, in human form, once used the neutralizer without dying, though she was badly injured. At the time, she was psionically protected by Charles Xavier™.

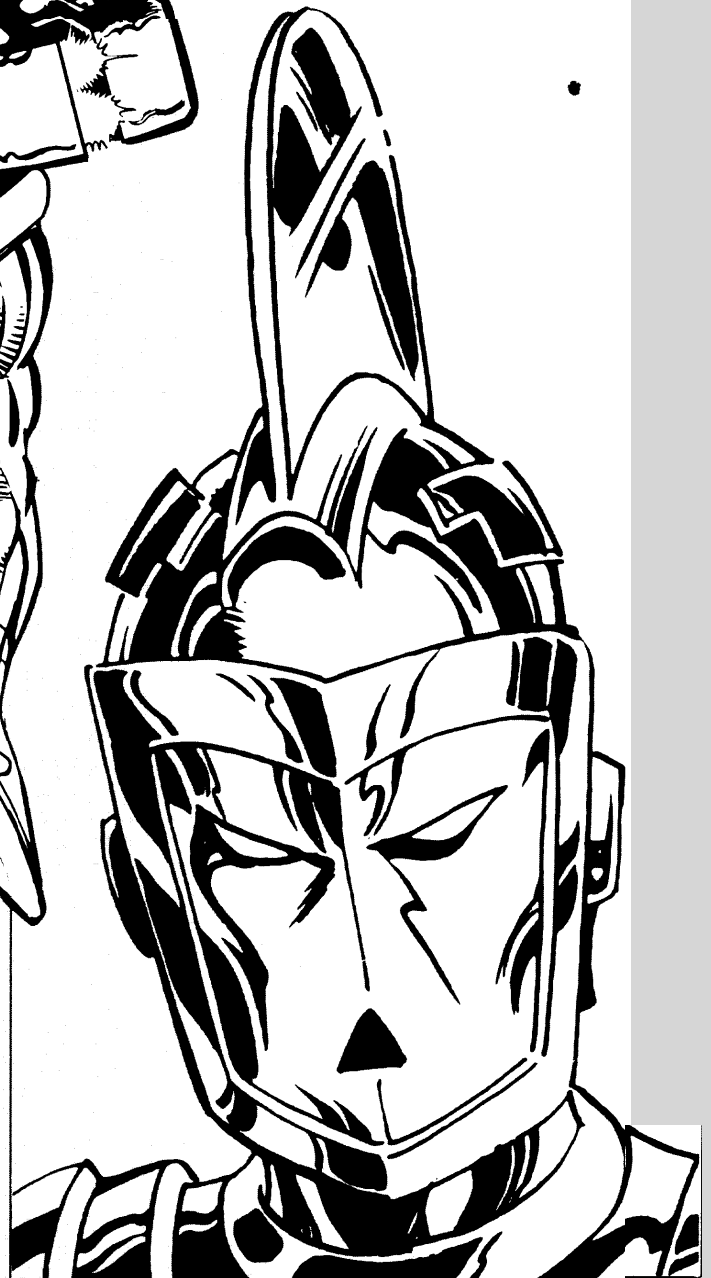

## Known Powers:

**FLIGHT.** Starshine, like Rom, had Unearthly flight ability.

**BODY ARMOR.** Starshine had Rom's Incredible body armor and could survive in deep space indefinitely.

**REGENERATION.** Starshine had Good regeneration abilities.

**LIGHT POWERS.** Starshine used a form of energy known as the "living light" of Galador. She could project beams of this light from her eyes, doing concussive damage of up to Unearthly levels, and she can control the power level to do less damage as well. She was also able to use this power to emit normal light.

---

## CINDY ADAMS™

### Orphan

Fighting: POOR (4)  
Agility: TYPICAL (6)  
Strength: FEEBLE (2)  
Endurance: POOR (4)  
Reason: TYPICAL (6)  
Intuition: GOOD (10)  
Psyche: REMARKABLE (30)

Health: 16  
Karma: 46

### Known Powers:

**SPECIAL INTUITION.** A Dire Wraith was killed while it was draining Cindy's memories, leaving a residue of the Wraith's consciousness in her mind. If she could make a successful Yellow Psyche FEAT roll, she could guess what the Dire Wraiths are up to if she had enough clues. The referee should decide how much she is able to guess.

---

## DIRE WRAITHS™

Fighting: GOOD (10)  
Agility: POOR (4)  
Strength: REMARKABLE (30)  
Endurance: REMARKABLE (30)  
Reason: REMARKABLE (30)  
Intuition: TYPICAL (6)  
Psyche: GOOD (10)

Health: 74  
Karma: 46  
Resources : AMAZING

### Known Powers:

**SHAPE-SHIFTING.** The Dire Wraiths most important power was their uncanny shape-shifting abilities. When faced with physical combat, the Dire Wraiths could change into the form of some alien beast more suitable for combat. The Dire Wraiths often took the form of the Deathwing:

F	A	S	E	R	I	P
Go	Ex	Ty	Re	Re	Ty	Go

Health: 66    Karma: 46

In Deathwing form, a Dire Wraith could fly at Typical speed and breathe fire one per turn for Incredible damage with Typical range.

**SPECIAL ATTACK.** The Dire Wraith's most insidious form of attack was its barbed tongue, which also secreted a powerful acid. The tongue instantly penetrated an unprotected human skull. If the skull was armored, the acid secretion and barbs of the tongue did Excellent damage to the armor each turn. Any item made of Monstrous material or better could not be pierced by the tongue.

The Beyonder removed all traces of Dire Wraith influence on Cindy's mind at the end of the Rom saga and resurrected her parents as well. Cindy's statistics may be used for a child in a similar predicament if desired.

---

## ROCKETEERS™

### Real names unknown

Fighting: EXCELLENT (20)  
Agility: GOOD (10)  
Strength: GOOD (10)  
Endurance: GOOD (10)  
Reason: TYPICAL (6)  
Intuition: TYPICAL (6)  
Psyche: TYPICAL (6)

Health: 50  
Karma: 18

### Known Powers:

**BATTLE-SUIT.** The Rocketeers wore special battle-suits which had rocket backpacks, enabling them to fly at Good speed and providing them with Good protection against physical attacks.

**RANGED WEAPON.** The Rocketeers carried special portable rocket launchers which had a four-area range and did Incredible damage. They each carried a maximum of five rockets at a time.

Special note: The original Rocketeers were human (from which the statistics above are derived). Later on, the Rocketeers were replaced by Dire Wraiths in human form.

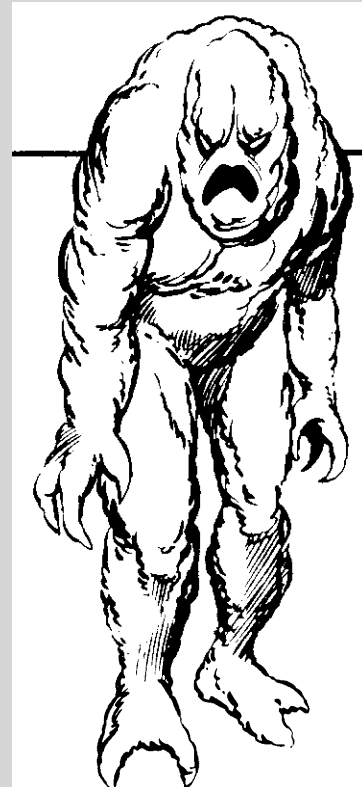

The tongue had range of one area. To successfully use the tongue, a Dire Wraith had to completely surprise a victim from behind or grapple an opponent and roll a hold result, indicating that the Wraith held the victim in front of itself.

The referee should allow a victim a dodge roll or escape roll before the Wraith's attack, because a successful hit indicates instant death to the victim. Right after the tongue hits, the victim's body turns into dust. The Wraith gains all the knowledge and memories of the victim, and the Wraith is now able to become a

perfect duplicate of the victim, down to the victim's voice. After taking a new form, the Wraith's physical abilities become those of the form taken. The Wraith loses all normal abilities and vulnerabilities except for its shape-changing power. If more damage is taken than its new form can withstand, it is forced to return to its true shape, and the previously taken damage is retained.

**HEAT RESISTANCE.** The Wraiths originated from a planet with a great deal of volcanic activity. They took half damage from fire- and heat-based attacks. At the same time, they took double damage from cold-based attacks.

**MAGIC.** The Dire Wraith species consisted of two branches: the males, who were experts in advanced technology, and the females, who were spell-casters. Female Wraiths had Monstrous Psyches and Good Reason scores (see pages 10 and 32 of the Campaign Book for rules concerning magic).

## HELL HOUNDS™

Fighting: EXCELLENT (20)  
 Agility: EXCELLENT (20)  
 Strength: GOOD (10)  
 Endurance: REMARKABLE (30)  
 Reason: FEEBLE (2)  
 Intuition: GOOD (10)  
 Psyche: POOR (4)

Health: 80  
 Karma: 16

### Known Powers:

**PHASING.** The Hellhounds had a phasing power similar to that of Shadowcat™. Any machinery a Hellhound phases through must make an Endurance FEAT roll or be scrambled and inoperative. Machinery without an Endurance score is scrambled automatically. Mechanical beings take Incredible damage, while battle suits and other machinery is made inoperative for 10 turns.

The Hellhounds attack with their phasing ability, using a Fighting FEAT roll to determine success. A success roll indicates that the Hellhound has phased through the person, causing Remarkable damage. Also, the victim must make a yellow Endurance FEAT roll or fall unconscious for 1-10 turns.

**Background:** When the Dire Wraiths first arrived on Earth, they used their advanced technology to mutate ordinary dogs into these powerful creatures.

## HYBRID™

Fighting: GOOD (10)  
 Agility: EXCELLENT (20)  
 Strength: GOOD (10)  
 Endurance: MONSTROUS (75)  
 Reason: EXCELLENT (20)  
 Intuition: EXCELLENT (20)  
 Psyche: UNEARTHLY (100)

Health: 115  
 Karma: 140

### Known Powers:

**FLIGHT.** Hybrid was able to fly at Typical speeds using his mental abilities.

**MENTAL ATTACK.** Hybrid was able to project mental blasts which could do up to Unearthly damage.

**MENTAL POWERS.** Hybrid had the powers of telepathy, image generation, telekinesis, and mind control at Unearthly levels.

**BODY ARMOR.** Hybrid's skin provided him with Excellent protection against all physical attacks.

**SHAPE-SHIFTING.** Hybrid had a Monstrous shape-shifting ability.

**MAGIC.** Hybrid had powerful magical abilities, using Personal and Universal energies with Remarkable skill.

**Background:** Hybrid was the first offspring of a human and a Dire Wraith, and was a sworn enemy of Rom.

## Spaceknight character generation

Though most players may want to play Rom or Starshine in a MARVEL SUPER HEROES campaign, some players might want to create their own Spaceknight characters. This section helps players do this. First of all, the procedure for rolling a hero's abilities is changed as follows:

**Fighting.** Roll on the following table:

Die roll	Fighting score
01-60	Excellent
61-80	Remarkable
81-96	Incredible
97-99	Amazing
00	Monstrous

**Agility and Strength.** Roll on the following table:

Die roll	Ability score
01-10	Excellent
11-30	Remarkable
31-70	Incredible
71-90	Amazing
91-00	Monstrous

**Endurance.** Roll on the following table:

Die roll	Endurance score
01-30	Amazing
31-90	Monstrous
91-00	Unearthly

Note that Endurance scores refer only to the need for rest, as Spaceknights could withstand exposure to deep space indefinitely.

**Reason and Intuition.** Roll as per the rules in the Campaign Book, but shift the results two ranks to the right, to represent the fact that the characters come from an advanced race. The characters have been fighting the Wraiths for a long time, too, which would increase their scores in general.

**Psyche,** Roll as per the normal Campaign Book rules.

All Spaceknight characters have the same flight, body armor, and regeneration abilities possessed by Rom and Starshine. In addition, each Spaceknight character may roll randomly for 1-2 extra powers using the hero-creation section in the Campaign Book. Some variations should be made to the powers, as noted below.

**Resistances and Senses:** Protected Senses, Extraordinary Senses, and Infravision are possible.

**Movement:** Lightning Speed and Teleportation are possible.

**Nature Control:** Not possible.

**Energy Control:** All powers are possible.

**Body Control:** All powers are possible except Plasticity, Shape-shifting, and Body Transformation.

**Distance Attacks:** All are possible.

**Mental Powers:** All are possible.

**Body Alteration (offensive):** All are possible.

**Body Alteration (Defensive):** All are possible.

**Weapons:** Only Unique Weapon are possible.

Keep in mind that these super powers are produced and made possible by the Spaceknights' advanced battle suits. The power ranks of their powers, after being randomly rolled, should be shifted to the right one column to indicate they have been created by an advanced technology. A power's rank should have a maximum of Monstrous.



# The Warlock™ Redux

## Adam Warlock™ and friends from the Marvel Universe™

---

by **Jon D. Martin**

---

In addition to his popular work on the Captain Marvel™ comic, Marvel's own Jim Starlin developed the Adam Warlock™ series, which found an extremely loyal following of its own. Warlock became an important part of the Marvel Universe™, and his comic remains one of the best of the past decade (in this writer's opinion, of course). If you liked the comic, you have some serious reading to do!

---

### ADAM WARLOCK™

Him™

Artificial being created by the  
Enclave™

F	In (40)	Health: 160
A	In (40)	
S	Rm (30)	Karma: 60
E	Am (50)	
R	Gd (10)	Resources: Fb (2)
I	Ex (20)	
P	Rm (30)	Popularity: 10

#### KNOWN POWERS:

*Body Armor:* Adam Warlock possessed Good body armor against all physical and energy-based attacks because of his dense body and bone structure.

*Force Bolt:* Warlock could generate a beam of concussive force with Incredible range and damage by manipulating cosmic energy through the cells of his body.

*Flight:* Warlock's cosmic energy-enhanced speed could reach Class 1000 in space (using natural space warps) or Shift X in atmospheres. If Warlock made a Red power stunt with this power, he could increase his speed to Class 3000 for brief periods.

*Life Support:* Warlock could survive in the vacuum of space with Class 1000 ability by manipulating cosmic energy.

*Protective Cocoon:* Warlock could spin a cocoon about himself in seconds at will, though he did so infrequently. The cocoon





was of Incredible material strength and granted him Monstrous recovery powers. Often, Adam underwent considerable growth in terms of physical and mental maturity within the cocoon.

*Ability Enhancement:* Warlock could gain a +2 CS to either Strength or Endurance for five rounds by manipulating cosmic energy. At his maximum Strength level, he could press 40 tons (his normal strength allowed him to lift 4 tons). This ability enhancement could be done once per day, and it granted him no increase in Health.

*Soul-Gem:* Originally a gift from the High Evolutionary™, this jade gem was one of six such gems scattered throughout the universe. Each of the gems was an item of vast power, and together their power could shatter stars. Thanos™ destroyed the other five gems in the process of draining their power, in his quest to destroy the stars as a love offering to Death™.

Warlock's gem had the following powers:

*De-evolution* – With this Amazing-strength power, Warlock could return beings which had been augmented in size and abilities to their original stock.

*Communication* – When necessary, the gem acted as a translator of Unearthly power and range, allowing Adam to communicate with other beings.

*Soul Absorption* – Power Stunts were required for the use of this Unearthly power, with the intensity equalling the Psyche of the intended victim(s). A +1 CS was applied to the intensity for each person beyond five people to be affected. Furthermore, this power could not affect more than two people with Amazing or better Psyche or one person with an Unearthly Psyche at a given time. In no case could the Soul-Gem affect any being with a Class 1000 or better Psyche.

When the gem drained a person's soul, Warlock gained access to the memories of the victim, granting him the benefits of any talents that the poor soul might have had. This may no longer be the case, for Warlock himself is currently imprisoned in the gem.

*Sentience* – The Soul-Gem has a mind of its own, and it is a world within itself. For the purposes of mental combat, the gem has the following statistics:

R	I	P
In	Mo	Un

In dire emergencies, the gem may substitute one of these attributes for Warlock's attribute of the same name for a duration of one round, allowing him to detect an otherwise lethal danger, puzzle out a complex problem, or resist a devastating mental attack. This, too, may have changed as a result of Warlock's stay in the Soul-Gem.

**TALENTS:** Aerial Combat; Martial Arts A, B, C, D, E; Thrown Objects; and, Spacecraft Pilot and Navigation. It should be

noted that Adam resisted being cast in the role of a leader in the past and would likely do so again if brought back to life.

**CONTACTS:** Warlock's last friendly contacts were with Pip™ and Gamora™. In the past, he was on friendly terms with the Avengers™, but the line-up of that team today is drastically different from the team with which he had dealings. Still, Moondragon™, Thor™, Captain America™, the Vision™, the original Iron Man™, and Spider-Man™ could be considered contacts. He was also on good terms with the original Fantastic Four™ and the High Evolutionary, but he is no longer on good terms with the Enclave (to put it mildly).

**LIMITATIONS:** In the past, Warlock had an adversary relationship with his Soul-Gem, which stemmed from his misunderstanding of the gem's true nature. A revived Warlock would know the truth about the gem and would most likely have fewer reservations about using the gem's powers in combat. To discourage this behavior, Warlock should be required to make a Psyche check at some point during a battle to avoid using the gem's powers to defeat foes. If he fails, the gem does its duty and Warlock loses 30 Karma. If Adam deliberately uses the gem to drain an opponent's soul, the Karma loss is raised to 50 points. Conversely, he should receive a 30-point Karma award for using the gem in a constructive or merciful way, including the absorption of the souls of dying people (+1 CS Power FEAT).

**PERSONALITY:** Adam Warlock was a champion of life in all of its forms. He possessed a strong sense of justice which did not allow him to stand idle in the face of oppression. Warlock was also extremely honest to himself and others, finding it difficult to lie even if given good cause. Wanderlust was another of his traits, and he literally crossed the galaxy in search of evil to fight or something interesting to do. More often than not, evil found him. In any event, Warlock should have no trouble keeping himself occupied if returned to life. If nothing else, Pip can get into trouble while Gamora and Adam are otherwise occupied.

**BACKGROUND:** Originally, Adam Warlock was called Him. Him was created as a weapon by a group of criminal scientists called the Enclave. Unfortunately for the Enclave, Him realized their scheme and destroyed their operations rather than become a part of it. For a period of years, Him wandered space, learning and maturing. After an encounter with Thor, he decided to return to his cocoon and contemplate his hitherto useless existence. The dormant Warlock was discovered by the High Evolutionary, creator of Counter-Earth™.

Upon his emergence from his cocoon, Him acquired his present name, the pur-

pose that he sought, and the Soul-Gem. Adam Warlock became the defender of Counter-Earth with that world's Doctor Doom™, who was a hero, and opposed the evil designs of the Man-Beast™. Warlock was slain in the course of the battle with the Man-Beast, but death did not hold him for long. He returned from the grave and used the power of the Soul-Gem to defeat the Man-Beast and his New Men™ once and for all.

For a time, Adam wandered the galaxy aimlessly. His wandering ended when he encountered the forces of the Church of Universal Truth™, an oppressive religious order founded by his own future self, the Magus™. The Magus was worshipped as a god by the Universal Church, and his frequent displays of power helped to insure both belief and loyalty on the part of his worshipers. Warlock fought his way across the galaxy through armies of these followers to confront his future self. Without the invention of Thanos of Titan, Warlock's cause would have been lost. Using the same Time Probe that he had used to recruit Gamora, Thanos allowed Adam to confront his life's destiny directly and choose the path that his life would take. To complicate matters further, the Magus had summoned the In-Betweener™, the being who had caused/would cause Adam's transformation into the Magus. Warlock managed to purify and destroy the path that led to the creation of the Magus, but he had little time to choose a new path. He leapt onto the nearest path, the shortest path, and journeyed to its end to absorb his own dying soul so that he could be certain that he did not become the Magus in his new life as well.

After a series of relatively minor adventures, Adam once more found himself involved with Thanos. This time, Adam realized Thanos's true nature as the champion of Death when he encountered the dying Gamora on a remote asteroid. She told him of Thanos's mad plan of stellar genocide, destroying the stars as a love offering to Death. Warlock used his Soul-Gem to absorb Gamora's essence and wasted no time in alerting the Avengers, Captain Marvel, the Kree™, and Moondragon to the cosmic threat. Together, they attacked Thanos but were defeated by him. Warlock was killed by Thanos during the battle.

However, Thanos imprisoned the Avengers instead of just killing them. The imprisoned Moondragon managed to send a telepathic distress call to Spider-Man, who sought out the aid of the Thing™. The two of them fared no better than the Avengers had against Thanos, but Spider-Man was able to free the Avengers from their prison. Their combined might was still not enough to insure victory over the mad demi-god. Spider-Man came through once more, knocking over a crystal globe in which Thanos had placed Warlock's Soul-Gem. Adam Warlock was freed from the gem and fulfilled the pur-

pose he had sought in life by defeating Thanos and turning him into stone with the power of the gem.

Warlock's spirit returned to the gem, where it resides with the souls of Gamora, Pip, and others who were affected by the gem's power. The gem itself is currently held by an Elder of the Universe™ known as the Gardener™. Adam's body was interred on Counter-Earth, which was later pulled from its orbit on the far side of the sun and dropped into a museum (!) by a race of beings known as the Beyonders™ —no relation to the Beyonde™ of Secret Wars™ fame, but unbelievably powerful nonetheless.

## PIP™

Prince Gofern  
Alien (Laxidazian Troll)

F	Ty (6)	Health: 42
A	Gd (10)	
S	Ty (6)	Karma: 24
E	Ex (20)	
R	Gd (10)	Resources: Typical
I	Cd (10)	
P	Pr (4)	Popularity: -10

**KNOWN POWERS:** Pip possessed no known super powers.

**TALENTS:** Larceny ( +2 CS to Resource checks, failure indicating that he's run afoul of the local law); Guns; Painting; and, Intoxication Liquors ( + 1 CS to Reason and Endurance).

**PERSONALITY:** Pip was degenerate, cowardly, obnoxious, and depraved. He was a likable chap! Pip was also loyal and could muster up what little courage that he had when he saw his friends in danger. Though a Troll by nature, Pip was a hero at heart. His optimism and humor served to counterbalance Warlock's brooding fatalism.

**CONTACTS:** Pip's only friendly contacts were Warlock, Gamora, and numerous bartenders scattered across the galaxy. He has many unfriendly contacts in the form of law enforcement officials on most of those same planets.

**BACKGROUND:** Pip was originally Prince Gofern of the Laxidazian race (two-hundred and sixtieth in the line of succession). His encounter with a group of Laxidazian Trolls changed that, and led him to discover firsthand that the liquor which the Trolls drank had properties that transformed the imbibor into a Troll. Pip was ostracized from mainstream Laxidazian society and wandered the galaxy, setting new standards for the Troll reputation for decadence as he did so.

Eventually, Pip was arrested and placed aboard the prison ship *Great Divide* by the forces of the Church of Universal Truth. In

the course of its travels, the *Great Divide* added Adam Warlock to its list of prisoners. Pip and Warlock became fast friends, and Pip aided Adam in the liberation of the ship. Pip continued to travel with Warlock, joining him in his struggle against the Magus. He later met his end at the hands of his "pal" Thanos while searching for Warlock. At present, his soul is contained in Warlock's Soul-Gem, along with those of Gamora, Warlock himself, and many others.



## GAMORA™

Alien (Xen Whoberis)

F	In (40)	Health: 140
A	Am (50)	
S	Cd (10)	Karma: 70
E	In (40)	
R	Gd (10)	Resources: Ty
I	In (40)	
P	Ex (20)	Popularity: -20

**KNOWN POWERS:** Gamora's natural abilities were raised to superhuman levels by Thanos so that she would be able to kill the Magus. She possessed no other super powers.

**TALENTS:** Martial Arts A, B, C, E; Weapon Specialist (dagger); Acrobatics; Tumbling; Stealth ( - 2 CS to opponent's Intuition checks); and, Spacecraft Pilot and Navigation.

**PERSONALITY:** Gamora feared nothing, but she did have the common sense to realize when a fight was out of her league.

She was calm, professional, and deadly to a fault. At the time of her death, she had begun to develop an attraction to Adam Warlock, a feeling that was mutual. If revived, she may continue to have these feelings — particularly since they've been together in the Soul-Gem for so long.

**CONTACTS:** Warlock and Pip are Gamora's only present friendly contacts. For several years she served the deceased Thanos of Titan, and beings who have knowledge of Thanos may know of Gamora by association.



**LIMITATIONS:** Gamora was created to kill the Magus. Thanos altered her moral perceptions so that she would have no qualms about slaying anyone who interfered with her mission. Her stay in the Soul-Gem has probably changed this. If so, she incurs normal Karma loss from killing. If not, she suffers no loss from directly killing a victim, but loses double the listed Karma penalty for noble deaths, mysterious deaths, and self-destructions that she allows to occur.



**BACKGROUND:** In what has become an alternate future timeline, Gamora was one of a peace-loving race that opposed the Magus and his Church of Universal Truth. The penalty for such opposition was annihilation, and the Xen Whoberis did not resist. Thanos saved Gamora from the holocaust and focused her newfound hatred of the Magus in intense physical and mental training. The purpose of the training was to make her able as well as willing to kill the Magus, Warlock's future self. To make her more able to carry out her task, the deranged Titan enhanced her natural abilities to superhuman levels.

Gamora fought alongside Thanos, Warlock, and Pip against the Magus. After the Magus was defeated, Gamora was ordered by Thanos to seek out and protect Adam Warlock because of his importance to Thanos's future plans. Before she could locate Adam, she herself was located by Drax the Destroyer™, a being who had been created to destroy Thanos. Drax attacked her on the basis of her association with Thanos. Gamora survived and returned to the starship *Sanctuary II* (*Sanctuary I* was destroyed in the battle with the Magus) to confront her master with new doubts that she felt about his purpose in seeking Warlock. She overheard him planning to build his star-destroying weapon using the power of the six Soul-Gems. Gamora attacked Thanos, hoping to end his madness with his life. She failed.

Warlock found the dying Gamora on a remote asteroid. With her last few breaths she told of her master's mad plan. Before she died, her spirit was absorbed by the Soul-Gem.

### The Warlock Revived

A few suggestions about the use of Adam Warlock in MARVEL SUPER HEROES™ game campaigns follow.

1. One of the major elements of the Warlock series was Adam's search for a purpose in life. If the campaign is to reflect the tone of the series, this element must be preserved. No matter how the Judge explains Warlock's return to life, he should have a good reason for it.

2. Do not carry the above statement to an extreme. A campaign in which some prophecy of cosmic gloom and doom dominates the player characters' every action is little or no fun to all involved. Pip is presented in this article for a reason — comic relief.

3. Be creative; there are a number of possible adventures for Warlock in the Marvel Universe. The Cult of Thanos still exists and could pose a threat to the galaxy. Warlock's "mate," Paragon™ (also known as Her™ — bet you'd never have guessed), is wandering the cosmos and would likely track Adam down if she learned of his return to life. Might she become a female version of the Magus? The possibilities are limitless! Use a few of them.



Copyright ©1987 Marvel Entertainment Group, Inc. All Rights Reserved. Marvel, Marvel Universe, and all Marvel characters and character likenesses are trademarks of Marvel Entertainment Group, Inc.

Of course, reviving Adam Warlock would entail retrieving both his body (on the missing Counter-Earth) and his soul (in the gem on Gardener's forehead) — and the Gardener's current whereabouts are unknown. . . .

[Editor's note: Those readers interested in adding Her (once known as Paragon™) to your campaign may use the statistics given below, adapted from the newly released accessory MA2, Avengers™ Coast-To-Coast, by Edward G. Sollers.]

## HER™

### Paragon™

Artificial being created by the Enclave™

F	Rm (30)	Health: 210
A	Rm (30)	
S	Mn (75)	Karma: 50
E	Mn (75)	
R	Gd (10)	Resources: Fb (2)
I	Gd (10)	
P	Rm (30)	Popularity: 0

### KNOWN POWERS:

*Warlock's Powers:* Paragon possesses the body armor, force bolt, flight, life support, and protective cocoon powers of Adam Warlock. In addition, she can utilize cosmic energy to rearrange the molecules within a small area (three cubic feet), though with sufficient power to do Amazing damage to anything within that vicinity. She can also project her cosmic life force in such a way as to reanimate dead beings, but this cannot restore a being's soul — the being is merely a zombielike construct. This latter talent succeeds with a Psyche FEAT on Her's part, and restores the Agility, Strength, and Endurance scores of the reanimated being to their former level. However, Fighting, Reason, Intuition, and Psyche are at Feeble levels.

**TALENTS:** Her has no known talents.

**CONTACTS:** Her has had few contacts with other super-beings and agencies, save for the Enclave (which she attacked). She is on good terms with the Thing, the High Evolutionary, and Starhawk™, however.

**BACKGROUND:** Her was the second (and last) artificial being created by the Enclave. Like her predecessor, she rebelled against the Enclave's control of her life and destroyed much of the Enclave's power. Retreating into a cocoon to consider her existence, she emerged on a search for Him — only to discover that Him had died as Adam Warlock. She attempted to resurrect his body but without success, as she lacked the Soul-Gem with his spirit. Afterwards, she went into space and was not heard from until recently, when she was seen to be heading back to Earth again.

# The Ultimate Addenda



*Fixing super-powers  
in the Advanced  
MARVEL SUPER HEROES® game*

by David Edward Martin

When I was finishing MA3, *The Ultimate Powers Book* (herein called the *UPB*), I had the vain idea that no addenda would ever be needed. The book would simply be the ultimate word on the subject of super-powers; any addenda would be pointless because everything would already be in the original book. That was the theory, anyway.

One week after the *UPB* hit the stores, that bubble burst. Karen, my wife and editor, told me she had gotten a call from a *UPB* reader (Matt from Washington, D.C., actually) who asked where the power of Elongation was. When she asked me, I said I thought we'd decided to incorporate it into Topological Change. Then she pointed out that Topological Change wasn't in the book, either. That night, as we sat watching "Alf," I compared my original draft with the published version — and discovered that I had forgotten not one or two powers, but NINE powers!

## Character types

Some of the Character Type listings do not include what columns of the Random Ranks Table (page 11) the players roll on to determine their heroes' abilities and powers. The types and their columns are shown in Table 1.

## Definitions of terms

I had forgotten to define some terms used extensively throughout the *UPB*. Definitions are given below.

**Bonus power:** This is a power that is automatically included as part of the package with certain other powers. The hero must take a stated bonus power and place it in one of his remaining power slots. If none are available, he must discard an already chosen power or the power to which the bonus power is attached.

**Optional power:** This is a power that is commonly associated with the already determined power. Players have the option of selecting one or more of these powers to fill their remaining power slots; this enables the player to tailor his hero's powers. Previously determined powers can be discarded in favor of the optional power.

**Nemesis:** This is a power that directly opposes or even defeats the power in question; think of it in terms of fire and water. The player cannot choose a nemesis! The nemeses are listed primarily for the Judge's benefit when choosing or creating suitable opponents for the heroes.

## New super-powers

Table 2 incorporates the accidentally omitted self-alteration powers. Use it instead of the one on page 16 of the *UPB*. Powers marked on the table with a number symbol (#) are new powers. Those marked with an asterisk (\*) count as two powers.

**S23/Bouncing Ball:** This is a specialized form of Shapeshifting. The



hero can transform his body into a resilient sphere, apparently transforming his body into a balloon-like caricature of himself. Heroes with this power are rarely taken seriously, but – despite the image problem – this power offers substantial benefits to the hero. While he is inflated, the bouncer can travel at power rank speed. His Fighting rank is increased by this power's rank number. He has +3CS resistance to blunt physical attacks. On the down side, he also has a -2CS resistance to slashing attacks. In a given situation, the bouncer can maintain this power for the number of turns up to his power rank number before he has to deflate and rest. After 10 turns, he can then reinflate himself.

**S24/Elongation:** This is a specialized form of Shapeshifting. The hero can temporarily increase the length of any part of his body without losing leverage or strength. The hero can elongate any single part a maximum number of yards equal to his power rank number. If two or more parts are elongated, this limit is the total combined length for all parts concerned. The hand counts as part of the arm unless the hero is specifically elongating his fingers; in this case, the maximum is divided by the number of fingers elongated. For example, Mr. Fantastic is usually shown elongating an arm with a normal hand at the end of it; this gives him a greater reach than if he elongated his hand instead. The hero can maintain any single act of Elongation for a number of turns up to his power rank number.

This power is primarily used by heroes like Mr. Fantastic to extend their reach or stride. Other heroes might also use the power to elongate body parts like the nose, ears, or eyes. This useful, albeit grotesque, tactic enables the hero to use his nose as a snorkel, his eyes as periscopes, and to eavesdrop on a room several floors away by sending his ear through the ceiling vent.

The optional power is Plasticity.

**S25/Growth:** This is a self-directed form of MC6/Enlargement. The hero can temporarily increase his physical size at will. As he grows, the hero becomes an easier target. The bonuses to be hit, given in Table 3, are not cumulative.

There are three ways the power can be attained: Atomic Dispersal, Atomic Gain, and Atomic Growth. The player randomly determines the method when he creates the character or when the character first gains this power, using the subtable below.

Die roll	Form
01-25	Atomic Dispersal
26-75	Atomic Gain
76-00	Atomic Growth

With Atomic Dispersal, the hero increases the distance between his own atoms, thus increasing his overall size. His mass remains the same no matter how large he becomes. The hero also becomes

increasingly fragile; his body's material strength decreases - 1CS with each doubling in size. At Shift X rank, the body becomes less dense than air. At CL1000 rank, the hero becomes intangible and can Phase through normal matter.

Atomic Gain enables the hero to somehow create or gain new atoms and incorporate them into his atomic structure. As the hero gains new matter, his size and mass increase as well. As the hero grows, his strength increases + 1CS for each +2CS of growth. The hero's Primary and Secondary abilities are unaffected. However, Health seems to increase because physical attacks do less relative damage. Bullets, for example, would be nothing more than grains of high-velocity sand to a giant hero. Note that when the hero returns to his original size, wounds decrease in size – but imbedded bullets and other objects do not!

Atomic Growth enables the hero to increase the size of his own atoms, thus increasing his overall size and mass. The hero's strength increases only enough to enable him to move his own body; lifting strength does not increase. This form of Growth has a dangerous side effect. As the hero's atoms grow, they are unable to interact with normal atoms. The hero is unable to breathe, drink, or eat normal matter. Fortunately, there is a 95% chance (determined at the time the hero is created) that the power envelops the hero's body in a field that temporarily increases the size of consumed matter. Note that this is the only form of growth that will enable the hero to travel into macroverses or, if the hero is originally from a microverse, enable the hero to reach our own universe.

The nemesis is MC4/Diminution; the specific nemeses for each form are, in order: Atomic Collapse, Atomic Reduction, and Atomic Shrinkage (see Shrinking).

**S26/Mass Decrease:** The hero can diminish his body's mass. His weight decreases to a percentage equal to his power rank number. For example, the Vision's Unearthly rank in this power decreases his weight by 100%, making him completely weightless. At Shift X and higher, the hero attains buoyancy and can lift additional weight. The added weight is a percentage of his normal body weight; for example, a 160-lb. man with Shift Z rank in this power can carry an additional 800 pounds (500% of 160 lbs.). When the hero is created, the player can increase the power's rank + 1CS by making its effect permanent.

The optional power is Gravity Manipulation.

**S27/Mass Increase:** The hero can increase his body's mass. His weight is multiplied by the power rank number. For example, a 98-pound weakling with Remarkable rank can increase his mass to 2,940 pounds (30 x 98). Fortunately, a side effect of this power increases the hero's basic strength. No matter how much the

hero weighs, he can still move as if he were his normal weight. Lifting strength remains the same. Of course, as the hero weighs more, he has a greater effect on the environment. At 2,940 pounds, our hero can fall through previously sound flooring or collapse the shocks on his 1973 VW Beetle. Physical force has a decreased effect on the hero because of his greater mass. In game terms, the power gives the hero power rank resistance to physical attacks. The hero can also use the power rank instead of his strength to inflict charging damage. Formerly weak characters can embarrass their adversaries with this new-found might. For example, the macho super-criminal Manbrute may flee into obscurity when Wimp-man simply sits on him with all 2,940 pounds, then delivers a stinging lecture on the benefits of niceness while the camera crews have a field day.

**S28/Phasing:** The hero can render his body intangible to normal matter. This enables him to pass harmlessly through any object. The hero's power rank must exceed the barrier's material strength in order for Phasing to occur. The hero can Phase through Force Fields, Body Armors, Resistances, and Invulnerabilities of lower ranks by making a green FEAT

Because the hero is out of phase with normal matter, he cannot breathe. Thus, the practical duration limit on this power is the length of time the hero can hold his breath. If the hero has some way around this problem, the duration is unlimited. Note that if the power is somehow "turned on" permanently, as happened to Kitty Pryde, the power gains the ability to transform air into phased particles that the hero can breathe.

In the Marvel Universe, Phasing has a damaging effect on delicate electronic devices. By Phasing through such devices, the hero can disrupt normal activity and scramble any on-line programming. If, during the character creation process, the player decides to forego this side effect, he can raise his hero's power rank + 1CS.

For modesty's sake, it is assumed that the power also transforms the hero's clothing and carried possessions into phased matter. The power's side effect automatically scrambles any electronics the hero is carrying (Kitty Pryde wears a wind-up watch, never a digital one). If the player wants to risk his hero's modesty for the sake of a more realistic game, the player can assume either that the power only transforms whatever the hero was wearing when he first got this power (severely limiting the hero's wardrobe) or that there is a base 70% chance that the power automatically transforms whatever the hero is wearing at the time. In either case, this must be determined when the hero is first created.

**S29/Plasticity:** The hero can change his body's topology; that is, he can twist, bend, pull, stretch or otherwise distort his body's shape into any form. The only

limitation is that the hero cannot normally create new holes in his body. For example, Mr. Fantastic can form himself into a parachute but not a sieve. If the hero wants to assume a shape that *requires* holes, he must make a red FEAT. For example, a higher-ranked hero could regularly transform himself into nets and ladders.

The hero's malleable flesh gives him power rank resistance to blunt Physical attacks. The hero is able to survive

**Table 1**  
**Character Types and Columns**

Modified Human	1
Modified Human: Extra Parts	2
Centaurs	5
Equimen	3
Fauns	2
Felinoids	1
Lupinoids	4
Avians (Angelics)	3
Avians (Harpies)	2
Chiropterans	2
Lamians	3
Merhumans	2
Angels/Demons	5
Deities	5

**Table 2**  
**Self-Alteration Powers Table**

Die roll	Self-alteration power	Code
01-02	Age-Shift	S1
03-09	Alter Ego	S2
10	Anatomical Separation	S3
11-13	Animal Transformation	S4
14-19	Animal Mimicry	S5
20-21	Blending	S6
21-27	Body Adaptation*	S7
28-30	Body Transformation*	S8
31-33	Body Coating	S9
34-37	Chemical Mimicry	S10
38	Energy Body*	S11
39-42	Energy Sheath	S12
43-44	Evolution	S13
45-49	Imitation	S14
50-55	Invisibility	S15
56-57	Physical Gestalt	S16
58-60	Plant Mimicry	S17
61	Prehensile Hair	S18
62	Self-Duplication *	S19
63	Self-Vegetation	S20
64-67	Shapeshifting	S21
68-70	Spirit Gestalt	S22
71	Bouncing Ball#	S23
72-74	Elongation#	S24
75-78	Growth#	S25
79-81	Mass Decrease#	S26
82-84	Mass Increase#	S27
85-90	Phasing#	S28
91-94	Plasticity#	S29
95-99	Shrinking#	S30
00	Two-dimensionality#	S31

without harm a fall from the number of floors equal to his power rank number by turning into a bouncing shape before he hits the ground.

The hero gains the bonus power of Elongation. Bouncing Ball is an optional power or may be simulated by a power Stunt.

**S30/Shrinking:** This is a personal form of MC4/Diminution. The hero can temporarily decrease his body's size. The hero's primary and secondary abilities remain unaffected. Even Strength is undiminished, although it is much harder for a shrunken hero to gain enough leverage to perform tasks that would otherwise be simple to perform. For example, consider the act of sharpening a pencil if you are only ladybug-size.

As the hero shrinks, he becomes harder to hit but conversely suffers greater

**Table 3**  
**To-Hit Bonuses Against Growth-Using Characters**

Rank	Resultant size	Bonus to be hit
FE	1.5x	+1CS
PR	2x	+1CS
TY	3x	+1CS
GD	4x	+1CS
EX	6x	+1CS
RM	8x	+2CS
IN	10x	+2CS
AM	12x	+2CS
MN	15x	+3CS
UN	200x	+3CS
X	50x	+3CS
Y	100x	+3CS
Z	200x	+3CS
CL1000	500x	+4CS
CL3000	1000x	+5CS
CL5000	10,000x	+6CS

**Table 4**  
**Attack Modifiers Against Shrinking Characters**

	Resultant size	Column shift
FE	50%	0
PR	25%	0
TY	12.5%	0
GD	6.25%	1
EX	3%	1
RE	1%	2
IN	.5%	2
AM	.25%	2
MN	.1%	3
UN	.01%	3
X	.001%	
Y	.00001%	5
Z	.0000001%	6
CL1000	10 <sup>-12</sup>	8
CL3000	10 <sup>-18</sup>	10
CL5000	10 <sup>-33</sup>	12

damage if struck. This is handled by the column shift as shown in Table 4. The column shift decreases the attacker's chance to hit and increases the damage by an equal shift. For example, a hero with Remarkable rank is -2CS to hit but suffers +2CS damage if the attack is successful.

In practical terms, a Shrinking rank of Shift X, Y, or Z is sufficient to reduce a normal human to the size of a single cell or virus. Either CL1000 or CL3000 will reduce him to atomic scale. CL5000 reduces him to the point a which he can enter microverse worlds. On such worlds, the hero is proportional to his new environment.

There are three forms of this power. When the power or the hero is first created, the player must determine which form is involved, using the following subtable.

**Die roll Form**

01-20	Atomic Collapse
21-40	Atomic Reduction
41-00	Atomic Shrinkage

Atomic Collapse decreases the distance between the body's atoms and subatomic particles, thus decreasing overall size. Mass and strength are unaffected. As density increases, the hero's body could collapse into neutronium (CL3000) or into a black hole (CL5000).

Atomic Reduction decreases the number of atoms in the hero's body. The lost atoms are either disintegrated (if the shrinkage is permanent) or temporarily removed from the hero's plane of existence and stored "elsewhere" until the hero reverts to his original size. Both mass and strength decrease as the hero shrinks; these ranks remain proportional to the hero's new size. If the hero loses too many atoms (by exceeding Shift X rank), his remaining structure becomes too simple to sustain his life force. For this reason, a hero with this form cannot voluntarily exceed Unearthly rank. If the limit is passed, the hero's life force is automatically stored away on the same plane with all the displaced matter that normally forms his body. At Shift Z rank, the hero's body consists of a single DNA molecule, which then vanishes when the next rank is reached.

Atomic Shrinkage reduces the size of the hero's atoms, thus reducing overall size and mass. Strength remains proportional to the hero's current size. This is the only form that enables the hero to reach a microverse. While this is the most popular form of Shrinking, it has a potentially deadly disadvantage. As the hero's atoms shrink, they can no longer interact with other, normal-size atoms. As a result, the hero cannot breathe, drink, or eat normal-size matter. Fortunately, there is a flat 95% chance (determined at the time this power is first gained) that the power envelops the hero with an aura that

temporarily reduces all atoms to be consumed. If the hero lacks this aura, he must have a proportionally sized supply of material for consumption or somehow not need to breathe. If not, the duration for this power is equal to the time the hero can hold his breath. There is an advantage to not possessing this aura in that electrons cannot flow from normal to shrunken matter; hence, the power acts as rank-level Resistance to Electricity.

The optional power is MC4/Diminution. The nemesis is MC6/Enlargement; the specific forms are, in order, Atomic Dispersal, Atomic Gain, and Atomic Growth (see Enlargement).

**S31/Two-Dimensionality:** The hero can harmlessly reduce his body (and any nonliving matter he carries) to a flat, two-dimensional version. To an onlooker, the hero appears to have transformed himself into a life-size photograph. The hero's body functions and abilities are unaffected. Because the hero is now extremely thin, gaining leverage on three-dimensional objects is extremely difficult. He is also extremely hard to hit if he can turn his flat side toward his opponents. While in a flattened state, the hero suffers less damage from blunt physical attacks; the power rank number decreases the damage by that much for each attack. On the other hand, a flat hero can suffer all sorts of abuse that he would

normally ignore. For example, Flatman could be forcibly folded like a map and locked in a glove compartment!

How thin the hero can get is determined by an Intensity FEAT. A green FEAT reduces the hero to the width of a piece of paper (about 1/256"). At this point, the hero can pass through the cracks around a door or adhere to a wall and pretend to be a poster. A yellow FEAT reduces the hero to one atom's width. At this width, the hero can pass through solid barriers by slicing through them as if he were an incredibly fine knife. The power enables the hero to pass any barrier with a Material Strength up to +5CS greater than this power's rank. Note that if the barrier is larger than the hero's body (such as a wall), then the slice made by the hero's passage immediately reseals itself. But, if the barrier was smaller than the hero (such as a chain), then the pieces fall apart as soon as the hero severs the entire width. A red FEAT removes the third dimension entirely; at this point, the hero can pass through barriers without damaging them, or he can be transported into a *Flatland*-type dimension where everyone has only two dimensions. In the latter case, the hero vanishes from sight.

The hero can choose to flatten himself in any direction. He can appear to be a front-back, left profile-right profile, top view-bottom view, or similar-shaped

two-dimensional image. Note that while one dimension is drastically altered, the remaining measurements remain the same.

When this power is applied to a weapon, the result is a micron-sword such as the one used by the late Nemesis. Such a blade completely severs any matter with a Material Strength up to +5CS greater than this power's rank.

The name "Two-Dimensionality" is a misnomer. While in the Marvel Universe it most commonly describes the ability of normal beings to pass into a *Flatland*-like state, it can also be used to shed more than one dimension. Three-dimensional beings can reduce themselves all the way down to a single line one atom or even one "point" in diameter. The power can also be used by multidimensional beings to enter into this one.

Those are the missing powers. Make of them what you will. As I mentioned in the *UPB*, if anyone can come up with a power I missed, then tell me! Give me a basic description of the power and, if possible, a super-character who uses that power; don't worry about the mechanics, since I'll take care of that part. Use any source, whether comics, literary, or media, in your search for the undiscovered powers. If I get enough of these, I'll include them in later "Ultimate Addenda" columns.

# WELCOME TO ADVENTURE

in the the Faerie Mound of Dragonkind. May you find in this mystical place of faeries and dragons the kind of solo role-playing adventure you seek.

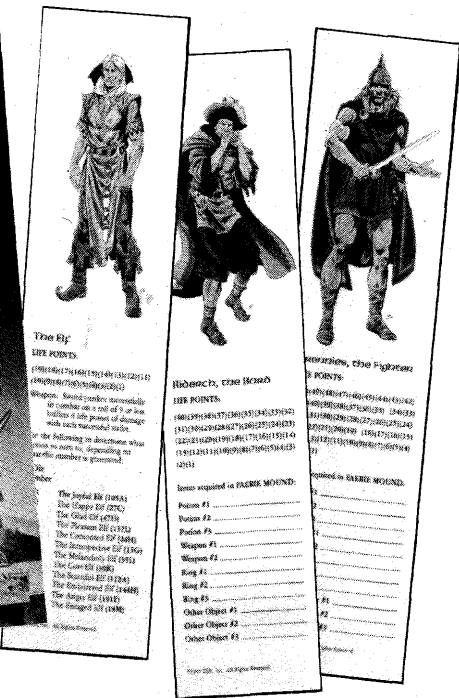
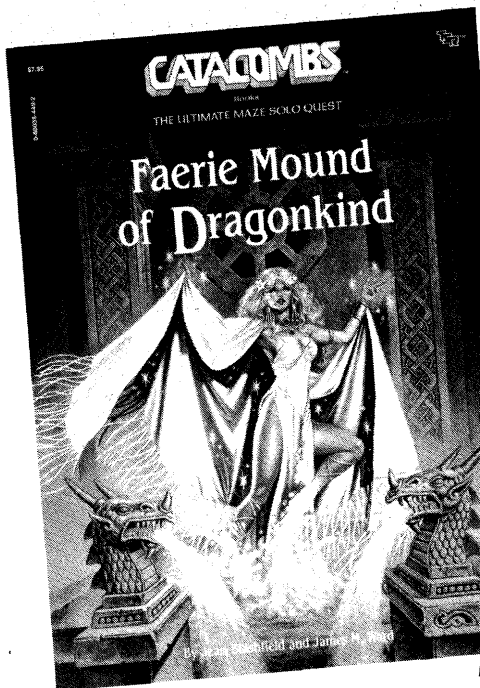
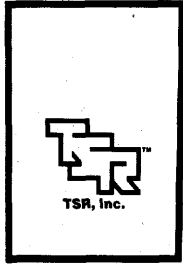

Expect to see numerous exciting full- and double-page illustrations, an intricate maze filled with magical challenges, the chance to choose between being a powerful fighter or a skilled bard, a mischievous elf whose unexpected visits can change your adventure in an instant, and a built-in system of random number generation and combat.



CATACOMBS and the TSR logo are trademarks owned by TSR, Inc. ©1987 TSR, Inc. All Rights Reserved.

# A Marvel® Monster-Phile

*A Halloween treat or three from the  
Marvel Universe®*

---

**by Douglas Lent**

---

*As a bonus for all Marvel-fans, we present three well-known faces from both legend and comics appropriate to a Halloween encounter. One warning,*

*however: Just because something looks like a monster doesn't mean that it's evil. . . .*



**FRANKENSTEIN'S  
MONSTER™**

## **FRANKENSTEIN'S MONSTER™**

**No name**

**Fugitive artificial being**

F	RM (30)	Health: 120
A	GD (10)	
S	RM (30)	Karma: 30
E	AM (50)	
R	GD (10)	Resources: None
I	GD (10)	
P	GD (10)	Popularity: 0

### **KNOWN POWERS:**

*Body Armor:* The monster has a thick skin that serves as Good body armor against physical attacks. Also, due to his unusual physical resilience, all physical combat effects against him are reduced by one color. Thus, Green results become White, Yellow becomes Green, and Red becomes

Yellow. He is therefore immune to "Kill" results from knives or bullets, and to results in a slugfest.

*Rapid Healing:* The monster can heal from wounds at a much faster rate than ordinary humans. He can regain his Endurance rank in Health points once every hour instead of only once a day.

*Suspended Animation:* Whenever the monster is subjected to cold of at least Remarkable intensity, he enters a state of suspended animation until he is revived, taking no damage from the chill. An Endurance FEAT is required to avoid this event.

**THE MONSTER'S STORY:** Baron Victor Frankenstein was a brilliant Swiss biology and chemistry student in the late 18th

century. Victor experimented with the reanimation of dead tissue as a key to immortality and succeeded in assembling a large humanoid using parts from several fresh corpses. Frankenstein also found a way to overcome deterioration and tissue rejection of organs from different bodies, making this work possible. Then, using a special process of his own invention, Frankenstein brought his creation to life. However, the sight of the monster terrified him so much that he abandoned the creature, hoping his creation would perish when left unprotected.

However, although the monster was as ignorant as an infant, he was also highly intelligent and quickly learned how to survive by secretly observing humans. Within a few months, the monster could speak and function as well as any normal human. He then began plotting his



## LIVING MUMMY™



WEREWOLF™

Marvel, Marvel Universe, Marvel Super Heroes, and all Marvel character names and likenesses are trademarks of Marvel Entertainment Group, Inc. ©1987 Marvel Entertainment Group, Inc. All Rights Reserved.

revenge on his creator for deserting him. The monster killed Victor's brother William, then struck a deal with Victor by promising to leave the baron's life forever if Victor would create a mate for the monster. Victor went back on the deal, destroying the female monster, and the monster killed his creator's best friend and wife, then fled into the Arctic. Frankenstein gave chase but died of exposure shortly after relating his tale to sea captain Robert Walton. Meanwhile, the creature lay in hibernation after being trapped in the ice, filled with regret for his deeds. Writer Mary Shelley published Walton's account of Frankenstein's story but the public considers it a work of fiction.

In 1898, Walton's great-grandson found the monster, who had since thawed out of his icy prison. The creature soon had a clash with Dracula, during which his vocal

chords were injured, rendering him mute. He was then again entombed in ice and was revived again only recently. Veronica Frankenstein, a descendent of the baron, operated on the monster's larynx, and he can again speak, though with some difficulty. The creature most recently clashed

with the Thing and Iron Man, and current whereabouts or activities are unknown. It should be noted that the creature is often wrongly referred to as "Frankenstein," though this is really the name of its creator.

### LIVING MUMMY™

**N'Kantu**

**Altered and immortal human**

F	EX (20)	Health: 129
A	PR (4)	
S	RM (30)	Karma: 22
E	MN (75)	
R	TY (6)	Resources: None
I	TY (6)	
P	GD (10)	Popularity: 0

### KNOWN POWERS:

*Body Armor:* The process that made N'Kantu a mummy also gave him super-tough skin that acts as Remarkable body armor.

*Environmental Independence:* Sustained completely by the life-preserving fluid in his veins, the Living Mummy no longer needs to eat, drink, breathe, or sleep. He

could easily survive in many places where an ordinary human would be killed instantly, He no longer ages.

**LIMITATIONS:** Because of N'Kantu's dependence on the special fluid that substitutes for his blood, any damage he takes from heat or fire gains a +1CS due to the effects of dehydration on the fluid. It is not yet known if N'Kantu could be killed by such attacks or would simply remain unconscious until the fluid had regenerated itself. N'Kantu can speak only with great difficulty since his throat is completely dry.

**THE LIVING MUMMY'S STORY:** N'Kantu was a chieftain of the Swarili tribe of

North Africa over three thousand years ago, when they were enslaved by the Egyptians: Bound in chains, N'Kantu and his people were forced to build a temple for the reigning pharaoh, Aram-Set. N'Kantu obeyed his captors, all the while plotting rebellion against them. When word of his plans reached Aram-Set and the high priest, Nephrus, they decided to have the slaves killed upon the temple's completion.

But N'Kantu and his followers struck before then and were able to slay the pharaoh himself before being subdued. To punish N'Kantu for his crime, Nephrus drained the Swarili chieftain's blood and replaced it with a special preservative fluid. He was then bound head to toe in bandages and entombed in a sarcophagus

beneath the sand, still conscious but completely immobile.

There N'Kantu remained until recent years when the paralysis effect wore off and he could at last move. Unfortunately, the three millenia he spent confined beneath the desert rendered him totally insane. Digging free of his tomb, N'Kantu went on a rampage which finally ended in the streets of Cairo. N'Kantu grabbed a telephone pole to use as a weapon and was electrocuted by a dangling power line. This left him in a comalike state for several weeks; upon awakening, his sanity had returned. Immortal, N'Kantu now wanders across Egypt and North Africa, seeking some purpose to his life.

## WEREWOLF™

Jack Russell  
Altered human

F	RM(30)	Health: 120
A	EX(20)	
S	RM(30)	Karma: 91
E	IN(40)	
R	TY(6)	Resources: EX
I	MN(75)	
P	GD(10)	Popularity: 20

### KNOWN POWERS:

**Claws:** Werewolf has razor-sharp claws and teeth and can inflict up to Remarkable edged-attack damage with them.

**Infravision:** Werewolf's sight extends into the infrared, allowing him to see in the dark by detecting heat emissions.

**Extraordinary Senses:** Werewolf's senses of sight, hearing, and smell are all Amazing. He can detect sensations far beyond the normal human range by making an Intuition FEAT roll. He can track by smell and remember scents previously encountered. He can hear a heartbeat at a one-area range and smell an approaching being within a three-area range.

**Running:** Werewolf can move at a rate of two areas per round for up to half an hour a day.

**Invulnerability:** As a supernatural creature, Werewolf has Amazing resistance to all forms of physical damage except that caused by silver weapons. Werewolf, if injured, cannot have his Endurance reduced below Feeble except by silver weapons.

**LIMITATIONS:** As mentioned above, silver weapons are the only ones unaffected by Werewolf's invulnerability and are one of the few things that can kill him. Each hit by a silver weapon causes all of Werewolf's physical abilities to make a -1CS. A Red or Yellow result from a silver edged or missile weapon is treated as a "kill"

Additionally, although Russell has gained the ability to change into Werewolf at will while still retaining his full intellect, the original curse over him is still in effect. On the three nights of the full moon, Russell automatically changes but has his Reason reduced to Feeble; his nature also becomes that of a savage beast.

Except for the curse, all the powers listed above are only for Russell's Werewolf form. When human, his stats are as given below:

F	A	S	E
TY	TY	TY	GD
	R	I	P
	TY	GD	GD
Health: 28		Karma: 26	
Resources: EX		Popularity: 6	

**WEREWOLF'S STORY:** Jack Russell was born Jacob Russoff, son of Transylvanian nobleman Gregory Russoff and his American wife, Laura. A scholar interested in the occult, Gregory was unaware of a dormant family curse from an ancestor who had been bitten by a werewolf. This would have mattered little had he not acquired a copy of the *Darkhold*, an arcane tome of evil magics created by the demon Chthon. Among the various fragments of occult lore contained within the book's covers was a detailed account of the origin of lycanthropy. Reading this section triggered Russoff's latent curse, and with the next full moon he was transformed into a werewolf. For several months afterward he terrorized the local countryside during the three nights of the full moon until he was killed by an angry mob of townsfolk.

Shortly before his death, Russoff sent his wife and their two young children to her native America for their own safety. When she learned of Gregory's death, Laura Russoff moved to Los Angeles and later married Philip Russell to give her children a father. Jacob (now Jack) Russell and his sister, Lissa, did well until Jack reached his eighteenth birthday and inherited his family's now-active curse. For the next two

years, Russell rampaged throughout the Los Angeles area on the nights of the full moon whenever his efforts to confine himself failed. Then the mystical extradimensional beings known only as "The Three Who Are All" gave him the power to control his changes while keeping his human intelligence. However, he still regressed when the full moon shone. Russell has since built a virtually escape-proof cell to isolate himself during such times.

Russell recently sought scientific help for his problem. Unfortunately, he turned to an unscrupulous scientist (Doctor Karl Malus) who tried to make him a mindless slave instead. Although Russell was able to thwart these plans, the treatments he received caused him to lose control of his changes once more, and his wereform became even more lupine in appearance. He has since recovered and is now an occasional crimefighter, sometimes even meeting and working with heroes like Iron Man and the original Spider-Woman. At present, Werewolf is a member of Night Shift, a team of super-powered villains and outcasts led by Shroud (see DRAGON® issue #93 for his statistics). Ω

## Guidelines

If you're interested in contributing an article to DRAGON® Magazine, the first thing you need is a copy of our guidelines for writers. Send a self-addressed, stamped envelope to "Writer's guidelines," c/o DRAGON Magazine, P.O. Box 110, Lake Geneva WI 53147; and we'll send you back a sheet with all the basic information you need to make sure your manuscript has the best possible chance of being accepted.







# The Ultimate Addenda's Addenda

## Yet more superpowers for the MARVEL SUPER HEROES® game

As promised in the last "Ultimate Addenda" (from DRAGON® issue #122), here are more superpowers that were created by you, the role-playing public, for the MARVEL SUPER HEROES® Advanced Set game. These powers are designed to fit with the format of MA3 *The Ultimate Powers Book* (herein known as the *TUPB*). Each new power is credited to the people who suggested it. This column also deals with a new class of "rule powers," which are powers that alter the game mechanics. Players and Judges should rewrite the Power Generation tables on pages 14-16 of the *TUPB* in order to accommodate these additions, if they are used.

### New Physical Form

**S32/Collective Mass:** Tom Lamphier looked at the Marvel Super Villain Swarm and came up with this variation of the S16/Physical Gestalt body type. The body of the character is a collection of individual bodies held tightly together and functioning as a single unit. Unlike Physical Gestalt, the individuals retain their distinct physical forms (though admittedly it may be hard to actually spot any given individual if they are tiny). One helpful side effect of this power is that the individual bodies do not physically suffer while they are joined together; breathing is assumed to occur without difficulty. However, the Collective Mass will probably have to break apart in order to allow the individual units to eat.

Primary and secondary abilities are rolled on Column 1 of the Rank Table on page 11 of the *TUPB*. Because of its peculiar dual nature, a Collective Mass has two sets of primary abilities. The first set represents the average abilities possessed by the individual component entities; the second set is that of the Collective Mass. The majority of powers can only be mani-

festated by the Collective Mass. Individual entities can at best exhibit Feeble-rank versions of the available powers; otherwise, why bother to be a Collective Mass in the first place?. The Collective Mass's abilities may be affected by the loss or addition of more individual entities to its form.

A Collective Mass gains +2CS Resistance to physical or directed energy attacks (lasers, for example). Its unique physical structure allows it to simply create holes in its body to avoid making contact with the attacking force. However, such beings have a peculiar weakness: A successful Grappling attack breaks the body into two masses! The body can automatically rejoin in 1-4 turns unless something prevents this, like teleporting half the body into a parallel dimension.

The Collective Mass can be any size, depending on the size and number of the individuals entities that compose it. Most Collective Masses in Marvel Universe campaigns are human-size and composed of smaller creatures generally less than 3" long (between the size of a mouse and a dragonfly). If the Judge allows, a Collective Mass may be a giant composed of human-size entities. In special cases, the Collective Mass may even be a titan composed of relatively large beings.

Ordinarily, the number of individuals composing the Collective Mass is less than the rank number of the Collective Mass's Reason, multiplied by 100. The individual entities can be of any nature, whether animal, plant, or machine; the individual components may be sentient or not. If the Collective Mass is composed of relatively ordinary creatures (as opposed to something strange, like a colony of snakes mutated by a nuclear test at Los Alamos), the Collective Mass has the option of

absorbing more of these component creatures into itself. A Red Psyche FEAT allows this to occur. In such a case, the addition may have the effect of increasing the Collective Mass's primary abilities.

In an Earth-based Marvel Universe campaign, the Collective Mass has the ability to transform itself into a human likeness by making a Psyche FEAT. However, the visual appearance of the individual bodies does not change; a disguise is needed if the Collective Mass is to impersonate a normal human.

### New superpowers

Each of these superpowers has a 2% chance of appearing during the random power-selection process.

**P18/Hyper-Intake/Expulsion:** This power was in my original *TUPB* proposal, yet not only did I forget to put this in the *TUPB*, I also forgot to put in in the original addenda article! This power is usually referred to as "Super Breath" and, while it is technically a Matter Control power, should be listed under the class of Physical Enhancement powers in the *TUPB*. The hero has the ability to ingest awesome amounts of matter, retain them indefinitely, then expel them with power rank force. When creating a hero with this power, the player must decide what the hero can handle. A random die roll determines his chance of having the power to handle gas, liquid, solids, or some combination of these.

### Die roll Category

- 01-16 Gases only
- 17-32 Liquids only
- 33-48 Solids only
- 49-64 Gases and liquids
- 65-80 Liquids and solids
- 81-00 Gases, solids, and liquids

This power enables the hero to absorb quantities far exceeding the normal volume of the human body. He can absorb a volume of gas equal to the power rank number times 100 cubic feet. Liquids and solids are limited to the number of cubic feet equal to the power rank number. A side effect of this power is that the ingested matter is somehow compressed, diminished in size, or displaced into a pocket dimension; this enables the hero to retain his ordinary shape, although his weight does increase a token amount. It is up to the Judge's discretion as to how much weight is gained, with a 1% weight increase being a rule of thumb. Note that a sudden failure of this power can be disastrous! Such catastrophes range from (at best) the sudden expulsion of all ingested matter, retention of the ingested matter with the hero suddenly bearing all of its weight, or the rapid expansion of the ingested matter to its original size (this latter possibility being quite fatal).

Normally, a hero can retain the ingested matter indefinitely. A side effect of the power gives the hero internal invulnerabil-



---

## Table for Random Rule Powers

### Die Power

01-12 Attribute Change	R1
13-29 Attribute Pool	R2
30-41 Attribute Rearrangement	R3
42-47 Award Change	R4
48-59 Award Pool	R5
60-65 Award Rearrangement	R6
66-71 Initiative Change	R7
72-00 Power Combination	R8

ity equal to his power rank, preventing major internal damage due to ingested poisons or physically damaging materials. Solids and liquids can be retained for as long as the hero can go without food; digestion normally stops while this power is in effect. If the gases ingested are toxic, the hero can only retain them for the amount of time he can hold his breath. If the mixture is not toxic and contains a sufficient quantity of oxygen, then the hero can hold his breath indefinitely.

The hero can expel the matter harmlessly or direct it into a blast that has power rank range and damage. He can also do damage by ingesting. For example, by inhaling all the air in a room, he can cause certain events to occur. One, everyone in the room must make an Endurance FEAT or pass out from the sudden absence of air. Two, the room can implode if the pressure difference exceeds the walls' material strength.

**P19/Hyper-Endurance:** A number of readers pointed out that I referred to this in the *TUIPB* as a power rather than as a primary ability. Sorry! Hyper-Endurance is designed to increase your hero's (hopefully) already formidable Endurance. The randomly determined rank is added to your PC's previously determined Endurance rank whenever he uses a power that drains his Endurance. In this way, heroes can exceed their physical limitations. Hyper-Endurance is an optional power for such things as Hyper-Running, Hyper-Swimming, and other powers requiring muscular effort.

**P20/Hyper-Strength:** I kept referring to this as a power, too, so here it is. Hyper-Strength is an addition to your hero's previously determined Strength rank. The player has two choices here: He can permanently combine the two ranks, or else make the addition a temporary one. In the latter case, the hero can "Hulk out" and manifest great strength during a limited time. The daily limit on this form of Hyper-Strength is a number of game turns equal to the power rank number. Also, the temporary form carries with it a bonus of +1CS rank.

**MG14/Probability Control:** I had intended this to be a variation of MG10/Reality Alteration (Alter Future). However, enough people have this power to justify its status as an independent power. Unlike the Alter Future power, this power func-

tions at a more limited range; the power takes effect the same turn it is used. The original Marvel heroine with this power, Scarlet Witch, could only create entropic effects. Other superhumans such as Roulette developed the ability to produce beneficial effects as well.

There are three ways the hero can use the power to affect his immediate future. The first way pits his power against the Psyche of the target. In this effect, the hero makes the target act in the way the hero intends. The second method pits this power's power rank against the material strength of the target. In this case, the hero can temporarily control the physical properties of the target. In the third case, the hero pits his power against the intensity rank of a target phenomenon (energy fields, magic, powers, etc.). In all three cases, the range is limited to the hero's immediate area.

**T24/Spinner:** George O'Ravis looked to the Whirlwind to come up with this peculiar Travel power. The hero can attain power rank ground speed by rapidly pivoting. The visual effect is that he blurs into a human top. The hero gains several useful side effects. This power's rank is added to the Fighting rank when a grappling attack is used against the Spinner. He gains power rank resistance to physical attacks. His Endurance rank increases by this power's rank number; this enables him to maintain his power for extended periods as well as avoid the obvious dizziness and nausea. The hero's visual acuity increases to give him the equivalent of Circular Vision; despite his rapid rotation, the hero perceives the world as a static, 360-degree field of vision. However, unless the player states otherwise, it is assumed that he is only looking directly outward. Thus, he can be surprised by attacks from below or above. If the hero has such powers as increased Strength (Incredible rank or better), Invulnerability, or Hyper-Digging, he can bore his way through any target with a Material Strength less than this power's rank. As a power stunt, the hero can develop his power to attain flight. This is treated as T23/Whirlwind flight of one rank lower than the Spinner's power rank.

**F6/Unique Weapon:** Edward and Adam Nevraumont brought up this variant from the Fighting Powers class. The hero possesses a specific tool or device that contains many of the powers assigned to the hero. When creating the hero, the player should assign only the Mental and Physical Powers to the hero himself; all other powers should be assigned to the Unique Weapon. Such assigned powers then can only be manifested by the weapon itself or by the hero's direct contact with the device. The player should work with the Judge to determine the shape and nature of the item, as well as who gets what power.

The nature and function of each Unique Weapon should reflect the powers availa-

ble, the player's imagination, the hero's background and physical type, and the campaign setting. The randomly rolled power rank becomes the material strength of the item.

A Unique Weapon is just that; lose it and you're out of luck. The hero can acquire his item in a number of ways. The most common are "I Found It," "I Received It," and "I Created It." The player should roll once on the Origin of Power Table (page 10, *TUIPB*) to see what the background on his item is. If the device was attained by accident or as a gift, the hero might not be able to replace or repair it. Such conditions must be resolved by the Judge.

**M34/Omni-Knowledge:** A reader named "Comalite J" created this interesting variant on the learning process. A character with this power has an innate, subconscious link to a sort of cosmic reference library. When he is presented with a question concerning information of which he was previously ignorant, the PC must make a FEAT. Green FEATs give him access to contemporary human knowledge. Yellow FEATs give him access to alien knowledge. Red FEATs give him access to Entity-level knowledge. Success means he is able to give a short, concise answer that only answers the initial question. As a limit to this power, the question must be asked of the hero by another person. Also, despite his ability to "know" any given topic, the PC might not be able to understand it. His comprehension is still limited by his Reason. This power enables the Judge to create idiot savants who can decipher the workings of Galactus's Worldship but are unable to tie their shoelaces,

For example: Ref-Book and his buddy Jaunt find themselves in the Watcher's recreation room, facing a piece of alien technology. Ref-Book has no idea of what the thing is, but when Jaunt asks the magic question "What is that?" Ref-Book's power goes to work. He makes a Red FEAT, gains the necessary knowledge, and says "It's a television set." "Well, how do we turn it on?" asks Jaunt. Ref-Book fails his next FEAT and says, "Beats me."

### Rule powers

Several powers in current RPGs exist only for the sake of altering the mechanics of that specific game. Such examples include Mystic Link (from Mayfaur's DC™ HEROES game) and Spending Karma (in the MARVEL SUPER HEROES game). I hadn't touched on these because most of these powers only function within the confines of their home games. They cannot be easily transformed into other settings, such as actions in a comic book. However, that doesn't justify my further ignoring their existence; hence, the creation of a new class of powers. The rule powers class is the rarest form of power. During the Character Creation process, this class of powers has only a base 3% chance of occurring. All rule powers have extremely short ranges; their initial effects

are limited to the hero and those beings and objects within the immediate vicinity (i.e., the same area). Rule powers include the following:

**R1/Attribute Change:** The hero has the ability to temporarily increase the rank of a specific ability or power by the rule power's rank. He can automatically retain the enhanced rank for 1-10 game turns, but he must make a Psyche FEAT each turn beyond that to retain the enhancement. For example, Cosmic Dasher possesses Incredible Attribute Change. He uses it to increase his normally Amazing Hyperspeed with an additional burst of energy, thus attaining Unearthly speed.

**R2/Attribute Pool:** The hero is able to directly combine his powers' or abilities' ranks with those of other heroes. The combined energy can then be channeled into a specific power or attribute shared by the affected characters and then used to perform a specific action. A Green FEAT is needed to perform this. In game terms, the players add their characters' ranks of the chosen ability; the sum is then temporarily reassigned as a new rank for each member of the group. For example, Cyber1, Cyber2, and Cyber3 pool their Excellent, Remarkable, and Amazing Strengths together; they each then achieve an effective rank of Unearthly Strength.

**R3/Attribute Rearrangement:** The

hero can reassign the basic value of his various abilities to enhance other abilities. In effect, the player has the ability to rewrite his hero's abilities and powers at will. The rule power's rank is used to make this FEAT. The effect initially lasts 1-10 game turns; beyond that, he must make a successful Psyche FEAT each turn to maintain the rearrangement.

**R4/Award Change:** The player can temporarily increase the size of the Karma game award previously given his or another's character. The player can increase his hero's Karma by this power's rank by means of a Green FEAT. The player can increase the size of an ally's Karma with a Yellow FEAT. A Red FEAT can either increase or decrease an opponent's Karma. Such changes occur in the same turn the power is used and last for 1-10 turns; after that, the hero must make a Psyche FEAT to maintain the effects.

**R5/Award Pool:** In the MARVEL SUPER HEROES game, this is called Karma Pooling. The player can temporarily pool his award value with that of other player characters, then use that increased reward to perform a group function. The pooling lasts for 10 turns plus a number of turns equal to the number of PCs participating in the pool.

**R6/Award Rearrangement:** The player can temporarily reassign the Karma values of other players' characters by

means of a Green FEAT. He can transfer a number of Karma Points equal to his power rank between either allies or opponents. Unscrupulous PCs can use this power to siphon Karma from civilian NPCs (onlookers, passers-by, etc.); this is considered a villainous act since it is akin to Vampirism.

**R7/Initiative Change:** The player can temporarily alter the order of play, deciding who plays in what order if he makes a successful Green FEAT. A Red FEAT can be used to either take away another character's turn or to instate a turn at a time when the affected player would otherwise be unable to roll.

**R8/Power Combination:** This power normally occurs only during the Character Creation process. Rolling this rule power requires the player to combine two of his hero's already existing powers into a new hybrid form. The new hybrid power permanently replaces the affected powers. Power Combination enables the player to create some really peculiar, unique characters. High-ranked NPCs may possess a special form of this power with which they can alter another character's powers at any time. However, the power's use is limited to once per day and only in non-combative situations. In this way, the Judge can create character-transforming incidents to enliven, confuse, or rearrange the existing campaign. Ω

# L E A D I N G E D G E

G A M E S



## LIVING STEEL™

High-Tech Adventure Game

Aliens stalk through the ruins of the Starguild Imperium . . .

Chaos and madness rule a devastated world . . .

And a small band of warriors and survivors is the last hope for a shattered Humanity, because they carry the dream that makes them . . .

## LIVING STEEL

Now in revised 2nd Edition, featuring a new Basic Combat System.

Living Steel boxed game ..... \$24.95  
 Operation Seven Swords supp ..... \$7.95  
 KViSR Rocks! scenario ..... \$8.95  
 Trident/R.M.B.K. scenario ..... \$8.95

**Join the revolution  
in game design!**

Now available from your local retailer, or by mail from: Leading Edge Games, P.O. Box 70669, Pasadena, CA, 91107.  
 Living Steel, Dragonstar Rising, and Dragoncrest are trademarks of Leading Edge Games. Copyright 1988 Leading Edge Games.

## DRAGONSTAR RISING™

Game of Man-to-Man Power  
Armor Combat

The free people of the Seven Worlds are under attack by the full might of the oppressive Starguild Imperium and by the alien, warlike Dragoncrests™. Badly outnumbered and outgunned, every one of the elite Seven Worlds warriors must be a hero if the dream of the Seven Worlds is to survive.

Dragonstar Rising, a fast-paced combat game, is the latest release from Leading Edge Games. Complete with maps and counters, Dragonstar Rising takes you to the most dramatic period of the Seven Worlds saga.

Dragonstar Rising boxed game ..... \$24.95





# Red Guns

Soviet  
firepower  
in the  
MARVEL  
SUPER  
HEROES®  
game



by William Wilson Goodson, Jr.

In DRAGON® issue #105 ("The Big Guns"), some basic rules were outlined for the use of heavy military equipment in the MARVEL SUPER HEROES® game. The MARVEL SUPER HEROES Advanced Set includes detailed rules for tanks, planes and such, but the descriptions of the different vehicles remain very vague. When playing against a submarine or helicopter, it helps to have a clear picture or exactly what the vehicle can and cannot do.

In a world-spanning campaign, your characters are likely to run into Soviet as well as American weapons. The Soviets are noted for their production of simple but

dependable equipment, and weapons manufacturing is one of their few profitable industries. Having licensed the production of their older weapon systems to

other countries, the Soviets now have instructors and advisors stationed all over the world. The vehicles mentioned in this article can be found in many places. For example, the Hind helicopter can be found in Afghanistan and Nicaragua, and Whiskey-class submarines are used to spy on Western countries.

Each description has a few uncertainties, as the Soviets do not publish details on their military vehicles if they can avoid it. Statistics agreed upon by most sources were used, as were the most common NATO designations. When ammunition or missile supplies for a weapon are not given, make up a reasonable result (up to 10 missiles and 1,000 rounds of ammunition).

The Russians constantly upgrade their equipment. Reports have reached the Western press that the newest Soviet tanks have armor that is highly effective against antitank weapons. The Soviets are also designing shells which they hope will crack America's new ceramic tank armor. In view of this, just about any of the superscientific weapons described in the MARVEL SUPER HEROES game may be placed on Soviet vehicles. You can bet the Soviets of the Marvel Universe® create weapons to deal with Western heroes as well as with super villains.

The following terms are used in the vehicle descriptions in this article:

**Body:** Body is the amount of damage a vehicle can take before it stops operating.

Different Body ratings are given against conventional, electric, and magnetic attacks.

**Bulls-eye targets:** These are the least-armored parts of a vehicle which a precision weapon may be able to hit. For example, an archer may not be able to damage the hull of a tank, but he could break the tank's infrared spotlight.

**Control:** This is how well a vehicle can execute changes in direction and speed.

**Crew:** This is the number of people a vehicle requires in order to operate. A crew member may carry almost any kind of hand weapon the referee chooses.

**Kill results:** If an attacker scores a Kill result on a vehicle, the hit should cause serious damage to the craft. For example, a Kill result against a ship might (at the Judge's option) stop the engine or jam one of the propellers.

**Protection:** This is the amount of armor a vehicle provides for passengers inside it. Different protection ranks are given against conventional attacks and both chemical and biological weapons. Soviet crew members may be individually protected by special suits which give Excellent Protection against chemical and biological weapons. Such a suit cuts Agility and Fighting abilities by two ranks and offers no protection against blows or gunfire.

**Speed:** This is the rank representing the maximum safe speed of a vehicle. One knot (used in seagoing-vessel descriptions) is about 1.15 MPH.

Armament descriptions have been kept as simple as possible so that each cannon, machine gun, or other projectile weapon will have a simple classification. This allows readers to use the game characteristics of the weapons, bombs, and missiles in the Advanced Set Players' Book on pages 41-46.

### Whiskey V class submarine

The Whiskey-class submarine was designed in the early 1950s and is a small vessel that forms a compromise between having a long cruising range and having the ability to maneuver close to a coastline. Approximately 260 of these subs were built, and they have been sold to Poland, North Korea, Cuba, Egypt, and Indonesia, among other places. The People's Republic of China has produced its own version of this model. A Whiskey-class submarine ran aground near a major Swedish naval base in 1981. Others have been detected in the same area since then, suggesting this submarine is being used for coastal reconnaissance.

The Whiskey-class submarine has Excellent Control, Poor Speed, and a Remarkable Body, with Excellent Protection for its crew of 54. Though small, this submarine has a heavy, pressure-resistant, compartmentalized hull; if one chamber is breached, it can be sealed to protect others from flooding. Each separate hull breach reduces the sub's Control and Body by one rank; if either ability reaches Fee-

ble, the helpless sub sinks. The electrical systems essential to both control and the life-support systems have Good Protection from electrical or magnetic attacks.

Bull's eyes may be scored against the periscope and radar disc. Damaging the disc (Good Material Strength) destroys the ship's radar system, making it possible for planes and ships to approach undetected. Damaging the periscope (Typical Material Strength) renders the ship blind while it is submerged.

A Kill result can damage one of the submarine's two propellers, cutting Speed and Control in half. If both shafts are damaged, the ship has no means of propulsion and sits dead in the water (though if submerged, it can surface by blowing its ballast tanks). A Kill result with enough power to penetrate the hull is able to damage one of the submarine's four engines. Two diesel engines are used when surfaced, and two electric engines are used when submerged (diesel engines require a great deal of air in order to work).

This submarine's top speed is 18 knots on the surface and 14 knots submerged. Its best depth is a secret but is assumed to be less than 500'. To go below this level requires a FEAT roll against the hull's strength. A White or Green result means the sub survives; a Yellow roll means the sub drops a rank in every class; and on a Red roll, the submarine is crushed and destroyed.

This submarine requires 25' of water to maneuver on the surface. In shallow water, the sub will run aground. Escape then requires a Green FEAT roll on the Typical column, but may be tried only once every 10 turns.

The primary weapons carried on this submarine are four bow torpedo tubes, each able to fire 21"-diameter torpedoes. This sub also has two stern tubes able to fire 16"-diameter torpedoes. The torpedoes can be treated as missiles (Excellent Body, Remarkable Control, Excellent Speed, 25-area Range), but they can only be fired at objects in the water. These torpedoes usually carry concentrated-explosive warheads (Remarkable damage), but NATO believes they can carry nuclear bombs of unknown size (Unearthly to Class 1000 damage).

Whiskey-class submarines have been observed with several types of deck guns, so the Judge may put almost any size machine gun or artillery piece there. Crewmen may be equipped with almost any type of hand weapon listed in the Player's Book.

### Nanuchka class III missile corvette

The Nanuchka-class corvette is produced by the Russians for their own navy, but these ships have also been sold to several countries in the Middle East and to India. Each corvette has Typical Control, Remarkable Speed, and a Remarkable Body providing Excellent Protection for a



crew of 100-120.

These missile corvettes were designed for firing antiship missiles. Each corvette has a wide hull which makes it a steady missile-firing platform in rough seas. They operate both as fleet escort vessels and as shore patrol boats. Though lightly armored, these ships have advanced electronic countermeasures of Remarkable efficiency to prevent them from being seen on radar.

These corvettes are compartmentalized to protect them from flooding. When the outer hull is breached, only one chamber will flood before that chamber is sealed off. Each breach of the hull causes the ship to lose one rank in both Body and Control. Whenever the ship reaches Feeble in either of these ranks, it sinks.

Possible Bull's-eye targets are the radar disc, radio antenna, and any crew members operating on the deck. The disc and antenna each have Good Material Strength. Damaging the radar disc kills the early-warning system, while breaking a corvette's antenna prevents the ship from communicating by radio and cuts off its electronic countermeasures.

A Kill result means one of the three propellers (Excellent Material Strength) has been damaged or fouled. This reduces the ship's control and speed by one-third. The Nanuchka-class corvette has six diesel engines and normally travels at 32 knots.

This corvette cannot move into water less than 40' deep or it will run aground. Escape then requires a Green FEAT roll on the Typical column; escape attempts may only be made once every 10 turns.

The Nanuchka-class corvette carries two close-range weapons systems: a 76-mm gun (treated as light artillery in the game rules) and a Gatling turret (treated as a military machine gun). Its principle long-range antiaircraft defense is a twin SA-N-4 surface-to-air missile launcher. The launcher is housed in the deck and requires about five minutes or 50 combat turns to pop up when needed. An SA-N-4 missile is fired vertically, then guided by radar (Good Body, Incredible Control, Excellent Speed, 60-area Range, concentrated-explosive warhead). The ship's main weapon is a set of two triple SS-N-9 surface-to-surface missile launchers. The SS-N-9 missile is a radio-linked missile, so its course can be corrected if fired at a target over the horizon (Excellent Body, Incredible Control, Excellent Speed, 68-mile Range, high-explosive warhead).

#### Mi-24 Hind helicopter

The Hind is a multipurpose attack antiarmor helicopter. It is in service all over the Soviet Union and has been used extensively in Afghanistan, where it has become known as a symbol of Soviet brutality against a poorly armed enemy.

This helicopter has Excellent Control, Remarkable Speed, a Typical Body, and provides Good Protection. The Mi-24 has a crew of two, a pilot and co-pilot, and can carry eight passengers. The helicopter normally offers Typical Protection, with Poor Protection from magnetic and electrical attacks. The crew and passengers receive no protection from the helicopter from chemical or biological weapons.

A Bulls-eye result against the Hind may damage the tail rotor, requiring the craft to land immediately. A Kill result destroys the motor or main rotor, causing the helicopter to crash immediately.

The Hind gunship has a cruising speed of 140 MPH and a 300-mile Range. It can land and take off in a single area and hover in one place until it runs out of fuel. While hovering, it can turn to face any horizontal direction.

The Hind comes in several versions, each with different types of armament. All versions can carry four missiles each. The Hind A has a heavy machine gun (treat as a military machine gun) mounted in its nose, The Hind C has no nose gun, while the Hind D and E each carry a four-barrel machine gun (treat as four military machine guns). The Hind A, C, and D carry either the AT-2 Swatter or AT-3 Sagger antitank missiles. The AT-2 Swatter is a heat-seeking missile with a concentrated-explosive warhead (Excellent Body, Remarkable Control, Excellent Speed, 7,000' Range). Its guidance system is designed to find hot tank engines. The AT

3 Sagger is a wire-guided missile with a concentrated-explosive warhead (Excellent Body, Excellent Speed, 840' Range). The Sagger's Control is equal to the operator's Agility since he guides the missile by sight. The Sagger, also known as the Milutka, can be fired by two-man teams on the ground. The Hind E carries four AT-6 Spiral missiles, which are guided by a laser beam focused on the target; the laser can be operated by the helicopter or by men on the ground. The Spirals concentrated-explosive warhead is designed to penetrate armor, while its Control rank is equal to the operators Agility (Excellent Body, Amazing Speed, 16,500' Range).

#### Sukhoi Sui-17 Fitter-C

The Sui-17 is a tactical ground-support jet fighter. The Fitter-C model was built in part for export and is used not only by Russia but by Peru, Egypt, and several Warsaw Pact countries. Sui-17s saw combat in both sides of the recent Libyan-Egyptian conflict.

This aircraft has Excellent Control, Shift X Speed, and a Typical Body providing Typical Protection. It is a single-seat aircraft with a crew of one (the pilot). The fuselage has Typical Protection, but the electronics system has only Poor Protection from electronic and magnetic attack. The plane has electronic countermeasures which provide Good Protection against radar detection. The pressurized cockpit gives Unearthly Protection to the pilot from all chemical and biological weapons as long as it remains sealed.

A Bulls-eye result may damage the plane's controls, requiring it to land immediately. A Kill result means the engine is knocked out and the plane will crash.

The Fitter-C has a single turbojet engine. At sea level its maximum speed is 798 MPH, while it can go 1,432 MPH at its standard altitude of 59,050'. It can climb 45,275' per minute. However, the Sui-17 is designed for close support of ground troops and often operates well at near-ground level. This fighter requires 25 areas of smooth, hard surface in a straight line in order to take off or land.

The Fitter-C carries two 30mm NR-30 cannons (treat as light artillery). One cannon is mounted on each wing with 70 rounds of ammo. The jet also carries drop tanks and has six wing pylons able to carry up to 11,023 lbs. of bombs, napalm, and missiles. This jet normally carries AS-7 Kerry air-to-surface missiles (Excellent Body, Remarkable Control, Excellent Speed, 6.8-mile Range, high-explosive warhead). The AS-7 is believed by Western sources to follow a beam sent by the aircraft to its target. It is not known if the beam is a laser or radar beam.

The Su-17 is equipped with radar and two separate radios - one for contacting its base and other aircraft, and one for talking to ground troops.

The Su-17 can ram for Remarkable damage to itself and its target if in flight.



**The World Conquest Board Game Fought in the Nuclear Age**

Test your tactical and strategic skills with airborne and amphibious assaults. Laser Stars give you a hi-tech edge against the constant threat of nuclear war.

*"... for an all-around, pretzel-munching good time while destroying what's left of this battered planet, Supremacy wins hands down ... Supremacy is an instant classic."* Matthew J. Costello.  
Isaac Asimov/*ANALOG Magazine*, Sept. 1986  
Chosen by the editors of *OMNI* and *GAMES MAGAZINE* as one of the best games of 1985.

**For your free color catalog call toll free**  
**24 hrs / 7 days 1-800-777-1908**  
Available direct or at better game stores worldwide. Supremacy Games Inc., 425 Statler Towers, Box E, Buffalo, NY 14202.

However, if either its Body or Control rank falls to Feeble, it blows up. It must make an immediate Control check (Yellow FEAT) in order to avoid going out of control when it strikes anything or is struck itself. If the plane is damaged, the pilot may eject if he makes a FEAT roll against his, Agility.

#### T-62 main battle tank

This vehicle is manufactured by the Soviet Union and is used by its own army, as well as by Bulgaria, Czechoslovakia, East Germany, Egypt, Hungary, Iraq, Israel, Libya, Poland, Romania, and Syria. It has an Incredible Body, Poor Speed, Excellent Control, and Remarkable Protection. The tank has a crew of four (commander, gunner, loader, and driver).

The T-62 has up to 3" of welded armor and weighs 16,600 lbs. The crew receives Excellent Protection not only from chemical and biological weapons but from radiation when the tank is sealed. Its electrical systems, including the ignition and radio, have Excellent Protection from energy attacks.

On the T-62 series, Bull's-eye targets include the radio antenna, headlights, and infrared spotlight. The tank also has two periscopes used by the commander when the hatches are shut. All these items have Typical Material Strength. On a Kill result, the Judge may decide to jam one of the treads or damage the engine, stopping the tank in place until it is repaired.

The T-62 has a water-cooled diesel engine and is capable of moving about 30 MPH on flat terrain. The tank can climb a slope of 60°, roll over a vertical obstacle 30" high, and ford water up to 4½' deep without modifications. Enough fuel is carried for traveling 310 miles, but extra gas tanks can be carried on the tanks rear. The infrared spotlight removes any Control loss during night travel.

The T-62 has a forward-mounted 115mm cannon (treat as heavy artillery) which uses shells with rear fins to stabilize them in flight. The cannon can only fire in the direction the turret is facing, but the turret can turn 360°. Also mounted on the turret is a 7.62mm machine gun (treat as a military machine gun). The infrared spotlight is mounted next to the guns and removes any loss of accuracy at night.

Like most Soviet tanks, the T-62 can produce a smoke screen of Excellent density. This screen is produced by pumping diesel fuel into the exhaust system, and it spreads over 1 area every 2 turns behind the tank.

The T-62 can ram for Remarkable damage. If it rams and rolls a Red result on the Remarkable column, it will run over the target (if the target is not too large) and do Incredible damage.

MARVEL, MARVEL UNIVERSE, MARVEL SUPER HEROES, and all Marvel character names and likenesses are trademarks of Marvel Entertainment Group, Inc.  
©1989 Marvel Entertainment Group, Inc. All Rights Reserved.



MT1 is the kickoff to TSR's MARVEL® Time-Warp adventure trilogy, a campaign that spans the entire history of Man on Earth. Don't miss out on the adventure! *All This and World War II* is available at hobby shops everywhere!

MT1, All This and World War II by Ray Winninger

MARVEL SUPER HEROES is a trademark of the Marvel Entertainment Group. All Marvel characters, CHARACTER names, and the distinctive likenesses thereof are trademarks of the Marvel Entertainment Group, Inc. © 1989 Marvel Entertainment Group, Inc. All Rights Reserved. The TSR logo is a trademark owned by TSR, Inc.

# Nobody Lasts Forever

But Death rarely has  
the last word on superheroes

by David Edward Martin

Let's think about the unthinkable—namely, death and its effects on your hero's career in the MARVEL SUPER HEROES™ game. Death doesn't usually change people physically. Oh, they don't breathe, are no fun at parties, and have hygiene problems, but on the whole, not much else occurs to the recently departed. Superbeings are a different case. Because of the powers that some superbeings (or their super-equipment) possess, death may cause unforeseen events with the loss of the deceased's conscious control.



You aren't likely to know what's going to happen to your character if he dies. Even if you do, you'll only have to deal with the aftereffects once. NPCs are a different case; they can drop like flies in tough campaigns. Judges should determine post-mortem effects beforehand, especially if the current adventure has a high risk of PC or NPC fatalities. The information should be kept secret unless later events enable someone to puzzle it out.

Since most PCs are unique individuals, post-mortem effects can be specifically selected or randomly determined for each superpowered hero as appropriate. Simply roll 1d100 on Table 1 for random results. If the character's powers are species abilities or are the results of processes used on a number of beings, one post-mortem effect should be sufficient for everyone in that group. The Judge should be prepared to decide how technologically produced superpowers are affected if the deceased equipment still operates after the death of its user or if such equipment is damaged at the time of the user's death.

## Post-mortem effects

Table 1 lists the various post-mortem effects that might occur when a superbeing dies. Of course, these effects may not apply if the superbeing was merely a normal (if athletic) human.

**PM1/Total Loss:** The body retains none of the powers possessed by the deceased and remains physically unchanged. For example, when Changeling died while impersonating Professor X, his body was locked into that form.

**PM2/Reversion:** The body retains none of its superpowers. It also reverts in death back to the deceased's original form. Werewolves are an example of this.

**PM3/Partial Loss:** The body loses some superpowers and retains others. Generally, those powers that required a conscious mind in order to operate are lost, while those powers that are a function of body structure remain. For example, a dead Armadillo would still have an armored hide and claws.

**PM4/Retention:** The body retains its superpowers, though it is, of course, unable to use them unless converted into a zombie or animated by a possessing life force. Some powers are localized in particular parts of the body. If those body parts are transplanted to another being, the recipient gains the superpowers inherent in those parts. For example, if the deceased had optical powers such as telescopic and microscopic vision, the transplanting of those eyes to another might give the recipient those powers. Such powers that remain decrease in rank as the body decays, but such decay halts if the parts are properly transplanted or stored.

**PM5/Self-Direction:** The body's powers turn upon itself. Each power releases a final, full-strength attack at the



body. This flurry of activity may destroy, transform, or otherwise alter the dead superbeing. If such self-directed attacks are of higher rank than the deceased's former Health, the body may be burned, disrupted, or even disintegrated outright. Afterward, the remains are inert and possess no remaining powers. For example, if the deceased possessed a petrifying power, the body may suddenly transform into a rock statue.

**PM6/Self-Destruction:** The body's powers turn upon itself. The deceased's power ranks are totaled and converted into a self-destructive blast of equal rank. If the blast is of higher rank than the deceased's former Health, the body is burned, disrupted, or disintegrated. For example, when the android Hyperion died, his body dissolved into protoplasm. However, no matter how destructive the blast, its effects do not extend beyond the body. The nature of the self-destruction should be characteristic of the deceased's body or powers if possible.

**PM7/Explosion:** The body's powers erupt in a single explosion as the body spontaneously detonates. The deceased's power ranks are added together and converted into a single explosion of equal rank. For propriety's sake, let's assume that organic beings completely disintegrate with little mess. Robots, cyborgs, and inorganic parts become shrapnel. If the deceased was sufficiently powerful, his death could mean the demolition of large parts of the countryside or even the planet. Again, the nature of the destruction should be characteristic of the deceased's body or powers.

**PM8/New Power:** For reasons unknown, the death trauma causes the deceased's existing powers to transform into a new power. The power is selected at random and may have nothing to do with the previously existing powers. The body emits this new power uncontrollably, much like a isotope emitting radiation. The body is not immune to this power; if the new power is destructive, the body soon disintegrates and the power ceases to function. However, if the power is useful or even valuable, the deceased may become a valued commodity. In the rare event that this new power somehow negates death, the character rises like Lazarus from the tomb.

## A question of resurrection

In comic books and their role-playing systems, death is reversible. Beside its obvious effect on the character, what effects does revival have on his powers? The answer is: *any* effect. It depends on what killed the being the first time, what happened to the body, and how revival occurred. The Judge should decide which of the following states applies.

Physical resurrection occurs when the body is returned to at least minimal Health and a life force is restored or developed. If the body is restored to the same condition

it had during its superpowered phase, such powers most likely reappear.

If the body is restored to a pre-super state (for example, a dead Thing being revived as a mid-20s Ben Grimm), such powers might not reappear. Of course, the potential for later development of powers remains (the revived Ben would still have his potential for mutation). Mental powers may reappear if they were a function of the physical structure of the brain or if the original life force returns.

If the deceased is cloned, you must consider whether the deceased's powers were genetic in nature. If the powers were not genetic, the clone is assumed to be the same as the deceased's pre-super form. If they were a function of the deceased's genetic code, the clone may be physically the same as the superbeing's original superbody. Powers that were based on later mutation or modification are not necessarily present in the clone, but the potential is there for recreation of those missing powers. For example, a clone of Ben Grimm would be human, but exposure to gamma radiation might make the clone orange, rocky, and superstrong. If the clone is possessed by the original's life force, mental or magical powers will probably reappear, although the clone may have initial difficulty in using familiar powers in an unfamiliar body.

Sometimes conditions transplant the deceased's life force into a new body. These "body transplants" give the hybrid a combination of the life force's mental or magical powers and the body's physical powers. For example, Walter Langkowski (formerly the orange-furred, male Sasquatch) was restored to life in the white-furred Sasquatch form that was once Snowbird's body. Langkowski thus retained the ability to transform between the white Sasquatch form and a human body, but that body was Narya's female form. (Fortunately, that little oversight has since been corrected.)

## Resurrection as remodeling

Resurrection is a handy way to alter or redefine a superbeing's powers. Superpowers result from a complex interaction between a life force, a physical body, and (perhaps) external forces. Death, even as a temporary state, alters the equation. Players and Judges should agree on the overall effect the resurrection will have on a superbeing's powers. Examples include:

- Retain the same powers but generate new ranks for them;
- Trade randomly selected powers for new powers;
- Throw out all powers and generate new ones;
- Alter the ranks of a randomly selected number of Physical Abilities;
- Keep only mental and magical powers (if this is a new body);
- Keep only physical powers (if this is a new life force);

- Combine old powers into new hybrid forms; or
- Add powers resulting from the means used to resurrect the deceased (for example, bionic implants to maintain the restored life force may possess additional abilities).

## Immortality and longevity

Now that you're depressed, let's deal with powers that help your PC avoid that unknown country from which few explorers return.

**P21/Immortality:** The *Players' Book of the MARVEL SUPER HEROES Advanced Set* deals with this power. However, you might want to know a few details, such as how old your pet immortal appears (Table

**Table 1**  
**Post-Mortem Effects for Superbeings**

### 1d100 Post-mortem effect

01-25	PM1/Total Loss
26-54	PM2/Reversion
55-69	PM3/Partial Loss
70-84	PM4/Retention
85-91	PM5/Self-Direction
92-95	PM6/Self-Destruction
96-98	PM7/Explosion
99-00	PM8/New Power

**Table 2**  
**Apparent Ages of Long-Lived or Immortal Superbeings**

### 1d100 Apparent age (years)

01-07	Baby (under 2)
08-14	Child (2-11)
15-29	Teen (12-19)
30-58	Young adult (20-40)
59-80	Middle age (41-60)
81-94	old (61-80)
95-00	Very old (81+)

2) and how old that being actually is (Table 3). Later, we'll also consider what happens if an immortal becomes mortal.

**P22/Longevity:** Adam Sonfield, a MARVEL SUPER HEROES game player, reminded me that a greatly increased lifespan is not necessarily the same as Immortality. Longevity does not automatically include immunity to disease, aging, or bodily destruction, and someone with Longevity merely has a greatly increased—but finite—lifespan.

When creating a character with this power, you need to determine both the actual age of the PC (Table 2) and his apparent age (Table 3). In the case of the recently born (those under 100 years old), the apparent age should be middle age or younger; otherwise, how would you know the hero was long-lived?

The total lifespan of someone with Longevity is determined by his power rank. The power rank number is cubed, then

multiplied by 70 years (current average human life expectancy) to generate the probable lifespan of the being in question (see Table 4). For beings with other lifespans, multiply the modifier in Table 4 by the lifespan common to that race. For example, a field mouse with Typical Longevity could reach an age of 216 years.

In such cases where the actual age of a hero is greater than his expected lifespan, assume the character was either affected by a process or event that further increased his lifespan (for example, being a time traveler) or that he is aware that his remaining days are few in number. In either case, this extension can lead to all sorts of plot complications. Is the character trying to complete a final task before dying? Is he trying to do something to prevent death and renew his as-yet-unexplained extension?

Remember that a long life expectancy includes no guarantee of actually living that long. PCs are still prey to accidents. For example, consider the case of a mad scientist who, having just completed a process that gives him a potential lifespan of thousands of years, promptly trips on a power cord and dies of a fractured skull.

A character's Longevity rank can be added to his Endurance rank when deter-

**Normal life:** Character is now a normal individual of his apparent age with a normal life expectancy. If the power can be later restored before a natural death occurs, he continues living on as if little had happened. If death occurs meanwhile, an immortal might still resurrect himself if the power is restored to his remains.

**Sudden aging:** The character rapidly ages to his true age but doesn't necessarily die. A character whose age exceeds his mining the effects of disease on a long-lived PC. If the Longevity rank is higher than the Endurance number, it can also be used to determine the character's rate of healing.

The player should also determine the character's aging rate. Does he age in a steady but incredibly slow rate? Does he suddenly gain a year's worth of aging once each century? Although this information might have little game use, the information will help flesh out your PC's long life story or give motivation to long-lived NPCs' machinations.

### Quick exits

But what happens to an immortal or long-lived character if that power is removed or negated? Roll 1d100 on Table 5 for the answer.

normal life expectancy withers to a mummylike state. If his age exceeds four times his normal life expectancy, the mummy is apparently lifeless. Consciousness remains, though, and the "mummy" is free to use its other powers as best it can. If the Longevity or Immortality power is later restored, the character might regain his previous appearance, depending on the circumstances and the Judge's discretion.

**Aging and death:** The character rapidly ages to his true age. The shock tends to be fatal, especially if the character's actual age is more than twice that of his normal life expectancy. Rapid decomposition occurs in 1-100 turns; the remains attain a state similar to that of a normal body the same age as the recently deceased's actual

**Table 5**  
**Aftereffects For Loss of Longevity/Immortality**

1d100	Effect
01-40	Normal life
41-60	Sudden aging
61-00	Aging and death

age. Bodies under 4,000 years old are mummified; those up to 10,000 years old become skeletons, and those older than that collapse into dust. If the power is restored to an immortal's remains, the immortal can eventually return to life (traditional vampires are an example of this). Longevity-powered characters require aid from such powers as Resurrection or Self-Revival before they can regain their previous physical conditions. Ω

Marvel, Marvel Universe, Marvel Super Heroes, and all Marvel characters, names, and likenesses are trademarks of Marvel Entertainment Group, Inc. Copyright 1989 Marvel Entertainment Group, Inc. All Rights Reserved.

**Table 3**  
**Actual Ages of Immortal or Long-Lived Superbeings**

1d100	Actual age (in years)	Birth era
01-06	Under 100	Modern industrial era
07-39	100-500	Post-Renaissance
40-67	501-1,500	Dark Ages
68-79	1501-4000	Classical period
80-88	4001-10,000	Ancient, post-Ice Age
89-94	10,001-100,000	Cro-Magnon, Ice Age
95-97	100,001-10,000,000	Primitive man
98-99	10 million-5 billion	Various prehistoric eras
00	5 billion +	Before Earth was created

**Table 4**  
**Life Expectancies of Long-Lived Superbeings**

Rank	Modifier	Life expectancy (years)
FE (2)	8	560
PR (4)	64	4,480
Ty (6)	216	15,120
GD (10)	1,000	70,000
EX (20)	8,000	560,000
RM (30)	27,000	1,890,000
IN (40)	64,000	4,480,000
AM (50)	125,000	8,750,000
MN (75)	421,875	29,531,250
UN (100)	1,000,000	70,000,000
Shift X (150)	3,375,000	236,250,000
Shift Y (200)	8 million	560 million
Shift Z (500)	125 million	8.75 billion
C1000	1 billion	70 billion
C3000	27 billion	1.890 trillion
C5000	125 billion	8.750 trillion

## 54° 40' ORPHYTE

Hard to find CHILL®, TIMEMASTER®, and STAR ACE® products now available, including complete original base games and most screens, modules, and supplements.

Send SASE to:  
54° 40' Orphyte, Inc.  
P.O. Box 2108, Naperville, IL  
60567-2108 for order form.

Dealer inquiries invited.

Sandman™, Wabbit Wampage®, Wabbit Wevenge™, and Chill: Black Morn Manor™ also available.



# Son of the Ultimate Addenda

Just how much  
Limbo can a superhero  
swallow, anyway?

by David Edward Martin

Like the two previous “Ultimate Addenda” articles in this magazine (in issues #122 and #134), this article deals with readers’ questions about MA3 *The Ultimate Powers Book*, a compendium of superpowers for the MARVEL SUPER HEROES™ Advanced Set. First, however, I must apologize to those readers who have personally written me and even included SASEs for the replies. I am horrible at answering letters—or rather, I am great at answering letters, but I tend to lose either the address or SASE of the person I am replying to, or I just forget to mail my response.

**What happens when a being with MG3/Internal Limbo uses that power to capture another character who also has Internal Limbo?**

I love topology: It’s so twisted. The answer to this depends on who used the power first. If only the attacker (call him “A-Man”) used this power, the victim (let’s call him “V-Man”) is sucked in just like any



other target. V-Man's own Internal Limbo ("Limbo-V") remains unaffected, save that its entry point is now located within the first person's Limbo ("Limbo-A").

If V-Man's power was sufficiently strong, he could capture everything within Limbo-A. A-Man would then have a Limbo-A empty of everything except for V-Man. Once V-Man has captured everything within Limbo-A, a Red FEAT would allow him to completely swallow even the empty space of Limbo-A. It would appear to A-Man that Limbo-A had completely vanished, though the still-captive V-Man would be present. The difficulty of the FEAT is determined by the rank of A-Man's Internal Limbo power. A final Red FEAT would enable V-Man to topologically reverse his situation: Limbo-V would reach out and swallow A-Man, while simultaneously spitting V-Man back into the real world.

If V-Man has TS/Dimension Travel or developed a Power Stunt whereby he can travel through his own Limbo and exit elsewhere, he can skip the above steps and use this power to escape from Limbo-A. However, his power rank must be equal or higher than the rank of the imprisoning power.

If both Internal Limbo powers were used, simultaneously, an extraordinarily twisted convolution occurs. The best example I can think of would be the *Doctor Who* episode in which the Master's TARDIS materialized inside the Doctor's TARDIS. Somehow the two extradimensional fields warped around each other, with the result that each TARDIS had the other within itself. The Doctor's TARDIS was in the Master's control room, while the Master's TARDIS was in the Doctor's control room. The trap was escaped only when both TARDISES simultaneously warped away from each other. In our example, both A-Man and V-Man would have to simultaneously use their powers to eject each other and free themselves.

#### **How far can a being with T9/ Hyper-leaping go if he also has S25/ Growth (Atomic Gain), mentioned in "The Ultimate Addenda" in DRAGON issue # 122?**

The initial impression one has is that the distance that being jumps will increase in length. However, both the Atomic Gain and Atomic Growth powers increase the character's weight geometrically. This decreases the distance an enlarged character can leap. In the case of a character who has only his normal strength to rely on, such leaps appear to decrease in length in inverse proportion to the degree that the character grows. For example, a being enlarged fourfold could make leaps that (to him) are only a quarter of the distance he could leap at normal size. In short, if the character could leap 6' at normal size, and then enlarges himself to four times his normal height, he can still only leap 6'. When the character

increases in size until he cannot leap farther than he can step, the character cannot leap at all and must walk.

When travel powers like Hyper-leaping are included, these proportionate decreases in leap length are altered, at least as far as the hero's perception of them is concerned. The rank of the Hyper-leaping increases in the same manner as the Strength rank—that is, the rank gains a + 1CS bonus for every 2CS of Growth rank above Feeble. For example, a person with Typical Hyper-leaping and Incredible Growth can leap 10' at normal size, 20' at Excellent-increased size, and 30' at Incredible-increased size.

With Atomic Dispersal, the character's leaps initially increase in inverse proportion to the character's size. However, since the character's density is decreasing, the leaps become harder to control. Wind currents can significantly alter the length of such leaps and can even carry away a low-density hero.

#### **How far can a being with Hyper-leaping go if he also has S30/ Shrinking (Atomic Shrinking), taken from issue #122?**

The following Hypothetical Physics lecture also applies to characters with the Atomic Loss form of Shrinking. Logically, the length of the leaps should decrease in proportion to the size of the miniaturized being. However, since the character's weight decreases with miniaturization, such leaps lengthen at the same time! Rather than burden players and Judges with a complex series of equations (which I wouldn't understand either), let's just say that from the character's point of view, the leaps increase in inverse proportion to the degree of miniaturization (e.g., shrinking to 50% of a character's original size gives leaps of 200% their original length), but this increase is negated because the

leaper is getting smaller, too. The end result is that, despite the degree of miniaturization, the hero's leaps are still the same length when measured in the unminiaturized "real world." For example, the half-inch Ant-Man and the normal-size Scott Lang can both make leaps of 6' in length, although such leaps would appear to Ant-Man to be 864' in length. Of course, in the light-weight miniaturized state, air currents will alter such leaps (the Judge must rule on these effects in a game).

When the effects of Hyper-leaping are considered, the perceived distances increase even more, but the actual distance covered remains the same. For example, consider the hypothetical villain Grasshopper, who has Ant-Man's shrinking power as well as his own Excellent Hyper-leaping. At normal size, he can leap 30', but when he is miniaturized to half an inch, those leaps appear to him to be 4,320' long but are still only 30' long.

Once the threshold to the Marvel Microverse is crossed, all leaping movement assumes the same proportionate lengths in relation to the moving character as such leaps possessed in the normal-size universe. Further miniaturization then starts the whole cycle over again.

The distance leaped by a character with the Atomic Collapse form of Shrinking seems to shrink in proportion to the character's overall height, because his weight remains the same regardless of height.

#### **What happens when a being has P5/Hyper-speed but not a travel power?**

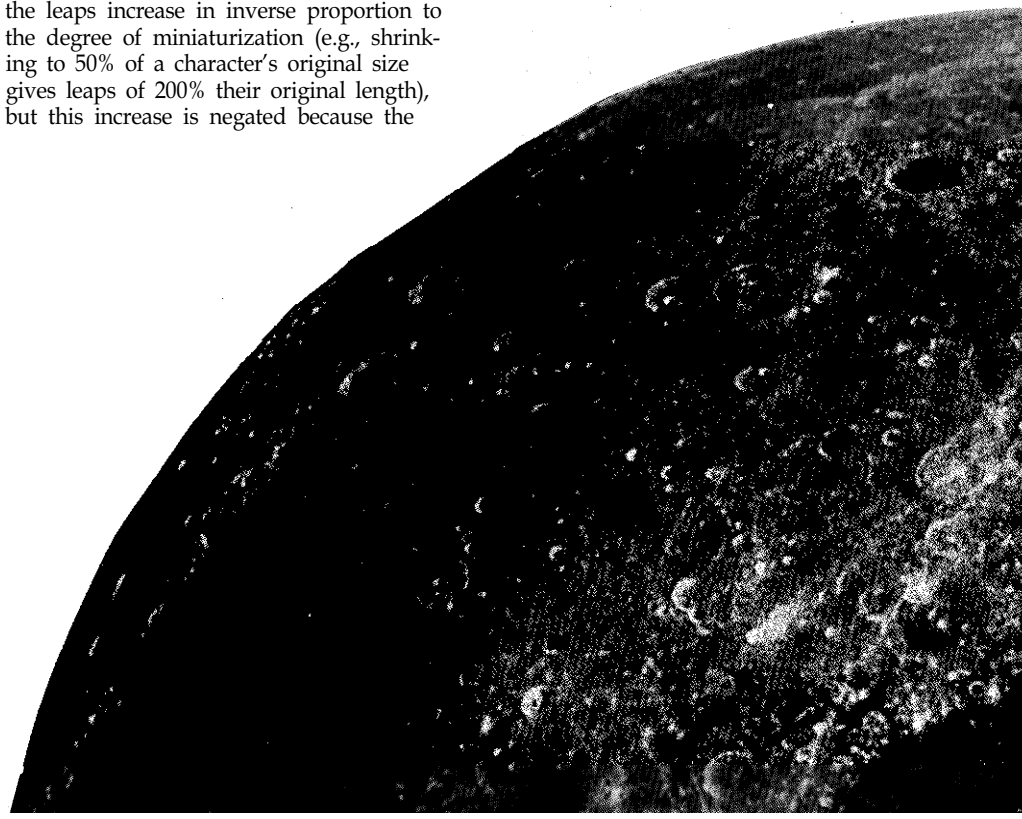

Hyperspeed increases the character's reaction time and movement rate. In the case in question, the hyper-speedster has a proportionate increase in his walking and running speeds, but not in the distances he can cover. Limits on normal fatigue still apply. For example, a relatively Typical person who happens to have Good Hyper-speed could walk at 40 MPH or sprint short distances at a speed up to 150 MPH, but he would tire out after covering the same distances that he could cover at normal speed. Of course, you might develop a Power Stunt that enables a character to rest at Hyper-speed. (I know that sounds oxymoronic, but the concept works.)

**What happens when you have both Hyper-speed and T10/Hyper-running at the same rank?**

I'll amend what I wrote in the Hyper-speed entry in *The Ultimate Powers Book*, page 78. There I wrote that the Hyper-speed rank can be substituted for a lower-ranked travel power's speed. Let's add two options designed to make the runner more equal to his aerial counterparts.

In option #1, the ranks of the two aforementioned powers combine to produce a higher speed. For example, Incredible Hyper-speed and Remarkable Hyper-running combine to enable the hero to run at Monstrous speed (135 MPH).

In option #2, the presence of Hyper-

speed pushes the travel power's speed and distance covered from the land-speed column to the air-speed column on the Movement Table (*The Ultimate Powers Book*, inside back cover). Thus, the presence of Hyper-speed of any rank increases a Remarkable Hyper-runner's speed from 90 MPH (the land-speed column) to 225 MPH (the air-speed column). If a second Hyper-speed power is generated during the character's creation, this can be used to push the speed over to the space/extradimensional-speed column on the movement table. In the example above, our Hyper-runner's speed would further increase to 4,000 MPH.

**What would be the FASERIP statistics of a character with EE3/Energy Doppelganger, both with and without his own mind? What happens if you give him the F1/Berserker power?**

The answer to this depends on the nature of the doppelganger and what powers are assigned to it. The doppelganger's Fighting and Agility ranks are the same as those of the character, while its Strength and Endurance are equal to the Energy Doppelganger power's rank. However, if the doppelganger lacks the means to solidify itself, its Strength rank is irrelevant.

If the doppelganger lacks a mind of its own and operates under the hero's direct

control, the RIP statistics are normally those of the hero. If control is broken, the doppelganger usually dissipates instantly. Independently minded doppelgangers require the player to generate new RIP ranks for them.

In either case, the player must decide whether the RIP statistics are merely averages for each doppelganger generated or represent point pools that are evenly divided among all doppelgangers simultaneously operating. This should be decided when the character is created.

Once that is settled, you can answer the Berserker question yourself given the specifics of your situation. In the case of a directly controlled doppelganger, the Berserker effect modifies only the doppelganger's FASERIP scores (if the Berserker power is assigned to the doppelganger) or the FASERIP scores of both the hero and doppelganger (if the Berserker power is assigned to the hero).

Do you have any more questions about *The Ultimate Addenda* and its superpowers? Send your comments, questions, and suggestions to me, care of DRAGON® Magazine. I can't guarantee I'll answer them right away, but I will read them. ☺

Marvel Super Heroes and Marvel Microverse are trademarks of Marvel Entertainment Group, Inc. Copyright ©1989 Marvel Entertainment Group Inc. All Rights Reserved.

Introducing

# Pure Illusion

A brand new and exciting range of high quality, limited edition, Fantasy Posters, measuring 34"x24" approx.

As an introductory offer, we are giving away 3 posters for the price of 1.

Everyone signed by the Artist and numbered.

Hurry as there will only be 1,000 of each printed.

The perfect Christmas gift for every fantasy enthusiast.

£20 plus P&P (overseas £5 — UK £2.50).

All payments in sterling. Cheques to be made payable to Pure Illusion.

P.O. BOX 65, SKELMERSDALE, LANCS. WN8 6YD, ENGLAND.

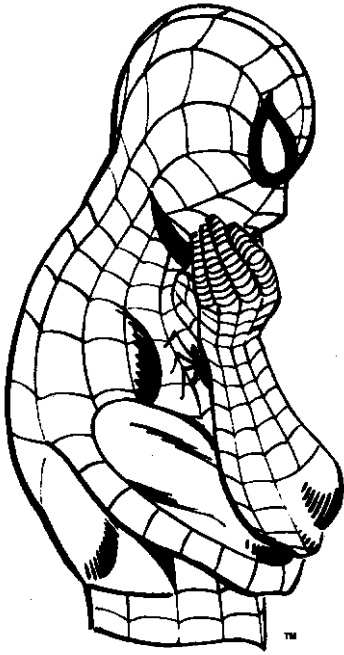

# Spider-Man To Wed Vanna White!

The Marvel Universe™ meets . . . the real world

by Fraser Sherman

If that sounds like an improbable headline, how about:

"Marilyn Monroe Was a Skrull!"

"New York Housewife Bears Captain America's Love Child!"

"Elvis: Was He Reincarnated As the Hulk?"

You won't see those titles at the local newsstand, but in the Marvel Universe, it's another story. Newspapers like the *National Enquirer* probably run as many stories about the Fantastic Four as they do about Joan Collins.

What would the world be like if super heroes were real? How would America change if some Americans had the power to level entire cities? This article covers how the Marvel Universe (hereafter called the MU) has adapted to its many super beings, what things could happen in a GM-created super hero universe, and what might happen if super heroes turned up in your home town. Though this article is oriented toward the MARVEL SUPER HEROES™ game, its ideas are applicable to other super hero RPGs.

## The Marvel Universe

In the MU, there have been super heroes as far back as World War I. The current heroic age, starting with the Fantastic Four, has lasted a little over 10 years (even though comic books about it have been appearing for nearly 30). Costumed heroes and villains are a fact of life.

That doesn't mean the public believes everything it hears. Outside New York City, few people have seen super heroes in action, and some suspect their powers and adventures are exaggerated, at least slightly, by the press. The weirder the news is, the more skeptical the public is. Iron Man is a lot easier to accept than Dr. Strange, let alone some blonde guy claiming to be the Norse god of thunder.

Not everyone likes super heroes, either. These heroes are very powerful, and power corrupts. Look at Iron Man's recent rampage against armored criminals; at Magneto, a former mutant terrorist; or at Daimon Hellstrom—would you trust someone once called the Son of Satan? Some super heroes aren't even human; there are mutants, synthozoids, androids, and aliens running around under those masks.

But the majority of people would admit that super heroes do a lot of good. Society needs them. That's why the law turns a blind eye (in the MU) to so many of their activities. It's understood that you don't make a fuss when super heroes commit breaking and entering, trespassing, assault and battery, and other illegal activities in the cause of justice. That's why so many people in comics say they don't like vigilantes. If they were in this world, taking the law in their own hands and answering to no one, I doubt I'd like them, either.

The "blind eye" helps some heroes more than others. Spider-Man has been harassed a lot by police over the years, largely due to *The Daily Bugle's* campaigns against him. The Avengers, on the other hand, have enjoyed government backing for most of their existence. New PCs may find their situation closer to Spidey's; the police—perhaps even other heroes—are unlikely to trust masked strangers until the strangers prove themselves.

Then there are other problems. In real-world America, it's unconstitutional to imprison a man in a cardboard box. But in the MU, super heroes did it to the Absorbing Man once, as it was the only way to keep him from using his powers to escape. The law has had to change to deal with super villains; punishments like this are not considered unconstitutional if they're necessary to keep a villain in jail.

Another precedent was set a few years

ago, during the trial of the Wraith (*Marvel Team-Up* #51). Being mind-controlled is now a valid defense against criminal charges. (Professor X and Moondragon were called as expert witnesses; the Wraith, his father's mental puppet, was found not guilty.) No doubt other attorneys have used that defense since, even when it's not true. When it is true, it must be very difficult to prove.

The law appears to give nonhumans at least basic human rights. For all the hatred leveled at mutants, no one has ever argued that as non-*Homo sapiens* they aren't legally human (which would mean they had no rights whatsoever). Although he's a synthozoid, the Vision's marriage to Scarlet Witch has been accepted by everyone, a good precedent if people ever ask "Is artificial life really human?"

On the other hand, the new Mutant Registration Act requires mutants to register their names and whereabouts with the government. Although it hasn't been tested in court yet, the act strikes me as being unconstitutional. Nevertheless, the MU government is going ahead with it.

For more on the subject of super heroes and the law, I highly recommend Robert G. Ingersoll's "Law is an Ass" column in *The Comics Buyers Guide*. It is very informative on such questions as suing super heroes, what constitutes a legal arrest, and whether Matt Murdock knows anything about the law.

Of course, the government may step in as well. The American government has wanted its own super heroes since the 1940s, when FDR commissioned a project to create an army of super-soldiers (the project was sabotaged after it created Captain America). Today, Marvel America employs the mutant group Freedom Force. Super agents are certainly useful, but they aren't necessarily reliable. Many militant



Resisters, who oppose the Mutant Registration Act, used to work for the government as the Mutant Force. S.H.I.E.L.D. tried to develop a super team, but half its recruits turned out to be traitors. And the U.S.S.R. has developed many super heroes (Crimson Dynamo, Black Widow, the Unicorn, etc.), but many of them have rebelled or defected.

Would the situation be the same in the real world? Would you accept Captain America as your President? Or would you fear that a super police force become as bad as the Sentinels in the MX Future in Flames module series? Look at the way people in the real world resist or succumb to the temptations of power, and decide for yourself. Loyalty might be a hero's most valuable trait.

Business will be affected by super heroes, too. In the MU, property can be insured against damages caused by super humans (I imagine there are personal injury policies, too). "Super hero insurance" is probably pretty cheap in most parts of the country; how many people in Milwaukee are likely to claim damages? But in New York, where buildings are leveled almost daily, premiums must be tremendous.

There will be clauses and exemptions, too. Insurance companies don't pay for damages caused by acts of war, so anyone who lost his house during the Wraithwar in the Rom comics is out of luck. And, contrary to a recent issue of *Avengers*, the companies probably didn't pay when Namor lead an Atlantean invasion of America, either. There may be other, special exemptions that may be fairly obvious ("Read the fine print. We don't pay for damages caused by Galactus.").

Super heroes haven't affected the rest of the business world much, but at least two new businesses have developed involving super humans. One supports the super-powered mercenary—people like Luke Cage, Paladin, or Silver Sable, who operate as heroes for hire. On the other side of the law, we have Justin Hammer and the Tinkerer, who create and repair the sophisticated equipment today's high-tech villains need.

Surprisingly, there has been little effort to merchandise super heroes except in comic books. When the Fantastic Four appeared, they were contacted by the MU versions of Stan Lee and Jack Kirby, who suggested adapting the FF's adventures into a comic book. The heroes agreed, and the book was such a success that Marvel has been signing up heroes ever since (*Nova #5* shows how Marvel goes about it). Steve Rogers once drew for his own *Captain America* comic.

## New worlds

So far we've covered how super beings have affected the MU, A new world, in which your PCs are the world's first heroes, would be another story.

To start off, the PCs have got to get

people to believe in them. If they're the very first super beings, people are going to be skeptical ("Special effects can do anything! Didn't David Copperfield make the Statue of Liberty disappear?"). There may even have been fake super humans trying to cash in with trickery ("Give me all your money! You can see by my costume that I'm a powerful super villain!").

Also, people won't be as nice about heroes bending the law as they are in the MU. It'd be one thing to stop a crime in progress, but assaulting suspected felons and breaking into alleged hideouts won't go over well with the American Civil Liberties Union. The heroes might even find themselves on the wrong end of a lawsuit. Before long, the "heroes" may run whenever the police appear, the way Spider-Man has done so many times.

The government may finally decide to accept this sort of unique law-enforcing activity. Then again, it might require super heroes to register with the police, as well as slap umpteen regulations on them. The government might even forbid super heroes to operate unless they work for the police, the FBI, the CIA, or some other official organization (or have them do it for at least a couple of years to prove themselves, then let them free-lance). On a local level, towns might want resident heroes to carry a bond against property damage or perform 20 (or 30, or 50) hours of community service a month as a goodwill gesture.

On the bright side, a nation that idolizes Vanna White ought to be *really* impressed with people who can fly. Super heroes could become the hottest celebrities around—invited to be on the "Tonight Show," begged to endorse politicians and products, become the stars of movies, TV, comic books, or even role-playing games, A starstruck America might forget any fears they had of these heroes, so long as the heroes don't get beaten or fail too often. PCs may meet or become heroes more concerned with saving their careers than saving lives. Or heroes could become so popular the public will let them get away with almost anything.

Then there are the super villains. How would a world like ours keep them imprisoned? If a PC captures a super-powered cyborg, would it be cruel and unusual punishment to remove or deactivate the foe's bionic limbs? If it were possible to take away criminals' super powers, would it be legal? And what about insurance? In a new world, insurance companies wouldn't be prepared to pay for the kind of damage super humans can do. Whenever your PCs start operating, insurance rates will skyrocket—if the companies don't just cancel everyone's policies. The current malpractice insurance crisis would be small potatoes by comparison.

## Getting started

To show some of the real-world situations that can affect any universe, ask

yourself what would really happen if super heroes turned up in your home town—or, say, my home town.

Fort Walton Beach sits next to a major military installation, a center for nonnuclear weapons research. That makes the town a natural source for PC or NPC origins ("The laser cannon imploded, and Sgt. Farren's glowing with energy!") and provides plenty of classified secrets for criminals to steal. And if the military ever decides to create its own super heroes, the research and development will probably be done here.

The military would take a keen interest in any super heroes who appear in town, monitoring or spying on them to learn whose side they're really on. Perhaps the military would even try to learn the heroes identities—in the interest of national security, of course.

Ft. Walton Beach is also a tourist town. Tourism-related business might be divided on the PCs' presence, both pro ("Think how safe they'll feel with the Protectors watching over them.") and con ("Everyone's afraid Wolverine'll be in the condo next door!"). And there's a conservative religious faction here, the kind that finds D&D® games to be "satanic." I doubt it'd be pleased if real magic-using super heroes appeared (or worse, a "false god" like Hercules or Thor).

Not everyone in the area with super powers will become a super hero. A cop who gets powers might decide to use them but as a cop ("This badge means more than any stupid costume!"). What about an IRS agent who reads minds? Or a salesman who mentally compels people to meet his prices? Or a farmer who grows super plants? ("Just got a green thumb, I guess.")

Do your players have any political views? Perhaps they'd like to have their PCs act on them (comic-book heroes seem to have no politics beyond upholding the cause of Good, but we're talking reality here). A new, hazardous landfill has become big news in this area; perhaps the heroes would like to crusade against it. But what if the landfill's backers are threatened by an eco-terrorist and the PCs have to protect the backers? What if the local KKK head is targeted by an assassin, and a black PC is asked to help save him? Suppose the PCs meet a hero who is ideal in every way except for being an outspoken bigot?

If one of the PCs is a mutant (and lives in the MU), would he protest the Mutant Registration Act or sign up? Perhaps he'd want to be a test case that a civil-rights groups could use to challenge the law in the courts. Or what if a mutant equivalent of Martin Luther King appears, urging nonviolent protest in the name of mutant rights? What would happen if he came to Ft. Walton? Would the PCs want to get involved? This sort of politics might not be to everyone's taste, but players with

*Continued on page 91*

## CONJUNCTION, July 27-29

This convention will take place at New Hall College, Cambridge, England. The guest of honor will be Gregory Stafford. Events include numerous RPGs, panels, a masquerade, and a dealers' area. Membership is £12 for those over 18. Write to: CONJUNCTION, 25 Wycliffe Road, Cambridge CB1 3JD, UNITED KINGDOM.

## 1990 GEN CON® Game Fair, August 9-12

Make your plans *now* to attend the biggest and best game convention of them all, at the MECCA Convention Center, Milwaukee, Wis.! An "Early Bird" registration form is located within this issue. Be one of the first to reserve your spot for this incredible game fair. We've pulled in over 10,000 people for two years running! Write to: 1990 GEN CON® Game Fair, P.O. Box 756, Lake Geneva WI 53147.

## GEORGIA FANTASY CON '90

September 28-30

This celebration of fantasy and horror is going to be held at the OMNI International Hotel and Convention Center, Atlanta, Ga. The guest of honor is Michael Moorcock, with many more guests to be announced. Events include four tracks of panels and workshops, a masquerade, an art show and print shop, video rooms, art, and consignment auctions! Write to: GEORGIA FANTASY CON, Box 148, Clarkston GA 30021.

Ω

## Editorial

Continued from page 5

Other conventions have done similar things (and I would love to hear from their organizers to find out how they did it).

The RPGA Network offered one piece of advice to me on this topic. If you want to donate some of your convention's proceeds to a helpful organization, contact several such organizations long before-hand and let them know what you are planning. Get them to respond and explain how they will use your donation, then choose the one that you feel will do the best job. If you are going to help others, help them wisely.

A convention may even support several different organizations and causes, if donations are made from different events. These events could be made regular convention features, offering the most challenging tournaments or entertaining auctions.

If you do nothing else, you can always set up a secure box for voluntary contributions, advertising its presence to all gamers and staff. At the end of the con, let everyone know how much was collected—and keep a year-by-year track of your donations (that seems to encourage better donations over time).

**At Home:** Okay, so you aren't a convention organizer or even a convention goer. But you have meetings with your fellow gamers at your home. You can still help.

Set up a voluntary tithing system for your campaign. Does your paladin have to make his monthly donation to his church? Toss a quarter into a piggy bank each time he does so. Does your thief have to give the guild a cut of his weekly profits? Drop a dime into a jar after you cross off his gold pieces. Is it time for your warrior to build a castle? Toss a dollar into the kitty. After three months, add it all up and send it off—with everyone's contribution going to his or her favorite real-world cause—and start over again. Even dumping pocket change into your "savings" can add up over the weeks.

And what if you live alone and play solo games? Toss a quarter into the pot every time you play out an adventure on paper or on your computer, and see it add up.

Picking a cause is easy, and every player can have a different cause. What worries you most: disaster relief? educational quality? pollution control? medical advancement? Does your local library, school, or hospital need a new wing? Do you have brothers, sisters, cousins, or friends who live in areas hard-hit by disaster or poverty? Have you had enough of sitting around and listening to the news rather than making the news yourself? Then do something about it!

**The Bottom Line:** It is a fact that 99% of all player characters do not care about anyone else but themselves. That's the way things are in most role-playing games. But that does NOT have to be the way things are in real life. You are greater than that, and you can make a difference in the lives of thousands, if not millions, of people in any part of the world you choose.

And all you have to do is play games. Hell of a system, isn't it?

For the good of our world, give it your best.

## Spider-man

Continued from page 78

strong views might enjoy putting them to the test.

## A final thought

You don't have to make your game "realistic" if you don't want to. Realism is not an end in itself. If you think the real world would hate, fear, and outlaw super heroes, but you and your players don't like that idea, don't use it. The purpose of realism in gaming is simply to make the game more enjoyable. RPGs are meant to be fun, after all.

MARVEL, MARVEL SUPER HEROES, MARVEL UNIVERSE, and all Marvel characters, names, and likenesses are trademarks of Marvel Entertainment Group, Inc.  
Copyright ©1989 Marvel Entertainment Group, Inc.  
All Rights Reserved.

# RAL PARTHA

HAS UNLEASHED

Advanced  
Dungeons & Dragons®  
MINIATURES

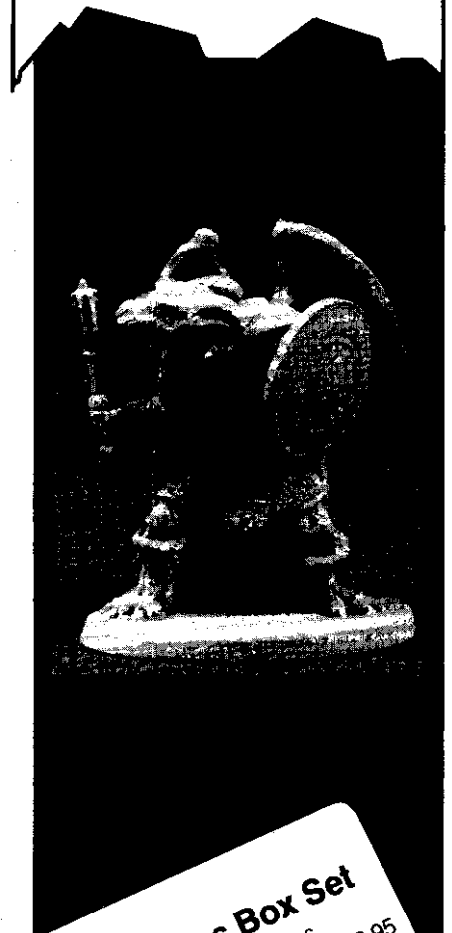

10-501

Draconians Box Set  
1 of 10 Draconians \$12.95

Advanced  
Dungeons & Dragons®

Advanced  
Dungeons & Dragons®

Call us now toll free 1-800-543-0272  
or send \$3.00 for our full photo catalog  
5938 Carthage Court Cincinnati, Ohio 45212



ADVANCED DUNGEONS & DRAGONS and the TSR logo are trademarks owned by and used under license from TSR, Inc. © 1989 TSR, Inc. All Rights Reserved.

# To the Ends of the

## Earth isn't the only world that needs heroes

by David Edward Martin

Role-playing in the MARVEL SUPER HEROES™ game is not restricted to having your heroes battle evil on Earth. Many of the greatest triumphs of the Avengers, the Fantastic Four, and the X-Men have occurred in outer space. Why not take your campaign to the stars, too?

But before you can go adventuring into the far-flung reaches of the universe, you first need a way to get there. A variety of means to reach the stars exists, from personal flight using superpowers to the use of external or mechanical means. Some examples of spacefaring methods include:

*Slower Than Light (STL) drives:* STL ships can reach speeds up to that of light. If such a ship is intended for interstellar flight, it may be equipped with suspended animation chambers or a life-support system capable of sustaining passengers for years or centuries.

*Faster Than Light (FTL) drives:* FTL ships are capable of exceeding lightspeed, but they still travel in "realspace."

*Advanced FTL drives:* Better engines enable advanced FTL starships to attain speeds 10 times faster than normal FTL drives.

*Warpdrive:* Warpdrive ships are capable of entering hyperspace and thus attaining FTL speed. Warpdrive ships might be limited to STL flight in normal space.

*Advanced warpdrive:* Better warp generators enable a starship to travel at speeds 100 times faster than can be achieved by normal warpdrives.

*Teleportation:* Instantaneous travel across the universe for individuals or small loads is possible with this power.

*Stargate:* A stargate uses a form of teleportation. A fixed-location device (the gate) instantaneously teleports an entire spacecraft to another stargate. Stargates are assumed to be rare, being so powerful.

The type of stardrive determines its speed range. The power rank number determines its basic speed value, which is then multiplied by the standard modifier for that class of travel. Table 1 shows the basic starship types and their speed for the MARVEL SUPER HEROES game.

**Table 1**  
Starship Types and Speeds

Rank	Speed (in multiples of lightspeed)			
	FTL	A-FTL	Warp	A-Warp
FE	2	20	200	20K
PR	4	40	400	40K
TY	6	60	600	60K
GD	10	100	1K	100K
EX	20	200	2K	200K
RM	30	300	3K	300K
IN	40	400	4K	400K
AM	50	500	5K	500K
MN	75	750	7.5K	750K
UN	100	1K	10K	1M
X	150	1.5K	15K	1.5M
Y	200	2K	20K	2M
Z	500	5K	50K	5M
1000	1K	10K	100K	10M
3000	3K	30K	300K	30M
5000	5K	50K	500K	50M

K = 1,000; M = 1,000,000.

### In the wink of an eye

Stargates and teleportation systems and powers enable travelers to instantaneously cross long distances. Travel time is limited by the amount of time it takes to make each jump and the number of jumps necessary to cover the desired distance. Most

**Table 2**  
Starship Flight Category

1d100	Category
01-10	STL
11-25	TRL
26-45	A-FTL
46-55	STL/Warp
56-75	FTL/Warp
76-85	A-FTL/Warp
86-90	STL/A-Warp
91-95	FTL/A-Warp
96-00	A-FTL/A-Warp

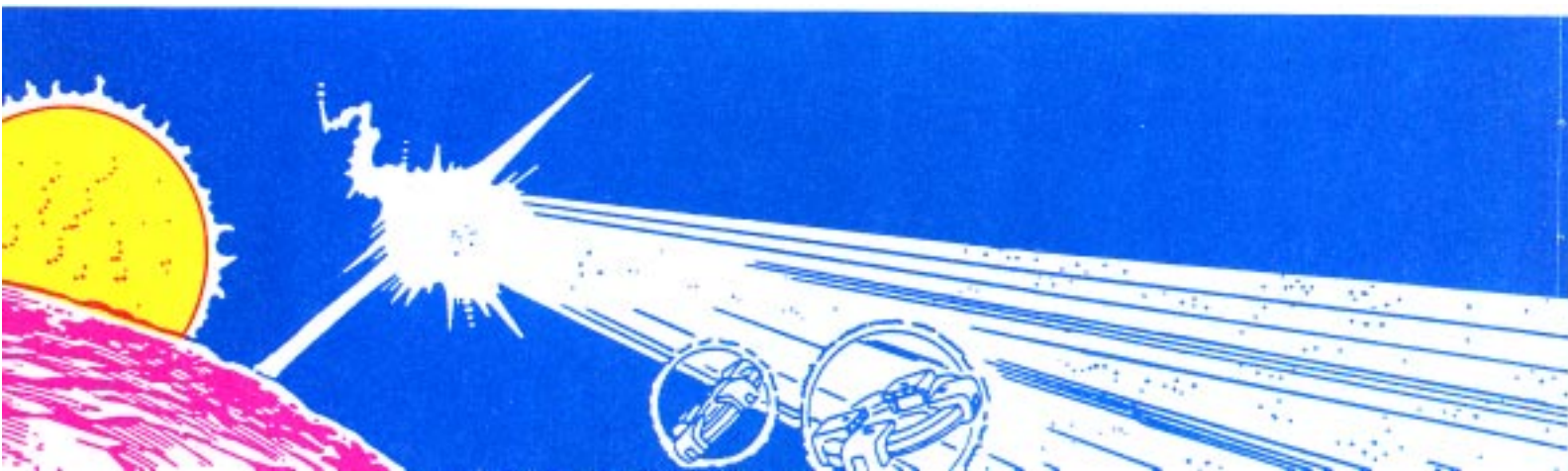



# MARVEL UNIVERSE™

teleportation systems are designed to handle individuals or small loads. They may be placed on planetary surfaces or built into spacecraft of any sort.

Stargates are immense portals capable of handling entire starships; these devices often appear to be titanic doors or hoops miles across. Objects must be able to physically pass through a stargate in order to use it. Starships can be moving at sublight speed when they use a stargate, although the ship must be piloted very accurately. The Shi'ar are the primary users of stargates; they maintain a network of them through the universe, including one within 10 lightdays of Earth. At this time, the gates are heavily guarded at the Shi'ar ends.

A portable stargate was left in Manhattan by Shi'ar agent Davan Shakari. This stargate is currently powerless and thus can only receive travelers. However, it can be made operational by a power source of at least Shift-X intensity (for example,

Firelord's cosmic power). This stargate's existence is known to the X-Men, X-Factor, Firelord, Lilandra, Misty Knight, and Jean Grey's parents. Although it was last seen on the roof of Misty Knight's apartment, the current location of the stargate is unknown. Unless the stargate is reprogrammed, it will send any user to the unnamed world within the Shi'ar Empire that holds the M'Krann Crystal. This barren world is normally uninhabited. This stargate can be reprogrammed by an Incredible Reason FEAT

## Natural spacewarps

The structure of the Marvel Comics' universe is riddled with spacewarps. These function as interdimensional tunnels that enable any ship capable of FTL flight to swiftly cross enormous distances in even less time than usual. Earth is near one of the largest junctions of spacewarps in the universe, a crossroads for half the known starfaring races. This is one of the reasons why Earth keeps attracting so many space travelers. Known warps include several linking Earth with various points in the Andromeda galaxy and one to the Kree Empire in the Greater Magellanic Cloud, a satellite galaxy of our Milky way galaxy.

## Your own starship

The MARVEL SUPER HEROES Advanced Set contains the basic procedure for building your own starship. If you take an Amazing Reason FEAT to design a star-drive capable of FTL flight. The Resource FEAT is X rank for a basic FTL ship, higher for a more advanced model.

Sometimes a powerful energy source can be used to modify an STL ship to FTL speeds. One such example was the use of Thor's Mjolnir to propel a Quinjet between the stars. Such an energy source must be of at least Unearthly rank, and the ship to be so modified must have at least an STL drive.

Starships can also be directly gained by a variety of means, proper and improper. Ships may be recovered if abandoned, stolen from their owners, or rebuilt from parts scavenged from damaged vessels. Terrans kidnapped by aliens might overthrow their captors and seize the aliens' ship for themselves. A starfaring race may present a Terran with a starship as a gift or reward, such as when Prince Dezan gave a Skrull starship to the Fantastic Four. If all else fails, travelers can always try buying a starship, assuming your PCs can find one for sale.

Tables 2-4 can also be used to quickly generate a starship with a few rolls of the dice. Table 4 determines the number of typical humanoids that can be kept alive by the life-support system, allowing at least one chair or berth for each potential passenger. If a cargo ship is desired, subtract 1-10 crew-beings and multiply the remaining number of passengers by 200 lbs. to get the starship's cargo limit.

**Table 3**  
**Starship Speed Ranks**

1d100	Speed rank
01-08	FE
09-16	PR
17-24	TY
25-32	GD
33-40	EX
41-48	RM
49-56	IN
57-64	AM
65-72	MN
73-79	UN
80-85	X
86-90	Y
91-94	Z
95-97	C1000
98-99	C3000
00	C5000

**Table 4**  
**Starship Passenger Loads**

1d100	Maximum passenger load
01-20	1
21-60	1-10
61-90	1-100
91-99	1-1,000
00	1-10,000

MARVEL SUPER HEROES is a trademark of the Marvel Entertainment Group, Inc. All Marvel characters, names, and the distinctive likenesses thereof are trademarks of the Marvel Entertainment group, Inc. ©1990 Marvel Entertainment Group, Inc. All Rights Reserved.

# In Harm's Way —At Home!

Danger rooms for MARVEL SUPER HEROES™ campaigns

by Michael Hollinger

The Uncanny X-Men had the first one. Just about every super-hero group with a base now has one, yet very few groups use one to its full potential. I am speaking of the danger room, a training arena that is one of the most useful, if seldom used, tools that a MARVEL SUPER HEROES™ game Judge has. With the system presented in this article, Judges will be able to make their own danger rooms for their crime-fighting groups, ready for super heroes to use within half an hour.

Before the procedure for creating a danger room is laid out, a few things should be said about running a danger room. First, heroes should take only one-

fourth normal combat damage in a danger room (robotic opponents pull their punches, etc.). I have my gamers' groups immediately sent to the clinic at their base after a danger-room workout, then decree that all damage taken has been healed (it saves on paperwork). Second, I have my danger rooms divided into small areas called tiles; one floor tile is equal to one MARVEL SUPER HEROES game area for determining a hero's movement, range, etc. Third, a floor tile is activated when any weight is placed on it. If a Judge wishes, the pressure necessary to trigger a tile can be so sensitive that a character flying overhead can set it off due to the slight

change of air pressure above it. Once activated, a tile presents a hero with a crisis (an attack robot or a trap) that must be confronted and overcome.

A danger room should not be so difficult that the heroes have no chance to "pass" it, but neither should the heroes be able to pick off crises with ease, one at a time. The best solution I've found is to start with easily triggered tiles until the heroes are up against impossible odds, then have whoever is controlling the danger room decrease the sensitivity until running across the tiles alone will activate them. As a last resort, if the heroes are overwhelmed, turn off the sensitivity of the tiles completely. The tiles cannot usually differentiate as to what causes the pressure on them, so the results of activating one tile could conceivably activate one or more other tiles.

It helps to assume that a nonplayer-character hero, one who doesn't go out adventuring very often, is in charge of the danger room and can design its horrors without the knowledge of the other heroes. An enthusiastic scientist/technician (something like Q from the James Bond movies) works best for the danger room's manager.

## Danger-room construction

The first step in creating a basic danger room is to draw the grid of tiles on which the characters will play out the scenario. (The design here is quite basic; more unusual designs may be developed, too.) I suggest the use of a manila folder on which to draw out the danger room. By folding the map up, you also have a handy folder for keeping all danger-room-related forms. In addition, the folder is the right size for play and is much sturdier than normal paper.

With a pencil, first draw out a large rectangle or square, about 10" across, centered on the unfolded folder. This is the outer wall of the danger room. The room's walls are 1/4" thick on paper. On the left side, draw in the control room, where the danger room's activities are monitored, and mark it as such (computers and control consoles may be added as well). On the right side, draw in lockers





and showers for the heroes to use after their workout. The ceiling height in the danger room itself is assumed to be about two stories. The material strength of the danger room's walls, ceiling, and floor is assumed to be Monstrous, though the Judge may alter this.

Next, mark along the top wall of the danger room itself, between the control room and the showers, in 1" segments, using a pencil and ruler. Starting in the top left corner, make the first tile (called A1) 1" long by 1" deep. Tile A2, moving right, should be the same size, and so on to tile A7. Row B, just underneath, is composed of six tiles; B1 is 1½" x 1", B2-B5 are 1" square, and B6 is like B1. Row C is like Row A, Row D is like B, and so on down to Row J, which is like Row B. (Optionally, the room may be lengthened by having the center tiles be 2" long by 1" wide.) This produces a bricklike layout of tiles.

It is much easier on the eyes if you put the outlines of the tiles and the outlines of the walls in different color pens, or have the walls in pen and the tiles in pencil. I can almost guarantee that if you don't do this, at some point a character will try to walk through a wall.

The danger room is specifically made with 10 rows and six active columns so that any location may be rolled with 1d10 to determine row and 1d6 to determine column (tiles A7, C7, E7, G7, and I7 are left inactive as "safe zones").

### A sea of crises

Now that the danger-room map is complete, it is time to fill the danger room with things to make the heroes jump, fall, get knocked unconscious, or what have you. The first step in filling a danger room is to determine the number of tiles that contain crises during a particular scenario. You can either select a number (start with 10-15 crises for introductory scenarios), or else you can generate a number. In the latter case, roll 1d6 for the tens' digit and 1d10 for the ones' digit, with a roll of 0 = zero, not 10. This die roll will generate a number between 10 and 69. Do not be alarmed at the fact that it is possible to have more active tiles than exist in the room; a tile can have more than one crisis on it. It is recommended, however, that no more than three crises be placed on any one tile. Remember: The more tiles that produce an effect, the longer the process

takes to fill out the danger room.

Danger rooms present crises in two basic ways: robots and traps. A danger room can arbitrarily hold a maximum of only five different types of robots and five types of traps. One specific robot type and one specific trap type have special programming, as detailed later, and usually only one of each of these will appear in the danger room at any one time. All other robots and traps have "generic" programs and are assumed to be unlimited in number. Each "generic" robot and trap should be designed before the game begins, using the section "Traps & robots" herein.

The special robot is an emulation robot, which is designed to look and act as though it is a real costumed hero or villain. All of its statistics come directly from criminal files (in game terms, the Advanced Set Judge's Book or any game module), and it is programmed to respond in a reasonably complex, "intelligent" manner, though the robot is not itself intelligent. Note that the real hero or villain copied by this robot might have powers not known to the super heroes, and these powers won't appear in the robot (surprise!). The special trap simulates a natural disaster. Once set off, this trap presents the effects of a volcano, tornado, blizzard, or the like over an expanding area of the danger room.

The method for determining what type of crisis is activated by a tile is rolled on the following table:

1d10	Result
1-4	Robot (type 1-4)
5	Emulation robot
6-9	Trap (type 1-4)
0	Natural disaster

Robots and traps are created using the section "Traps & robots" herein. Secondary die-roll encounter tables should be created for the four robot and four trap types, with one of each appearing per tile

activation. Results from this table need not be assigned to each tile prior to its activation, but assignment will let the Judge better control the scenario. Once a tile has been activated and its crisis dealt with, it becomes "safe" for the rest of the scenario if no other crisis has been assigned to it.

If an event is selected for a tile that has already been activated and is now presenting a crisis, the Judge has three options. He can either reroll the location, use the second crisis for the second time the tile is activated, or place the crisis on an adjacent tile. Again, allow no more than three active crises per tile per scenario.

### Your mission is...

Now the Judge should determine the mission that must be completed in order for Karma to be awarded for the scenario and in order to have the danger room turned off, unless the team wishes to admit defeat. (Of course, the danger room can be shut down by the controller if the heroes look like they're about to be killed!)

For random mission determination, roll on the following table using 1d6. If the Judge wishes to make the mission slightly harder or easier, merely add an appropriate modifier. Note that the Clear mission is usually so hard that it cannot be randomly rolled without a modifier. Also, the object of any mission will always be a nonliving thing; to use living victims would be cruel. The table to generate the object of a mission is given later on.

1d6	Result
1	Transport
2	Recover
3	Destroy
4	Protect
5	Assemble
6	Survive
7+	Clear

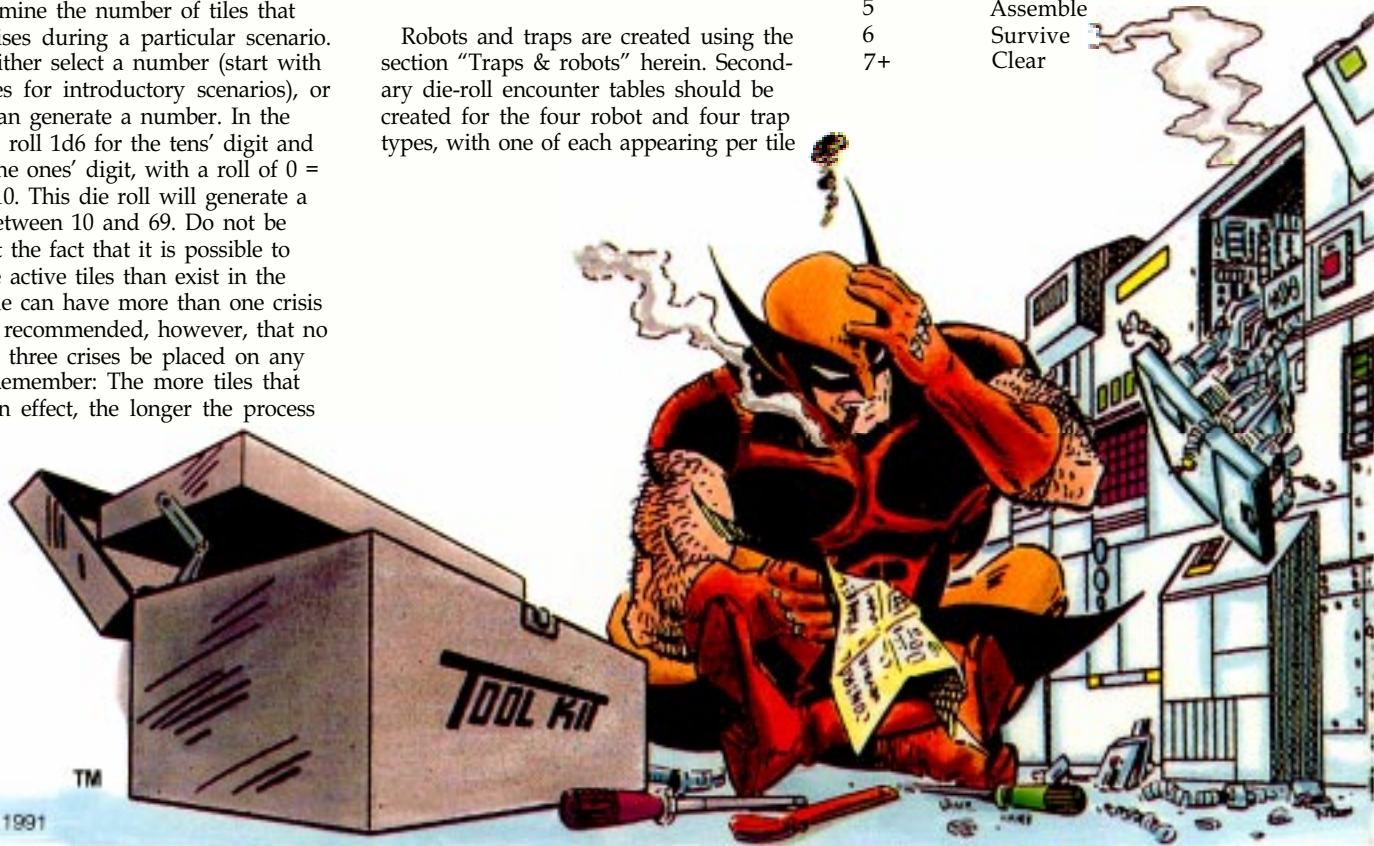



*Transport:* Roll for or select two tile locations, the first being where the object starts and the second being its destination. The heroes' objective is to move the object from the starting point to its destination. Because this mission is usually easy, the Judge is encouraged to assign extra complications or crises.

*Recover:* Roll one tile location; this is where the object is originally situated. The objective of this mission is to bring the object in question outside the danger room. On this mission, a robot always guards the door. (Roll up the robot's statistics as per a normal robot player character in the game; do not count this one against type allotments for the danger room.)

*Destroy:* Roll for the tile location of the object. Next, give the object either body armor or a force field. Roll 1d100; the rank in which the number falls is the rank of the armor or field. For instance, if a 53 is rolled, the rank is Amazing (53). The object of the mission is to bypass the defenses and destroy the object. Certain rolls may be disregarded and rerolled if the armor or force field is too strong or too weak to challenge your heroes, but always allow the heroes a chance at victory.

*Protect:* After placing the object in question on a randomly rolled tile, roll up two robots (using player-character rules for the game) for every three characters in the group. The players must prevent the robots from destroying the object. The PC robots will not move until they are attacked or until a hero activates the tile on which the object is located. Once this happens, no more tiles that activate robots will function; however, traps and currently active robots will remain active. The players must clear all remaining robots

from the danger room.

*Assemble:* After creating an object using rules given later in this article, have it be disassembled, then roll a random location for each piece. The objective of the mission is to put all the pieces together again. It takes one turn to put two pieces in the same area together, or two turns if the object is deemed awkward by the die rolls in the following section.

*Survive:* Do not select an object for this mission; the mission is hard enough as is. Roll 1d20 + 10 to generate a number between 11 and 30. This is the number of turns for which all the heroes must remain conscious. Generate two robots, using player-character rules, for every character entering the danger room. Make all powers for the robots combat related (e.g., don't take Plant Control), and have one of the robots for each hero possess a power geared to take advantage of that hero's greatest weakness or to confront his strongest power. The rank on this power should be equal to the hero's power that it is working against, with a bonus of +1CS. For example, Iceman, with Ice Generation—Remarkable (30), is going into the danger room; a robot specifically designed for him might have Fire Generation. (If the Judge is unsure of what a good opposing power would be, find out what its nemesis is in MA3 *The Ultimate Powers Book*, a volume most certainly worth its price). The Judge should start off with all tiles active but, in all probability, will soon have to turn them off.

*Clear:* In this mission, no object is created, as the players will not have time to deal with one. The players must deactivate every single robot in the complex. Each turn, a number of robots equal to three times the number of the characters is

automatically activated. In addition, one emulation robot per turn activates. Again, this is a very difficult mission. Use it sparingly but threaten characters with it often.

Next, use Table 1 to generate the characteristics of the object of the mission. Roll once each for the object's size, weight, and material strength. If the mission is "Assemble," roll for the number of pieces. The term "object" is deliberately generic so as to let the Judge throw in an interesting twist. For instance, the heroes will treat a glass figurine much differently than a lump of tin.

If the term "awkward" is rolled, make a note of it and reroll for its weight. In addition to the Strength FEAT, the character attempting to move an awkward object must also make an Agility FEAT vs. Remarkable intensity. Should the term "awkward" be rolled again, increase the intensity of the Agility FEAT by +1CS each time.

After determining the mission and its object, roll for complications. The exact number is left up to the Judge, but the suggested number is six minus the number of the mission rolled. This allows the Judge to balance out the danger room. Thus, if you've consistently rolled up easily beaten opponents, you can still challenge the players with complications. Conversely, the "Survive vs. Godzilla's Five Cousins" mission can be made playable by having one or two of the creatures explode on the eighth turn.

Roll 2d6 on the following table to see which complications come into play. With the exception of "May self-destruct" and "Will self-destruct," any repeat rolls are cumulative. The complications are explained in the following section.

2d6	Complication
2	Timed (1d6 turns)
3	Stay 1d6 extra turns
4	Combine two missions
5	Object is hostile
6	Object moves
7	Object is hidden
8	Timed (3d6 turns)
9	Object is protected
10	Object moves quickly
11	May self-destruct
12	Will self-destruct

*Timed:* The mission must be completed within the allotted amount of turns or else one random tile per turn will be activated at double-normal potency. If the random tile activates a robot, double all its ranks (by number) to a maximum of Monstrous. Traps will automatically move beneath the hero and have doubled effects. If the tile rolled was unoccupied, no effects are felt.

*Stay 1d6 extra turns:* After the mission is completed, the group must set off half the tiles and overcome them all. Should they succeed before all extra turns are up, keep sending things at them one at a time.

*Combine two missions:* Roll for another mission but keep the same object, then

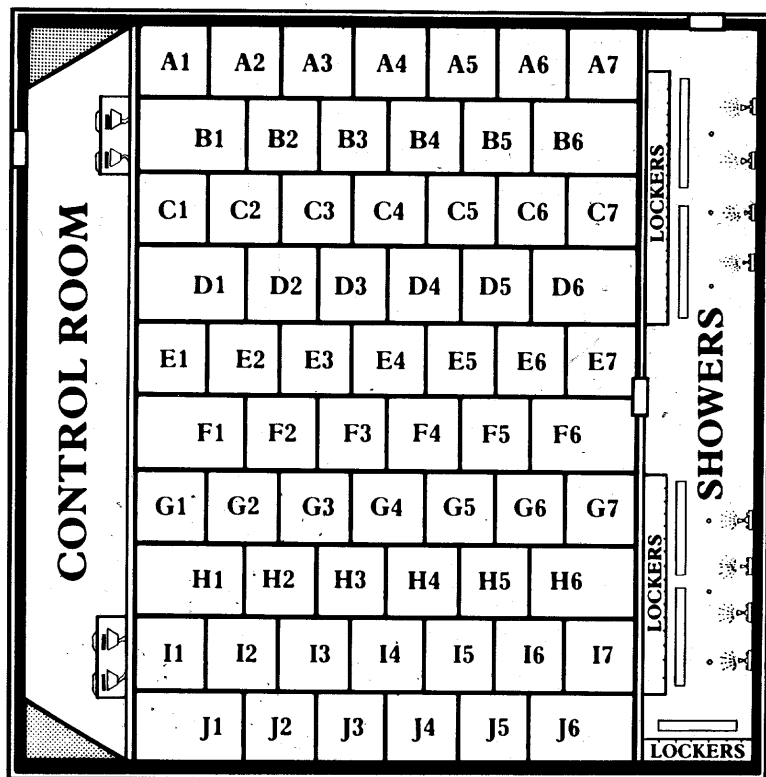

combine the two missions. For instance, Transport and Survive are rolled. The characters might have to bring a robot to a tile where it will activate, then must destroy it and stand guard. Even better, the characters must catch an emulation robot and transport it to a giant garbage disposal or "prison" on a certain tile, standing by to ensure its destruction or capture. The possibilities are limitless.

*Object is hostile:* The object has a weapon for use against anything that comes into its area.

*Object moves:* The object moves 1-4 tiles every turn in any direction the Judge chooses.

*Object is hidden:* The object in question is hidden beneath a tile (the Judge might not tell where), and the tile covering it must be activated in order to gain access to the object. Any traps or robots lying in wait are also sprung when the tile is activated. If the Judge decides not to tell where the object is, the heroes must search for it. While Penetration Vision or other powers will work, the easiest and most fool-proof searching method is still the Accidental Mine Detector routine (i.e.: pray, step, pray, step, etc.).

*Object is protected:* Four robots are already protecting the object from any type of outside interference.

*Object moves quickly:* On each turn, roll 1d6. On a 5 or 6, the object moves to a totally random location (roll location on 1d6 for the row, 1d10 for the column) either by flight, teleportation, running, or some other form of locomotion. If the object moves by any means other than teleportation, the characters must make an Agility FEAT vs. Amazing intensity to

catch it while it is in motion. Any tiles the object runs across, flies over, or lands upon are automatically activated.

*May self-destruct:* Each turn that the characters occupy the same tile as the object, there's a 50% chance that a timer will be set off, allowing 1d6 turns to pass before the object explodes, doing Incredible (40) force and Excellent (20) edged attack damage. The heroes should be informed of this complication but should not know the number of turns before it explodes. The longer the heroes hold on to the object, the more exciting this complication gets.

*Will self-destruct:* The timer is set for 1d20 +5 turns and starts when the first tile is activated. Any character on the same tile as the object (or on an adjacent tile) in the turn in which the object explodes takes Incredible force and Excellent edged attack damage as before. The heroes should be informed of this complication but should not know the number of turns they have before the object explodes. Again, the longer the scenario, the more suspenseful this complication gets.

### Enjoying the scenery

After the mission and all its complications are finalized, the Judge should add 1-3 landforms to vary the room's topography. Roll for the location of one tile as a starting point for each landform, then expand the landform's size to a minimum of three tiles. The following table is intended for use only if the Judge is unsure of what to put in.

2d6	Landform
2	Stream or river
3	Pit
4-6	Hill
7-8	Pond or lake
9-10	Bluff or cliff
11-12	Chasm

Any variation in height is usually one story high or deep. If a character falls off a ledge, treat it as a charging attack against the ground. Short-circuiting robots in water is a very common ploy in my scenarios, so add a pond at least.

In no case should a topographic feature interfere with an active tile. For instance, a robot that emerges from a tile beneath a lake would be resistant to water. A trap at the same place might indicate that the lake is really made of poisonous water or acid.

### Traps & robots

The last step in creating a danger room is to give identities to the various traps and robots that infest the room. Emulation robots should each be assigned a personality as noted previously (Doctor Doom is the best!), and all disasters should be worked out.

A trap is easy to describe but often hard to design. Some ideas to get you started would include:

- power-nullification traps
- web-casting traps
- logic traps (the character must solve a riddle to escape)
- pit traps
- spike traps
- moving-wall traps (walls move in at the rate of one area per round)
- character-specific traps
- acid traps
- power-lowering traps (-2CS power drop)
- traps that use a character's power against him
- illusion traps
- traps that cause a character to fight his group

**Table 1**  
**Mission Object Table**

1d6	Size	Strength to lift	Pieces	Material strength
1	Very small	PR	2	FB
2	Small	TY	3	PR
3	Medium	GD	4	GD
4	Large	RM	5	EX
5	Very large	IN	7	IN
6	Awkward		9	AM

**Table 2**  
**Robot FASE Statistics**

1d10	Rank
1	PR
2-3	TY
4-5	GD
6-7	EX
8-9	RM
10	IN

**Table 3**  
**Robot RIP Statistics**

1 d 1 0	Rank
1-3	FE
4-5	PR
6-7	TY
8	GD
9	EX
10	RM

**Table 4**  
**Robot's Number of Powers**

1d10	# powers*
1	(0,1,0)
2	(0,1,1)
3	(1,1,1)
4	(1,2,0)
5	(0,2,1)
6	(1,2,1)
7	(1,2,2)
8	(1,3,1)
9	(2,3,1)
0	(2,3,2)

\* The first number is the number of detection/movement powers; the second number is offensive powers; the third is defensive powers.

- gas-spray traps
- entangling traps
- machine-gun traps
- traps that set off 1-3 other tiles
- paralysis traps

**Disasters:** A natural disaster is very similar to a trap, except that its area of effect keeps expanding by one tile per turn in all directions. Starting on the fourth turn, the Judge should roll 1d10 on the following table to see the progress of the disaster. If "No change" is rolled as the first result, the expansion of the disaster's area of effect continues.

1d10	Result
1-5	No change from previous roll
6-8	Expansion/retreat halts
9-0	Area of effect retreats one tile in all directions

Some ideas for potential natural disasters include:

- Volcano: blinding ash, lava (TY (6) force, IN (40) heat), poisonous gas of RM (30) intensity
- Forest fire: blinding smoke, heat (TY (6) + 1CS per turn, max. AM (50)), poisonous gas of EX (20) intensity
- Nuclear explosion: instantaneous RM (30) force, AM (50) heat, AM (50) radiation optional
- Monsoon: winds, flying debris and water doing EX (20) edged attack damage
- Sea wave: water with AM (50) force and triple speed (no halt/retreat)
- Blizzard RM (30) intensity cold, blinding snow doing EX (20) edged attack damage.

**Robots:** A normal robot is generated by a series of 1d10 rolls on Tables 2-4. Roll four times on the first table for each of the FASE scores, then three times on the second table for each of the RIP scores. If any three of the mental statistics is FE (2), this type of robot has no on-board intelligence. As such, the robot takes a -3 modifier on the number of powers it possesses, but it is invulnerable to all mind-affecting powers. No danger-room robot is truly self aware; they are simply well programmed. After determining the robot's statistics, roll for its number of detection/movement powers, offensive powers, and defensive powers, then select them at your discretion from the Advanced Set booklets or *The Ultimate Powers Book*. Ranks can be determined by using the MARVEL SUPER HEROES game tables or by rolling 2d20 + 10 and using the rank number so indicated (i.e., for 42, the rank is Incredible).

Roll up a danger room and show your heroes how much trouble they can have without ever leaving home! Ω

Marvel characters and the distinctive names and likenesses thereof are trademarks of Marvel Entertainment Group, Inc. and are used with permission. Copyright ©1991 Marvel Entertainment Group, Inc. All Rights Reserved.



# Keeper's Kit

**A Rugged Package of  
Globular Goodies,  
Blasphemous Bookcover,  
Protoplasmic Poster,  
and a Stupefying Scenario.**

The **Keeper's Kit** is an aid for both keepers and players of the **Call of Cthulhu** roleplaying game. It contains a plethora of rare and valuable items garnered from the dark recesses of mankind's imagination. Within is a keepers screen summarizing all of the forbidden secrets contained within the mysterious **Call of Cthulhu** tome; a giant poster depicting a mind-searing vision of Mythos Horror; a packet of new Investigator Sheets on which to chronicle your character's plunge towards insanity; a new tale of Mythos perfidy; either a back-window sticker or a bumper sticker to proclaim your support of Miskatonic University; and a notepad for the keeper on which to plan and scheme.

**AVAILABLE ON MAY 1st**

Item #5108

\$14.95

Available from your local games retailer.

**Chaosium Inc.**

950-A 56th Street, Oakland CA 94608-3129

Write or call 415-547-7681 for a free catalog. M/C, VISA orders accepted.

## Editorial

Continued from page 7

18. We look for unique and interesting plots (a) in module proposals for DUNGEON Adventures before all else, though a proposal had better have a good length, game accuracy, and an interesting setting, too. There are lots of other things we look for, too, like distinctive characters, but plot comes first. Does the module tell a story? If not, out it goes.

19. An article that takes up 25 pages in DRAGON Magazine is far too long for our tastes these days, so answer (b) is important. But (e) is important, too, because there's absolutely no point in replacing a brand-new official game system until that system has been tried and tested. The AD&D 2nd Edition *Complete Psionics Handbook* deserves a fair shake. None of the other reasons given make any difference. Note in particular that DRAGON Magazine has published unofficial additions and changes to official rules hundreds of times; it's our stock in trade.

20. You're best off starting with (b) to make sure you aren't publishing something lifted word-for-word from a copyrighted source. A game inconsistency (a half-elven magic-user in the D&D game) was mentioned, but this might have been easy to fix on the editor's part. Sillier ideas have been published and have proven to be quite popular, and sometimes it's okay to railroad the characters into an adventure, so long as you're careful about how you do it and so long as you don't do it very often.

So now you have an idea of what goes through your editors' heads as they look over your article, module, or game submission. \*\* And you thought anyone could do this.

Next month, another topic—but no test. Enjoy!

*Roger Moore*

\* And don't send us a module with a dungeon in a dead brontosaurus, either. The Avalon Hill Game Company has already published one of those in a RUNEQUEST® module. I am completely serious.

\*\* If you were about to send us a module in which a tinker gnome in battle armor must fight a goliath-monster with a *Bohemian ear-spoon* +5 that has taken over a planetoid shaped like a klein bottle inhabited by a shirokinukatsukami, think again.



Basic battle tactics for your super heroes

# “It’s clobberin’ time!”

by Dale A. Donovan

When my gaming group started playing the MARVEL SUPER HEROES™ game back in high school, we were all still gaming rookies. As my game mastering and the players’ skills improved over the next several months, I wanted to introduce a sense of strategy and tactics into the group’s battles. I tried to have my villains use intelligent tactics whenever appropriate in an effort to show the heroes the benefits that having a sound battle plan can produce. And, after their heroes got their heads handed to them once or twice, the players caught on.

This article will help you develop an understanding of some basic tactics that you can use to help your heroes win more of their battles against the forces of evil and villainy everywhere. Heroes are sorted into various categories with titles borrowed mostly from the military, with each having certain offensive and defensive strengths. Although I’ll be using MARVEL SUPER HEROES characters and game terms as examples, the categories describe heroes in general, and the tactics should apply equally well to any superhero RPG.

## Combat categories

**Infantry:** This category of heroes is made up of ground-based (no flying, gliding, etc.) heroes who have few or no true super powers and whose main tactic is to close with the enemy and engage in melee. In the MARVEL UNIVERSE™, this category is represented by the likes of Captain America, Black Knight, Mockingbird, Black Panther, Wolverine, and Daredevil. Their styles and weapons are irrelevant, as all of these heroes do the majority of their fighting in close quarters with the enemy. Other powers or abilities that heroic infantry might possess are: martial arts, weap-



TO SAVE  
THE DREAM--



ons, or acrobatic skills; injury-resistant or enhanced senses; or the ability to make multiple attacks per combat round.

**Offensive tactics:** Like its military name-sake, heroic infantry is the best force around at taking and holding ground. When attacking foes, infantry's success or failure often determines the ultimate success or failure of the combat. To insure success, infantry needs support from other types of heroes and should develop some alternatives to the all-too-common frontal assault. Attacking your foes from their flanks or rear is a great way to confuse and distract them. Forcing your foes to react to two or more groups of heroes, coming from different directions, often causes those foes to split up their own forces in order to deal with the threats. Just be aware that dividing your forces for a flanking attempt will also weaken your group as a whole, especially if you are discovered before you are ready to attack. If you doubt that heroic infantry can do much damage in a flanking maneuver, consider what would happen if the Daredevil, Captain America, and Wolverine attacked your heroes from behind.

**Defensive tactics:** Since infantry seldom has true powers, it often cannot withstand an all-out attack by super-powered foes. It is often best, when under this kind of attack, for the infantry to find cover and wait for the other heroes to give it an opening to turn the tide. If no such help is available, the infantry should stay together and make the enemy come to it. Prepare an ambush or some confining trap. Play "cat and mouse" with the foe, and use teamwork to pick off enemies one at a time. These are tactics that Wolverine has used quite successfully

many times. The Dodging and Evading tactics from the MARVEL SUPER HEROES Advanced Set *Player's Book* can also be effective defensive tactics.

**Speedsters:** In super-hero games, this term refers to characters with super speed or other heightened ground-movement powers. In the MARVEL UNIVERSE, some notable speedsters are Quicksilver, Makkari, Super Sabre, and the Whizzer. Any hero qualifies who possesses a power that allows him to cover larger-than-normal ground distances in a round (such as lightning speed or leaping) or allows him to make multiple attacks per round. Note that not all GMs allow speedster characters to make multiple attacks merely because they possess super speed; they must also possess an "extra attacks" power. Characters like this may also have a high agility, endurance, or an injury-resistance power (body armor, etc.). The most common tactic used by these heroes is to simply close with the enemy and enter melee.

**Offensive tactics:** A hero of this type often does have multiple attacks, and this can be used to even the odds if the heroes are outnumbered. This is achieved by distributing the hero's multiple attacks among several targets within the hero's movement range. This gets more enemies involved in melee, preventing the other heroes from being overwhelmed by sheer numbers. A tactic for these heroes who do not possess multiple attacks, but who do possess a high endurance or some form of body armor, is the charge. High speed

means a lot of momentum and a lot of damage to anyone who absorbs that momentum with his body. You can also use these characters to foil enemies' plans by getting behind their lines, committing sabotage, etc. How can the evil scientist fire his atomic mutagen splurge-gun at your heroes if your speedster hero can race to the wall and unplug it before the scientist can start the firing sequence? Or imagine Maximus trying to escape from Quicksilver by running through an open doorway, only to have Quicksilver run to the door, close it, and lock it just as Maximus barrels headlong into it.

**Defensive tactics:** Many of the previous tactics work well in a defensive situation, too. The ability to attack multiple foes can be very important, slowing or even stopping an enemy advance. This tactic can also be used to help cover any retreat the heroes need to make. These heroes' high movement rates also allow them to harass foes, making them the ultimate hit-and-run artists. The ability to move so quickly also makes these heroes excellent choices for running diversions or feints. Foes have to pay attention to heroes who can literally run circles around them.

**Airborne:** This type of hero possesses some means of flight that also represents his primary super-power, outside of possible super-strength. The Sub-Mariner (when he could fly), Wonder Man, Namorita and Nova of the New Warriors, and both the original Angel and Ms. Marvel fall into this category. The most common combat tactic of these heroes is to fly to

the enemy and engage them in melee.

Airborne heroes might have other powers or abilities that supplement their flight capabilities.



**Offensive tactics:** If their flight abilities are properly used, these heroes can accomplish a variety of functions. They can perform aerial reconnaissance before or during the battle, giving the heroes a better idea of their opposition. (The more you know about your enemy, the better prepared you'll be.) These heroes can also intercept any flying foes who could otherwise attack heroic infantry. Their flight abilities also could allow them to get behind their foes and attack any leaders, important machinery, or weapons caches. This type of attack could have the same effect as a successful infantry flanking maneuver. And any hero who can fly while invisible is a wonderful person to have around. Imagine all the security systems (including guards, dogs, and super villains) that an invisible flying hero could bypass. This particular hero would qualify for the stealth category mentioned later.

**Defensive tactics:** The main objective of airborne heroes in a defensive battle should be to prevent any aerial attacks on heroic forces who might already be overburdened. Many of the offensive tactics mentioned before could help to turn the tide in a defensive battle. Consider bombing foes with large objects, diving down onto foes (gaining bonuses on the attack), or merely scouting the battle area, looking for the foes' movements or finding a defensible position or escape route for the heroes.

**Shock troops:** These heroes, also known as "bricks," are the assorted strongmen of comics. They generally possess great strength, some degree of resistance to injury, and few or no other powers. The Thing, She-Hulk, and Colossus all qualify for this category. These heroes usually seek out foes similar to themselves in powers and abilities.

**Offensive tactics:** Shock troops are trained to lead an attack, and that is exactly what these heroes should do. Since most of them can dish out and absorb huge amounts of damage, they are the logical choice (in conjunction with speedsters) to lead any charges made by the heroes. It is often after a successful charging attack that the heroic infantry can move in. These heroes should seek out any shock troops of the enemy and engage them so that the foes' shock troops cannot harm the other heroes. Heroic shock troops can also seek out the foes' leaders or artillery heroes (described later) and eliminate them from the fight, again making things easier for the rest of the heroes.

**Defensive tactics:** Defensively, these heroes should try to do pretty much the same things that they do offensively, with a few modifications. Often, these heroes can use their strength to slow or stop any attackers by using the "Shockwave" tactic—striking the ground and setting up

shockwaves that knock foes off their feet (Advanced Set *Player's Book*, page 30), or by throwing or otherwise placing large objects in the advancing foes' path. Shock troops can also become strong points around which other heroes can rally and turn the tide. In this case, they should serve as "defensive linemen" for the hero team. Heroic shock troops should try to force the enemy to get past them in order to reach the other heroes. Similarly, they can cover any necessary retreats the heroes must make. Imagine trying to get past the Thing when he is determined to stand in your path!

**Artillery:** This type of hero has physical powers or abilities that affect targets at a distance. Some of these heroes can also fly. Examples of this type of hero are the Human Torch (I and II), Hawkeye, and Cyclops. These heroes generally do not enter melee if they help it, preferring to remain away from their foes and use their missile capabilities. Heroes having primarily "Distance Attack" powers from the Advanced Set *Player's Book* qualify for this category.

**Offensive tactics:** Beyond their combat-support role, these heroes can assist shock troops in the heroes' initial assault and can also support heroic infantry when it moves in. These heroes can use the "Groundstrike" tactic from the Advanced Set *Player's Book*, page 30, blasting the ground in front of the foes and causing injuries from the flying debris. These heroes can also clear the sky of aerial foes by literally shooting them down. They should try to stay out of physical combat and find cover from which to launch their attacks (unless they're fliers). Flying heroes of this type can get behind enemy lines and wreak much havoc.

One little-used option for this type of hero is playing the role of a sniper. This can be a very effective use of this kind of hero. Imagine Hawkeye in a dense forest, shooting arrows (from an almost completely silent weapon—his bow) at foes who are moving through or near the woods. Even if the sniper doesn't severely injure his foes, the victims most likely will send some of their forces to find him, again weakening their total strength and setting up the searchers for a possible ambush.

**Defensive tactics:** For the most part, these offensive tactics work equally well on the defensive, especially the sniper option. Artillery heroes can cover the retreat of the rest of the heroes from their positions of cover. These heroes can also keep any flying foes from harassing the retreating heroes by shooting the fliers down. Defenses can consist of some form of body armor, a force field, or even another hero acting as a "shield bearer," protecting the artillery hero from direct

attack.

**Stealth:** These heroes have powers or abilities that allow them to approach or contact enemies without their knowledge. Nightcrawler, Shadowcat, the Invisible Woman, and the Wasp all qualify for this category. Any powers that allow a hero to get into a location unnoticed (e.g., shrinking, invisibility, teleportation, wall-crawling, intangibility, etc.) qualify the hero for this category. These heroes most often use their abilities to surprise foes and fight them as best they can.

**Offensive tactics:** These heroes, like the airborne and other flyers, are excellent choices for performing reconnaissance before combat begins and acting as scouts. Infiltrating the foes' base and returning with important information can make the coming battle much easier to win. Getting behind the enemy and sabotaging or disrupting him is another option for stealth heroes. In this way, you can think of them as commandos—moving in, striking, and (if they're lucky) getting back out before their foes can react. Since these characters can often infiltrate their foes' base, they are also a good choice to set up ambushes and guerrilla hit-and-run attacks.

**Defensive tactics:** As before, getting behind the enemy, setting up ambushes, and especially performing sabotage are tactics these heroes should take when put on the defensive. These heroes can often demoralize foes if they can damage the enemy and deny the foes a chance to strike back. Stealth heroes can also often hide themselves from foes, thereby forcing those foes to use their resources to find the heroes or risk letting the heroes run around loose in their midst.

**Mentalists:** These heroes usually possess exclusively mental or mind-affecting powers that allow them to perform a wide variety of feats. Some MARVEL UNIVERSE heroes in this class are Marvel Girl, Psylocke, and Phoenix II (Rachel Summers). Any hero possessing powers primarily from the "Mental Powers" category of the Advanced Set *Player's Book* also qualifies for this category. These heroes tend to avoid melee, using their mental powers on their foes from a distance.

**Offensive tactics:** Like stealth heroes, many mentalist heroes make wonderful infiltration agents, especially if they can directly affect others' minds. Psychic reconnaissance and astrally scouting ahead for danger is also an option, usually one with very little risk. If the mentalist can cause others to see illusions, a mentalist can seriously affect the morale of opponents (imagine an illusory elephant herd charging toward the enemy as the foes prepare to attack the heroes). Ambushes are also an option, again especially if the mentalist can psychically prevent detection of himself and other heroes. Mental-



ists also make great communicators, passing information, instructions, or battle plans to other heroes who couldn't otherwise be reached due to ambient noise, darkness, etc.

**Defensive tactics:** Many of these tactics, especially illusions and ambushes, would also work equally well in defensive situations. A tactic that Psylocke has used in the past is to put into a foe's mind an illusion that causes one of her foe's allies to appear as a hero, often Psylocke herself. The victim of the illusion then attacks his ally. Mentally communicating plans or coordinating a possible heroic counterattack are further possibilities. At least in the MARVEL UNIVERSE, it is quite difficult for an enemy to sneak up on an alert hero with telepathic powers, as these telepaths often sense the thoughts of approaching foes.

**Special forces:** These are the heroes who possess such powerful, variable, or numerous super-powers, magical spells, or other abilities that they do not neatly fit into any of the previous categories. Some MARVEL UNIVERSE heroes who qualify are Thor, Quasar, Doctor Strange, the Vision, and the Silver Surfer. These heroes are so varied that any discussion of specific offensive or defensive tactics for this category of heroes as a whole is difficult. What can be done is to break down each special hero's powers into the categories above and adopt those tactics when using those powers. As an example, I'll categorize the powers of one of my favorite MARVEL UNIVERSE heroes, Thor, as he appears in the Advanced Set *Judge's Book*.

First, Thor has a degree of body armor, is immensely strong, and can inflict Shift X damage with his mystic Uru hammer, Mjolnir. This qualifies Thor for the shock-troops category. Second, by throwing Mjolnir and holding onto its thong, he can fly—qualifying Thor as airborne. Third, Thor can throw Mjolnir, and the mystic hammer also gives Thor weather-control powers (lightning bolts, winds, etc.), both of which qualify him for the artillery category. Thor can, depending upon his

choice of action, use any of the tactics of the categories listed in this example. Similar breakdowns can be performed for most other special-forces heroes.

**Power stunts:** Something must also be said about Power Stunts in the MARVEL SUPER HEROES game, and the ability to "push a power" that is present in several other super-hero game systems. Both of these concepts can give a tremendous tactical edge to the hero or heroes who devote the thought, time, and Karma to developing these abilities. The list of possible Power Stunts is far too long to describe here, but you can carefully read the "Powers" section of the Advanced Set *Player's Book* for Power Stunt ideas. Feel free to borrow ideas from the comics themselves, too. In my campaign, two heroes used a version of the X-Men's "Fast-ball Special" long before the Advanced Set came out with the official rules for that maneuver.

### Group tactics

Now that individual tactics have been noted, fitting these tactics into a coherent whole comes next. The objective of this section is to make the sum of the heroes' abilities greater than the individuals' separate powers.

Since several of the tactics mentioned here suggest splitting up the heroes to perform reconnaissance and the like, it is a good idea to divide your group into "fire teams." A fire team is a small group of heroes who work in concert whenever possible, and whose powers and abilities complement each other. One infantry hero (Wolverine), one stealth hero (Nightcrawler), one artillery hero (Cyclops), and one airborne hero (original Angel) is an example of a fire team. Working together also allows the heroes (and the players) to get used to one another's tactics, power stunts, and personalities.

Once you have fire teams set up, develop a few standard routines of action that the heroes will take whenever faced with certain situations. I remember a certain futuristic, teenage super-team from Marvels competitor that had a coded series of such actions. The leader of the team would shout out a code phrase to alert the rest of the team as to what was going on and what to do next. It is best to keep these routines simple; the more complicated they become, the fewer applications each routine will actually have.

A classic military axiom is "Make the enemy fight your fight." If you can force the opposition to react to your actions, as opposed to you reacting to theirs, then your battle is half won. This same idea applies in sports (the best defense is a good offense). If your team sticks to your game plan (tactics), and the other team has to improvise to stop you, you stand a much greater chance of winning. For example, if your team is made up primarily of infantry and artillery heroes, you don't want to end up toe-to-toe with your

opponents' shock troops. What you probably do want is to have a running battle, hitting the enemy with your artillery heroes until the enemies close the gap. Then, with your infantry providing cover as best they can, have the artillery heroes retreat and start the process over. This should eventually wear down the opposition to the point where it is safe for the infantry to move in and finish off the foes.

### Conclusion

For more on tactics in the MARVEL SUPER HEROES game, see the tactics section in the Advanced Set *Player's Book*, pages 29-31. Also, the comics themselves are great sources for tactical inspiration. Marvel Comics' *The Avengers*, *Avengers West Coast*, *The Uncanny X-Men*, *The Fantastic Four*, *New Warriors*, and other hero-team books give good examples of some sound (and less-than-sound) tactics on the parts of both the heroes and the villains.

These tactics can also apply to other genres of RPGs, especially fantasy. Using the AD&D® game as an example, warriors are the infantry and, at higher levels, evolve into shock troops. Spell-casters, especially mages, are great examples of artillery. Rogues fit the stealth category. Psionicists easily qualify as mentalists. Most priests probably fall into the infantry category, as their spells are not generally offensive in nature and their ability to turn undead, while very important, is too specific to qualify them for shock troops. This wide variety of abilities (spells, good melee skills, and turning undead) could qualify priests as special forces, though.

Remember, GMs, that these categories and tactics apply equally well to villains as well as heroes. And remember, heroes—watch your backs, and think before you leap into the fray!

**Note:** For a similarly structured article discussing the basic personality types of heroes, see "The Mentally-Balanced Super-team," by David Rogers, in ICE's *Adventurer's Club*, issue #15, Winter 1990. The article categorizes heroic personalities. Although that article and this one were produced independently, they complement each other quite well. *Adventurer's Club* is published by Iron Crown Enterprises Inc., PO. Box 1605, Charlottesville VA 22901.

*This article is dedicated to the players of my (admittedly on-again-off-again) MARVEL SUPER HEROES game campaign: Leon, Tim, Kevin, and the casualties thereof: Donny, and Jeff. Thank you, one and all, for all the fun and for the patience to endure what I put you through.* Ω

MARVEL SUPER HEROES, MARVEL UNIVERSE, and Marvel characters and the distinctive names and likenesses thereof are trademarks of Marvel Entertainment Group, Inc., and are used with permission.

## SUPPORT YOUR LOCAL GAME CONVENTION!

A game convention is the perfect place to make new friends who enjoy the same hobbies you do—whether you like Aboard games, role-playing games, miniature war games, or just shopping around. If you've never attended a game convention before, please check out the Convention Calendar feature in this issue for the game convention nearest you. Take some of your own gaming friends along, too — and make it an experience to remember.

# Wear Your Best Suit!

by Justin Mohareb

Color by Steve Sullivan

## Advanced armored battlesuit rules for the MARVEL SUPER HEROES™ game



*Scenario one* (from the *Iron Man* comic book): Tony Stark, as Iron Man, fights Firepower and receives several damaging blows. Tony is beaten senseless and has his armor nearly destroyed, so he has to fly warily to his nearby helicopter.

*Scenario two* (from the MARVEL SUPER HEROES™ game): Tony Stark, as Iron Man, fights Firepower and receives several damaging blows. Tony is beaten senseless and flies his undamaged armor at top speed to his nearby helicopter.

Notice the difference? In the MARVEL SUPER HEROES game, armored battlesuit combat should be handled differently to reflect damage incurred to the armor during combat, and to better represent the unusual abilities of an armored hero. The system in this article showcases an alternate method of generating and playing high-tech armored characters.

### Creating armored heroes

This article assumes that you have MA3 *The Ultimate Powers Book*. If you don't, simply use the *Players' Book* from the Advanced Set rules, selecting the powers you think are reproducible by machinery or electronics. Using this system, armored heroes are rolled up using column 2 ("Normal Folks") of the character-generation table, not column 3 ("High Technology") as in both the *Ultimate Powers Book* or the Advanced Set rules). These abilities are the character's normal levels. This is to reflect that the character is a normal human wearing an armored suit that supplies him with his super powers.

Judges may wish to allow a character to increase his physical stats when wearing



the armor by rolling once on Table 1 here, then dividing the results among the hero's four physical abilities (FASE). Note that the ability scores indicated when the character adds the modifiers to his personal attributes reflect the benefits of the armor only when it is being worn. For example, a character whose Strength is Typical (6), with a +3CS modifier for the armor, might add +1CS, +2CS, or +3CS to his Strength, or he might not increase his Strength at all, preferring to divide +3CS among his other three physical statistics.

If the character created his own armor, he also receives a +1CS to his Reason, a +1CS to his Electronics talent, and another +1CS to repair and modify his personal armor. If the character receives the armor from someone else, it is assumed that the original owner or people he knows (all NPCs) can repair it. In the latter case, the hero would not receive any of the Reason bonuses above, though he could receive training later on, at the Judge's discretion.

The character then rolls up the number of his armored suit's powers, using the usual tables in the *Ultimate Powers Book* or the Advanced Set rules. This character automatically has Body Armor at Excellent (20) rank, though this can be increased (see the note under "Defensive powers," which follows). When the character's powers are determined, a special power rank called Armor Endurance is also created. This is usually called ECM (electronic

countermeasures) and is used against attempts to control the armor from outside sources.

Because of their nature, armored heroes can use only certain powers that could be technology based. A suggested list of these powers, from the *Ultimate Powers Book*, is given here:

*Defensive powers:* Body Armor (already taken but can be taken again; +1CS each time this is chosen as a power), Force Field, Reflection, Resistance to Energy Attacks, Resistance to Physical Attacks.

*Detection powers:* Circular Vision, Energy Detection, Hypersensitive Hearing, Hypersensitive Touch, Life Detection, Microscopic Vision, Penetration Vision, Radarsense, Sonar, Telescopic Vision, Thermal Vision, Ultraviolet Vision.

*Energy Control powers:* Electrical Control, Energy Sponge, Hard Radiation Control, Magnetic Manipulation.

*Energy Emission powers:* All except for Energy Doppelganger.

*Fighting powers:* Weapons Creation.

*Illusory powers:* Illusion-Casting, Illusory Duplication.

*Life Control powers:* Sleep—Induced.

*Magical powers:* None.

*Matter Control powers:* Bonding, Machine Animation.

*Matter Conversion powers:* Disintegration.

*Matter Creation powers:* Missile Creation, Spray, Webcasting.

*Mental Enhancement powers:* Clairaudience, Clairvoyance, Communicate With Cybernetics, Danger Sense, Speech-throwing, Total Memory. (These powers are not mental powers per se, but are technological versions of mental powers.)

*Physical Enhancement powers:* Hyper-Speed, Lung Adaptability, Stealth, Waterbreathing, Water Freedom.

*Power Control powers:* None.

*Self Alteration powers:* Blending, Invisibility.

*Travel powers:* Gliding, Hyper-Digging, Hyper-Leaping, Hyper-Running, Hyper-Swimming, and Rocket.

Players can choose their armor's powers from this list. If you find this list to be too limiting, just use your imagination. The cornerstone of super-hero gaming is the use of powers in new ways.

Once the powers for the battlesuit have been selected, rolls are made on Table 2 for the power rank of each power. These rolls are not modified, with the exception of Body Armor (as previously noted). Also generate a power rank for Armor Endurance at this point.

## Damaging armor

To add depth to armored combat, each power—including Body Armor—and each of the FASE ability modifiers is then assigned a number as part of a random-roll table. These numbers will determine which of the armor's systems are damaged when an attack exceeds the suit's Body Armor (or applicable Force Fields, etc.) by more than +1CS, as noted later. The numbers should be arranged so as they can be rolled on a simple die: 1d8, 1d10, 1d12, etc. Optionally, assign two or more numbers on such a table to a power that would have a greater chance of being damaged, like Body Armor or Flight, depending on your vision of the character's armored suit and the placement of his weaponry and equipment.

We now get to the *raison d'etre* for this expanded system: armored suit combat. Every time the character is in combat and receives a blow that inflicts more damage than his Body Armor rank, the character takes damage equal to the amount of damage minus the amount absorbed by his body armor. For example, if a hero has Remarkable (30) Body Armor and is hit by an Incredible (40) rank Force bolt, the hero takes 10 points of damage (40 - 30 = 10). This is per the normal rules.

If the damage is 2CS or more than the Body Armor rank, the character takes the appropriate damage, and percentile dice are then rolled on the rank of the attack - 4CS to determine if the character's armor was damaged by the attack. For ex-

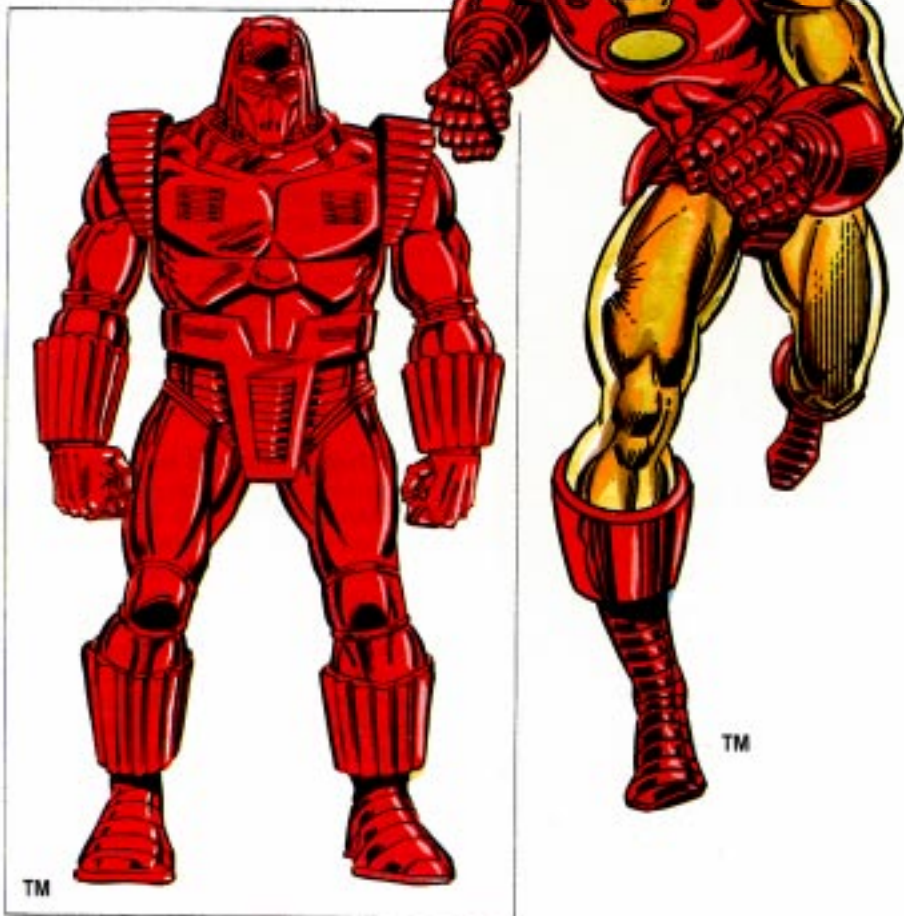



ample, if the hero as above with Remarkable (30) Body Armor was punched by a villain possessing Amazing (50) Strength, the hero would take 20 points of damage and would roll 1d100 on the Good (10) column (50 - 4CS = 10). If the result is red, then roll on Table 3.

Energy attacks are a special case, as Body Armor is 20 points less effective against energy attacks than against physical ones. When a hero is hit by an Energy attack capable of breaching the armor's reduced rank vs. Energy attacks, the character must follow the procedure for determining armor damage from physical attacks as before. Armored heroes can take Resistance to Energy Attacks to cover this weakness.

### Repairing damage

Fixing damaged armor is relatively simple. The hero must make a Reason FEAT roll to make the proper repairs correctly. A Resources FEAT roll might be called for as well, to see if the hero can afford to make the repairs. Other strictures can be applied to the roll at the Judge's whim.

It is often a good idea for the Judge to make the Reason FEAT roll for the hero in secret. That way, if the roll is a failure by a narrow margin—say, within five points of the number needed for success—the hero may mistakenly believe that his armor is repaired when it actually might fail at an important moment. This is a nasty thing to do, but I leave the decision whether or not to use this up to each Judge.

### Armored advancement

The player may, at some point in his hero's career, attempt to modify the hero's armor by adding new powers. Armor

powers can be added, up to the maximum number that was determined at creation, by spending 3,000 Karma for each, plus 10 times the starting rank number for that power (this is also the formula by which robots can add powers). Power advancement is done normally, by spending 10 points times the current rank plus 500 points for cresting from one rank to another.

A Reason FEAT roll should be called for, with the difficulty equal to the new rank, if an old power is being advanced to a new, higher rank or if a new power is set at its starting level. A Resource FEAT roll might also be needed to see if the hero has the cash to perform the modifications.

The Judge should make his own rulings on how to do the "total makeover" that's so popular with armored heroes, including such things as resetting Popularity to zero,

upping appropriate powers and FASE abilities one rank, or adding new things. This should cost a great deal: about 10,000 Karma points, a high Resource FEAT roll (Amazing or better), and access to high-tech equipment or a high (Incredible or better) Reason FEAT roll. (This is, of course, up to the individual Judge.) All other forms of advancement are performed normally.

Creativity is the key to any successful and enjoyable role-playing game. This system can only get you started on the way. Where you go now is up to you. ☐

Marvel's characters and the distinctive names and likenesses thereof are trademarks of Marvel Entertainment Group, Inc. and are used with permission. Copyright ©1992 Marvel Entertainment Group, Inc. All Rights Reserved.

**Table 3**  
**Armor Damage Table**

1d100	Damage result
01-20	One power is at - 2CS
21-40	One FASE ability modifier is at - 2CS
41-65	One power is inoperative
66-90	All powers are at - 1CS
91-94	All FASE ability modifiers are - 1CS
95-98	All FASE ability modifiers and powers are at -2CS
99-00	Massive systems overload. All FASE ability modifiers are at - 2CS, and all powers, with the exception of one (of the player's choice) are inoperative

**Table 1**  
**Armor Modifiers for FASE Abilities**

1d100	Result
01-10	Unchanged
11-20	+1CS
21-45	+2CS
46-75	+3CS
76-95	+4CS
96-00	+5CS

**Table 2**  
**Power Rank Generation Table**

1d100	Power rank
01-05	Feeble (2)
06-10	Poor (4)
11-20	Typical (6)
21-40	Good (10)
41-55	Excellent (20)
56-80	Remarkable (30)
81-95	Incredible (40)
96-00	Amazing (50)



TM