

A FANTASY GAMES UNLIMITED PUBLICATION

DAREDEVIL

Adventures TM

featuring **DEADLY COINS**

by J. ANDREW KEITH

AND OTHER STORIES

NOT
10¢



DAREDEVIL

Adventures™



This book is a set of adventures designed for use with the DAREDEVILS™ rule system. It is intended for the Game-master. Players should not read this book until the adventures are completed. Information is often given in brief form with only pertinent details highlighted with lesser points left for the Gamemaster to fill in. There is still a great deal of information packed into each adventure. Be sure to read all of it before running one of them. Important details are not always in one place. This has been done for two reasons. One, players who do sneak looks at this book will not be able to get all the data they need with a simple peek. Two, often much of the information needed would have such detail that the flow of the explanation would be interrupted. Such material has been abstracted into sidebars. Character motivation will usually be found with the character description while pertinent clues might be as easily found in the description of the location in which they are found as in the overview of the scheme or the description of the action 'off-stage.' Some details in these adventures may have to be adjusted to suit your campaign.

VOL. 2

No. 1

THE POWERS OF DR. REMOUXby Stefan Jones.2

A death on campus causes concern among the students and faculty alike. A dark shadow stalks the collegiate nights and the police seem baffled. Is there a connection? The daredevils find action and mystery behind ivy covered walls.

BRING IT BACK ALIVE!.by Bob Charrette.6

A contract from a mysterious millionaire is a ticket for adventure in far places. Double-dealing, danger and death may await the daredevils as they face the unknown and attempt to capture it alive!

DEADLY COINSby J. Andrew Keith.14

Death for a few dollars more? Hardly. Sudden violence dogs the path of some curious coins in the seething streets of Hong Kong. Just knowing about them can mean death! The daredevils uncover a trail of tenuous clues which will lead them into a confrontation with the evil Doctor Ling.

U.S. COPYRIGHT NOTICE

Game publication issued by Fantasy Games Unlimited Inc., P.O. Box 182, Roslyn, N.Y. 11576. 'The Powers of Dr. Remoux' is copyright, 1983, by Stefan Jones. 'Bring it Back Alive!' is copyright, 1983, by Robert N. Charrette. 'Deadly Coins' is copyright, 1983, by Marischal Adventures. Illustrations for 'Deadly Coins' are by William H. Keith, Jr. and are copyright, 1983, by Marischal Adventures. Cover painting and other illustrations are copyright, 1983, by Robert N. Charrette.

All rights reserved. No part of this book may be used or reproduced in any manner whatsoever without permission, except in the case of brief quotations embodied in critical articles or reviews. Any relationship herein to real persons and institutions is purely coincidental.

A FANTASY GAMES UNLIMITED PUBLICATION

THE POWERS OF DR. REMOUX

BY
STEFAN JONES

This adventure is set in a 1930's college town. It is a small but bustling little place with soda fountains, well-kept parks and quiet lanes. The college grounds proper have an group of ivy-colored, brick buildings of various age and designs. The player characters can be introduced to the adventure in a number of ways. Perhaps they have just returned from a journey into the wilds of Africa and are now giving a lecture. In any case, while in a lounge or cafeteria the group will overhear a conversation between two young lads nervously seeking a solution to a pressing problem. Apparently, the pair and another young man and lady were out late last night, pulling a prank on old Professor Wyte. They were about to tie a dead dog to his work table in the physics lab when something discovered them. In the nightmarish chase that followed, both Jimmy Young and Darla Cowling disappeared. They have not shown up at any of their classes and no one in their dorms has seen them. The boys are deliberating whether to tell the dean or the police what happened. A friendly daredevil could at this time help the lads choose the right course of action. . . and pick up some clues at the same time. The boys are Davy Billings and Ralph Tompson.

OTHER CLUES

On the day following the encounter in the lounge with the two students, some shocking news will surface. Jimmy Young was found dead in the town park. The body is badly scarred with what look like the teeth-marks of a large animal. Billings and Tompson will be called in to identify the body, as they are known to have been pals of the unfortunate lad. If the daredevils accompany the boys, they will get a chance to see the body, and may convince the coroner to let them examine the remains. Forensics or Advanced medical skill will allow a player character to discover that the body was subjected to crushing and tearing as well as the more obvious mauling by some toothy animal. If any of the characters has had experience with killer apes, they will suspect that the boy was killed by one of those fearsome beasts! Announcing this to the coroner or police will evoke disbelief and possible hostility . . . no one tells the (blank) town police how to operate!

INVESTIGATIONS

Several sub-culture skills will yield results. The chart below will list a clue letter for each result of a contact task using the noted sub-culture skill. The 'Campus' column is implemented by hanging out around campus ('Legwork'). If the daredevils performing this task can disguise themselves as students or visiting professors, or even as sundry staff members, they will gain a bonus to the reaction roll die equal to their disguise+mimicry skill BCS scores. Additional measures may result in additional bonuses to the roll. Sources of information are given in parentheses after the letter code. If no source is indicated the game-master may attribute any source he desires.

SUBCULTURE

Value Number	Academic	Criminal	Campus
+6	A (Wyte)	B (a Thug)	C (Jessie)
+2, +4	D (Rumors)	D (Rumors)	E (Students)
+1	F (Rumors)	G	H
-2 or -4	I	J	J
-6	K	K	K

CLUES AND RUMOR DESCRIPTIONS

A. Professor Wyte, a physics expert, comes to the daredevils and tells them of the attempt on his life thursday night. This was the night that Jimmy Young disappeared with Darla. Wyte had gone into his lab to get some notes, and was attacked by a killer ape! Fortunately he escaped after frightening the beast with a electric device in the lab. Wyte suspects that one of his rivals in the department, a Dr. Remoux, sent the beast after him. He has kept silent until now out of fear of reprisals.

B. The investigating daredevil learns that a local gangster has hired out two of his boys to a kooky professor on campus. One of the hoods has quit. He can tell the daredevil of Remoux's secret hideout in the old field house, and of the presence of the killer ape. The thug will also speak about the doctor's crazy machine.

C. A distraught young girl stumbles into the daredevils late one night. She is hysterical and scared out of her wits. She was asked to do some late-night lab work by Dr. Remoux. When she refused he summoned a giant monkey which grabbed her and brought here to the old gym. The ape itself will make a short appearance at this time (peering in a window, etc.) then flee into the darkness. This will frighten the poor girl and cause her to faint.

D. A couple of wierd crates came through town the other night, bound for the physics lab. Some shady-looking characters were present. No one on the staff of the college knows what the crates contained. If received from a criminal source, the daredevils will get the information from a local bum that the crate smelled like it contained an animal of some sort.

E. The investigating daredevils overhear some students discussing the pros and cons of accepting 'The Lord's offer' (to help him in the lab at night). 'The Lord' is the students' appellation for Dr. Remoux, who occasionally goes into bizarre fits of raving paranoia and self-aggrandizement.

F. The physics department has been shaken up lately, and there is intense competition for positions.

G. If you know who to go to, there are some people on campus who can appreciate muscle and pay well for services of various sorts.

H. Jimmy Young was seen by a janitor on the athletic field late Thursday night, sneaking around the field house.

I. Dr. Remoux learns of the investigation and begins to take action to cover his tracks. His late-night experiments will be legitimate and those volunteering to help will not be harmed.

J. The hoods in the employ of Dr. Remoux begin harassing the daredevils. The investigators will have rumors about them sown on-campus that will hamper further investigation.

K. The killer ape is set loose on the characters! The creature has gained enough experience to avoid blundering into traps, and will try to pick off the heroes one at a time.

DR. REMOUX'S OPERATION

The doctor is conducting a fiendish series of experiments in an old, crumbling field house by the college athletic fields. He has quietly installed large amounts of equipment and has gained the confidence of the local mobsters by providing them with a source of scientific goodies

and technical advice. Most recently, Remoux has been experimenting with a G-Ray Vitality Unculator, a horrid device which drains the energy out of living beings and stores it for other uses. The doctor has been obtaining victims from the students who help him conduct lab-work late at night. He hypnotizes or drugs these unfortunates, and tests out his equipment on them before bringing them back to the lab in the physics building and reviving them. This work went unnoticed for some time. Now Dr. Remoux has gone a little far and charged himself up on the G-Ray energy. He has become even loonier than usual and plans the demise of his rivals in the physics department. His acquisition of a killer ape has helped him in this task. One professor was secretly killed several weeks ago, and the administration is getting worried over his prolonged absence. The bungled attempt on Professor Wyte's life has already been mentioned. Once the doctor suspects that the daredevils are on his trail, he will make increasingly bold attempts to kill, or preferably kidnap, them. He is a clever operator and will pretend to help the investigation in order to lure one or more of the characters into his clutches for experimentation.

INVESTIGATING REMOUX

The doctor is a somewhat mysterious figure on campus. No one knows his background, other than that he is a frequent contributor to

physics journals, has been on the teaching staff for 10 years, and is an orphan. He lives in a boarding house in town, and some questions here will reveal further plot elements. The landlady, Mrs. Bernard, is a widowed middle-aged woman. She is too conscientious to talk about the doctor behind his back, but she will mention in passing that he is a good tenant and has often helped her fix things around the house. She will let the daredevils into Remoux's room if coaxed properly, but will watch over them like a hawk while they are inside. The room will yield little of practical use, but a successful detect hidden roll will turn up a small, button-covered box under the carpet. A cable leads from the box through a hole in the floor, into the basement. Mrs. Bernard will mention at this point that the doohicky is part of the 'electricity saver' that the doctor put in lieu of one month's rent. The rest of the device is in the cellar: a large metal box festooned with dials and coils of sparking glass and wire. An electrical engineer will be able to determine that the contraption is indeed generating electricity, if the dials are correct. A small trap door on the side of the device will reveal a small drawer containing an emaciated and dazed house cat, rigged up with a wire harness and provided with an automatic feeder. Mrs. Bernard will go into hysterics at the sight. The animal is her beloved pet which disappeared several weeks back. The creature is well-fed and undiseased, but seems strangely drained of energy. It is as limp as a rag doll and listless as a muddy river.

CAST OF CHARACTERS

Davy Billings

Davy Billings is one of the students who was on the raid into Professor Wyte's lab on Thursday night. While a bright young man, Davy is a bit of a prankster and spends much of his time socializing and goofing off. He will already tell his version of the incident in the lab. While tying a dead collie to Wyte's table, a huge form sprang out of the dark and tackled Jimmy Young. Davy ran like the wind and got out of the building, dragging the deceased mutt behind him. Davy can be of great help to the investigators when they are traveling and working on-campus. He is a tall, skinny kid with red hair and beady eyes, and favors preppy-looking sweaters.

WT	WL	STR	DFT	SPD	HLH	CDA	DRT
12	15	10	12	10	9	2	20

SKILLS: English (16); AM.Hist (12); Stealth (10); 'campus sub-culture' (16); Brawling (8/2).

CLOTHING: Street Clothes (AV 1)

Ralph Tompson

Ralph's reason for being in on the mischief at the physics building was more sinister. He was trying to change some class records at the time of the raid. While Davy, Jimmy and Darla were messing about in the lab, Ralph was supposed to be standing guard. He knows he could have warned his friends in time to prevent Jimmy and Darla's capture, and feels guilty that he was rummaging through the files at the time. If interrogated, Ralph will repeat Davy's story and claim to have seen nothing from his assigned post by the front door. Ralph will not help the investigators. He may be treated as an Average Quality Rabble.

Jimmy Young

One of Davy's partners in rowdiness, Jimmy was in on the raid for the fun of it. He was helping Darla bollix some test tubes when a huge hairy form lunged at him from the doorway and knocked him flat with a blow. He and Darla were dragged unconscious to the field house and locked in the locker room. Jimmy did manage to make an escape, only to be caught by the ape and mauled. Dr. Remoux had the beast leave the poor boy in the park.

Darla Cowling

A pretty brunette, Darla is a good student and charming girl. She went on the lab raid on a dare, and to try and make friends with Jimmy Young. She ended up as Remoux's prisoner and test subject, and is now near death from being drained of her vital life-forces. Even if the daredevils bring her consciousness, she will be of little help and will swoon at the slightest provocation. She can direct the players about the field house, with a 40% chance of error due to grogginess. Treat Darla as a Poor Quality Extra.



Professor Wyte

The professor is an absent minded old bat, who uses outmoded teaching methods and can drop a student at fifty paces with his lecturing style. Conversations with him will be long and tedious, full of digressions and asides on his physics projects. He can prove useful for information on the school and physics. He will be able to correctly determine the nature of the device in Remoux's boarding house as a device used to suck energy out of living things. Wyte is an Average Quality Rabble.



Jessie Holt

Jessie is a dowdy-looking girl with a big nose, eyeglasses and a talent for wearing horrible dresses. She is beginning to discover the attractions of the male sex and will very likely fall in love with any daredevil who is kind to her. She was helping Remoux in the lab when he began to hypnotize here. Luckily, her glasses fogged up at just the right moment and she sneezed out the doctor's soporific fumes. She snapped out of the growing trance and was horrified to see a giant ape panting at her from behind Dr. Remoux's shoulder. Jessie made a quick escape. If the proper rumor/event is rolled she will run into the daredevils. Treat Jess as an Average Quality Rabble. She has excellent knowledge of the campus and will gladly help the daredevils. Since she is an avid reader of Nancy Drew books she would be thrilled to help!

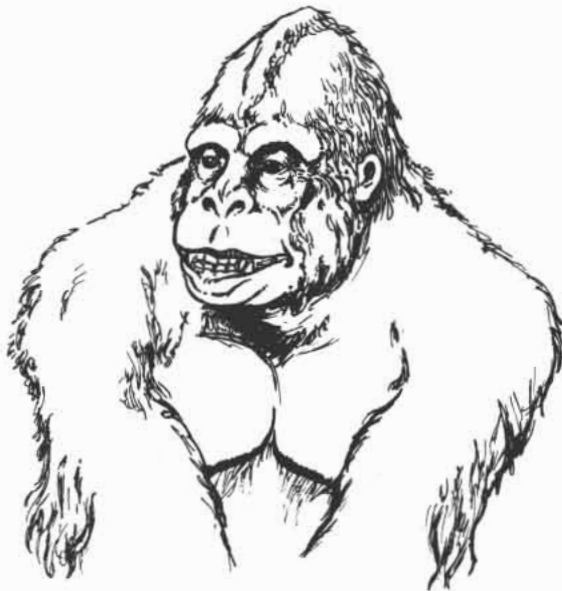

Jack and Clyde

These are two thugs from the retinue of a local gangster. If event B comes up, Jack will defect and may rat on his former employer. He is more anxious to get out of town than to make trouble for the professor, but will provide the information described in the rumor.

WT	WL	STR	DFT	SPD	HLH	CDA	DRT
10	10	15	15	15	12	3	25

SKILLS: Nightstick/club: (16); Knife (15); Pistol (11); Brawling (10).

WEAPONS: Knives, pistol, club.

CLOTHING: Street Clothes.



Dr. Jacques Remoux

Born in France, Remoux was the son of a famous scientist. When his parents were killed in the war, young Jacques was put in an orphanage and, since his mother had been American, eventually ended up in the States. He received a scholarship and went to school at Cornell. He quickly became a master scientist and inventor. It was during this time that the genius first began to slip towards insanity. He socialized little, and treated others in an arrogant and obnoxious manner. Unable to become a professional physicist, Remoux turned to teaching and came to university. At first he made an effort to fit in; all too soon the rivalry of academic life drove him bonkers. The doctor had a tendency to drift off the subject of lectures and begin telling tales of his life and ambitions. When a student tries to intervene, the mad doctor shouts the poor scholar down and goes into frothing fits of megalomania. He conceals this trait when around other professors.

For the last year, the doctor has been working on his Unculator device. He has used himself for the receiving end of the collected bio-energy and has made a superman of himself at the expense of his sanity and intelligence.

WT	WL	STR	DFT	SPD	HLH	CDA	DRT
(10)	30	25	35	25	25	4	51

SKILLS: Physics (20); Electrical Engineering (12); French (12); English (16); Academic Subculture (14); Research (12); Pistol (11); Fencing (13); Brawling (14). Special Skill: Advanced Hypnotism.

WEAPONS: Pistol

CLOTHING: Lab Coat, Street Clothes (Armor Value 2).

THE FIELD HOUSE

The doctor's hidden laboratory is located in the old university field house. The building is covered with ivy and the windows and doors are boarded up and/or locked. There are two entrances in use by the doctor and his cohorts: a side door seemingly rusted shut, and a secret entrance via a tunnel to the gym basement. No lights escape at night to give away the location, but a detect hidden roll will reveal that the electric lines to the building are new and humming with power. A map of the interior of the building is provided.

A. This is the door used by the doctor and his thugs. It is locked, but a good hard bashing will knock it down. (Barrier Value = 10) Examination will reveal that the door has been used recently.

B. This is a storage room, with a door opening on a flight of stairs leading to the basement. There are well defined footprints leading to these stairs.

C. A former snack stand. This room is used as a kitchen-cum-chemistry lab by the doctor. Several boxes of fresh food and a small refrigerator are present. A big bunch of bananas and a box of cheap meat pieces are also present (food for the killer ape).

D. These are store rooms with little of interest.

E. A locker room. Darla Cowling is kept here during the day. The room has been equipped with a cot and chairs. If the daredevils break in during the day, they will find the poor girl lying on the cot in a state of near catatonia.

F. Another locker room. This one is occupied by the killer ape. The animal uses the stairs to get to the other part of his cage downstairs. The ape knows this territory very well and will take advantage of his knowledge to ambush the daredevils if they burst in on him.

G. The field house proper. It is equipped with bleachers and basketball hoops.

H. This cluttered area contains broken crates, garbage, old gym equipment, and other refuse. A tripwire on the stairs rings a bell in J, alerting whoever is inside. The door to J has a Barrier Value of 30, and has a Complexity 5, Barrier 20 lock, and a peephole. The two doors in the south end are concealed by rubbish.

I. This is a low-ceilinged tunnel leading to the main gymnasium, about 120 yards away. Formerly an accessway for use by the students and staff in bad weather, it was locked up some years ago. The door in the gym is located in that building's basement, and is locked on the tunnel side. This tunnel will be used by Dr. Remoux for a quick getaway.

J. The laboratory proper. This area is filled with mysterious gadgets, tables full of notes and half-assembled gizmos, and other mad-scientist stuff. Notable among the gadgetry is a device similar to an iron maiden: a metal shell which closes upon an occupant seated inside. Instead of spikes, this contraption has electrodes and other stuff rigged in it. This is the current version of the G-Ray Vitality Unculator. The Doctor's victims are placed inside and have their vital energies drained out and stored in leyden jars. See the separate description for details on the operation of the inunculator. The west wall is equipped with sets of shackles and chains for the restraint of people awaiting their turn in the device.

K. This room opens onto area J via a barred entrance. The door here and in the south wall can be opened via remote control in room J. Bodo, the killer ape, is kept here when his presence is required in the lab area, and during feeding times.

L. This is another junk-filled section. The killer ape has made his lair here, and the area is quite ripe of smell. The door to the stairs is open, the others are remotely controlled from room J.

THE UNCULATOR

The G-Ray Vitality Unculator uses the little known element uranium and a network of photo-electric cells to sap the juices of life from living things. In operation, the Unculator removes 1d4 points from Strength, Health and Will per hour of operation. These are converted into electricity at a rate of 3 battery-style charges per point. The process can be reversed: every six drained points used equals one point added onto the Strength, Will, Health, and Speed of the person receiving the points. These bonus points last for one month. Those who have lost points regain them in a similar manner (one/month). The device is somewhat dangerous: there is a 5% chance that it will explode with each use. This will kill (50%) or super-power (50%: add 2d6 to each of the attributes mentioned above permanently) the person in the device. The explosion is otherwise equivalent to a stick of dynamite.

THE FIELD HOUSE

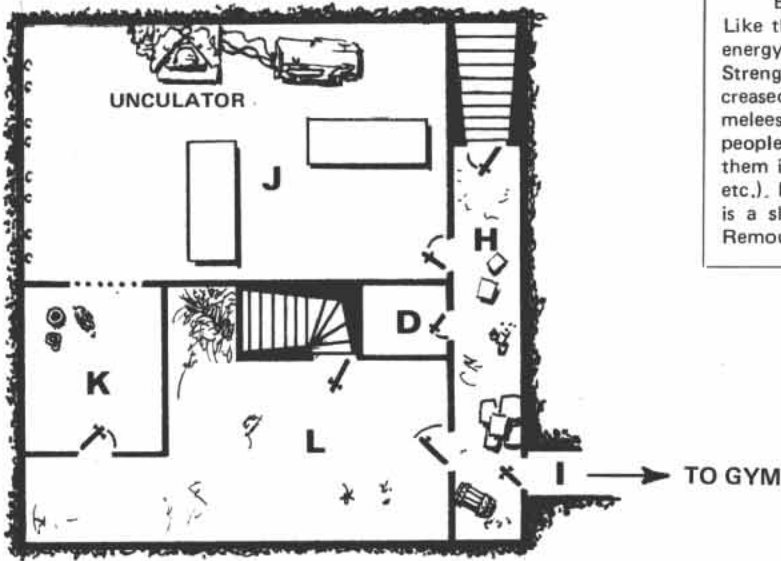

BASEMENT

THE APE
 Bodo is a Red Ape of Mangamaka (see 'Bring It Back Alive!'). Like the doctor, Bodo has been receiving charges of G-Ray vitality energy. He has double the normal Damage Resistance Total and a Strength group of 8. The device and Remoux's training have also increased the beast's intelligence somewhat: he won't charge into melees or walk into gunfire. Treat Bodo as a clever killer, able to rip people apart but more likely to grab them one at a time and drag them into hiding to play with (i.e. bounce the head, bend the arm, etc.). Bodo has a soft spot for girls and will not kill a female. There is a slight chance that the creature will turn sides if he sees Dr. Remoux mistreat a lady prisoner.

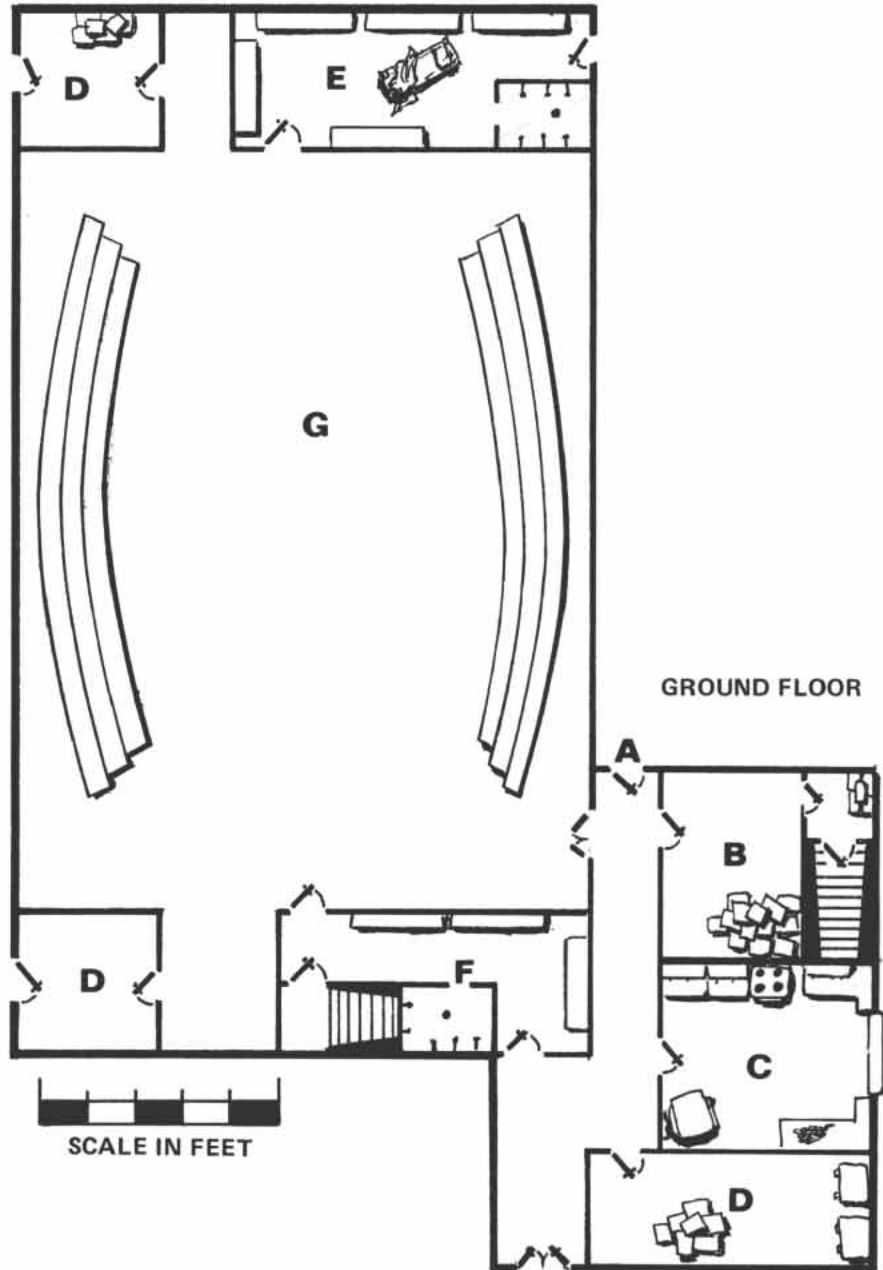

GROUND FLOOR

BRING IT BACK ALIVE!

by
BOB CHARRETTE

Bring It Back Alive! is a 'search and explore' adventure for DAREDEVILS. It can be set before or after The Powers of Dr. Remoux. In either case, it can be related to that adventure. This adventure is a challenging but not insurmountable test of the players' resourcefulness.

OPENING SCENE

An inquiry is received by mail as to the availability of doughty fellows willing to take some risks in order to make some good money. The letter is signed by one J. Alfred Simmington, Attorney-at-law. His address and phone number are included for the recipient's convenience in replying. The daredevils can learn more about this offer by contacting the lawyer.

If the daredevils are operating as a formal group or organization, the letter will be addressed to them collectively. If not, it will be received by the one whom the Gamemaster deems the likeliest candidate. This individual will be invited to recruit reliable helpers for the task. If this adventure occurs after Dr. Remoux is encountered, any daredevils whose names are linked to that escapade would be likely recipients of the letter.

THE JOB

Simmington's employer, the wealthy C.D. Dowdler, wishes the daredevils to obtain something for him: a red ape of Mangamaka. If Dr. Remoux's ape was captured, Dowdler will be seeking a mate for it. If that ape was killed, Dowdler will still want one but will not be particular as to its sex. In either case, he wants the ape alive and well.

The obvious source of knowledge of these apes is Dr. Remoux's acquisition, Bodo. If The Powers of Dr. Remoux has not yet been used, Dowdler will have gleaned hints of the existence of such apes from other sources. The ape then supplied by the daredevils might become the one Dr. Remoux receives. In either case, the financier will have learned of the apes' habitat.

Dowdler will have Simmington handle all arrangements. Transportation arrangements and schedules will be left to the lawyer as will arrangements for shipping the capture back to the States. Simmington will exclude the daredevils entirely from the last item. Simmington will accompany the team to ascertain that the daredevils comply with the contract and to serve as the judge of the correctness and quality of the quarry. Naturally, Dowdler may overrule the lawyer's judgement.

The daredevils will most likely desire to gain as much information as possible before they set out. Simmington will tell them little other than 'a South Pacific destination' but will promise more information once they are underway. Research into the beasts themselves will gain little. Any character with Zoology Skill will know that the red-haired orangutan is the only great ape native to Asia. If Bodo has been seen, that zoologist will know that he is not an orang-utan. Little is known of the orang-utan's life in the wild and nothing is known about this new form of ape. Research into Mangamaka will only yield the general information given in the section on the Mangamaka Archipelago.



THE CONTRACT

The party of the first part, C.D. Dowdler hereafter referred to as the employer, undertakes this contract with the parties of the second part, those whose signatures are affixed below and hereafter referred to as the team. This contract shall be executed and administered by the party of the third part, J. Alfred Simmington, hereafter referred to as the agent, on behalf of the employer.

The team shall undertake to acquire and prepare for shipment to an address yet to be designated one (1) live and intact creature as specified and identified by the agent.

The team shall consist of ___ members. One member, _____ is designated by mutual consent of all parties as the team leader. The team leader shall be responsible for the behavior of the team.

The team agrees to acquire one (1) and only one (1) of the creatures. The team, jointly and severally, agrees never to participate in any way in the acquisition of another of these creatures except at the behest of the employer.

The team agrees, jointly and severally, never to publish, announce, or otherwise disseminate information regarding this contract, the creature, or the employer.

The team agrees to execute their responsibilities under this contract with all reasonable haste.



In payment for services rendered, the team shall receive the sum of twenty thousand dollars (\$20,000.00) to be divided equally among the members. Payment shall be disbursed upon arrival of the creature at its final destination.

The team shall be responsible for transportation of the creature from the capture site to a reasonable point of shipment. The determination of such point of shipment shall be at the discretion of the agent.

The agent shall arrange for transportation to and from the capture locality.

The agent is herewith authorized to make all reasonable and necessary expenditures pursuant to achieving the task as specified in this agreement. Such funds may be drawn from the employer's accounts and shall be subject to review and approval by the employer.

This contract shall be null and void if delivery of the creature is not made within three (3) months of the date on which the contract is signed.

 AGENT _____ DATE 2/7/35

 EMPLOYER _____ DATE 2/6/35

_____	_____
TEAM MEMBER	DATE
_____	_____
TEAM MEMBER	DATE
_____	_____
TEAM MEMBER	DATE
_____	_____
TEAM MEMBER	DATE

FLIGHT TO MANGAMAKA

The daredevils must travel to the west coast where they will board one of the great 'China Clipper' -type seaplanes for the trip to the South Pacific. The craft has been chartered for them by Dowdler. Passage is from San Francisco to Manila with stops at Honolulu, Midway Island, Wake Island and Guam. The flight will take 60 + 2D6 hours.

The team will land in Manila and spend the night. In the morning, Simmington will introduce the daredevils to Jocko Slade, Patch Maupiere, and the Bluebird. Slade will fly the team to Surabaya, Java via Bandar Seri Begawan, Borneo. The team will then function out of Surabaya since the target archipelago will then be within the Bluebird's range for a round trip.

Simmington will present the team with a map of the Mangamaka Archipelago. The players may be allowed to see the map in the book. The Gamemaster should prepare an overlay or notes to indicate the exact location of the specific locales mentioned later in this adventure.

The lawyer will inform the daredevils that the apes come from one of the islands. Slade knows which one but he isn't telling. Simmington will also reveal that the apes are hostile to man and cite the disappearance of the last capture team as evidence of this. The lawyer will also inform the daredevils that the natives of the islands are believed to be headhunters. It is now up to the capture team to determine how they will fulfill their contract.

THE MANGAMAKA ARCHIPELAGO

The archipelago is situated in the midst of the Java Sea between Borneo and Java proper. The island group is not commonly visited by people from the major islands in the area since it lies beyond the normal ranges of the fishing fleets. Like most of the area, the island vegetation is that of a tropical rain forest. Temperature is relatively constant throughout the year, ranging from 70 to 90 degrees Fahrenheit. Daily fluctuations are slight. Since humidity is quite high, treat the temperature as 25 degrees higher for purposes of calculating the Heat Factor.

The native population of the area is mostly Malaysian. The dominant religion is Islam. The predominant language is Indonesian although some of the natives speak the language of the ruling colonias, Dutch.

Almost the only 'civilization' outside the port cities of the colonias consists of various privately owned plantations (rubber, cacao, etc.) and of mission schools. Such outposts are scattered throughout the Java area but none are known to be operating in the Mangamaka Archipelago itself.

The colonial government is on good terms with the United States. Like most governments in the South Pacific, they are uneasy at the unrest in China and the expansionist stance of Imperial Japan.

Mangamaka

This is the largest island of the group from which the rest take their name. Several native villages (each or 2D1U + 30 adults, 3D10 + 30

children) are known to be present. Mangamaka actually contains little of interest to the daredevils but will require a good deal of time to search carefully.

Kepuban

Kepuban is the second largest island in the group. It boasts an active volcano. The natives avoid this island as Taboo and speak in hushed whispers of the angry god and his servants who rule it. There is a slight chance (10%) that a red ape may be discovered to be living there. The specimen probably was tossed up there by a typhoon and will be emaciated and unhealthy. Most certainly it will be unsuitable for presentation to the daredevils' employer.

Masadura

Masadura is the third largest island in the group. It is the site of Father Raemaeker's mission. Several native villages (each of 2D10 + 20 adults and 2D10 + 30 children) besides the one associated with the mission school (60 adults and 72 children) are established on this isle. All the inhabitants are well aware of the good father's presence and his penchant for long walks in the forest. Most occasionally visit the mission especially after the supply boat calls since the father then has various 'gifts' for the members of his 'congregation'. The natives think little of his sporadic attempts to convert them but they gladly accept the trinkets and foodstuffs that he bestows upon them.

Although the island was once inhabited by the red apes, the indigenous population is long extinct. Their remains can, however, be still found. Without the priest's aid, such remains will be difficult to find. Even with his aid, the remains will be fragmentary and, to science in general, inconclusive.

Tangean

This is the isle that the daredevils seek. It is the second smallest of the sea islands in the archipelago. Resident on the isle is a remnant population of the red apes. There are some thirty remaining.

This island is also the site of a volcano. It is mostly inactive now but the natives can report signs that a trained geologist could recognize as indications that it might not remain inactive for long. The local native population consists of 43 adults and 62 children who all reside in a single village.

Liugaya

Although the smallest in the group, this isle hides a secret. Deep within the interior rain forest lies a long abandoned 'village'. The growth of the forest has almost reclaimed the stone walls which once marked its perimeter. These are of unmortared cyclopean construction. The wood and thatch buildings within the walls have long since been reduced to mere lumps of rich soil. Small artifacts of stone and bone may be unearthed in scattered locations around the compound. Archaeological Skill or Anthropological Skill will recognize these as early Stone Age items of a very primitive culture. These same skills can also allow a character to realize that the artifacts are not indicative of the ancient islander culture and must represent an unknown tribe of some variant derivation. Some animal remains may be discovered in pits to be found at various locations around the outside of the walls. The pits will at first appear to be mere depressions in the ground. Digging is required to unearth the bones. Study of the remains will reveal that some have been charred by fire. Carefully sorting of the evidence will reveal no remains belonging to either humans or apes although some of the bones from the pits are monkey bones.

The island also contains a long active volcano. A character with geology skill will note traces of volcanic ash in the vicinity of the 'village'. Analysis of the conditions of the soil and the ruins will allow that character to determine that the ashfall occurred sometime after the abandonment of the habitation.

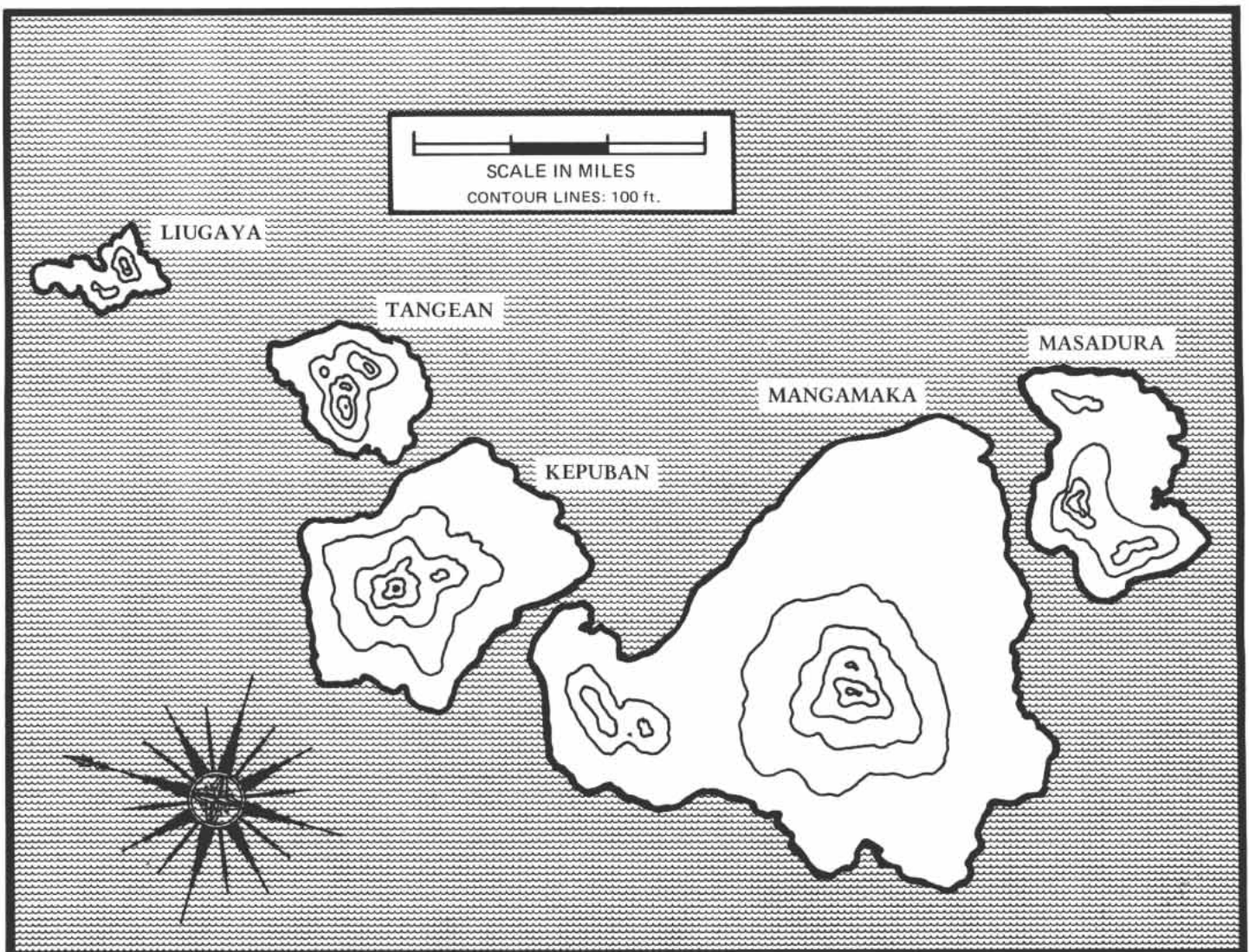

ENCOUNTERS IN THE ARCHIPELAGO

Aerial

While attempting to gather information on the islands, the daredevils may wish to over-fly them for aerial observation. Since the vegetation is heavy on all the islands, little can be seen from the air. Native villages are hidden things that must be spotted with a Perception Roll. Use the best value among the observers. The mission village of Father Raemaeker can easily be spotted from the air. It is located along the shore of the southern bay of Masadura. Other things might be observed during the flight. Roll once for each aerial trip over the islands. The Bluebird can spend about half an hour in the air over the islands and still have enough fuel to make it back to Surabaya.

Die Roll	Event
1-4	No event.
5	The supply ship is headed to or from Masadura. It calls once every 6 to 8 weeks.
6-11	An ape is spotted. On any island other than Tangean this will be an orang-utan. Even on that island there is a 70% chance that it is an orang-utan. It will be almost impossible to determine the creature's species from the air.
12-14	A group of 1D6 ten-man canoes are observed pulling for one of the islands. This is a raiding party of headhunters.
15-19	One of the Bluebird's engines fails. The craft must put down at the nearest island. Repairs will take 3D10 hours.
20	A tropical storm hits. The team will have sufficient warning to decide whether to run for Java, land at an island of their choice, or try to ride it out. The storm lasts for 2D6+6 hours and requires a Pilot Skill BCS to ride out safely.

Island

For every two hours that the daredevils spend moving across an island, make a roll on the table provided. Travel on the islands is reduced to 25% of normal. Check once every four hours if they are camped. If the team is not being quiet, add 2 to the die roll. At night, subtract 2 from the die roll.

Naturally, any stationary things on the islands such as native villages, ruins, the mission village, etc. will be met as the group moves to them.

The gamemaster is encouraged to use the table as an idea generator and follow the implications of an encounter in relation to the activities of the daredevils. Not all encounters will be hostile. Some may even pass without the adventurers being aware of them.

Die Roll	Encounter
(-1)-0	A mated pair of red apes*
1-2	A read ape.*
3-4	An orang-utan.
5	A tiger.
6-8	Island deer. Good for food.
9-14	No encounter.
15-	Islanders (1D6 children).
16-17	Islanders (1D6 gatherers).
18-19	Islanders (1D6 hunters).
20-22	Headhunters on a raid.

*On any island other than Tangean there will be no encounter.

When first met, native islanders are likely to be simply curious. If bad relations have already been established with the daredevils, the chances of hostility are, of course, greater.

Headhunters move in groups of 1 'canoe' (10 men). They are armed with spears, cudgels and tebutje. They wear coconut fiber armor (Armor Class 4) and sharks-tooth and fiber helmets (leather helmets equivalent). Treat them as Superior Rabble. They will flee if half their number is downed. When one 'canoe' is encountered, there is a 40% chance that 1D6 more are on the island. Headhunters speak an Indonesian dialect.



CAST OF CHARACTERS

C.D. Dowdler

Dowdler is a reclusive financier with a taste for the unusual. He will not appear in person nor will he daign to speak to the daredevils over the telephone. All communications will be through his attorney Simmington.

Dowdler's reasons for this job are his own and are not to be revealed to his employees. If The Powers of Dr. Remoux has not been used Dowdler may be acquiring the ape to sell to the doctor. Otherwise he is seeking a specimen for his private collection of the unusual.

Dowdler never has been above a shady deal but has always covered his tracks well. There is no hint that he is anything other than the legitimate businessman that he appears on the surface. He is, however, known throughout the business world as an eccentric.

'Patch' Maupierre

'Patch' is rarely called by anything other than his nickname. His past is sordid and he speaks little of it. He is surly and uncommunicative with most people but is loyal to his partner of 10 years, Slade.

Patch is half-french and half polynesian. He is very resentful of any treatment as an inferior, especially by europeans or americans. Though angered he will rarely take immediate action. His style is more suited to back alleys and dark streets. He will gladly beat an offender to within an inch of his life in order to prove that the half-breed is an equal if not a superior. He is rarely moved to lethal violence over such matters.

WT	WL	STR	DFT	SPD	HLH	CDA	DRT
10	12	17	15	9	13	3	28

SKILLS: Brawling (14/4); Pistol (12); Knife (14/4); Navigation (12); Pilot (8); Mechanic (12); Polynesian (16); Indonesian (15); French (17); Dutch (8); English (8); Criminal Subculture (15); Polynesian Culture (15).

WEAPONS: Standard barrel Luger P08; Bowie Knife.

CLOTHING: Tropical dock clothes (Armor Class 1).



Father Bastiaan Raemaeker

Father Raemaeker is a member of an obscure Dutch missionary order of the Roman Catholic Church. He was assigned out here as something of a disciplinary action. His work with the islanders has not been what his superiors would call admirable. Upon his arrival he was resentful of his assignment but got the mission school built despite his lack of motivation. His personal attitude has improved since his discoveries in the forest but his absorption with them has increased his neglect of the 'congregation'. His intense focus on his extra-curricular activities blinds him to the failure of his religious mission here. The enthusiasm he feels for his non-religious work is transferred to his religious work so that he perceives things as going very well despite his neglect.



Raemaeker is a tall thin man with thinning hair and an intense probing stare. His blue eyes spark with a lively intelligence. The priest will gladly join in on anthropological or archaeological discussions and, if he perceives that the person with whom he is talking is competent in the field, will rapidly turn the conversation to his discoveries and theories.

The discoveries are indeed remarkable but they are also somewhat meager. His collection consists of a few tools, a number of isolated bones and a nearly complete skull. All belong to the red apes. His theory is that these belong to ancestors of the South Pacific islanders and are strong indications of evolutionary processes. The great differences between men and these primates is, he feels, due to the action of the creator as he instilled souls into the beast to make it a man. The recent age of the remains substantiate his belief in the young (about 10,000 years) age of the earth. He continues to search the surrounding forest for more evidence which he believes will support his theories. He is writing a thesis that he feels will irrevocably prove the age of the earth and the nature of Genesis as a parable of the evolutionary process of creation.

WT	WL	STR	DFT	SPD	HLH	CDA	DRT
16	19	8	14	10	15	2	29

SKILLS: Anthropology (10); Archaeology (8); Paleontology (4); Rhetoric (15); Restoration (12); European Culture (15); Polynesian Culture (8); Dutch (19); English (16); Polynesian (12); French (12); Indonesian (10); Academic Subculture (12).

WEAPONS: None.

CLOTHING: Priestly robes (Armor Class 1).

J. Alfred Simmington

Simmington is a prissy, fastidious lawyer with a flair for fine clothes. He is also a hard-nosed, no-nonsense negotiator and crack legal eagle.

He is but one of a group of special attorney/agents for C. D. Dowdler and has been assigned the task of seeing that the acquisition of a red ape is successful. This is a task he finds somewhat distasteful as it will take him to what he considers an unsavory part of the world. He is, however, dedicated to his work (as well as bound



to a strict contract) and will attempt to accomplish the job as rapidly and effectively as possible.

Simmington is little good in a fight since he prefers to leave the 'fisticuffs and other such violence to hired rowdies' such as the daredevils. This does not mean he is a coward. He is not.

Simmington will attempt to keep the daredevils' expenditures to a minimum. He will also endeavor to get them to move along as rapidly as possible in acquiring the ape. Once acquired he will expedite its shipment to the U.S.

Simmington will, under no circumstances, entertain any suggestions that the red apes may be intelligent. He will steadfastly refer to them as 'brutes, dumb and vicious'. This conviction will not be shaken by evidence to the contrary. Being an intelligent man, he will see such evidence but will find some way to rationalize it away so that his perception of the world and man's place in it will remain undisturbed.

WT	WL	STR	DFT	SPD	HLH	CDA	DRT
27	30	8	15	12	10	3	29

SKILLS: Law (18); Business Subculture (18); High Society Subculture (16); Politics Subculture (16); Finance (15); American History (18); Rhetoric (18); Euro-american Culture (18); Interrogation (14); Research (14); Driver (12); Fencing (10).

WEAPONS: Sword cane.

CLOTHING: Business suit (Armor Class 1) until Manila is reached where he will change into a very natty safari outfit including a pith helmet (Armor Value 1, tropical).



Jocko Slade

Slade is a grizzled veteran of the seamier side of life in the South Pacific. He flies his plane for hire and has not always been particular about his clientele. Though not quick to anger, he has been known to hold a grudge for a long time. When angered though, he will attempt to bring the situation to a final conclusion. He has a reputation as a bad man to cross.

The flashiest thing about Slade's appearance is the handle of his revolver which is subtly carved ivory, inlaid with mother-of-pearl. The business parts of the weapon are scrupulously well kept. He wears this weapon in a low-slung, fast-draw holster on his left side in imitation of 'murican cow folks'.

Slade's orders at hiring were to follow Simmington's orders even if nominally placed at the disposal of the daredevils. Since his fee was only partially paid with the rest to follow on satisfactory completion, he will honor this arrangement. Being a man of discretion he will not mention this facet of the deal.

Slade is something of a glibulous man and will tell tall tales of his adventures around the South Pacific, some of which are even true. He will not speak of his Australian origins even though his accent brands him as having come from that nation. He is fond of strong drink but holds it well. He will respect anyone who can drink him under the table.

WT	WL	STR	DFT	SPD	HLH	CDA	DRT
15	18	17	22	14	23	3	41

SKILLS: Pilot (16); Navigation (15); Pistol (16); Rifle (12); Knife (16/4); Brawling (16/4); Mechanic (8); Electrician (6); First Aid (7); Criminal Subculture (14); Business Subculture (8); Law Enforcement Subculture (5); Polynesian Culture (12); India Culture (10); Chinese Culture (8); Japanese Culture (7); Euro-american Culture (15); English (16); French (12); Dutch (12); Indonesian (12); Polynesian (10); Chinese, Japanese and Indian (6).

WEAPONS: .45 ACP Colt New Service Revolver, Bowie Knife.

CLOTHING: Tropical work clothes (Armor Class 2).

THE BLUEBIRD

The Bluebird is Slade's trusty but dilapidated aircraft. It is a modified Junkers G24 seaplane. Although the replaced engines are reliable, the plane will give the impression that it could fall apart at any time. The G24 normally requires a crew of three but Slade gets by with only his co-pilot Patch. The plane carries no radio. It is partially converted over to cargo carrying and so has a passenger capacity of six instead of the usual nine. The craft's name comes from the fact that its metal skin is painted a medium blue all over. The Bluebird is registered in the American-controlled Phillipines but a secret compartment conceals alternate registration papers and a selection of paint for altering registration markings. The compartment also contains a Mauser KAR98 and an ammo belt with 10 spare clips.

Max. Speed (kph)	Accel.	Hand.	DUR	BAR	Range (km)	Passengers	Year
200/182 cruising	40	2	10	10	860	2+6	1925 (Ger)

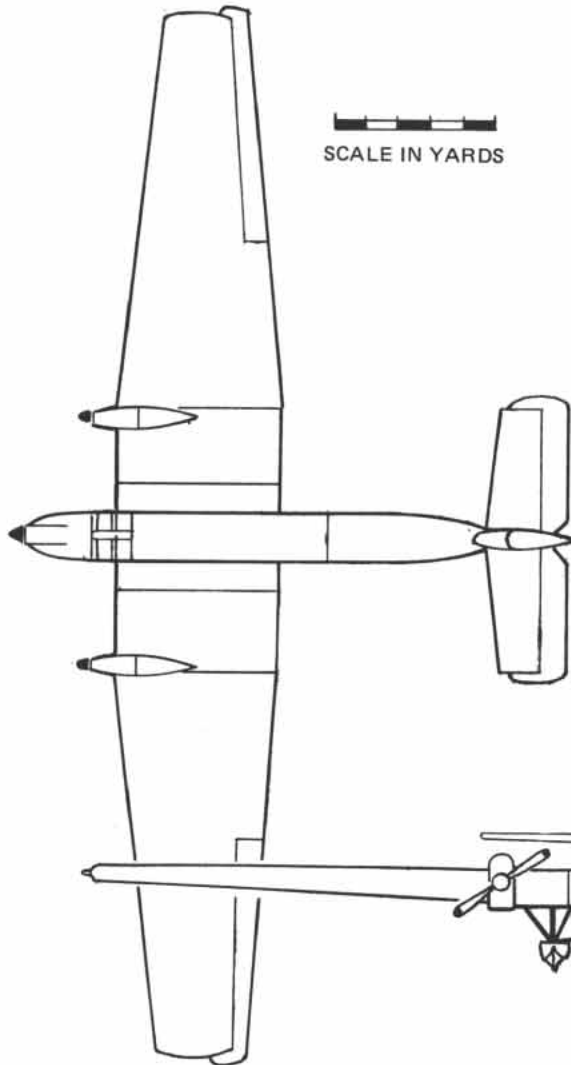
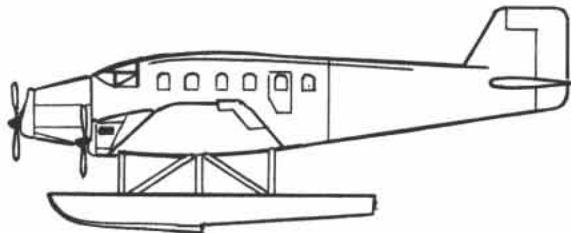

SCALE IN YARDS

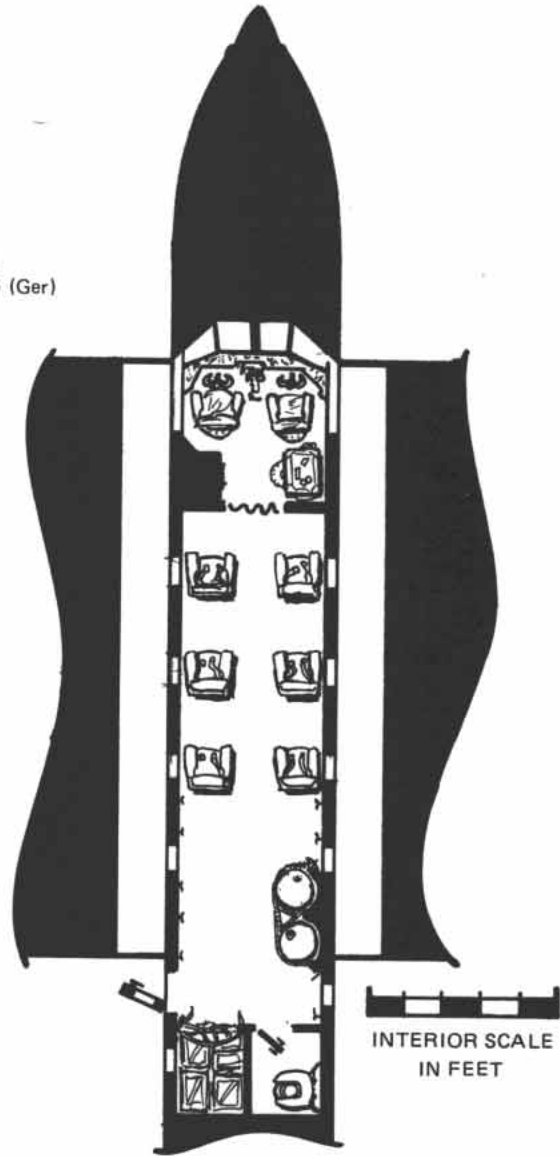

INTERIOR SCALE
IN FEET

MANGAMAKAN ISLANDERS

The islanders speak Indonesian almost exclusively. A few (7%) speak broken Dutch and fewer still (3%) speak broken French. On Masadura triple these chances.

In general they are a quiet and gentle folk who are quite happy to let the outside world go on its own way. They are untouched by the Islamic faith of the region and are merely amused by the religion of the somewhat neglectful Father Raemaeker. Their long-standing pagan ways of animistic faith are still very strong in their culture. They are very close to their land and to the sea. They know their home islands very well.

The population subsists on the bounty of the sea and the benefit of the forest.

Although the tribes are not war-like, they can be very fierce and tenacious warriors when the need arises. This is fortunate since they are subject to raids by vicious headhunters from a neighboring island group. These raiders are referred to as 'The Un-people' and are readily reviled by the islanders. Coincidentally, they refer to white men as 'Un-people' but the Gamemaster should note the lack of 'The' and use it to sow confusion for the Player Characters in their interactions with the natives.

The Mangamakan islanders speak fondly of the 'Woodsmen' with whom they say they share the islands. These Woodsmen are said to be wise and benevolent creatures who dwell in the forest and maintain its spirit. Sometimes the islanders will leave gifts of food in the forest to please these spirit folks. If questioned on the appearance of these Woodsmen, most natives will reluctantly admit that they have never seen them. The traditional description cites a short, red-haired man with large dark eyes. If skin color is brought up, they will say it is 'normal' like their own.

The islanders will refuse to aid in any attempts to capture a Woodsman since this would be detrimental to the forest. They will also try to prevent anyone from removing a Woodsman from the islands for the same reasons. Such resistance could easily escalate to violence.

When forced to violence only half of the adult population will fight (the males). A third of these will have woven coconut fiber armor (Armor Class 4). All will carry a spear for throwing and a hand weapon for melee. Most (65%) of these hand weapons will be cudgels and the rest will be tebutje (shark toothed-edged clubs equivalent to machetes). Treat the typical warrior as an Average Extra and the armored warriors as Superior Rabble.

RED APES OF MANGAMAKA

The red apes of Mangamaka are responsible for the Woodsmen legends of the islanders. Indeed, they once behaved as in the descriptions in those legends save that they are not responsible for the well-being of the forest. Their temperament has since changed, becoming vicious. They could easily be described as killer apes.

Since the natives have attributed spirit powers to these Woodsmen, most colonials discount the existence of such creatures. A low circulation edition of Sir Thomas Stanford Raffles's 'History of Java' published in the mid-nineteenth century contains the english naturalist's account of an encounter with one of the apes. Other editions of the work delete this section as Sir Thomas's editors felt it would detract from his reputation. Most europeans identify Sir Thomas's 'man-like ape' and the Woodsmen with the orang-utan and assume that the natives have merely applied imagination to this gentle creature.

The red apes are actually confined in range to the isle of Tengean. They are a remnant population of a once more numerous primate. Their current population is declining due to a lack of certain trace elements in their foods in this confined range. Birth rates are reduced and non-viable offspring are common. The apes may well be gone in a generation or two. Some have even tried mating with their cousins the orang-utan with no success.

The apes are degenerated from an ancient near-hominid stock related to the orang-utan. They stand about five feet tall when erect and mass around 160 kilograms. They are covered with reddish orange hair. Their stocky build makes it easy to mistake them for orang-utans at a distance or when glimpsed through the undergrowth of the rain forest.

Careful observation by a zoologist or close examination by an observant character will reveal that these apes are not orang-utans at all. Limb proportions are different as is the head shape. The teeth are markedly different as their diet is far more omnivorous than that of the retiring, mostly vegetarian orang-utan. Examination of a skel-

A HUNTING FOR TO GO

Obviously, the Player Characters will be desirous of capturing one of the Red Apes of Mangamaka once they ascertain just where to find them. The variety of methods which might be employed by creative players is great. Thus, we can only give guidelines to the Gamemaster to aid him in administering this adventure.

The daredevils may elect to employ traps. If they have not purchased materials beforehand, such will have to be improvised on the spot. Traps skill will thus be invaluable to the expedition. When the hunters are building traps, the Gamemaster must evaluate the design and assign it a Task Value. Pits are simple (10 points), snares are more complicated (20 points), and baited cages with trip-released doors are even more so (30 points). Task Turns should be about half an hour. In this way the amount of time spent in construction, placement and concealment can be assessed. Characters unskilled in Traps skill may still construct traps. Substitute Deftness Critical Saving Throws for the skill score. Even when successfully completed, such traps will be less likely to function and more likely to be detected by their intended prey.

Once a trap is emplaced, it may be checked by the daredevils once a day to see if anything has been caught. The Gamemaster should use the island encounter table to see what has encountered the trap. Whatever is indicated may detect the trap with a standard Hidden Thing check. If the trap is undetected, it still must succeed in its 'BCS' to capture whatever encountered the trap. This 'BCS' is the same as the BCS of the Trap skill or Deftness Critical Saving Throw of whomever designed the trap. The Gamemaster should roll 1d20 in the normal fashion to see if a capture is made.

The Gamemaster may wish to ignore encounters other than Red Apes in an effort to speed play. Alternatively, he may wish to simply decide what is encountered and when it is encountered in such a fashion as to generate an interesting play session for his Player Characters.

Even once something is caught in a trap, it may not be held until the daredevils arrive to inspect it. Any islanders who blunder into a trap are likely to be rescued by their fellows. This could result in bad feelings between the natives and the adventurers. Red Apes are likely to help members of their species to escape as well. This is especially likely if one of a pair is captured. The mate of a captured ape, if unable to free the captive, will likely lurk about waiting for an opportunity to do something. Remember that the apes are quite strong and shoddy construction will not stand up to the onslaught of an enraged ape for long.

etion will reveal significant differences from any known simians. Observations of behavior will also reveal differences as the red apes are more aggressive and violent than their cousins. In the wild the apes will hunt for meat and even engage in combat when they meet other members of their species. They are unafraid of man and will attack if disturbed, annoyed, frightened, surprised or threatened.

Though once possessing a primitive tool-using culture, the apes are slowly losing their simple but human-like intelligence and reverting to basic bestial instincts. They are, however, quite cunning. They will sometimes (30%) use weapons in a fight. Usually an improvised cudgel (90%) though some may have acquired native tebutje. A rare ape (5%) may have picked up and be wearing native ornaments.

The red apes, like their relatives, are usually solitary. Unlike their simian cousins, a mated pair will travel together for quite some time. The pair will hunt together and, in general, support each other.

Following some ancient rhythm or racial memory, the apes gather yearly at the lip of the volcano where they toss fruits and tubers into the caldera. An anthropologist might glean the remnants of a religious ritual in the actions of the creatures. This gathering takes place at the beginning of the rainy season. It is the only time that the entire population is in one place at one time. The apes begin to drift into the area around the volcano about two weeks before the trip up the mountain. Two or three days after all arrive they move up the slope and perform their 'ritual'. They remain in the area and socialize for another week or two before they begin drifting off again to their solitary ranges.

Perc	Coor	HLH	DFT	DRT	Movement	CDA	
16	15	14	28	35	2/7/21	3	
AV	Size	Fer.	Attack	Freq.	BCS	Damage	Notes
2	1	3	bite	1	9	1D6	Hug
			2 claws	2-6	15	1D10+1	
			or				
			weapon	—	12	1D10 base	

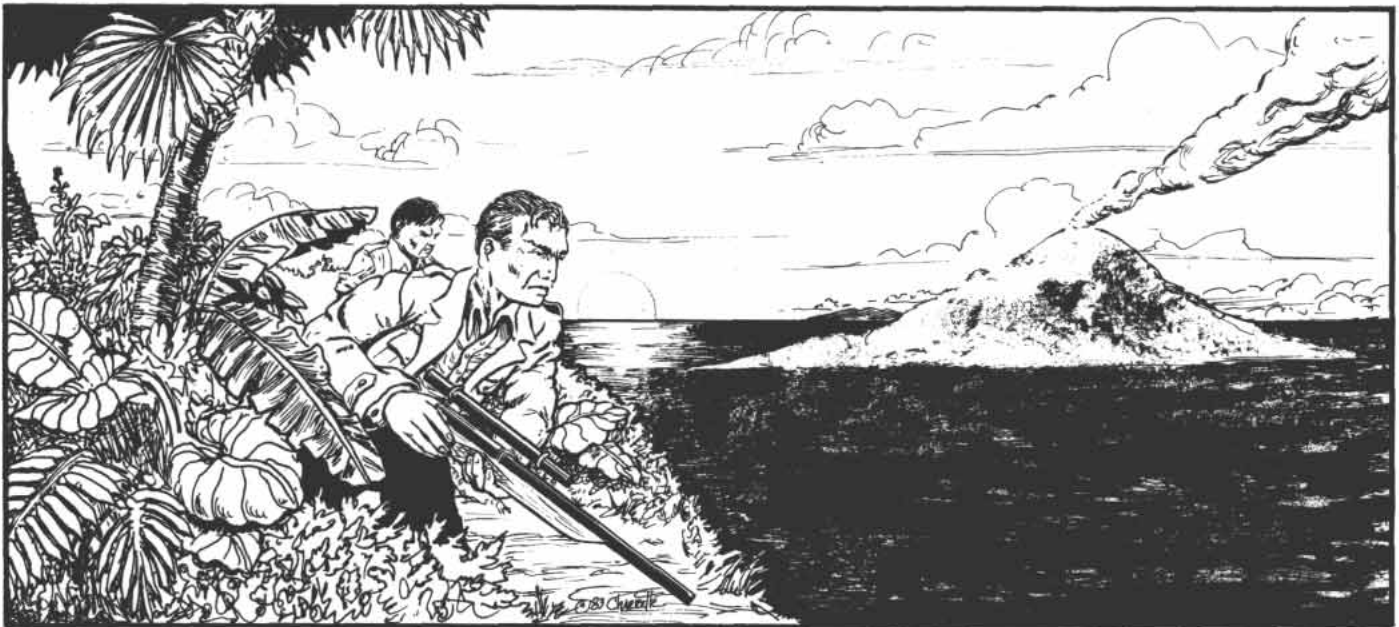

Should the daredevils elect to employ devices that maim in order to capture or to seek to wound an ape in order to capture it they will be discouraged from this course of action by Simmington who will pointedly remind them of the provision in the contract that specifies an intact creature and his designation as the one person to determine the definition of 'intact' in this context.

It should be noted that tranquilizer darts are unavailable for purchase.

Thus, the daredevils must cope with the vagaries of the environment while stalking their prey and attempting its capture. Time too is their opponent since the contract limits the amount of time they will have to traipse about the islands and tend their traps.

FULFILLING THE CONTRACT

As noted before, Simmington holds the key to the fulfillment of the contract. He has the final say in terms of the definitions of the

words in the contract. He can and will make his definitions stick, either in an argument or a court of law.

Simmington will participate as little as possible in the actual physical labor of the expedition. He will even intervene in the planning and decisions of the group only when they are in danger of preventing the completion of the contracted services by their actions. He will leave the daredevils to whatever methods they choose to capture a healthy specimen. Once captured, he will allow the adventurers to crate it, load it on the Bluebird, and fly it to Surabaya. Whenever possible, he will endeavor to have one or more members of the team perform any labor required in camp. If all refuse, he will do nothing but wait until a suitable time arises to instruct Jocko to get the work done either by himself or by Patch.

If more than one of the apes are captured, he will insist on its release even if this might endanger the team. If they refuse, he will undertake to have the animal killed since its removal from the island will be a violation of the contract.

Simmington will not hurry the team along in its pace but his will keep a close eye on the dispatch with which they perform their tasks. It might be sufficient to later prove that they did not perform their contractual duties 'with all reasonable haste'. He will, however, eventually point out undue malingering although he will not point out its consequences. Once he has been moved to this step, he will consider the contract violated and, upon return to civilization, recommend that Dowdler initiate action against the violators.

Payment will indeed be forthcoming if the daredevils fulfill their part of the contract even if the turn of events might cause them to suspect that they will be 'stiffed'. Payment will be made via cashier's check which will be mailed to a designated address in care of the team leader.

Simmington will have made plans for the transfer of the creature from a rented warehouse in the waterfront district of Surabaya. He will not allow the daredevils to accompany the ape on the steamship which will carry it to America. He has already booked passage for them on another ship. He will be prepared to enforce this course of action with the aid of large numbers of nasty local ruffians, all well armed. This should discourage the Player Characters from disputing the decision with him at this point. Simmington will not, of course, inform the daredevils of the ape's destination and the ship's papers have been falsified with regard to destination.

Simmington's control of the purse strings of the expedition allows the Gamemaster to limit what equipment is actually available to the Player Characters. It also enables the lawyer to afford the hire of extra thugs to enforce the contract should this become necessary. While on the islands, he will only have Jocko and Patch for protection but the money available to him will ensure their loyalty.

Ultimately, if the daredevils fulfill their part of the contract, they will be treated fairly within the letter of the contract and left alone. Should they break the contract in any way or harm Simmington, they will be subject to the vengeance of the agents of the shadow empire of C.D. Dowdler but this is another adventure (or a whole series of them).

EXERPT FROM 'HISTORY OF JAVA'

Suddenly, the whole forest seemed to be still.

My bearers were somewhere behind me, yet I could not hear their progress through the undergrowth. Sunlight streamed down in irregular shafts to brighten the forest floor. That the birds and insects were still struck me as odd. Yet, I was not afrighted and stood to marvel at the wonders of the Lord's creation spread before me.

I know not how long I stood thus enraptured. A slight rustle in the brush behind me caused me to turn. Expecting to see my bearers, I received a shock. Before me was a large hairy being which, had it been in poorer light, I might have mistaken for an ape.

Its, no . . . I must say his, eyes gleamed with mischief like those of a young child who had just played a prank on an elder. Around his neck was a thong of plaited grass which he fingered as we stared, each upon the other. He stood nearly as tall as I and was covered all over with red hair. An innocent child of nature, noble in his savagery, he knew no shame such as was visited upon mankind by a sinful Eve in the Garden.

Slowly he reached out an arm. I flinched not for I felt no evil intent behind the gesture. He seemed curious about the glints of sunlight from the buttons on my shirt. Before he could touch one, there came a crashing in the brush. It was my bearers finally re-joining me. The noise startled him and he fled. As I watched him disappear deeper into the jungle, I knew that I had met one of the wise old men of the forest of whom the natives tell. The bearers said that they saw him not but, to my descriptions, named him 'oran-u-tann'.

I saw him not again in all my travels throughout Java, but still I recall the look of peace and innocence in those dark eyes.

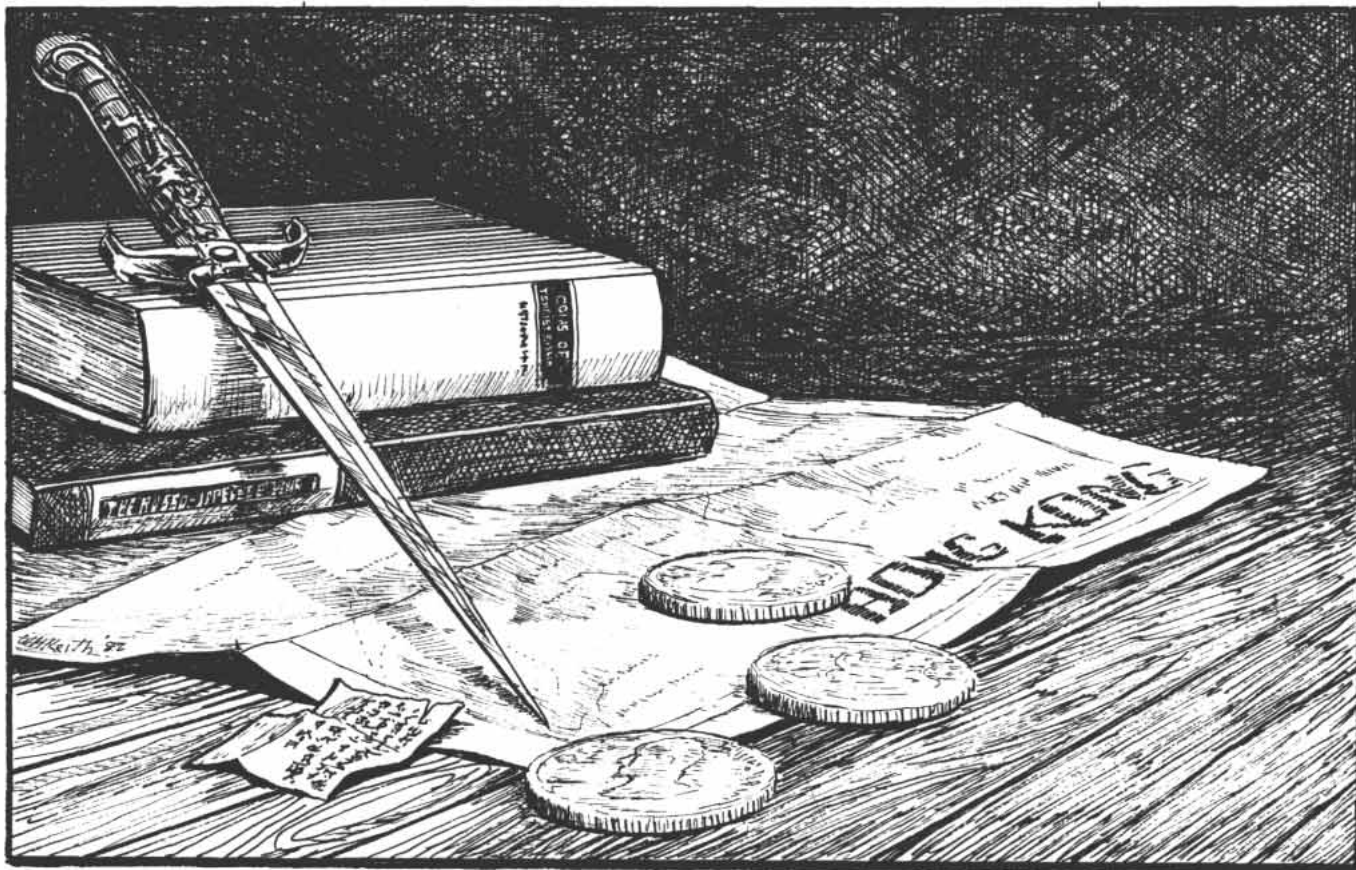

DEADLY COINS

BY
J. ANDREW KEITH

Based on an idea by William H. Keith, Jr.

Illustrations by William H. Keith, Jr.

'Deadly Coins' is a full-fledged **DAREDEVILS** adventure composed of several set pieces. The Gamemaster must interweave the story line presented here with the decisions and actions of the Player Characters. This may often require modification of the story line to best fit the needs of telling an exciting and dramatic story. Subtle direction of the course of the adventure is of key importance, and a thorough understanding of the adventure's background and overall direction is absolutely necessary to such subtlety. Through judicious manipulation of events, the Gamemaster should be able to build this adventure into a solid narrative filled with a steadily mounting sense of tension and impending danger, which ends in a satisfying climax.

THE OPENING SCENE

The daredevils have just completed an undertaking which led them to Hong Kong, and tonight are celebrating the successful end of their mission with an elegant dinner at the Peninsula Hotel in Kowloon. Their dinner is quiet and goes without incident. As they are finishing, they are approached by a gentleman in evening dress. He gives his name as Sir Roger Fentiman, and asks if he might join the party for a moment to discuss a matter of mutual benefit.

Sir Roger is a British baronet with an interest in travel and a large personal fortune. He has been staying at the Peninsula for the past six months, indulging his passion for seeing exotic lands and adding to his sizable collections of rare books and unusual coins.

Four days ago, Fentiman purchased three gold coins from a numismatist's shop in Tsim Sha Tsui. These coins, Fentiman says, were part of a group of ten from which Fentiman chose to buy three in order to examine them more closely. He planned to return to buy the others after the first three were authenticated.

The coins are Russian in origin, Czarist coins minted in 1903 and 1904. Of greatest interest to Fentiman was the fact that they were somewhat corroded, as if they had been immersed in water for some

time. Fentiman had checked with a local expert and determined that they were authentic, but, on returning to the shop two days ago, discovered that another collector had purchased the remaining coins. According to the clerk at the shop, this other collector had been upset at having only a portion of the original batch of coins available. Fentiman thinks the other man was an American, but he is not certain of this since he did not fully understand the broken English of the clerk.



SETTING THE SCENE

The action in this adventure takes place in Hong Kong early in the year 1932. In the Orient, growing Japanese militarism has been increasingly evident, with the invasion of Manchuria and an incident in which Japanese troops occupied the Chinese city of Shanghai. There is considerable tension throughout the East, as the first storm clouds of coming strife gather on the horizon.

The British Crown Colony of Hong Kong is shown in the accompanying sketch maps. Hong Kong itself lies on an island off the Chinese coast. Just across a narrow strait, on the Chinese mainland, is Kowloon and the so-called 'New Territories', incorporated into the Colony more recently than the original island trading post. There are also nearly a hundred other islands, large and small, surrounding these primary centers of habitation.

On the maps, major districts and points of interest are indicated. These are provided primarily to aid the Gamemaster in setting the general mood of the story. It is important to keep in mind the nature of the Colony when presenting the adventure; the players should be periodically reminded of the locale by the nature of the descriptions given. Hong Kong is a crowded, exotic setting for an adventure, and this should be played up at all times. Never make the mistake of allowing the players to confuse Hong Kong with Hoboken . . . a major part of the flavor of the adventure is the romantic character of the Oriental setting.

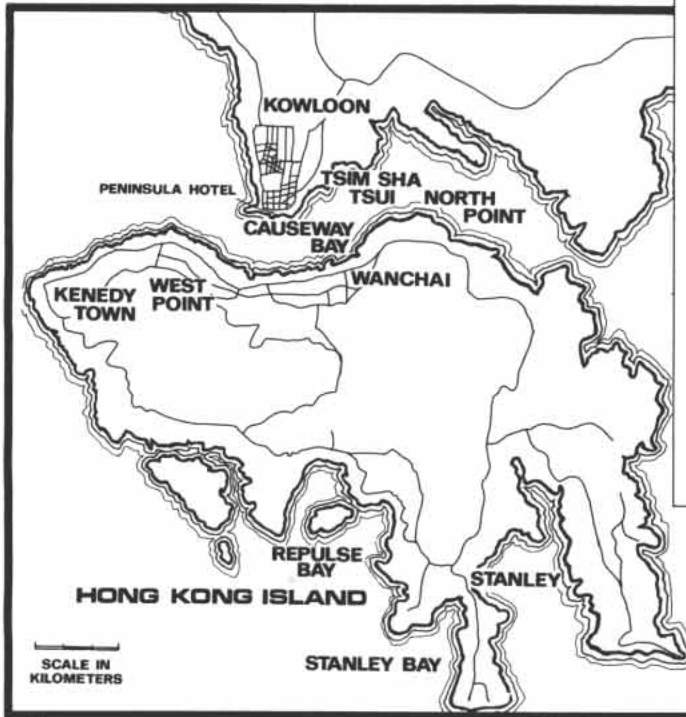

SCALE IN KILOMETERS

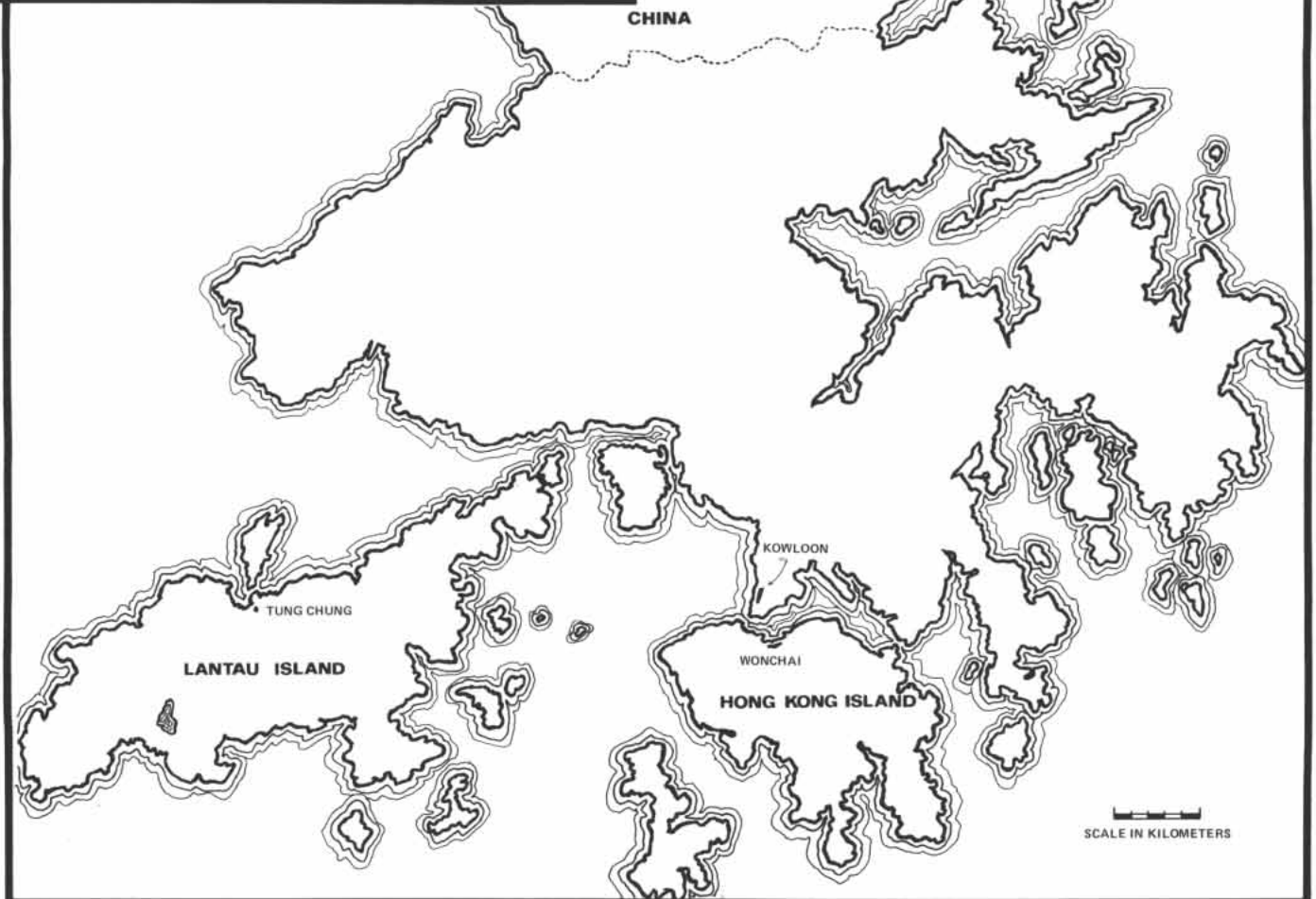

SCALE IN KILOMETERS

Yesterday afternoon, Fentiman goes on, he was out on an excursion to visit the Pak Tai Temple on the island of Cheung Chau. On his return today, he discovered that his hotel room had been broken into and ransacked. His valet, Chambers, was dead of a broken neck. A hasty inventory of the various valuables kept in the room revealed that the Russian coins were the only missing objects, though there were several other coins of far greater value, and a great deal of money, as well.

The Hong Kong police have already inspected the room, but do not hold much hope of finding the perpetrators. Fentiman, who has heard of the exploits of the daredevils from a mutual acquaintance, wants the group to look into the matter for him. Aside from the murder of Chambers, Fentiman is quite upset at the theft and the vandalism, and wants to bring those responsible to justice.

THE HOTEL SUITE

Fentiman takes the daredevils to his hotel suite to show them the scene of the crime. Inspector O'Neil of the Hong Kong police and several constables are on the scene, still examining the site of evidence. O'Neil is not particularly pleased to see the baronet and his companions, but Fentiman carries enough political and social weight to force the police to back down and let the daredevils look the suite over.

The accompanying sketch map shows the layout of the hotel suite. Only the sitting room area is in disarray; the other rooms are quite undisturbed. A number of clues can be obtained simply through observing the room, while others require specific attention to a particular area, and still others qualify as Hidden Things. Clues to be found here include:

- Most of the furniture in the room has been overturned or otherwise disturbed. Chairs and sofas have been slashed open, and the stuffing pulled out. Drawers from the chests and desks were emptied onto the floor.
- The door to the suite was broken in by force. Examination by a character with Martial Arts skill will indicate that it was probably shattered by a forceful kick from the outside.
- Examination of the desk shows that several locked drawers were splintered by well-directed blows before being pulled out. Fentiman indicates that his coins were kept in one of them.
- The police found no fingerprints in the room. Player Characters who repeat the process will be similarly disappointed.
- Examination of Chamber's body will show that he was killed by having his neck broken. See the description of Chambers for further details.

- There is one clue to the break-in which is quite hard to notice. It is a Hidden Thing which will only be discovered by examinations taking place in the hall just outside the room. **Hidden Thing:** A scrap of paper bearing the words 'Lantau ferry-boat leaves 6 p.m.' in Chinese. It can be translated by characters who make a Chinese Language BCS roll.

Other clues may be given out in response to specific inquiries made by the players, or at the Gamemaster's discretion.

WHAT HAPPENED

In order to allow the Gamemaster a better understanding for planting clues and answering questions as the daredevils carry out their investigation, we present an account of the break-in as it actually occurred.

Two Guardians of the Blue Dragon visited the suite in the middle of the afternoon, breaking in the door to the suite with a kick. They immediately began to ransack the room, pausing only to dispose of Chambers, as he came out of his room in response to the sudden noise. Working methodically, they tore the room apart until they reached the desk, where they discovered the coins they sought. There was no need to continue their search further.

As they left, one of them accidentally dropped a note reminding them of a rendezvous place and time for the next day. This ended up in an almost unnoticeable corner in the hall, not far from the door to the room.

INVESTIGATIONS

In attempting to follow up the mystery of the break-in, the Player Characters can pursue several different courses of action. The most obvious of these are outlined below. If the players elect to follow some other course, the Gamemaster must be prepared to make adjustments, finding ways to expose the group to the information they need while allowing them to take the proper action.*

The most obvious course of action for the group to follow is to seek out LeValier's coin shop, where Fentiman acquired the coins. This might lead them to other people who were interested in the coins, such as the man who purchased the remainder of the set before Fentiman could return. Results of a visit there (which must wait until the shop opens up again on the morning after the daredevils are first contacted) are detailed in the section entitled 'The Coin Shop'.

Another possibility is to contact the coin expert who authenticated the coins for Fentiman, Lin Wu. He might be able to give an opinion on the value of the coins, or on people who might wish to acquire these coins. The results of this line of inquiry are detailed in the character description of Lin Wu.

Most other lines of inquiry will probably be dead ends, and should eventually bring the group back to LeValier's as a logical place to check.

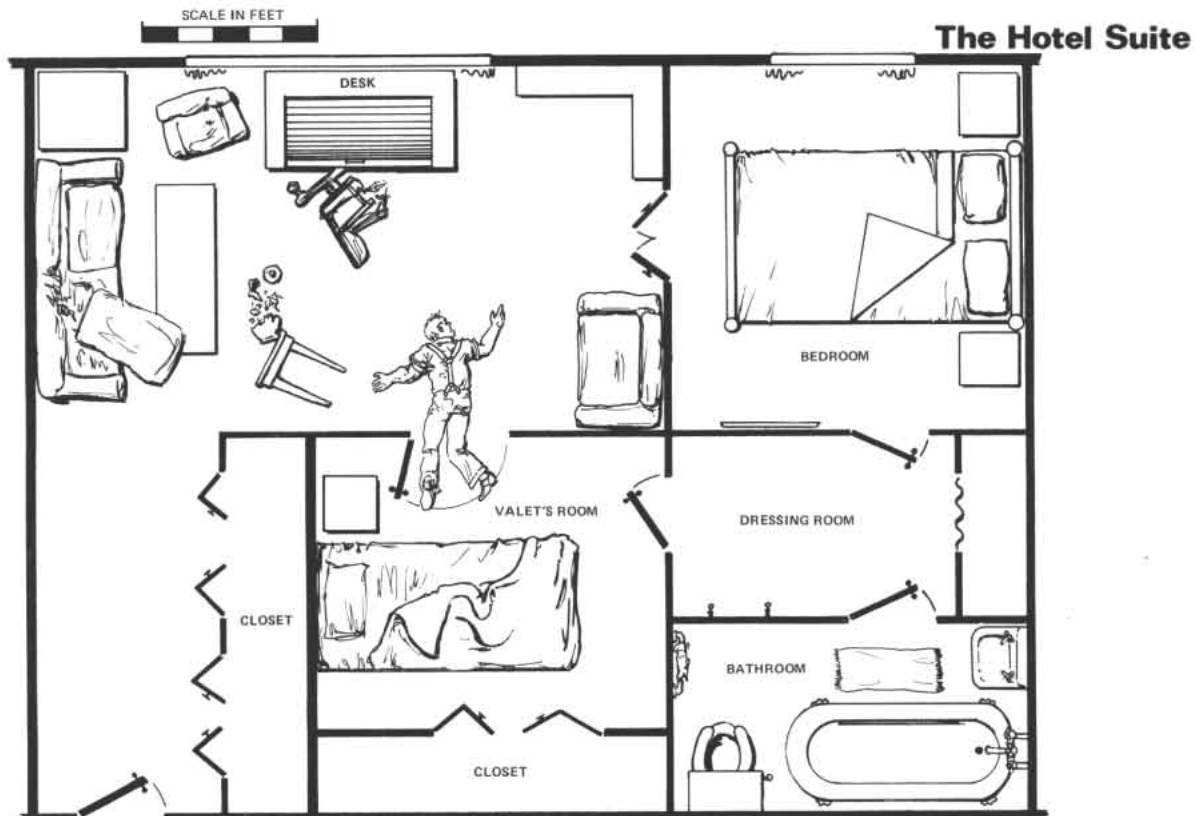

The Coin Shop

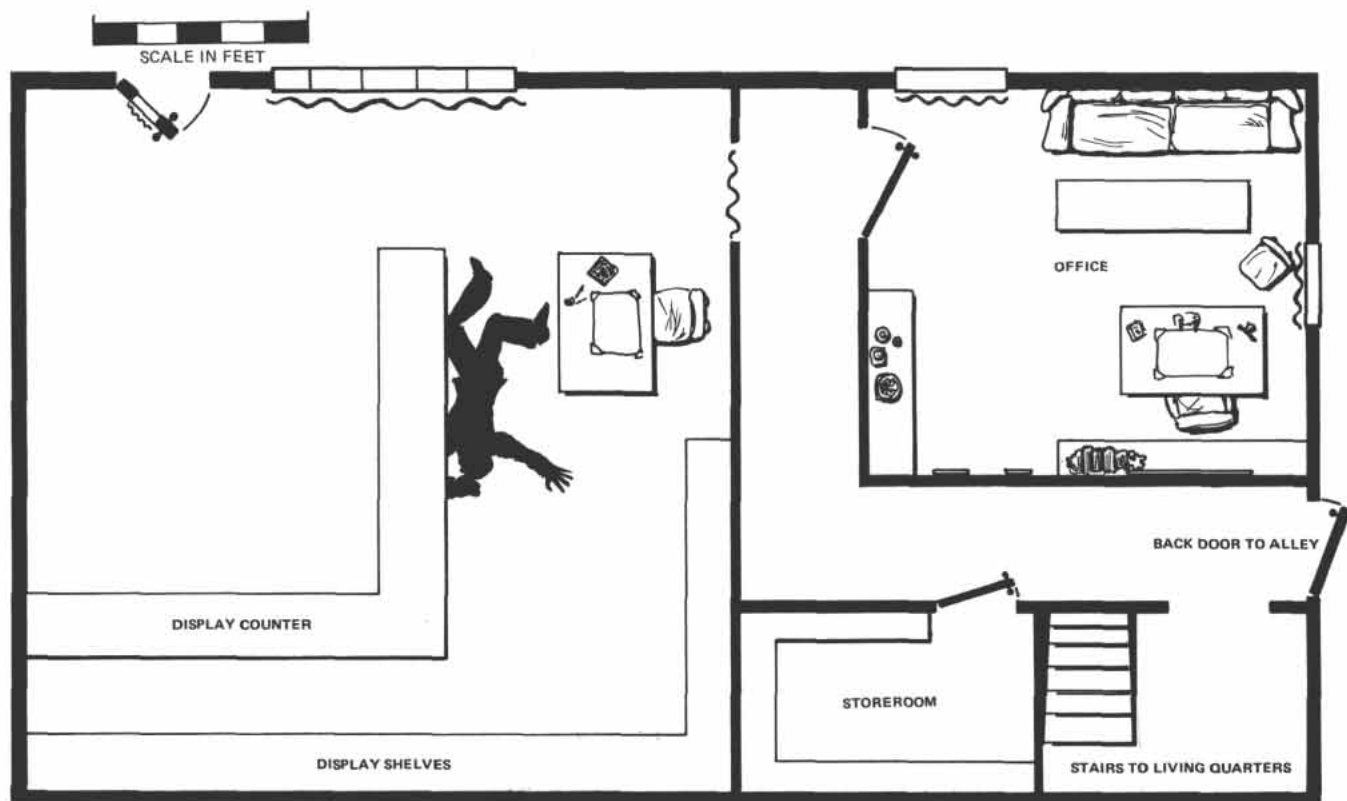

THE COIN SHOP

A visit to LeValier's coin shop will almost certainly take place at some point in the investigation of Sir Roger's coins. The accompanying sketch map shows the arrangement of the shop and the office area in back. Stairs lead up to a small flat where LeValier and his daughter live.

When the daredevils arrive at the shop, no one is in the front to attend customers. A moment or two after they arrive, however, someone comes out in response to the bells which sound when the door opens. This individual is a dark, muscular man of Malaysian ancestry.

The Malay will be quite apologetic, but cannot answer any inquiries. The owner, the owner's daughter, and the clerk Sir Roger dealt with are all out of the shop. The Malay is new, and knows nothing. He cannot give any definite time that the daredevils might try again.

During the course of all of this, there are several clues which may pass unnoticed. All are **Hidden Things**:

- The Malay bears a tattoo of a blue dragon on the back of his left hand.
- A display of coins beside the curtains leading to the back room has been upset, spilling several coins on the floor.
- A sandaled foot is protruding slightly from behind the counter.

The Malay will do his utmost to convince the daredevils to depart and call again later. If they do so, however, a woman's scream will ring out from the back room just as they are leaving the shop.

When this occurs, or when the characters realize something is wrong and attempt to take action against the Malay, an interlude of action occurs. The Malay is one of two Guardians of the Blue Dragon (the other is a Chinaman), who have come to LeValier's shop to obtain more information about the coins. In a brief struggle, they killed LeValier's Chinese clerk (it is his foot which is still partially visible behind the counter). They have taken Jacques LeValier and his daughter into the back room to be questioned. The Malay attempted to keep the daredevils from suspecting, but, when this fails, the two Martial Arts experts will fight.

Resolution of the fight is, of course, up to the actions of the Player Characters and their interaction with the Gamemaster. Certain things, however, should be interwoven into the proceedings to keep the adventure moving in the proper direction. First, Jacques LeValier, a middle-

aged but very robust man, will attempt to intervene as the fight breaks out. He will, however, fail in his attempt to aid the Player Characters, and will be killed with a quick blow by one of the Guardians.

Regardless of the course of the fight, one of the Guardians will break away, snatch up a large, leather-bound ledger book from the desk, and flee out the back door of the shop. If this proves infeasible, a previously hidden confederate may escape with the book while the daredevils are otherwise occupied.

It is up to the Gamemaster (and the actions of the players) to determine whether only one of the Guardians escapes, or if both of them do. Someone must get away, in order to make the adventure continue properly. The individuals will **not** be taken alive. Those that stay will fight until killed or subdued; if subdued, the unfortunate will bite down on a hollow tooth filled with a rare eastern poison which kills him almost instantly.

When the fight is finished, the daredevils will be in a position to learn a number of important facts, and will be able to begin following up on various leads.

Marie LeValier can attest that the two killers were interested in the coins. The ledger book they stole was a record kept of business transactions made by the shop, with the names and addresses of all those who bought or sold anything at the shop. They asked several questions concerning the Russian coins and the man who sold them to Marie's father.

Marie will also be able to reveal the existence of a second ledger, kept by her father in their flat upstairs, to which entries from the past week had just been posted. This allows the daredevils access to the same information, including the name and address of the other buyer, and the name and address of the man who sold the coins in the first place. Refer also to the character descriptions of Jacques and Marie LeValier for more details.

At this point, many different possibilities for further examination are opened up. The most important of these are briefly discussed below; if the players select a direction not covered here, some improvisation may be necessary.

One option is to follow up on the other buyer, who was supposed to have been interested in Fentiman's purchase of the coins. The ledger book gives his name as Arnold Willoughby, and indicates that he is staying at a small, unfashionable hotel in Tsim Sha Tsui, only a few blocks from the shop.



Secondly, the party can track the coins' previous owner, one Chin Lee, whose address is in the Wanchai area of the Colony.

The daredevils may want to investigate the two killers from LeValier's shop. This will not be an easy task, but there is a possible lead that might turn up worthwhile information. A character who makes a Chinese Culture or Chinese History BCS roll will recognize the blue dragon tattoo as the symbol of a secret society; this same information can be uncovered if the daredevils carry out a Research Task directed at discovering the nature of the tattoos.

Delving into the background of the Society of the Blue Dragon, the daredevils will learn only a few very general facts. The Society was one of several which flourished in China in the period 1890-1910 or so, and was dedicated to the overthrow of Western power in the Orient. After the Chinese Revolution, the Society is believed to have gone underground, and some hints of illicit activities have surfaced from time to time. Finally, it is believed that the Society includes a number of so-called 'Guardians' who are experts in the field of Martial Arts, and are masters of many other uncanny Eastern skills and disciplines.

Further research into the Society is useless unless an individual engaged in the work makes a BCS roll against the average of his Chinese Culture and Criminal Subculture skills. In this case, rumors may crop up concerning the head of the society, an individual referred to as 'Dr. Ling.' This individual is variously said to be a scientific genius, a master of the forgotten arts of an obscure Tibetan religious sect, a frighteningly powerful servant of the Manchus determined to bring about their return, and a liberator who has promised to drive the Gwailos ('foreign devils') from China's shores. Little can be discovered beyond these hints and rumors.

THE PROFESSOR

If the daredevils choose to follow up the trail of Arnold Willoughby, who bought the remaining coins from LeValier's, they will come to a run-down, third-rate hotel in Tsim Sha Tsui. The clerk at the desk knows Willoughby as 'the American Professor,' and says he is still registered at the hotel. When he rings the hotel room, the line is busy.

When the daredevils go upstairs to the room indicated, they find that they are once again too late. The room bears a great resemblance to the shambles created in Fentiman's room. Willoughby, a frail-looking, elderly man, is dead, killed by the same sort of blow as killed Chambers. No sign of any of the coins is found in the room.

As the daredevils examine the room, they are interrupted by a knock on the door. This proves to be a delivery boy from a nearby book shop, bringing an order phoned in by the Professor only an hour before. The books in his parcel are of particular interest. Titles include: *Coins of Tsarist Russia; The Russo-Japanese War; An Account of the*

CAST OF CHARACTERS

John Chambers

Chambers was Sir Roger Fentiman's 'gentleman's gentleman'; he acted as valet, butler, and general helper for his employer. He was killed in the break-in at Sir Roger's hotel suite.

Chambers was a large, powerful man, and had once been a skilled boxer. An examination of his body shows no sign of a prolonged fight; a single blow killed him. This blow broke his neck.

A character with Martial Arts skill who examines the body and who makes a successful BCS roll will be able to tell that the blow which killed Chambers was characteristic of a particular school of Martial Arts associated with the training of certain Chinese secret societies. In common parlance, the move is known as the Shanghai Twist, and is a move mastered by only a few experts.

The same information can be learned if the daredevils establish a Contact (+3 or better) with the Hong Kong police.



Sir Roger Fentiman

Though he hires the daredevils in the first place, Sir Roger Fentiman is a comparatively minor character who plays little part in later events. He is vain, foppish, and rather inane, given to quick bursts of curiosity and interest that are just as quickly redirected elsewhere. Within a few days of the break-in, Fentiman will have lost interest in following up on the matter. He will follow through with any agreements he makes, but will tend to downplay the incident. He will most certainly not be willing to spend any of his own time on the case — 'If I was goin't ' waste all that jolly effort 'n energy chasin ' 'round myself, I certainly wouldn't have gone and done and hired you chaps, don't you know?' Eh, what?'

The Gamemaster should treat Fentiman as an Average Quality Non-Player Character. It may be useful, if a slow point in the adventure is reached, to have Fentiman attacked and/or killed by Ling's henchmen (who have been instructed to eliminate all those who had anything to do with the coins). Naturally, such an attack would leave behind evidence similar to that from the attacks on Chambers, LeValier, and Willoughby.

Captain George Ferguson

Ferguson is captain of the tramp steamer 'Singapore Sue'. A large, jovial Australian, he has been sailing throughout the Orient for years. He knows those waters well, just as he knows every bar and pub from Darwin to Shanghai.

When he is encountered, Ferguson will be more than willing to talk with the daredevils — as long as they're buying the drinks. He remembers meeting Chin Lee a few days ago, in the Silver Moon bar. Chin Lee presented himself to Ferguson, seeking a working passage on 'Singapore Sue's' next voyage — to Rangoon. The Chinaman claimed expertise as a radio operator, but was unwilling to give past references. Ferguson finally agreed to take him on as a cargo handler.

Ferguson can give them the address Chin Lee supplied him with, a rooming house on the Wanchai waterfront. He adds that he is scheduled to sail the next morning.

It should be noted that the daredevils will be disappointed if they try to wait for Chin Lee to board the ship the next morning. He will not show up at the appointed time, and Ferguson will sail without him. If this happens, and the adventurers check up on him, at the address Ferguson gives them, he will prove to have been detained by Dr. Ling's underlings.

George Ferguson should be treated as a Superior Quality Extra.



Chin Lee

Chin Lee is a member of the Society of the Blue Dragon. He has been mistreated on several occasions by Dr. Ling, and has determined to escape. Chin Lee stole several golden coins from Ling's secret base, then waited for the ideal moment to flee. This moment came while Ling and his henchmen ventured to Hong Kong; Chin Lee, part of the crew of Ling's ship, decided that the busy port would be ideal for making good his escape. Selling the coins to raise some money, Chin Lee began searching for a suitable ship on which to take passage. Few had any openings, and it took several days before he discovered 'Singapore Sue' and signed aboard.

Moving from one boarding-house to another in Hong Kong's seamier districts, Chin Lee managed to stay ahead of Ling's henchmen for quite some time. But, when the daredevils first encounter him, his luck, and his time, have run out.

Chin Lee is a Poor Quality Extra who, when first met, is already on the verge of death, thanks to Ling's Guardians of the Blue Dragon.

Jacques LeValier

Another victim of the Blue Dragons, LeValier was the proprietor of the shop where Fentiman purchased his coins, and was Marie's father. A Frenchman by birth, LeValier's family moved to England early on, and Jacques grew up there. He married an English woman shortly after moving to Hong Kong to seek his fortune in the East. Marie was six when LeValier lost his wife and had to raise the child alone.

Jacques parlayed a deep interest in antiquities, and particularly old and rare coins, into a small but thriving business. He was very meticulous about his management, and kept very detailed records of customers and transactions, so that he could follow up particular sources or sales as the need arose. Two sets of records were maintained; one set was posted daily, and was kept in the shop, while the other was kept in LeValier's flat above the shop and updated weekly.

Marie LeValier

Marie LeValier, daughter of a French father and an English mother, has worked in her father's numismatic business for much of her life. She was very close to her father, who was the only parent she every really knew (her mother died when Marie was six years old).

When Player Characters first encounter Marie, she will be able to describe the events leading up to her father's death in detail, and will be a valuable ally in tracing Professor Willoughby and Chin Lee. She will be frightened at first, and will refuse to be left behind as the Player Characters carry out their research and legwork. Later, she will turn her thoughts to revenge, and can be counted on to behave rashly if an opportunity for vengeance against her father's killers (any of the Blue Dragons will do) presents itself. The Game-master may find this a useful way of forcing action upon the players.

WT	WL	STR	DRT	SPD	HCH	CDA	DRT
16	12	8	10	15	17	2	27



SKILLS: Pistol (5); Driver (5); Research (11); Restoration (11); Finance (5); Business Subculture (9); European/American Culture (7); Chinese Culture (7); English and French Languages (14); Chinese Language (10); English History (4); Numismatic History (history of coins) (10).

WEAPONS: Colt New Service (.44 special) in desk drawer at shop.

CLOTHING: Ordinary, fairly inexpensive street clothes (Armor Value 1).

Dr. Ling

Dr. Ling is a Chinese scientist of obscure background. An old man, Ling is believed to have studied in Tibet for many years before appearing again in his homeland as an adviser to the Dowager Empress in the last years of the Manchu Dynasty. He is the secret head of the Society of the Blue Dragon, and has pursued a course of determined opposition to the West.

While in Tibet, Ling discovered and translated many ancient inscriptions relating to the history, science, and technology of the lost continent of Mu, which sank beneath the Pacific Ocean thousands of years ago. Among the information he discovered was the secret for harnessing and controlling volcanoes, and for creating earthquakes, both processes mastered by the Murians. He also learned of the Nine Stones of Uighur, a collection of large, artificial gems of some unknown substance which were used in the gigantic mechanisms which triggered the destruction of the lost continent. He has embarked upon a campaign to recover the lost stones as part of his plot to unite the East in a great empire under his leadership.

For several years, Ling worked with the Japanese, hoping to use them as the instrument of his crusade against the West. Two years ago, however, he realized that he could not continue to work with them, as they refused to really embrace the idea of working with other Orientals against the Westerners. The High Command did not fully accept Ling, and would not abandon plans directed at China. The final break came when Ling's plans for a stupendous new battleship, electrically powered and featuring innovations that would make it the most awesome weapon afloat, were drastically revised and altered to suit the hidebound opinions of the High Command. Still, the resulting plans are impressive and work is scheduled to begin soon on the battleship, which is to be known by the name of 'Yamato'.



Since leaving Japanese service, Dr. Ling has been working on his own to carry out his plans. He is currently searching for the Nine Stones intensively. An inscrutable, sinister figure with a brilliant mind and a fiendish sense of humor, Dr. Ling is a very dangerous opponent.

WT	WL	STR	DRT	SPD	HLH	CDA	DRT
40	39	10	10	10	10	2	35

SKILLS: Martial Arts (15/4); Pistol (10); Stealth (11); Survival (9); Cryptography (19); Interrogation (20); Research (20); Restoration (10); Traps (10); Anthropology (8); Archeology (8); Chemistry (10); Finance (10); Geology (10); Chinese History (20); European History (10); Murian History (10); Linguistics (10); Military Science (9); Occult Studies (10); Physics (10); Rhetoric (7); Academic Subculture (15); Criminal Subculture (9); Political Subculture (8); Chinese Culture (8); Polynesian Culture (9); Japanese Culture (14); English and Micronesian (9); Tibetan and Russian (10); Murian Language (14); Chinese (17).

WEAPONS: Nambu pistol; dagger.

CLOTHING: Normally wears silk Oriental robes (Armor value 1).

SPECIAL POWERS: Compulsion; Talent Abilities and Powers for Charismatic (11), Esthetic (11), and Scientific (10); Spirit Power.

Inspector O'Neil

O'Neil is a member of the Hong Kong police, assigned to investigate the break-in at the Mandarin. Crisp and efficient, O'Neil does not like crimes taking place in 'his' Colony. He also resents individuals who take the law into their own hands, and can make things hard on daredevils who try to fight their own private war. He is not, however, adverse to sharing information — as long as such sharing works both ways, and the official police are brought in before things get out of hand.

O'Neil will be uncooperative unless he is approached in an open, honest manner with information given in exchange for information requested. He is quiet, polite, and softspoken under most circumstances, and rarely loses his patience or his temper.

WT	WL	STR	DFT	SPD	HLH	CDA	DRT
15	14	15	15	12	18	3	32

SKILLS: Pistol (9); Driver (6); Interrogation (8); Forensic Science (11); Law (6); Law Enforcement Subculture (8); European Culture (4); Chinese Culture (4); English History (7); English Language (14); Chinese Language (6).

WEAPONS: Walther PP. 7.65mm.

CLOTHING: Street clothing (Armor value 1).

NOTES: Inspector O'Neil has two major functions. He can be a Contact to cultivate in the Hong Kong police, making it possible for the daredevils to learn information they may not otherwise have access to about the various crimes which occur during the adventure. The Inspector is also a good fellow to have on tap in case things get completely hopeless for the player characters. When all seems lost, the appearance of Inspector O'Neil on the scene can turn the tables and save the day.

Naturally, the gamemaster must use discretion in staging such rescues, and should never ruin the excitement of the adventure by depriving the group of the opportunity of saving themselves. If O'Neil does appear in this fashion, he should be accompanied by several Constables. These are Average Quality Extras, armed with Colt Police Positives (.32 calibers) and nightsticks.

Professor Arnold Willoughby

A slight, frail, elderly man of retiring disposition, Professor Willoughby was an American historian engaged in a prolonged tour to study certain aspects of Oriental culture. He discovered the coins at LeValier's shop by accident; they immediately attracted his attention and interest.

Willoughby, like Chambers, was killed by an expert in Martial Arts; a successful BCR roll made while examining the body will establish this, or a Contact with the Hong Kong police can pass the information on at a later date.

Checking Willoughby's background, characters will discover that he is (was) considered an expert in Japanese and Chinese history, and has (had) a wide range of knowledge in the area of numismatics and related fields.

Lin Wu

A local expert on numismatics, Lin Wu is an elderly Chinaman who works out of a small shop in Kowloon. He has a wide range of experience in coins of all kinds, and was the individual who authenticated the coins for Fentiman.

Fentiman, however, did not particularly notice the fact that Lin Wu had a tattoo on the back of one hand — a blue dragon. As a member of the Society, the coin expert realized the source of the coins, and hastened to contact his master, who was already in Hong Kong on other business. This is what first put the Society on to Fentiman and, from his story to Lin Wu, to LeValier as well.

If the Player Characters approach Lin Wu, he will be polite, friendly, but quite unable to help them in their investigations. During any meeting with him, it is a Hidden Thing for any of the daredevils to notice his tattoo. Once the characters have visited Lin Wu, they will become known to the Society, and can expect to receive a visit from Guardians determined to stop them.

Lin Wu himself should be treated as a Poor Quality Extra.

Battle of Tsushima Straits Between the Navies of Imperial Japan and Imperial Russia; A Pilot's Guide to Japanese Waters, and Lost Treasure of the Tsars: The Admiral Nakhimov and its Cargo.

The daredevils, (or some outside source, if the players are slow on the uptake), should be able to determine that the coins Willoughby and Fentiman bought had a connection with the Battle of Tsushima Straits, the decisive naval clash of the Russo-Japanese War in 1906. By reading through some of Willoughby's books (a Research Task), Player Characters can learn that the Russian cruiser 'Admiral Nakhimov' was reputed to carry a large cargo of money, which was lost after the battle when the ship was scuttled off the island of Tsushima. This, combined with the indications of the long immersion of Fentiman's coins, should lead the players to the conclusion that they were indeed recovered from the lost cruiser. If they do not reach this conclusion on their own, a Wit Attribute Saving Throw by one of the Player Characters should allow the Gamemaster to pass the data on as conclusions the characters can reach.

Willoughby's death brings the trail to an end, and will probably force the group to consider seeking out the Chinaman, Chin Lee, who sold the coins to LeValier's.

ON THE CHINAMAN'S TRAIL

Chin Lee, who sold the coins to LeValier, can be traced to a boarding house in Wanchai by using the information available from the coin shop's ledgers. However, on arriving here, the daredevils discover that Chin Lee stayed at this address for three nights, and then moved on several days ago, leaving no hint of his destination.

If she is handled correctly (through skillful verbal interrogation or a sufficiently large sum of money), the woman who runs the boarding house may suddenly recall that Chin Lee mentioned that he was looking for employment aboard an outbound freighter, and suggests that the group try a bar, the Monsoon Haven, that he frequented in search of a suitable ship-captain. This same information can also come as the result of general legwork in the Wanchai district.

The woman will also be able to describe Chin Lee in some detail. The most significant element of the description is the mention of a tattoo on the back of his hand of a blue dragon.

At the Monsoon Haven, a rough bar catering to the waterfront trade, inquiries will eventually lead the group to Captain George Ferguson. Refer to his character description for details containing this information.

Acting on Ferguson's information, the daredevils can track Chin Lee down at last. When they arrive at his most recent hotel, the daredevils will realize that they may be too late — the Chinaman is trying desperately to defend himself from attack by three Guardians. At least one of these will have been encountered previously (either at LeValier's shop or in a Gamemaster-imposed attack on the party as a result of incautious inquiries). A fight ensues. As before, the villains will either flee or fight to the last. If defeated, they will commit suicide if unable to escape.

In the fighting, Chin Lee is mortally wounded, but will be able to speak a few words before he expires.

'Beware the Master . . . His revenge is terrible . . . the sung cache . . . Tung Chung . . .' With these rambling warnings, the man dies, leaving the party nearly as much in the dark as ever. They may, however, be able to use his dying clues to discover the secret behind these mysterious events.

THE COINS

The ten Czarist coins sold to LeValier's Rare Coins by Chin Lee have a surprising history which throws some light on the activities of Dr. Ling. Not all of this information will actually be unearthed in the course of this adventure; the full story is provided for the Gamemaster's enlightenment, and to fill in certain elements of background for use in further adventures involving Dr. Ling and his plan for dominion in the East.

As is apparent from the research done by Professor Willoughby before his death, the coins, minted in Russia in the years just prior to the outbreak of the Russo-Japanese War (1905-1906), were connected with the course of the war. Their corroded condition, suggesting immersion in sea water, is an indicator of the nature of their story.

The coins were a part of the store of gold carried on board the cruiser 'Admiral Nakhimov', one of the ships of the ill-fated Russian Baltic Squadron which sailed to the Far East after the fall of Port Arthur and the destruction of the Russian Pacific Fleet. The ship was one of those which succumbed to the Japanese Fleet in the Tsushima Straits, where Admiral Togo annihilated the Baltic Squadron. 'Admiral Nakhimov' was scuttled by her crew off the island of Tsushima. The money carried on board was not, as far as anyone knows, taken off the ship.

As a matter of fact, the gold aboard the sunken cruiser remained at the bottom of the straits for over a quarter of a century, when it was recovered by Dr. Ling during undersea investigations relating to another, quite different treasure which he believed could also be discovered there. Though the gold meant little (for Dr. Ling's wealth was already phenomenal), it was recovered.

Chin Lee, part of Ling's Society of the Blue Dragon, fancied himself the victim of persecution by Ling and his henchmen, and determined to leave the Society. He stole a few of the coins to help him pay his way. Accompanying Ling's expedition to Hong Kong, Chin Lee made his break, but failed to get a berth in time to avoid his Master's vengeance.

Ling, discovering the coins missing, knew that someone might realize where they were from — and thus trace his operation (which is still in progress). He ordered his minions to track Chin Lee and all who came in contact with the coins, and eliminate them systematically. He was only partially successful, however . . . and now is threatened by the daredevils and their knowledge.

Naturally, the clue of the coins points to the Tsushima Straits, between Japan and Korea, as a possible place to follow up Ling's activities.



THE SOCIETY OF THE BLUE DRAGON

In the twilight days of the Manchu Dynasty, the Society of the Blue Dragon was one of several secret societies which flourished in China. Like the Boxers, the Blue Dragons hated the influence and outright domination of the Western Great Powers. The Society differed from the Boxers in several crucial respects, not least of which was patience.

The Boxers failed in their attempt to throw the foreigners out of China. By biding their time, though, the Blue Dragons managed to avoid being caught in the same trap. They survived, and in the early days of the new century gained a great deal of power, largely due to the influence of one man — Dr. Ling.

Ling assumed a position of considerable power by becoming a highly trusted adviser to the Dowager Empress. No one at this time realized that he was also the major power behind the Blue Dragons; it is true, however, that his advice was consistently anti-Western. In the end, he failed, thanks to the growing movement, led by men such as Dr. Sun Yat-Sen, which supported an acceptance, rather than a rejection, of Western Progress.

In the wake of the Revolution, Ling and the Blue Dragons disappeared . . . but continued to operate in the shadows. The Society is working to unite Orientals throughout the East in determined resistance to the West. There are Japanese, Koreans, Malays, and many others, aside from Chinese, in the Society. All are sworn to obey their leader, Dr. Ling, and to eject the foreigners from their lands when the time is right. That time is growing near.

Members of the Society are distinguished by a tattoo of a blue dragon on the back of the left hand. A select group of the Society's membership, the Guardians of the Blue Dragon, are extensively trained in martial arts and related skills, and are highly dangerous opponents.

Guardian of the Blue Dragon

WT	WL	STR	DFT	SPD	HLH	CDA	DRT
15	18	10	28	15	10	4	22

SKILLS: Martial Arts (18/5); Stealth (14); Traps (9); Criminal Subculture (6); Chinese Culture (5); Chinese Language (15); Chinese History (3).

WEAPONS: None. Guardians rely on Martial Arts abilities.

CLOTHING: Chinese traditional clothes (Armor value 1).

SPECIAL POWERS: 'Cat Ability'; Danger Sense; Heightened Senses (hearing); Shadow Blend (BCS=10); Spirit Power.

Other members of the society should be treated as Average Quality Extras.

Research into the name Tung Chung will help clear up the matter. Tung Chung is a valley on the island of Lantau; this fact can be established by any character who makes a Wit Attribute Saving Throw. Characters who make a Chinese History BCS roll, or who carry out a successful Research Task looking for information on the island, will be aware of certain specific facts concerning Tung Chung.

Tung Chung served as a place of refuge for Sung Dynasty Chinese fleeing from the Mongols in the 13th Century A.D. The Chinese are reputed to have hidden various items of value near their settlement in the valley. This, of course, would seem to tie in with the reference Chin Lee made to the sung cache. The daredevils will thus be put on the track of the Society . . . leading to the climax of the adventure.

CONFRONTATION AT TUNG CHUNG

It is night when the party reaches the sung ruins at Tung Chung, after a long boat ride and an overland journey. In the darkness, they have only a vague idea of their surroundings, but, eventually, some sounds and the glimmer of lights attract their attention to a specific part of the ruins. At this point, the group should not be permitted anything more than a general description of their surroundings. The map is for use by the Gamemaster, only.

As the group approaches through the ruins, the Gamemaster must follow their course on the map, describing their surroundings and implementing any encounters that might take place. Each point labelled 'S' is the location of a sentinel, one of the Guardians of the Blue Dragon maintaining vigil from the concealment of shadows. If players pass near a sentinel, he will wait for them to get by him, and then attack and raise the alarm simultaneously, unless the daredevils are proceeding with great care and pass a Wit Critical Saving Throw to notice the individual.

TUNG CHUNG EXCAVATION

In the 13th Century, Sung refugees from the Mongol invasion hid valuables and documents in pottery jars, and secreted them within a shallow cave under a limestone cliff.

Years later, after the village buildings had already collapsed into overgrown mounds, the face of the cliff crumbled, filling in the cave, but leaving a tell-tale notch in the hillside.

Ling's excavators have dug a trench into this notch, clearing out the cave-in rubble, and revealing the long-lost treasure cache.

SCALE IN METERS

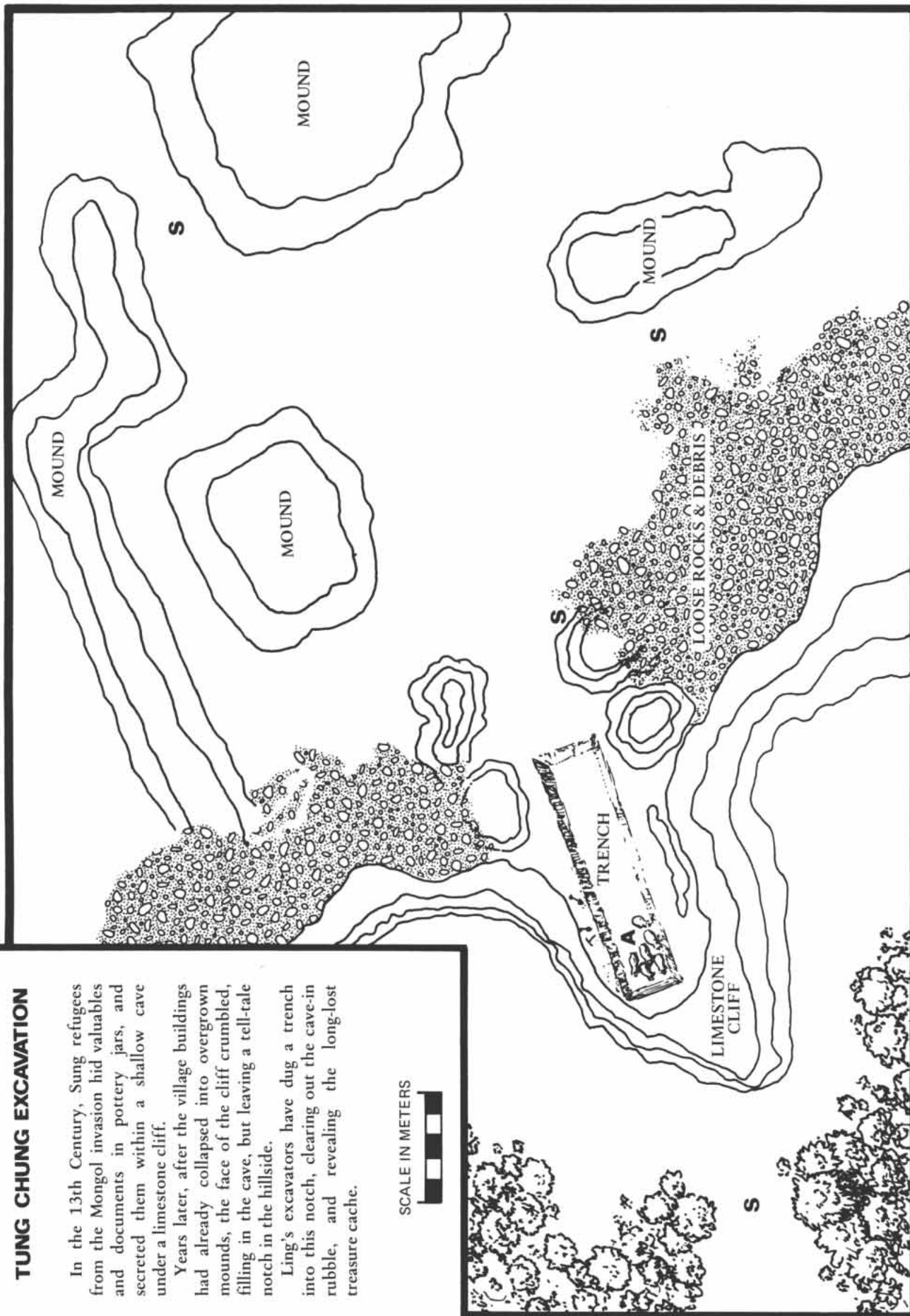

In the area marked 'A', amid a ring of lanterns, Dr. Ling and a number of henchmen (1D6+2 Guardians and perhaps 10 laborers) are supervising the removal of a large chest from a recently excavated trench. If you direct events properly, the group should get close enough to see and hear everything taking place here just as the chest is lifted out.

Dr. Ling, a slight, stooped, aged individual, can be seen prying open the lid of the chest. He lifts a single large gemstone out of it, holding it above his head to catch the light, and he speaks to his followers in tones of triumph.



'Now, at last, I have found it! Brought here, to this desolate island, by the last of the Sung Emperors as he fled the Mongol onslaught. Lost here, to become part of a forgotten treasure horde . . . and now, recovered, to rejoin its mates. Three stones I have now, from Tibet, from Peking, from Hong Kong. Six more remain. With the Nine Stones of Uighar, I can unlock powers the Western Devils have never dreamt of!' (Note: Dr. Ling can give this speech in Chinese — he is, after all, addressing Orientals — and thus be understood only by characters who themselves speak the language. However, it is perfectly within the character of the typical pulp adventure to have Ling make his harangue in slightly broken English. For Gamemasters who feel a need to explain, we point to the multi-national character of Ling's Society, and suggest that English is the only tongue they all happen to have in common. Usually explanations are considered superfluous in cases such as this).

At this juncture, the stage is set for the final confrontation. If the daredevils seem disposed to play a passive role, they may need some prodding; if they decide to take action, allow them to act freely. Those groups which choose to wait and watch may become aware of a sentinel suddenly materializing from the shadows, or they may have the bad luck to make a slight noise at the wrong moment. At any event, the lines are drawn for the moment of truth.

Actual resolution of the situation will depend upon the actions taken by the daredevils. Dr. Ling will be most concerned with escaping, and he and a handful of Guardians will attempt to disengage as quickly as possible. The adventurers may be able to win their fight, or they may mismanage things and be defeated. See 'To be Continued . . .' for details on the possible outcomes of the adventure.

Regardless of what happens, Dr. Ling escapes to a waiting motor boat anchored just off the island, which in turn takes him to a freighter in his service at sea. The daredevils will not be able to kill, catch, or follow him successfully, though they may be able to recover the gemstone.

Now the stage is set . . . The diabolical Dr. Ling's crusade against the Western Powers is slowly gathering power. Even if he is thwarted in Hong Kong, he will surely try again.

In an upcoming Daredevils Adventure, 'The Menace Beneath the Sea,' the daredevils will meet the inscrutable villain again, and learn more of the Nine Stones of Uighur and the power they hold for evil.

TO BE CONTINUED . . .

There are two possible outcomes to the confrontation at Tung Chung, depending upon the desires of the Gamemaster and the actions of the players.

If the daredevils get the upper hand at Tung Chung, as they will be able to do if they exercise any care at all, they will be in a position to thwart Dr. Ling. He and his underlings will be defeated, though the villain and several others will disappear into the night and make good their escape. If this happens, the player character will recover the object of Ling's search, a magnificent, diamond-like gem.

None of the player characters will be able to identify this gem, nor will anyone in Hong Kong be able to tell anything about it. The stone is, in fact, one of the so-called 'Nine Stones of Uighur,' a relic

of an ancient lost continent which Ling is very interested in. Future adventures dealing with Dr. Ling will show how the Stone, the coins, and other discoveries from this adventure lead the daredevils to a fresh encounter with the mastermind.

Should the daredevils fail to defeat Ling, they will be taken prisoner, and, together with the Stone, will be taken to Ling's ship. Ling will then return to his secret lair, there to question the daredevils on their reasons for interfering, and to continue his plot against the West. The Gamemaster can build an adventure around an escape attempt to be staged by the daredevils, or the players can create new characters who assemble to rescue the first batch (and stop the doctor).

In either event, details will be presented in an upcoming issue of Daredevil Adventures, in 'The Menace Beneath the Sea.'

We hope you will enjoy these adventures. If you do, let us know care of Fantasy Games Unlimited. If you do not enjoy them, let us know about that. We do read the letters we get and, time and energy permitting, will attempt to answer any questions you may have on either the rules or the adventures if you leave space on your letter for the answer. Please include a stamped, self-addressed envelope.



GET CARRIED AWAY WITH THE

EXCITEMENT

ACTION AND ADVENTURE

IN EACH AND EVERY
THRILLING ISSUE

OF

DAREDEVIL

Adventures

NOT
10¢
at any newstands

DAREDEVIL

Adventures™



IN THIS ISSUE:

THE POWERS OF
DR. REMOUX

by
Stefan Jones

BRING IT BACK ALIVE!

by
Bob Charrette

and
DEADLY COINS

by
J. Andrew Keith

DAREDEVIL ADVENTURES is a play aid for use with the **DARE-DEVILS™** role playing game. It is not a complete game but rather a collection of plots and characters to help a game-master take his players along on action-packed adventures.

from *The Powers of Dr. Remoux*

We had finally found the professor's secret lab. It was pretty musty in there and April griped about the smell. Still, we had a mystery to solve so she carried on like a real trooper.

There were tables full of scientist type stuff and a couple of weird machines. I didn't know what any of it was but then, I didn't have to because Murray was there and all that kind of gimcrackery was right up his alley. He seemed at home as he prodded and pried.

It was beginning to look like our intrepid band wouldn't have any need of my specialties when a door suddenly banged open and a shadow fell across the room. Despite April's stifled scream, I figured she was just startled and I'd only have to take care of some hired gorilla or two. I turned to the doorway and saw that I had chosen my words better than I had thought.

