

H.G. Wells' Little Orc Wars

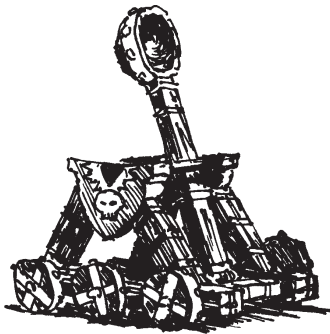

By H.G. Wells, Michael O. Varhola, Brendan Cass, John Kadolph,
and the Skirmisher Game Development Group
With marginal illustrations by George Sieretski

H.G. Wells' Little Orc Wars



By H.G. Wells, Michael O. Varhola, Brendan Cass, John Kadolph,
and the Skirmisher Game Development Group
With marginal illustrations by George Sieretski

H.G. Wells' Little Orc Wars

By H.G. Wells, Michael O. Varhola, Brendan Cass, John Kadolph,
and the Skirmisher Game Development Group
With marginal illustrations by George Sieretski



Skirmisher Publishing LLC
499 Mystic Parkway
Spring Branch, TX 78070

Website: <http://skirmisher.com>
Email: webmaster@skirmisher.com

Cover image by Geoff Weber

Technical edit by William T. Thrasher

Copyright 2014 Skirmisher Publishing LLC

TABLE OF CONTENTS

INTRODUCTION	5
Miniatures, Models, and Accessories	6
Types of Wargame	8
Composition of Forces	9
BASIC RULES	11
The Battlefield	11
Turns	11
Movement and Catapult Fire	13
Counter-Battery Fire	15
Melee and Capturing Prisoners	16
Missile Fire	19
Casualties	20
ADDITIONAL RULES (TROOPS)	21
Heroes	21
Champions	21
Paladins	21
Rangers	22
Priests	22
Clerics	22
Necromancers	23
Wizards	25
Air Mages	25
Earth Mages	26
Fire Mages	27
Water Mages	30

Undead	31
Giants	33
Warbeasts	35
Dwarves	36
Elves	37
Abnormally Stable Creatures	37
Amphibious Creatures	37
Aquatic Creatures	38
Inferior Troops	38
Elementals	39
ADDITIONAL RULES (BATTLEFIELD)	41
Structures	41
Fortifications	42
Rubble	43
Escalade	44
Terrain	45
Hills	45
Forests	45
Bodies of Water	47
Boats	48
CUSTOMIZED RULES	51
Traditions	52
Tips	54

INTRODUCTION

This book contains the rules for *H.G. Wells' Little Orc Wars*, a fun, simple, fast-paced system that is designed to be quick to learn and easy to play, so that players can focus on concerns like strategy and having fun, rather than on mechanics. It includes both basic rules that can be used alone, plus a variety of optional rules that players can add as they see fit to take their games to the next level. These include guidelines for Giants, War Beasts, Undead, Dwarves, Elves, Amphibious and Aquatic Creatures, Elementals, Structures, Siege, Terrain, Boats, and Heroes like Champions (Paladins, Rangers), Priests (Clerics, Necromancers), and Wizards.

These rules generally assume matches between two opposing sides, but in a large games, such as public ones played at conventions, individual players might take charge of specific units within larger forces. It is also possible that independent factions might periodically crop up during the game, and the extent to which players of such groups cooperate with or oppose each other is completely up to them.

As their name suggests, the rules contained in this booklet are based on and inspired by the rules and concepts presented by genius writer and game designer H.G. Wells in his works *Floor Games* (1911) and *Little Wars* (1913). Both of these books have gone in and out of print in the century since they were originally released and have also been republished by Skirmisher Publishing LLC and are currently available from it. The *Little Orc Wars* rules have been inspired by and based on them and are true to the spirit of Wells in every way possible.

These rules are also fully supported by d-Infinity Online game magazine, and players should keep an eye on it for addenda, errata, and optional rules and expansions designed to incorporate more detail, options, and complexity.

Miniatures, Models, and Accessories

In his afore-mentioned works, Wells is unequivocally critical of the models and miniatures available in his day, in terms of both quality and variety. He would doubtless be pleasantly surprised today with the wide range of beautiful models of all sorts. It is pretty obvious from his writings, however, that he would be much less pleased with games that could easily allow the use of any miniatures or models but insist that only their own branded items be used. Accordingly, within the limits imposed by the rules (i.e., some sort of missile-firing engines, ideally catapults, are assumed), almost any desired models and miniatures can be used to play this game. One of the purposes of this game is, in fact, to allow players to use all of their favorite miniatures and models in a single game.



These rules do assume, of course, that anyone choosing to play them is probably going to want to use miniatures and models reminiscent — if not of actual Orcs — of a fantasy, medieval, or Dark Ages, setting. We also have our own favorites, of course, and they have provided the inspiration for many of the images and examples of play that accompany this book.

For miniatures, the bulk of our armies are generally made up of Orcs from our own “Orcs of the Triple Death” line, augmented by Dwarven Forge Skeletons and Lizard Men and a variety of miscellaneous fantasy and historical miniatures and toys. Almost any sorts of metal, plastic, or resin miniatures or toy soldiers with infantrymen between one and two inches high will also be suitable. Those used in a particular game should all be approximately the same size, however, and cavalrymen should be of proportionate sizes.

For terrain and building models, we use a mix of the excellent offerings from the Miniature Building Authority — whose Town Walls and Keep are the basis for the illustrations of fortifications on the cover of this booklet — Fantascene, Dwarven Forge, and Armorcast. These are augmented with a variety of homemade terrain features and models and a number of nongaming products acquired from places like craft stores. Toy blocks, books, boxes, packaging, pieces of styrofoam or wood, and all sorts of other items can also be impressed into good service for these purposes. (*Floor Games* and *Little Wars* both also include useful tips and guidelines on practical model and prop building).

For firing catapults, we prefer a heavy-duty, soft plastic, rubber-band-powered model produced by toy manufacturer Papo. A wide variety of firing catapults, cannons, and other devices are available from many other sources, and almost any of these might be suitable for this game. In the absence of these, the game can be played using just the rules for melee or by some mutually acceptable — and non-hazardous — means

of projecting missiles from the spots occupied by nonfiring tokens representing catapults (e.g., paper “footballs”).

A couple of dozen six-sided dice, both for randomly determining things such as who is entitled to move first and for resolving close combat between opposing groups of soldiers.

Finally, each player needs to have either two pieces of string — one two feet in length and the other six inches — or some other means of measuring distances on the Battlefield, such as a ruler or tape measure.

Types of Wargame

Players can engage in various types of wargame, some of which are described here.

Fight to the Finish. Players move in from any points they like on their back lines and try to kill, capture, or drive over the opposing back line the whole of their opponent’s force. Players score 100 points for victory, 10 for every catapult they hold or are in a position to take, $1\frac{1}{2}$ for every cavalryman still alive and uncaptured, 1 for every infantryman still alive and uncaptured, $\frac{1}{2}$ for every man that is a prisoner in the hands of the enemy, and $\frac{1}{2}$ for every prisoner he has taken. If the battle is still undecided when both forces are reduced below 15 men, the battle is drawn and the 100 points for victory are divided.

Strike to the Rear. This game is decided when at least three men of one force reach any point in the back line of their antagonist. The player whose line was fatally breached is then assumed to have suffered a strategic defeat, and he must retreat his entire force over the back line in six of his moves. Anything left on the field after these six moves capitulates to the victor. Points are calculated as in the preceding game, but this variation lasts a shorter time and is better adapted to a cramped Battlefield with a short back line. With a long rear line the game is simply a rush at some weak point in one player line by the entire cavalry

brigade of the other. Instead of making the whole back line available for the Strike to the Rear, the middle or either half may be taken.

Defensive Position. In this variation, a force of defenders two-thirds as strong as that of its opponent's tries to prevent the latter arriving, while still at least a quarter of its original strength, upon the defender's back line. The Battlefield must be made by one or both of the players before it is determined which shall be defender. The players then roll for choice of sides, and the winner of the roll chooses to be either the defender or the attacker. Whoever the winner of the roll has chosen to defend becomes Player Two and sets up his forces on his own side of the Battlefield, anywhere that is at least one full move from the middle line. The other player then becomes Player One and sets out his men along his back line (as described under part 2 of "Turns"). The defender may open fire immediately on his turn and does not need to wait until after the second move of his opponent (as described under part 4 of "Turns").

Composition of Forces

Except as noted above, or when otherwise agreed upon, the forces engaged should be equal in number and similar in composition. The methods of handicapping are obvious. A slight inequality (e.g., "fortunes of war") may be arranged between equal players by leaving out 12 men on each side and rolling with a pair of dice to see how many each player shall take of these.

A good arrangement and proportion of forces is in small bodies of about two dozen infantrymen and a dozen cavalrymen per catapult. Such a force can maneuver comfortably on a front of 4 or 5 feet. A good size and composition for each force in a typical game is up to about 72 infantrymen, 36 cavalrymen, and up to a half dozen catapults. Larger games might include twice as many troops.



Players may, of course, organize their forces on the Battlefield as they desire (e.g., form all of their cavalry into a powerful striking force).

The composition of a force may also be varied considerably. Proportionally more catapults, however, lead to their being put out of action too early for want of men, too large a proportion of infantry makes the game sluggish, and more cavalry — because of the difficulty of keeping large bodies of this force under cover — leads simply to early heavy losses by catapult-fire and violent and disastrous charging.

In general, the bigger the battlefield the more room will be available for maneuver and the longer the game will last; a battlefield at least eight feet long is ideal, and ones as much as 20 feet long are eminently suitable.

“One good Fight to the Finish game we tried as follows,” Wells says. “We made the Battlefield, tossed for choice, and then drew curtains across the middle of the field. Each player then selected his force from the available soldiers in this way: he counted infantry as 1 each, cavalry as 2, and a [catapult] as 10, and, taking whatever he liked in whatever position he liked, he made up a total of 150. He could, for instance, choose 100 infantry and five [catapults], or 100 cavalry and no [catapults], or 60 infantry, 40 cavalry, and three [catapults]. In the result, a Boer-like cavalry force of 80 with 3 [catapults] suffered defeat at the hands of 110 infantry with four.”

“Here, then,” says Wells, “are the rules of the perfect battle-game as we play it in an ordinary room ... ”

BASIC RULES

The Battlefield

A specific area, such as an agreed-upon section of a room or a pair of large tables, must be designated as a Battlefield.

(1) One player is selected randomly or by mutual agreement to arrange the Battlefield with the available props, models, and terrain features.

(2) The other player can then choose which side of the field he will fight from.

(3) Once the game begins, the Battlefield must be disturbed as little as possible. Nothing in it should be moved or deliberately set aside to facilitate the firing of catapults. A player must not lie across the Battlefield so as to crush or disturb it if his opponent objects. Anything that is moved by accident shall be replaced after the end of the move.

Turns

(1) After the Battlefield is set up and the sides chosen, then — and not until then — the players shall randomly determine who will take the first move. The player winning the die roll is hereafter referred to as Player One.

(2) If a screen, curtain, or other means of blocking view of the opposing sides of the Battlefield is available, then both the first and second players can place down their forces at the same time. If no screen or curtain is available, Player One should arrange his forces as he chooses along the back edge of his side of the Battlefield. Player Two should then do the same.

Both players may take as much time as they need for the placement of their troops and, when they are done, the screen is removed and the game can begin. Any men the players place behind or in front of their back lines shall count in the subsequent move as if they touched the

back line at its nearest point.

(3) Subsequent moves after the placement of forces are timed. Length of time given for each move is determined by the size of the forces engaged. About a minute should be allowed for moving 30 men and a minute for each catapult, rounding fractions up to the next full minute. Thus, for a force of 70 men and two catapults, a player would be allowed four minutes. As the battle progresses and troops are killed off and catapults destroyed, the time allowed for each move is reduced in accordance with the number of troops (rounding up to the next minute, as usual).

The player about to move stands at attention a yard behind his back line until a timekeeper (e.g., the other player) says "Go." He then proceeds to move his forces until his allowance of time is up. He must instantly stop at the cry of "Time." Warning should be given by the timekeeper two minutes, one minute, and thirty seconds before time is up.

Any disturbances to the Battlefield should be rearranged and men accidentally overturned replaced in a proper attitude before the next player's move during an interval that should not exceed five minutes.

(4) Catapults can be fired beginning with Player One's second move — not counting initial troop placement as a move — but not before. Thus, Player One places his forces, then Player Two places his (or both do so simultaneously if a screen to divide the Battlefield is available), then Player One moves, then Player Two moves, and the two forces are then believed to be within effective range of each other, Player One may open fire if he wishes to do so.

(5) When moving his forces, a player must either move or fire his catapults if he wishes do so before moving the rest of his troops. There is no exception to this rule of "Catapults First!"

(6) Every soldier may be moved and every catapult moved or fired at each move, subject to the rules governing Movement.

Movement and Catapult Fire

During each of their turns, players can move their forces as described hereafter.

(1) Each infantryman can be moved up to a foot.

(2) Each cavalryman can be moved up to two feet.

(3) A catapult is in action if there are at least four men of its own side within six inches of it. If there are not at least four men within that distance, it can neither be moved nor fired. If a catapult is in action, it can either be moved or fired on a player's turn, but not both.

(4) If player opts to fire a catapult, it can be used to discharge as many as four shots in each move. It may be swung round on its axis (the middle point of any one of its wheel axles) to take aim, provided the Battlefield about it permits. Friendly soldiers about it may, at the discretion of the firer, be made to lie down in their places to facilitate its handling, and soldiers in the line of fire of their own catapults may also lie down while the catapults fire over them. After firing, the catapult must be left without further adjustment and pointing in the direction of

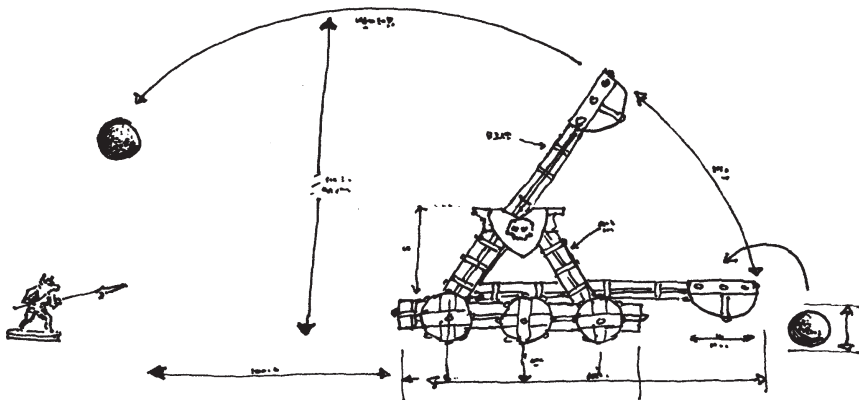

the last shot and two soldiers must be placed behind the catapult, one behind each of its rear wheels.

(5) If a catapult is moved and not fired, then at least four figures who are with the catapult must move up with it to its new position and be placed within six inches of it there. The distance that a catapult can be moved is determined by the sorts of troops that are with it and is half the normal movement of the slowest in the group. Four cavalry, for example, can move a catapult one foot, while a mixed four group cavalry and infantry, or just four infantry, can move a catapult six inches.

(6) Every man must be placed fairly clear of hills, buildings, trees, catapults, and the like. He must not be jammed into narrow gaps between terrain features and other objects, and either player may insist upon a clear distance between any man and any catapult or other object of at least $1/16$ of an inch.

(7) Any troops knocked over by catapult shots are killed, as are any that shot cause to fall or to lean so that they would fall if unsupported. Furthermore, if a shot strikes a man but does not knock him over, he is dead, provided the shot has not already killed another man. But a shot cannot kill more than one man without knocking him over, and if it touches several without oversetting them, only the first touched is dead and the others are not incapacitated. A shot that rebounds from or glances off any object and touches a man kills him, even if it simply rolls to his feet, subject to what has been said in the previous sentence.

(8) If a catapult is accidentally struck by fire from an allied catapult and has not already fired that turn, then it loses one shot for each strike, as noted above. If it has already fired the turn in which it is struck, there is no effect.

(Once a catapult has been struck by fire, whether enemy or friendly, a good way to indicate the number of shots it has remaining is to place in front of it a die displaying the pertinent number.)

Counter-Battery Fire: Players can use their catapults to suppress the fire of enemy catapults.

(1) For every time that a catapult is struck during its opponents' attack phase, its capacity to fire on its own turn is reduced by one shot (e.g., if a catapult is struck three times by its opponents' weapons, its own troops will only be able to fire it once, rather than four times, on their own turn).

(2) If a catapult is struck by a Fireball (see Fire Mages, below), it catches on fire and, if they wish, its crew must use their entire next move to extinguish it. If it does not have a full, four-man crew, then it is destroyed. If a catapult is struck by two Fireballs, it is destroyed regardless of how many crewmembers are present.

(3) If a catapult is accidentally struck by shot from an allied catapult and has not already fired that turn, then it loses one shot for each strike, or catches fire if struck by a Fireball and must be extinguished, as noted above. If it has already fired the turn in which it is struck, there is no effect, unless struck by a Fireball, in which case two shots from its next turn are lost if a full crew is available to extinguish it.

(4) If a catapult is struck with four or more shots in any single turn

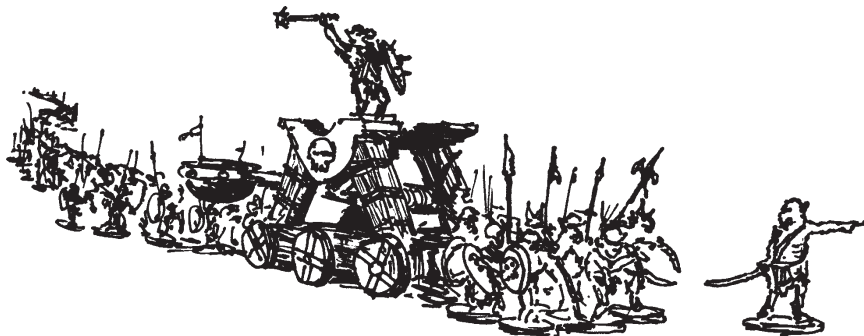

— whether from enemy or friendly fire — it is destroyed.

Catapult Malfunction: If the rubber band or other firing mechanism of a catapult breaks during a player's turn, then he loses any shots he had remaining that turn. Similarly, if a player is adjusting the tension on one of his catapult's rubber bands and it malfunctions in between his turns, he loses all shots he would be entitled to on his next turn if he is still repairing the catapult when his turn begins.

Damage to the Battlefield from Catapult Fire: Periodically, catapult fire will knock over or blow chunks off of various battlefield features. Features knocked over or damaged as the result of catapult fire should be left as they are for the duration of the battle, rather than remediated in between turns as with player damage. Furthermore, troops knocked over as the result of such disruptions — but not just brought into contact with them — should be considered slain.

Melee and Capturing Prisoners

(1) A soldier or a body of troops that has less than half its own number of men on its own side within a move of it is Isolated. But if there is at least half its number of men of its own side within a move of it, it is Supported.

(2) Soldiers can charge into virtual contact (i.e., between 1/8 and 1/16 of an inch) with men of the opposite side. They must then be left until the end of the movement phase.

(3) At the end of movement, if there are men of the side that has just moved in contact with any men of the other side, they are considered to be joined in melee. All the men in contact and any other men within three inches of them — measuring from any point of their persons, weapons, or horses — are involved in the melee. At the end of the move the two players examine the melee and dispose of the men concerned according to the following rules.

Melee: In addition to direct attacks with hand weapons, melee is assumed to include the use of hurled weapons like darts, daggers, axes, spears, and the like. To resolve melee, each player rolls one *Melee Die* for each infantry soldier and two *Melee Dice* for each cavalry soldier involved in a particular battle (and various sorts of special troops described hereafter, such as Heroes, Giants, and Warbeasts, might have two or more *Melee Dice* each).

(1) If there are more than a dozen troops involved on the attacking side of a melee, divide them into multiple groups that contain no more than 12 attackers in each. In such cases, ensure that there are not any attacking or defending troops that get committed to more than one melee. (Separating the various meleeing groups with pieces of string is one easy way to help keep accomplish this.)

(2) Once the dice are rolled, each player should arrange his in order of highest to lowest. The players then compare each highest roll with the other, each second-highest roll, etc.

(3) For each roll where one number is higher than another, the player with the low roll loses one soldier. In cases where the defender has rolled a 6, however, the attacker also loses one soldier.

(4) For each roll that is a tie, two soldiers are locked in combat and neither is killed.

(5) After the number of soldiers killed on each side is determined, the attacking player can select which from each side are removed from the battlefield. He can opt to substitute two normal kills for a creature with two *Melee Dice* (or three for a creature with three *Melee Dice*, etc.).

Capturing Prisoners: If a force that joins in melee is isolated and the opposing force is at least twice as large/powerful, then upon agreement of both players the isolated force may surrender and the opposing stronger force take it prisoner. If both sides are not amenable to this then melee is resolved as usual.

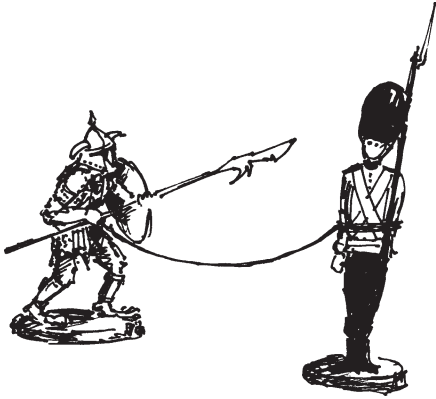

All of the procedures associated with melee take place after a player's movement is completed, in the interval between each player's moves, and the time taken for them does not count against the time allocated either for movement or re-adjusting the Battlefield.

The player moving next may, if he has taken prisoners, move them.

Prisoners may be sent under escort to the rear or wherever the capturer directs, and one man within six inches of any number of prisoners up to seven can escort these prisoners and go with them. Prisoners are liberated by the death of any escort there may be within six inches of them, but they may not be moved by their player until the move following that in which the escort is killed. As soon as prisoners are taken they are assumed to be disarmed, and if they are liberated they cannot fight until they are rearmed, which requires them to return to the back line of their own side. Once an escort has successfully conducted prisoners to his own back line, they are considered to be beyond the reach of liberation. The escort can then return to the battle.

Once troops have been made prisoners, they cannot fight again until they have returned to their own back line and been rearmed. It follows, therefore, that if after the adjudication of a melee a player moves up more men into touch with the survivors of this first melee, and so constitutes a second melee, any prisoners made in the first melee will not count as combatants in the second melee. Similarly, recently freed and as-yet-unarmed former prisoners cannot be used to escort enemy prisoners to the rear.

(4) Any Isolated body may hoist the white flag and surrender at any time.

(5) A catapult is captured when there is no man whatever of its original side within six inches of it, and when at least four men of the antagonist side have moved up to it and have passed its wheel axis going in the direction of their attack. This latter point is important. An antagonist's catapult may be out of action, and a player may have a score of men coming up to it and within six inches of it, but it is not yet captured; and he may have brought up a dozen troops all round the hostile catapult, but if there is still one enemy just out of their reach and within six inches of the end of the catapult, that catapult is not captured: it is still in dispute and out of action, and he may not fire it or move it at the next move. Once a catapult is fully captured by a player, however, it follows all the rules of one of his own catapults.

Missile Fire

Soldiers armed with weapons such as bows, crossbows, rudimentary firearms, or slings can opt to engage enemy troops with missile fire. Range for missile attacks is two feet. If a point buy system is being used to build armies, the cost for a missile-armed infantryman is 2 points and the cost for a missile-armed cavalryman is three points. When missile troops are in bodies of troops engaged in melee use the normal melee rules for resolving the conflict.

(1) Missile troops who are not engaged in combat or otherwise occupied (e.g., as part of a crew that has moved or fired a catapult that turn) can fire at opposing troops. All such attacks are resolved ahead of normal melee and by rolling one Melee Die for each archer (mounted troops with missile weapons roll just one die for these purposes, even if they would roll two dice in close combat).

(2) The attacker can choose which of the enemy troops he wishes to have his soldiers fire at. Targets that are not similarly armed can only

try to resist being killed by such attacks and cannot counterattack against the opposing missile troops (until they close to normal melee). Troops with missile weapons that are attacked as part of such volleys, however, can return fire and these attempts should be represented by using different-colored dice for each defending troop that is so armed (e.g., colored dice for soldiers with missile weapons and white ones for those without them).

(3) When dice are compared in such melees, the color of the defending troops' dice will indicate whether missile or non-missile troops are slain. This is an exception to the rule specifying that the attacker selects casualties on both sides.

(5) If troops with missile weapons are on some elevated position (e.g., a castle wall), the range from them to their targets should be measured horizontally from the base of the structure, rather than diagonally from them to the targets.

Casualties

Troops eliminated as the result of catapult fire, melee, missile fire, or other effects are variously assumed to be killed, grievously injured, maimed, knocked unconscious, or otherwise rendered unable to continue fighting. Whatever the case, all such casualties from a particular army should be removed from the battlefield and placed together in a pool for the duration of the game, as doing so helps facilitate a number of rules, including calculation of victory points.

ADDITIONAL RULES (TROOPS)

HEROES

Heroes are soldiers that have become more proficient than normal soldiers or who have acquired significant special spiritual or arcane abilities that can be applied on the battlefield. Such figures include various sorts of Champions, Priests, and Wizards. If a point-buy system is used to build armies, Heroes on foot cost 6 points each and mounted ones cost 7 points each.

CHAMPIONS

Champions are professional soldiers who have advanced through the ranks and become tougher, deadlier combatants than normal soldiers. Champions on foot have 2 melee dice, and those that are mounted have 3 melee dice for purposes of their melee attacks (but, as per regular cavalry, 2 melee dice for purposes of how much damage they can withstand).

Paladins

Paladins are holy soldiers whose faith and martial prowess make them especially deadly against Undead creatures as described below.

(1) Once per turn, a Paladin who does not move or take any other action can attempt to turn a single Undead creature within 2 feet. If it is a normal undead creature (1 Melee Dice), the turning is automatic; if it is special (2 or more Melee Dice), the Paladin must roll a number on a d6 equal to or greater than the creature's Melee Dice number. A turned undead creature will immediately take a full move directly away from the Paladin, maneuvering around obstacles in such a way as to get as far away as possible from him.

(2) Anytime an enemy Undead creature is in virtual contact with a Paladin, the holy soldier receives an extra die in the ensuing melee.

Rangers

Rangers are fierce frontier soldiers adept at battling giants. A miniature with a bow or crossbow should be used to represent such a troop. If a point-buy system is used, a Ranger costs 6 points.

(1) Anytime an enemy giant is in virtual contact with a Ranger, the wilderness soldier receives an extra die in the ensuing melee (i.e., 3). Only two dice worth of kills are required to eliminate a Ranger engaged in melee with a giant, however.

(2) If a Ranger engages in any missile fire (either as an attacker or a defender), it can roll 3 dice rather than 2.

PRIESTS

Priests are spellcasters who, as the result of spiritual devotion to various divine or infernal powers, can wield power over the forces of life and death. Those affiliated with life are known as Clerics and those with death as Necromancers.

(1) A Priest on foot has 1 melee die, while those that are mounted have 2 melee dice for purposes of their melee attacks (but, as per regular cavalry, 1 melee die for purposes of how much damage it can withstand).

(2) If a point buy system is being used to build armies, the cost for a Priest is 6 points (i.e., he is considered to be equivalent to six normal foot soldiers).

(3) A Priest may perform a ritual on the firing phase of its owner's turn (i.e., when catapults are fired) or move, but not both.

Clerics

Clerics are holy men and women who, as a result of their spiritual beliefs and training, have the ability heal grievously injured soldiers and even raise from the dead those who have been slain. If a point-buy system is used, a Cleric costs 6 points. These abilities are reflected by the following:

(1) Each turn a Cleric does nothing else, it can heal/raise from the dead a single creature from its side's pile of slain troops, provided it does not have more than 1 Melee Die (e.g., a normal infantryman or human-sized war beast). It is initially returned to play in virtual contact with the Cleric.

(2) Over two or more turns, a Cleric who does nothing else can heal/raise from the dead a single slain creature from its side that has 2 or more Melee Dice. On the first turn, the figure is returned to the field, laid in virtual contact with the Cleric, and marked to indicate it is being healed (e.g., with an adhesive ring). Each turn thereafter, the creature receives another mark to indicate the progress of its healing, until a number of turn equal to its Melee Dice has elapsed (e.g., three turns for a Giant with 3 Melee Dice). The following turn, the creature can move and act normally. If the Cleric is killed or the creature is struck with a catapult shot or designated as a casualty in melee, the process is interrupted and the creature cannot be returned to service; there is no such thing as a partial healing or raising for these purposes.

Necromancers

Necromancers are priests capable of animating the corpses of fallen creatures and sending them into battle as Undead. Spellcasters of this sort are most useful in games where the Battlefield includes mausoleums, graveyards, tombstones, and similar sepulchral structures.

(1) If he does nothing else, a Necromancer within 6 inches of a sepulchral structure may cause an Undead creature to rise up within 1 inch of the structure. The newly animated creature cannot act until the following turn.

(2) A Necromancer can also use his turn to animate one creature from those slain in the army of which he is part, and it can be placed anywhere within 6 inches of the Necromancer. He cannot use this ability

to animate more allied creatures than have been slain. As with the above, the newly animated creatures cannot act until the following turn.

(3) If slain creature with abilities are animated, they do not retain those abilities in their undead form (e.g., an animated Wizard is just another zombie).

(4) In all cases, the Undead troops animated by a Necromancer must be represented by miniatures different than those used for normal, living troops.

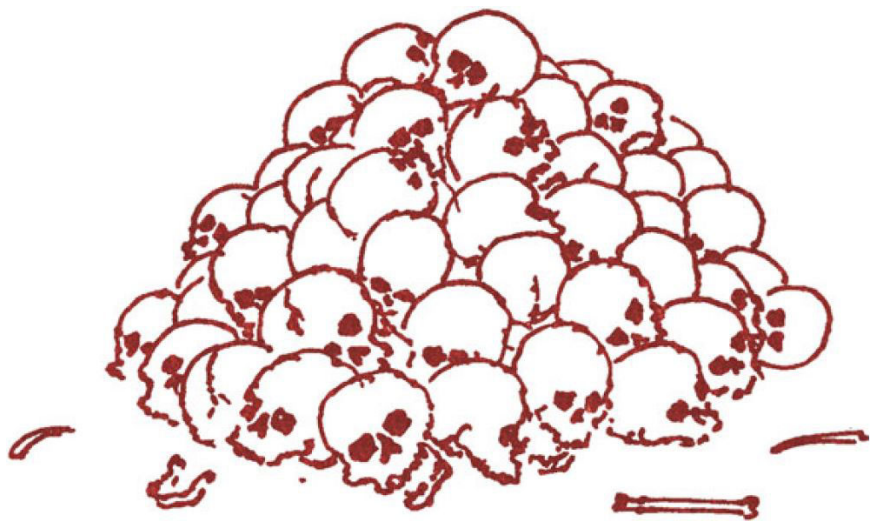

Wizards

Wizards are spellcasters who have powers over the elements that they can use to influence the course of battle. Presumably, such characters have all sorts of minor and esoteric powers beyond those described, but as they play no role on the battlefield, they are not noted here. Players should employ distinctive miniatures to represent such special troops.

(1) A Wizard who is on foot has 1 melee die, while those that are mounted have 2 melee dice for purposes of their melee attacks (but, as per regular cavalry, just 1 melee die for purposes of how much damage they can withstand). Because Wizards know a variety of ranged spells that they can direct at nearby enemies, however, such combatants should also be treated as if they were armed with missile weapons.

(2) Unless noted, a Wizard may either cast a spell or perform some special function on the firing phase of its owner's turn (i.e., when catapults are fired) or move, but not both.

Air Mages

Air Mages are Wizards who can surround troops in a sheath of air and launch them far distances using catapults. If possible, players should use catapult shot that is white, transparent, gray, or otherwise similar in appearance to air.

(1) If within 6 inches of a catapult, an Air Mage can launch any 1 point troop that is in virtual contact said catapult. Doing so takes up one of the catapult's shots for each troop launched this way. Launching the actual miniature is not recommended and troops moved in this way should instead be represented with normal shot, which is swapped out for miniatures once it has landed. Wherever the die lands, the miniature should be placed.

(2) Kills caused by launched troops should be ignored. The protective cushion of air that protects the launched troop from getting hurt also

protects enemy soldiers from getting hurt.

(3) Air Mages may launch larger creatures (e.g. war beasts, giants, etc.) at the cost of extra shots from the catapult. For example, a two melee dice war beast that is launched in this way costs the catapult two shots. Creatures larger than four melee dice cannot be launched by an Air Mage.

(4) If the launched troop lands in a location that would be hazardous to the troop (e.g. in water if it is armored) or if it lands out of the designated play area, that troop should be considered dead.

(5) If desired, an Air Mage may launch itself from a catapult so long as there are still four units available to man the catapult after the Wizard is launched.

Earth Mages

Earth Mages are Wizards (q.v.) who can make the shot fired from catapults harder and considerably more destructive to structures. If possible, players should use catapult shot that is brown, black, gray, otherwise at similar in appearance to earth or stone.

(1) If within 6 inches of one, a, Earth Mage can turn all of the shots fired from a single catapult into Earthballs.

(2) If a structure is struck by an Earthball, it suffers twice as much damage as it would from a normal piece of shot (i.e., 2 points instead of 1).

(3) Neither catapults nor troops struck by Earthballs are affected differently than they would be by normal catapult shots.

(4) If desired, an Earth Mage can turn two catapult shots — if available — into a single Mega Earthball. Such a projectile will affect troops and structures as a regular Earthball and once it stops moving will create a 3-inch diameter crater (easily represented with a cardboard disk). The attacker may place this in any way so long as the catapult



shot would be entirely within it.

(5) Any troops caught completely within the area of the crater must give up 6 inches of movement to get out of it. Similarly, any movement through a crater is doubled.

(6) Craters that intersect with a bodies of water will fill the turn after they are created and thereafter be treated as pools.

(7) If within 6 inches of a damaged structure (e.g., a tower), an Earth Mage can repair up to 2 points of damage to it as his action for the turn.

Fire Mages

Fire Mages can turn the shot fired from catapults into Fireballs that ignite certain kinds of targets. If possible, players should use catapult shot that is red, yellow, orange, or otherwise at least mildly evocative of fire.

(1) If within 6 inches of one, a Fire Mage can turn all of the shots fired from a single catapult into Fireballs.

(2) If an enemy catapult is struck by a Fireball, it catches on fire and, if they wish, its crew must use their entire next move to extinguish it. If it does not have a full, four-man crew, then it is destroyed. If a catapult is struck by two Fireballs, it is destroyed regardless of how many crewmembers are present.

(3) If a friendly catapult is accidentally struck by a Fireball from an allied catapult and has not already fired that turn, then it catches fire



and must be extinguished, as noted above. If it has already fired the turn in which it is struck, two shots from its next turn are lost if a full crew is available to extinguish it, and it is otherwise destroyed.

(4) Structures made of wood or other flammable materials struck by Fireballs catch fire and begin to burn. Only the first such structure struck by a particular Fireball can be ignited. A structure will burn for one turn for every square inch of its dimensions, after which it is destroyed and should be treated as a Debris Field (q.v.). Troops can attempt to battle a fire instead of moving or engaging in melee. Half as many troops as a structure has square inches can extinguish a fire in two turns, and a number equal to the dimensions in square inches can extinguish it in one turn.

For example, a farmhouse that is two inches wide and three inches wide has an area of six square inches. If caught on fire, it would thus burn for six turns before being destroyed. Three soldiers could put out the fire in two turns and six could put it out in one.

(5) Structures made almost entirely of stone, such as fortress walls, do not suffer additional damage from Fireballs.

(6) If desired, a Fire Mage can turn two catapult shots — if available — into a single Mega Fireball. Such a projectile will affect troops and structures as a regular Fireball and once it stops moving will create a 3-inch diameter fire (easily represented with a cardboard disk). The attacker may place this in any way so long as the catapult shot would be entirely within it.

(7) Any troops caught completely within the area of the fire are killed and no other troops are able to enter it. The fire will burn for 7 turns, including the one in which it is ignited.

(8) If a Mega Fireball lands in water, an area of fire will be created and burn for that turn. The following turn, however, it will be extinguished.

Water Mages

Water Mages can both part bodies of water so that troops can pass through them and turn the shot fired from catapults into Waterballs that can extinguish burning targets (if possible, players should use catapult shot that is blue, green, or otherwise at least mildly suggestive of water for this latter function).

(1) If within 6 inches of one, a Water Mage can turn all of the shots fired from a single catapult into Waterballs.

(2) If a burning catapult or structure is struck by a Waterball, it is extinguished. None of the damage it has already suffered from fire or other causes is restored, however, and should be kept track of in case it is reignited or otherwise suffers further damage.

(3) Catapults, troops, and non-burning structures struck by Waterballs are affected just as if they had been hit by regular catapult shots.

(4) If desired, a Water Mage can turn two catapult shots — if available — into a single Mega Waterball. Such a projectile will affect troops and structures as a regular Waterball and once it stops moving will create a 3-inch diameter pool (easily represented with a cardboard disk). The attacker may place this in any way so long as the catapult shot would be entirely within it.

(5) Any troops caught completely within the area of the pool must give up 6 inches of movement to get out of it if unarmored. Otherwise, they are drowned. Similarly, a pool is treated like any other body of currentless water for purposes of movement and the like.

(6) If in virtual contact with a body of water, a Water Mage can cause a path 6 inches wide and up to 24 inches long open up in it. This path will remain open as long as the Water Mage wishes it to, provided he does not move, does not cast any other spells, and is not killed.

UNDEAD

Undead are the animated corpses of slain soldiers and other once-living creatures and include such monsters as skeletons and zombies. They function in all ways like normal infantrymen, war beasts, or the like, subject to the following:

(1) Undead creatures of various sorts have a movement rate equal to that of living creatures of the same sort (e.g., 12 inches per turn for foot soldiers).

(2) Undead creatures can operate catapults just like other creatures of the same sort.

(3) Undead cannot be taken prisoner nor can they be used to take or escort prisoners.

(4) Undead can be forced to retreat by Paladins (q.v.).

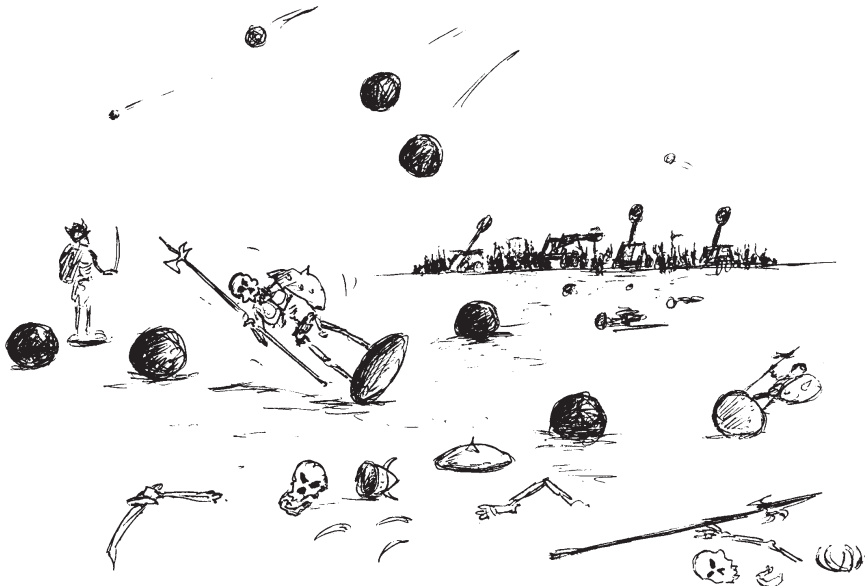



PAGE 32



Skirmisher Publishing LLC

Giants

Giants are humanoid creatures that are larger — sometimes much larger — than normal humans. While such creatures undoubtedly have sophisticated cultures and all sorts of nuanced characteristics, they are described here because of their abilities to serve as walking artillery batteries and to obliterate entire squads of enemy troops and walk away unscathed.

Almost any bipedal miniatures larger than normal soldiers can be used to represent giants and how powerful they are is a function of their size, as reflected on the table below. The smallest figures we recommend for these purposes should be larger than normal soldiers and up to 2" in height. The largest miniatures we recommend for these purposes are up to 6 inches in height, and if somewhat larger figures are used then they should follow the rules for the 6+'' category.

(1) If a point buy system is being used to create armies, giants cost considerably more than normal soldiers. The precise amount is a function of their sizes and is reflected on the table below.

(2) Because they have a longer stride than normal soldiers, giants can cover more ground per turn. Rate of movement for a particular giant is a function of its height and is shown on the table below.

(3) A pair of small giants, those with just 2 melee dice, can both move a catapult a distance based on their rate of movement and operate it in the same way that four man-sized creatures would.

(4) Larger giants generally don't move and cannot operate catapults but can hurl big weapons, boulders, tree trunks, and other objects and debris on their own! Any turn in which a giant of 3 or more melee dice does not take any other action, it can hurl such missiles. Such attacks are represented by and resolved with additional shots from a catapult. To do this, temporarily remove the giant from the battlefield and line up the front edge of a catapult with the front edge of the giant's location.

The number of shots used to represent the giant's boulder-hurling is a function of its size and is shown on the table below.

If desired, two larger giants of 3 melee dice or a single giant of 4 melee dice or more could move a catapult a distance equal to their movement.

(5) If a giant is struck by a catapult shot and knocked over, it is killed. If it is struck but not knocked over, however, it might survive. To determine one way or the other, the attacker must roll a d6; if the number rolled is equal to or greater than the number shown under "Melee Dice" on the table below, then giant is killed. Otherwise, it is unaffected.

(6) When it is involved in a melee, a giant rolls a number of dice as indicated under "Melee Dice" on the table below. For a giant to be killed in melee, a number of dice equal to its special Melee Dice must be defeated by the enemy player. If a giant is the only creature on one side involved in a particular melee and the number of dice needed to kill it is not met, then it is simply unaffected.

(7) Giants armed with bows, crossbows, or slings can engage in Missile Fire (q.v.), rolling a number of dice as shown on the table below. Such attacks must be made separately and not in conjunction with other melee or missile fire resolution rolls. Furthermore, not more than a single enemy per turn can be slain by a particular giant's missile fire.

Height	Points	Movement	Boulders	Melee Dice
Up to 2"	3	16"	0	2
2" - 3"	5	18"	1	3
3" - 4"	8	20"	2	4
4" - 5"	11	22"	3	5
5" - 6+''	14	24"	4	6

WAR BEASTS

War beasts are non-human creatures that are frequently bigger, stronger, and more dangerous than normal troops. Beasts roughly the size of men (e.g., wolves) should be treated in all ways like infantrymen if they are bipedal and cavalrymen if they have four or more legs.

(1) War beasts two, three, or even six times more powerful than normal infantrymen might also be used in the game. Point buy for such creatures should be one-and-a-half times greater than their power multiplier or Melee Dice (e.g., 3 points for a war beast as powerful as two normal infantrymen, 9 points for a war beast six times more powerful).

(2) War beasts can be used to move catapults a distance equal to their rate of movement (e.g., four wolves could move a catapult two feet per turn). Four man-sized war beasts, two 2x or 3x man-sized war beasts, or a single 4x or larger war beast can move a catapult. Such creatures cannot, however, be used to fire catapults, unless they are at least partially humanoid (e.g., centaurs).

(3) Figures used for war beasts should be appropriate in size and appearance to the power multiplier associated with them. If it is not readily obvious how powerful a particular beast is, however, it should



be marked in some way (e.g., have an appropriate number of binder reinforcements hung on its appendages).

(4) War beasts more powerful than normal troops might not be killed if struck by catapult shots that do not actually knock them over. In such cases, the attacker should roll a d6, and if the number is equal to or greater than the power multiplier, the beast is killed. Otherwise, it is unaffected. No roll is needed, however, for those actually knocked over by catapult shots.

Size	Points	2-Leg/4-Leg Movement	Melee Dice
Up to Man Size	1 ½	14"/21"	1
2x Man Size	3	16"/24"	2
3x Man Size	4 ½	18"/27"	3
4x Man Size	6	20"/30"	4
5x Man Size	7 ½	22"/33"	5
6x Man Size	9	24"/36"	6

DWARVES

Dwarves are short, stocky people who are skilled at mining, metalwork, and building things from stone.

(1) Because they have stubby little legs, Dwarves do not move as quickly as Orcs or other normal sized people and only have a movement rate of 8 inches per turn. Rubble, rough terrain, and hilly terrain up to 2 inches in height do not affect Dwarves' movement, however.

(2) Dwarves are highly proficient with missile weapons like shortbows and crossbows, and anytime a point buy system is used to build armies, up to one-quarter of a Dwarven force may be equipped with such weapons at no extra cost.

ELVES

Elves are effete, lanky people who dwell in forests and meadows and excel at such things as arts and crafts, singing, and dancing.

(1) Elves have normal movement for creatures of their sort. When moving through forest terrain, however, such creatures are not slowed in any way.

(2) Elves are inferior combatants in melee and convert all rolls of 6s to 5s, 4s to 3s, and 2s to 1s. They are superior bowmen, however, and both enjoy a range of three feet with such weapons and no conversion of dice rolled for them.

(3) If a point buy system is used to build armies, up to one-half of an Elven force may be equipped with bows at no extra cost.

ABNORMALLY STABLE CREATURES

By definition, an abnormally stable creature is one represented by a miniature that is not likely to be knocked over even if struck directly by a catapult shot. Examples include, but are by no means limited to, prone snakes, giant centipedes, alligators, and crocodiles.

(1) Movement for abnormally stable creatures is $\frac{3}{4}$ normal over most surfaces. Those that are aquatic or amphibious in nature, however, have full normal movement in water.

(2) Point cost to purchase such creatures is 1 more than it would otherwise be for a creature of the sort in question (e.g., 2 $\frac{1}{2}$ rather than 1 $\frac{1}{2}$ for a warbeast of up to man size).

AMPHIBIOUS CREATURES

A wide variety of amphibious humanoids and monsters like Lizardfolk, Kuo Toa, and Deep Ones might appear on a fantasy battlefield and many sorts of miniatures suitable for representing such creatures exist. If a point buy system is used, an amphibious creature costs 1 point more

than a creature of its sort normally would.

(1) Amphibious creatures have a movement rate as per other creatures of their sort (e.g., one foot for infantrymen), and can move equally well both across land and through water.

(2) If in water, an amphibious creature is only slain by catapult fire if it is both knocked over and the first creature struck by a piece of shot.

(3) Amphibious creatures can move catapults across water obstacles at double the normal cost for movement (non-Amphibious creatures cannot move catapults across water obstacles). Such engines cannot, however, be fired from the water (this rule, however, in no way precludes the individual fire of Amphibious missile troops, such as Lizardfolk slingers).

(4) When engaged in melee with creatures that are neither Amphibious nor Aquatic (q.v.) while both parties are in the water, an Amphibious creature is entitled to roll one additional melee die than it would otherwise be entitled to.

AQUATIC CREATURES

Creatures like sharks, some species of dinosaur, and even some races of humanoid are native to an aquatic environment and are unable to leave it. Such creatures are treated in all ways like amphibious creatures (q.v.), with the sole exception being that they are unable to move across land. Aquatic creatures with long appendages might be able to melee with creatures on land if they are able to move into virtual contact with them, however, and those with missile weapons can fire at targets on land.

INFERIOR TROOPS

Armies might sometimes include substandard sorts of combatants like Goblins, Gnomes, Kobolds, Halflings mounted on Shetland ponies, and the like (Elves are a special sort of inferior troops and are described

separately). Soldiers of this sort can be especially well represented by plastic 1/72 scale ancient and medieval figures of various kinds.

(1) If a point buy system is being used, inferior troops cost half of the cost for regular troops of the sort in question (i.e., 1/2 point for foot soldiers, 3/4 point for missile-armed foot soldiers or war beasts, 1 point for cavalry).

(2) When engaging in melee (or missile fire, if appropriate), inferior foot soldiers and war beasts convert all rolls of 6s to 5s, 4s to 3s, and 2s to 1s. Inferior cavalry do not convert their melee dice, but are instead treated in all ways as a 1 melee die combatants, rather than 2 melee die combatants (rolls for any missile weapons such troops might wield, however, would be subject to the above-described conversion).

(3) Because they are relatively small and weak, eight rather than four inferior soldiers are needed to operate a catapult.

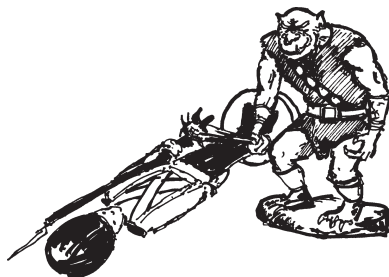

ELEMENTALS

Elementals are powerful creatures created of the elements themselves. If possible, miniatures suggestive of the particular element that the Elemental is representative of should be used.

(1) Elementals are fast, their size does not determine this. An elemental moves at a rate of 24 inches per turn.

(2) Elementals greater than 1 inch tall have a number of Melee Dice equal to its height in inches greater than 1 (e.g. a 2 inch elemental is 2 melee dice, 3 inches are 3 melee dice, 4 inches 4 melee dice, etc.).

(3) If a point buy system is being used the value for a 1 inch Elemental is 2 points. For Elementals of greater size, it is 2+the number of melee

dice the Elemental has.

(4) To get an Elemental representative of a particular element, the player must also have a Wizard of the corresponding element (e.g. to buy Earth Elementals the player must have an Earth Mage).

(5) If all Wizards of an Elemental's parent element are killed, the Elemental is too killed (e.g. if all a player's Earth Wizards are killed, all Earth Elementals are killed too).

Air Elementals: Air Elementals may travel in a manner similar to the way Air Mages transport troops. When an Air Elemental is using its ability, replace it with a catapult and launch a die from it. Wherever the die lands is the Elemental's new location.

Earth Elementals: Earth Elementals may attack buildings directly. Damage dealt by Earth Elementals can be found in the following way: Roll all of the Elemental's Melee Dice and every roll of 5 or greater deals one point of damage to the building. Additionally, Earth Elementals are in no way impeded by terrain. When moving across solid land an Earth Elemental's movement is always a full 24 inches.

Fire Elementals: If a Fire Elemental is in virtual contact with a building, the building receives one point of burning for every round the Fire Elemental is in virtual contact with it.

Water Elementals: A Water Elemental that is in water has an infinite movement rate, it can be placed anywhere within a single contiguous water feature. Moving into the water uses all of the Elemental's land movement, and so it must wait until the next round to move onto land. Additionally, when engaged in combat with a Fire Elemental, double the number of Melee Dice the Water Elemental gets to roll (e.g. a 3 Melee Dice Water Elemental fighting a Fire Elemental receives 6 dice instead of 3).

ADDITIONAL RULES (BATTLEFIELD)

STRUCTURES

Structures, including fortifications and other buildings, can be attacked with catapults and affected by other actions in the game.

(1) Every sort of structure can sustain a certain number of hits by a catapult, after which it collapses and is destroyed. The number of Structural Points (SPs) a building has can be quickly and easily determined based on its footprint.

For fortified structures, multiply length times width to determine how many structural points it has (e.g., a 7 1/2-inch long, 2-inch wide wall would have 15 SPs, an 8-inch wide, 8-inch long keep would have 64 SPs).

For unfortified structures, multiple length times width and then halve the total to determine how many structural points it has (e.g., a 4-inch



wide, 6-inch long townhouse would have 12 SPs).

Optionally, once a section of self-standing wall up to a foot in length — such as part of a wall surrounding a town or castle — has lost half its SPs, it can be considered breached and to have a hole equal to half its width knocked in it.

(2) If any structure or other Battlefield prop (e.g., a tree, a headstone) is struck by a catapult shot and knocks over a soldier as a result, that soldier is killed.

(3) If a structure with troops on or in it is destroyed, those soldiers are slain as a result.

Fortifications

Armies attempting to hold areas or withstand attacks can have their chances greatly enhanced by fortified structures like crenellated castle walls, towers, keeps, and gatehouses.

(1) Troops struck by catapult fire are killed (or have the same chances of being killed if touched but not knocked over by shot), regardless of whether they are protected by fortified structures.

(2) Troops knocked over as the result of the fortification they are on being struck by catapult fire have the same chances of being killed as those touched but not knocked over by shot (i.e., only one can be killed, as chosen by the firer). Those actually knocked off of fortifications, however, are killed, as are those on fortifications that are toppled or destroyed as the result of catapult fire.

(3) Troops on fortified structures receive substantial protection from missile fire directed at them. All of their defensive rolls to resist such fire of 1 or 2 are considered to be 3s if their fortification is made of wood, and their rolls of 1, 2, or 3 are considered to be 4s if their fortification is made of stone.

(4) Troops on fortifications are, for the most part, immune to melee

attacks from enemies without missile weapons (and troops who wish to attack them must employ maneuvers such as Escalade, q.v.). Figures at least as tall as the fortifications they are attacking, however, can make melee attacks against defenders, but they are protected in the same way as for missile fire. Figures two or more times as tall as the structures they are facing, however, are not impeded in their melee attacks against defenders on them.

Rubble

When a structure is destroyed, a field of rubble is left in its place that should be marked in some way.

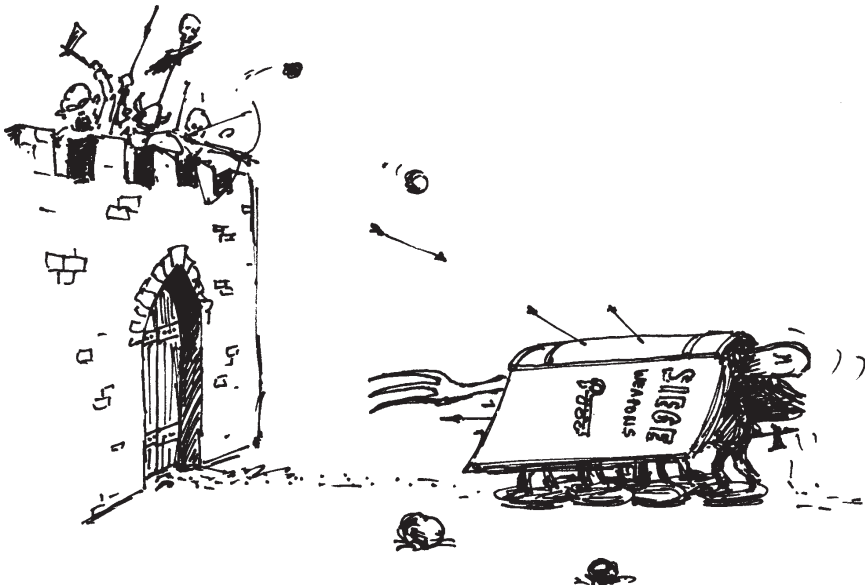

(1) Movement through a rubble field is the same as for rough terrain and each inch or fraction thereof counts as two.

(2) Rubble fields, rough terrain, and areas conforming to the same game characteristics might also be placed on the Battlefield at the beginning of a game.

Escalade

Troops can attempt to directly storm walls, by climbing, using makeshift ladders and grappling hooks, and employing other measures that do not need to be represented with any sort of tokens or props.

(1) Man-sized soldiers, bipedal war beasts, and quadrupedal warbeasts like big cats, bears, and dragons can attempt to scale walls up to 4 inches in height, and giants and larger war beasts can attempt to scale walls of a height up to 3 inches greater than their own height or length (e.g., up to 9 inches for a 6-inch tall giant).

(2) Cavalry troops and quadrupedal warbeasts like horses, elephants, or dogs cannot scale fortifications or structures as described here.

(3) To scale a wall, an appropriate creature must begin its turn in virtual contact with a wall or other structure (i.e., it must end its movement there the previous turn and is subject to missile fire and possibly other sorts of attacks while there).

(4) The player controlling a force of escalating creatures must roll their melee dice, as if making an attack. From the regular total number of dice he must subtract a number equal to the melee dice of any defenders physically on the wall being scaled.

(5) For every roll of 2 or greater, he may move one melee die worth of creatures to the top of the wall. For every roll of 1, he takes 1 melee die worth of casualties. Troops that successfully make it to the top of a wall cannot make any additional movement that turn.

(6) Creatures taller than the walls they wish to climb need pay 2

inches of their movement for each vertical inch of the wall (e.g., 8 inches of movement for a 4-inch-tall wall). Such creatures do not need to roll for success and, if they have sufficient movement at their disposal, do not need to halt at the bases of walls before scaling them nor halt movement afterward.

TERRAIN

Terrain features of various sorts can make the battlefield more interesting, give parts of it a specific character, and both impose challenges and grant benefits to the armies deployed on and around them.

Hills

Hills are areas of elevation higher than the surrounding terrain. Such features can be represented by commercially purchased diorama components, sheets of Styrofoam, pieces of board, or even books (the latter two items of which were among Wells' preferences), and can be constructed in multiple tiers.

(1) Soldiers can climb a hill, or a single tier of one, by paying two inches of movement for every vertical inch traversed (e.g., 8 inches of movement to ascend a 4-inch-tall hill or tier).

(2) If a hill, or tier thereof, is too high for a soldier to climb in a single turn of movement (e.g., more than 6 inches for a soldier with a 12-inch move rate), then it is considered to be too difficult for that soldier to climb.

(3) Catapults cannot be transported over hills.

Forests

Forests are areas of relatively dense vegetation, generally consisting of trees of various sizes with intervening underbrush. Such areas can be

represented by homemade or commercially manufactured trees — which, for convenience, can be affixed to sheets of board or Styrofoam — or, less impressively but much more simply, even green-colored pieces of paper or cardboard. Forests represented by actual models, however, not only look more impressive, they might actually serve as an obstacle to catapult fire.

(1) Movement through forested areas costs twice as much as it does



over open ground (e.g., moving 6 inches into a forested area would require all 12 inches of a foot soldier's movement).

(2) Troops within a forested area enjoy some protection from enemy missile fire. When rolling to resist such attacks, figures with such cover can convert all of their rolls of 1 or 2 to 3s.

(3) Catapults can be transported through forests but at only one-quarter the normal movement rate of the troops moving them, rather than one-half their normal rate.

Bodies of Water

As *Little Orc Wars* is a land-based game, it is recommended that bodies of water be limited in size and placed mainly to serve as obstacles and for purposes of introducing new rules and tactics. With this in mind, rivers or lakes should not be more than 2 feet wide (i.e., so a *Water Mage* can be used to cross them), although they might be as long as a room is wide and separate one side of a *Battlefield* from the other.

Ponds, lakes, and other relatively small bodies of standing water do not generally have any current. The person setting up the *Battlefield* must determine whether flowing bodies of water have no, weak, moderate, or strong current and in which direction it is moving.

(1) Troops with no or light armor (e.g., leather, shield) can attempt to ford or swim bodies of water. Each inch of movement through water counts as two of the inches a soldier is able to move (e.g., an 8-inch-wide river would require 16 inches of movement to cross). Troops unable to make it completely across a body of water in one turn remain in it until they can complete their movement across it.

(2) If a body of water has a current, troops within it are driven downstream each turn (including the first, if it only takes them one turn to cross it). The distance they are moved downstream is 1 inch for weak current, 2 inches for moderate current, and 2 inches for strong current. If

moving directly downstream, the current may simply be added to their movement, and if moving upstream it should be subtracted from it.

(3) Troops crossing bodies of water are also at risk of drowning in them if any sort of current is present. To determine if this happens, each troop must roll 1d6 and if they get 1 in weak current, 2 or less in moderate current, or 3 or less in strong current they are drowned. Creatures with multiple Melee Dice get to roll all of them and thus have very little chance of drowning (i.e., a 2 Melee Dice creature always rolls at least a 2 and thus cannot drown in a weak current).

(4) Amphibious and Aquatic Creatures (q.v.) can cross bodies of water both at their normal movement rate and without risk of drowning. They are still subject, however, to being moved downstream by current.

(5) Catapult shot that lands in water kills only a creature that is both knocked over and the first creature struck by it and is thereafter considered to have sunk (meaning any casualties caused by its continued movement across the Battlefield should be disregarded).

Boats

Many different sorts of boat models are available or can be improvised, and these can be used to ferry troop across rivers, lakes, and other bodies of water. They are assumed to be operated by crewmen that cannot act independently and do not need need to be represented with figures of their own.

(1) Boat models can convey as many troops as can be stood up within them; bases can be pressed against each other but should not overlap. Models large enough to carry catapults can be used to do so provided there is also room for them to carry sufficient crew to operate them (e.g., four regular troops).

(2) If a boat berthed in a body of water is in virtual contact with the shore or a structure like a pier, troops on its landward side and within 6

inches of the vessel can use their moves to board it.

(3) The turn after troops embark upon a vessel, it can be moved up to 12 inches across a body of water. If moving downstream rather than simply across a river or lake, this distance can be increased to as much as 18 inches. If moving upstream, the distance is reduced to 6 inches.

(4) Once a boat touches the land for which it was headed, the player controlling it can immediately disembark his troops at any point within 6 inches of the vessel. Catapults carried on vessels can be placed within 6 inches of them the turn after they make landfall (provided adequate crew are available).

(5) If a player wishes to fire a catapult from a boat, the vessel must remain stationary for an entire turn while the crew prepares to use the weapon. After it is fired, if desired the player can allow the vessel to drift 6 inches straight downstream if in a river.

(6) If a laden vessel is struck by catapult fire, any troops struck or knocked over are killed as usual. Furthermore, any who might not be killed under the normal rules but who are knocked overboard are killed. If a vessel is capsized, all the troops and equipment on board it are destroyed.



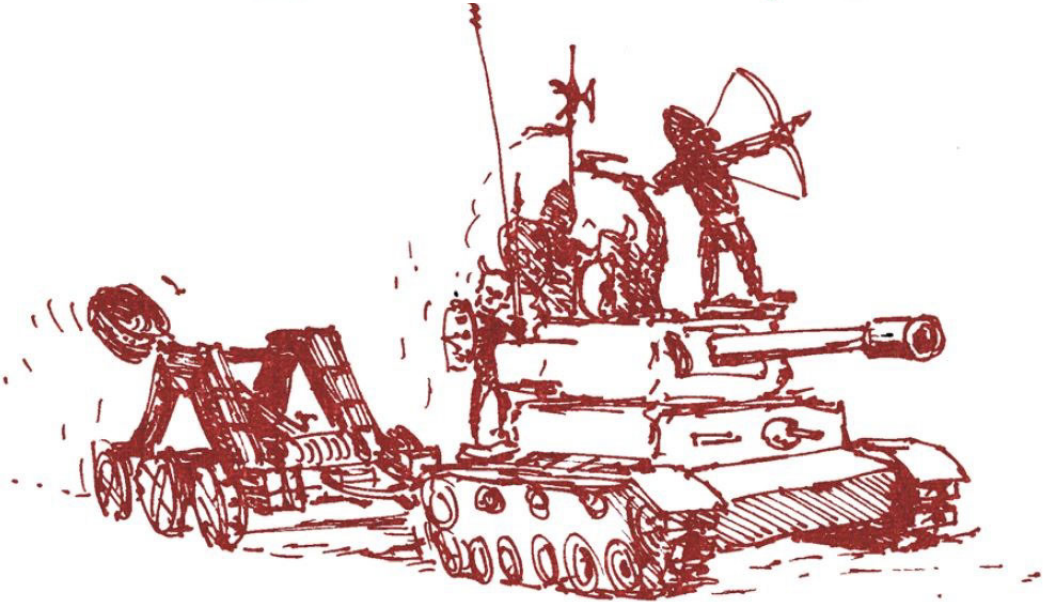
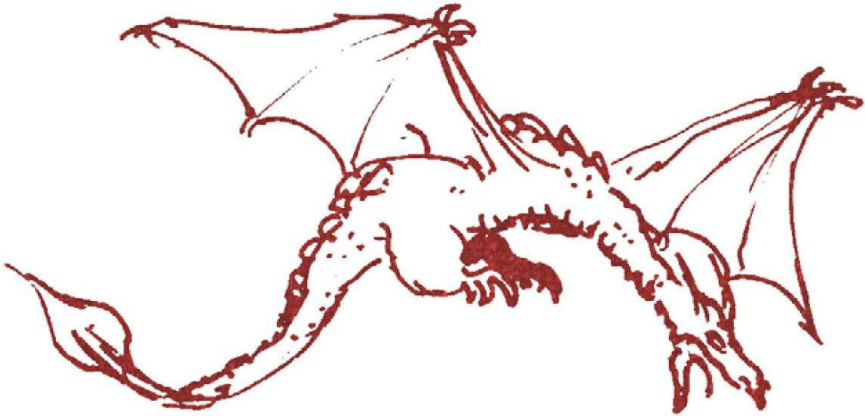

CUSTOMIZED RULES

Different gaming groups will have access to widely different varieties of miniatures and models and it is completely appropriate to develop customized rules that allow them to be used in the game. Indeed, we encourage this, and designed *Little Orc Wars* in part so that players could use in the context of a game some of their favorite toys and props (including those that should have game characteristics not covered by these rules). This philosophy is also in the spirit of H.G. Wells' attitudes toward gaming.

Some new and customized rules will be better than others, and players may determine that some are not particularly fun or that they contribute to an unbalanced game. Experimentation can help keep a game new, vital, and fun, however, and should be indulged in when the worst consequences are possibly unsatisfactory results. And, if everyone is playing by the same rules, they are by their very nature fair, and that is the most important thing in a game.

Following are some of the customized rules used by the Skirmisher Game Development Group. Players without access to the same miniatures and models as our group may not be able to use all of these rules — which is why they are not included in the main body of the text — and they are presented largely as examples of what players can develop for their own games.

Mountain of the Lich Lord: This option makes use of our reproduction 1970s Marx Toys mountain, used with a variety of dinosaur, military, and Wild West sets and an impressive addition to our own battlefield.

1) The cave mouths on this model count as sepulchral structures and possession of it allows the player who starts with it in their territory to purchase a Lich Lord for 12 points. This figure is a double-strength



Necromancer who has 2 melee dice and a 2-die ranged attack out to two feet.

2) This uber-Necromancer is also capable of animating two undead creatures each round from sepulchral structures other than the mountain. If standing at the top of the mountain, however, he can call forth one standard undead creature from each of the three cave mouths each turn. If desired, the

player controlling the Necromancer can opt to call forth any combination of creatures worth 3 points (e.g., two 1.5-point undead warbeasts).

3) Undead creatures called from the mouths are placed just in front of them the turn they are called; can be moved to any point on or within an inch of the base of the mountain the following turn; and can be moved normally each turn thereafter.

4) If a catapult shot enters one of the cave mouths, it is assumed to have collapsed and no more undead creatures can be called forth from it. The other mouths are unaffected unless so struck, however, and the mountain itself cannot be destroyed.

(With little modification the custom rules described above could just as easily be used for a Mountain of the Orc Warlord or anything else along those lines.)

TRADITIONS

Every gaming group will — and should — develop its own traditions. The Skirmisher Game Development Group is no exception, and following are some of the traditions and house rules that we have adopted for our Little Orc Wars games. Most of them are matters of personal preference or have no bearing on the outcome of a game, however, and

that is why they are not listed as rules elsewhere in this book.

No shoes: We encourage players in our group not to wear shoes during games played on the floor. One reason is so that the floor will be cleaner for people crawling around on it moving their armies and firing their catapults. Another is that being barefoot or in stocking feet tends to make people a bit more agile and less likely to stomp on battlefield features or deployed troops.

Hats when firing: Yeah, it might seem silly, but like any good soldiers, our gamers are encouraged to wear appropriate headgear — if not during the entire game, at least while they are firing. This tradition actually goes back to H.G. Wells himself, as indicated by photographs in the 1913 edition of his *Little Wars* showing he and his friends suitably covered. Our hats of choice vary by player but have included fezes, berets, helmets, crowns, and even jester hats.

Soft shot only: After numerous playtest sessions, we have determined that very hard catapult shot — such as the popular d12s — causes inordinate damage to props and have thus decided to ban it. Periodically seeing a miniature shot in half is, naturally, amusing, as is witnessing chunks being blasted off of models. Post-game repair sessions became too protracted, however, and too many troops needed to be permanently retired. Acceptable ammunition for our games includes the shot that comes with our Papo catapults, Dots brand candy, a particular sort of decorative plastic rocks designed for arts-and-crafts projects, and d4s (the shape of which dramatically reduces their velocity).



TIPS

☠ If melee is inevitable for a group of your soldiers — particularly one that includes special troops like spellcasters — try to be the one to initiate it. That way, you will be the one to select which combatants become casualties and can reduce the chances that your own special creatures will be slain.

☠ While this game has been designed so that the characteristics of figures are generally obvious just from looking at them, telling the difference between heroes of various sorts of war beasts or giants of differing sizes can still sometimes get confusing, especially in larger games. A good tool for managing such figures are small Post-It Notes, such as the ones that are 2 inches by 1.5 inches (or any similar product). Critical information like *Melee Dice* and movement rates can be written on such notes, the sticky edge of which can be affixed to the bottom of the figure in question.



H.G. WELLS'
LITTLE WARS



By H.G. Wells

*With an Introduction by Michael J. Varhola
and a Foreword by Gary Gygax*

H.G. Wells' Little Orc Wars is a miniatures game based on the rules and concepts published by the genius science fiction author nearly a century ago. It is, in fact, one of the most flexible, innovative, and fast-paced miniatures rule systems for use with fantasy miniatures and models ever created. Indeed, a primary feature of this game is that it can be played with virtually any miniatures, setting it apart from the vast majority of fantasy miniatures games, which demand that only their branded products be used in play. This booklet contains the basic *Little Orc Wars* rules along with options for Wizards, Giants, and more.



<http://skirmisher.com>