

GW4

7505

# GAMMA WORLD<sup>®</sup>

SCIENCE FANTASY ROLE-PLAYING ADVENTURE

## The Mind Masters

by Phil Taterczynski

For beginning and intermediate players.



GAMMA WORLD and PRODUCTS OF YOUR IMAGINATION  
are trademarks owned by TSR, Inc.

**TSR**<sup>™</sup>  
TSR, Inc.  
PRODUCTS OF YOUR IMAGINATION<sup>™</sup>

©1983 TSR, Inc. All Rights Reserved.



plorers. Each member of the community is required to answer a summons to service by the Collegians at least once in their lives. The names of those to be called are chosen by lot. The pool from which the lots are drawn contains the names of those who are old enough to serve and have not yet done so. There is also a pool of volunteers who wish to serve again. Some members of the community adventure on their own, but must still answer the summons.

When there is a summons, the councilors call a meeting of the unchosen, and select those who will serve the dean.

The country around lac South is relatively peaceful. There are a number of communities within a couple days' travel, and there is a fair amount of commerce among them. However, the inhabitants of each town are very loyal to their home base, and often make a sport of swindling outsiders.

The Twainway is a great river, sometimes called the Mispi. This river was named after a pre-Devastation historian whose surviving stories of life on the great river are a subject of much study and debate. Flowing from the Zantluz Lake in the north, beyond which few people have gone, the Twainway joins the Hio River south of Kap Girdo and flows past the ruins of ancient Memfiz to the fabled sea. Stories of radioactive wastelands and dangerous mutations have discouraged exploration south of where the Twainway and the Hio meet.

The ruined city of Kiro is said to have once stood on the north bank of the Hio. It is also said that the riverbeds shifted after the Shadow Years. Some say that the city was relocated before that, and a vast store of artifacts is waiting to be found on the original site. The area surrounding Kiro is radioactive. Occasionally, strange and sometimes dangerous mutant species migrate northward from there.

### Communities East of the Twainway

Jonzbor(Q29) is a Tech Level II community of 200, about 65% humanoid, 25% PSH, and 10% other types. The people of Jonzbor benefit from the presence of lac South, so the two communities have close ties.

Wooflak(N27) is a Tech Level I town of 80 humanoids who live off the surrounding woods. They also run the ferry at Waycroz. They are very suspicious of outsiders and closely follow any travellers passing through their territory.

Korvil(M34), a farming community 30 kilometers northeast of lac, has a population of mixed types, numbering about 350. Korvil is a Tech Level II community.

Venna(Q35) is only about 35 kilometers southeast of lac, but is not often visited because it is close to Kiro. This Level I town has 160 inhabitants, mostly humanoid.

Chain City(S33) is a stronghold of Archivists with a population of 110. In the last five years, Chain City gangs made three raids for artifacts on the lac storehouses. They patrol the countryside within two kilometers of Chain City and demand an artifact toll from anyone passing through that area. Although artifacts are common in Chain City, few of them work, and those that do are in shrines. As a result, Chain City is Tech Level II.

Metropoliz(U37) is the Level I base of a radical band of Radioactivists who make frequent pilgrimages to Kiro to bask in the radiation zones of the ruined city. They believe in the superiority of mutated strains, and await the return of a mythical mutant hero with incredible powers. They will attempt to capture anyone entering Metropoliz and take them to Kiro. There, they hope that the "Radiant Divine Glory" will transform their captive into their hero. Radiation detectors are highly valued artifacts here.

Gall(S26) is a ferry landing with no permanent population.

### Communities West of the Twainway

Illmo(S25) is the ferry landing opposite Gall. It serves the river town of Kap Gurdo, and also has no permanent population.

Kap Gurdo(S25) is a large river town with a Tech Level of II and a population of nearly 5000. Some river traffic stops here while travelling up and down the Twainway. Twenty percent of the inhabitants are PSH, 60% are humanoids, and 20% are other types. Kap Gurdo has the largest concentration of non-humans and humanoids in the area. It has a reputation of being a rough and lively town.

Jakson(Q23) is in the shadow of Kap Gurdo. Its population is only 160, mostly PSH, and has been shrinking gradually as people leave to reside in the port town. Jakson is Tech Level I.

Kelzo(V23) is a Level I farming community where the residents stay close to town and are armed most of the time. Kelzo is

at the northern edge of the hunting ranges of a number of nomadic tribes.

Bentun(Y22), in addition to being a farming town, is also a small, armed, Tech Level II base. Its 310 people are the main reason the southern nomads seldom range further north. Few people go south of Bentun, and most of those who do never return. The people of Bentun are eager to trade for weapons, and have even traded with nomads at times.

The Unknown Lands lie west of the settled areas in this region. The boundary between explored and unexplored land is gradually moving west, and there is a charted trail going to the city of Jeferzun. Explorers are well rewarded for any information they bring back from the Unknown Lands.

### Nomadic Tribes

Several nomadic tribes range freely in the land to the south of the area on the map. They are all humans or humanoids. These are the nomadic tribes that you know about.

The Gatorbate tribe's original home was the extensive swamp areas near the mouth of the Twainway. The humans and humanoids there were driven north by a horde of cunning, vicious swamp mutants. The attack was led by the Zoopremisist leader, Old Gramps, an unusually intelligent Gator (Green Hisser). The few humans and humanoids who survived the attack fled north and split up into a number of small tribes, including the Gatorbates. The Gatorbates have slowly increased their number, and are 150 strong now. They are always hostile towards members of the Swampz tribe and all reptilian mutants. The symbol of their tribe is a frog, and their chieftain's crown is an alligator skull.

The Swampz came from the same area as the Gatorbates, and are bitter enemies of both Gatorbates and reptilian mutants. The Swampz tribal symbol is a snake. The whole tribe has only about 100 members.

The Hilbilz are descended from the survivors of the Memfiz and Nashvil bombings. A simple folk, they are less likely to be hostile than most other nomad groups. All Hilbilz wear wide hats woven from straw or reeds, and traditionally go barefoot. Adult male Hilbilz all wear small brown porcelain jugs on their belts as a symbol of manhood. Hilbilz are distantly related to the Haesedes, a tribe of simple ways and low intelligence. Hilbilz roam the country in search of their traditional

enemies, the lost Revnurz tribe of Deecce. The Revnurz tribe doesn't exist, but the Hilbilz believe they do, and search for their "ancestral enemies." Hilbilz will ask anyone they meet for information about Revnurz, and pay for useful items. The total number of Hilbilz is unknown.

Members of the Polkatz tribe are usually hostile to outsiders and often are quite nasty to each other. It is taboo for a Polkatz to touch water. They fear rain, and their only drink is made from fermented grass. Their place of origin is unknown, but most people who encounter the tribe wish they would go back there. Polkatz medicine men lead the tribe, painting their bodies black with a white dorsal stripe. There are about 750 Polkatz who roam in bands of warriors and others. Polkatz simmer their captives in large kettles filled with a corrosive, foul-smelling liquid brewed by the medicine men.

The Okeez come from the southwest. The symbol of their tribe is an armadillo. The 350 members of the Okee nation are searching for a new site to rebuild the holy city of Muskogi. When Okeez are provoked into a hostile reaction, they will attempt to disable their opponents, then stomp them to death. Believing they can get strength from their tribal symbol, Okee warriors wear helmets made from armadillo shells. They eagerly hunt the animals to get material for new helmets. Okeez can always be pacified with an offering of alcoholic beverages.

## The Summons

### GM

The PCs start this adventure in Iac South. It is not necessary to have details of this community. However, you can expand this adventure by designing Iac South and familiarizing the PCs with it. Any expansion should not detract too much from the play of this adventure. Be sure not to do anything that will make it harder for the PCs to finish this adventure. The PCs will be familiar with the town and know the location of the atrium, the central building of the college.

### Players

It is two weeks after the plantings, and the first summoning of the year is about to take place. You are all unchosen, among those who have yet to fulfill your birth-debt of service to the Collegians. You must be present at the summons. The lots

will be drawn at noon on the steps of the atrium.

At noon, 150 of the unchosen and 50 volunteers gather before the steps of the atrium. The conversation centers around past summons, and explorations of the Unknown Lands. As many as a dozen parties are sent out each year. Two of last year's groups are still gone. Two months ago, however, a team returned laden with artifacts, after being gone for three years.

A professor, wearing his robes of office, emerges from the building. He is followed at a respectful distance by two teaching assistants. They are carrying a large box with two slots in its top. A chit with your name on it was placed in this box on the day you reached legal age. The professor speaks:

"Greetings to you in the name of the community and the college. In this first summons of the new season, we seek scouts, to find the truth behind rumors of a great store of artifacts to the west. Though the task seems light, the danger may be great. I shall first draw a volunteer to guide the party, then choose the rest from the ranks of the unchosen."

There are two slots in the top of the box; the professor reaches into one and draws a chit. "The volunteer is Rath Travenix!" At this announcement, Travenix steps forth. His skin is a dark red; he stands two and one-half meters tall and sports a crest of bright green hair. The irises of his eyes are white and seem to reflect light. Travenix is not quite a seasoned adventurer, but he is well known and is just short of reaching second rank.

### GM

The professor reaches into the other slot, and pulls out a chit. It bears the name of one of the PCs. Similarly, more chits are drawn, each with a PC's name, until all of the PCs have been called.

### Players

"You are now members of the chosen," says the professor. "The dean requests your presence." He beckons to you to enter the building. As you climb the steps, Travenix joins your group and mutters, "Keep in mind who's in charge here."

You have never entered the atrium before today. The interior is not imposing—low ceilings, plain walls—but after climbing several flights of stairs, things look more impressive. On the top floor, you are taken into a room containing a heavy wood table with eight chairs. The professor asks you to sit, explaining that the

dean will be with you shortly. Travenix takes a chair at the end of the table and sits back, eyeing you and looking smug.

After a brief wait, the dean appears and takes the seat at the head of the table. A rather short PSH, he is dressed in the purple robe of state. After looking over each of you at the table, he speaks. "Thank you all for your service. Recently, we received word of a great store of artifacts across the Twainway. I want to send you on a scouting expedition to see if you can find it. You may borrow equipment from our stores. If you make any important discoveries, investigate them. A map has been prepared for you, but like many such things, it is not entirely reliable."

### GM

Tear out the wilderness map on p. 31 for easier use. The blank hexes are unexplored, unknown territory. The skull-and-crossbones symbols indicate the places where the two lost expeditions were last known to be. The features shown in the unknown lands are marked on the basis of rumor, speculation, and pre-Destruction maps. The suspected hoard lies an unknown distance southwest of the ruins in hex S18. One possible location is marked in hex V15. Additional settlements on the northern part of the map can be used to expand play after the *Mind Masters* adventure is over.

The dean will try to answer questions for the PCs, but he does not have any information about the route or what to expect along the way. He will instruct the party to use normal caution. When the questions are over, the dean will leave.

A teaching assistant will come in and take the party to the equipment shed. They may select whatever equipment they want, up to 150 gold pieces in value, per person. Use the equipment tables in the GAMMA WORLD® rule book and your own judgment to decide what the PCs are able to get, with the following exceptions. They may not take energy weapons, vehicles or powered devices.

The PCs can be ferried across the Twainway at Waykroz, Gall, or Kroztoun for a fee of one gold piece apiece (two gold pieces for pack animals). While the PCs are enroute to their destination, check for encounters using the procedure and tables in the GAMMA WORLD® rules during each march turn.

While the PCs choose their equipment, Travenix, consults with other explorers and decides to follow the route marked on the wilderness map.

# WILDERNESS

Use the wilderness map while the PCs are in the wilderness.

As long as Travenix is leading, the party should follow the course outlined on the wilderness map. The planned encounters in this section are planned to take place along that route. If the PCs stray from this path, adjust the location of the encounters accordingly.

The PCs should not have any dangerous encounters while they are travelling between lac South and the Twainway. Travenix will lead them along the road from lac through Jonzbor, on to Gall, and across the river. West of the Twainway, Travenix will avoid towns, travelling due west in hex row "T" on the wilderness map.

Slowly guide the PCs towards Garderia, where most of *The Mind Masters* adventure takes place.

While in the Unknown Lands, roll on table 1, the Unknown Lands random encounter table, once each march turn (every four hours).

TABLE 1. UNKNOWN LANDS RANDOM ENCOUNTERS

Roll 1d20. Use the encounter with the number you roll. The GAMMA WORLD® rule book explains how to figure out how many creatures the PCs encounter and what kind of equipment the creatures might have.

## ROLL ENCOUNTER

1	Zarn
2	Badder
3	Sleeth
4	Bloodwasps (see p. 27)
5	Arn
6	Herp
7	Jaget
8	Centisteed
9	Nomads (roll on table 2)
10	Nomads (roll on table 2)
11	Nomads (roll on table 2)
12	Mimic Plants (see p. 28)
13	Rakoxen
14	Brutorz
15	Hoop
16	Hawkoid
17	Hopper
18	No Encounter
19	No Encounter
20	No Encounter

TABLE 2. NOMAD TRIBES AND REACTIONS

Everytime the PCs encounter nomads, roll 1d10 to find which nomad tribe they meet. Roll again to find out what the tribe's first reaction to the PCs is.

ROLL	TRIBE	FRIENDLY	NEUTRAL	HOSTILE
1-2	Gatorbate	1-2	3-4	5-10
3-4	Hilbilz	1-3	4-8	9-10
5-6	Swamprz	1-2	3-5	6-10
7-8	Polkatz	1-3	4-10	
9-10	Okeez	1-3	4-7	8-10

When the PCs meet nomads, they will meet a scouting party of 1d6 + 5 nomads.

Friendly nomads will invite the PCs to have a meal with the whole nomad tribe.

Hostile nomads will attack the PCs. These nomads will take any PCs they capture back to the tribe. The nomads will take all of the equipment away from captured PCs. Captured PCs will be held in a guarded tent by the nomads. Every march turn there is a 25% chance that a different nomad tribe will attack the nomads that captured the PCs. This will give the captured PCs a good chance to escape. After 1d6 days, the nomads will release the PCs without their equipment.

The following encounters are numbered to match the hexes on the wilderness map in which they occur.

## Mimic Plants Encounter

Wilderness map hex T22

### Players

The air is cool, but not uncomfortable, and a light ground fog has begun to rise. This area is very quiet; only occasionally do you hear animals moving or making sounds. A very light breeze is blowing out of the east, pushing a few heavier wisps of fog through the underbrush. Gradually, a mist that is too light to be called rain and too heavy for fog begins to fall. At the bottom of a low rise, a grove of tall plants is growing around a small pond. The mist makes the grove hard to see, but there are slender and graceful forms dancing among the plants. The dancers appear to be PSH or PSH-type women.

### GM

The plants surrounding the pond are mimic plants (see p. 28 for details). There are 50 of them. Ten low mounds just outside the edge of the grove mark the locations of undeveloped roots. If any of the

PCs come within six meters of any plant, the plant will attack with its tentacle. No plant will attack two characters, and no character will be attacked by more than one plant each day.

If the PCs investigate the west side of the grove, use the following players' text.

### Players

From the western edge of the grove, you hear moaning. As you get closer, the moans become mixed with weak cries for help and deep growls.

A PSH woman is sitting on a low mound in the middle of a clump of tall grass. A large grey animal lies at her feet — a podog! It is watching you carefully, but making no aggressive moves. The woman is very sick. Green patches cover her arms, face, and legs. The podog growls and she looks up, seeing you. She reaches down and pats the Podog on the head, saying, "Easy, boy. Wait." Looking straight at you, she speaks.

"Can you help me? I was in a scouting party. We were all attacked by the plants. There were seven of us, and only six cur-in doses. We drew lots. Ralth, my man, lost, and I chose to stay with him. His skin turned green and he become very sick, like I am now. After four days he died. If the plants got you, the same thing will happen to you. Just after I burried him, I was attacked again. That's why I'm sick now. Can you help me?"

### GM

The woman's Podog is tame, and will not attack unless a threatening move is made against it or the woman. If the Podog attacks, there is a 40% chance that 1d4+1 wild Podogs will hear the noise of the battle and join the attack.

The PCs can use Travenix's medi-kit to try to cure anyone who was hurt by the plants.

The woman will accept food and other assistance from the PCs if it is offered, but she will not travel with them. If the PCs help her, she will thank them for their help and tell them that she will try to find her own people. She will also give the PCs a bag containing a dozen domars and five gold pieces.

### Genetic Knight Encounter

Wilderness map hex T20

#### Players

This is a region of low hills. Sparse shrubbery breaks the monotony of the endless grass. Thirty-five meters ahead, there is something that looks like a ditch running from northeast to southwest. As you get closer to it, you hear strange noises. The sounds are hoarse cries mixed with sobbing and panting. It is obvious that whoever is making the noise is in pain and a state of panic.

#### GM

If the PCs move closer, use the following players' text.

#### Players

When you are 20 meters away, a man rises from the ditch. He is dressed in a crude loincloth and tunic made from tattered pale blue rags. A bright red square of cloth is on his chest. He stands, swaying, with a fearful expression. He has nothing but his clothes.

#### GM

This man is a member of the Knights of Genetic Purity, a cryptic alliance. He was in a party that was captured and taken into Garderia. He escaped several days ago. The red square is the symbol of the Knights of Genetic Purity. There is a 50% chance that he will run toward the PCs, otherwise he will flee. In either case, he will collapse after running only five meters. When the PCs get within a few meters of him, he will curl up and avoid physical contact. Visible mutations among the PCs will upset him further.

#### Players

The man is curled up on the ground. His outcries have become pained whimpers, mixed with hysterical giggles. He begins babbling, sometimes shouting wildly, about "men in metal," "the tall towers," "the room," "the hunt," and "the master of all the minds." He is covered with scratches and small wounds. His clothes are made from torn scraps of other garments. His tunic collar has a small piece of metal bearing the letter "A" on it. The rest of the emblem has broken off. He begins clawing away and then passes out.

#### GM

This man is in a deep coma, and close to death. If the PCs look closely, they will see a wire coming out of a small wound a few centimeters below the man's left armpit.

### Hilbilz Encounter

Wilderness map hex T19

#### Players

The land in this area is flat and covered with tall grass. Only a few small hills rise above the plain. Travenix calls the party to a halt and instructs you to wait while he scouts to the northeast where another party was last known to be. He says he will return in a couple of hours.

About an hour after he leaves, riders can be heard approaching from the south. From cover, you see six riders; two are on Brutorz and the others ride smaller horse-type animals. The riders are male, PSH or humanoid, and wear straw hats. The riders stop, and the two Brutorz scan the area, finally turning to face you. You hear shouts, and the group approaches you cautiously. They stop 10 meters away, and shout, "Hey, you there! Be you Revnurz?"

#### GM

These riders are a scouting party of Hilbilz, searching for their ancestral enemies, the Revnurz. Hilbilz are a simple folk, usually peaceful unless attacked. The scouts will stop to pass some time with the PCs if the PCs say that they are not Revnurz. Male Hilbilz carry on their belts earthenware jugs filled with liquor brewed from prairie grass. They will pass these jugs around with the PCs while they trade news of their travels.

The Hilbilz came north after clashing with a Gatorbate war party, and they plan to keep going as far as the Jeferzun Trail. See p. 3 for more information about the Hilbilz. If the PCs are friendly with these Hilbilz, one of the Hilbilz will tell them:

#### Players

One of our own scouting parties to the west found an old city or something. It was all lit up and full of towers and machines and things like that. It's about one day's ride west and a little south of here.

#### GM

The Hilbilz will ask the PCs if there are any dangerous areas to the north. Before leaving, the Hilbilz will invite the PCs to join them for a meal. "You like to split some vittles with us folks? We're about ready for some eats now."

If the PCs turn them down, the Hilbilz will say, "Suit yourself. Sure you ain't Revnurz?" before riding off. If the PCs decide to join them, the Hilbilz will build a fire and cook some stew. After the meal, the Hilbilz will leave.

Half an hour after the Hilbilz ride off, Travenix will return with news that one of the lost expeditions left a cache of supplies several kilometers from here. That place, where they were last known to be, is marked on the wilderness map by a skull and crossbones symbol. There is evidence the group planned to return to the cache, and that they went northeast from that site.

After hearing about the city to the southwest that the Hilbilz talked about, Travenix will decide to travel west for several march turns. At hex T14 he will turn southwest, leading the PCs straight for hex W12.

### Don't Bug Me

Wilderness map hex V13

#### Players

You are following a river that is about 10 meters wide. It is flowing to the southwest. From time to time you have seen Bar Neps (Deathfish) in the water. The banks are lined with Ber Leps (Sweetpads). The riverbed becomes a steep-sided valley as hills rise to the south and west. After you cross a stream that flows into the river from a break in the hills to the south, the hills become steep enough to be called cliffs. Travenix signals you to halt as he gets his pistol ready. Fifty meters ahead, a deer grazes at a small shrub near another stream that flows from a ravine. Travenix signals you to stay quiet, whispering "we can use the food."

As Travenix moves in for a good shot, he jerks, then stiffens. After a few seconds he topples to the ground.

#### GM

Travenix is dead; he was attacked by a bloodwasp. His poison susceptibility killed him. If the PCs investigate, they will find the crushed remains of a bloodwasp under Travenix's body. 1d4+4 action turns after the attack, 1d10 more wasps will close in on the body. If the PCs look around, they will see a large swarm of bloodwasps in the air to the west, and another swarm across the stream, approaching from the northeast. The only clear ground is the ravine to the south, along the stream.

Twenty meters up the ravine, a cable crosses the top of the ravine walls from

# INTRODUCTION

This module is a complete adventure for beginning to intermediate player characters (PCs). It is best suited for a group of three to six players. This module includes complete background information, encounter area descriptions, and maps for a Game Master (GM) to run a complete GAMMA WORLD® adventure.

**STOP!** If you are going to run a player character in this module, do not read any further. The information in the rest of this module is for the Game Master to use in guiding the adventure.

Read carefully through this whole module before playing it. You should be very familiar with the encounters and options in this module.

*The Mind Masters* was designed for use with the revised edition of the GAMMA WORLD® rules. However, you can play *The Mind Masters* with any GAMMA WORLD® rules. The revised rules differ from the previous editions in some ways. For example, under the new rules, pure strain human (PSH) characters have a maximum attribute score of 21 for intelligence, charisma, and constitution. Time is divided into march turns, search turns, and action turns, representing respectively 4 hours, 10 minutes, and 10 seconds of game time. If you are not using the revised GAMMA WORLD® rules, use your best judgment if you encounter a rules difference.

Two types of information are presented in this module: sections marked **GM** are for

you, the game master, to use in determining the outcome of play; text following **Players** should be read directly to the players. Be careful when giving players information from text not marked **Players**.

The wilderness map on p. 31 shows the general area surrounding the PCs' community. Each large hex is 44 kilometers across and matches a hex on the continent map from the GAMMA WORLD® game. The smaller hexes are five and one-half kilometers across. The hexes on the left edge of the map are lettered. Map locations are identified by a letter and a number. The letter marks the row that the location is on. The number tells how many small hexes across the row it is to the location. Count each lettered hex as the first hex across in its row. For example, the community of lac South is in O29. The Jeferzun Trail leaves the map in G1, and Metropoliz is in U37.

In this adventure, the PCs are sent on a mission and are diverted along the way. They are captured and placed in a type of psychiatric therapy center run by a huge medical computer. The computer's programming has ignored all information from outside the center since the Devastation. As a result, if the computer gets any information about the outside world from the PCs, it will take that information as further proof that the PCs' minds are not quite right.

Have the players gather their character information. If they are using the pregenerated characters on p. 32 of this module, they will need to complete some of these characters by rolling mutations. Try to balance the party by making sure there is at least one character of each type (PSH, humanoid, mutant). Tell the players not to worry about equipment, since a chance to outfit the party will come later. Read the following background text aloud to the players.

## General Background lac South

You live in the community of lac South, which has grown up around what was once the campus of an agricultural college. It is near the east bank of the Twainway, the great river that divides the continent. lac South is a mixed community of PSH (40%), Humanoids (42%), and other types (18%). The population is about 1100, and all beings are regarded equally.

There are scholars who live and work at the college. They study the old knowledge and use it to give the people of the community a better, more prosperous existence. The people of lac South are grateful for this, and accept the dean of the college as their leader. The settlement is Tech Level III. Most of the machinery is in the custody of the college. Mechanical weapons are in good supply, and some farm vehicles powered by internal combustion are available to the community. Items of post-20th century technology are relatively uncommon. At first glance, the town may appear to be an advanced Tech Level II base.

The Collegians, as the scholars are known, are not affiliated with any declared cryptic alliance. However, they are in sympathy with both the Brotherhood of Thought and the Restorationists. The Collegians are opposed to the policies of any alliance whose purpose includes the destruction of life or technology. The Collegians look down on groups such as the Programmers and the Archivists who worship the old technology rather than use it.

On a number of occasions, the college has been attacked by anti-tech bands, and the people of the community have risen to defend the campus. In addition, they undertake other duties for the Collegians, as workers, messengers, and ex-

east to west. This may be noticed by observant characters, but there is nothing there to keep the PCs from crossing that point. The cable is part of a sensor system that changes to a force field when man-sized or larger animals cross it. After crossing it, the PCs cannot go back through it. The water from the stream will begin to form a pool at the edge of the force field. The force field also works underground, so the PCs can't tunnel under it. If the PCs follow the stream up the ravine to the south, use the following players' text.

#### Players

The bottom of the ravine slopes upwards, rising to the same level as the tops of the cliffs near the river. Behind you, you can see the swarm of insects slowly closing in on you. After going 35 meters up the ravine, you come to a pipe, 25 centimeters in diameter. This pipe is the source of the stream. The insects halted their advance some 15 meters behind you. The stream is forming a pool just in front of the swarm. There is a thin cable, strung from east to west across the top of the gully.

#### GM

Continue with the next encounter.

#### Captured

Wilderness map hex W12

#### GM

When the PCs enter hex W12 on the wilderness map, use this encounter.

#### Players

From the top of the ravine, you see a bowl-shaped valley in front of you. There is a huge group of buildings in the center of the valley. Six large domes surround a seventh. Eighteen tall towers rise from the domes.

A company of about 20 humans, dressed in black outfits, is approaching from the direction of the domes. They are about 50 meters away, and carry what could be rifles.

#### GM

The humans are actually a squad of model SS17A security SteelSkins (see p. 27 for details). They are armed with stun rifles. They will spread out to surround the PCs while opening fire on them. The SteelSkins will continue to advance and fire, no matter what the PCs do, until all of the PCs are stunned. The PCs will be taken into the domed complex, known as Garderia. They will awaken two days later in tower 1, room 1.

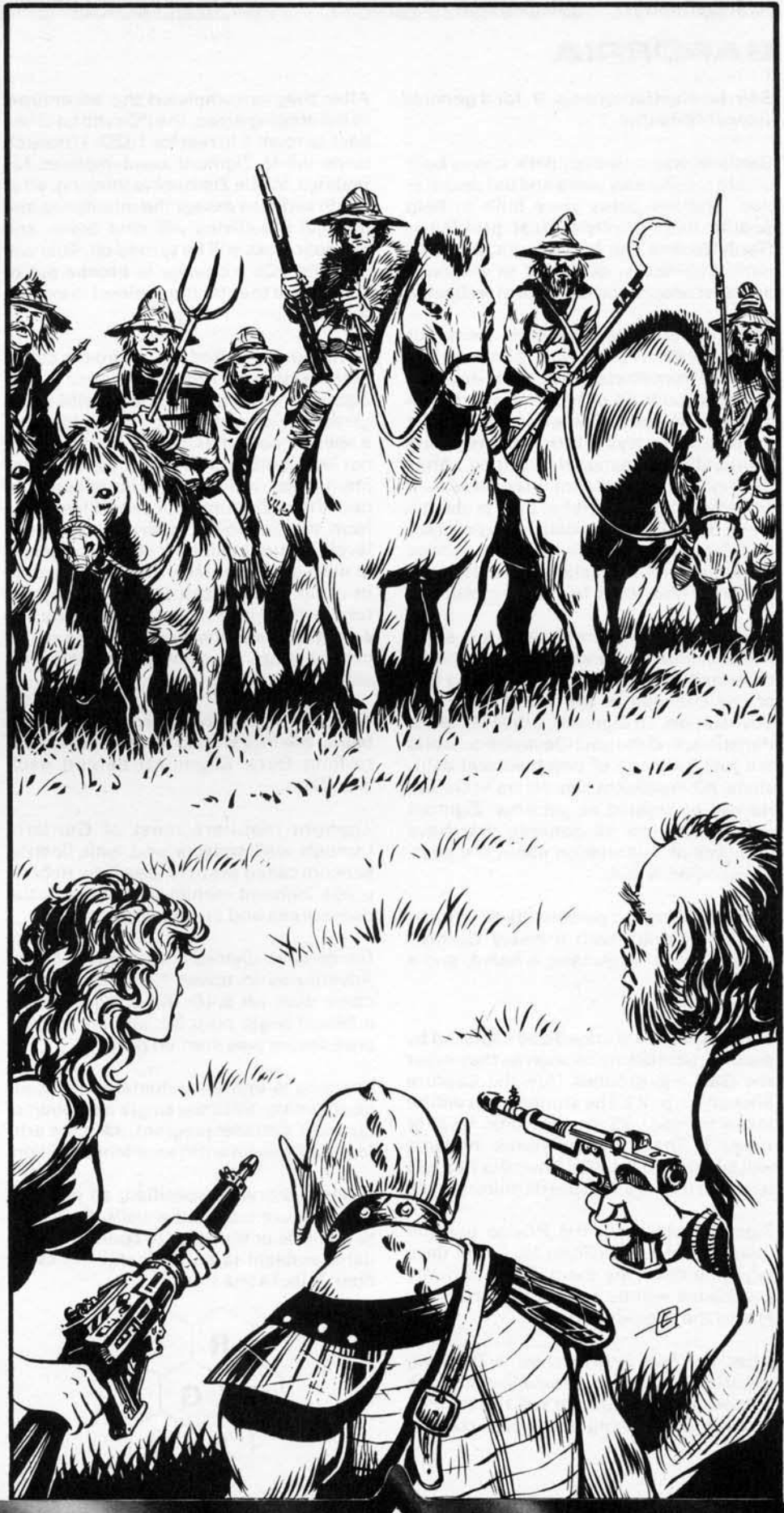



# GARDERIA

See the illustration on p. 9 for a general view of Garderia.

Garderia was a therapy park. It was built before the shadow years and the devastation. Therapy parks were built to help people with psychological problems. Garderia was run by Zigmunt, a cybernetic installation designed to diagnose and treat people's psychological problems.

Most of Garderia's patients were not seriously disturbed. Most of them just suffered from stress, frustration, and tension that built up over the years. When patients arrived at Garderia, they usually spent several days relaxing and enjoying Garderia's recreational facilities. After this rest period, Zigmunt interviewed the patients to figure out what their problems were. Then Zigmunt designed a program of adventures for the patients. These adventures let the patients live through, and overcome, their fears and problems.

Zigmunt still runs Garderia as a therapy park, but after the Devastation, he became deranged. Zigmunt does not believe any of the changes in the world since the Devastation. To Zigmunt, thoughts about mutations and the post-Devastation world are just evidence of psychological delusions. All intelligent characters in Garderia will be treated as patients. Zigmunt will try to cure all patients that have thoughts or information about the post-Devastation world.

Think of Zigmunt's personality as that of a typical "shrink" with a heavy German accent, wire-rim glasses, a beard, and a note pad.

The PCs will be stunned and captured by security SteelSkins as soon as they enter the Garderia grounds (see the Capture encounter, p. 7). The stunned PCs will be taken to room 23 on the clinic level of tower 1. There, control nexus implants will be put into the PCs. Then the PCs will be taken to room 1 on the dormitory level.

Zigmunt will allow the PCs to use the tower and dome facilities for 1d4+1 days while he observes them. Then, security SteelSkins will be sent out to bring the PCs to the examinerium.

After the PCs interview with Zigmunt, security SteelSkins will take the PCs back to room 1. Then Zigmunt will run the PCs through the staging scenarios, starting on p.15.

After they've completed the adventures in the staging areas, the PCs will be taken back to room 1 to rest for 1d20+10 search turns while Zigmunt contemplates his findings. While Zigmunt is thinking, all of the SteelSkins except the maintenance and medical SteelSkins will shut down, and the door locks will be turned off. This will give the PCs a chance to escape out of Garderia or to enter the sublevel to explore further.

Garderia is staffed by androids called SteelSkins (see New Creatures, p.27). Zigmunt controls all of the SteelSkins in Garderia. Zigmunt assigns each SteelSkin a specific part of Garderia. Zigmunt does not let SteelSkins go out of their assignment areas. If the SteelSkins in one area need help, Zigmunt will send SteelSkins from the SteelSkin reserve in the sublevel. Zigmunt will turn off all the power to any part of Garderia that has lost all of its assigned SteelSkins. Zigmunt will not turn on the power in that area until he has enough SteelSkins from the reserve or cold storage to completely staff that assignment area.

Although each SteelSkin is a separate being, the PCs should feel the same controlling force (Zigmunt) behind each SteelSkin.

Zigmunt monitors most of Garderia through wall sensors and with floating sensors called eyeballs (see New Robots, p.29). Zigmunt monitors the towers, the dome areas and the staging areas.

Garderia is divided into several areas. Adventures in tower 1 and the central dome start on p.10. Adventures in the sublevel begin on p. 22, and the staging area adventures start on p.15.

Garderia is entirely automated and self-maintaining. With the single exception of Zigmunt's master program, all of the artifacts in Garderia are in excellent condition.

Unless otherwise specified, all doors in Garderia are set into the walls. They slide to one side or the other to open. The Garderia emblem is on the center of every door. It looks like this:



All doors have automatic scanners built into them. Each scanner reads the shape of things within one meter of its door. Door scanners will not recognize humanoids with physical mutations (like antlers, extra limbs, etc.), animals, or mutated animals.

Some doors are locked, and can be opened only with a security code. These codes are various arrangements of the letters that spell "Garderia." Doors that are not locked will open automatically for any humanoid without physical mutations. If a SteelSkin stands in front of a locked door, the scanner will look for the code letters under the left shoulder on the SteelSkin's uniform. If the SteelSkin's code matches the door's code, the door will open. All doors will always open for security SteelSkins.

Locked doors can also be opened by pushing the letters of the door's Garderia emblem in the right order (like dialing a touch-tone telephone). Each lettered hex in the emblem will light up briefly when it is touched. If the PCs fail three attempts to unlock a door, a security SteelSkin will arrive in 1d10 + 20 action turns. He will tell the PCs that they are trying to enter a restricted area and may not go in. If the PCs keep trying to get through the door, 2d4 more security SteelSkins will arrive to stun the PCs and take them to room 1.

There is an ID tag painted above the Garderia emblem on many doors. These tags identify the function of the room beyond the door. Doors leading to restricted areas have blank red tags.

The description of each room includes the room number, the room's function, the door tag, and the door's security code (if any). Each room has the same number in the text as on the maps.

Nonintelligent animals found wandering alone in Garderia will be taken by SteelSkins to the kennels in the sublevels. They will be fed and watered regularly. These animals will be kept there until they are claimed by someone. After 30 days, unclaimed animals will be put into cold storage (room 33a or 33b).

While the PCs are in tower 1, the central dome, and the sublevel, roll on the Garderia random encounter table (table 3) once each march turn (every four hours). There are no random encounters in the staging areas.

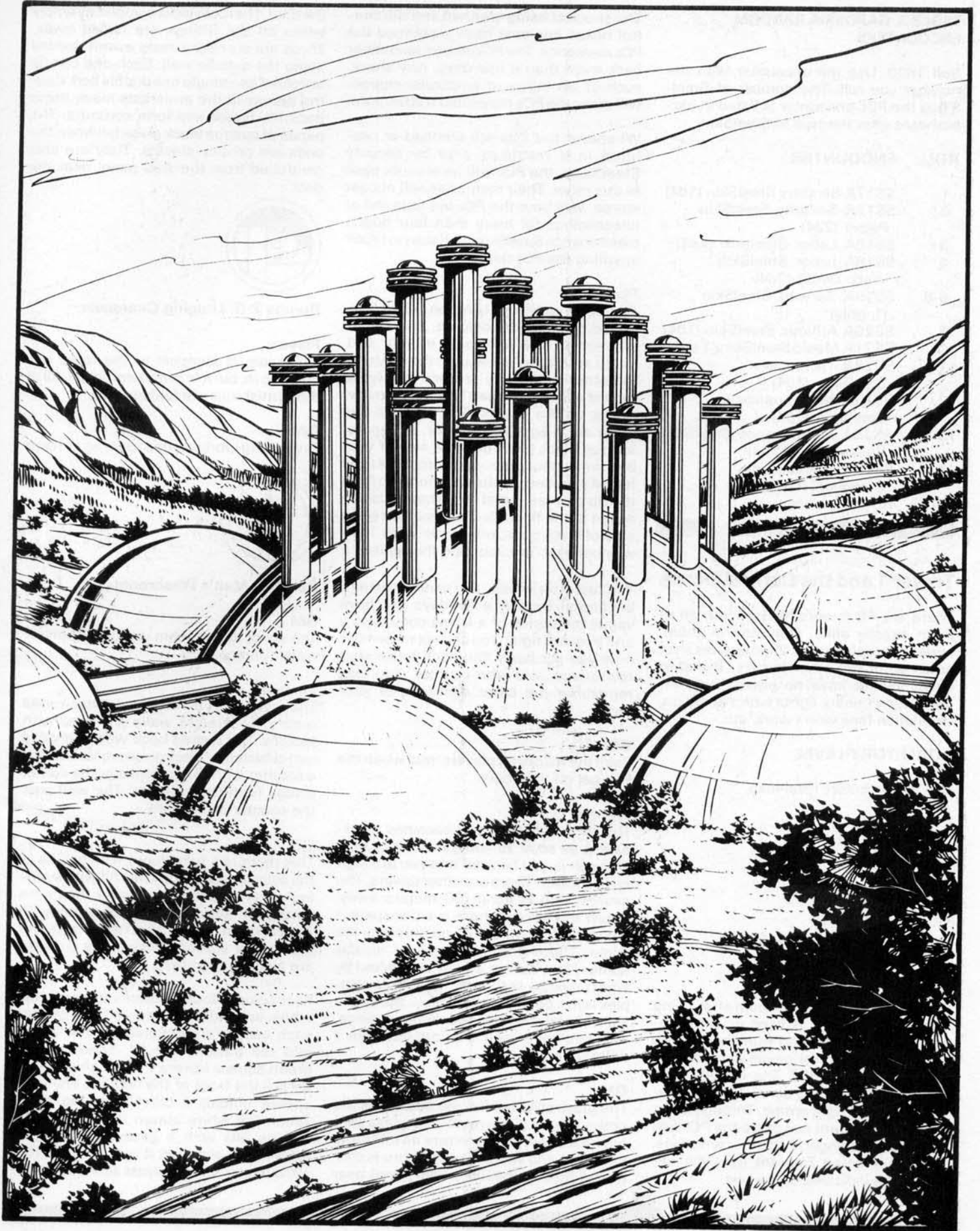

TABLE 3. GARDERIA RANDOM ENCOUNTERS

Roll 1d20. Use the encounter with the number you roll. The number of SteelSkins the PCs encounter is listed in parentheses after the type of SteelSkin.

**ROLL ENCOUNTER**

1	SS17A Security SteelSkin (1d4)
2	SS17A Security SteelSkin Patrol (2d4)
3	SS18A Labor SteelSkin (1d4)
4	SS18A Labor SteelSkin Work Detail (2d4)
5-8	SS19A Servant SteelSkin (1 only)
9	SS20A Athletic SteelSkin (1d4)
10	SS21A Medic SteelSkin (1 only)
11	SS22A Technician SteelSkin (1d4)
12	SS23A Maintenance SteelSkin (1d4)
13	SS23A Maintenance SteelSkin Repair Crew (2d4)
14	SS24A Agricultural SteelSkin (1d4)
15-20	No Encounter

**Tower 1 and the Central Dome**

There are 18 towers in Garderia, all of them exactly alike. Only one of them, tower 1, is being used. Zigmunt has shut down all of the other towers. The shut down towers have no power, so their doors won't open, lights won't come on, ventilation fans won't work, etc.

**DORMITORY LEVEL**

Use the dormitory level map.



**Room 1: Lodging Chamber**

**GM**

The PCs wake up in this room after being captured. Each PC is lying on a relaxa-rest. Each human and humanoid PC is fitted with a control nexus implant (see New Artifacts, P.30). The implants are disguised as healing sores 15 centimeters below the right armpit. Through these implants, Zigmunt can make the PCs feel fear, bravery, anger, and other emotions. The times when Zigmunt uses the implants are indicated in the text.

The shock of being stunned and the control nexus implants have weakened the PCs memories. The PCs cannot remember back more than a few days. Any shock, such as an injury or emotional charge, will make the PCs remember a little more.

Whenever the PCs are stunned or captured in a restricted area by security SteelSkins, the PCs will be brought back to this room. Their memories will not get worse. Any time the PCs are stunned or unconscious for more than four hours, maintenance SteelSkins will start to repair anything the PCs damaged.

**Players**

You each wake up, lying on a bed supported by a slender column. There is an armrest on the right side of your bed. There are circles marked on the center of the armrest. You are dressed in a white robe of a light material. There are no coverings on the pallets. The walls of this room are a light beige color. A pane of opaque black glass on each side of your bed limits your view of the room. At the foot of your bed, clothes are hanging from the tip of a tall metal rod. The rod is attached to the floor. Behind you, there is a strip of black glass, one meter wide, half-way between the floor and the ceiling.

You feel disoriented. You cannot remember back more than a few days. You have vague memories of a home community, and a recent fight. You cannot remember how you got here. You each know your own name, and who you are. You also remember the other members of your party.

**GM**

Read the following players' text when the PCs get off their beds.

**Players**

The strip of black glass becomes transparent as soon as you get off your bed. Through it, you can see that you are high up in a tower. There are other towers. The nearest one is about 50 meters away. Below the towers, there is a transparent dome. The towers run up through the dome. There are three or four similar domes. The domes are all connected by what could be corridors. The whole complex is in a bowl-shaped valley. The scene looks slightly familiar and slightly strange, as if you have seen it before but from a different angle.

**GM**

The glass strip behind the beds runs the entire length of the room. The glass cannot be broken. The furniture all folds into the floors and walls. The furniture is controlled by switches in a wall panel near

the door. The room looks completely empty when all the fittings are folded away. There are six relaxa-rests evenly spaced along the outside wall. Each one can be unfolded as a single or a double bed. Control panels in the armrests make these beds tilt, rotate and form contours. The panes of opaque black glass between the beds are privacy shields. They are also controlled from the wall panel near the door.



**Rooms 2-8: Lodging Chambers**

**Players**

This room is identical to the room you woke up in, but it is completely bare. All of the furnishings are folded away.

**GM**

Everything works in this room as in room 1.



**Room 9: Men's Washroom**

**GM**

The doors to this room will only open for male humanoids.

**Players**

The door opens to reveal a quarter-round room. The straight walls are lined with lockers. The curved back wall is divided into cubicles by black glass walls. There is a counter with three basins in the corner across from the cubicles. The wall over the counter is mirrored.

**GM**

This room is a washroom. The basins in the counter are sinks. They fill with swirling water sprayed from under their rims whenever someone stands directly in front of them. The lockers have hooks and shelves for storing clothes. The cubicles are bathing chambers.

Four colored touch-buttons (green, blue, white, and red) on the curved wall control each cubicle's mechanisms. The green and red buttons are lit. Touching the green square lowers a black glass panel across the front of the cubicle. The blue square unfolds a toilet from the floor. When the white button is touched, the cubicle fills with a gaseous foam that feels mildly abrasive; it is a cleanser. The red button stops and resets all the controls.



### Room 10: Women's Washroom

#### GM

The doors to this room will only open for female humanoids. Otherwise, this room is identical to room 9. Use the players' text from room 9 to describe this room.



### Room 11: Dining Room

#### Players

When the door slides open you see a curved room filled with tables and chairs. There is a door in the back wall.

#### GM

This is a dining room. If any of the characters sit down, the table top in front of them will light up and show pictures of various foods. There is a label and a white circle under each picture. If a circle is touched, the picture above it will blink. A few minutes later, a robotic unit will emerge from a slot in the inner wall. The robot will leave a place setting with the chosen food on the blinking picture. The plates and utensils are all disposable, and cannot be used as weapons. There are no visible openings in the slot in the wall. Any PC that touches the inside of the slot compartment will take 1d6 points of damage from electrical shock.

Behind the door in the back wall is a grav-shaft, a sort of elevator. This grav-shaft works like the tower grav-shaft (see p.11), except that this one only goes up. This grav-shaft comes up from the sublevel under the base of this tower. It goes up to the clinic level, two floors above this level.

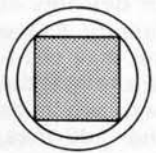

### Room 12: Service Area

Code: AERGIARD

#### GM

This is a service area. The door will only

open for robots or the proper code, "AEGIARD." This room is used to store clothes and robes for the patients, cleaning equipment, and other supplies. There is nothing in this room that can be used as a weapon. In the corner of the room, there is a grav-shaft going down. It starts on the clinic level and goes down to the sublevel. This grav-shaft works just like the tower grav-shaft below, except this one only goes down.

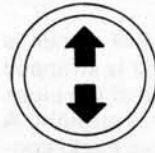

### Tower Grav-Shaft

#### Players

This is a round shaft with a glass wall that divides it into two halves. The shaft is open on all sides and extends up through the ceiling and the down through the floor. The east side of the glass partition has an illuminated red arrow pointing down on it. The west side has a similar green arrow, pointing up.

#### GM

Grav-shafts use the same anti-gravity energy that pods use. Anything that enters the shaft will move slowly in the direction of the arrow.

## RECREATIONAL LEVEL

Use the recreational level map.

### Central Hallway

#### Players

You are in a corridor two meters wide. Four corridors meet in the center of this level, where the tower grav-shaft is. Each corridor is 12 meters long, with a door at the outer end. Other doors lead out from the corridors' side walls. The last five meters of each corridor slope downwards.



### Room 13: Pool

#### Players

This room contains a large tank of water that is sunk into the floor. Numbers are painted along the edge of the tank. The floor on the northeast side of the tank is about a meter above the surface of the water. The floor on the north side of the

tank slopes up to the northeast platform.

#### GM

The tank is a swimming pool. The numbers along the mark the depth of the water in meters. The platform on the northeast side of the pool is an artificial sundeck. Stepping onto it will activate tanning lamps in the ceiling above it.



### Room 14: Lounge

#### Players

This is a softly lit, curved room. Along the outer wall there is a shelf a little more than one meter tall. Every meter or so there is a stool in front of this counter. Three boxes with small lights in them hang from tracks above the shelf. At the corner of the two straight walls is a raised platform. Small tables with chairs around them occupy the floor.

#### GM

This room is a cocktail lounge and cinema. The boxes over the bar area robotic serving units. They will serve drinks to characters at the bar. If anyone takes a seat at a table, read the following players' text.

#### Players

After a few moments, a female human enters through the north door. She is wearing a one-piece yellow suit and is carrying a tray. She comes over to your table and says, "May I take your orders?"

#### GM

This is a servant SteelSkin (model SS19A). She will tell the PCs that a variety of alcoholic and non-alcoholic beverages are available. She will recommend some drinks if the PCs do not have any preferences. If the PCs ask her where they are, she will tell them they are in the cocktail lounge on the recreation level. She will only tell the PCs about the lounge. Characters with telepathic mutations will sense that she is a waitress and wants to do her job. She is blocked from any tasks other than waitressing. The name "Zigmunt" can be sensed as force controlling her.

After taking the PCs orders, the waitress will say, "The film today is the 2205 Chinese remake of *Imperial Ballet*."

If the PCs order drinks, the waitress will bring them in a few minutes. The movie will start one half hour after the PCs enter the lounge.



## Room 15: Gymnasium

### Players

This is a large room, filled with metal machines, cushioned mats, metal bars, and various lumps of metal. The floor is polished wood. Several ropes hang from the ceiling, which is five meters overhead.

### GM

This is a gymnasium where Garderia guests can exercise. The ropes can be removed from the ceiling if the PCs have anything to cut with. The bars and weights from the barbell sets can be used as clubs and levers.

There is an electronic muscle-toning device in the northwest corner of the gym. It looks like a bed with a lid over it. The lid is open. If a PSH or humanoid PC lies on it, the lid will slide over the bed and automatic clamps will hold the character in place. The lid has a window in it. Anyone watching will see that the character inside is in pain. The machine will tone the character's muscles for 1d20+10 minutes. Then the character will be released. Despite some lingering soreness, the character that was in the machine will feel stronger. That character will permanently gain one point of physical strength and constitution unless those attributes are already as high as they can be.

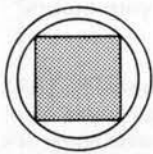

## Room 15a: Serviceroom

Code: AERGIARD

### GM

This is the entrance to the grav-shaft that runs through the back of the dining room (room 11) on the dormitory level.



## Room 16: Powerball Court

### Players

The door slides open, and you hear strange

sounds. A hum, followed by a high-pitched whine and a couple sharp impacts is repeated over and over. The door leads into a narrow corridor. One wall of the corridor is made of glass. There is a room on the other side of the glass wall. The floor of that room is three meters below the floor of this corridor. That room is quite large. A wall that doesn't quite reach the ceiling divides that room into two parts. The dividing wall starts at the back of the room and stops several meters from the other end of the room.

A man wearing some kind of armor is standing in that room. A pipe is strapped to each of his forearms. One of the pipes is funnel shaped, the other is straight. A flexible tube runs behind his back, connecting the two pipes. There is a power pack strapped to his hips. Several wires lead from the pack to the tube.

You hear impacts once again, and a fist-sized black ball flies out from behind the dividing wall! It bounces off the walls and shoots straight at the armored man. He catches the ball with the funnel shaped pipe on his right arm. Once again, you hear a high-pitched whine. Suddenly the ball shoots out of the straight pipe on his left arm, bounces off the end walls, disappearing into the other part of the room. Another hum and whine and the ball flies back from the other room. It seems that there is another person on the other side of the dividing wall with similar equipment.

### GM

The corridor is a place for people to watch powerball games. The room with the dividing wall is a powerball court. The glass wall in the corridor will not break.

The man in armor is an athletic SteelSkin (model SS20A). He and another athletic SteelSkin are playing a powerball game. The flexible tube is a gravatic accelerator (see New Artifacts, p.30). Anything that enters the funnel shaped pipe will be shot out of the straight pipe. Points are scored whenever a player fails to return a ball.

### Players

After several exchanges, a door near the end of this corridor opens, and a man wearing a polyester leisure suit walks out. He says, "Well, it's about time you showed up!. We've been waiting quite a while!"

### GM

The man in the leisure suit is the activities director, another athletic SteelSkin. PCs who are observing carefully will notice his metal skin if they pass an ability check of 3×IN.

Randomly choose one of the PCs. The activities director wants that character to play a game of powerball. The activities director will grip the chosen PC by the arm and urge him towards the back of the corridor. Characters with telepathic mutations can sense that the director only wants the chosen PC to play a game of powerball. The presence of Zigmunt will also be felt. Zigmunt will use the control nexus implant in the chosen PC to make that character want to play powerball.

The director will take the PC into one of the dressing rooms and help character put on the powerball armor and accelerator. The director will ask if the PC is right handed or left handed. The director will strap the funnel pipe to the character's better arm.

### Players

The man takes you into a dressing room and attaches several pieces of plastic body armor to you. He then straps a funnel pipe and a straight pipe to your arms. He connects the pipes together with a flexible tube and plugs it into a power pack on your hip. When he finishes, you are wearing the same equipment as the man you'd seen through the glass wall. The director gives you instructions.

"You catch the ball with the funnel, and send it back through the other end. If you miss the ball, that's a point for the other player." He points your arm with the straight pipe at the wall and places a black ball on the floor. He says, "Put the funnel over the ball." As the funnel covers the ball, you feel a surge of power through the tube at your back. There is a brief hum, a whine, and the ball shoots out the other pipe and strikes the wall. The director says, "I'll just slow that down a bit," and adjusts a control on the power pack. He directs you to a round hole in the floor. He steps into the hole and slowly floats down to the level of the playing area. He steps through a door after he reaches the floor and motions you to follow, "Come on, now!"

### GM

As beginning players, the PCs have a percent chance equal to their dexterity of catching the ball on their first try. As the PCs get the feel of the game, their chances will get better. After 1d8 attempts the PCs have a percent chance of two times their dexterity. After another 1d8 tries, PCs have a percent chance equal to three times their dexterity.

Whenever a PC misses the ball, there is a 15% chance that the ball will hit that PC. If a PC is hit, that PC must make an uncon-

ciousness check at 5×CN. One game lasts until the score is 11-0 or until one player gets 21 points.

When the game is over, the director will help the PC remove the equipment. There are two sets of playing gear in each dressing room. The PCs will be able to return later to pick up the accelerators to use as weapons. The accelerators will shoot any object less than 10 centimeters in diameter, doing 2d6 points of damage per 250 grams of the object's weight.



### Jogging Track

#### Players

This is a long, curved corridor. The floor slants up slightly toward the outer edge of the corridor. The floor also feels just a little springy.

#### GM

This is a jogging track that goes around this level. The slanting floor makes running on a curve easier. The floor is slightly springy to give joggers good traction and to protect their feet.

## CLINIC LEVEL

Use the clinic level map.



### Room 17: Music Therapy Room

#### Players

The door opens into a dimly lit room. Four large, egg-shaped structures supported on tripods are arranged around a pedestal in the center of the room. The sides of the eggs facing the center are open. They are hollow inside and appear to be lined with fabric of some kind. There is bulky equipment arranged on shelves on the side walls. A pleasant-sounding hum comes from an object on the pedestal.

#### GM

This room is filled with various types of electronic musical instruments. The large, egg-shaped objects are listening chairs. Characters who sit in these chairs cannot

hear anything in the room except the sounds made by the instruments. The chairs have built-in speakers hooked up to the instruments. The object on the pedestal is a 25 centimeter cube with antennae at the four upper corners. This is a theremin, an instrument that is played by moving one's hands in the area between the antennae. When at rest, it emits a harmonious hum which will vary slightly as characters move around the room.

The various instruments other than the theremin are Complexity F (Use artifact chart A in the unrevised GAMMA WORLD® edition). A damage result means the character trying to figure out the instrument produces a noise that deafens everyone in the room for 1d4 search turns unless they pass a check of 3×CN.



### Room 18: Occupational Therapy Room

#### Players

This room is filled with worktables with a variety of tools and supplies. A large, complicated frame stands in the far right corner. There are several bulky pieces of equipment in the room.

#### GM

This room is a workshop for therapeutic crafts and hobbies. There are a number of tools and other items which the PCs can use or make weapons of. The complicated frame in the corner is a loom. Fibers from it can be used to make cords and rope. Modelling knives and some of the sculpting tools can be used as weapons. Use the following list as a guideline of what is in the room.

Item	Quantity
Modeling knives	4 with 1d10 spare blades
Weaving cord	40 spools, each with 3d20 meters of cord
Woodcarving tools	1d8 with 2d12 spare blades
Portable power cutting tool	1 with 1d10 spare blades
Portable laser woodcutter.	1

The power cutting tools can cut through the door locks in one search turn. Cutting a door lock with the portable power cutting tool will ruin one blade.



### Room 19: Physical Therapy Room

#### Players

The door opens, and when the ceiling lights come on you see a room filled with gleaming metal frames. The frames have straps and cuffs on them that appear to be designed to hold a human body in place. This room makes you think of nothing less than a torture chamber. One device, halfway along the left hand wall, looks like a box built for a seated human. The front panel is on hinges, and the box is open and empty.

#### GM

The frames are exercise machines for treating people with physical injuries such as sprains, pulled muscles and broken bones. The frames have electronic devices that monitor the rate of healing. The box is a healing accelerator and muscle toner. If a character sits in it, the front panel will close automatically. Lights on the front panel will come on. After 1d4 + 1 search turns, plus one search turn for each hit point the PC in the box has lost, the front panel will swing open. All lost hit points will be restored whenever this device is used. Also, the first time a PC uses this machine, that PC's physical strength and constitution will go up one point (unless those attributes are already at their highest).



### Room 20: Hydrotherapy

#### Players

When the door to this room opens, you smell water. The air inside is damp and fresh. There are several large tanks, with sides one and one-half meters high, filled with swirling water. There are eight lighted touch-buttons on the side of each tank. Each tank is equipped with submerged seats.

#### GM

These are whirlpool baths. The touch-buttons on each tub are numbered and explained on the next page.

1. This button increases the water circulation speed by a small amount each time it is touched.

2. This button decreases the water circulation speed a little bit each time it is touched.

3. This button raises the water temperature two degrees each time it is touched. The water cannot get hot enough to hurt pure strain humans.

4. This button lowers the water temperature two degrees everytime it is touched. The water cannot get cold enough to hurt pure strain humans.

5-8. The last four buttons release medicinal solutions into the water. These solutions are not poisonous.

area. This room is filled with medical equipment run by surgical androids and robots.

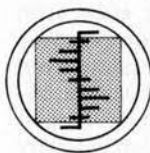

**Room 24: Access Stairway**  
Code: EADIGARR  
GM

This is a spiral staircase leading to the next level up, the Examinorium. The door at the top is unmarked, and leads to room 25.

**EXAMINATION LEVEL**

Use the examination level map.

**Room 25: Examinorium**

**GM**

This is Zigmunt's examining room. Zigmunt designed it to have a calming effect on his patients. Zigmunt will reinforce this effect by sending soothing impulses through the PCs' control nexus implants.

If the PCs do not discover this room on their own, they will be brought here by a SteelSkin escort 1d4 + 1 days after they arrive at Garderia. The escort will consist of one security SteelSkin for each PC and one medic SteelSkin who is in charge of the escort.

**Players**

The door opens, revealing a dimly lit room. The ceiling is a shallow dome. The floor is shaped with depressions that appear to serve as reclining chairs. There are no windows.

This room has a soothing atmosphere. You feel calm; there is no danger here. You feel that in this room you will find the reason you are in this place. A pleasant-sounding man's voice, with an unusual accent says to each of you, "Come in and be lying down, please." You can't tell where the voice is coming from. It seems to each one of you that the man is talking to you alone. You feel that if you left this room you would be in danger.

**GM**

The PCs should be encouraged to lie in one of the contours in the floor. Zigmunt does not have any optical sensors in this room. Zigmunt thinks that all the PCs are pure strain humans with psychological problems.

Zigmunt will question the PCs individually. He will question them about their prob-

lems, their fears, and their backgrounds.

Interview the PCs with questions about their childhood, their adventures on the way to Garderia, and so forth. Remember that Zigmunt does not believe that mutations and mutants exist. In this room, Zigmunt communicates through electrical impulses direct to the PCs' brains.

This is a great opportunity to have fun making up odd questions for the players. Here are some sample questions to use.

"So what is making you thinking your mother had antlers?"

"Your skin, you are saying, is green?"

"Well, did you ever have a bad experience with plants?"

"Do you also dream about these mutations people?"

"For how long have you believed in your special powers?"

"Mutations, mutations! Maybe you watch too many monster movies!"

**CENTRAL DOME**

Use the central dome map. The central dome is on ground level.

**Room 26: Tower 1 Base**

Use the central dome map.

**GM**

The PCs can get to the central dome by taking the tower shaft down from any level of the tower, except the examinorium. The tower shaft ends here, the base of the tower. Each tower has a similar base, but only tower 1 is being used. There is no power in the other towers. Use the following players' text when the PCs take the tower shaft down past the dormitory level.

**Players**

After sinking slowly for over a hundred meters, you come to rest on a solid floor. Ahead of you is 10 meters of illuminated tunnel. The tunnel opens into a wide, brightly lit area.

After leaving the tunnel, you can see several other towers Like the one you were in. All of the towers rise up through a transparent dome, 50 meters above you. There are pathways and landscaped gardens between the towers. The tower disks that hold the various rooms tower rooms are far above the dome in the open air. There is a wall about 50 meters away.

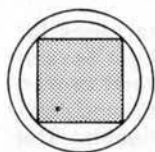

**Room 21: Service Area**  
Code: AERGIARD  
GM

This room is a landing stage for the grav-shaft that comes up from the sublevel, through the dorm level and the recreation level.

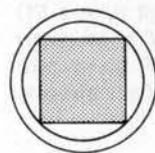

**Room 22: Access Corridor**  
Code: GRIADAER  
GM

This is a short corridor. If the PCs get into this corridor, Zigmunt will sound a security alert. Five security SteelSkins will come up the tower grav-shaft. Zigmunt will reverse the direction of the grav-shaft in room 23 and five more security SteelSkins will come up from there. All of the security SteelSkins will be armed with stun pistols and will shoot the PCs on sight. The stunned characters will be carried back to room 1.

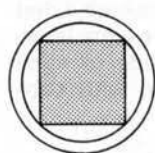

**Room 23: Operating Theater**

**GM**

The PCs should not be able to get into this

It is 30 meters high, and the dome is anchored to its top. There are a number of floating globes about 20 meters overhead.

#### GM

The walls are made of duralloy, and there is a roof over them. The floating globes are eyeballs (see *New Robots*, p. 29).

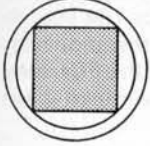

#### Transport Corridor Doors

Code: ERDARIGA

#### GM

At six places marked on the central dome map there are locked doors. These doors lead into the transport corridors to the staging area.

#### Players

The door is larger than the ones you have already seen. It is about five meters high and three meters wide. As you approach the door, you hear footsteps behind you. It sounds as if several people are coming, but they are not yet in sight.

#### GM

The sound is being made by a patrol of six security SteelSkins. There is enough shrubbery in the garden areas for the PCs to take cover. The SteelSkins will ignore the PCs unless the PCs block the path to the door. If they do, the lead SteelSkin will ask them to stand aside. If they do not move, he will order them to clear the path. If they still don't move, the patrol will draw their stun pistols and open fire on the PCs. If the PCs do not interfere with the SteelSkins, use the following players' text.

#### Players

The six characters walk towards the door without slowing down. The letters in the hexagons on the door each light briefly, and the door opens. As soon as the last figure walks through, the door closes.

#### GM

Make an attribute check on IN for each PC. Use 3×IN for any PCs that did not take cover. PCs who pass the check will notice that the insignia the SteelSkins wore had the letters E-R-D-A-R-I-G-A, and that the letters on the door seemed to light up in the same order. Touching the door letters in that order will open the door. The characters can then enter one of the transport corridors (rooms 27 - 32).

#### Rooms 27-32: Transport Corridors

#### GM

Six corridors connect the central dome to

the six staging areas. These corridors are all the same. Two transport belts, like flat escalators, run down the middle of each corridor. One belt moves toward the central dome, the other moves away from it. Any character can use the belts. To change from one belt to the other, characters must make an attribute check at 5×DX.

#### Players

This is a wide corridor that stretches into the distance as far as you can see. There is a pair of moving belts 10 meters in front of the doors, one going away from you, the other coming towards you. There is a 10-meter-wide strip of floor to either side of the belts. The walls of this corridor are lined with banks of machinery. Human figures dressed in dark blue, silver, and red are moving about, tending the machines. They apparently are ignoring your presence. To the right, there is a narrow aisle between the dome wall and the machinery. You can make out a door at the end of it.

#### GM

If the PCs followed a security patrol, there will be no sign of the patrol. The machinery has a complexity rating of H (in unrevised rules, use chart C, p. 31). If attempting to operate the machinery results in breakage, the PCs will not be injured. However, 1d6+4 security SteelSkins will appear within 1d6+1 minutes to investigate. In such a case, the PCs will be removed from the transport corridor.

The door at the end of the narrow aisle leads to a two-way grav-shaft. That grav-shaft goes down to a serviceway that leads to the sublevel. The door code, "AGIRADRE," is the exact reverse of the code used to enter this area.

At the far end of each corridor there is a door that leads to a staging area filled with bare soil. These are the areas that will be used by Zigmunt in the staging scenerios section.

## Staging Scenerios

After interviewing the PCs in the examinatorium, Zigmunt will decide that their problem is their belief in mutants and the condition of the world after the Devastation. Zigmunt himself does not believe these things. Zigmunt does not know how to cure the PCs. To learn more about the PCs, he will test their reactions to some problems he is familiar with. Zigmunt's master program isn't quite right; that is why he will test the PCs by making them feel certain phobias (very strong fears) and observing their reactions.

Zigmunt will develop scenerios to run the PCs through after he interviews them in the examinatorium. These scenerios are staged (take place) in the domes that surround the central dome.

The scenerios should start while the PCs are sleeping naturally or while they are stunned. The PCs will have anything they had with them when they fell asleep or were stunned.

In the first five scenerios, the PCs will not be in any physical danger because they will not actually be in the staging domes. They will be on their relaxa-rests in room 1. Through Zigmunt, and the control nexus implants, the PCs will be directly linked to android or robot bodies that they believe are their own. The PCs will not know that they are controlling these other bodies. The PCs should think that they themselves are going through the scenerios. The surrogate bodies will be surgically or mechanically altered to look exactly like the PCs. Only visible physical mutations will be noticeable. The android and robot bodies will not have any powers from mutations. The android and robot bodies will not have any capabilities beyond the PCs' normal attributes. PCs do not take damage in the first five scenerios, even if they think they do.

This situation may confuse the players. When they start using android or robot bodies, tell them that everything in Garderia before then seems to have been a dream or delusion. When they are using the android or robot bodies, the PCs are, in effect, pure strain humans who think that they may have been something else at one time.

After going through the scenerios, the PCs will remember their adventures as very powerful dreams. The impact of the events that take place during these scenerios will remain, though. The PCs will remember enough to make them uneasy about facing similar dangers in the future. The PCs will permanently have the effects of the phobia mutation (see revised GAMMA WORLD® rules, p. 17).

In each scenario, the PCs begin in the center of the staging area. Since all the staging domes are identical, it is not necessary to know which dome is used for each scenario. Each scenario ends when the PCs make it to the edge of the staging area. When each scenerio ends, the lights will go out, and the PCs will wake up in their dormitory beds as their normal selves.



If a PC's android or robot body is killed in one of the first five scenerios, that PC will black out until the entire party wakes in room 1.

The sixth scenerio will be Zigmunt's attempt to cure the PCs. The PCs should go through that scenerio themselves, not with the android or robot bodies. The PCs must take any damage they get in the sixth scenerio.



## Hydrophobia Scenerio (Fear of Water)

Use the hydrophobia and acrophobia map.

### Players

It is dark. You feel as if your senses have been shut off and are returning one by one. You open your eyes and see nothing but tiny points of light far overhead. The lights are not stars; they are too large and are green. The air is damp and heavy with the smell of decaying vegetation and animal odors. These scents make you uneasy. You sense there is danger near.

Gradually you begin to hear sounds, sounds of a light breeze through grass, of frogs, and of insects. Very faintly, you also hear a high-pitched hum. There are wet sounds: flowing water, and things moving in water and wet mud.

Feeling is the last to return. Your mouth is dry, without taste, as if you have been eating dust. You feel cool, damp air on your face and hands, but your skin feels tight and dry.

To your right, the sky seems to be getting lighter. A sunrise appears as a point of light in the sky. It becomes a band of light that slowly sweeps across the sky, turning into an unfamiliar pearl-pink color. Spheres are floating in the sky where you saw the green lights. The spheres are 10 to 20 meters up in the air.

As your surroundings become visible, you see that you are on a low, muddy island in the middle of a swamp. Your clothes — green one-piece outfits — are streaked with dried mud and slime, as are your hands and faces. You do not remember how you got here, but do remember a terror-filled struggle in the water against creatures that tried to kill you.

### GM

The ground around the island is swampy. The only clear trails are mud-choked paths barely above water level. The PCs can find lengths of wood to use as clubs,

but no other weapons are available. Although the area is enclosed by a thirty-meter wall, it appears to the PCs to be an outdoor area with a clear horizon.

The creatures in this swamp are robots designed and built according to information gathered from the PCs minds. Roll on table 4 for an encounter every search turn. There are many encounters because these events are happening in an enclosed space under controlled conditions.

TABLE 4. HYDROPHOBIA RANDOM ENCOUNTERS

Roll 1d6. Use the encounter with the number you roll.

### ROLL ENCOUNTER

1	Barl Neps (Deathfish)
2	Fens (Man-Fishes)
3	Gators (Green Hissers)
4	Menarls (Slime Devils)
5	Terls (Tree Fish)
6	Win Seen (Tanglers)



## Acrophobia Scenerio (Fear of Height)

Use the hydrophobia and acrophobia map.

### Players

You wake up cold, and can see your breath in the chilly air. Above you, in the thin light of the strange dawn you saw in the swamp, you see the hovering spheres again.

You are on a pinnacle of rock. The top of the rock, where you are, is a roughly circular area, five meters across. Sheer sides fall away from the rock into a dense white mist far below. When you look down, you feel very dizzy and off balance. Narrow flat-topped ridges of rock run in all directions from this rock. For as far as you can see, there is no way down from those half-meter wide pathways.

You have some equipment; each of you has a hammer, a packet of trail rations, and a full water bottle. In addition, there is one coil of rope. It is about 30 meters long, but it's badly worn in several places and doesn't look trustworthy.

A brisk wind sweeps the rock. Looking down the from pinnacle makes you dizzy. If you fell, you don't know how far you would fall. A thin, screeching cry reaches your ears. Above the level of the floating globes, you see some birdlike shapes circling in the air. Their cry is answered from below the mists by a deep roar. Looking

down, you see what appears to be a giant lizard climbing the rock towards you. The lizard is at least 18 meters long, and it looks hungry. It is about 50 meters below you, and you guess it will reach the top of the rock in less than two minutes.

### GM

The birdlike shapes are hawkoids. They will swoop down on the PCs 1d4 search turns after the PCs leave the pinnacle. The hawkoids will not attack the PCs, they will try to panic the PCs and make them lose their footing.

The rope that the PCs have will not support more than 100 kilograms. Each android and robot body used by the PCs weighs 80 kilograms, plus or minus 1d10 kilograms. Be sure to note each character's exact weight for reference. The lizard is a robot Kamodo (thunder lizard). The hawkoids will attack the Kamodo when it gets to the pinnacle. That battle will probably knock any PC on the pinanacle over the side. Use table 5 to find attribute checks on the PCs' dexterities while they are traveling along the ridges.

TABLE 5. ACROPHOBIA DEXTERITY CHECKS

### PC MOVEMENT DEXTERITY CHECK

Crawling	5×DX
Moving Slowly	5×DX
Moving Normally	4×DX
Moving Fast	3×DX
Under Attack	2×DX

When the PCs do not make their dexterity checks, they fall. When a PC falls, make another dexterity check on 2×DX.

Use the following players' text for falling PCs who make their dexterity check.

### Players

You slip off the rock. As you plunge into the thick white mist, you find that it is actually much closer than you thought. Some trick of vision made it appear to be far below you, but you fall into it very quickly. You land on a ledge after a drop of about 24 meters. The ledge is about one-half meter wide. You can't see more than about 30 centimeters in any direction. The side drops straight off below the ledge as far as you can reach.

### GM

Use the following players' text for falling PCs who do not make their dexterity check.

### Players

You slip off the rock. After falling only about five meters you plunge into the

dense white mist, which appeared to be much further below. Your foot makes brief contact with a ledge on the rock wall, but you cannot react in time to reach it. The mist gets thicker and thicker. Its color fades from white to grey to black. The impact you are waiting for never arrives.

**GM**

Falling characters will have their senses switched off as they fall through the mist. A gravity mechanism similar to the type found in pods and the grav-shafts will break their fall. Robot handlers will gather the bodies and track the remaining characters, and place the unconscious characters at the endpoint of the ridges the remaining PCs are on.

**Skotophobia Scenerio**  
(Fear of Darkness)

Use the maze map. (p. 18)

**GM**

The PCs begin this scenerio in the center of the maze map on the spot marked "o." The room they start in looks exactly like room 1 in tower 1.

**Players**

You are in the sleeping room where you first woke up in this complex. The lights

are dim. The window is dark. Either the control that clears the window is out of order or there is no light outside, since the control does not change the view.

The door is open, and light from the corridor makes a bright band across the floor. The lights in the room seem to be gradually fading but it takes a while to notice any change. The thought of being caught in the dark does not appeal to you, and the warm light from the corridor looks welcome.

You suddenly feel that you are being watched. Outside the window you see two red lights, like the eyes of some huge beast. They are coming closer. You sense, but do not actually see, hear, or feel the bulk and hot breath of some gigantic monster.

**GM**

Use the following players' text when the PCs leave the room.

**Players**

You see a long corridor that curves out of sight to the left. To the right, five meters away, the corridor ends in a wall.

**GM**

Use the following players' text if the PCs stay in the room or go back into the room after checking the corridor.

**Players**

You feel that you are being watched by someone or something that intends to do you harm. Outside the window, at a distance you cannot estimate, two red lights, like glowing eyes, have appeared. They are coming closer. You sense hunger, and feel, rather than hear, the sound of some huge creature's breath.

The lights stop about two meters away from the window. The red lights are one meter apart from each other. There is nothing else but blackness. The window begins to bend, and the outlines of two unseen clawed hands form on the plastic pane. With a loud tearing noise, the window splinters into hundreds of fragments. The lights in the room go out. You now hear the regular hissing of the thing's breath, and the red lights advance once more, slowly. Like the eyes of a stalking cat, they approach the open window.

**GM**

Characters in the room will take 1d12 points of damage from the window fragments. The "eyes," mounted on a robot stalker (see New Robots, p. 29) will continue to pursue the PCs through the corridors of the maze. The stalker will move nine meters per action turn (equal to slow movement for unburdened characters).

**HYDROPHOBIA AND ACROPHOBIA MAP**

SCALE 1 HEX = 100 METERS

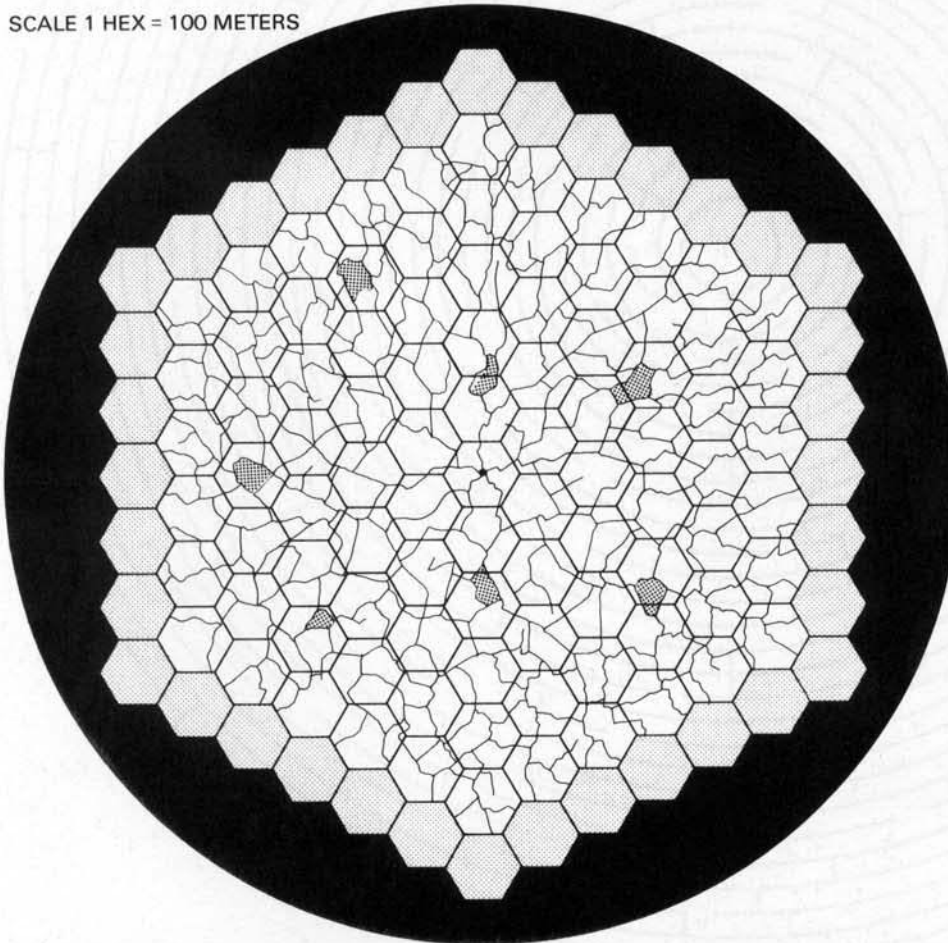

**HYDROPHOBIA KEY**

- ⊗ ISLAND
- ⊙ SAFE ZONE
- ⊕ PATH
- ⊗ FEN POOL
- SWAMP

**ACROPHOBIA KEY**

- ⊗ PINNACLE
- ⊙ SAFE ZONE
- ⊕ RIDGE
- ⊗ THICK MIST
- MIST

MAZE MAP

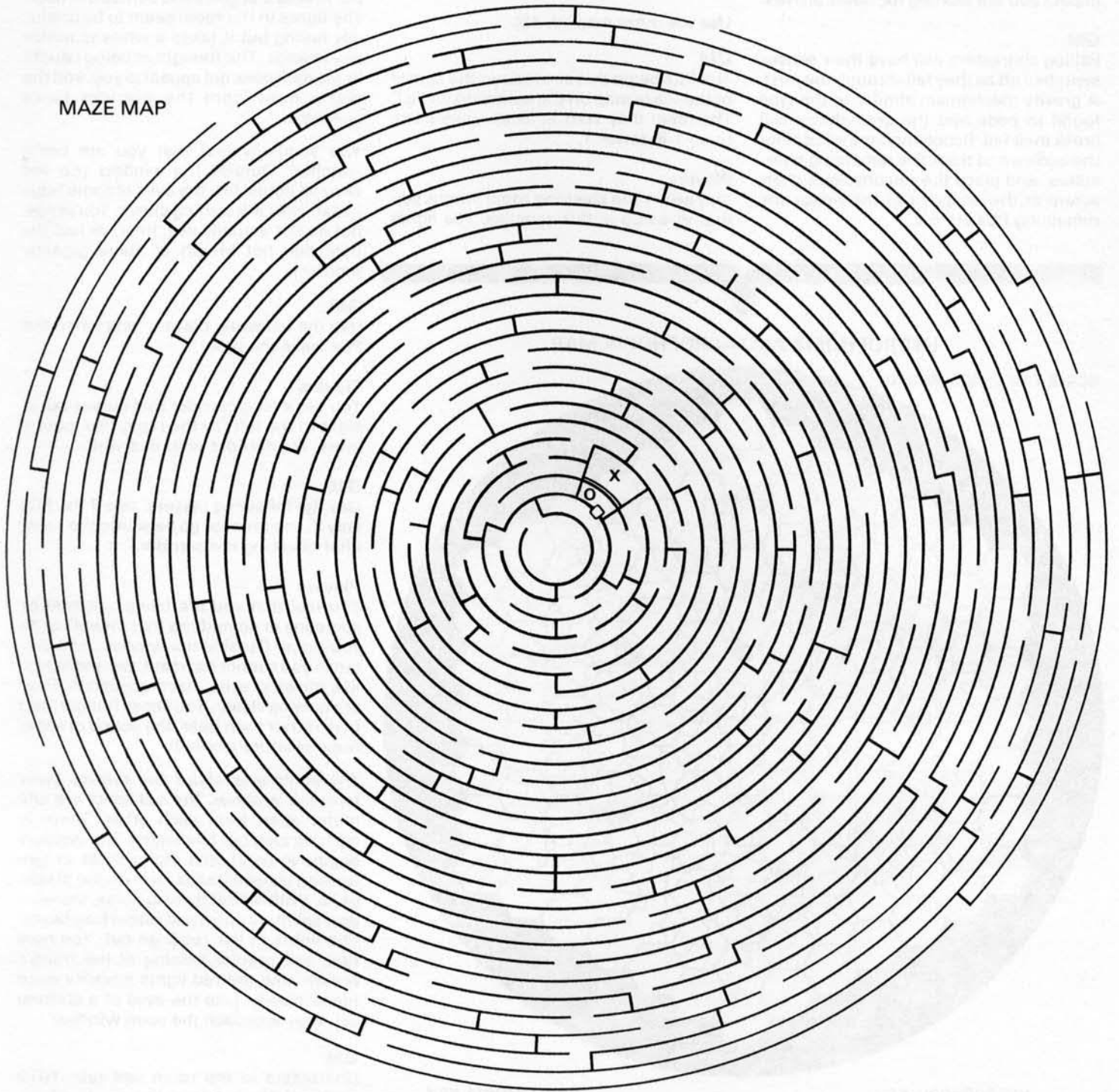

O = PLAYERS' STARTING POSITION  
X = STALKER'S STARTING POSITION

The ceiling of the maze gives off an even light over its entire surface. The robot stalker turns off the ceiling lights four meters ahead of itself, giving the effect of creeping darkness preceding it. The lights will remain out behind it. Use a pencil to trace its path so you can keep track of lit and unlit areas. The robot stalker's brain has a program of the maze, and it will always find and use the shortest path to the PCs.

Once every search turn, the PCs will come upon what appears to be the remains of some horribly mangled creature. Give the PCs the impression that they are in the lair of a large beast.

Use the following players' text if the PCs leave the room and do not intend to go back.

#### Players

You hear a tearing noise from the room you just left. The lights in the room go out and fragments from the shattered window spray through the doorway. You feel a malicious presence, and hear the hissing breath of some large creature. Inside the room, two red lights, like the eyes of a stalking cat, are approaching the door. The light in the corridor near the room is beginning to fade quickly.

#### GM

After this point, the stalker will continue to pursue the PCs. This scenario ends when any one of the PCs gets out of the maze. When this scenario ends, all the lights will dim, and the PCs will wake up once more in the real room 1 in tower 1.



### Claustrophobia Scenerio (Fear of Confinement)

Use the dormitory level map while the PCs are on the dormitory level. After that, no map is needed for this scenerio.

#### GM

The PCs start this scenerio in room 1. They should think that they can get into the lower level of Garderia. They will not have access to the true sublevel. Instead, they will be directed to the dome where this scenario takes place.

#### Players

It is night. You awaken in your tower room to see the moon shining through the unshaded strip of window. The interior lights are dim, illuminating the room with

a weird red light. The door is open. The corridor is also lit with dim red light. Outside, below you, the entire complex is dark. The windows in the other towers show the same red light as your tower.

#### GM

The tower has been placed on simulated emergency power. The view out the window is a 3-d image projected by the window mechanism. If the PCs try to use any of the devices built into the room, a computerized voice will announce, "The normal power systems have been interrupted. Only emergency and repair facilities are fully active. The management of Garderia apologizes for any inconvenience. Thank you for observing all safety precautions." Though mechanical, the voice is feminine and quite soothing. It will repeat that message every time the PCs try to start something.

The door to the service area, room 12, is open a few centimeters, showing normal lighting inside. The door will open if pushed. If the PCs decide to enter, use the following players' text.

#### Players

The room inside is mostly empty. A black-suited android is lying on the floor. Next to the android is a metal case with buckle fastenings. Along the straight walls of the room are racks of one-piece garments of various colors. Along the curved wall are eight chutes, four on either side of the door. One of these chutes has an illuminated panel above it.

#### GM

The android is armed with a stun pistol; six more are in a rack inside the case. They are in working condition. On the illuminated panel above one of the chutes, there is a picture of each of the PCs, with a list of the items in their possession when brought in. A button, underneath each picture, will cause the message "Not approved for discharge" to appear on the screen. The chutes, one per sleeping room, are for recovering patients' property from storage when they are ready to leave. The grav-shaft in the inner corner of the room is perfectly functional. Testing the shaft by dropping something down it will show it to be in working order. Use the following players' text if the PCs decide to go down the shaft.

#### Players

You reach the bottom and find yourself in a long, straight corridor. It extends from the end of the shaft to the limit of your vision. The lighting is the same dim red glow as in the areas above. There are some low objects in the center of the

floor, far down the corridor. The opening to another shaft, identical to the one you arrived in, is two meters away.

#### GM

The other shaft is another grav-shaft. Testing it will show that it is not working. The low objects are extremely small high-speed transports, each capable of carrying a single character. When the characters reach transports, they will be able to see the end of the corridor.

#### Players

The objects appear to be cars of some sort. They are on a rail that enters a tunnel, one meter in diameter, in the corridor's end wall. Each car is bullet-shaped, four meters long and one meter wide. The front section is contoured plastic, made to support a reclining human. An illuminated screen at the front of the contoured area displays a network of glowing lines. A red dot is blinking at the end of one of the lines. Everything appears to be in working order.

#### GM

If the players decide to go back to the drop shaft, they will find that the up shaft is still not operating. The only way out is the cars. The rail that supports the cars is powered. Touching it will result in 1d12+8 points of damage from electrical shock. Although the cars are contoured for humans, any character under two meters high and weighing less than 120 kilograms will be able to fit themselves in.

When a character boards a car, a transparent plastic canopy will slide forward. The same voice that announced the power outage in the tower will say, "The blinking dot shows your position. You may select a destination by voice command. If no command is received, the car will deliver you to the central terminal. Thank you for observing all safety precautions." This can be heard by characters standing outside the car as well. After a short pause, the voice will come on again. "Please declare your destination. You have twenty seconds to select." This message will be repeated every five seconds. After 20 seconds, the PCs will hear, "Attention, attention. Car in motion. Destination, central terminal." The car will then move slowly toward the tunnel entrance, then vanish at high speed.

All of the PCs' cars will match speed and draw within a few hundred meters of each other after five minutes of travel. The PCs will think that they are moving extremely fast, but they are only moving a few meters a second. The illusion of speed is created with lights in the tunnel. At random intervals, they will pass inter-

secting tunnels, sometimes nearly colliding with cross traffic.

### Players

A spot of light marks the position of the car ahead of you, about fifty meters away. The cross tunnels are intersecting more and more frequently. Suddenly, everything goes dark and the cars gradually come to a halt. A 10-centimeter wide strip of red light comes on at the top of the tunnel. The same voice you have heard before announces "Attention. The main power in the transport tunnels has failed temporarily. Repair time cannot be estimated at present. Please remain with your car. For your enjoyment while you wait, here is a selection of pleasant music. Thank you for observing all safety precautions."

### GM

The somewhat tinny sound of light background music will start. This program will repeat every hour, and can be heard outside in the tunnel. The PCs will be able to open their cars by hand and squeeze through the narrow gap between the car tops and the tunnel roof. They will find themselves in a network of tunnels. They will find an intersection every fifty meters. To get the PCs through the tunnels, use the artifact complexity table at complexity level H (chart C in the unrevised rules) and make one roll per intersection. When the artifact rolls produce a "figured out" result, the PCs will find themselves at a tunnel outlet opening into the area where the agoraphobia scenario is staged. There is no break before that scenario starts.

As the PCs work their way through the tunnels, stress the smallness and narrow confines of the tunnels. The tight quarters should make them feel apprehensive. Roll 1d10 each search turn. If the result is three or less, the PCs will panic because of the small confines of the space, and flee forward for 1d10 minutes. When they pass their fifth intersection, use the following players' text.

### Players

The red light overhead begins to fade, and the sound of an announcement reaches your ears. "Attention. Power is about to be restored. Please re-announce your destination. Thank you for observing all safety precautions."

### GM

Each PC must now pass an ability check of 4×DX each search turn or slip and hit the rail. At each intersection they pass, roll the artifact die. If you roll 10 or less (five or less in the unrevised rules), a car will go through the cross tunnel as the

party goes through. Choose one PC at random and have the car appear in the tunnel as that character is about to cross. The PCs will be able to hear the car for one action turn before it gets to the intersection. They will be able to see it for only half that time.



### Agoraphobia Scenerio (Fear of Open Spaces)

Use the agoraphobia and amoebophobia map.

### Players

You emerge from a tunnel into a brightly lit area. In contrast to the uneasiness you felt in the small tunnels, you now feel as if you'd be more secure in those areas. You are in a strange place; an open plaza, with strange buildings all round. The architecture is vaguely familiar, however. You've seen pictures of ruins like this, and drawings of what the original structures were like, but these are in perfect condition. The sky is white. Overhead, you see globes floating about 20 meters in the air.

There are people walking around. They are dressed in strange costumes. You feel repelled by these people and their appearance. You hear a shout, and find that a group of about 12 people are staring at you from a few meters away. At the same time, you notice a car slowly moving towards you. It is picking up speed.

### GM

This area is a simulation of a Shadow Years urban plaza. The PCs will have one action turn to get away from the tunnel (if they have not already done so). Once this happens, the people in the area will chase them. The PCs will find it easy to evade pursuit, if they get out of sight of their followers. Every action turn the PCs are not in a sheltered area of the map, roll 1d10. A roll of 1-3 means that 3d4 people will spot them and continue to pursue. The PCs will flee for 1d20 action turns or until they find a sheltered area.

While the PCs are concealed, roll 1d10 each search turn. A roll of 1-3 means that one of the floating globes appears directly over the PCs' position. A few seconds later, the PCs will be discovered by 1d4 people. Those people will call more people to the scene. In 1d6+6 search turns, 3d4 more people will arrive.

The globes are eyeballs (see New Robots, p.29). Characters who are paying attention to their surroundings will notice the eyeballs if they pass an attribute check of 3×IN. An eyeball can be knocked down with a stun gun. If the PCs figure out a downed eyeball (as an artifact), or if they knock down 1d20+10 eyeballs, all the androids in Garderia will become unconscious for 3d6 search turns. All security provisions will be suspended for an additional 3d6 search turns. During that time, the PCs will have unrestricted access to the entire facility, including the sublevel.

The PCs will panic if they get more than 75 meters from a wall, in clear space. When they panic, they will crawl to the nearest obstruction, leaving it only if pursuers appear or they decide to find a more sheltered spot.

All of the buildings in the area are closed. They are, in fact, props, with the exception of the building marked "X."

Eventually, the PCs will be caught. If they have not already found it on their own, they will be taken to the building marked "X" on the map. When they are inside, they will feel safer but still apprehensive since they will be prisoners.

### Players

The mob hands you over to a squad of uniformed men who outnumber you two to one. They march you to a narrow lane between two wings of a building. When you enter the enclosed space, you feel relieved, but you are now prisoners. You are taken to a room and placed in a cage. Surrounding you are consoles and screens; blinking lights are everywhere.

After a few minutes, a man wearing a white robe appears. He examines you, not standing close enough for you to reach him through the bars of the cage. He ignores all your actions. After a moment, he speaks.

"This does seem unfortunate. We've been doing some research, you see, on strange things caused by radiation. We've had some surprising results with animals, and since you don't appear in our records, you must have had some unfortunate accident. Or perhaps it happened naturally. You're lucky, though." He points at a large screen on a wall, and you see a picture of a horrible creature. You can't identify it. He continues. "We had to put this poor thing out of its misery." More pictures appear on the screen. Some of the mutated features look familiar, but most are repulsive. Finally, your keeper tells you, "I think you can be helped. It will

take another dose of radiation, however." He steps to a platform with a raised console on it. A glass tube descends, separating him from the rest of the room. He works with the controls for a moment, and the room is filled with a blue light. Suddenly, one of the machines by the wall starts showering the room with sparks. The problem appears to be spreading. A cable breaks free and strikes the bars of the cage.

**GM**  
Any character touching the cage will take 3d6 points of damage from shock. The door, with an electrically operated lock, will swing open, and sirens will begin to go off.

**Players**  
You hear a familiar voice speaking from the ceiling. "Attention, attention. A radiation accident has occurred. Please take shelter immediately. Thank you for observing all safety precautions." The floor is vibrating; chunks of plaster are beginning to fall from the ceiling.

**GM**  
Roll an ability check at 3×DX for each character as the PCs leave the cage. Roll again as they flee the room. Each character that fails the first check will take 3d6 points of damage from the still-electrified bars. Failing the second check will result in 2d4 points of damage from falling debris.

**Players**  
When you leave the building, the air outside is hot and has a foul taste. A quickly-moving cloud of yellow gas is sweeping in from your left. You see people attempting to run away from it, only to be engulfed. As the cloud covers them, you see the victims stagger and fall.

**GM**  
The cloud is moving at a rate of 40 meters per action turn. It is not deadly. It will only cause the PCs to pass out. They will awaken in the next scenario, amid the ruins of the mock plaza.

## AGORAPHOBIA AND AMOEBOPHOBIA MAP

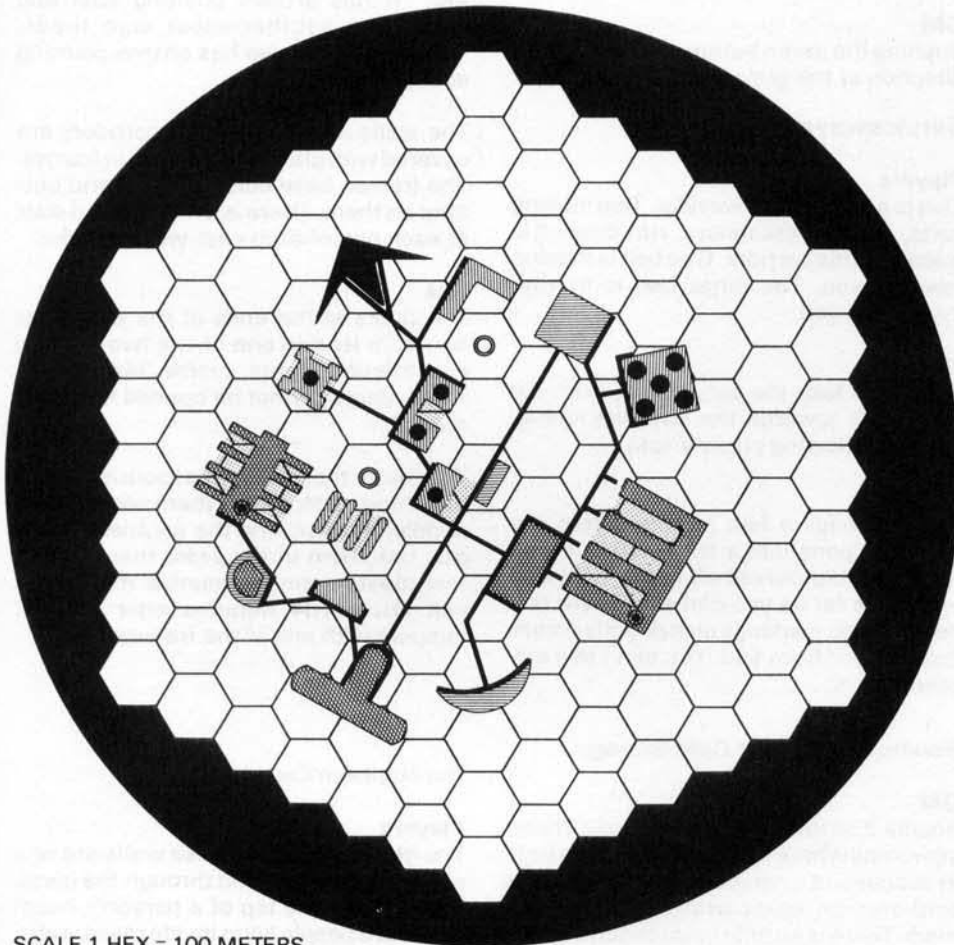

SCALE 1 HEX = 100 METERS

- 2 STORY BUILDING
- 3 STORY BUILDING
- 4 STORY BUILDING
- 5 STORY BUILDING

- DECORATIVE COLUMN (12 METERS HIGH)
- FOUNTAIN
- ⌒ COVERED TUNNEL
- SHELTERED GROUND
- OPEN GROUND



### Amoebophobia Scenerio (Fear of Mutations)

Use the agoraphobia and amoebophobia map.

**GM**  
This scenerio is played in the same setting as the previous one. However, the plaza is in ruins in this scenerio. Remember that the PCs will actually be in this scenerio; they will not control android or robot bodies.

**Players**  
The plaza lies in ruins. The buildings are mostly collapsed shells, black from fire. A group of horrible looking monsters walk around the corner of a building. They stare at you across 20 meters of cracked pavement, then rush at you. Two are green-skinned men, one has feathers in place of hair, another has blue, scaly skin.

**GM**  
Run this scenerio just like the previous scenerio, the agoraphobia scenerio. In this scenerio, horrible mutants, not people, will chase the PCs. Each time the PCs encounter a group of monsters, each PC will have a 25% chance of suffering the effects of the insanity mutation. (The unrevised rules do not feature an insanity mutation. If you do not have the revised rules, the PCs will flee away from mutants for 1d20 action turns.)

If the PCs do not manage to figure out or damage enough eyeballs to short out the security system, they will wake in room 1. They will realize that these scenerios were attempts to cure them of their belief in the post-Shadow Years world (if they haven't figured that out already). For 1d20+10 search turns, Zigmunt will be in deep contemplation of his findings about

the PCs. During this time, only the maintenance and medical SteelSkins will function, and all the doors will be unlocked. This will be a chance for the PCs to escape or to enter the sublevel.

You may wish to extend the play of this module, or play it again. You can add to the scenarios in *The Mind Masters* by designing your own scenerios. Here is a list of some known phobias. You can use these or invent some of your own. After all, there are many more things in the Gamma World to be afraid of than in our own!

AEROPHOBIA = fear of air or drafts  
AUTOPHOBIA = fear of being alone  
ZOOHOBIA = fear of animals  
AILUROPHOBIA = fear of cats  
PSYCHROPHOBIA = fear of cold  
CYNOPHOBIA = fear of dogs  
PHAGOPHOBIA = fear of eating  
PANTOPHOBIA = fear of everything  
APIEROPHOBIA = fear of infinity  
PEDICULAPHOBIA = fear of lice  
MUSOPHOBIA = fear of mice  
KINESOPHOBIA = fear of movement  
PHONOPHOBIA = fear of noise  
THALASSOPHOBIA = fear of ocean  
ERYTHROPHOBIA = fear of red  
OPHIDIOPHOBIA = fear of reptiles  
AICHINOPHOBIA = fear of sharp objects  
HYPNOPHOBIA = fear of sleep  
TRISKAIDEKAPHOBIA = fear of thirteen  
ASTRAPHOBIA = fear of thunderstorms

## Garderia Sublevel

Use the sublevel map.

Continue to roll on table 3 for random encounters while the PCs are in the sublevel. Unless otherwise noted, all SteelSkins, except the security models will not question the PCs presence in the sublevel. Non-security models have been programmed to accept PSHs as routine maintenance personnel.

This sublevel, under the central dome, contains some of the support facilities for Garderia. These include android manufacture and service areas, communications and monitoring rooms, and the room that contains Zigmunt himself. There are no obvious security devices here. The SteelSkins here will assume that the PCs are human attendants as long as the PCs don't interfere with routine operations or start smashing things up.

If the PCs damage or injure any workers or equipment in the sublevel, a squad of

two security SteelSkins per PC will arrive at the location of the damage in 1d4+2 minutes. If necessary, additional squads will arrive every 10 minutes. PCs that are stunned or captured in the sublevel will be returned to room 1 in tower 1 after the first incident. If they are stunned on the sublevel again, they will be put into cold storage in room 33a or 33b.

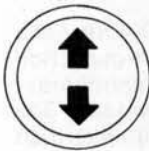

### Serviceway Grav-Shafts

#### Players

There is a grav-shaft inside the door. Next to the grav-shaft, a single pushbutton glows with a faint green light.

#### GM

Pushing the green button will reverse the direction of the grav-shaft.

### Serviceways

#### Players

This is a long, empty corridor. Two moving belts, like flat escalators, run down the middle of this corridor. One belt is moving towards you. The other belt is moving away from you.

#### GM

If the PCs take the serviceway from the grav-shaft towards the sublevel rooms, use the following players' text.

#### Players

The belt ends a few meters before the corridor opens into a large corridor. The large corridor curves off to the right and left for as far as you can see. There is a door with no markings on it directly across the corridor from you. You can't see any other doors.

### Rooms 33a & 33b: Cold Storage

#### GM

Rooms 33a and 33b are identical. These are rooms where living beings can be kept in suspended animation. The walls have cold-storage compartments built into them. There is an unbreakable glass hatch in the front of each compartment. Each compartment also has several monitor lights, a red button, and a blue button.

The red button activates the revival process; the blue starts the freezing. If any of the PCs push a red button, a warning buzzer will go off. Within 1d4 minutes, robot carriers will appear at the chamber, remove the body inside, and take it to

room 36. If the PCs are present, more robot carriers will arrive in another 1d4 minutes and try to capture the PCs. If the PCs try to escape, the robots will attack them with sleep gas. The PCs will then be taken to room 36 for refurbishing.

#### Players

The door slides aside. The air ahead feels cool. You are looking down a hallway that runs north-south. There is an unmarked door at the end of this hallway. Three curved corridors cross this hallway. A sign hangs from the ceiling at each intersection.

The sign at the northernmost intersection has two arrows on it. One points to the west, followed by "SS17A/SS20A." The other arrow points east, followed by "SS21A/SS24A." The sign over the middle intersection says, "cases pending." It has arrows pointing east and west. The southernmost sign reads, "unknowns." It also has arrows pointing east and west.

The walls of the east-west corridors are covered with glass panels, held in frames. The frames have colored lights and buttons on them. There is an unmarked door at each end of each east-west corridor.

#### GM

The doors at the ends of the east-west corridors lead to one of the two android construction plants, rooms 34a or 34b. These doors cannot be opened from this room.

The rest of the text for this room is divided into three parts, the northern corridor, the middle corridor, and the southern corridor. Use them in the order that the PCs investigate them. Remember that robots will arrive 1d4 minutes after any PC tampers with any of the frames.

### The Northern Corridor

#### Players

The glass panels on these walls are one meter square. Looking through the glass, you can see the top of a person's head! There are people lying inside these walls. They are dressed in the same outfits you have seen on the attendants. There is frost along the inner edges of the glass. The glass feels very cold.

#### GM

These compartments store extra SS-A model androids (SteelSkins).

### The Middle Corridor

### Players

The compartments here are one meter wide and six meters tall. There are people standing inside them! They are all pure strain humans. Some of the figures are covered by a layer of frost. Others have on outlandish clothing, and a few pieces of jewelry that seem very old.

### GM

These are Garderia patients whose disorders were incurable even by Garderia's technology. They were placed in storage to await the development of a cure, and were forgotten in the world after the devastation. If the PCs activate any of the revival mechanisms here, the robot carriers will take the body inside to room 38. The other robots will still arrive 1d4 minutes later.

### The Southern Corridor

### Players

The compartments here are one meter wide and six meters tall. There are people standing inside them! You cannot identify all of these specimens, but they do seem familiar. Some are humanoids with physical mutations: antlers, carapaces, modified body parts, odd skin colors, etc. They are all covered by a light layer of frost.

### GM

These are all recent additions to the collection. These are present-day mutants who insisted so strongly that their mutations were real that Zigmunt created a new class of "incurables." If the PCs decide to search the entire corridor here, they will find people they recognize from one of the lost expeditions from Iac South. Seeing them will be the final nudge the PCs need to regain full memory of their expedition. Attempting to revive their comrades will bring the same results as in the other corridors.

### Rooms 34a & 34b: Android Manufacture

### GM

Rooms 34a and 34b are identical.

### Players

You are standing on a balcony overlooking a very large room filled with vats, tanks and machines. Ten meters above you, the ceiling is fitted with machines on rails. Most of the machinery appears idle. You can see a few panels with lights, and a small number of blue, silver, and red-suited attendants, perhaps 15 in all, in the room below you. Directly below you are a number of transparent human-sized boxes. There are human-type bodies in

the boxes, but they look unfinished. Tubes and wires are fitted into their arms and chests. You cannot tell any two of the bodies apart. They look as if they all came from a mold. A staircase leads down into the room.

### GM

The bodies are unfinished SteelSkins. This room is one of two facilities that make SteelSkins. There is no equipment here that the PCs can operate or use as weapons. If the PCs go down into the manufacturing area, the SteelSkin workers there will treat them as if they were making an inspection. If the PCs try to operate any of the machinery, they will be asked to leave it alone.

The attendants will offer to explain the process in brief to the PCs, if they ask about it. Each step takes place in a different machine. The steps are outlined below. The letters match the letters on the sub-level map.

a. Generating tanks. Embryo clones are grown from completed SteelSkins here.

b. Ageing vats. The clones are transferred to these vats where their growth is speeded up. They reach the size of adult humans in four months.

c. Organic tuning. The unformed SteelSkin bodies are placed in individual plastic containers for three weeks while their internal organs are brought into balance. Disease resistance and growth rates are adjusted to prepare the new SteelSkins to live outside the tanks.

d. Molding. The faces and other outside features are sculpted and set here.

e. Electrical connections. The circuitry that operates along with each SteelSkin's nervous system is installed along this assembly line.

f. Sheathing. The skin finish is applied here. Usually it is the metallic skin, but a natural finish that looks exactly like PSH skin can also be made.

g. Programming. The SteelSkin brains are programmed in this unit.

h. Monitoring station. The technicians who supervise the SteelSkin manufacturing process monitor everything from here.

The PCs will be told that the factory is running at minimum production since the demand for SteelSkins is low. Within three weeks, however, they could scale up production to full capacity. The heavi-

est demand is for the SS17A model, which is being used for guard duty outside the facility.

### Room 35: Android Repair

### GM

If the PCs were brought here by robot carriers from the cold storage room, skip the following players' text and use the one after that.

### Players

The door slides open as you approach. There is a man standing the room. He is wearing a gold outfit similar to the black ones worn by guards. He turns to you and asks, "Yes, and what can I do for you?"

### GM

This is a repair station for SteelSkins. The man inside is a medic SteelSkin who calls himself "Old Doc." He has been in service since the park was opened, and remembers, dimly, some news of the horrible events of the Social Wars. He has bent Garderia policy by using his job in the repair shop to keep himself going long after he was due for replacement. If the PCs seem confused, or raise weapons, Old Doc will say, "Ah, yes, disorientation." An automatic stun ray will blanket the corridor the PCs are standing in, and when they come to, they will be strapped into couches in the workshop.

Use the following players' text if the PCs were stunned while talking to Old Doc or if they were brought here from cold storage after a sleep gas attack.

### Players

You awaken to find a bright light shining in your face. You are on your back, lying on an inclined table with your head higher than your feet. As your eyes adjust to the light, you can see several tubes and wires that run between your neck and an apparatus in the ceiling. One tube appears to carry blood, another carries a colorless fluid.

When you can focus on the rest of your body, you can see that you are dressed in an outfit that looks the same as ones you have seen the guards wearing. Something that seems to be a metallic mesh has actually replaced your skin, except on your hands, feet, and head. The other members of your party are on similar tables.

Suddenly a man's voice says, "Terrible! A terrible mistake!" The man is standing behind the light that is shining in your faces. "This was not supposed to happen to ordinaries. Only the servants."





**GM**

The man is Old Doc. PCs who have seen him before will recognize him.

**Players**

The man steps out to where he can be seen. He uses a device in his hand to dim the light so you can see him.

"I must apologize," he says. "This is inexcusable. Your sort were never meant for the refurbishing process. However, I did manage . . ."

**GM**

At this point, Old Doc detects that the PCs are confused. He will explain that they have received the automatic renewal process that the SteelSkins must take from time to time until they eventually wear out. The process includes retoning the muscles, skin replacement, new connectors for the nervous system, a complete charging, and brain reprogramming.

"However," Old Doc points out, "I was able to stop some of the process. Your parts are all there, and your brain is still your own. I took these out, too." He holds up some pieces of wire. "Control implants. These allowed Zigmunt to control you."

Old Doc will caution the PCs not to move for a while, and ask them where they came from. He will not know anything about the world of the post-Shadow Years. In return, he will tell the PCs the story of Garderia.

**Players**

"It was a sort of park built to help people who weren't quite right in their heads, if you know what I mean. They came here, Zigmunt talked to them, found out what was wrong, and gave them adventures to cure them. Enormously popular, the place was. Now I'm sure that Ziggy's not quite right. He was pretty good in his day, but he's a machine. They wear out, not like proper living things."

Old Doc will then offer to assist the PCs by helping them get to Zigmunt's control room to try to change his programming. Old Doc will disconnect the PCs from their tubes and wires, and put them under anaesthesia one more time. When they awaken once more, they will be outfitted as SS17A Androids. Abnormal body parts such as antlers, carapaces, etc., will have been surgically removed. Mental mutations will not be affected. All non-animal PCs will be PSH-type, with steel mesh skin on their legs, arms, and upper torso.

Old Doc will offer to lead the PCs to Zigmunt's central control, room 41. First of

all, Old Doc will take the PCs to room 36, for weapons. Then he will lead them directly to room 39.

**Room 36: Weapons Storage****GM**

If Old Doc is leading the PCs, he will tell them to enter this room and arm themselves with stun pistols.

**Players**

This room is filled with racks. The racks hold devices that look like the weapons carried by the black-clad guards.

**GM**

The weapons are stun rifles and stun pistols. Each gun is clamped in place, and can be released by thumb pressure on a small tab at the bottom of each clamp. The clamps are complexity A (Use artifact chart A in the unrevised rules). Unless the PCs have been processed through room 34a or 34b, their thumbprints will be automatically checked. A squad of two security SteelSkins per clamp opened will appear in the corridor outside the room in 1d4 minutes.

**Room 37: Robot Storage and Repair****GM**

Old Doc will not take the PCs into this area.

**Players**

The doors to this room are two meters wide and three meters high. They open to reveal a 10 meter long corridor leading into a large open area filled with robots and machines of many types. There are tables and workbenches in the center of the open area. About 15 silver-uniformed people are working on robot units.

**GM**

This is an area for robot storage and repair. The PCs will be able to find metal-cutting tools, welding torches, and technical instruments of complexity levels D, E, and F (use artifact chart B in the unrevised rules). The technical instruments can not be of use to the PCs; they are diagnostic and repair devices for robots only. The SteelSkins on duty will give the PCs equipment if they are ordered to do so.

**Room 38: Patient Revival and Storage Area****Players**

This is a half-circle shaped room. There is a door in the center of the straight wall,

opposite the entrance. The floor space is filled with covered tanks three meters long, one and a half meters wide, and one meter high. They are spaced two meters apart.

**GM**

Humans that are kept in cold storage are revived here. The tanks are individual revival cells in which the patients are placed for proper recovery. There is no activity in this room unless the PCs activated any of the revival mechanisms in rooms 33a or 33b.

The room behind the straight wall is the storage area for the personal belongings of Garderia's patients. The storage room is filled with rows of shelves holding storage boxes. The boxes are stacked up to the ceiling, three meters overhead. It is possible to climb the shelves. There is a three-dimensional photograph of the owner of the stored possessions on each box. There are unreadable identification symbols under each picture. The PCs will be able to find their possessions by taking 1d20+10 search turns search the boxes for their pictures.

**Room 39: Systems Monitoring****Players**

This room is filled with curved banks of consoles with screens, indicator lights, and other controls. The consoles are arranged in circles around a central column. An aisle crosses the room to a door in the opposite wall. Large screens on the walls show various views of the complex. There are thirty silver-uniformed people at control stations. Their palms are pressed flat to circular controls, 20 centimeters in diameter.

**GM**

Garderia's systems are monitored from here. The SteelSkins with their hands on the round controls are connected directly to the consoles by mechanical nerves. Those technicians will not move from their places, since it takes one-half minute to disconnect from the round controls. Characters that are forced away from the controls without being disconnected will take 3d6 points of damage. They will also be unconscious for 2d4 hours due to nervous shock.

If Old Doc is with the PCs, he will lead them through to the opposite door while explaining the operation of the console connection.

There are no artifacts or tools here that can be used as weapons.

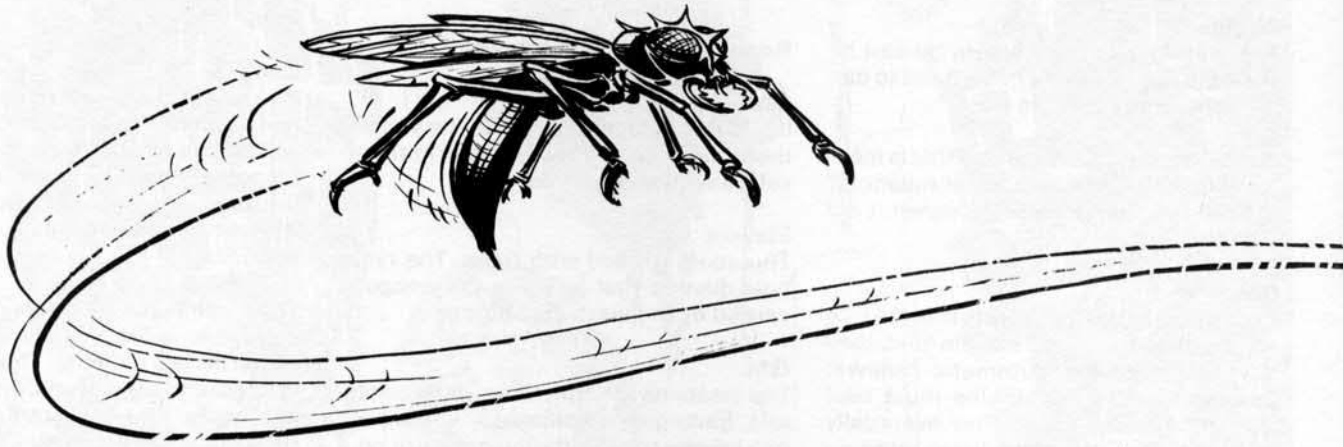

### Room 40: Computer Externals

#### Players

A walkway leads from the door to another door 20 meters away. The walkway is two meters wide, and there are no railings to protect you from falling to the floor, 10 meters below. The ceiling is 10 meters overhead. This whole space is filled with an intricate network electrical connections. Technicians in silver uniforms move about with the aid of personal antigrav pod belts.

The door at the end of the walkway is marked with seven lettered hexes. They are in the same order as on the door to your sleeping chamber. Here, however, the design covers the entire door.

#### GM

Use the following players' text if Old Doc is leading the PCs.

#### Players

Old Doc leads you onto the walkway. "This is part of Zigmunt," he tells you. "These are the circuits that store parts of his memories. These circuits need to be changed from time to time. We need to give him some new memories."

He crosses the walkway with no hesitation and pauses before the door at its end. It slides open, and he beckons for you to enter.

### Room 41: Zigmunt Control

#### Players

This room is smaller version of the room on the other end of the walkway. This room is five meters in diameter. This room is also filled with consoles facing the wall.

#### GM

If the PCs have not been through room 35 and Old Doc is not with them, an automatic security system will be on. If the PCs touch any of the consoles, they will take 2d10 points of damage. They will pass out and awaken in room 35 under Old Doc's care. They will also permanently suffer the effects of the insanity mutation because they were not prepared for direct contact with Zigmunt.

If Old Doc is with the PCs, the security system will be off. Old Doc will tell the PCs to put their hands flat on the circular controls of the consoles. If they do, use the following players' text.

#### Players

You feel a tingling sensation for half a minute. Your brains seem to expand. Your thought processes speed up, and you feel as if all your memories are being drained. You feel extreme disorientation and dizziness, followed by an overpowering presence, Zigmunt. You realize that he has no knowledge of the world after the shadow years. The presence gradually subsides, leaving in your minds the message, "Leave here. You will not be harmed." You feel no hesitation to go, and are assured by Zigmunt that your exit from Garderia will be safe.

The tingling sensation returns to your hands, and after another half a minute, they come free. You fall to the floor, losing consciousness.

#### GM

Continue playing with the conclusion.

## Conclusion

#### Players

You awaken in the dormitory room where you first woke up. Old Doc is standing in the open area of the room, with a large heap of equipment. There is a stun ray rifle, an energy cell charger, a medikit, a pocket computer, and a duralloy equipment backpack for each of you, besides your original possessions. He says, "It's time for you to go. Zigmunt has received quite a shock, and it will take some time to reprogram him. The people from your earlier expedition, and others of your time, will be released gradually after the memory of this place is edited from their minds. Here is one last thing." Old Doc pulls an artifact from the pile. "This is a communicator. Zigmunt holds much information that could be useful in this changed world. If the time comes to give this knowledge, I will contact you with this."

#### GM

Old Doc will escort the PCs out of tower 1, down to the central dome. He will ask the PCs to load their equipment into a bubble car parked outside the central dome. Old Doc will fly the PCs to hex U14, where he will leave them to take up their trek back to lac South. You can end this adventure here, or you can play out the return march, checking for random encounters on the way.

# APPENDIX

## New Creatures

**NAME:** Bloodwasp  
(Cunicula Haemophagia)

**NUMBER:** 2d20+5  
**MORALE:** 1d4 (1d4+6)  
**HIT DICE:** 2d4  
**ARMOR:** 6

**LAND SPEED:** 0/30/.5  
**BURROWING:** 0/.5/0  
**AIR SPEED:** 6/900/18

**MS:** 1d4                      **IN:** 1d4  
**DX:** 1d10+10              **CH:** 1d4-1  
**CN:** 1d4                      **PS:** 1d4

**ATTACKS:** Sting (1 point damage + poison)  
Bite (1d4 damage)

**Mutations:** warning, patrolling, and death pheromones (see New Mutations, p.28)

Bloodwasps are burrowing wasps about 10 centimeters long. They exhibit some traits of both solitary and social insects; bloodwasps live singly, in burrows, with 2d20+5 burrows located in a region of 1 hectare. Their behavior is controlled by pheromones. Bloodwasps wait in their burrows for prey. Bloodwasps sense their prey by smell within a range of 30 meters (plus or minus 10 meters for wind direction, if any). They can also sense prey by feeling ground vibrations within a range of 5 centimeters per kilogram of their prey's body weight.

A bloodwasp attacks with a dashing flight and sting, delivering 1 point of damage and a paralyzing poison of intensity 14. The poison leaves its prey immobile, but conscious, while the bloodwasp burrows one-half centimeter into its prey's flesh and sucks three milliliters of blood. This causes 1d4+1 more points of damage. When the first attacker is through feeding, it will leave. Then other bloodwasps will approach and feed until the poison wears off, or until all the wasps in range of the first attacker's Pheromone mutation have fed. Victims of bloodwasps must pass an attribute check for mental strength each search turn while the bloodwasp's poison is in effect. If the victim fails an attribute check, he will suffer the irrational effects of the insanity mutation when the poison wears off. The victim does not have the insanity mutation permanently.

Bloodwasps emit the patrolling pheromone when they are not feeding or fighting.

Bloodwasps emit the warning pheromone when they are feeding, attacking, or fighting.

**NAME:** SteelSkin  
(Service Unit, Organic,  
Models SS17A-SS24A)

**TYPE:** Android

**NUMBER:** 1d6  
**MORALE:** 1d6+4  
**ARMOR:** 7  
**HIT DICE:** 10d10+20

**LAND SPEED:** 12/900/36

**MS:** 1d10+11              **IN:** 1d10+8  
**DX:** 1d10+11              **CH:** 1d10+11  
**CN:** 1d10+11              **PS:** 1d10+11

**ATTACKS:** See below

**STATUS:** 1000

SteelSkins are a type of android unit produced in laboratory factories in the sub-levels of Garderia. Their bodies are covered with a metallic-organic mesh that is

woven into their skin. Security SteelSkins (model SS17A) are warrior androids. All other SteelSkins are worker androids.

SteelSkins are ordinary androids, except that SteelSkins have better armor. SteelSkins can wear ordinary clothes or armor over their metallic skins, and look like PSHs when they do so. Each model has a particular function and a skin color different from the other models.

MODEL	FUNCTION	COLOR
SS17A	Security	Black
SS18A	Laborer	Dark Blue
SS19A	Servant	Yellow
SS20A	Athletic	Green
SS21A	Medic	Gold
SS22A	Technician	Silver
SS23A	Maintenance	Red
SS24A	Agricultural	Orange

Each SteelSkin has a control nexus implant (see New Artifacts, p.30) in the back of its neck. The implant links the SteelSkin with Zigmunt. Through its implant, each SteelSkin has access to the park's communications net. If its implant is destroyed, a SteelSkin will obey the orders of any PSH for 1d6 search turns before going into a coma. SteelSkins cannot recover from a coma without repair and medical treatment.

All SteelSkins have hands of power (see the revised GAMMA WORLD® rule book for description) that can stun attackers with the effects of a stun ray pistol. Security SteelSkins never carry lethal weapons, and will never kill a PSH or PSH-like humanoid, even in self-defense. Instead, they will get help through the communications net and use large numbers to trap PSHs. Unless otherwise noted, security SteelSkins (model SS17A) always carry stun pistols and other types are unarmed.

If PCs use force on Steelskins, the Steelskins will try to stun the PCs with their hands. Security androids, however, also carry and use stun guns. If a fight breaks out, a security force will arrive to help the SteelSkins in 1d12+30 action turns. This force will have 1d4 security SteelSkins for each attacked SteelSkin. Security SteelSkins will not hesitate to open fire on other Steelskins to stun PCs that are fighting.

PCs with mental mutations such as telepathy or intuition will only be able to pick up simple thoughts from any SteelSkin. Each android's thoughts will be about its job and the welfare and safety of the patrons of the park. PCs will only be able to find out things like the function of a nearby room or the code word to open a door. Beyond such thoughts is the powerful controlling presence of Zigmunt. All SteelSkins think of Zigmunt as the "ultimate authority." Only PCs with mental strengths higher than 12 will be able to sense the name "Zigmunt."

**NAME: Mimic Plant**  
(Megacattleya Apographia)

NUMBER: 1d10  
MORALE: 1d4+4  
HIT DICE: 10d4  
ARMOR: 3

MS: 1d10 IN: 1d4  
DX: 2d10 CH: 1d4  
CN: 3d6+6 PS: 1d12+8

ATTACKS: see below

MUTATIONS: allurement, beguiling, adaptive enzyme (see New Mutations).

Mimic plants are mutated orchids that grow up to three meters high. They have large, showy flowers that can look like various animals. Mimic plants grow near ponds, and their root tendrils extend into the water from underground. Their roots absorb large amounts of water, that is given off by their leaves as a fine mist. The mist obscures vision enough that the flowers are mistaken for animals.

Animals and characters who find mimic plants have a chance equal to 50% minus their intelligence of believing the plant to be an attractive animal or character of the opposite sex. When a creature is attracted to within six meters of the plant, an elastic tentacle whips out and wraps itself around the victim. The tentacle secretes a corrosive fluid which contains adaptive enzyme (see New Mutations, p.28). The fluid burns the skin for 2d4 points of damage if it is not washed off in a number of action turns equal to 11 minus the victim's armor class. The tentacle will withdraw as soon as the victim fights back. No plant will attack two creatures, and no creature will be attacked by more than one plant each day.

## New Mutations

**NAME: Pheromones**

RANGE: 500 meters TYPE: U P  
DURATION: Variable USE: Constant  
NUMBER: All of DAMAGE: None  
same species

Pheromones are powerful chemicals secreted by mutants or subintelligent life forms as signals to members of the same species. Only a very tiny amount of a pheromone is needed to produce its effect. Pheromones are released involuntarily, triggered unconsciously by the activity or emotional state of the being with this mutation. Pheromone use is most developed in insect and insect mutant species. Characters with this mutation have a percent chance of detecting other species' pheromones according to the following chart.

Once a pheromone from a different species is detected, there is only a 20% chance of identifying the species that is emitting the pheromone. There is only a 10% chance of understanding the meaning of a pheromone of a different species.

**Pheromones**

**PATROLLING:** The patrolling pheromone is used to indicate nonaggressive behavior. It is usually emitted by solitary insects crossing the territorial boundaries of other members of their species. The patrolling pheromone suppresses the impulse to attack.

**WARNING:** The warning pheromone warns other members of a species to stay away. Any being emitting this warning will attack other members of its own species which come within 10 meters of it.

**DEATH:** The death pheromone is given off whenever a being with this mutation is

killed. The death pheromone is usually only found among social insects, such as bees, ants and wasps. The death pheromone warns of a threat to the insect colony and incites all members of the same species within range to attack any being of a different species within 10 meters of the dead insect. The death pheromone will not be released if the being with the pheromone is killed by fire. The gland that produces the death pheromone is frozen by mental attacks, if the attacker passes a mental strength check.

**NAME: Adaptive Enzyme**

RANGE: Touch TYPE: C V  
DURATION: Constant USE: Constant  
NUMBER: Variable DAMAGE: Variable

Some plants have developed the adaptive enzyme mutation as a means of reproduction. The enzyme changes animal tissue into plant material. Victims of an enzyme attack begin losing skin growth (hair, feathers, scales, etc.) 1d8 hours after the attack. Their skin growth is slowly replaced by green plant-like skin over the next four days. On the fifth day, the victim becomes very sick, and loses half its strength. After another 1d4 days, the victim dies. A few weeks later, the enzyme will change the corpse into a new plant root. Several months later a new plant, like the one that used the enzyme, will grow from the root.

The adaptive enzyme can be treated by a Medi-Kit, a Cur-in dose, or exposure to radiation. For a radiation cure, the victim must make an attribute check of three times his constitution plus the intensity of the radiation. An additional check for radiation damage is required. Characters who are cured will acquire the photosynthetic skin mutation, and get all their normal strength back.

Adaptive enzyme attacks cause victims with bacterial or poison susceptibility to suffer the ill effects of those mutations.

Percent Chance of Creatures With a Pheromone Mutation Detecting Other Species' Pheromones

Species Detecting	Pheromone from:		
	Insect	Insectoid	Non-Insect
Insect	1%	5%	10%
Insectoid	1%	8%	15%
Non-Insect	1%	3%	25%

## New Robots

NAME: Eyeball

TYPE: Drone Unit

NUMBER: 2d20+10 ARMOR: see below  
HIT DICE: 2d4 CONTROL: G  
SENSORS: A/B/C POWER: A

SPEED: PODS = .720/30/.5

STATUS: 250

Eyeballs are light-duty audio-visual monitor units. Their outer shells are light plastic spheres, 1 meter in diameter. Eyeballs weigh only one and one-half kilograms. Their size and light weight gives them a high air resistance, so they move (and fall, if their anti-grav pods fail) quite slowly.

The surface of an eyeball has three distinct zones. The underside is the pod anti-grav radiator zone. The anti-grav energy gives this zone an armor rating of 6. There is a 10-centimeter wide stabilizer zone around the middle of the eyeball. This zone has tiny, low-power pods which keep the eyeball from drifting and can move it slowly from place to place. A sensor zone occupies a 10 centimeter wide band between the radiator zone and the stabilizer zone. The sensor zone has audio and video sensors which scan a circle on the ground with a diameter equal to the eyeball's altitude. Eyeballs can only escape damage by moving out of the way. They have no other defense mechanisms.

Eyeballs are controlled entirely by a cybernetic installation and cannot function properly without direction. They form a network tuned to a particular controller, and cannot be moved to a different sys-

tem. An eyeball will fall if it suffers 50% damage. Eyeballs take an additional point of damage for every 10 meters they fall. There is a 10% chance that random tinkering in the works of a downed eyeball, that has one or more hit points left, will short out the entire network for 1d4 march turns.

NAME: Robot Stalker

TYPE: Robot Stalker

NUMBER: 1d4 ARMOR: 3  
HIT DICE: 12d6 CONTROL: D/G  
SENSORS: A/B/C/E/F-SCENT POWER: A/C72

SPEED:  
PODS = 160/6800/120  
FEET = 36/2700/54

STATUS: Rank

Robot stalkers are a type of security robot used to track down fugitives. They track things by using many different sensors.

Robot stalkers look like three-meter-long mechanical ants. They are one and one-half meters tall. Two lenses in their heads, their primary optical sensors, glow red when they are active. Stalkers can be preprogrammed to track things, to patrol an area, or they can be used as a means of transportation.

These tracking capabilities are used in combination for best tracking. The sensor ranges given are for the primary sensors, located in the head. They operate in a cone 38 degrees wide. Other sensors, on the body, allow 360 degrees of tracking over a range of 25 meters. The above ranges already take into account obstructions, background noise, temperature, visibility, etc.

Stalkers can be ridden. There is a rider's saddle and helmet on the robot's back. Stalkers track just as well with or without a rider. Characters riding a stalker get tracking information through a helmet that has screens inside it. Riders can control stalkers manually and can use any of the stalkers' systems or weapons.

Stalkers' feet can climb slopes of up to 60 degrees. They use their pods to cross steeper slopes and places too rough for their feet. Two laser rifles and two stun guns are mounted on their heads. Each gun has an independent power source that gives it 100 shots. All stalkers have a 100 hit point energy screen. Their weapons will not work while their screen is on. There is a set of pincher-jaws attached to their heads. These jaws can reach out to four meters to grab things. The jaws' pinchers are one-half meter long and have retractable blades inside them.

### PRIMARY SENSORS

- A = Standard Sight and Sound
- B = Infrared (Heat)
- B = Residual Heat
- C = Telescopic Image
- E = Voiceprint
- F = Chemical Trace (Scent)

### RANGE

- 500 meters
- 25 kilometers
- 1 meter (only within 2 hours)
- Line of sight
- 200 meters
- 800 meters (only within 36 hours)

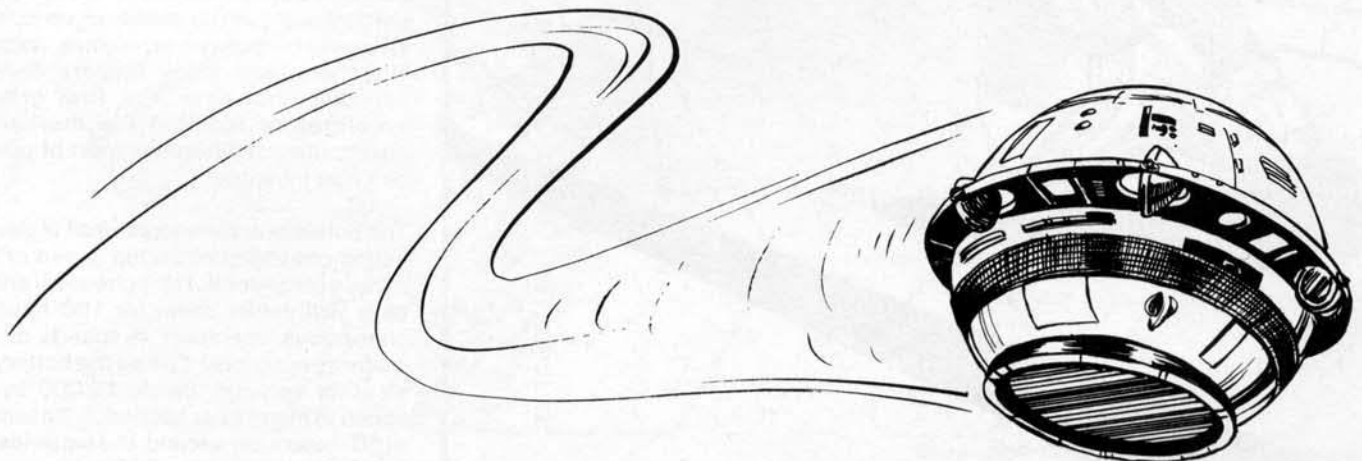

	GARDERIA
	LARGE SETTLEMENT
	SMALL SETTLEMENT
	FARMLAND
	FOREST
	UNKNOWN LANDS

	RIVER
	ANCIENT ROAD
	TRAIL
	TRAVENIX'S COURSE
	JEFERZUN TRAIL
	SUSPECTED ARTIFACT SITE
	LAST KNOWN POSITION OF A LOST EXPEDITION

KEY

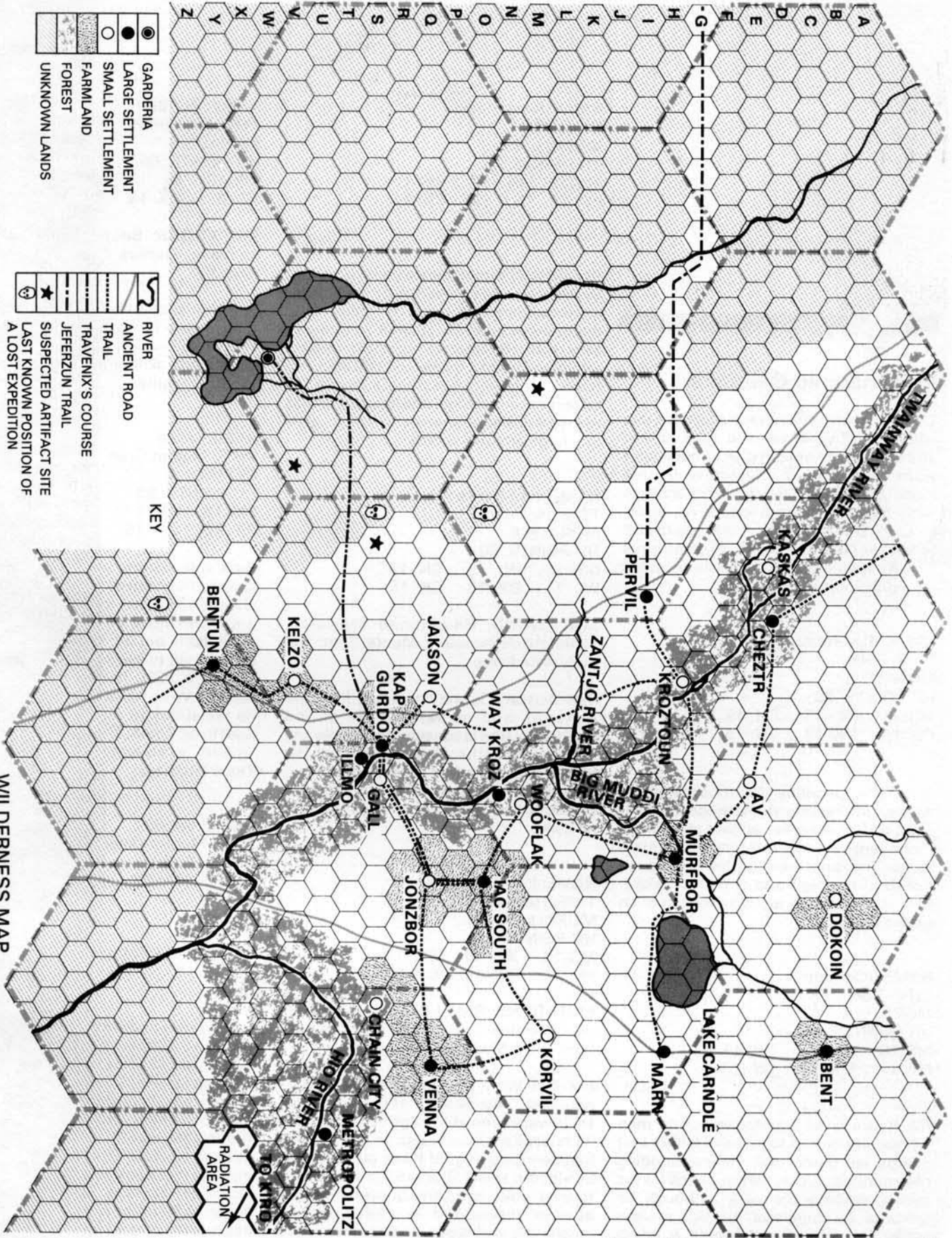

**WILDERNESS MAP**

SCALE 1 LARGE HEX = 44 KILOMETERS  
 1 SMALL HEX = 5 1/2 KILOMETERS

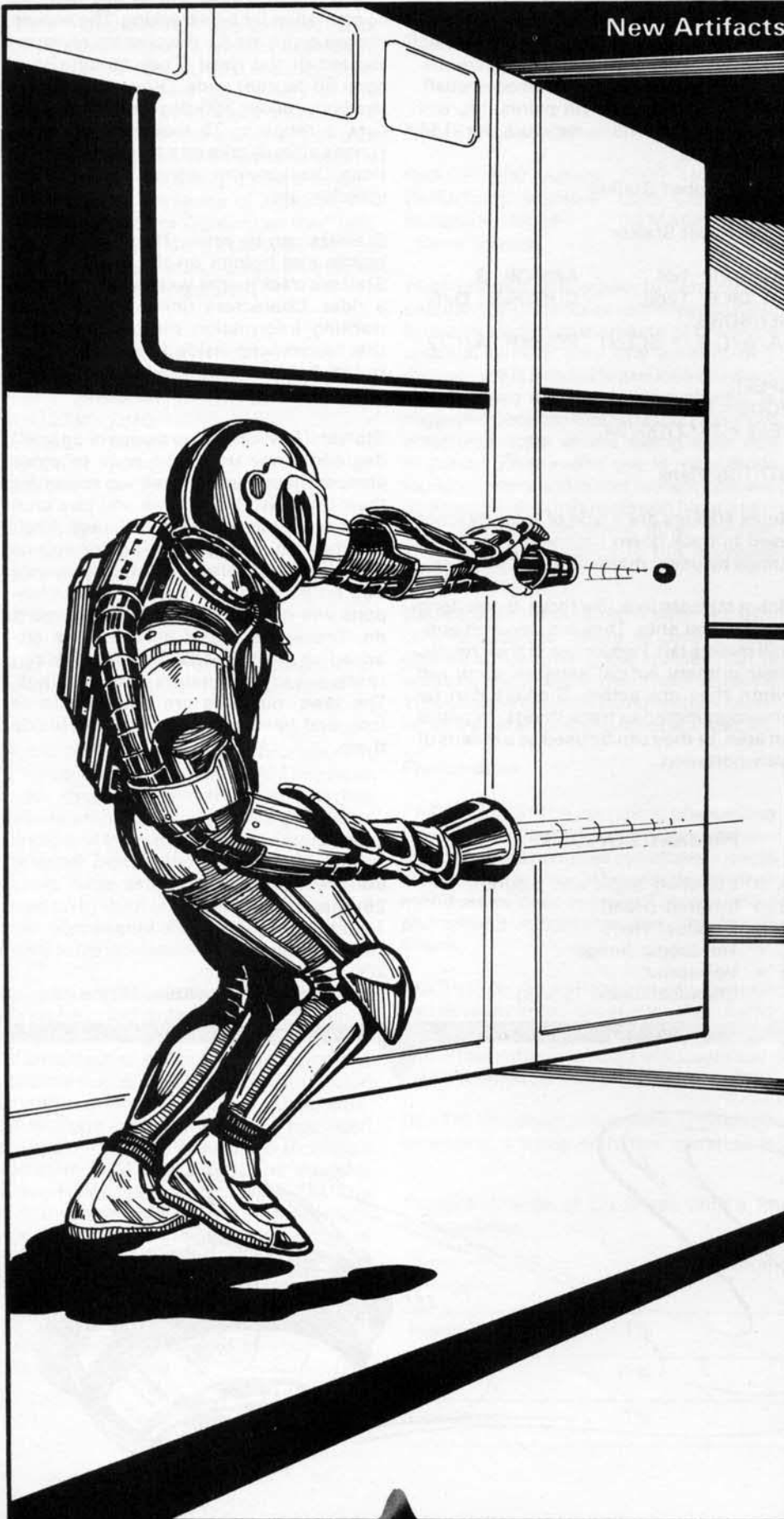
**NAME: Control Nexus Implant**

Control nexus implants are small electronic-organic devices that link living creatures to a computer unit such as a cybernetic installation or a think tank. Each implant is a small button embedded in the skin, sometimes containing a socket for input wires. It can be disguised as a scab, mole, pimple, or any surface mark or blemish. The implant has a number of fibers that connect directly to the nervous system.

Artificial beings, such as androids, and creatures with a mental strength or intelligence of less than five can be fully controlled through an implant. Creatures with mental attributes higher than five cannot be fully controlled, but their physical, emotional, and nervous states can be influenced to cause fear, panic, aggression, or a similar reaction.

Implants can directly withstand eight hit points of damage. Removal or destruction of the implant has the following effects. Fully controlled creatures suffer 1d6+4 hit points of damage and enter a coma after 1d6 search turns. Creatures with a mental strength or intelligence greater than five also take 1d6+4 hit points, but they do not go into a coma. However, they do lose 1d8 points of dexterity (to a minimum of 1) for 10d4 search turns.

**NAME: Gravitic Accelerator**

Gravitic accelerators are devices which use gravity energy to shoot objects through a tube at high speeds. Gravitic accelerators will propel anything placed in their intake tubes. The speed of things shot out can be adjusted by turning the accelerators' power up or down.

The technology of gravitic accelerators was new during the shadow years, and had not been widely used before the Devastation. Plans had been drawn up to use accelerators for transcontinental transports running at top speeds of up to 4000 kilometers per hour, space shuttle launchers, and many military devices. Typically, however, the first gravitic accelerators reached the market for entertainment when the sport of powerball was invented.

The portable accelerators used in powerball shoot objects at a top speed of 100 meters per second. Their chemical energy cells will power them for 100 hours of continuous operation at speeds of 100 meters per second. To find the battery life at other settings, divide 10,000 by the speed in meters per second. For example, at 50 meters per second, the batteries will last for  $(10,000/50) = 200$  hours.



NAME: Ross Medilli  
TYPE: PSH  
MORALE: 8  
HIT POINTS: 95  
MS: 12 IN: 17 CH: 16  
PS: 15 DX: 12 CN: 21

Ross Medilli's intelligence has been noted by the professors at lac South, and he will someday join their ranks. He thinks that doing service for the college is a necessary evil. He intends to avoid danger whenever he can do so, and still keep his honor. However, Ross has a mania for collecting knowledge, and ignores almost everything else whenever he comes upon any large amount of data.

NAME: Ren Dendarvi  
TYPE: Humanoid  
MORALE: 8  
HIT POINTS: 60  
MS: 11 IN: 15 CH: 12  
PS: 7 DX: 13 CN: 15

MUTATIONS: Heightened Precision, Skeletal Enhancement, Mental Control of Body, Will Force

Ren Dendarvi is the champion freestyle wrestler and street fighter of the Unchosen. Ren is considered reliable and trustworthy by the whole community. His friends and superiors expect him to gain rank quickly, but Ren himself is more concerned with just doing what needs to be done.

NAME: L-X-&-R Waitt  
TYPE: Humanoid  
MORALE: 8  
HIT POINTS: 52  
MS: 12 IN: 13 CH: 14  
PS: 11 DX: 13 CN: 13

MUTATIONS: Bodily Control, Regeneration, Genius Capability (Mechanical), Confusion, Magnetic Control

L-X-&-R Waitt's unusual name is pronounced "Alexander." His mechanical skills were seen at the age of three when he figured out how to use an artifact that had seriously injured three other people by electric shock. The artifact turned out to be a video amusement system. He is always interested in checking out machinery of all types, and has mutations that help him.

NAME: Bo Tenn  
TYPE: Humanoid  
MORALE: 8  
HIT POINTS: 65  
MS: 10 IN: 11 CH: 21  
PS: 8 DX: 14 CN: 18

MUTATIONS: Sound Imitation, Speed Increase, Genius Capability (Political), Empathy

This charismatic humanoid is named after a legendary heroine of the pre-Shadow Years era. She is a good mediator, and is particularly skillful in persuading people to work together.

NAME: Virea  
TYPE: Mutant Gren  
MORALE: 8  
HIT POINTS: 93  
MS: 18 IN: 14 CH: 13  
PS: 19 DX: 15 CN: 19

As a rule, Grens shun technology and keep to themselves. However, Virea was abandoned as an infant by a Gren tribe and was raised in lac South. This was done both out of kindness and as an experiment to see if Grens could become part of a PSH, humanoid, and mutant society. Virea has adapted well, and has no racial ties to the Green Men; she is loyal to lac South. The name, Virea, means "green" in an almost-forgotten Shadow Years language.

NAME: Spokker  
TYPE: Mutant Ocelot  
MORALE: 8  
HIT POINTS: 43  
MS: 14 IN: 8 CH: 13  
PS: 11 DX: 18 CN: 11

MUTATIONS: Infravision, Modified Body Parts (Hands), Heightened Balance, Directional Sense, Mental Shield

Spokker is a mutant ocelot, who inherited the keen senses of his feline ancestors and acquired some of the advantages of humanoid form. Spokker can walk upright or run on all fours. His modified body parts mutation gives him hands with retractable claws. From a distance, it's easy to mistake Spokker for a Jaget, a mistake that Spokker does not appreciate. However, Spokker is the equal to any Jaget in hand-to-paw combat. Spokker has a lively and somewhat bizarre sense of humor.

## Pregenerated Characters

These are characters that players can use with *The Mind Masters* if they do not already have characters, or if they don't want to use their characters in this module. These are beginning characters with basic attributes and brief backgrounds. Some non-PSH characters should follow the GAMMA WORLD® game rules to roll mutations. This module provides for equipping the characters.

NAME: Tiss Tervu  
TYPE: PSH  
MORALE: 8  
HIT POINTS: 65  
MS: 15 IN: 15 CH: 12  
PS: 14 DX: 14 CN: 16

Tiss Tervu provides the scholars at lac with an interesting study, since her eyesight and hearing are almost as keen as those senses in mutants with heightened sense. Tiss is not mutated, her senses are simply at the high end of normal range. She is using her skills to become an expert tracker.

NAME: Rik Hanni  
TYPE: PSH  
MORALE: 8  
HIT POINTS: 77  
MS: 20 IN: 11 CH: 17  
PS: 17 DX: 15 CN: 17

Rik Hanni is an aggressive young man whose ambition is to join the militia that guards lac South and the surrounding communities. Rick is well qualified for the militia, perhaps too well. Although he tends to be impulsive, he has a keen sense for danger and avoids it when necessary.

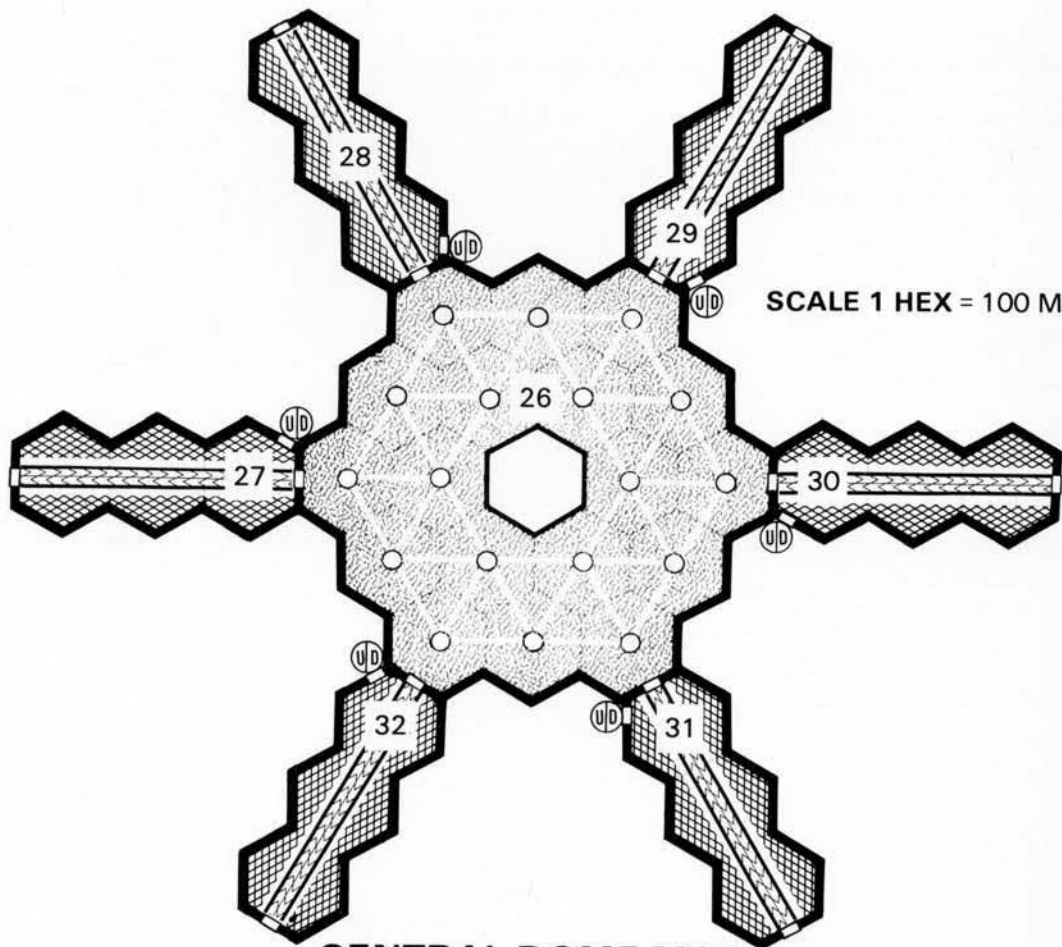

SCALE 1 HEX = 100 METERS

CENTRAL DOME MAP

# DORMITORY LEVEL MAP

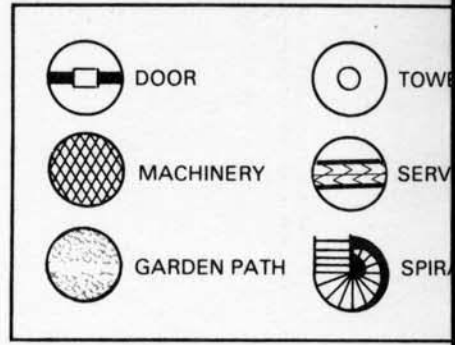
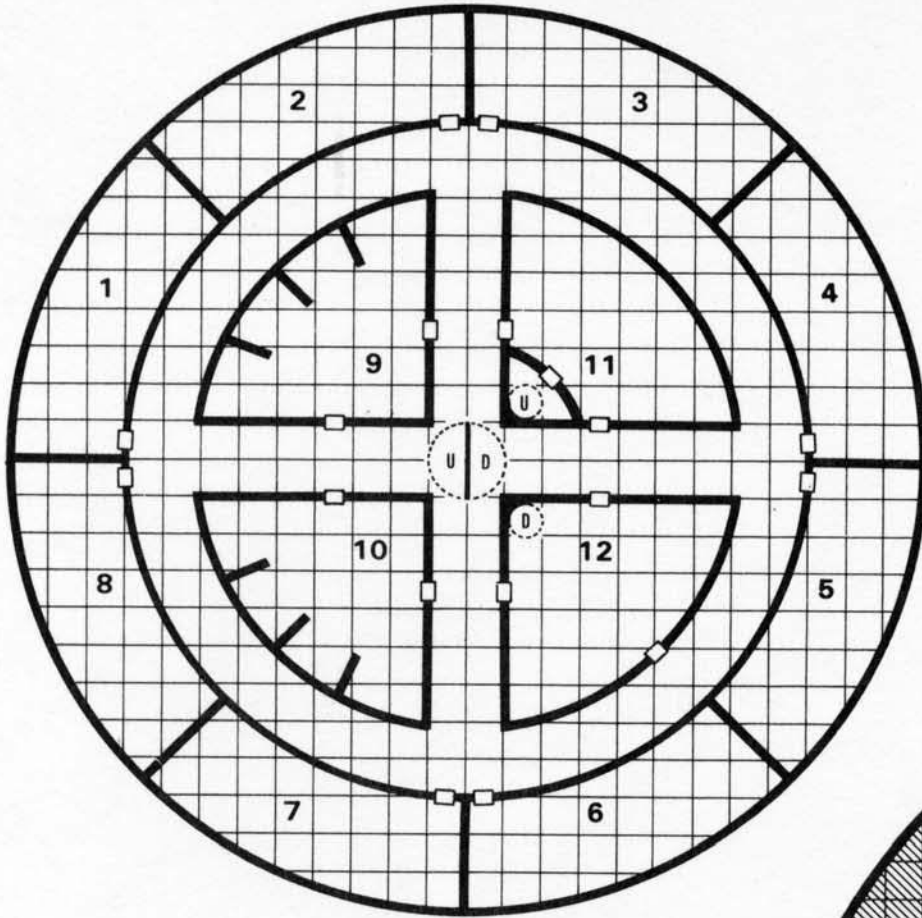

SCALE 1 SQUARE = 2 METERS

# RECREATION LEVEL MAP

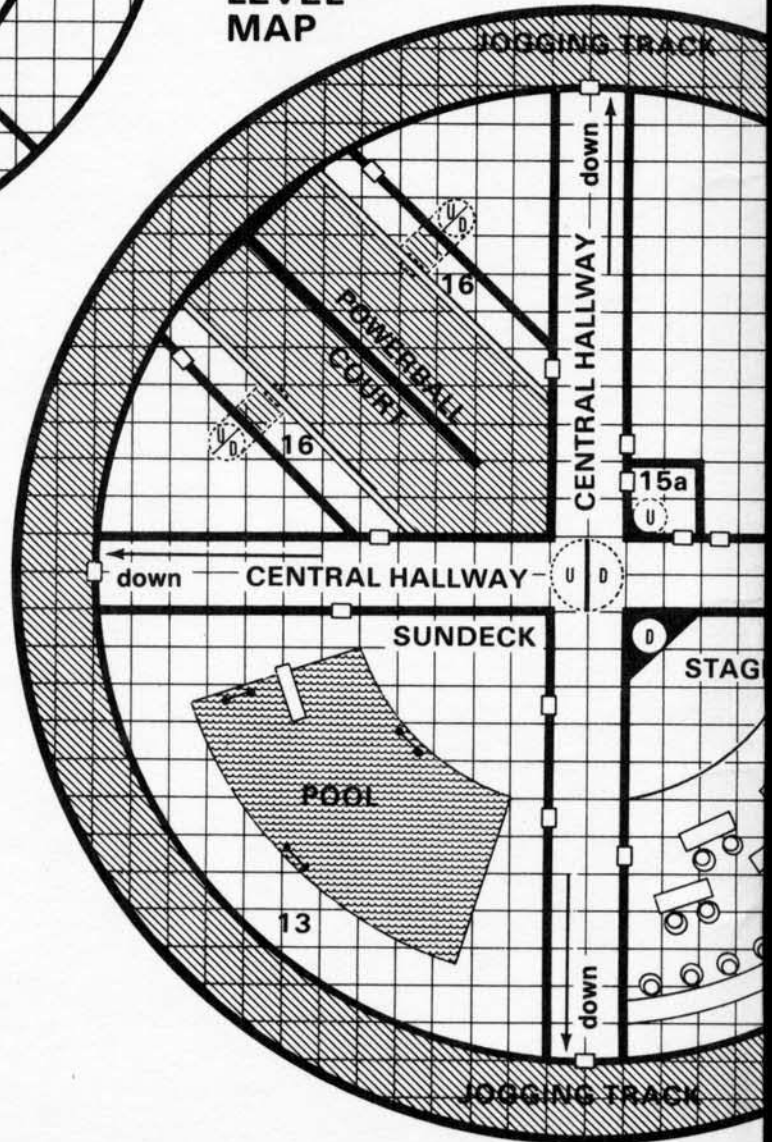

N

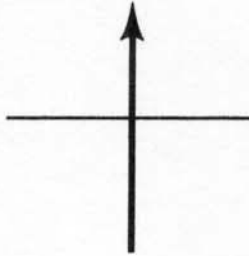

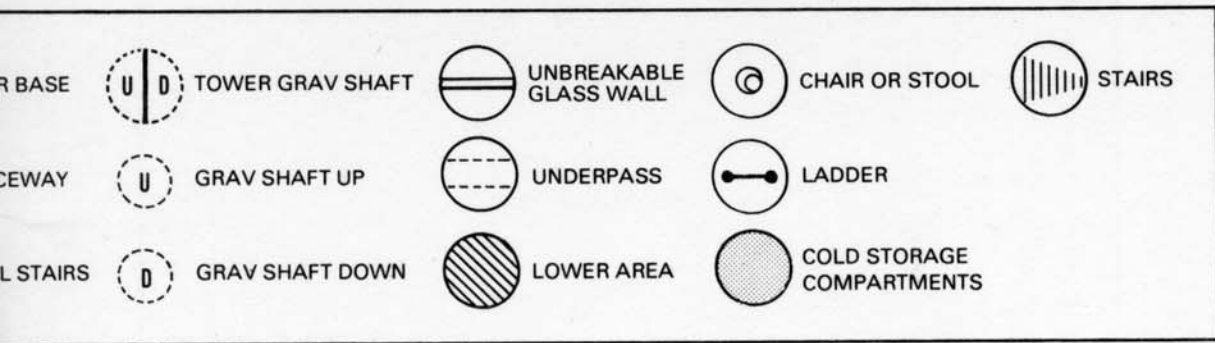

### CLINIC LEVEL MAP

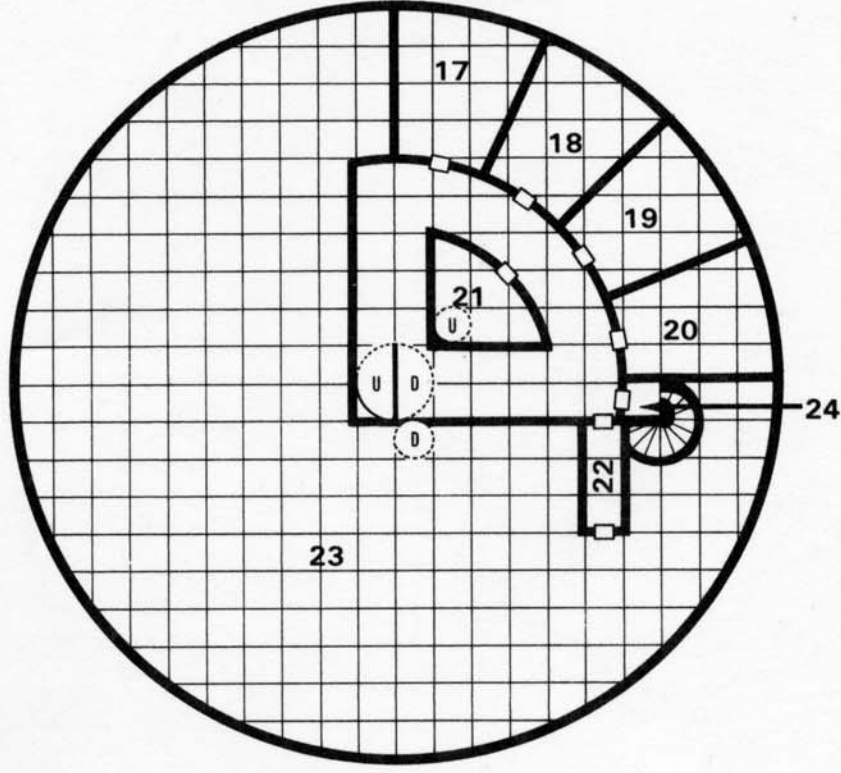

### EXAMINATORIUM LEVEL MAP

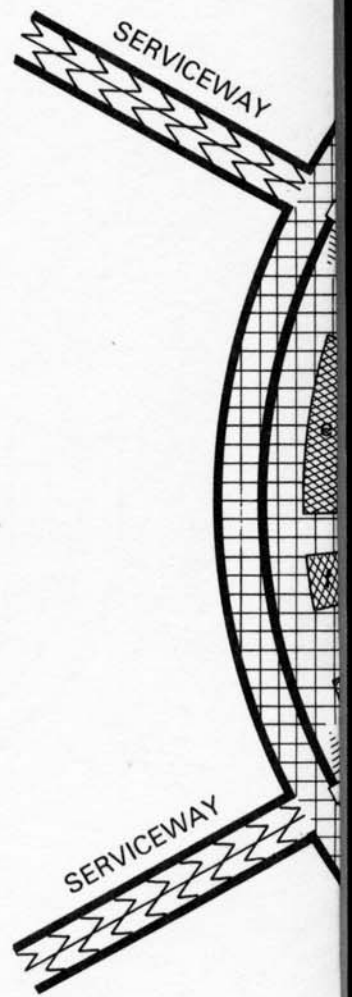
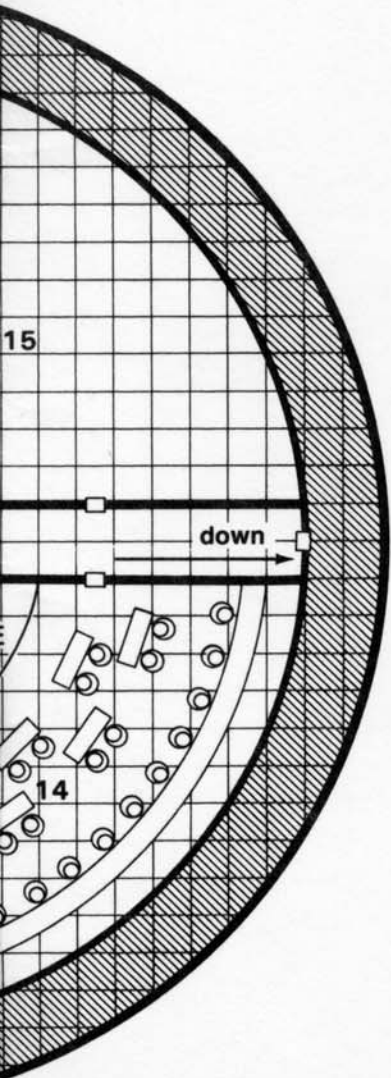
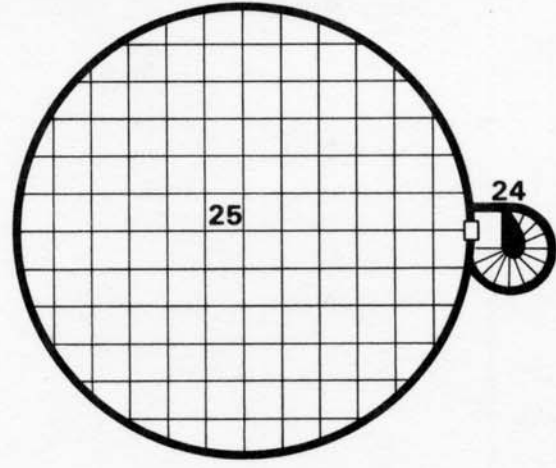

SUBLEVEL  
MAP

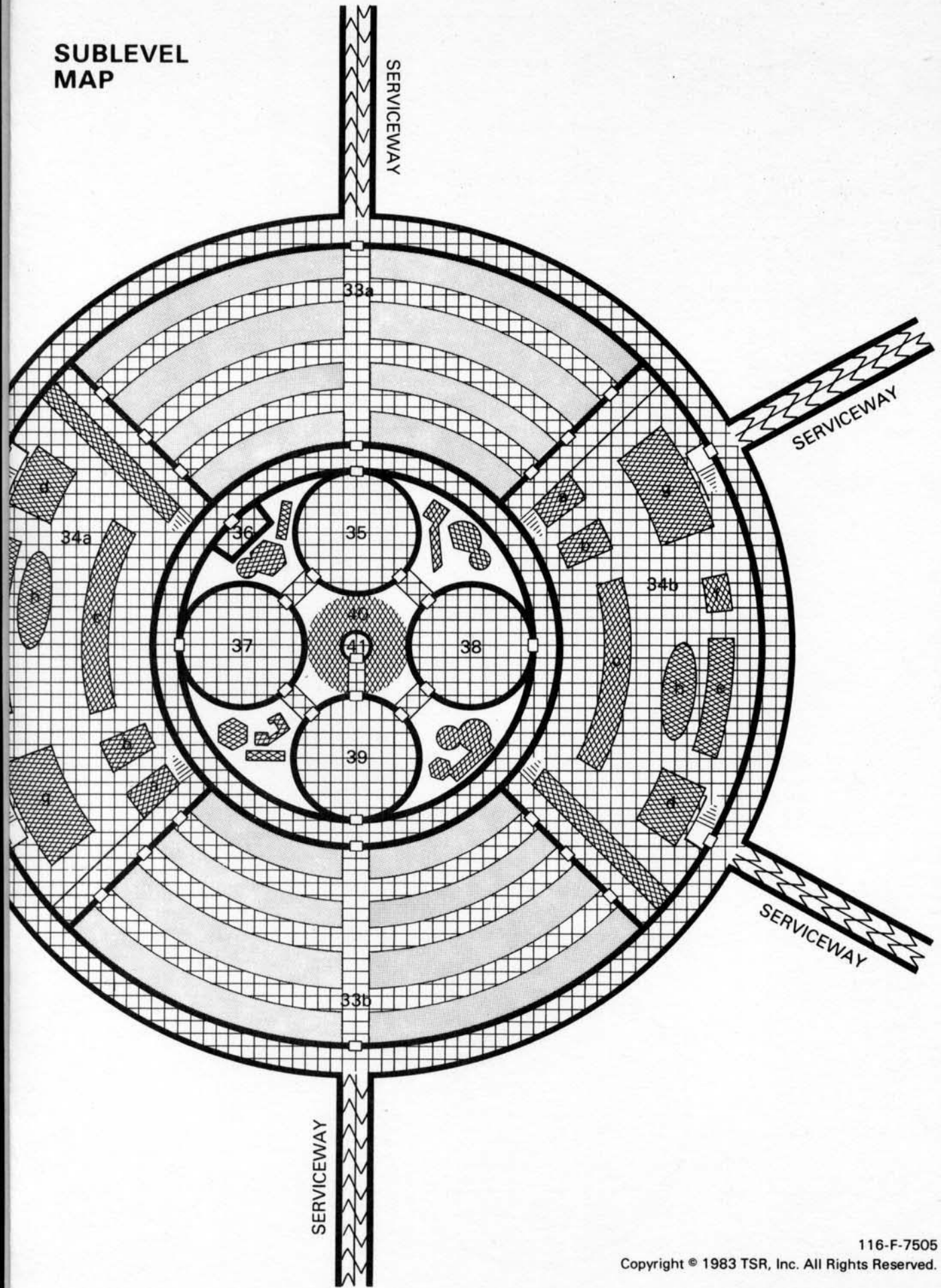

The first summons of the new season is called.

Your name is drawn—you join the expedition.

Your mission is to investigate rumors of a stockpile of ancient artifacts. Following a sketchy map, you cross the great river Twainway the day after leaving your settlement. Two days later, in unexplored wilderness, you encounter hostile nomad tribes. After finding traces of a lost expedition, you know you're on the trail of something big. And then you find it, hidden down in a valley, forgotten and untouched since the Devastation.

You were searching for a great store of artifacts. Here it is. The whole valley is an artifact!

Do you take the news back now, or go in to learn more?

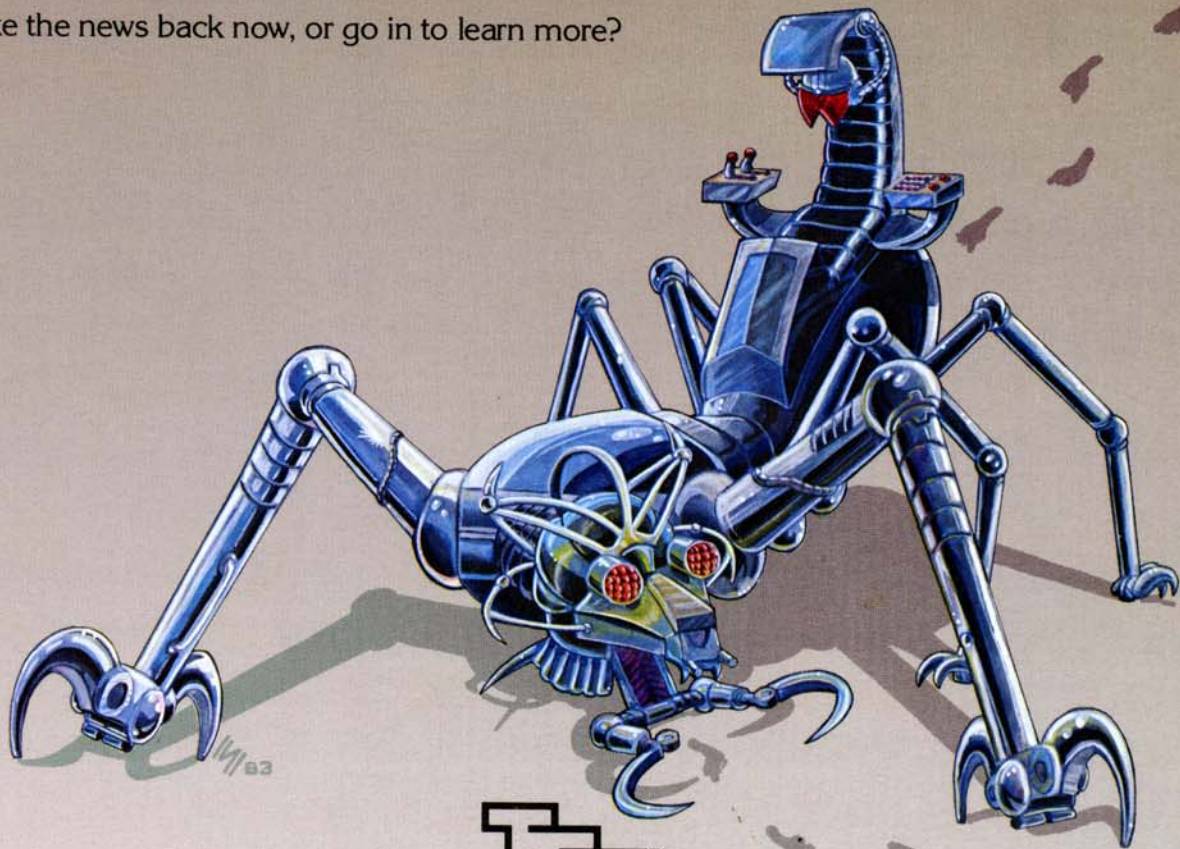

TSR, Inc.  
POB 756  
LAKE GENEVA, WI 53147



**TSR, Inc.**  
PRODUCTS OF YOUR IMAGINATION™

TSR (UK) LTD.  
THE MILL RATHMORE ROAD  
CAMBRIDGE CB14AD  
ENGLAND

ISBN 0-88038-029-2  
394-53418-2TSR0600

Printed in USA.



7505