

# 1

# OVERVIEW

Welcome to a flight into the bizarre . . .

Tonight the adventurers will board a commercial airliner for a cross-country trip, the kind made by students and businessmen every day of the week. Only, for these people, on this aircraft, life is about to take on a whole new dimension.

*Flight 13* can be played as an adventure using only the rules in *GURPS Basic Set*, (Third Edition). Material from *GURPS Horror* can be incorporated for additional campaign possibilities. The game can also be played as a futuristic scenario using *GURPS Space*. The airliner becomes a space-shuttle; two new alien races are in this book.

This adventure is intended for three to six 100-point characters. Almost any kind of character is welcome, so long as he has an excuse for traveling on the flight.

Unfortunately, this is as far as you can read in this book, unless you are the Game Master. To read any further will betray the mystery before it even begins to unfold.

## Designing Player Characters

The following suggestions may be useful for a character created specifically for this adventure.

### Advantages

Adventurers will find any of these Advantages useful: Acute Vision, Alertness, Clerical Investment, Danger Sense, Legal Enforcement Powers, Luck, Night Vision, Peripheral Vision, Psionic Powers (any), Rapid Healing, Status, Strong Will, Toughness.

### Disadvantages

These Disadvantages should prove entertaining: Addictions, Alcoholism, Cowardice, Delusions (particularly odd political beliefs — the Commies will attack, the Rockefellers run New York, and so on), Dependents (especially if they travel with you), Greed, Honesty, Lane, Overconfidence, Pacifism (self-defense only), Paranoia, Phobias (any), Squeamishness, Unluckiness, Weak Will.

### Skills

Parties will be appreciative of members with any of these skills: Acrobatics, Animal Handling, Anthropology, Archaeology, Astrology, Computer Operation, Detect Lies, Diagnosis, Driving, Escape, Fast-Talk, First Aid, Gesture, History, Interrogation, Leadership, Lock-picking, Mechanic, Occultism, Physician, Physics, Piloting (aircraft/ spacecraft), Psionics, Psychology, Running, Scrounging, Shadowing, Stealth, Survival, Tactics, Theology, Tracking, Zoology, and all combat-related skills.

## PLAYERS: READ NO FURTHER!

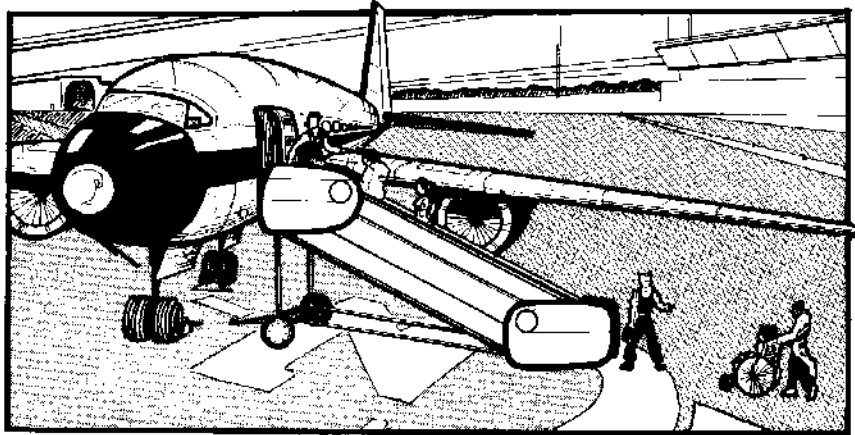

## Organization of This Book

This *Overview* provides you with a brief synopsis of the adventure, and some suggestions for how to run it. Read this first.

Next comes the *Adventure*. It is divided into dramatic episodes, or chapters. Each chapter begins with a convenient list of pre-game preparations. After each episode, some background material for that part of the adventure is provided.

### The Situation

Think of this adventure as a struggle between titanic forces.

**The Markann:** A coldly cerebral race intent on finding the capabilities of other intelligent races — by kidnapping specimens of each species, and subjecting them to lethal experiments!

**The Pseudo-Humans:** Thanks to the super-technology of the Markann, these biological constructs look and act just like humans — perfect subjects for Markann experimentation!

**The Rogue Scientists:** Some Markann have secretly rebelled against the strict research code of their elders — they have the same goals as their fellow scientists, but even fewer scruples! The regular Markann scientists are content to observe the strange situations they create; the Rogues intervene directly to stimulate their subjects into interesting reactions.

**The Random Element:** The crew and passengers of a lost airliner are the Rogue ingredient in what was supposed to be a routine Markann experiment.

### *The Tie-Up*

Markann investigators, searching the galaxy for intelligent life, discovered the planet Earth in the 1980s. Their sensors captured everything about the world which they considered important. In particular, they took a sensor “snapshot” of a small human city — a perfect recording, one which they could recreate on a distant world for further study.

Time passed — perhaps centuries.

The 20th-century human city, encapsulated in the sensor shot, is reconstructed and populated with Pseudo-Humans — constructs molded to human form and “printed” with recorded human personalities. Markann research teams divide the city into sectors, where each will pursue a program of study that most other civilizations would consider diabolical . . .

### *Enter the Adventurers*

Wishing to add a random element to an otherwise routine experiment, the secret band of Markann Rogue scientists bring a commercial airliner filled with unsuspecting victims into the experiment, several hours after the official “re-search project” has begun.

In a modern-day campaign, the adventurers were “snapshot” (or kidnapped) by the Markann while on a routine cross-country flight. They have now been reconstructed on (or transported to) this alien planet.

In a futuristic campaign, they were “snapshot” (or kidnapped) by Markann observers stealthily monitoring a peaceful planet. The adventurers were on a commercial shuttle, descending into atmosphere . . . and have now been reconstructed, here on this distant world.

The adventurers are not aware of any “lost time” in their lives — as far as they are concerned, their flight is normal until a storm suddenly pops up.



### *The Plot*

Entering the storm, the aircraft’s crew discovers that they have lost all contact with ground-based controllers. Lost in the strange weather pattern and disturbed by the sudden fly-by of an unidentified flying object (the Rogues’ research ship), the passengers should be thoroughly shaken by the time a “friendly” air controller (another Rogue) radios the craft and guides it in for a landing.

The travelers will be shocked to find the airport abandoned; futuristic characters will be surprised to find themselves apparently dislocated in time (back to the 20th century). Meanwhile, their fellow passengers will cause their own disturbances.



### *Starting Equipment*

GMs: Before play begins, have the players organize each character’s possessions into three categories:

1. *Carry On.* The items an adventurer has on him, plus whatever he can fit in the overhead compartment of an airliner or shuttle.

2. *Baggage.* The items which the character takes on this routine flight. If he exceeds the limit (70 lbs.), he must pay for excess baggage.

3. *Left Behind.* All items not included in #1 and #2 must be left at home or at some other “base.”

Airline security will not allow firearms and explosives onto the flight. The GM decides what gets past security, and what doesn’t.

Characters must also specify where their money is; in cash and on their person, at a bank, or at some other location.

*Remember:* This is only a routine flight. The GM may require an IQ-5 roll for any PC before he can bring an odd or exotic piece of equipment with him. If he fails the roll, he never thinks of bringing the item along.

### *Magic, Psionics and Aliens*

If the GM wishes to allow magic or psionics in his campaign, then spell-casting or psionic characters are welcome in this adventure. Futuristic players may use any aliens allowed by the GM.

## ***Keeping the Adventure On Earth***

If the GM does not want to duplicate the PCs or take them off Earth, here's an alternative that keeps the adventure intact. It can therefore be used in any campaign without permanently changing its course!

The Markann built their duplicate "City of Austin" in the middle of the *Rub al'Khali* — the "Empty Quarter" of the Arabian desert. This untracked wilderness contains nothing but hundreds of thousands of square miles of rock and sand. Weather-control devices kept the sand pushed back, and the temperature and humidity at an appropriate level.

Flight 13 was captured intact and teleported to the duplicate city. Therefore, all the PCs remain their "real selves," and will not melt back to protoplasm as the experiment ends. Instead, they will be left in a deserted city, rapidly being reclaimed by the desert.

Once the Markann are gone, it will be possible for the PCs to pick up radio transmissions from outside. Most of what they get will be in Arabic (which most North Americans won't recognize), but there will be a few transmissions in English — enough to reassure them that they are still on Earth. However, they will be unable to transmit calls for help.

As the desert sands move back in, overwhelming the suburbs, they will have to escape. They could attempt to leave by ground, but few people have the experience to cross the Empty Quarter alive — even if they can loot a whole city for equipment! Common Sense should reveal that to at least one party member.

So they will have to fly. If none of the party's survivors have the appropriate skills, the GM may create a pilot NPC — another human from Flight 13 — who has been hiding at the airport. At least one small plane will be airworthy.

Note that this variant allows the PCs to profit from their adventure, if they think to loot Austin's banks or jewelry stores before they leave! But there will be no returning; the city will be totally swallowed by the sands and untraceable before anyone can get back.

If the travelers venture into the city, they will blunder into the experiments of the "normal" Markann scientists: flesh-eating toddlers, mists of anger, and hordes of transforming killers. If the PCs don't explore of their own free will, the Rogue scientists will attempt to push them from situation to situation, monitoring their reactions. And as time goes by, the city humans — actually Pseudo-Humans — will begin to regress to their natural form.

As the plot reaches its climax, the traditional Markann will begin to realize what the rebels have done. As fighting breaks out between scientist and rebel, can the PCs escape this planet?

## **Your Options**

To tailor this adventure to an ongoing campaign — and to keep the players guessing — you must choose one of the following options concerning *what* the PCs (and their fellow passengers) are.

### ***Option #1: Kidnapped Humans***

The Rogue scientists stole the PCs, aircraft and all, and kept them in stasis until they were wanted.

The aircraft mysteriously disappears, leaving no trace — yet another baffling mystery. Optionally, the Rogues might fake wreckage to divert curiosity.

In a futuristic campaign, there may be an interstellar search for the missing shuttle, especially if aliens are suspected. One possibility is to raise the status of one of the passenger NPCs to guarantee interstellar concern. This might not bring the Space Patrol to the rescue, but searching patrol cruisers might be within communications range.

**Advantages:** Avoids the problems of "double" characters.

**Disadvantages:** It is almost impossible to return kidnapped modern-day victims to their original campaign — they are lost in *time* as well as in space.

### ***Option #2: Pseudo-Humans***

The PCs and their fellow passengers are not humans at all, but are Pseudo-Humans with the PCs' personalities superimposed. In time, the transformation will begin to regress — bringing a final moment of terror when the PCs realize they are not what they think they are . . .

**Advantages:** The PCs aren't the "real" player characters — they never left home. (Be sure to secretly preserve the pre-adventure character sheets.)

**Disadvantages:** Creates doubles for every PC — the character on the original planet, and the reconstructed copy on the Markann world. Also introduces new technology to the campaign. Some PCs may not survive regression.



### ***Option #3: "Stable" Pseudo-Humans***

Here, a technological breakthrough by the Rogue scientists is postulated — the ability to create a permanent Pseudo-Human.

**Advantages:** As above, and does away with the "surviving regression" problem.

**Disadvantages:** As above. Also avoids the fun of regression.

# THE STORM

# 2

**Synopsis:** The adventurers board Flight 13, meeting some of their fellow passengers in a variety of encounters. The aircraft flies into a violent storm. When a Markann spacecraft makes a close pass, the pilot has a heart attack and the plane goes into a nose dive — the PCs must save the day.

## Boarding the Flight

Nothing important happens until the aircraft flies into the mysterious storm — at least, nothing that advances the plot. But there's more than plot to this adventure.

The short roleplaying encounters which follow allow one-on-one encounters between PCs and NPCs. They start from arrival at the airport, and continue right up to the storm, helping to narrate the flight and make it real to the players.

There are two ways to use these encounters:

**Planned.** Match specific encounters to specific PCs. If Wrambo the Vietnam Vet needs to run into the peace-militizing social workers, it happens. Select one encounter for each PC (trying to select one encounter from each grouping), and run the encounters in the same order as they are presented in this book. If the PCs enjoy the encounters, run extra encounters.

**Random.** The *Random Encounter Chart* (see sidebar, p. 9) allows rolling dice to select encounters.

Above all else, keep the action fast and entertaining. If the players are bored, move to another encounter — and if they're still bored, bring on the storm!

## Passenger Encounters

These NPCs are described in the appendix, starting on p. 61.

### Arriving at the Airport

#### *The Near-Miss*

Ask how the PCs arrive at the airport: by shuttle bus, taxi, personal car or whatever. They may come as a group, or separately. Describe the drive to the terminal: the ranks of airport parking lots, congested traffic, air freight buildings, hotel courtesy vans . . .

Then, suddenly: "A van swerves into the lane in front of you!" The driver of the PC's vehicle must make a Driving roll to avoid collision. If the vehicles collide, the damage is minor.

The van is a colorful spectacle: battered, hand-painted, spilling out a half-dozen peace activists in torn T-shirts and faded jeans and several nuns in traditional attire (see *Nuns/Pacifists* on p. 62). A banner proclaims "Save The Children," while buttons read "U.S.A.: Get Out" and "Say 'Yes' to Love."

The nuns apologize, introduce themselves, and provide insurance information (and first-aid) if needed.

### At the Ticket Counter

#### *The Escape*

Arriving at the airline counter to collect their tickets, the PCs must stand in line. They notice a man approach with six leashed dogs, of varied breeds and sizes. When he is bumped by a hurrying businessman, a poodle breaks free and runs in the PCs' direction, trailing its leash.

"Mitzi, Mitzi!" yells the man.

#### *Nuns/Pacifists*

#### *Animal Trainer*

## Pre-Game Preparations

1. Decide where Flight 13 is coming from and going to.
2. If the "planned" encounter method is to be used, match PCs and encounters.
3. Select the identity of the Rock Star NPC.

## Get The PCs To Sit Together

If necessary, "bump" the PCs from their first-class seats so that everyone is in coach class (or vice versa — this can be fun if roleplayed). If all of the adventurers are in the same compartment, the action during the storm will be easier to stage.



## "How Did I Get Here?"

Help the players decide why their characters are on this flight.

Another adventure can be merged with this one. The PCs might receive a letter offering them an occult research assignment in Guinea (or some other exotic locale).

Futuristic characters always need to make planetfall for one reason or another. Many civilized planets would rather have visitors ride registered shuttles to the surface than let foreign spacecraft land. Government regulations, research, and financial dealing too sensitive to be conducted other than in person, are all good excuses for going dirtside.

## **Futuristic Encounters**

### **The Near-Miss**

Flight 13 departs from an orbiting space platform. The potential collision is between the PCs' ship and a ramshackle converted freighter with defective instrumentation. The nuns are aliens.

### **The Escape**

The creatures aren't dogs — they are gnossi, yellow-feathered simians with flexible tapir-like snouts (see p. 62).

### **An Overheard Conversation**

Instead of the conversation, the agent hands the pilot a sheet of paper. Looking worried, the pilot walks away — dropping the paper.

Any PC grabbing it will find that it is a recall notice for an artificial heart, registered to someone named Lester Morgan. The heart valve assembly has a tendency to "freeze" under stress, causing the equivalent of a heart attack.

### **Lost Little Girl**

No changes.

### **High Pressure**

The flight engineer jokes about how far off course high winds could deflect the shuttle.

### **Purse Snatching**

It isn't a purse — it's a credkey. The copilot is marrying a starship owner's daughter.

### **Recognition**

No changes.

### **Water Attack**

No changes.

### **An Interested Traveler**

The "wheelchair" is actually a small levitation unit.

### **Seat Wars**

No changes.

### **Falling Drunk**

No changes.

### **VIP Entrance**

Shuttles don't taxi — rather, the docking cylinder is re-extended.

### **Clutching Trouble**

The shuttle maneuvers gently clear of the station.

### **Refreshments**

The shuttle has begun its descent.

### **On the Line**

The shuttle passes from day side to night side. The "phone" is a vidphone relayed through satellites, and can reach anywhere on the planet or within orbit.

If any PC wishes to help, let him make a DX roll or an Animal Handling roll (at a +3 bonus — this is a friendly animal). If he succeeds, he catches the dog and receives the profuse thanks of the trainer, who explains about his life in the circus and the abilities of each of his animals (see *Animals*, p. 62). If none of the PCs catch the dog, the man and the dog disappear from sight through the crowd. Later, tell the character that the same man is on the aircraft.

### **An Overheard Conversation**

Standing in line at the airline counter, the PC notices a uniformed man push through the crowd. (Any character succeeding at an IQ roll recognizes the man as an airline pilot.) He speaks with an airline employee, who hands him a small container.

Have the nearest PC — choose one randomly — make a Hearing roll. If he fails, he hears nothing. If he succeeds, he overhears the ticket agent say, "Your heart medicine, Captain Morgan." (Morgan is Flight 13's pilot.)

### **Lost Little Girl**

A ticket agent is processing the PC's paperwork when a sobbing 3-year-old comes to the desk. She clasps the character about the knees, crying, "I'm lost." The airline employee pages the girl's parents, leaving the adventurer with the girl.

If he tries to comfort the child, have him roleplay the action — then decide which of the following skills was used: Diplomacy, Fast-Talk (tricking or distracting the kid), Bard (telling stories), Singing, or — if nothing else applies — IQ (with a -5 penalty). Empathy advantage provides a +2 bonus to the skill roll. If he succeeds at the skill roll, the girl calms down and is very talkative, asking curiously about the PC. She trustingly answers all questions put to her.

After several minutes, the paging system makes an announcement and the girl's family shows up: father, mother and the girl's seven-year-old brother (see *The Children*, p. 61). They thank the PC, and scold the girl for wandering off.

### **High Pressure**

As the airline attendant hands the PC his boarding pass, a uniformed man emerges from the office behind the counter, talking with an airline employee.

Have the nearest PC make a Hearing roll. If he succeeds, the PC overhears the conversation. The flight engineer is very worried about a high-pressure ridge on the latest weather reports, and makes a feeble joke about what tornado-force winds could do to an aircraft. If the PC fails the roll, he notices only that the man looks very worried.

This is a red herring. The weather front is in the wrong direction, and is of concern to this airline employee only because he owns a beach house there. The flight engineer is worried because he *always* worries (see *The Flight Engineer*, p. 61).

### **At the Security Barrier**

#### **Purse Snatching**

The PCs are halted at the security barrier, beyond which only ticketed passengers and authorized personnel are allowed. They witness an emotional scene — a young, attractive woman slaps a uniformed man, then runs into the terminal, dropping her purse. The man doesn't see the purse fall as he stalks away.

If any PC grabs the purse and runs after the woman, she sees him and claims her purse. Grateful, she pours out her heart — the copilot is her boyfriend, but he is marrying an Italian shoe-manufacturer's daughter for money. The story is long — have the player make an IQ roll. If he fails, he is late for the flight and is assigned a different seat; otherwise, he notices his peril and is on time.

### **The Pilot**

### **Vacationers**

### **The Flight Engineer**

### **The Copilot**

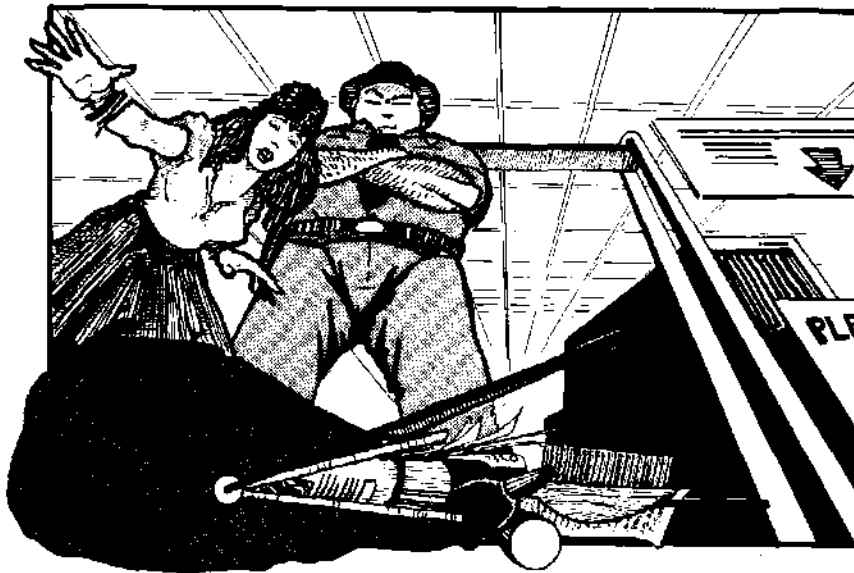

If any PC tries to steal the purse, have him make a Sleight of Hand roll (at -5 — this is a security area, watched by live guards and recording cameras). If he fails, a guard relieves the PC of the bag. If he succeeds, the PC may keep the purse — which contains \$500 in cash.

If the PCs do nothing, a security guard eventually picks the purse up, asking the PCs if they know anything about it.

### *Boarding the Plane*

#### *Recognition*

As the characters board the plane, the head stewardess greets them and checks their boarding passes. As she takes one adventurer's pass, she smiles pleasantly. "What a surprise! It's been years . . ."

The stewardess believes that she and the PC went to the same school years ago. (Whether this is true is up to you — if he's the last survivor of Atlantis, the stewardess is probably wrong . . .)

If he denies the relationship, the stewardess insists that she's right — and grows suspicious of the PC.

#### *Water Attack*

As the characters move along the aisle toward their seats, a young boy pops up from behind a seat and draws a bead on one of them (select one randomly) with a water pistol.

Have the PC make a Dodge roll. If he fails, he takes a faceful of water (no damage).

An efficient stewardess quickly grabs the boy and belts him into his seat. "They're orphans," she explains, indicating the girl and boy. "Difficult children." The little girl sticks her tongue out at the adventurer.

From now on, the orphans take a special interest in this PC, following and pestering him.

#### *An Interested Traveler*

As the PCs belt themselves in, a stewardess assists a young woman down the aisle in a specially-built, airline wheelchair. When a passenger asks for a pillow, the stewardess stops to get one from an overhead compartment . . . leaving the young woman parked beside one of the PCs (select one randomly).

#### *The Chief Stewardess*

#### *The Orphans*

#### *The Wheelchair Lady*

### *Destination: Terror*

Where is this flight going? It really doesn't matter — but don't let the players figure that out! Since it will be interrupted, for plot purposes it can start anywhere and lead anywhere.

As a default, make it a transcontinental flight from San Francisco to Atlanta.

Flight 13 is intended as an evening flight, but it doesn't have to be. Adventurers on a daylight flight who find themselves landing after the storm at a night-shrouded airport must make an additional Fright Check!

The flight does not need to overtly be the city captured in the Markann "snapshot." The Rogue Markann are the ones who really transport this aircraft, and it travels light-years. When the passengers find themselves hundreds of miles off their flight path, they *should* be suspicious — "What? This is Pittsburg? But California Airways doesn't fly east of Colorado!" (Make a Fright Check, please . . .)

What airline is operating this flight? It doesn't matter — as a default, let it be "Trans Globe Airways"



## *GMing the NPCs*

*Make the NPCs interesting.* Try associating each NPC with a friend or celebrity — any personality that can easily be pictured. Then, when roleplaying that NPC, imagine the chosen person playing that role. Think of it as casting imaginary people in the adventure. This technique can make GMing more vivid.

*Make the NPCs memorable.* Make sure the PCs know who they are talking to. Perhaps they won't remember the name, but there should be something about the character that sticks in the memory — even if it's just “the lady in the wheelchair” or “the old man who keeps snapping his fingers.”

A wide variety of NPCs have been supplied. Some, but not all, recur in the story as presented here. The rest are left for the GM to use as needed; many have special abilities that can help to advance the adventure. Complete descriptions of the NPCs appear on pp. 61-62.



“Have you noted the emergency exits?” the wheelchair woman asks, striking up a conversation. Though not morbid, she believes in knowing her options — just in case disaster comes her way. She is an avid flyer, and talks excitedly about airline disasters until the stewardess moves her on.

### *Seat Wars*

### *Businessman*

A somber figure in a dark suit comes to the PCs' row, looks at his ticket, then signals for a stewardess. “This person is in my seat,” he protests, singling out one of the characters (select one randomly).

When the stewardess tries to find out what the problem is, the businessman loudly proclaims his need to reach an important convention in time. At length, the stewardess admits there has been an error and asks the adventurer to change seats and let the businessman have this one.

If the character agrees, the stewardess is his friend for the rest of the adventure. This can also be worked into a love interest. If the PC resists, roll for the stewardess' reaction to each (the businessman is Status Level 3). The one with the better reaction keeps the seat. In the event of a tie, the argument continues while tempers flare and an impatient pilot waits for takeoff — roll again.

### *Falling Drunk*

### *Eagle Legionnaires*

Three conventioners reel down the aisle. They have been partying right up to flight time — they are very “happy” just now.

Randomly select a PC, and have him make an IQ roll to notice his danger.

If he fails, he is too busy reading the airline magazine to notice the drunks.

If he succeeds, he sees his danger. Have him make a Dodge roll to avoid the falling drunk — if he succeeds, he takes no damage.

If the adventurer fails his Dodge roll, or does not get to make one, the drunk falls on him. The coughing, comically apologetic legionnaire leaves a damp stain on the PC's shirt. A stewardess helps the legionnaire find his seat, then returns to mop at the character's stain.

### *Concealed Weaponry*

### *“Angels”*

A trio of loud teenagers, wearing garish orange jackets that appear to be some sort of uniform, come down the aisle. They play a game with a rubber ball, narrowly missing the PCs, until a stewardess forces them to put it away.

Make a Vision roll for a randomly selected PC. If he fails the roll, tell him that one of the boys has an oddly shaped tattoo. If he succeeds, tell him that he notices — as one of the kids stashes the rubber ball in his pocket — the protruding hilt of a knife.

Having concealed weapons on an aircraft is a crime. However, the flight is behind schedule, and the hurried stewardesses are reluctant to listen to any complaints. If the adventurer protests strongly, the youth will be searched by the Flight Engineer. By then, of course, the knife will be stashed elsewhere, and the PC will have made an enemy.

### *On the Runway*

### *VIP Entrance*

### *The Singer*

The aircraft is ready to taxi onto the runway. At the last minute, the collapsible gangway is re-extended — two airline employees usher a mysterious figure onto the plane. The person wears heavy, concealing clothes and dark glasses.

Make IQ rolls for curious PCs. On a successful roll, the disguise is penetrated and this famous NPC is recognized. Use discretion when applying adjustments to the skill roll — Maude the Librarian might be at a -5 penalty to recognize Madonna.

### Clutching Trouble

### The Embezzler

As the aircraft taxis onto the runway, an adventurer's attention (select one randomly) is caught by a nearby passenger clutching a laptop computer.

Make an IQ roll for the PC.

If he fails, he notices only that the man seems nervous and suspects he might be airsick before landing. A stewardess forces the man to place the computer in the upper luggage compartment during takeoff, despite the man's reluctance.

If he succeeds at the roll, the PC is more perceptive. He notes that the man is anxious, glancing suspiciously about the plane, then whispering to his heavily made-up female companion. When the stewardess reaches toward the portable computer, intending to help the man stow it above, his reaction is violent — he clutches the device to his chest, and it takes several seconds before he gets himself under control and allows the woman to take it.

The computer contains codes the man needs to access his secret bank accounts. He is a thief, and is worried that something will prevent him from making his departure from this city.

### Romantic Bucklers

### The Researcher

As the aircraft moves out onto the main runway, the stewardesses quickly move about the cabin, making a final check on seat belts and folding trays.

Have a random PC make a Hearing roll.

If he fails, he notices only that a young couple — college students, by their appearance — have to be interrupted from their romantic embrace to fasten their seat belts.

If he succeeds at the roll, he also hears a few passionate phrases — enough to assure him that the young couple is very much in love.

### In Flight

#### Blanket Politics

#### Senior Citizens

While the stewardess explains emergency procedures, a white-haired lady shuffling along the aisle tugs on an adventurer's sleeve (select one randomly) and asks him to help her get a blanket from the overhead compartment, which is too tall for her to reach. Her husband has taken a chill, and she would like to get a blanket for him.

If the character is kind to her, this lady will be a friend to him throughout the adventure. If the adventurer is at least civil to her, this lady will respect his opinions and follow his leadership later. If the PC is rude, however, he makes an enemy — this woman, small and harmless as she may seem, has an unforgiving heart and a quick temper. From now on, any idea he proposes will be ridiculed by her. If the PC tries to lead the others, she opposes him (and is backed by the large coalition of senior citizens on this flight).

### Refreshments

### The Novice Stewardess

As the plane levels off at cruising altitude, stewardesses roll along the aisle with food carts, dispensing drinks and meals. As the stewardess comes to their row, she asks a random adventurer what he would like to drink.

Make an IQ roll for the PC. If he succeeds, he realizes that this stewardess is unusually clumsy — she's a new trainee on her first flight.

No matter what he asks for first, the stewardess cannot find it. If the PC wants to help, he may — on a successful IQ roll, he finds it.

If she does find the drink, the stewardess nervously spills it on him. The character can make a Dodge roll to avoid getting the liquid in his lap.

If the adventurer is nasty to the stewardess, she avoids him for the rest of the adventure.



### The Random Encounter Chart

Select a player character, and roll 1 die. Count down the uncrossed-out boxes starting at the top of the chart. When the count equals the number rolled, cross out the box on that line, and use the encounter listed there.

Roleplay the encounter.

For further PCs, continue the same sequence *with one difference*: Start the count with the last crossed-out box. If the last box is reached, start over at the top.

*Example*: The GM decides to pick on PC "Joe" first. Rolling a "5," he discovers an encounter with the Flight Engineer. Box #5 is crossed out. When that encounter is done, the GM rolls a 4 for PC "Tina." Her encounter is with the Wheelchair Lady (#9), four boxes lower than the Flight Engineer's box.

*Modifiers*: If there are more than 3 PCs, subtract 1 from the die roll; if there are more than 6, subtract 2. Numbers less than "1" count as "1."

- The Near-Miss
- The Escape
- An Overheard Conversation
- Lost Little Girl
- High Pressure
- Purse Snatching
- Recognition
- Water Attack
- An Interested Traveler
- Scat Wars
- Falling Drunk
- Concealed Weaponry
- VIP Entrance
- Clutching Trouble
- Romantic Bucklers
- Blanket Politics
- Refreshments
- On the Line



## Reentry

For a shuttle, the "storm" comes up during reentry over the night side of the planet. The shuttle is automated — loss of contact with orbital and ground instrumentation temporarily "blinds" the pilot. He must shift to onboard instrumentation.

## Psychic Reactions

The transition to the Markann world is a violent one for any character with psionic ability.

The psychic "shock" is equivalent to a 1d+3 mental blow (see p. B169). Characters with their shields "down" may make a Mind Shield Roll, with a -2 penalty — if successful, their Mind Shield snaps shut just in time. (Mind Shields provide protection — see p. B169).

Victims who succeed at their subsequent sensing roll will not be able to identify their attacker, but sense only a nauseating wave of disquiet — they must make a Fright Check at -3 penalty.



## Space Communications

In the futuristic adventure, the "headphones" are tri-dee screens installed in the seat backs. Both the tri-dee screens and the politician's vidphone are knocked out when the shuttle enters the storm.

If he is kind, however, make a Reaction roll for the stewardess. On a result of "good" or better, she *likes* the PC and will follow him through the adventure. (If the result is "Very Good" or better, she has a crush on the PC.)

## On the Line

Have a random PC make an IQ roll. If he fails, tell him about the beautiful sunset on the clouds below. In minutes the sky is dark. Cabin lights come on. If he succeeds, *also* tell him that he notices a tall man in an expensive suit (Status 3 at least). This man has been making calls on the inflight telephone since takeoff.

## The Politician

## Entering The Storm

The aircraft, flying in dark skies, unexpectedly enters a storm. The transition is abrupt — the storm is suddenly *there*. Turbulence rocks the plane. The pilot comes on the intercom, identifying himself and pointing out that the "fasten seat belts" sign has been relit. He assures the passengers that they should pass through the "weather front" shortly.

(The pilot is lying. He doesn't know what in the world is going on, and has lost contact with the ground controllers.)

A number of minor incidents occur simultaneously.

## Fainting

A passenger suddenly slumps in his chair, drooling saliva down his rumpled shirt. The man is well dressed (though he's worn the clothes all day — they need pressing), wearing a brown tweed suit and a plaid tie. His glasses are rimless, and he has a receding hairline. (He is the Psychic Researcher — see p. 62 for his stats.)

This psi-sensitive has just suffered a psychic blow (see the sidebar, if you want the details). The man will be ignored by the others in the general confusion, only to resume consciousness during the landing attempt . . . unless the adventurers do something.

If the PCs come to his aid, their actions attract a stewardess. She immediately loosens his tie and reclines his chair. A second stewardess shepherds the characters back to their seats, assuring everyone that all is well — the man is only "exhausted."

With attention, the scientist soon recovers from his swoon. He acts confused and bewildered, but when the stewardess tells him that he is all right now, the man shakes his head. "We are not all right," he says. (He has a presentiment of doom.)

If anyone asks what happened to him, the man will vaguely speak of a dark claw that tore at his heart. He will apologize, explaining that those words are the best description that he can manage of what occurred.

## The Headphones

On Flight 13, headphones allow the passengers to listen to a variety of sound channels — some prerecorded, and others relayed directly from whatever broadcast stations are within range.

A neighbor of one of the PCs — a college student returning home — shakes his head, and removes his headphones to examine them. Complaining that they don't work, he asks to borrow the PC's set. When they don't work, he asks the adventurer for help in figuring out what is wrong.

The PC should quickly discover that the headphones are fine — it is the selected channel which has gone dead. Several of the channels are now dead. (Make an IQ roll for the PC — if he succeeds, he realizes that only the pre-recorded channels now operate.)

The irritated student complains to a stewardess.

### **The Telephone**

Using his stage-quality voice, the white-haired politician calls for a stewardess to help him. He complains that the phone service has disconnected him, and that he doesn't know how to get the operator back on the line. All he hears from the phone is static.

If the PCs investigate, the politician shuns them — unless they succeed at a *Savoir-Faire* roll. Only static comes from the phone's receiver, as the communications stations are no longer there.

### **Other Clues**

If the PCs become suspicious, you may allow them to notice some of the following:

- The stewardesses are very nervous, though they are trying to conceal it. The chief stewardess repeatedly visits the galley, where she speaks with the pilot over the private intercom. The novice stewardess has gone pale.

If an adventurer has made friends with a stewardess, she will make sure that he has his seat belt fastened. She tells him nothing, but a wink is a warning.

- The embezzler is again anxiously clutching his portable computer.
- The clouds outside are not the white, fleecy clouds of an earthlike world. Though this is difficult to spot in the darkness — a *Vision* roll at -3 is required — the clouds are brown and grainy.

If any character has *Danger Sense*, let him have warning now. All PCs must make *Fright Checks*.

### **The Fly-By**

To make sure that the insertion of the aircraft within the experiment sector — a delicate operation — has gone well, the Markann Rogue scientists now make an inspection pass of the aircraft. They believe this act will “stimulate” their experimental subjects . . .

### **What the PCs Experience**

A blinding shaft of light pierces the aircraft, starting from the left rear and moving to the forward right before it disappears. The entire transit takes less than five seconds.

Characters attempting to look directly at the light suffer blindness for 2d minutes. Their best recollection will be of seeing an incredibly bright pinpoint of light. Anyone making a successful *Vision* roll will also see two globes of dull red light flanking the pinpoint and slightly below it.

Characters who do not immediately shield their eyes suffer *dazzlement* (-2 to DX) for 2d seconds.

All PCs must make a new *Fright Check*, at -2 penalty.

### **The Dive**

As the plane violently rocks from side to side, the hurried voice of the senior stewardess comes on the intercom. “If there is a doctor on this flight, would he please check in with one of the stewardesses?”

The rocking quickly shifts to a different movement — a nose dive. Any characters not seated must make a DX roll to avoid falling. The elderly woman in the aisle falls, blocking the passage. From the rear of the PCs' compartment, the wheelchair lady is rolling along the aisle.

It is obvious that something is wrong with the plane; given the previous call for a doctor, the most likely thing is pilot failure. Any pilot's instinctive reaction is to head for the cockpit and try to take control. The wheelchair lady is already on her way. Any adventurer with pilot skill gets an IQ roll at a bonus of +4. On a success, he also heads for the cockpit, ignoring any other problem.

### **Violent Manuevers**

Work through the following stages as Copilot Anderson flies the aircraft, gradually increasing the danger to raise excitement. If the adventurers move promptly to the cockpit and get things under control, not all of these stages will be used.

*Stage One:* The aircraft dives sharply. The wings vibrate, while a humming noise fills the cabin.

*Stage Two:* Anderson banks suddenly. The wings begin to warp noticeably, panicking the NPCs who witness it.

*Stage Three:* After a steep bank, another dive begins. The humming noise is replaced by a piercing shriek.

*Stage Four:* The overstressed aircraft blows a seal, causing an explosive depressurization. As the air whistles out of the cabin, all standing characters must make a DX roll to remain standing. Air masks fall from the automatic containers over each seat. (Small children and unconscious characters will need help with the oxygen masks.) In the resulting thin atmosphere, talking becomes impossible unless characters are within three feet of each other. Characters take 1 point of fatigue for every five consecutive seconds without an oxygen mask.

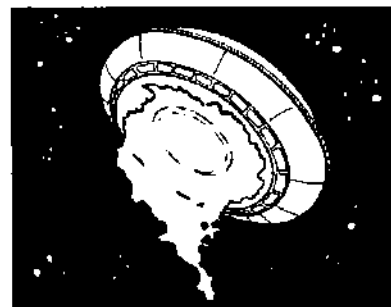

### **Flying the Shuttle**

The required skill for operating a commercial orbit-to-ground shuttle is *Piloting* (Aerospace Vehicle/TL), which defaults to IQ-6 or *Piloting-4* (any other specialization). In addition to all other modifiers, “bad flying conditions” currently apply — a further -2 penalty.

### **Leveling Off**

Once the plane/shuttle has returned to normal flight, a new *Piloting* skill roll is required for every 15 minutes of travel time. On a critical failure, a new violent maneuver is triggered. On a normal failure, the airplane pitches but remains in the sky.

Characters examining the instruments for red flashing lights or other signs of failure see plenty (especially if there has been an explosive depressurization). Flight 13 is in terrible mechanical shape.



### **Fright Checks for Pseudo-Humans**

If the PCs are Pseudo-Humans, keep a secret written track of which characters fail Fright Checks. Each failure brings the beginning of regression two hours sooner (see Transformation and Regression, p. 60). For time tracking, consider transformation to Pseudo-Human form as taking place the instant that the plane enters the storm (see p. 10).

### **NPC Reactions to the Fly-By**

- "I'm blind! I'm blind!" shouts a hysterical elderly woman. She stands in the aisle, flailing about with her handbag. The novice stewardess, biting her lip, moves to subdue her.
- An ecstatic young student claims to have seen God. A stern-faced nun slaps her. "Snap out of it, child," she advises.
- Saying that she doesn't want to die belted into her seat, the Wheelchair Lady transfers herself to the narrow airline wheelchair and heads for the cockpit.
- Allow a random PC to make a Hearing Roll. If he succeeds, he hears a "snick" — and notices that one of the teenage Angels has drawn a switchblade.
- "Stay in your seats!" booms the politician, still at the communications station. "That was a nuclear device — the backblast will reach us at any moment." Half of the passengers heed his warning, and crouch low in their seats.
- A panicked child assaults a random PC, pummeling him with her tiny fists. "I want my Mommy! I want my Mommy!" she screams. ("Mommy" is at the rear of the plane, looking for her missing child.)
- Many passengers sob, pray, or are transfixed with fear.

### **The Storm**

Following this, the plane continues violent maneuvers — jerking from side to side, pitching and other sudden shifts which threaten to warp the aircraft and to throw the adventurers off their feet.

This is the moment for the adventurers to do something. What should they do? They are *supposed* to go to the cockpit, there to take an active and controlling role in the next stage of the adventure. If the PCs need further prompting, the chief stewardess begins babbling, unaware that the cabin-wide intercom is still on. "The captain's had a heart attack . . . who's going to fly this plane!"

### **In the Cockpit**

When the PCs finally get to the cockpit, they find a strange scene. Captain Morgan (the pilot) lies half out of his seat. His face is pale, and he is feebly gasping. (He has had a heart attack.) Copilot Anderson is at the controls, but is raving, "Am beginning my run now, Red Rover. Activating bomb sight . . ." He has a severe drug dependency, and is suffering a stress-induced "flashback" from his combat-flying days. Flight Engineer Carstairs may escape the notice of the PCs at first, since he crouches in the left-rear corner of the cabin, curled into a fetal ball.

*Flying the plane.* The required skill for operating a commercial airliner is Piloting (Multi-Engine Jet or High-Tech Aerospace Vehicles), which defaults to IQ-6. Characters familiar with piloting private single-engine prop aircraft suffer a -6 skill penalty (see p. B69 for a complete list of modifiers). In addition to all other modifiers, "bad flying conditions" currently apply — a further -2 penalty. A successful skill roll will return the plane to level flight.

The automatic pilot is useless in this situation. Any experienced pilot will know that the device can be used only after the plane has returned to level flight. Besides this, it will not engage as it cannot pick up any of the ground signals it expects to use for navigation.

### **If the Adventurers Cannot Fly the Plane**

Captain Morgan cannot under any condition fly the plane. Copilot Anderson can be momentarily returned to normal by engaging him in conversation. He will remain lucid for 2d seconds, during which time he may pilot the plane with his normal skill. Immediately afterward, he lapses into a psychotic episode; make an IQ roll for him. If he succeeds at the roll, he releases the controls before the hallucinations get control — the plane resumes its nose dive. If Anderson fails his IQ roll, he flies the plane while hallucinating — a series of violent maneuvers ensues, risking the structural safety of the aircraft (if an explosive depressurization has not yet occurred, this is a good time for one).

Flight Engineer Carstairs is incapable of flying the plane in his current condition. However, if he can be lured out of his catatonic state — requiring a successful Diplomacy or IQ-2 roll (Empathy provides a +2 bonus to the roll) — he can verbally coach any PC attempting to fly the plane. This coaching provides a +3 bonus on the skill roll.

The Wheelchair Lady is a fine pilot. If the PCs have not brought her to the cockpit, make sure she arrives when the PCs are thoroughly desperate. She must be helped into the pilot's chair. Unfortunately, she needs help from a PC to

operate the control pedals — the PC must succeed at his IQ rolls, or he misunderstands her directions.

### Recovery

If, in the end, the adventurers seem incapable of saving the plane, Copilot Anderson snaps out of his flashback and takes over the controls. Whether he returns to his psychotic state or not is up to the GM — it depends on how well the players are doing. All PCs must make a Fright Check at this point, as shock catches up with them.

### The Heart Attack

Immediately after level flight has been resumed, the chief stewardess enters the cabin and insists that Captain Morgan receive medical treatment. Following her is Sister Pacifica, a nun trained in First Aid. If a PC tries to treat the captain, Sister Pacifica argues with him. If he can't establish better credentials than she has, she insists on treating the pilot herself.

The captain's heart attack is obvious. Characters with Diagnosis or Physician recognize the symptoms immediately, as will anyone making a successful First Aid roll. The captain is breathing weakly and has a faint pulse.

All characters with Physician skill, and characters who make a successful First Aid roll, are able to apply emergency treatment. They place the pilot in a semi-sitting position at the rear of the cockpit, using the wall to prop him upright, and wrap him in blankets, jackets or anything to keep him warm. Captain Morgan will not be of any use to the PCs until after the landing.

### In Command

After the PCs restore order on the flight deck, they temporarily find the NPCs looking to them for leadership (especially the chief stewardess).

The following facts are now available to the players, if they ask:

- Minutes ago, the plane abruptly entered an uncharted storm. Carstairs says it just "appeared" all around them, and before that it didn't show on any of the instruments.

- At the same time, Anderson lost communications with the air traffic controller he was talking to. Carstairs immediately began checking communications frequencies, but concluded that the storm was blocking all frequencies. (Anyone making a successful Meteorology roll realizes this is unlikely — a storm that so powerfully blocked communications would be filled with lightning, and no lightning has been seen.)

- Also at the same time, the craft's automatic navigation systems went out. Captain Morgan swore, blaming the problem on an electrical failure (his guess), and switched to manual flight.

- A very bright object — Carstairs insists that it was a UFO, but Anderson says it was an air-to-air missile — then flew directly across the nose of the plane, temporarily dazzling the flight crew. In a shuttle, Carstairs says they were buzzed by an alien ship of unknown configuration, while Anderson insists a missile flew past.

- The object (the Markann spacecraft) did not show up on radar or other instruments (sensors).

- Immediately afterward, Captain Morgan clutched his chest and slumped in his chair. The bright light also brought on one of the copilot's drug flashbacks.

- Seeing the pilots incapacitated, Flight Engineer Carstairs suffered an anxiety attack and slipped into catatonia.

- All communications with the ground (and space) have been lost. If no adventurer tries the communications equipment, Carstairs will . . . to no avail.

### Aircraft Specifications

*Length:* 180 feet.

*Wing Span:* 170 feet.

*Tail height:* 60 feet.

*Outside width of fuselage:* 20 feet.

*Inside cabin diameter:* 19 feet.

*Maximum weight with passengers and fuel:* 430,000 lbs.

*Thrust rating of each jet engine:* 60,000 lbs.

*Number of engines:* 2

*Cruising speed:* 600+ miles per hour.

*Non-stop range with normal fuel reserve:* 4,400 miles.

*Average passenger load:* 270-380.

*Fuel capacity:* 21,700 gallons.

*Maximum passenger and cargo load:* 101,700 lbs.

*Flight crew:* 9 — pilot ("Captain"), copilot, flight engineer, chief stewardess, five stewards/stewardesses.

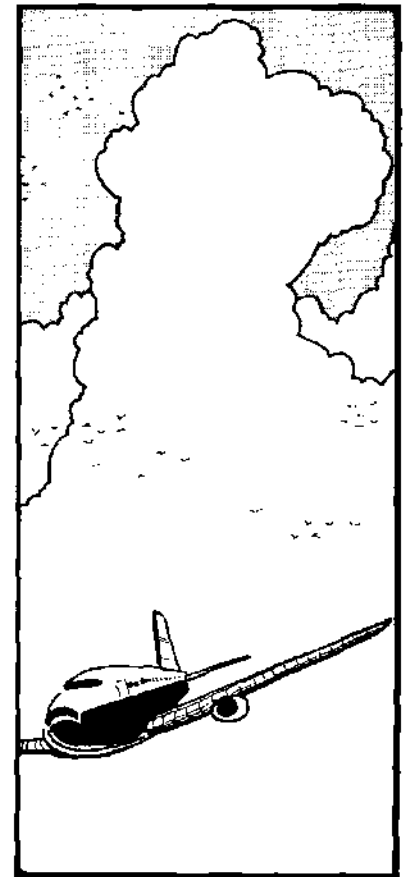

- Radar (sensors) does not have contact with any airborne objects. Many dense clouds remain on the scope.

The PCs must make Fright Checks as they learn new, shocking information.

### Conclusion

Continue the scene as long as it seems enjoyable. The PCs could become involved with first aid among the passengers, restoring order and seeing that the passengers remain buckled in, making speeches on the cabin-wide intercom system, and so on. If they do nothing, the politician and several of the senior citizens will bang on the cockpit door, demanding to know "what's going on in there."

When ready, begin the events in the next chapter.

## Background: The Aircraft

A generic airliner is provided here: it can be modified to serve as a space shuttle. The exact specifications of the aircraft are irrelevant to the plot — the GM may substitute a different aircraft if desired. Make sure that the aircraft selected can land at the destination airport.

Two aircraft views are provided — an Overhead View of the main deck, and a Side View showing the belowdeck areas (see p. 15).

### Aircraft Locations

*First class seating.* Seats are more comfortable here, the food is better, and there are fewer passengers per stewardess.

*Coach class seating.* The seats are cramped and uncomfortable, and it is hard to get the attention of an overworked stewardess. The overhead luggage compartment must be shared by too many people at the same time. Food portions are meager (or a "snack" may be substituted for the meal served in first class).

*Cargo.* There are three cargo compartments. The *Forward* and *Center Cargo Compartments* contain passenger luggage. If the plane is flying to more than one destination, cargo for the first destination is placed in the forward compartment, while the center compartment holds luggage for the second destination. The *Aft Cargo Compartment* is reserved for large, bulky containers — crates, trunks, and so on.

*Exits.* Though one of the forward pair of doors is normally used for boarding the aircraft, the other doors marked on the map may all be used in the event of an emergency. When an emergency door is opened, an escape ramp automatically inflates to form an exit chute. The two wing doors are not provided with an exit ramp; anyone leaving the plane through these doors must jump to the wing and then to the ground. The wing is slippery (-3 to DX to remain standing). The leading edge is seven feet from the ground and the trailing edge is five feet, if the landing gear is down.

*The Jet Engines.* It is dangerous to walk in front of an operating jet engine. If the engines are not properly throttled down after landing, they remain a hazard (and a noisy nuisance). A character walking within three feet of one must make a ST roll to resist the suction; on a failure, the character is sucked into the engine — ruining a valuable piece of equipment.

*Galley stations.* Note that the galley is two-level. The food preparation area is belowdecks, connected to the upper galley/serving area by a single elevator large enough to accommodate an airline food cart or two people. The elevator is the only inside link between the upper and lower decks.

*The Component Spaces (Electronics Bay, Sensor Bay, and the Auxiliary Power Unit Cubicle)* are not intended for inflight inspection, although entry can be made through a removable hatch.

*The Landing Gear Bays* are not pressurized, and cannot be entered from within the aircraft.

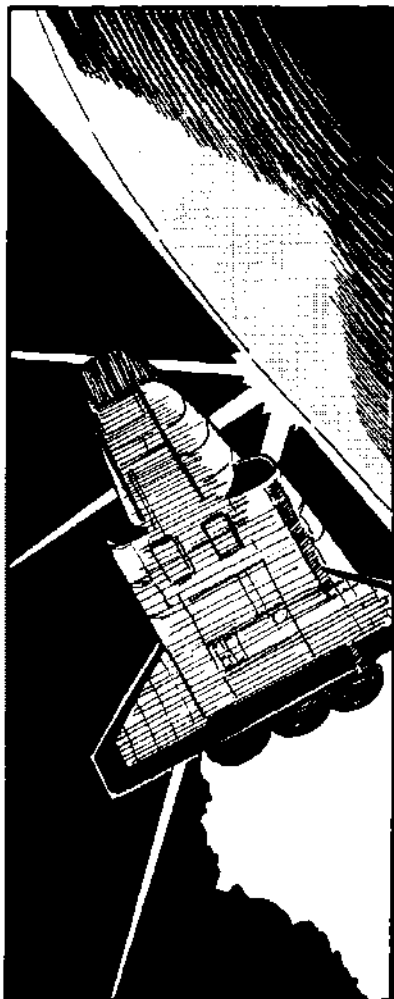

### Modifications for the Shuttle

*Exits.* The main exits include two-man airlocks for emergency use. The emergency exits do not include airlocks, and for safety reasons will not open unless the shuttle is in an atmosphere.

*Sensors.* Use equipment of the current TL. The shuttle has the minimum instrumentation needed to perform its mission.

*The Engines.* Use reaction engines of the current TL.

## Side View of Cabin

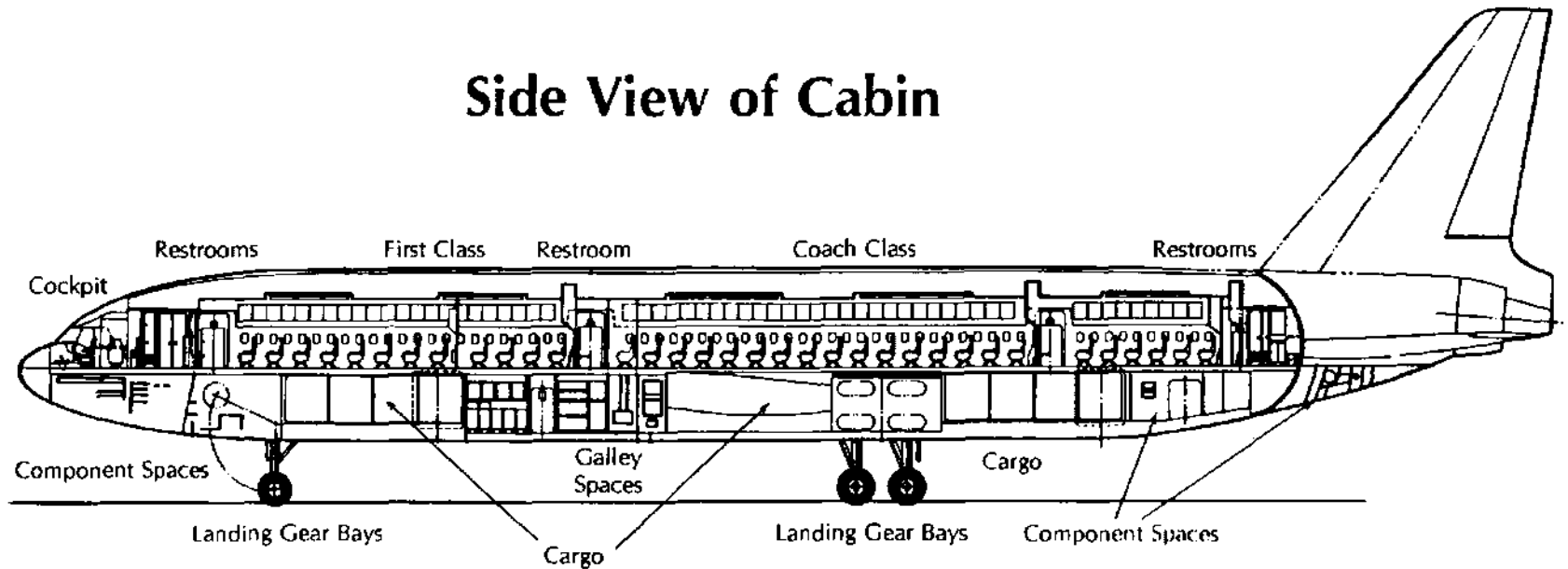

— 15 —

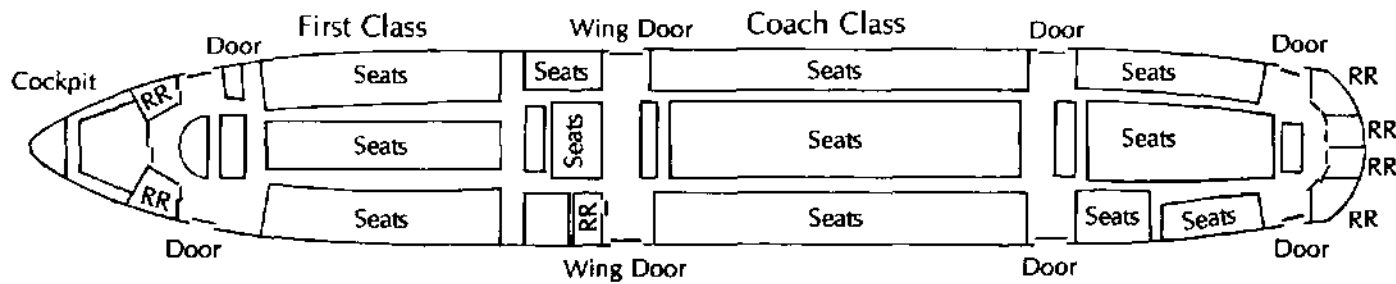

## Top View of Cabin

1 inch = 20 yards

# 3

# THE LANDING

**Synopsis:** Ground controllers (in reality, the Rogue scientists) guide Flight 13 in for a landing. The PCs find the airport deserted. They explore the airport terminal, looking for the person who guided them down. They blunder into a variety of horrific encounters.

## Pre-Game Preparations

1. The GM must decide whether to run this adventure as it is written, or customize it. To customize it, substitute the city of choice for the city presented here — Austin, Texas.

2. The airport provided is modeled on Robert Mueller Municipal Airport in Austin, Texas. To customize the adventure, obtain the floor plan for an airport in the chosen city.

3. Decide which NPC passengers to emphasize in the adventure.

## Detecting the Subterfuge

If the characters involve the distant radio operator in lengthy conversation, his "alienness" might be revealed. He does not understand any slang used, and his knowledge of radio procedures is very basic. He has no sense of humor.

No matter what, the Markann radio man will insist that he is the human air controller at the airport. (One possible giveaway: Aircrew and controllers pronounce it Robert Miller. Even an instructed alien will probably say Robert Mewler.)

## Going Somewhere?

The party has nowhere else to land and fuel will soon run out. (*Exception:* In a futuristic campaign the shuttle has a fusion plant good for two centuries.)

If they descend to look at the scenery below the clouds (which requires a successful Piloting roll), they discover that the clouds continue. If they risk a very low approach — forcing a Piloting roll at -2 penalty — they sight a bristling array of needle-sharp peaks.

The characters aren't likely to overfly the re-created city accidentally . . . but it may be allowed if the players seem dead set against landing at the airport.

If they fly too far from the airport, the Markann spacecraft buzzes them again, forcing them to turn back.

## Landing Elsewhere

Alternate landing attempts within Austin may be made along any major highway. Apply an additional -3 penalty to the approach skill roll, and a -1 penalty to the final landing skill roll.

## The Beacon

If a call is made on the aircraft radio, this call comes in response: "Flight 13, this is Robert Mueller Municipal Airport in Austin, Texas. May we be of assistance? Over."

Otherwise, this call is received: "Attention, all aircraft. This is Robert Mueller Municipal Airport. If you can receive this signal, please reply. Over."

Futuristic characters will be surprised. The signal comes in on an archaic emergency channel, and is voice only (very primitive). Unless the PCs have knowledge of Earth, the "Austin, Texas" location will be meaningless to them. When they learn they are apparently on a different planet, a Fright Check is required (at -5 penalty); when they learn the year, another Fright Check is required (at -3 penalty).

The operator eagerly presents an explanation for what happened. He reports that a freak solar flare knocked out communications all over this part of the country, and that interference continues. The solar "pulse" also damaged or disrupted computer and electronics circuits.

If the adventurers agree, the radio man gives them the directions necessary to maneuver toward the airport. He claims to have them on his radar.

If they refuse to cooperate, the "airport" signs off from the conversation, but continues to broadcast the "Attention, all aircraft" message.

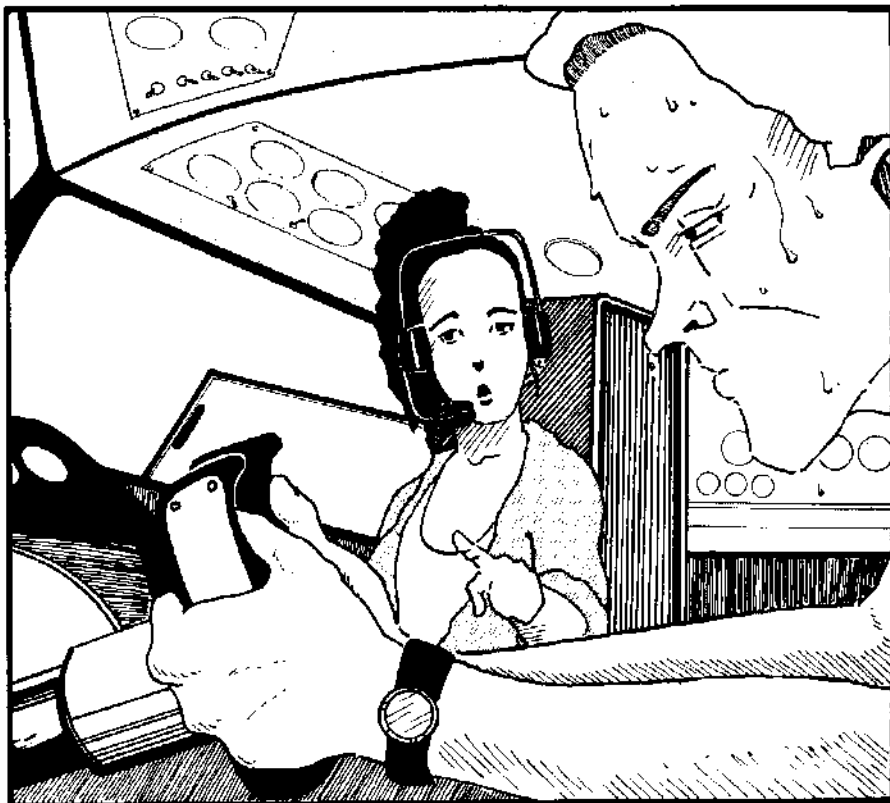

## Clear Air

Minutes after changing course at the request of the radio man, Flight 13 emerges from the brown clouds into clear air. Below are the twinkling lights of a city at night. Passengers will cheer, and begin to congratulate themselves on surviving this nightmare. (If it was daylight when the PCs entered the storm, they must now make a Fright Check.)

### *What the PCs See*

If Austin is the city, the description below applies. If another city has been substituted, give the players a description of that city as it would be seen during a night approach.

“Standing out against the starry night is the skyline of Austin, a dozen skyscrapers illuminated from within. Nearby is the dark ribbon of a (the Colorado) river, slicing a path between downtown and the (southern) suburbs. Traffic is light, but a few vehicles are moving on the main roads and across the river bridges. A floodlit, white building (the state capitol) also stands out.”

The adventurers may cruise over the city for a while, if they care to. During any prolonged observation, make IQ rolls for the PCs — if they succeed, they notice that the circle of clouds surrounding the city is steady. The portions of the city beyond the circle remain invisible. (Beyond the circle, the city has not been re-created — there is only the original planet.)

The air controller urges the aircraft to make a prompt landing.

## Landing

Descending over downtown Austin, the airliner comes into view of the airport. Two major runways are clearly lit — the main 7,200-foot east-west runway (“31L”), and the accessory 5,000-foot northwest runway (“35”). The radio voice instructs the aircraft to use the main runway.

Wreckage of an airliner can be seen on the northwest runway. Half a dozen other airliners stand in off-runway positions on the field, powered-down but with their emergency lights flashing. Another half dozen planes are parked at the small terminal. A building adjoining the field (the National Guard Armory) is on fire. A park adjoins the airport (actually, it’s a golf course). The neighborhood looks to be residential or light industry.

To make the final landing approach correctly, the pilot must succeed at a Piloting roll. If the roll is failed, the aircraft must circle and make a new approach. On a critical failure, a dramatic near-miss occurs: the plane buzzes the control tower, narrowly misses a skyscraper, almost lands on a street rather than a runway, or something of this sort.

If the approach is correctly made, a landing may be attempted. This calls for a second Piloting roll. Pilots are at a -2 penalty, due to the length of the field.

If the pilot succeeds at his roll, the plane lands safely. If he fails, the landing is traumatic; apply 1d-2 crushing damage to all passengers for a very shaky landing (double damage to anyone not strapped in). The aircraft runs off the strip, grounding itself in a gravel bed close to a perimeter fence.

On a critical failure, the landing is too hard — the landing gear collapses. The plane skids in on its belly, raising a cloud of sparks. Apply 2d-2 damage to all passengers (triple for anyone not strapped in). The stewardesses commence an evacuation immediately. The cargo compartments are severely damaged, making it difficult to recover the passengers’ luggage. Fuel from a ruptured tank spills onto the runway, adding to the hysteria — the fumes are strong. (A shuttle does not have fuel to spill.)

### *On the Runway*

Under normal conditions, the control tower issues taxiing instructions to

## The Approach

The approach directed by the Markann takes Flight 13 across downtown Austin as they near the runway.

Observant passengers may see any of the following, if their players mention that they are looking down below *and* succeed at a Vision roll. (If the adventurers aren’t paying attention, clue them in by having an NPC remark out loud about one of these sights.) Select sights from the list below, or roll a die.

### *1. Fire*

A thick plume of smoke rises from one or more buildings, reaching for the sky. No fire fighters are seen.

### *2. Crooked Cars*

As the plane comes low over a main thoroughfare, the adventurer notices that the cars along the road are parked, not moving, though their headlights are lit. Several of the cars are on the shoulder of the road, or set at angles to the road.

On a critical success, he notices that the drivers aren’t present — otherwise, he can’t tell. (This calls for a Fright Check.)

### *3. Flickering Lights*

His attention is attracted by a colorful flickering of lights from the buildings below, like fireflies or Fourth of July fireworks.

If he has any experience with 20th-century firearms, have him make an IQ roll — if he succeeds, he realizes a night battle is in progress.

### *4. Bodies*

For a brief moment, a wide plaza comes into view with bodies spread-eagled on the pavement. (Fright Check at -1 penalty).

### *5. Suicide*

His attention is caught by two tiny sparks of light in motion. A suicidal person, holding a lit torch in each hand, takes a running start and jumps from the top of a major business tower. (Fright Check at -3 penalty.)

### *6. Ramming*

A police car with its lights flashing accelerates down a main thoroughfare, then impacts solidly into a department store. It is obvious that the action was intentional . . . and that the driver must have been severely injured. (Fright Check at -1 penalty).





### **Clammy Air**

As the plane's doors are opened, the PCs note that the "fresh air" they expect is instead clammy, moist and warm. There is also a prevalent smell, similar to that of fish. This calls for a Fright Check.

### **Taxiing the Aircraft**

Any character can taxi the aircraft. Piloting rolls (defaulting in this case only to Driving-3) are required only for intricate maneuvers — to pull up close to the terminal, for instance, or to make a sharp turn without leaving the runway and getting stuck on the gravel shoulder.

### **Getting Out of the Aircraft**

If the adventurers can taxi the plane to the terminal gates, someone can get inside and extend the collapsible gangway. The passengers can then disembark normally.

Gangways are available on the field, but are too low to reach the hatches of this large aircraft.

Lastly, there are the normal and emergency exits.

landed aircraft. However, there is no further contact from the radio voice once Flight 13 has landed. The travelers are left in a throttling airplane at the end of the runway. If there has been a crash, no emergency vehicles rush to the site. The PCs are on their own as far as caring for the injured, and must move on foot if they wish to explore the airport.

### **Pandemonium**

What will the other passengers do now?

The following material provides possible actions and motives for each of the major NPCs and NPC groups on the aircraft. DON'T USE ALL OF THESE — use those which the players will most enjoy or be most frustrated by. Remember that NPCs also exist to be used as cannon fodder.

*The Businessmen.* Reluctant to believe that anything is wrong, their concern is to catch a connecting flight. They are in a rush to get to the airline counter. When they find it deserted, their priority is to find transportation to downtown.

*The Pilot.* Slipping in and out of consciousness, Captain Morgan mutters about filing reports with local government agencies.

*The Copilot.* Intensely tired, his overpowering urge is for sleep (1d hours). After a rest, he will be eager to find a flyable aircraft and zoom away from this nightmare.

*The Animal Trainer.* He is frantic about getting to his animals. Anyone who volunteers to help rescue them from the cargo compartment, gets a +4 reaction.

*Eagle Legionnaires.* Convinced that Arab terrorists are responsible — one says he saw Iranian markings on the "fighter jet" that buzzed the plane — these overage, overeager ex-soldiers want to assault the terminal in military style. They also want to impress any young women, especially stewardesses. (see p. 23)

*Embezzler.* Frightened, this man is driven by his need to escape. Therefore, he forces himself to the forefront. He is always accompanied by his heavily-madeup "secretary." The party may also notice his ever-present laptop computer. Given a choice, he will protect it rather than the woman.

*The Flight Engineer.* Ashamed, he wants to join any group entering the terminal. His Cowardice disadvantage (see p. B24) should make this interesting.

*Angels.* The Angels want to check things out on their own. They are very vocal about their rights. When the chief stewardess tries to stop them from going off on their own, they might wave the switchblade around.

*The Novice Stewardess.* She attaches herself to the adventurers' party (after getting the chief stewardess' permission). She has the bad habit of lingering, and investigating strange noises by herself. (If you already have a PC like this, you don't need her.)

*The Nuns/Pacifists.* They have a "take charge" attitude toward medical care, insisting that the injured must be taken to the nearest hospital for proper care (especially Captain Morgan). They ask the PCs for help. They suspect the current predicament was caused by a military mishap, probably including "Star Wars"/SDI technology or neutron bombs. (In a futuristic campaign, they suspect secret military research has gotten out of hand, breaking the "time/space barriers.")

*The Orphans.* Unless prevented, the orphans are first to join any group leaving the plane. If stopped, they find a way to escape from the plane anyway and try to join the adventurers . . . probably wandering into trouble on the way. (The orphans exist for the sole purpose of giving the PCs a headache.) They think this situation is "awesome."

*Politician.* This man wants to be in charge, and he "runs for election" with every speech-and-promise-making instinct in his repertoire. The senior citizens love him. He is good at making loud speeches when the adventurers want quiet. His proposals are all inappropriate, but if one is rejected he will advance another. Some examples: find a fallout shelter (he thinks there has been a nuclear

exchange), remain at the terminal and hoard food and water, report to the disaster relief office at city hall/the state capitol building/police headquarters.

*The Psychic Scientist.* Disturbed by his dream, and concerned that this situation might be a mass delusion or other psychic manifestation, he is eager to join the exploration teams. His psi powers might be useful, but he is liable to collapse from mental stress at inopportune moments.

*Rock Singer.* This celebrity wants to hire the adventurers to protect him and run errands, such as fetching a limousine and arranging for a hot meal. He pays in cash at first, then in personal property (chains, rings, clothing), and finally in promises ("I can make you a star . . .").

*The Chief Stewardess.* She insists on getting the captain to the hospital, but says she cannot go herself — her duty is to care for the passengers. She wants them to remain together where she can keep an eye on them, except for small groups which leave to explore in an organized fashion. She is confident that organized relief will come soon. See sidebar.

*Senior Citizens.* Confident in the forces of law and order, these passengers want to get the group organized, elect officers and a ruling council, collect personal goods in a central arsenal, split off into committees, and generally bureaucratize survival. They are against anything rash, including the destruction of private property or the use of weapons (unless a threat is obvious). They want to contact the "authorities."

*The Vacationers.* The family members huddle in a sheltered place. The father can be lured away from his family if the adventurers stress his greater duty to find out what is going on outside. The mother thinks this all sounds like something she read in a horror novel.

*The Wheelchair Lady.* She insists on joining any exploration party, doing everything she can to prove that her handicap won't slow her down. Her goal is to get to the radio room and communicate with the government. She believes there's been a natural disaster.

## Background: The Airport

The airport below is modeled after Robert Mueller Municipal Airport in Austin, Texas. Except for the terminal, it is deserted.

### Guide to the Airport Map

*The Control Tower.* The tower is well lit, and is attached to the main terminal building.

*Freight Company Offices.* These are the offices of overnight express delivery services, and are filled with shipping equipment and packages. If the PCs choose to visit here, improvise a grisly find: a decapitated body, someone hanging from the ceiling with an extension cord wrapped around his neck, and so on.

*Instrumentation.* Several of the items listed on the map — LDIN, the localizer antennae, TVOR, VORTAC and MALSR — are aviation instrumentation. All are in perfect working condition.

*The National Guard Armory.* It contains heavy weapons, if the party can beat the flames. If the party needs heavy weapons, the Armory is only smouldering. Otherwise, it is a glorious conflagration punctuated by the explosion of stored grenades, rockets and cannon shells.

*Parking Areas.* There is only mild disorder in the parking lots. Most cars are parked normally, but there are a few abandoned vehicles with their lights on, doors ajar and engines running. Guard posts and moving barriers block exit from the lots.

*The Perimeter.* The airport is surrounded by a double line of tall chainlink



### Mother Knows Best

The chief stewardess is sure that she knows better than anyone else what must be done. Above all, there must be no panic and confusion. The way to prevent panic and confusion is to do, in an orderly fashion, those things that are guaranteed to prevent panic and confusion. Panic and confusion come from rushing around trying to find out what is going on. What is going on doesn't matter, what matters is that there be no panic and confusion. If everyone will remain calmly in place and follow the instructions of the attendants, there will be no panic and confusion. If anyone starts moving around, or questioning instructions, the result will be panic and confusion.

The normally poised and confident woman is avoiding the reality of the situation by refusing to admit that what is happening needs any solution. As long as she can get anyone to follow her orders, she will seem to be in control of herself. If she is defied or ignored, she is liable to snap and go either berserk or catatonic, whichever is most embarrassing to the adventurers.

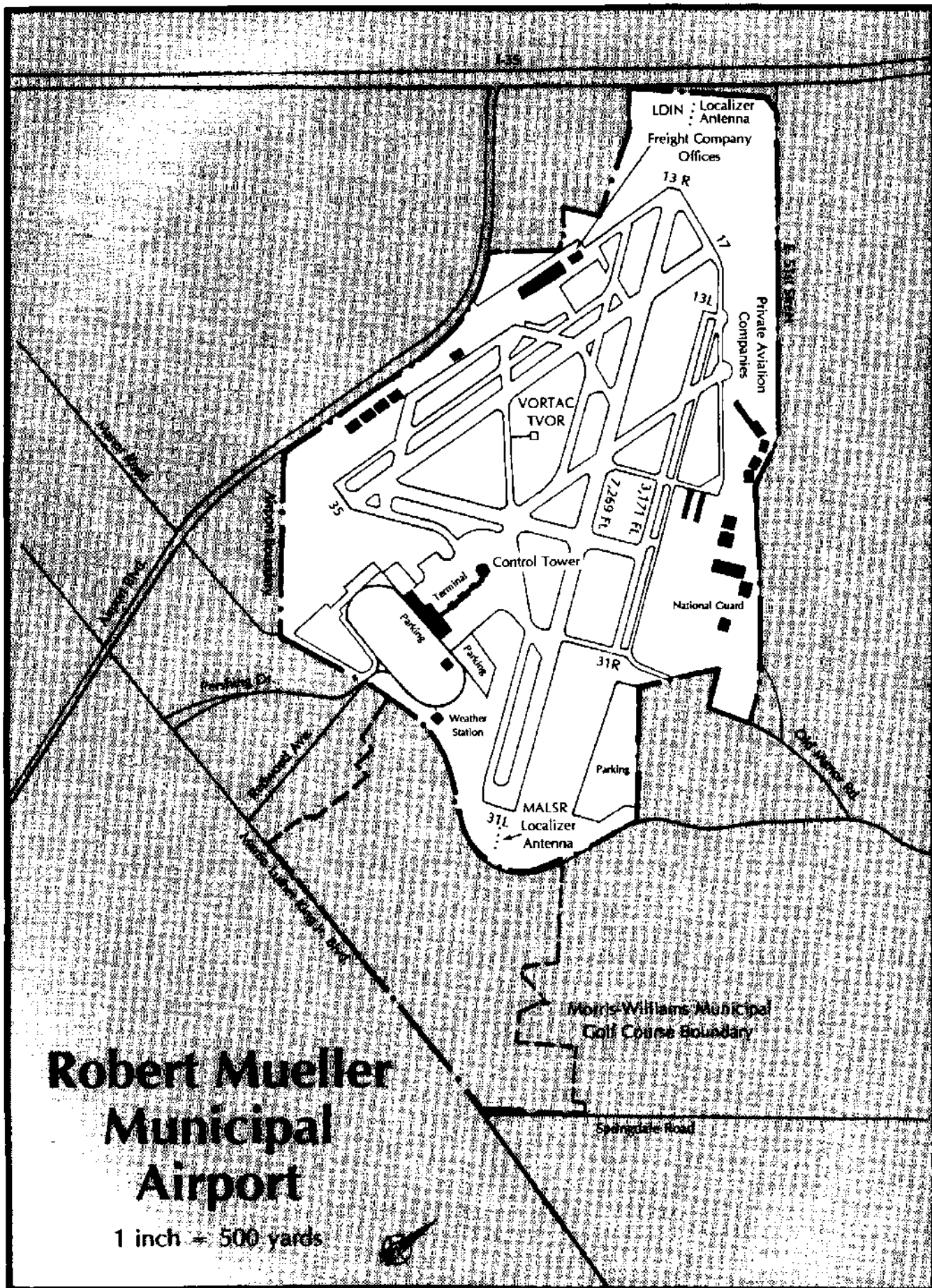

fences. Gates are marked on the maps. There is a guard shack at the main gate, but the moving barrier is raised.

*Private Aviation Companies.* These are only uninhabited offices. See “Freight Company Offices” for improvised encounter suggestions.

*The Weather Station.* Meteorological equipment is here, of course, as well as a detailed weather log (see sidebar, p. 24). The sudden arrival of a bizarre weather front is noted, commencing 12 hours *before* the PCs entered their storm.

### Terminal Events

This next part of the adventure is player-driven. The PCs go where they want, and the GM provides the actions. This doesn't mean the GM can't improvise — encounters can be adapted, relocated, deleted (or added) to meet the needs of the adventuring group.

The following encounters occur in the airport terminal (see the Terminal Map on p. 25). Be sure to use *The Weeper* as an early encounter, allowing the adventurers to pick up a weapon before facing some of the hostile forces.

#### *The Weeper*

A refugee from Research Sector 3 (see p. 46), this crazed woman now suffers from the delusion that she is flying home to see her mother. In her right hand she clutches an expired airline ticket and an overstuffed piece of luggage. At the end of her limp left arm dangles a huge automatic pistol, but she has forgotten that she has it — anyone can take it from her.

Weeping loudly, Mrs. Laura Pendleton may be encountered hurrying down the flightway (to catch her plane . . .) or waiting at any of the flight gates for her departure. In her mind, the airport is still operating normally and is full of travelers. She does not realize that she is crying.

If the PCs try to question her, she can only speak two sentences at a time before drifting into incoherence. It will take a successful Psychology roll from one of the PCs before she can reveal her horrid story, but even then she will remain demented. Characters hearing her story must make a Fright Check.

Her luggage contains dirty clothes and random junk. She will not object to a search, but will insist on repacking afterwards.

#### *The Flock*

This hits the party if they get overconfident. The idea is to give them a scare, but not so great a fright that they remain huddled in the terminal. If in doubt, roll one die every time someone goes outside. When a 6 is rolled, the flock dives to the attack.

A flock of eight Avians (see p. 39 for stats) has wandered from Sector 2 and is looking for prey. As the party emerges from any exit of the terminal, the alien Avians attack. Due to darkness, they achieve total surprise. They fight until satiated or dead.

See p. 36 for instructions on running combat against the Avians, including notes on Fright Checks.

#### *The Monster*

As the characters come within 30 feet of the stairs leading to the basement, make Hearing rolls for them. Those who succeed notice a low moaning sound, but must succeed at a second Hearing roll to tell where the sound comes from. The moaning sound is deeper and louder than any human could make — almost like a distant foghorn.

The noise comes from a prematurely regressing Pseudo-Human. The imprinted human personality — a teenage girl! — still dominates but has snapped under the strain of the transformation.

#### *Long Hall*



#### *Any Exit*

#### *Any Basement*

The creature stops moaning as soon as it notices anyone else — which will happen when the stair door opens, if not before. If anyone enters the basement, it tries to hide in the darkest corner. If anyone comes within two yards of the being, it goes Berserk (see p. B24). See p. 60 for regressed Pseudo-Human stats.

A Fright Check is required when anyone first hears the moaning. A second Fright Check at -3 penalty is required when the creature is seen.

### ***The Markann Researcher (optional)***

Eager to get first-hand reports on the behavior of their test subjects, the Rogue Markann violate another of their scientific traditions. They plant an observer on board Flight 13.

This involves experimental technology — a Pseudo-Human imprinted with two personalities.

The first personality is that of the college student who was earlier seen embracing his girlfriend (see p. 9).

The second personality is that of a Markann Rogue scientist.

The Rogues believe that the Markann personality will dominate the created being, but be able to draw on the resources of the human personality to maintain his masquerade.

So far, the experiment is working. The student tries to be everywhere, listening intently to everything without actively influencing events.

As he does so, his girlfriend trails after him. ("Henry, where are you going? Wait for me. Don't you care about me anymore?")

#### ***The Option's Option***

The GM may want to complicate the adventure by arranging for a player character to be the researcher! Assign the PC to one of the personalities. Resolve conflicts using Contests of Will (the researcher's Will score is 12). If the adventurer is the human personality, he won't know what is happening to him. The GM describes the confusion and the sense of the human personality that he is being "possessed" by an alien. Select a player who can deal with the psychic disintegration of his character; this role is not for everyone. If the PC is the Markann, the player must be willing to roleplay a convincing alien.

### ***Getting Them Out***

Curiosity or a need for weaponry should drive the PCs away from the airport and into the city. If not, the Rogues will take their usual steps — see p. 26 for a description of their subtle methods.



#### ***Mr. Nice Guy***

This electronics technician is using the powerful radio equipment in the control tower in a futile attempt to contact the military and obtain help. Any character at the door may make a Hearing roll — if successful, he hears the beeps and key-clicking of the radio operator at work.

It is not so important, however, *who* the NPC is . . . as what he's done. Jose Armenta and his friends were ambushed by a cycle gang in a downtown bar, and in the confusion he killed a young woman. He now has Paranoia (p. B35) — he is convinced that people want to lock him up for the murder he has committed. When nervous, he sweats effusively (a -1 Odious Personal Habit).

Jose is also convinced that the murders are some trick of the Soviet Communists. He is intent on contacting the military to organize resistance. If the adventurers can work around these flaws, Jose is a great aid because of his electronic skills.

Make an IQ roll for anyone observing Jose carefully. If successful, he notices a host of suspicious clues: bloody streaks on his coveralls, his broken fingernails, and a long scratch on his forearm.

#### ***The Drinking Prophet***

This older man, lean, leathery and bewhiskered, is alone at the restaurant bar.

#### ***Airport Restaurant***

He is surrounded by a wide assortment of wines and other alcoholic drinks, but there aren't a lot of empties — Fred Beacon is savoring his drinks, not gulping.

He challenges all comers with, "What do you want with me, son?" If the person appears sane and non-violent, Fred is wary but stays where he is. If the person appears troublesome, Fred produces a very sharp butcher knife and tells the intruder to leave him alone. If attacked, Fred flees.

Fred claims to have received a "vision." A beautiful female angel warned him that the world was about to come to a violent end. He obediently began warning his neighbors — as the "angel" directed — but, finding that no one believed him, Fred started bar-hopping instead.

Fred has seen little of the other violence in town. He refuses to travel with the PCs, preferring to remain at a quiet bar. (Some of the passengers are likely to join him.) He actually suffers from a Delusion (see p. B32).

### *The Playful Children*

Two of the Beast Children (see p. 47) have wandered here, and are playing on the luggage carousel.

Laughing and playing, they should seem harmless to anyone at long range. Up close, the blood-smeared mouths, protruding fangs and gore-stained clothing are a dead giveaway. When the adventurers have been lured within range, the children will attack.

For complete stats and GMing instructions on the children, see pp. 47-48.



### *Survivor!*

Toni Packard — an airline employee — narrowly escaped from a gang of maniacs, and came here to trade her torn clothing for a fresh uniform from her locker. She is ransacking the desks, looking for anything which might be of use.

Toni suspects all men of being psychotic killers. If she sees any male, she will scream and jump to a desktop, where she will swing her baseball bat to keep attackers at bay until assured of their peaceful intentions.

She desperately wants protection.

### *Taxi Driver*

In an insanely disturbed world, only the insane can cope.

William Daniels is a psychopath, using a taxi to lure unsuspecting victims to their deaths. He does not understand what is happening to the world, nor does he care — so long as he can continue with his pastime. If asked what's going on, he will reply only, "Been a rough night."

Beneath the maps and papers on the front seat is a loaded revolver. William also keeps a crowbar on the floor beneath his seat. Make an IQ-6 roll for anyone in the car — if successful, they notice that the picture on the cabbie's license does not match William.



### *Patriots in Action*

The Eagle Legionnaires are convinced that something is terribly wrong with the country, and that something has to be done, as soon as they have a drink. They occupy the Airport Lounge in force. They are prepared to accept recruits, but are careful of their security precautions.

"You want to help, huh. Great, we need all the good Americans we can get. Who won the Super Bowl in '68? Who was Archie Bunker's daughter? What's a low-rider?"

Anyone who fails, or even hesitates, at an answer is suspect. For suspects the grilling intensifies. "What was Carter's middle name? Who shot J. R.? What are the teams in the Southwest Conference? When did the speed limit change to 55?"

Unfortunately, the Legionnaires are not entirely sure of the answers to these questions themselves. After a few drinks they may start arguing among themselves on the more obscure points, but they will unite against any outsider. Anyone willing to drink, argue about sports and damn all foreigners is liable to be accepted on his merits regardless of his answers.

The Legionnaires know that they need heavy firepower to fight off whatever alien force has ruined Austin. An adventurer with the right skills might even get them to do something besides talk. Roll a contest of Leadership or Fast-Talk against any Legionnaire's IQ (stats are on page 61). On a success, that Legionnaire and 2d of his comrades will join in any suitably militaristic project.

In a futuristic campaign, the Legionnaires will be asking questions about the sports, history and customs of their society, not about 20th-century Earth. Their reaction to mistakes will be the same.

William wants no more than three people in his cab, and prefers young, blonde women. He will not attack until on a lonely stretch of road some distance from the airport.

(If the adventurers will not go with him, some of the businessmen are sure to force their way into a one-way ride.)

### Guide to the Terminal Map

The terminal gives an impression of having been hurriedly abandoned.

*Administration offices.* These second-story offices contain little of use to the PCs — perhaps a broken window, and a body lying on the sidewalk below? The Security office does have a crash kit (+1 to First Aid Rolls).

*Airline offices.* In front are the ticket counters for five major airlines. Behind the ticket counters are the airline offices, including locker space for each employee and luggage processing equipment. The ticket computers are “down,” functioning but out of contact with the central computer.

*Airport restaurant and lounge.* This small facility features a casual bar area with a more restaurant-like table area for diners. The kitchen is in minor chaos; cooking food has long since blackened.

*Basements.* Air conditioning and furnaces, janitorial storage, workbenches and maintenance tools — nothing obviously useful. However the PCs might come up with a use for it. There is a basement encounter, see *The Monster*, p. 21.

*Control tower.* This tower is nine stories tall (ten, if you count the rooftop platform — and there is a basement beneath.) The ninth floor is for the visual controllers, while the floors beneath are for controllers using radar and radio. The fifth floor contains the master radio gear.

*Flight Gates.* All of these are second-story, tall enough to easily reach the small-to-medium jets without use of special bridging equipment. Beneath each gate is a room of identical size, reached by the stairs shown, used by the airline workers.

*Gift shops.* The small gift shop in the terminal wing offers little more than candy, small toys, magazines and knick-knacks. The larger gift store in the main terminal has more expensive wares, including cut glass, souvenir handicrafts, luggage and a small assortment of overpriced clothing.

*Insurance machines.* These automatically dispense flight insurance for a fee.

*Lockers.* For the price of four quarters, any of these lockers will give up its key and let a character lock his belongings within. Breaking into the locked lockers yields nothing more interesting than other people’s luggage.

*Police car.* Abandoned, with its lights on, engine running, and both doors open. There is a quarter tank of gas, and the keys are in the ignition. The trunk contains 50 feet of rope, a pair of walkie-talkies, a crash kit and two pairs of handcuffs with keys. The two-way radio in the car is working; it is on the same frequency as the walkie-talkies. The shotgun from the dash rack is missing and the rack’s lock has been forced.

*Luggage carousels.* These are operating, even though no new bags are coming down the ramp. Unclaimed bags circle, as small children play among them (see *The Playful Children* on p. 23).

*Rent-a-Car booths.* Keys can be found here for cars in the appropriate rental section of the parking lot.

*Security Station.* The X-ray machine and metal detector are turned off.

*Taxi.* Idling in the pick-up lane, lights on and engine running. This is an encounter — see p. 23 for details.



### Stealing A Car

There are plenty of vehicles here, but keys don’t come with them. Breaking into a car and “hot-wiring” it requires a successful roll at either Streetwise or Mechanic (Automobile Engine) — but there is a 2-in-6 chance that any car broken into will have an alarm installed.

Futuristic characters probably don’t know how to operate these vehicles. This is worth a -5 penalty to Driving rolls.

### The Weather Log

At the end, the weather log trails off into hysteria. The final entry reads:

“Yellow, yellow, yellow — the crawlies have almost everyone now. Only the blood of the Firstborn can appease them.”

Anyone reading this must make a Fright Check.

## Terminal Diagram

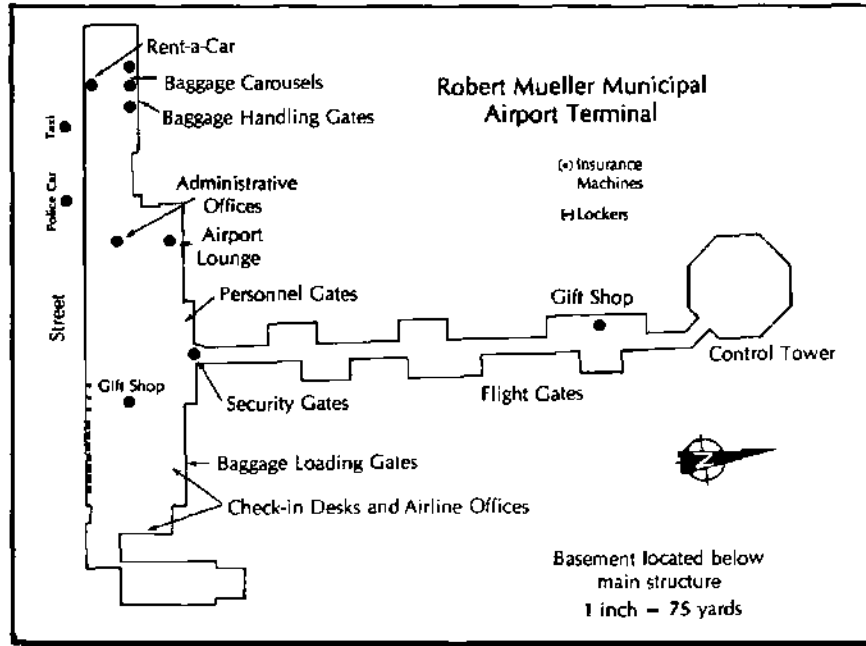

## Control Tower (Detail)

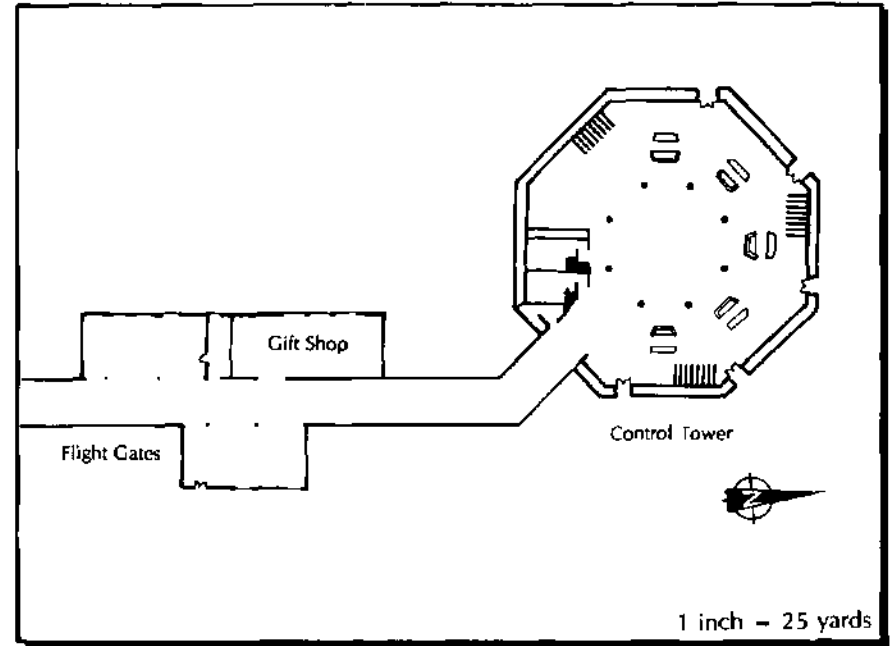

## Administration Offices (Detail)

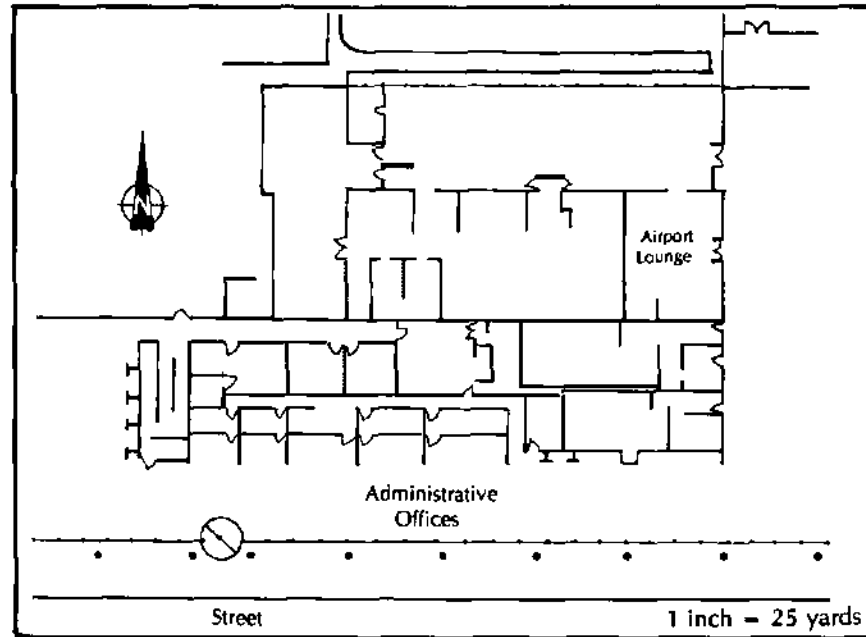

## Baggage Handling Gates (Detail)

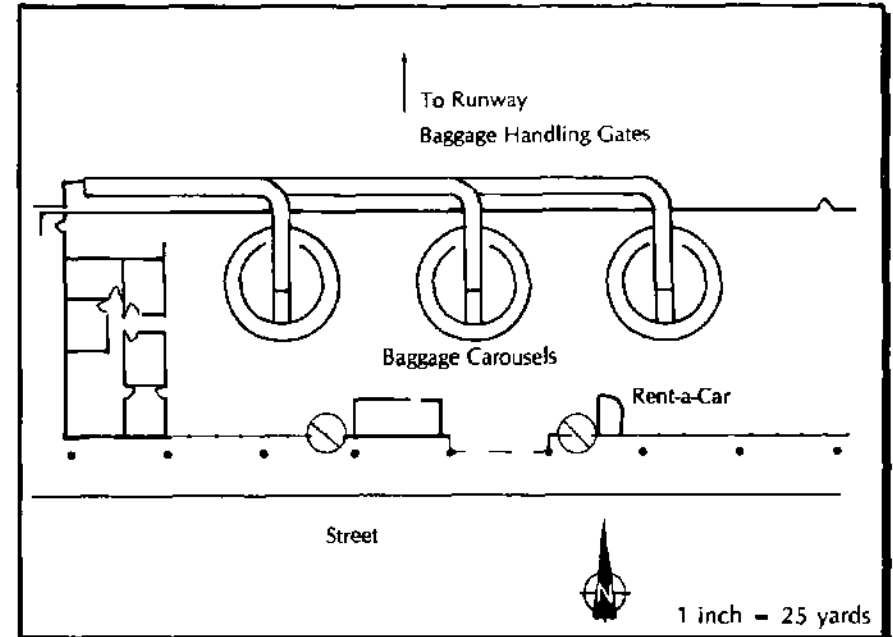



# 4

# CITY OF FEAR



## Pre-Game Preparations

Though this adventure has been written to be set in Austin, Texas, it can be transferred to another city by following these steps:

1. Select a city.
2. Obtain a street map of the city.
3. Select a portion of the city to use for this adventure. (The Markann won't rebuild the entire community — only a portion large enough for their experiments.) A circular region about six miles in diameter will do.

This city section should include:

- a. a commercial airport.
- b. a business/downtown area.\*
- c. a football stadium (professional, college or high school).\*
- d. a shopping mall (it can be a small one).\*

4. Place smaller circles on the map, one for each of the Markann experiment sectors. These areas should be equally spaced, and should not overlap. A good size is a region one-and-a-half miles in diameter. There must be at least three sectors; more, if custom sectors are added.

(\*) The asterisked items from the list above should each have an individual sector.

5. Match the scenarios from the next chapter to the map, placing one scenario in each sector.

6. If there are more than three sectors, design new encounters for those places.

**Synopsis:** The player characters leave the airport and enter the city, under their own steam or forced by the Rogue scientists. Two kinds of encounters occur: *fixed* encounters, which take place when the PCs reach a selected area; and *timed* encounters, which take place in order as time passes.

As the PCs blunder through Austin, they will stumble into areas where Markann experiments are in progress. (And if they don't "stumble" into these areas on their own, the Rogue scientists will attempt to herd them there.) These encounters are explained in the next chapter, *Experiments Bizarre*.

Meanwhile, the Rogue scientists' private research project comes to the attention of the traditional scientists, leading to a Markann versus Markann showdown. These events — which occur in sequence, at a pace which the GM controls — are described in Chapter 6, *Markann Revealed*.

## The Rogue Scientists

Their research program has a single method — stir things up! They want to keep the adventurers (and the other airline passengers) moving, blundering from one shocking scene to another, inciting trouble if they have to in order to witness humans under stress.

Whenever the PCs are about to settle down, the Rogues use one of the following methods to get them back into motion. Start at the top of the list, and use the same technique repeatedly until the party no longer responds (the Rogues have little imagination, and no respect for human intelligence) — then shift to the next technique.

(In game terms, the Rogues make sure that the adventurers pass through each of the scenarios in the next chapter.)

## The Shriek

A piercing scream, like that of a young girl, splits the night.

The sound comes from the direction in which the Rogues want the adventurers to travel (in other words, the direction of the nearest unplayed scenario from the next chapter).

Characters with appropriate Disadvantages — for instance, Sense of Duty (toward all humanity) — must make an IQ roll to avoid going to the rescue. Apply a +2 bonus to the roll for every previous instance in which a scream has been used by the Rogues.

If the adventurers delay, the Rogues play more of the recorded tape. The screaming girl seems to run away from the PCs, followed by the sound of a pack of growling dogs or wolves. Her screams become more and more hysterical, until she is at last devoured by the pursuers (characters who listen to the entire tape must make a Fright Check each time, unless the group realizes that the noise is a recording).

If the party begins to follow, the Rogues do not finish the tape, but replay the first scream at intervals to lead the adventurers on. If the characters delay again, the rest of the tape is again played.

PCs hearing the longer tape more than once may recognize the sequence. Make secret IQ rolls (at -3 penalty) for each PC. If the roll is successful, tell them that they suspect the sounds are coming from a recording.

The sound is actually broadcast by a Rogue on a floater (see sidebars, pp. 51 and 57).

### *The Enticing Scent*

The Rogues decide to try to tempt another human instinct. With the shriek, they tested the human urge to protect the species; they now cater to the basics of appetite.

Have the players make Smell rolls for their characters, at a -4 penalty (see p. B92). Those PCs who succeed at their roll detect the smell of fresh cooking somewhere close at hand.

If the party refuses to respond, the Rogues increase the intensity of the smell. It goes from -2 penalty, to no penalty, to such a strong smell that only someone with Anosmia (see p. B29) can miss it.

The smell comes from the direction in which the Rogues want the PCs to travel, and is being broadcast from a floater.

At the GMs discretion, in a futuristic campaign, PCs may have to make IQ rolls to identify smells that are obvious to 20th-century humans. Non-human PCs must make a HT roll at +2 bonus when they first smell each scent. If the roll is failed, the smell nauseates them (-2 IQ, -2 DX), until 3d combat rounds after the smell fades away.

### *Trails of Lucre*

Appealing to another basic urge of mankind, the Rogues leave a trail of money leading toward the destination of their choice.

The items are at first close together, then are gradually spaced out as the trail is followed. Let the PCs try IQ rolls to discover who first spots the trail. Once the first item has been spotted, the character gets a +3 bonus to his roll to spot the second item; additional items are located at a +6 bonus.

The Markann aren't sure what items will attract humans — see the sidebar on p. 28 for some suggestions. Futuristic characters may not recognize currency (see p. 30).

### *The Sounds of Combat*

If the adventurers can't be drawn by money, perhaps they can be herded by the sounds of peril.

Have the players make Hearing rolls for their characters, at a -4 penalty (see p. B92). Those PCs who succeed at their roll detect the sounds of combat somewhere close at hand.

If the party refuses to respond, the Rogues increase the intensity of the sound. It goes from -2 penalty, to no penalty, to such a loud sound that only someone with Deafness can miss it.

Adventurers in a futuristic campaign may be unfamiliar with 20th-century combat and may not recognize combat sounds unless they succeed at an IQ roll.

### *The Phone Call*

The sound of a ringing telephone is clearly heard by the adventurers. Futuristic characters will recognize this sound only if they have already had phone experience or succeed at a History (20th century) roll (defaults to IQ-6); otherwise, tell them they hear a persistent ringing.

### *Making Scents*

The Rogues use a variety of food smells, but their knowledge of human cuisine is somewhat flawed. The following list gives some suggestions — Random scents may be selected by rolling 2 dice.

2. *Onions* — When this scent becomes powerful, all characters get watery eyes: make an IQ roll, or suffer -2 IQ, -2 DX until 20 combat rounds after the smell stops.

3. *Bubble Gum\** — (This should definitely make the PCs suspicious.)

4. *Popcorn\**

5. *Barbecued Beef\**

6. *Hamburgers*

7. *Pizza*

8. *Fresh Baked Bread*

9. *Oranges\**

10. *Roses* — (A Rogue miscalculation.)

11. *Pine Trees* — (Another miscalculation; derived from room deodorizer studies.)

12. *Zgwortz* — (The scent broadcaster has been mis-set, and now puts out an alien food scent. Each character must make a HT roll when first detecting this odor. Those failing their roll are *nauseated* by the smell (-2 IQ, -1 DX) until 10 combat rounds after the smell stops.)

\* PCs must succeed at an IQ roll to identify this smell; otherwise, it is only "familiar."



### Coining a Trail

Some items the Rogues might use to create a trail (roll two dice to choose randomly).

2. Diamonds (-5 penalty to notice)
3. Emeralds (-6 penalty to notice)
4. Gold Krugerrands (-3 penalty to notice)
5. Silver Dollars (-4 penalty to notice)
6. Dimes (-5 penalty to notice)
7. Pennies (-6 penalty to notice)
8. Quarters (-4 penalty to notice)
9. Pearls (-4 penalty to notice)
10. Arcade Game Tokens (-4 penalty to notice)
11. Paperclips (-4 penalty to notice)
12. Malted Milk Balls (-5 penalty to notice)

### Rogue Options

If some of the PCs are narcotized (see p. 29) but others hold up in safety, the Rogues might try some adventuresome alternatives:

- Stalk down the missing characters one by one.
- Take the prisoners away, leaving the free ones behind — if they do this, make sure the free PCs have a way to find the captured ones.

### Adding Sectors

Feel free to add new sectors and new scenarios to the adventure, beyond those detailed in Chapter 5.

If the PCs answer the phone, the caller gives precise instructions leading to the next planned encounter. The caller then hangs up. The directions might go something like this: "Listen carefully. Drive north on the road you are now on for two miles, until you come to an intersection with a wrecked fire engine. Turn west, and drive another half mile. I will contact you again."

Secretly make an IQ roll for the adventurer if he heard the air controller's voice earlier in the adventure; if successful, he recognizes this as the same voice.

If the adventurer tries to interrogate the caller, roleplay the conversation. The caller (a Rogue) wants to lure the PCs by using a mystery as the bait. If forced to be specific, he will claim to be part of a "resistance force," but will be vague about the nature of the invaders being resisted.

Characters who succeed at Fast-Talk, Psychology and Detect Lies *and* roleplay their part in the conversation may get more information than the Rogue wishes to disclose . . . be creative!

### Lightning Storm

As a last resort, the Rogues use a real threat to herd the adventurers — an artificial electrical storm.

Let the adventurers notice a growing fog. If the characters are stationary, the fog forms around them; if they are on the move, the fog forms in front of them. (If the PCs travel fast enough, they might outdistance the storms before the Markann can activate any of the more spectacular phenomena.)

Next, a single dark cloud forms about 20 feet off the ground, coalescing out of the mist. The cloud is mobile but slow, moving no faster than 20 mph.

The electric potential of the cloud slowly rises. As it does so, the following symptoms occur in sequence:

- *creepy feeling* — All characters who succeed at their IQ roll, *and* all characters with Danger Sense, get an undefined feeling that something is wrong. This requires a Fright Check from those who feel it.
- *hair stands up on arms* — A successful IQ roll reveals this. Clothing also crackles during movement. This too requires a Fright Check.
- *crackling sound in the air* — Heard on a successful Hearing roll. The sound is very faint, similar to that made by a neon light.
- *ball lightning* — Anyone who succeeds at an IQ roll notices a green glow

around the nearest tall, pointed objects (especially light poles and antennae). If there are no pointed objects handy, substitute any tall object. If there are no tall objects, empty air begins to glow.

The glow grows brighter, until the green light is as strong as a low-watt light bulb. This calls for a Fright Check. If described properly, the glow might be misinterpreted as a ghost or spirit. If touched, the ball lightning discharges, doing 1d-1 crushing damage.

- *hair stands up on head* — The static charge in the air grows until other objects acquire a charge, and repel each other. Hair "stands up." Metal objects give off an audible shock when touched, doing 1 hit of damage.

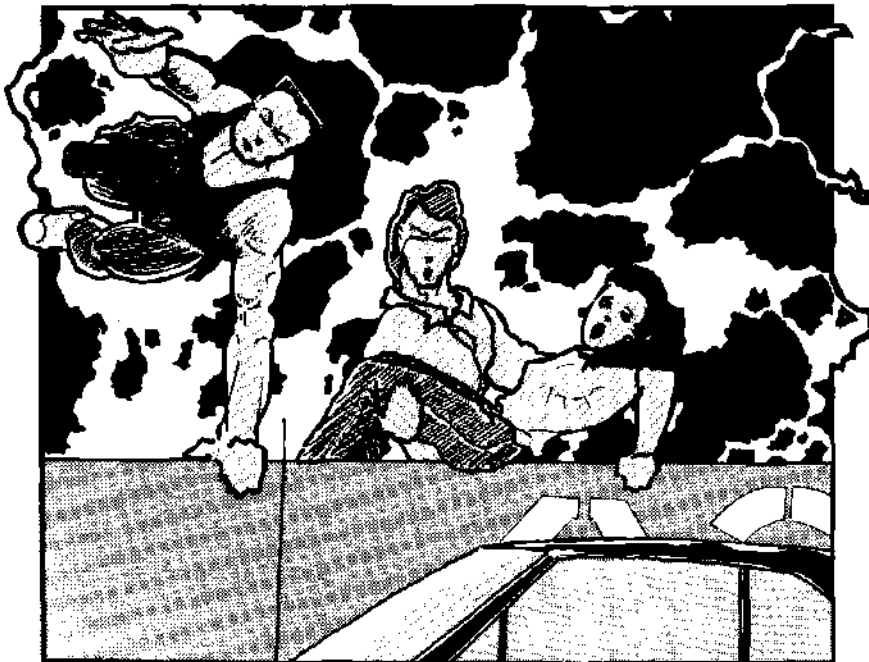

• *lightning* — Bolts of lightning strike out of the cloud once every 1d rounds, doing 1d-2 damage (minimum of 1 hit). When the bolt strikes, randomly select a player character and roll 1 die. On a roll of 6, the lightning strikes the character. On any other roll, the bolt misses — it lands 3d hexes away, in a random direction.

The Rogues do not want to injure the adventurers. After the first PC is hit, the storm suddenly dissipates.

### **The Last Resort**

Very frustrated Rogues will finally fall back on a technique guaranteed to work. They catch the adventurers outdoors, narcotize them and take them to where they are wanted.

The party suddenly notices a fine rain drizzling down. Any character succeeding at a Smell roll detects a strange odor. Anyone observing the rain may make an IQ roll. If successful, he notices that this drizzle is only falling in a region 30 hexes across.

A HT roll is required for every five turns spent within the rain. Failing the roll means the character falls into a deep sleep. Seeing the first one affected by the rain calls for a Fright Check. (Non-humans first make a preliminary HT roll. If the roll succeeds, that race is immune to the affects of this mist. Otherwise, the normal HT roll must be made.)

The Rogues can match any speed the humans try, using a floater to distribute the mist. The rain cannot follow indoors. It affects people inside a vehicle only if they are sitting next to an open window, or are otherwise exposed to fresh air.

If the PCs escape the Rogues' trap, wholly or in part, the scientists give up on maneuvering the party and merely monitor their movements.

### **The Pseudo-Humans**

Most — and, if that option is selected, *all* — of the humans in *Flight 13* are not human at all, but are Pseudo-Humans (see Chapter 7) transformed by the power of Markann technology.

This process requires special equipment and trained operators. The "transformed" Pseudo-Human is a precise image of what the Markann intend. There is no way to tell the difference, except to probe to molecular levels with electron microscopes.

The transformation is never permanent. Pseudo-Humans begin to regress 2d×3 hours after their transformation. (That is, after the Pseudo-Human first enters the game.) Passengers on the plane are "transformed" at the instant that the plane enters the storm (see p. 10). Stress and bodily injury bring on regression much sooner; for each Fright Check failed, and for each hit taken, regression will occur two hours sooner.

### **Dissolution**

Dissolution is what happens as the Pseudo-Human begins regression. It takes several hours to complete — the exact number equals the (original) HT of the character. The body is breaking down into a molecular "goo," the most basic building block of Pseudo-Human physiology.

The process is not uniform. At the start of each hour, roll on the Parts of the Body chart (see p. B203) to determine which body part starts to regress. The initial regressions will be small and minor, perhaps unnoticed or concealable. Later regressions are major, and the entire body dissolves in the final hour. Subtle changes may require an IQ roll for the affected character to notice.

Each noticed change requires a Fright Check from the affected character, with penalties varying from -1 (mild changes, such as a suppurating sore), -7 (small but strange changes, such as a finger tendril), and -10 (an entire hand

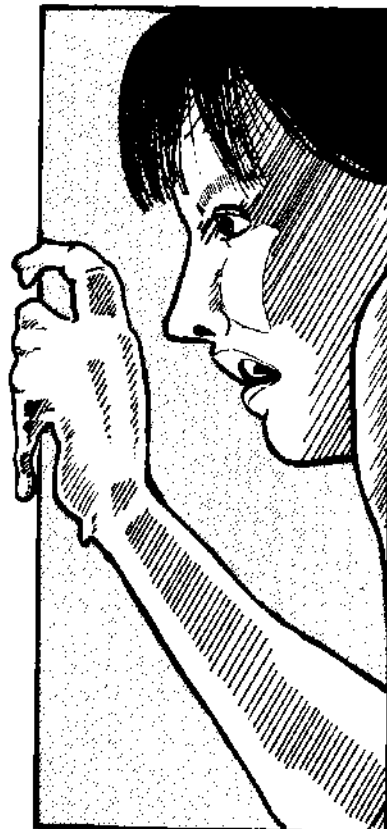

### **Describing Dissolution**

Be creative in inventing and describing these changes to the player characters. For instance, a result of "hand" from the Parts of the Body chart might be interpreted as:

- A growing, suppurating "sore" on the back of the hand (an initial regression).
- A finger that has become a gelatinous tendril.
- An entire hand that is now a blob of animate goo (a late change).

### **Resisting Dissolution**

A PC may resist dissolution by succeeding at a Will roll. Encouragement through telepathic contact helps — +1 bonus if any contact is made during that hour, and +3 bonus if the contact is constant.

If the roll is successful, no further dissolution occurs that hour.

If the roll succeeds by 2 or more points, *reverse* dissolution goes into effect. That is, dissolved body parts resume human form.

On a critical success, dissolution stops permanently. The PC Pseudo-Human is now stable.

turned to goo). The penalties apply only the first time that a change of that type is noticed. For instance, Mabel Greely has a Fright Check at -7 when her ear turns to slime, but is back to her normal Fright Check when the gaping, pus-tulous wound appears in her arm — she's growing used to the idea.

### ***Ammo, Guns and Horror***

The decision about the availability of guns and ammunition will drastically affect the feel of this adventure. The PCs need firepower or the nasties will devour them, but . . .

#### ***The High Firepower Adventure***

If the lost travelers can walk into police stations and gun shops and come out with armloads of automatic weapons, the foundation is a laid for a "shoot 'em up in the ruined city" adventure. Players who enjoy guns will love it. *Flight 13* then becomes a Chuck Norris-style horror adventure.

However, PCs with M-16s don't get "scared" easily. Or, more precisely, while the PCs still fail their Fright Checks, the players may not feel "horrified."

#### ***The Low Firepower Adventure***

In this option, the adventurers are limited to what they can scrounge up in the city. Gun shops are already plundered or in hostile hands, or weapons can be found but ammo is limited and precious. Inventive PCs may be forced to improvise Molotov cocktails and the like, or resort to whatever they can get ("A crossbow? How do I use it?").

The limited firepower allows the "horror" of the situation to be felt. Being under attack by a flock of Avians while in a stalled car is much more terrifying when you don't have a dozen grenades. At the same time, players who enjoy firepower may be frustrated by the lack of it.

If the adventurers turn out to be under-gunned, they can always be saved by one of Damnation Jim's patrols (see p. 33).

#### ***The "Fight for Firepower" Adventure***

This option assumes that any firepower the party doesn't already have is controlled by someone else, human or inhuman. As the adventurers enter the seemingly abandoned police station, they don't see the lurking Beast Children . . .

The object is to force the PCs through a "horrifying" experience in order to get their heavy firepower. Since the characters are out of their cars, this is a good opportunity for adventure mischief. Once again, however, if the adventurers obtain heavy firepower, they become partially immune to the following horror.

### **Futuristic Characters in the 20th Century**

Depending on Tech Level and time period, futuristic adventurers may have a lot of trouble figuring out how to do even the simplest things.

#### ***Obsolete Equipment***

The skill roll penalty when dealing with technology of a lower level is -1 for the first level, with an additional -2 penalty for each lower level. Characters from TL10 in this TL7 city have a -5 penalty to their rolls!

In situations where no skill rolls are required, impose appropriate limitations on the PCs. Some suggestions:

**Computers.** Characters who fail their IQ roll cannot communicate with the computer at first (they expect it to *talk* with them). They expect all computers to have easy access to worldwide integrated databases.

**Medicine.** Physicians must make an IQ roll to correctly identify medicines and medical equipment.

**Money.** The idea of physical units of money — bills and coins — may be foreign to the characters, if electronic banking is in general use.

**Radio.** Futuristic characters expect video/audio technology — audio-only seems archaic. They may not be aware that FTL radio is not available.

**Telephones.** Again, they expect video technology. They expect to identify the person they wish to speak with, and have a computer operator make the connection — "phone numbers" are unknown. (Failing an IQ roll, they might try to contact someone by dialing their driver's license or social security number.)

**Vehicles.** 20th-century cars are smelly, creaky, slow and unsafe. Make an IQ roll for the driver. If he fails, he forgets that the vehicle needs to be refueled, and drives until it runs dry.

**Weaponry.** The idea of cartridge ammunition is foreign to characters raised on energy weapons with battery packs. If a gun jams or misfires, make an IQ roll for the PC. If he fails, he discards the gun as "broken."

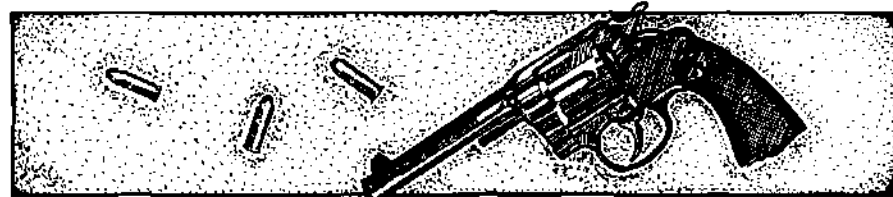

#### ***Useful Skills***

Anthropology, Archaeology and History skills are all useful in understanding Old Earth technology. There is a -1 penalty to the skill roll, unless the character has selected no specializations in his field (but if his specialty is Old Earth, he gets a +5 bonus!) — see p. B43.

In addition, assess penalties depending on how common the technology is. An anthropologist might easily decipher the workings of a telephone, but figuring out how to run an X-ray machine would entail a substantial penalty.

Characters who succeed at these rolls understand how to operate the equipment, but may not understand how the device works, or how to handle malfunctions. The historian who successfully operates the telephone, for instance, might be totally baffled by the busy signal he gets (have him make an IQ roll to figure it out).

## City Facilities

**Telephones.** The phone system is operating erratically. Phones ring for no reason, odd noises plague calls, and calls placed by the adventurers may be routed elsewhere or be broken suddenly. This is only partly under the control of the Markann.

**Utilities.** Water, electricity and sewers are functioning. Sudden "brown-outs" are common. The water has an odd taste.

**Food.** Supplies can be pilfered from supermarkets, restaurants and fast-food places. The food will be normal and nourishing to humans, but may cause problems for aliens.

**Streets.** Streetlamps light the mostly-deserted streets.

## Miscellaneous

**Day and Night.** It will be "night time" for the duration of the adventure. The permanent cloud cover of K'ssg blocks the sun.

**Driving.** When making a Driving roll, the speed of the vehicle at the time of the skill roll is important. Use the following table to determine skill modifiers:

Vehicle traveling	
0-20 mph	+1 to skill
21-30 mph	no modifier
31-40 mph	-1 to skill
41-60 mph	-2 to skill
61-75 mph	-3 to skill
76-90 mph	-5 to skill
91+ mph	-7 to skill

If the vehicle is travelling in reverse, add another -3 penalty to the skill roll.

**Leaving the City.** There is a sudden transition, at the end of the experimental zone, between the re-created city and the natural surface of this world. The ground becomes rocky and jagged, almost impossible to walk through. The air is thick with brown clouds, limiting visibility to 15 feet. The low oxygen content of the air makes it unbreathable.

## Resistance

The GM chooses how much opposition the party has from the Pseudo-Humans and occasional nasties in the city. This choice also affects the style of the adventure.

There is a "horrific" feel to an abandoned city, but looting an abandoned city is boring. On the other hand, a city in which every gun shop and gas station is a fortress will force a very militaristic adventure, and the horror elements may get totally lost. Even worse, the adventurers may refuse to leave their vehicles.

There should be the possibility of running into trouble whenever the adventurers get out of their cars. If they leave their vehicles or belongings untended, there should be consequences — bring on an improvised encounter. A Beast Child (see p. 47) could always try to drive away in an unlocked car. An Avian (see p. 39) might be curious enough to burn its way through a car, and be waiting within when the driver and crew come back and drive off . . .

When improvising encounters with the Pseudo-Humans, adjust the NPCs to fit the style of the campaign. Survivalists and biker gangs are a nice element to add to a "high firepower" adventure. For the more horrific "low firepower" campaign, focus on psycho killers, the insane, or the incredibly strange.

Roadblocks and other obstacles can also add an element of frustration.

## Markann Meddling

The Rogues want to keep the adventurers stirred up — or terrified, in other words. Certain elements — especially guns and vehicles — give the adventurers security. The Rogues don't like that, and they have some technological tricks up their sleeves to deal with this.

### "It doesn't work!"

If an item seems particularly effective, the Rogues do "something" to it (using their superior technology). The cause might be obvious and natural, invisible and mysterious, or obvious and mysterious. For instance, the ex-Marine's Uzi jams, and when he disassembles it, he finds a major assembly welded solid (Fright Check!).

In the case of a large convoy, the Rogues might knock out vehicles one by one. This could be very subtle — after each stop, one new vehicle refuses to start. Mechanics can find no reason for this (Fright Check, again).

The Rogues might also target a key vehicle — for instance, the van carrying all of the high explosive the PCs liberated earlier. As the PCs are forced to get out of their vehicles and reload the crates, a horrific encounter ensues . . .

### "It isn't working right!"

The Markann will sometimes let an item function, and sometimes they won't. Or it works, but not quite correctly. This technique is useful with cars and radios. Every vehicle in the group might suddenly slow to 30 mph and the headlights flicker, or static might temporarily shut down the radio frequency the PCs had their walkie-talkies set for.

### "I can't see!"

A simple but scary technique is to kill all of the lights in an area, including headlights and flashlights. Sound might also be dampened, creating an unnatural silence.

## Vehicles and Horror

As with firepower, the presence or absence of heavy vehicles will mold the style of the adventure. At one extreme, the adventurers can commandeer eighteen-wheelers or even National Guard vehicles; at the other extreme, only damaged economy cars can be found.

Likewise, gasoline can be scarce or plentiful. This, too, is left for the GM to decide as best fits his players.

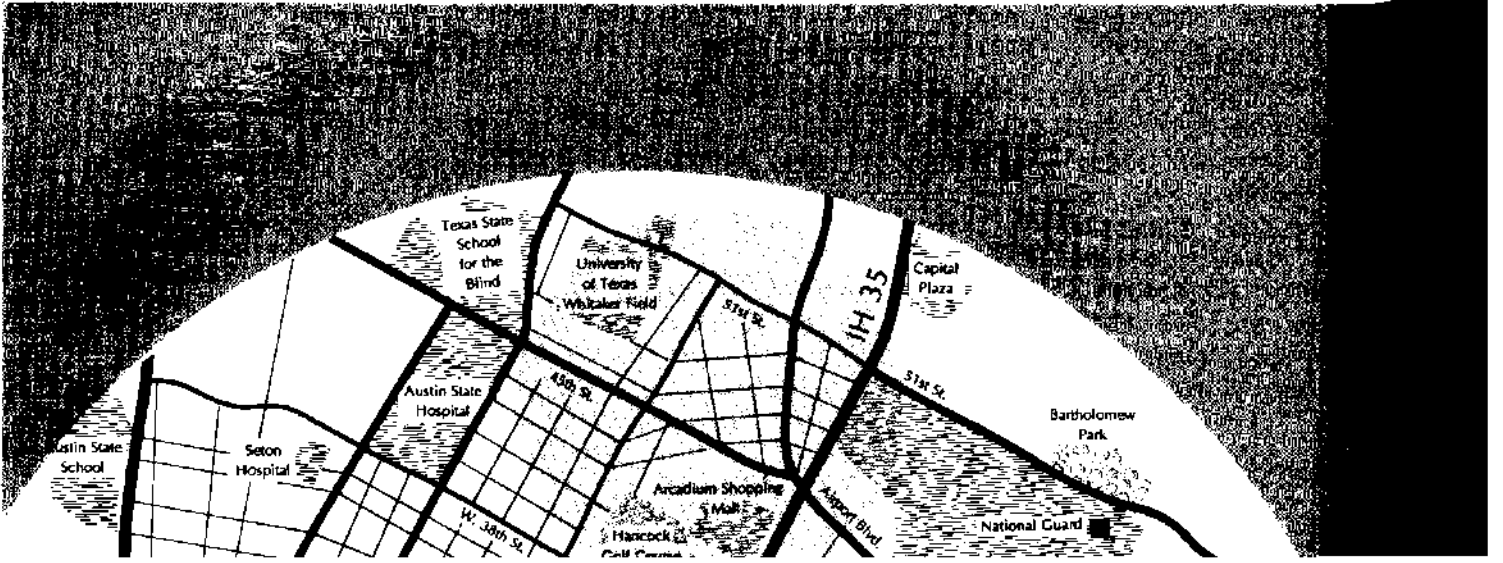

# EXPERIMENTS BIZARRE

# 5

**Synopsis:** The city is divided into *sectors* — regions dedicated to different Markann research teams for their psychological experiments. The players generate new encounters as their characters move (or are herded by the Rogues) from one part of the city to another.

Each sector is described below, along with a brief explanation of what the Markann scientists are trying to learn. *Minor Encounters* are brief episodes which can be inflicted on the PCs at any time. *Major Encounters* are for a longer, more challenging scene in the adventure at this point.

The GM decides which encounters to run. *It is not necessary to run the players through every scenario in this chapter.*

## Things of the Night

*The Research Goal: Team 1 has been assigned the simplest of all studies, but one that produces interesting results from sentient species — the test of racial adaptability. The subjects' universe will be radically altered by a remorseless, unexpected menace. Researchers should be careful to note signs of: the disintegration of social and family bonds, loss of individual sanity, and the difficulty of the race in adapting to unexpected circumstances.*

— Excerpt, Markann Research Log

The Markann research team has inundated this part of the city with a horde of black, boneless, wriggling creatures carefully designed to be repulsive to human beings. The creatures have one weakness, light (see sidebar, p. 36).

The creatures transform among three forms. *Avians* resemble oversize terrestrial bats. *Rompers* are swift four-legged things about the size of a dog. *Worms* are limbless entities with the ability to devour stone and metal. For full descriptions see pp. 39-40.

## Jim's Fortress

The largest group of survivors in this sector has found refuge in an aging shopping center, under the direction of a colorful local known as "Damnation Jim." Their very success, however, has attracted more and more of the alien creatures. Jim's fortress now seems doomed.

The players can become involved in this drama in any of several ways.

*The CB Radio.* Jim is constantly on the CB with his requests for help — "especially mortars." If the adventurers don't have a radio, let them find an abandoned emergency vehicle (such as the police car at the airport).

*The flocks.* Let the PCs observe "flocks of birds" flying in the direction of the shopping center (these are Avians reinforcing the original flock). The characters might decide to investigate.

*Jim's patrols.* One of Jim's patrols, searching for weapons and explosives, encounters the party and asks for their help. Better yet, the patrol might rescue the adventurers from a threatening encounter. The PCs can show their gratitude by saving the shopping mall.

## Pre-Game Preparations

1. Prepare a half-dozen notes which read: "Your character has just failed a resistance roll, and now has an obsessive hatred of {blank}. Do not write this on your character sheet at this time. Roleplay!"

2. If this adventure is to be customized, the GM will need:

- plans for a small shopping center, containing a restaurant and a movie theater
- plans for a football stadium (professional, college or high school)

## Sector 1

This is an older middle-class part of the city, packed with one-family houses (not apartments), small parks, baseball fields, elementary schools, and a single decaying golf course. People from a variety of backgrounds and ethnic groups live here, though the affluent live further north (beyond the boundaries of the re-created city).

Many people in this sector perished in the first throes of the experiment. The survivors now huddle in improvised forts throughout the sector, desperately awaiting aid from the outside world. People are easy to find, if looked for — they are hiding from beasts, not from other humans.

## Major Encounter



## The Shopping Center

The Arcadium was built thirty years ago, and has long since been eclipsed by newer and larger malls elsewhere in the city. Through the middle of the complex runs a covered walkway, with many stone benches for shoppers. In the center is a tiny plaza with a broken fountain — a few inches of stagnant water lie in its basin.

*Oriental Express* is a no-frills Chinese restaurant, featuring very fast, inexpensive food. The furnishings are plain, booths along both walls and metal tables in the middle. Orders are placed at the inside counter. Large containers on side tables are for free refills of iced water and tea. Photographs and hand-lettered descriptions of the meals are taped in the window.

*Bob's Hardware* is a garden-variety hardware store. A small selection of power tools and parts can be found here, as well as a very limited supply of lumber (no plywood sheets).

*Central Office Supplies* combines three businesses in one: stationery and office supplies, typewriter repair and official U.S. post office.

*Major Department Store* is a large department store of any type. This is an older store, and the selection is very limited. A portable searchlight is located on a trailer parked outside, and was recently used for a sales promotion.

*Discount Movie House* is a theater that has fallen on hard times. It is now reduced to showing last-run movies at an admission rate of one dollar, catering largely to the college crowd and young families. The marquee currently advertises a re-released Disney classic, a kung fu picture, a romantic comedy, and a violent detective film. Old arcade games crowd the faded lobby.

*Fleming and Mausser, Attorneys*, is an office for a pair of small-time lawyers.

*Central Cleaners* is an old, but well-kept, dry-cleaning shop. The machinery gleams with lots of chrome. "Perk," a liquid used in dry cleaning, is available in six large drums. Perk fumes are strong; anyone who breathes the fumes must make a HT roll to avoid passing out.

*Roy's Barber Shop* is decorated with stuffed animal heads, hunting and fishing magazines, and boxes of hair products for sale (combs, hair wax, barbers' scissors and so on). A sawed-off shotgun can be found in the cupboard beneath the cash register, while some very sharp straight-edge razors accompany each barber chair.

*The Rainbow Store* contains racks of canned paints, many of which are highly flammable in their liquid state.

*Major Retail Store* (five-and-dime variety). It contains a wide variety of normally useful items, but nothing more dangerous than model-airplane paint and knitting needles.

## What Jim Has Done

"Damnation Jim" Hitchcock, an unemployed oil-field worker, was asleep on the couch at his sister's place when the invasion of creatures began. He was able to fight off the initial incursion long enough to bundle his sister's family together and head for the mall, which he figured would be a good rallying point and easier to defend than a private home. He cruised the nearby streets for as long as it was safe, using a bullhorn to call the people to the shopping center.

There are almost a hundred people in the shopping center, but half of those are small children. Jim has formed the adults (men and women, including any teenager old enough to operate a gun) into five 10-man teams: Alpha, Beta, Cracker, and Donkey teams are the combat groups, while Everest Team — made up of the eldest, the sick and the injured — provides housekeeping and tends the children.

Alpha and Beta teams have been assigned to the west side of the mall, and alternate duties — patrols throughout the west mall are made every half hour. Cracker Team is stationed in the northeast mall, and Donkey Team has the movie theater. Half of Everest Team is in the movie house with the children, while the other half is in the restaurant kitchen preparing food.

One member of each combat team has a shotgun or rifle. Four of the other members have light handguns. Ammunition is limited; most is held in reserve by the team commanders. There is a wide variety of melee weapons: hunting knives, barbers' razors, aluminum knitting needles, saws, hammers, butcher knives and chopsticks.

Passageways have been knocked in the walls of adjoining shops, allowing the patrols to move within their part of the mall without exposing themselves. However, movement between isolated parts of the mall remains hazardous.

Several parked cars remain in the lot. Unfortunately, these cars have fallen prey to Worms (see p. 40) trying to reach the heat-radiating engines, and are now junk. In addition, the lot is infested with Rompers. They will attack anyone who approaches the cars.

Jim has ordered exterior lights extinguished, including the parking lot lights. Mall windows have been covered on the inside with blankets, stacked furniture and paper. He hopes that the creatures will go away if they cannot see human beings.

Using a radio discovered in the hardware store, Jim or one of his assistants has constantly been monitoring the emergency-broadcast band. Though they have had temporary contacts, no one has arrived with help. Too often, the communications have been interrupted by sounds of violence or by a sinister burst of interference.

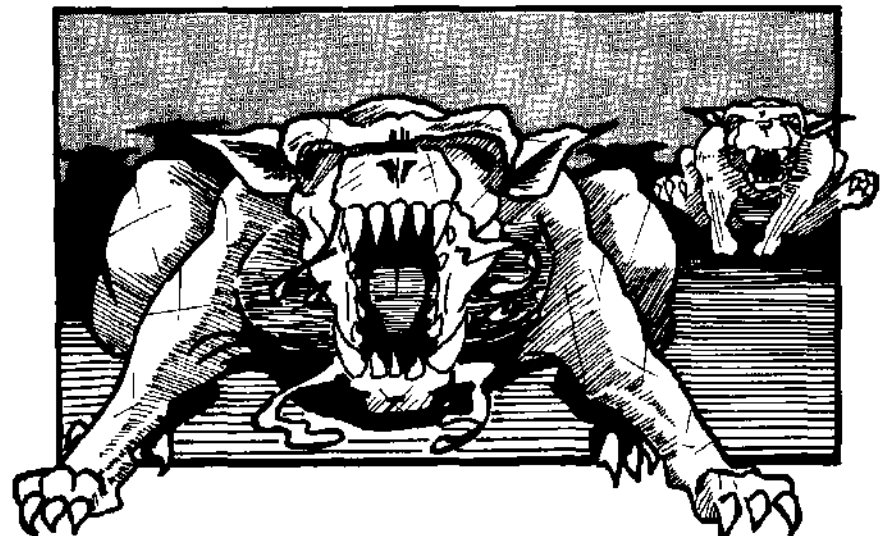

# Arcadium Shopping Mall

1 hex = 1 yard

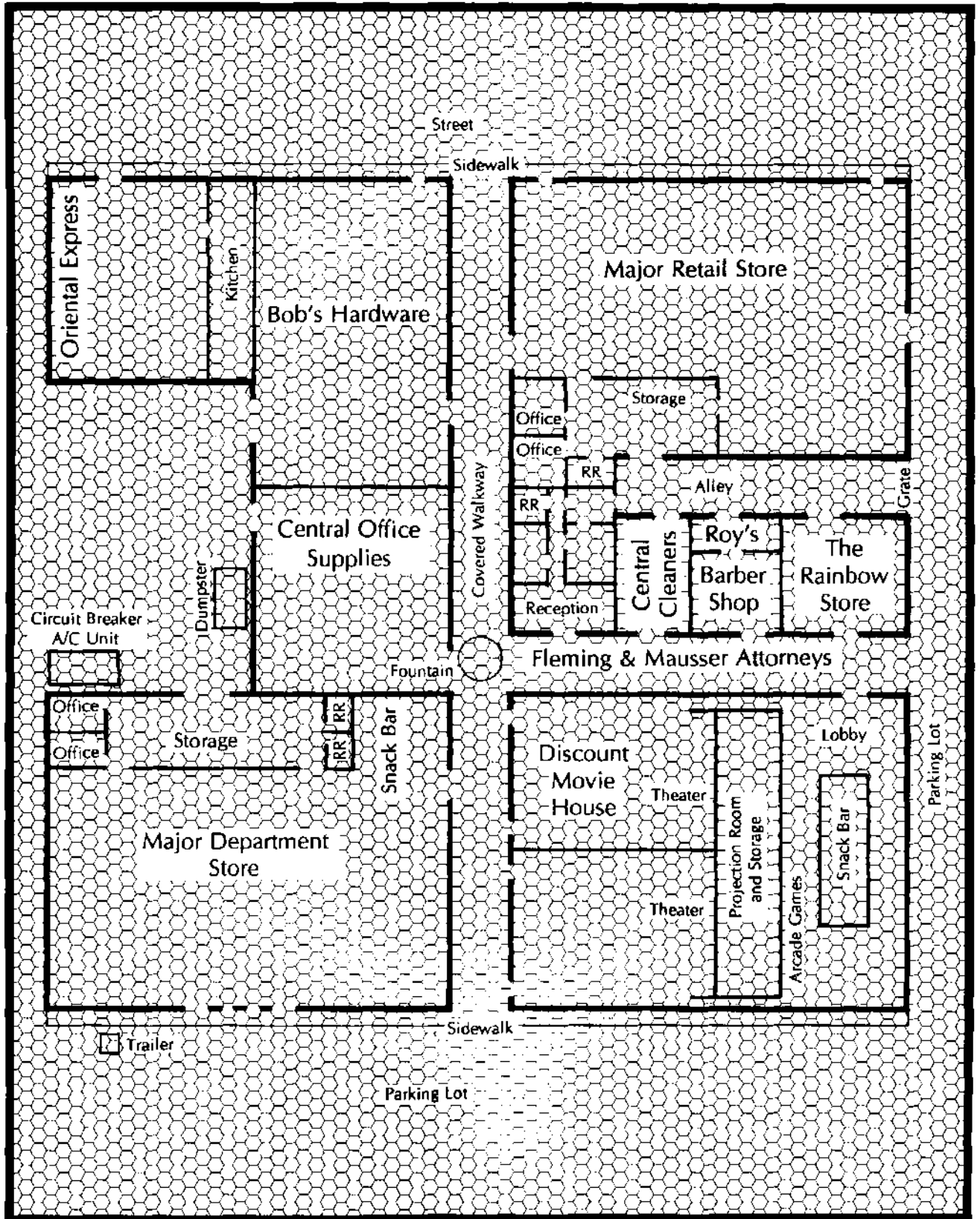

### Killing the Predators

The only quick way to kill one of these beasts — in any of the three forms — is to give it a burst of high-intensity light. As a guide, a list of light sources is presented, along with the distance in hexes at which they will kill one of these aliens:

searchlight	30 hexes
camera's flash	10 hexes
bonfire (or paint fire)	5 hexes
flash powder	5 hexes/lb
movie projector lamp	4 hexes
car's headlamps	3 hexes
light bulb	1 hex
incandescent light	1 hex*
flashlight	1 hex*
neon light	1 hex*
match	no effect
candles	no effect

\* no damage, but the creature will break off the attack.

Rompers avoid bright light. Worms hate light, and will transform into Rompers to escape. Avians who are blocked from a target by a dangerous light will attack that light, using a suicidal diving approach that avoids the flash of the light until the last moment.

### Getting In

The PCs will have no great difficulties approaching the shopping center until they reach the final few yards. The horde is gathered at the mall, and has no attention to spare for lesser targets.

Dark masses of predators in Romper form, swaying in unison and honking, dot the parking lot (requiring a Fright Check at -3 penalty). Alert PCs may notice (on a successful IQ-4 roll) a mound of wriggling objects on top of the restaurant, bringing on a second Fright Check at -2 penalty.

Crossing the parking lot on foot is obviously impossible. Driving across is safe as long as the car's headlights are on. The Rompers are repelled by light, and will move back.

To make it more difficult for the driver, some of the Rompers will transform into Avians and attack the vehicle (if not seen before, this is worth a Fright Check!). Weaving about, buffeting the windshield and trying to get inside, the Avians will force a Driving roll every turn the driver's view is restricted (see p. 31).

If the skill roll is failed, the vehicle slews violently to one side — all passengers who might be thrown clear must make a DX roll to remain inside the vehicle. On a critical failure, the vehicle runs into a light pole — all characters take 2d-2 damage and are stunned until a successful IQ roll is made, while the vehicle is inoperable. Alternatively, if the vehicle is close enough to the shopping mall, have it crash into one of the stores.

If the PCs come anywhere close to the mall, members of the nearest defense team will open a door and provide covering fire to give the characters a chance to get inside. If there is cargo, two members of the team will help unload it. Nearby lights will be turned on to aid the PCs.

As the lights are turned on, the characters have a rare opportunity to obtain the secret. An Avian flying beneath a turned-on light falls to the ground dead. Unfortunately, only PCs who are looking in the right direction and who aren't distracted by the combat will have a chance of noticing. Make an IQ roll for qualifying characters and, if they succeed, tell them that they just saw an Avian die for no apparent reason. If the player cannot puzzle out the reason for it, he may make an IQ roll (at -2 penalty) for his character to figure the mystery out.

The predators are dazzled by the sudden action, and will be slow to develop an attack. (The idea is to get the player characters inside the mall, not drive them off.) If the PCs seem likely to get themselves killed by the predators anyway, use Jim's secret weapon (see p. 37) to drive the beasts back long enough for a team from the mall to rescue them.

### Meeting Mr. Damnation

If Jim has not already talked to the PCs over the radio, he will quickly ask them if they know what is going on and how long it will be until help arrives. Neither Jim nor any of his people have any idea what is going on elsewhere in the city.

While he quizzes the adventurers, he will give them the quick tour of the "fortress." Jim is proud of the team organization, of the passageways he's opened throughout the mall, and of the way his neighborhood is defending itself.

He is also eager to show off and boast

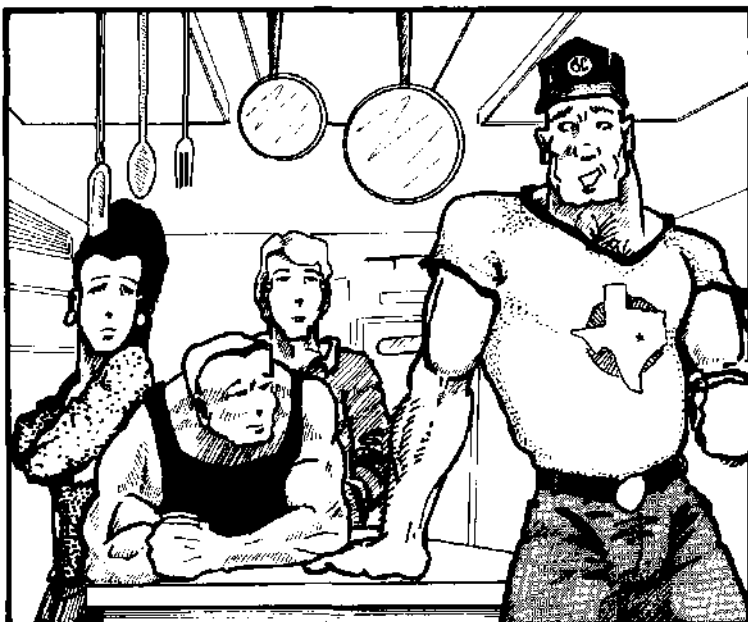

about his "secret weapon." Jim has misinterpreted some facts, and now believes that fire is the best weapon to kill the predators. Two of his men have rigged up a powerful, impromptu trebuchet (Gunner (catapult), special, SS 0, Acc 1, ½D 50, Max 100, Wt. 100, RoF 1/20, Shots 1, ST —, Rcl —, Cost —, TL 3) that can sling paint cans anywhere within the parking lot. The cans of oil-base paint are rigged with burning wicks. They weigh 10 lbs. and do 2d crushing damage. When the cans strike the parking lot, the contents burst into flame and spread out in a 3-hex circle. The light from the burning fire will kill predators up to 5 hexes distance from a burning hex. The flame lasts for 5 seconds.

Jim is also proud to tell a little about his own life history — see his character description in the sidebar.

Though he is familiar with all three forms of the predator, Jim does not understand the danger of the Worms. He alternates between feelings of security ("how can the mothers get in here?") and anxiety ("we're low on ammo, and they outnumber us a million-to-one . . .").

### *Just Dropping In*

As the PCs arrive in the Chinese restaurant — whether as a result of the tour, or because they tipped Jim off to the "pulsating mass" on the rooftop — the next phase in the assault begins.

Three places in the shopping mall especially attract the predators: a circuit-breaker and air conditioning installation, at the rear of the mall; the movie theater, crowded with children; and the kitchen of the restaurant. All of these, of course, are heat producers.

A trio of Worms has just burrowed tunnels through the ceiling of the restaurant. The Worms will now drop into the kitchen, changing into Rompers when they land, and will attack the kitchen help. Other predators will follow in the same manner, at the rate of 1 to 4 per turn.

Four members of Everest Team are in the kitchen; a fifth is serving meals in the restaurant proper. Everest Team members have stats as the typical NPC on p. 61 with additional disadvantages. They are nice but helpless: a very pregnant young woman, an elderly lady who uses a metal-frame walker to get around, "Pops," a popular but frail older gentlemen, a young man with a leg in a cast and an arm in a sling due to a recent car accident, and Sylvia, who is mentally handicapped.

As the battle begins, let the PCs hear screams from the kitchen . . . and the sound of something large hitting the ground. Up to 10 off-duty members from teams Alpha or Beta may be placed in the restaurant, depending on how much help the GM thinks the PCs will need.

There is probably no way for the players to win a total victory in this scenario. The holes in the ceiling cannot easily be patched, which means that the aliens will keep coming in. As soon as Jim realizes this, he will order his men to conserve their ammunition and retreat, leaving the restaurant to the predators.

Creative players may think of keeping the creatures out by placing fires or lights under the openings in the ceiling. If they succeed in doing this without burning down the building, this solution should work.

The players should consider themselves victorious if they can rescue the helpless citizens from the invasion, and escape with their lives.

### *Desperate Moments*

Following the battle in the Chinese restaurant, Damnation Jim will realize that his situation is hopeless. The aliens can enter anywhere, given time, and will eventually overrun the entire mall. The security given by the buildings is only temporary.

A council of war, involving Jim and the five team leaders — a plumber, a

### *James Earl "Damnation Jim" Hitchcock*

Age 45; red hair, green eyes, several gold teeth; 6'5", 280 lbs.

ST 16, DX 12, IQ 9, HT 12.

Thrust 1d+1; Swing 2d+2.

Basic Speed 6; Move 6.

Dodge 6; Parry 6.

Advantages: Charisma 3; Combat Reflexes, High Pain Threshold, Strong Will 3.

Disadvantages: Major Delusion (This is the end of the world, but if we keep our heads, we'll come through it); Fanaticism (Modern Science is conspiring to hide the truth from us, but I have found it); Sense of Duty (The people at the Mall, especially the children).

Skills: Bard-12; Brawling-14; Gunner-11 (Infantry mortars); Guns-12 (familiar with bolt-action rifles, shotguns, assault rifles, pistols and revolvers); Judo-12; Knife-12; Mechanic/TL 7 (Oil-Field Machinery)-12; Area Knowledge (this city)-11.

Weapons: Fighting knife (Cut 2d, Imp 1d+1).

Big, red-headed Jim Hitchcock has had a varied career. A notable high-school athlete (all-conference at football and wrestling), he did a hitch in the Marines as an unarmed-combat instructor. He then tried used-car sales, professional wrestling, private security, furniture moving and oil-field work. Two years ago, he walked away from his latest job, and settled down on his sister's couch for some serious thinking.

Jim's intellectual concerns had always been a trifle strange; now he settled to a serious study of tabloid science, paperback mysticism and television theology. His studies convinced him that the world was on a slippery road to damnation. He became determined to save at least a few from the coming holocaust.

For over a year, Damnation Jim has been a local character. Most people find him an amiable and entertaining eccentric; the exceptions mostly don't want to find out if he is as tough as he looks. Since a few hours ago, he hasn't seemed nearly as hard to believe!

Jim is sincerely concerned for his people. He carries only a big knife for a weapon; his personal guns have been distributed to his followers. "I'm the biggest," he says, "others need the equalizers more."

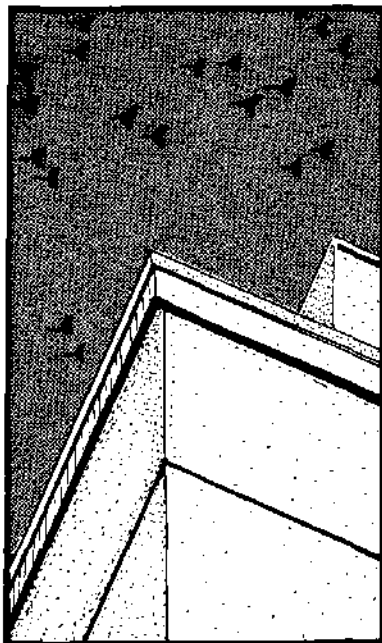

### What Next?

By now, it's probably time to proceed directly to the Finale, below. However, if the players are really enjoying themselves, other actions might be improvised. There are several good options.

**Black-out.** When the Worms finally break through to the circuit breaker, all power will be lost throughout the mall (including lights). There is a gasoline-powered back-up generator in the hardware store, but the characters will have to figure out how to use it.

**Evacuation.** When the Worms break through in the movie theater, there will be pandemonium. There are 50 children to rescue, all of whom must cross the walkway to get to any other part of the mall. To vary the combat, have the Worms transform into Avians for fighting in the large room. The light from the movie projector will kill more than a few predators — perhaps the PCs will finally catch on.

**Experiments.** If the PCs don't think of this, have Damnation Jim appoint one of the adventurers as his chief of research. Order him to capture and study one of the predators, to figure out ways to kill it. Have the NPCs offer many useless ideas (dry-cleaning "perk" chemicals, heat, cold, drowning, electrocution . . .). Others might want to tame the beast, communicate with it, or surrender to it.

housewife, an aging insurance salesman, a female corporate executive, and a Vietnam veteran — ensues. The PCs are welcomed to join in the debate; they have no vote but are a powerful lobby.

Joe Rigorsio, the *Vietnam vet*, will argue for an all-out assault on the creatures in the parking lot, using every last bullet they have.

Victor Jenkins, the *insurance salesman*, wants to hold out, fighting room to room. He is sure that help will arrive soon.

Tricia Slavens, the *corporate executive*, wants more information, and keeps asking anyone who speaks "how sure they are of the facts." She is a hindrance to the discussion.

Mona Brown, the *housewife*, is concerned for the children.

Juan Rodriguez, the *plumber*, confesses that he abandoned a wife and three children in Omaha two years ago, and feels that guilt weighing him down. He will volunteer for any job that sounds dangerous, risking his life to make up for his past misdeeds.

How the war council votes is up to the GM, who should select the option that suits his players. If the adventurers support an attack, then there will be an attack — according to the plan designed by Jim and the PCs. If the characters urge a delaying strategy, the NPCs will go for the room-by-room proposal. The PCs might volunteer to find help — in which case, Jim will promise to hold out until the characters return, or until radio contact is lost.

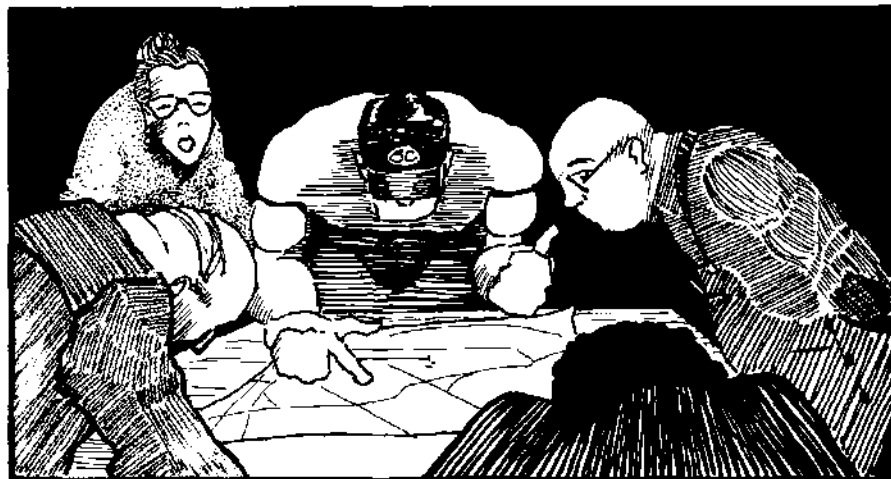

### The Finale

Much depends on the player characters.

If anyone has stumbled onto the notion that *light* kills the creatures, or by sheer accident decides to try the searchlight as a weapon, the battle is easily won. The predators, after astounding losses, will break and flee.

Any other type of battle, using the trebuchet, heavy weapons or high explosives, might be lucky enough to dent the hungry mob. If the characters have fought a good fight, let the crowd of Rompers transform into Avians and fly away . . . but keep several flocks ominously cruising overhead.

If there is a battle and the results are poor, confusion strikes. One of the NPCs will yell, "Breakout! Every man for himself!" The mall people streak across the parking lot, mowed down by rows and rows of predators. Damnation Jim will reach the PCs' vehicle, throw in two or three small children, yell "Save these kids!" and rush back into the battle. The player characters will hopefully escape with the rescued children.

As a last resort, there are the Rogue scientists. They want the adventurers to move on to new scenes, not to remain in the shopping mall. If the PCs delay their

exit, the Rogues will do anything within their power to “prod” the adventurers — especially if the PCs move outside the mall building. They might even fake a radio call to Jim, promising him a load of dynamite if his men can come pick it up. He’d be suspicious, but couldn’t let the opportunity pass.

### Minor Encounters

The following ideas may be used for brief scenarios in this part of the city.

**Flight Attack in Formation.** Prior to the major scenario, the PCs might be attacked by a single flock of Avians. The strafing attack is sure to force a Driving roll or two. If any NPCs are present, let the Avians try some practice diving. If the flying attacks proceed well, transform the Avians into Rompers — Fright Check, please — and try a second round. If the attack is going too well, have the Avians break off and flee.

**Deserted Barricades.** The adventurers, driving along a road, come to an intersection blocked with a crude barricade. No one is in sight. As the PCs come closer, bodies become apparent . . . as do Avians and Rompers, feeding hideously on the fluids of the dead (Fright Check). The satiated predators do not attack, allowing the PCs to disassemble the barricade and drive through. (A lone Avian or two may attack, to make things interesting . . . but mostly, the PCs are watched by a hostile but unmoving crowd.)

**The Last Survivors.** As the PCs drive past an elementary school, their progress is blocked by a man with a white flag. Extolling the adventurers as saviors, he tries to load four NPCs into their vehicle — two wounded men, a young boy, and an expectant mother.

The man explains that they have been under attack by savage animals (having failed a Fright Check, he is now convinced that wolves have entered the city), but the attack was broken off just moments before the PCs arrived. The man — Oscar Levine, a psychologist — will remain here with his neighbors, but he wants the four NPCs taken to safety. He will threaten the characters with a gun, if he feels it necessary, but he will not fire the weapon.

Regardless of what the PCs decide, the encounter is an adventure excuse to get a lot of people out in the open — mostly the NPCs — so that a wing of Avians can make a mass dive-bombing attack out of the blue. Let the players sort out what they can from the battle.

### The Creatures

#### Avian

ST: 7	Speed/Dodge: 20/10	Size: 1
DX: 12	PD/DR: 1/1	Weight: 50-75 lbs.
IQ: 5	Damage: 1 imp	Origin: Alien
HT: 14/5	Reach: C, 1	Habitats: Alien

Black and glossy, as if constructed of oily plastic, these flying predators are composed of wing and neck. The wing — “wings” would be incorrect, as there is no body to separate the single wing into right and left portions — ripples constantly and appears boneless. The neck is likewise elastic, and ends in a long, tapering, hollow tube with a razor-sharp edge. The entire creature is 5 feet long.

Avians have two forms of attack. The *strafing run* is the most common. A wing formation of Avians makes a shallow dive toward a target, attacking with their razor-sharp beaks during a relatively slow fly-by (10 hexes/turn). Favorite targets are the eyes, the face, and the chest.

The *dive* is more of an emergency tactic, and is never used by more than half of the birds in a flock. The birds dive straight down at their targets, doing impaling damage equal to double their ST. If the DX roll is successful, the Avians impale their targets (and take 1d of damage themselves). If the creatures critically

### Alien Characteristics

All forms of the alien predator share the following characteristics.

#### Infrared Vision

They see in a different spectrum than humans, and their eyes are internal rather than on the surface. They suffer no Vision penalties in darkness.

#### Heat-Seeking Instinct

The predators are attracted by heat — not only biological heat, but the warmth created by functioning engines, air conditioners and incandescent lights.

They will attack an inanimate heat source for 1d turns, until convinced that it is inanimate. They will then find another target, and every member of that group of predators will now know that the heat source is not prey.

#### Group Instinct

The predators prefer two formations — the wing and the wedge (see p. 40) — and will attack using them whenever possible.

During an attack, the creatures are careful to maintain the formation as long as possible. Members outside the formation will take the place of inside members lost or killed.

They have an instinct for group preservation. If any group is down to one-fourth of its starting strength, the survivors flee. They transform to Avians to do so, if possible. There is a 4-in-6 chance that they will find reinforcements, and be back in strength within 20 minutes.

Most flocks of these creatures contain 10-20 individuals, though flocks will band together against large or difficult prey.

#### Feeding

The predators do not “eat” their victims. They sometimes chew them, but only to extract the blood and other body fluids.

Any character witnessing a feeding must make a Fright Check at -3 penalty.

#### Transformation

The creature must land to transform. Transformation takes three seconds; during that time the creature can take no action, has no PD/DR and has HT 2. This is their most vulnerable time!

Anyone witnessing transformation for the first time must make a Fright Check at -3. The creature looks like a melting, bubbling combination of two shifting forms.



### *Avian Kamikaze*

Rompers stay away from light; Worms run away from light; Avians try to destroy light. They aggressively hunt out and attack light sources.

They attack in a suicide dive, but not a frenzied or unplanned assault. Single Avians peel off from the formation to deal with the light source. The more intense the light, the more careful is the preliminary maneuvering before the final dive. If the first attack fails, other members of the formation will make attempts.

A diving Avian is -5 to hit for size (a very narrow profile) and a further -2 for its jinking, shifting approach. It begins the dive from less than 100 yards altitude, and is in sight for only 1d-1 seconds. It avoids the light until the last possible moment, since it dies as soon as exposed within range (see sidebar p. 36). The end of the dive is a dead Avian slamming into and hopefully extinguishing the light.

fail their DX roll, they impact a nearby hard surface and die. When applying modifiers for the dive, use the target's profile from a vertical viewpoint. Most attacks against humans will be at -3, due to the small size of the head and shoulders.

Successful divers must succeed at a ST roll to break free of their impaled prey, and are sometimes distracted from doing so by the opportunity to drink a victim's blood (-1 fatigue/turn). Likewise, the victim can detach the Avian by succeeding at a ST-2 roll; the attempt does 1 hit of damage. If the Avians cannot get a straight dive at their targets, they will not attack in this manner. Dives are often used "kamikaze style" to take out dangerous lights, but are not used against other inanimate objects. The Avians have a 3-in-6 chance after each dive or strafe of transforming to Rompers to continue the battle on the ground.

### **Romper**

<b>ST:</b> 7	<b>Speed/Dodge:</b> special/8	<b>Size:</b> 1
<b>DX:</b> 12	<b>PD/DR:</b> 1/1	<b>Weight:</b> 50-75 lbs.
<b>IQ:</b> 5	<b>Damage:</b> 1-2 cut	<b>Origin:</b> Alien
<b>HT:</b> 14/5	<b>Reach:</b> C	<b>Habitats:</b> Alien

These four-legged predators, the size of large house dogs, have toad-like bodies with canine heads. Their skin is oily, black and thick. The mouths lack lips, leaving the white, razor-sharp teeth permanently exposed.

Rompers are great leapers. They can jump 5½ feet straight up, or 7 yards (21 feet) horizontally. Rompers never jump backward.

Rompers may not leap more often than once every third turn. When not leaping, Rompers crawl at only one hex per turn.

The preferred attack of these vampires is to leap to close quarters, then bite in close combat. A Romper successfully scoring a taste of flesh will stop to savor his triumph for 1d turns, making no further attacks during that time — and leaping away if attacked, or if crowded by other Rompers. As a general rule, Rompers do not leap "onto" their prey.

Victorious Rompers will transform back to Avians to search for more prey. Rompers frustrated from closing with their prey may transform to Worms, but never more than half of a pack will change.

### **Worm**

<b>ST:</b> 7	<b>Speed/Dodge:</b> 1/5	<b>Size:</b> 1
<b>DX:</b> 8	<b>PD/DR:</b> 0/0	<b>Weight:</b> 50-75 lbs.
<b>IQ:</b> 5	<b>Damage:</b> 2 cr	<b>Origin:</b> Alien
<b>HT:</b> 14/5	<b>Reach:</b> C	<b>Habitats:</b> Alien

Least attractive of the creatures' forms, the Worms closely resemble a tadpole. Their ugly heads are disproportionately large compared to the propelling tail. The skin is loose, smooth and oily in appearance.

Worms do not attack living prey — or at least, not directly. The function of this form of the predator is to penetrate barriers between the flock and the heat-radiating quarry. The rough-textured "head" of the creature produces a powerful corrosive juice that dissolves cement, stone and even metal.

If attacked, a Worm's first choice is to transform into a Romper for combat. If surprised, however, the Worm may fight in its own form. Damage is caused by flailing with the "head," hoping to bring the corrosives into contact with the attackers. The acid burns for 1 hit per turn, and remains active for one minute after exposure to the air. Victims will continue to take damage from acid until the injuring slime is wiped off. Once a Worm has made an opening for its fellow Worms to exploit, it usually transforms to Romper form.

## That Old School Spirit      Research Sector 2

*The Research Goal: Competition is a sword with a double edge. While it can drive a race to triumph, it can also lead to destruction. Using a variety of medical techniques in an escalating sequence, Team 2 will incite the experimental subjects to violence in an effort to induce total self-destruction. Researchers should maintain a careful record of which techniques produce the best results, both in terms of effect and duration.*

— Excerpt, Markann Research Log

The Markann researchers have used three techniques — subsonics, chemical mists, and direct brain stimulation (see sidebars pp. 43-44) — to incite and maintain violence between social and ethnic groups within this sector. Their goal is to continue this process until the last inhabitants have wiped themselves out.

Hindering the researchers' attempts, however, has been the impulse of the human subjects to band their small units into larger and larger combat teams. Likewise, human territorial instincts have interfered.

In the residential areas, the fighting is largely split along racial lines, black versus white versus Hispanic. In the vicinity of the college campus, however, a conference football game has provided the excuse for escalating violence between "Longhorns" and "Aggies."

### *The Big Game*

### *Major Encounter*

Twelve hours ago — when the experiment began — a college football game was in progress in this stadium.

This is more than just a game. The teams have been traditional rivals for more than half a century, and the game has an importance out of all proportion to the teams' relative standings this season.

The "Longhorns" are the home team, and were heavily favored to win. Their supporters made up two-thirds of the crowd — mostly young students, although the more expensive seats held an impressive pack of socially-important alumni and government officials.

The "Aggies" were the underdogs. Their supporters in the crowd, bussed in from a distant city, were outnumbered by the home-town crowd . . . but they made up for the deficit by enthusiasm. Though many of their crowd were young students, most were older alumni who tended to be tough men in "cowboy chic" (tailored jeans, alligator-skin boots, designer-label cowboy hats).

And then the Markann interfered.

A mysterious storm blew in, drizzling the stadium with its misty chemicals. The droplets contained a Markann formulation, distantly linked to the steroids that sometimes cause abusers to burst into irrational fits of violence. Players on the field became more violent, cheered on by the crowd, and each resulting injury escalated the fever pitch. Fistfights among the spectators sparked off brawls throughout the stands. Now the rival camps survey one another from behind impromptu barricades of beer coolers and overturned hot-dog stands, hurling empty bottles at the enemy.

When sports officials tried to end the game at the official time, the referees were ejected from the game. Time ceased to matter, as the game has gone on and on — driven by the need to produce "the final victory, once and for all!"

Several hours ago, due to injuries and exhaustion, each side ran short of players. Eager spectators volunteered to fill the ranks. This provided such a glut of participants that NCAA regulations were relaxed, to allow thirty players on the field for either side.

This is the situation as the PCs enter the scene.

### *Sector 2*

A large portion of this sector is taken up by the University, associated student housing, fraternity and sorority houses, and apartment buildings. Further from the school, small shops and residential neighborhoods are the rule.

This part of the city is volatile. A road that was abandoned when first passed, might be barricaded and in the control of a neighborhood gang when next seen.

### *How The Adventurers Become Involved*

Use any of the following techniques to tempt the players into investigating this part of the city.

The lighted stadium and the roar of the crowd can be seen and heard for a respectable distance.

The play-by-play broadcast is the only show still on the radio.

Recruiting teams are scouring the nearby city in search of potential players (see the "Crooked Pete" sidebar, p. 42).

Any player character entering this sector might run into one of the security barricades (see p. 42).

### *Optional Encounters*

#### *Subsonics*

As the PCs pass through part of the stadium, they come close to one of the Markann subsonic units. These devices (see p. 43) create violent anger and frustration in susceptible characters; this unit is hidden in a hot-dog stand now part of the barrier between rival sections of the stadium.

Characters failing their Subsonics roll (HT modified by Will) will attack the rival spectators with berserk fury unless prevented by their companions.

#### *The Pacifist*

If any PC makes a remark critical of the continuing violence, let a medical technician overhear. This medic — Lionel Horn — is immune to the mist, and cannot understand what is happening here.

Lionel wants to halt the game, and has the beginnings of a plan — cutting off the field lights. Lionel is a "cannot kill" pacifist (see p. B26), and will not attempt a plan which has too much risk in it.





### ***Crooked Pete and Wanda Sue***

"Crooked Pete" has made the circuit — if the school has been investigated by the NCAA for suspicious recruiting practices, Pete worked there. He most recently served as a recruiter for Southern Methodist University (SMU), before moving here.

His favorite outfit is a yellow sportscoat, matched with red slacks, red knitted tie, and a large gold tie-tack in the shape of a football. His hair piece is very obvious, and tends to slide around.

Assisting Pete is his sports therapist, Wanda Sue Peterson. Always attracted to athletics (or athletes, as the case may be), this attractive young woman turned down a career in cheerleading in order to pursue a job offering more personal contacts: sports massage.

Both Wanda Sue and Crooked Pete suffer from Lecherousness (see p. B34), though neither finds the other attractive. Pete exploits Wanda Sue for his own ends, often nudging potential male recruits behind her back, and remarking "Great pair of lungs, right, kid?" She is unaware of this.

### ***The Security Barricades***

Whether the PCs are trying to get to the stadium, are merely moving through this part of the city, or are escorted by recruiters (see below), their first planned encounter will be at a roadblock set up by alumni.

The road has been sealed off with a rolled-over Metro Transit bus, with room left for only one vehicle to pass. A few of the streetlights have been shot out, so a garbage can has been filled with rubbish and lit. Periodically, a guard will squirt gasoline from a can into the flames, giggling at the small explosions.

The six guards have all been drinking (-1 to DX and IQ). Each is armed with a hunting rifle liberated from a local sporting goods store. The chief guard is an off-duty policeman, who has an exaggerated belief in his own importance (see "Overconfidence," p. B34). If the PCs haven't yet met them, the recruiter and his assistant are also here.

The challenge yelled by the guards is, "Aggie or Longhorn?" Either answer is correct. If the characters yell, "Longhorn," then the barricade is manned by Longhorn sympathizers; if they yell "Aggie," then these are Aggie supporters. If any attempt is made to stall, the guards take aim threateningly. "There can be no neutrals in this struggle," says the chief guard. If the PCs still refuse to take sides, the chief guard will yell — "They're all Aggies! Shoot them all!" and a battle will erupt.

If the PCs provide an acceptable answer, the chief guard will let them pass through the barricade and signal for them to pull over. Acting sympathetic, he will explain to them that the struggle has finally come out into the open, and that the time has come to settle it once and for all. He won't identify *what* struggle this is until asked. Then, he'll act as if it were obvious: "Aggies versus Longhorns," he says. As with most of the people involved in this scenario, he takes this contest with the seriousness normally reserved for major ideological and geopolitical rivalries.

If the PCs have not yet met the recruiter, he will interrupt the chief guard at this point. It is also at this point that a damp drizzle begins to fall.

Should the party do anything suspicious, the chief guard may decide that they are all supporters of the rival team and try to shoot them. It will take a successful Diplomacy or Fast-Talk roll to change his mind (make the players roleplay this, of course).

When it comes to fighting rivals, the guards are fanatical. Fortunately for the PCs, they are rotten shots (Guns skill 10 or below).

### ***The Recruiter***

Crooked Pete will take a professional interest in the three characters in the party with the greatest ST, as well as all characters of ST greater than 15. The adventurers may feel like meat on the rack, as the recruiter looks them over from head to toe. If any of the strong characters are female, he will give them special attention, murmuring cryptic remarks such as "Look good with a mustache" or "We'll have to bind in that chest" — Pete wants good players, and is not above sneaking a few women onto the field if they can play the game.

At length, Pete will proposition the stronger characters with offers to play college football . . . immediately. Starting with the standard incentives (scholarships, money, romantic opportunities), he will be quick to add anything the PCs want. "Explosives? You want explosives? Just give me 90 minutes on the playing field, do your best, and I'll get you a whole truckload of explosives!" Pete is lying, of course, but he's a very good liar.

Influencing the characters' decisions, unknown to them, is the chemical mist which has just sprinkled the PCs. (A small spray unit has been programmed by the Markann scientists to follow the recruiters, giving out bursts of mist as

needed.) Secretly make Mist rolls for the player characters (see sidebar). Those who fail their rolls will be seduced by Pete's sales talk. GMs might secretly pass their players a note similar to the following:

"Pete's offer is too good to refuse — in fact, you already feel a hatred growing in you for the enemy team, and all they stand for. This hatred is quite irrational, and is total. Roleplay this well."

If the characters accept, Pete will bundle two of the strongest into his own pick-up so that he can brief them on the ride, while Wanda Sue is delegated to ride in the PCs' vehicle. He then leads the way to the stadium.

If the characters decline, the local NPCs (including the guards, if they are present) risk losing control — make IQ rolls for them. NPCs who lose control will begin raving at the party, lauding the virtues of their own team while deploring the faults of the other team, and explaining the need to bring this struggle to a final conclusion. If the PCs still balk, NPCs who failed their earlier roll must roll again; if they fail the roll, they go Berserk (see p. B31) and attack the adventurers.

Even if the PCs decline to play and violence is avoided, Pete will want to bring them to the game. "No trip to Austin is complete without this," he says. "It's the game of the century."

### *Arriving at the Stadium*

There are no planned encounters during the journey, although any of the minor encounters listed later might be used.

More barricades surround the stadium, and guards will again bellow the challenge: "Aggie or Longhorn!" If Pete is with the party, he will get them through the correct barrier. Otherwise, the PCs must again deal with suspicious guards, but no recruitment attempt will be made until the characters are inside the stadium.

The PC recruits are taken in charge by a junior coach when they arrive on the sidelines. Salvaged uniforms taken from injured players are jury-rigged to fit, while a new player number (three digits long!) is pinned onto the rear of the shirt. And, matching the latest "relaxation" of regulations, the characters are provided with garbage can "shields" (PD 1, 2 lbs., 3 hits) and a choice of official weapons: a bicycle chain (treat as a flail), a 3-foot length of copper pipe (treat as a mace, but it weighs 10 lbs.), or boxing gloves weighted with lead and set with spikes (does normal thrusting damage, impaling, 5 lbs.).

The field is a mess, littered with cans, paper and broken glass thrown by the fans. Inflamed by the incitements of the Markann, the players often continue fighting for several minutes after the conclusion of each down. Pass receiving, now that the referees have been ejected, is especially dangerous. The 30-man teams help, providing the two quarterbacks with plenty of time in the "pocket" before throwing.

The cheerleading squad — now composed of fifty of the most fanatic (as well as attractive) women in the crowd — is adept at chanting blood-curdling slogans. "Grab them, rip them, knife them, stab them!" (Spirit takes precedence over rhyme.) In playful mime, the cheerleaders act out various acts of slaughter, scratching with their fingernails and wielding harmless plastic bats.

The scoreboard is inactive — due to escalating threats from both sides, the operator finally chose to be neutral — except for the current score. Longhorns — 236, Aggies — 197. This is the 25th quarter.

The PCs can hear the coach giving orders, both to his junior coaches and, by radio, to his quarterbacks. "That big ape on the other line, whatever his name is, Lupe — get four or five of our guys on him on the next play. That oughta take care of him." Similar overheard remarks reinforce the adventurers' correct impression of violence in this game.

### *The Markann Techniques*

Three simple techniques allow the Markann to mastermind the insanity in this sector.

*The Chemical Mist.* Small aerial robots drift about the sector, loaded with spray units containing a powerful drug. Some of the machines have been programmed to follow specific human beings, marked as "inciters" by the scientists (including the recruiters from the stadium). Other machines follow a random pattern, using sensors to detect and then dose non-violent humans.

The drug works by contact with the skin, and is not persistent — characters who swathe themselves in thick body-covering clothing will be safe from infection. Holding one's breath is not sufficient to avoid contamination.

For each character who comes in contact with the drug, an IQ roll must be made — not by the player, but by the GM. Strong Will and Pacifism each provide a +3 bonus to the roll. The following Advantages and Disadvantages are each worth a -2 penalty to the roll: Bad Temper, Berserk, Bully, Fanaticism, Impulsiveness, Intolerance, Paranoia, Weak Will and Sadism.

Characters failing the roll are now *susceptible*. See the sidebar on p. 45 for the effects.

*The Subsonic Generator.* This device broadcasts inaudible sound waves that affect the human brain on an unconscious level. It is much more diabolical than the chemical mist since it bypasses all of the higher mental functions. The devices have been concealed throughout this part of the city, and switch on and off according to a random sequence.

Make an IQ roll for any character coming within 10 hexes of a subsonic generator. Characters who fail their rolls go Berserk (see p. B31), and attack the nearest living beings which can possibly be identified as enemies.

Protection from the subsonic vibrations is almost impossible, but some simple measures make resistance easier: earplugs (+1 bonus), muffling the head completely in thick layers of clothing (+2 bonus), or wearing a tight, confining helmet (+3 bonus). Deaf characters automatically receive a +1 bonus against this attack.

*Continued on next page . . .*

## The Markann Techniques (Continued)

Characters driven berserk by the sub-sonic generator show several side effects: unconscious snarling, rapid blinking, and a dislike for closed spaces. Speech is possible only if a successful IQ roll is made.

If a critical failure is rolled when attempting to avoid the influence of the device, the character suffers a *sensory overload*. Victims collapse, and are able to do nothing except rock in place and growl. The fit continues until 2d turns after the generator switches off, or after the character is out of range of the device.

PCs compelled to attack friends receive a special IQ roll immediately prior to making the attack. If the roll is successful, the character manages to stop the impulse — receiving 1d fatigue points due to the effort.

Snapping out of the Berserk state is done in the normal fashion, except that there is a -4 penalty for attempts made within range of the generator.

### Direct Mental Stimulation

The Markann will use this technique to prevent peacemakers from interfering with their experiment. The Direct Mental Stimulator (DMS) weighs a ton, and is mounted on a shielded floater. It takes three turns to fire the weapon: one turn to aim, one turn to electronically “register” the target, and a final turn to fire. The energy bolt produced by the DMS is invisible.

The victim must immediately make an IQ roll. If the roll is successful, the character feels a violent jolt and faints (remaining unconscious for 2d minutes). On a failed roll, the character immediately goes Berserk.

All characters within 3 hexes of the victim at the time of the firing will feel a static electric charge. Their body hair will stand up, and their clothing will crackle.

Snapping out of the Berserk state is done in the normal fashion, except that there is a +2 bonus to the attempt.

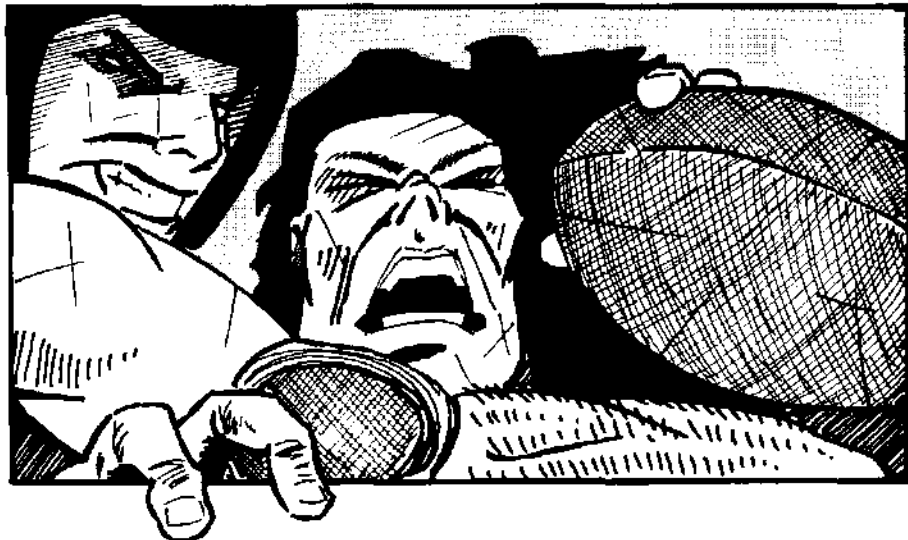
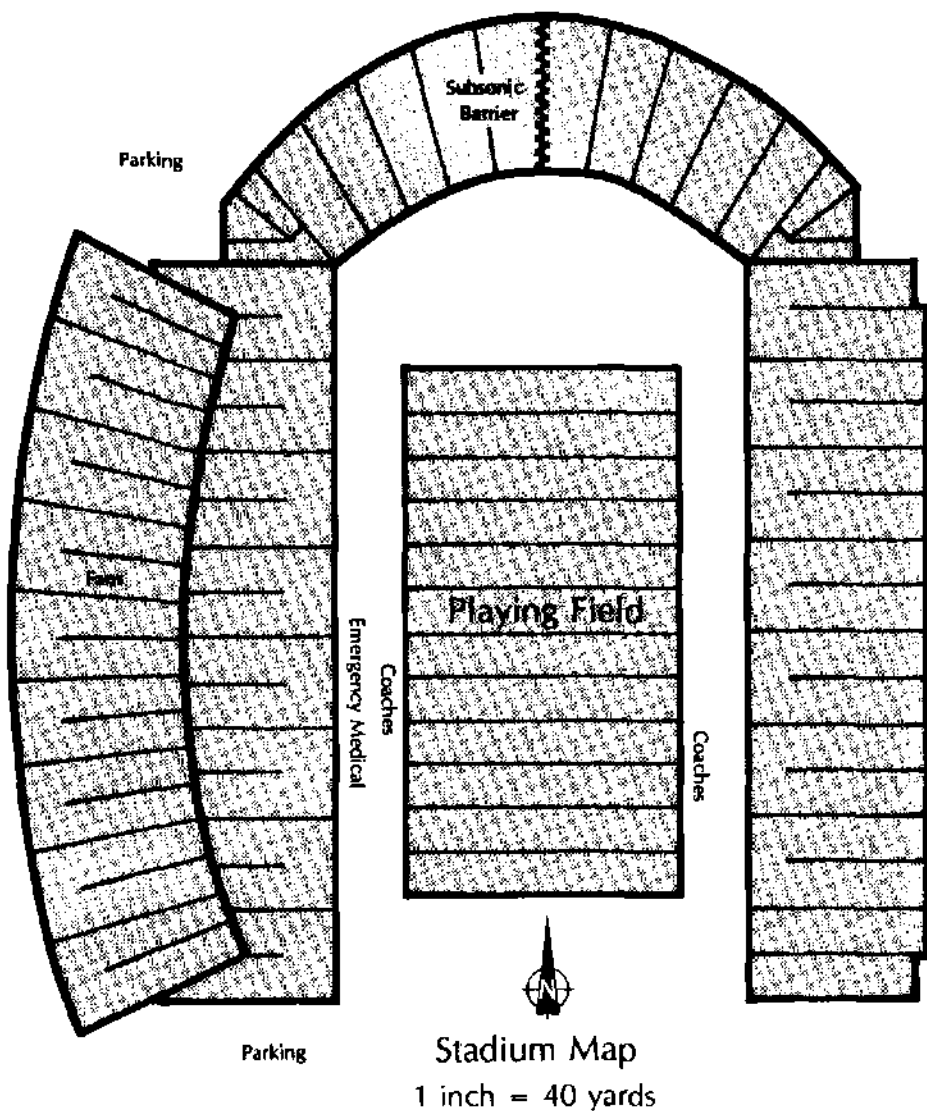

### **The Final Play**

If the players seem intrigued by the game, let them participate in a play or two. If not, jump directly into the following action.

The straw that breaks the camel's back is the next touchdown, scored by the rival team.

The crowd in this stadium has, step by step, retreated to barbarism. No matter how grim the scene might appear to the untrained observer, the monitoring scientists are impressed. Human beings show an advanced ability to control violence through societal conventions. However, this is a test to destruction. The Markann will keep the pressure up until the last reserve cracks.

Upset by the point just scored, an irate fan produces a submachine gun and begins shooting up the field. In response, guns are produced throughout the stadium (a quick-thinking PC football player might well have a handgun concealed beneath his uniform).

The first wave of violence will not harm the adventurers, but it should be described in a threatening way: "Bullets stitch their way across the field, moving in your direction. Explosions sound downfield, by the enemy locker room." This space of time is allowed so that the characters can gather in one spot and devise a plan for survival. When the players have begun to sort themselves out, let a party of rival fans pick on them.

"Get them! They were on the team!" The enemy party has the same number of characters as the player group. Half are armed with hunting rifles; the other half have clubs and broken bottles. If the PCs wipe out this group, bring in another bunch.

The idea is to keep the pressure on the player characters, but not to kill them. Keep the action fast and loose, trying not to resort to a round-by-round enactment.

It is not difficult for the PCs to find weapons, as stockpiles are poorly concealed throughout the stadium — especially along the sidelines. Weapons should be confined to light non-automatic rifles (with 1d × 10 rounds) and handguns (with 2d × 10 rounds). Fortunately, the enemies are also drunk (effective Guns skills of 6 and less).

There are three possible exits from the stadium: through the locker rooms, through the main exits, or out through the press boxes. When the PCs reach this part of their escape, resolve the battle with round-by-round combat.

Once free of the stadium, the PCs can commandeer any of several vehicles whose owners have been rendered lifeless in the running battle. As the fans spill out into the city, this area will be unsafe for hours to come — from both organized bands and lone psychotics.

### **Minor Encounters**

The following may be used for other encounters in this sector of the city.

**The Capitol.** A large subsonic generator, keyed to the dimensions of this building, has been installed by the Markann in the Capitol rotunda. Its influence will be felt by anyone entering the building.

Any individuals the PCs might encounter here are too far gone into lunacy to be very threatening . . . but the effect could be frightening. For instance, a man in an expensive suit (a legislator) spots the PCs while he is standing on a second-floor balcony. Overcome by berserk rage, he springs at them — and crashes to the floor, where the impact probably takes him right out of the picture.

**The Drizzle.** As the PCs speed through this part of town, enroute for some destination of their own choosing, they experience a brief drizzle. Of course, the drizzle is the Markann chemical. For the next fifteen minutes, the adventurers are wide open for all kinds of strange obsessions . . .

**The Street Wars.** Elsewhere in this sector, fighting has broken out along

### **Susceptibility**

Anyone hit by the Chemical Mist (see sidebar p. 43) may be *susceptible* for fifteen minutes after exposure. Anyone who is *susceptible* (that is who failed the IQ roll made by the GM at the time of exposure) is unusually receptive to angry impulses.

Susceptible people will develop a hatred for anything they hear other people decrying. Casual opinions voiced by the PC blossom into obsessions — for instance, an adventurer who remarked, "I dislike this shirt," would develop an obsessive hatred for that shirt.

Characters may not have more than one hatred at a time. Select which hatred is developed, if there are several possibilities.

To inform players about the sudden obsessions of their characters, either take them aside privately to detail the sudden change, or pass a secret note to the player. Do not explain the reason for the change. The player must figure this out for himself, if he can.

Hatreds formed during the 15-minute susceptibility phase last longer than the original drug effects. Make IQ rolls for affected characters once per hour after the first hour; if the roll is successful, the obsession wears off.

While a character is subject to an obsessive hatred, he has the potential of becoming Berserk (see p. B31) when confronted by the object of his hatred. To avoid going Berserk, the character must be successful on a GM-performed IQ roll. Contrary to normal Berserk rules, however, a mist-obsessed character will only attack the object of his obsession (unless others try to stop him).

If a PC has acquired a hatred which is out of character for him — for instance, a pacifist with a hatred for small, harmless birds — the GM may allow the character a special bonus to the IQ roll when attempting to avoid going Berserk.

Once a character has recovered, the shock of what he did while berserk or obsessed may damage his mind. A Fright Check is called for.

The following modifiers apply to the roll:

Killed anyone:	-3 penalty
Killed 2-5 people:	-5
Killed 6-12 people:	-7
Killed 12+ people:	-9

If the killing was done in a particularly gruesome manner, there is an additional -2 penalty.

Any action taken which was seriously contrary to the character's nature causes an additional -1 to -3 penalty.

### ***Surviving the Beast Children***

The goal is to give the adventurers a good fight, without killing them (but killing an NPC or two is always a good idea). The players should feel surrounded by a horde of mischievous devils. "Teddy bears from Hell" sums up the approach.

#### ***If They Are About To Escape***

If they've done so through good play, great — let them go.

If they are escaping easily only because they have the firepower to drop 20 children in half as many combat rounds, they need more challenge (see the sidebar on p. 47).

#### ***If They Are About To Be Killed***

One way to save the characters is to bring in a carload of friendly NPCs, perhaps from Jim's fortress (p. 33). The PCs might stumble onto a load of needed arms in the building rubble at a convenient moment.

The Rogue scientists will do something, if nobody else does. They won't let their subjects die so easily.

#### ***If They Hole Up In Their Cars***

The Beast Children aren't stupid. A few bricks will take care of the car windows (DR2, HT2).

Better yet, scare the adventurers into the open by tossing one or two flaming objects under the vehicle. The flaming objects are only torches, but the party might suspect Molotov cocktails and bail out!

### ***Making the Encounter Scary***

This scenario doesn't emphasize the frightening transformations from playful child to ferocious animal — that should have been brought out in the earlier encounter at the airport terminal (see p. 23).

Instead, this fight is heavy on strange happenings by shadowy figures. Try to keep the characters confused about the number of their attackers, and their identities, for as long as possible. Remember that the PCs can only see in the light of their own headlamps, plus the light from any functioning streetlamps the GM charitably allows.

For instance, when the light poles come tumbling down, let the adventurers spot an "ape-like" figure riding the pole, which then scurries away. Then comes the crashing thump on top of the car (as a rope-swinging child makes a landing), or the swinging blur passing in front of the car (a child that missed).

ethnic and cultural lines. As the PCs drive through a Hispanic neighborhood, a distraught man mistakenly identifies one of the passengers in the vehicle as his missing girl. A carload of berserk vigilantes takes off in pursuit of the adventurers.

Complicating matters is the fact that the player group has just passed over the border between neighborhoods. As the pursuit car threatens to catch up with them, they see barricades. The hostile guardians of a black neighborhood loom ahead. Neither side is friendly to non-Hispanic, non-black player characters.

(When customizing this scenario for a different city, use whatever ethnic groups are appropriate for that area.)

## **Playtime**

*The Research Goal: For reasons we can only dimly perceive, many of the prospering sentient races share a trait unknown to Markann society — ties of loyalty within family groups. It is already known that such tribal and clan bonds aid some subjects in preserving racial integrity. The purpose of this experiment is to determine the results when family ties are violently disrupted.*

*Special thanks go to Dr. Kkktqy of Team Three for devising the simulacrum which will be used to replace the subjects' infants.*

*— Excerpt, Markann Research Log*

Dr. Kkktqy is brilliant, even by Markann standards. He has perfected a way to surgically cut and paste personalities, taking parts from different beings and combining them to form a new mind. Team technicians can do this on a grand scale.

Starting with a dangerous predator as his basis, Dr. Kkktqy replaced the beast's normal stalking and hunting instincts with psychological grafts from human children's engrams. The result is a predator that "hunts" its prey by acting out childish games.

Altered by cosmetic surgery, the predator/child creatures were substituted for all of the human children below the age of 12 in this sector of the city. Great carnage was the result — this is a part of the city where well-gnawed bodies litter the streets.

The children, however, are too cunning to be spotted as easily . . .

## **Getting Out Alive**

Endowed with a fair share of cunning, the predators have come up with a primitive plan. They delay springing any of their traps until the adventurers are in the center of the pack's territory.

### ***Entering***

As the party enters this sector, gradually introduce them to the details which make this sector different. The buildings have a ravaged, ruined air. There is a lot of trash on the road (as the PCs veer around one such obstacle, it turns out to be a well-chewed remnant of a human body — Fright Check at -1 penalty).

This encounter can be located anywhere. If it takes place on the north side of the river, it might occur among the luxury high-rise riverfront hotels (by the easternmost bridge in the sector), or among an area of abandoned buildings and vacant lots (near the middle bridge), or by the municipal sewage plant and YMCA (the westernmost bridge).

Make an IQ-2 roll for each character. Those making their roll will separately notice, during the next few minutes, the smallest glimpse of a Beast Child: "You see a dark shape leap from one building top to another," "A shadow stands framed in the broken glass of a shop window, then disappears," "A

## **Research Sector 3**

## **Major Encounter**

manhole cover rises above the pavement, and you see the gleam of two eyes watching from beneath it," and so on.

If the PCs continue on course, spring the trap as they drive down the street. If they start to leave the sector, the Beast Children attack immediately.

### The Beast Children

Imagine a small, fierce predator from an alien world — akin to Earth's wolverine in personality, but two or three times the size.

Graft into that predator's mind certain segments from a child's mind: the memories of games played, tunes hummed, the behavior pattern for greeting Mom or Dad when they come home from work.

Place the grafts so that they supplant the predator's natural hunting instincts. Imagine the result — a beast that, scenting its prey, feels compelled to hum a happy tune, bounce a small red rubber ball, or jump up and down and yell "Mommy! Daddy!" . . . while its animal mind desires only hot, fresh blood.

Place the new mental construct into a body engineered to resemble a human child. Implant more grafts, so the predator mind can operate in its new environment. Improve the original design, adding steel-spring reflexes and blinding speed to the outward shell of a toddler, a stumbling first-grade student or the light, lean frame of a 10-year old . . .

#### Beast Child

ST: 9-15 (1d+8)	Speed/Dodge: 8/8	Size: 1
DX: 12	PD/DR: 4/2	Weight: 150 lbs.
IQ: 3-8 (1d+2)	Damage: 1d-1 cut	Origin: Alien
HT: 3	Reach: C	

#### Special notes:

**Appearance:** Anyone getting a good look at a Beast Child— in good light or within 2 hexes — gets an IQ roll to notice valuable clues, the blood-smeared face and blood-stained clothing.

Most humans find it difficult to "blow away" such child-like creatures on first sight. Characters without Sadism or a similar disadvantage must make an IQ roll to successfully attack; Strong Will provides a bonus, but Squeamishness or Empathy add penalties to the roll. No IQ roll is necessary once the character has been attacked.

**Cunning.** Thanks to the mental grafts, these Beast Children can tap into a high grade of intelligence — with the older children, the mental equivalent of a 13-year-old! Under the domination of beast instincts, however, this added IQ is used for only one purpose — hunting. These animals love to devise traps, and enjoy "toying" with their prey.

**Mimicry.** When the hunting beast scents prey, it automatically switches to its "stalking" instincts . . . which have been replaced by the mental patterns of a human child at play. Therefore, when a human is detected, a Beast Child will start to play: bouncing a rubber ball, skipping, singing to itself, or playing in the dirt. The purpose of the play is to allow the child to get within attack range of the quarry, or to lure the quarry within attack range. Once the prey is close enough, all "play" is abandoned and the child attacks ferociously.

**Senses.** While Beast Children have no advantages over humans in sight and hearing (generic sensing level 10), their sense of smell is highly developed (Smell roll of 19).

**Self-Protection.** These predators live only to kill and eat, and have no instinct for protecting themselves. They never run away in order to "live to fight another day."

**Weapons.** Beast Children generally do not use weapons, as they forget about

### Sector 3

This part of the adventure takes place in the high-rise downtown section of Austin. Elegant waterfront hotels line the river shore. A handful of modern office towers share Congress Avenue, the main street, with antique buildings lately restored and rebuilt. It is in this sector, in the area north of the river, where the "Children" lie in wait for those who might pass by.



### Deadlier Encounters

Here are a few ideas:

#### The Old Buick

Beast Children don't drive well — riding lawn mowers are about the best they can deal with competently — but they *can* drive . . . at a 10-year-old's proficiency level!

Let an old Buick rumble onto the scene, crammed with as many children as can pack inside and hold on to the hood and roof (about 30). Not understanding the intricacies of driving, the children might use the vehicle only to block the PCs' car and get themselves into combat range. Alternately, have them approach at high speed intending to ram — that should get the adventurers into action!

#### The Pitcher

Beast Children sometimes throw things from rooftops. Usually these are bricks or bottles, but the missiles could be more deadly. One Beast Child tossing grenades along with the non-explosives can be fun. It is up to the GM whether the predator has learned to arm the grenades first. Duds in the middle of the car can be enough to freeze the blood of the party. If the Beast Child pulls the pins, his aim is rotten, taking out a few of his own people before he hits the adventurers (thus giving them "fair warning" before killing any of them).

# Beast Children Road Map

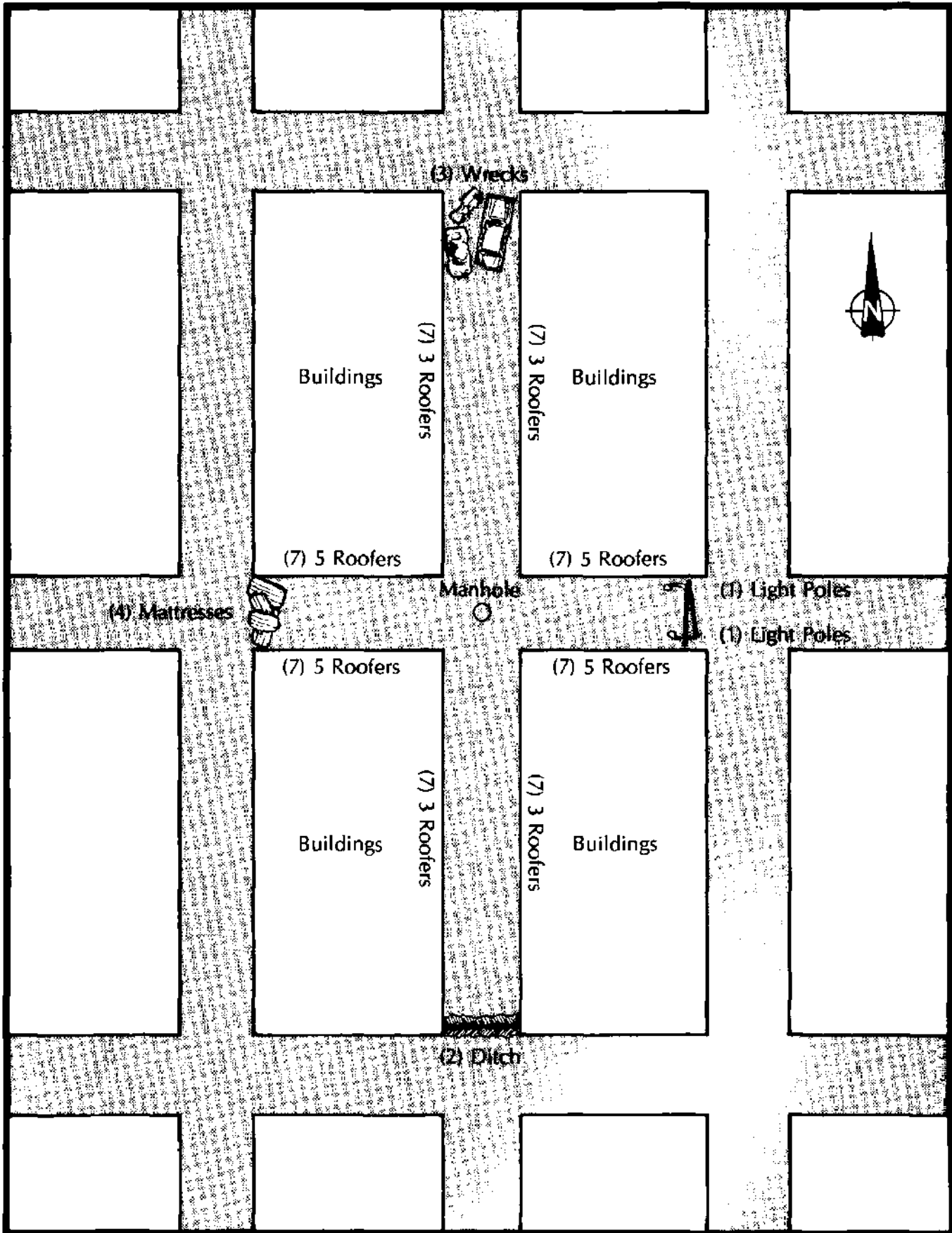

1 inch = 25 feet

them in the heat of battle and use their teeth anyway. An occasional Beast Child will throw bricks or stones while closing for toothed combat.

### *Guide to the Map*

1. *The Light Poles.* With a single Beast Child perched on the top of each, these poles come toppling down to block the road. The PC driver must make a Driving roll (see p. 31) to avoid slamming into the nearest pole.

Characters in any vehicle which runs into a toppled light pole take 1d damage for every 20 miles/hour the vehicle is travelling above 20 mph. (For instance, if the car was travelling at 45 mph, the passengers would take 2d damage.) Halve damage if seat belts are worn.

The pole is virtually impossible to destroy or move without getting out of the car. Impacts dent the pole, but it remains in essentially the same spot. The pole weighs 750 lbs. — see p. B89 for rules on lifting and carrying it.

The Beast Children on the poles will attack any nearby adventurers, and will defend the poles.

2. *The Ditch.* Have the PCs immediately make Vision rolls to detect the low ditch in the poor light. Then the driver must make a Driving roll to avoid the ditch — there is a -2 penalty to the roll, unless the driver saw the ditch earlier or was warned by another character.

If the skill roll is failed, the car winds up in the ditch and all characters inside take 1d-2 damage for every 20 miles/hour the vehicle was traveling above 20 mph. On a critical failure, the car rolls and is ruined — increase damage to 2d, and all characters are “stunned” until they succeed at an IQ roll. Increase DR by 5, for this instance only, if seat belts are worn.

The ditch is filled with gasoline-soaked rags, which the four Beast-Child sentries will light after the car has stopped. The predators want the fire as a barrier to keep the characters from escaping, not as a barbecue to kill the PCs (they don't like cooked meat).

3. *The Wrecks.* This street is closed with wrecked cars. Six Beast Children hide within the hulks, waiting to leap out at unsuspecting characters. This hazard is obvious — no Driving roll is necessary. The wrecks cannot be moved without towing equipment or more labor than the PCs should have available.

4. *The Mattresses.* Eight Beast Children are in the process of dragging mattresses across the road (the light pads make an excellent road block that is also easy to dismantle).

If the PC driver wants to slow down, he must make a Driving roll. If he fails, he strikes the mattress barrier and comes to a halt; for every 20 miles/hour the vehicle was travelling above 20 mph, the people in the vehicle take 1d-2 damage. On a critical failure, the car's wheels are knocked out of alignment. The vehicle's maximum speed is now 25 mph, and it makes a loud squealing noise when operating.

If the driver tries “threading the needle” — driving through the gap where the last mattress has yet to be laid — he must succeed at a Driving roll at a -3 penalty. If he fails, he strikes a mattress and must make a *second* Driving roll. If he succeeds at the second roll, he retains control of the car and exits the trap; if he fails, the vehicle skids into the mattresses and comes to a stop. People in the vehicle take 1d-2 damage for every 20 miles/hour the vehicle was traveling above 20 mph. (Seat belts halve all damage.) On a critical failure, the car's wheels are knocked out of alignment; the vehicle's maximum speed is now 25 mph, and it makes a loud squealing noise when operating.

5. *The Manhole.* Eight Beast Children hide beneath the manhole cover, waiting to attack any stopped vehicles and their passengers. They peek out every 10

### *Blood Lust*

Beast Children must make an IQ roll when they see “fresh meat” — a dead or unconscious human — within 10 hexes.

If the roll is failed, the creature rushes to the victim and begins to feed.

Children gnaw at carcasses with their teeth, using their hands only to steady the meal. Only three Beast Children may dine on a human-sized body at the same time (surplus predators arriving at the body only to find no room to eat resume the hunt).

Predators in battle need not make the IQ roll. If a feeding child is attacked, an IQ roll is necessary before it can break off its dinner and fight back — but there is a bonus to the roll equal to the amount of damage rolled for the attack.

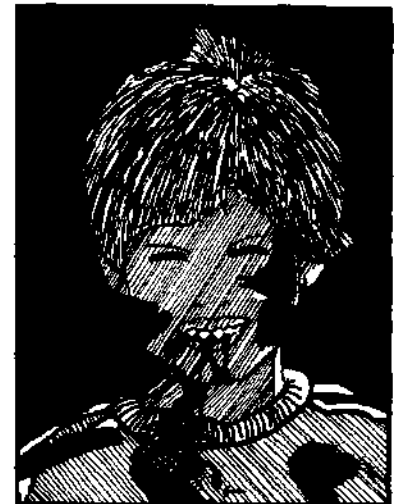

### *Speech*

Beast Children are incapable of understanding human speech, and can only speak themselves as part of their play instincts. They babble phrases stored in memory as part of the play routine.

For instance, a Beast Child carrying a baseball bat might approach the PCs, smile, and ask “Want to play ball?” However, if the PCs were to interrogate the child (“Where're your folks, boy? Have the Russians attacked?”), he would not understand what was said, and would continue to repeat phrases connected with his original statement (“Nice day to play ball, isn't it” “Betcha I can hit the ball farther than you”).

Among themselves, the Beast Children communicate in growls which are more than animal noises but less than an organized system of speech.



### *Howdy, Pardner*

One Beast Child with a pistol can put some "holes" into the party's plans. He can operate the weapon, but his aim is awful (use a skill level of DX-6). Wearing a cowboy hat, gunbelt and twirling a plastic toy lariat, he should be able to get to close range before opening up with his six-shooter. He cannot reload the weapon.



seconds or so, and can then be spotted by an adventurer on a successful Vision roll. If the party moves toward the manhole, the lurking children will delay coming out until the characters are as close as possible.

**6. *The Cavalry (optional).*** Concealed in the first floor of one of the buildings on the central intersection is the Beast Children's secret weapon, their mounted-combat unit. As soon as the PCs cross the center of the intersection, or as soon as the trap is sprung, five riding lawn mowers and their crews will depart from the building in pursuit of the adventurers.

Each riding lawn mower carries three Beast Children. One is the driver, and two passengers sit on the front hood. The driver will remain with his steed; the passengers might run forward on their own if exposed humans are visible.

Riding lawn mowers have a Speed of 12. If a vehicle runs into a lawn mower, the lawn mower is ruined and its passengers killed. Passengers in the car take 1d of damage for every 20 miles/hour the vehicle is travelling above 20 mph.

Do not use this encounter with players who dislike "silly" situations. Alternatively, substitute the Old Buick (see sidebar, p. 47).

**7. *The Roofers.*** Ropes are stretched from the rooftops on one side of each road to the roofs on the opposite side. Beast Children swinging on the ropes would naturally come down in the middle of the street below, but with effort can maneuver themselves so they can swing as far as the opposite side of the street.

On a successful DX roll, a Beast Child can land on top of a slow-moving vehicle (-1 modifier for each 5 mph the vehicle is traveling above 20 mph). There are five Beast Children per block on each side of the main street, and three Beast Children per block elsewhere.

**8. *The Buildings.*** There is nothing special planned for the interiors of these buildings, but encounters can be improvised. The Beast Children have torn up as much as they can, searching for prey or useful hunting equipment.

### *Minor Encounters*

Ideas for other excitement in this sector of the city:

***Holding the Bridges.*** Three of the four useful bridges over the Colorado River are contained in the Beast-Child sector. Though in the early hours of the adventure the Children haven't secured the bridges, they may stumble onto the importance of these roadways as trap sites as time goes by.

Characters who get themselves "stuck" south of the river, thanks to a well-staffed bridge blockage by Beast Children, will have to be inventive about how to get north again. A floating restaurant onboard a replica sidewheel steamer is moored between the easternmost and middle bridges in this sector — it could make for a most unusual transit.

***The Misprogrammed Beast.*** Dr. Kkktqy isn't perfect. Imagine a mirror-image of a Beast Child, a child whose play memories have been replaced with stalking grafts from a predator mind, then implanted in the "improved" beast-child body.

The result is a creature with the same technical stats as the Beast Child provided above. However, he's a totally different being; a "real" kid, except that when he feels like being playful, he starts to act like a beast on the trail of prey — to him, it's fun. However, he has none of the animal instinct for killing or eating of the prey once found. In fact, "prey" is more likely to be ice cream bars, candy, toys and other items desirable to the child.

Perhaps the PCs find this youngster "stalking" something, and follow to find him happily gorging himself in a deserted candy shop. Or perhaps mystified NPCs bring this captured child to the PCs' attention.

# MARKANN REVEALED

# 6

**Synopsis:** As the events in the last chapter expire, weave these encounters in. First, the adventurers spot a Markann scientist. Later, they capture a Rogue. With the knowledge gained, the PCs eventually move to the final encounter at the Rogue base. This is their chance to escape this planet.

## Night Phantom

## Encounter #1

This encounter should come into play when the players are growing frustrated (or bored) by events in the city, and want clues as to what is behind this adventure. The party must be in an open location.

### Interference

As the adventurers move through the city, they find themselves in an *electrical interference zone*, caused by a Markann floater operating without shields (see below). They will experience one or more of the following symptoms.

- (1) If a radio is in use, it suddenly emits a wild burst of static.
- (2) Complicated electronic equipment — computers, stereos, digital watches — fails within 5 seconds. Other electronic equipment malfunctions. Gas engines run roughly; advanced engines (those using electronic chips) go out of control, revving up or shutting down.
- (3) Simple electrical equipment fails. All engines and ignition systems fail (not even a “click” when the key is turned). Lights — street lights, headlamps and flashlights — shine dimly and occasionally flicker.
- (4) As the lights fail, the PCs hear a scream ahead of them. (On an IQ roll, they recognize the voice as a woman’s.) They also spot a human silhouette 20 yards ahead of them.

### The Spectre

The average Markann enjoys feeding on Pseudo-Humans, though regulations prohibit it during experiments. Hungry researchers sometimes indulge anyway . . . but to avoid detection by the monitors, they must drop the shields that normally hide them from human view.

A Markann, suspended from a floater, has lowered his shields (causing the interference above). He now swoops down to collect a snack. His victim spots him, freezes in place, and screams.

**Vision rolls.** Have the players make Vision rolls at -1 penalty to spot the black shadow. Characters failing the roll see nothing.

If successful, the PC spots a motorcycle-size bulk descending from above, moving toward the spot where the silhouette was seen.

On a critical success, the adventurer sees more. He can make out two objects — the shark-like silhouette of the floater, and the multi-limbed shadow of the Markann suspended beneath it.

### The Dive

As the alien dives toward his victim, he fires a stun rifle and then snatches the unconscious bulk in his arms. As soon as the body is securely in his arms, the Markann reactivates his shields — from the PCs’ point of view, disappearing from sight. Electrical equipment suddenly is restored to operation.

## Floaters

These 5-foot-long, shark-shaped devices are personal contragrav units used by the Markann.

**Speed:** 20 mph (Move 10).

**Altitude:** Limited to within 100 yards of the surface.

**Range:** Operates for a week, then needs recharging.

**Load:** Can carry 1,000 lbs. in addition to its own 750-lb. weight.

### Special equipment:

**Shields:** While these are powered, the vehicle is invisible and silent. However, shielded ships can be detected by the Markann — this is how the researchers monitor one another. The shields also provide protection; they have PD 8 and DR 2 while on.

**Shield Detector:** This device shows all functioning Markann shields within a one-mile radius.

**Weapons:** A stun rifle is built into the fuselage, and cannot be detached.

**Communicator:** This simple device allows the researcher to communicate with his headquarters. Broadcasting messages in any language but Markann will alert the Rogues to the loss of a floater.



### **The Alien Body**

If the adventurers kill the Markann, they can learn a lot about Markann anatomy — see p. 57 for a full description.

Strapped to the chest of the dead alien is a universal translator (requires a successful Electronics roll to recognize). A second successful roll is required before the character can operate the device. It translates to/from English/Markann only.

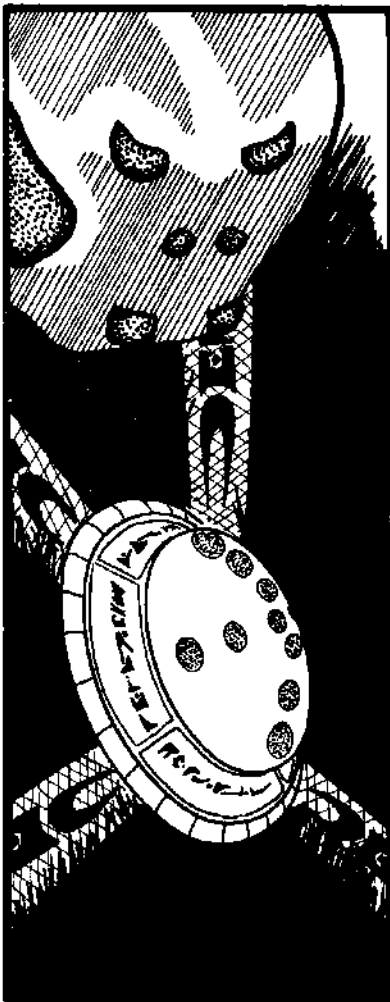

The player characters can interfere in this process.

**Combat.** Any shots which strike the Markann or his floater startle him. The PCs get a brief glance of multi-faceted “bug eyes” shining in reflected light as he turns to stare at them, and then the alien reactivates his shield and disappears.

Actually scoring a hit on the researcher is difficult. The target is at least -2 to hit due to size, motion and darkness; distance and height must be taken into account. Hits scored hit the floater/Markann combination. There is only a 2-in-6 chance that the hit wounds the alien; other shots strike the floater, making a metallic sound. Stats for Markann are given on pp. 57-58.

Characters who make a critical success on their Vision roll may fire directly at the alien. The “to hit” penalty is now -3 for size, motion and darkness, but all hits scored affect the Markann. The alien ignores all sounds, including shots which fail to strike him or the floater.

### **Aftermath**

**If the PCs kill the Markann.** The dead alien loses his grip on the floater and falls to the pavement. (If the Markann is only unconscious, the impact kills him.) The floater climbs gradually until it is lost from sight. The adventurers have a body to examine.

**If the PCs save the victim.** If the adventurers need help, it turns out that they’ve rescued an old friend — one of the stewardesses from Flight 13. She relates how she went exploring in the city with other passengers, and how all but she have been slaughtered. If she can be calmed, it turns out that some of her companions were captured by the “flying spiders” — the Rogues’ round-up campaign has begun (see sidebar p. 54).

If the adventurers don’t need another NPC in the party, have the victim be insane. She flees from the party.

### **The Mishap**

### **Encounter #2**

This encounter should be the beginning of the end for the adventure. This could occur when the adventures have finished all of the major encounters in the last chapter, or when they have become too “wise” to the prodding of the Rogue researchers.

### **The Accident**

As the adventurers are “prodded” to a new destination by their Rogue watchdogs (see p. 26), the unexpected happens. A Markann and his floater collide with power lines. Normally, the floater’s shields protect its passenger. However, the Rogues have been forced to run with their shields at low power in order to baffle the shield detection sensors and not expose themselves to the Markann authorities.

**What do the PCs see?** There is a dazzling gout of sparks from the collision site. Characters who are facing the flash must make a HT roll. If they fail, they have a -3 DX penalty for a minute; if they succeed at the roll, the penalty lasts only 10 seconds.

On the heels of the flash comes the sound of a metal object crashing to the street. An amplified voice speaks in English. “Help me! Help me!”

### **The Wreck**

The floater is a total ruin. Trapped under the broken floater and the fractured canopy, a Markann Rogue is hurt (damage equals ½ of his normal HT) and afraid. It is his voice, interpreted by his chest-mounted translator, which the PCs hear.

Adventurers running to the site see the blackened equipment, and must succeed at an IQ roll to note that something lies under it. On close inspection, the alien’s hairy *strap-hand* is seen protruding from under the wreck, waving feebly.

Rescuing the Markann requires lifting the floater off him. The machine weighs 750 lbs. — see the rules on p. B89 to see whether the characters can lift this much. (A total ST of 30 will do the job without extra effort.) The wreck must be lifted straight off, not dragged or shoved over, or the Markann will die.

#### **What He Can Tell**

K'kra's purpose in this adventure is to give the players information. He'll give up the information under torture or threat. He'll trade information for transportation to Rogue HQ and its medical facilities.

Torture is one method. K'kra hasn't the will to do anything but spill the truth about the Rogues, the PCs' role in the experiment, and the location of the base (see sidebar).

If K'kra is unpressured, he invents a tale. He correctly claims to be part of a rebel organization within the Markann research establishment. Then he lies. He says that his group is fighting to free the experimental subjects, and claims to be a chief officer in the rebellion. He makes no mention of Pseudo-Humans, and will not voluntarily comment if the subject is brought up.

Having told his tale, K'kra urges the PCs to head for Rogue headquarters to speak with "the only people who can secure your freedom."

#### **Aftermath**

The intention is that the party head for the Rogue base (and the following scenario).

The Rogues eventually realize that one of their observers is missing, but don't know where he went down. The adventurers have lost their shadow — the researchers do not know where they are, and can no longer "prod" them to new locations.

Meanwhile, the traditional Markann locate the downed floater. This evidence verifies their suspicions of a Rogue faction.

*If the characters do not head for the base.* Play out further adventures from the last chapter until the players grow tired. Then launch a Rogue attack on the party, using the sleep mist described earlier (see p. 29). They awaken to find themselves in the Rogue base.

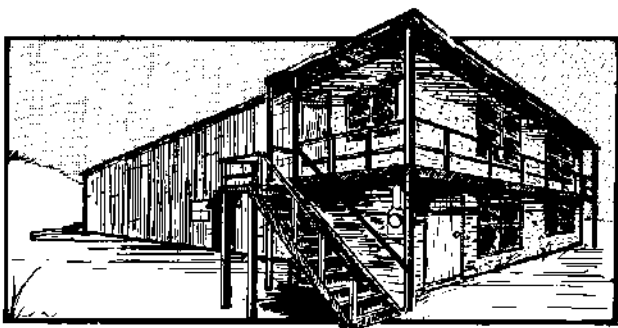

#### **Rogue Base**

**Synopsis:** The player characters, by their own will or by force, have come to the Rogue base. As they are meeting with the Rogue leaders, the traditionalist Markann launch an exterminating assault. The confusion allows the PCs their final chance — they may capture a Markann space vehicle.

#### **Getting Started**

*If the adventurers want to meet the Rogues.* The Rogues detect the approach of the party, but know that the humans cannot harm them. Overconfident, they willingly meet with the characters — intending to capture them with the mist gas if and when it becomes necessary. Proceed to "The Reception."



#### **The Prisoner**

The Rogue is named K'kra. A research technician, he is of an unstable sort of mind typical in lower-echelon rebel units. In short, he's an underqualified flunky.

#### **Interrogating Him**

Creative adventurers might want to ask the Markann some questions before releasing him from his impromptu prison. So long as K'kra is under the floater, PCs have a +3 bonus when interrogating him. If they deliberately shift the floater to give him pain, their Interrogation bonus is +6! (See p. B51 for more about this skill.)

#### **Providing First-Aid**

Treatment for the alien first requires a successful Diagnosis roll, with a -5 penalty applied due to the unknown physiology. If the diagnosis is made correctly, there is no penalty due to physiology for the medical treatment roll.

K'kra is paranoid about his injuries, believing that he has major internal damage (which he doesn't). Bowing to need, he allows the PCs to apply first aid, but trusts them to perform no further treatment. His overpowering goal is to get back to Rogue headquarters and competent medical attention.

#### **Befriending Him**

If the adventurers are nice to him, K'kra condescends to be polite to them — humoring them, as a pet's master might do. To him, the player characters are useful but of a lower grade of mind — occasionally cunning but never intelligent.

#### **The Final Encounter**

## The Base

The Rogues have taken over a deserted kennel in an obscure portion of the recreated city. This is their base.

The kennel consists of a tin-sided warehouse and an attached house. The house is two-story. The lower story is built of brick, while the upper level is wooden and includes a balcony-like deck on three sides. A door from the house's lower story leads into the warehouse (there is no connection on the second floor).

The warehouse is largely empty — it contains broken crates, a wall rack of ill-assorted tools and lots of cobwebs. At one end, a second level has been built with steel bars and mesh floors; it is reached by climbing one of two metal ladders. The metal walls are wet with condensation.

Catwalks have been installed in the ceilings of most areas. The Markann prefer to walk "upside down" suspended from these catwalks.

**The Cages.** Fearful that they might be caught by the Markann authorities, the Rogues have gathered the Flight 13 survivors and placed them in these prison cells. The cages are made of steel mesh: PD 1 / DR 3 (against impaling attacks, PD 0, DR 1). The GM selects which passengers to include in this assortment (see p. 61).

**The Starcraft.** The Rogues have one of their starships parked next to the closed cargo doors of the warehouse. See p. 57 for a complete description. Two Rogues stand guard at its entryway.

**The Intelligence Center.** In this second story office within the warehouse, the Rogue command has surveyed the progress of its experiment. A giant wall display shows a 3D display of the city. While the passengers were loose in the city, glowing green dots showed their progress as reported by the Rogue observers — all of the dots are now within the warehouse. Technicians are now disassembling and packing the vital gear contained here.

**The Armoury.** The second story of the attached house is used for weapons and munitions storage by the Rogues. Concealed gun positions allow them to lay down excellent perimeter fire except where the warehouse blocks line of sight. Markann use lasers and stunners; they depend on force fields for protection.

In futuristic campaigns, adjust the Markann weapons technology so that it is at least one tech level higher than the players' campaign.

**The Other Offices.** It is impossible to tell what once was stationed here, since the equipment has been packed and waits in crates for transport.

*If the adventurers have been taken prisoner.* They awaken to find themselves in the cages, along with the other survivors of Flight 13. The Rogue leaders speak to the caged adventurers from behind the large window of the Intelligence Center, using an advanced-tech two-way public address system. Proceed to "The Speech."

*If the adventurers intend to attack.* The party approaches, but the overconfident Rogues take no steps to protect themselves. Before the characters can attack, however, the Markann authorities launch their assault. Skip "The Reception" and turn directly to "The Assault."

## The Reception

Before the PCs can open the door, it swings open from within. A Markann guard beckons for the characters to enter. "We've been expecting you," says Major Kk'krit, a robed figure suspended from the ceiling catwalk. His voice is familiar — PCs succeeding at their IQ roll recognize it as the voice of their air controller at the airport (see p. 16). Major Kk'krit is the commanding Rogue.

"Would you care to join your friends?" asks Kk'krit, motioning toward the cages in the warehouse. He does his best (Diplomacy of 17) to make a good impression on the party, amiably answering their questions. He tells the truth, watching eagerly for their reactions.

If the adventurers decide to fight here, let the attack of the Markann authorities start immediately. Proceed to "The Assault," p. 56.



## The Speech

Major Kk'krit isn't worried by the "lower lifeforms" — he looks on this encounter as further opportunity for study. He wants to see the reaction of the airline passengers as he explains the full truth about this adventure . . . and the fact that he is about to exterminate all of them.

Major Kk'krit first tells the tale of the Markann, and their search through the universe for the clues to their own racial failure (see p. 57). He explains about the survey of Earth, and the sensor "snapshot" taken of this city.

Next, he explains about the Markann experiment; how the city was divided into sectors, and what each experiment was and its purpose (see p. 33).

Then he explains about his rebel organization — their dedication to absolute truth, and the need to violate the ancient traditions of their forefathers to gain knowledge. He explains how they brought Flight 13 into this experiment.

If the PCs are not human (see p. 59), he reveals this secret.

Lastly, he tells about the wrecked floater, and the risk that the Markann

# Rogue Base Map

1 hex = 1 yard

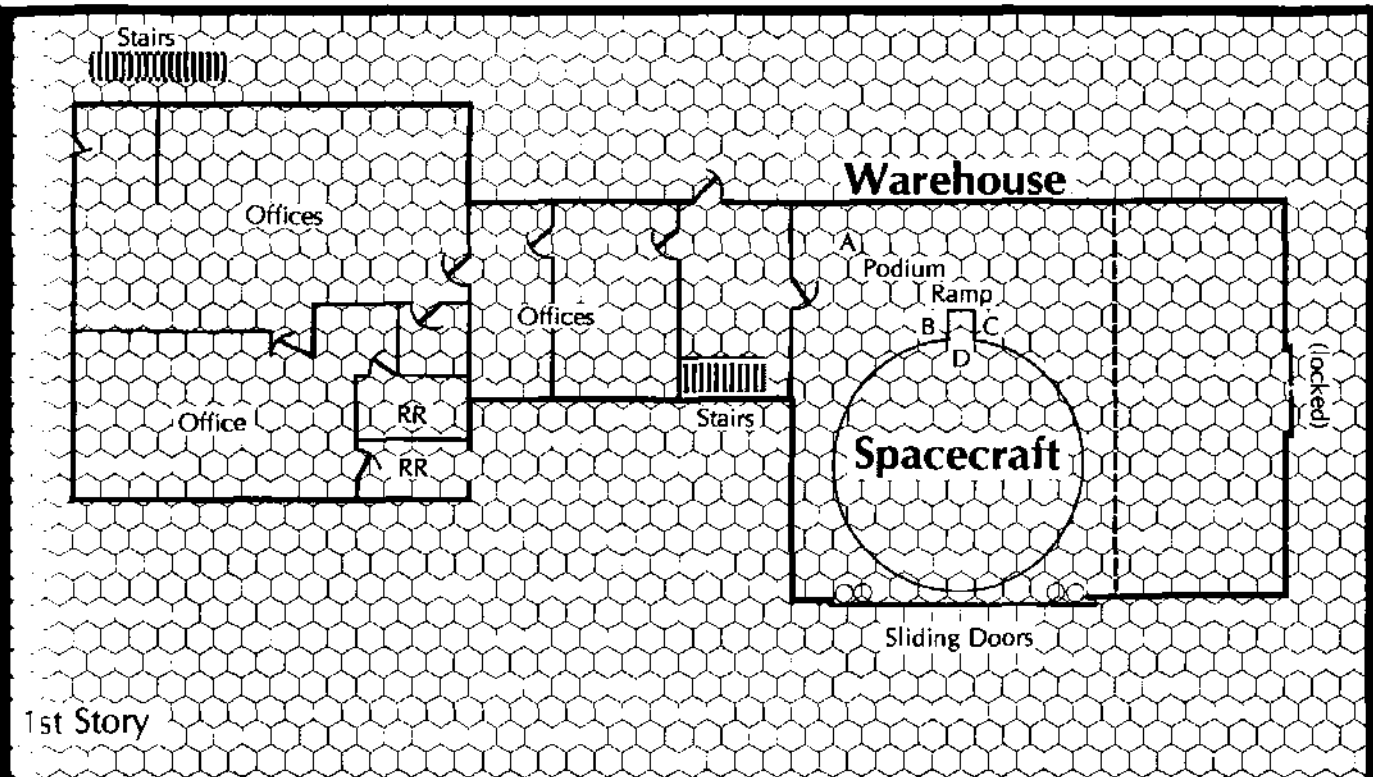

1st Story

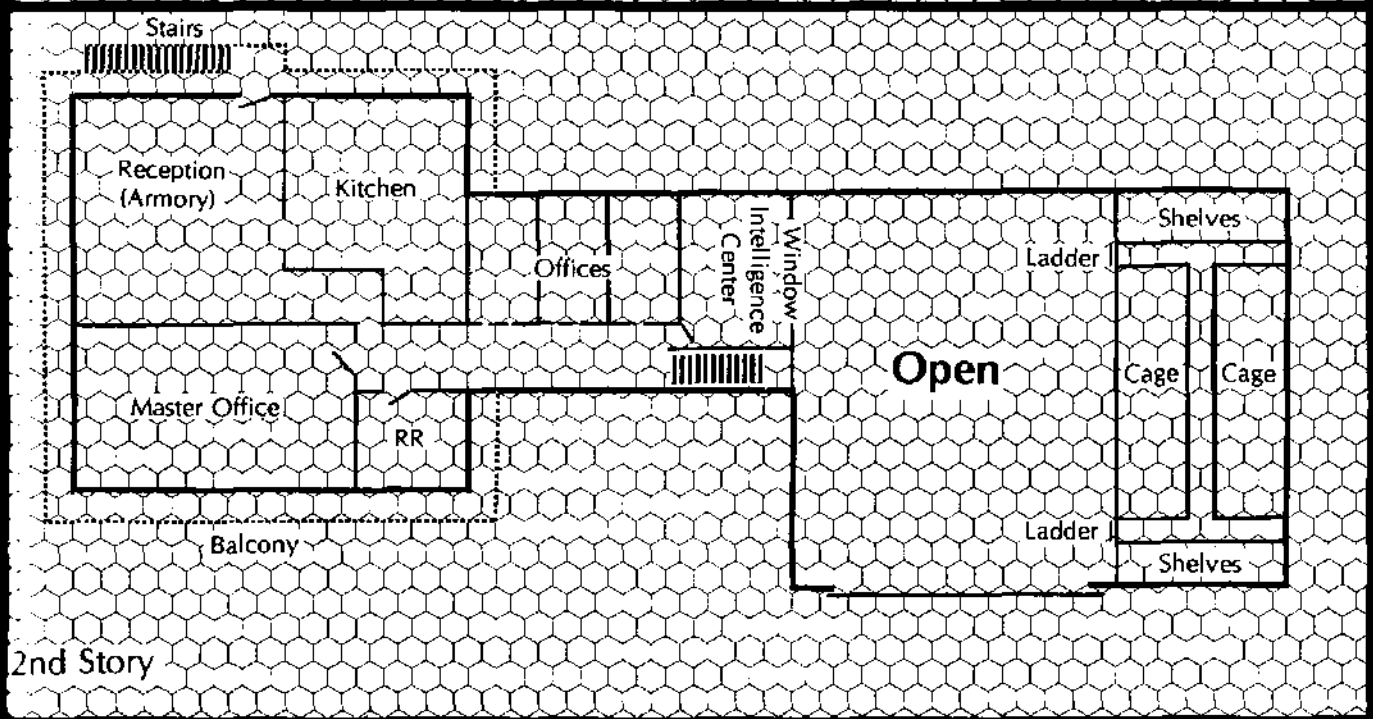

2nd Story

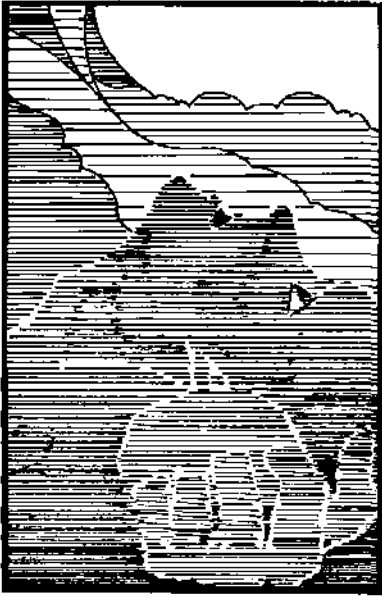

### The Gas

Should K'kra (or anyone else) press the brown button on the podium, a small explosion rips open the valve on the tank suspended from the ceiling. Deadly gas pours out in foggy chunks, tumbling to the floor.

The heavier-than-air gas fills the warehouse, starting in the hex directly below the blown valve and spreading into an additional three hexes per turn. The gas may spread evenly, or it may extend thick (one-hex) tendrils along the floor. The GM chooses the description that is most useful to his game. The gas fills each hex to a height of one yard. Once the floor is filled, the height of the cloud slowly rises (unless someone thinks to open an exit) — one foot every 10 turns. After two minutes (120 turns), the tank is empty.

Characters breathing the gas must make a HT roll; if they fail, they die. If they succeed at the roll, they take 2d-2 damage; on a critical success, they only take 1d-1 damage. The gas is also cold; any character passing through the fog loses 1 fatigue point per turn. The Markann — and any non-human succeeding at an initial HT-2 roll — are immune to the gas, but still suffer the penalties from the cold.

Coming within one yard, vertically or horizontally, of the gas requires a HT roll. Any failure causes coughing (-5 DX), which continues until the character succeeds at a HT roll while at least one full yard away from the gas. Shielding the mouth in any way — cloth over the mouth, for instance — protects from this danger.

authorities have stumbled on the Rogue activities. He “regrets the necessity” of getting rid of the evidence — including the passengers of Flight 13.

He explains that the button on the podium next to him releases a gas within the warehouse. It is harmless to Markann, but deadly to humans.

(Make frequent Fright Checks, as the PCs learn new, frightening facts.)

### The Assault

The Markann authorities are not as stupid as the Rogues believe. The discovery of the wrecked floater was all the evidence they needed — they are launching an assault to *exterminate* the Rogue scientists who have violated research traditions (“blasphemy!”).

Describe the attack as a fantastic show of superior technology — shields springing to life to repulse brilliant assault beams, shadowy floaters duelling in the night mists, concussions shaking the ground. Weird sonics stun the Markann in the warehouse (-3 to DX), but humans are immune.

Within the building, the attack comes as a complete surprise. The lights flicker out, then come back on in red emergency hues as alarm bells ring. Most Markann are knocked clear of their catwalks by the initial blast, and roll dazedly on the floor (due to the sonics). Major Kk'krit — unaffected — rushes from the room, commanding as he departs: “Kill the prisoners.” The starship begins to hum as it powers up in case an emergency departure becomes necessary.

If the PCs are outside the kennel, they have no trouble reaching the prisoners — the Markann are preoccupied by their own problems. If possible, guide them directly to the warehouse.

If the adventurers are prisoners, a concussion blows apart a section of the warehouse. The cage breaks open. Anyone who fails his IQ roll is stunned for 1d turns.

### Mayhem and Confusion

If the party has just entered the warehouse, the passengers explain the situation to them: “Stop that alien before he presses the button!” shouts Captain Morgan, his head crudely bandaged.

The flunky at “A” (K'kra, if he's available; otherwise, a generic Rogue) heads for the button, following his master's orders. The guards at B and C fire to keep the prisoners (and their attackers) under control, while trying to stay at their posts defending the starship. Before they can do anything, however, they must stand up. Their weapons are stunners. They also carry lasers and will shift to them if stunners are not enough to control the prisoners. Shifting weapons takes two seconds.

See the sidebar on p. 57 for a description of the effect of the Markann sonic weapons on the Rogues.

If the PCs are winning too easily, let the Markann pilot (D) appear from the starship and begin firing. He'll come out on the catwalk.

### Escape

The Rogue starship is the player characters' ticket out of this adventure. Within is a Markann pilot, warming up all systems for takeoff.

The ship is a prize catch, containing a variety of high-tech and obscure-tech devices. The spacecraft is an utter mystery, but the onboard computer speaks English (thanks to a built-in translator) and is easily talked into obeying anyone. (The Markann are arrogantly convinced that no alien will ever capture one of their ships, so they have no security codes.)

In either case, capturing the pilot and getting him to cooperate is desirable. His name is K'grigi, and he is confident in his eventual rescue by pursuing Markann. He will take the PCs wherever they want to go, and show them how

to operate the technology. However, betraying his civilization's secret existence is something he cannot willingly do; he will not land the ship on an inhabited world, or rendezvous with any non-Markann starship. If the ship does land, K'grigi secretly trips the emergency engine overload switch. The adventurers will have to leave within 10 minutes, before the ship destroys itself.

## Background: The Markann Civilization

*Imagine:* a hyper-cerebral race of sapients, dedicated to mental pursuits to the exclusion of all else.

This race — the Markann — begin to probe their home galaxy. Great institutes are dedicated to every science, including categorizations of knowledge not yet dreamed of by Man.

Yet within a decade of perfecting their starflight technology, the Markann civilization tears itself apart in bitter warfare. At last only a handful of survivors remain in a few planetoid fortresses. Were it not for a last-minute discovery of new medical technologies, the race would have died out.

And, perhaps, it did. For the remaining Markann feel betrayed by their ancestors. What is wrong with their culture? Were they fated to slide to destruction, while the other races of the galaxy rise to power and success?

Obsessed by a quest to find their own inadequacies, the surviving Markann secretly study the other intelligent races. Generation after generation of Markann research craft plunge into the galaxy, seeking out intelligence. Once found, the quarry is recorded with every instrument at the disposal of an eons-old civilization. Only when every last relevant fact has been wrested from the pinpointed worlds do the investigators leave, lugging their detection equipment back to a Markann study world.

At the study world, the experiments begin. These tests-to-destruction probe the depths of psychology, ethics and conscience to find what makes the other species superior to the Markann.

### Markann

### 0 points

Markann are warm-blooded, air-breathing insectoids. They are covered throughout with a stiff purple-black fur, varying in length from an inch (on the hands and undersurface) to a half yard (on the abdomen).

The body is divided into thorax and abdomen. The thorax contains the brain, and is equipped with four pairs of eyes (two large, faceted compound eyes, and two small near-sighted, non-compound eyes) and mandibles. The compound eyes are good at spotting motion, but poor at finding motionless targets which blend into their surroundings. The abdomen contains the breathing spicules, digestive and circulatory systems, and connects to the eight limbs.

Four pairs of limbs project from their bodies. The rearmost pair are used as *legs* (and are important during egg laying). The next pair of elongated legs are known as *strap-hands*, and are used by the aliens when hanging themselves from overhead; they can also serve as legs. Next to these are the *major arms*, ending in four-fingered hands — these limbs are used for tasks requiring strength. The final pair, or *minor arms*, end in eight-digit fine manipulators — these low-strength limbs are used for operating controls and performing delicate actions.

Markann have lost the ability to spin thread. They do not bite their enemies, but rely instead on their technology for combat. All Markann are male. Reproduction is made possible through their technology.

*Environment.* Markann are native to an .8 G Terrestrial world with an average temperature of 80° — slightly warm by human standards. However, they have a wider temperature tolerance than humans. They can live anywhere a human can. They breathe a standard Terran oxygen mix at .93 atmospheres.

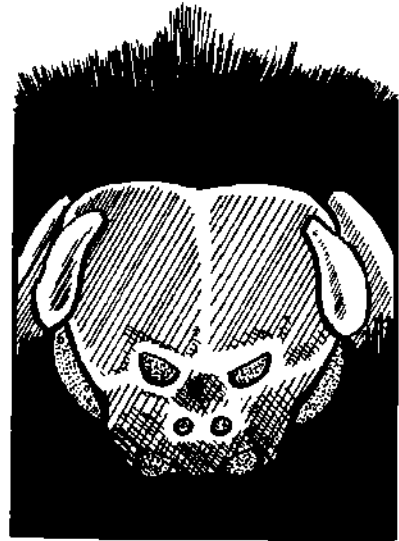

### Weird Sonics

Roll 1 die at the start of each combat round. On a roll of 1 or 2, the sonics may affect the Markann. Any Rogue failing a HT-2 roll presses his strap-hands to his ear holes in agony; he cannot fire, and loses any aiming bonuses. On a critical failure, the alien rolls into a ball on the floor.

Other non-humans must make a HT +2 roll at the start of this fight. If they fail the roll, they too experience the effects of the sonic weapons.

If necessary, balance this fight by modifying the sonics die roll or the penalty to the HT roll to resist the sonics roll. The idea is to give the PCs an exciting adventure, not to kill them off.

The GM may want to "fudge" a roll or two — having the flunky poised over the button, for instance, then reeling away as the sonics affect him.

### If They Remain Behind . . .

The adventurers might ignore (or blow!) their chance to get off-world, and stay on this world permanently.

This could be the start of a guerrilla warfare campaign. The adventurers become raiders, living "behind the scenes" of the Markann experiments in the same way that mice live behind the walls of a human home. Researchers are ambushed, equipment is stolen, and spacecraft are the ultimate prize. . .



### **The Master Law**

The ancient law of the Markann scientists is this: remain concealed. Do not let the galaxy know that you exist. In particular, do not let the subjects of an experiment know that they are being experimented on — it will skew the data, ruining the test. Be invisible observers.

The penalty for violating the Master Law is ceremonial slow death as the fodder-host of a new generation.

### **The Rogue Scientists**

Major Kk'krit and his organization represent a new breed of Markann. Obsessed with the need to fulfill the Quest, they chafe at the restrictions laid down by their more cautious ancestors.

The Rogues want to:

- participate directly in experiments,
- introduce random elements into otherwise simple experiments,
- test for racial resourcefulness and integrity by letting selected individuals become aware that they are experimental subjects,
- conduct experiments on alien homeworlds, rather than in the sterile environment of the research planets,
- experiment with actual aliens, rather than Pseudo-Being transformees.

### **The Research Planet**

The world which the Markann call K'ssg orbits around a dim star in an obscure cluster.

The clouded, humid atmosphere of nitrogen keeps the surface perpetually hidden from view. Thanks to the axial tilt, a wide variety of climates can be found on the surface — an excellent quality for a Markann study world, where alien environments are to be reproduced.

Besides its remote location and varied climate, K'ssg's prime value to its masters is its mineral wealth. There are more than enough metals and gems to continue the Markann research program for millennia. The Osmid (see p. 59) are used to mine the resources, which are sent out of system to the Markann manufacturing worlds.

**Advantages and Disadvantages.** Markann have -2 to HT, and +1 to DX. They automatically have the advantages of Acute Taste and Smell (+2), Double Jointed, Night Vision and Peripheral Vision. They have the racial disadvantages of Color Blindness, Fanaticism (the Markann Quest), Intolerance (lower-TL lifeforms, 5 points) and Overconfidence. They are a foot shorter than humans of the same ST, and weigh 30 lbs. less than a human of the same length (height).

**Psychology:** Evolved from a spider-like ancestor, these aliens would rather snare their enemies than fight open battles. They have little regard for the feelings or emotions of others, especially "lower" lifeforms. Typical individuals cooperate excellently, and unquestioningly obey orders from their superior.

Markann prefer to hang suspended from overhead, and build catwalks which they use as humans use sidewalks. When moving upside-down along their catwalks, they use their normal Move score; when moving on the ground, reduce their Move by half, rounding down. For greater distances, they sling themselves beneath contragrav floaters.



### **The Rogue Spacecraft**

The spacecraft occupying this warehouse is Kk-1B2C, a modified Markann heavy scout. The Rogues have prepared this ship for a special mission.

The ship is gray in color, nine yards across and five yards tall, and saucer shaped. Open-girder tripod legs support it on the cement surface, with the glowing dome of the contragravity generator unit clearing the ground by a mere two feet. Other upper-surface details include the prominent laser at the apex of the saucer; the airlock (currently open, with ramp extending up to the catwalks); "wide-slit" pilot windows (1 pair), and various ports.

Inside, there are two decks. The upper deck — to which the airlock leads — contains the bridge and sensor rooms, crews' quarters, and a tiny galley. Below-decks (reached from hatch-ladders in the bridge and galley) is a cramped engineering station, and a large cargo hold filled with functioning freeze capsules.

All equipment is designed for use by creatures hanging suspended from overhead catwalks. Human operators will have extreme difficulty (-2 to all rolls, -5 to all skill rolls for hurried actions) until the artificial gravity field is inverted, allowing the pilots to crouch on the ceiling as the Markann would. Human operators may also get very tired of reconstituted zgwartz and algae-based synthetic grubs, but the galley will produce nourishing edibles indefinitely.

The freeze capsules were intended for holding "kidnapped" specimens for later experiment. Placing a character into freeze is very easy, as the equipment is automatic. Frozen characters must make a HT roll after each century frozen; on a failed roll, deterioration occurs — use the Hit Location Chart and imagination to invent interesting side effects. Thawing characters must also make a HT roll; if they fail the roll, they take 2d-2 damage; on a critical failure, they die. If a physician supervises the thawing process, a Physician roll may be substituted for the HT roll. The warehouse doors may be operated from controls on the ship's main console.

# DEEP BACKGROUND

# 7

## Regression and the Osmids

Most — and, if you select that option, *all* — of the humans in *Flight 13* are not human, but are Osmids transformed by the power of Markann technology.

### The Osmids

0 points

These peaceful agrarians superficially give no indications of their unusual physiological abilities; they look like humanoid bipeds. Their skin looks thick and is the tan color of sanded wood. Their joints are thick, and their hands and feet are oversize — no one would ever mistake them for Earthlings. Osmids have hair only on the backs of their hands and feet, and on the tops of their heads.

However, all Osmids are *plasmoid* — that is, they have a limited ability to remold their bodies (see sidebar). If these physiological abilities were known to scientists, they would be amazed — the Osmid race is unlike any other in the galaxy. Some would speculate that the race didn't evolve at all, but was genetically engineered by one of the lost Precursor civilizations.

Unfortunately, the Osmids are known only to the Markann, who use them for their own amoral purposes.

### Racial Characteristics

**Environment:** Osmids are native to a 1.1 G Terrestrial world with an average temperature of 90° — hot by human standards. On K'ssg, they wear heavy clothing to protect against what they consider "cold" winds. They need oxygen to breathe, but have a wider tolerance than humans; the high-nitrogen, low-oxygen atmosphere on K'ssg is unpleasant but breathable to them.

**Advantages and Disadvantages:** Osmids have +2 to HT, +1 to ST, and -1 to DX. They automatically have the advantages of Absolute Direction, Ambidexterity, Common Sense, Double Jointed, Empathy, Longevity, Plasmoid (*Special* — see above), Rapid Healing, Regeneration (*Special*: 1 extra hit per 12 hours, *in addition to* "normal" healing or medical aid) and Toughness (DR 2). They have the racial disadvantages of Enemy (Markann), Epilepsy, Pacifism (self-defense only), Phobia (machinery), Primitive, Stubbornness and Weak Will. In their natural state, they are a half foot taller than humans of the same ST, and weigh 20 lbs. more than a human of the same height.

### Culture and Government

The Osmids live on the surface of K'ssg, mostly in the watered canyons. Each community is a tribe, made up of clans claiming descent from venerable ancestors — the ruler is the *yulaf*, or chief. They survive by raising crops in the thin soil, and by harvesting the cloud-borne spores with crevice-mounted nets.

The tribes are separate from, but totally at the mercy of, the Markann technocrats. Markann raiding parties come twice yearly to most settlements, seizing specimens. Sometimes they take the strong and young, for use in the forced-labor farms and mines. Other times they select a careful sampling, designed to match some need in the Markann experiments.

A few escape from the labor camps and return. Larger numbers of the experimental subjects return, but by Osmid custom speak of their ordeal only to their prophets — they are often scarred, physically and mentally.

### Plasmoid Abilities

Osmid plasmoid physiology provides the following abilities.

#### Skin Molding

Any Osmid can manipulate his skin, and the change will remain. Such molding is only skin deep (two inches maximum). An Osmid could sculpt a new face around his basic skull, for instance, but he couldn't mold a new hand from his chest. Takes 1 turn.

#### Flesh Folding

Through a process similar to a taffy pull, an Osmid can extend a limb or neck up to four feet in extra length. The limb or neck remains at a constant diameter — the new body material is "pulled" from the torso, which shrinks slightly. Similarly, limbs or neck can be folded all the way into the torso, leaving only appendages or a head jutting out. It takes 3 turns to fully extend or fold a limb.



## Transformation and Regression

The Markann have learned how to force the Osmid *plasmoid* physiology one step further: They can temporarily remold the entire anatomy of the beings, utilizing the Osmids' unique molecular structure against them.

The process requires special equipment and trained operators. It is very painful to the Osmid. If they fail an IQ roll, the results are traumatic. However, in practice the Markann simultaneously "implant" a synthetic personality over the Osmid identity — the "new" creature believes himself to be normal, avoiding the immediate problems of trauma. The "transformed" Osmid is a precise image of what the Markann intend. There is no way to tell the difference, except to probe to molecular levels with electronic-scanning microscopes.

The transformation is never permanent. The Osmid begins to regress (2d × 3) hours after his transformation. Stress and bodily injury bring the regression on much sooner: two fewer hours for each Fright Check failed, or each hit taken.

Regression has two stages, *dissolution* and *solidification*

### *Dissolution*

For a description of dissolution, see p. 29.

On a critical success during a Fright Check while dissolving, the character temporarily becomes a Split Personality (see p. B28) — the Osmid personality surfaces from beneath the implanted personality. Both personalities are aware of each other, and can use each other's memories.

A surfaced Osmid personality can be a great asset to the party. He is aware of the Markann, knows that this is all some sort of experiment and knows that the humans of the city are really Osmid Pseudo-Humans. If he can convince the party that he is telling the truth, he is a vital intelligence resource.

Convincing the party should not be easy. In a city full of deluded and insane victims of terror, the Osmid will sound like just one more crazy. Detect Lies or Empathy should make people more likely to believe him. Those with Paranoia or Common Sense are more likely to assume insanity.

If the Osmid can win the adventurer's belief, he can try to get them into contact with the Osmid tribes outside the city. With the Pseudo-Human personality suppressed, the Osmid can now breathe the atmosphere of K'ssg. Any previous difficulty he may have had was psychosomatic. If other members of the party are Osmids, just telling them that they can breathe won't work. The conditioning is too deep in the human personality. The tribal Osmids will help, within the limits of their racial Pacifism and machinery Phobia.

### *Solidification*

Solidification begins when the transformee has totally dissolved, and lasts for 1d hours. During this time, the Osmid/implant personality is conscious, but the body will not perform any action — communication is possible only through telepathy (if a psionic PC is present).

At the end of solidification, the Osmid is again in its natural form. If hits were taken before or during regression, the new body is thinner than it was before — however, all parts are still there. (If a hand has been chopped off, it regrows during regression. The severed hand itself does not regress, though.)

During each hour of solidification, the implant personality must make an IQ roll. If the roll is failed, the personality breaks up — the Osmid no longer has a split personality.

The implant personality can be reinforced by encouragement through telepathic contact. There is a +1 bonus if any contact is made during that hour, and +3 bonus if the contact is constant.



### *Osmid Psychology*

The Osmids' cultural heart is their pastoral religion, presided over by "Old Ones of the Mountains." These shamans have preserved the race's history in the form of vague and distorted legends.

Individuals are encouraged by these prophets to cultivate patience, self-knowledge and virtue. While an Osmid dislikes to waste time, he also avoids hurry; they are philosophical beings who occasionally take action based on their ideals.

All Osmids hate the Markann yoke, and aspire to freedom — but only a few believe in that hope.

# WHO'S WHO ON FLIGHT 13

Unless the GM decides otherwise, Flight 13 is a typical flight — crowded with nearly 300 passengers. While detailed stats cannot be provided for all of these — or we'd have to rename this volume *The Book of Airline Passenger Stats* — some common "types" are provided below.

The typical NPC is ST 10 (basic damage — thrust, 1d-2; swing, 1d), DX 10, IQ 10, HT 10. Basic Speed: 5. Move: 5, Dodge 5. Encumbrance: none (20 lbs. or less). Street clothes provide little protection: Passive Defense 0, Damage Resistance 0.

Unless stated otherwise in the individual descriptions, NPCs have a 12 in skills you think they should know. (This provides a Parry score of 6, if the character has a weapons skill and the appropriate weapon — however, most of the human NPCs have no experience with weapons.) All NPCs are literate.

## The Flight Crew

All of the airliner crew have Duty (airline), a responsibility for the welfare of the passengers and the aircraft.

### The Pilot

Captain Lewis Morgan has succeeded in his career by projecting the image of the cool, self-assured pilot.

Advantage: Voice.

Skills: Diplomacy-16, Leadership-9, Piloting (Multi-Engine Jet or Aerospace Vehicles)-15, Savoir-Faire-18.

His heart attack leaves him at HT 1.

### The Copilot

Rick Anderson is a gung-ho, former military pilot.

Advantages: Appearance (Handsome, +2/+4), Combat Reflexes.

Disadvantages: Addiction (illegal hallucinogen), Hallucinations (*Special*: treat as Epilepsy (p. B28), but roll versus IQ rather than HT; results in combat flashbacks rather than seizures), Overconfidence.

Skills: Guns-14, Navigation-12, Piloting (Multi-Engine Jet or Aerospace Vehicles)-16, Piloting (Military Jet, Space Fighter or campaign equivalent)-12 (he's rusty).

### The Flight Engineer

Allan Carstairs is a technician.

Disadvantages: Anxiety (*Special*: anxiety attacks are brought on in the same manner as epileptic seizures (see p. B28), through the roll is against IQ rather than HT; the results of failing the IQ roll are identical to failing a phobia roll, see p. B35), Cowardice.

Skills: Electronics (Communications)-14, Meteorology-17, Navigation-14.

### The Chief Stewardess

Jane Hartley is a competent, emotionally sterile woman.

Advantages: Strong Will.

Skills: Administration-14, Diplomacy-12, Karate-12, First Aid-12.

### The Novice Stewardess

Pam Chavez is very emotional.

Advantages: Intuition.

Disadvantages: Impulsiveness, Squamishness, Unluckiness.

Skills: Diplomacy-10, First Aid-10, Judo-13, Sex Appeal-14.

### Other Flight Attendants

Skills: Diplomacy-11, First Aid-11.

## The Passengers

### The Angels

This group is an avowedly anti-violence, anti-drug social organization for urban youth. They are returning from a government-sponsored wilderness camp. The switchblade: "Not mine man; I just found it and was gonna turn it in."

Advantages: Alertness, Toughness (+1).

Disadvantages: Bad Temper, Impulsiveness, Overconfidence, Poverty (Poor), Youth. (One has Kleptomania.)

Skills: Brawling-13, Climbing-12, Escape-15, Knife-14, Running-16, Stealth-12, Streetwise-13.

Move score is 7.

### The Animal Trainer

Pete Mingus is a performer returning home after a successful tour. For the stats of his animals, see p. 62.

Advantages: Animal Empathy.

Disadvantages: Lameness (Crippled Leg), Sense of Duty (to his animals).

Skills: Brawling-14, Guns-10, Streetwise-12, Ventriloquism-14 (his hobby), Veterinary (his animals)-12.

### The Businessmen/Merchants

These people are busy professionals, absorbed in their own concerns.

Advantages: Status 2+, Wealth (at least Comfortable).

Disadvantages: Bully, Delusion (that everything is normal — +2 bonus on all Fright Checks), Fanaticism (personal profit), Stubbornness.

Skills: Administration-12, Area Knowledge (their assigned geographic or

astrographic beat)-12, Fast Talk-12, Law-11, Merchant-16. One in three has Guns-11.

### The Children

Orphans or family vacationers, they are curious, impetuous, and likely to get into trouble.

Attributes: ST 7, DX 9, IQ 8, HT 8. (Or see p. B7 to match specific attributes to specific ages.)

Advantages: Acute Hearing (+3), Animal Empathy, Charisma (+2), Rapid Healing.

Disadvantages: Gluttony, Impulsiveness, Phobia (loud noises), Truthfulness.

Skills: Detect Lie-10, Fast Talk-10, Sleight of Hand-10.

### The College Students

All are returning for a new semester.

Advantages: none.

Disadvantages: Intolerance (older people), Overconfidence (think they know everything), Poverty (Struggling). Half have some form of Pacifism.

Skills: Carousing-11, Politics-12, Psychology-10, Research-13, Scrounging-12. If the PCs need a character with a specific skill, roll 1 die. On a roll of 1 to 5, one of the students has this skill at 1d+10.

### The Eagle Legionnaires

These members of an organization for retired soldiers are returning from a wild convention.

Advantages: Danger Sense.



**Disadvantages:** Alcoholism, Lecherousness.

**Skills:** Armoury (Guns)-11, Brawling-13, Carousing-15, Demolition-11, Guns-14. One of them has Leadership-11, Tactics-12.

### **The Embezzler**

Philippe Toland formerly worked for a major television evangelist, and diverted funds electronically from the church to a Swiss bank account. He is now fleeing the country. He carries a laptop computer, and is accompanied by his former secretary.

**Advantages:** Eidetic Memory, Mathematical Ability.

**Disadvantages:** Bad Sight, Dependent (secretary), Greed, Miserliness, Paranoia, Stuttering, Weak Will.

**Skills:** Accounting-16, Computer Operation-18, Computer Programming-16, Guns-9, Theology-12.

Except for her Greed and Lecherousness, his secretary — Marie Hatch — is unremarkable.

### **The Nuns/Pacifists**

On tour raising money for their charitable work, they advocate non-violence, and provide first aid. The leader is Sister Pacifica.

**Advantages:** Clerical Investment.

**Disadvantages:** Fanaticism (peace), Pacifism (cannot kill).

**Skills:** Diagnosis-12, First Aid-16, Gesture-14, Linguistics-12, Physician-9, Theology-13. Sister Pacifica has Leadership-11. Another has Psychology-15.

### **The Politician**

Chase Josephs is a junketing denizen of the chicken-dinner circuit, with an offensive, oily manner.

**Advantages:** Appearance (attractive, +1), Status (4), Voice.

**Disadvantages:** Odious Personal Habit (oily, -1), Cowardice, Lecherousness, Megalomania, Phobia (the dead), Unluckiness.

**Skills:** Bard-14, Fast Talk-14, Law-15, Leadership-7, Politics-16.

### **The Psychic Researcher**

Wendell Poropat is an academic with a special interest in extra-sensory perception.

**Advantages:** Psionic Powers (ESP, power 16).

**Disadvantages:** Addiction (pipe tobacco), Bad Sight (glasses).

**Skills:** Anthropology-12, Clairaudience-11, Clairvoyance-12, Guns-11, Hypnotism-13, Linguistics-11, Occultism-13, Psychology-18, Psychometry-15, Procognition-11, Research-14.

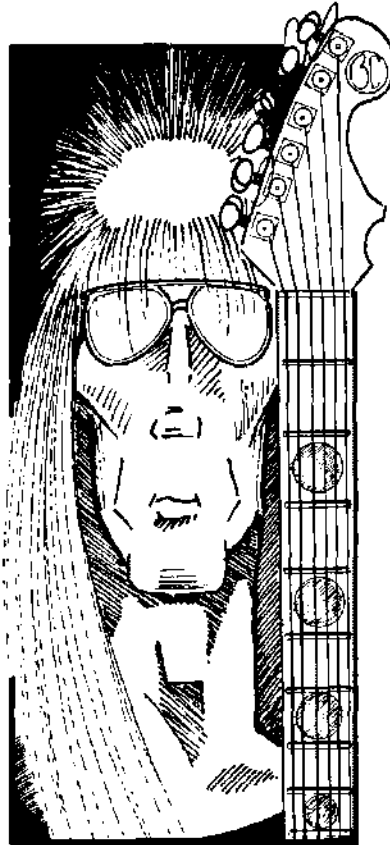

### **The Rock Singer**

This well-known celebrity has been forced to travel publicly due to the breakdown of his private aircraft/shuttle.

**Advantages:** Appearance (Very Handsome, +2/+6), Charisma (+1), Combat Reflexes, Musical Ability (+5), Status (5), Voice, Wealth (Filthy Rich).

**Disadvantages:** Intolerance (toward Status 2-), Laziness, Lecherousness, Phobia (dirt).

**Skills:** Acting-12, Dancing-15, Disguise-13, Musical Instrument-15, Singing-19.

### **The Senior Citizens**

These are a tour group assembling for a jaunt overseas. They are naturally social. These conservatives believe in traditional order, and are against anything that sounds illegal.

**Attributes:** Change to DX 8, HT 6.

**Advantages:** Common Sense, Intuition.

**Disadvantages:** Age, Appearance (Unattractive, -1), Bad Sight, Bully, Hard of Hearing, Sense of Duty (to society).

**Skills:** If the PCs need a character with a specific skill, roll 1 die. On a roll of 1 to 4, one of the senior citizens has this skill at 14. One in four has Guns-10.

### **The Vacationers**

Ordinary family-oriented people, these passengers are "on vacation." (For their offspring, see "Children" p. 61.)

**Disadvantages:** Dependents (children).

### **The Wheelchair Lady**

Amanda Ewels is a gutsy adventurer who lost the use of her legs in an aircraft accident. (Her copilot fouled up; she dragged him from the wreck despite her own injuries.)

**Advantages:** Absolute Direction, Charisma (+2), Combat Reflexes, High Pain Threshold, Peripheral Vision, Strong Will.

**Disadvantages:** Addiction (requires medication), Lameness (effectively legless), Phobia (oceans/drowning), Stubbornness.

**Skills:** Acrobatics-12, Animal Handling-13, Archaeology-12, Detect Lies-13, Free Fall-13, Guns-14, Lockpicking-11, Navigation-14, Occultism-9, Piloting (Twin-Engine Prop or High-Tech Aerospace Vehicles)-16, Powerboat-13, Riding-7 (including penalty for being paraplegic), Tracking-12, Veterinary-11.

### **Animals**

The animal trainer's dogs: ST 1d+4. DX 12. IQ 5. HT 14/ST+1. Speed/Dodge 8/6. PD/DR 0/0. Damage (see below). Reach C. Size 1.

All of the dogs are well trained, and obey simple directions from their master (only). Roll 1d+12 to discover each dog's Smell Roll. Dogs bite in close combat, doing cutting damage for their ST.

In a futuristic campaign, substitute yellow-feathered simians with flexible tapir-like snouts — called *gnossi*. ST (1 die). DX 15. IQ 6. HT 14/ST. Speed/Dodge 8/7. PD/DR 0/0. Damage 1d-4 crushing. Reach C. Size 1.

Gnossi are as well-trained as the dogs above, and have the same scenting abilities. Their greater intelligence lets them follow more complex instructions.



# SHIP RECORD

Class: Markann Heavy Scout Size: 155 cy TL: 12+  
 Registration: Secret Owner: Markann Rogue Scientists Captain: K'grigi

						Total Cost	Mass (Tons)	Cubic Yards	Power (MW)
Hull: Size	<u>155</u>	cy	\$/cy	<u>2,000</u>	mass/cy	<u>.0002</u>	310,000	.03	
Armor: DF	<u>None</u>	cy	\$/cy		mass/cy				
Force Field: DF	<u>1 (with Markann cloaking, see Note 2)</u>						50,000	5	2.5
Streamlining:	<u>No</u>								
Compartmentalization:	<u>Standard</u>								
Stress rating:	<u>155 tons</u>								
Power plant:	<u>Pocket Antimatter</u>		Base:						
Output:	<u>50</u>	MW	\$/MW	<u>1,000</u>	cy/MW	<u>.025</u>	50,000	1.25	1.25
Fuel:	<u>Anti-hydrogen</u>								
Capacitors: MW-h	<u>None</u>								
Maneuver Drive:	<u>(see Note 1)</u>		Thrust			tons			
Reaction Mass:									
FTL Drive:	<u>Inertialess Warp Thrusters (200 WTF)</u>						12,000	11	22.5
Crew:	<u>3</u>						12,000	3	75
Passengers:	<u>10 freeze capsules</u>						550,000	5	20
Lifesystem:	<u>Full for 3</u>						6,500	3.5	10
Weapons:	<u>1 Light Laser</u>		Total FP:			<u>10</u>	5,000	1	1
						Total FP:			
						Total FP:			
						Total FP:			
						Total FP:			
Sensors:	<u>Standard Suite</u>						50,000	5	5
Computer:	<u>Complexity 7 Mainframe</u>						10,000	.1	.1
Airlocks:	<u>1 standard</u>						10,000	1	8
Accessories:	<u>Artificial gravity unit</u>						20,000	1	1
	<u>Stealth Suite, miniaturized (-1)</u>						500,000	5	2
	<u>Landing gear</u>						1,000	1.6	
	<u>Contragravity</u>						50,000	1	4
						Totals	1,636,500	44.5	152.4
						Cargo Capacity		110.5	2.6
						Loaded Mass		155	155

Notes: 1. Fractional controls on the Warp Thrusters allow for sublight maneuvering. Maximum acceleration is 1/10 G, so contragravity is necessary for planetary landings.  
2. The force field and stealth suite combine to cloak the ship against visual and sensor detection. Sensors attempting to detect this ship are at -3 for each TL below 14.  
3. The sensor suite is highly accurate. It can detect and track a starship at two parsecs in deep space, or 20 AU in a system. It can locate a planet from two parsecs distance.

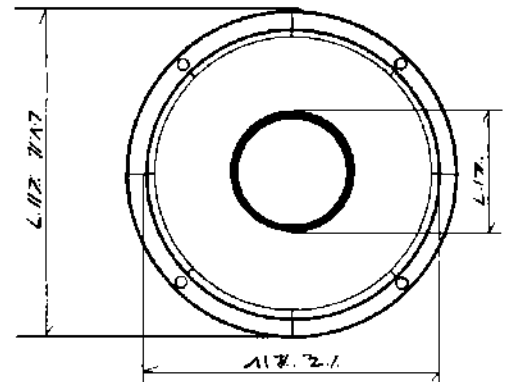
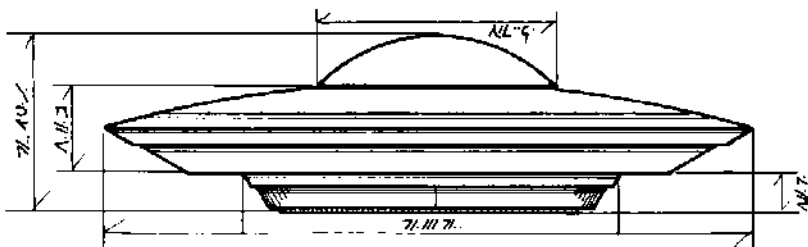

# PLANETARY RECORD: K'ssg

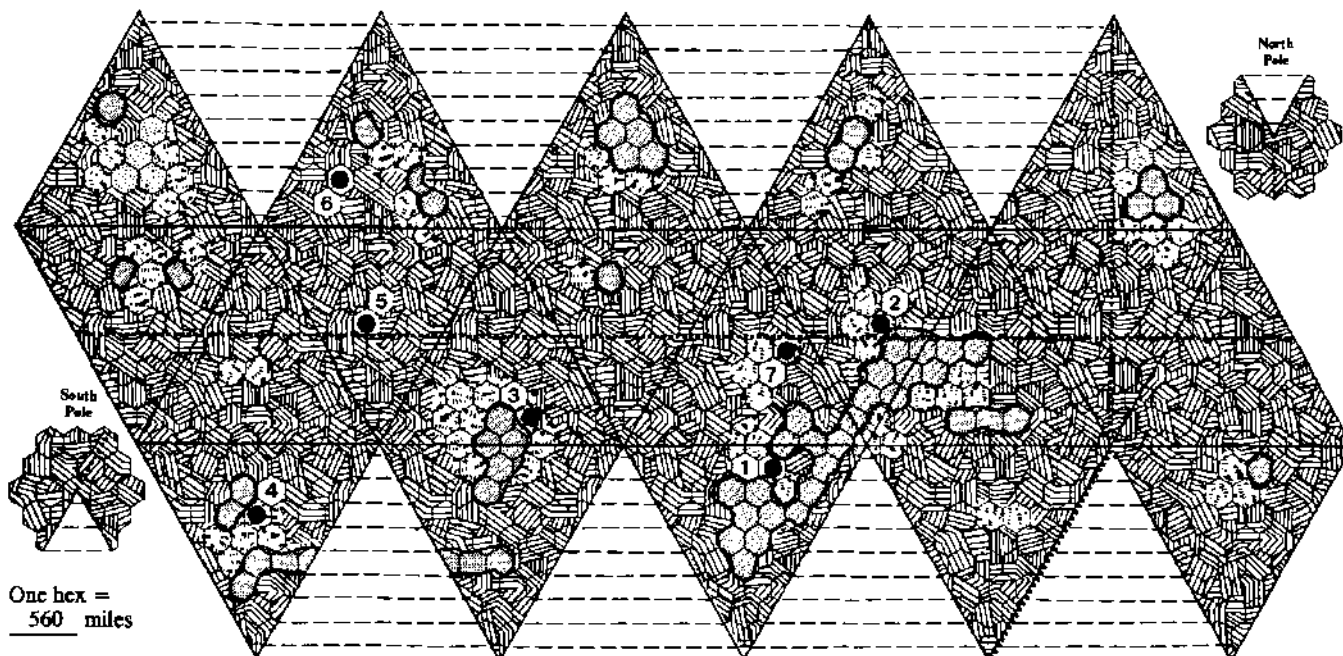

Planet type Hostile greenhouse Diameter 8,000 mi. Gravity 1.0 G Density 5.5 Composition medium-iron  
 Axial Tilt 41° Seasonal Variation Major Length of Day 600 hrs. Length of Year 7.2 local days/ .49 Earth years  
 Atmosphere: Pressure 1.1 (standard) Type and Composition High Nitrogen  
 Climate Warm Temperatures at 30° latitude: Low 70° Average 90° High 110°  
 Surface Water 10% Humidity 18% Primary Terrain Mountainous/volcanic  
 Mineral Resources: Gems/Crystals Plentiful Rare Minerals Extremely plentiful Radioactives Plentiful  
 Heavy Metals Extremely plentiful Industrial Metals Plentiful Light Metals Plentiful Organics Absent  
 Moons None

**Biosphere:** Dominant life form Lichen (native); Markann race and Osmids (imported)

Other significant life forms Airborne spores

**Civilization:** Population(s) 50,000 (Markann) (PR7), 100,000 (Osmids, varics) Tech Level(s) 12/3 Control Rating Total (6)

Society Markann rules through technocracy

Starports K'lep (Class IV) is concealed Markann scout base; Kkk'd (Class II) is former port.

Installations Markann "Webtowns": (1) K'brin, (2) K'zah, (3) Kk'm, (4) Kkk'snd. Markann research center: (5) K'k.

Forced-labor Osmids mining at Kkk'l (6). Osmid religious shrine at Oylne (7).

Economic/Production Exports minerals to Markann production facilities on other worlds; imports foodstuffs and manufactured items.

**Other notes:** Sophisticated orbital monitoring devices watch for intruders entering solar system; system never thoroughly explored by Markann.

## System Information:

Star Name Kkk'ropt Type K3 V Location Secret  
 Biozone .5 - .6 Inner Limit 0.0 Number of Planets 7

Planet	Orbit	Distance	Type	Diameter	Density	Gravity	Atmosphere	Notes
K'ssg	1	.6	Hostile greenhouse	8,000	5.5	1.0	Nitrogen	research world
	2	1.0	Asteroid belt					several C-type
Unnamed	3	1.4	Gas giant	45,000	2.1	2.2	Hydrogen	
Unnamed	4	2.2	Gas giant	41,000	2.5	2.3	Hydrogen	
	5	3.8	Asteroid belt					mostly S-type
	6	7.0	empty					
Unnamed	7	13.4	Gas giant	120,000	1.5	4.1	Hydrogen	
Unnamed	8	26.2	Gas giant	60,000	1.2	1.6	Hydrogen	
Unnamed	9	51.8	Icy rockball	9,000	5.9	1.2	trace	
Unnamed	10	103.0	Gas giant	80,000	2.4	4.4	Hydrogen	

Hilly/Rough



Desert/Barren



Mountain/Volcanic



Ocean

