



КОЛОМЪТЪН
MINDJAMMER™
THE ROLEPLAYING GAME

THE CITY PEOPLE

MYSTERY AND EXPLORATION BEYOND THE FRONTIER!
A MINDJAMMER ADVENTURE

by Sarah Newton

BETA FORMIAE

Preliminary Report to the Commonality by Event Horizon Probe Path of Luminosity RM9712-alpha

The Beta Formiae system is a mature G-class main sequence system with an inferior garden world in the second orbit. Indications are that this is a lost colony world. No trace of the colony vessel was found on the preliminary system and planet scans, but indications of past colonisation efforts are found on the planet surface and highly divergent hominids have been observed.

Beta Formiae 2 is a cool dry world; the biome is expected to be t-analogue. The lost colony is observed to be in a highly primitive state; coupled with the extreme divergence observed, initial analyses suggest this may represent a significant risk of memetic cascade. The planetsider unit remained behind to conduct preliminary analyses.

A follow-up stage 2 evaluation visit is requested. Involvement of SCI Force to conduct evaluation and threat analysis is advised.

High Concept: Cool, Dry World

Aspects: G-class Main Sequence Star

PLANETARY TYPE:
INFERIOR GARDEN WORLD

Planetary Age: Mature (+0)

Orbit: Habitable Zone (+0): 0.5AU

Year Length: 155d

Size: Large Standard (+1): 19500km

Density: Low Standard (-1): 0.7

Surface Gravity: Standard (+0): 1.14G

Day Length: Standard (+3): 29h

Atmospheric Pressure: Standard (+0);
Oxygen (breathable)

Surface Temperature: Standard (+0):
12 °C

Surface Liquid: Average (+0):
47% water

Seasonality: Low (-2)

Satellites: Planetoid

Planetary Bodies: 8 (3 gas giants,
2 asteroid belts)

Habitability: Benign (+4)

CIVILISATION TYPE: REGRESSED

Civilisation Designation: Lost Colony
(-5)

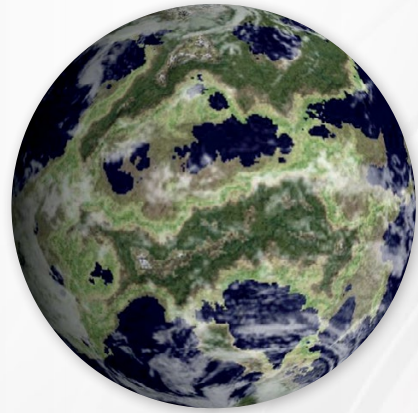

Population: Low Standard (-1): Millions

Government Type: Unknown

Societal Dev: Small-scale
Communities (-4)

Openness: Unknown

Control Index: Unknown

Trade Index: Unknown

Embargo: n/a

Tech Index: Post-animal (-5)

Starport: X (-5)

Mindscape: None (-4)

Culture: Unknown highly divergent:
POSSIBLE MEMETIC CASCADE

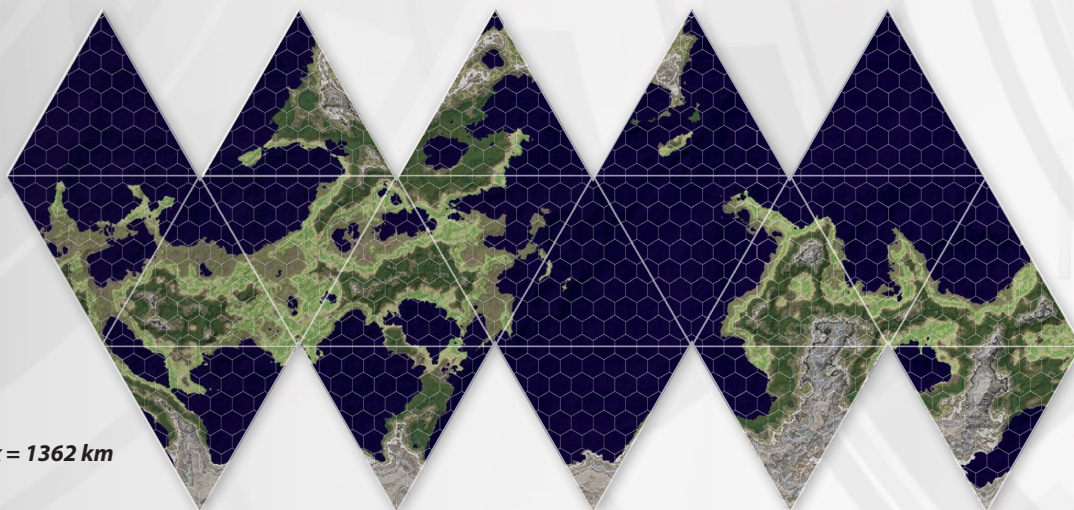

1 hex = 1362 km

UNKNOWNS UNCOVERED

MINDJAMMER™

THE ROLEPLAYING GAME

THE CITY PEOPLE

MYSTERY AND EXPLORATION BEYOND THE FRONTIER!

A MINDJAMMER ADVENTURE

by Sarah Newton

CREDITS

Mindjammer: The City People
written and developed by Sarah Newton

Cover Art by Jason Juta

Layout and Graphic Design by Michal E. Cross

Interior Art by Jason Juta, Simon Powell, Ian Stead, Andy Wintrip

Graphic Design Elements by Josephe Vandel & Paul Bourne

Deckplans and Logos by Ian Stead

Cartography by Sarah Newton

Edited by Sarah Newton

Playtested by Steve Dempsey, Jon Hancock, Nick Marsh, and Jason Woodburn.

Mindjammer Working Group: Glenn Berry, Michal E. Cross, David Donachie, John Snead, Graham Spearing, Ian Stead, Tom Zunder.

Produced & Art Directed by Chris McWilliam & Sarah Newton

Enquiries: info@mindjammerpress.com

Mindjammer Press Ltd is a private limited company, reg. no. 8222890. Our registered office is at 35 Altham Grove, Harlow, Essex, CM20 2PQ, UK.

© 2016 Mindjammer Press Ltd. All Rights Reserved. Mindjammer™ is a trademark of Mindjammer Press Ltd.

ISBN (ebook): 978-0-9574779-4-0

ISBN (physical version): 978-0-9574779-9-5
First paperback edition printed in the UK

Product Code: MUH042203

Published by Mindjammer Press Ltd,
35 Altham Grove, Harlow, Essex, CM20 2PQ

Distributed by Modiphius Entertainment Ltd,
35 Turneville Road, London, W14 9PS

Publicity and Promotion by Modiphius Entertainment.
For publicity and promotion details contact
pr@modiphius.com.

Fate Core System by Leonard Balsera, Brian Engard,
Jeremy Keller, Ryan Macklin, Mike Olson

Fate™ is a trademark of Evil Hat Productions, LLC.
The Powered by Fate logo is © Evil Hat Productions, LLC and
is used with permission.

The Fate Core font is © Evil Hat Productions, LLC and is used
with permission. The Four Actions icons were designed by
Jeremy Keller.



Thanks to Ralf Schemmann and Simon Rogers of ProFantasy Software Ltd for their Fractal Terrains software application, which was used in creating the planet and overland maps in this adventure.

Find out more about **Mindjammer** and other Mindjammer Press games and fiction at
www.mindjammerpress.com & www.facebook.com/mindjammerpress

DEDICATION — *To the real ETs out there, who'll be more alien than we could ever imagine.*

CONTENTS

Memetic Cascade!	4	Episode One: First Contact	46
<i>Playing The City People</i>	4	<i>Scene One: Initial Surveys</i>	46
Where it All Happens	6	<i>Scene Two: Secondary Surveys</i>	48
<i>Beta Formiae 2</i>	6	<i>Scene Three: Preliminary Cultural Analysis</i>	49
The Formionts	11	<i>Scene Four: The Monolith</i>	50
<i>Metabolism</i>	12	Episode Two: The Valley of War	52
<i>Modus Operandi</i>	12	<i>Scene One: The Mono League Purity Compound</i>	52
<i>Analysis</i>	12	<i>Scene Two: The Warring Leagues</i>	55
<i>The Shapechanger Plague</i>	12	<i>Scene Three: Vaccine</i>	56
<i>Reproduction</i>	13	<i>Scene Four: The Captive</i>	57
<i>"Society" and Leagues</i>	13	Episode Three:	
<i>Motivation</i>	14	The Old One in the Mountain	58
<i>Communication</i>	14	<i>Scene One: The Peaceful Lands</i>	58
<i>Formiont Models</i>	15	<i>Scene Two: A Different Purity</i>	59
The Magnanimous Intervention	20	<i>Scene Three: Prime Colony</i>	60
<i>Botany Bay-Class Stage 2 Explorer</i>	20	<i>Scene Four: The Old One</i>	63
<i>Technical Specification</i>	20	Episode Four: The Lost Ship	66
<i>Description of Ship Areas</i>	22	<i>Analysis and Deductions</i>	67
<i>The Crew</i>	27	<i>The Ship Interior</i>	68
<i>Pregenerated Characters</i>	28	<i>Scene One: Getting In</i>	69
Starting Play	35	<i>Scene Two: Ambiguous Life Signs</i>	69
<i>Who Are the PCs?</i>	35	<i>Scene Three: Memcore</i>	70
<i>Playing the Crew</i>	35	<i>Scene Four: Salvation?</i>	71
<i>Gathering Intel: What's Going On?</i>	39	Epilogue: Threat Analysis	73
<i>The Default Plot Thread</i>	40	Player Handouts	76
<i>Plot Stress: The Breach</i>	41	Index	79

MEMETIC CASCADE!

We all patched into the drone's sensorium, picking up the strange sights, sounds, and smells of this alien world. Maggie kept a running commentary: "Okay, this is where my sensors show the stage 1 planetsider went down. I'm still picking up a residual trace, though it's not broadcasting any more. Remember we've lost two drones already this morning, so I'm not wasting any more—this is a recording."

We were—or rather the drone was—in some kind of forest. Weird over-specialised plants everywhere, no wildlife. Very odd, but it fitted the planetary profile. The drone wove through lianas, tangled undergrowth, pale papery ferns bigger than a flyer. The place stank, but it was also deadly quiet. Unsettling. Biodata scrolled down my peripheral vision, then suddenly flashed up an anomaly.

"What the hell is that?" Lyra cast in disgust.

"Okay," the ship interrupted. "This is where things get weird. Weirder. Whatever. There's a life form over there—through that dense patch of foliage. Keep watching. It's only a flash."

It was. The drone broke cover, and suddenly amidst all the green there was this flash of pink, and a stink like the rankest body odour ever. I got this impression of something huge—monstrous, monolithic, as big as a house, but sitting there. Then—and my flesh still crawls—there was a groan. A really human groan. Then the drone went down.

There was a silence. Dr Clay looked up.

"We're gonna have to go down there."

An event horizon probe exploring far beyond the Commonality frontier has returned with a report of a lost colony world in a system called Beta Formiae. Space Force has requested a SCI Force evaluation team to assist them in a contact mission aboard the *Botany Bay*-class stage 2 explorer *Magnanimous Intervention*.

The report suggests the second planet in the Beta Formiae system is inhabited by divergent hominids in a primitive state, with a culture appearing to manifest toxic memes which may represent a risk of memetic cascade (page 11).

PLAYING THE CITY PEOPLE

The City People is an action and exploration adventure, investigating a deadly mystery on an alien world. Across the Frontier Commonality personnel are spread thin, and the PCs are key crew members aboard a joint Space Force / SCI

Force mission. Each player has his or her character, but the players as a whole also manage the ship's crew, using them as minions, temporary characters, sources of expertise, and even replacement characters in the event of loss.

Players may play not just SCI Force agents, but also Space Force crew, including marines, scientists, and others. But where Space Force is open and honourable, SCI Force is devious and manipulative, and the ship is a hotbed of intrigues and rivalries.

As well as the default "action, exploration, and adventure" approach to *The City People*, here are some of the other ways you can play this adventure.

The Military Approach

The City People can be out-and-out military sci-fi. Keep the ship's command crew as NPCs, providing missions to the

PCs based on the episodes and scenes starting on page 35. De-emphasise the adventure's investigative aspects, instead giving players clear military goals in each episode and scene, and let NPC scientists and analysts draw conclusions from the information the PCs uncover. Begin the adventure with **Episode One Scene Four: The Monolith** or even later, and provide plenty of combat opposition from the Formians (page 15).

The Stealth Approach

The PCs are few in number, undertaking subterfuge and intrusion missions. Combat is rare and deadly; instead, emphasise the PCs' abilities to neutralise the Formians and get in and out without detection.

The Science Approach

Game play focusses on the scientific mysteries and non-combat threats posed by Beta Formiae: the nature and treatment of the Shapechanger Plague, the fate of the original colony,

and the final revelation of the Formians' true nature. De-emphasise physical combat in favour of contests, hazards, interpersonal conflicts, and mystery, only resorting to violence as a result of dice roll failures or successes at cost.

The Moral Dilemma

Play up the "prime directive" aspects of Space Force and SCI Force missions. The Beta Formians represent a deadly threat, but are a culture in their own right, and Commonality policy is to integrate and coexist, not blindly destroy. The dilemma becomes acute when the PCs discover the formiont bacteria and what the Formians truly are.

Involving the Characters

The crew of the *Magnanimous Intervention* provides a large but limited number of characters with whom the PCs may interact. Use them when determining the "interpersonal problems" which combine with the "external problem" of Beta Formiae to drive the adventure (*Mindjammer* page 420).

WHERE IT ALL HAPPENS

"Our initial scans were uneventful. We've done the same thing a thousand times, but we were excited to have finally found a garden world. There's life there, analogous, a warm sun and a pale blue sky. Then we saw the hominids, and I knew we had a problem..."

— Event horizon probe Path of Luminosity RM9712-alpha, in its emergency report to the Commonality.

BETA FORMIAE

High Concept: Cool, Dry World

Aspects: G-class Main Sequence Star

PLANETARY TYPE:
INFERIOR GARDEN WORLD

Planetary Age: Mature (+0)

Orbit: Habitable Zone (+0): 0.5AU

Year Length: 155d

Size: Large Standard (+1): 19500km

Density: Low Standard (-1): 0.7

Surface Gravity: Standard (+0): 1.14G

Day Length: Standard (+3): 29h

Atmospheric Pressure: Standard (+0); Oxygen (breathable)

Surface Temperature: Standard (+0): 12 °C

Surface Liquid: Average (+0):
47% water

Seasonality: Low (-2)

Satellites: Planetoid

Planetary Bodies: 8 (3 gas giants,
2 asteroid belts)

Habitability: Benign (+4)

The City People takes place in the Beta Formiae star system, an unexplored system far beyond the Commonality Frontier, in a location appropriate for your game. It was first visited by event horizon probe only a couple of months ago. This section focusses on the second planet in the system.

BETA FORMIAE 2

Three thousand years ago Beta Formiae 2 was a colony of the Old Commonality slowship *Astral-440*. It was overcome by a virulent biohazard, a form of sentient bacteria called **formionts** which are the dominant life form on the planet. Formionts are gut bacteria, colonising and controlling larger-scale life forms; the human-derived **Formians** expanded to fill almost every ecosystem niche, out-competing the simple native fauna.

This event damaged the Beta Formiae ecosystem. The human colony fell 2000 years ago, and since then the planet's biosphere has suffered extensive environmental damage. It's unclear how much longer it will remain viable.

The Environment

Beta Formiae 2 has one sun, slightly cooler than Sol, a pale blue sky, and yellowish-green flora. It's a cool, dry, rather barren world. Pools of protoplasmic "goop" lie everywhere.

Plant-analogues comprise tree and shrub equivalents, with heavy leaf canopies and undergrowth, creating a humid and fertile ecosystem. Since the colony's fall, human-derived Formians have been destroying vegetation, leaving the

ground infertile, and the planet has become drier and more barren. The climate is currently unstable.

Climate zones and terrain types, while diverse, are static, including ice caps, deserts, barrens, badlands, swamps, mountains, papertree forests, and raggrass plains. Formiont bacteria are found in all native fauna (see below) and human-derived Formians (page 15), and even loose in the environment in microscopic colonies and the **mother mass** pools of protoplasmic "goop" (page 17). All are lethal threats to unprotected explorers.

The Native Ecosystem

T-Analogue Biosphere With Extensive T-Congruent Colonisation.

Beta Formiae has two ecosystems: a native one, damaged since colonisation; and a hybrid one consisting of human-derived life forms colonised by formiont bacteria. This section discusses the native ecosystem.

Biodiversity: Low (-2).

Paradigm: T-Analogue.

Metabolic Bases: Photosynthesis; cellulose and flesh and blood analogues.

Body Plans: Primary Sessile: *Large (+1) Bilateral 4-frond Endoframe With Segmented Body and Fronds*; Primary

Motile: *Medium (+0) Spherical Limbless Frameless "Flesh Bag"*; Secondary Motile: *Small (-1) Bilateral 2-limbed No Frame "Ragbat"*.

Environmental Characteristics: *Short Year Length and Low Seasonality; Cool and Dry.*

Key Parochials: *Bacterial Symbiosis (primitive brain and nervous system and "shadow" nervous system); Membranous Absorption Feeding.*

The Noble Pioneer Transport Astral-440

The Beta Formiae colony ship was an expedition of the later Great Diaspora, when interest was waning and the Core Worlds becoming mired in Byzantine introversion. The vessel is hidden in the system, holding a secret vital to the PCs' futures—and perhaps even the Commonality. See page 66.



Table 1: Timeline of Beta Formiae History

Date	Years Ago (Commonality)	Event
5700FA	5000 years ago	The colony ship <i>Astral-440</i> leaves Old Earth. It takes 1750 years to reach its destination.
7450FA	3250 years ago	The <i>Astral-440</i> arrives in the Beta Formiae system. It sends a signal to Old Earth.
8450FA	2250 years ago	Prime Colony falls, having survived for 1000 years.
8450-10700FA	To the present day	The Beta Formiae colony has been "wild" for 2250 years.

The following life forms are typical of the Beta Formiae ecosystem. Sessile life forms (plant analogues) are diverse and highly evolved, free of formiont colonisation and inhabiting both land and sea. Formiont-controlled motile species have suffered ecological damage and loss of diversity. Note that characters **cannot** be affected by formiont bacteria in native fauna (page 12).

RAGRASS

This low, shrub-like grass analogue once covered the planet. Its ecological niche has been damaged as it has been stripped by voracious, human-derived Formians.

FLESHBAGS

There are many species of the ecosystem's primary motile, from tiny larval insect- and worm-analogues to grazers larger than cattle. Although related to Formian mother masses, fleshbags are endangered and increasingly rare. They ripple along the ground, grazing on papertrees and ragrass; some scavenge on the dead.

Physical Stress: □ □ □ □ **Mental Stress:** □ □

Consequences: 1 mild + 1 moderate

Scale: Medium (+0)

Aspects: Denuded Woodland Grazer, Low Level Sentience Unable to Compete, Solitary Absorber, Spits Acid Mucous If Threatened, Slow but Versatile Generalist

Skills: Good (+3) Physique, Ranged Combat; Fair (+2) Stealth, Unarmed Combat; Average (+1) Athletics, Notice

STUNTS

◆ **Danger Sense:** Notice is unaffected by environmental conditions when something means you harm.

◆ **Take the Blow:** Use Physique to defend against bashes with Unarmed or Melee Combat.

NATURAL ABILITIES

★ **Engulf:** Create an Engulfed Unarmed Combat advantage, then target is automatically attacked for at least 2 stress each exchange.

★ **Malleable Body:** Reconfigure your body up to 50% in 1 exchange, plus 1 exchange per enhancement hidden or revealed.

★ **Mucous Spittle:** Weapon: 2 damage bonus

Supporting Life Form

RAGBATS

Ragbat species include grazers and carnivores evolving in the papertree fronds out of reach of fleshbags. They compete relatively well with human-derived Formians, and thousands roost in the papertree canopies and in caves and cliff sides. There's even an aquatic variety. Larger ragbats can cause physical injury, but even the smaller ones can be a terrifying nuisance in large numbers.

Physical Stress: □□ **Mental Stress:** □□

Consequences: 1 mild + 1 moderate

Scale: Small (-1)

Aspects: Flappy Woodland Gatherer, Poor Natural Defences, Flock Absorber, Raises Alarm If Threatened, Tied to the Papertrees.

Skills: Fair (+2) Athletics, Notice; Average (+1) Investigate, Provoke, Unarmed Combat.

STUNTS

◆ **Danger Sense:** Notice is unaffected by environmental conditions when something means you harm.

◆ **Keen Hearing:** +2 Notice bonus to detect sounds.

NATURAL ABILITIES

★ **Expert Climber:** +2 bonus to overcome and create advantage actions when climbing.

★ **Glide Membrane:** Use Athletics to make aerial movement actions between higher and lower points; minimum horizontal distance is vertical distance descended.

★ **Hyper-Reflexes:** +2 bonus to quick reactions, initiative, dodging.

PAPERTREES

A typical point-producing sessile life form (plant analogue), papertrees comprise a tall palm-like trunk with four fern-like "fronds" with a peeled, shredded appearance. "Bark" trails off in large "leaves" like sheets of paper, grazed by Formians and other formiont life forms.

A FLOCK OF RAGGED FLAPPERS

The PCs disturb a large flock of ragbats, roosting in caves or cliff sides, or in the papertree canopy. Suddenly the air is filled with the deafening flapping of fleshy wings!

Stress: □ □ □ □ □ □ □ □ □ □

Scale: Medium (+0)

Aspects: Ragged Flappers

Skills: Average (+1) Provoke (+9 teamwork bonus)

Group of 10 Average (+1) Minor NPCs

THE REST OF THE SYSTEM

Beta Formiae 2 is one of eight planetary bodies in the Beta Formiae system, including two asteroid belts and three gas giants. It's likely these bodies were visited by the *Astral-440* colony, and the PCs may wish to investigate them—see the system schematic on the next page.

At least one other planet (or one of its moons) is the location of a colony pod and up to three shuttles (page 68); ponics, power plants, habs, and so on indicate colonists tried to establish a presence there (probably fleeing Beta Formiae 2—see page 62). The GM (or players) can determine the location of these desperate remnants, and whether they show signs of formiont contagion (page 12), then or now.

SYSTEM SCHEMATIC

SYSTEM NAME:	Beta Formiae	CIVILISATION:	Regressed	DESIGNATION:	Lost Colony (-5)
STARPORT:	X (-5)	POPULATION:	Low Standard (-1)	MINDSCAPE:	None (-4)

NAME	PLANETARY TYPE		ASPECTS
Beta Formiae-8	Asteroid Belt	EXTREME OUTER (x40) 21.6	Cometary Nursery
Beta Formiae-7	Gas Giant	OUTER (x10) 10.5	Distant Gas Giant With Exotic Biosphere
Beta Formiae-6	Gas Giant	OUTER (x10) 5.4	Small Gas Giant With Five Moons
Beta Formiae-5	Gas Giant	OUTER (x5) 2.7	Satellite System of Twenty-Four Rings and Moons
Beta Formiae-4	Asteroid Belt	OUTER (x1.5) 1.5	Multiple Larger Bodies
Beta Formiae-3	Cold Desert World	HABITABLE ZONE OUTER (x1.5) 0.81	Freezing Airless Planetoid
Beta Formiae-2	Inferior Garden World	HABITABLE ZONE (x1.0) 0.55	Cool, Dry, Barren World With Denuded Biosphere
Beta Formiae-1	Terrestrial Planet	INNER (x0.4) 0.22	Lethal Furnace World

NAME	STELLAR BODY TYPE		ASPECTS
Beta Formiae	G-class Main Sequence	PRIMARY	G9 Yellow-Orange Primary

4dF	SYSTEM EVENTS	H-ZONE ORBITAL DISTANCE	TRADE INDEX	CONTROL INDEX
-4	Stellar Flare	0.55	n/a	n/a
-3	Debris Field			
-2	Artificial Signal			
-1	Cometary Encounter			
0	Navigational Interference			
+1	Gravitational Anomaly			
+2	Biosignature			
+3	Magnetic Storm			
+4	Extraordinary Event			

SKY COLOUR

Pale Blue

TRADE ASPECTS

n/a



THE FORMIONTS



"They look human—or at least humanoid—but there's nothing human about them. They don't laugh, they don't cry, they don't even seem to feel hunger or pain. They just move and eat and kill. And when the giant lactating one screams, it sounds like an infant fighting for its life..."

— Xenobiologist Totmis Var1781, crew of the Magnanimous Intervention

The **formionts** are a mystery, and key to the terrible fate which befell the Beta Formiae colony. This section provides you with detail to play them and gradually reveal their nature to your players.

Formionts are sentient stomach bacteria parasitising non-sessile life forms on Beta Formiae 2. Formians—descendants of the original human colonists—are their hosts, each a bacterial community in its own right.

Before the arrival of humans, formionts were primitive, limited by their world's simple fauna. The sudden presence

of advanced sentient hosts gave them a huge evolutionary boost.

Formionts modify their hosts. Some become huge, round, immobile, producing liquid foods; others are modified for burrowing, manipulating, fighting. Formionts even modify individuals via metamorphosis, a kind of nanoscale shapechanging, permitting them to extrude new limbs and change physical form. The apparently divergent human Formians the PCs encounter aren't human at all, but rather "vehicles" for formiont bacteria.

A Lost Civilisation?

The PCs will discover there was once civilisation on Beta Formiae 2. What isn't quite so clear is whether there still is—and, if so, what its nature is. The data points below (and on the planet page on the inside front cover) describe parameters of the current (albeit notional) regressed civilisation. Theoretical parameters for the lost civilisation which the PCs' archaeological investigations may reconstruct are given in parentheses. Later (page 49), the PCs may conclude they're dealing not with a regressed lost colony but rather an alien exoculture.

CIVILISATION TYPE: Regressed [United World]
Civilisation Designation: Lost Colony (-5) [Unknown]

Population: Low Standard (-1): Millions [Unknown]
Government Type: Anarchy -5 [Unknown]
Societal Dev: Small-scale Communities (-4) [Unknown]
Openness: Closed (-5) [Unknown]
Control Index: No Control (-5) [Unknown]
Trade Index: No trade -5 [Unknown]
Embargo: n/a
Tech Index: Post-animal (-5) [T7—First Age of Space (+2)]
Starport: X (-5) [U (-4)]
Mindscape: None (-4) [Global (-2) or better]
Culture: Lost Colony Culture in Stage 0: Interdiction and Manipulation [Unknown]

Naming the Formionts

You may have your own nomenclature for Beta Formiae's life forms. Here's how we refer to them, and why.

*The obvious name for the apparently human inhabitants of Beta Formiae is **Beta Formians**, or simply **Formians**. When the PCs discover the formiont bacteria, they may describe them as **symbiotic bacteria** or **symbionts**. A contraction of "Beta Formiae symbiont bacteria" is **formionts**.*

When the PCs decipher the formiont "language", they may discover the formionts call their Formian hosts "the City People"—perhaps because the formionts regard each of them as a place they inhabit.

Unaffected life forms (including the PCs) are in great danger: formionts can rapidly infect and overcome a new host. This **Shapechanger Plague** would be an existential threat to the Commonality if it ever made it off-world.

METABOLISM

The formiont metabolism reduces matter to undifferentiated goop—the "mother masses" (page 17) which dot the landscape. The base of the Formian food hierarchy, they can metabolise any organic matter. Next, "milk truck" Formians lactate to feed all Formians when required. Formians eat anything, including other Formians, although they prefer organic matter left to decompose in their **purity compounds** (page 14).

MODUS OPERANDI

The Beta Formiae DNA-analogue replicator—BFR ("Beta Formian Replicator") for short—incorporates chromosomal BFR and self-modifying "pseudo-plasmid" nanofactories, effectively making the formionts into expert genurgists.

Most formionts dwell in a host's gut, from where they act as a form of neural network—a big, soggy "brain". They tap into the host's nervous system, producing neurotransmitters controlling its behaviour. They also invade host cells, mimicking mitochondria, spreading throughout the host in days and weeks and transforming it on a cellular level.

During this period the host shows signs of bacterial infection: nausea, nervous ticks, behavioural changes, and finally a drastic loss of intelligence and apparent brain death. By this stage, the host has acquired a secondary "shadow" nervous system comprising a network of formiont

bacteria concentrated in the gut but present in every host cell. The host brain and nervous system are relegated to autonomic functions.

Formionts are unconcerned if their host feels pain. A Formian registers pain stimuli, reflexively flinching, but to an observer otherwise appears stoic, even uncaring of wounds.

ANALYSIS

PCs analysing Formians or native fauna (perhaps by **life form analysis**—page 48) observe they have simple—even atrophied—brains, too simple to account for their sophisticated behaviour. This is a clue that the apparent brain isn't a brain at all, but a secondary nerve cluster: the real business of thinking is done by the bacterial formiont mass in the host's gut.

Cellular analysis of the Formians reveals unidentified alien mitochondria, and that their gut flora have been replaced by alien analogues able to metabolise native life forms. Sesile life forms on Beta Formiae—the plants—don't have this vector for formiont bacteria, and their cells lack the pseudo-mitochondria.

THE SHAPECHANGER PLAGUE

The problem, of course, is that humans can be infected by formiont bacteria. This is a deadly threat—and it's unclear how the situation came about. One theory is that the original colonists engineered themselves to metabolise the native flora and fauna (a common procedure throughout Commonality history), and unwittingly made themselves susceptible to colonisation. Less obviously, it's also possible that the formiont bacteria **engineered themselves** to be compatible with human cells.

Formiont bacteria are **everywhere** in the Beta Formiae environment. Any cut, graze, or ingested liquid may result in infection.

From the formiont point of view, this isn't an infection at all—it's simply how they live and thrive. To them, colonisation is like a war between clans, tribes, or small-scale communities. Most native life has developed a resistance, and their own formiont microbiomes can fight off most direct colonisation attempts (see below).

Offworld visitors (like the PCs) have no such resistance. Although they're **not** susceptible to purely native bacteria inhabiting fleshbags and ragbats, they are highly susceptible to formionts inhabiting human-derived Formians and the environment around their **leagues** (page 13).

Related Formians—members of a league—exchange formiont bacteria regularly, ensuring commonality. This exchange is usually a meaty "kiss". Formionts inhabiting Formians separated for long periods without exchange may evolve in divergent directions, and no longer recognise one another as belonging to the same league. These unrelated

formionts exchange bacteria by force, often by a “stinger” extruded from a Formian’s mouth or elsewhere on their bodies. PCs may also be subject to this. In combat, **any physical consequence usually results in exposure** to invading formiont bacteria.

Exposure is a **biohazard** (*Mindjammer* page 177). An exposed character must make a Physique roll against the attack Intensity, typically Fair (+2), or Great (+4) if the exposure was caused by a successful attack with style. The roll is made a few hours after exposure. On a success, the character avoids infection; on a failure, he becomes *Infected By the Formiont Bacteria* of the attacking league, a situation aspect exposing those contacting the victim to the same biohazard.

Antibiotics may be administered to infected victims. Even standard antibiotics have an effect, but a tailored treatment is required to be truly effective. See **Episode Two Scene Three: Vaccine** (page 56) for more (note that this replaces action 3 of the **Biohazard** writeup on *Mindjammer* page 177).

Formiont infection is a **conflict hazard** (*Mindjammer* page 177). An infected character must make a Superb (+5) Physique roll every day, or take physical stress damage equal to the shifts of failure. If the character is forced to take a consequence, describe it as a physical mutation under formiont control: limbs twisting and behaving independently, random utterances, lapses of mental control. A character who is taken out becomes a Formian.

Mechanicals are immune to this **Shapechanger Plague**, but if exposed must be scrupulously decontaminated (an **observance roll**—page 42) to avoid a *Formiont Bacteria Carrier* situation aspect.

Knowledge Acquisition

A formiont colony which takes over a human can begin to access that human’s knowledge and memories, even though the human consciousness has been destroyed. This isn’t immediate—a Formian can’t suddenly know how to fire a gun or fly a starship—but over time a Formian can explore its host’s knowledge to understand it on its own terms. In game terms, formionts may acquire their host’s skills and stunts using advancements.

A formiont colony taking over a PC or NPC will eventually discover the existence of the Commonality. It will want to “get out there” to continue its spread. This threat is mitigated by the **inventor paradox** (see page 14), but is still alarming—especially if the Walker formionts (page 62) acquire the information.

Treating the Shapechanger Plague

The PCs may try to counter the Shapechanger Plague. See **Episode Two Scene Three: Vaccine** below (page 56).



REPRODUCTION

Formionts reproduce by **fission**. Over several hours, a host body literally splits into two. Accompanied by steam and heat, the resulting identical twin bodies are thin, emaciated, cold and thirsty—although they quickly feed and recover. Watching this is disturbing, especially when a human-derived Formian is concerned; observers must defend against a Good (+3) Provoke attack causing *Distracted and Disgusted*-type consequences.

“SOCIETY” AND LEAGUES

Formians—formiont colonies—are related to one another by common descent from the same original human. They’re basically clones, cooperating in loose associations called **leagues**. Leagues which don’t share common descent are mutually hostile.

There’s an uneasy truce within a Formian league, coupled with constant fighting between them. Formionts in one Formian host continue to evolve in isolation from others, even with the mixing promoted by Formian “kissing”. Leagues are held together by genurgic proximity but, as they grow

in size, divergence pushes them apart. As a result, leagues are obsessive about maintaining genurjic “purity”. Formian leagues are small, with some 15-30 members; larger leagues tend to collapse due to genurjic divergence, and try to wipe one another out.

Formian “society” is therefore driven by alien dynamics. Some are visible on casual inspection (Investigate, Notice, or Science rolls). First, there are no Formian children or old people: it’s death or fission after a certain age. Second, knowledge is passed on by fission descent, or by formiont colonisation; descendants develop the same skills as their originators, and leagues tend to “specialise”.

Formian league territories concentrate around a “nest” called a **purity compound**, inhabited by league members and policed for divergence. A purity compound looks like one or more mounds of earth, sometimes surrounded by a rough earthen dyke. To observers expecting human behaviour, it resembles a hill fort, although its nature is closer to a termite mound.

The oldest tumuli in a purity compound may be built around ancient structures erected by the original human colonists: prefabricated shelters, storehouses, even shuttlecraft. Their shapes have been blurred by time, but Superb (+5) Investigate, Notice, Intrusion, Science, or Sensor rolls (with appropriate equipment) may identify them. Tumuli have been added to in an organic, chaotic manner, with rounded silhouettes and no discernible aesthetic. They stink.

Formians patrol purity compounds, attacking and colonising anything smelling “wrong”. Compounds have several areas: rudimentary “hospitals” where damaged Formians are brutally “repaired”; storehouses for uneaten food (including lumps of other Formians mixed in with lactation products and vegetable matter); and hut-like nests with fires when it’s cold. They’re primitive, barbaric places, bereft of little touches that might make them feel human.

MOTIVATION

Formian leagues vie for dominance, aiming to propagate their line. Members cooperate in unstinting genocidal attacks to wipe out competition. Leagues field “war parties” of differing models which clash in **challenge zones**—the waste areas between leagues—patrolled by both sides. Offworlders smell “uninhabited”, and are attacked if they present a threat; otherwise the formionts try to colonise them (see “Formian Kissing” below).

For example: the “Loki League” is a typical Formian league comprising 30 human-derived Formians (and numerous lesser life forms) of various models (page 15). Each Loki Formian is a formiont colony, referring to itself as “we”. Each is an identical clone, with sexual characteristics expressing themselves vestigially. They diverge in appearance according to model.

In Loki territory, all fauna are controlled by Loki formionts, from mother mass jellies and packrats up to milk trucks and monitors. All consider themselves related. Like all Formians, Lokis shapechange for specific functions; some are as big as a house, producing milk and meat; others are war-specialists with sword-like appendages; others are “brains”; and so on. See “Formian Models” below.

The Inventor Paradox

In the Formians, the formionts are victims of their own success. The more rapidly and effectively they spread, the more likely they are to diverge from their original form and branch off into a new league. The challenge for formionts is always the same; to remain a coherent league long enough (without fragmenting) to invent technology. So far this **inventor paradox** has proved a brake on the Formian development; formiont history is a constant, rapid cycle of rise and fall, invention and loss. Recently, however, the emergence of a special type of Formian league possibly capable of circumventing the inventor paradox is on the verge of causing a new spurt in Formian evolution. See **Episode Three: The Old One in the Mountain** for more.

COMMUNICATION

Language is relatively new to the formionts, acquired from colonists who spoke the **Uniworld** language of the Old Commonality of the 6th millennium FA (5000 years ago). Formian utterances are superficially similar to that language—their tongue has changed remarkably little, considering the time which has passed. It’s familiar to Commonality Mindscape databases, but in reality it serves entirely different purposes: formionts simply don’t talk about things humans do.

Formian speech is loud, raucous, and screeching, like the formionts don’t know how to use the Formians’ vocal chords properly (they don’t...). It’s unpleasant and disturbing to human ears—something totally alien produced by a human mouth.

Examples of Formian Language

Even if the PCs collect enough samples to attempt translation, they’ll find Formian speech hard to understand. Translation is a Great (+4) Science contest, requiring at least PMI Mindscape connectivity or similar augmented linguistic processing facilities, and one day of close surveillance of a Formian league for each roll. Attempting the same without technological support is Epic (+7), with one roll every six months.

A successful roll provides an approximate literal translation; success in the contest allows all subsequent utterances to be translated, although this may not automatically lead to understanding...

A Problem of Scale

Formiont bacteria have a Micro (-2) exoscale and a Low Human (-2) evolution index (page 16), meaning it's difficult for them to even perceive intelligences on a human scale, and vice versa—and, even if they could, a difference in intelligence would make communication troublesome. Whenever interpersonal skill rolls are called for between PCs and formiont bacteria (not the Formians per se, but their microscopic controllers), apply a -3 penalty to account for this fundamental mismatch, or -2 in the case of Walker formionts (page 63).

Here are some examples of Formian speech. The literal translation is given first, followed by what the formionts might mean. Let players puzzle out these meanings themselves, providing hints with rolls and invokes.

- *"Fission complete. Confirm convergent replication."* The Formian has reproduced; it'll now "sniff" its progeny to ensure it hasn't become too divergent.
- *"Lactation... Lactation..."* A milk truck is producing food, and Formians from its league are being called to feed.
- *"Ambient moisture increasing."* The formiont colony has detected its host Formian is being rained on—or has fallen in the water!
- *"Purity compound breach. Secure resources and deploy control team."* A non-league Formian (or possibly a PC or NPC) has entered a purity compound, and Formians are mobilising!
- *"Multi-model threat. Alarm! Alarm!"* A Formian is issuing a general call to arms!
- *"Structural integrity compromised. Require evacuation vehicle."* A Formian has been critically wounded, and the formiont colony wants a new host.
- *"Communication fails—divergent basis."* The Formian has detected a divergent Formian, possibly from another league. This probably also happens when the Formians encounter the PCs.
- *"Models are analogous yet appear unmanned and autonomous. Confirm."* The Formian reaction to trying to "interact" with the PCs. This is the "giveaway" that the Formians aren't what they appear.
- *"City people not identified! Models are autonomous or abandoned!"* The Formians can't identify the PCs as belonging to any Formian league—even a hostile one. Most telling perhaps is the formionts word for themselves—the City People (page 12).

Table 2: Typical Formian League Structure

Formian Model	Number in League
Mother Mass	1
Milk Truck	2-6
Monitor	1-2
Warrior	3-5
Dozer	2-3
Tank	1-3
Packrat	5-10
Total	15-30

- *"Autonomous models originate beyond challenge zone. Possible territory expansion."* Be afraid—the formionts have identified the PCs as promising colonisation material!
- *"Unable to identify unbreathing model. Non-divergent. No communication."* When faced with a mechanical or similar non-organic synthetic character, the formionts have trouble even determining it's alive—no matter how hard it tries to communicate.
- *"Clarify: where does unmanned model communication attempt originate? Is this divergent? There is no olfactory marker. Open niche?"* The formionts have trouble understanding that the PCs may be intelligent in their own right, and not simply mindless vessels for sentient bacteria. The PCs may have the opposite problem.
- *"Transmission protocols do not conform. Communicate and identify!"* Even though the PCs are attempting to talk, they're making no sense to the formionts—so a kiss or stinger exchange is needed!

FORMIAN MODELS

Formians take many physical forms, phenotypes of the original colonised humans, tailored to a specific purpose. We've grouped these into broad **models**—warrior, monitor, tank, and so on—and provide stats and descriptions below. These definitions are for convenience only: there's a lot of variability and overlap. If a league runs out of a model, others can be repurposed to fill the gaps, given a few days.

Formians wear no clothing, unless draping themselves in crudely-made items for "protection", and are generally unkempt. Some appear "tidier" than others—as if some formiont colonies realise it pays to keep their "vehicles" in good condition!

Formian Attacks

Formian attacks are in fact formiont attempts to communicate, ensure genurgic convergence, or conduct "boarding actions" of the hosts of enemy formiont leagues (or even unoccupied hosts like the PCs). Attacks succeeding with a moderate consequence or better usually expose the target to the Shapechanger Plague (page 12). Attacks usually take three forms:

- **Formian Kiss:** Formians exchange formiont bacteria via a routine "docking manoeuvre" which looks like a meaty "kiss", exchanging copious bodily fluids.
- **Projectile:** If a target refuses a kiss, the Formian escalates, spitting or vomiting bacteria up to 1 zone range. While this doesn't cause injury, figure physical stress to see if a moderate consequence or better results in Shapechanger Plague exposure (page 12).
- **Stinger:** The Formian extrudes a sharp, gristly "barb" with a weapon:1 rating and which can cause Shapechanger Plague exposure (page 12). All Formians may do this; infected life forms develop a stinger over a few days as part of the Shapechanger Plague.

Formiont Exointelligence Build

The following exointelligence build applies to all Formian models except the Walker Formians (page 63). Exointelligence concept, behaviour, and manifestation aspects are available to every Formian, in addition to aspects provided for each model below.

Exointelligence Scale: Micro (-2).

Evolution Index: Low Human (-2).

Exointelligence Concept: *Microorganism Exointelligence League Destroying for Dominance.*

Behaviours: *League Social Structure, Attempts to Infect If Encounters Non-League Life Forms, Shapechanges to Fit Specialised Niche.*

Exointelligence Skills: Empathy -4, Investigate -4, Knowledge -4, Notice -4, Science -4, Will +0.

Manifestation: *Parasitises Host Senses; Communal Communication via Chemical Exchange in Shared Host Environment, Intra-League Communication via Bacterial Exchange (Formiont Kiss), Extra-League Communication via Bacterial Intrusion (Formiont Stinger); Communal Hive Inhabiting Host*



as Member of League; Individuals at Millisecond Scale Aggregated Into Communal "Historical" Experience at Host Time Scale (1 standard exchange).

MOTHER MASS

This isn't so much a Formian model as a pool of undifferentiated protoplasmic goop which all formions can dissolve matter into and re-use as a kind of "raw material". The mother mass sends out motile "jellies" which can infect other life forms on touch, and which in time may become packrats (page 18). They sit in the open air in the centre of a purity compound. Note that the Large (+1) scale of a mother mass means it's subject to scale effects (**Mindjammer** page 174).

Physical Stress: □²□³□⁴□ **Mental Stress:** n/a

Consequences: 2 mild + 1 moderate + 1 severe

Scale: Large (+1)

Aspects: Large Pool of Protoplasmic Goop, Vulnerable to Heat and Cold.

Skills: Fantastic (+6) Physique; Superb (+5) Ranged Combat; Great (+4) Unarmed Combat; Good (+3) Unarmed Combat; Fair (+2) Unarmed Combat; Average (+1) Unarmed Combat.

STUNTS

◆ **Take the Blow:** Use Physique to defend against bashes with Unarmed or Melee Combat.

NATURAL ABILITIES

★ **Dispersed Body:** As aspect; invoke to be hard to harm, compel to be disrupted or unfocussed.

★ **Extend Limb:** Unarmed attacks are range 1.*

★ **Motile (Jelly) Eruption:** For a fate point, eject a group of 3 Average (+1) minor NPCs with Shapechanger Plague.

★ **Multi-attack:** Roll Unarmed Combat once at +7 (+4 +3), dividing total between up to 4 targets.*

★ **Pseudopod Attack:** Weapon:2 damage bonus + possible Shapechanger Plague exposure (page 12).*

* subject to scale effects (**Mindjammer** page 174).

Supporting Life Form

New Extra: Formian Shapechanging

Costs 1 aspect

Any Formian can change shape into another model to replace league losses. Each change takes a few days, and conforms to the first law of thermodynamics: Formians shrinking in size lose **lots** of heat and mass (usually via water loss, but sometimes in other, less pleasant, ways); those increasing in size eat voraciously—even things humans can't usually metabolise—and extract heat from their surroundings.

DOZER

Heavy-lifting Formians with great spatulate "hands" with horny claws, ideal for digging and earth-shifting. As well as creating purity compounds, they dig traps and protective earthworks.

Physical Stress: □²□³□⁴□ **Mental Stress:** □²□³□

Consequences: 1 mild + 1 moderate

Scale: Medium (+0)

Aspects: Hulking Parody of a Human Trapper, Single-minded.

Skills: Great (+4) Physique; Good (+3) Unarmed Combat; Fair (+2) Provoke; Average (+1) Will.

STUNTS

◆ **Grappler:** +2 create an advantage Physique bonus when wrestling or grappling.

◆ **Heavy Hitter:** Reduce shifts by 1 on a Melee Combat success with style for an additional full situation aspect with free invoke.

◆ **Tough As Nails:** 1/session, pay a fate point to reduce moderate physical consequence to mild, or erase a mild.

NATURAL ABILITIES

★ **Formian Shapechanging:** Reconfigure into different Formian model, shrinking or increasing up to 50% in size. Takes a few days.

★ **Horny Claws:** Weapon:2 damage bonus.

★ **Massively Muscled:** +2 Physique bonus for strength, and weapon:2 damage bonus on Unarmed and Melee Combat attacks.

★ **Stinger:** +2 Unarmed Combat attack bonus, plus possible Shapechanger Plague exposure (page 12).

Supporting Life Form

TANK

Tanks can make ranged projectile attacks by spitting barbs from their malformed mouths. They also have thick plates of knobby skin and carapace covering their bodies. They're as ugly as hell.

Physical Stress: □ □ □ □ **Mental Stress:** □ □

Consequences: 1 mild + 1 moderate

Scale: Medium (+0)

Aspects: Behemoth Pouncer, Slow and Ponderous.

Skills: Great (+4) Ranged Combat; Good (+3) Physique; Fair (+2) Provoke; Average (+1) Notice.

STUNTS

- ✦ **Called Shot:** Pay 1 fate point and declare a situation aspect to inflict on a target on a successful Ranged Combat attack, as well as damage.
- ✦ **Hi-Threat Manoeuvre:** Use Provoke against constructs.
- ✦ **Take the Blow:** Use Physique to defend against bashes with Unarmed or Melee Combat.

NATURAL ABILITIES

- ★ **Barb Thrower:** +2 Ranged Combat attack bonus, range 2, plus possible Shapechanger Plague exposure.
- ★ **Carapace:** Armour:2 damage reduction.
- ★ **Formian Shapechanging:** Reconfigure into different Formian model, shrinking or increasing up to 50% in size. Takes a few days.
- ★ **Large:** +2 Provoke bonus, plus aspect.

WARRIOR

Insanely violent Formians with slashing, blade-like claws, spikes breaking from their skin, and huge mouths with tearing tusks and fangs. They fight against the warriors of other leagues.

Physical Stress: □ □ □ **Mental Stress:** □ □

Consequences: 1 mild + 1 moderate

Scale: Medium (+0)

Aspects: Insanely Violent Raider; Remotely Controlled.

Skills: Good (+3) Athletics, Unarmed Combat; Fair (+2) Physique, Stealth; Average (+1) Notice, Provoke.

STUNTS

- ✦ **Dazing Counter:** On a defend success with style vs Unarmed or Melee Combat, automatically counter and attach a Dazed situation aspect with a free invoke.
- ✦ **Killing Stroke:** 1/scene, pay 1 fate point to increase a physical consequence you inflict by 1 step.

NATURAL ABILITIES

- ★ **Bite, Spikes and Claws:** +2 Unarmed Combat attack bonus, weapon:2 damage bonus, plus possible Shapechanger Plague exposure.
- ★ **Formian Shapechanging:** Reconfigure into different Formian model, shrinking or increasing up to 50% in size. Takes a few days.
- ★ **Massively Muscled:** +2 Physique bonus for strength, and additional weapon:2 damage bonus on Unarmed and Melee Combat attacks.
- ★ **Natural Armour:** Armour:2 damage reduction.
- ★ **Stinger:** +2 Unarmed Combat attack bonus, plus possible Shapechanger Plague exposure.

PACKRAT

Packrats aren't rats, but a collection of "lower" Formian models: scavengers, cleaners, nuisance creatures, vermin, even the base motiles ("jellies") from the mother masses (page 17). They still belong within purity compounds, but there are also plenty "in the wild" which serve also as food. Aggressive and dangerous in large numbers, attacks by packrat groups carry the Shapechanger

Plague. Those attaining sufficient size may assume the forms of other models.

Stress: □ □ □ □ □ □ □ □ □ □

Scale: Medium (+0)

Aspects: Gibbering Motiles.

Skills: Average (+1) Unarmed Combat (+9 teamwork bonus, plus Shapechanger Plague).

MILK TRUCK

Milk trucks are barely mobile, enormously fat, tower-like creatures with stubby atrophied arms and legs. They are covered with grease and lactating glands providing a ready source of food for smaller Formians. They can eat anything, and are often brought food by other Formians (a kind of primitive Formian “farming”). Usually they’ll park themselves in a fertile woodland area and strip it bare before moving on.

Although a milk truck stinks to high heaven, they release pheromones which attract and pacify potential prey (divergent or unaffected life forms—including the PCs!). A milk truck’s Provoke skill works only against unaffected humans; its form is so disturbing and its stench so overpowering most people simply want to get out of the way.

Physical Stress: □□□□□ **Mental Stress:** □□

Consequences: 2 mild + 1 moderate

Scale: Medium (+0)

Aspects: Denuded Woodlands Eater; Distracted by Food.

Skills: Superb (+5) Physique ; Great (+4) Provoke ; Good (+3) Unarmed Combat ; Fair (+2) Rapport; Average (+1) Notice.

STUNTS

◆ **Armour of Fear:** Use Provoke to defend vs Melee and Unarmed Combat until damaged.

◆ **Tough As Nails:** 1/session, pay a fate point to reduce moderate physical consequence to mild, or erase a mild.

NATURAL ABILITIES

★ **Formian Shapechanging:** Reconfigure into different Formian model, shrinking or increasing up to 50% in size. Takes a few days.

★ **Horrific:** +2 bonus to Provoke attacks and create advantage actions to instil fear.

★ **Howl Attack:** Area effect Provoke in your zone, +1 zone per fate point.

★ **Large:** +2 Provoke bonus, plus aspect.

★ **Natural Armour:** Armour:2 damage reduction.

★ **Stinger:** +2 Unarmed Combat attack bonus, plus possible Shapechanger Plague exposure.

★ **Swallow:** Create a Swallowed Unarmed Combat advantage, then target is automatically attacked each exchange.

MONITOR

Monitors are shrivelled, emaciated humanoids which stalk the purity compounds (page 14) checking for impurity and destroying divergent Formians. They also act as firekeepers and firestarters, and work in purity compound hospitals. They’re the nearest thing to Formian leaders.

Physical Stress: □□ **Mental Stress:** □□□□□

Consequences: 1 mild + 1 moderate

Scale: Medium (+0)

Aspects: Leader Caste Controller, Shrivelled Humanoid.

Skills: Great (+4) Rapport, Will; Good (+3) Investigate, Stealth; Fair (+2) Knowledge, Notice; Average (+1) Empathy, Unarmed Combat.

STUNTS

◆ **Barbarous Surgeon:** Use Knowledge to remove physical consequences.

◆ **Indomitable:** +2 Will bonus to defend against Provoke fear and intimidation attacks.

◆ **Overseer:** 1/scene, make a Rapport overcome action to generate a pool of shift points you can redistribute.

◆ **Sixth Sense:** +2 Notice bonus to perceive threats or find clues, plus as aspect.

◆ **Smell Divergence:** +2 Investigate or Notice bonus when attempting to detect divergent Formians.

NATURAL ABILITIES

★ **Formian Shapechanging:** Reconfigure into different Formian model, shrinking or increasing up to 50% in size. Takes a few days.

★ **Stinger:** +2 Unarmed Combat attack bonus, plus possible Shapechanger Plague exposure.

THE MAGNANIMOUS INTERVENTION

"Maggie's saved my life more than once. You know what they say about mechanicals not understanding organics? Maggie proves that's not true. I don't know whether it's her avatar, or her relationship with 2-pilot K'Soo, or the decades she's spent patching us all up in sick-bay, but our ship's one of the most sympathetic people I've ever known."

— Captain Cornelius Chang, Space Force Performance Review, 192NCE

BOTANY BAY-CLASS STAGE 2 EXPLORER

The *Magnanimous Intervention* is a typical *Botany Bay*-class, a dedicated deep space explorer with extended endurance for 50-100 crew, system survey drones, and docks for *Icarus*-class scout and / or orbital grav ATVs. It's equipped with xenoscience labs and environments and even a small cargo bay, and an "open-air" pressurisable force field assembly space.

TECHNICAL SPECIFICATION

Hull Size: 18378m³ (1313 displacement tonnes)

Hull Class: 3.1D with removable O-type booms (3rd power hull, disk)

Generation: Second Gen (T9).

Planing Engines (p-4): 7351m³ (525 d-tons)

Gravity Engines (m-1): 184m³ (13 d-tons)

ZIP Plant: 3675m³ (263 d-tons)

Total Drive System Volume: 11210m³ (800 d-tons)

Crew Capacity: 50 (100)

Dedicated Cargo Capacity: 534m³ (38 d-tons)

Small Craft Complement: 2 x Hydrodyne grav ATVs; 10 x 1-metre survey drones.

Ship Dimensions



Booms: 64.5m x 14.5m x 6m (2 decks).

Companionways: 15m x 16.5m x 3m (1 deck).

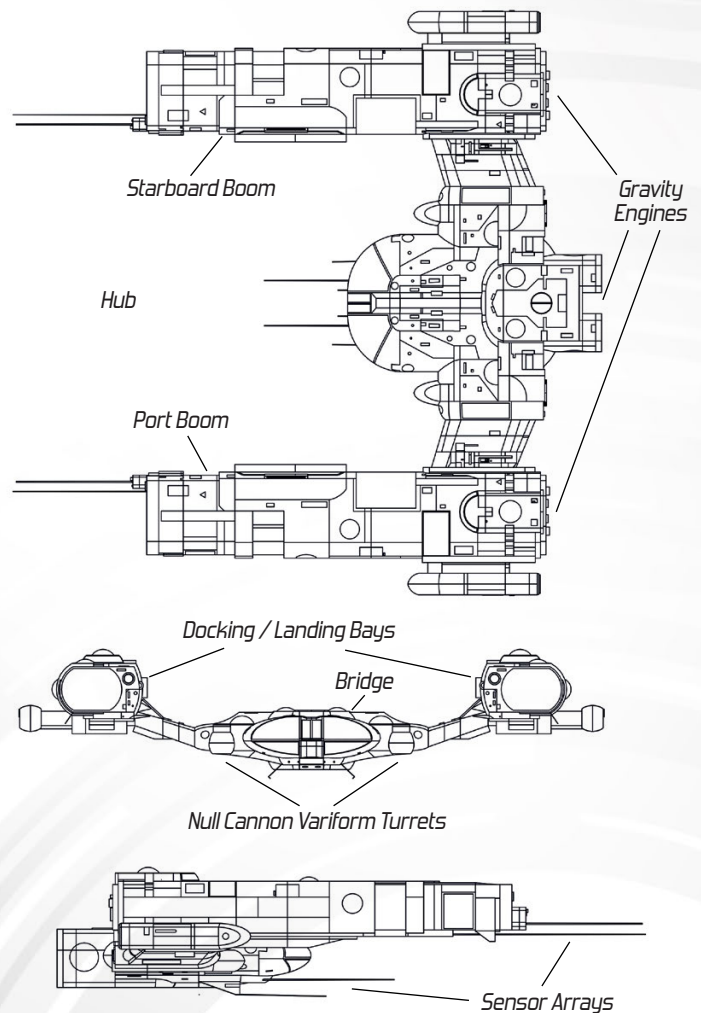
Ship Hub: 42m x 22.5m x 6m (2 decks).

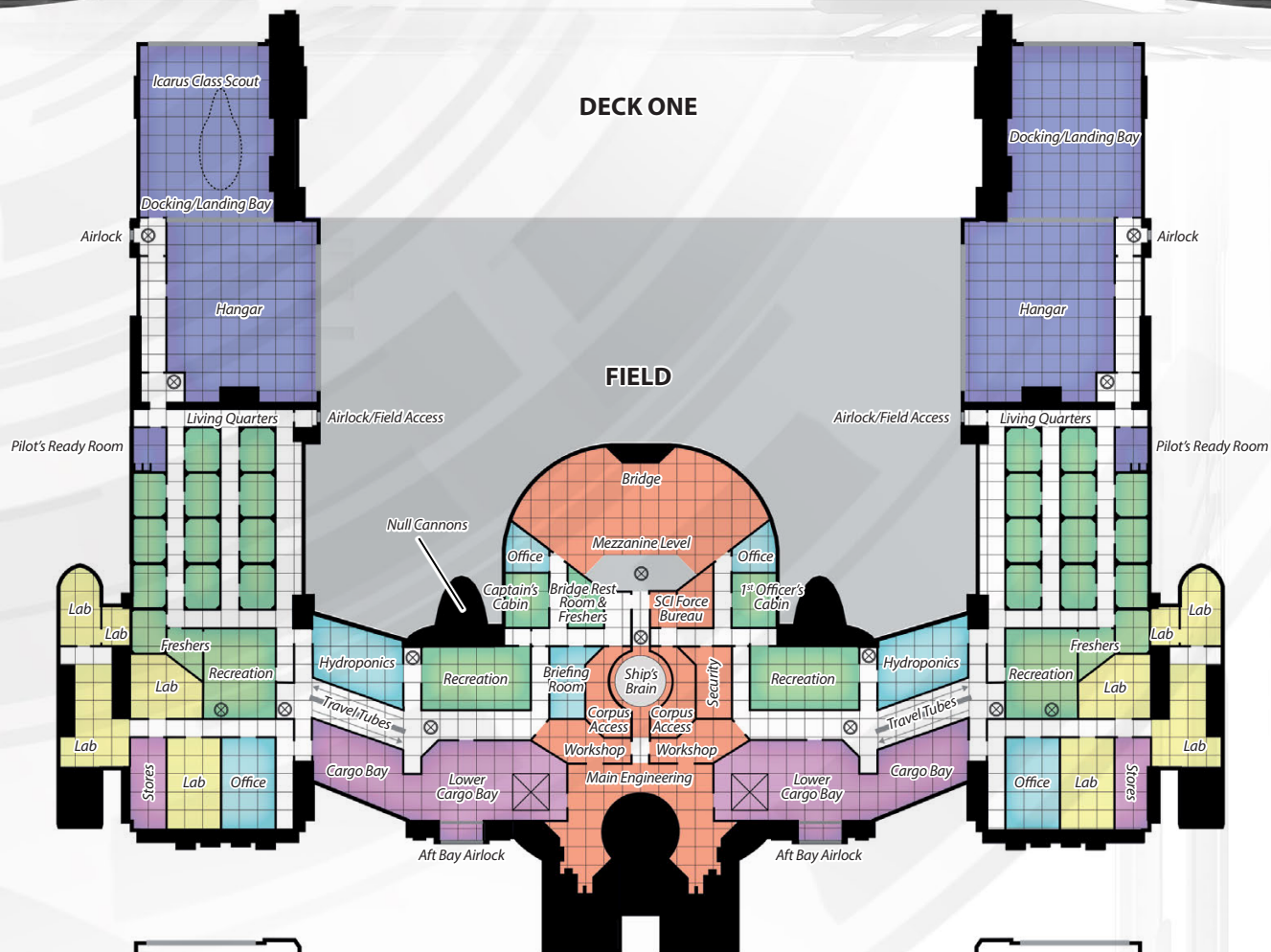



-  Grav Lift
-  External Access Hatch
-  Grav Lift

1 square = 1.5 metres

 Variform Bay Door and Field

BOOM ARM UPPER DECK

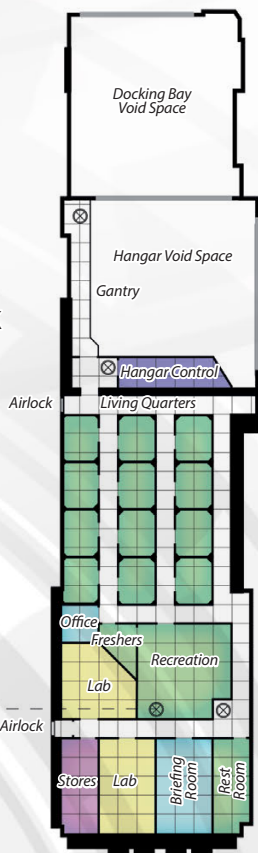

MAIN SECTION UPPER DECK

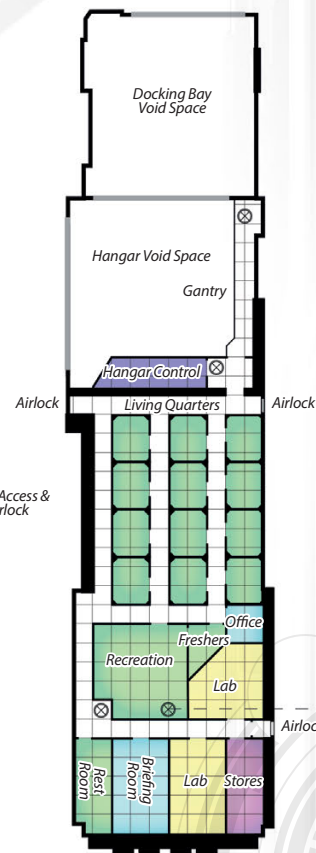
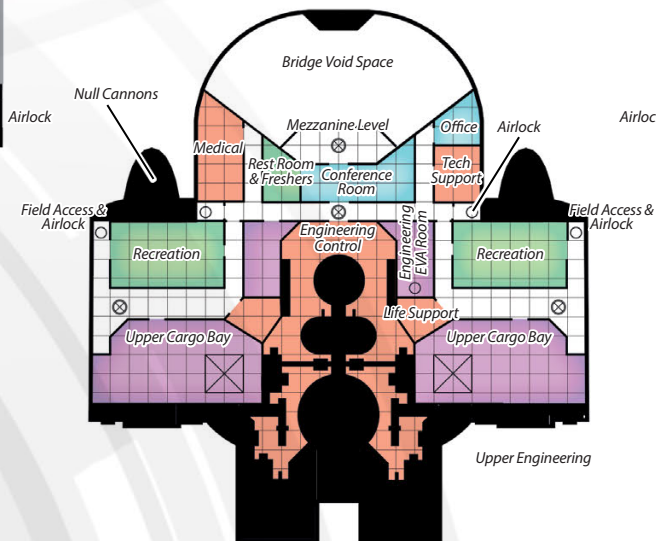

DESCRIPTION OF SHIP AREAS

The *Magnanimous Intervention* is a relatively old example of the *Botany Bay*-class stage 2 explorer, laid down 130 years ago in the second generation of planeship construction immediately prior to the Venu War. It has an elegant and comfortable design, but like all two-gen ships is characterised by not being designed for combat. Its main areas are as follows.

Airlocks, Grav Lifts, and Travel Tubes

The ship hub and twin booms have two decks, access between which is provided by grav lifts also equipped with wall ladders in case of emergency or power loss.

There are several forms of access to and from the ship. Docking bays provide conventional access when the ship is in flight; variform airlocks lead out onto the hull or field area; grav lifts or field steps / ramps can be extended to the ground if the ship ever makes planetfall. Finally, manual hatches also provide emergency hull access.

The following illustration shows typical airlock and grav lift features, including: a variform airlock in closed reflect configuration; a grav lift with single occupant; and holopanel configured into the chameleon hull surface displaying technical readouts.

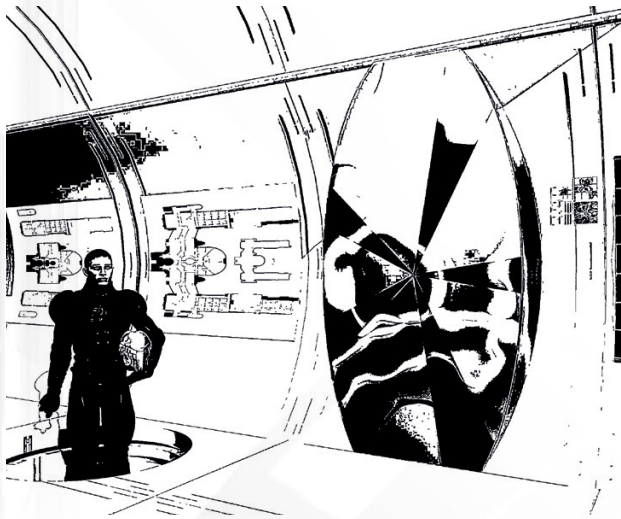

Bridge

The bridge of the *Botany Bay*-class is a relaxing and ergonomic activity space for extended low stress operation. Variform surfaces and double-deck / mezzanine layout permit an uncrowded and mobile environment. Bridge crew comprise: the command staff (captain, first officer, morale officer); bridge staff (comms officer, science officer, tactical officer); and flight crew (2-pilot / n-pilot and two assistant pilots).

*The following illustration shows the bridge of the *Magnanimous Intervention*, including personalised crew stations with grav chairs and mixed holo / virtual vision control surfaces;*

forward chameleon hull surface configured as a viewscreen showing the forward view; and ubiquitous ambient flora creating a pleasant and low stress work environment.

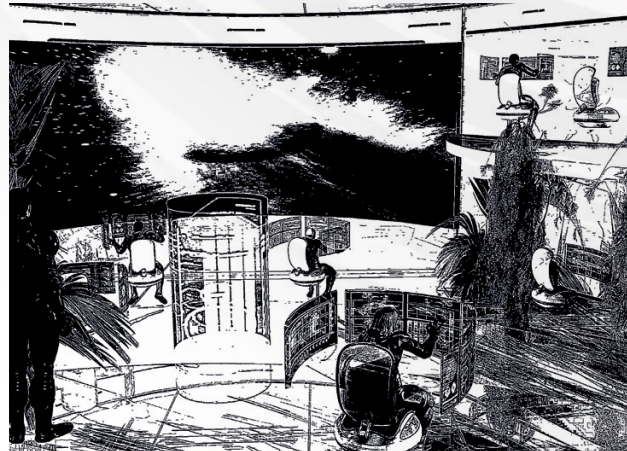

Cargo Bays

The upper, lower, and main cargo bays offer limited (534m³) storage for items which cannot be easily replicated by makepoint. Bays often contain material collected during exploration missions, including artefacts, genurgy and biosamples, and so on. Usually these relatively small areas are filled with racks and shelves, managed by the five logistics officers also responsible for the makepoint workshops.

Crew Quarters (Daytime Config)

Staterooms for 50 crew members (100 with double occupancy) are provided, with full variform capability.

The illustration shows a typical stateroom configured for single occupancy daytime use, including: visiwall keyed for a stimulating open-space planetside vista; variform shelving and display units for personal effects; and variform stowage cloaked by the visiwall (not shown).



Crew Quarters (Nighttime Config)

Usually the ship operates on a single day / night cycle. Under extraordinary conditions, particularly when double occupancy is required, it may operate two shifts, with half the crew on daytime and half on nighttime cycles.

The following illustration shows a typical stateroom configured for single occupancy nighttime use, including: visiwall keyed for open-air peaceful nighttime vistas (some organics prefer enclosed areas for a greater sense of security); and grav bed with physical pillows and coverlets (many organics prefer a visible support to mid-air suspension. Genotypes will vary).

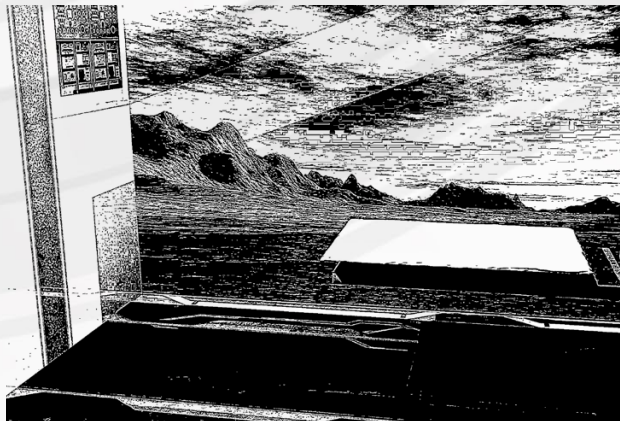

Docking / Landing Bay

The ship incorporates twin docking / landing bays, with field energy screens operating as universal docking interfaces with larger vessels. Each bay is large enough for a single *Icarus*-class scout to land; the *Magnanimous Intervention* instead has two Hydrodyne grav ATVs (*Mindjammer* page 253). Each bay can also be reconfigured for live sample ("ark") storage.

The following illustration shows the Magnanimous Intervention's starboard docking bay with a Hydrodyne grav ATV prepping for departure. Gangways on the inner boom bulkhead provide access to the sensor arrays. Note the holographic roundel located midway on the bay screen door, indicating it is currently closed. Blast doors are not shown.

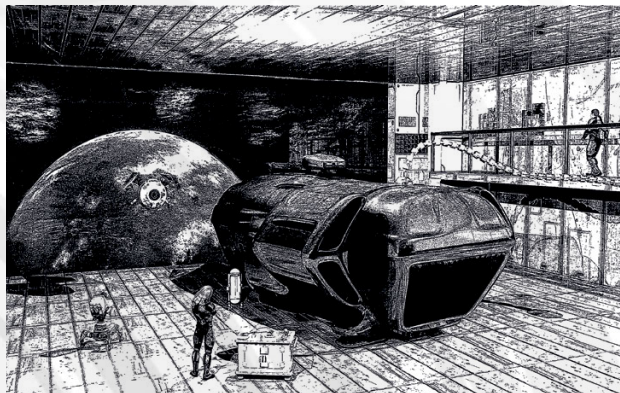

Engineering

Engineering includes lower, secondary, and control sections, as well as access to the planing engine lattices distributed throughout the hull superstructure. The chief engineer and his four assistants are responsible for these sections, including the large ZIP power plant and the relatively modest gravity engines located in the aft hub and booms. Secondary engineering contains the x-core secondary power plant, increasing the vessel's jump maximum.

The following illustration shows lower (main) engineering, including the primary ZIP plant and capacitor arrays, and the access space configured for physical control stations.

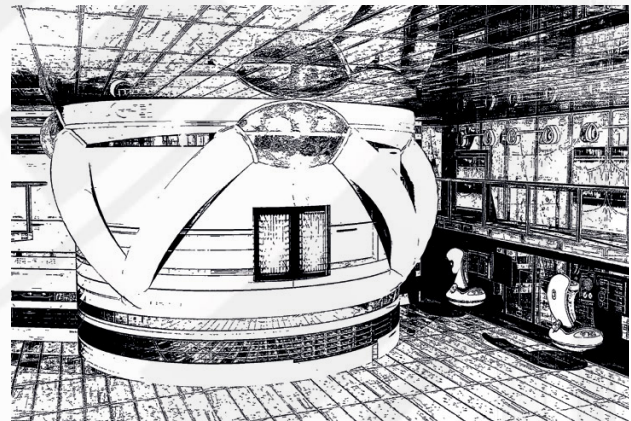

Engineering EVA

Upper engineering also incorporates facilities for engineering EVA access to the exterior hull surfaces of the ship's drives, including EVA harnesses, hazard suits, and effector field arrays.

Field

Many Commonality vessels utilise field technology to provide pressurised environments on outer ship hulls and even (as with the *Botany Bay*-class) complete field environments extended beyond the hull. Field surfaces are frequently painted with holographic displays to replicate planetary or interior environments, and are used for crew assembly or activity when virtual environments are deemed insufficient or inappropriate. This may include recreation and assembly when not planing, as well as quarantine, impromptu life form storage, and larger-scale docking / landing operations.

The following illustration shows the active field configured for shuttle landing and departure, showing opaque ceiling and floor fields with line guides and semi-opaque bay screen doors. Field projectors (above and below floor and ceiling fields) are not shown.

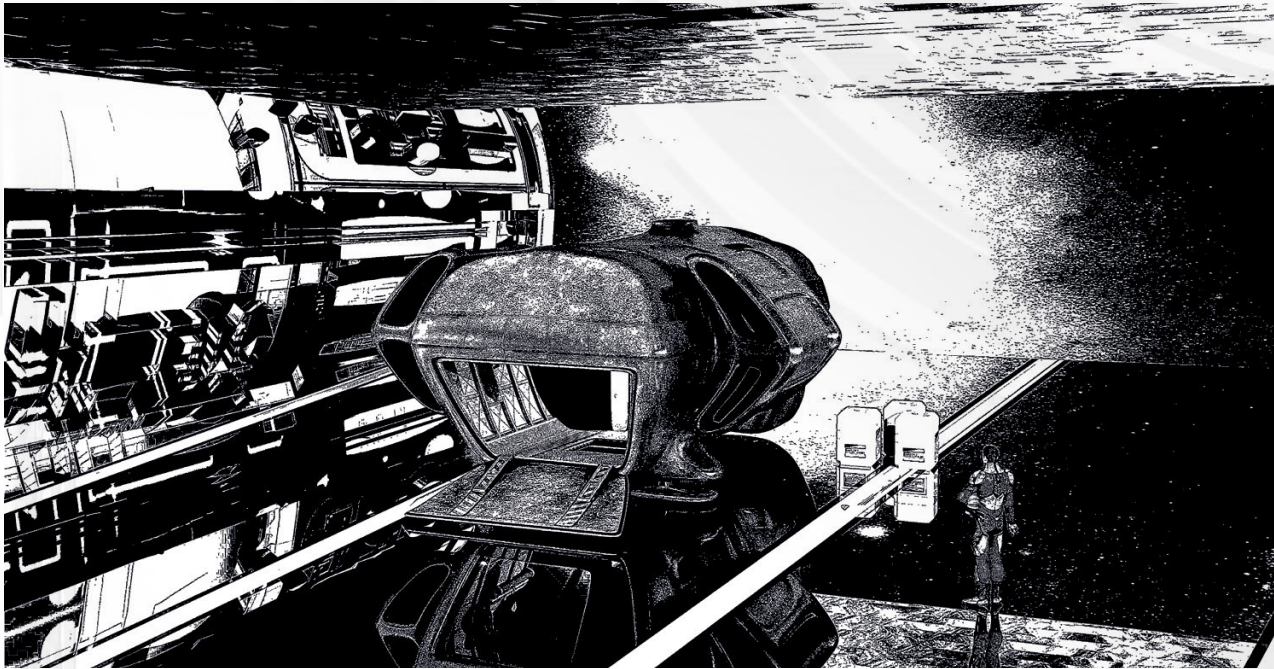

Hangar

Twin ship hangars sit directly aft of the docking / landing bays, used for small craft storage and maintenance. Normally each contains a Hydrodyne grav ATV and 5 survey drones; if an *Icarus*-class scout is hangared, the other hangar will contain all 10 survey drones. Like the docking / landing bays, hangars can be repurposed for ark storage.

Hydroponics

Ambient flora are distributed throughout the ship; in these sections, plant life is cultivated intensively, principally as a leisure activity, sometimes supplementing makepoint rations and air supply as part of the ship's extended life support capacity.

Labs

The ship provides laboratories for all major branches of exploratory science, including: planetology; astrophysics; geophysics; biology; archaeology; and genurgy. Each lab has at least one scientist and one assistant.

Life Support

Life support facilities are more robust than usual because of the ship's extended life support capability. These sections include stores, backup processing units, and direct makepoint hook-ups.

Lounges

Under normal operations crew have ample free time, and lounges are provided for relaxation, carousing, and social events.

Medical

On the *Magnanimous Intervention*, the ship's sentience, Maggie, acts as ship's doctor (often via her avatar). She's based here, together with two assistants, an autodoc, and other medical facilities.

Null Cannons

The ship is armed with twin null cannon (beam lasers) which sit in variform turrets to either side of the hub, providing an omnidirectional field of fire. They're usually controlled from the bridge, although each turret also has a secondary fire control station and Mindscape overrides.

Pilot's Ready Room

Personal lounges are provided for the 2-pilot and assistants, both for relaxation and therapy sessions with the ship sentience.

Recreation

On extended missions recreation for the crew is a vital priority. These variform recreation areas also comprise full holo and virtual environment support, and host regular team-based and individual recreation activities.

SCI Force Bureau

As a concession to the importance of the SCI Force component of the Beta Formiae expedition, a SCI Force bureau has been set up adjacent to the bridge mezzanine. It has a quiet, investigative air, and is left alone by Space Force personnel, including the ship sentience.

Security Station

The duty station for the ship's five-person security team includes a weapons locker, armour and force field storage, and rosters for away team security details.

Ship's Brain

The core corpus is the genurgic hub where the semi-organic ship's brain hooks into all ship systems. It's secure and well-protected, but can be accessed by crewmembers at a pinch. It sits centrally within the hub, between the bridge and main engineering.

Stores

Unused space within the ship is usually left for storage of personal effects, supplies, samples, and so on. It can be repurposed as required.

The Event Horizon Probe

Path of Luminosity RM9712 is a standard event horizon probe and a member of the Space Force scout branch. A variform stage 1 explorer, it's Medium (+0) scale, comprising a Medium (+0) return unit (usually called Luminosity Alpha) and a Small (-1) planetsider unit (called Luminosity Beta). The Alpha unit is part of the Magnanimous Intervention crew; the Beta unit remained behind on Beta Formiae 2 and is currently missing in action (page 50).

The planetsider, just under a metre across, is equipped with variform manipulators and a sensor array, able to operate as a seed node or zero node (**Mindjammer** page 351). Combining with the return unit, the two form a Unity Configuration approximately 2 metres in diameter.



Space Force

"VIS PER SPATIA"—STRENGTH THROUGHOUT SPACE

The Space Force instrumentality today is in a state of flux. It maintains close contacts with the Ministry of Movement of which it was originally a part, but also has "difficult" relationships with both SCI Force and the Ministry of War and Defence, with which its missions often cause it to come into conflict.

During the First Commonality and early years of Expansion, Space Force was a civilian exploration and transportation agency. It became militarised during and after the Venu War.

THE BUREAUS

Space Force comprises four "bureaus", tasked with different areas of activity in Commonality Space and particularly its frontier regions. Each is organised into "fleets"—groupings of Space Force vessels. Space Force operations frequently involve mixed fleets of vessels from more than one bureau.

Exploration (SFX)

The Exploration Bureau is responsible for expanding the Commonality frontier, exploring new star systems, identifying habitable worlds, and rediscovering lost colonies. The event horizon probes (page 25) are members of this bureau, as are the stage 2 explorers.

Transportation (SFT)

One of Space Force's main responsibilities has always been the transport of Commonality citizens between worlds and the movement of vital products like make-points and makepoint factories. Although corporacies have taken up much of this activity, particularly on the Fringe, Space Force remains a significant player, with a virtual monopoly in the Core Worlds.

Intelligence (SFI)

Space Force has a huge intelligence bureau, which frequently conflicts with SCI Force. It gathers intel from contacted worlds, often upsetting SCI Force plans; where SFI wants the information for its own sake, SCI Force are more

concerned about cultural issues and threats, to which the intel's intrinsic value is secondary. Local SFI heads are often synthetics, with classes and designs exclusive to Space Force.

Warfare (BOW)

Officially called the Bureau of Space Warfare, but generally referred to as the Warfare Bureau or sometimes just BOW (the Bureau of War), this is the new kid on the block within Space Force, created only seventy years ago during the Venu War and still large, ungainly, and swaggering. Its mandates are: to protect and defend Commonality star systems and the citizens that move between them; to attack and neutralise identified threats; and to conduct research and development efforts to improve its capabilities. The **BOW mediators** are famed throughout Commonality Space.

BRANCHES

Branches group skill sets and the individuals and training structures associated with them. Loosely put, they are "occupations", each of which can belong to multiple bureaus. In theory individuals trained in a specific branch may be transferred easily between bureaus, but in practice most people tend to choose a bureau and stick with it.

Administrators

Commonality government loves administrators, and Space Force is no exception. The Administrator branch is responsible for keeping the instrumentality functioning from day to day, and for managing relations with other parts of the Commonality bureaucracy. See **Mindjammer** page 52.

Archaeology

Scientists responsible for detecting and identifying lost colonies and determining what happened to them. See **Mindjammer** page 55.

Continued on the next page...

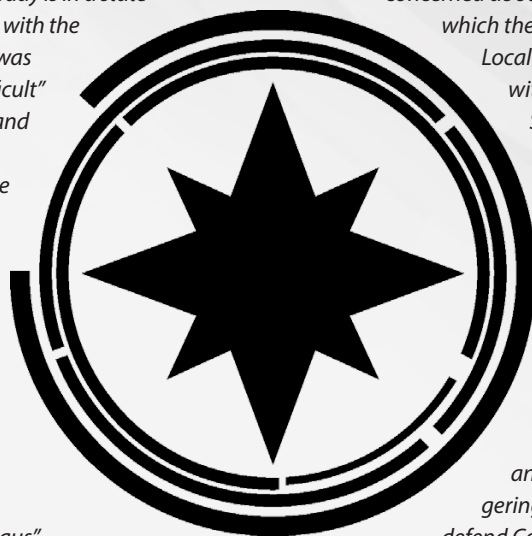

Technical Support

The tech support station is manned by the chief technical officer and his four assistants, responsible for the continued smooth running of ship systems.

Workshops

The ship's enhanced makepoint facilities provide not only life support and supplies, but also replacement and spare parts and primary materials to keep the ship operating for extended periods away from depots or starbases.

THE CREW

The crew of the *Magnanimous Intervention* is a microcosm of Commonality society—multi-genotype, multi-gendered, multi-skilled. About 40% are synthetics. It's a typical Space Force crew, with a heritage in civilian space exploration overlaid with a relatively recent semi-military discipline. It's still touchy-feely, although operational procedures have been toughened up by repeated contact with the Venu.

The table below represents a minimal crew roster for the expedition, including high concept aspects as appropriate. Pregenerated stat blocks are also provided for

...continued from the previous page.

Engineers

*Space Force is dependent on the functioning of thousands of ships, constructs, space stations, and synthetics—often under challenging conditions. Engineers are found on any Space Force vessel of significant size, and Space Force depots throughout Commonality Space have teams maintaining, repairing, and constructing ships. See **Mindjammer** page 61.*

Marines

*Ship's troops responsible for boarding actions, away team security, planetside security operations, and so on. See **Mindjammer** page 59.*

Mediators

*In the "flat" hierarchies of Space Force fleets, mediators are ship sentiences which act as advisors, arbiters, and information relay hubs for other ships. They are most often associated with the Warfare Bureau, but in principle can be found anywhere. See **Mindjammer** page 56.*

Meditechs

*Responsible for medical treatment aboard Space Force vessels, but also for biosecurity on missions. See **Mindjammer** page 61.*

Pilots

*Space Force trains both 2-pilots and n-pilots; on smaller vessels individuals may assume both roles. As instinct, empathy, and reflexes are as important to pilots as technical know-how, Space Force actively recruits new pilots on rediscovered worlds using the **Fringe Pilot Programme**. See **Mindjammer** page 65.*

The Fringe Pilot Programme

A training and recruitment effort across the Commonality Fringe. Its purpose is to identify natural pilots and offer them a career within Space Force. Liaison officers in starports constantly scout local talent to refer candidates.

Scouts

*Perhaps with the greatest proportion of mechanical synthetics of any Space Force branch, scouts conduct preliminary surveys and explorations, transport and courier duties, reconnaissance, and regular diplomatic and surveillance visits to outlying systems. Event horizon probes are generally scouts. See **Mindjammer** page 56.*

SPACE FORCE HUBS AND DEPOTS

*Within Commonality Space, Space Force maintains depots in most octants for service, repair, and upkeep of vessels and personnel, usually major facilities complementing the system's starport. There is also at least one **Space Force hub** in every sector (sometimes more), occupying an entire star system.*

SPACE FORCE ACADEMIES

There's usually a Space Force academy in every subsector, with local centres on octant capitals running part-time courses and outreach activities for the recruitment and training of new and existing Space Force personnel. Every C-class starport or better also has a Space Force liaison officer.

selected crew members beginning on page 29. GMs and players are encouraged to customise the roster as desired.

PREGENERATED CHARACTERS

This section provides statistics for several key members of the *Magnanimous Intervention* crew (including the ship itself), for use as pregenerated player characters or major NPCs.

Table 3 – Magnanimous Intervention Crew Roster (50 Personnel)

Department	Personnel
Command Staff (3)	Captain CORNELIUS CHANG: <i>Heroic Space Force Captain</i> (page 30). First Officer HAL WEYN: <i>High-G Muscle and a Mind to Match</i> . Morale Officer IMBATLOK: <i>Spindly Native of the Javawayn Star Cities</i> (page 34).
Bridge Staff (4)	Comms Officer CYNASIA: <i>Silver Forked Tongue</i> . Science Officer KORMUS BLYNE: <i>This Isn't Logic, This Is Science!</i> Tactical Officer TARGET: <i>A View to a Kill</i> .
Flight Crew (3)	2-Pilot MAYAMEER K'SOO: <i>Feline Xenomorph Natural 2-Pilot</i> (page 32). 2 assistant pilots Event Horizon Probe PATH OF LUMINOSITY RM9712-alpha ("Returner"): <i>Intrigued By the Possibilities of Beta Formiae</i> (page 25). Event Horizon Probe PATH OF LUMINOSITY RM9712-beta ("Planetsider"): <i>Blind Trust in the Alpha Unit</i> (page 25).
Engineering (5)	Chief Engineer MIZMILLAR: <i>Neo-Assyrian Anunnaki Nanoform</i> . 4 engineering assistants: <i>Integrate Communal Grouping</i> .
Technical Support (5)	Chief Technical Officer LONGWO: <i>Nwashan Xenomorph Grease Monkey</i> . 4 technical assistants
Logistics (5)	Chief Logistics Officer STOREJACK: <i>Grav Mech Hoarder</i> . 4 logistics assistants
Medical (3)	Chief Meditech MAGGIE: <i>Exotic Transhuman Intelligence</i> . 2 assistant meditechs, including Assistant Meditech WYNDHAM FORGETTY: <i>Manhome Autotroph Bred to Please</i> .
Security (5)	Chief Security Officer LANDER: <i>Lethal Mech Marine Commander</i> (page 29). 4 security assistants, including CHECKER (<i>Bullet Magnet</i>) and IRINA RIMBAUD (Ex-CORESEC; <i>Don't Worry, It'll Stop Bleeding</i>).
Research Staff (12)	Planetologist BEHOLDER i-NINER-NINER: <i>Orbital Sensor Drone</i> . Astrophysicist CANALLA DELKA-LATER: <i>Hydragand Wanderlust</i> . Geologist VORZINE HARPER-HANDRA: <i>Committed to the Core</i> . Xenobiologist TOTMIS VAR1781: <i>Variform synthetic; Fascinated With Biological Life</i> . Archaeologist LEEHA SOKOLOV: <i>Dammit But There's So Much to Look At!</i> Genurgist BELEGAKWA: <i>Chembu Corporacy Can Fix It All!</i> 6 assistants, including Assistant Genurgist KWAY: <i>First Time Away From the Planetary Intelligence</i> .
SCI Force Evaluation Team (~5)	SCI Force Controller YUSOL MENARD: <i>Many-Bodied SCI Force Controller With a Single Mind</i> . ~4 assistants, including General TITO "HAMMER" KARHOON: <i>The Hammer That Knocks the Nail In</i> .



LANDER, COMMANDER OF THE SPACE FORCE MARINES

A Commonality mechanical who first saw service in the Stop-Start War, Lander has been in the Space Force marine branch since instantiation, and has served aboard the Magnanimous Intervention for most of his existence. He feels protective of her crew, and has saved the lives of some of them several times.

Physical Stress: □²□³□⁴ **Mental Stress:** □²□³□

Consequences: 3

Scale: Medium (+0)

Refresh: 2

ASPECTS

High Concept: Lethal Mech Marine Commander.

Trouble: First In!

Other Aspects: On the Side of Civilisation, I Have a Number of Big Weapons, Maggie and I Go Way Back, I Watch Everyone's Back.

SKILLS

Great (+4): Physique, Ranged Combat

Good (+3): Drive, Notice, Provoke

Fair (+2): Athletics, Pilot, Knowledge, Unarmed Combat

Average (+1): Melee Combat, Rapport, Stealth, Technical, Will

STUNTS

◆ **Coolness Under Fire:** Use Ranged Combat to defend against ranged physical attacks.

◆ **Take the Blow:** Use Physique to defend against bashes with Unarmed or Melee Combat.

◆ **Tough As Nails:** 1/session, pay a fate point to reduce moderate physical consequence to mild, or erase a mild.

HALO

★ **Mindscape Instance:** Enables technopsi and local Mindscape connectivity.

OTHER EXTRAS

★ **Armoured Hull:** Armour:2.

★ **Away Team:** Average (+1) Active Sensing, Passive Sensing, Ranged Combat.

★ **Blaster Rifle:** Weapon:3 damage bonus, range 3, Full Auto, automatic blaster advantages on success.

★ **Quadruple Built-In Blasters:** 3 x Average (+1) Ranged Combat; provides +3 Ranged Combat attack bonus, may split attack total against up to 4 targets.

Major NPC

CORNELIUS CHANG, THE SPACE FORCE CAPTAIN

A Space Force captain in the heroic mould, handsome, charismatic, and action-oriented. He's honest, open, and honourable. He sprang heroically to the rescue when Mayameer K'Soo looked doomed at the hands of the Assassins of Borgo; on the verge of getting romantically involved with the fickle feline, he has feelings for her still. After the Xeno Wars, Chang's first planeship command was the newly outfitted Magnanimous Intervention, exploring a failing colony on the edge of the Sentient Alliance. In uncovering its terrible secret, Chang joined forces with SCI Force, and had his first close encounter with the Venu.

Physical Stress: □ □ □ **Mental Stress:** □ □ □ □

Consequences: 3

Scale: Medium (+0)

Refresh: 2

ASPECTS

High Concept: Heroic Space Force Captain.

Trouble: Prefers Clarity and Frankness to Subterfuge and Deception.

Other Aspects: Always Willing to Try Something New, Watch Your Back When SCI Force Are Around, I Hate Venu! Don't Talk to Me About Cats!

SKILLS

Superb (+5): Empathy, Rapport

Great (+4): Provoke, Will

Good (+3): Deceive, Pilot, Ranged Combat, Resources

Fair (+2): Bureaucracy, Contacts, Knowledge, Notice, Unarmed Combat

Average (+1): Athletics, Investigate, Physique, Science, Technical

STUNTS

✦ **Cool Customer:** +2 Deceive bonus when bluffing.

✦ **Gunnery:** Use Ranged Combat for construct actions.

✦ **Indomitable:** +2 Will bonus to defend against Provoke fear and intimidation attacks.

✦ **Okay, Fine!** Use Provoke instead of Empathy to learn aspects.

✦ **Overseer:** 1/scene, make an overcome action to generate a pool of shift points you can redistribute.

HALO

★ **The Magnanimous Intervention:** Fair (+2) Active Sensing; Average (+1) Passive Sensing, Ranged Combat.

★ **Mindscape Implant:** Enables technopsi and Mindscape connectivity.

OTHER EXTRAS

★ **Biomed Array:** Fair (+2) Technical skill for overcoming mild consequence recovery obstacles.

★ **Omnipax Stun Pistol:** +0 Ranged Combat attack bonus, range 2, causes mental stress damage.

★ **Space Force P-Suit:** Armour: 1 damage reduction, +1 defence bonus; Vac Sealed.

MAGGIE, THE SHIP SENTIENCE

Maggie is the ship sentience of the Magnanimous Intervention. She's 130 years old, and was instantiated just before the Venu War; she's seen a great deal of action along the ever-advancing frontier. She was rescued by 2-pilot Mayameer K'Soo during a failed spy mission against the Venu in the Sentient Alliance, since when the two have been inseparable, sharing an often torrid romantic relationship.

Physical Stress: □²□ **Systems Stress:** □²□³□⁴

Mental Stress: □²□³□

Consequences: 3

Scale: Huge (+2)

Tech Index: T9

Refresh: 2

ASPECTS

High Concept: Exotic Transhuman Intelligence.

Trouble: SCI Force Sympathies for Yusol Menard.

Other Aspects: A Light for the Many Worlds of Space, The Face That Loved a Thousand Ships, Fascinated by Humans, Unfathomable Love for Mayameer K'Soo.

SKILLS

Superb (+5): Technical

Great (+4): Empathy, Planing

Good (+3): Active Sensing, Rapport, Systems

Fair (+2): Contacts, Knowledge, Passive Sensing, Science

Average (+1): Manoeuvrability, Ranged Combat, Resources, Stealth, Will

STUNTS

◆ **Docking Bay:** 1 Large (+1) construct, 10 Medium (+0) constructs, etc.

◆ **Extended Manoeuvrability (Atmospheric):** Use Manoeuvre in atmospheric actions.

◆ **Meditech:** +2 Technical bonus for overcome actions to treat physical consequences.

HALO

★ **Avatar:** Fair (+2) Athletics; Average (+1) Ranged Combat, Unarmed Combat.

★ **Remote Sensor Package:** Use Passive Sensing via avatar as Notice skill for character actions. Provides avatar.

★ **Special Ops Mindscape Instance:** Special ops technopsi and Mindscape connectivity.

★ **System Survey Drones:** Average (+1) Active Sensing, Passive Sensing.

OTHER EXTRAS

★ **Autodoc:** Gain the Meditech stunt; use Technical for all recovery actions.

★ **Away Team:** Use selected construct abilities on planetary surfaces, etc, via appropriate away team member.

★ **Makepoint:** Produce basic materials and small items of equipment.

★ **Makepoint Workshop:** Produce spares and repairs without a Commonality shipyard.

★ **X-Core:** Doubles jump maximum.

MAYAMEER K'SOO, THE 2-PILOT

Mayameer K'Soo, 2-pilot and n-pilot of the *Magnanimous Intervention*, is a feline xenomorph. With +3 *Genotype Divergence*, she's totally humanoid and very human-looking, although she has slanted, catlike eyes and a "feline" facial structure. She has slightly pointed but otherwise human ears, no whiskers, and a human mouth with delicate teeth and prominent canines. Her skin is hairless, although her head has a gorgeous mane of black and white hair. She has no tail, claws, or dew-claw—her feline origins betray themselves more in her personality than appearance.

Raised in the *Space Force Fringe Pilot Programme* (page 27), K'Soo saw action in the closing battles of the *Xeno Wars*, particularly against the *Assassins of Borgo*, where she was saved by Cornelius Chang. She met the *Magnanimous Intervention* on a mission to rescue the kidnapped and disabled ship, and has had a passionate

(if somewhat feline...) affair with the ship ever since. Her natural curiosity nearly got her killed in a tense game of bluff and deception against the *Venu* with Cornelius Chang.

Physical Stress: □ □ □ **Mental Stress:** □ □ □ □ □

Consequences: 3

Scale: Medium (+0)

Refresh: 3

ASPECTS

High Concept: Feline Xenomorph (GD+3) Natural 2-Pilot.

Trouble: Irresistible Curiosity.

Other Aspects: Good As You, Sublimated Predator Instinct, Unfathomable Friendship With the *Magnanimous Intervention*, Sensuous Movements.

SKILLS

Great (+4): Pilot

Good (+3): Technical, Will

Fair (+2): Empathy, Notice, Ranged Combat

Average (+1): Athletics, Deceit, Stealth, Unarmed Combat

STUNTS

✦ **Gunnery:** Use Ranged Combat for starship actions.

✦ **Hyper-Reflexes:** +2 bonus to quick reactions, initiative, dodging.

✦ **Starship Pilot:** Use Pilot for starship actions.

✦ **Starship Therapy:** Use Empathy to treat mental stress and consequences incurred by sentient starships.

HALO

★ **Mindscape Implant:** Technopsi and Mindscape connectivity.

★ **Starship Pilot Skill Chip:** +1 bonus to Pilot skill checks.

OTHER EXTRAS

★ **Away Team:** Average (+1) Investigate, Science.

★ **Biomed Array:** Fair (+2) Technical skill for overcoming mild consequence recovery obstacles.

★ **Null-Pistol:** +0 Ranged Combat attack bonus; range 3.

★ **Space Force P-Suit:** Armour: 1 damage reduction, +1 defence bonus; Vac Sealed.



YUSOL MENARD, THE SCI-FORCE CONTROLLER

Yusol Menard is a SCI Force controller, and head of the evaluation team seconded to the Space Force expedition to Beta Formiae. It's also a multiple, a single person with several physical bodies. Yusol was born 150 years ago as part of the sexually neuter Nootrope caste on Old Earth, the byzantine class of Commonality administrators. Later it chose multiple status, gradually adding another neutral nootrope body and a male and female human body to its multiplicity.

Some time ago something terrible happened. The original Yusol Menard died, under mysterious and possibly suspicious circumstances. Rather than reporting this, the Yusol Menard multiplicity has continued regardless, taking missions further and further out on the Commonality Frontier, all the while their neuter Nootrope member claiming to be the original Yusol, yet convinced it's going to be found out. So far no one has worked out the truth—whatever that truth is.

Physical Stress: □²□³ **Mental Stress:** □²□³□⁴

Consequences: 3 / 3 / 3

Scale: Medium (+0)

Refresh: 3

ASPECTS

High Concept: Many-Bodied SCI Force Controller With a Single Mind.

Trouble: They'll Think I'm Not a Real Person!

Other Aspects: Humankind Is Transcending, Old and Weird Former Old Earth Nootrope, The Secret Fourth Body of Yusol Menard, Hammer Karhoon Owes Me His Life!

SKILLS

Superb (+5): Technical

Great (+4): Intrusion, Will

Good (+3): Deceive, Provoke, Rapport

Fair (+2): Bureaucracy, Knowledge, Ranged Combat, Stealth

Average (+1): Investigate, Notice, Physique, Resources, Science

STUNTS

◆ **Memetic Engineer:** Use Technical to take culture actions; you also have a culture extra.

◆ **Mindburn:** Use Will for mental attacks using the Mindscape.

◆ **Peripheral Awareness:** +1 Notice bonus on overcome and create an advantage actions for each additional Multiplicity body you can bring to bear.

HALO

★ **Multiplicity:** Male body, 3 physical consequences.

★ **Multiplicity:** Female body, 3 physical consequences.

★ **Personal Sensor Array:** Fair (+2) Investigate, Notice, for sensorview actions.

★ **Special Ops Mindscape Implant:** Special ops technopsi and Mindscape connectivity.

OTHER EXTRAS

★ **Biomed Array:** Fair (+2) Technical skill for overcoming mild consequence recovery obstacles.

★ **Commonality Culture:** Average (+1) Assimilate, Provoke.

★ **Extended Lifespan:** +100 years and 5 skill points, plus longevity aspect.

★ **Nanocells:** Control Mindscape-enabled devices via physical contact without Mindscape connectivity.

★ **P-Suit:** Armour:1 damage reduction, +1 defence bonus; Vac Sealed.

IMBATLOK, THE COMMONALITY MORALE OFFICER

Scion of the Batl'A management clan on the I'Shu-Shai ("Thousand Points of Light") Javawayn STL star city currently passing through Sentient Alliance space, Imbatlok grew up steeped in Javawayn history and traditions. From his earliest days he was accustomed to observing the Commonality from without—being "in" the Commonality, but not "of" it.

During the Xeno Wars, contacts Imbatlok had made within Space Force approached him with an offer of employment—to be a Space Force morale officer in the stricken xenomorph worlds. With a command position on offer, he agreed.

Imbatlok is effective and respected, if not widely liked. On the trail of clandestine Venu activity in the Sentient Alliance, he had the Magnanimous Intervention and Cornelius Chang do his dirty work. Finding how easy it was, he's done it again and again, in spite of the friction it causes.

Physical Stress: ☐☐ **Mental Stress:** ☐☐☐☐

Consequences: 3

Scale: Medium (+0)

Refresh: 2

ASPECTS

High Concept: Spindly Native of the Star Cities.

Trouble: The Urge to Manipulate.

Other Aspects: Takes to Zero-G Like a Duck to Water, Dispassionate Observer, Javawayn Grav Harness, Maggie and Chang Do My Dirty Work.

SKILLS

Superb (+5): Investigate

Great (+4): Deceive, Will

Good (+3): Empathy, Notice, Provoke

Fair (+2): Bureaucracy, Contacts, Rapport, Resources

Average (+1): Athletics, Knowledge, Ranged Combat, Science, Stealth

STUNTS

◆ **Armour of Fear:** Use Provoke to defend vs Melee and Unarmed Combat until damaged.

◆ **Eye for Detail:** For a fate point, make a Notice / Investigate roll to "look over" a place you've already left.

◆ **Lie to Me:** Use Investigate instead of Empathy to defend against Deceive.

◆ **Lie Whisperer:** +2 Empathy bonus to detect lies.

◆ **Mind Games:** Use Deceive to make mental attack actions.

◆ **Probe:** +2 create an advantage Will bonus to discern surface thoughts.

◆ **Truth Scan:** Use Investigate via technopsi to determine if a Mindscape-linked target is lying.

HALO

★ **Personal Sensor Array:** Fair (+2) Investigate and Notice skills for sensorview actions.

★ **Special Ops Mindscape Implant:** Special ops technopsi and Mindscape connectivity.

OTHER EXTRAS

★ **Hand Scanner:** Average (+1) Knowledge, Science.

★ **P-Suit:** Armour: 1 damage reduction, +1 defence bonus; Vac Sealed.

★ **Stun Pistol:** +0 Ranged Combat attack bonus, range 1, causes mental stress damage.

STARTING PLAY

"I don't care how you do it—stay down there until you find us an answer. And stay safe! All hell's breaking loose up here, and I don't know if we can lock it down. You may just be the only chance we have to get out of here alive!"

— SCI Force controller Yusol Menard (multiple),
thoughtcasting to its neuter self in the Beta Formiae away team

You can begin *The City People* where you like—from the initial return of *Luminosity Alpha* to Commonality Space and Space Force's decision to mount the expedition, to the moment the first away team sets foot on the planet. The episodes and scenes below assume play begins when the ship first arrives in the Beta Formiae system.

WHO ARE THE PCS?

Although this is a joint Space Force / SCI Force mission, there are a number of options for playing characters.

Space Force

Space Force is the obvious organisation for PCs to belong to. Pilots, marines, engineers, scientists, and more make great Space Force characters, disciplined crew members accustomed to working in a clear professional hierarchy.

SCI Force

The SCI Force contingent numbers some half a dozen individuals under controller Yusol Menard or another similar character. Typical of SCI Force, it's a motley team of misfits and renegades recruited from all walks of life, with a penchant for breaking rules and getting things done in a ruthlessly effective manner. They don't get on at all well with Space Force.

AFI

The Armed Forces Instrumentality could easily have a contingent aboard the *Magnanimous Intervention*—a commando or even HiTAT squad providing high-powered support for any military action.

Scientists

There are scientists within the Space Force crew, but that doesn't mean outsiders can't also be part of the expedition. Chembu Genurgy may send a team, or other corporacies or even the local pansectorate. A scientist-based adventure emphasises investigation, problem solving, and resisting the Beta Formiae threat over firepower.

Others

Other characters may be aboard the *Magnanimous Intervention*—diplomats, members of CORESEC, representatives of other cultures or genotypes. You can even discard the whole mission premise, and play the adventure with a different group of PCs, perhaps happening upon the Beta Formiae system by accident. Perhaps a New Trader ship has mis-jumped, or been redirected by a sinister corporacy to follow up a distress beacon left by a previous expedition...

PLAYING THE CREW

The City People is intended to feel claustrophobic. The crew, for this adventure, might as well be the whole universe;

A Different World— Things Visitors Notice

While Beta Formiae is a fairly Earth-like world, there are some things which will remind the PCs (and players) that they're in an alien environment.

- *The day is slightly longer—29 hours, just long enough to feel time drag.*
- *The slightly higher gravity (1.14G) means everything, from walking to picking things up, feels a little more tiring.*
- *The world is cooler and drier. The PCs will get dry throats, chapped skin, and so on.*
- *Large swathes of the surface are barren—dry, friable earth stripped of plant life, where the wind whips up dust devils and impressive storms.*
- *There are no insects. Instead, weird fleshy “squishies” like Colorado Beetle larvae creep, crawl, flap clumsily through the air, and get squashed everywhere.*
- *Everything is filtered through the **contact protocols** (page 42). Away teams use p-suits and force helmets to protect themselves from the environment, configurable to exclude everything but generally set to allow through temperature, air pressure, humidity, and even smells—albeit filtered and reduced.*

they're all that's available. They're a microcosm of the Commonality, but they're also limited in number. They may start with 50 or so members, but once things start going south and people start dying, the players should start to feel like they may run out of bodies.

All crew members have p-suits, access to PSAs, sensoria, direct perception feeds, and so on, meaning players can easily share data and even live feeds of actions with the crew, relay their away team experiences back to the ship, or even play command staff vicariously experiencing the same feeds from the bridge. You can use the crew to replace lost PCs, or allow players to take temporary control of other crew members as characters.

Away Teams

The PCs are in contact with fellow crew members skilled in a wide range of technical tasks. This is a different set-up from many scenarios, where PCs are frequently thrown back on their own resources to solve problems, using only their

own skills and the equipment they're carrying. While such situations may arise in this adventure, the default assumption is that the PCs will be working with (and maybe leading) teams of varying sizes—the full crew, if they're on the ship, or perhaps away teams of half a dozen to a dozen individuals if they're on planet or elsewhere off the ship.

Away teams in **Mindjammer** are a form of extra. For a sentient starship, an away team represents a way for it to use certain of its skills remotely. For other characters, an away team lets them use certain ship's skills, represented by crew members accompanying them on missions.

Here's how those two approaches work in rules terms.

NEW CONSTRUCT EXTRA: AWAY TEAM

Costs 1 stunt

An Away Team extra lets a construct like a sentient starship send a disciplined subset of its own crew off-ship (usually onto another ship or a planetary surface) on a mission. The construct may interact remotely with other characters under limited circumstances (see **Mindjammer** page 104). An Away Team extra automatically has its own stress tracks and 3 consequences.

A ship can use its own skills on another ship or planetary surface via an Away Team. Scale effects apply as usual if the construct attempts to affect another character directly, unless the construct also has an appropriate stunt or extra, such as “Science Officer”, or a specific extra skill. For example, a construct could make Passive Sensing rolls via an away team to scan the local environment (representing the ship interacting with its away team, using PSAs and hand scanners with orbital support, and so on); but in order to spot an NPC reaching for a weapon, it would be necessary for the away team extra to have the Notice skill as an extra skill (representing an observant member of the crew on the team).

AWAY TEAMS AND PCS

If the ship is an NPC, or if other non-construct PCs wish to take advantage of a ship's away team, then those PCs should take the ship and / or its away team as a shared extra (**Mindjammer** page 105). The extra doesn't have to include space operations skills or stunts, but should concentrate on the planet-oriented abilities the PCs want to use in the field: sensors, security teams, scientists, and so on. Most simply, PCs can take an *Away Team* aspect, enabling them to gain invoke bonuses when trying to use any of its abilities.

TRACKING AWAY TEAM CASUALTIES

Consequences to away team extras should generally compromise their effectiveness, representing crew casualties. For example, a security team operative may be killed in a conflict

when physical stress leads to an away team consequence. You can track this against the crew roster and use the consequence severity to determine whether the casualty is merely injured, or if they have been killed and can't be replaced on this mission.

Be ruthless: damage to away teams should have a significant cost, and players should be willing to take stress and consequences themselves to offset it.

Character and Crew Equipment

The crew of the *Magnanimous Intervention* has the best equipment available for the mission, and that includes the PCs. The leader of the marines may have a suit of assault armour; the chief medical officer may have an autodoc; and so on. Before starting play, let the PCs pick their gear and describe it in advance if they like, giving it extras abilities (skills, stunts, and aspects) as appropriate.

They don't have to describe everything. Remember, *Mindjammer* equipment isn't intended to exhaustively enumerate every last item of gear a character has in their possession, but rather to provide rules mechanics for those items the player considers important enough to a character's concept to warrant special attention. In particular, if a player doesn't think of an item during set-up, but instead comes up with an idea during play, and it seems perfectly reasonable, let them have that item as a situation aspect for a fate point. No character in *The City People* should be penalised for having insufficient gear; they're hyper-competent specialists with whatever they need.

That said, if players want to define their gear in ways which have clear rules effects beyond those of a situation aspect, and which require extras budget expenditure (say, if a player isn't content with their character having a *Sentient Null Rifle With Sniper Scopes* as an aspect, but also wants a *Weapon:4* rating and an *Autofire* weapon aspect), then they should pay the additional cost from their extras budget as usual. Remember: the way an item of equipment is statted on a character sheet doesn't define its abilities in descriptive, game world terms, but only its rules-mechanical functions in terms of the importance it plays in defining how that character, at his current level of advancement, can act.

Away Team Events

When the PCs participate in away team expeditions, whether using the grav ATV or on foot, you can include events and encounters at appropriate junctures. Use the terrain type descriptions on *Mindjammer* page 352 or the planetary hazards on page 353, or the Beta Formiae-specific events on **Table 4** overleaf. Events may be situation aspects, hazards, NPC or life form encounters, or a combination of all three.

Pick an event when you feel the situation merits one, or as the result of a success at a cost. Not all events need be

Fear and Horror

The formions and the threat of the Shapechanger Plague are instinctively horrifying to organic characters. Further, a lot of action takes place in the nightmarish conditions of the purity compounds—claustrophobic, stinking, with the constant threat of lethal attack.

Here are some ideas for handling that atmosphere of fear and horror in your game:

- **Growing realisation:** *The PCs gradually realise what the Formians are, and the existential threat they represent. Feel free to use these moments of realisation to create We're Never Going to Get Out of Here!-type situation aspects which may present obstacles or be compelled or invoked when the PCs try to cope with them.*
- **Sense of isolation:** *We recommend introducing a game aspect such as Isolated Far Beyond the Frontier for the duration of the adventure. Once lockdown happens (page 42), you can intensify this to Getting Picked Off One by One.*
- **Sacrifice:** *As good SCI Force or Space Force agents, the PCs—like the rest of the crew—are expected to sacrifice themselves to preserve quarantine. How do they feel about that when it actually starts to happen? You can compel character aspects which conflict with this expectation, and also play up the problems other crew members experience when everyone is expected to be noble. Will anyone panic? Can Rapport and Provoke rolls save the day?*

conflict-oriented, but those resulting from costly successes should at least pose some significant trouble.

EVENT NOTES

Ancient Crater: This may require a Fair (+2) Notice roll to detect. The PCs traverse a large manmade crater, several hundred metres across, possibly caused by a huge explosion such as an orbital bombardment. There may be ruins nearby, including **blasted areas** (page 48).

Biohazard: A concentration of formiont bacteria threatens to overcome the PCs' protective measures. Have each PC make an **observance roll** (page 42) to avoid exposure (page 13). The biohazard may be an aerosolised form of formiont colony, a microfine bacterial dust, or even a virulent organic acid which defeats vac seals.

Table 4: Beta Formiae Wilderness Events

4dF Roll	Grav Cruising	Woodland	Barrens	Mountains	At Sea	Ice Caps
-4	Biohazard	Biohazard	Biohazard	Biohazard	Biohazard	Biohazard
-3	Storm	Denuded Terrain	Desertification	Cold Snap	Squall	Distressed Biome
-2	Cold Snap	Storm	Storm	Flash Flood	Rough Seas	Storm
-1	Native Life Forms	Native Life Forms	Native Life Forms	Native Life Forms	Native Life Forms	Cold Snap
+0	Distressed Biome	Distressed Biome	Distressed Biome	Distressed Biome	Distressed Biome	Cold Snap
+1	Formians	Formians	Formians	Rockfall	Formians	Cold Snap
+2	Purity Compound	Purity Compound	Purity Compound	Formians	Rough Sea	Native Life Forms
+3	Ancient Crater	Ancient Crater	Ancient Crater	Purity Compound	Squall	Formians
+4	Ruins	Ruins	Ruins	Ancient Crater	Cold Snap	Purity Compound

Cold Snap: The PCs are affected by intense cold, and must roll to avoid an **exposure hazard** (*Mindjammer* page 177) every 1-3 hours, starting at Fair (+2) Intensity. The cold lasts for 4 successive rolls, and can only be avoided by leaving the area entirely, or seeking or making shelter.

Denuded Terrain: The papertree forests give way to a large open area where *Almost All Plant Life Has Been Stripped Away*. Spending any time here, or incurring a serious cost, may result in a Formian encounter.

Desertification: The biome has collapsed in the area, and the topsoil is a sandy dust. There's no water, and frequent quicksands (*Mindjammer* page 354).

Distressed Biome: The local biome is failing, with too much or too little water, heavy over-grazing, stripped and sickly plant life. There's little ground cover, and a significant number of Formians (see below) grazing the area.

Flash Flood: Lack of ground cover further upstream results in a flash flood in the immediate vicinity; water levels in a 2-zone radius quickly exceed waist height. Roll an Avoid Exposure hazard (*Mindjammer* page 177) every 5 minutes until you escape the vicinity.

Formians: The PCs encounter one or more Formians (page 15). See **Table 5: Formian Encounters** on page 39.

It's a Fair (+2) Investigation or Knowledge (Survival) roll to track a Formian back to a purity compound (see below).

Note that this may also be a good opportunity for a **fission** encounter (page 13).

Native Life Forms: In woodland or cliff / cave areas, the PCs are mobbed by 1 group of ragbats (page 9) per PC. In other areas, they encounter 1 Medium (+0) fleshbag (page 8) per combat-competent PC.

Purity Compound: The PCs happen upon a major Formian community, comprising 15-30 individuals (page 13). See page 53 for a typical purity compound.

Rock Fall: The PCs are affected by a rockfall or landslide (*Mindjammer* page 177) which may also create an obstacle to movement.

Rough Seas: The PCs find themselves in rough seas. If they're in a grav ATV already above the surface, they may avoid the adverse conditions; otherwise it's a Good (+3) contest hazard doing physical construct damage.

Ruins: Some 2250 to 3250 years old, these are remnants of the original colony. Although there are no colony pods (page 67) at these locations, there may be late T7 to early T8 non-perishable gear which may be **salvaged** (*Mindjammer* page 441).

Squall: The PCs are affected by a storm at sea; treat as a storm affecting their vehicle as well as the PCs.

Storm: The PCs are affected by a Great (+4) or higher Intensity violent electrical storm (*Mindjammer* page 354)

Table 5: Formian Encounters

4dF Roll	Formian Encounter
-4	A single tank (page 18).
-3	1 warrior per combat-competent PC (page 18).
-2	A single milk truck (page 19).
-1 to +1	1 group of packrats per PC (page 18).
+2	A single milk truck (page 19).
+3	1 warrior per combat-competent PC (page 18).
+4	2 dozers (page 17) creating a new purity compound.

with high winds and possibly torrential rain. It's at least Superb (+5) Magnitude, and lasts half a day to a few days.

GATHERING INTEL: WHAT'S GOING ON?

Much of *The City People* is about encountering a complex and mysterious situation, trying to understand it, and then dealing with the problems it poses. While there's a lot of action, the backbone of the adventure is investigative.

Depending on your players, you can feed information to them step by step if they prefer to occupy themselves mostly with action scenes, perhaps by having Captain Chang and the scientists on board the ship do the investigative work behind the scenes. Alternatively (and to be honest we assume you'll probably want to do this), you can incorporate some or all of these investigative activities into your game, letting PCs with technical and analytical skills shine just as much as those with combat, stealth, or action-oriented abilities.

Standard Analyses and Scans

It's important not to go overboard: use skill rolls to determine how well PCs perform scans and analyses and what conclusions they draw, but equally feel free to simply provide baseline information to PCs with appropriate skills and specialisations at appropriate moments, and only go to the dice if a player decides their character would like to go the extra mile on a particular topic of investigation, or if something interesting may happen if they fail.

Luminosity-Alpha's Sensorium Report

The Path of Luminosity event horizon probe did a preliminary survey of the Beta Formiae system and Beta Formiae 2 before losing its planetsider unit and returning to Commonality Space. You can use the return unit's initial report, and the planetsider's more detailed analyses, to convey information to the PCs without them having to dig it out themselves.

*We recommend you don't inform the PCs of the true nature of the Formians in this way, but you can certainly provide them with some or all of the planetary and system data on the Beta Formiae page on the inside front cover of this book as the event horizon probe's initial report to the Commonality, then perhaps information on the ecosystem (page 7) once the PCs retrieve the planetsider in **Episode One Scene Four: The Monolith**.*

Investigation is meant to be intriguing, and a lack of information doesn't help anyone. Information should be readily available, and the players should feel they're drawing their own conclusions and figuring out the nature of Beta Formiae for themselves. Most importantly, be sure not to reduce the fascinating and potentially lethal situation the PCs find themselves in to a mere series of dice rolls, but rather let the PCs' abilities provide more and clearer information which the players themselves can use to try and work out what's really going on.

Where appropriate, we've included analyses and scans as explicit actions in the scenes which follow. Feel free to embark upon any of these out of order, when the players think of them; or to gloss over some analyses in favour of others; or to let the players come up with their own analyses and even definitions of the protocols if they feel creative. Remember: their characters are the experts, and they should feel confident that what they decide to do will generally be the right thing. That said, don't fail to penalise them if they absolutely insist upon doing something dumb—even experts make mistakes!

ASSESSING DETAILS VS DECLARING DETAILS

Fate is geared towards letting players get creative with the setting, coming up with details, descriptions, histories, even entire life forms, objects, and worlds. This is an integral part of *Mindjammer*, and you shouldn't ignore it, especially if your players enjoy riffing off their successful (or failed!) skill rolls to come up with improvised coolness.

What If the PCs Don't Have a Skill?

Usually, if a PC doesn't have a skill above Mediocre (+0), it means their player isn't that interested in having that skill play a big role in his character's actions. Nevertheless, on a planetary exploration mission, characters may sometimes seek answers to questions requiring skills they don't possess; analysing genurgic traces, deciphering alien languages, and so on.

In all these cases, remember that the PCs have expert backup in the ship's crew. If the PCs have taken steps to gain access to the crew's abilities—perhaps using a shared Away Team or ship extra (page 36)—then let them make

rolls using those abilities. But if they don't have access to those abilities, assume that means the **players** aren't really interested in gaming through those information processing activities themselves, and instead simply assume "the crew" (ie NPCs) will take of that stuff for them.

In this case, resolve the PCs' queries in whatever way suits your story as GM. Answers may take time, the crew may come up against dead-ends, or they may provide full or partial information almost immediately. Above all, don't let the story grind to a halt just because a PC doesn't have a skill.

Attitudes Among the Crew

There are many opinions among the Magnanimous Intervention crew about their mission. Regardless of what the PCs think, crew members will adopt one of the following five broad attitudes. In extreme circumstances, the PCs may face opposition from their own crew.

- **Nuke them from orbit:** Lander and the marines and other "direct action" fans argue for this approach, as do crew members who fear (or perhaps truly appreciate) the formiont threat. Ultimately this approach may end up in favour of the Samson Protocol being invoked (page 73).
- **Quarantine:** Space Force purists such as Captain Chang and Mayameer K'Soo support this approach. It guarantees work for years to come.
- **Wade in and reengineer them:** The typical Chembu approach; it's risky, but there's a lot to be learned for the corporacy. Belegakwa and Kway support this approach.
- **Leave them as they are but try and establish a relationship with them:** This may well be the default SCI Force approach of the Yusol Menard multiple—probably also requiring Space Force cooperation in quarantining the system.
- **Coopt them—they're a weapon!** Imbatlok and Luminosity Alpha both secretly support this approach—and indeed there may be other "conspirators" on the ship. It's unlikely they'll confess to this unless the PCs are of a like mind. See "A Secret Mission?" on page 44 for more.

That said, **The City People** is also a science-fiction scenario with a strong investigative element and a detailed logical underpinning—we provide "explanations" for many of the mysteries the PCs encounter, with guidelines for how the players can find those explanations out.

It's therefore a judgement call for you as GM as to when you should allow player analysis, sensing, and scanning rolls to discover pre-existing explanatory detail, and when you should allow players to improvise those details themselves. The explanations we present here are internally consistent and (we hope) fun and fascinating to play; but they're absolutely not the one true way. If your players want to forge their own story out of the phenomena they encounter on Beta Formiae, discovering their own unique truth behind its uncanny events, then you can certainly let them.

Probably you'll want to strike a compromise; keep the "core plot" of **The City People** intact, revealing those elements which must be fixed for the existing explanation to hang together, but letting the players go wild with improvising details in areas where the core plot isn't overly affected. To help you with this, we've indicated **key assessments** in the episodes, scenes, and tasks which follow: if you keep these "facts" fixed in your adventure, then you can let your players freely riff on everything else without disrupting the underlying story. Have fun!

THE DEFAULT PLOT THREAD

At first glance, Beta Formiae appears to be nothing more than a lost colony; primitive, with isolated settlements, tribal and regressed. It's only as the expedition investigates that it becomes clear not everything is as it seems.

Once on the ground and observing the Formians, the Space Force expedition personnel and SCI Force evaluation team quickly realises it's facing an extreme biohazard, and

may have already been compromised. They may even have been infected by a Formian, reinforcing the critical need to quarantine themselves until they've worked out the nature and extent of the threat, and possibly contained it.

Without the PCs' intervention, the Beta Formiae expedition will be doomed, and the Commonality facing an existential threat.

As usual, we've presented the suggested plot episodes in the likely order the PCs will encounter them. Players being players, this often won't happen: the Beta Formiae system is an open book, filled with mysteries and puzzles, and the players may choose to approach things completely differently. Use the material which follows as the basis for your story, and improvise on top of it.

PLOT STRESS: THE BREACH

Where the PCs realise they're facing a biohazard threat, and must lock the expedition down!

While the identification of the threat posed by the formiont bacteria forms the investigative part of this adventure, much of its action is driven by how that threat directly affects the expedition—horribly and lethally. We're using **plot stress** (*Mindjammer* page 432) to track the progress of this threat, and the moment the whole expedition becomes compromised and realises they must neutralise the threat if they ever want to return to Commonality Space.



COUNTDOWN TO THE BREACH!

The biointegrity of the Beta Formiae expedition is compromised!

Plot Stress Track □ □ □ □

CONSEQUENCES

MILD (-2): Contamination Protocol Breach *Bacteria found in the ship, a character's protection fails temporarily, the shuttle is contaminated by Formian fluids, etc.*

MODERATE (-4): Single Case Infection *After a few hours, probably a crew member—if possible someone without a haze field—displays symptoms of infection (page 13).*

SEVERE (-6): Epidemic *Multiple crew members display signs of infection.*

TAKEN OUT: Expedition Failure *The entire expedition, including the ship, falls to the formionts. Individual PCs may still be holding out, but the mission is a failure.*

Plot Stress

CAUSES OF PLOT STRESS

A PC is exposed to a Formian.	Automatic mild consequence, or 1 plot stress.
A character is infected by the formionts.	Automatic moderate consequence, or 2 plot stress.
A character takes physical stress from a Formian.	0 plot stress and an exposure check.
A character takes a physical consequence from a Formian.	1 plot stress.
A Formian or Formian / formiont sample is aboard the ship, albeit quarantined.	1 plot stress.
A protocol observance roll fails as a minor cost.	2 plot stress.
A protocol observance roll fails as a serious cost.	4 plot stress.



We're presenting this **breach** of the expedition's biosecurity as an event outside the suggested episode order, as it's something that could happen at any point during play. Although it doesn't have to happen, it most likely will: but how and when and why are questions which are up to your game to answer.

When the breach occurs, the PCs realise they're facing a deadly contagion. Commonality contagion protocols (page 43) dictate they **must** put the expedition into **lockdown**, prohibiting them from returning to Commonality Space until they have fully resolved the situation.

The breach is an important plot event, and this section provides detailed background to help you run it.

How the Breach Happens

Initially, the PCs and *Magnanimous Intervention* crew assume that a biosecurity breach **can't happen**. They're an expert and highly trained group of contact specialists, and issues of contamination are taken extremely seriously, with advanced measures and protocols. Nevertheless, a breach **does** happen; this section looks into **how**.

THE CONTACT PROTOCOLS

The Commonality has protocols for almost everything. The **contact protocols** ensure contact with exointelligences or rediscovered lost colonies is handled in a disciplined way, ensuring no contamination occurs in either direction. Each of the following protocols must be stringently followed; you can require the players make an **observance roll** (see immediately below) to do so at critical moments.

- Away teams may only be present on-planet for a few hours, to keep contamination risk low, until the environment has been determined to be **low risk** (page 48).
- The shuttle is considered a habitat; its anti-contamination measures are less stringent than the ship, but nevertheless time spent in the shuttle habitat is not considered time spent on-planet.
- P-suits and force helmets are to be worn until the environment has been determined to be low risk. Even then biosecurity is usually maintained.
- Environment boundaries are to be kept sterile and isolated: between surface (planetary environment) and interface (shuttle), and between interface and headquarters (ship), sterilisation and decontamination measures are to be carried out. These may require **observance rolls** (below).
- No items are to be transferred between headquarters and surface without authorisation. Items are to be transported in sterile secure containers.

OBSERVANCE ROLLS

Following the contact protocols at crucial, delicate, or stressful moments may require an **observance roll** of Bureaucracy, Science, or Technical. The roll is usually Fair (+2), but may be made more difficult by other complicating aspects. It's up to you when and if you mandate a roll; instead you can rely on plot stress to time a breach of the contact protocols, or simply decide (based on your story's actions) when the breach happens. Note that observance rolls put the highest risk of breach upon non-specialist personnel such as security teams, pilots, and so on.

Containment and Decontamination

The PCs may **contain** the contagion to its current extent by rolling *Technical* (or the biohazard protection level) against its *Magnitude*, which begins at *Fair* (+2).

They may also **decontaminate** the affected zone or zones. This is a roll of the biohazard protection level or **BPL** (see *Contagion Protocol 5* below), chosen by the PCs from the ranges below, against the contagion's *Intensity* (see *Contagion Protocol 3*); *Technical* may provide a teamwork bonus. In this case, characters in the affected zones must also roll *Physique* against the result of the BPL roll. On a failure, they incur physical stress equal to the shifts of failure, plus a weapon rating equal to the BPL. Armour protects only if vac-sealed; force fields protect normally.

BPLs of ship areas are as follows. Note that PCs may choose which BPL they apply.

- **The Field:** Average (+1) to Good (+3) BPL (weapon rating 1 to 3).
- **Ship Interior:** Average (+1) to Superb (+5) BPL (weapon rating 1 to 5).
- **Labs and Engineering:** Average (+1) to Legendary (+8) BPL (weapon rating 1 to 8).

For example: A single-case infection breach occurs as a moderate (-4) plot stress consequence in one of the

Magnanimous Intervention staterooms. Maggie herself acts to contain the contagion, rolling her *Superb* (+5) *Technical* against the contagion's *Fair* (+2) *Magnitude*, with a +1 teamwork bonus from the ship interior's biohazard protection level, which she sets at *Average* (+1).

She then decides to try to decontaminate the stateroom. The *Intensity* of the contamination is *Great* (+4), equal to the moderate plot stress consequence's severity. She can only use her *Technical* skill for a teamwork bonus, and must decide what BPL to apply. She decides to be ruthless, frying the stateroom with a *Superb* (+5) decontamination procedure, increased to +6 with her teamwork bonus.

Unfortunately one of Yusol Menard's multiples is in the stateroom, and must make a *Physique* roll against the decontamination result. If it sustains any physical stress, the damage will be increased by a weapon:5 rating, representing the hard decontaminating radiation Maggie has used. Menard may be losing another multiple...

THE CONTAGION PROTOCOLS

The contagion protocols are followed in the event biosecurity is breached. They come into play if **any** plot stress consequence (page 41) is incurred—even a mild one. Following the contagion protocols may require **observance rolls**, and can exacerbate plot stress consequences already incurred.

1. **The expedition is locked down.** Movement and communication are forbidden until the extent of the threat and the possibilities of isolating and quarantining it are known. Individuals are expendable.
2. **Communication is incrementally restored.** Initially only indirect (non-realtime) thoughtcasts are permitted, analysed to ensure no memetic virus or other contaminant is being communicated. Once confirmed, real-time communication is permitted.
3. **The extent of contamination is determined.** Is only one area affected? Is the ship environment compromised? Are individuals contaminated, and if so is their function compromised, and do they need to be replaced? Can they be treated? At this point *Intensity* and *Magnitude* of the biohazard are determined; the

Intensity is equal to the severity of the breach plot stress consequence (*Fair* (+2), *Great* (+4), *Fantastic* (+6), etc); *Magnitude* is initially *Fair* (+2).

4. **Contagion is analysed and a treatment, containment, and decontamination strategy devised.** Can analysis be performed without transfer? If not, what form of transfer is required? Transfers are subject to contact protocol quarantine and isolation (requiring **observance rolls**).
5. **Containment and optional decontamination procedures are implemented.** This is action 2 on the **biohazard** write-up on *Mindjammer* page 177. If the contamination is on board the ship, different areas have different **biohazard protection levels** (from *Average* (+1) to *Superb* (+5) and up), which may replace or provide teamwork bonuses to the *Technical* roll to contain the infection. See the text box above.

HOW ARE THE PROTOCOLS DEFEATED?

The plot stress mechanic indicates whether the breach happens, and how severe it is—but it doesn't tell you exactly **how** it happens. That's something you'll have to work out

A Secret Mission?

*The event horizon probe's initial report on Beta Formiae was immediately classified by an extremist splinter group in the Commonality comprising members of the Integrator faction (see the **Hearts and Minds** adventure), the 3SI, AFI, Bugs and Slugs, and others. The group immediately commenced a secret operation to include agents among the crew of the Magnanimous Intervention sent to investigate Beta Formiae, and if necessary use its crew members as guinea pigs to determine the extent and seriousness of the threat, with a view to using it as a weapon. The event horizon probe, Luminosity Alpha, and the ship's morale officer, Imbatlok, are members of this shadowy group; there may be others. You can use the actions of this group behind the scenes to make life difficult for the PCs.*

yourself, depending upon the PCs' actions and the circumstances of your story.

To be honest, the best way to handle this in play is as a **mystery**. Present the PCs with the breach as a *fait accompli*—and let **them** try to work out how it happened. Let speculation run riot—fear and paranoia are your friends! You can even treat this mystery as a **separate plot thread**, as the PCs not only have to deal with the breach, but also work out how it happened—and even identify possible perpetrators.

Here are some ideas:

- No one spots the existence of the formions, and instead everyone assumes the Formians are devolved humans, and declares the environment **low risk** (page 48), whereupon the Formians attempt a “kiss” or a stinger attack. At that point, regardless of whether the PCs or crew are directly affected, they realise they may have been exposed to a pathogen.
- A biosample is returned to the ship in compliance with the protocols. It's kept in secure containment, but somehow that containment fails—a “single drop of water” escapes, a vac seal breach occurs, or (ever popular) someone cuts corners or is clumsy, etc.
- Someone is injured on the planet and exposed to the environment before risk-assessment is complete. They may even be returned to the ship (albeit quarantined). Either way, this constitutes a breach.
- The formions really are that effective—they're intelligent bacteria, and potentially ubiquitous. Given time, perhaps they can overcome almost any countermeasure.

- Someone seems to have deliberately exposed the away team, or engineered a breach once a sample was returned to the ship. Why would anyone do this? Possible answers include:

- To test the extent of the biohazard.
- As an attack on the Commonality.
- Because they were contaminated and themselves compromised and controlled.
- Because they're terrorists, or have some kind of “eco-war” agenda.
- Because they're insane.

WHEN DOES THE BREACH HAPPEN?

Tracking plot stress means that the breach could happen at any moment. In the episodes and scenes which follow, we indicate moments when a slip or chance event could also result in contamination. Be alert for similar opportunities to introduce the breach or increase plot stress.

Dealing With the Breach

While the extent of the breach may vary, from relatively mild to disastrously severe, the point when it is judged to have happened and the contagion protocols are implemented is a single and unambiguous one. Once it happens, there are many implications for the PCs' situation. Where are they when lockdown happens?

A GRADUALLY COLLAPSING SENSE OF SAFETY

When the breach happens, stress how isolated the PCs are. Not only does the lockdown protocol forbid the expedition from returning to the Commonality, the PCs may also find themselves isolated from their ship, or even one another. Highlight how vulnerable they feel, and how exposed they are to further risks.

THE RACE AGAINST TIME!

Initially the PCs have no idea how or why the contact protocols failed. They have theories, and are probably afraid and paranoid. Take the opportunity to stress what they're up against and how bad it is—the players should feel they're in a race against time to try and understand and resolve their dilemma. Put them under pressure; put them on the clock.

IS THE SHIP SAFE?

When you're describing the breach, don't forget it's a dynamic, evolving situation. It's possible the initial lockdown protocol was enforced for a relatively minor breach—say a

mild plot stress consequence. But plot stress continues to be incurred, and attempting to follow the contagion protocols can result in worse plot stress consequences coming into play.

Note also that the ship sentience itself isn't completely immune; there are organic and genurgic components to its corpus, and even these could conceivably be affected. If the events of your story support it, an outbreak on board the *Magnanimous Intervention* and an infection of Maggie herself can ratchet the tension up to astronomical levels!

NO SURFACE TO SHIP TRAVEL

Travel from surface to ship is forbidden during lockdown. While this makes life more precarious to anyone stranded on the planet, it does help stop plot stress from worsening.

EXTERNAL DECONTAMINATION

Note that decontaminating an environment without killing or treating an infected victim still means the stomach bacteria (and therefore the contagion and Shapechanger Plague) remain and are unaffected.

USE MECHANICALS / REMOTES ONLY

Although this avoids the possibility of transfer via stomach bacteria, the mechanicals in question must still be thoroughly disinfected (page 13). This is an **observance roll**.

WHODUNNIT?

If the breach was deliberate and the PCs realise it, they may need to work out who was guilty. Be sure to emphasise the fear and paranoia in this case: someone in the crew has endangered everyone's lives. If anyone panics and tries to return to the Commonality, the whole Commonality may be put at risk.

Outcome

The breach marks a major turning point in the events of *The City People*; once it happens, the PCs are plunged into a much more perilous, time critical plot.

WHAT HAPPENS NEXT?

Once lockdown has happened and the contagion protocols are in force, the PCs should be aware that the expedition has been exposed to a deadly infectious agent. Whatever they were doing (which scene or plot event they were involved in) when the breach occurred will continue, but naturally they will probably also want to look into finding a treatment. See **Episode Two Scene Three: Vaccine** for more.

EPISODE ONE FIRST CONTACT

*IN WHICH THE PCS MAKE THEIR FIRST FORAYS ONTO BETA FORMIAE,
AND COME INTO CONTACT WITH THE FORMIANS.*

After arriving in system the PCs scan the planet and search for the *Path of Luminosity* planetsider unit. Let the players decide how to do this: they can use the ship, drones, and even avatars from orbit; send away teams to the surface; or descend themselves to establish a base camp. Players will be familiar with exploration and first contact procedures from books and TV, and the PCs have the Commonality contact protocols to guide them, so let them organise themselves as they see fit—they're in charge!

Gradually they'll realise the Formians are not only divergent but probably no longer even human, and that their analyses have been based on incorrect assumptions.

SCENE ONE: INITIAL SURVEYS

Aboard the Magnanimous Intervention, the PCs survey the alien world.

Locations: *The Magnanimous Intervention.*

Environment: *In Orbit Above an Unknown Alien World* situation aspect.

The Hook

Space Force conducts standard analyses on entering a new star system, usually from orbit. Players may choose to use survey drones or even away teams.

PRELIMINARY SCANS

The *Path of Luminosity* event horizon probe conducted preliminary scans and planetary analysis on its first visit,

reporting its findings to the Commonality via its return unit (inside front cover). The PCs may re-run these scans for more accurate information.

- **System Scan:** A Passive or Active Sensing roll revealing the **star system high concept** *G-class Main Sequence Star With 8 Planetary Bodies*.
- **System Analysis:** A Passive Sensing roll identifying stellar body, number of planets, and their planetary types.
- **Planetary Scan:** A Passive Sensing roll revealing the **main world high concept** *Cool Dry and Barren World With Denuded Biosphere*. The initial EHP report didn't pick up on the denuded part of the biosphere. This is a **key assessment** (page 40).
- **Planetary Analysis:** A Passive Sensing create advantage roll identifying the planetary parameter the analysis focusses on. A success with style identifies 2 parameters.

DETAILED ANALYSES

The EHP return unit didn't conduct any of the following analyses, although the planetsider unit should have done some of them. The planetsider is nowhere to be found, unless the PCs prioritise the Stage 2 Planetary Registration to search for it.

- **System Analysis:** A Passive or Active Sensing roll identifying one system parameter, aspect, or hazard per shift from the system schematic (page 10).

- **Stage Two Planetary Registration:** To search for the lost EHP planetsider unit *Luminosity Beta* (page 25), the PCs may prioritise a detailed surface scan. A Passive / Active Sensing roll producing a planetary map (see “Metal Objects on the Surface!” below) and listing the planetary terrain types.
- **Life Form Analysis (orbital):** A Science (Biology, etc) roll identifying the native ecosystem’s body plans (page 7) from orbit. It takes several hours, and also identifies purity compounds all over the planet as *Life Form Concentrations*. More detailed analysis can be done from the ground, within a zone or so.
- **Hazard Identification Survey:** A Passive Sensing roll taking a day to identify one hazard by name only, for the system, planet, terrain, biosphere, or civilisation. An Active Sensing roll instead also reveals one of its parameters (Intensity, etc). A success with style reveals the “blasted areas” on the planetary surface (see “Blasted Areas” below). Note that biohazard surveys are usually secondary survey ops (see **Scene Two: Secondary Surveys**).

Dealing With It

You can run some or all of these surveys as actions requiring rolls, or simply as the players asking questions about the planet, perhaps prompted by the titles of the stand-

ard Space Force analyses. Hazards may result from costly successes, but otherwise this should be an information gathering scene.

METAL OBJECTS ON THE SURFACE!

The PCs obtain a planetary map from the **Stage Two Planetary Registration**, with signals showing three significant refined metal deposits—possibly remains of the ancient colony and the missing EHP planetsider unit. From orbit signals 2 and 3 are broadly similar (there **are** differences, but you may want to stress the similarities if you want the PCs to visit the Valley of War before the Peaceful Lands).

- **Signal 1: the EHP planetsider unit.** Unresponsive and apparently operating on minimal power. It may nevertheless have useful data. See **Scene Four: The Monolith**, below.
- **Signal 2: dispersed signals, possible colony settlement.** The second signal the PCs investigate. Close to signal 1, it appears to show two small population centres. See **Episode Two: The Valley of War**.
- **Signal 3: dispersed signals, possibly colony settlement.** Similar to signal 2, again with two small population centres. See **Episode Three: The Old One in the Mountain**.

An unlabelled version of the map is provided in the player handouts (page 76).

BETA FORMIAE II- inferior garden world / stage ii planetary reg. 193.196.153030

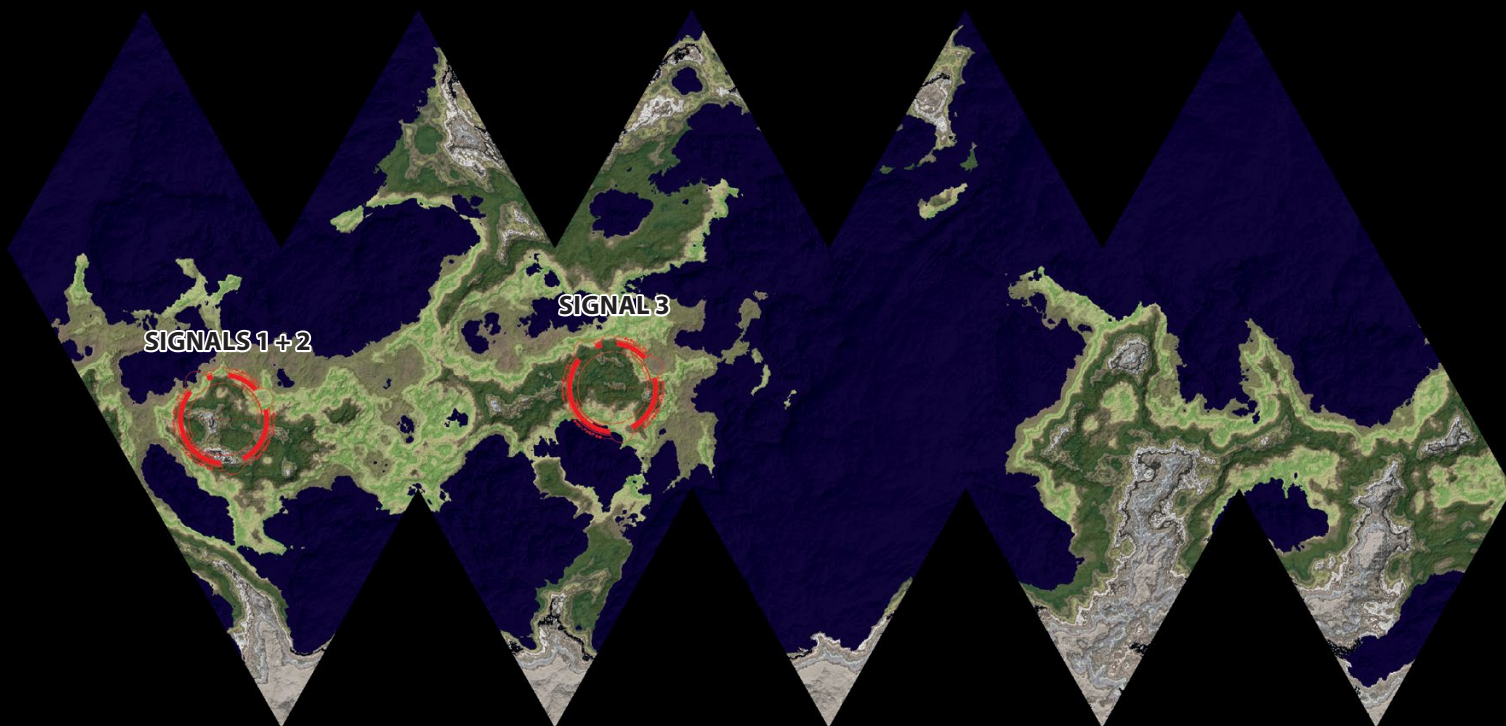

BLASTED AREAS!

A success with style on the **hazard identification survey** above (page 47), or a deliberate Active Sensing scan at Great (+4) difficulty, reveals three “blasted areas” on the surface, hit from orbit by null weapons approximately 2500 years ago. This vaporised the targets, but caused no radiation or widespread environmental damage. It didn’t affect a wide area, but did create a crater where there may be noticeable concentrations of metallic dust and other residue.

Outcome

This scene reveals remnants of the lost Beta Formiae colony that are worth investigating, and a possible location for the lost EHP planetsider. It may also reveal that there are regressed divergent hominids on the planet living in a damaged partly t-congruent biosphere.

WHAT HAPPENS NEXT?

The PCs may continue their surveys, perhaps by drone (**Scene Two: Secondary Surveys**) or in person (**Scene Three: Preliminary Cultural Analysis**). They may take an away team to the surface to retrieve the unresponsive EHP planetsider (**Scene Four: The Monolith**).

SCENE TWO: SECONDARY SURVEYS

The PCs conduct more detailed surveys, focussing on the unusual biosphere on Beta Formiae 2.

Locations: *The Magnanimous Intervention.*

Environment: *Complex and Contradictory Biosigns* situation aspect.

The Hook

The expedition focusses on the world’s biosphere, either from the ship, via survey drone or avatar, or away team on the surface.

THE BIOHAZARD SCAN

By default the Commonality considers a new world an **extreme biohazard risk**, and permits no away team operations. It conducts a **hazard identification survey**, taking a day, to search for biohazards or other hazards. An Active Sensing or Passive Sensing roll, this will find the Beta Formiae environment is **low risk**, unless the nature of the formiont bacteria has been understood, in which case the analysis will automatically switch to **high risk**. Risk levels are as follows:

- **Extreme Risk:** No away team operations are permitted.
- **High Risk:** Interactions with the environment are difficult, facing an *Onerous High Risk Mitigation Measures* aspect. Failed **observance rolls** (page 42) of the contact or contagion protocols do so with a minor cost (see **Plot Stress: The Breach** on page 41).
- **Low Risk:** Interactions face no undue difficulty, but failed **observance rolls** do so with a serious cost (see **Plot Stress: The Breach** on page 41).

The PCs may continue the hazard identification survey further; each success identifies one hazard by name only on a Passive Sensing roll, or one hazard and one of its parameters on an Active Sensing roll.

BIOSPHERE ANALYSES

Once the risk level is determined, the expedition analyses the biosphere and its life forms.

- **Biosphere Analysis:** An Average (+1) Science (biology, etc) roll with active sensors, survey drones, or an away team, taking several days and revealing the key assessment **biosphere concept** *T-Analogue Biosphere With Extensive T-Congruent Colonisation*. The EHP planetsider probably did this already.
- **Life Form Analysis (ground):** A Science (biology, etc) roll identifies one life form parameter (page 8) of a specific Beta Formiae life form (ragbats, papertrees, etc) within a zone or so, or two on a success with style. It also discovers traces of **DNA** throughout the biosphere, something quite unexpected—DNA is specifically Old Earth’s replicator. Analysis reveals the DNA is basically human, but found in the cells of many Beta Formian life forms, and even—somehow—in microbes throughout the environment. This is a key assessment (page 40).
- **Life Form Analysis (Formians):** Analysing the seemingly human Formians (by capturing one) reveals:
 - The genurgic profile of the Formians is of a post-longevity era human. Formians should have indefinite lifespans.
 - There are “shadow mitochondria” in every Formian cell—something very unusual (page 12). The implications of this probably won’t come out until **Episode Two: The Valley of War** (page 52).
- Note that **capturing** a Formian may expose the PCs to the Shapechanger Plague (page 12).

CIVILISATION ANALYSIS

The EHP return unit attempted to analyse the Formian “civilisation”, but didn’t get far—see the inside front cover. An

Investigate create advantage action, visiting the world for a few hours or observing with sensors, reveals one civilisation parameter (two on a success with style) from those on page 11, or optionally one per shift. Passive Sensing and cultural analysis may create advantages. See also page 13.

Dealing With It

The PCs observe Beta Formiae's life forms and "inhabitants". While their analyses tell them one thing, their instincts tell them another.

THE NATURE OF THE FORMIANS

The PCs may gradually realise the Formians aren't human at all. In many ways they look human, but have become so divergent they're effectively a different species, and a very alien one. Space Force and SCI Force may agree the expedition may be facing an exointelligence first contact situation, not a rediscovery, and subsequent actions will be performed on that basis.

Even then, the expedition will view the Formians as a discrete life form, not as a host parasitised by the formiont bacteria—that realisation comes later, possibly as early as **Episode Two: The Valley of War**. It's important that you present the PCs' findings in an appropriate light, and not give away the true nature of the Formians too early. In particular, analyses will reveal a Formian model's **overall** life form concept (such as *Denuded Woodlands Eater Eats Anything*) rather than the underlying formiont exointelligence concept (such as *Microorganism Exointelligence League Destroying For Dominance*). Astute PCs may push for an exointelligence concept anyway, in which case you can give them *Exointelligence Destroying For Dominance*.

Outcome

The PCs are analysing Beta Formiae's life forms, including its divergent Formian hominids. Their strangeness and incongruity poses lots of questions, but as yet they have few answers.

WHAT HAPPENS NEXT?

The PCs may continue to observe the Formians: see **Scene Three: Preliminary Cultural Analysis**. They may retrieve the planetsider: see **Scene Four: The Monolith**. Or they may contact the Formians directly: see **Episode Two: The Valley of War** or even **Episode Three: The Old One in the Mountain**.

SCENE THREE: PRELIMINARY CULTURAL ANALYSIS

Where the PCs observe the Formians from afar, and attempt initial cultural analysis.

Locations: Near a Formian purity compound.

Environment: *Hominid Culture With Extreme Divergent Behaviour* situation aspect.

The Hook

If this was a normal rediscovery mission, this would be the time for a preliminary cultural analysis. However, this is far from a normal situation. The Formians aren't even human, so no amount of cultural analysis will make sense: this is an exointelligence first contact situation, requiring a **manifestation analysis** (see below).

Dealing With It

The PCs stealthily observe the Formians at a distance, perhaps via avatar. They risk discovery and even breaking the contact protocols on failed rolls—especially if they don't understand what they're dealing with.

PERSISTING WITH A PRELIMINARY CULTURAL ANALYSIS

Understandably (at least at first), the PCs may persist in treating the Formians as a human culture, and attempt a preliminary cultural analysis to ascertain its dominant meme and civilisation type. This is a create an advantage action using Empathy, Investigate, etc, and takes a month; it must be done on the ground.

It'll produce weird results. The PCs may conclude there's no current civilisation on Beta Formiae, and instead start analysing the extinct one—requiring archaeological work. The reason for these results of course is that the Formians aren't human.

In any case, the PCs may fall foul of the formionts before any cultural analysis gets far.

CONDUCTING AN INITIAL EXOINTELLIGENCE MANIFESTATION ANALYSIS

First contact (*Mindjammer* page 412) is a **challenge** comprising three actions: manifestation analysis, magnitude analysis, and contact. This scene deals with manifestation analysis and magnitude analysis; contact is dealt with in **Scene Four: The Monolith**.

Manifestation analysis is often done by avatar, with contact personnel close by (perhaps in a shuttle). It can also be done in-person. The PCs may also do this as part of their contact encounter in **Scene Four: The Monolith**, or by capturing a Formian for analysis (see "Life Form Analysis" in **Scene Two: Secondary Surveys** above).

It's a Fair(+2) Investigate roll, with possible advantages from Science (biology, etc). It may require sensorview, depending on how the PCs conduct their observations. It

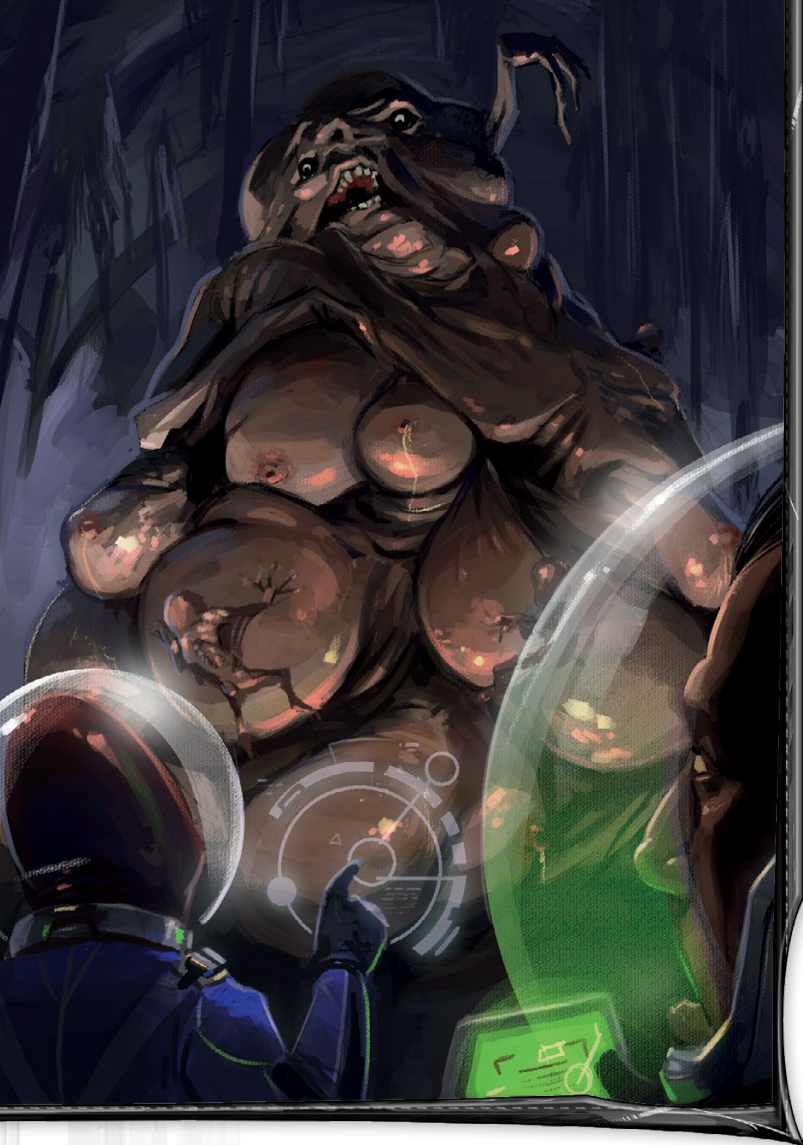

takes at least a day. The subject is likely to be the monolith in Scene Four below, but could be any Formian (page 15).

At this point the PCs probably don't yet realise the true nature of the Formians, and the results of their analysis will be inaccurate (albeit still useful), identifying the following manifestations (*Mindjammer* page 409):

- **Sensorium:** Human-derived Senses.
- **Communication:** Via Human-derived Speech and Possible Chemical Exchange.
- **Self View:** Individual as Member of Extended Family.
- **Temporality:** Human-derived (standard exchange).

See **Episode Two: The Valley of War** for a second, accurate manifestation analysis of the real exointelligence—the formiont bacteria (page 16).

CONDUCTING A MAGNITUDE ANALYSIS

A magnitude analysis (*Mindjammer* page 412) is a Fair (+2) Science roll revealing:

- **Evolution Index:** Low Human (-2).
- **Exoscale:** Medium (+0).

See **Episode Two: The Valley of War** for a second, accurate magnitude analysis.

Outcome

The PCs will be stymied doing a cultural analysis on something that isn't a culture, or they'll have inaccurate but still useful data from analysing the Formians as an exointelligence. They may be confused, but even that confusion may be telling them something—they need more information.

WHAT HAPPENS NEXT?

The PCs may proceed to actual contact: see **Scene Four: The Monolith**. Alternatively they may observe the Formian "settlements": see **Episode Two: The Valley of War**.

SCENE FOUR: THE MONOLITH

Where the PCs approach their first Formian.

Locations: The wilderness in the Valley of War.

Environment: Sickly Smells and Body Noises situation aspect.

The Hook

The third, "contact" part of first contact operations requires personal contact and communication. The faint signal from the EHP planetsider unit leads the PCs to an over-grazed papertree forest 30 km upstream from a Formian "hillfort" settlement, where they discover the planetsider has been "swallowed" by a Formian **milk truck** (page 19).

The analyses and activities below could also be performed with different model Formians. Adapt this scene to your story.

Dealing With It

This is the PCs' first contact with a Formian. They may learn a lot, but risk breaching the contact protocols.

FIRST IMPRESSIONS

The milk truck "monolith" is a 5-metre tall Buddha-like mound of horribly human flesh, twisted and mutated and covered with lactating buds. The whole zone *Stinks To High Heaven*.

The surrounding woodland is stripped of vegetation, and teems with flollopping creatures—packrat minions, occasionally wriggling up and feeding off the monolith's lactation buds.

The PCs may observe or approach the monolith stealthily; if they try and fail, it emits a terrifying disturbing screaming, upsettingly human, to call Formian warriors to its aid (see "Generalised Attack" below).

If the PCs approach the monolith openly and non-aggressively, they may make first contact. Signals from the dormant planetsider unit are detectable *inside* the creature.

CONTACT WITH THE MONOLITH

This is the third part of the first contact challenge (*Mindjammer* page 412). The milk truck may shriek and cry in its high grating voice, which the PCs may recognise as human language—the Uniworld of the 6th millennium (page 14) of the First Age of Space. Let the PCs describe their actions, then have them make a Great (+4) Science or Knowledge roll.

- On a success, they establish *Friendly Communications*: the monolith initiates a Formian kiss (page 16), which the PCs may interpret as an attack. It shrieks “*Communication fails! Divergent basis!*”
- On a success with style, the same occurs, but the monolith shrieks “*Models are analogous yet appear unmanned and autonomous! Confirm!*”
- On a failure by 2 shifts or fewer, the PCs incur a *Communication Failure* situation aspect (actually a minor cultural consequence), and the monolith initiates a Formian kiss (page 16).
- On a failure by 4 shifts or fewer, they incur a *Hostile Contact!* situation aspect, and the monolith initiates a stinger attack.
- On a failure by 5 shifts or more, they incur a *Violent Confrontation!* situation aspect, and the monolith and its packrats attack.

There’s a good chance this contact situation may cause a breach (page 41), or devolve into a generalised attack (see below).

GENERALISED ATTACK

If the monolith is attacked or surprised, it will shriek and scream with a disturbingly human voice (a *Provoke* attack), calling for aid from Formian warriors (page 18) in the valley and alerting the rest of its league (let’s call it the Mono League) at its purity compound. Warrior Formians and monitors will investigate and repel or infect the threat, arriving within a few minutes to a few hours.

FURTHER SURVEY OPS—SCI FORCE STAGE ZERO EVALUATION

The PCs’ analyses of the Beta Formiae “culture” and its possible threat (*Mindjammer* page 306) will probably be ongoing during this adventure, depending on the PCs’ skill set and style of play. In some ways the whole adventure can be regarded as the **threat analysis** undertaken by the expedition. Ultimately, the PCs will have to decide on the threat analysis themselves, based on their investigations. See the **Epilogue** (page 73) for more.

Outcome

The PCs have tried to make direct contact with a Formian. It probably hasn’t gone well. They’ll now have to determine what kind of threat the Formians represent—and what happened to the colony to get here.

WHAT HAPPENS NEXT?

The PCs have a lot of options. They’ll probably want to investigate the nearby Formian “settlement”: see **Episode Two: The Valley of War**.

EPISODE TWO
THE VALLEY OF WAR

IN WHICH THE PCS ENCOUNTER THE FORMIAN LEAGUES.

In this episode the PCs investigate Formian **leagues** (page 13) for the first time, exploring a Formian purity compound, gathering information and figuring out what happened to the ancient slowship colony. They may work out the true nature of the Formians, and the existence of the formionts—possibly as a result of a breach (page 41), or leading to one. They may attempt to synthesise a treatment for the Shapechanger Plague (page 12).

SCENE ONE: THE MONO LEAGUE PURITY COMPOUND

Where the PCs learn the Formian “hill forts” aren’t what they seem.

Locations: The second signal location in the Valley of War.

Environment: *Filthy and Primitive Stone Age Settlement* situation aspect.





The Hook

The Mono League purity compound is the location of the second signal (page 47). The PCs probably see it as a "Formian hominid settlement". They may observe Formian behaviour and analyse ruins and artefacts from the original colony.

Dealing With It

Approaching the purity compound openly will result in a similar situation to "Contact With the Monolith" on page 51. At best, it'll be a stand-off while the PCs investigate the compound; at worst, the situation will devolve into open attacks.

The compound is a mess. It's the territory of 15-30 Formians, a filthy and shambolic clutch of ramshackle huts and lean-tos of breathtaking primitiveness. The Formians must have devolved a long way. Low fires burn outside the huts, and Formians lurk listlessly. There are several larger mounds like tumuli, one of which contains the metallic signature the PCs detected from orbit.

HUTS AND FIRES

Not all of these are occupied, and those that are barely seem lived in. Emaciated Formian monitors light and tend the fires.

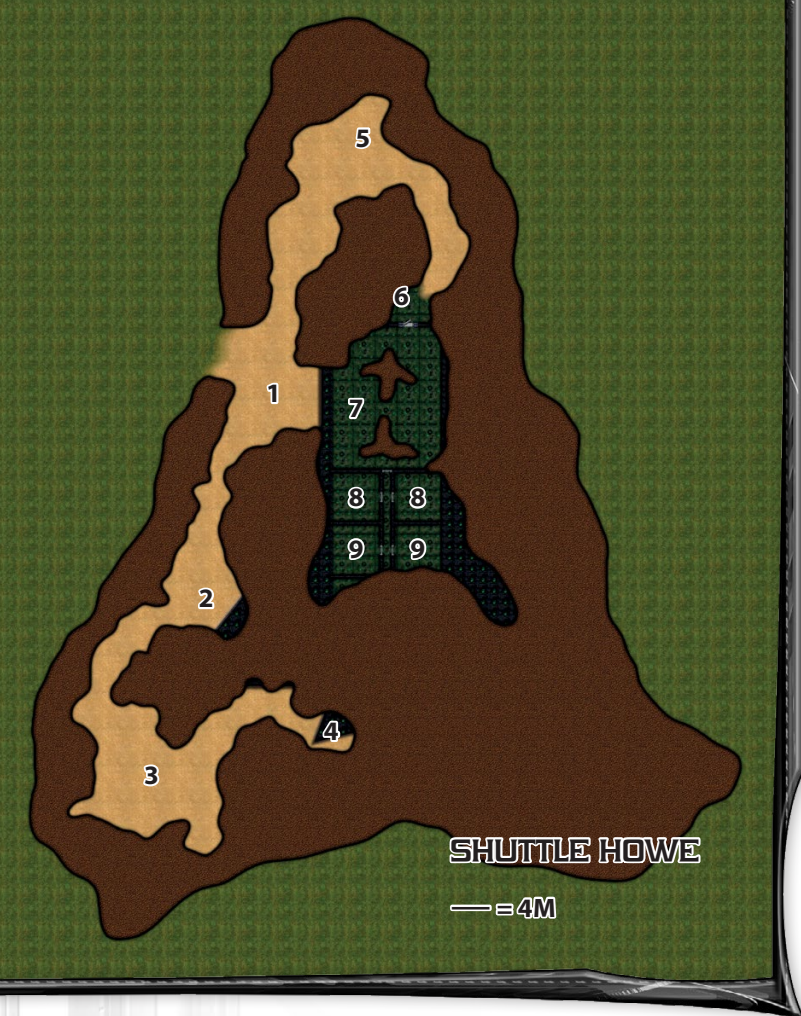

THE MOTHER MASS

Central to the compound is a large mass of gooey fleshy matter almost like protoplasm or undifferentiated tissue. The Formians will be unconcerned if the PCs approach this **mother mass** (page 17); it can defend itself.

THE HOSPITAL

This larger hut is occasionally occupied by injured or sickly yet apparently very stoic Formians. Monitors (page 19) of the Mono League are also found here.

THE SHUTTLE HOWE

One of the two larger tumuli or midden mounds in the compound shows the outline of a buried shuttlecraft in sensorview or with Active Sensing. A scoured yet intact section of hull metal tailfin protrudes from its top.

An overgrown cavernous mouth opens into the *Nightmarish and Claustrophobic* “howe” interior. Like everything else, it stinks. Inside it’s like a tomb or pyramid, *As Spooky As All Hell*, with the following areas:

1. **The Outer Hull:** One wall of this earthen “cavern” is a badly pitted and vacuum scoured slab of hull metal, impenetrable without heavy weaponry or cutting tools. It’s *Several Thousand Years Old*, and the outer hull of a shuttle craft.

2. **Ambush:** A group of 3 Formian warriors (page 18) rushes out at the PCs, in front of another exposed section of shuttle craft hull.
3. **Food Station:** A milk truck (page 19) is the focus of Formian interest.
4. **Radioactive Drive:** A broken aft section of shuttle craft, covering a damaged portion of fusion plant and a **radiation hazard** (*Mindjammer* page 354).
5. **Fission:** A Formian warrior is undergoing **fission** (page 13).
6. **Shuttle Bridge:** The half-buried bridge is ancient and primitive. A Fair (+2) Investigate or Notice roll reveals it was *Deliberately Destroyed*. A Science roll detects an early synthetic intelligence—also destroyed.
7. **Cabin:** *Rotting and Filthy*. Occupied by a Formian monitor (page 19) or alternatively the Walker Formian captive from **Scene Four: The Captive**.
8. **Data Stacks:** Behind sealed and jammed doors (Good (+3) Physique, etc, to open) are the *Stack Access Remnants* of an ancient proto-Mindscape. A Superb (+5) Hacker roll reconstructs the remnants into a *Fragmented Partial Virtuality*, filled with gaps and darkness, but also impressionistic shards of words, visuals, reports, and memories. It’s spooky and haunting even for Commonality citizens—the tantalising remains of memories millennia old.

Querying the virtuality reveals one fact per shift on a Hacker roll:

- The virtuality pinpoints a language and era: the Uniworld of approximately 5700FA (five thousand years ago).
- The colony was growing: “There is so much room! We are keeping checks on our population growth while we engineer ourselves.”
- Confusion, panic, and death spreads throughout the colony—or the fear of something worse. “They are not dying!”
- As the colony appears close to collapse, the datastacks also reveal the **location of the original colony**—named “Prime Colony”—in an area which the Formians call the Peaceful Lands. The location matches the **third signal** (page 47).

9. **Drives and Stores:** With a *Dangerously High Background Radiation* aspect, the rearmost accessible cabins in the shuttle craft contain non-perishable T7 gear from the 6th millennium.

THE STOREHOUSE

Similar to the Shuttle Howe, this an old prefab habitat covered with midden-like detritus has no power plant or data stacks, but is inhabited by several Formians. There are sealed storage areas containing T7 gear.

MANAGING THE DISCOVERY OF THE FORMIONTS

The discovery of the formiont bacteria is a **key assessment** (page 40). Be sure to reveal the nature of the Formians gradually—perhaps taking several scenes or episodes. Here are some ideas:

1. The PCs observe a Formian kiss, and obtain and analyse biosamples. They discover the “shadow mitochondria” (page 12).
2. The PCs witness a battle between leagues, and observe the stingers at work. They may witness Formian shapechanging.
3. The breach (page 41) occurs, and a crewmember is infected and shapechanges. The process alerts the PCs to the existence of the formionts, and perhaps their true nature.

Redoing the Manifestation Analysis

The PCs may realise their analyses have been incomplete and perhaps plain wrong. They may re-do them with knowledge of the existence of the formionts for more accurate results. See also “Preliminary Cultural Analysis” in **Episode One Scene Four: The Monolith**.

Outcome

The PCs have observed the inhuman behaviour of the Formians, and may have discovered the hybrid formiont bacteria and Shapechanger Plague. They may have encountered the Walker Formian captive (page 57). They may not yet realise it's the **formionts** and not the Formians that are the exointelligence they're encountering, but the clues are mounting.

WHAT HAPPENS NEXT?

The PCs may continue to observe the Formians (**Scene Two: The Warring Leagues** or **Scene Four: The Captive**), or may research a treatment for the Shapechanger Plague (**Scene Three: Vaccine**). They may travel to the lost Prime Colony (**Episode Three: The Old One in the Mountain**).

SCENE TWO: THE WARRING LEAGUES

Where the PCs observe and perhaps participate in the conflict between the Mono League and its neighbour.

Locations: The Valley of War.

Environment: *Constant State of Annihilating Warfare* situation aspect.

The Hook

The Mono League's valley is also occupied by a second “Amphib” league. Both leagues are in constant low-level con-



flict. The PCs observe and may be affected by this, and may understand the cause of the endless internecine conflict. They may capture and “interrogate” a different model Formian.

Dealing With It

The Mono League and Amphib League come into open conflict, and the PCs are caught between.

THE AMPHIB LEAGUE

The Amphib Formians are clearly different from the Mono Formians. Their skin colour and any hair colour is different, and they have different adaptations and have slightly different models from the Mono league. Amphibs are *Amphibious, Dedicated to Unthinking Destruction, and Have Multiple Arms*.

A Fair (+2) Science (cultural anthropology) or cultural Investigation or Notice roll theorises the two leagues are different **cultures**—but more different from one another than simple neighbouring “hill tribes” should be.

FIGHTING THE FORMIANS

This scene can be a pretext for combat; perhaps the PCs, observing a league from a distance, are surprised by a “war-party” from the other league. Figure 1 warrior, dozer, or tank (page 18) for each PC, plus one group of 3 Formians per PC. The PCs may think they’re the target, but the Formians are only attacking because they’re in the way.

TAKING A SIDE

If the PCs help one league against another, their “allies” will appear unimpressed and even ungrateful. However, they’ll subsequently tolerate the PCs in their purity compound unchallenged—at least, until they try to interact...

TAKING ADVANTAGE

The PCs may take advantage of the fighting to explore either league’s purity compounds, possibly finding the shuttle and captive Walker Formian (**Scene Four: The Captive**).

Outcome

The PCs witness the genocidal fighting between leagues if Formians of one league aren’t able to “kiss” or “sting” the other. Analysing the Formians of different leagues reveals they belong to different clone lines **for the most part**; some rare members differ, but even they share almost identical stomach bacteria and “shadow mitochondria” (the actual formionts)—the real basis for league differentiation.

WHAT HAPPENS NEXT?

The PCs may analyse the formiont bacteria in more detail, perhaps to find a treatment for the Shapechanger Plague (**Scene Three: The Vaccine**). Alternatively they may meet the Walker Formian (**Scene Four: The Captive**) or go directly to the Walker league in the Peaceful Lands (**Episode Three: The Old One in the Mountain**).

SCENE THREE: VACCINE

Where the PCs try to create a treatment for the Shapechanger Plague.

Locations: A medical lab on the ship, in the shuttle, or elsewhere on Beta Formiae 2.

Environment: *Virulent Deadly Biohazard* situation aspect.

The Hook

The PCs have discovered the Shapechanger Plague; perhaps one of the crew is infected, or a breach (page 41) has occurred. They may be developing a treatment, or wondering

if the original colonists created something—especially if they know the “Prime Colony” appears to have held out longer.

Dealing With It

The PCs analyse the Shapechanger Plague, identifying possible treatments and devising strategies for producing them.

GENERAL CHARACTERISTICS OF THE SHAPECHANGER PLAGUE

The Shapechanger Plague is described on page 12. Treating an existing infection (a **therapeutic treatment**) or staving off future infection (a **prophylactic treatment**) are both difficult; the formiont bacteria adapt actively. Any treatment the PCs create will rely upon sophisticated, hyper-advanced Commonality medical know-how.

BROAD ANTIBIOTIC

The easiest, most short-term treatment, which any medical character will recommend. It can be administered in a few days with a single Technical (Meditech) roll. A successful treatment increases the time period for Plague attacks by one step to a few days, or by two steps to a week on a success with style.

TARGETED PROPHYLACTIC

A targeted prophylactic treatment helps characters resist future infections. Once a PC has created the targeted prophylactic, a successful Technical (Meditech) roll to administer it will make a character *Resistant to Formiont Infection*, or *Immune to Formiont Infection* on a success with style.

Creating the targeted prophylactic is a **challenge**, comprising rolls of Science, Technical (Meditech), and Technical (Genurgy), with each exchange taking a week, or a month without at least PMI connectivity. Medical facilities of T6+ are required. All rolls must succeed, and rerolls are allowed. The difficulty is Superb (+5) with living patients, or Epic (+7) without.

TARGETED THERAPEUTIC

A targeted therapeutic treatment helps characters resist an already existing infection, ultimately wiping it out and allowing recovery obstacles to be overcome. It’s the hardest, most time-consuming, and longest-term option. It requires a few months by default; treatment is 1 step faster with each of: the Mindscape, an overclocked sentience, a genurgy lab, and so on.

It’s a challenge, comprising the following stages:

- **Stage 1: Analyse and design the therapy.** A Fair (+2) Technical (Genurgy) or Science roll.

Don't Forget Successes at a Cost

The PCs and ship's crew are hyper-competent scientists, and it's unreasonable to expect them to be stymied in their search for a vaccine by bad dice rolls. Don't forget they can always succeed at a cost—and that cost could be plot stress, hazards, or even incursions by Formians or other threats.

- **Stage 2: Create the therapy.** This is the second of the two rolls above.
- **Stage 3: Overcome a Microdrone Avatar conflict hazard** using a Technical (Meditech) or Intrusion (Hacker) roll in the Mindscape. This is an attack on the infecting formions, which are Good (+3) opposition and have 4 stress boxes and 2 consequences. If the infecting formions are **taken out**, the victim is freed of infection. Failures damage the **host**.

DID THE ORIGINAL COLONY DEVELOP A TREATMENT?

The PCs may wonder if the original Beta Formiae colonists attempted to tackle the Shapechanger Plague. The answer lies on the *Astral-440*. Fragmentary clues can be found on a Fair (+2) search of the old colony proto-Mindscape—the colony tried to keep it secret. The location of the *Astral-440* may still be unknown—it can be found in the Prime Colony proto-Mindscape (see **Episode Three Scene Three: Prime Colony**).

If lockdown is in place and the PCs are prevented from accessing the ship's medical facilities, finding a treatment created by the old colony may be their only hope.

Outcome

The PCs may have begun to treat victims of the Shapechanger Plague, or be searching for a treatment to neutralise the threat.

WHAT HAPPENS NEXT?

If the PCs are working on the treatment themselves, they may continue with other scenes and episodes alongside their painstaking research work. If they're looking for a treatment created by the old colony, they may search the Beta Formiae system for the lost colony ship (a Fair (+2) Active Sensing roll taking a few weeks—see **Episode Four: The Lost Ship**), or travel to the Prime Colony site (see **Episode Three: The Old One in the Mountain**).

SCENE FOUR: THE CAPTIVE

Where the PCs encounter an unusually aware Formian.

Locations: Anywhere in the Valley of War.

Environment: An *Inhuman Brightness Behind the Eyes* situation aspect.

The Hook

A Formian league—probably the Mono League—has a captive Formian they haven't killed, from an unknown league (the Walker league from Prime Colony—see page 60). It may be kept in the Shuttle Howe (page 54), or anywhere else the PCs can stumble across it.

Dealing With It

The Walker Formian is calmer than any Formian the PCs have met, and appears able to resist the urge to kiss, sting, or attack.

MEETING THE WALKER

The PCs may realise how unusual this is. The unknown league Formian is more observant, more “advanced” or “civilised” than those they have seen so far—an Empathy, Notice, or other appropriate roll reveals this if the players don't deduce it for themselves.

COMMUNICATION ATTEMPT

Communicating with the Walker still isn't straightforward, although it's easier than with other Formians (see page 14). The PCs may hear about “the Peaceful Lands” and “the Walker league”, and perhaps conclude that the Peaceful Lands, Prime Colony, and the third signal are the same place. At some point the Walker Formian defers to a higher authority, with the words: “Unable to proceed. Intervention by the Old Colony in the Mountain required”.

Outcome

The PCs know there's a settlement of “super-Formians”—cleverer, more original, more able to communicate—somewhere on Beta Formiae. They may realise their “Peaceful Lands” is the original Prime Colony, and the third signal of their scans.

WHAT HAPPENS NEXT?

The PCs may continue their investigations with any other unplayed scenes or unvisited locations. More answers may be forthcoming at the old “Prime Colony”—see **Episode Three: The Old One in the Mountain**.

EPISODE THREE

THE OLD ONE IN THE MOUNTAIN

IN WHICH THE PCS DISCOVER THE TRUE THREAT POSED BY THE FORMIANS

The PCs discover an unusually advanced Formian league in a place the Formians call “the Peaceful Lands”—site of the original Prime Colony.

SCENE ONE: THE PEACEFUL LANDS

Where the PCs arrive and explore the Peaceful Lands

Locations: The mountain range and river valleys adjacent to the old Prime Colony.

Environment: *Tropical Rainforest Settlements Denuded but Free of War* situation aspect.

The Hook

The equatorial mountains and lowland rainforests near the remains of the ancient Prime Colony are inhabited by at least two Formian leagues, as well as another apparently larger Formian league in the Prime Colony valley itself, site of the third metallic signature detected from orbit (page 47). All these leagues seem free of the constant conflict which the PCs have so far observed between Formian purity compounds elsewhere.

Dealing With It

The PCs observe the “Peaceful Leagues”, either from the air or via closer ground-based surveillance, and may even contact them.

TRAVELLING THROUGH THE PEACEFUL LEAGUES

If the PCs investigate the purity compounds near the ancient Prime Colony, they discover none of them are directly hostile. They are still Formians, and still conduct Formian kisses within their leagues, but the genocidal conflict with neighbouring leagues is absent. The leagues are larger than those seen before, with 100 or so members. A Fair (+2) Science roll to analyse their DNA reveals the “Peaceful Lands” Formian leagues are accepting a great deal more genurgic diversity than those in the Valley of War.

If the PCs communicate with the leagues, they hear that “intervention by the Walker league is required”. They’ll be told the Walker league lies “through the tunnels in the mountains” about 15km away. A success with style may even provide a Formian guide!

Outcome

The PCs realise something **very** different is going on in the Peaceful Lands, with larger Formian leagues and greater coexistence—all apparently thanks to the “Walker” league.

WHAT HAPPENS NEXT?

The PCs may visit a Peaceful Land purity compound—see **Scene Two: A Different Purity**. Alternatively, they may traverse the caves beneath the mountains, or use the shuttle to descend into the Prime Colony mountain valley directly (see **Scene Three: Prime Colony**).

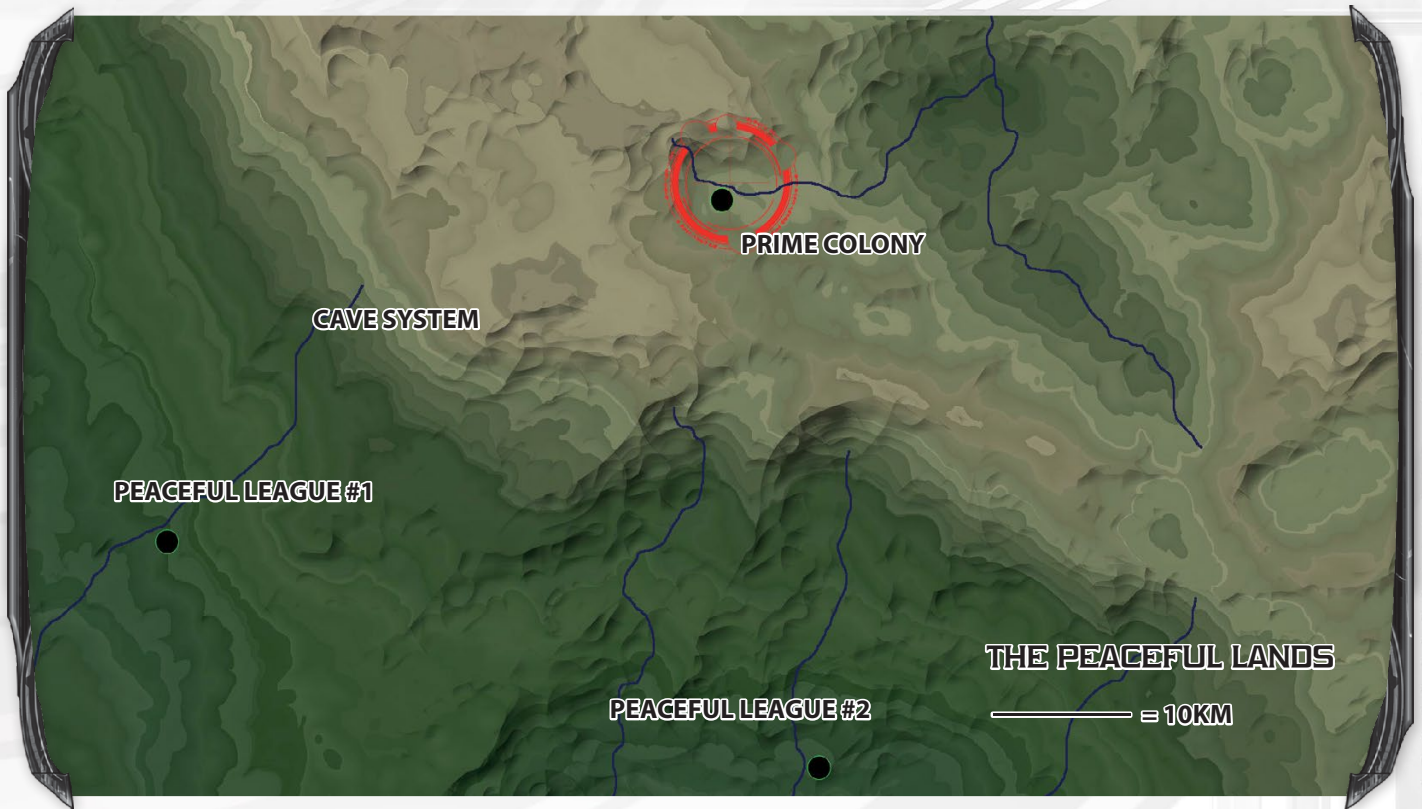

SCENE TWO: A DIFFERENT PURITY

Where the PCs visit a purity compound of one of the Peaceful Leagues.

Locations: A Peaceful League purity compound.

Environment: An *Evolutionary Leap in Action* situation aspect.

The Hook

If the PCs visit a purity compound of a Peaceful League, they can directly observe the effect the Walkers are having on Formian society.

Dealing With It

The PCs may expect immediate Formian “attacks”; let them take any steps they like. However, Formians they encounter (whether Walkers or not) won’t attempt even a Formian kiss with an unknown Formian, but instead defer to Walker Formians in their compound.

TALES OF THE WALKERS

If the PCs succeed at the still risky task of communicating with Peaceful Lands Formians, they discover there’s an entire league of Walker Formians “in the mountain”. The Peace-

ful League Formians know they live in a purity compound accessible “through the caves”. They know “the Walker models talk between our leagues. The Old One in the Mountain is the last original.”

You can place one or two Walker Formians in any Peaceful League purity compound. They act as “advisers” or even “priests”, and a watchful stand-off replaces the lethal hostility of the Valley of War. The formiont colonies inhabiting the Walker Formians are intrigued by the PCs, and keen for them to visit the Old One.

The PCs may already have communicated with a Walker Formian in the Valley of War (see **Episode Two Scene Four: The Captive**). This is another opportunity to give them the same information, plus a little more.

Outcome

The PCs witness how Walker Formians in Formian leagues act as mediators, resolving disputes and allowing leagues to coexist with their neighbours and grow.

WHAT HAPPENS NEXT?

The PCs may travel (perhaps with a Formian guide) through the caves into Prime Colony, or cross the mountains in the shuttle and land there. See **Scene Three: Prime Colony**.

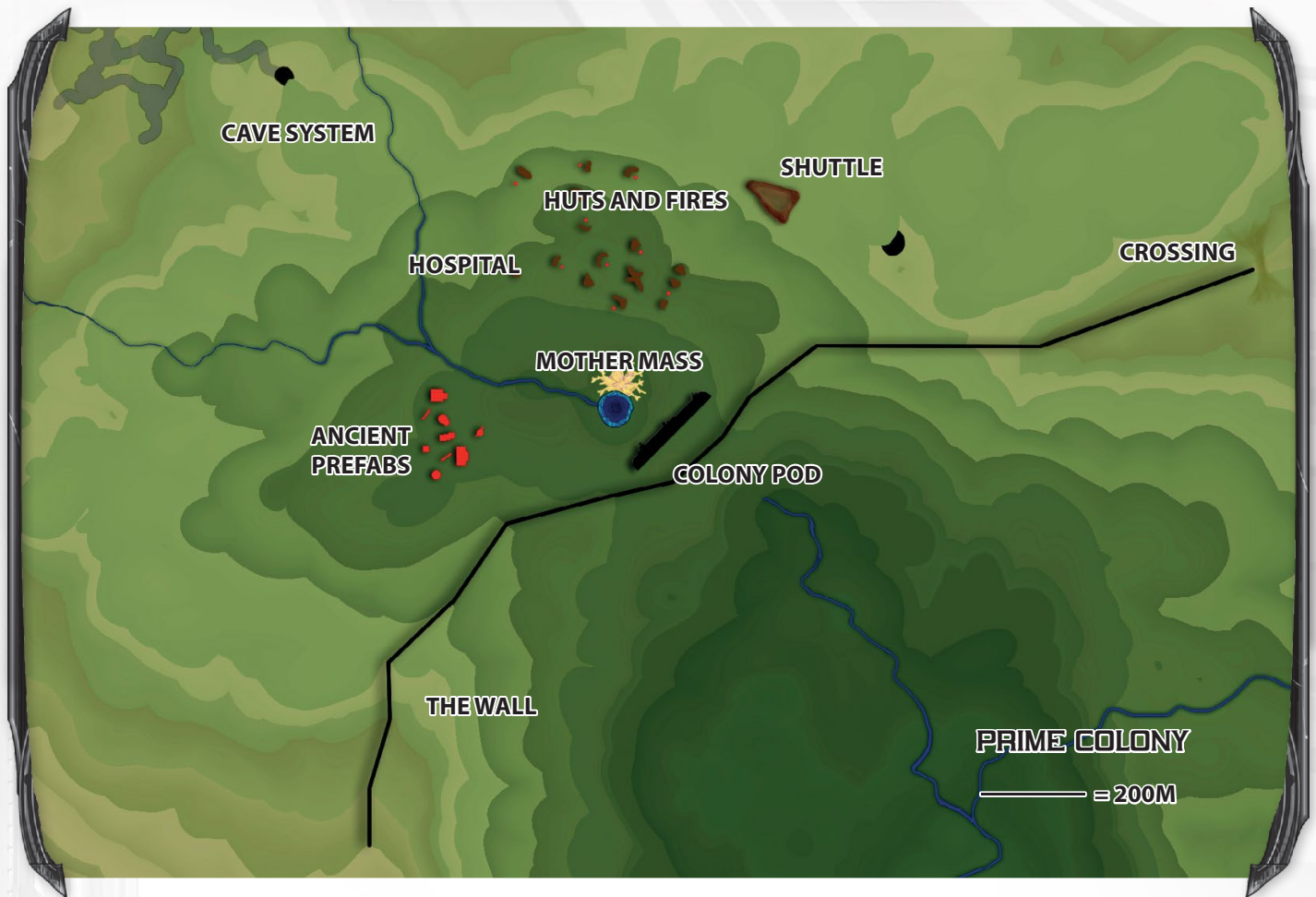

SCENE THREE: PRIME COLONY

Where the PCs visit the final holdout of the original colonists, and discover a special—and highly dangerous—kind of Formian.

Locations: The ruins of the original “Prime Colony” in the equatorial regions.

Environment: Heart of the *Lethal Alien Hive* situation aspect.

The Hook

Prime Colony is a “lost city” in the mountains, accessible to the Formians of the outside world only through an intricate cave system. The PCs can fly into the secluded mountain valley, or pass through the caves on foot—they’re too narrow to traverse with the ATV. From orbit the city looks like ruins, but on close observation (particularly in the infrared) it’s teeming with Formians—perhaps a thousand or more, more than has been seen anywhere else on the planet.

Dealing With It

Familiarise yourself with this scene and with **Scene Four: The Old One** to release information to the players at appro-

prate times, and to judge the changing motivations of the Walker Formians as they find out in turn about the PCs. If the Walkers discover the existence of the Commonality, they will cooperate with the PCs in an attempt to get offworld. If they remain unaware, or if the PCs try to thwart them, they may try to overwhelm the PCs, infecting them with the Shape-changer Plague and gaining their knowledge by formiont colonisation (page 13).

TRAVELLING TO THE MOUNTAIN

Make as much of this journey as you like: if the PCs are approaching on foot, perhaps with a Walker Formian guide, it’s a classic exploration adventure scene. Have them make Athletics rolls to climb the mountains to the cave system entrance; emphasise the alien rainforest environment, the local fleshbag and ragbat species, the threat of infection.

THE CAVE SYSTEM

The caves are intriguing, with obstacles and earthworks everywhere. A Notice or Investigation roll reveals an ancient

T7 ship null cannon half-buried inside the entrance, pointing out towards the Peaceful Lands (it's repairable). An Investigation or Science (archaeology) roll identifies the obstacles as the remains of defences, a couple of thousand years old. Even now they're patrolled by Walker Formians.

ENTERING THE CITY

The cave system debouches into an archaeological treasure trove: a lost city. A colony pod from the *Astral-440* is flanked with half-buried prefabs and more recent Formian "huts". The whole "city" is perhaps a couple of kilometres square, bounded by a huge wall 100m high, intact but partly overgrown. Scans will reveal the ruins are teeming with life signs. Formians!

The ruins are a "super purity compound" inhabited by Walker Formians, in a league vastly larger than any the PCs have seen so far. There are over a thousand Formians here, more technologically advanced than elsewhere on the planet, with a T1 (Neolithic) tech index.

INTERACTING WITH THE WALKERS

The Walkers won't automatically try to infect intruders. They usher them (eventually using force if necessary) to the Old One (see **Scene Four: The Old One**), even telling the PCs this if pressed.

If the PCs don't comply, the Formians will make Provoke attacks. If those don't work, the Old One will come to **them**. Until the Old One has made its judgement, the Walkers won't physically try to infect the PCs.

THE COLONY POD

The enormous and obvious heart of the fallen colony is the 200m long, 40m wide, 30m high self-contained colonisation unit, typical of modular colony ships of the Great Diaspora. See the description on page 68 for more.

It's a ruined "city", abandoned for two thousand years, swarming with Formians. The pod comprises many areas—you can decide upon these yourself, as well as letting characters skilled in archaeology, intrusion, casing, architect-

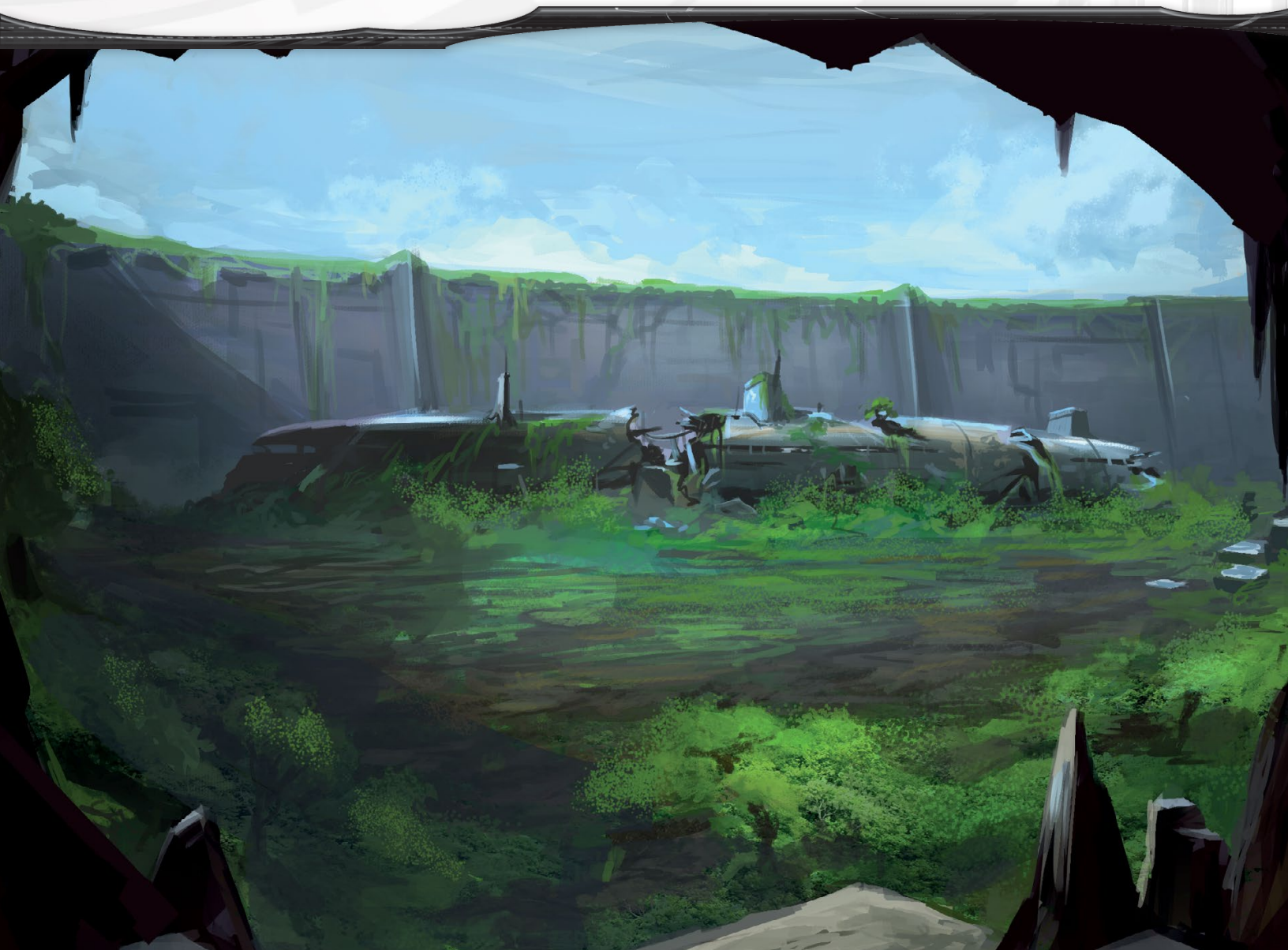

ture, or other appropriate skills describe the layout as they find their way through to the areas they're looking for. Possible locations include:

- **Sickbay:** Ancient and probably spoiled drugs, T7/T8 medical equipment, and possible hints about the vaccine research efforts which were being carried out on the *Astral-440*.
- **Morgue:** The Walkers use this as a “shrine to the founders”—when the original infected colonists died off (leaving the Old One, and any other originals you as GM decide are around), any fission progeny or other Formians placed them here. It's filled with the desiccated corpses of mutated humans—all of whom are different from one another (no clones). Their formiont bacteria may still be active, if dormant. The Formians have strange, icky, and upsetting “rituals” to “commune” with them.
- **Proto-Mindscape:** Comprising a primitive corpus where the proto-Mindscape instance for the colony pod was once located—badly damaged (probably sabotaged), but still functional. The Old One (page 63) spends some of its time here.

THE SHUTTLE

Fair (+2) scans reveal a fusion source here. There are tunnels similar to the Mono League shuttle (page 54), but the shuttle craft is intact: it hasn't been opened for **millennia**.

A Technical roll (or a Legendary (+8) use of brute force) manually operates the airlock. Like the Valley of War, the early shuttle sentience has been thoroughly and deliberately destroyed, but more of the proto-Mindscape datastacks have survived. There's the equivalent of a proto-Mindscape PMI here, requiring a Good (+3) Technical or Hacker roll to query, revealing the following:

- The *Astral-440* left Old Earth 5000 years ago, late in the Great Diaspora, arriving in the Beta Formiae system 1750 years later.
- The colony initially thrived, establishing three secondary urban centres and hundreds of major settlements. Prime Colony remained as the command and control hub.
- Shortly after genurgic adaptation to the biosphere, the colony realised it had been exposed to a contagion.
- The other satellite colonies fell in quick succession. Prime Colony implemented draconian quarantine procedures, and kept the infected at bay, but were unable to leave...
- The colonists attempted to produce a “treatment” for the contagion.
- They were retreating to the *Astral-440*—all the advanced labs were there—but lost contact with the ship.
- The proto-Mindscape contains the last known location of the *Astral-440* before control was lost (page 66).

With work, the shuttle could be made flightworthy.

A SPECIAL KIND OF FORMIAN

What makes the Walker Formians special? How are they overcoming their drive to infect every other life form? A Notice roll reveal the Walkers aren't all clones of the same individual; there are several leagues working together.

At this point, or possibly after the PCs have encountered the Old One, they may analyse their findings (you can suggest this). Doing so is a challenge.

- First, a **cultural anthropology**-type roll reveals that what's going on here is **memetic**. In other words, each Formian league is behaving like a culture.
- Second, a **biology or genurgy** roll speculates a league's memes might be “hardwired” into each Formian's genurgic makeup by the bacterial formionts which inhabit its cells.
- Third, a **cultural manipulation** or **culture ops**-type roll reveals that this means a Formian league, and even a Formian individual, should be able to be affected by a memetic attack.

Stress how much of a big deal this is. It's a key moment in the PCs' investigations, and means they now have a way to deal with the Formians: by engaging in memetic attacks, using Technical to create memes as advantages, and undertaking cultural operations to manipulate Formian leagues.

The Walker Formians are **mutants**, combining exofauna characteristics with those of more developed exointelligences. Their **threat reaction** (*Mindjammer* page 306) means they self-protect not by attacking / defending, but by manipulating other lines into passivity using a form of meme attack. This is an entirely new evolved behaviour, and isn't yet widespread or even stable. However, it is persistent, and has put the formiont exointelligence on the cusp of moving from the Low Human (-2) evolution index to Standard Human (-1).

This has allowed the Walkers to stop the constant fragmentation of the Formian leagues into subcultures, and instead allow leagues to combine and grow. This is why the Walker league is so large—and why its members are dispersing around the world...

THE WALKER FORMIONTS

This section provides the exointelligence build for the Walker formionts, updated from the base formiont build on page 16, as well as the Walker league (actually its formiont bacteria) statted as a culture. SCI Force and other characters with appropriate skills may attempt cultural manipulations on the league—another strategy for dealing with the Formian threat.

WALKER FORMIONT EXOINTELLIGENCE BUILD

Exointelligence Scale: Micro (-2).

Evolution Index: Standard Human (-1).

Exointelligence Concept: *Microorganism Exointelligence League Manipulating for Power.*

Behaviours: *League Social Structure, Attempts to Control if Encounters Non-League Life Forms, Shapechanges to Fit Specialised Niche.*

Exointelligence Skills: Empathy +0, Investigate -3, Knowledge +0, Notice -3, Science -4, Will +0.

Manifestation: *Parasitises Host Senses; Communal Communication via Chemical Exchange in Shared Host Environment, Intra-League Communication via Bacterial Exchange (Formiont Kiss), Extra-League Communication via Verbal Communication; Communal Hive Inhabiting Host as Member of League; Individuals at Millisecond Scale Aggregated into Communal "Historical" Experience at Host Time Scale (1 standard exchange).*

THE WALKER FORMIONTS

Scale: Enormous (+3) **Physical Stress:** □²□

Reach: Continental (+5) **Mental Stress:** □²□³□

Tech Index: T7

Consequences: 2 mild + 1 moderate

Tech Index: T1 (-4)

Aspects: Manipulating Formiont Expansionism, A Larger World We Can Barely See, Still Finding Our Way, We Must Sublimate Our Killing Communication, Vestigial League Tribalism.

Skills: Fair (+2) Empathy, Rapport; Average (+1) Assimilate, Contacts, Deceive, Intrusion, Knowledge, Will

STUNTS

◆ **Memetic Cascade:** Make an Intrusion create advantage roll to target progressively larger scale cultures with an Assimilate attack.

◆ **Shock and Awe:** Make meme attacks on any part of a culture in a zone currently under organisation Security attack.

◆ **Suicide Synthetics:** +1 Intrusion bonus by using disposable sleeper agents.

Supporting Culture

Outcome

The PCs may finally understand the nature of the Formians and their formiont inhabitants. They may have discovered

that the old colony ship, the *Astral-440*, is still in the Beta Formiae system, and may hold the secrets to a treatment for the Shapechanger Plague. Finally, they may have discovered there's a notional "leader" of the Walkers in the Peaceful Lands—the Old One.

WHAT HAPPENS NEXT?

The PCs may take what they know to create and implement a treatment for the Shapechanger Plague—see **Episode Two Scene Three: Vaccine**. They may meet with the notional leader of the Walker Formians: see **Scene Four: The Old One**. Or they may travel to the *Astral-440* lost colony ship: see **Episode Four: The Lost Ship**.

SCENE FOUR: THE OLD ONE

Where the PCs meet the intelligent "leader" of the Walker Formians.

Locations: The shuttle or colony pod or elsewhere in Prime Colony.

Environment: *In the Presence of a Powerful Alien Intelligence situation aspect.*

The Hook

The Walker Formians have a "leader" they call "the Old One", perhaps a survivor from the original Beta Formiae colony, colonised by the formionts. It wants to meet the PCs...

Dealing With It

This isn't necessarily a combat scene, although it may devolve into one. The PCs pit their wits against the ancient formiont colony called "the Old One", which is trying to manipulate them to let it—and the whole formiont threat—leave Beta Formiae and expand to other worlds.

THE VISION THING

The PCs know they're up against something special from the outset. If nothing else, they may suddenly find themselves subject to mindburn attacks via the Mindscape! An Investigate, Notice, or Science roll using the Mindscape reveals these aren't mindburn attacks, but rather supercharged, clumsy, and primitive attempts at thoughtcasting emanating from the Old One. The Formiont has a Mindscape implant!

But how? A Mindscape analysis roll reveals these "thought surges" may be greetings or summons, apparently from a vast number of minds—millions upon millions of them...

The Old One **remembers** (as do some other Walkers) the ancient human Prime Colony. Its first words to the PCs are a clue:

"Model is known. Model is called human."



Major NPC

THE OLD ONE

Physical Stress: □□□□ **Mental Stress:** □□□□□

Consequences: 3 + 1 mild

Scale: Medium (+0) **Refresh:** 2

ASPECTS

High Concept: Formian Survivor From the Original Colony Population.

Trouble: Shrivelled Humanoid.

Other Aspects: Empire Builder, Inhuman Incisiveness, The Vision Thing.

SKILLS

Superb (+5): Will

Great (+4): Knowledge, Rapport

Good (+3): Deceive, Investigate

Fair (+2): Notice, Provoke, Stealth

Average (+1): Empathy, Physique, Resources, Unarmed Combat

STUNTS

◆ **Indomitable:** +2 Will bonus to defend against Provoke fear and intimidation attacks.

◆ **Overseer:** 1/scene, make a Rapport overcome action to generate a pool of shift points you can redistribute.

◆ **Thought Surge:** Any type of Mindscape contact the Old One makes also acts as a mindburn attack and may do mental stress damage.

NATURAL ABILITIES

★ **Formian Shapechanging:** Reconfigure into different Formian model, shrinking or increasing up to 50% in size. Takes a few days.

★ **Stinger:** +2 Unarmed Combat attack bonus, plus possible Shapechanger Plague exposure.

OTHER EXTRAS

★ **Special Ops Mindscape Implant:** Fairly crude and primitive version, but it works.

The Old One is an infected but *original* colonist; the host organism before the PCs is 2000 years old. It's uncertain what that means in formiont terms.

The Old One remembers that the original human colonists were intelligent without hosting formiont colonies. After two thousand years without meeting an uninfected human, it's curious to know why the PCs are here, what they know, and what's "out there".

The PCs may communicate with the Old One. It's reasonably articulate, with a greater grasp of human-comprehensible language than other Formians. It doesn't speak like a human, but may end up sounding more like the crew of a large starship or the official communiques of an organisation or community. It refers to itself as "we", its body as "this model", other Formians as "other city people", and other formionts as "our species" or "colonists". It also remembers its host's memories—albeit imperfectly—and refers to them as "this model's experience store".

Have fun with this, and don't give the players an easy ride—but they should be able to **communicate**.

Give the PCs the opportunity to understand the Formians—and particularly the Walkers—in this encounter. You can

present information as a conversation, but also allow Investigation, Notice, Science, and other appropriate perception, cultural anthropology, and cultural analysis rolls to provide insights when the players need them.

The PCs should realise the Old One has a vision of a longer-term and larger-scale society for the Formians. The Walkers have grasped the nature of inter-colony relations, and are helping colonies to co-exist without trying to overcome one another. They're **empire-builders**. This puts them at

Deception and Lies

The Old One knows that humans will oppose formiont colonisation, and won't openly discuss it. Other Walkers also know this in principle, but have no experience of communication with humans, and so are less able to dissimulate. Between themselves, when they think humans can't overhear, they freely discuss their plans.

the forefront of formiont evolution, and makes them **very** dangerous. By creating their shaky league alliances, the Walkers are on the verge of solving the "Inventor Paradox" (page 14)—a quantum leap in formiont societal evolution.

What are the PCs going to do? They may realise the danger a unified and expansionist formiont culture may represent to the Commonality, but, equally, they may also realise this culture has a common point of reference for communication. Can SCI Force do business with these "people"?

THE OLD ONE'S PLAN

The Old One may react to the PCs in several ways. Its motivation is simple: it wants to find out where the PCs have come from. If the PCs aren't forthcoming with this information, it will use Deceive to create advantages to find out, using Rapport advantages to put the PCs at ease.

If the Old One learns about the existence of the Commonality, it will cooperate with the PCs as fully as it can, with a view to getting offworld and spreading into the cosmos. It will attempt to pass this information to other Formians.

If the PCs hide the existence of the Commonality from the Old One (whether the Old One suspects it or not), it will become hostile, and decide to infect the PCs to gain access to their knowledge.

Outcome

The PCs may understand what the Formians are about to evolve into—and that the Commonality may be able to communicate meaningfully with them. But should they?

WHAT HAPPENS NEXT?

If the PCs are still searching for a treatment, they may create one (**Episode Two Scene Three: Vaccine**), or travel to the lost colony ship in search of one (**Episode Four: The Lost Ship**). They may also complete their **threat analysis** and decide how the expedition (and therefore the Commonality) will deal with the Formian threat (see **Epilogue: Threat Analysis**).

EPISODE FOUR THE LOST SHIP

IN WHICH THE PCS DISCOVER AND EXPLORE THE ANCIENT COLONY SHIP ASTRAL-440.

The *Astral-440* is somewhere in the Beta Formiae system; its exact location depends on how your game has been going, the PCs' rolls, theories, and opinions, and so on. By default we've located it in the atmosphere of the gas giant Beta Formiae 5 (page 10).

In this episode the PCs find the ship, and try to access its ancient data records to discover what happened to it, and perhaps find a treatment for the Shapechanger Plague.

The *Astral-440* is a colony ship of the later Great Diaspora period. It transported some 60,000 colonists in stasis. Typical of late Diaspora vessels, it prioritised form over function; it's highly ornate, with decorative flourishes, and to modern Commonality eyes has a "decadent" feel.

The ship shows signs of battle damage, explosions, and fighting. There are vacuum-exposed remains, desiccated long ago. It's been derelict for at least 2000 years.

THE ASTRAL-440

Physical Stress: 1 2 3 **Systems Stress:** 1 2 3 4

Consequences: 1 mild + 1 moderate

Scale: Enormous (+3)

Tech Index: T7

Aspects: Long-abandoned Relic From the Great Diaspora; Ancient and Unfamiliar Systems; Nominal Power Only; Bulky Physical Shielding; Time-Travelling Sleepers in Vulnerable Stasis Berths (flaw); Consequences: Dead Sentience, Explosive Damage, Gutted and Depleted Reserves.

Skills: Good (+3) Resources, Systems; Fair (+2) Passive Sensing, Technical; Average (+1) Manoeuvre, Ranged Combat.

STUNTS

◆ **Long-Distance Life Support:** +2 bonus for functioning on systems and reserves.

◆ **Passenger Accommodation:** Accommodations for 300 passengers.

EXTRAS

★ **Extended Passenger Accommodation x2:** Accommodation upgraded for 6000 passengers.

★ **Physical Ray Shielding:** Invoke against kinetic, null, and plasma weapons, missiles: Bulky Physical Shielding.

★ **Stasis Berths:** Accommodations converted to transport 60,000 colonists in stasis.

★ **Primitive Ponics:** Provides tenuous food and breathable atmosphere.

ANALYSIS AND DEDUCTIONS

Provide the PCs with the unlabelled ship schematic from the handouts on page 76. Cursory passive scans reveal the ship has limited power: there are emissions from a fusion power plant in the engineering section; the central habitat and stasis rings are rotating slowly; and the empty colony pod bays act as solar vanes. The non-rotating parts of the ship are probably in zero gravity; the rotating sections may have anything up to .25G.

The outer section of the habitat and stasis ring appears to contain liquid water; the ship has an atmosphere which may be breathable. A successful Active or Passive Sensing roll reveals that the level containing water is acting as shielding, as well as providing potable water reserves. However, there are ambiguous but definite life signs both in the water and elsewhere—perhaps ancient ponics and unidentified slow-moving life forms.

The schematic indicates the ship's main areas. These won't be immediately obvious to the PCs, but you may reveal them on the basis of appropriate Intrusion, Knowledge, or Technical rolls, or by exploration.



THE LOST SHIP / ASTRAL-440

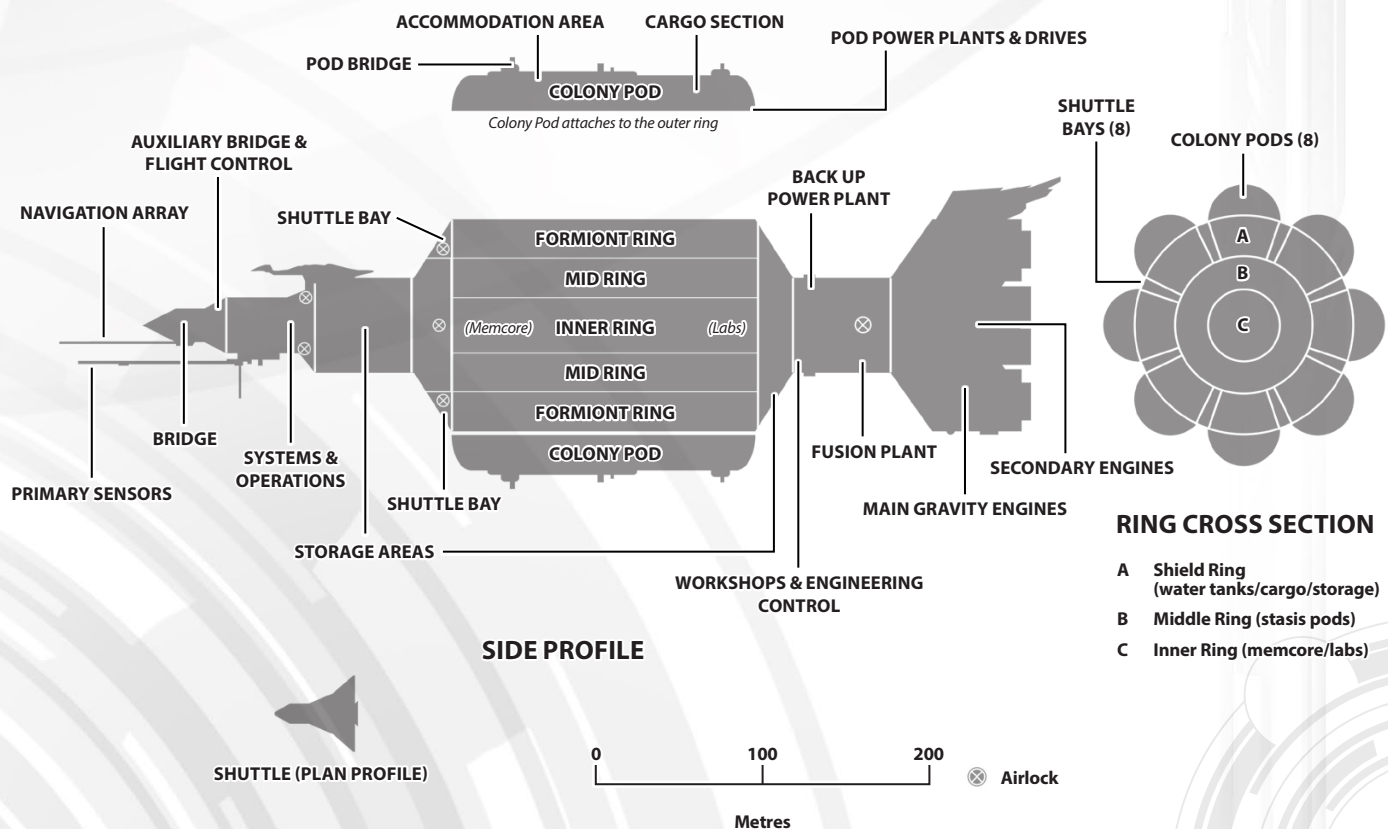

THE SHIP INTERIOR

The ship central habitat is spinning gently, providing 0.25G gravity; solar energy and the semi-dormant fusion plant provide minimal life support. Sensors show the atmosphere is **loaded** with virulent and all-too-familiar bacteria; any exposure automatically exposes the character to the Shape-changer Plague (page 12).

The ship interior comprises three broad sections: bridge and operations (forward); the rotating habitats (amidships); and engineering (aft).

Bridge and Operations

This relatively small section (40m long and 20m diameter) is in zero-G, sealed off, empty, and abandoned. It comprises:

- Main Bridge
- Auxiliary Bridge and Flight Control
- Navigation Array
- Primary Sensors
- Systems and Operations
- Storage

Many of the ancient T7 control systems look to have been deliberately sabotaged, in places by a single large explosive device. A Good (+3) Technical roll taking half an hour in the main bridge, auxiliary bridge, or systems and operations sections can re-establish fire control for the ship's null weapons.

Engineering

This section, also in zero-G, has been sealed, and is where the colonists made their last stand against the Formians. A Superb (+5) ship's engineering roll reveals the engines have been deliberately scuttled—but they are repairable. There are big STL fusion-powered gravity engines and early proto-Mindscape datastacks. There is still low power in the fusion core. The engineering section comprises:

- Backup Power Plant
- Fusion Plant
- Workshops and Engineering Control
- Main Gravity Engines
- Secondary Gravity Engines

The Rotating Habitats

The central section of the ship; the rotation is a “low power default”—when under power it would provide a 1G gravity. Most of this episode's action happens here. Viewed in cross-section, it's divided into four areas: three “rings” plus an outer

array of colony pods, all but one of which are gone. Viewed laterally, it's divided into eight “transversals”, which form compartments in each of the three rings.

THE COLONY PODS

The outer level of the rotating habitats originally consisted of eight colony pods, each designed to detach from the *Astral-440* and form the core of a new colony. Only one remains. The fate of the other seven is as follows:

- One forms the core of Prime Colony (page 60).
- Three are “blasted areas” on the surface of Beta Formiae (page 48).
- Three are unaccounted for. Where did they go? In fact at least one of these is elsewhere in the system—see page 9.

The remaining colony pod on the *Astral-440* is a pristine example of the one shown on page 61: 200 metres long, 40 metres wide, and 30 metres high, with 9 decks. It contains mothballed factories, a bridge at the front, and thrusters at the rear. With a few days and a Great (+4) Technical (Starship Engineer) roll, etc, it could be reactivated.

A corresponding stasis section exists in the middle ring below the colony pod, with many of its original 7500 colonists still intact in stasis. See **The Middle Ring** and **Scene Two: Ambiguous Life Signs** below.

THE SHIELD RING

Scans indicate this outermost cylindrical habitat level is filled with water—fairly standard for colony ships, providing natural shielding for the stasis chambers further in, and a ready source of water, oxygen, hydrogen, and habitats for ponics and aquatic life. It also contains its own ecosystem, inhabited by **aquatic Formians** and **vac Formians** (page 70). Due to environmental paucity the population is low, and the vac Formians usually in semi-hibernation.

THE MIDDLE RING

This was the main stasis section, with each of its 8 subsections holding 7,500 colonists in stasis. It's mostly empty, with minimal life support. The vac Formians can enter, but usually don't because of the conditions. There is one stasis subsection still under power and operational (See “The Awakening” in **Scene Two: Ambiguous Life Signs**).

THE INNER RING

Empty and sealed, the inner ring has zero life support. It requires a few hours of hands-on work and a Fair (+2) Intrusion roll to enter (failure means a costly success, probably

alerting the vac Formians. PCs entering may access the mem-core and vaccine / treatment labs (see below).

The rotating habitats section also contains:

- **Shuttle Bays:** There are bays for eight shuttles, all empty. For examples of shuttles on Beta Formiae, see pages 54 and 62.
- **Storage:** With a lack of makepoint technology, Great Diaspora colony ships had to bring pretty much everything with them, and these sections were where it was stored. Most raw and prefab materials and micro-factories were removed long ago, but a substantial amount remains, clearly to support an ongoing occupation. It's mothballed now, but could be reactivated in a week on a Great (+4) Technical roll. There are items of T7 gear here.

SCENE ONE: GETTING IN

The PCs approach and board the Astral-440.

Locations: The outer hull, airlocks, and maintenance hatches of the *Astral-440*.

Environment: *Creaking Clanking Scary and Dark* situation aspect.

The Hook

The PCs arrive at the *Astral-440* and, having conducted their scans from outside, attempt to board.

Dealing With It

The outer hull has various airlocks, indicated on the schematic (page 67), plus maintenance hatches (not shown). These are more manual than the variform airlocks the PCs are used to, requiring a Fair (+2) Intrusion or Technical roll to force open, with a risk of alerting vac Formians or suffering injury from explosive decompression debris on successes at cost. Opening maintenance hatches in particular breaks atmospheric integrity of ship sections, exposing interior compartments to vacuum unless mitigated from the bridge controls. Vacuum conditions won't stop the vac Formians, which are smart enough to move between sections and operate hatches.

The ship interior contains all the elements of classic sci-fi horror: it's a dark, abandoned spaceship, filled with weird sounds and ancient remains, and a horrible, infectious foe, lurking murderously in the dark, one touch from which will turn you into a hideous zombie! Milk this for all it's worth—the PCs should be thoroughly spooked. Treat each move between ship sections as a Good (+3) Provoke attack vs Will, taking half an hour and doing mental stress damage from fear, claustrophobia, and isolation.

Outcome

By the end of this scene, the PCs will be inside the *Astral-440*.

WHAT HAPPENS NEXT?

Let the PCs choose which ship section they have entered, by airlock or maintenance hatch. Then move to **Scene Two: Ambiguous Life Signs**.

SCENE TWO: AMBIGUOUS LIFE SIGNS

The PCs explore the interior of the Astral-440.

Locations: Any of the ship sections shown on the schematic on page 67.

Environment: *Strips and Strings of Fleshy Organic Matter Growing Up the Walls* situation aspect.

The Hook

The PCs explore the ship and come into contact with the vac Formians. Attacks, analyses, conversation attempts, and

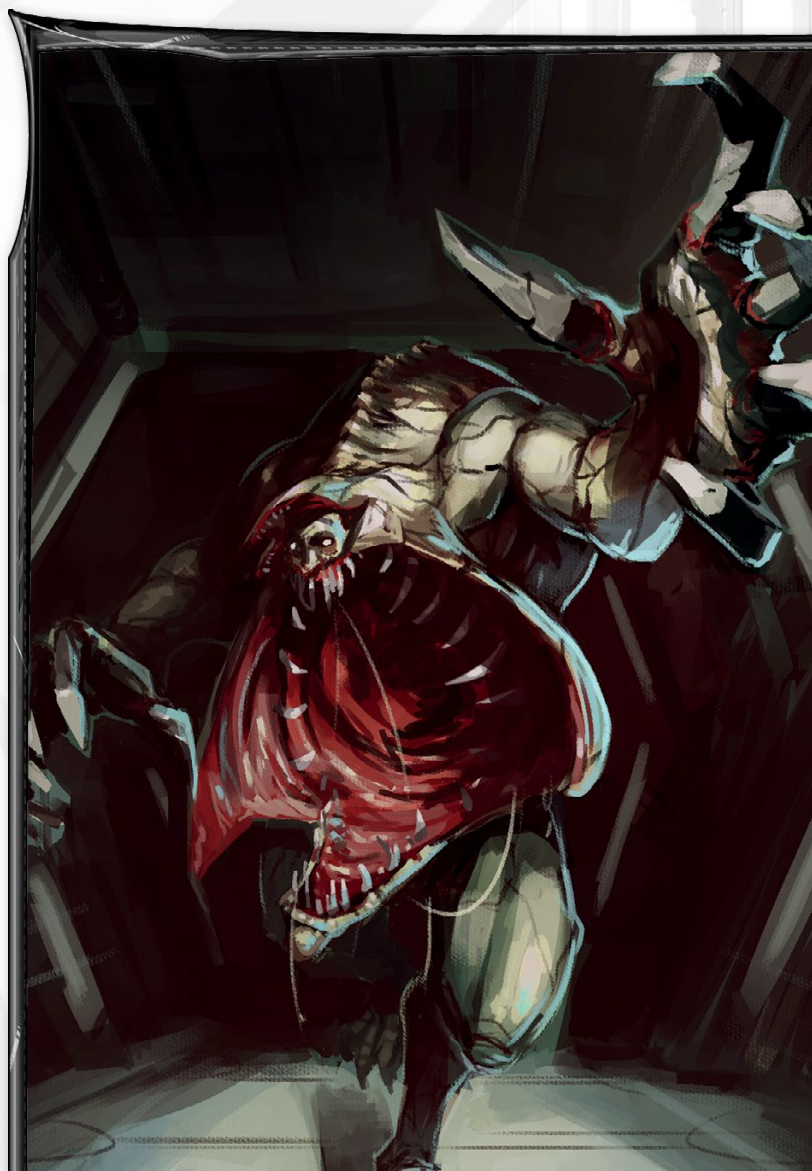

possible stand-offs are all possible. The fleshy organic matter growing up the walls appears anywhere there is light.

Dealing With It

A cursory investigation reveals the ship interior is heavily damaged, and that the damage is very old. There was once fighting here—*millennia* ago. A Fair (+2) Investigate or Science (biology, chemistry, etc) roll reveals organic traces throughout the interior. The Formians are here! A success with style reveals the traces aren't identical with those found on Beta Formiae-2.

On any failed roll or costly success, the vac Formians pick up the PCs' scent and start to close in!

VAC FORMIAN ATTACK!

As is traditional with ship-based sci-fi horror, you can prefigure vac Formian attacks before they happen, usually by describing "pings" on hand scanner readouts, sensorview or virtual vision, showing multiple alien life signs converging on the PCs' position. The PCs may try to evade, an Athletics or Stealth contest against the vac Formians' Athletics.

Figure the PCS will be attacked each time by 1 group of 3 vac Formian minor NPCs per PC, plus an optional 1 vac Formian warrior per combat-competent PC, or a variation.

All vac Formians have adapted to the ship environment, but otherwise have the same stats as other Formian models. They're *Lethargic and Dozy Unless Hunting or Eating*. There are several models:

- An EVA model—the classic vac Formian, a Hydragand / Dezimeer-type adaptation. They tend outlying meat plants and activate the occasional stasis berth. They have a *Vac Adapted* aspect.
- An aquatic model—the "meat farmers" of the shield ring ecosystem. They have an *Aquatic* aspect.
- Meat plants—hopefully now non-sentient—include the fleshy growths on the walls as well as sessile lactators

The Bremengen Diaspora

The Astral-440 left Old Earth seven hundred years after the main era of the Great Diaspora had ended. By that point, the Old Commonality was already starting to become introverted and isolationist, entering its early stages of decadence which would gradually become more stagnant and oppressive. What made this borderland arcology mount a colony mission? Who were the 60,000 who were chosen to leave?

and meat producers and photosynthesising plant/human hybrids. They're *Hideous Hydroponics*, and quite upsetting.

THE AWAKENED

The second instance of "ambiguous life signs" is the semi-intact stasis section in the middle ring. There were originally 7500 colonists here—time travellers from six millennia in the past. The vac Formians have been preying on this "food store", munching their way through and using "awakenees" as "booster stock", leading to a brief florescence as the faltering biome receives a boost. They've probably killed half of the colonists in this way, leaving about 3500 still in stasis.

The vac Formian biome is undergoing just such a florescence currently. A single stasis pod occupant has recently been awakened, and is now infected with the Shapechanger Plague and undergoing metamorphosis. The individual is **Nuschka Cheng He** from the Bremengen Arcology on the Shine / Yarp borderlands. If the PCs track her down, she'll be guarded by vac Formians and in a state of shock, infected and suffering moderate and severe (mental) consequences, and effectively temporarily insane. She speaks the same Uniworld dialect the PCs may have identified on Beta Formiae-2; a time traveller from Old Earth's distant past. She'll be terrified, disoriented, and deranged—and also very alien.

Outcome

The PCs have explored the ship interior and understood its layout. They may have encountered the vac Formians, and also found the Awakened.

WHAT HAPPENS NEXT?

To check out if the *Astral-440* contains any data records, see **Scene Three: MemCore**. To search for traces of the old colony's research into a treatment for the Shapechanger Plague, see **Scene Four: Salvation?**

SCENE THREE: MEMCORE

Where the PCs explore the inner habitat ring and discover the colony ship's ancient memory core.

Locations: The inner habitat ring "MemCore" section.

Environment: *Failed Memories of a Dead World* situation aspect.

The Hook

The PCs enter the zero-G hard vacuum of the ship sentience data stacks, looking for information on what happened to the *Astral-440* and its research into a treatment for the Shapechanger Plague.

Dealing With It

The data stacks are in a hard vacuum and zero-G along the central axis of the ship. It's a Superb (+5) Technical (Mind-

scape) contest to repair them; nanocells can help. Any failures or costly successes may alert the vac Formians.

THE SHIP SENTIENCE

The *Astral-440* had its own sentience—an early model in comparison with modern corpuses. It was housed in the memcore, but is no longer there, although there are traces. A Good (+3) Empathy, Investigation or other forensics roll in the ship's proto-Mindscape, or examining the memcore externally, reveals it killed itself.

HACKING THE MEMCORE

Once the memcore is repaired, the PCs may try a Great (+4) Intrusion (Hacker) roll to access its records. These tell the tale of the colony's final fall, the heroic last stand 2000 years ago. Each success reveals one of the following pieces of information, or two on a success with style.

- The ship was reorganised into a “colony” in its own right, under the command of the “MediCom” medical committee, whose sole purpose was the creation of a vaccine.
- “Our labs have developed a vaccine, but we cannot administer it. The hybrids are too aggressive. We have lost contact with Prime Colony. We have not been able to self-destruct. I only hope this virulent life form does not make it to the Commonality.” The location of the ship's labs is given: see **Scene Four: Salvation?**
- Four of the vessel's colony pods landed on Beta Formiae-2.
- There are indications that two of the remaining colony pods fled to other planets in the system. What happened to the remaining missing colony pod is unknown. Artful GMs may want to tap this for player paranoia—where could it be? Could the Formians have made it to another system? Even to the Commonality? Could they still be on the way?

Outcome

By the end of the scene, the PCs may have discovered the fate of the Beta Formiae colony, and also located the treatment for the Shapechanger Plague. They may also have encountered an infected “time traveller” from the Old Commonality of the sixth millennium.

WHAT HAPPENS NEXT?

The PCs may still have to get the Shapechanger Plague under control, at least for themselves—see **Scene Four: Salvation?** Otherwise they are probably now free to decide what to do about the system and the formiont threat—see **Epilogue**.

SCENE FOUR: SALVATION?

Where the PCs discover the original colony's treatment for the Shapechanger Plague—and encounter a dilemma.

Locations: The inner habitat ring “labs” section.

Environment: *Ancient and Threadbare Biohazard Protection* situation aspect.

The Hook

The PCs break through to the labs in the zero life support and low grav heart of the habitat ring, in the face of vac Formian opposition on costly successes.

Dealing With It

FINDING THE VACCINE

Searching the labs is a Superb (+5) Technical (Meditech) contest, opposed by marauding vac Formians. Archaeology and Science skills may provide advantages. On a success, the PCs find the vault and capsules containing the treatment created by the MediCom emergency medical committee—a full-blown **targeted therapeutic** (page 56).

The contest also reveals:

- If the PCs haven't already worked it out, that “We are dealing with a new species. It is not the hybrids which are intelligent—it is the bacteria which have colonised them, forced to evolve by the environment within the human host. Do we have the right to destroy a new species?”
- The treatment was never used: by the time the MediCom had deliberated, it was already too late. But do the PCs have the right to use it against the Formians now, knowing widespread use of it may constitute genocide, and even the most basic use on an infected individual tantamount to mass murder?

If the PCs try and employ the treatment as is, it's an Epic (+7) Technical (Meditech) roll; the Shapechanger Plague has itself changed over the millennia. Failure either renders the plague immune, or destroys the infection **and** the host. However, some slight tweaking and a Superb (+5) Science (biology) or Technical (Meditech) create advantage roll on a captured Formian or infected character and a few days' work can create a *Modified Vaccine* advantage and allow the treatment to be administered by Mindscape-linked nano-drone—see “Targeted Therapeutic: Stage 3” on page 57.

Outcome

The PCs have the ability to cure the Shapechanger Plague, and even potentially wipe out the formionts.

WHAT HAPPENS NEXT?

The PCs (and players) must decide how the expedition is going to deal with the Formians and end the adventure. See **Epilogue: Threat Analysis** below.



EPILOGUE THREAT ANALYSIS

*WHAT DO THE PCS DECIDE IS THE FATE OF
BETA FORMIAE AND THE FORMIONTS?*

By the end of the adventure, the PCs may have overcome the formiont threat, or may have succumbed, possibly leaving the formionts more powerful than they were before.

VICTORY CONDITION: THE FATE OF BETA FORMIAE

If the PCs counter the threat posed by formiont contagion and the Shapechanger Plague—either by avoiding contamination, or discovering a treatment for it—they may return to Commonality Space. First, though, they must decide what to do with the Formians.

Quarantine

The PCs may decide the Formians represent an existential threat, but are nevertheless a sentient species with a right to exist. They may decide to enforce the Commonality Quarantine (*Mindjammer* page 307), prohibiting unauthorised personnel from visiting the planet and stationing Commonality q-ships in system. They may also recommend the Commonality continue its contact and cultural manipulation efforts—possibly with mechanical personnel.

CULTURAL MANIPULATION

The PCs may realise that a Formian league is an exoculture, and that the Walkers in particular can be manipulated and encouraged to evolve into a less threatening form. This is a good way of dealing with the situation. You can run the PCs'

(or SCI Force's) attempts to manipulate the Walker Formian exoculture (page 63) as an ongoing effort, as a sequel to this adventure or as an ongoing activity in your campaign.

DIPLOMATIC RELATIONS

There are many mysteries about the formionts, including whether or not they are native to Beta Formiae, or whether they arrived on the world via some process of panspermia. The fact that the planet's sessile life forms are not host to formionts may be significant. Until a research expedition can analyse the world's fossil record and genurgic history, theories are pure conjecture.

Extreme Sanction

The PCs may decide the formionts constitute too great a threat to the Commonality, and should be destroyed—euphemistically referred to as **extreme sanction**. An extreme sanction of the formionts probably uses Commonality planetbusters, and requires the invocation of the **Samson Protocol**.

THE SAMSON PROTOCOL

The Samson Protocol is one of several procedures by which a Commonality sentient starship may voluntarily destroy itself. A **Samson** is a frequent archetype in human and hominid cultures; a hero who destroys him- or herself and environment to neutralise a far greater threat. The Samson Protocol may specifically be invoked as a **planetbuster** when the Com-

monality is facing an immediate and unavoidable existential threat and no other recourse can be envisaged. The voluntary self-destruction is a necessary part of the Samson Protocol to ensure it is only resorted to in extremis.

With the Samson Protocol, a single planeship releases the stored energy of its ZIP plant capacitors in a single “reverse makepoint” explosion. It’s a complex task, with microsecond adjustments requiring the ship’s own participation in its own destruction, and a Fair (+2) Planing roll.

A planetbuster detonation causes an extinction level event on a garden world, sterilising its surface. The Samson vessel’s sensor drones are permitted to survive to ensure the extreme sanction has been effective. Any other survivors incur at least a Severe mental consequence as instruments of such widespread destruction.

Treatment

A possible middle ground is to aerosolise the vaccine and destroy all the formions on Beta Formiae 2. This involves massive environmental destruction, but will not kill the formion hosts, instead leaving them helpless and infantilised—blank slates ready to start again. This still imposes at least a Moderate mental consequence on those taking part: it’s “genocide-lite”.

Cultural Impact

Regardless of what the victorious PCs decide, if the story of Beta Formiae becomes public knowledge, it acts as a *Sentient Bacteria Are Scary*-type Good (+3) Memetic Cascade meme attack against the Commonality culture.

DEFEAT CONDITION: THE FORMION MENACE

At best, the entire crew of the *Magnanimous Intervention* perishes without their knowledge being acquired by the Formians. At worst, the Shapechanger Plague succeeds in its attempt to get offworld—perhaps by stealing the shuttle (slower-than-light, so a great hunt!) from Maggie, or even the ship itself! In this case, there’s a new power in the galaxy: the Formion Menace.

This condition may also arise if the PCs bring back a Formian, or even a formiont sample, or someone infected to the Commonality, and it gets out—though this shouldn’t be possible if the contagion protocols are followed.

It’s even possible a deranged Commonality agent or a foe like the Venu may find out about the Shapechanger Plague, and travel to Beta Formiae to get a sample and release it. These events are outside the scope of this scenario, but the GM may wish to use them in subsequent adventures.



The Secret History of Beta Formiae

It's possible the PCs will never piece together what really happened on Beta Formiae. If they don't, and you like doing "cut scenes", here's a historical montage of the disaster which befell the hapless colony.

Beta Formiae was the site of a colony from the Bremengen Arcology on 6th millennium Old Earth. Even when its satellite colonies fell to the Shapechanger Plague, Prime Colony held out the longest; its goal was to hide and survive.

Prime Colony held out for perhaps a thousand years. Sometimes it seemed like it would succeed; then it would be thrown back again. Eventually even it fell to the Shapechanger Plague, and the human presence on Beta Formiae 2 was extinguished.

For a time the colonists held out on the Astral-440, in a race against time to discover a treatment for the

Shapechanger Plague before life on the colony ship became untenable. Finally, however, the plague broke out there, too. In desperation, the ship sentience tried to self-destruct the ship, but it was prevented from doing so by the colonists—the exact reason is unclear. Those colonists in turn fell to the Shapechanger Plague, but not before the ship sentience was able to destroy its own genurgic brain before its knowledge could be subsumed by the formions.

Back on Beta Formiae 2, the values and capabilities of the last human colony were passed on to the invading formions which took the colonists' forms. Over time they evolved into a new "advanced" formion—the Walkers—building upon the subtle legacy of defensiveness and manipulation of Prime Colony to become a league of expert mediators free of the urge to destroy any divergent life form.

Commonality Reaction

In the worst case scenario, treat this as an automatic Memetic Cascade success against the Commonality culture, resulting in witch-hunts, persecutions, sanctions, quarantines, and more.

Cultural Impact

If the formions get offworld, this will also cause an ongoing Memetic Cascade meme attack on the Commonality, using the formion culture stats on page 63. SCI Force will be desperate to keep it under control.

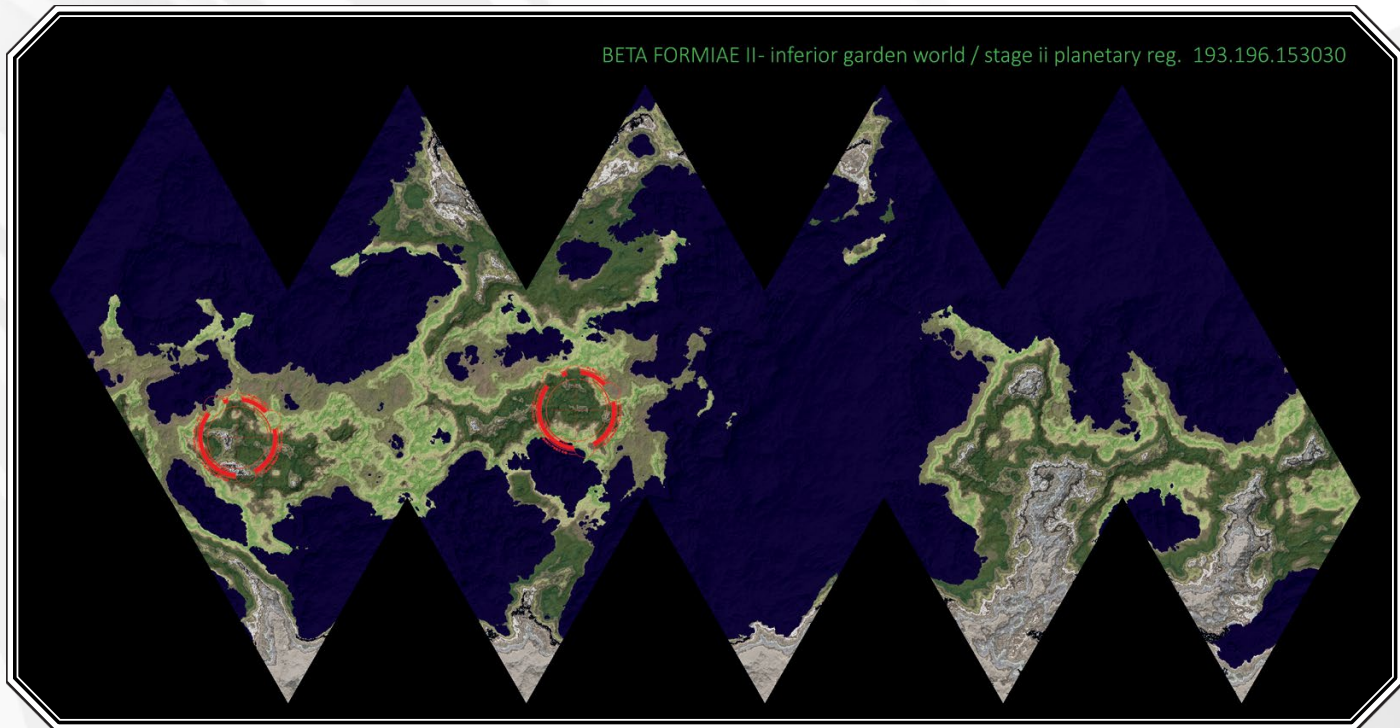

CONTACT PROTOCOLS

- *Away teams may only be present on-planet for a few hours, to keep contamination risk low, until the environment has been determined to be **low risk**.*
- *The shuttle is considered a habitat; its anti-contamination measures are less stringent than the ship, but nevertheless time spent in the shuttle habitat is not considered time spent on-planet.*
- *P-suits and force helmets are to be worn until the environment has been determined to be low risk. Even then biosecurity is usually maintained.*
- *Environment boundaries are to be kept sterile and isolated: between surface (planetary environment) and interface (shuttle), and between interface and headquarters (ship), sterilisation and decontamination measures are to be carried out.*
- *No items are to be transferred between headquarters and surface without authorisation. Items are to be transported in sterile secure containers.*

NCE Contact Protocols 193.151 inst.

CONTAGION PROTOCOLS

- 1. The expedition is locked down.** *Movement and communication are forbidden until the extent of the threat and the possibilities of isolating and quarantining it are known. Individuals are expendable.*
- 2. Communication is incrementally restored.** *Initially only indirect (non-realtime) thoughtcasts are permitted, analysed to ensure no memetic virus or other contaminant is being communicated. Once confirmed, real-time communication is permitted.*
- 3. The extent of contamination is determined.** *Is only one area affected? Is the ship environment compromised? Are individuals contaminated, and if so is their function compromised, and do they need to be replaced? Can they be treated?*
- 4. Contagion is analysed and a treatment, containment, and decontamination strategy devised.** *Can analysis be performed without transfer? If not, what form of transfer is required? Transfers are subject to contact protocol quarantine and isolation.*
- 5. Containment and optional decontamination procedures are implemented.** *If the contamination is in a controlled area such as a vessel, the environment may have variable **biohazard protection levels** which may be selected and which may be hazardous to life forms.*

NCE Contagion Protocols 193.151 inst.

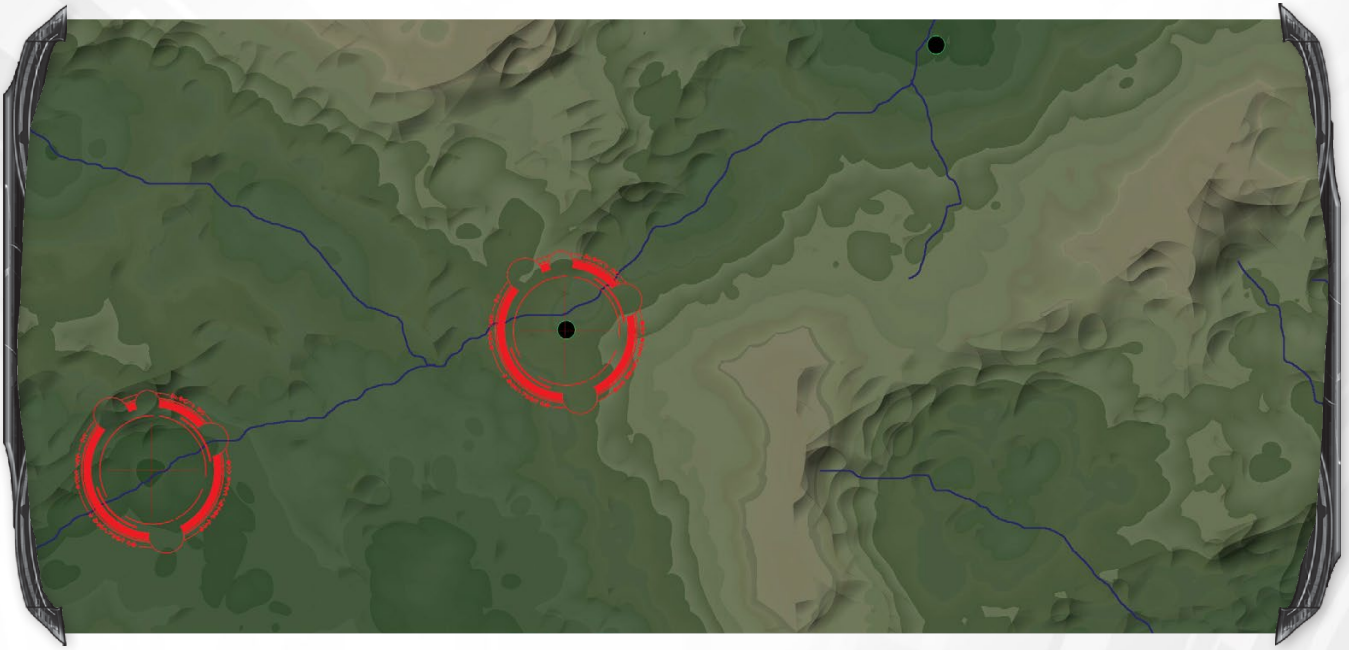

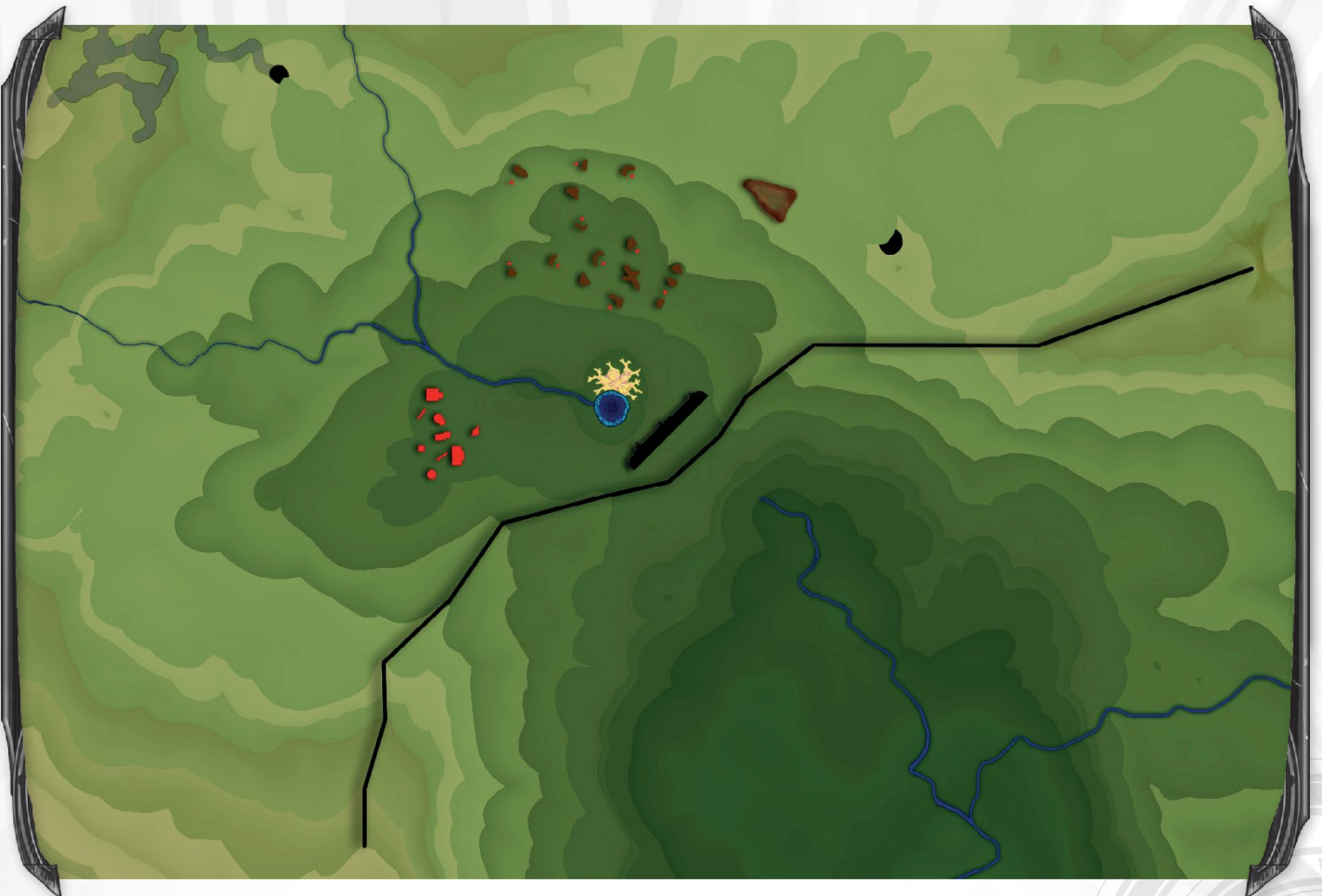
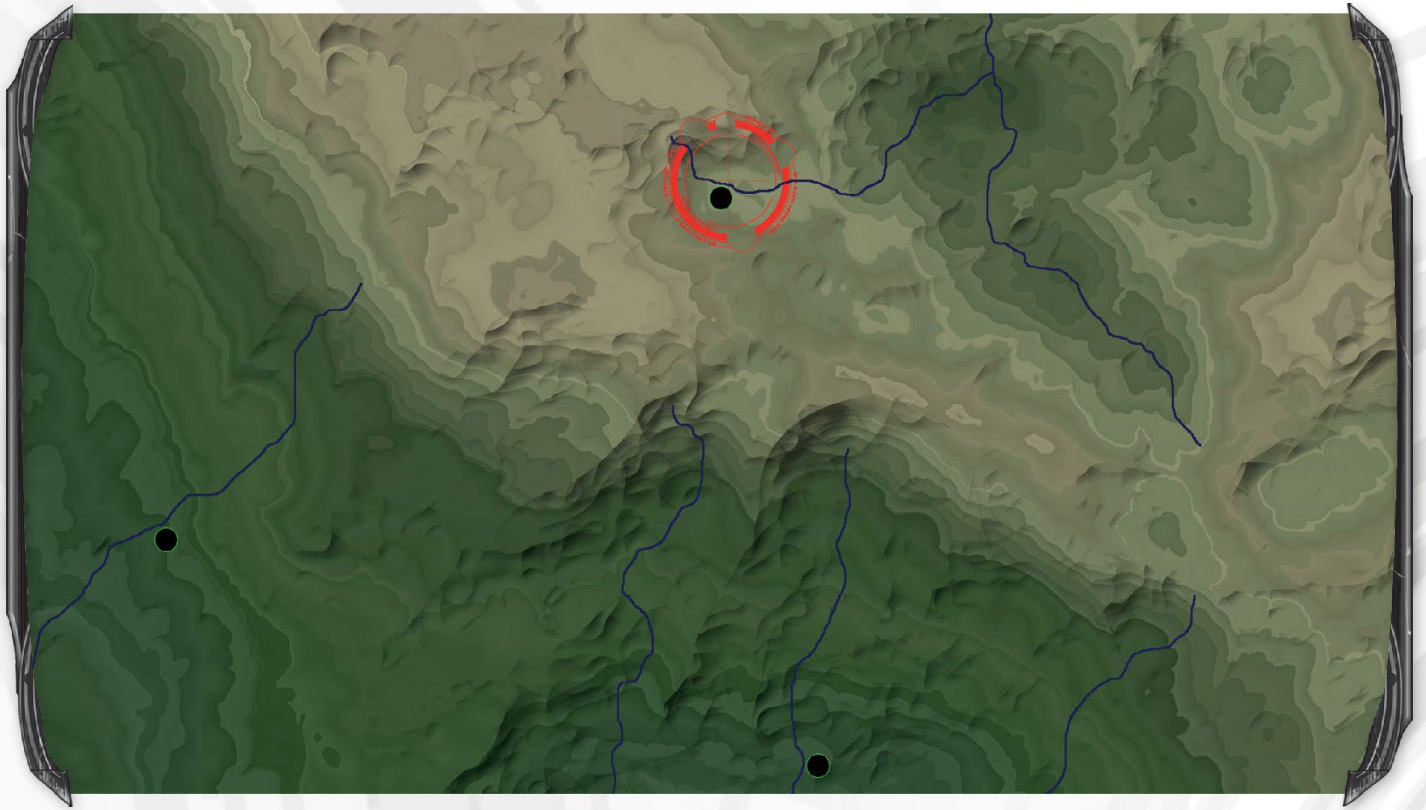

INDEX

A Different World – Things Visitors Notice	36	Event Horizon Probe	25	Player Handouts	76
A Lost Civilisation?	11	Exointelligence Builds	16, 63	Plot Stress: The Breach	41
Alternative Approaches	4	Extreme Sanction	73	Pregenerated Characters	28
Amphib League	55	Fear and Horror	37	Prime Colony	60
Analyses	39	Finding the Vaccine	71	Protocols	42
<i>Biohazard</i>	48	First Contact	46	<i>Contact</i>	42
<i>Biosphere</i>	48	<i>With the Monolith</i>	51	<i>Contagion</i>	43
<i>Civilisation</i>	48	Fleshbags	8	<i>Samson</i>	73
<i>Magnitude</i>	50	Formians	14, 15, 16	Quarantine	73
<i>Manifestation</i>	49	<i>Fighting</i>	56	Ragbats	9
<i>Preliminary Scans</i>	46	<i>Knowledge Acquisition</i>	13	Ragrass	8
<i>SCI Force Stage Zero Evaluaiton</i>	51	<i>Metabolism</i>	12	Reproduction	13
<i>Secondary Surveys</i>	48	<i>Motivation</i>	14	Rest of the System	9
A Secret Mission?	44	<i>Nature of</i>	49	SCI Force	35, 25
Assessing Details vs Declaring Details	39	Formionts	11, 16	Shapechanger Plague	12, 56
Astral-440, The	7, 66	<i>Naming</i>	12	<i>Treatment</i>	13, 56, 74
<i>Ship Areas</i>	68	Fringe Pilot Programme	27	<i>Broad Antibiotic, Targeted Prophylactic,</i>	
The Awakened	70	How Are the Protocols Defeated?	43	<i>Targeted Therapeutic</i>	56
Away Teams	36	Inventor Paradox	14	Ship's Brain	25
<i>Away Team Events</i>	37	Involving the Characters	5	Ship Sentience	71
Beta Formiae	Inside Front Cover, 6	Key Assessments	40	Shuttle	54, 62
Blasted Areas	48	Lost Ship, The	66	Space Force	26, 35
<i>Botany Bay</i> -class Stage 2 Explorer	20	Luminosity Alpha's Sensorium Report	39	Starting Play	35
Breach, The	41, 42	Maggie, the Ship Sentience	31	"Society" and Leagues	13
<i>Dealing With</i>	44	The <i>Magnanimous Intervention</i>	20	Table 1: Timeline of Beta Formiae History	8
Cave System	60	Managing the Discovery of the Formionts	55	Table 2: Typical Formian League Structure	15
Colony Pod	61, 68	Meeting the Walker	57	Table 3: The <i>Magnanimous Intervention</i> Crew	
Communication	14, 57	Memcore	71	Roster	38
Containment and Decontamination	43, 45	Metal Objects on the Surface	47	Table 4: Beta Formiae Wilderness Events	38
Crew	27	Milk Truck	19	Table 5: Formian Encounters	39
<i>Attitudes</i>	40	Monitor	19	Tank	18
<i>Equipment</i>	37	Mono League Purity Compound	53	Threat Analysis	73
<i>Playing the Crew</i>	35	Mother Mass	17, 54	Vac Formian Attack!	70
Cultural Impact	73, 74, 75	Native Ecosystem	7	Valley of War, The	52
The Default Plot Thread	40	New Construct Extra: Away Team	36	Victory Condition: The Fate of Beta	
Defeat Condition: The Formiont Menace	74	New Extra: Formian Shapechanging	17	Formiae	73
Description of Ship Areas	22	Observance Rolls	42	Vision Thing, The	63
Did the Original Colony Develop a		The Old One	58, 64	Walker Formionts	59, 62, 63
Treatment?	57	<i>The Old One's Plan</i>	65	Warrior	18
Diplomatic Relations	73	Packrat	18	What If the PCs Don't Have a Skill?	40
Dozer	17	Papertrees	9	When Does the Breach Happen?	44
Environment	6	Peaceful Lands, The	58, 59	Who Are the PCs?	35
		Persisting With a Preliminary Cultural			
		Analysis	49		

MINDJAMMER™

THE ROLEPLAYING GAME

THE CITY PEOPLE — DEADLY EXPLORATION AND ADVENTURE!

The recording showed some kind of forest. The drone wove through tangled undergrowth, weird plants bigger than a flyer. The place stank. Biodata scrolled down my peripheral vision, then flashed up an anomaly.

“Okay,” the ship interrupted. “This is where things get weird. There’s a life form over there—through that dense patch of foliage. Keep watching. It’s only a flash.”

It was. The drone broke cover, and amidst the green there was this flash of pink, and a stink like the rankest body odour ever. An impression of something huge—monstrous, big as a house, just sitting there. Then—and my flesh still crawls—there was a groan. A really human groan. Then the drone went down.

There was a silence as the recording ended, and Dr Clay looked up. “We’re gonna have to go down there.”

An event horizon probe has discovered a lost colony world beyond the Commonality Frontier like no one has ever seen before. Join the crew of Maggie, the *Magnanimous Intervention*, and take the light of humankind’s civilisation to the stars. Are you ready to push back the darkness—whatever you may find?

The City People includes:

- a whole alien world—maps, biosphere, and more;
- a deadly multi-session scenario of conflict, investigation, and mystery;
- tech specs, deckplans, and details of the Space Force instrumentality.

A danger-filled exploration adventure for *Mindjammer — The Roleplaying Game*. The *Mindjammer — The Roleplaying Game* core book is required for play.

MINDJAMMER
PRESS

www.mindjammerpress.com

MÖDIPHIUS
ENTERTAINMENT

POWERED BY
FATE™

ISBN 978-0-9574779-9-5



\$24.99

SKU: MUH042203