

DUNGEONS & DRAGONS®

Expert Game Adventure

Quagmire!

by Merle M. Rasmussen



To the rescue! The murky sea is swallowing an exotic spiral city, and you are its only hope! But who are these creatures that want you to fall?

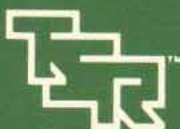

TSR, Inc.
PRODUCTS OF YOUR IMAGINATION™

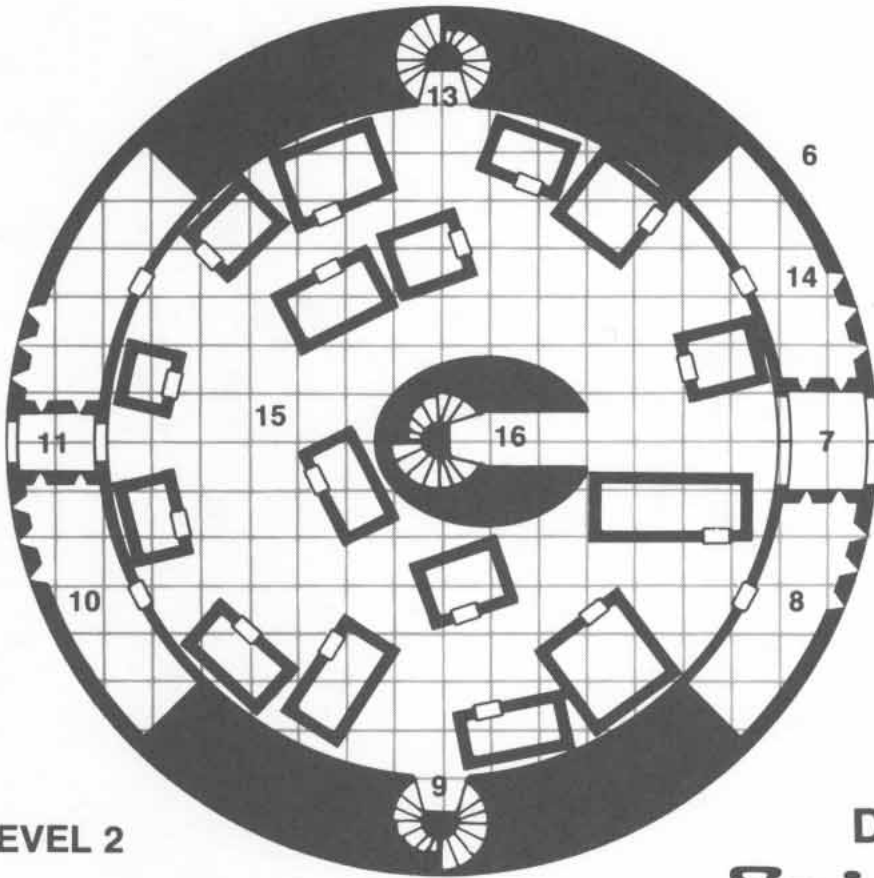
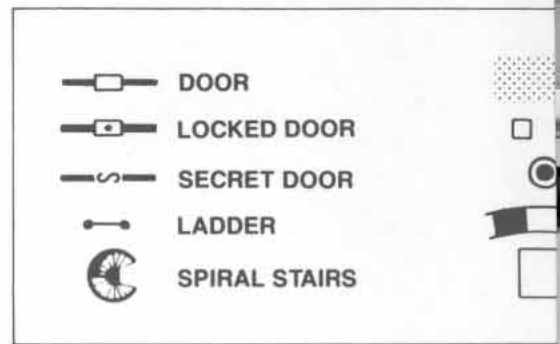

LEVEL 2

DM MAP 3
Spiral City

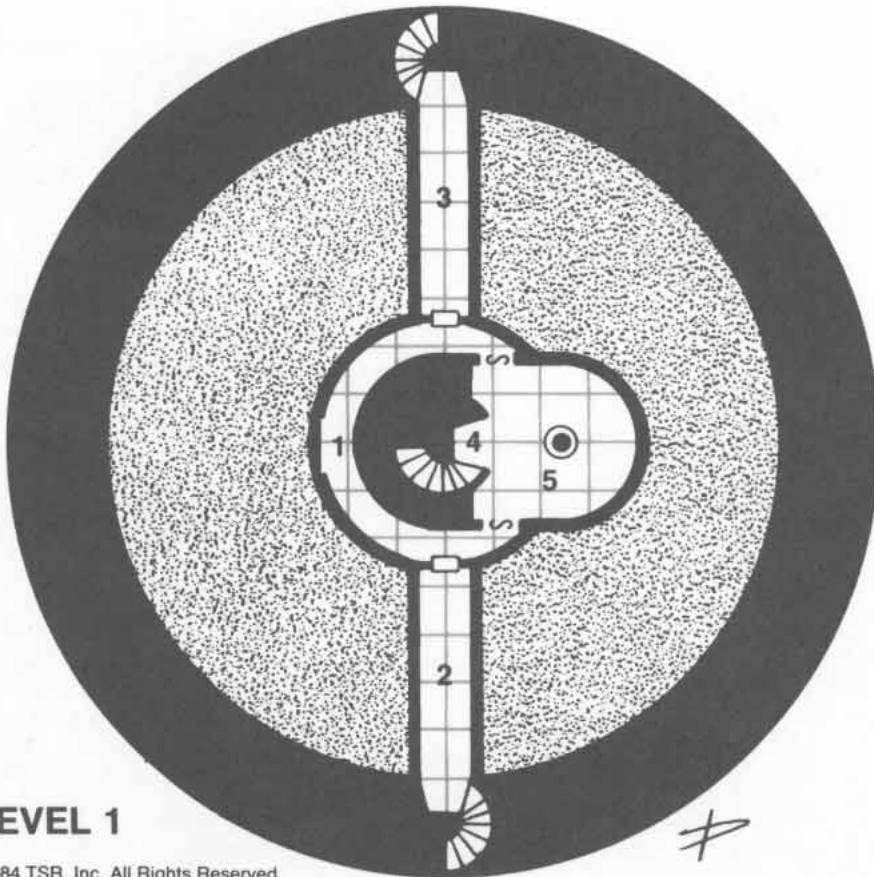
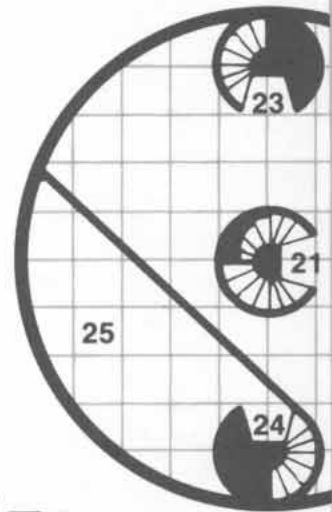

LEVEL 1

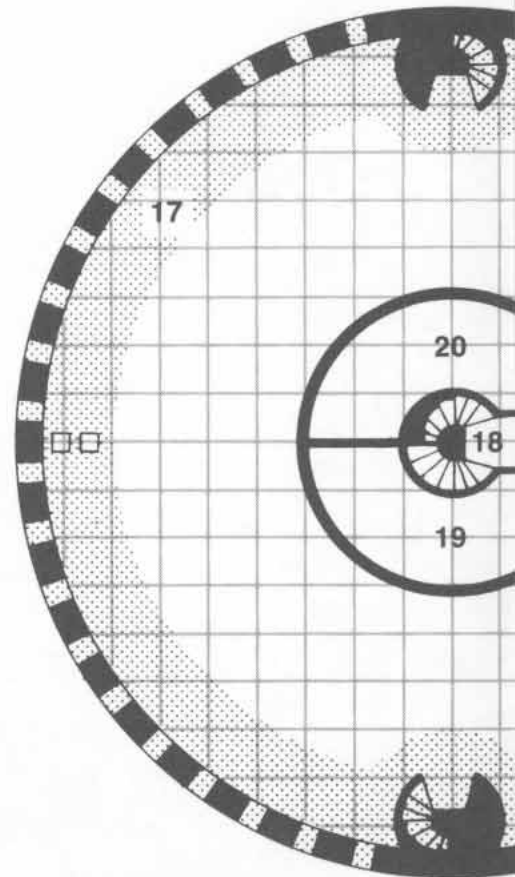

DUNGEONS & DRAGONS

Expert Game Adventure

QUAGMIRE

by Merle M. Rasmussen



Editor: Tim Kilpin
 Cover Artist: Steve Peregrine
 Interior Artist: Jeffrey Butler
 Graphic Designer: Ruth Hoyer
 Maps: Diesel

Distributed to the book trade by Random House, Inc., and in Canada by Random House of Canada, Ltd. Distributed to the toy and hobby industry by regional distributors. Distributed in the United Kingdom by TSR (UK) Ltd.

DUNGEONS & DRAGONS and D&D are registered trademarks owned by TSR, Inc.

©1984 TSR, Inc. All Rights Reserved. Printed in U.S.A.

This adventure is protected under the copyright laws of the United States of America. Any reproduction or other unauthorized use of the material or artwork contained herein is prohibited without the express written permission of TSR, Inc.

TSR, Inc. TSR (UK) Ltd.
 POB 756 The Mill, Rathmore Road
 Lake Geneva, Cambridge CB14AD
 WI 53147 United Kingdom



ISBN-0-88038-112-4
 394-54006-9TSR0600

TABLE OF CONTENTS

PREPARING FOR THE EXPEDITION

About this adventure	2
Adventure setting: The wild lands	3
Adventure background	5

WILD LANDS ADVENTURES

Area encounters	6
Set location encounters	14

SPIRAL CITY ADVENTURES

Level 1: Well area	22
Level 2: Entry areas	22
Level 3: Barracks	23
Level 4: Money chamber	24
Level 5: Market area	24
Level 6: Service area	25
Level 7: Private quarters	26
Level 8: Rented rooms	26
Level 9: Dining area	26
Level 10: Ruler's quarters	27
Level 11: Jail	28
Level 12: Spiral staircase	28
Level 13: Pinnacle of flame	28

APPENDIX

Monsters	29
Thanegia wilderness encounter tables	30
Prerolled characters	32
New magic items	32

LIST OF PLAYING AIDS

Table 1: Gales & Hurricanes	4
Table 2: Map Hex Distances	5
Table 3: Area Encounters	6
Table 4: Storms & Effects	7
Table 5: Subsurfaces	9
Table 6: Sandy Shoreline Debris	9
Table 7: Floating Flotsam	10
Table 8: Rocky Coastline Debris	13
Table 9: High Seas Encounters	14
Table 10: Island Gravesites	19

Trade Items Chart	12
Thanegia Wilderness Encounter Tables	30

DM Map 1: The Wild Lands	16-17
DM Map 2: Quagmire Area	15
DM Map 3: Spiral City	inside cover
DM Map 4: Spiral City — Side View	18
Players' Map: The Wild Lands	outside cover



Preparing, p. 2



Area encounters, p. 6



Set location encounters, p. 14



Spiral city adventures, p. 22



Appendix, p. 29

PREPARING FOR THE EXPEDITION

About this adventure



Quagmire is a combined wilderness and dungeon adventure designed to provide players with a wide variety of new settings in which their characters may explore. Throughout

out the course of the adventure, characters travel across strange seas, swampy peninsulas, and burning deserts. Each terrain holds new challenges for the characters, some that pertain to the characters' goals, and some that simply provide excitement. The adventure also allows for characters to explore three separate cities.

The adventure is also designed to provide you, the Dungeon Master, with a wide range of encounters set in various types of terrain. How you run these encounters directly affects how well the characters perform their duties, and how excited the players get while taking part in the game. When characters are exploring swamps, give the encounters in those areas an especially menacing and mysterious feel. As characters move through the desert or across the sea, describe their encounters as sunny and monotonous. When characters explore mudflats and estuaries, describe these areas as sticky, dangerous, and filled with thousands of strange life forms.

There are six main areas of adventuring in Quagmire: the continent, Serpent Peninsula, the area surrounding the city of Quagmire, Thanegia Island, the spiral cities (Quagmire, Thanopolis, and the Sunken City), and the seas.

The areas introduced in Quagmire are designed to expand the D&D® world outlined in the Expert rulebook and other Expert adventures.

You may also place the areas and events of Quagmire within an already existing campaign setting, as long as you make sure the geographical areas of your campaign match those set forth in this adventure.

Before beginning play, you should read the entire adventure carefully and become completely familiar with it. Most of the information given in the area descriptions is for your eyes only, although you should read all boxed text to the players as their characters enter specific areas. Feel free to use your imagination to embellish the encounters as you wish. Make sure you don't give the players too many clues or suggestions, however.

Plot synopsis

The adventure begins when the characters receive an urgent plea from the leader of a city called Quagmire. The city, once a thriving trading port, is now sinking into the sea, and the city's leader is calling for help.

If the characters decide to help the people of Quagmire, they may set out from any of these locations: Slagovich, Specularum, Pramayama, Ierendi, or the Isle of Dread.

When the characters reach Quagmire, they find that it is under siege by creatures from the surrounding swamp. Once the characters enter the city, survivors there ask the characters to escort them to the legendary city of Thanopolis. According to the survivors, Thanopolis lies on the southwest side of the island of Thanegia.

Thanopolis does indeed exist, but it is infested with denizens of the surrounding swamps and jungles. Within the legendary city, which is a duplicate of Quagmire, are clues to a third sister city. This third city sank centuries ago, and is now inhabited by mermen. The characters may also try to find this city.

Encounter maps

DM Map 1 is a detailed view of the wild lands. It shows portions of the continent, Serpent Peninsula, Thanegia Island, and the surrounding seas. DM Map 2 shows the area that surrounds the city of Quagmire. The large hexes on this map are equal in scale to the small hexes on DM Map 1. DM Map 3 shows the 13 levels of the spiral cities (Quagmire, Thanopolis, and the Sunken City). All three cities utilize the same map. DM Map 4 shows a side view of the spiral city.

The outside cover gatefold features a players' map of the wild lands. Several areas on this map have been left blank. As characters explore the wild lands, the players may add terrain and other notes to this map. The reverse side of this map contains the parchment the characters find at the start of the adventure. It also features a rough map of the wild lands. This map shows how the wild lands tie together with the areas of the world outlined in adventures X1-X5.

To get a better idea of how the wild lands relate to other areas of the D&D® world, note that the eastern edge of DM Map 1 in this adventure is situated 11 hexes west of the Continent Map on p. 16-17 in adventure X1, The Isle of Dread.

If you have adventure X4, you may line up the top 3½ hex rows of DM Map 1 from this adventure so that they overlap the bottom 3½ hex rows on the Map of the Great

Waste (p. 7 in adventure X4, Master of the Desert Nomads).

The Map of Hule on p. 31 of adventure X5 (The Temple of Death) shows the port city of Slagovich and some of its surrounding terrain. You may also find Slagovich on DM Map 1 in this adventure. Map 2 in the D&D® Expert rulebook (p. 33) shows the sea trade routes the characters may travel from Specularum and Ierendi in this adventure.

Statistics and abbreviations

Monster statistics are listed in the following order:

Monster/NPC Name (No. appearing, if more than one); Armor Class; Hit Dice or Class/Level; hit points; Movement per turn (round); No. of attacks per round; Damage per attack; Save As: Class/Level; Morale; Alignment; Experience Point value; and abilities for NPCs (such as spells), when appropriate.

The following abbreviations are used in this adventure:

AC	- Armor Class	F	- Fighter
HD	- Hit Dice	ML	- Morale
hp	- hit points	AL	- Alignment
MV	- Movement	L	- Lawful
#AT	- no. of attacks	C	- Chaotic
D	- Damage	N	- Neutral
Save	- Save As	XP	- Experience Point value

The party of adventurers

Quagmire is designed for a party of 2-8 characters. Each character should be between the 4th and 10th levels of experience. A party of characters should include a cleric who is no lower than 6th level. Each character should have two or three magical items, including magical swords and armor. All characters should be outfitted for a wilderness adventure.

Wandering monsters

An east-west line runs through the city of Quagmire on DM Maps 1 and 2. This line is the Wandering Monster line.

When you are checking for wandering monster encounters, check to see if the characters are traveling above or below the Wandering Monster line. If the characters are above the line, use the Wilderness Encounter Tables from the D&D® Expert rulebook (p. 30). If the characters are below the line, use the Thanegia Wilderness Encounter Tables on p. 31 of this booklet.



Use the Thanegia Wilderness Encounter Tables as you would the encounter tables in the Expert rulebook. The Thanegia tables have been set up to represent the different, more exotic types of animals that characters find in remote southern terrains.

Capturing wild animals

During the adventure, characters may want to capture wild herd animals (horses, mules, and camels, for example). To capture a wild animal, a character must rope the animal.

Whether a character is on foot or on the back of another animal, his chance of roping a wild animal is the same as if he were trying to hit it with thrown oil or holy water. Consider an animal roped once a lasso hits it.

For each character who ropes an animal, roll 3d6. If the dice roll total is greater than the character's Strength score, the animal escapes. Otherwise, the animal is considered to be roped.

Each rope on an animal eliminates one of the animal's attacks. If an animal has two attacks, characters must rope that animal twice before it can be considered captured.

Adventure setting: The wild lands

(DM Map 1)

Pages 16-17 of this adventure feature a large-scale wilderness map. Use this map as a guide when characters travel by land or sea to Quagmire and beyond.

This map may also serve as an example of a large-scale wilderness design. You may want to base dungeon and wilderness adventures on this map, or you may expand the map by designing wilderness areas where the map leaves off.

Following is a key to the areas mentioned

on the map. The key gives only a brief background of most areas. You may "flesh out" individual encounter areas with your own information.

To read the wild lands map, start at the top and read from left to right. The key below is divided into seven parts: south central continent; Serpent Peninsula; Sea of Dread; Shallow Sea; Thanegia Island; Western Thanegioth Archipelago; and the Western Sea.

Wild lands map key

South central continent: This area of land includes the city of Slogovich, Bush Country, the Sind Desert, the Burning Waste, and the Barren Plain.

City of Slogovich: This opulent, Western Sea trading port stands at the western end of the Sind Desert Caravan Track. Characters may find all kinds of exotic goods being exchanged in the streets of this hilly city. Slogovich's rocky port features excellent, deep harbor facilities.

Bush Country: This remote grassland stretches southeast from Slogovich to the Neck Grasslands. It is bordered on the east by the Sind Desert and on the west by a sandy shoreline that runs along the Western Sea. Various types of wildlife are abundant here; so are nomadic hunters.

Sind Desert: This desert is more barren and stony than sandy. Rocky areas, craggy bluffs, and patches of dry thorn bushes dot the landscape. During the daytime, temperatures often reach 100 degrees or higher. At night, the temperatures drop to as low as 30 or 40 degrees.

Experienced travelers do not travel during the noon or afternoon on the Sind Desert. Most traveling is done during the morning, late afternoon, and early night. If characters insist on traveling through the desert during the hottest part of the day, have each of them make a saving throw vs. death ray. Those

who fail their saving throws take 1d4 points of damage from the intense heat.

Burning Waste: This region of craggy, eroded rocks lies over an active geothermal subsurface. Minor quakes and avalanches rock this area frequently, and geysers and tar pits are common. The shifting rocks of the waste occasionally release natural gases, which then burst into flame. These gases burn for weeks, sending dark clouds of smoke into the desert sky. Because of the area's violent, unpredictable terrain, there are no permanent dwellings or communities in the Burning Waste. Pitch, which is used for sealing ships, is the area's only valuable commodity.

Barren Plain: This sandy, rolling stretch of land is warm and windy. Little plant or animal life survives here. It is bordered on the north by the Sind Desert and the Burning Waste. A rocky shoreline that runs along the Sea of Dread forms the plain's southern border. The Silt River, which flows from the Burning Waste to the Sea of Dread, cuts the plain in half. The Barren Plain is known for its inclement weather.

Serpent Peninsula: How this stretch of land earned its name is not known for sure. Some have speculated that it was so named because of the serpentine trade route that ships must follow along its coast. Others feel the name is a reference to the large number of snakes that live throughout the area. A caravan route known as "The Necklace" separates Serpent Peninsula from the south central continent. The Necklace connects the east coast village of Sea Camel to the west coast village of Mule Beach. The geographical features of Serpent Peninsula include: the Neck Grasslands; the River Hills; the Rain Forest; the Lagoon Lowlands; the Fangs; and the Serpent Keys.

Neck Grasslands: So named because of the narrow isthmus they cover, the Neck Grasslands are teeming with several kinds of dangerous creatures. The Throat River slices through the center of the grasslands and empties into the Western Sea at Mule Beach. Both of this area's coastlines are sandy.

River Hills: Grass and trees cover these rolling hills. Many of the peninsula's meandering rivers start here and run down into other types of terrain in the form of waterfalls.

Rain Forest: Daily thunderstorms drench this forest and form rivers that wind to the surrounding seas. The Sea of Dread borders the forest on the east; the Western Sea borders on the west. Wildlife abounds in this tropical region. Both of the forest's coasts are muddy.

Lagoon Lowlands: Three large, fresh-water lakes lie in this sticky region. The land of this marshy bog gives with each footstep. The earth here is so low and swampy that it is difficult to tell where the muddy coastlines end and the swampy lands begin. Seawater mingles with the roots of gnarled trees along the coasts.

The Fangs: These muddy points of land are the southeast and southwest tips of Serpent Peninsula. Traders use the Fangs as landmarks. East Fang Cape is due north of the city of Quagmire. A sea trade route that runs between the two capes separates the Lagoon Lowlands and the Serpent Keys.

Serpent Keys: These low, swampy islets lie just off the coast of the Lagoon Lowlands. The keys serve as natural breakwaters to protect trade ships from the direct force of the Sea of Dread. Some of the smaller keys are no more than offshore sandbars. Most of these keys have muddy coastlines.

Sea of Dread: This body of water is bordered by the continent to the north, Serpent Peninsula to the west, and the Thanegioth Archipelago to the south. Many rivers empty from the continent and peninsula into the Sea of Dread. Sea Camel Gulf is a northwest extension of this sea.

Narrow channels from this sea run past the city of Quagmire into the Shallow Sea.

Shallow Sea: This body of water is bordered by Serpent Peninsula to the north and Thanegia Island to the south. Channels that run past the city of Quagmire connect this sea to the Sea of Dread. More channels run past a handful of islands at this sea's western end, connecting it to the Western Sea.

Thanegia Island: The history of this island is shrouded in mystery. Legends speak of the Yavdlom, an early race of man that lived here in harmony with the island's natural beauty. At that time, several different forms of life were said to have filled the island. The legends also say, however, that some unknown force eventually decimated the island's life forms, and the Yavdlom apparently moved on to other lands. The unknown force was actually the slow sinking of the land that now makes up the floor of the Shallow Sea.

New forms of rare and exotic plant and animal life now thrive on this mysterious island. The tropical island has four distinct regions: the Sinking Keys; the Thanegian Swamp; the Thanegian Jungle; and the Hill Country.

Sinking Keys: These keys are little more than sandbars covered by swampy vegeta-

tion. They stretch all along Thanegia Island's northern coast, forming a natural breakwater. The coasts of these keys tend to be muddy and swampy.

Thanegian Swamp: This swamp is similar to the Lagoon Lowlands on Serpent Peninsula. There are, however, no fresh-water lakes in this swamp. This swamp forms the coastline for the entire island, and is only broken by a few slow rivers.

Thanegian Jungle: This jungle is similar to the Rain Forest on Serpent Peninsula. There is a greater variety of plant and animal life in this jungle, however.



Hill Country: Grass and trees cover these rolling highlands. All of the island's rivers flow from these hills. This region is so far inland that no one has ever seen it from aboard a ship. Similarly, characters could stand on the highest hill of this region and still not be able to see the water that surrounds the island.

Western Thanegioth Archipelago: This archipelago stretches northeastward from Thanegia Island's eastern coast. These low, swampy isles support more exotic forms of life than their sister islands to the east. Even though most of these isles are swampy, their coastlines are sandy.

Western Sea: This body of water is bordered by the Gulf of Hule to the north and by Serpent Peninsula to the west. Channels running through scattered islands connect this sea to the Shallow Sea.

Weather and climate

The general weather patterns of this part of the world move from east to west. The world's equator lies just south of Thanegia

Island. The climate of this area is similar to that of Florida or Cuba.

Hurricanes: If you begin this adventure at the suggested time (around the beginning of summer), this part of the world is in the middle of the hurricane season. There is a chance that, when characters encounter gales at sea, they find themselves in a hurricane. You may use the Optional Water Movement Modification Chart (p. 44, D&D® Expert rulebook) to determine if the characters encounter gales.

The percentage chance that a gale turns into a hurricane is given on Table 1 below. Find the percentage chance given for the month or season and roll percentile dice. If the dice roll is lower than or equal to the indicated percentage chance for that month or season, the gale becomes a hurricane.

**TABLE 1
GALES & HURRICANES**

Season/Month	% Chance That Gale Becomes Hurricane
Winter	6%
January	6%
February	6%
March	6%
Spring	22%
April	6%
May	20%
June	39%
Summer	61%
July	50%
August	71%
September	63%
Autumn	44%
October	47%
November	49%
December	47%

The effects of a hurricane are the same as the effects of a gale, except that extremely heavy rains accompany hurricanes. These rains are likely to flood ships. Even if a ship survives the effects of the high winds, there is a chance that it sinks from being filled with rainwater.

A galley has a 40% chance of flooding and sinking. A sailing ship has a 20% chance of flooding and sinking. Characters may decrease the chance of sinking by throwing cargo overboard. If characters throw all of their cargo overboard in such a situation, the chances of sinking are reduced to 20% for galleys, and 10% for sailing ships.

If the characters find themselves knee deep in water, you may tell the players that throwing cargo overboard increases the characters' chances of staying afloat.

Adventure background

Finding the plea for help

If your characters are at a sea coast, you may have them find this plea for help. If they are not, have another party of adventurers find the plea, and have this party carry word of the plea to your characters.

Characters discover the plea written on a piece of parchment that has been rolled up and sealed inside a glass bottle.

When the characters find this parchment, cut the third panel from the cover of this adventure, and give it to the players. This panel features a copy of the parchment and a map of the wild lands. The players may use this map to chart the wild lands as their characters explore them. You may read the following boxed text to the players, or you may let them read it themselves from their copy of the parchment. The message is written in Common.

We, the people of the city of Quagmire, cry out for help in our time of need. The sea, which once was our very source of life, has become our enemy. Our great city of trade is sinking beneath the salty waves. Without a safe mooring we have no trade. Without trade we have no food or water. A fever has decimated our population, and still it rages on.

The denizens of the lowlands that surround us have blockaded our city and are now preying upon us in this weakened state. They capture our messengers and keep trade ships from reaching us. They plan to besiege us until we can no longer defend ourselves. If we fall, they will overrun us, kill us, and squander the fortunes and staples that we have stored up.

Our hopes go with this message—hopes that the pleas we have cast into the waters shall reach civilized people, hopes that brave and unselfish souls will find one of our

messages and look upon our plight with pity, hopes that there are those who have the resources to run the hideous blockade and bring our people food and water.

We offer five times the normal price for food and fresh water. If our rescuers can lead us to a new home and help us resettle, we will certainly pay more. We may not be able to pay an army; we seek the help and guidance of a small band of strong and courageous souls.

I set my hand to this page on the first day of spring. I believe our people can last no longer than 6 months. May the hand that plucks this testament from the sea deliver us to safe, high ground in all haste.

*Molariah
King of the Swamp
Ruler of the
city of Quagmire*

If characters check around in the local taverns and inns, they hear that Quagmire is a rich trading capital. The characters also hear rumors that lizard men have been harassing the trading ships in the area around East Fang Cape, near the southern tip of Serpent Peninsula.

If characters investigate further, they find that no one can recall the last time a ship arrived from Quagmire. Some think the city is doomed. Others think it has already fallen.

Preparing for the journey

If possible, this adventure should begin close to the first day of summer. You may alter this, however, depending on your time table and your campaign.

The characters may begin their journey in any of these locations: Specularum, Slagovich, Pramayama (from X4, Master of the

Desert Nomads), Ierendi, or Tanaroa on the Isle of Dread (X1, The Isle of Dread). You may have the characters start from some other location more fitting to your campaign, if you decide to fit Quagmire and its surrounding areas into your campaign setting.

The characters may travel to Quagmire by sea, by land, or in a combination of the two.

If the characters decide to travel by sea, they must acquire a ship. Most character parties should have no trouble raising enough money to buy a small sailing ship. If the characters cannot afford a ship, you may arrange matters so that the characters are able to get a boat or small ship that can sail the seas.

Characters who travel known river and sea routes from the north or east should enter DM Map 1 at the hex marked "B." Characters who travel from Tanaroa should enter DM Map 1 at the hex marked "C."

If the characters decide to travel by land from any of the starting locations to the north or east of the wild lands area (except Ierendi), they should enter DM Map 1 at the hex marked "A." Characters who follow the Sind Desert Caravan Track to its western end start at the city of Slagovich.

Sailing to Quagmire

During the characters' voyage to Quagmire, use the wilderness rules from the D&D® Expert rulebook. Remember to check for weather once each day. If a gale comes up, remember that there is a chance it may become a hurricane. See the rules on Weather and Climate in this section for details.

While the characters are at sea, you should check for a wandering monster encounter at least once per day. See the rules on Wandering Monsters in this section for details.

If the characters sail out of sight of land and have no navigator aboard, check to see if the characters become lost.

Traveling by land to Quagmire

Use the wilderness rules in the D&D® Expert rulebook. Check for wandering monster encounters at least once per day. See the rules on Wandering Monsters in this section for details.

Moving off the map

Table 2 shows the distance (in numbers of hexes) from Specularum, Ierendi, Pramayama, and Tanaroa to particular hexes on DM Map 1. You may have encounters take place on these unseen hexes, or you may decide to give the characters a few "days off" while they travel through these areas.

TABLE 2
MAP HEX DISTANCES

From Location	To Hex Lettered		
	A	B	C
Specularum			
by land	39	—	—
by sea route	—	45	—
Ierendi			
by sea route	—	33	—
Pramayama			
by land	9	—	—
by river/sea route	—	18	—
Tanaroa			
by sea	—	—	27

WILD LANDS ADVENTURES

Area encounters

(Use DM Map 1.)



These encounters do not take place in specific locations on the map. Rather, each of the encounters is designed to take place in certain regions on DM Map 1. When the characters enter

a specific region, check Table 3 to determine which of the 25 encounters given here may take place in that area. Most regions have more than one possible encounter.

For example, if the characters are traveling through the Hill Country on Thanegia Island, they may be involved in encounter 5 (Heat Plague), encounter 7 (Drenching Rains), or encounter 15 (Personal Servant). You may decide which of the three encounters takes place.

You also have control over the timing of these encounters. If you want, you may have the characters involved in one encounter per day, or you may subject them to three or four encounters in one day, depending on the terrain. Such timing will help you prepare the characters for their work in Quagmire, or it may help you adapt the adventure to your own campaign more smoothly.

Some of the encounters may occur only once. Others may occur several times, in different terrain types. Try to separate repeating encounters with at least one wandering monster encounter.

The map areas listed on Table 3 are arranged alphabetically.

TABLE 3
AREA ENCOUNTERS

Map Area	Possible Encounters
Barren Plain	2, 4, 14, 16, 18
Burning Waste	2, 3, 4, 15, 16, 18
Bush Country	1, 4, 17, 18, 19
Coastal Trade Route	12, 25
Coastline:	
Muddy	5, 7, 10
Rocky	24
Sandy	11
Hill Country	5, 7, 15
Lagoon Lowlands	5, 7, 8, 9, 10
Neck Grasslands	1, 5, 6, 17, 18, 19
Necklace Trade	
Route	5, 22
Open Sea	15, 25
Outskirts of:	
Slagovich, Mule	
Beach, or Sea	
Camel	21, 22
Rain Forest	5, 6, 7, 8, 9, 20
River Hills	5, 6, 15, 18
River Mouth	12, 15
Serpent Keys	5, 7, 8, 9, 10
Serpent Peninsula	
Lakeshore	5, 7, 8, 9, 10
Sind Desert	2, 15, 16
Sinking Keys	5, 7, 8, 10, 13
Thanegian Jungle	5, 7, 8, 13, 20
Thanegia River	
Banks	8, 10, 13, 23
Thanegian Swamp	5, 7, 8, 10, 13
Western Thanegioth	
Archipelago	5, 7, 8, 11, 13, 15

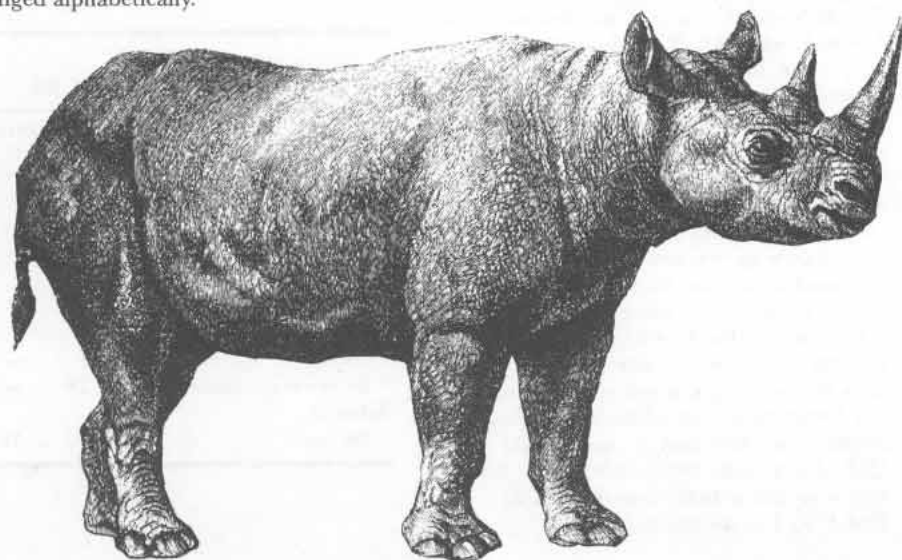

1. RHINO HERD

This encounter should occur only once.

Scrub brush dots this gently-rolling grassland. A small herd of grazing animals moves slowly along the horizon. Thick, gray hides cover these creatures, which, at the shoulder, stand as high as a dwarf. As the beasts amble closer, they appear to be much larger and heavier than they seemed at first. Suddenly, the lead animal stops and raises its horned head to sniff the air.

Twelve rhinoceros are moving in a direction that will intersect with the characters' path in a few minutes. If the characters stand still or retreat, the lead animal lowers its head. Five minutes later, the herd crosses the characters' path.

If the characters move toward the herd, the lead animal paws the ground and faces the

characters, even if they are invisible. If the characters threaten, surprise, or charge the herd, the animals stampede in a random direction. These stampeding animals use their nose horns to gore all in their path. The horns cause double damage on the first attack.

Rhinoceros (12): AC 5; HD 6; hp 27; MV 120' (40'); #AT butt or trample; D 2-8 or 2-16; Save F3; ML 6; AL N; XP 275

For a complete description of these creatures, turn to the Appendix.

2. MOBILE MIRAGE

A short hill rises just ahead. From the top of the hill, the land stretches outward in desolation. A green shimmer rises slowly on the horizon. A small clump of palm trees sways in the waves of heat that dance on the sands.

The oasis is just a mirage. The distance to this mirage is about 24 miles. If characters walk toward the mirage, it still remains 24 miles away. The mirage moves, tracing a circular pattern of 6 hexes around a central hex. The mirage continues to move for as long as the characters follow it. If the characters ignore the mirage or do not travel toward it, it disappears.

3. THIN CRUST

This encounter should occur only once, when the characters pass through the Burning Waste.

Geysers spout and mudpots bubble amid broken boulders and balanced rocks here. The smell of sulfur permeates the entire area. The ground sizzles continuously, sending waves of heat upward.

A white patch of level ground lies just beyond spires of broken rock. No geothermal activity marks this patch, which is bare and lifeless.

The white patch of ground is actually a mineral crust over boiling underground water. The characters may circle around the patch by going through the surrounding rocks and mudpots, but it takes them an hour to do so.

If the characters send an animal or throw a weight of some sort onto the patch, the ground cracks slightly. No cracks appear if the animal or item weighs less than 1,000 cn. If the characters try to walk across the patch, the first character weighing over 1,000 cn

falls through the crust and into the hot water below after walking 100 feet.

The hot water causes 1d6 points of damage per round of contact. Characters or animals that fall through the crust cannot climb out of the water unassisted, because each attempt they make only breaks more of the crust. Characters could use magic to rescue a character or animal trapped in the water. Otherwise, the characters should treat the crust as thin ice when rescuing a trapped character or animal.

4. INCLEMENT WEATHER

Tell the characters that huge, dark clouds are massing on a distant horizon. The clouds approach rapidly, driven by a howling wind. The storm hits 2 hours after the characters first spot it. Just before the storm hits, the wind dies for a moment. Even insects stop chirping.

Roll 1d6 and refer to Table 4 to determine what kind of storm hits the area. If the characters take precautions to protect themselves before the storm hits, reduce the damage given on the table by 1/2.

TABLE 4
STORMS & EFFECTS

Die Roll	Storm	Effect
1	Hail	1d4 points of damage to anyone with AC 6 or lower; animals stampede if not tied
2	Wind	1d20 points of wind damage; tents or shelters flattened; anything not fastened blows away
3	Rain	flash flood washes all light, unattached items away, and causes heavy items to sink out of sight
4	Sand	1d4 points of damage unless characters take shelter
5	Thunder	lightning bolt falls nearby; each character must make saving throw vs. breath attack or take 6d6 points of damage; successful throw reduces damage to 3d6
6	Tornado	combine rain and wind effects

Characters cannot outrun storms. If they take cover in depressions, they are likely to survive high winds or tornadoes. Depressions

may not be good protection from flash floods, however.

If characters try to travel during storms, reduce their rates of movement as you see fit. Cut characters' visibility by half in this situation as well. Storms may last 1d6 hours; the height of a storm lasts 2d12 minutes.

5. HEAT PLAGUE

Humid breezes blow across the land as the sun beats down relentlessly. The air is thick with moisture; its stifling heat and heaviness make every action a major effort—even breathing.

If the characters drink salty water or eat extra salt in their meals, they replace the salt they lose through perspiration while in this area. If the characters take in no salt, each must make a saving throw vs. dragon breath. Characters who fail their saving throws contract heat plague. Any animals that accompany the characters are also affected by the heat plague.

The symptoms of heat plague include blurred vision, dizzy spells, and shortness of breath. The symptoms last for 1d4 hours. A heat-plagued fighter suffers a -2 penalty to his hit rolls. Any monster that attacks a heat-plagued character gains a +2 hit roll bonus. A *cure disease* spell remedies the effects of heat plague.

6. IMPERIAL MISSION

This encounter should occur only once. Characters may already have searched for the expedition described here (see set location encounter G).

Just ahead, a group of 12 men moves slowly over a low hill of grass. Two ox carts accompany the men, who are moving toward the west. The group appears to be well armed and provisioned.

The men do not spot the characters, unless the characters try to get their attention. The men do not appear to be traders or bandits. In fact, they are members of an expedition party sent by an aristocratic family of the Kingdom of Ierendi to find a short route across the Neck Grasslands. Eleven of these scouts are human warriors. A human swash-buckler leads the party.

Warriors (2nd level fighters); AC 7; HD 2; hp 9; MV 120' (40'); #AT 1; D 1-6 or by sword; Save F2; ML 8; AL N

WILD LANDS ADVENTURES

Swashbuckler (5th level fighter): AC 5; HD 5; hp 32; MV 120' (40'); #AT 1; D 1-6 or by two-handed sword; Save F5; ML 9; AL N

If the characters approach the men in a friendly manner, the men speak in Common and offer to share their provisions with the characters. They tell the characters that their employer sent them by ship to Serpent Peninsula to find another short route across the grasslands so a new trade route could be set up. The Kingdom of Ierendi, they say, no longer wants to use the expensive Necklace route across the isthmus.

If the characters are specifically searching for this expedition (see set location encounter G), remind the players that their characters agreed to either escort the expedition back to its parent ship, or to send word of the expedition's status to the ship's captain.

7. DRENCHING RAINS

Huge thunderheads tower over the horizon and move rapidly closer. Lightning flashes and thunder echoes against the hills as the storm approaches.

A severe tropical downpour moves in 1d4 hours after the characters first spot the thunderheads. The storm lasts for 1d4 hours. During this time, cut each character's movement rate and range of vision in half. The water from the rain carries away anything that is light and unattached. All heavy items sink in the mud.

8. SWAMP SICKNESS

After the characters have been in this area for a while, tell them that they begin to feel sick to their stomachs. They also develop mild headaches.

The heat and moisture of the tropics provide a breeding ground for diseases. Every time characters move through a swamp or jungle, there is a chance that they contract a disease. Have each character make a saving throw vs. death ray. Characters whose saving throws fail take 1d4 points of damage from the sickness.

9. SCAVENGER PARTY

Twenty lizard men, armed with spears, shamle forward. Each carries a net and a

sack. They appear to be preoccupied, and do not investigate the area around them. They only look forward.

Lizard Men (20): AC 5; HD 2+1; hp 10; MV 60' (20'); #AT 1; D 1-6; Save F2; ML 12; AL N; XP 25

The lizard men are headed toward the city of Quagmire. They do not see the characters.

The characters may try to outrun the lizard men, hoping to head them off before they reach the city.

If the characters make too much noise as they stalk the lizard men (even if they speak in a whisper), the lizard men hear them and stop. They break into two groups of 10 lizard men each and circle around, hoping to trap the characters between the two groups.

If the lizard men capture a character, or if they force him to surrender, they net the character, search him for food and treasure, and then carry him toward their camp. The lizard men's camp is located on East Fang Cape. The captured character is set aside to "take part" in the victory feast the lizard men have planned to celebrate the eventual fall of Quagmire.



10. THAT SINKING FEELING

Leaf debris and spotty growths of live vegetation mark the surface of the ground here. In some places, a thin layer of water covers the soggy ground. Roots and vines seem to stretch outward, slithering across the land and through the small puddles. The ground grows softer with each step.

If characters take the time to probe the ground ahead, they are able to find firm footing around the soft ground.

If a character steps forward into the soft ground without taking any precautions, the earth begins to slowly swallow him. A character cannot escape such a trap without the use of magic or without the help of other characters. A trapped character does not know how deep the subsurface is until he reaches bottom.

Roll percentile dice and refer to Table 5 to determine what kind of subsurface the characters have come upon. Roll the dice again to determine the subsurface's maximum depth. Each subsurface has a fixed sinking rate listed on the table.

TABLE 5
SUBSURFACES

Dice Roll	Sinking Subsurface	Max. Rate*	Depth**
01-50	Mud	1/2	1-3
51-79	Quicksand	1	1-12
80-94	Dangerous Quicksand	1 1/2	1-12
95	Giant Amoeba	2	5-30
96	Black Pudding	2 1/2	5-30
97	Gelatinous Cube	2	1-10
98	Gray Ooze	2 1/2	1-3
99	Green Slime	2 1/2	1-3
00	Ochre Jelly	2	1-12

* in feet per round; if the victim struggles, double the sinking rate

** in feet

Monsters: Characters may encounter monsters while they are trying to deal with the murk in this area. If the subsurface is mud, there is a 75% chance that a wandering monster appears. If the subsurface is quicksand, there is a 50% chance that a wandering monster appears. If the subsurface is dangerous quicksand, there is a 25% chance that a wandering monster appears. No monster appears if any other subsurface is rolled on Table 5.

11. SANDY SHORELINE DEBRIS

The water has stranded pieces of driftwood and dried seaweed along the shore here. Worthless shells, rotting fish, and uprooted plants are scattered along the sand. The gentle rippling of waves is the only sound.

Roll 1d12 and refer to Table 6 to determine what other items the characters find lying along the shore.

12. FLOATING FLOTSAM

The coast rises and falls in the distance with the ship's bobbing. Sea birds wheel overhead as the ship draws closer to the shoreline. A flying fish occasionally glides

past the ship, racing it through the waves. These salty waters abound with fish.

Roll 1d12 and refer to Table 7 to determine what type of flotsam the characters find floating around their ship.

13. AMBUSH PARTY

Murky puddles flood the ground in this area. A low gurgle rises from behind a thick stand of bushes 50 feet ahead.

If the characters stop to listen, they hear a momentary hissing sound coming from the bushes. A band of 10 lizard men is hiding in the bushes, preparing to ambush the characters as soon as they draw near. The creatures, in groups of five, plan to attack both the front

TABLE 6
SANDY SHORELINE DEBRIS

Die Roll	Debris Found	Die Roll	Debris Found
1	Worthless seaweed mixed with green slime: AC can always be hit; HD 2**; hp 9; MV 3' (1'); #AT 1; D special; Save F1; ML 7; AL L; XP 5.	9	A mound of sand, 3 feet in diameter. If characters dig into the mound, they find 30 newly-laid sea turtle eggs. Characters may eat these eggs.
2	Pirate skeleton buried in the sand (AC 7; HD 1; hp 5; MV 60' (20'); #AT 1; D 1-6 by rusty sword; Save F1; ML 12; AL C; XP 10).	10	A large, empty conch shell worth 10 gp. The first character to hold the shell to his ear hears a chanting voice: "Seek a shell, unlike the one you hold; By sailing north, to where you're told. From West Fang follow coast to river first; In tidal pool floating, slake not your thirst. Rescue me from my tiny sea, and three tasks shall I do for thee." Characters may find the answer to this puzzle by going to set location encounter I.
3	Rotting wooden box containing 1d20 ancient gold pieces.	11	Dead giant marauder jellyfish stranded on the beach. This dried-out creature is 10 feet across and has 40 tentacles. Even though the creature cannot attack, it inflicts 1d6 points of damage on any character who touches one of its tentacles. A character touching the creature must also make a saving throw vs. paralysis or be paralyzed for 1d6 rounds.
4	A sealed bottle containing a parchment note from Molariah, ruler of Quagmire. The note is identical to the one the characters received at the start of the adventure.	12	A primitive, 20-foot-diameter fishing net, rimmed by wooden floats.
5	A wrecked native war canoe, holding 1d6 shrunken heads. The canoe cannot be repaired but does provide 1 day's worth of firewood.		
6	A trail of a tailprint and webbed footprints left by a lizard man. The trail leads in the direction of Quagmire.		
7	A recently constructed sand castle of Quagmire. The structure depicts rafts attacking from East Fang Cape.		
8	A crusty anchor weighing 150 pounds. A rigid, 20-foot length of chain is attached to the anchor. The rusty chain weighs 50 pounds.		

TABLE 7
FLOATING FLOTSAM

Die Roll	Flotsam Found	Die Roll	Flotsam Found
1	A bed of green kelp, edible but not tasty. The kelp equals 2d20 rations.		
2	A light green bed of seaweed. If characters come within 40 feet, they find that it is actually green slime (AC can always be hit; HD 2**; hp 9; MV 3' (1'); #AT 1; D special; Save F1; ML 7; AL L; XP 5).	8	A coconut floating on the waves. The milky fluid and lining inside the shell is worth 1 ration.
3	A sealed bottle containing a parchment note from Molariah, ruler of Quagmire. The note is identical to the one the characters received at the start of the adventure.	9	A 2-inch-thick, 6-foot-long wooden staff. This is a <i>staff of healing</i> , which only clerics may use.
4	An empty lifeboat.	10	A 3-foot-diameter, wooden wagon wheel. Characters may use it for 2 hours' worth of firewood.
5	Six elves clinging to a ship's mast. If characters rescue the sailors, they tell of a giant octopus that crushed their sailing ship while they were on their way to rescue the good people of Quagmire. They have a bottle that contains a parchment note identical to the one the characters received at the start of the adventure. The sailors are first level elves.	11	A small, uncharted tropical isle, approximately half a mile in diameter. Turtles, sea birds, and mussels live here, and may serve as 2d20x5 rations for the characters. Each hour, the isle drifts 1 mile further away from the coastline. Characters cannot detect this movement at first.
6	A wooden barrel containing 20 rations of fresh water.	12	A black film covering the water ahead of the boat. The film stretches for half a mile in each direction. The film is a crude oil spill. Characters may avoid the spill by turning their ship at least 90 degrees from their current direction and sailing at least 1 mile in a new direction. If the oil is ignited, it burns for a week. A ship caught in an oil fire suffers 2d12 points of hull damage per round.
7	A man floating on a plank. He waves his arms to signal the characters, but he does not yell. He is actually a zombie (AC 8; HD 2; hp 9; MV 90'		

and the rear of the character's party. The lizard men attack no matter how many characters and NPCs are in the characters' party.

Lizard Men (10): AC 5; HD 2+1; hp 10; MV 60' (20'); #AT 1; D 1-6; Save F2; ML 12; AL N; XP 25

These creatures are armed with clubs.

The characters may outrun the lizard men by fleeing to the right or left, rather than forward or backward. The characters may also sneak around behind the bushes and surprise the lizard men.

If the lizard men capture a character, or if they force him to surrender, they net the character, search him for food and treasure, and then carry him toward their camp. The lizard men's camp is located on East Fang Cape. The captured character is set aside to "take

part" in the victory feast the lizard men have planned to celebrate the eventual fall of Quagmire.

14. SCORCHED PREY

This encounter should occur only once.

A few hundred yards in the distance, scavenger birds circle over a tiny speck in the rocky wasteland. The speck draws slowly closer. It is a human being. From time to time, the figure stops dragging its feet forward and collapses. When this happens, the huge birds call out to each other and swing lower in the sky. The figure manages to pull itself up and crawl forward. It is an unarmed man.

If the characters approach the man, they find that he is close to death. Cuts and bruises cover much of his body. His clothes are torn and dirty.

The man is lying on the ground when the characters draw near. Slowly, he raises his head and tries to crawl a few more feet. He does not notice the characters until they are standing just before him.

Dying Warrior: AC 9; HD 2; hp 6; MV 60' (20'); #AT 1; D 1-4 by bare hands; Save F2; ML 5; AL N

The man is extremely grateful to the characters if they try to help him. If the characters ask, the man tells them that his name is Gasker, and that he is a messenger from the city of Quagmire. If characters ask what he is doing in this wasteland, he answers them in a slow, uneven voice.

"I was on my way to Pramayama by raft when I was hit by strong winds. My raft broke up, and I drifted into Sea Camel. I rode my horse, Blazer, from there, taking her across the Barren Plain. She died where the Silt River splits in two. I've come far, friends, but I'm afraid I won't reach Pramayama now. I've failed to complete my mission."

If the characters ask Gasker about his mission, he tells them about the sinking city of Quagmire and its search for rescuers. If the characters tell Gasker that they are headed to Quagmire for just that purpose, his eyes brighten considerably.

"Bless you, brave ones. I only wish I could help. I did leave behind a *potion of swimming* and a pouch of gemstones in Blazer's saddlebags. I figured I wouldn't need any of that out here—it would just weigh me down. It's yours if you find it." Gasker removes a ring from a thong hanging around his neck and hands it to the nearest character (determine randomly, if necessary). "This is a *ring of water adaptation*," he tells the character. "You may need it. If you take me to civilization where I can heal, I'll happily go with you to Quagmire. I'll even lead you to Blazer's saddlebags." For a description of the ring, turn to the New Magic Items in the Appendix.

If the characters do not tell Gasker that they are headed for Quagmire, he asks if they will take him to civilization, where he can be healed and can recruit a party of rescuers.

Gasker also tells the characters, "Another messenger named Lenuwol was sent to Tanaroa. He traveled along the islands east of Thanegia. I hope he made it."

If you want, you may have Gasker join the characters as an NPC. When he has been fully healed, his statistics are:

Healed Warrior: AC 9; HD 2; hp 9; MV 120' (40'); #AT 1; D 1-8 by sword; Save F2; ML 8; AL N

15. PERSONAL SERVANT

This encounter should occur only once.

A few feet ahead, the bottom of a large, heavy-looking ceramic jug sticks out of the ground.

If the characters dig up the jug, they find that it feels empty. There is no writing on the jug. It is about 3 feet high. Wax and strips of metal seal the jug's stopper.

The jar is a magic *efreeti bottle*. If the characters break the seal and pull out the stopper, a puff of smoke snakes out of the bottle and slowly takes the form of an *efreeti*. The *efreeti* has come forth to serve whoever opened the jug. The *efreeti* promises to act as that character's faithful servant for 101 days, or until it is slain. After its term of service has ended, the *efreeti* returns to its home (the fabled city of Brass on the elemental plane of fire).

The *efreeti* serves only the character who opened the bottle. If several characters opened the bottle at once, roll randomly to determine who becomes the *efreeti*'s master.

If its master is killed, the *efreeti* vanishes immediately, even if the master is later brought back to life.

16. CAMEL HERD

A herd of camels lopes along a low hill in the distance. The camels do not flee as the characters approach. Rather, they stop and stare at you.

Roll 2d4 to determine how many wild camels are in the area. Characters cannot ride wild camels, but they may sell them in Slagovich, Sea Camel, or Mule Beach. If the characters try to capture the camels, refer to the Capturing Wild Animals rules in the Preparing for the Expedition section.

Camels (2-8): AC 7; HD 2; hp 9; MV 150' (50'); #AT 1 bite/1 hoof; D 1/1-4; Save F1; ML 7; AL N; XP 20

The camels stampede away in the opposite direction as soon as the characters make any loud noise, produce a bright light, or come within 250 feet of them.

17. WILD HORSES

A herd of wild horses runs along a low hill in the distance. The horses do not flee as the characters approach. A few gallop in wide circles around the characters, while others simply stop and stare.

Roll 10d10 to determine how many wild horses are in the area. Characters cannot ride wild horses, but they may sell them in Slagovich, Sea Camel, or Mule Beach. If the characters try to capture the horses, refer to the Capturing Wild Animals rules in the Preparing for the Expedition section.

Wild Horses (10-100): AC 7; HD 2; hp 9; MV 240' (80'); #AT 2 hooves; D 1-4/1-4; Save F1; ML 7; AL N; XP 20

The horses stampede away in the opposite direction as soon as the characters make any loud noise, produce a bright light, or come within 250 feet of them.

18. MULE HERD

A herd of mules meanders along a low hill in the distance. The mules do not flee as the characters approach. A few of the mules wander curiously toward the characters. The others simply ignore the characters.

Roll 2d6 to determine how many wild mules are in the area. Characters cannot ride wild mules, but they may sell them in Slagovich, Sea Camel, or Mule Beach. If the characters try to capture the mules, refer to the Capturing Wild Animals rules in the Preparing for the Expedition section.

Mules (2-12): AC 7; HD 2; hp 9; MV 120' (40'); #AT 1 kick or 1 bite; D 1-4 or 1-3; Save F1; ML 8; AL N; XP 20

The mules stampede away in the opposite direction as soon as the characters make any loud noise, produce a bright light, or come within 250 feet of them.

19. GRAB GRASS

Scores of bleached animal skeletons lie among the 4-foot-tall grass just ahead. It appears as if all of the animals just lay down and died on the spot.

Characters may avoid the area of skeletons by circling 100 feet around one side or the other. Grab grass takes hold of any character who walks within 5 feet of any skeleton.

Grab Grass: AC 9; HD 1 per 5-foot-square area; hp 4 per 5-foot-square area; MV 0; #AT 1; D special; Save NM; ML 12; AL N; XP 10

For a complete description of this "creature," turn to the Appendix.

A wandering monster appears at the instant the grab grass takes hold of a character.

20. KILLER TREES

Hundreds of animal bones lie scattered beneath a stand of trees just ahead.

The trees here are actually 12 killer trees. Characters may avoid the area of bones by circling 150 feet around one side or the other. If any character comes within 10 feet of one of the bones, the nearest killer tree uses one of its 20-foot-long tentacles to reach out and grab the character.

Killer Trees (12): AC 5; HD 6; hp 27; MV 0; #AT 4 limbs/1 mouth; D 0/3-18; Save F3; ML 12; AL N; XP 275

For a complete description of these creatures, turn to the Appendix.

21. SLAGOMANN CORRALS

Three large animal corrals and three barns stand at the edge of town. Wild horses, camels, and mules run along the corral fences.

Roll 2d6 to determine how many animals are in each corral. Inside each barn are 1d6 of each animal type tamed for riding. All of these animals are for sale. An agent of Bondee Slagomann, the man who owns these corrals, happily sells you an overpriced steed. He also happily buys any horses, mules, or camels you bring in (for a very low price, of course).

If characters ask the agent where they can find wild horses, he says, "You can find large horse herds out there in the Bush Country or along the Neck Grasslands." If characters ask him about wild mules, the man snorts and says, "Them animals and me, we don't get along. But if you want some for yourself, go to the Burning Waste or down to the River Hills." If characters ask him about wild camels, he smiles and says, "Ah, the finest beast of burden for these parts, I tell you. Ships of the desert! You can find camels out at the Twin Oases, about 2 weeks from here. Some say there's camels in the eastern Sind. Now there's a good hot place to stay away from!"

If characters ask the agent where the Twin Oases are, he tells them that they lie in the western Sind.

22. MAGIC MONGERS

A caravan of eight merchant wagons stands beside the trail here. Two oxen are hooked up to each wagon. Several tables

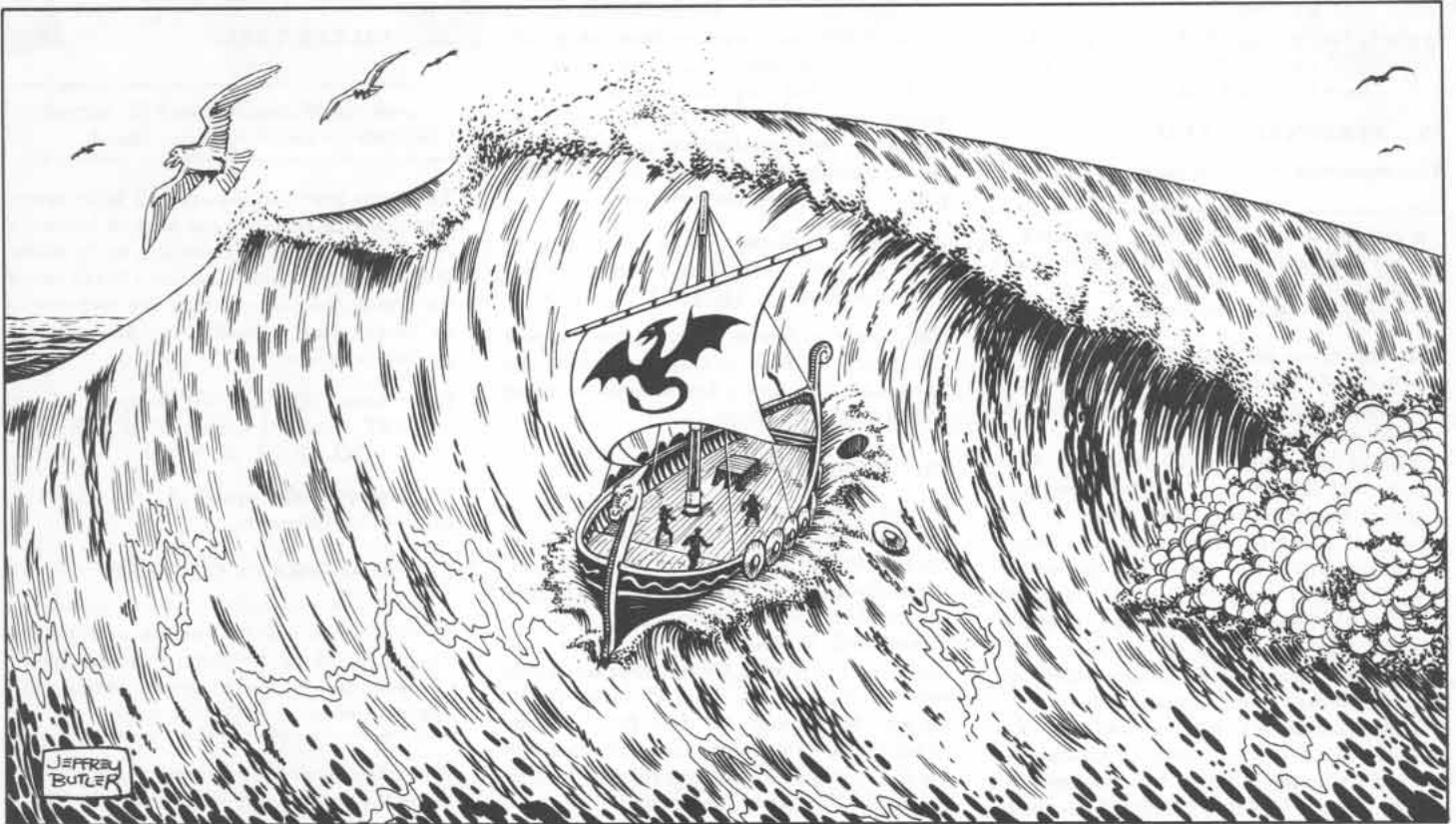

are set up around the wagons. Each is loaded with at least 40 items. The prices on the items range from 300 to 1,800 gp each.

A sign has been painted on the side of each wagon. The signs read, from the front of the caravan to the back, "Magical Swords For Sale," "Weapons for the Discriminating Master (No Swords Here)," "Super Armor and Infallible Shields," "Magic Potions at Low Costs," "Scrolls Guaranteed Not to be Cursed," "Powerful Rings of Various Uses," "Slightly Used Wands, Staves, and Rods," and "Miscellaneous Magic Items."

Only one item on each of the tables is magical. Characters may use *detect magic* to tell which of the items is genuine. Otherwise, there is only a 3% chance per table that a character chooses the one magical item at random. The rest of the items are fake look-alikes. Because of this, many normal items on these tables have wildly inflated prices. Characters may sell their possessions to the magic mongers manning the tables at normal prices, but the mongers are unwilling to sell anything on their tables at anything less than the inflated prices. All items listed on the Trade Items Chart cost 3d6x100 gp each.

TRADE ITEMS CHART

Item	Expert Subtable
Swords	a
Other Weapons:	b
arrows, axe, bow, dagger, mace, quarrels, sling, spear, war hammer	
Armor and Shields:	c
leather armor, chain mail armor, plate mail armor, shield	
Potions	d
Scrolls	e
Rings	f
Wands/Staves/Rods	g
Miscellaneous Items:	h
amulet, bag, boots, bottle, bowl, brazier, broom, carpet, censor, cloak, crystal ball, drums, gauntlets, girdle, helm, horn, medallion, mirror, rope, scarab, stone	

To determine which item on a table is magical, find the item category for a specific table on the Trade Items Chart. The subtable

entries on the chart correspond to the subtables on p. 36 of the Expert rulebook. Roll percentile dice on those subtables to determine which specific item on one of the magic mongers' tables is magical.

If characters ask for an item not listed on the chart, they are able to get the item from the mongers at the prices listed on p. 19 of the Expert rulebook.

The magic mongers try to convince the characters that all items on the tables are magical, but that they don't know how to activate them. The mongers haggle on the price of any item that they know is not actually magical.

23. STILT VILLAGE

A small village stands beside the water a few hundred yards ahead. The huts of the village stand on 3-foot to 9-foot-high stilts. The huts are made of palm branches and mud. Canoes are tied to the stilts of all of the huts. Smoke circles through holes in the hut roofs.

A band of natives lives in this village. Roll 1d10 and multiply the result by 30 to determine how many natives live here.

The natives do not notice the characters

unless the characters draw attention to themselves. The characters may pass the village undetected by coming no closer than 300 feet to the village and by moving under the cover of vegetation.

If the characters attack, the natives defend themselves. If the characters are friendly, the natives are friendly in return.

The natives are willing to trade for gemstones and normal items or animals, but they do not accept money. The natives do not understand the concept of coinage. If the characters try to trade an item that is obviously magic, there is only a 25% chance the natives accept it.

The natives of each village the characters visit all speak the same language, but each village has its own particular dialect. You should also tell the characters that, as they travel upriver, they notice that the natives almost always build their villages on the left river bank. On the right river bank facing each village is a burned-out ceremonial clearing littered with the charred remains of the village's dead.

Natives (30-300): AC 9; HD 1-1; hp 4; MV 120' (40'); #AT 1; D 1-6 or by weapon; Save F1; ML 7; AL any; XP 5

24. ROCKY COASTLINE DEBRIS

The water has stranded pieces of driftwood and dried seaweed along the shore here. Worthless shells, rotting fish, and uprooted plants are scattered among the rocks. The gentle rippling of waves is the only sound.

Roll 1d12 and refer to Table 8 to determine what other items the characters find lying along the shore.

25. THE HIGH SEAS

The water seems to stretch forever, rolling out to where the sea and sky meet at the horizon. Their colors seem to mingle, until it is impossible to distinguish the two. A sea bird occasionally wheels overhead, breaking the silence with its squawk. Flying fish sometimes glide past the ship, racing it through the waves. These salty waters abound with fish.

Roll 1d12 and refer to Table 9 to determine what encounter the characters have on the high seas.



**TABLE 8
ROCKY COASTLINE DEBRIS**

Die Roll	Debris Found	Die Roll	Debris Found
1	Worthless seaweed mixed with green slime: AC can always be hit; HD 2**; hp 9; MV 3' (1'); #AT 1; D special; Save F1; ML 7; AL L; XP 5.		
2	Pirate skeleton buried in the sand (AC 7; HD 1; hp 5; MV 60' (20'); #AT 1; D 1-6 by rusty sword; Save F1; ML 12; AL C; XP 10).		
3	Rotting wooden box containing 1d20 ancient gold pieces.		
4	A wrecked, 3-foot-long ship's figure-head that is actually a wood golem (AC 7; HD 2+2*; hp 13; MV 120' (40'); #AT 1 fist; D 1-8; Save F1; ML 12; AL N; XP 35).		
5	A sealed bottle containing a parchment note from Molariah, ruler of Quagmire. The note is identical to the one the characters received at the start of the adventure.		
6	A wrecked native war canoe, holding 1d6 shrunken heads. The canoe cannot be repaired but does provide 1 day's worth of firewood.		
7	A 10-foot-deep tidal pool, which is 30 feet in diameter. The pool contains starfish, three edible sea urchins, six edible mussels, and gray ooze (AC 8; HD 3*; hp 14; MV 10' (3'); #AT 1; D 2-16; Save F2; ML 12; AL N; XP 50).		
8	A 15-foot-long, beached whale skeleton. Its white ribs curve toward the		sky. Characters may use the ribs to build a shelter. If the characters dig up the whale's skull, they find a 200-pound ivory tusk worth 4,000 gp. The whale was a narwhal.
		9	A crusty anchor weighing 150 pounds. A rigid, 20-foot length of chain is attached to the anchor. The rusty chain weighs 50 pounds.
		10	A large, empty conch shell worth 10 gp. The first character to hold the shell to his ear hears a chanting voice: "Seek a shell, unlike the one you hold; By sailing north, to where you're told. From West Fang follow coast to river first; In tidal pool floating, slake not your thirst. Rescue me from my tiny sea, and three tasks shall I do for thee."
		11	Dead giant marauder jellyfish stranded on the beach. This dried-out creature is 10 feet across and has 40 tentacles. Even though the creature cannot attack, it inflicts 1d6 points of damage on any character who touches one of its tentacles. A character who touches the creature must also make a saving throw vs. paralysis or be paralyzed for 1d6 rounds.
		12	A primitive, 20-foot-diameter fishing net, rimmed by wooden floats.

TABLE 9
HIGH SEAS ENCOUNTERS

Die Roll	Encounter	Die Roll	Encounter
1	A sperm whale, locked in a battle with a giant squid, smashes into the bottom of the characters' ship, causing 2d12 points of hull damage.	7	The captain (or navigator) mysteriously disappears from the ship.
2	The ship strikes an uncharted sea-mount, which causes 2d20 points of hull damage and throws two men overboard. The men are not injured, but they do attract a wandering monster.	8	The ship snags a huge fishnet. To set the ship free, characters must burn or cut the net. A storm giant then appears and demands 10,000 gp as payment for the damaged net. The characters may bargain the giant down to 2,500 gp.
3	A sealed bottle containing a parchment from Molariah, the ruler of Quagmire floats by. The note is identical to the one the characters received at the start of the adventure.	9	A huge wave, higher than the main mast, plunges down on the ship and causes 2d10 points of hull damage. The wave also tosses 1d6 crew-members overboard. The wave drives the ship 24 miles in a random direction (roll 1d6: 1-north; 2-northeast; 3-southeast; 4-south; 5-southwest; 6-northwest).
4	A lifeboat manned by a human and an elf floats into view. If characters rescue them, the two tell how their ship's crew mutinied and set them adrift. The man is a captain. The elf is a navigator.	10	A freakish current causes the ship to end the day where it started.
5	A shipboard fire destroys the sails and rigging, stranding the ship. Rowers can move the sailing ship at 1/3 speed, if the characters have no spare sails aboard.	11	A doppelganger stowaway kills crew-members and secretly throws their bodies overboard. Doppelganger: AC 5; HD 4*; hp 20; MV 90' (30'); #AT 1; D 1-12; Save F8; ML 12; AL C; XP 125
6	Worms infest and destroy all rations aboard the ship.	12	Skillful sailing adds an extra 24 miles to the distance the characters travel in a day.

Set location encounters

(Use DM Map 1.)



Each of the encounters below is set in a specific hex on DM Map 1. When the characters enter a lettered hex, refer to the corresponding lettered encounter here to determine

what, if anything, the characters see in that area.

Some of these encounters are no more than guidelines to help you mark the characters' movement toward or away from Quagmire. When the characters are in a specific region (the Burning Waste, for example), use the notes given under the Wild Lands Map Key to

describe the characters' current surroundings.

These encounters should occur as given here only once (the first time the characters enter that lettered hex). If the characters leave a lettered hex and return to it again later, alter the encounter based on the characters' first visit to that area.

When appropriate, read the boxed text to the players as their characters enter the lettered hex.

A. LAND ROUTE

The characters are on the Barren Plain. They see no signs of life around them.

If the characters travel north for 7 hexes and then east for 2 hexes, they reach Pramayama. If they travel northeast for 15 hexes and then east for another 14 hexes, they reach Specularum.

B. SEA TRADE ROUTE

The characters are just off the coast of the Barren Plain.

If the characters travel the sea trade routes to the northeast for 9 hexes, they reach the mouth of the Asanda River. If they pass the Asanda and follow the coast for 14 hexes, they come to a point of land. The characters may then reach Ierendi by turning south at this point and traveling for 10 hexes. If the characters continue to follow the coast past the point of land, they reach Specularum after traveling 22 hexes.

C. SEA ROUTE

As characters approach this area, they see a black pillar of smoke rising high into the sky from an island to the south. If the characters are here at night, they see a fire burning on the island's beach. The island is part of the Western Thanegioth Archipelago.

If the characters land on the island to investigate the smoke, go to encounter D.

If the characters travel east by northeast for 15 hexes, they reach a point on an island in the Thanegioth Archipelago. From there, they may reach Tanaroa on the Isle of Dread by traveling east for 12 hexes.

D. MAROONED MESSENGER

A rickety lean-to made of palm branches stands at the edge of a clearing on the shore of this island. A driftwood fire burns near the hut. If characters go into the lean-to, they see a man asleep on the ground. The characters' movements do not wake him. His clothes are tattered, and he looks very ill. He has no weapon.

If any character makes a loud noise or touches the man, he awakens with a start.

Dying Warrior: AC 9; HD 2; hp 6; MV 60' (20'); #AT 1; D 1-4 by bare hands; Save F2; ML 5; AL N

The man is extremely grateful if the characters try to help him. If the characters ask the man who he is, he stands up very slowly and offers his hand to the characters.

"I am Lenuwol. I'm a messenger from the city of Quagmire. I was on a raft sailing toward Tanaroa on the Isle of Dread when pirates attacked me. They captured me, and I think they planned to sell me as a slave. Fortunately for me, I contracted some weakness, so instead of selling me, they marooned me on this island." Lenuwol pauses and takes a long look at the characters. "I'm still weak, but now that you're here, perhaps my mission won't fail."

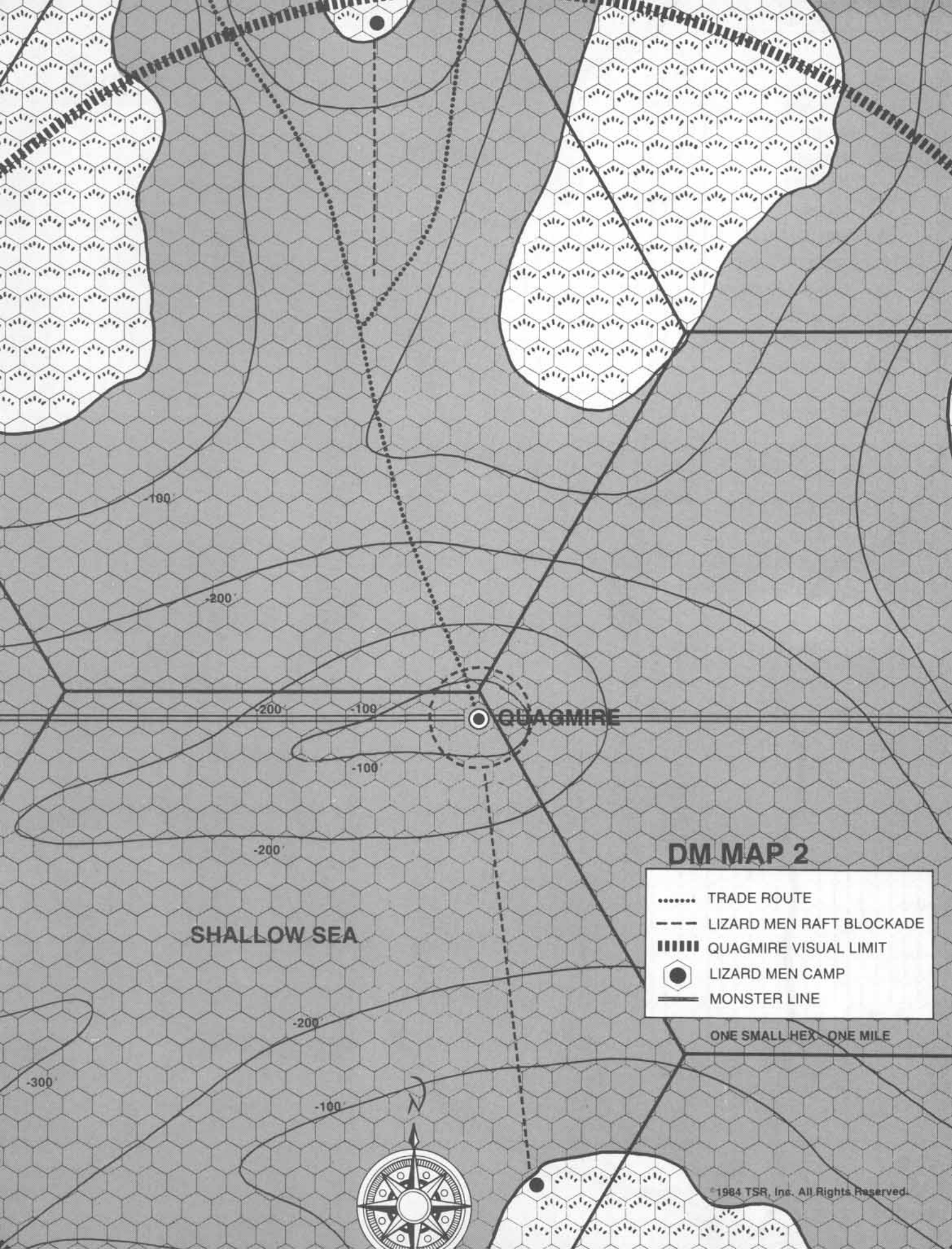

SHALLOW SEA

QUAGMIRE

DM MAP 2

- TRADE ROUTE
- - - LIZARD MEN RAFT BLOCKADE
- ||||| QUAGMIRE VISUAL LIMIT
- LIZARD MEN CAMP
- MONSTER LINE

ONE SMALL HEX = ONE MILE

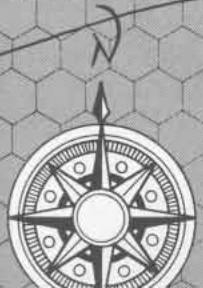

The Wild Lands

	CITY
	VILLAGE
	RIVER
	WATER
	DESERT
	HILLS
	MOUNTAINS
	BROKEN LAND
	GRASSLANDS
	JUNGLE
	SWAMP
	TRADE ROUTE

ONE HEX - 24 MILES

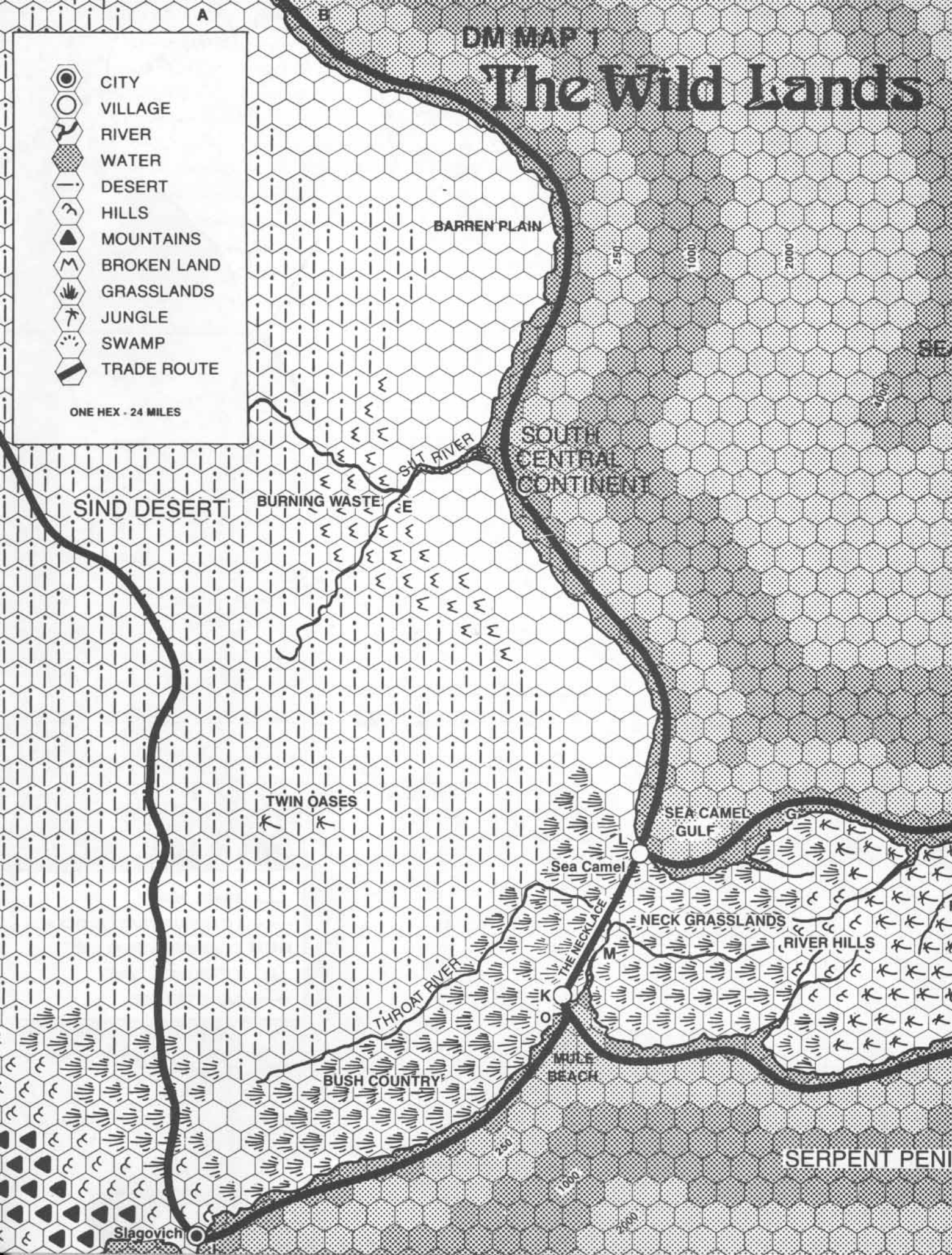

SIND DESERT

BURNING WASTE

TWIN OASES

BUSH COUNTRY

BARREN PLAIN

SOUTH CENTRAL CONTINENT

SEA CAMEL GULF

NECK GRASSLANDS

RIVER HILLS

SERPENT PENINSULA

Slagovich

THROAT RIVER

SILT RIVER

MULE BEACH

Sea Camel

THE NECKLACE

250

1000

2000

250

1000

2000

4000

A

B

C

D

E

F

G

H

I

J

K

L

M

N

O

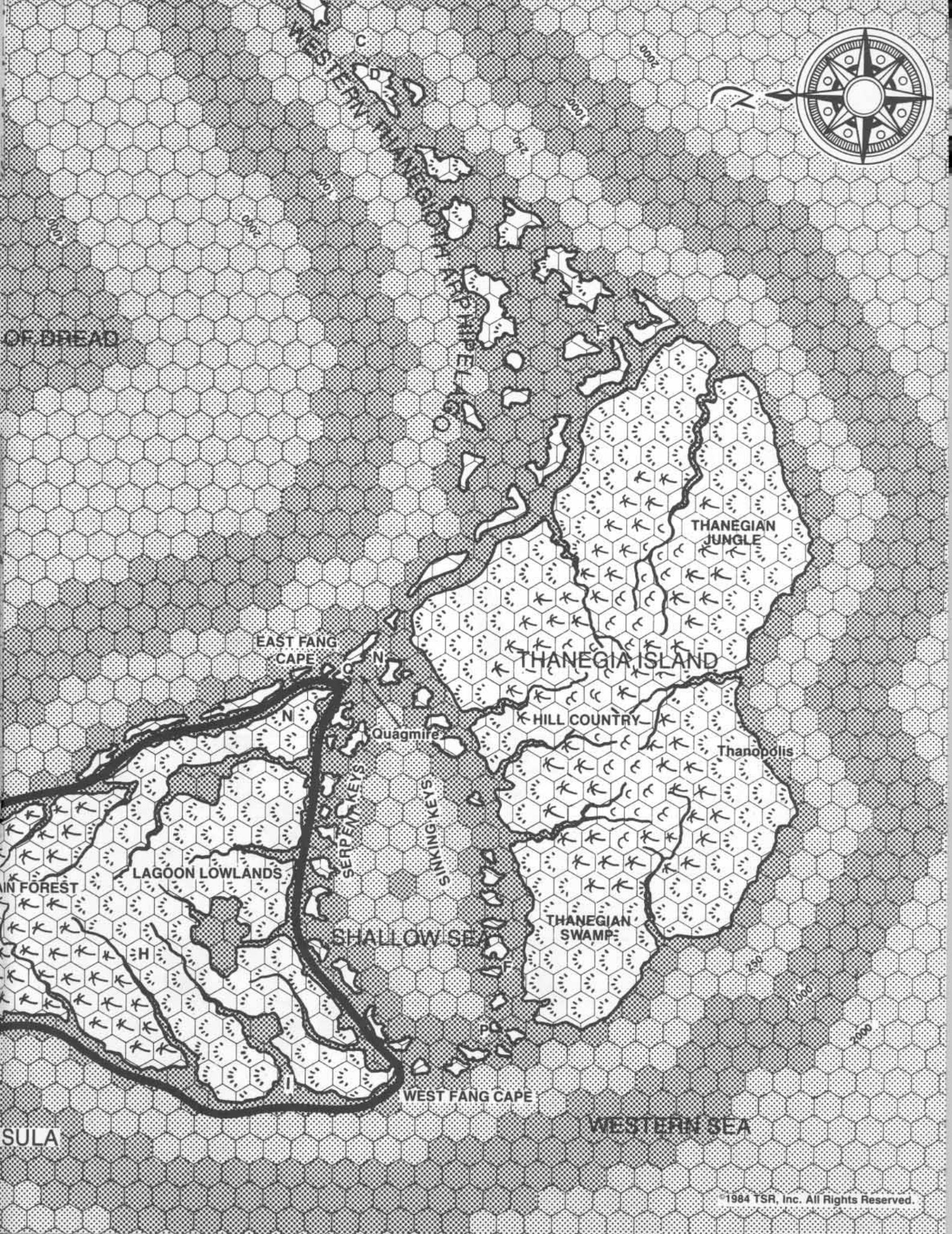

DM MAP 4

Spiral City - side view

W ← → E

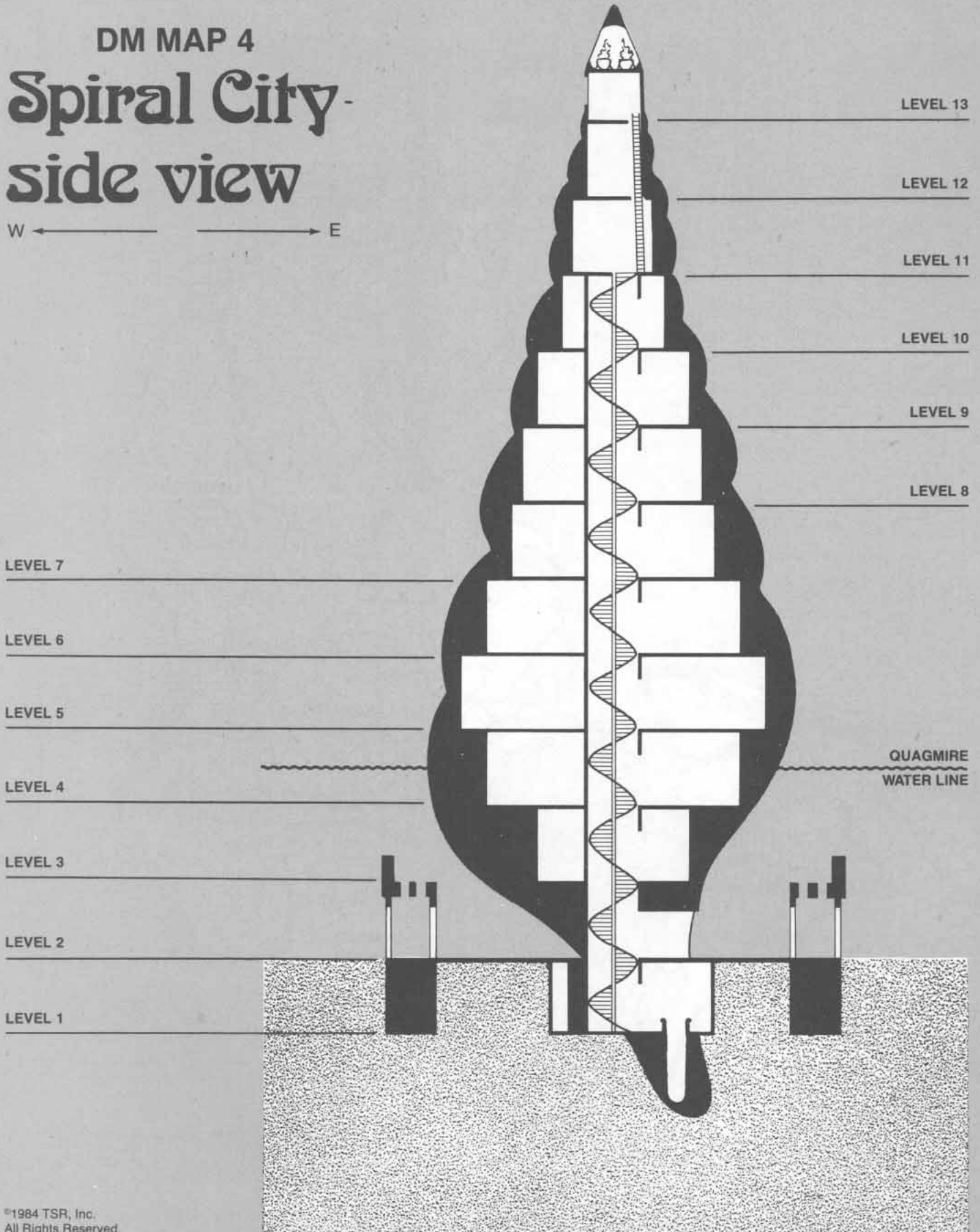

If the characters ask Lenuwol about his mission, he tells them about the sinking city of Quagmire and its search for rescuers. If the characters tell Lenuwol that they are headed to Quagmire for just that purpose, he smiles weakly and reaches out to shake the nearest character's hand.

"Ah, such good souls you are. Then there is hope. I know where the pirates' supply cache is—you know, it may help. There's a *returning spear* there, and some magical underwater devices. It's all yours if you can find it, but I could surely lead you there." Lenuwol stretches his aching muscles. "If you could take me somewhere where I can heal, I'll gladly go with you to Quagmire."

If the characters do not tell Lenuwol that they are headed for Quagmire, he asks if they will take him to civilization, where he can be healed and can recruit a party of rescuers.

Lenuwol also tells the characters, "Another messenger named Gasker was sent to Pramayama. I wonder if he was successful."

If you want, you may have Lenuwol join the characters as an NPC. When he has been fully healed, his statistics are:

Healed Warrior: AC 9; HD 2; hp 9; MV 120' (40'); #AT 1; D 1-8 by sword; Save F2; ML 8; AL N

E. SADDLEBAGS

The Silt River winds north, cracking this empty land in two. The river itself splits here, one tributary running to the northwest, the other to the northeast.

Ferocious screams and growls rise on the sticky wind. A band of rock baboons is gathered in a dry stream bed 300 feet away, hunched over an animal carcass.

If Gasker is with the characters, he recognizes this area as the place where his horse Blazer died. The rock baboons are feeding on the horse's carcass. If the characters want to get to the horse, they must defeat or drive away the rock baboons.

Rock Baboons (15): AC 6; HD 2; hp 12; MV 120' (40'); #AT 1 club/1 bite; D 1-6/1-3; Save F2; ML 8; AL N; XP 20

If the characters get the creatures away from the horse, they find that the horse's leather bridle, saddle, and saddlebags are still intact. A *potion of swimming* is in one of the bags. A leather pouch containing five 100 gp garnets is in the other bag. See the Appendix for a description of the *potion of swimming*.

F. PIRATE CACHE

Human and demi-human footprints cover this small island. The prints crisscross the island from shore to shore and connect a number of clearings. Still-warm cookfires smolder in each of the clearings. Scores of grave-size patches of piled stone, each marked by weathered strips of leather and cloth, dot the island.

There are two islands on DM Map 1 that are marked with an "F." If the characters are with Lenuwol on the island marked F in the Western Thanegioth Archipelago, Lenuwol leads them to a patch of large stones. He tells the characters that the pirates' supply cache is buried beneath these stones (see the first Gravesite Contents entry on Table 10 for the contents of the cache).

If Lenuwol is not with the characters, or if the characters are on the island marked F in the Sinking Keys, the characters must dig up the gravesites at random if they want to find the pirate cache. Refer to Table 10 and roll percentile dice for each gravesite the characters dig up.

G. SURVEY SHIP

A large sailing ship manned by a crew of 20 is anchored here, just off the coast of the Neck Grasslands. The ship and crew appear to the characters to be friendly. The crew-members wave as the characters' ship approaches, but they do not signal for the characters' ship to stop.

If the characters hail the ship peacefully, the ship's crew allows the characters to board. The ship is a private vessel sent by a wealthy merchant from the Kingdom of Ierendi. The crew is waiting for a 12-member expedition to return from the Serpent Peninsula. The crew-members tell the characters that the expedition has been gone for a week. They set out to look for a new, short trade route across the peninsula. If the expedition can find such a route, the crew-members explain, the Ierendi merchants won't have to use the expensive Necklace trade route between Sea Camel and Mule Beach.

The crew-members are beginning to worry that the expedition members are dead or lost. The crew still has 500 iron rations and plenty of fresh water, but they fear that the expedition might have run out of provisions by now.

The ship's captain offers the characters 50 gp and a fourth of his ship's rations to search for his expedition party. He offers an extra 150 gp and another fourth of his ship's rations if the characters return with any survivors from the expedition.

TABLE 10
ISLAND GRAVESITES

Dice Roll	Gravesite Contents
01-03	Pirate cache containing 50 iron rations, 50 fresh water rations, a <i>returning spear</i> , a <i>ring of water adaptation</i> , and a <i>potion of water breathing</i> (new magical items described in Appendix)
04-06	Type A treasure horde
07-50	Human corpse
51-60	Elf corpse
61-70	Dwarf corpse
71-79	Halfling corpse
80-85	Skeleton angered at being disturbed: AC 7; HD 1; hp 6; MV 60' (20'); #AT 1; D 1-4 with bare finger bones; Save F1; ML 12; AL C; XP 10
86-90	Zombie angered at being disturbed: AC 8; HD 2; hp 9; MV 90' (30'); #AT 1 claw; D 1-8; Save F1; ML 12; AL C; XP 20
91-94	Ghoul angered at being disturbed: AC 6; HD 2*; hp 9; MV 90' (30'); #AT 2 claws/1 bite; D 1-3/1-3/1-3 + special; Save F2; ML 9; AL C; XP 25
95-97	Wight angered at being disturbed: AC 5; HD 3*; hp 14; MV 90' (30'); #AT 1; D energy drain; Save F3; ML 12; AL C; XP 50
98-99	Wraith angered at being disturbed: AC 3; HD 4**; hp 18; MV 120' (40') on land, 240' (80') flying; #AT 1 touch; D 1-6 + energy drain; Save F4; ML 11; AL C; XP 175
00	Mummy angered at being disturbed: AC 3; HD 5+1**; hp 25; MV 60' (20'); #AT 1 touch; D 1-12 + disease; Save F5; ML 12; AL C; XP 575

The characters may meet up with this expedition in area encounter 6.

Explain to the characters that if they agree to the captain's offer, they must either return the expedition party to the ship, or they must send word of the expedition's status.

If the characters decide not to search for the expedition, they may buy rations and fresh water from the ship's captain.

H. STAIRWAY TO WATER

A 15-foot-diameter circle of hewn stones, overgrown with vegetation, lies in this area. Inside the circle, a 5-foot-wide spiral staircase winds downward.

WILD LANDS ADVENTURES

If the characters go down these stairs, they come to a flat, stone landing resting 15 feet below the ground. The landing leads east to a room shaped like a crescent moon.

A 30-foot-deep stone well stands in the center of the room. Pure water fills half of the well. A carving of two triangles rests in the east wall behind the well. The bases of the equilateral triangles touch, forming a diamond whose upper point tilts slightly to the left. A rough X has been carved at the top point of the diamond.

This carving was made by a Yavdlom mapmaker. The triangles show the spatial relationship of the cities of Quagmire, Thanopolis, and Yavdlom (now the Sunken City). The diamond point marked by an X shows the proposed location of the Yavdlom's fourth city. Actually, this well room was to have been that fourth city's first level. The sinking lands of Serpent Peninsula decimated the Yavdlom race, however, and this city was never finished.

I. TIDAL POOL

A 30-foot-diameter tidal pool lies at the mouth of this river. A single coconut floats in the center of the rocky pool. Five edible sea urchins and twelve edible mussels lie at the bottom of the pool.

If a character breaks open the coconut, he releases a djinni. (The coconut meat, incidentally, is worth 1 ration.)

The djinni erupts from the shell in a burst of smoke. As soon as it takes shape, the djinni turns toward the character who cracked the coconut shell (determine randomly if necessary).

"You are my liberator," thunders the djinni in Common. "For you, I shall complete three tasks, if they are within my power. I am yours to command, liberator!"

Djinni (Lesser): AC 6; HD 7+1**; hp 39; MV 90' (30') on land, 240' (80') flying; #AT 1 (fist or whirlwind) + special; D 2-16 (fist) or 2-12 (whirlwind); Save F14; ML 12; AL C; XP 850



The djinni ignores all voices except its liberator's. It speaks in Common. The djinni tries to do whatever its liberator commands, within its seven powers. It performs no more than three tasks. Once the djinni has performed its tasks, it vanishes in a flash of light and a clap of thunder.

If he wants, the character who liberated the djinni may command it to disappear or return to its shell.

J. SLAGOVICH

This opulent trading city rises from the shore of the Western Sea at the end of the Sind Desert Caravan Track. Merchants fill the streets, hawking their goods. The city wharf never sleeps, as ships load and unload throughout the day and night. Slagovich is a stopping place between Hule to the north and Mule Beach to the south. A ship either arrives or leaves Slagovich every day.

Camels are everywhere around Slagovich. If characters ask, they find out that caravans leave weekly on 1,900-mile treks across the Sind Desert to Akesoli in the Republic of Darokin. Other caravans wind even further, going an extra 300 miles to Glantri City in the Principalities of Glantri.

If the characters take their time wandering through the streets of Slagovich, tell them that they come across this advertisement posted on a wall: "Wanted. Wild horses, mules, and camels. Best prices paid. 100 gp paid for wild camels. 75 gp paid for wild riding horses. 30 gp paid for wild mules. Bring your roped animals to the agent of Bondee Slagomann at the corrals on the outskirts of Slagovich, Mule Beach, or Sea Camel. No healthy beast of burden turned away. Broken animals also sold." This advertisement was posted fairly recently.

If characters have animals they want to take to Mule Beach, hint to them that they should probably not travel along the coast from this city to Mule Beach. The wild animals and brigands that live in the nearby Bush Country would make such a trip treacherous. The characters should take animals to Mule Beach by ship.

Because the three cities of Slagovich, Mule Beach, and Sea Camel are so remote, the cost of transportation between them is doubled. See p. 19 of the Expert rule book for normal land and water transportation costs.

K. MULE BEACH

This dusty-brown trading village stands at the spot where the Throat River empties into the Western Sea. Mule Beach makes up the west end of The Necklace, the ancient land trade route that separates Serpent Peninsula

from the continent. Because of this, Mule Beach is a well-known village. It is here that cargo from ships is loaded onto the backs of pack animals, and vice versa. Ships arrive at or leave the village wharf every other day.

Horses, camels, and mules stand all around this village, waiting to be loaded or unloaded. Caravans leave every other day for Sea Camel, which lies at the other end of The Necklace. Characters can walk The Necklace in 6 days. There is no charge to join a caravan that travels The Necklace, but anyone who joins must provide his own transportation, food, and water. Those who join such a caravan must also help defend the caravan if it is attacked.

If the characters take their time wandering through the streets of Mule Beach, tell them that they come across this advertisement posted on a wall: "Wanted. Wild horses, mules, and camels. Best prices paid. 100 gp paid for wild camels. 75 gp paid for wild riding horses. 30 gp paid for wild mules. Bring your roped animals to the agent of Bondee Slagomann at the corrals on the outskirts of Slagovich, Mule Beach, or Sea Camel. No healthy beast of burden turned away. Broken animals also sold." This advertisement was posted fairly recently.

If characters have animals they want to take to Slagovich, hint to them that they should probably not travel along the coast from this city to Slagovich. The wild animals and brigands that live in the nearby Bush Country would make such a trip treacherous. The characters should take animals to Slagovich by ship.

Because the three cities of Slagovich, Mule Beach, and Sea Camel are so remote, the cost of transportation between them is doubled. See p. 19 of the Expert rule book for normal land and water transportation costs.

L. SEA CAMEL

This solitary jewel of a city rests on the shore of its own gulf. Its white walls and red-tiled roofs greet sailors from the Sea of Dread and weary traders from The Necklace. This tiny, clean village has an excellent, deep harbor. Ships arrive at or leave its docks every other day.

Horses, camels, and mules graze on the village green, waiting to be loaded with ship cargo. Caravans of pack animals leave for Mule Beach every other day. When a caravan is not leaving, one is arriving. The trip across The Necklace lasts 6 days.

If the characters take their time wandering through the streets of Sea Camel, tell them that they come across this advertisement posted on a wall: "Wanted. Wild horses,

mules, and camels. Best prices paid. 100 gp paid for wild camels. 75 gp paid for wild riding horses. 30 gp paid for wild mules. Bring your roped animals to the agent of Bondee Slagomann at the corrals on the outskirts of Slagovich, Mule Beach, or Sea Camel. No healthy beast of burden turned away. Broken animals also sold." This advertisement was posted fairly recently.

If characters have animals they want to take to Slagovich, hint to them that they should probably not travel through the grasslands to that city. The wild animals and brigands that live in the surrounding Bush Country would make such a trip treacherous. The characters should take animals across The Necklace to Mule Beach and trade them there.

Because the three cities of Slagovich, Mule Beach, and Sea Camel are so remote, the cost of transportation between them is doubled. See p. 19 of the Expert rule book for normal land and water transportation costs.

M. BRIGAND FERRY

A ferry, which can hold 50 passengers or 12 pack animals, operates at the point where The Necklace crosses the Throat River. Two ropes guide the raft from one landing to the other. The passengers use the ropes to pull the ferry across.

Bands of brigands, one on each river bank, charge for the use of the ferry. Normally, use of the ferry would be free. The brigands demand 1 gp per human or demi-human and 2 gp per animal. If the characters don't pay, the brigands do not allow them to use the ferry.

The Throat River is 500 feet wide at this point, and it flows quite fast. The only ways characters can avoid the brigands' highway robbery are to defeat the brigands and drive them off the banks, or try to ford the river themselves.

If a character tries to ford the river alone, he has a 50% chance of success. A character riding an animal has a 75% chance of successfully crossing the river. An animal that has no rider has a 25% chance of successfully crossing the river. Increase these odds by 10% if the animals and/or characters tie themselves together before crossing. There is a risk to this approach, however. If any animal tied to other animals fails to cross successfully, all animals behind the fallen animal are lost, unless the characters cut the fallen animal loose.

If a character riding an animal fails to cross, the animal throws the character. Consider any character who fails to cross alone as a "thrown" character, also.

The river washes all thrown characters downstream. Have each thrown character roll 1d20 to see if he is able to reach either riverbank without help. If the number rolled is lower than or equal to that character's Strength score, the character reaches the shore of his choice. If the number rolled is higher than that character's Strength score, the character cannot reach either shore. He must remove any heavy armor that he has on, or he drowns. He may make another die roll in the next round.

The brigands who live downstream claim any pack animals or supplies lost by the characters in the river.

If the characters try to defeat one of the brigand bands, the brigands on the other bank are warned to be prepared for the characters when they cross. If the characters drive the brigands off, all of the survivors regroup and attack the characters further along The Necklace.

Brigands (10-40): AC variable; HD 1; hp 5; MV 120' (40'); #AT 1 weapon; D by weapon; Save F1; ML 8; AL C; XP 5

N. LIZARD MAN CAMP

The smoke and flame from a dozen cooking fires rise from the center of this island. Six rafts are tied up on the beach. Several lizard men mull around the beach, tending to their rafts. Each of the rafts looks large enough to hold 35 lizard men.

These two islands are lizard man camps. To determine how many lizard men are in a camp at any one time, roll 6d6 and multiply by 10.

Not all of the lizard men in these camps attack the characters or Quagmire during the course of this adventure. The lizard men maintain a large force so they can intimidate the people of Quagmire and prevent supply ships from reaching that city. They hope to starve out the survivors without having to engage in combat.

The lizard men do not see the characters if the characters don't draw attention to themselves. If they do, however, the lizard men send out a raft of 6d6 lizard men to investigate.

A guard force of 2d4 lizard men positions itself on a raft just outside Quagmire. Its job is to prevent anyone from entering the city. The lizard men of this force are also under orders to capture anyone who tries to leave the city.

Lizard Men (2-8 by city, 6-36 on raft, 60-360 in camp): AC 5; HD 2+1;

hp 10; MV 60' (20') on land, 120' (40') swimming; #AT 1 weapon; D by weapon +1; Save F2; ML 12; AL N; XP 25

O. THANOPOLIS

This ancient city, built in the shape of a giant sea shell, rises from the swamp to a height of 150 feet. Green vegetation hangs down, staining the city's smooth outer walls of gray stone. Swamp birds circle the spiral city's pinnacle, calling out a welcome. Swamp vegetation chokes the area at the base of the city. Large spaces at the city's pinnacle are the only visible openings.

For more details about the city of Thanopolis, see the Spiral City Adventures section.

P. SUNKEN CITY

Characters can see this city only during the daytime. The city rests 50 feet underwater, so the characters can see it only if they are underwater themselves, or if they are in the sky directly above it.

Fifty feet below the water's surface in this area, the tip of a giant spiral sea shell dances in the waves. The shell's tip widens to smooth walls of white stone, now stained green by vegetation. In some spots, colorful coral clings to the walls of the shell. Sea creatures swim in circles around the pinnacle of the great underwater city during the day. Large spaces in the pinnacle and a large space at the shell's base are the only visible openings in the city's walls.

For more details about the Sunken City, see the Spiral City Adventures section.

Q. QUAGMIRE

This ancient city, built in the shape of a giant sea shell, rises from the sea to a height of 150 feet. Green vegetation hangs down, staining the city's smooth outer walls of white stone. A black pillar of smoke rises from the spiral city's pinnacle during the day. At night, a small orange flame burns at the pinnacle. Fresh holes have been punched into the city's wall at the base. The water line seems to be very close to these holes. Large spaces near the city's pinnacle are the only other visible openings.

For more details about the city of Quagmire, see the Spiral City Adventures section.

SPIRAL CITY ADVENTURES



The three spiral cities located on the Serpent Peninsula area are described here. The three cities are Quagmire, Thanopolis, and the Sunken City.

The layouts of these cities are identical. You may use DM Maps 3 and 4 as a guide to all three cities. A room on DM Map 3 might feature a different encounter in each city, however. For example, the Money Exchange Chamber (area 22) in Quagmire features lizard men, while the same room in Thanopolis features a goblin king, and the same room in the Sunken City features mermen.

Only one area description has been given for rooms that are identical in all three cities. If a room in one city is different from the same room in another city, however, the differing descriptions are listed in the following order: Quagmire, Thanopolis, and the Sunken City. Quagmire descriptions always list where a room's doors or hallways lead. This information is not repeated in the same room's Thanopolis and Sunken City descriptions, as it doesn't change from city to city.

If a room's contents differ only slightly in the other cities, a general description is given first. The differing cities are then listed, along with the features that make each city's room slightly different.

Level 1: Well area

1. CRESCENT HALL

This dark hall is totally flooded. A wooden door at the north end of the hall leads to area 3; a wooden door at the south end leads to area 2. Secret doors made of stone stand in the walls opposite these wooden doors. Each leads to area 5.

Thanopolis: This hall is not flooded. A gelatinous cube lives in this dark hallway. Characters must defeat the creature before they can pass through the hall.

Gelatinous Cube: AC 8; HD 4*; hp 18; MV 60' (20'); #AT 1; D 2-8 + special; Save F2; ML 12; AL N; XP 125

Sunken City: The wooden doors here have rotted away.

2. SOUTH SPIRAL STAIRCASE PASSAGE

This dark, flooded hallway connects the cres-

cent hall (area 1) to the south spiral staircase.

Thanopolis: The hall is damp and musty, but is not flooded.

3. NORTH SPIRAL STAIRCASE PASSAGE

This dark, flooded hallway connects the crescent hall to the north spiral staircase.

Thanopolis: The hall is damp and musty, but is not flooded.

4. BOTTOM OF THE STAIRWAY

Quagmire: The dark, flooded landing at the bottom of these stairs leads to area 5. The stairs spiral up to area 16 on Level 2.

Thanopolis: Human bones clutter this dark landing. The landing is not flooded.

Sunken City: The dark, flooded landing at the bottom of these stairs is the home of a black pudding, which devours any debris that falls down the stairs.

Black Pudding: AC 6; HD 10*; hp 45; MV 60' (20'); #AT 1; D 3-24; Save F5; ML 12; AL N; XP 1,600

5. ROOM OF THE WELL

Quagmire: A stone well stands in the center of this flooded, crescent-shaped room. The room is dark. A wooden bucket tied to a 15-foot-long rope floats against the ceiling. Salt water fills the 15-foot-deep well. A short hallway leads west to area 4. Secret doors made of stone stand in the north and south walls. They lead to area 1.

A pattern of two equilateral triangles is carved into the room's east wall. The triangles' bases touch, forming a diamond whose upper point tilts slightly to the left. A rough X marks the diamond's right point. This crude map shows Quagmire's location in relation to the other Yavdlom cities (Thanopolis, the Sunken City, and the unfinished fourth city—see set location encounter H for details).

Thanopolis: A stone well stands in the center of this dark, crescent-shaped room. A wooden bucket tied to a 15-foot-long rope sits beside the well. Fresh drinking water fills half of the 15-foot-deep well.

The triangle pattern on the wall is marked at the bottom diamond point by an X. This X shows the location of Thanopolis in relation to the other Yavdlom cities.

Sunken City: This area is similar to the area in Quagmire, except that the X on the triangle pattern is carved on the left point of the

diamond. This X shows the location of the Sunken City (or Yavdlom) in relation to the other Yavdlom cities.

Level 2: Entry areas

6. OUTER WARD

Quagmire: Fish swim around this submerged boat dock. Abandoned fishermen's huts stand along the dock.

Thanopolis: Mud and quicksand make the footing here treacherous. See That Sinking Feeling (area encounter 10) for details on how to run this encounter.

Sunken City: Fish circle around the wall of the city. The remains of a wooden dock sway in the current.

7. MAIN GATEWAY

Double doors stand on each side of this flooded, 10-foot-wide tunnel. Heavy beams bar the 5-foot-wide doors from the inside. Arrow slits mark the north and south walls. Three slits in the north wall face area 14; three slits in the south wall face area 8. Two 1-foot-square murder holes rest in the ceiling of the tunnel. These holes lead to area 17.

Thanopolis: The tunnel here is not flooded.

Sunken City: There are no doors or beams here.

8. SOUTHEAST GATEHOUSE

Quagmire: Five warped longbows and 100 warped arrows float against the ceiling of this dark, flooded chamber. Three arrow slits in the east wall look out onto the outer ward (area 6). Three more arrow slits pierce the north wall, connecting this area to the main gateway (area 7). A single door in the west wall leads into the inner ward (area 15).

Thanopolis: Five longbows and 100 arrows lean against the south wall of this dark chamber. This chamber is not flooded.

Sunken City: This area is similar to the area in Quagmire, except that the bows and arrows have rotted away, leaving 100 metal arrowheads on the chamber floor. There is no wooden door in this chamber.

9. SOUTH SPIRAL STAIRCASE

A wooden door stands closed at this dark, flooded landing. The door opens onto the inner ward. Spiral stairs lead up to area 17 on Level 3, and down to area 2 on Level 1.

Thanopolis: The landing here is not flooded.

Sunken City: There is no wooden door at this landing.

10. SOUTHWEST GATEHOUSE

Quagmire: Four warped longbows and 80 warped arrows float against the ceiling of this dark, flooded chamber. Three arrow slits in the west wall look out onto the outer ward (area 6). Three more arrow slits pierce the north wall, connecting this area to the postern gateway (area 11). A single door leads from the east wall into the inner ward (area 15).

Thanopolis: Four longbows and 80 arrows lean against the south wall of this dark chamber. This chamber is not flooded.

Sunken City: This area is similar to the area in Quagmire, except that the bows and arrows have rotted away, leaving 80 metal arrowheads on the chamber floor. There is no wooden door in this chamber.

11. POSTERN GATEWAY

Double doors stand on each side of this flooded, 5-foot-wide tunnel. Heavy beams bar the 5-foot-wide doors from the inside. Arrow slits mark the north and south walls. Three slits in the north wall face area 12; three slits in the south wall face area 10. Two 1-foot-square murder holes rest in the ceiling of the tunnel. These holes lead to area 17.

Thanopolis: The tunnel here is not flooded.

Sunken City: The tunnel here has no doors or beams.

12. NORTHWEST GATEHOUSE

Quagmire: Two crossbows (still usable) float against the ceiling of this dark, flooded chamber. Two wooden cases, each holding 30 metal quarrels, lie on the floor. Three arrow slits in the west wall look out onto the outer ward (area 6). Three more arrow slits pierce the south wall, connecting this area to the postern gateway (area 11). A single door leads from the east wall into the inner ward (area 15).

Thanopolis: Two crossbows and 60 metal quarrels lean against the north wall of this dark chamber. This chamber is not flooded.

Sunken City: This area is similar to the area in Quagmire, except that the crossbows and quarrel boxes have rotted away, leaving 60 metal quarrels scattered about on the chamber floor. There is no wooden door in this chamber.

13. NORTH SPIRAL STAIRCASE

A wooden door stands closed at this dark, flooded landing. The door opens onto the inner ward. Spiral stairs lead up to area 17 on Level 3, and down to area 3 on Level 1.

Thanopolis: The landing here is not flooded.

Sunken City: There is no wooden door at this landing.

14. NORTHEAST GATEHOUSE

Quagmire: Two warped shortbows and 20 warped, silver-tipped arrows float against the ceiling of this dark, flooded chamber. Three arrow slits in the east wall look out onto the outer ward (area 6). Three more arrow slits pierce the south wall, connecting this area to the main gateway (area 7). A single door leads from the west wall into the inner ward (area 15).

Thanopolis: Two shortbows and 20 silver-tipped arrows lean against the north wall of this dark chamber. This chamber is not flooded.

Sunken City: This area is similar to the area in Quagmire, except that the bows and arrows have rotted away, leaving 20 silver-tipped arrowheads scattered on the chamber floor. There is no wooden door in this chamber.

15. INNER WARD

Quagmire: Fish swim around the flimsy, submerged lean-tos and wooden huts that stand in this dark, flooded area.

Thanopolis: Twenty gnolls live in these flimsy huts and lean-tos. This area is not flooded.

Gnolls (20): AC 5; HD 2; hp 9; MV 90' (30'); #AT 1 club; D 2-5; Save F2; ML 8; AL C; XP 20

Sunken City: Fish and other sea creatures circle around this flooded, enclosed area. Seaweed and other underwater plant life sway in the current.

16. SPIRAL ENTRANCE

This dark, flooded landing leads to a 5-foot-wide wooden door. A wooden beam rests across the door. Gray stone steps spiral up to area 18 on Level 3 and down to area 4 on Level 1.

Thanopolis: This dark landing leads to a 5-foot-wide wooden door, which stands open. A heavy wooden beam, which is used to bar the

door shut, lies across the threshold. This landing is not flooded.

Sunken City: The wooden doors have rotted away.

Level 3: Barracks

17. CURTAIN WALKWAY

A stone battlement (5 feet tall and 2½ feet thick) runs around the wall of the city at this level, protecting a 7½-foot-wide walkway. The battlement, which consists of alternating high and low segments, protects the walkway from the outer ward area. The entire walkway is flooded.

Spiral staircases lead down from the north and south positions on the walkway. The northern staircase leads to area 13; the southern staircase leads to area 9. Sets of murder holes are cut into the floors at the east and west positions on the walkway. Each murder hole is 1 foot wide. A pile of rocks lies next to each hole. The western murder holes are centered over area 11; the eastern murder holes are centered over area 7.

Thanopolis: This walkway is not flooded. Six trolls patrol this walkway at all times.

Trolls (6): AC 4; HD 6+3*; hp 45; MV 120' (40'); #AT 2 claws/1 bite; D 1-6/1-6/1-10; Save F6; ML 10 (8); AL C; XP 650

18. SPIRAL LANDING

Quagmire: This dark, flooded landing leads to a 5-foot-wide hallway. Wooden doors stand in the north and south walls of this hallway. The north door leads to area 20; the south door leads to area 19. Gray stone steps spiral up to area 21 on Level 4 and down to area 16 on Level 2.

Two holes, each 3 feet in diameter, have been punched into the stone of the hallway's east wall. One hole is at floor level; the other is at ceiling level. Sea water, fish, and other sea creatures occasionally pass through these rough-edged holes.

Thanopolis: This area is not flooded. There are no holes in the east wall.

Sunken City: There are no holes in the east wall of this area. The wooden doors have rotted away.

19. NIGHT BARRACKS

Quagmire: The frames of six wooden bunkbeds bump against the ceiling of this

SPIRAL CITY ADVENTURES

dark, flooded room. A wooden door in the south wall leads to **area 18**. Two gray oozes live here.

Gray Oozes (2): AC 8; HD 3*; hp 14; MV 10' (3'); #AT 1; D 2-16; Save F2; ML 12; AL N; XP 50

Thanopolis: Six wooden bunkbed frames line the curved south wall of this dark chamber. The bodyguards for a goblin king sleep here. They are here only at night.

Goblins (12): AC 8; HD 3*; hp 14; MV 90' (30'); #AT 1 sword; D 1-8; Save NM; ML 7 (9 with king); AL C; XP 5

Sunken City: This area is similar to the area in Quagmire, except that it has no door or bunkbeds. There are no gray oozes here, either.

20. DAY BARRACKS

Quagmire: The frames of six wooden bunkbeds bump against the ceiling of this dark, flooded room. A wooden door in the north wall leads to **area 18**. A green slime clings to one corner of the room's ceiling.

Green Slime: AC can always be hit; HD 2**;
hp 10; MV 3' (1'); #AT special; D special; Save F1; ML 7; AL L; XP 5

Thanopolis: Six wooden bunkbed frames line the curved north wall of this dark chamber. The bodyguards for a goblin king sleep here. They are here only during the day.

Goblins (12): AC 8; HD 3*; hp 14; MV 90' (30'); #AT 1 sword; D 1-8; Save NM; ML 7 (9 with king); AL C; XP 5

Sunken City: This room has no door or bunkbeds. There is no green slime here, either.

Level 4: Money chamber

21. SPIRAL LANDING

Quagmire: This dark, half-flooded landing leads to a large chamber (**area 22**). Three feet of salt water covers the landing and the bottom step of the spiral staircase. Gray stone stairs spiral up to **area 26** on Level 5 and down to **area 18** on Level 3.

Thanopolis: This landing is not flooded.

Sunken City: This landing is totally flooded.

22. MONEY EXCHANGE CHAMBER

Quagmire: Two spiral staircase landings open into this dark, half-flooded chamber. One landing is in the center of the room (**area 21**); the other stands along the north wall (**area 23**).

A party of 2d4 lizard men stands inside this chamber. They attack as soon as characters enter.

Lizard Men (2-8 in chamber, 6-36 outside):
AC 5; HD 2+1; hp 10; MV 60' (20');
#AT 1 spear; D 2-7; Save F2; ML 12;
AL N; XP 25

Two holes, each 3 feet in diameter, have been punched into the east wall of the chamber. One hole is at floor level; the other is at ceiling level. Fish and other sea creatures occasionally swim through the lower hole. The chamber floor is covered by 3 feet of salt water.

The characters will probably use the holes in the east wall of this chamber to enter the city of Quagmire. A party of 6d6 lizard men attacks the characters from a raft as characters enter or leave through these holes.

Thanopolis: There is no water standing in this chamber. There are no holes in the east wall.

A goblin king lives in this chamber. He attacks the characters as soon as he sees them. The king's trained dire wolves also attack. The king tries to escape if the battle goes badly for him, but he commands his wolves to stay and fight.

Goblin King: AC 6; HD 3; hp 15; MV 120' (40'); #AT 1 sword; D 2-9; Save F2; ML 7; AL C; XP 35

Dire Wolves (4): AC 6; HD 4+1; hp 22; MV 150' (50'); #AT 1 bite; D 2-8; Save F2; ML 8; AL N; XP 125

Sunken City: This area is totally flooded. There are no holes in the east wall.

This area is the barracks for 22 mermen. There are always at least 10 mermen and a leader in this chamber. The mermen attack the characters on sight.

Mermen (10-22): AC 6; HD 1; hp 5; MV 120' (40'); #AT 1 trident; D 1-6; Save F1; ML 8; AL N; XP 10

Merman Leader: HD 2; hp 9; Save F2; XP 20

23. NORTH NARROW SPIRAL LANDING

Quagmire: This dark, half-flooded landing leads to a large chamber (**area 22**). Three feet of salt water covers the landing and the bot-

tom step of the spiral staircase. Gray stone stairs spiral up to **area 28** on Level 5.

Thanopolis: This landing is not flooded.

Sunken City: This landing is totally flooded.

24. SOUTH NARROW SPIRAL LANDING

This dark, humid landing leads to a dark chamber (**area 25**). Gray stone steps spiral from the landing up to **area 29** on Level 5.

Sunken City: This landing is flooded.

25. TRIBUTE STORAGE

Quagmire: Ten metal chests stand in this dark, humid room. Nine of the chests are unlocked and empty. The locked chest contains two leather sacks. In one sack are 15 garnets, 10 topazes, and 5 rubies. These gems' combined value is 11,500 gp. The other sack contains 500 gp. A landing in the southeast corner of the room leads to a spiral staircase (**area 24**).

Thanopolis: Ten metal chests stand in this dark, humid room. The locks on the chests have been broken. All of the chests are empty.

Sunken City: A school of 10 giant goldfish is swimming around this dark, flooded chamber. Treat the goldfish as an animal herd.

Giant Goldfish (10): AC 7; HD 2; hp 9; MV 240' (80'); #AT 1 butt; D 1-4; Save F1; ML 5; AL N; XP 20

The characters may try to herd the fish out of the room rather than fight them.

Four locked metal boxes stand in the northwest corner of the chamber. Characters must get past at least five of the fish to see the boxes. The first box the characters open contains 2,450 gp. The second box contains 11 garnets worth a total of 1,100 gp. The third box contains 1,050 gp worth of jewelry. The fourth box contains a *returning trident* (treat as a *returning spear*). See the Appendix for details on this new magic item.

Level 5: Market area

26. SPIRAL LANDING

Quagmire: This landing leads to a large chamber (**area 27**). Gray stone steps spiral from the landing up to **area 30** on Level 6 and down to **area 21** on Level 4.

The first character to step onto this landing

comes face-to-face with 12 spear points. A band of men wields the spears.

Normal Humans (12): AC 9; HD 1; hp 6; MV 120' (40'); #AT 1 spear; D 1-6; Save NM; ML 12; AL N; XP 5

One of the men says in Common, "If you come in peace, throw us your weapons and we will welcome you."

If the characters give up their weapons, the men allow them to enter **area 27**. If the characters do not give up their weapons, the men attack, fighting to the death.

Thanopolis: This landing is empty. It is not flooded.

Sunken City: This landing is empty.

27. MARKETPLACE CHAMBER

Quagmire: Three spiral staircase landings stand in a row in this chamber. One stands in the center of the room (**area 26**), one stands near the north wall (**area 28**), and one stands near the south wall (**area 29**).

If the characters gave up their weapons in **area 26**, the men from that area allow them

to enter this chamber. Then they search the characters.

The men offer gold pieces for the characters' rations. They pay 75 gp for a week's worth of iron rations, 25 gp for a week's worth of standard rations, and 5 gp for a quart of fresh water. These people are very hungry and thirsty, so they are very eager to bargain with the characters.

If the characters are friendly to the people, one of the men suggests that the characters go up to speak to Molariah, the ruler of Quagmire. If characters ask, the man tells them that Molariah's chamber is five levels up.

Thanopolis: This area is dark and empty.

Sunken City: This area is dark, flooded, and empty.

28. NORTH NARROW SPIRAL LANDING

This landing leads to a large chamber (**area 27**). Gray stone steps spiral from this landing up to **area 33** on Level 6 and down to **area 23** on Level 4.

Thanopolis: This landing is dark.

Sunken City: This landing is dark and flooded.

29. SOUTH NARROW SPIRAL LANDING

This landing leads to a large chamber (**area 27**). Gray stone steps spiral from this landing up to **area 32** on Level 6 and down to **area 24** on Level 4.

Thanopolis: This landing is dark.

Sunken City: This landing is dark and flooded.

**Level 6:
Service area**

30. SPIRAL LANDING

This landing leads to a large chamber (**area 31**). Gray stone steps spiral from this landing up to **area 35** on Level 7 and down to **area 26** on Level 5.



SPIRAL CITY ADVENTURES

Thanopolis: This landing is dark.

Sunken City: This landing is dark and flooded.

31. COMMERCE CHAMBER

Quagmire: Two spiral staircase landings stand in this chamber. One landing stands in the center of the room (**area 30**); the other stands near the south wall (**area 32**).

As the characters enter this area, a group of women and children moves up the stairs from **area 30** to **area 35** on Level 7. There are 14 women and 16 children in the group.

Normal Humans (30); AC 9; HD 1; hp 4; MV 120' (40'); #AT 1; D 1-4; Save NM; ML 6; AL N

Thanopolis: This area is dark and empty.

Sunken City: This area is dark, flooded, and empty.

32. SOUTH NARROW SPIRAL LANDING

This landing leads to a large chamber (**area 31**). Gray stone steps spiral from this landing down to **area 29** on Level 4.

Thanopolis: This landing is dark.

Sunken City: This landing is dark and flooded.

33. NORTH NARROW SPIRAL LANDING

This dark, humid landing leads to a dark chamber (**area 34**). Gray stone steps spiral from the landing down to **area 28** on Level 5.

34. DRY STORAGE

Quagmire: This dark, humid chamber contains 100 iron rations and 25 full wineskins. A spiral staircase (**area 33**) leads down out of the room.

Thanopolis: This dark, humid chamber is the webbed lair of three giant black widow spiders.

Giant Black Widow Spiders (3); AC 6; HD 3*; hp 14; MV 60' (20'), 120' (40') in web; #AT 1 bite; D 2-12 + poison; Save F2; ML 8; AL N; XP 50

Sunken City: This dark, humid chamber is the only room in this city that is not flooded. A large air pocket in the room makes it possible for characters to breathe normally here, although the air is quite stale.

This room is the prison of Kazandra Slago-

mann, the daughter of a wealthy Slagovich merchant.

Once the characters have convinced Kazandra that they will not hurt her, she tells them in Common, "My father, Bondee Slagomann, will pay you dearly for my safe return." Kazandra tells the characters that mermen captured her a week ago and have kept her in this prison by herself ever since.

If characters return Kazandra safely to her father in Slagovich, Slagomann rewards each character with a free camel and a jeweled medallion worth 1,500 gp.

Level 7: Private quarters

35. SPIRAL LANDING/ SQUARE CORRIDOR

This landing opens onto a square corridor lined with 16 closed, wooden doors. Gray stone steps spiral from the landing up to **area 38** on Level 8 and down to **area 30** on Level 6.

Thanopolis: The landing here is dark.

Sunken City: The landing here is dark and flooded. All of the wooden doors have rotted away.

36. PRIVATE QUARTERS

These rooms contain the personal possessions of human families. The rooms' wooden doors open onto a square corridor (**area 35**). These doors can be locked.

Thanopolis: These rooms are dark and empty.

Sunken City: These rooms are dark, empty, and flooded. The wooden doors have rotted away.

37. PRIVATE BATHS

Each of these dark rooms contains an empty bathtub. These rooms' wooden doors open onto a square corridor (**area 35**). The doors can be locked.

Sunken City: These rooms are all flooded. All of the tubs are filled with salt water. The wooden doors have rotted away.

Level 8: Rented rooms

38. SPIRAL LANDING/ SQUARE CORRIDOR

This dark landing leads to a square corridor lined with 16 wooden doors. Gray stone steps

spiral from the landing up to **area 41** on Level 9 and down to **area 35** on Level 7.

Sunken City: This landing is flooded. The wooden doors have rotted away.

39. RENTED ROOMS

These dark rooms are empty. The rooms' wooden doors open onto a square corridor (**area 38**). The doors can be locked.

Sunken City: These rooms are flooded. The wooden doors have rotted away.

40. PUBLIC BATHS

Empty, human-sized bathtubs stand inside these dark corner rooms. The room's wooden doors open onto a square corridor (**area 38**). The doors can be locked.

Sunken City: These rooms are flooded. The tubs are filled with salt water. The wooden doors have rotted away.

Level 9: Dining area

41. SPIRAL LANDING

This dark landing leads to a dark, 5-foot-wide hallway. Wooden doors stand in the hallway's north and south walls. The north door leads to **area 43**; the south door leads to **area 42**. Gray stone steps spiral from the landing up to **area 44** on Level 10 and down to **area 38** on Level 8.

Sunken City: This landing is flooded. The wooden doors have rotted away.

42. KITCHEN

This dark, musty room was once a kitchen. Dust covers the floors and cupboards here. The room doesn't appear to have been used in a long time. There is no food here. A wooden door in the northeast wall leads to **area 41**.

Sunken City: Cooking equipment floats against the ceiling of this flooded kitchen. The wooden door has rotted away.

43. DINING HALL

A long, wooden table surrounded by wooden chairs stands in this dark, curved room. A thick layer of dust covers the table and chairs. A wooden door in the southeast wall leads to **area 41**.

Sunken City: Bronze plates and eating



utensils float against the ceiling of this flooded room. The wooden door has rotted away.

Level 10: Ruler's quarters

44. SPIRAL LANDING

This dark landing leads to a locked wooden door. A sign, written in Common, hangs on the door. It reads, "Ruler's Private Apartment." The door leads to **area 45**. Gray stone steps spiral from the landing up to **area 46** on Level 11 and down to **area 41** on Level 9.

Sunken City: This landing is flooded. The wooden door has rotted away.

45. RULER'S APARTMENT

Quagmire: This brightly-lit, ring-shaped room is the home of Molariah, ruler of Quagmire. Molariah is a very sick man (only 1 hp left). If characters do not attack him, Molariah speaks in Common as they enter.

"You must rescue my people from Quagmire before it sinks. You are our last hope. There is an ancient city called Thanopolis. It

is a spiral city like ours. It stands on the southwest shore of Thanegia Island. Please lead my people safely to Thanopolis and help them resettle. If you do this, the people will proclaim you leaders and will serve you in your time of need. Go now, please, and seek out Thanopolis. My people will follow you there, but I cannot. I will die soon—I will enter the sea within my own city. Farewell."

In this room are Molariah's personal possessions, two tapestries worth 100 gp each, and a carved wooden throne. A wooden door in the east wall opens onto **area 44**.

A total of 12 men, 14 women, and 16 children live in Quagmire. They immediately gather their belongings and supplies when characters tell them that they are taking them to Thanopolis. The people will go only to Thanopolis.

If the characters successfully resettle Molariah's people in Thanopolis, the people thank the characters profusely and tell them that they will gladly help the characters in times of need. The people also give the characters the remains of their treasury (listed in the description of **area 25**, Level 4).

Thanopolis: Rotting tapestries hang on the walls of this dark, ring-shaped room. A wooden throne stands along the west wall. A

jeweled crown worth 1,500 gp lies under the throne.

Sunken City: This dark, flooded room is a merman ruler's throne room. The merman attacks as soon as characters enter the room.

Merman Ruler: AC 6; HD 4; hp 18; MV 120' (40'); #AT 1 trident; D 1-6; Save F4; ML 8; AL N; XP 75

Level 11: Jail

46. SPIRAL LANDING

This dark landing leads to a locked wooden door. A sign, written in Common, hangs on the door. It reads, "Dangerous Prisoners." The door leads to **area 47**. Gray stone steps spiral from the landing down to **area 44** on Level 10.

Sunken City: This landing is flooded. The wooden door has rotted away.

47. RING CORRIDOR

Quagmire: Twelve lizard man prisoners are living in this dark cell. The lizard men attack as soon as characters enter.

Lizard Men (12): AC 5; HD 2+1; hp 7; MV 60' (20'); #AT 1; D 1-6; Save F2; ML 12; AL N; XP 25

A wooden door in the east wall opens onto **area 46**. A ladder leads from this corridor up to **area 48** on Level 12.

Thanopolis: Several items are scattered on the floor of this dark, ring-shaped room. Characters may find a *potion of swimming*, a *potion of water breathing*, a *ring of water adaptation*, a *returning spear*, and a sealed tube in this room. Inside the tube is a tattered, ancient scroll, written in Common. The surviving piece of parchment reads, "Equally distant from each city is yet another constructed by the Yavdlom people. Destruction fell upon them before they completed their fourth. Their third city, Yavdlom, now rests beneath the Shallow Sea. These tools I have collected in order to explore this sunken city."

A wooden door in the east wall opens onto **area 46**.

Sunken City: This dark, flooded room is a merman living area. None of the creatures are here when the characters enter.

Level 12: Spiral staircase

48. STAIRCASE

Quagmire: Natural light floods this narrow spiral staircase. There is no landing at this level. A ladder leads up to **area 49** on Level 13 and down to **area 47** on Level 11.

Thanopolis: This area is similar to the area

in Quagmire. During the day, however, it is the nesting place for 10 normal bats.

Normal Bats (10): AC 6; HD 1/4; hp 1; MV 9' (3') on land, 120' (40') flying; #AT confusion; D nil; Save NM; ML 6; AL N; XP 5

Sunken City: This flooded area serves as a merman guardpost. Two mermen are on guard here when the characters enter. As soon as characters enter, one merman attacks, while the other swims off to alert the other mermen (in **areas 22** and **25**).

Mermen (2): AC 6; HD 1; hp 5; MV 120' (40'); #AT 1 trident; D 1-6; Save F1; ML 8; AL N; XP 10

Level 13: Pinnacle of flame

49. BRAZIER

Quagmire: Three metal beams support a 5-foot-tall metal cone 10 feet above the stone

floor of this open area. Three huge braziers stand around the outer edge of this level. Oil burns continuously in each of the braziers, producing a bright orange flame at night and a black pillar of smoke during the day. A ladder leads down from this level to **area 48** on Level 12.

Thanopolis: There is no oil in the braziers here. A flock of 24 piranha birds uses the braziers as nests.

Piranha Birds (24): AC 6; HD 1/2; hp 3; MV 30' (10') on land, 180' (60') flying; #AT 1 bite; D 1-4; Save NM; ML 9; AL N; XP 5

For a complete description of these creatures, turn to the Appendix.

Sunken City: Nine sea snakes live in the flooded braziers here.

Sea Snakes (9): AC 6; HD 3*; hp 14; MV 90' (30'); #AT 1 bite; D 1 + poison; Save F2; ML 7; AL N; XP 50

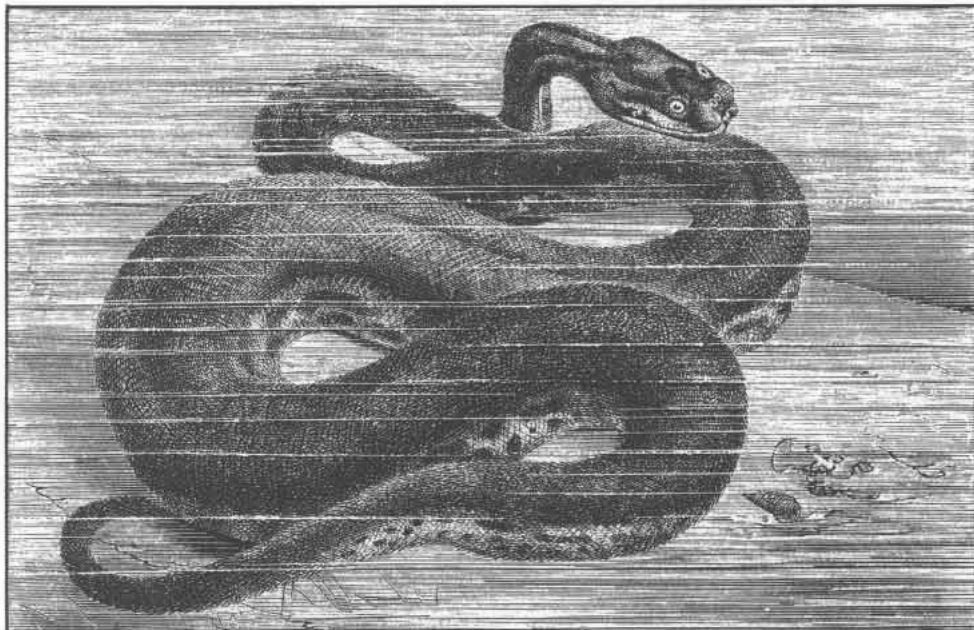



Monsters

Fish, Giant

	Giant Piranha	Giant Catfish
Armor Class:	6	4
Hit Dice:	3 + 3	8 + 3*
Move		
(swimming):	150' (50')	90' (30')
Attacks:	1 bite	1 bite/ 4 feelers
Damage:	1-8	2-16/ (1-4) x4
No. Appearing:	0 (2-8)	0 (1-2)
Save As:	Fighter: 2	Fighter: 4
Morale:	7	8
Treasure Type:	Nil	Nil
Alignment:	Neutral	Neutral
XP value:	50	1,200

Giant piranha. These deadly fish are 5 feet long and have green and black scales. They attack anything that disturbs the water near them. Up to eight giant piranha can attack the same target. Once they draw blood, piranha go into a feeding frenzy (no morale checks allowed). Piranha inhabit warm, fresh waters and prefer rivers to lakes.

Giant catfish. This chalky-white fish is about 15 feet long. It has two long feelers that sprout from each side of its mouth. Giant catfish lurk in the cool muck of rivers and lake bottoms.

Grab Grass

Armor Class: 9
Hit Dice: 1 per 5-foot-square area
Move: 0
Attacks: 1
Damage: special
No. Appearing: not applicable
Save As: Normal Man
Morale: 12
Treasure Type: Nil
Alignment: Neutral
XP value: 10

Grab grass looks like ordinary, tall grass (3-5 feet tall). Grab grass is animated and tries to hold any individual that moves into or through it. There is a 5% chance per round that anyone with a Strength score of 12 or lower can break free of the grab grass. For every point of strength greater than 12, the chance increases by 5% (an individual with a Strength score of 16, for example, would have a 25% chance each round to break free).

Killer Trees

Armor Class: 5
Hit Dice: 6
Move: 0
Attacks: 4 limbs/1 mouth
Damage: 0 each/3-18
No. Appearing: 0 (2-12)
Save As: Fighter: 3
Morale: 12
Treasure Type: Nil
Alignment: Neutral
XP Value: 275

Killer trees look like large trees. They can resemble any tree species. Killer trees are part animal and part vegetable. They need both sunlight and meat to survive. Some of the limbs of a killer tree are actually tentacles. These tentacles can reach out 20 feet and grab victims. The tree then uses its tentacles to drag its victim to its mouth, which is disguised as a large tree-bole. Each limb has 1 Hit Die. If a character does 5 or more points of damage to a killer tree limb, the limb is severed. One round after a limb grabs a character, the tree pulls the character into its mouth, causing 3d6 points of damage per round until the character cuts loose.

Piranha Bird

Armor Class: 6
Hit Dice: 1/2 (1-4 hit points)
Move: 30' (10') on ground
180' (60') flying
Attacks: 1 bite
Damage: 1-4
No. Appearing: 4-24 (4-24)
Save As: Normal Man
Morale: 9
Treasure Type: Nil
Alignment: Neutral
XP Value: 5

The piranha bird is a 1-foot-long, garishly colored bird always hungry for fresh meat. Individual piranha birds may have green, blue, red, brown, black, or even purple feathers—the entire variety of colors displayed in a single flock. Their beaks are sharp and pointed, and have razorlike edges so that the bird can stick its beak into the flesh of a creature, bite, and fly away with a snack.

Piranha birds can fly with hummingbird-like maneuverability; they can make sudden changes in direction, or even hover in the air. When one piranha bird catches sight of a potential meal, it utters a high-pitched whistle, thus alerting the entire flock. They always attack warm-blooded creatures, and do not have to check morale until half of the flock has been eliminated.

Piranha birds may be found in all climates except the very coldest or those barren of any shade. They prefer to live in regions of dense forest or in underground caverns, and seem to have developed limited infravision, which allows them to detect prey up to 30 feet away even in total darkness.

Pocket Dragon

Armor Class: 8
Hit Dice: 3
Move: 90' (30')
120' (40') flying
Attacks: 1 bite
Damage: 1-3 + venom
No. Appearing: 1-6 (2-12)
Save As: Magic-user: 3
Morale: 8
Treasure Type: K, L
Alignment: Neutral
XP Value: 35

The pocket dragon is a 3-foot-long lizard that resembles a small green dragon. It is usually found resting on a small pile of treasure and other shiny objects. It is lazy and peaceful by nature, feeding on insects and plants and rarely attacking larger creatures unless it is angered. It has no breath weapon, but its bite carries a venom that lowers both saving throws and hit rolls by 2 unless the victim makes a successful saving throw vs. poison. A cure disease spell cures this effect. The creature shares with dragons a love of hoarding treasure, but its sense of value is not as fine as its larger cousin; its treasure often consists of broken glass and other shiny trinkets.

Spider, Giant Hunting

Armor Class: 8
Hit Dice: 2
Move: 120' (40')
Attacks: 1 bite
Damage: 1-6
No. Appearing: 1-4 (2-12)
Save As: Fighter: 2
Morale: 7 (wild), 8 (tamed)
Treasure Type: U
Alignment: Neutral
XP value: 20

Hunting spiders are fur-covered spiders the size of dogs, and are used as watch-animals and hunters in several primitive societies. In the wild, hunting spiders run in packs to bring down their prey. They may be found in any terrain. Their fur matches the color of their surroundings. The hunting spider does not build a web, but rather stalks his prey over almost any terrain, and attacks with large but non-poisonous jaws.

#	River	Swamp	Hills	Ocean	Jungle
1	Men	Men	Men	Men	Men
2	Flyer	Flyer	Flyer	Flyer	Flyer
3	Humanoid	Humanoid	Humanoid	Swimmer	Insect
4	Insect	Swimmer	Unusual	Swimmer	Insect
5	Swimmer	Undead	Animal	Swimmer	Humanoid
6	Swimmer	Undead	Humanoid	Swimmer	Animal
7	Animal	Insect	Dragon	Swimmer	Animal
8	Dragon	Dragon	Dragon	Dragon	Dragon

1. ANIMALS

#	River	Hills	Jungle
1	Animal Herd, Goat	Animal Herd, Goat	Animal Herd, Goat
2	Animal Herd, Goat	Animal Herd, Goat	Animal Herd, Goat
3	Boar	Animal Herd, Goat	Boar
4	Cat, Panther	Baboon, Rock	Boar
5	Cat, Tiger	Baboon, Rock	Cat, Panther
6	Crab, Giant	Baboon, Rock	Cat, Panther
7	Crab, Giant	Mule	Cat, Panther
8	Crocodile	Mule	Lizard, Giant Draco
9	Crocodile	Mule	Lizard, Giant Draco
10	Crocodile, Large	Snake, Rattler	Lizard, Giant Gecko
11	Fish, Giant Bass	Snake, Rattler	Lizard, Giant Horned
12	Fish, Giant Catfish	Snake, Rattler	Rat, Giant
13	Fish, Giant Piranha	Snake, Rattler	Rat, Giant
14	Fish, Giant Rock	Snake, Viper	Shrew, Giant
15	Fish, Gt. Sturgeon	Snake, Viper	Shrew, Giant
16	Leech, Giant	Snake, Viper	Snake, Viper
17	Rat, Giant	Snake, Viper	Snake, Python
18	Shrew, Giant	Snake, Viper	Snake, Spitting
19	Termite, Fr. Water	Snake, Viper	Spider, Crab
20	Toad, Giant	Snake, Viper	Spider, Crab

2. HUMANOIDS

#	River	Swamp	Hills	Jungle
1	Bugbear	Gnoll	Dwarf	Bugbear
2	Elf	Goblin	Giant, Hill	Cyclops
3	Gnoll	Goblin	Giant, Hill	Elf
4	Hobgoblin	Hobgoblin	Gnome	Giant, Fire
5	Lizard Man	Lizard Man	Goblin	Gnoll
6	Nixie	Lizard Man	Kobold	Goblin
7	Nixie	Nixie	Kobold	Lizard Man
8	Ogre	Ogre	Orc	Ogre
9	Orc	Ogre	Orc	Ogre
10	Sprite	Orc	Troglodyte	Orc
11	Thoul	Troglodyte	Troll	Troglodyte
12	Troll	Troll	Troll	Troll

3. MEN

#	River/Lake	Swamp	Hills	Ocean	Jungle
1	Adventurer	Adventurer	Adventurer	Adventurer	Adventurer
2	Bandit	Bandit	Bandit	Buccaneer	Bandit
3	Buccaneer	Berserker	Berserker	Buccaneer	Berserker
4	Brigand	Brigand	Brigand	Native	Brigand
5	Cleric	Cleric	Cleric	Native	Brigand
6	Fighter	Fighter	Fighter	Pirate	Cleric
7	Magic-User	Magic-User	Magic-User	Pirate	Fighter
8	Native	Native	Native	Pirate	Magic-User
9	Native	Native	Native	Trader	Native
10	Native	Native	Native	Trader	Native
11	NPC Party	NPC Party	Native	Trader	Native
12	Trader	Trader	Trader	Trader	Trader

4. FLYERS

#	All Terrains
1	Bee, Giant
2	Cockatrice
3	Gargoyle
4	Griffon
5	Harpy
6	Harpy
7	Hippogriff
8	Hippogriff
9	Insect Swarm
10	Lizard, Giant Draco
11	Pegasus
12	Piranha Bird
13	Pixie
14	Pocket Dragon
15	Robber Fly
16	Roc, Small
17	Roc, Large
18	Roc, Giant
19	Sprite
20	Stirge

5. SWIMMERS

#	River/Lake	Swamp	Ocean
1	Crab, Giant	Crab, Giant	Crab, Giant
2	Crab, Giant	Crab, Giant	Crab, Giant
3	Crocodile	Crab, Giant	Crab, Giant
4	Crocodile, Large	Crab, Giant	Giant, Storm
5	Fish, Giant Bass	Crocodile	Giant, Storm
6	Fish, Gt. Sturgeon	Crocodile	Gray Ooze
7	Fish, Gt. Piranha	Crocodile, Lrg.	Gray Ooze
8	Fish, Gt. Catfish	Crocodile, Lrg.	Gray Ooze
9	Gray Ooze	Fish, Gt. Rock	Hydra, Sea
10	Gray Ooze	Fish, Gt. Rock	Hydra, Sea
11	Leech, Giant	Gray Ooze	Hydra, Sea
12	Leech, Giant	Gray Ooze	Merman
13	Lizard Man	Leech, Giant	Merman
14	Lizard Man	Leech, Giant	Merman
15	Merman	Lizard Man	Snake, Sea
16	Merman	Lizard Man	Snake, Sea
17	Nixie	Merman	Snake, Sea
18	Nixie	Merman	Termite, Salt Water
19	Termite, Fr. Water	Termite, Swamp	Termite, Salt Water
20	Termite, Fr. Water	Termite, Swamp	Termite, Salt Water

6. DRAGONS

#	River/Ocean	Swamp	Hills	Jungle
1	Chimera	Chimera	Chimera	Chimera
2	Dragon, Gd.	Dragon, Black	Dragon, Gold	Dragon, Gold
3	Dragon, Gd.	Dragon, Gold	Dragon, Red	Dragon, Green
4	Hydra, Fly.	Hydra, Flying	Hydra, Flying	Hydra, Flying
5	Hydra, Fly.	Salamander, Fl.	Salamander, Fl.	Salamander, Fl.
6	Wyvern	Wyvern	Wyvern	Wyvern

7. INSECT

#	All Terrain
1	Ant, Giant
2	Bee, Giant
3	Beetle, Fire
4	Beetle, Oil
5	Beetle, Tiger
6	Insect Swarm
7	Rhagodessa
8	Robber Fly
9	Scorpion, Giant
10	Spider, Black Widow
11	Spider, Crab
12	Spider, Giant Hunting

8. UNDEAD

#	All Terrain
1	Ghoul
2	Mummy
3	Skeleton
4	Spectre
5	Wight
6	Wraith
7	Vampire
8	Zombie

9. UNUSUAL

#	All Terrain
1	Basilisk
2	Blink Dog
3	Centaur
4	Displacer Beast
5	Golem, Amber
6	Golem, Bone
7	Golem, Bronze
8	Golem, Bronze
9	Golem, Wood
10	Gorgon
11	Killer Tree
12	Living Statue, Crystal
13	Living Statue, Iron
14	Living Statue, Rock
15	Lycanthrope, Wereboar
16	Lycanthrope, Wererat
17	Lycanthrope, Weretiger
18	Medusa
19	Shadow
20	Treant

APPENDIX

Prerolled characters

Seven different characters are listed below. Each description includes a list of weapons, armor, and magic items (if the character has any). Allow the players to choose equipment for these characters from p. 19 of the Expert

Hugi Tunneltrue

Neutral 6th level Dwarven Myrmidon

Strength	11	Dexterity	10
Intelligence	10	Constitution	14
Wisdom	4	Charisma	12
Armor Class	2	Hit points	50

Weapons: war hammer +1; sword; dagger
Armor: plate mail and shield

Hrothgar the Sly

Neutral 7th level Pilferer

Strength	5	Dexterity	15
Intelligence	9	Constitution	9
Wisdom	11	Charisma	8
Armor Class	6	Hit points	25

Weapons: dagger +1; sword

Armor: leather armor

Harold Forkbeard

Neutral 7th level Champion

Strength	16	Dexterity	7
Intelligence	6	Constitution	14
Wisdom	17	Charisma	14
Armor Class	4	Hit points	61

Weapons: war hammer +2; hand axe; dagger

Armor: chain mail byrnie (coat of mail)

rule book. You should also allow each character to start the adventure with 3d6x100 gp. These characters must secure their own supplies and mounts, however.

Magnus the Mage

Neutral 7th level Sorcerer

Strength	15	Dexterity	10
Intelligence	15	Constitution	14
Wisdom	13	Charisma	7
Armor Class	9	Hit points	30

Weapons: dagger +1; wand of cold

Armor: ring of protection +1

Spells.

First level: read magic, magic missile, shield, sleep

Second level: ESP, mirror image

Third level: fly, fireball

Fourth level: charm monster

Leander Lostburrow

Chaotic 6th level Halfling Myrmidon

Strength	5	Dexterity	11
Intelligence	11	Constitution	10
Wisdom	14	Charisma	9
Armor Class	3	Hit points	31

Weapons: dagger +1; shortsword; five javelins

Armor: plate mail

These characters come from the DUNGEONS & DRAGONS® Game Accessory, "The Shady Dragon Inn," which features over 100 prerolled characters.

Katharos the Pure

Lawful 9th level Patriarch

Strength	6	Dexterity	8
Intelligence	11	Constitution	14
Wisdom	14	Charisma	10
Armor Class	3	Hit points	57

Weapons: mace +1; five bottles of holy water; three holy symbols

Armor: plate mail and shield

Spells.

First level: cure light wounds, detect magic, protection from evil

Second level: bless, resist fire, snake charm

Third level: cure disease, remove curse, striking

Fourth level: cure serious wounds, sticks to snakes

Idris Darkelf

Neutral 7th level Elven Champion Sorcerer

Strength	9	Dexterity	9
Intelligence	12	Constitution	9
Wisdom	12	Charisma	15
Armor Class	2	Hit points	40

Weapons: sword +1; dagger; bow and 10 arrows

Armor: plate mail and shield

Spells.

First level: charm person, detect magic, floating disc, sleep

Second level: levitate, web

Third level: haste, lightning bolt

Fourth level: charm monster

New magic items

Potion of swimming. The user may swim in any liquid at the rate of 180' (60'), even if he is encumbered. The user does not sink (even if he is pushed below the surface) unless he is carrying more than 3,000 cn in weight. The potion doesn't allow the user to breathe water. The effects of this potion last for 8 hours.

Potion of water breathing. The effects of this potion are identical to the 3rd level magic-user spell.

Ring of water adaptation. This is a ring of

elemental adaptation for water. The wearer of this ring can freely breathe, see, and move through water as if it were air.

Returning spear. This hand-hurled missile weapon returns to the caster if it misses its target. It acts as a sort of "boomerang." If it misses its target, the spear returns at the end of the round; the character who threw the spear automatically catches the returning spear, unless he is paralyzed, confused, immobile, etc. If it hits its target, the spear does not return by itself.

We, the people of the city of Quagmire, cry out for help in our time of need. The sea, which once was our very source of life, has become our enemy. Our great city of trade is sinking beneath the salty waves. Without a safe mooring we have no trade. Without trade we have no food or water. A fever has decimated our population, and still it rages on.

The denizens of the lowlands that surround us have blockaded our city and are now preying upon us in this weakened state. They capture our messengers and keep trade ships from reaching us. They plan to besiege us until we can no longer defend ourselves. If we fall, they will overrun us, kill us, and squander the fortunes and staples that we have stored up.

Our hopes go with this message—hopes that the pleas we have cast into the waters shall reach civilized people, hopes that brave and unselfish souls will find one of our messages and look upon our plight with pity, hopes that there are those who have the resources to run the hideous blockade and bring our people food and water.

We offer five times the normal price for food and fresh water. If our rescuers can lead us to a new home and help us resettle, we will certainly pay more. We may not be able to pay an army; we seek the help and guidance of a small band of strong and courageous souls.

I set my hand to this page on the first day of spring. I believe our people can last no longer than 6 months. May the hand that plucks this testament from the sea deliver us to safe, high grounds in all haste.

Molariah
King of the Swamp
Ruler of the
city of Quagmire



The Wild Lands

PLAYERS' MAP

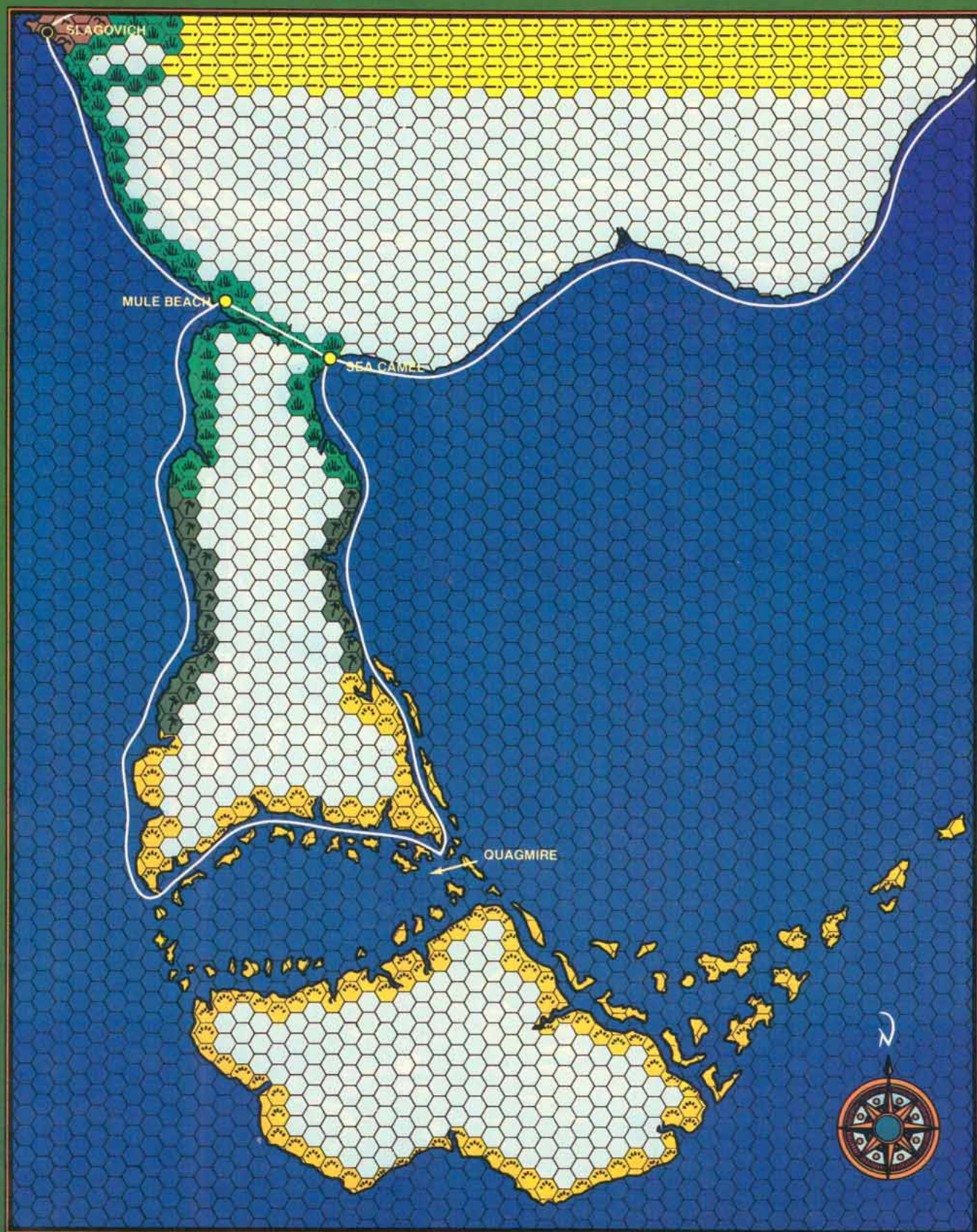

Cut along the fold here and give this panel to the players when the characters discover the message in a bottle.

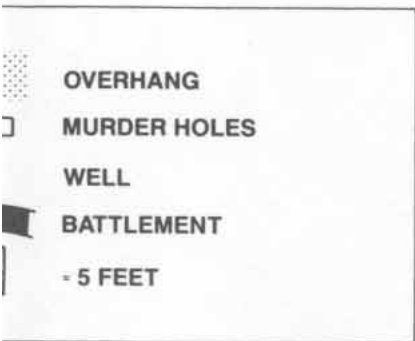

LEVEL 4

WATER SURFACE
QUAGMIRE ENTRANCE

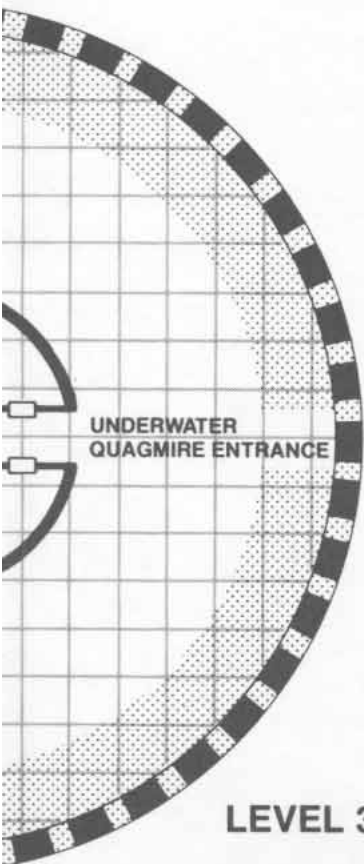

LEVEL 3

UNDERWATER
QUAGMIRE ENTRANCE

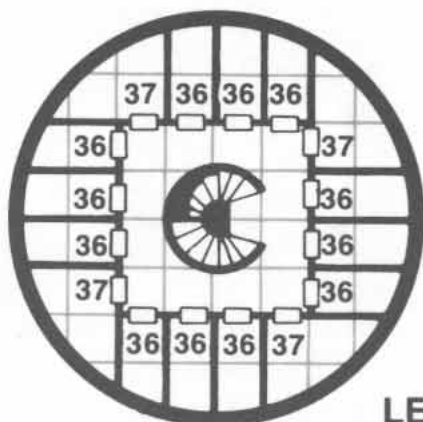

LEVEL 7

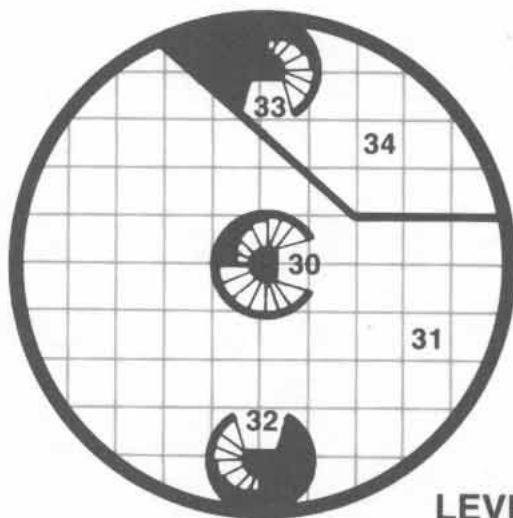

LEVEL 6

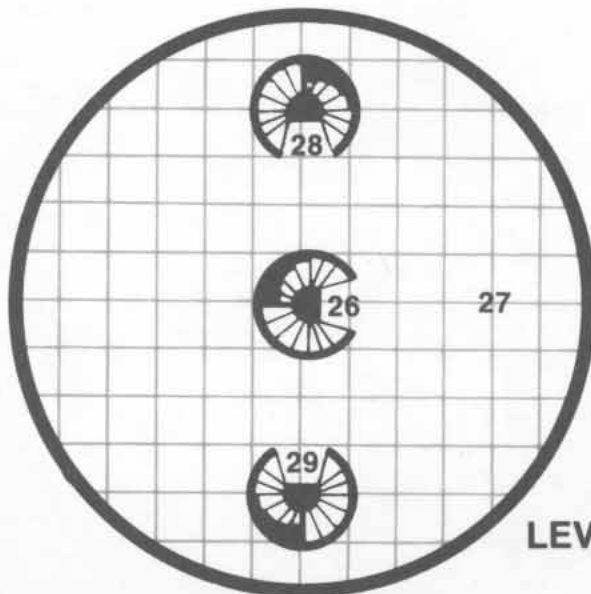

LEVEL 5



LEVEL 13



LEVEL 12



LEVEL 11



LEVEL 10

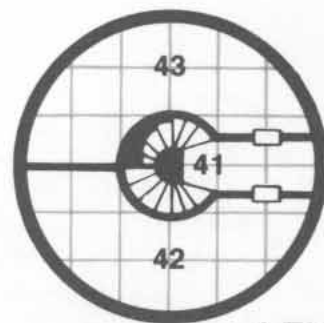

LEVEL 9

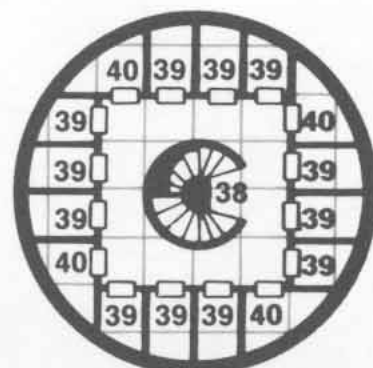

LEVEL 8



Expert Game Adventure

Quagmire!

by Merle M. Rasmussen

Swamp creatures! They surround you now as you move slowly through the gurgling muck. How will you reach Quagmire now? Each day, the hungry sea swallows more of the ancient port city. A fierce fever ravages its people, and now—these foul monsters! Their beady eyes glimmer from deep within the tangled vines. Are these the creatures that have blockaded the city, turning away the ships that are the city's lifeline? Are these the scum that are starving the people of Quagmire, threatening an entire race with extinction? These creeps?

Let's clean this jungle out!

Quagmire includes a large-scale map that expands the D&D world and introduces new areas to explore. The adventure also includes new magic items and a special, expanded monsters section.

Hurry! Hoist your colors, or saddle your horse—go before the city by the sea becomes the city beneath the sea!

This adventure is for use with the DUNGEONS & DRAGONS® Expert set, which complements and expands the D&D® Basic rules. This adventure cannot be played without the D&D® Basic and Expert sets produced by TSR, Inc.

© 1984 TSR, Inc. All Rights Reserved. Printed in U.S.A.

TSR, Inc.
POB 756
Lake Geneva,
WI 53147

TSR (UK) Ltd.
The Mill, Rathmore Road
Cambridge CB14AD
United Kingdom

ISBN 0-88038-112-4
394-54006-9TSR0600

