

MGP  
3003

TRAVELLERS' TALES

d20  
system

# SHIPS OF THE ELVES



This Product Requires the use  
of the Dungeons and Dragons®  
Player's Handbook, Third Edition,  
Published by Wizards of the Coast®



# ***Ships of the Elves***

Mike Major

## **Contents**

- 2 Introduction
- 4 Elves at Sea
- 8 Crews
- 12 Weaponry
- 14 Ships of the Elves
- 32 OGL & D20 licences

## **Credits**

**Editor** – Matthew Sprange

**Cover Art** – Anne Stokes

**Interior Illustrations** - Nathan Webb,  
Danilo Moretti, Philip Renne, Anthea Dilly

**Production Manager** – Alexander Fennell

**Proof Reading** – Ian Barstow

**Special Thanks** – Steve Mulhern

## **Playtesting**

Harris Rotman, Tommy Foster, Jim Sparling, Shannon Sparling, Jimi Braun,  
Michelle Braun, Jason Thorn, William J. Pennington, Steve Mulhern, Jeff Ibach,  
Dawn Ibach, Cheryl Van-Mater Miner, Phillips Van-Mater Miner, Rob Longmuir,  
Royce Groff

## **Open Game Content & Copyright Information**

Ships of the Elves is ©2001 Mongoose Publishing. All rights reserved. Reproduction without the written permission of the publisher is expressly forbidden. Ships of the Elves is presented under the Open Game and D20 Licences. See page 32 for the text of these licences. All game stats and pages so designated are presented as Open Game Content. All other significant characters, names, places, items, art and text herein are copyrighted by Mongoose Publishing. All rights reserved. 'd20 System' and the 'd20 System' logo are Trademarks owned by Wizards of the Coast and are used according to the terms of the d20 System Licence version 3.0. A copy of this Licence can be found at [www.wizards.com](http://www.wizards.com). The mention of or reference to any company or product in these pages is not a challenge to the trademark or copyright concerned. Dungeons & Dragons® and Wizards of the Coast® are Registered Trademarks of Wizards of the Coast, and are used with permission. Printed in the UK.

## **MONGOOSE PUBLISHING**

Mongoose Publishing, PO Box 1018, Swindon, SN3 1DG, United Kingdom

[info@mongoosepublishing.com](mailto:info@mongoosepublishing.com)

Visit the Mongoose Publishing website at [www.mongoosepublishing.com](http://www.mongoosepublishing.com) for regular updates.





## INTRODUCTION

Upon the waves, the ships of the elves are now only seldom seen. Once the ancient race ruled the oceans and none dared challenge their mastery. Now the new races have taken up the challenge of the sea and sail with vigour to all corners of the world. Many may have forgotten the elves, but their rule of the waves has by no means been surpassed.

The elves go to sea for many reasons; to defend the waters of their nations, to trade with the lesser races and to dare the unknown. They are seen only when they choose for they know many of the old trade routes and currents not yet discovered by the younger races. Elven trading ships are faster than most warships and, when confronted, will usually just speed away under a great cloud of white canvas. The ships of the explorers, including the awesome *Vorncir* (Corsair) will often trade if given the option but, if faced with aggression, will sail arrogantly away with complete disdain of any threat from their 'attacker.'

Those pirates unlucky enough to encounter an elven warship or explorer that chooses to fight will soon re-learn an ancient lesson. To challenge the elven race upon water is to meet certain death, for elves seldom board enemies and rarely take prisoners. They simply sink ships with devastating firepower and incredible manoeuvres. Any surviving crew will be left for the sharks and other terrible sea creatures, aside from the occasional few who cling to life and spread tales of elven might.

Travellers' tales tell of the rare times that warships of the elven navies have taken sides in battle, often against massed goblin or orc fleets that threaten whole oceans. Although such appearances are rare, they create legends which are told on the decks of human ships for generations. Rhymes speak of ships of great beauty and mystic power with a speed and manoeuvrability completely unmatched by anything afloat, ships so majestic that sailors whisper in awe of their workmanship, even as their own begins to sink.

## TRAVELLERS' TALES

*Ships of the Elves* expands and enhances the information provided in *Seas of Blood*, also available from Mongoose Publishing. This series of

supplements, designed for use in any fantasy-based d20 games system, takes an exhaustive look at not only sea travel and nautical adventures, but also the specific ships used by various races within the worlds of fantasy. This supplement has been preceded by *Ships of the Goblinoids* and will shortly be followed by *Ships of War*; two supplements guaranteed to give nautical scenarios and campaigns an additional boost that will thrill players and Games Masters alike. It is also recommended that Games Masters interested in such adventures look for *The Slayer's Guide to Sahuagin*, packed with information on one of the cruellest races to lurk beneath the waves.

## SHIPS OF THE ELVES

Every book in this series focuses on the ships and crews of a single race or group of races – in this case the elves. Within these pages, you will find detailed information on how elves operate at sea, how they fight and the deadly, mystic weaponry they use. Many new ship designs are presented, all demonstrative of the elven mastery of the ocean. From the tiny *Spindrift* fire support vessel to the great *Sea Haven* floating town, *Ships of the Elves* will show you how this race could easily rule the waves – if they only chose to do so.

These ships are suitable for all levels of play. Whilst a single party of amoral low-level adventurers may find their pirate ship in trouble against a small elven merchant, a more scrupulous party might have the opportunity to join the crew of one of the famous *Corsairs* and find themselves helping to defend it from attacking pirates. Higher level parties commanding their own ships may ally with an elven navy to destroy an entire goblinoid warfleet. Finally, a party may choose to form the crew of an elven explorer ship – braving new and distant shores in search of adventure and profit. Such a campaign could easily last for years!

*Seas of Blood* gives all the information required to run exciting nautical adventures in any gaming group. *Ships of the Elves* takes such adventures to new levels, presenting players with a familiar race seen in a completely new light.



Hakar snarled in disgust at the tiny ship that danced back and forth on the waves across his bow. Peering through the tiny view slits cut in the for'ard wall of the heavy cabin he had to squint against the blazing sunlight. Sometimes, bein' captain wasn't all it was cracked up to be, he thought. Like now when he had to burn his eyes against the sun to keep an eye on that damned ship.

'She's comin' round again Hakar,' Morfin grumbled.

'I can see that, ya fool. Them idiots on the catapult ain't hit the thing yet!'

'Hard to see in that bright sun, Cap'n.'

'Ya think I don't know that, Morfin? Me own eyes is stingin' jus' peerin' through this here hole! Get out there an give 'em a hand!'

'Cap'n?' The second was shaken by such a foul duty. An orc *officer*? Out in the *sun*?

'Ya heard me, Morfin,' he said fingering the heavy falchion he called *Jugular*, after its favourite targets. 'Now go!'

'Aye, aye,' grumped Morfin as he headed for the hatch, fastening his blinders in place.

'An the rest 'a ya useless lugs!' the captain screamed at the oarsmen seated in the rowing galleries to either side of the central walkway in the dim, covered ship. 'I want real *ramming* speed when I give the order. We're gonna *get* that thing!'

Hakar's galley, *Stabber*, churned through the waves, bearing down on the much smaller sailing ship which darted back and forth across its bow, tacking into the wind. The little lateen-rigged ship was painted bright green with a white trim that almost made it seem part of the sea foam as it rose and fell in the high waves. There were times when Morfin's sun-blinded vision could not make out more than her pale sails as her hull went completely behind a swell. He felt *Stabber* surge forward as Hakar's bellows got some mileage from the orcs manning the oars. 'C'mon you dogs!' He called to the catapult crew; 'Tackin' into the wind has slowed 'em some. This might be our best shot. If he gets past that headland he'll be able to run with wind abeam an' then we'll never catch 'im. Load some fiireshot. That'll slow 'im down!'

The gigantic galley continued to slowly close as the orc lieutenant's crew got the arm down and fiireshot loaded. They could hear the sound of the whips below as the captain tried to squeeze even more speed from the oar-orcs. Given the searing pain of his eyes from the bright sun, Morfin was beginning to wish he was manning an oar and only having to put up with a lash to his broad back. Anything was better than standing out in the sun. 'Fire!'

With a thunderous *SLAM* the catapult arm smashed into the crossbeam sending its flaming cargo toward the green ship. Fired into the same wind that was slowing the sailing vessel, the shot hit just short of her stern – falling into the water with a hiss so loud Morfin fancied he could hear it from here. 'Reload!'

It all seemed to happen at once. Just as their prey began to turn, apparently to begin another tack, Morfin was thrown hard against the forward structure of the catapult, his teeth hitting hard enough for one of his fangs to snap right off. The world was filled with the tremendous grinding crunch of steel on stone with the backdrop of timbers shattering as *Stabber* ran aground in water too shallow, previously concealed by the high waves. A secondary impact drove what few crew had regained their feet back to the deck as something struck the stern and backed away leaving all the aft decks covered in a sea of flame. A group of four eagles – giant ones the size of ponies – dropped from the skies and added more tiny packets of misfortune, which blossomed into fiery doom amidships.

The last sight the lieutenant's eyes took in was that of the green sailing ship turning broadside and firing ballista bolts of all things! The wind, which had hurt his catapult, added range to the spears fired by the warship. The second to strike turned into a full-blown storm of lightning which tore the bow apart even as it flung the charcoaled remains of Morphin into the sea.





## ELVES AT SEA

**R**enowned throughout the world as the best of mariners, an elven-crewed ship will outsail anything else on the waves. Their warships sail rings around larger and slower opponents whilst merchantmen are able to outrun any buccaneer. Even the most aggressive pirate or warlike admiral will think twice before taking on an elven vessel.

Elven cultural characteristics include a civilisation that builds in such harmony with the land one might almost consider it symbiotic; a wealth of finely crafted items which are both beautiful as well as functional, and a very high level of individual skill. These attributes also characterise elves at sea. Elven communities that dwell on or near the shore always have a subculture of the sea just as humans do. These 'sea elves' have such an affinity for the deep that many spend centuries wayfaring on the ocean and only seldom venture ashore. In this way they are very like the old salts one finds in human coastal communities. Ocean-going elves share the same love of wind and wave, and often find human sailors very much kindred spirits – sometimes even more so than those of their own race who choose to remain ashore.

In elven seagoing societies there are three very distinct subcultures which only seldom mix. These are the traders, warriors and explorers.

## TRADERS (HARMANIL – TREASURE SEEKERS)

In ancient times, when men were still a very young and primitive race the elves ruled the oceans. Warships were unnecessary and elven vessels plied the waves in search of new horizons and profitable markets for their goods. When more primitive races were encountered, these seagoing elves would frequently trade with them in order to establish friendly relations and elven superiority. The explorers would return home with raw materials for elven craftsmen that would be sold to finance future expeditions.

In time, many elven nations came to rely upon this trade for most of the goods needed to produce fine elven wares. Elves closed mines, lumberyards and tanneries, with all their associated pollution and came to rely on trade goods for raw materials. Those working in the industries now turned their skills to direct craftsmanship or scaled back their operations to produce only the specialities that could not be easily traded for.

As this change took place, elven explorers found themselves slowly overwhelmed. Their ships could not carry enough cargo to support the trade demand and, in response, some captains turned their backs on the dangerous work of exploration and modified their vessels to carry goods, becoming the first true merchantmen of the high seas. Eventually purpose built trading vessels were made to replace the ageing converted explorers and the mercantile navy was born.

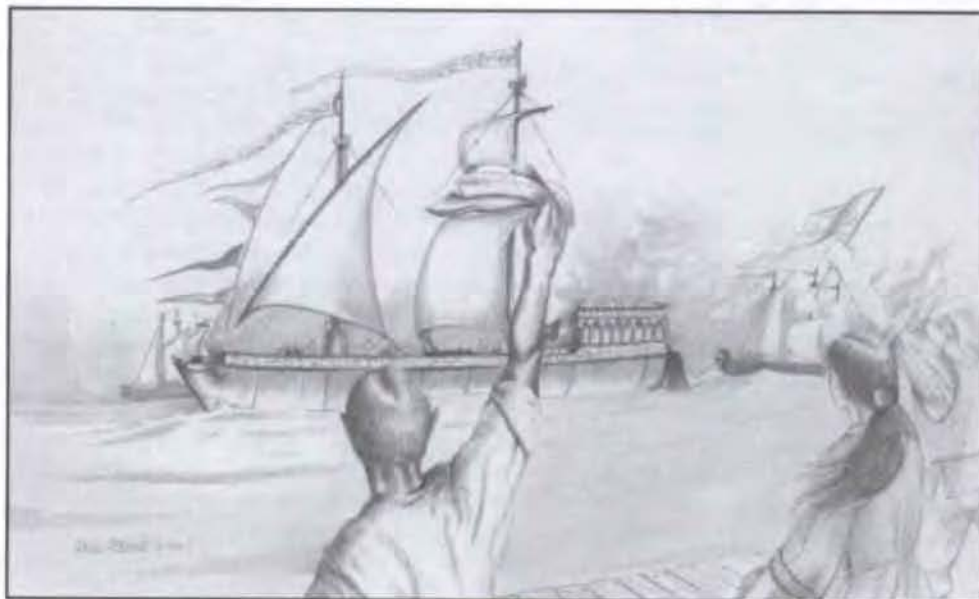

Today, after many centuries of continued development, elven merchant ships are the pride of the oceans. Long and sleek, three and four masted vessels with the ability to outpace the winds, elven clippers under full sail are the most majestic of sights upon the ocean.





Elves never use this style of attack. With smaller, extremely well-constructed ships, the crews of elven vessels do not need to be numerous and, in many cases, elven craft make do with less than half the crew one might expect from a human vessel of similar size and rig. This lack of fighting men on board gives such ships a very long range, as food and water last far longer, but also

## WARRIORS (DAGORDAIN - BATTLEWROUGHT)

Eventually other races put forth upon the seas, challenging the elven mastery of the ocean. Some of these barbarians were happy to continue trade with the elves whilst others turned pirate – preying upon human and elven merchantmen alike. The unarmed merchants were not the sleek vessels of today and proved easy prey for raider ships full to the brim with barbarian warriors. Whilst faster and sleeker merchant ships were built, coastal raids upon towns and villages quickly brought home the hazards and risks of giving up control of the ocean. The elven kings required warships.

In true elven fashion, the nations put their shipbuilders to the task and the first true warships set sail upon the waves. Those early galleys bear little resemblance to the mighty frigates and ships of the line elves now use but the ancient traditions of victory at sea have been carried down through the centuries resulting in the very best sea-borne warriors in the world. Modern elven warships are quite different from those of other races. Tending toward smaller vessels than other navies, they rely on speed, manoeuvrability and skill in order to win battles in place of sheer size and might. No warship larger than the *Sea Eagle* has ever been sighted.

The tactics of the elven navies are unique. Most navies place a heavy emphasis on boarding actions to take enemy vessels by their marines and crew. Even ramming is generally used mostly as a means of locking a pair of vessels solidly together to facilitate direct conflict of crew-on-crew.

renders an elven vessel vulnerable to boarders. In addition, elven ships are so superior to anything another race may construct they have no need of captured vessels, which will not be as seaworthy or as well built.

These factors combine to give the elves a single goal in ship-to-ship combat – send the enemy to the bottom of the ocean with all speed. All of their tactics, fleet designs and formations revolve around this one simple aim. Traditionally, light elven vessels will first move in to immobilise and cripple the most dangerous enemy warships. Ships of the line and frigates initially provide supporting fire and destroy lighter vessels that might threaten the elven attack craft and once this is accomplished, the larger vessels move in on the capital ships of the enemy fleet and either set them afire or sink them with magical weapons. Elves are so skilled at this style of fighting that small fleets have been known to destroy attackers up to ten times their number and of far greater size, simply by relying exclusively on their own strengths in naval warfare. In such lopsided actions, they cripple the great ships and move on from one to the next until the entire enemy fleet is dead in the water. They then move in to finish the enemy off or leave them to be destroyed by hunger, wind and wave. Because of this style of battle, members of other races frequently consider elves ruthless and inhumane warriors.

## EXPLORERS (GILRANDIR - STAR WANDERER)

The most frequent encounters with elves on the seas



## ELVES AT SEA

are with the explorers. Alone amongst their race, these elves are afflicted by wanderlust and a passion for high adventure. Explorers sail their vessels and fleets to the four corners of the earth, in search of new markets for the elven merchants and to map that which no one has yet charted. Explorer groups vary widely in size but captains tend to be related by blood to one another. They may possess only a single small ship or may have a great fleet led by a *Sea Haven*, but most tend to be small squadrons consisting of a *Corsair* and a group of light scouting vessels.

Less commonly, explorers may be descendants of the original explorer clans – the very first elves to go to sea. These tend to be rare as exploration goes hand-in-hand with the very real dangers of the unknown. From rocks and shoals, to unfriendly natives and deadly sea monsters, the chances of a clan of explorers surviving so long is low. However, some still exist, and the result is the very finest skills of the elven race, concentrated into a very small group of dedicated individuals. The ancient clans of explorers possess skills, magic and expertise out of all proportion to their size and equipment.

Rarest of all explorer groups is the *Vanwanor (Lost Land)*. The *Vanwanor* is a large group of elves who have abandoned dry land and gained a completely seaborne lifestyle. It is within these groups that the elven *Sea Havens* are usually found, giant trimarans, a city afloat with all that might be found in any land-bound community including streets, docks, shops, gardens and tree groves. No two are exactly alike but each supports a fleet of smaller vessels that perform all the hunting, exploration, trading and the bulk of the defence of the Lost Nation.

The wanderlust of the explorers is as well known as their skills. These sailors may not return to their homeport for decades as they sail from place to place beyond the furthest reaches of their charts. They will brave the deepest of seas, the fiercest of storms and the most dangerous of monsters simply



to fill in an empty space on some ancient map. The dangers they encounter also make them a valuable early warning system for any elven nation. It is frequently the explorers who warn nearby communities of approaching sea monsters, invading fleets or other threats discovered during their travels.

Explorers, as a rule, are gregarious. They prefer to make friends rather than enemies and in general tend to be far more outgoing than other elves. They laugh more, make jokes and have a great deal of fun at the expense of their dour kin. Where the opportunity exists, some groups of explorers may put down roots with friendly human settlements, even to the unusual extent of marriage between the races. The vast majority of half-elves in many regions are a direct result of such relationships and, indeed, many fine shipbuilders in human nations have been either half-elves born in such communities or humans who have picked up some of the secrets of elven shipbuilding during repairs or layovers.

## EAGLES (ELVEN - THEREN)

The nature of elven culture and psychology results in them living very close to the land and in harmony with the creatures thereof. Nowhere is this seen more than in the elven alliance with the ancient race of giant eagles. Many elven land-bound communities feature roosts, perches and nests for the great eagles that work with the elves both in peace and war. While not all elf races have made



this alliance, those that have extended the union with them onto the high seas.

A personal alliance with a giant eagle is a mark of great respect in elven society. The eagles are a proud and noble race and do not give their friendship easily. While any elf, in theory, may seek such a relationship, the nature of society means those of higher social standing tend to have the most time and best resources with which to establish such an association. This results in captains and officers, for the most part, being the only elves who will have giant eagles on smaller ships. Space on the poop is kept clear of spars and rigging and mounted with a perch for these beasts. In larger organisations, such as the explorer clans and military, there will frequently be an entire corps of eagle riders who work in tandem with the ships below during battle or reconnaissance.

The uses of eagles at sea are many. In addition to having truly amazing distance-oriented eyesight for scouting missions, eagles are capable of dropping ship-killing firebombs, making attacks on exposed steering and command crew, and shred rigging with equal ease. The sight of even a single giant eagle taking to the air is frequently enough for many pursuing vessels to take flight.

## MAGIC AND SHIPBUILDING

It has been mentioned that elves are skilled shipbuilders and even the very finest human ship

seems to wallow when compared to an elven vessel. Where the ponderous craft ploughs its way over the waves, an elven ship cuts through them like the keenest razor, moving easily in high seas with little roll or pitch.

There are many reasons for the incredible skill the elves show in shipbuilding. Very old elves with centuries of experience hold great

ocean wisdom, and the elven culture of craftsmanship is dominant in their shipyards, but the key to mastery of the waves is their understanding of nature itself. Unlike the ships of other races, which are constructed with their general purpose foremost in the shipwright's mind, an elven ship is built for the sea itself. The hull's interaction with wave, wind and swell is carefully calculated, and its length to width ratio – critical to shipbuilding and a science completely unknown to the other races – is adjusted with great attention. Only after the ship's seaworthiness is certain do elves begin to concern themselves with the vessel's eventual purpose. This focus on, and respect for, the sea grants the elves much of their amazing reputation as naval architects.

Another reason for elven superiority is, quite simply, their strong use of magic. Elves are almost alone in designing vessels whose primary propulsion is sorcerous rather than relying on the more usual efforts of oar and wind. On truly rare or expensive vessels even some of the main timbers may be reinforced with magic and the very finest ships are not hewn from wood but grown through the use of natural magicks. They also frequently enchant weapons of naval warfare and build them into their vessels. A prime example of this are the elven fire projectors, called fire towers, which make use of bound fire elementals rather than fluid pressure and dangerous, volatile liquids.

Elves have the finest ships upon the entire ocean and wise captains of other races covet them from afar whenever sighted.





# CREWS

The crews of elven ships can best be described as magnificent. Even the lowliest cabin hand is likely the equal in skill of a veteran sailor from another race and their seamen are without compare. Elven crews are renowned for their order, discipline, courage under fire and loyalty. No ship's captain could ever want for a better crew.

Elves take to the sea for a variety of reasons, a simple desire for adventure, duty to their nation, or mercantile gain. An elf who believes his nation is best served by improved relations with other races might go to sea with the trader castes. One who sought monetary gain might well brave the risks of the explorers rather than take the long slow road to success with the traders. Those searching for adventure could easily join any caste available, or even take to the sea on board a vessel owned by another race if he thought the elven system too slow or not of sufficient interest.

Trader vessels will usually be exclusively crewed by sailors and only very seldom carry marines. Frequently, such vessels are owned by familial clans and many, if not all, of the crew may be family members or close friends. In such cases no wages will be paid to the crew, but all share equally in the profits of the venture. Other trader vessels are run in a manner humans would find more traditional, with the crew paid a salary and occasional bonuses whilst the captain or owner reaps the greater share of profits.

Elven warrior vessels are an entirely different matter. These ships are all owned by the king and all crew are soldiers, members of the military with sworn oaths to their nations and the citizens thereof. As such, salaries are paid from the national treasury for both officers and men. Warships tend to fill the bulk of their 'passenger' space with highly skilled marines during times of war though in times of peace usually only one half to one third of this space will be occupied by warriors.

Elven marines bear specific mention as they also make up a portion of the vessel's combat strength at range.

All naval combat personnel are skilled archers and normally equipped with superb elven composite bows. While the ship's crew man the various weapons of destruction, marine commanders are trained to pick up the target selection from the captain's orders to his artillery crews and direct fire to the enemy if it is within bow range. Out of range, the marine commander will either have his men stand down and take cover to avoid casualties or simply select another target on his own initiative. Targets will be vulnerable sailing crew, who have no cover in the rigging, followed by visible weapon crews and deck officers. There are times when archery alone will so reduce an enemy's fighting ability that little action is necessary on the part of the artillerists to render a ship incapable of combat.

Ships of the explorers are almost exclusively owned and operated by elven families and their fleets by extended clans. As with traders, 'pay' is not really an issue as the ship is owned by the crew and the officers are elected for their abilities. Any marines on board an explorer ship will be members of the clan who find the actual work of sailing distasteful.





These will pursue other careers in cartography, biology, botany, anthropology and trade. As many of these talents are only used during small portions of the voyage, all will have some minimal amount of seamanship skill but will be primarily warriors and trained as such. Their combat will be less disciplined than their naval counterparts as their path is more 'warrior' than 'soldier.'

## HIRING ELVES

Elves are seldom willing to sail for other races, and when they do it is usually as individuals who will have no real effect upon a crew as a whole. When elves hire out to another race as a group, it is their entire vessel that accepts the contract – not just crewmen but also captain and ship. Their rates tend to be very expensive but will occasionally be met by those who understand the value of their service. There is no easy way to put a price on such charters, save to say the cost will easily be at least five to seven times the cost of hiring any human vessel and frequently much higher, particularly if a dangerous assignment is expected.

However, for those Games Masters who run a campaign world with a somewhat different elven culture, rates are provided for the hire of such crewmen. Their skills command a high price by a standard.

### Elven Sailors

Elves are extremely skilled sailors possessing high morale and legendary discipline. Any vessel crewed by a majority of elves gains a +2 competence bonus to all Morale and Mutiny checks.

## CREWMEN

Listed below is a set of sample elven crewmen along with a guide to how much a captain might expect to pay for their services, if they are available at all. Note that if an entire vessel is hired, the cost will be far higher as the Captain will expect all operating costs to be covered plus 'Ship Shares' for bonuses equal to at least twice the rate of the total crew salaries and possibly far higher.

The rules for preparing Crew Rosters and engaging in crew combat are detailed on Page 41 of *Seas of Blood*. Players should keep in mind that only the

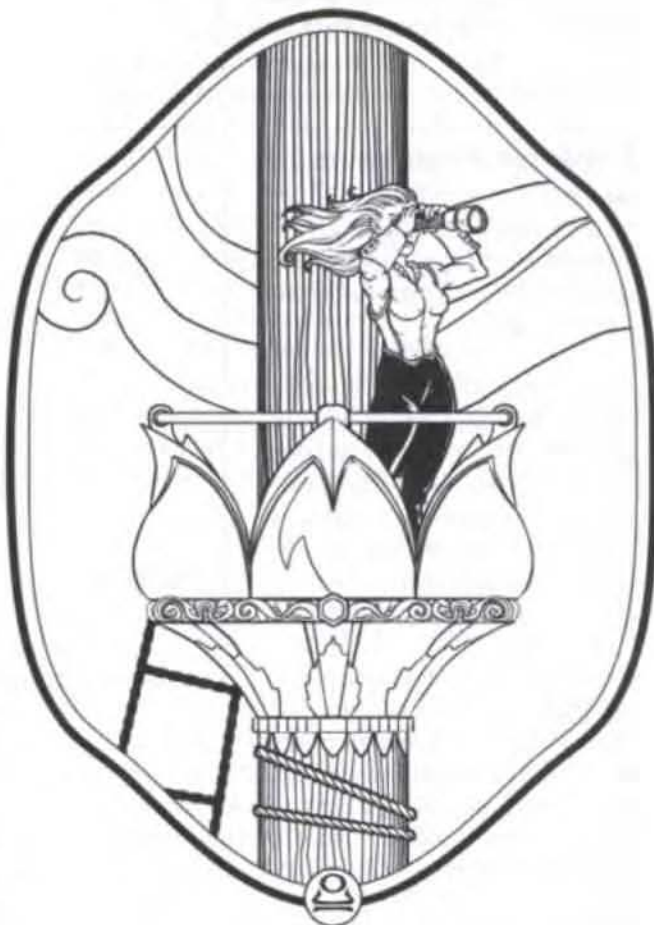

majority of the crew are taken into account in Crew Rosters and so should plan their recruitment carefully. A single elf will have little impact upon the performance of a crew and larger groups of elves willing to work for others will be exceedingly hard to locate, much less hire.

### Common Seaman (12 gp/month)

These are the common sailors of elven fleets, found on board all vessels of the castes.

#### 2<sup>nd</sup> level Rogue

Str: 14, Dex: 18, Con: 10, Int: 10, Wis: 14, Cha: 15; HP 9; Initiative +4; AC 15 (+4 Dex, +1 padded armour); Attacks: short sword +3 melee or composite short bow +6 ranged; Damage: short sword 1d6+2; composite shortbow 1d6; Fort +0; Ref +7; Will +2; Skills: Climb +7, Jump +4, Knowledge (geography) +2, Knowledge (seamanship) +2, Listen +6, Search +4, Spot +8, Swim +3, Use Magic Device +4, Use Rope +9, Wilderness Lore +4;



## CREWS

Feats: Evasion, Sneak Attack +1d6, Weapon Focus (composite shortbow).

Seamanship +2

### Explorer Seaman (18 gp/month)

Veteran sailors are found exclusively on board explorer ships that have survived many trials and long voyages.

3<sup>rd</sup> level Rogue

Str: 14, Dex: 18, Con: 10, Int: 10, Wis: 14, Cha: 15; HP 13; Initiative +8; AC 15 (+4 Dex, +1 padded armour); Attacks: short sword +4 melee or composite shortbow +7 ranged; Damage short sword 1d6+2 or composite shortbow 1d6; Fort +1; Ref +7; Will +3; Skills: Climb +8, Jump +5, Knowledge (geography) +2, Knowledge (seamanship) +2, Listen +7, Search +5, Spot +9, Swim +4, Use Magic Device +5, Use Rope +10, Wilderness Lore +4; Feat: Evasion, Improved Initiative, Sneak Attack +2d6, Uncanny Dodge, Weapon Focus (composite shortbow).

Seamanship +2

### Marine (18 gp/month)

Common seagoing fighters, these elves may be found on board any ship, although rarely upon trader vessels. On explorer ships they may possess a few additional knowledge and profession skills but will retain a solid combat capability. On board warrior ships they will be highly disciplined fighters, trained to work as a team.

2<sup>nd</sup> level Fighter

Str: 16, Dex: 16, Con: 12, Int: 12, Wis: 13, Cha: 11; HP 17; Initiative +3; AC 19 (+4 scale mail, +2 shield, +3 Dex); Attacks: longsword +6 melee or mighty composite longbow (+2) +6 ranged; Damage: longsword 1d8+3 or mighty composite longbow 1d8+2; Fort +4; Ref +3; Will +1; Skills: Climb +0, Jump +0, Ride +6, Swim -3; Feats: Combat Reflexes, Weapon Focus (composite longbow), Weapon Focus (longsword).

Seamanship +0

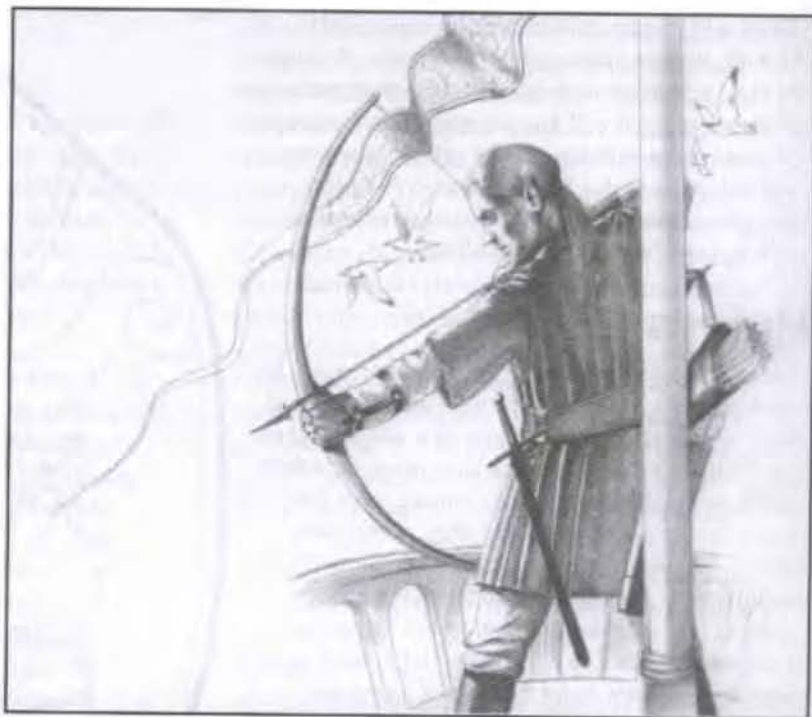

### Veteran Marine (35 gp/month)

Found only on board the pick of warrior vessels, veteran marines are the cream of elven naval troops and form the elite guard for diplomats and royalty. Many may act as marine commanders of troops on lesser ships.

4<sup>th</sup> level Fighter

Str: 17, Dex: 17, Con: 12, Int: 11, Wis: 11, Cha: 8; HP 30; Initiative +7; AC 19 (+4 scale mail, +2 shield, +3 Dex); Attacks: longsword +8 melee or mighty composite longbow (+3) +8 ranged; Damage: longsword 1d8+3 or mighty composite longbow 1d8+3; Fort +5; Ref +4; Will +1; Skills: Climb +1, Heal +1, Intimidate +1, Jump +2, Knowledge (seamanship) +1, Swim -3; Feats: Dodge, Improved Initiative, Point Blank shot, Weapon Focus (longsword), Weapon Focus (composite longbow).

Seamanship +1

## ELVEN CAPTAINS

Whilst no two ship's captains will ever truly be alike, the following examples can be used as representative of the commanders on board various types of elven vessel. Commanders of smaller ships (such as a *Spindrift* or *Sea Rage*) will likely be of lower level while those commanding rare vessels such as the *Iron Wolf* or *Sea Haven* would be much higher.



## Merchant Captain

9<sup>th</sup> Level Rogue

Str: 11, Dex: 19, Con: 11, Int: 15, Wis: 10, Cha: 12; HP 34; Initiative +4; AC 16 (+2 leather armour, +4 Dex); Attacks: short sword +10/+5 melee or composite shortbow +11/+6 ranged; Damage: short sword 1d6 or composite shortbow 1d6; Fort +3; Ref +10; Will +3; Skills: Appraise +14, Balance +13, Bluff +9, Climb +8, Heal +6, Intimidate +9, Jump +12, Knowledge (seamanship) +8, Listen +2, Search +4, Sense Motive +9, Spot +11, Swim +8, Ride +9, Tumble +9; Feats: Combat Reflexes, Evasion, Expertise, Sneak Attack +5d6, Uncanny Dodge, Weapon Focus (composite shortbow), Weapon Finesse (short sword).

Seamanship +8

## Naval Captain

10<sup>th</sup> Level Fighter

Str: 16, Dex: 16, Con: 12, Int: 10, Wis: 12, Cha: 14; HP 74; Initiative +7; AC 19 (+4 scale mail, +3 Dex, +2 shield); Attacks: long sword +14/+9 melee or mighty composite longbow (+2) +14/+9 ranged; Damage: longsword 1d8+5 or mighty composite longbow 1d8+2; Fort +8; Ref +8; Will +4; Skills: Bluff +2, Climb +1, Heal +3, Intimidate +4, Jump +0, Knowledge (seamanship) +4, Listen +3, Search +2, Spot +3, Swim -8, Wilderness Lore +2; Feats: Cleave, Combat Reflexes, Improved Critical (longsword), Improved Initiative, Leadership, Lightning Reflexes, Power Attack, Weapon Focus (composite longbow), Weapon Focus (longsword), Weapon Specialisation (longsword).

Seamanship +4

## Explorer Captain

11<sup>th</sup> Level Rogue, 7<sup>th</sup> Level Wizard

Str: 12, Dex: 18, Con: 10, Int: 15, Wis: 10, Cha: 12; HP 58; Initiative +8; AC 16 (+4 Dex, +2 ring of protection); Attacks: Rapier +15/+10/+5 melee; Damage: rapier 1d6+1;

Fort +5; Ref +13; Will +8; Skills: Appraise +13, Bluff +11, Climb +12, Concentration +7, Diplomacy +8, Gather Information +8, Heal +6, Intimidate +13, Jump +15, Knowledge (seamanship) +15, Listen +2, Ride +7, Scry +9, Search +4, Spellcraft +9, Spot +2, Swim +8, Use Magic Device +9, Use Rope +14, Wilderness Lore +6; Feats: Combat Casting, Combat Reflexes, Evasion, Improved Evasion, Improved Initiative, Leadership, Scribe Scroll, Spell Focus (conjuration), Spell Mastery, Sneak Attack +6d6, Weapon Finesse (rapier); Hawk Familiar; Spells: 0 level: *Daze, Detect Magic, Light, Ray of Frost, Resistance*; 1<sup>st</sup> level: *Cause Fear, Colour Spray, Sleep, Shield, Feather Fall*; 2<sup>nd</sup> level: *Invisibility, Mirror Image, Darkness, Web*; 3<sup>rd</sup> level: *Fireball, Water Breathing*; 4<sup>th</sup> level: *Summon Monster IV*.

Seamanship +15





# WEAPONRY

In the main, the elves use many of the same weapons other races put to use on ships. Ballistae of all sorts are very common and are generally used for launching spears against enemy crews or delivering enchanted bound bolts.

Catapults, however, are looked upon with distaste in elven shipyards and are virtually unheard of on their ships. The roll and pitch of the sea can make these weapons more difficult to aim than straight-line weaponry and nimble ships can frequently dodge their slow shots. Rams are only rarely used on elven ships as, without oars, a vessel is virtually impossible to free from its victim. As elves never use oared craft, those few examples sighted with rams are clearly specialised vessels with unique methods of magical propulsion, high steel prows and metal-clad rams.

Elven nautical tactics revolve around the sinking of enemy vessels from range rather than the more common tactic of launching boarding actions. With this in mind, elven shipwrights and sea mages have dedicated their efforts to creating weaponry that will further the simple end of sending opposing ships to the bottom of the sea as efficiently as possible. Since elves forego the use of ship-smashing catapults and trebuchets, the heavy ballista was developed to fill their role. When mechanical fire projectors proved too troublesome to maintain, fire towers were developed. Finally, in an effort to give their smaller ships increased lethality, a variety of specialised ammunition was created to increase the effectiveness of existing weapons such as the humble ballista.

## HEAVY BALLISTA (SARNTHALION)

When catapults first began making their appearance upon the sea, elves developed their own unique version of the weapon. With typical elven attention to the realities of the environment, they knew rough seas could make indirect weaponry difficult to fire accurately. The solution was the heavy ballista. Larger than a conventional ballista, the heavy ballista is characterised by a larger, metal lined launch track, a cup-like fitting built into the cable and a much more powerful throwing bow. The bow is unique in that, instead of a single stave like a great crossbow, each arm is independent and

powered by torsion boxes, which are mounted on either side of the projectile track.

Heavy ballistae can fire spears like a normal ballista but may also choose to fire solid shot in order to smash hull timbers, or any other type of conventional catapult munitions, such as fire shot. Due to their unique method of launching these heavy shots, heavy ballistae do not suffer from a catapult's weakness of being unable to fire upon close targets.

## FIRE TOWER (NARBARAD)

Early in their mastery of the seas, a great elven engineer developed the first clockwork pressure mechanism for use at sea to throw *Naredhel* (*Elven Fire*), now known to humans as Naphtha. While the fire thrower was hailed as the salvation of the elves at sea, the engineer was never satisfied and continued to work, bettering his creation until the day he was killed at sea testing a new variant. Years later a coalition of elven sea mages perfected a new type of fire thrower which was to eventually replace all clockwork mechanisms in the elven fleets. The *Narbarad* or 'Fire Tower' is an elaborate ceramic and brass lantern two feet in diameter and four feet tall, mounted atop a thirty-foot hardwood pole. Within the lantern is bound a fire elemental which can spit long cones of flame on command. Elven ships mounting these weapons carry them upright, normally mounted on the bow in pairs. When battle is joined these weapons are lowered over the decks of enemy vessels, either forward or to the broadsides, and fired.

An elven fire tower functions in the same way as a fast-firing conventional fire projector, save that it only requires a crew of one, will never misfire and cannot run out of fuel. A targeted *dispel magic* spell that succeeds against DC 23 will prevent the affected tower from firing for the duration of the spell. It will not release the bound elemental within, however, and the fire tower will be ready for use once more when the spell expires.

## BOUND BOLTS (LOKVALUVA)

With a preference for small vessels, elven naval architects have always had a challenging task – that of increasing the firepower of small ships where



deck space for additional weaponry is at a premium. One solution was to create more powerful ammunition for existing weaponry, allowing a shot from a simple ballista to do serious damage to the hull of a vessel. With the elven preference for magical answers to problems, bound bolts were created.

A bound bolt is a long hardwood shaft the same size as a normal ballista bolt but has no metal head and is carved with intricate elven runes. These shafts are carefully grown by druids to prepare them for their eventual use. When ready, an elven mage enchants them in much the same way as a magical weapon is forged. A spell of the wizard's choice is then cast and recorded in runes on the shaft. Any spell may be bound within a bolt for use against an enemy. When fired by either a ballista or heavy ballista, the spell within the bound bolt is automatically triggered on contact with a ship, creature or the sea.

Bound bolts can be somewhat dangerous to use as they occasionally trigger through the force of being fired. On any attack roll of a 1, a bound bolt will misfire and go off prematurely, its area of effect centred on the launcher. For this reason, large area-affecting spells which do not affect elves such as *sleep*, or those which detonate in a forward arc like *burning hands* or *lightning bolt* tend to be preferred. *Fireballs*, while devastatingly effective against enemy ships, can be lethal to an elven vessel during a misfire. However, very daring or desperate commanders may still carry such risky bound bolts for truly dire situations.

*Caster Level:* Varies (minimum needed to cast bound spell); *Prerequisites:* Craft Magic Arms and Armour, *imbue with spell ability*; *Base Price:* Spell level x Caster Level x 100gp.

## NAPHTHA (NAREDHEL)

Originally created by elven alchemists to be poured on enemy vessels or shot from fire projectors, *elven fire* is a truly deadly, sticky mix of chemicals that can burn under virtually any conditions – even under water. There are few sights more terrifying for a sailor in a sea battle than seeing an allied ship sinking, continuing to burn as it disappears into the depths. Originally limited strictly to elven navies, the alchemical communities of several races have now learned to produce naphtha, allowing it to be found at other ports at very expensive prices.

Often mistaken for a magical compound, those attempting *dispel magic* spells to nullify its effects are frequently horrified to find this terrible compound is completely mundane in nature. Magical processes are used to produce it, but the final form is not enchanted. Naphtha may be used in many ways, but is most often utilised as a more powerful version of the common fire shot (see p67 *Seas of Blood*). It may also be used in conventional fire projectors or can simply be poured onto opposing ships from a fire-proof container suspended on a yardarm and set alight. Finally, barrels of this nasty incendiary are also piled near the roosts of giant eagles for them to carry aloft and release upon doomed ships below.

However it is used, naphtha does no more damage than conventional flame but will instead continue to burn, dealing additional damage for 1d6 rounds against any target struck by it. Crews fighting fires created by naphtha will halve the amount of Fire Damage they can put out, rounding down, as described on p39 of *Seas of Blood*. The only effective way to combat naphtha is through the use of magic, such as *quench* or *cone of cold*.

Naphtha is difficult to make, even for elves, and will cost no less than 600 gp per ton. If purchased from other races it can easily cost a similar amount for a single shot.

### Elven Shipboard Weaponry

Weapon	Cost	Damage	Structural Damage	Critical	Range Increment	Rate of Fire	Crew
Heavy Ballista (Solid Shot)	900 gp	-	-	-	150 ft.	4	2
(Bolt)	-	3d6	1d6	-	-	-	-
Fire Tower	5,000 gp	4d6	1d6	X3	30 ft. max.	1	1





# SHIPS OF THE ELVES

This chapter introduces just a few of the many types of elven ship encountered on the high seas. Without exception these ships are both beautiful and highly functional, able to outsail any equivalent vessel built by another race.

Elven ships have awesome capabilities at sea and thus require additional rules to reflect their speed, strength and durability. Three new ship subtypes for use with elven ships are detailed below.

## SUBTYPE - ELVEN SHIP

Ships built by elves are noted for being fast, agile and yet strong. Even ships built using common construction methods in an elven shipyard receive a +2 bonus to all Manoeuvrability and Seaworthiness checks. Elven ships are also noted for requiring far less crew due to their superior rigging and handling. A month's normal supplies on board an elven ship will automatically be stretched to two months, whilst rationing will allow the same amount of supplies to stretch to three months. Unless they also have the Magical Propulsion subtype, all Elven Ships are considered to be sailed.

## SUBTYPE — STALWART HULL (CIRYAGON — SHIP OF STONE)

Elves often magically reinforce the wood of their vessels during construction, resulting in extremely tough hulls. Basic rituals of enhancement are performed on virtually all elven craft and are included in the subtype *Elven Ship* above.

However, elven clans with the means to do so will actually have most of a hull's structural members grown into shape. Elven druids are called upon to bring the forces of nature to bear upon oaken saplings, guiding them into the shapes of ribs and keel. These vessels are extremely strong and gain +1 Hardness, as well as +2 structure points to each Structure Dice.

## SUBTYPE — STEEL PROW (TELCANGREN — STEM OF IRON)

A very few elven craft, notably ramships, have their prows both enclosed and sheathed in metal to prevent susceptibility to fire and to further strengthen the hull. A Steel Prow prevents a ship from catching fire from an adjacent vessel and ignores two points of Fire Damage per turn. The ship also receives a +4 bonus to its Armour Class and crew on the deck will benefit from three quarters cover (+7 AC, +3 Reflex) from all missile attacks launched from the front of the ship.

## SUBTYPE — MAGICAL PROPULSION

Some extremely rare vessels make use of Magical Propulsion in order to move through water, instead of utilising sails or oars. This can take many forms, though the use of bound elementals of the air or water is the most common. All magically propelled ships gain a +3 bonus to Manoeuvrability and will be considered to be an oared vessel whose crew will never tire. However, they also require the presence of an arcane spellcaster of at least 12<sup>th</sup> level to operate at all. The spellcaster directs the ship as he wishes, though is free to take other actions, such as cast spells at enemies or engage in combat, without penalty.

*Ships of the Elves* includes two examples of magically propelled ships, both utilising elementals in different ways. The Screw Ram makes use of air elementals to spin props which drive the vessel through the waves whilst the Elemental Ram is directly pushed through the water by a bound water elemental. Other examples of Magical Propulsion might include winged demons pulling the craft, air elementals permanently filling the sails or even summoned whales.

## TRADERS (HARMANIL)

*Sea Rage (Aearaha) Fast Courier Small Warship (Light, Stalwart Hull, Elven Ship)*

**Structure Dice:** 2d10 (11 sp)

**Hardness:** 6 (+1 Elven Ship)

**Manoeuvrability:** +3 (+1 Size, +2 Elven Ship)



**Speed:** 70 ft./168 miles  
**Turn Rate:** 40 ft.  
**AC:** 11 (+1 Size)  
**Weapons Fore:** None  
**Weapons Aft:** None  
**Weapons Broadside:** None  
**Damage:** None

**Crew:** 6  
**Passengers:** 8  
**Cargo:** 6 tonnes  
**Building Time:** 6 months  
**Cost:** 120,000 gp

Possibly the fastest and most manoeuvrable ship afloat, the *Sea Rage* is a vessel only elves would even consider constructing. Its high cost, magically enhanced frame and small cargo capacity make it a vessel that could only be profitable carrying the most valuable of cargoes. Elven traders restrict it to the service of communities which specialise in low mass, high value commodities such as jewellery, spices and mystic artefacts. On return trips, the vessel will often be packed to the bulwarks with gold or platinum.

*Sea Rage* vessels are sometimes constructed for the military where they are used on special missions to deploy small and extremely skilled raider squads to lonely shores far behind battle lines. These will move inland undetected to harass enemies, disrupt supplies, rescue captives or assassinate enemy commanders. Their deployment vessel will either retreat to the safety of elven-controlled sea lanes or lurk within hidden bays to pick up the commandos when the mission is complete.

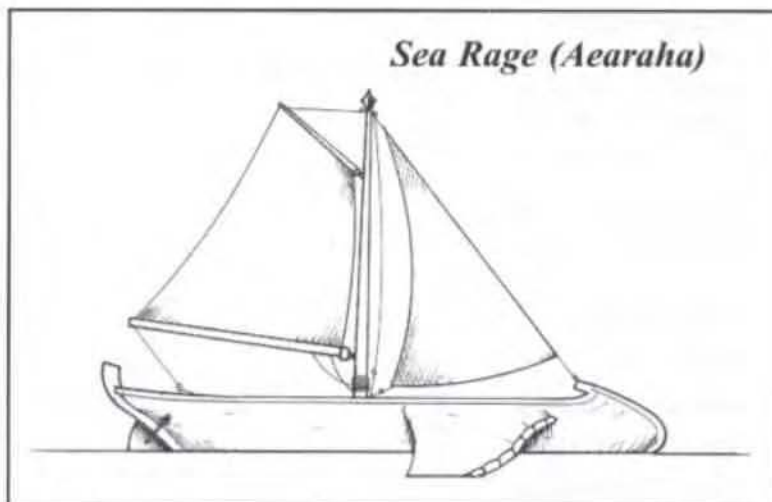

### *Windmaker (Sulech) Trader* Medium Warship (Elven Ship)

**Structure Dice:** 4d10 (22 sp)  
**Hardness:** 6  
**Manoeuvrability:** +2  
**Speed:** 50 ft./120 miles  
**Turn Rate:** 80 ft.  
**AC:** 10  
**Weapons Fore:** Ballista  
**Weapons Aft:** None  
**Weapons Broadside:** None  
**Damage:** Ballista 3d6/-

**Crew:** 25  
**Passengers:** 30  
**Cargo:** 100 tonnes  
**Building Time:** 6 months  
**Cost:** 140,000 gp

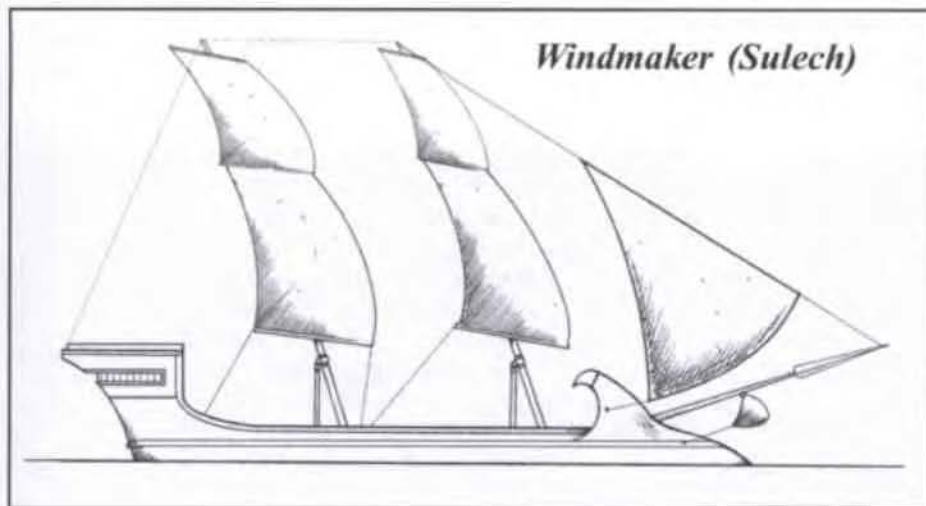

The *Windmaker* traders are the most frequently encountered elven vessel after their sister ship, the *Corsair*. Built on the same hull, the *Windmaker* differs in that it carries only two masts and sacrifices weaponry for additional cargo space. Whilst lacking the large cargo capacity of a true merchantman due to its warship-quality construction, it is an



amazingly fast and manoeuvrable vessel capable of outrunning pirates with ease whilst still carrying a reasonable cargo, an entourage of dignitaries or important diplomatic messages.

***Glittering Rainbow***  
***(Brilninniach)***  
**Trading Clipper**  
 Large Merchantman  
 (Elven Ship)

**Structure Dice:** 6d8  
 (27 sp)

**Hardness:** 6

**Manoeuvrability:** -1 (Large -1, Merchantman -2, Elven Ship +2)

**Speed:** 60 ft./144 miles

**Turn Rate:** 100 ft.

**AC:** 8 (-1 Merchantman, -1 size)

**Weapons Fore:** None

**Weapons Aft:** 1 Ballista

**Weapons Broadside:** 2 Ballistae

**Damage:** Ballista 3d6/-

**Crew:** 40

**Passengers:** 40

**Cargo:** 190 tonnes

**Building Time:** 9 months

**Cost:** 160,000 gp

One of the most majestic sights on the waves is an elven clipper under full sail. The *Glittering Rainbow* is representative of many classes of three and four masted *Harmanil* merchant ships, each carrying acres of sail on its masts. In addition to

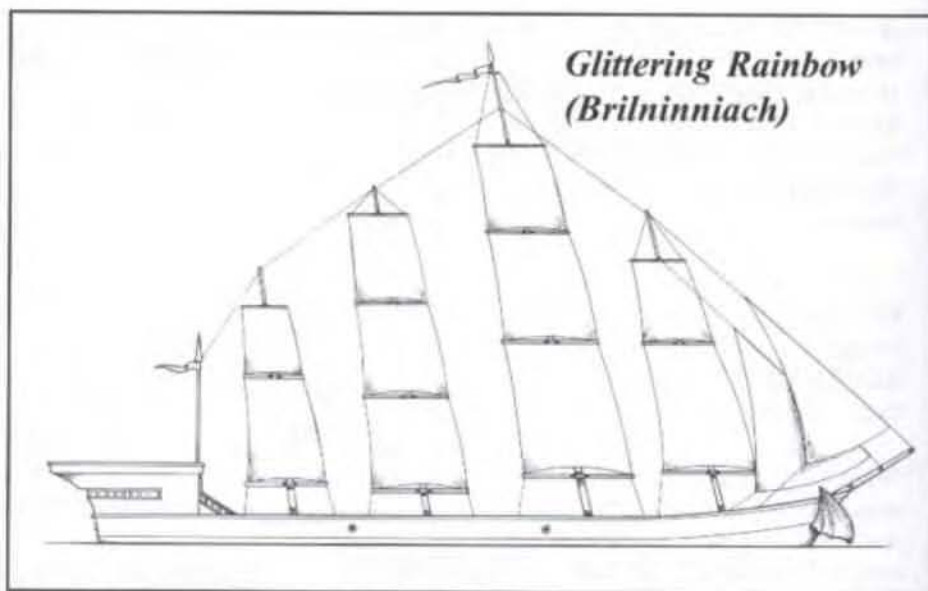

***Glittering Rainbow***  
***(Brilninniach)***

their usual square rigging, flying booms and additional jibs are commonly rigged, accounting for this vessel's truly amazing speed. While unable to carry as large a load as a human-built vessel of similar size, a *Glittering Rainbow* is so much faster that it can frequently make three trips in the time it would take a human vessel to make one. Clippers of various classes are the only *Harmanil* vessels normally set up to accommodate a giant eagle for the captain and/or senior officers.

Sailing a clipper is a far more complex task than operating a conventional sailed ship, requiring a highly skilled crew to even attempt it. If unfamiliar with clipper rigging, a crew will only manage half the base speed listed above. The best elven captains operating on long distance voyages have been known to hunt out hurricanes and use the leading edges to drive their ships to unbelievable speeds, sometimes halving their normal journey times at the cost of much greater risk.

'Ah - look at that, lad. Didya ever see such a sight as that? Nah, that's not no human ship, laddie. That be an elven clipper. Lookit 'er, slidin' across the waves as smooth as if she weren't even touchin' 'em. Clouds 'a canvas on a rig th' like a' which you ain't seen a'fore and ain't likely to see agin if you stay at sea two score years. It fills me 'eart wit joy jus' lookin' at 'er. Nah, t'ain't no warship, boyo, but a merchant. I know, I know, you's gonna tell me that old, old saw - admire a sleek ship but put yer' goods in a fat 'un. Well, that sleek ship's at least four times faster'n any cog 'er caravel and safer to boot. Now shut yer' trap and let me look, laddie. In all my years at sea that's only the second one I've ever seen under full sail an' I mean to enjoy 'er afore she leaves us behind in a cloud 'a spray.'

**First Mate Drakkar, on sighting an Elven Clipper**

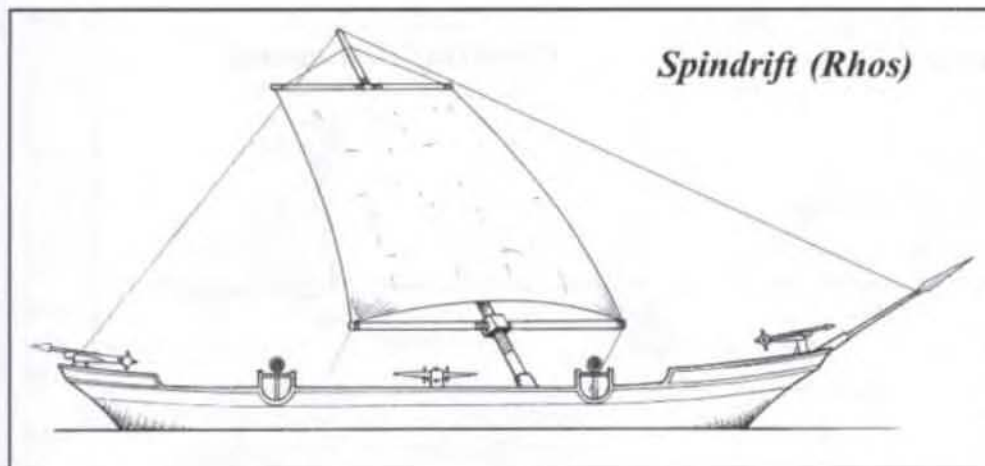

*Spindrift (Rhos)*

attack rolls made against this tiny craft as its captain weaves and dodges over the sea.

Like many elven military vessels, this deadly little ship has but one purpose - the close support of other attacking vessels. A slender, single masted cutter, the

## WARSHIPS (DAGORDAIN)

### *Spindrift (Rhos)* Fire Support Ship

Small Warship (Stalwart Hull, Elven Ship)

**Structure Dice:** 2d10+2 (13 sp)

**Hardness:** 6

**Manoeuvrability:** +3 (+1 Size, +2 Elven Ship)

**Speed:** 60 ft./144 miles

**Turn Rate:** 40 ft.

**AC:** 11 (+1 Size)

**Weapons Fore:** 1 Heavy ballista

**Weapons Aft:** 1 Ballista

**Weapons Broadside:** 1 Heavy ballista, 2 arrow catapults

**Damage:** Heavy ballista 4d6/1d6, arrow catapult 1d6/-

**Special Qualities:** Nimble Ship

**Crew:** 22

**Passengers:** 6

**Cargo:** 2 tonnes

**Building Time:** 6 months

**Cost:** 125,000 gp

**Nimble Ship:** *Spindrifts* are incredibly agile while remaining very stable even in the roughest seas. Enemy catapults and trebuchets suffer a -2 to all

*Spindrift* is little more than a fast, nimble platform from which to launch ballistae shots and arrows. In battle, a captain will take the cutter in amongst the enemy and then use speed and manoeuvrability to stay just at the edge of the effective range of their weapons. Frequently, such vessels will be equipped with enchanted projectiles to increase their effectiveness even further.

### *Bloodstained (Agarwaen)*

#### Elemental Ram

Medium Warship (Elven Ship, Steel Prow, Magical Propulsion)

**Structure Dice:** 4d10+4 (26 sp)

**Hardness:** 6

**Manoeuvrability:** +5 (+2 Elven Ship, +3 Magic Propulsion)

**Speed:** 70ft. (20ft./36 miles by sail alone)

**Turn Rate:** 0ft. (60 ft by sail alone)

**AC:** 14 (+4 Steel Prow)

**Weapons Fore:** Metal shod ram, 2 fire towers

**Weapons Aft:** None

**Weapons Broadside:** None

**Damage:** Ram 4d10/3d6; fire towers 4d6/1d6 each

**Special Qualities:** Elemental Manoeuvring

**Crew:** 1 Mage, 3 Sailors

**Passengers:** 8

**Cargo:** 0 tonnes

### *Bloodstained (Agarwaen)*

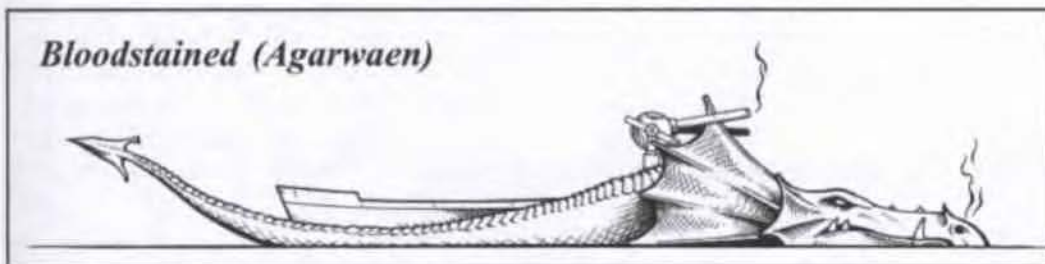



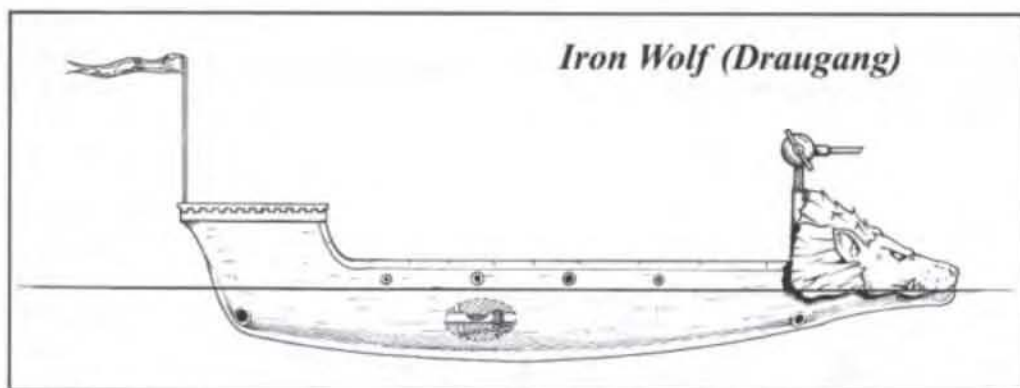

**Building Time:** 1 year  
**Cost:** 230,000 gp

**Elemental Manoeuvring:** Due to the presence of the elemental, these ramships will never become locked to an enemy ship during a ram unless the mage controlling the vessel wishes it to, for the water elemental simply inserts itself between the hulls of the trapped ships and exerts pressure in both directions, forcing them apart.

The *Bloodstained* elemental ram is a highly unusual design being one of the very few ships relying solely on magical propulsion. The auxiliary sails, kept below deck, are used only in emergencies and the craft handles poorly under sail by elven standards. The vessel is quite small at only 35 feet in length and resembles a rowing scull tipped with a great steel prow that rises up above the decking in the bow.

Elemental rams function by the simple expedient of an elven mage, one of the few real 'crew members,' controlling the water elemental bound to the ship's hull and using it to move the vessel as he wills. With such propulsion, the *Bloodstained* can move very quickly and is so manoeuvrable that it can actually spin in place. These vessels charge in at high speed, often accompanied by the larger screw rams, and wreak havoc on enemy fleets by

ramming capital ships, setting them aflame and then pulling away to repeat the process.

***Iron Wolf (Draugang) Screw Ram***  
**Medium Warship (Elven Ship, Stalwart Hull, Steel Prow, Magical Propulsion)**

**Structure Dice:** 4d10+4 (26 sp)  
**Hardness:** 6  
**Manoeuvrability:** +5 (+2 Elven Ship, +3 Magic Propulsion)  
**Speed:** 50 ft./120 miles  
**Turn Rate:** 60 ft.  
**AC:** 14 (+4 Steel Prow)  
**Weapons Fore:** Metal shod ram, 2 fire towers, 2 ballistae  
**Weapons Aft:** 2 Heavy ballistae  
**Weapons Broadside:** 2 Heavy ballistae, 2 ballistae  
**Damage:** Ram 4d10/3d6; fire tower 4d6/1d6; heavy ballista 4d6/1d6; ballista: 3d6/-

**Crew:** 12, including mage  
**Passengers:** 50 marines  
**Cargo:** 10 tonnes  
**Building Time:** 18 months  
**Cost:** 325,000 gp

While of great use in direct battle, the elemental ram is very much a short-ranged ship. The *Iron*

'No, yer stupid boy! Ye'll shut yer gob or by god I'll be doin it for ya. I don' care who ya think ya are or how important ya might be ashore, we ain't no way tryin' ta outrun *that!* No, I'm not sure wot' it is and neither are you! The flag's elven and I ain't seen nuthin' like it but I heard tales. The elves, they only run a couple 'a ships wit' rams so they say. And ain't none of 'em what you'd call *normal*, neither. Oh! Ya thinks ya know so much? So tell me, landlubber, what's movin' it? There ain't no sails, there ain't much wind anyhow and I don't see no oars. It's witchcraft I tell ya! Pure 'an simple. The elves, they call things like them *Dagorlain*, which means built for killin'. Cap'n's smart. Them elves say heave to an' that's exactly what we're gonna do. If it makes you late that's too damn bad, because if there's a fuss you'll be even later - as in food fer crabs.

**First Mate Drakkar to an adventurer during boarding by an *Iron Wolf*.**



*Wolf* screw ram was developed to address this shortcoming and, whilst wildly successful, it is possibly the most expensive warship on the sea. As much a magical item as a ship, this 125 foot vessel is driven by a pair of screws mounted in the stern below the waterline, each turned by a set of windmill blades mounted on a central shaft and enclosed in a steel chamber. Bound wind elementals spin these shafts as directed by the presiding mage, turning the screws and driving the vessel through the waves at tremendous speed, never tiring.

Tactically, the *Iron Wolf* is used in classic galley fashion, closing with enemy vessels and destroying them by fire and ram, and a marine company is often carried to engage in or repel boarding actions. The steel prow helps keep the vessel from catching fire as well as protecting the crew from missile fire during high speed ram approaches. The *Iron Wolf* has no rigging, nor need of any.

### ***Bright Death (Rilgurth) Patrol Vessel***

**Medium Warship (Elven Ship)**

**Structure Dice:** 4d10 (22 sp)

**Hardness:** 6

**Manoeuvrability:** +2 (Elven Ship)

**Speed:** 50 ft./120 miles

**Turn Rate:** 80 ft.

**AC:** 10

**Weapons Fore:** Heavy ballista

**Weapons Aft:** Heavy ballista

**Weapons**

**Broadside:** 3

Ballistae, 1 heavy ballista

**Damage:** Ballista

3d6/-; heavy ballista 4d6/1d6

**Crew:** 30

**Passengers:** 40

**Cargo:** 30 tonnes

**Building Time:** 1 year

**Cost:** 140,000 gp

The *Bright Death* is another vessel built upon the superb *Corsair* hull, sacrificing

cargo space for additional weaponry and room for more passengers, usually marines. Often mistaken for the more frequently encountered *Corsair* due to their identical hull shape and similar rigging, these patrol vessels are fast, seaworthy and heavily armed. In times of peace, they are utilised in patrol and anti-piracy operations. In the battle line, *Bright Death*, *Corsairs* and other similar vessels make up the first line of support ships which maintain a combination of withering fire and precision manoeuvre whilst rams and close support vessels do their work. Once the enemy fleet is disrupted, larger elven warships and patrol vessels move in to finish off the enemy. Similar to the arrangement on board a *Corsair*, the aft deck is normally kept clear to enable the giant eagle retained as a mount for the captain to land with ease. These creatures are invaluable in reconnaissance and scouting missions.

### ***Tall Tower (Halbarad) Pursuit ship*** **Medium Warship (Light, Stalwart Hull)**

**Structure Dice:** 4d10 (22 sp)

**Hardness:** 6

**Manoeuvrability:** +3 (elven ship, light)

**Speed:** 60 ft./144 miles

**Turn Rate:** 70 ft.

**AC:** 10

**Weapons Fore:** Heavy ballista, 2 boarding planks

**Weapons Aft:** 2 arrow catapults

**Weapons Broadside:** 4 ballistae, 1 heavy ballista

**Damage:** Ballista 3d6/-; heavy ballista 4d6/1d6; arrow catapult 1d6/-

**Special Qualities:** Castled

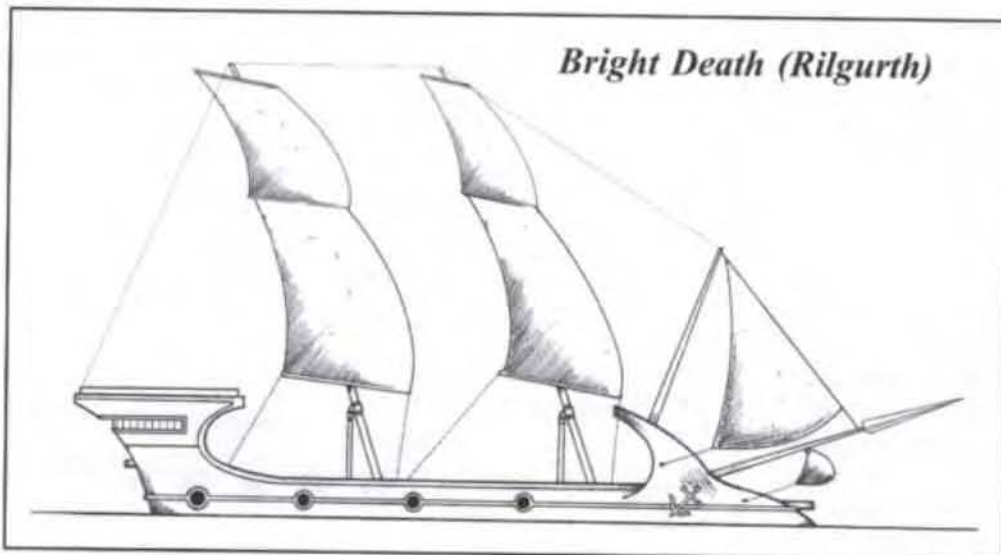

## SHIPS OF THE ELVES

**Crew:** 30  
**Passengers:** 60  
**Cargo:** 10 tonnes  
**Building Time:** 1 year  
**Cost:** 165,000 gp

**Castled:** The *Tall Tower* mounts two large wooden castle-type structures, fore and aft. These provide the majority of crewmen with a greater amount of protection during battle and are thus a common fitting to many of the larger warships. Crew on castled ships receive a one-half cover bonus (+4 AC, +2 Reflex).

The *Tall Tower* is a rare vessel in elven navies and certainly one of the most unusual. With a hull stripped down for speed, but still mounting slender fore and aft castles, it has an unusual and rakish silhouette that is feared by those who cross the elves at sea.

While elves generally prefer to send their enemies to the bottom with extreme prejudice, there are times when the rescue of hostages or the gathering of intelligence must override such concerns. The *Tall Tower* exists for these such missions alone. With a light hull and large amounts of sail, it can catch most ships afloat. Having closed, the *Tall Tower* crew will make use of its many ballistae and boarding planks to send a reinforced company of elite marines aboard. After all resistance has been obliterated, the elves will either open the sea cocks and let their victim sink or set the enemy

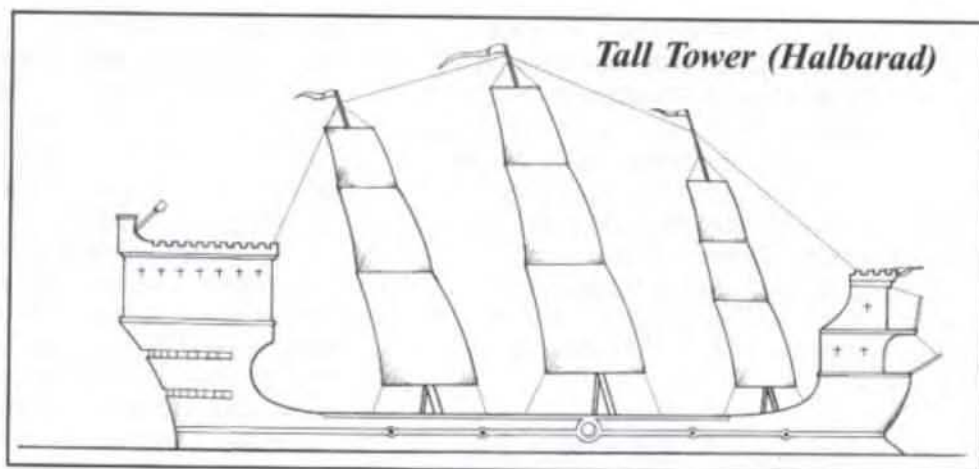

ship aflame, leaving no trace of what has occurred. Many tales of ships mysteriously vanishing at sea have been founded by the actions of this ship against the enemies of elven kingdoms.

### *Fortress of Fire (Narchost) Heavy Warship*

**Large Warship (Elven Ship)**

**Structure Dice:** 6d10 (34 sp)

**Hardness:** 6

**Manoeuvrability:** +1 (-1 size, +2 Elven ship)

**Speed:** 40 ft./96 miles

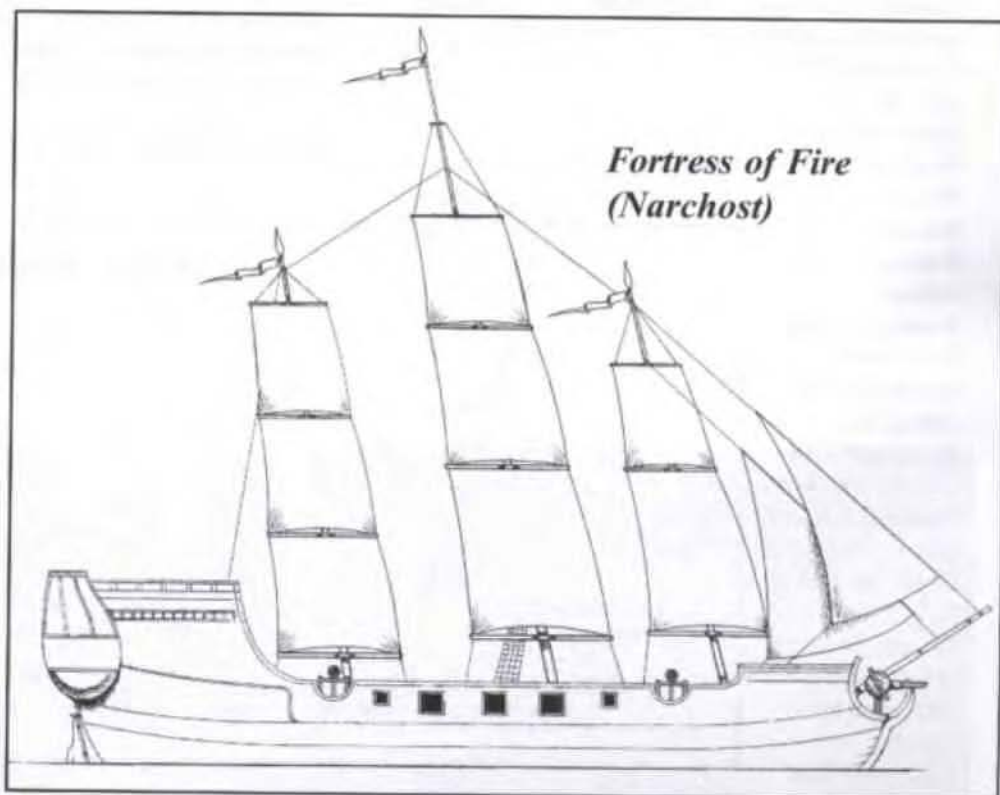



**Turn Rate:** 90 ft.

**AC:** 9 (-1 size)

**Weapons Fore:** 2 Fire towers, heavy ballista,

**Weapons Aft:** Heavy ballista

**Weapons Broadside:** 3 Heavy ballista; 2 ballistae;  
2 arrow catapults

**Damage:** Heavy ballista 4d6/1d6; ballista 3d6/-;  
fire tower 4d6/1d6; arrow catapults 1d6/-

**Crew:** 70

**Passengers:** 60

**Cargo:** 60 tonnes

**Building Time:** 2 years

**Cost:** 180,000 gp

One of the largest of the pure battle vessels sailed by the elves, the *Fortress of Fire* is nearly as fast as an elven patrol vessel and provides a significant improvement in firepower. Primarily used to destroy enemy vessels from range, the broadside of three heavy ballistae, combined with impressive agility for such a large ship, enables the *Fortress of Fire* to outmanoeuvre any foe its own size or larger and pound it to pieces. There are accounts of these

beautiful, yet deadly, warships taking on enemy craft three or four times their own size and tearing them apart in a war of manoeuvre and launching repeated salvos of enchanted ballista bolts and naphtha fireballs. Valuable in the extreme and time consuming to build, elves protect these ships heavily in any conflict. Space on the quarter deck is provided for up to four giant eagles which may accompany the captain and his officers.

### *Dread Hand (Borgoroth) Heavy Fire Support*

Large Warship (Elven Ship, Stalwart Hull)

**Structure Dice:** 6d10+12 (46 sp)

**Hardness:** 7

**Manoeuvrability:** +1 (-1 size, +2 Elven ship)

**Speed:** 40 ft./96 miles

**Turn Rate:** 90 ft.

**AC:** 9 (-1 size)

**Weapons Fore:** Heavy ballista

**Weapons Aft:** Heavy ballista

**Weapons Broadside:** 8 Heavy ballista

**Damage:** Heavy ballista 4d6/1d6;

*Dread Hand (Borgoroth)*

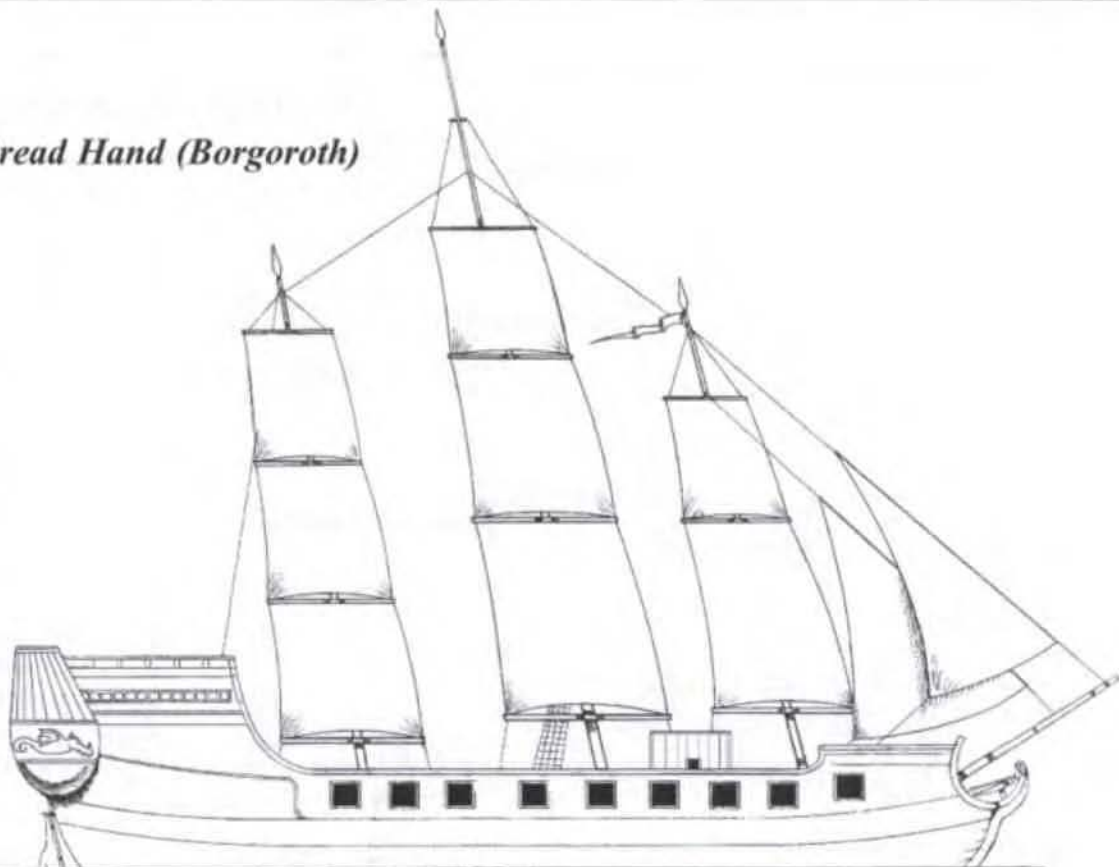

## SHIPS OF THE ELVES

**Crew:** 70  
**Passengers:** 30  
**Cargo:** 60 tonnes  
**Building Time:** 2 years  
**Cost:** 195,000 gp

Built on the same hull as the *Fortress of Fire*, the *Dread Hand* has even greater firepower at the cost of flexibility. Designed exclusively to destroy enemy vessels with artillery, the large quantity of weaponry aboard leads to some very aggressive tactics. Once the ramships have done their job and battle proper is joined, the commanders of *Dread Hand* vessels frequently take them straight amongst enemy fleets so as to put both broadsides fully to work. This ship is built exclusively with magically reinforced hulls to grant success in these risky manoeuvres. Space on the quarter deck is provided for up to four giant eagles which may accompany the captain and his officers.

Captains of *Dread Hand* class vessels are often dashing, devil-may-care commanders with great confidence and courage. Frequently, they are former commanders of *Spindriffs*, and use the same tactics with their great warships as they did with their light vessels. They are universally loved by

their crews and well known in ports of call for their quite 'un-elven' antics.

### *Sea Eagle (Thorongaer) Support Ship*

**Huge Warship (Elven Ship)**

**Structure Dice:** 8d10 (44 sp)  
**Hardness:** 7  
**Manoeuvrability:** +0 (-2 size, +2 Elven ship)  
**Speed:** 30ft./72 miles  
**Turn Rate:** 140 ft.  
**AC:** 8 (-2 size)  
**Weapons Fore:** Heavy ballista  
**Weapons Aft:** Heavy ballista  
**Weapons Broadside:** 1 Heavy ballista; 1 ballista; 2 arrow catapults  
**Damage:** Heavy ballista 4d6/1d6; ballistae 3d6/-; arrow catapult 1d6/-  
**Special Qualities:** Eagle Roost

**Crew:** 80  
**Passengers:** 120  
**Cargo:** 160 tonnes  
**Building Time:** 2 years  
**Cost:** 260,000 gp

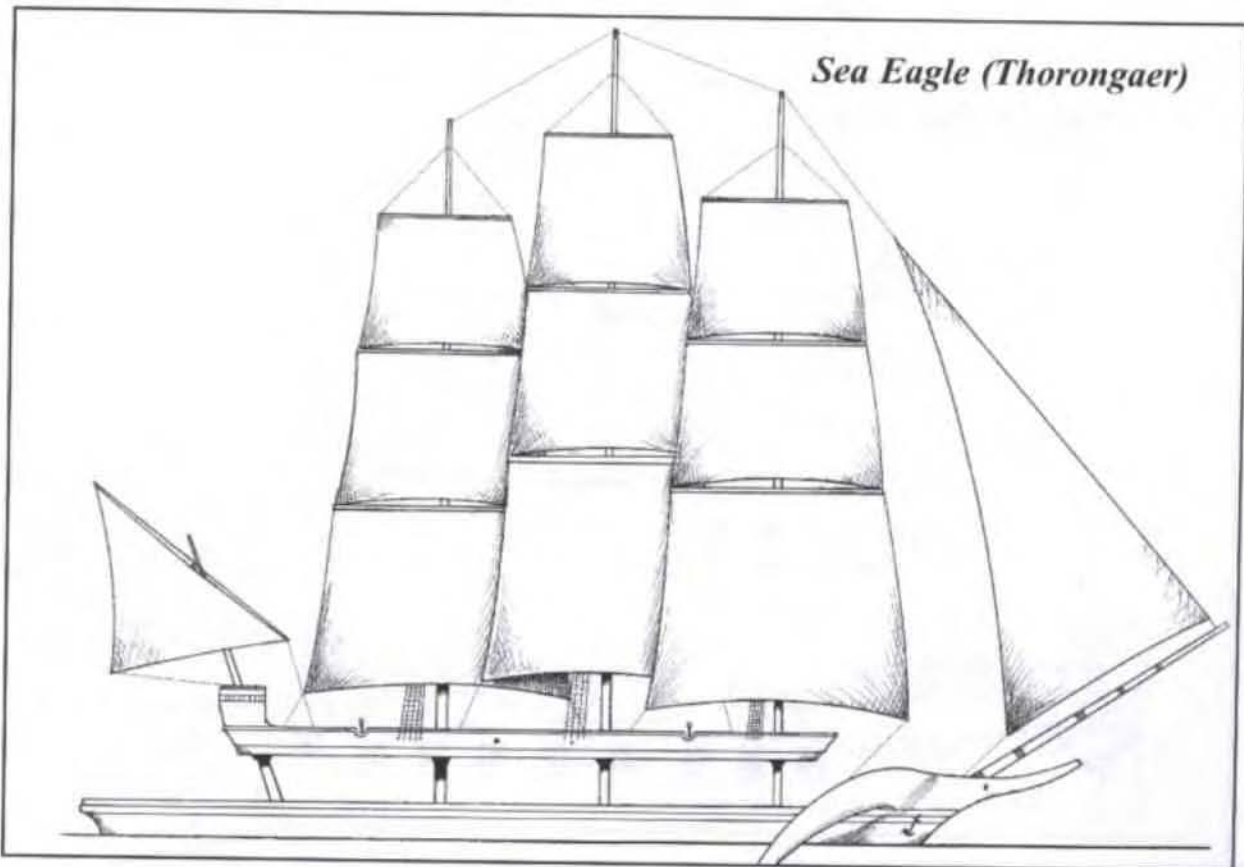



**Eagle Roost:** Built down the centreline of this ship is a long structure that forms an eyrie for giant eagles, protecting the creatures during inclement weather and from the worst effects of storms at sea. A *Sea Eagle* may carry up to 30 eagles along with their riders. A vessel mounting an eagle roost has sufficient space on her decks to allow up to twelve eagles to take off or land at once.

The *Sea Eagle* seems very oddly constructed at first glance for her masts are extremely tall and the lower levels of the vessel are virtually clear of rigging. The main decking is built out over the water in slender platforms, each mounting one or more roosts for giant eagles. Atop the huge centreline roost is a secondary deck which allows easy access to the rigging and mounts most of the ship's weaponry. *Sea Eagles* are the largest of the *Dagordain*, able to withstand tremendous damage and still be very quick for their size. Despite this they are very lightly armed for a huge warship, their main focus being to bring flocks of giant eagles into the fray to destroy enemy vessels from above.

## EXPLORERS (GILRANDIR)

### *Sea Wanderer (Aerandir) Scout Vessel*

Small Warship (Light, Elven Ship)

**Structure Dice:** 2d10-2 (9 sp)

**Hardness:** 6

**Manoeuvrability:** +3 (+1 Size, +2 Elven Ship)

**Speed:** 70 ft./168 miles

**Turn Rate:** 30 ft.

**AC:** 11 (+1 Size)

**Weapons Fore:** Arrow Catapult

**Weapons Aft:** None

**Weapons Broadside:** 1 Ballista

**Damage:** Ballista: 3d6/-, arrow catapult 1d6/-

**Special Qualities:** Over Armed, Simple to Sail

**Crew:** 4

**Passengers:** 8

**Cargo:** 9 tonnes

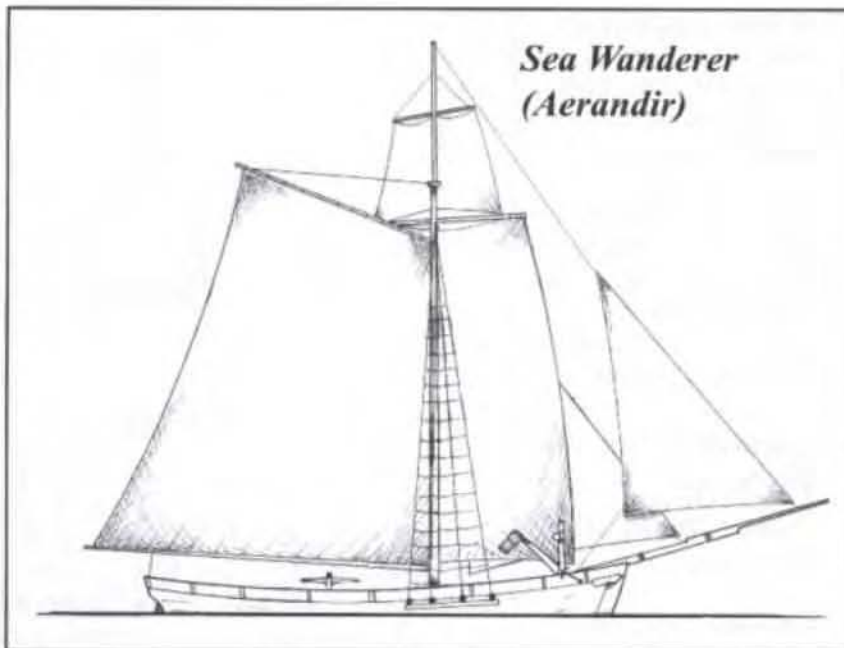

**Building Time:** 4 months

**Cost:** 65,000 gp

**Over Armed:** While the *Sea Wanderer's* small crew is more than sufficient to crew the vessel even in the worst of storms, in battle the vessel is severely undercrewed if more than one weapon is to be used. Crew may be pulled from the rigging to man the weapons if desired, with appropriate penalties resulting from a reduced crew (p47 in *Seas of Blood*). Passengers may, of course, man the weapons, freeing crew to sail the ship.

**Simple to Sail:** The rigging on a *Sea Wanderer* is so well designed that two crew can operate the sails without penalty. A single person can sail the ship as a reduced crew. The ship may never fall to the skeleton crew level.

The *Sea Wanderers* are the scout ships of the *Gilrandir*. Fast and light, quick to build and easy to man, such small craft range ahead of the larger explorer vessels, warning of dangerous creatures, deadly shoals and hostile natives. While not as tough as the *Sea Rage* class, which is far too expensive for explorers to operate, the *Sea Wanderer* is not lacking in capability. Simple rigging combined with elven design make the vessel so easy to sail that a crew of four can easily manage it, even on long voyages. When operating as part of an explorer fleet, a group of capable elven rangers usually functions as a landing party as well as helping to man weapons in battle.

*Aerandir* class ships are possessed of beautiful yet simple lines even when compared to other elven vessels. Many sea shanties and sailors' rhymes have been written about this little ship for she possesses a grace that only elven clippers can match but a charm they cannot hope to touch.

### ***Corsair (Vorncir)*** **Explorer**

Medium Warship (Elven Ship, Light)

**Structure Dice:** 4d10-4  
(22 sp)

**Hardness:** 6

**Manoeuvrability:** +2 (Light)

**Speed:** 50 ft./120 miles

**Turn Rate:** 80 ft.

**AC:** 10

**Weapons Fore:** Ballista

**Weapons Aft:** None

**Weapons Broadside:** 3 ballistae

**Damage:** Ballista 3d6/-

**Crew:** 30

**Passengers:** 20

**Cargo:** 90 tonnes

**Building Time:** 1 year

**Cost:** 100,000 gp

The *Corsair* is a direct descendant of the original *Gilrandir* exploration vessels. Light and quick, it relies more upon speed and manoeuvrability to evade danger, instead of placing emphasis on raw firepower. Still used as exploration vessels and following routes known only to elven crewmen, the *Corsair* is an incredibly ancient design that has sailed the seas for centuries. The hull design and rigging arrangements are so successful that many variants of this ship exist, often with only internal differences. Because of this, the *Corsair* and its sister vessels are the most commonly sighted ships in any elven navy and form the backbone of the explorer fleets.

The capacious hold is frequently divided into stores of trade goods and large amounts of additional

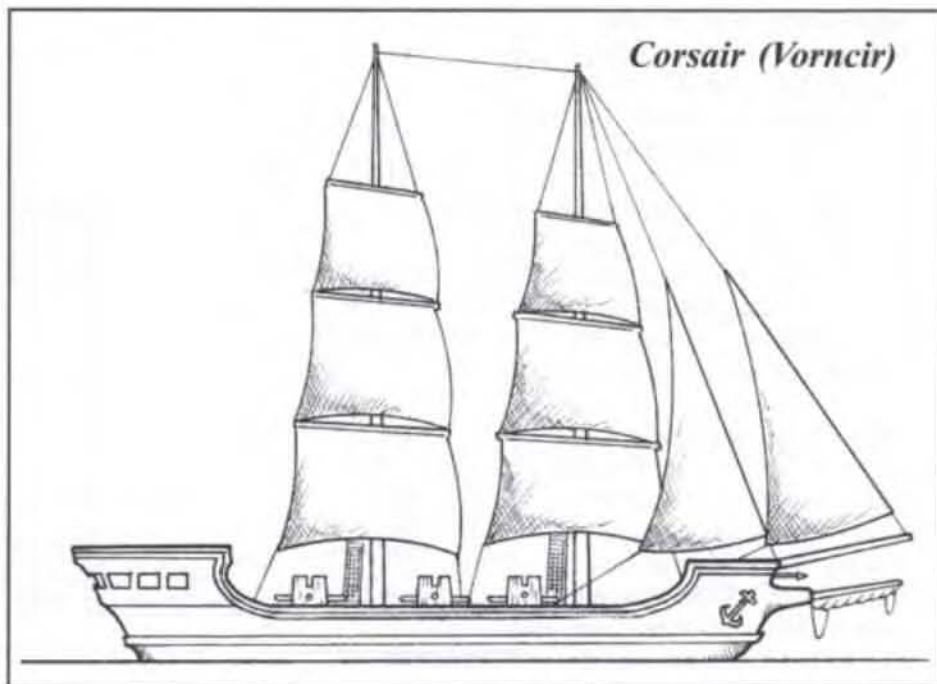

fresh food and water. *Corsairs* also carry a large number of spares, additional timber and many even mount a full woodworking shop. With just shipboard stores, these ships can stay at sea for months under normal conditions without needing to re-provision. The aft deck is kept clear on a *Corsair* to enable the giant eagle commonly kept on board as a mount for the captain to land with ease.

### ***Sea Haven (Lonnaer)*** Elven Great Vessel

Colossal Merchantman (Cumbbersome, Elven Ship)

**Structure Dice:** 40d10 (220 sp)

**Hardness:** 8

**Manoeuvrability:** -12 (-10 size, -2 Merchant ship, -2 Cumbbersome, +2 Elven ship)

**Speed:** 10 ft./24 miles

**Turn Rate:** 2,500 ft.

**AC:** 2 (-8 size)

**Weapons Fore:** 24 Heavy ballistae, 40 ballistae, 20 fire towers

**Weapons Aft:** 24 Heavy ballistae, 40 ballistae, 15 fire towers

**Weapons Broadside:** 35 Heavy ballistae, 60 ballistae, 30 fire towers, 80 arrow catapults

**Damage:** Heavy ballista 4d6/1d6; ballista 3d6/-; fire tower 4d6/1d6; arrow catapult 1d6/-

**Special Qualities:** Docking, Eagle Roost



**Crew:** 980

**Passengers:** 6,000

**Cargo:** 4,000 tonnes

**Building Time:** 50+ years

**Cost:** 7,000,000 gp (at least)

**Docking:** The *Sea Haven* is so huge it is really more of a floating island than a vessel. Its trimaran style construction allows mooring between the vast hulls of the ship and beneath the decking. Each *Sea Haven* can harbour an entire fleet of ships safely during storms, with up to 20 *Large* sized vessels being able to dock beneath it.

**Eagle Roosts:** Built down the centreline of the port and starboard hulls of the *Sea Haven* are long structures which serve as shelters for giant eagles. These protect the creatures during inclement weather and from the worst effects of storms at sea. Up to 180 eagles may be housed along with their riders. The *Sea Haven* is so large that there is no limit on the number of eagles which may take off and land at any time.

None doubt the skill of the elf shipwrights, but the *Sea Haven* defies both sense and belief. Over two thousand feet long and well over fourteen hundred

feet wide, it is thought no two *Sea Haven* vessels are truly alike. It is difficult to say for certain, however, as these ships are so rare that they are more the stuff of legend than reality. Most sailors will go their entire lives hearing of these ships, but never sighting one.

Built on a decked-over trimaran style hull, the *Sea Haven* is literally a town floating upon the waves. Between masts that seem to scrape the sky, gentle minarets look out over delicately fashioned cabins that are as well appointed as the forest homes they resemble. Elven clans that live aboard will either frequent the resource-rich fishing grounds of warm coral atolls and tropical isles or else take to the deep oceans, staying completely out of sight of land for decades at a time and living entirely as part of the ocean biome. In such deep ocean clans, large sections of the hull, masts and weapons will have been completely re-built over the centuries with bone, horn and shell replacing the original wood, the entire structure gently carved and painted in a truly beautiful fashion.

The giant *Sea Havens* are not fast ships, but they can move by spreading, literally, thousands of acres of canvas across gigantic yard arms. When under

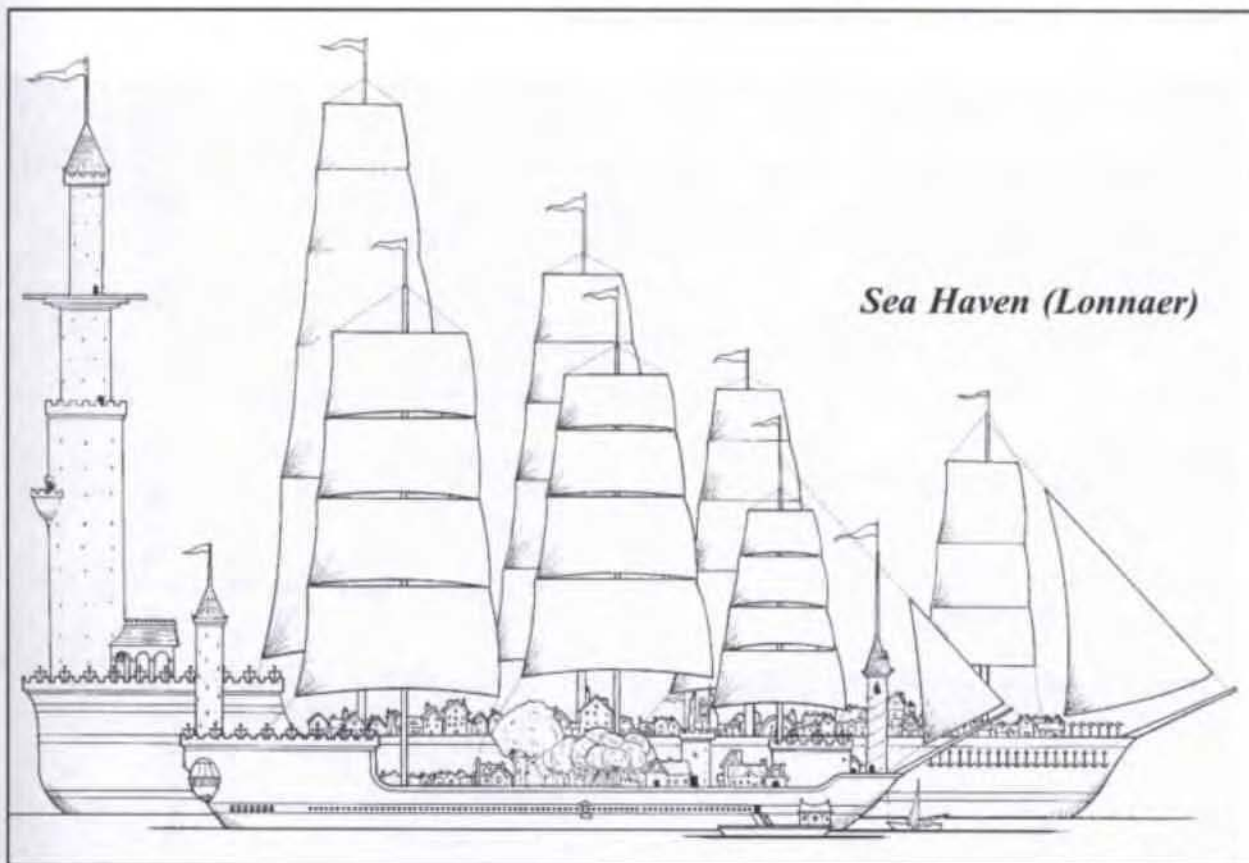

*Sea Haven (Lonnaer)*



full sail, some regions of the ship are so cut off from the great dome of the sky that stars are seen only on the low horizon beneath the edge of the huge sheets. Entire eyries of giant eagles are also frequently found aboard these immense vessels. These creatures have completely adapted to sea-borne life and earn their keep by catching sharks, marlin and other large creatures which they share with the elven community. Anything up to two hundred giant eagles may be found on board and more will be found amongst the clan's attendant fleet. Legends tell of some of these vessels even housing small nests of trained rocs.

*Sea Haven* captains are loathe to risk their floating home anywhere near battle. While they are superbly defended with both ship-killing weapons, thousands of elven warriors and a sizeable fleet of ships, they can still prove vulnerable due to their lack of mobility and sheer size.

'Calling me a liar are you?.'

'They pulled me from the deeps, them point-ears. I'd been afloat on a spar after the *Constance* went down and was sure I'd never see the shores of home again. I know some as have tangled with them point-ears and say they can be mighty cruel, but they pulled me from the ocean's bosom, no lie.

'So there they stand, all a-chatterin' in that warbly language of theirs when lo! The captain, he comes and blindfolds me! I figured that'd be the end of ol' Jeredar right there and then for sure but it weren't like that. They fed me and treated me okay and gave me water to wash up in and a place to sleep – the only curious thing was that damned blindfold. They made me wear it for what had to be two days at least.

'I'm on deck when he takes it off. Off it comes and the light blinds me but good. While I'm all a'squintin' and the like it gets all kinda dark. Like the sun went behind a cloud. Well I finally get me sight back and whatdya think I see? The biggest gol-durned ship anyone had ever seen!

'No, I don't know for sure how big it was, but big enough for three frigates to park under the deck in the shade with lots of room ta spare.

'I was there for three days, afore they took me home. I saw the strangest things you can imagine. Kids playin' on the deck. Wimmin doin' what wimmin do. Why, the great captain, he even had a house that was all made of shell. Huge it was! I found out later it was from some dragon turtle.

'There was trees and parks and pools and fountains and more. Regular town up there on them decks and these sea folk – they live there all their birth 'til death. Most of 'em have never set foot on land all their lives.



Permission granted to photocopy for personal use. These ship plans may be downloaded from our web site.

## Ship Deck Plans

Sea Rage (Aearaha)

1 Square = 5 feet

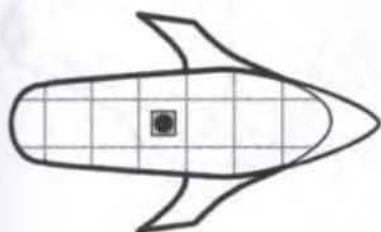

Spindrift (Rhos)

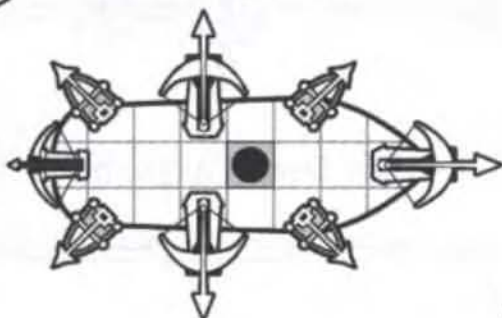

Sea Wanderer (Aerandir)

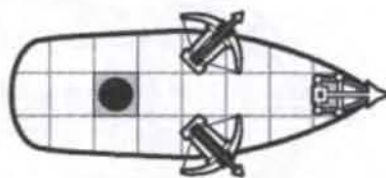

Windmaker (Sulech)

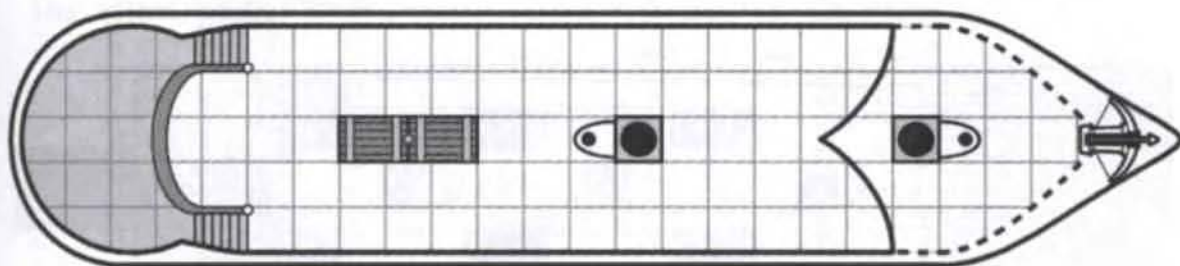

Bloodstained (Agarwaen)

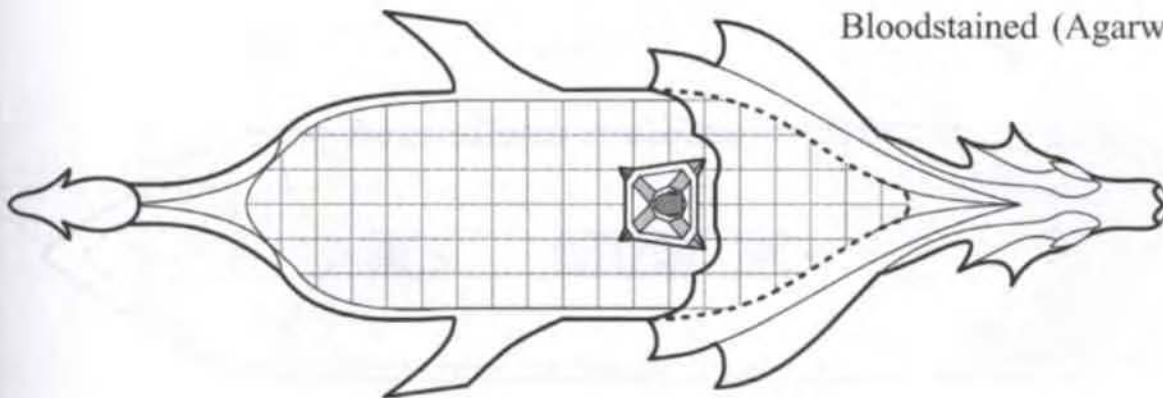

## SHIPS OF THE ELVES

Permission granted to photocopy for personal use. These ship plans may be downloaded from our web site.

### Iron Wolf (Draugang)

1 Square = 5 feet

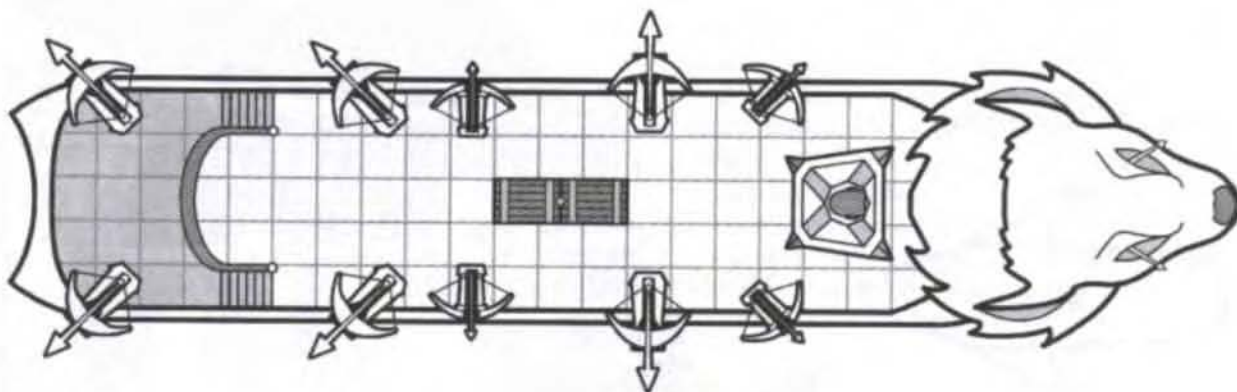

### Bright Death (Rilgurth)

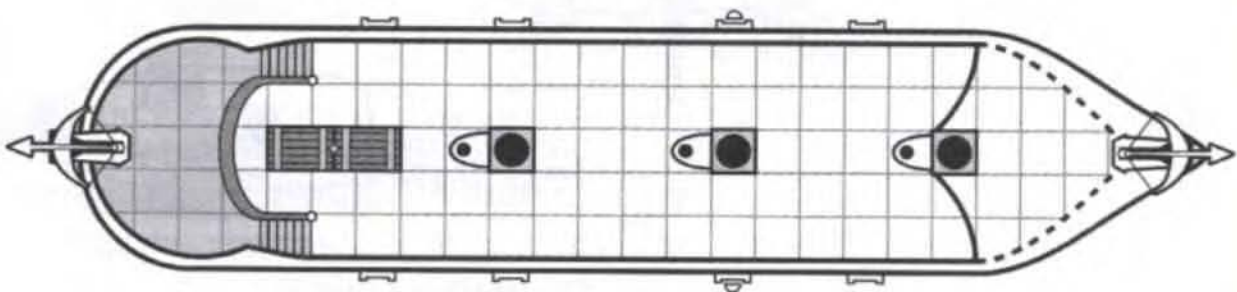

### Tall Tower (Halbarad)

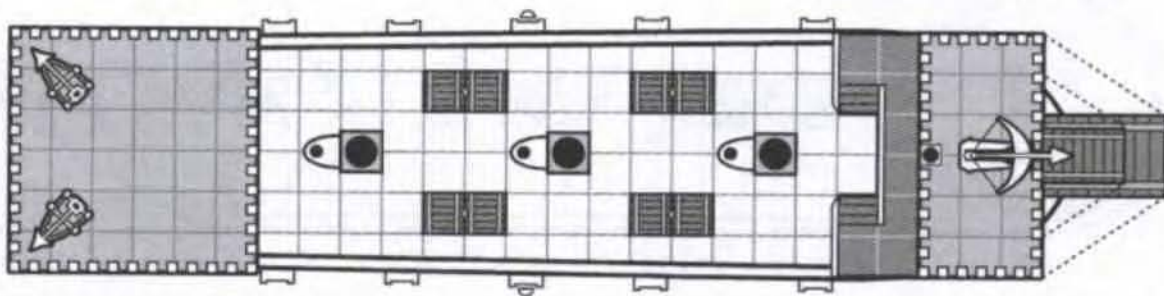

### Corsair (Vorncir)

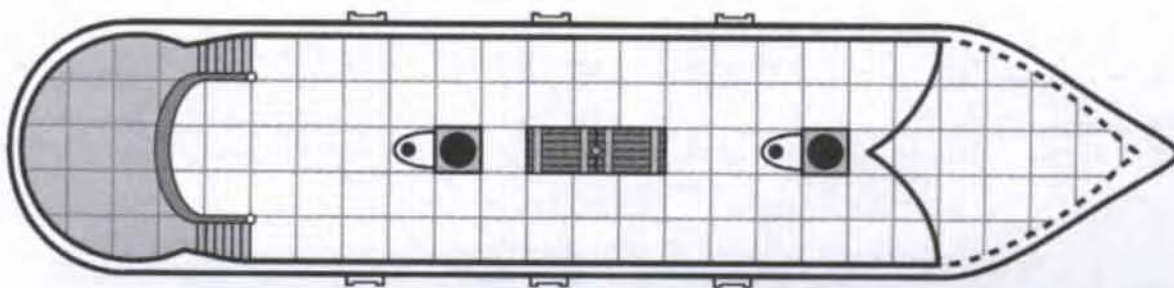



Permission granted to photocopy for personal use. These ship plans may be downloaded from our web site.

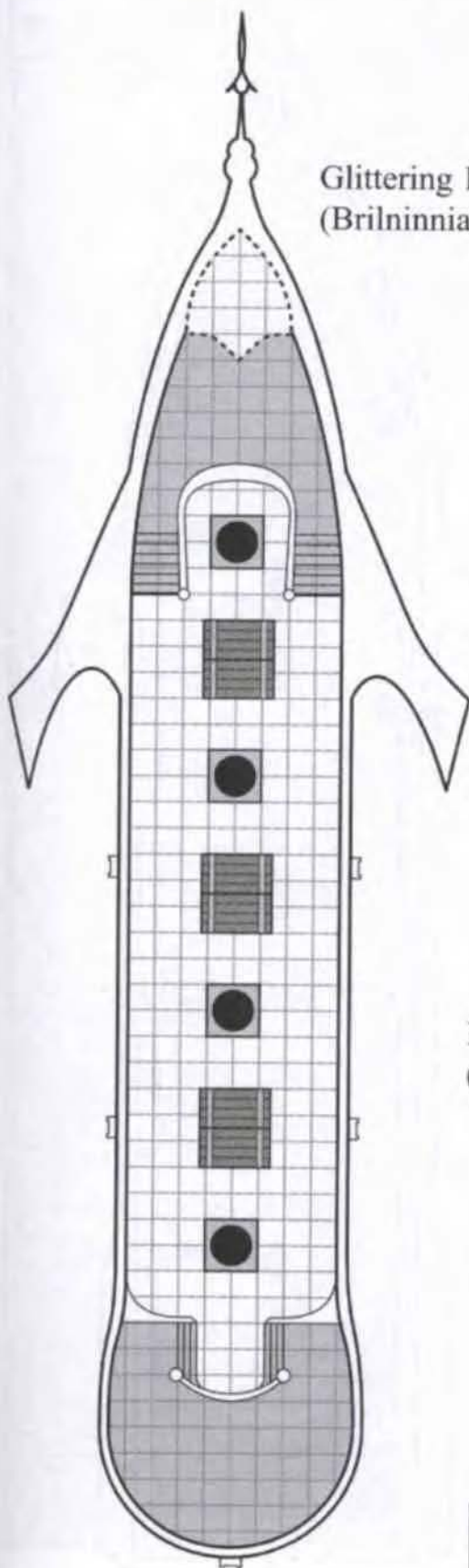

Glittering Rainbow  
(Brilninniach)

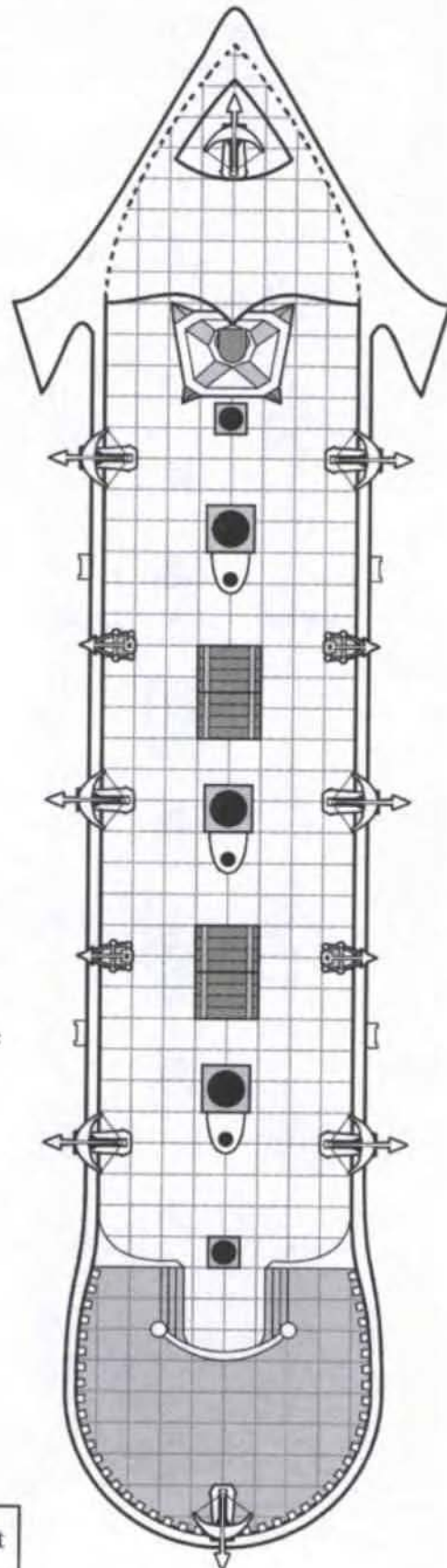

Fortress of Fire  
(Narchost)

1 Square = 5 feet



## SHIPS OF THE ELVES

Permission granted to photocopy for personal use. These ship plans may be downloaded from our web site.

Dread Hand  
(Borgoroth)

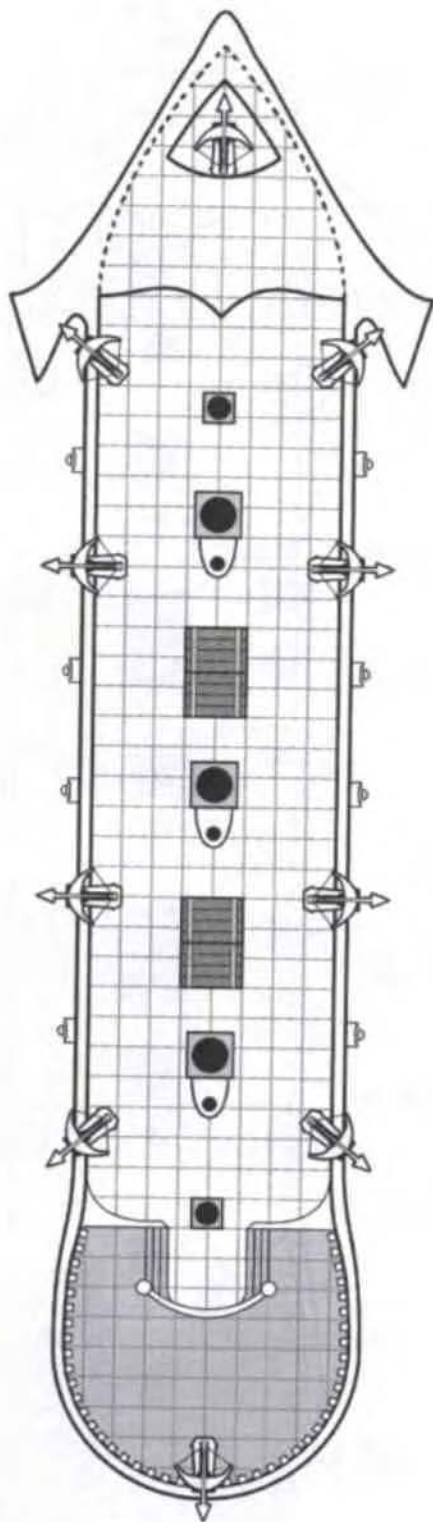

1 Square = 5 feet

Sea Eagle  
(Thorongaer)

1 Square = 10 feet

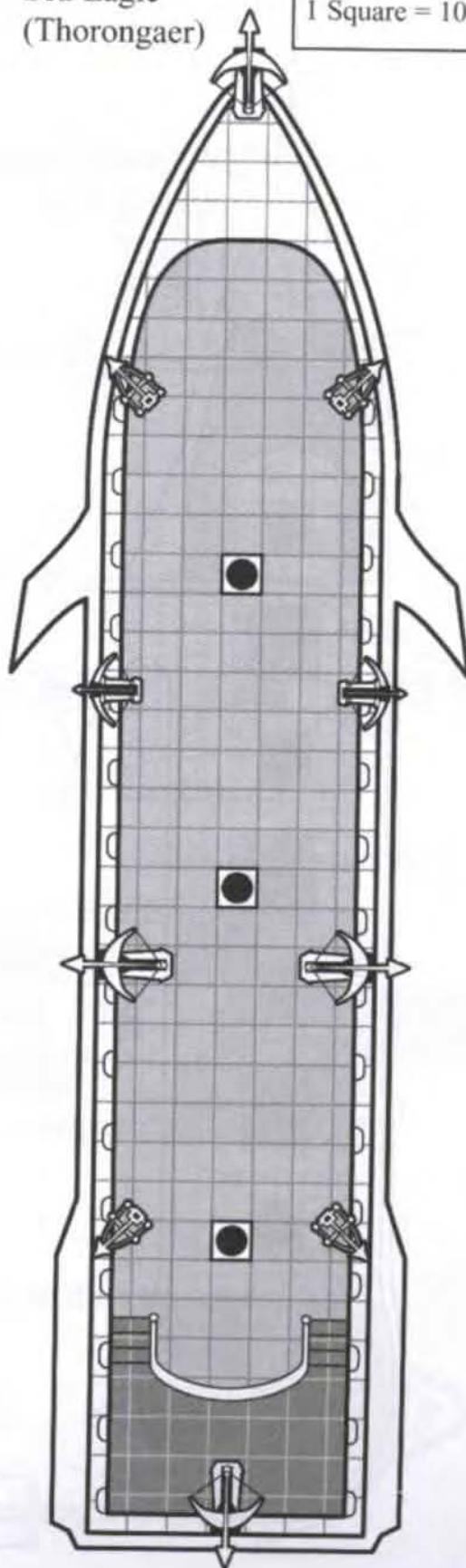



Úlaire sang with all his heart. His pale robes were soaked in spray, his thin golden hair plastered back on his narrow elven skull. He sang of spirit and life, of love and loss. His tears mixed blood salt with the sea salt on his cheeks even as his crew and marines tried to shield themselves from the agonizing beauty of his lament.

The ocean seemed alive with his anguish, roiling and churning, the sea unsettled in its bed as it carried the small ship along. Before the mithril-sheathed prow, a great wave rose – concealing the low profile of the hull from that which lay ahead.

Úlaire continued to sing, a vocal suffering that flayed the eardrums of his brethren.

'We are close,' the marine whispered under the dirge to his commander. 'Soon *Dagger of Tears* will engage regardless of whether they take the bait.'

Timdomeril nodded, trying to tear her mind from the mage's pain. 'They will take it Carelaes. The ores aboard that galley have proven tremendously aggressive. Say what you like about them, their commander is no idiot. In such a slow ship as that,' she nodded toward what little could be made out of the *Broadsword* beyond the persistent bow wave that heaved taller than their ship, 'very few manage to take a *Windmaker* trading vessel. If he knew these waters better, or the sun did not render him half blind, this would not work.'

Carelaes nodded in response, ducking as the unnatural sea threw more spray upon them. Serving aboard an elemental ram could be trying at the best of times but he'd never imagined how it would be when a soul-lost mage controlled the water spirit that drove them toward their enemies.

On the wind came the noise of screaming timbers, quickly followed by the crack and rumble of magical lightning. The mage-captain wound down his song of tragedy and paused to look at the handful of marines. 'Ready yourselves,' he said in a voice cracked with strain, 'it begins.'

As the marines took their places behind the great metal-shod prow to repel boarders the song began again. Still sad, it quickly built through despair and into anger, violence and revenge. The ocean tossed with wrath and even veteran Timdomeril flinched as the crests of waves formed fists, horns, tentacles and fanged maws as the *Dagger of Tears* jolted forward in a rush, her great ram catching a bone in its teeth. To either side sailing crew lowered the fire towers on their long poles, muttering words that caused the arcane lanterns to flare with crimson light and hiss like serpents as they sizzled the spray away in clouds of steam. The ram ship dropped its disguising wall of water and cut through the waves at breakneck speed straight for the vulnerable stern of the great orc galley. A cry went up from the aft catapult on the goblinoid ship as *Dagger* sliced a great wave in twain with the kiss of her magically driven ram and fairly screamed through the water straight at the stricken vessel. The orcish catapult thumped mightily in defiance and the rock caromed off the metal shod bow leaving a huge dent that wasn't enough to even slow Úlaire's retribution.

The elven ramship took the stern of the galley with a shuddering crash that buried her ram deep and threw everyone but Úlaire to the hardwood decking. The two sailors at the fire tower poles quickly grabbed them and muttered strange hissing words. The lamps responded by bathing the stern of the galley in flame. Screams vied with the sound of wind and wave as burning ores rolled wildly on the decks or threw themselves into the sea. *Dagger* backed off and struck again and again, each time staving in more hull timbers to let in the waves. The rear of the galley was heavily wreathed in flames even before the repeated impacts jarred loose the lantern head of the port fire tower causing it to shatter upon the enemy's deck. From within the shards of ceramic and brass the bound elemental leaped to freedom striking down anything that came near and spreading the fire further.

After the first impact Carelaes had been too busy to think. Smouldering and burning ores had tried to cross the bow sheathing at least four times. Several had made the leap from the flaming wreck of their own catapult onto the deck of *Dagger of Tears* and had to be dispatched in desperate close combat. His sword had run red with dark orc blood and the seconds seemed like hours. Finally, he buried his longsword in the last orc as they pulled away. The great galley had caught completely and the screams of burning and drowning ores echoed over the waves.

The *Broadsword* burned. Úlaire's murdered wife was avenged in cleansing elven fire.





## LICENCES

### OPEN GAME LICENSE

THIS LICENSE IS APPROVED FOR GENERAL USE. PERMISSION TO DISTRIBUTE THIS LICENSE IS MADE BY WIZARDS OF THE COAST!

#### OPEN GAME LICENSE Version 1.0a

The following text is the property of Wizards of the Coast, Inc. and is Copyright 2000 Wizards of the Coast, Inc ("Wizards"). All Rights Reserved.

1. Definitions: (a) "Contributors" means the copyright and/or trademark owners who have contributed Open Game Content; (b) "Derivative Material" means copyrighted material including derivative works and translations (including into other computer languages), potation, modification, correction, addition, extension, upgrade, improvement, compilation, abridgement or other form in which an existing work may be recast, transformed or adapted; (c) "Distribute" means to reproduce, license, rent, lease, sell, broadcast, publicly display, transmit or otherwise distribute; (d) "Open Game Content" means the game mechanic and includes the methods, procedures, processes and routines to the extent such content does not embody the Product Identity and is an enhancement over the prior art and any additional content clearly identified as Open Game Content by the Contributor, and means any work covered by this License, including translations and derivative works under copyright law, but specifically excludes Product Identity. (e) "Product Identity" means product and product line names, logos and identifying marks (including trade dress; artifacts; creatures characters; stories, storylines, plots, thematic elements, dialogue, incidents, language, artwork, symbols, designs, depictions, likenesses, formats, poses, concepts, themes and graphic, photographic and other visual or audio representations; names and descriptions of characters, spells, enchantments, personalities, teams, personas, likenesses and special abilities; places, locations, environments, creatures, equipment, magical or supernatural abilities or effects, logos, symbols, or graphic designs; and any other trademark or registered trademark clearly identified as Product Identity by the owner of the Product Identity, and which specifically excludes the Open Game Content; (f) "Trademark" means the logos, names, mark, sign, motto, designs that are used by a Contributor to identify itself or its products or the associated products contributed to the Open Game License by the Contributor (g) "Use", "Used" or "Using" means to use, Distribute, copy, edit, format, modify, translate and otherwise create Derivative Material of Open Game Content. (h) "You" or "Your" means the licensee in terms of this agreement.

2. The License: This License applies to any Open Game Content that contains a notice indicating that the Open Game Content may only be Used under and in terms of this License. You must affix such a notice to any Open Game Content that you Use. No terms may be added to or subtracted from this License except as described by the Licensee itself. No other terms or conditions may be applied to any Open Game Content distributed using this License.

3. Offer and Acceptance: By Using the Open Game Content You indicate Your acceptance of the terms of this License.

4. Grant and Consideration: In consideration for agreeing to use this License, the Contributors grant You a perpetual, worldwide, royalty-free, non-exclusive license with the exact terms of this License to Use, the Open Game Content.

5. Representation of Authority to Contribute: If You are contributing original material as Open Game Content, You represent that Your Contributions are Your original creation and/or You have sufficient rights to grant the rights conveyed by this License.

6. Notice of Copyright: You must update the COPYRIGHT NOTICE portion of this License to include the exact text of the COPYRIGHT NOTICE of any Open Game Content You are copying, modifying or distributing, and You must add the title, the copyright date, and the copyright holder's name to the COPYRIGHT NOTICE of any original Open Game Content you Distribute.

7. Use of Product Identity: You agree not to Use any Product Identity, including as an indication as to compatibility, except as expressly licensed in another, independent Agreement with the owner of each element of that Product Identity. You agree not to indicate compatibility or co-adaptability with any Trademark or Registered Trademark in conjunction with a work containing Open Game Content except as expressly licensed in another, independent Agreement with the owner of such Trademark or Registered Trademark. The use of any Product Identity in Open Game Content does not constitute a challenge to the ownership of that Product Identity. The owner of any Product Identity used in Open Game Content shall retain all rights, title and interest in and to that Product Identity.

8. Identification: If you distribute Open Game Content You must clearly indicate which portions of the work that you are distributing are Open Game Content.

9. Updating the License: Wizards or its designated Agents may publish updated versions of this License. You may use any authorized version of this License to copy, modify and distribute any Open Game Content originally distributed under any version of this License.

10. Copy of this License: You MUST include a copy of this License with every copy of the Open Game Content You Distribute.

11. Use of Contributor Credits: You may not market or advertise the Open Game Content using the name of any Contributor unless You have written permission from the Contributor to do so.

12. Inability to Comply: If it is impossible for You to comply with any of the terms of this License with respect to some or all of the Open Game Content due to statute, judicial order, or governmental regulation then You may not Use any Open Game Material so affected.

13. Termination: This License will terminate automatically if You fail to comply with all terms herein and fail to cure such breach within 30 days of becoming aware of the breach. All sublicenses shall survive the termination of this License.

14. Reformation: If any provision of this License is held to be unenforceable, such provision shall be reformed only to the extent necessary to make it enforceable.

#### 15. COPYRIGHT NOTICE

Open Game License v 1.0 Copyright 2000, Wizards of the Coast, Inc.

d20 System Rules & Content Copyright 2000, Wizards of the Coast, Inc.; Authors Jonathan Tweet, Monte Cook, Skip Williams, based on original material by E. Gary Gygax and Dave Arneson.

Open game content from Ships of the Elves Copyright 2001, Mongoose Publishing.

#### The d20 System® License version 3.0

By downloading the enclosed graphic files and/or by returning the Confirmation Card as presented in the file "card.pdf", the Licensee ("You") accept to be bound by the following terms and conditions:

#### 1. Copyright & Trademark

Wizards of the Coast, Inc. retains title and ownership of the d20 System trademark logos, the d20 System trademark, and all other copyrights and trademarks claimed by Wizards of the Coast in The Official Wizards of the Coast d20 System Trademark Logo Guide version 1.0, incorporated here by reference.

#### 2. License to use

You are hereby granted the non-transferable, non-exclusive, royalty-free license to use the d20 System trademark logos, the d20 System trademark, and certain other trademarks and copyrights owned by Wizards of the Coast in accordance with the conditions specified in The Official Wizards of the Coast d20 System Trademark Logo Guide version 1.0 (the "Licensed Articles").

#### 3. Agreement not to Contest

By making use of and/or distributing material using the d20 System Trademark under the terms of this License, You agree not to contest the ownership of the Licensed Articles.

#### 4. Breach and Cure

In the event that You fail to comply with the terms of this License, You will be considered to be in breach of this License. Wizards of the Coast will attempt to notify you in writing by sending a Registered Letter to the address listed on the most recent Confirmation Card on file, if any. You will have 30 days from the date the notice (the "cure period") to cure the breach to the satisfaction of Wizards of the Coast. If no Confirmation Card is on file, you will be considered to be in breach of this License immediately.

#### 5. Termination

If, at the end of the cure period, the breach is not cured, Wizards of the Coast may terminate this License without further written notice to You.

#### 6. Effects of Termination

Upon termination, You shall immediately stop all use of the Licensed Articles and will destroy any inventory or marketing material in Your possession bearing the d20 System Trademark logos. You will remove any use of the d20 System Trademark logos from your advertising, web site, letterhead, or any other use. You must instruct any company or individual that You are or become aware of who is in possession of any materials distributed by You bearing the d20 System Trademark logos to destroy those materials. You will solely bear any costs related to carrying out this term of the License.

#### 7. Penalty for Failure to Comply with Termination Instructions

If You fail to comply with the Effects of Termination, Wizards of the Coast may, at its option, pursue litigation, for which You shall be responsible for all legal costs, against You to the full extent of the law for breach of contract, copyright and trademark infringement, damages and any other remedy available.

#### 8. Updates

Wizards of the Coast may issue updates and/or new releases of the d20 System Trademark logos without prior notice. You will, at the earliest possible opportunity, update all material distributed by You to use the updated and/or new version of the d20 System Trademark logos. You may continue to distribute any pre-existing material that bears an older version of the d20 System Trademark logos.

#### 9. Changes to Terms of the License

Wizards of the Coast may issue updates and/or revisions to this License without prior notice. You will, at the earliest possible opportunity, conform in all respects to the updated or revised terms of this License. For a period of 90 days You may continue to distribute any pre-existing material that complies with a previous version of the License. Thereafter written consent should be obtained from Wizards of the Coast. Subsequent versions of this License will bear a different version number.

#### 10. Updates of Licensee information

You may transmit an updated version of the "card.pdf" Confirmation Card at any time to Wizards of the Coast.

#### 11. Notices to Licensor:

Wizards of the Coast  
d20 System License Dept.  
PO Box 707  
Renton, WA 98057-0707

#### 12. No maintenance or support

Wizards of the Coast shall have no obligation whatsoever to provide You with any kind of maintenance or support in relation to the d20 System Trademark logos.

#### 13. No Warranty / Disclaimer

THE D20 SYSTEM TRADEMARK LOGO FILES ARE MADE AVAILABLE ON AN "AS IS" BASIS. WIZARDS OF THE COAST DOES NOT MAKE ANY REPRESENTATION OR WARRANTY, WHETHER EXPRESS OR IMPLIED, AS TO THE FITNESS FOR A PARTICULAR PURPOSE, USE OR MERCHANTABILITY. WIZARDS OF THE COAST MAKES NO REPRESENTATION OR WARRANTY THAT THE D20 SYSTEM TRADEMARK LOGO FILES ARE ERROR-FREE.



MGP  
3003

TRAVELLERS' TALES

20  
system

# SHIPS OF THE ELVES

## Deadly Grace

Upon the waves, the ships of the elves are now only seldom seen. Once the ancient race ruled the oceans and none dared challenge their mastery but now the new races have taken up the challenge of the sea and sail with vigour to all corners of the world. Many may have forgotten the elves, but their rule of the waves has by no means been surpassed. The elves go to sea for many reasons; to defend the waters of their nations, to trade with the lesser races or to simply dare the unknown.

### Inside You Will Find:

#### Elves at Sea:

Never before covered history and information on the sea-borne clans of elves and their total mastery of the ocean. Covering traders, explorers and warriors in exquisite detail, players and Games Masters alike may discover the true secret behind the elves' supremacy on the waves.

#### Crews:

Elves do not hire out their services to just any captain and even then can prove extremely expensive. However, for the captain who will settle for nothing less than the very best, gold cannot hire a better crew than one comprised solely of elves.

#### Weaponry:

New shipboard weapons employed by the elves, including the Heavy Ballista, Fire Tower, Bound Bolts and Naphtha Elven Fire.

#### Ships of the Elves:

Nearly 20 new vessels are featured, covering the entire vista of elvish ingenuity in ship design. From the glorious and rarely seen Sea Haven to the deadly fast Elemental Ram, few pirates are foolish enough to challenge an elven fleet at sea, be it from the explorer, trader or warrior clans.

FOR GAMES MASTERS AND PLAYERS ALIKE

Requires the use of the Dungeons and Dragons® Player's Handbook, Third Edition,  
published by Wizards of the Coast®

**MONGOOSE  
PUBLISHING**

[www.mongoosepublishing.com](http://www.mongoosepublishing.com)

US \$ 9.95

ISBN 1-903980-12-7



9 781903 980125 >