

FOR ANY FANTASY  
CAMPAIGN

# Convention Special Dungeon Crawl Classics #3.5 The Haunted Lighthouse



by Dave Arneson  
AN ADVENTURE FOR CHARACTER LEVELS 4-6



Remember the golden days of role playing, when adventures were underground, NPCs were there to be killed, and the finale of every dungeon was the dragon on the 20th level? Well, those days are back. Dungeon Crawl Classics feature bloody combat, intriguing dungeons, and no NPCs who aren't meant to be killed. Each adventure is 100% good, solid dungeon crawl, with the monsters you know, the traps you fear, and the secret doors you know must be there somewhere.

This adventure was specially prepared for Gen Con Indy 2003. In The Haunted Lighthouse, a terrible storm forces the players to take refuge in a lighthouse that warns travelers of a nearby moor. But what appears at first glance to be a safe haven is in fact a trap set by the malevolent ghost of a long-dead troll. Can the players find and slay the ghost troll? Or will they be trapped forever in the haunted lighthouse?

If you enjoy this adventure, look for the rest of the Dungeon Crawl Classics series!



[www.goodman-games.com](http://www.goodman-games.com)



# The Haunted Lighthouse

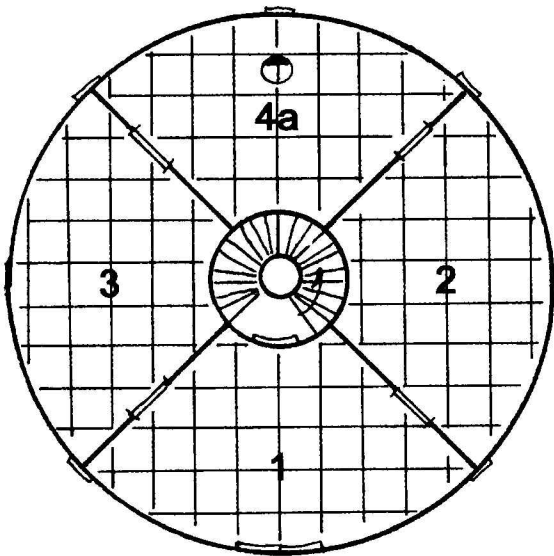

First Level

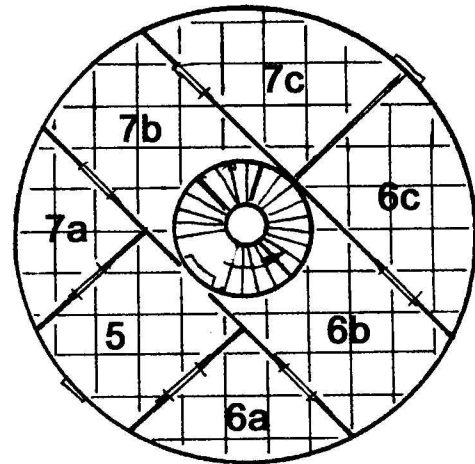

Second Level

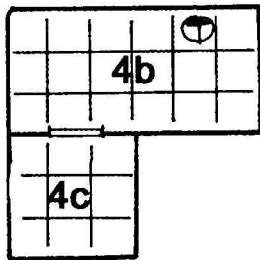

Sub-Basement

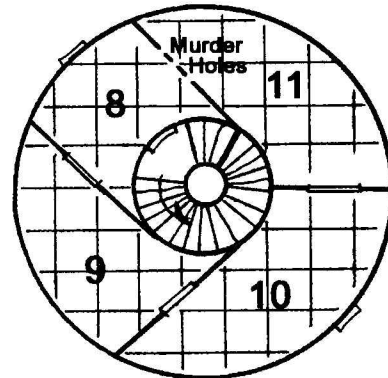

Third Level

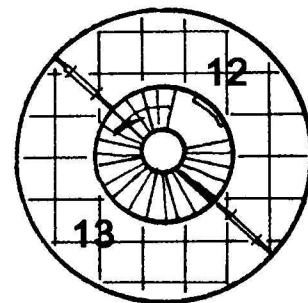
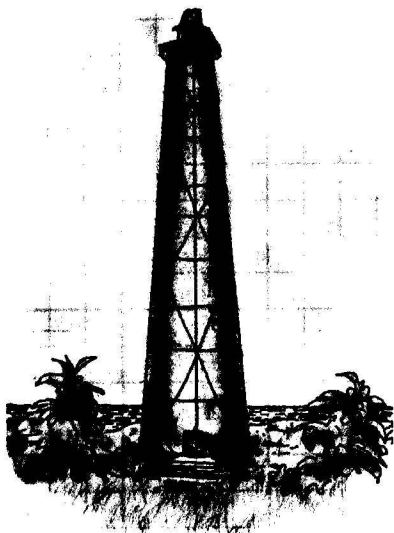

Fourth Level



Up



Trap Door



Scale



N

# Dungeon Crawl Classics #3.5

## The Haunted Lighthouse

by Dave Arneson

AN ADVENTURE FOR CHARACTER LEVELS 4-6

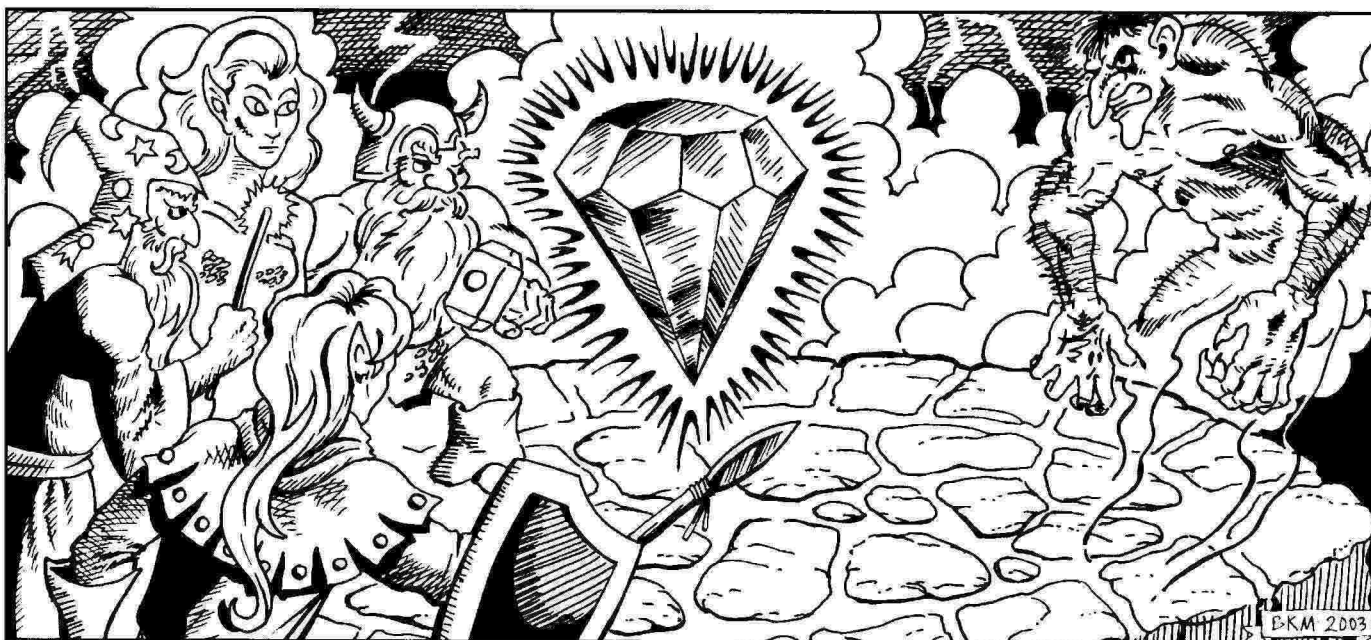

### Credits

**Writer:** Dave Arneson  
**Contributing Writers:** Dustin Clingman, Jeff Quinn  
**Cover Artist:** Erol Otus  
**Interior Artist:** Brad McDevitt  
**Cartographer:** Clayton Bunce  
**Copy Editor:** Joseph Goodman  
**Graphic Designer:** Joseph Goodman (with all due respect to the early-80's modules that inspired it)  
**Playtesters:** Nancy Daniels, Arthur Gardiner, Darry Huskey, Brian Mellem, Susie Quinn, Shaun Rattigan, Alexandra Sloan

### Table of Contents

Introduction .....	2
Game Master's Section .....	2
Background .....	4
The Haunted Lighthouse, Level 1 .....	5
The Haunted Lighthouse, Level 2 .....	8
The Haunted Lighthouse, Level 3 .....	12
The Haunted Lighthouse, Level 4 .....	13
Appendix A .....	15



[www.goodman-games.com](http://www.goodman-games.com)

If you like this adventure, be sure to look for the rest of the Dungeon Crawl Classics series at your local game store.

Log on to our web site for freebies, news, special offers, and more. Be the first to know when this book is revised to version 3.75!

# Introduction

Remember the golden days of role-playing, when adventures were underground, NPCs were there to be killed, and the finale of every dungeon was the dragon on the 20th level? Well, those days are back. Dungeon Crawl Classics feature bloody combat, intriguing dungeons, and NPCs who are meant to be killed. Each adventure is 100% good, solid dungeon crawl, with the monsters you know, the traps you fear, and the secret doors you know must be there somewhere.

The Haunted Lighthouse is designed for four to six players of 4th through 6th level. While the characters can be of any basic character class, a rogue and a good aligned cleric are recommended for the ultimate survival of the party and completion of the adventure. One strong fighter with a magical weapon would also be helpful but is not necessary.

## Adventure Summary

The party is traveling overland when they are surprised by the quick onset of a powerful storm. High winds accompanied by an unnatural amount of deadly lightning quickly press the importance of finding a safe place to wait out the weather. While searching for shelter, the party sees the bright lantern of an old inland lighthouse on the edge of a bog in the distance. As they make their way to the lighthouse, they come upon the ghastly remains of countless souls whose gnawed bones are tossed into piles at the base of the tower. Do they continue on, or face the storm in the open? Being the adventurers that they are, the choice is obvious. You can't fight a storm, but you can certainly get XP from whatever is producing the corpses!

## Game Master's Section

### Encounter Table

To help the GM prepare, we have included a quick reference table showing all encounters at a glance. The abbreviations used are: Loc – the location number keyed to the map for the encounter, listed as level and room number. Pg – the module page number on which the encounter can be found. Type – this indicates if the encounter is a trap (T), puzzle (P), or combat (C). Encounter – the key monsters, traps, or NPCs that can be found in the encounter. Names in italics are classed NPCs. EL – the encounter level.

### Encounter Table

Loc	Pg	Type	Encounter	EL
1-2	6	C	2 shadows	4
1-3	6	C	2 wights	4
1-4b	6	P	<i>Loeb</i>	4
1-4c	8	T	Built-to-collapse trap	6
2-5	8	C	Wraith	5
2-6b	9	C	<i>Douglas</i> <i>Halgrid</i>	4
2-6c	9	C	<i>Montague "the Cook"</i>	4
2-7c	11	C	Wight Wraith	6
3-8	12	C	Shadow	3
3-9	12	T	Camouflaged pit trap	3
3-10	12	C	Wraith	5
3-11	13	C	Shadow	3
4-12	13	C	<i>Mickle</i>	7
4-13	13	P	Lighthouse Gem	4

## Getting the Players Involved

The following hooks can be used to get the players into the lighthouse:

- If the players try to bypass entering the lighthouse, they continue to be assaulted by high winds, lightning strikes and blinding rain. The storm is considered Severe and will blow out any natural lighting that the players use. Eventually their path is blocked by a quickly flooding river that is too turbulent to swim (Swim DC 40 or they are carried away and drowned). A now-useless washed-out bridge was the only way across. If they linger at the bridge, flash flooding begins as the banks of the river overflow and threaten to carry them away. Each character must make Fortitude save every three rounds (DC 15) to prevent being swept away by the flooding. Flying characters must make the same check to keep from being blown out of the air and possibly into the river. It should become obvious that someone will be hit by a lightning bolt or be swept away by the flooding. The lighthouse will seem like a good plausible alternative to fighting off these harsh elements.
- If the players investigate the terrible scene outside of the lighthouse, they find a couple of gold pieces that have fallen from a bag partially stuck in the

closed door. They can retrieve the bag if they open the door and upon pulling it out will discover that it contains 5 gp and a small ruby worth 15 gp. Feel free to adjust these amounts or litter small treasures around the outside of the lighthouse to let their greed build until they overcome their fear of entry. If they continue to linger outside, bring weather elements described above into play to get them in the door.

## Player Death

Characters who enter the lighthouse and are killed become incapacitated and appear dead, but they do not expire at this time. They are in a state of stasis awaiting conversion into a ghostly form. The lighthouse is a magical residence for spirits contained within. If the entire party is wiped out, they will be converted to ghosts or wraiths in due time. If any single member of the party destroys the lantern, the entire party is restored to full health and the curse of the lighthouse is broken.

## Treasure

Treasures in The Haunted Lighthouse have some unique properties, due to the nature of the curse that is affecting the area. Use the following table to determine what each item's properties are. The abbreviations used are: Loc – the location number keyed to the map for the treasure, listed as level and room number. Pg – the module page number that the treasure can be found on. Type – this indicates if the treasure fades when the lighthouse light is destroyed (T), a permanent item that can be removed from the lighthouse (P), or an item that an NPC will want back after the light is destroyed (N). Treasure – the treasure that can be found in the room. Treasures in italics are magic items.

Treasure Table

Loc	Pg	Type	Treasure
1-1	5	P	Wall tapestry (350 gp)
1-2	6	P	Masterwork silver-plated steel longsword with a jet jewel set in the hilt (550 gp)
1-3	6	P	Brass mug with jade inlays (350 gp)
1-4a	6	T	<i>Potion of magic weapon (oil)</i>
1-4b	6	N	<i>Circlet of blasting (minor)</i>
1-4c	8	P	500 gp +1 full plate +2 bastard sword
2-5	8	P	2,500 gp
2-6b	9	P	1,000 gp 4 gems (10 gp azurite, 10 gp rhodochrosite, 50 gp onyx, and 100 gp jade) Pink pearl necklace (3,500 gp)
2-6c	9	P	Masterpiece painting (1,400 gp) Divine scroll (CL 1st; <i>comprehend languages, detect undead, doom</i> )
2-7a	10	P	Bone statuette (55 gp) Tools (30 gp)
2-7c	11	P	+2 light hammer
3-9	12	T	300 cp <i>Candle of truth</i> <i>Bag of holding</i> <i>Wand of web</i>
3-10	12	P	800 sp
3-11	13	P	+1 shocking composite longbow (+3) 4 masterwork swords

# Background Story

The Legend of the Lighthouse details the strange circumstances surrounding the lighthouse and its peculiar keeper named Mickle. Bards and characters with ranks in Knowledge (local) can try to remember the details of the tale with a check (DC 14).

## The Legend of the Lighthouse

Mickle was said to be an angry fellow who despised his position as keeper of the lighthouse. In an attempt to ensure his dismissal for incompetence, he intentionally and spitefully left the lantern dark on numerous nights to endanger travelers near the bog. One night when the lantern was dark, a local noble's son drowned in the bog while returning home from his travels. When his treachery was discovered, Mickle was brought before the noble to face punishment for his foul deed. He was beaten severely but not killed. When the noble's guards grew tired of beating him, Mickle was sentenced to serve the remaining days of his life in the service of the people as the lifelong keeper of the lighthouse. The noble's final warning to Mickle involved a detailed account of the decades of torture that awaited him if he failed to light the lantern again. The noble's threats went so far as to include killing Mickle and having his clerics raise him from the dead, just to kill him again and again. This imagery eroded away at any semblance of sanity that the keeper might have had left.

Though Mickle was an outcast and a prisoner of the lighthouse, the noble sent him regular supply wagons on a monthly basis. His intent was to make sure that the keeper would have plenty of strength to live out his prison sentence. Mickle's mental state continued to decay as he obsessed over his captive condition. His heart was full of rage and hatred for all those who had shunned him, especially the noble who had bound him to the lighthouse prison cell.

In time, the noble passed away and the supply wagons that had provided Mickle with his sole source of sustenance stopped coming. The noble's wishes that his punishment continue even in the event of his death were not abided and Mickle was left to die. When Mickle realized his suppliers were not coming back, he began to leave the lighthouse for longer and longer periods of time in a search for food and water. He turned to raiding travelers and passers-by, though he always returned in time to light the lantern each night.

One evening an especially terrible storm was passing through the land. Mickle had activated the lantern (which was powered by a magical gem) and was guarding over it when a knock came at the door of the lighthouse. An old hag who was drenched from the storm asked for shelter and some food. Mickle, who was completely insane by this point, threatened to kill her if she

did not leave immediately. She continued to plead with him for assistance, but he refused to help her. The angry old hag, who the legend reports was actually a witch, is said to have cast a spell upon Mickle to punish him for his cold heart. Most reports say that the witch summoned a troll who dispatched with Mickle and has since made the lighthouse his new home.

## The GM's Eyes Only

Once the players have entered the lighthouse, the door will slam shut and cannot be opened by any means, magical or otherwise. Those who are within 5 feet of the door when it closes are pulled inside unharmed. Anyone who is outside when the door slams will be unable to open the door and will be left to survive the elements. Be careful before letting the door slam, as this may become a terribly short adventure for those characters guarding the horses. The lighthouse is designed to travel to the ethereal plane when the door is shut, making its ghostly inhabitants corporeal and attackable.

This mysterious lighthouse continues to be haunted by many types of dangerous spirits. The most powerful of these spirits is a ghost troll that was formerly the lighthouse keeper, Mickle. The witch referenced in the legend polymorphed Mickle into a troll as it expressed his truly cold heart for all to see. When news of Mickle's disappearance became known, thieves, looters and general adventurers sought out the lighthouse in the hope of finding something of value. With his newfound strength as a troll, Mickle routinely defeated these threats to the lighthouse. As time passed and the body count began to rise, he realized the spirits of those he had killed were haunting the place. In time he too succumbed to the powerful spirits that haunted the building, whereupon he discovered that his spirit was also trapped and bound to the lighthouse in a ghostly form. The witch's curse holds the spirits of the dead captive and prevents them from their eternal rest.

On any given day Mickle's primary motivation is to light the lantern at the top of the lighthouse. Even as a ghostly troll Mickle remains vigilant to this responsibility. His insane fear of the noble's threat has followed through to the afterlife and finds him carefully presiding over the light each night. Within the lighthouse (in room 5) the players will find Mickle's journal, the latter pages of which account for his slowly growing understanding of the witch's curse. (When he became a troll, he still tried to write but it turned out much less legibly.)

The curse that was put on the lighthouse is powered by an enchantment placed on the magic lantern at its top. If the lantern is destroyed, the curse will be broken and all the spirits trapped within will be freed. The lighthouse will return to the material plane and will allow the survivors to exit. Any players who are killed during the course of play will be restored to their previous states and allowed to leave.

## Player Beginning

*The need for shelter and the lure of adventure has brought you into this eerie place. The keen instincts that have kept you alive tell you that something about this place is not right. The piles of dead outside assure you that something foul inhabits the dark recesses and shadows of this place. As the door slams shut behind you it begins to glow with a faint green light. Your hands search for your weapons. As you find them you sense that it's time to do a little housecleaning.*

## The Haunted Lighthouse, Level 1

All walls are 10 feet high and made of good masonry. The outer wall of the lighthouse has been magically treated and reinforced from the many years of exposure to the ethereal plane, and is difficult to break through. All doors are good wooden doors on well-oiled iron hinges. Unless otherwise specified in the room text, all walls, doors, and floors on this level have the following game statistics.

**Magically treated masonry walls (outer walls):** 1 ft. thick; break DC 55; hardness 16; hp 180; Climb DC 15. Moderate enchantment; CL 9th; Craft Wondrous Item; Cost 1,500 gp/10-ft. square.

**Masonry walls (inner walls):** 1 ft. thick; break DC 35; hardness 8; hp 90; Climb DC 15.

**Flagstone floor:** 2 ft. thick; break DC 35; hardness 8; hp 180; Balance DC +0.

**Good wooden door:** 1 1/2" thick; hardness 5; hp 15; break DC 16 (stuck), 18 (locked).

**Room 1 – Tower Entrance:** Once all the characters have entered into this room through the door leading in from the rain, read or paraphrase the following:

*Pleasant warmth begins to chase the storm's chill from your bones. To the left, the lit hearth and plush carpets look inviting. A beautiful wall tapestry adorns the north wall, to the right of a wooden door, depicting a white lighthouse framed in pearls with a thread-of-gold beam of light over a field of black velvet. A pegboard on the right side of the lighthouse's entry door has been bolted to the wall.*

*Two other doors stand in the middle of the northwest and northeast walls.*

This is the only chance the characters have of escaping the haunted lighthouse before it goes into the ethereal plane. Once all characters are 10 feet into the lighthouse, the door snaps shut. Read or paraphrase the following:

*"You who have invaded my lighthouse, be aware that you are my prisoners," comes a booming voice from everywhere at once. "You have been saved from the lightning and rain, but are now mine.*

*"Prepare your souls for eternal torment at my hands!"*

The voice is that of Mickle, the ghost troll who resides in room 12 on the top level of the lighthouse. Using the power of the lighthouse light (see room 13), he has closed the door and transported the lighthouse to the ethereal plane. No attacks will come to the players in this room, and the only object of value is the wall tapestry (worth 350 gp, weight 35 lbs.), which was given to the first lighthouse keeper by a grateful wizard from a northwestern coastal province (Appraise or Knowledge (local) check (DC 14) to recognize the tapestry's origins).

The door in the north wall leads to the central staircase that connects all four floors of the lighthouse. The northwest door leads to the dining room, and the northeast door leads to the sitting room.

While the main entrance door is open, it has standard door stats for this level. When the door shuts, use the following stats. If the door is broken, the characters will be able to enter the ethereal plane.

**Magically treated iron door:** 2" thick; hardness 20; hp 180; break DC 48 (stuck), 48 (locked).

## Room 2 – Sitting Room (EL 4):

*This once comfortable room appears to have fallen into disrepair. Fine chairs and small stands have decayed over the years into piles of stuffing and rotting wood.*

*It is very cold in here, and it appears the shadows on the walls are mocking you.*

This sitting room was once used to greet guests. When people stopped coming to the lighthouse, Mickle let this room fall into ruin. A Search check (DC 20) reveals an ancient masterwork silver-plated steel longsword with a jet jewel set in the hilt (worth 550 gp, weight 4 lbs.) hidden under a pile of debris against the northeast wall. A bardic knowledge check or Knowledge (nobility and royalty) check (DC 25) reveals that this weapon bears the mark of the noble Bick family.

If the characters spend more than three rounds in this room, the two shadows (arrogant nobles turned victims by the lighthouse) occupying this room will attack. If the characters flee from this room, the shadows will not follow.

Note that because the tower is on the ethereal plane, the shadows are considered corporeal for this encounter (like all “incorporeal” undead in this adventure, with the exception of Montague in room 6c). As a result, they can be harmed by mundane weapons. (To scale the adventure for more powerful characters, change this aspect and keep the combat on the material plane, where the undead remain incorporeal.)

**2 shadows:** CR 3; Medium undead (incorporeal); HD 3d12; hp 12, 22; Init +2; Spd fly 40 ft. (good); AC 13, touch 13, flat-footed 11; Base Atk +1/–; Atk +3 melee (1d6 Str, incorporeal touch); Full Atk +3 melee (1d6 Str, incorporeal touch); Space/Reach 5 ft./5 ft.; SA Create spawn, strength damage; SQ Darkvision 60 ft., incorporeal traits, +2 turn resistance, undead traits; AL CE; SV Fort +1, Ref +3, Will +4; Str –, Dex 14, Con –, Int 6, Wis 12, Cha 13.

*Skills and Feats:* Hide +8, Listen +7, Search +4, Spot +7; Alertness, Dodge.

## Room 3 – Dining Room (EL 4)

*Two ghastly looking humanoids sit quietly around a large table in this shadowy room. They appear to be having dinner.*

The two humanoids were adventurers turned into wights by the lighthouse’s curse. They are currently

dining on the remains of the corporeal bodies of the shadows from room 2. If the characters attempt to pass through this room or interact with the wights, they will leap across the table and attack (a charge maneuver). If the characters flee from this room, the wights will give chase to any room except rooms 2, 12, and 13.

There are humanoid remnants on the table that have deep tooth marks in them. The cutlery and dinnerware is of less than poor quality, except for a brass mug that has jade inlays (worth 350 gp, weight 2 lbs.).

**2 wights:** CR 3; Medium undead; HD 4d12; hp 27, 38; Init +1; Spd 30 ft.; AC 15, touch 11, flat-footed 14; Base Atk +2/+3; Atk +3 melee (1d4+1 plus energy drain, slam); Full Atk +3 melee (1d4+1 plus energy drain, slam); Space/Reach 5 ft./5 ft.; SA Create spawn, energy drain; SQ Darkvision 60 ft., undead traits; AL LE; SV Fort +1, Ref +2, Will +5; Str 12, Dex 12, Con –, Int 11, Wis 13, Cha 15.

*Skills and Feats:* Hide +8, Listen +7, Move Silently +16, Spot +7; Alertness, Blind-Fight.

## Room 4a – Kitchen

*This appears to be a kitchen that has been unused for some time. Cobwebs hang from corroded copper kettles and tin cooking utensils. A barrel of dried flour has been knocked over and covers the floor. A rack of spices and oils hangs above the unlit, rusted iron stove.*

If a player states they wish to search the room, a trap door can be found under the spilled flour on the floor (Search check, DC 15). A more successful Search check (DC 22) is required to find the one useful item in the room, a vial of *oil of magic weapon* that can be found on the spice rack.

**Room 4b – Larder (EL 4):** Beneath the kitchen is the larder, but the trap door leading to it is stuck and swollen with age. Use the following statistics for the trapdoor.

**Stuck Trapdoor:** 1 1/2” thick; hardness 5; hp 15; break DC 16.

Once the trapdoor has been bypassed, the characters see a ladder leading 10 feet down into the darkness of the larder. If characters descend into the larder, read or paraphrase the following.

*The musk of death and decay hangs in the air of this 15-foot by 30-foot room. Numerous crates can be seen here, but most are broken*



and ready to fall to pieces. Other than the trapdoor, it appears that the only other exit from this room is a door in the western portion of the south wall.

A small skeletal foot sticks out from under a pile of these toppled crates in the northwest corner of the room.

If the characters come within 15 feet of the skeleton, the ghost of Loeb, a female halfling rogue, appears by the ladder and speaks.

*"Oh no! He got you too," wails a translucent female halfling. "Blast that bloody troll to the hells that spawned him!"*

*She looks at you curiously, twirling her ghostly hair around her finger. "Do not be afraid. I am, or was, the mighty rogue Loeb 'Lightfingers' Mooran. And I too am a victim of this cursed lighthouse."*

If the characters attack Loeb, she will vanish through the wall and return when the characters have left.

Loeb is a helpful ghost. If the characters promise not to harm her or her body, she will tell them how to defeat Mickle and undo the curse of the tower, which will bring her back to life. If the characters are willing to stay and listen, read or paraphrase the following.

*"It was about nine years ago, when myself, Montague, Douglas, and Halgrid came upon the lighthouse during a terrible storm. We sought refuge within its inviting warmth, and were met by a ghostly power barring the door behind us when we entered.*

*"Montague was the smart one of us, and he knew immediately that we were in trouble. He also told us that this Mickle held a book of arcane power that Montague desperately wanted. You see, Montague is what we call a 'cook caster,' since he uses food in his spells instead of their normal components.*

*"Montague and his hirelings, Douglas and Halgrid, foolishly went off on their own to find the book in the upper floors, while I searched the first floor for a way out."*

*Loeb appears to turn an even paler shade of white as she swallows hard and continues.*

*"I went to investigate, and found that Douglas and Halgrid had been attacked by Mickle. They told me that Mickle had been turned into a troll during life, and the lighthouse wouldn't let him*



*leave, even in death. So Mickle had become a troll's ghost. They also told me that Montague had found the book he was looking for, but was also killed by Mickle. Then they died."*

*She points to a small scrap of old paper lying on the floor near her desiccated body.*

*"Montague had enough time to scribble that note on a scrap of paper. It said, 'the light is the key to the curse.'*

*"If you can defeat Mickle and break the curse, I believe all those that have been turned into ghosts, like me, will be able to come back to life. But, to break the curse, you must first break the lighthouse light. Will you do this for me?"*

If the characters agree to help her, and haven't been aggressive towards her, Loeb will lead an obvious-looking spellcaster (preferably an arcane type) to a *circlet of blasting (minor)* with the hopes that this item could aid them in defeating Mickle. However, if they do succeed and she does come back to life, she wants the *circlet* back.

If the characters have already defeated Loeb in battle, a Search check (DC 30) will reveal the location of the *circlet*.

Loeb also knows that Mickle has a treasure chest in the next room (room 4c). But she does not know about the collapsing wall, or about the contents of the chest (she is too frightened of Mickle to go near the chest, thinking it magically trapped).

Loeb is tethered to this room by her body, which died when Mickle pushed a stack of crates on her while she was attempting to hide from him. Characters should be rewarded only half the usual experience points if they defeat her in combat, but full experience points (for her CR) if they help her.

**Loeb, female halfling (ghost) Rog2:** CR 4; Small undead (incorporeal); HD 2d12; hp 10; Init +4; Spd fly 30 ft. (perfect); AC 18, touch 18, flat-footed 11; Base Atk +1/+0; Atk +1 melee (1d2-1 subdual, unarmed); Full Atk +1 melee (1d2-1 subdual, unarmed); Space/Reach 5 ft./5 ft.; SA Sneak attack (+1d6), frightening moan, manifestation; SQ Evasion, trapfinding, rejuvenation, +4 turn resistance, incorporeal traits, undead traits; AL NG; SV Fort +1, Ref +8, Will +4; Str 9, Dex 19, Con –, Int 12, Wis 16, Cha 17.

*Skills and Feats:* Disable Device +6, Hide +21, Listen +18, Move Silently +11, Open Lock +9, Search +14, Sense Motive +8, Sleight of Hand +9, Spot +16; Combat Reflexes.

**Room 4c – Cold Storage (EL 6):** Before the characters can enter this room, they must first bypass the trapped wall. Any character touching the door will cause the trap to go off and fall on all those in a 10-ft.-by-10-ft. area.

Once the wall has been dealt with, read or paraphrase the following.

*This 15-foot by 15-foot room appears to have only one outstanding feature: a large wooden chest against the middle of the south wall.*

The chest is not locked or trapped, but it does contain Mickle's earthly possessions: a +2 *bastard sword*, a suit of +1 *full plate armor*, and 500 gp. These items were hidden away in this cold storage room before the noble's son's death was avenged.

**Built-to-Collapse Wall Trap:** CR 6; mechanical; proximity trigger, no reset; Atk +20 melee (8d6, stone blocks); multiple targets (all targets in a 10-ft.-by-10-ft. area); Search DC 14; Disable Device 16.

## The Haunted Lighthouse, Level 2

All rooms are 10 feet high and the interior walls are made from wood. All doors on this level are good wooden doors on well-oiled iron hinges. Unless otherwise specified in the room text, all walls, doors, and floors on this level have the following game statistics.

**Magically treated masonry walls (outer walls):** 1 ft. thick; break DC 55; hardness 16; hp 180; Climb DC 15. Moderate enchantment; CL 9th; Craft Wondrous Item; Cost 1,500 gp/10-ft. square.

**Wood walls (inner walls):** 6 in. thick; break DC 20; hardness 5; hp 60; Climb DC 21.

**Uneven wood floor:** 1 ft. thick; break DC 20; hardness 5; hp 60, Balance DC 10.

**Good wooden door:** 1 1/2" thick; hardness 5; hp 15; break DC 16 (stuck), 18 (locked).

**Room 5 – Keeper's Office (EL 5):** This common room has entrances in the middle of the northwest and southwest walls. Once the characters make their way off the stairwell read or paraphrase the following.

*This room appears to have served as an office of some sort. A desk against the far wall has papers strewn about indicating the presence of*

*a significant struggle. In the middle of both the northwest and southwest walls are closed wooden doors. Several crates of supplies have been smashed and their contents tossed about the wooden floors of the room. One stack of crates in the southeast corner is still intact. Peering around the room you catch a glimpse of something moving in the shadows. As the darkness begins to float towards you, its fiery red eyes become visible and its arms reach out to attack!*

This room was the space that the keeper used as his office. A wraith has made this his home and is initially floating around the room. When he hears the party ascending the stairs he hides behind the crates and attacks the players as soon as they enter.

A search of the room (Search, DC 20) will reveal a series of notes that Mickle wrote about his captivity. These writings start out sensible but they steadily degenerate until they are nothing more than depraved and senseless ramblings. The crates in the corner contain 2,500 gp.

**Wraith:** CR 5; Medium undead (incorporeal); HD 5d12; hp 39; Init +7; Spd fly 60 ft. (good); AC 15, touch 15, flat-footed 12; Base Atk +2/–; Atk +5

melee (1d4 plus 1d6 Constitution drain, incorporeal touch); Full Atk +5 melee (1d4 plus 1d6 Constitution drain, incorporeal touch); Space/Reach 5 ft./5 ft.; SA Constitution drain, create spawn; SQ Darkvision 60 ft., daylight powerlessness, incorporeal traits, +2 turn resistance, undead traits, unnatural aura; AL LE; SV Fort +1, Ref +4, Will +6; Str –, Dex 16, Con –, Int 14, Wis 14, Cha 15.

**Skills and Feats:** Diplomacy +6, Hide +11, Intimidate +10, Listen +12, Search +10, Sense Motive +8, Spot +12, Survival +2 (+4 following tracks); Alertness, Blind-Fight, Combat Reflexes, Improved Initiative.

**Room 6a – Common Room:** This common room has a door in the northeast wall. When the players enter the room, read or paraphrase the following:

*This corner room contains smashed crates and some remains of long-rotted foodstuffs. It appears to have been used as a storage area for dry goods and smoked meats. The rotten contents of the smashed crates remain as colorful stains on the wooden floor.*

There is nothing of value in the room.

**Room 6b – Common Room (EL 4):** This common room has a door in the northeast wall. When the players enter the room, read or paraphrase the following:

*This room contains piles of rubbish and smashed furniture scattered around the floor. The damage in the room appears to have been caused during a battle. Two ghostly humans with bloodshot eyes both appear to be dragging a heavy sack towards the southeast door. They immediately take notice and assume an attack posture. The warriors stand side by side, wearing chainmail armor and holding longswords in their hands.*

The troll killed these warriors when they were caught trying to drag a sack of valuables out of the lighthouse. The sack they were dragging when the players entered the room is their tether to this plane. If the players eventually remove the sack, the spirits will be freed from this room, but not from the witch's curse that binds them to the lighthouse.

**Tactics:** That said, the ghosts will do whatever it takes to protect their sack of goods. Their loot is their life, and they will not relinquish it. They attack until they are dispersed using their special abilities.

A search of the rubbish piles finds the shattered

skeletons of the two warriors. They are wearing ruined scraps of chainmail and grasping masterwork longswords in their long-dead hands. The sack they were trying to drag contains 1,000 gp, 4 gems (10 gp azurite, 10 gp rhodochrosite, 50 gp onyx, and 100 gp jade), and a pink pearl necklace (3,500 gp).

**Douglas, male human (ghost) War1:** CR 3; Medium undead (incorporeal); HD 1d12; hp 6; Init +3; Spd fly 30 ft. (perfect); AC 15, touch 15, flat-footed 10; Base Atk +1/+3; Atk +6 melee (1d8+2, masterwork longsword); Full Atk +4 melee (1d8+2, masterwork longsword); Space/Reach 5 ft./5 ft.; SA Corrupting gaze (Fort, DC 13), manifestation; SQ Rejuvenation, +4 turn resistance, incorporeal traits, undead traits; AL CE; SV Fort +2, Ref +3, Will +2; Str 14, Dex 17, Con –, Int 12, Wis 12, Cha 14.

**Skills and Feats:** Intimidate +6, Jump +6, Listen +10, Sense Motive +3, Spot +10; Weapon Finesse (longsword), Weapon Focus (longsword).

**Halgrid, male human (ghost) War1:** CR 3; Medium undead (incorporeal); HD 1d12; hp 8; Init +2; Spd fly 30 ft. (perfect); AC 13, touch 13, flat-footed 10; Base Atk +1/+5; Atk +6 melee (1d8+4, masterwork longsword); Full Atk +6 melee (1d8+4, masterwork longsword); Space/Reach 5 ft./5 ft.; SA Draining touch, manifestation; SQ Rejuvenation, +4 turn resistance, incorporeal traits, undead traits; AL CE; SV Fort +2, Ref +2, Will +3; Str 18, Dex 15, Con –, Int 13, Wis 8, Cha 12.

**Skills and Feats:** Bluff +4, Climb +8, Ride +6, Swim +8; Iron Will, Power Attack.

**Room 6c – Library (EL 4):** This room has no other exits or entrances. When the players enter, read or paraphrase the following:

*This room has rows of bookshelves along the outside wall. Several reading chairs line the northwest wall. On the wall above the reading chairs is a painting of a sumptuous feast. In the center of the room is a pedestal with a large book that is opened and being reached for by a transparent man. He appears to be human and dressed quite uncomfortably in badly fitted leather armor. He stands in place next to the pedestal and continually reaches out to grasp at the book but his incorporeal hands pass through it each time. He doesn't appear to notice the presence of others in the room and diligently continues to try to lift the book from the pedestal.*

The ghost in this room is a famous chef from the northwest region named Montague the Cook.

Montague was renowned for his ability to imbue magic into his cooking, creating incredible feasts worthy of kings. Many of his spell components were foods that he used to create his great uniquely flavored meals. He was sent on a quest by his lord to unearth the arcane recipes contained in a magical cookbook known as *Delicacies & Desserts, version 3.5*.

The release of this long-lost book immediately made all other cookbooks obsolete. Because it was so popular, many booksellers sold the book early, and most copies were hoarded and never resold, making the tome difficult to obtain.

Using his magic, Montague discovered that this particular copy of the book had been stolen by Mickle during one of his raids and then brought to the lighthouse. Montague's desire to return the book to his liege was so strong that it proves to be the tether that binds his spirit to this room. He cannot rest until he gets his hands on the book and it is delivered to his lord. Montague's companions were killed in the other room when they were looting the lighthouse and failed to protect him from the troll. He will immediately attack the players to stop them from taking the valuable book.

**Tactics:** Montague will assault anyone who in any way disturbs his attempts to pick up the book. He uses his special abilities in lieu of a specific weapon.

Unlike the other undead in the tower, Montague remains incorporeal even on the ethereal plane. This is a special aspect of the tower's magic that affects only him. It prevents him from ever picking up the book he so desperately wants to get.

A search of the room finds the remains of the cook, who is wearing a ruined set of leather armor and has a +1 *dagger* at his waist. The dusty but beautiful painting of a sumptuous, appetizing feast is worth 1,400 gp, but it measures 3 ft. x 4 ft. and is rather awkward to carry.

The bookshelves contain numerous books on regional history, many of which were torn to shreds by the rampaging troll (but see also Appendix A). Hidden among the books is a divine scroll (Search DC 20; CL 1st, *comprehend languages, detect undead, doom*). On the pedestal is the famous tomb *Delicacies & Desserts, version 3.5*. This book contains numerous recipes for such tasty meals and desserts as *Wine of Resentment* and *Faux Crow*. The book is worth approximately 60 gp this year or 90 gp next year.

**Montague "the Cook," male human (ghost)**  
**Wiz2:** CR 4; Medium undead (incorporeal); HD 2d12; hp 21; Init +1; Spd fly 30 ft. (perfect); AC 14, touch 14, flat-footed 10; Base Atk +0/-2; Atk -2 melee (1d3-2, unarmed); Full Atk -2 melee (1d3-2, unarmed); Space/Reach 5 ft./5 ft.; SA Malevolence, manifestation, telekinesis; SQ Rejuvenation, +4 turn resistance, incorporeal traits, undead traits; AL CE; SV Fort +0, Ref +1, Will +5; Str 7, Dex 13, Con -, Int 16, Wis 14, Cha 17.

**Skills and Feats:** Bluff +5, Concentration +4, Craft (food preparation) +8, Gather Information +5, Move Silently +3, Open Lock +2, Profession +6, Spellcraft +7; Eschew Materials, Run, Scribe Scroll.

**Wizard Spells Known** (caster level 2; save DC 13 + spell level; 4/3): 0th – *acid splash\**, *arcane mark, dancing lights, daze\**, *detect magic, detect poison, disrupt undead, flare, ghost sound, light, mage hand, mending, message, open/close, prestidigitation, ray of frost\**, *read magic, resistance, touch of fatigue\**; 1st – *animate rope, cause fear\**, *charm person, chill touch\**, *detect secret doors, detect undead, enlarge person, erase, expeditious retreat, feather fall, jump, magic weapon, ray of enfeeblement\**, *reduce person*.

Spells marked with \* are currently memorized.

**Room 7a – Maintenance Room:** This corner room has a door in the northeast wall. When the players enter the room, read or paraphrase the following:

*This 15-foot by 15-foot room contains a number of tools that were used to properly maintain various parts of the lighthouse's lantern. Some of the larger tools hang from the wall while others are strewn about the floor. A door on the northeast wall leads out of the room.*

The tools that are not damaged have a sum value of 30 gold pieces. As the players walk across the floor they may detect the sound of creaking boards (Listen, DC 10). This is part of a pit trap that is found in room 9, above them. Some areas of this floor appear to be rotting and are easily avoided without skill checks. Even the seemingly rotten areas of the floor will hold the weight of a number of individuals unless they are crashing into it from above. A thorough search (Search, DC 20) reveals a primitive bone statuette among the tools (worth 55 gp; a dropped artifact of some passing adventurer). There is nothing else of value in the room.

**Room 7b – Common Room:** This common room has an exit on the northeast wall that leads out. When the players enter the room, read or paraphrase the following:



*This room is completely empty save for a layer of dirt and dust on the floor.*

There is nothing of value in the room.

**Room 7c – Workshop (EL 6):** This room was formerly used as a workshop to handle general carpentry repairs to the lighthouse. When the players enter the room, read or paraphrase the following:

*This room appears to have been a workshop to handle repairs on the lighthouse. In the southern corner there are piles of planks that were used to repair various wooden parts of the lighthouse. The northwest wall is lined with workbenches and tools for completing carpentry work. On the northeast side of the room appears to be a standing corpse of some sort. Suddenly, to the surprise of all, the corpse charges to attack!*

A wight and a wraith currently occupy this room and will attack all who enter. A search of the room reveals several 2 sets of quality woodworking tools, each with a value of 15 gp. Additionally, a +2 *light hammer* can be found hidden among the tools. Its superior quality and craftsmanship is obvious in any search (Search, DC 15).

**Tactics:** The wight will attack instantly, and the wraith, who is hiding in the shadows of the north-

west corner, will attack with his special abilities when he feels it is to his best advantage. They are not working together in any planned way, but will both delight at destroying the party.

**Wight:** CR 3; Medium undead; HD 4d12; hp 37; Init +1; Spd 30 ft.; AC 15, touch 11, flat-footed 14; Base Atk +2/+3; Atk +3 melee (1d4+1 plus energy drain, slam); Full Atk +3 melee (1d4+1 plus energy drain, slam); Space/Reach 5 ft./5 ft.; SA Create spawn, energy drain; SQ Darkvision 60 ft., undead traits; AL LE; SV Fort +1, Ref +2, Will +5; Str 12, Dex 12, Con –, Int 11, Wis 13, Cha 15.

*Skills and Feats:* Hide +8, Listen +7, Move Silently +16, Spot +7; Alertness, Blind-Fight.

**Wraith:** CR 5; Medium undead (incorporeal); HD 5d12; hp 39; Init +7; Spd fly 60 ft. (good); AC 15, touch 15, flat-footed 12; Base Atk +2/–; Atk +5 melee (1d4 plus 1d6 Constitution drain, incorporeal touch); Full Atk +5 melee (1d4 plus 1d6 Constitution drain, incorporeal touch); Space/Reach 5 ft./5 ft.; SA Constitution drain, create spawn; SQ Darkvision 60 ft., daylight powerlessness, incorporeal traits, +2 turn resistance, undead traits, unnatural aura; AL LE; SV Fort +1, Ref +4, Will +6; Str –, Dex 16, Con –, Int 14, Wis 14, Cha 15.

*Skills and Feats:* Diplomacy +6, Hide +11, Intimidate +10, Listen +12, Search +10, Sense Motive +8, Spot +12, Survival +2 (+4 following tracks); Alertness, Blind-Fight, Combat Reflexes, Improved Initiative.

## The Haunted Lighthouse, Level 3

The walls, doors, and floors on this level are the same as those on Level 2, except where noted in room descriptions.

**Room 8 – Common Room (EL 3):** This common room served as a reading area for the keeper of the lighthouse. The door in the southwest wall is closed. When the players enter the room, read or paraphrase the following:

*This room contains several pieces of comfortable looking furniture. A small table sits in the middle of the room with an empty mug atop it. A closed door is the only feature on the southwest wall. The room is dusty and has not been entered in some time.*

This room was once used as one of several storage rooms for the stolen items the troll brought back from his raids. The furniture was tossed in here haphazardly, and was not meant to look as organized as the end result. A shadow lurks in the darkness waiting for a good opportunity to strike out. A close inspection of the northeast wall will reveal a series of hidden murder holes (Search check, DC 18), but there is no danger from them. Beyond the old furniture, there is nothing of value in the room.

**Tactics:** The shadow will wait for the party to sit and rest or leave the room in order to get a sneak attack. He will not retreat once he makes his initial attack, but he lies in wait for the best chance to take the party by surprise.

**Shadow:** CR 3; Medium undead (incorporeal); HD 3d12; hp 23; Init +2; Spd fly 40 ft. (good); AC 13, touch 13, flat-footed 11; Base Atk +1/–; Atk +3 melee (1d6 Str, incorporeal touch); Full Atk +3 melee (1d6 Str, incorporeal touch); Space/Reach 5 ft./5 ft.; SA Create spawn, strength damage; SQ Darkvision 60 ft., incorporeal traits, +2 turn resistance, undead traits; AL CE; SV Fort +1, Ref +3, Will +4; Str –, Dex 14, Con –, Int 6, Wis 12, Cha 13.

**Skills and Feats:** Hide +8, Listen +7, Search +4, Spot +7; Alertness, Dodge.

**Room 9 – Troll's Lair (EL 3):** This common room has a door leading out from the southeast wall. When the players enter the room read or paraphrase the following:

*This room is covered with three large piles of rubbish that may have served as a sleeping*

*area for a large creature. Several piles of gnawed skeletal remains line the western wall of the room. Some of the large piles of rubbish appear to glimmer when observed from a short distance.*

During the troll's living days, this room served as his lair. Each of the three large piles of rubbish contains 300 cp (the source of the glimmer) plus valuables as detailed below. Ask the players which of the three piles they are searching, in order of distance to the door. Piles two and three contain treasure discarded by the troll as valueless: a *candle of truth*, a filthy *bag of holding* (type 4, empty), and a *wand of web* (37 charges; the command word is inscribed on the wand in Elven, which the troll couldn't read). Pile one, closest to the door, sits atop a camouflaged pit trap. Any characters searching through pile one must reckon with the pit trap as described below.

**Camouflaged Pit Trap:** CR 3; mechanical; location trigger; no reset; DC 20 Reflex save avoids; 30 ft. deep (3d6, fall); multiple targets (first target in each of two adjacent squares); Search DC 24; Disable Device DC 18. Note: Characters who fail their save will fall from room 9 into room 7a (on the second floor) where they will crash through the floor and proceed down to room 3 (on the first floor).

**Room 10 – Guard Barracks (EL 5):** This common room has a strong wooden door that is currently locked on the north wall. When the players enter, read or paraphrase the following:

*This large room contains the remnants of what appears to be a sleeping area. The room is mostly ransacked save for a couple of tables against the east walls. Overturned beds and boxes are scattered about, along with the remains of several human skeletons. Standing in front of the door in the north wall is a vile creature with the appearance of a horrid corpse. He spies the party and charges to attack!*

This room was the former guard barracks built to house a group of warriors in the event of attack. The room contains several beds that are tossed and destroyed. The wraith that makes his home in this room will attack the party members when they enter. A basic search of the room (Search DC 10) reveals 800 sp scattered haphazardly around the floor.

**Wraith:** CR 5; Medium undead (incorporeal); HD 5d12; hp 39; Init +7; Spd fly 60 ft. (good); AC 15, touch 15, flat-footed 12; Base Atk +2/-; Atk +5 melee (1d4 plus 1d6 Constitution drain, incorporeal touch); Full Atk +5 melee (1d4 plus 1d6 Constitution drain, incorporeal touch); Space/Reach 5 ft./5 ft.; SA Constitution drain, create spawn; SQ Darkvision 60 ft., daylight powerlessness, incorporeal traits, +2 turn resistance, undead traits, unnatural aura; AL LE; SV Fort +1, Ref +4, Will +6; Str -, Dex 16, Con -, Int 14, Wis 14, Cha 15.

*Skills and Feats:* Diplomacy +6, Hide +11, Intimidate +10, Listen +12, Search +10, Sense Motive +8, Spot +12, Survival +2 (+4 following tracks); Alertness, Blind-Fight, Combat Reflexes, Improved Initiative.

**Room 11 – Guard Post (EL 3):** The door leading into this common room is locked and can be opened with a successful Open Lock check (DC 20). When the players enter the room real aloud or paraphrase the following:

*This room contains various weapon racks and three shelves of jars and pouches. The weapon racks line the eastern wall and contain several bows, crossbows, spears and swords along with a few standard looking helms. A table stands in the northwest corner saddled by two stools. A couple of unlit lanterns are laid on the floor near the entrance. The room appears to be empty.*

This room is in fact not empty. A shadow is lurking in the northwest corner of the room. He knows that the players are on this level as he can see through several murder holes in the northwestern wall. The shadow will attack the party when they search through the room. Unlike the other shadows, it speaks; as the haunted, insane remnant of a once-powerful fighter, this shadow hisses about “protecting my weapons from the thieves.”

The murder holes were originally placed to allow for the better defense of the lighthouse in the event of an attack. Mickle used these holes at one point to assassinate and spy on unwelcome visitors.

The weapon racks contain various types of swords, spears and bows and helms. There are four weapons of extraordinary value (see below). The shelves contain chemicals that were used to create the multicolored signal rockets designed to give advance notice in the event of invasion. These reagents can be identified by a successful Craft (alchemy) check (DC 11). The chemicals are not combined into the proper controlled amounts to make a signal rocket. If fire is applied to the shelves, there is a 25% chance it will ignite everything on the shelves and cause an explosion doing 3d6 damage to all within 10 feet of the shelves (Reflex save DC 20 for half damage). Anyone who tastes the materials in the jars must make a Fortitude save or take damage as below.

A Search of the room (DC 13) reveals four masterwork swords and a +1 *shocking composite longbow* (+3).

**Signaling Chemicals:** Type: ingested; Initial Damage (1 Con); Secondary Damage (1d4-1 Con); Fortitude save avoids. (DC 18).

**Shadow:** CR 3; Medium undead (incorporeal); HD 3d12; hp 12; Init +2; Spd fly 40 ft. (good); AC 13, touch 13, flat-footed 11; Base Atk +1/-; Atk +3 melee (1d6 Str, incorporeal touch); Full Atk +3 melee (1d6 Str, incorporeal touch); Space/Reach 5 ft./5 ft.; SA Create spawn, strength damage; SQ Darkvision 60 ft., incorporeal traits, +2 turn resistance, undead traits; AL CE; SV Fort +1, Ref +3, Will +4; Str -, Dex 14, Con -, Int 6, Wis 12, Cha 13.

*Skills and Feats:* Hide +8, Listen +7, Search +4, Spot +7; Alertness, Dodge.

## The Haunted Lighthouse, Level 4

**Room 12 – Mickle’s Room:** Before entering this room, the characters must first bypass the locked door off the staircase (Open Lock check, DC 18). Roll a Listen check for Mickle (automatically successful if the characters do not attempt to keep quiet). On a success, Mickle opens the door and attacks with his horrific appearance ability, then pulls back through the door to wait for the characters.

Otherwise, the characters breach the door and are attacked by Mickle. If the combat goes badly, he lures them out one of the doors to area 13, where the lighthouse light cooperates with him in the combat.

As soon as the characters catch their breath to observe the room, read or paraphrase the following.

*Standing in the center of this half-circle room is a large chair. Two doorways, one on each stretch of the southern wall, lead outside to an open-air porch. An eerie green light spills in from the open doors.*

**Tactics:** On the first round, Mickle attacks the closest person who is wielding a sword (or any person wielding his +2 *bastard sword* from room 4c) with his troll attacks. (Remember that the characters are on the ethereal plane, so the ghost can attack with his normal complement of physical abilities.) In an effort to protect the gem in area 13, he will attempt to keep all characters away from the doors that lead out to the deck (room 13). However, if things go badly, he will move the battle to room 13 so the lighthouse light can aid him in the fight.

Since he regenerates, Mickle is a very difficult encounter. If the characters flee, he will chase them to any room in the lighthouse.

There is nothing of value in this room. Even the chair appears to be in disrepair, with claw marks and large gouges taken out of its once fine wood.

**Mickle, male troll (ghost):** CR 7; Large undead (incorporeal); HD 6d12; hp 38; Init +2; Spd fly 30 ft. (perfect); AC 18, touch 11, flat-footed 17; Base Atk +4/+14; Atk +9 melee (1d6+6, claw); Full Atk +9 melee (1d6+6, 2 claws), and +4 melee (1d6+3, bite); Space/Reach 10 ft./10 ft.; SA Rend (2d6+9), corrupting touch, horrific appearance (Fort, DC 13), manifestation; SQ Darkvision 90 ft., low-light vision, regeneration 5, scent, rejuvenation, +4 turn resistance, incorporeal traits, undead traits; AL CE; SV Fort +11, Ref +4, Will +5; Str 23, Dex 14, Con –, Int 6, Wis 9, Cha 10.

*Skills and Feats:* Listen +13, Spot +14; Alertness, Iron Will, Track.

**Room 13 – The Deck (EL 4):** This uncovered deck was once used as the lighthouse's observation platform. Once outside, the characters will be able to see the endless expanses of the ethereal plane. They should immediately realize that they no longer see a bog or terrible storm; they're not in Kansas anymore. Read or paraphrase the following.

*In the center of the deck, a large glowing gem appears to hang in the air, three feet above the floor. It glows an eerie green and seems to pulse with life.*

The light was once an enchanted gem that gave off the light by which the lighthouse performed its func-

tion. It is now a semi-intelligent construct, corrupted from its original nature by a combination of the curse, Mickle's rage, and exposure to the ethereal plane. It shares a bizarre symbiotic relationship with Mickle, whereby it lures victims for his depredations, and is in turn rejuvenated by the negative energies released when they die. If anyone comes within 15 feet of the light, it attacks.

**Tactics:** The light will try to use its abilities to either kill the characters or hurl them off the deck into the ethereal plane. Characters touching the light will receive a shock from its *shocking grasp* ability, and characters attempting to fire missile weapons at it will discover that the light has placed a *wind wall* around it (a constant effect).

**Lighthouse Light:** CR 4; Small construct; HD 4d10; hp 40; Init +0; Spd 0 (cannot move); AC 20, touch 20, flat-footed 20; Base Atk +2/–; Atk +9 ranged (2d8, wind slam); Full Atk +9 ranged (2d8, wind slam); Space/Reach 2 1/2 ft./2 1/2 ft.; SA *Gust of wind* (at will), *shocking grasp* (at will, 5d6 electrical damage, only when touched or hit in by a melee attack), persistent *wind wall*; SQ Hardness 12, construct traits; AL CN; SV Fort +1, Ref +3, Will +4; Str –, Dex –, Con –, Int –, Wis 1, Cha 24.

When the lighthouse light is destroyed, a brilliant flash of light engulfs the entire area. Characters may be temporarily blinded by the effect (Reflex save, DC 15, avoids; otherwise, blinded for 1d4 rounds). As the light fades, the curse is broken. The lighthouse has instantly reappeared on the material plane, and the characters are treated to the depressing vista of the storm-ridden bog that started the whole adventure. Characters hurled off into the ethereal plane in the combat with the light may or may not come back, at the GM's discretion; finding a missing party member may be fodder for a subsequent adventure, if you so choose.

All unnamed undead remaining in the lighthouse instantly disintegrate as their souls are released to the planes where they should be at rest. If still alive, the souls of the named NPCs – Loeb, Montague, Douglas, and Halgrid – are freed from their curses and returned to their bodies (which are healed to 1 hp; Loeb has just enough strength left to push aside the crates on her body). Loeb may come to find the characters and request the return of her magic item. Any players who are killed during the course of play will be restored to their previous states and also allowed to leave. From this point on the lighthouse is simply a mundane tower with a destroyed lantern at the top.



# Appendix A: Books in the Library

The lighthouse's library reflects the eclectic tastes of Mickle. Prior to the onset of insanity and his sad descent into madness, he was a well-read individual, though well-read in all the wrong places. Rather than the classics and literary giants, he read the medieval equivalent of Weekly World News. After all, when you're stuck in a lighthouse next to a bog, you want excitement, not enrichment.

As a result, Mickle's library is entertaining, to say the least. Here is a small sample of some of the titles to be found by players who take the time to do a thorough search in room 6c.

**The Best of "Dear Archmage Abby":** One of the most popular advice columnists of the age, Archmage Abby is a 17th level wizard who specializes in divination. She's made a career for herself not for her magical abilities but for the way she combines them with an astute understanding of the human heart. This popular tome, penned in the past decade, features excerpts from the best of her columns. Some of her most memorable work came from the advice she gave adventurers over the years concerning issues common to all: how to deal with mages who hoard magic items, what to do about working with thieves and others of ill repute, and the best ways to prepare dragon meat barbecue.

**The Weekly Plague Report Annual:** The Weekly Plague Report started during the worst years of the bubonic outbreak. Originally it was a weekly circular devoted to morbid facts, depressing figures, and rather excitable travel advisories ("Watershallow knee-deep in bodies! Avoid at all costs!"). But disaster sells, as every journalist knows, and what was supposed to be a do-gooder publication preventing spread of the disease turned into the most well-read magazine of its day. Despite the fact that roughly 2% of the plague-ridden circulation died every month for the first several years of its existence, the publishers capitalized on their staggering circulation to turn the magazine into a general-interest periodical. Such features as "Pockmarked and Proud," the "Survived and Now I'm Single" personals section, and the ever-popular comic strip Bubonic the Barbarian attracted record advertising revenue. Now the Weekly Plague Report is in its thirteenth edition, with an annual best-of collection published every year. The library has every one.

## OPEN GAME LICENSE Version 1.0a

The following text is the property of Wizards of the Coast, Inc. and is Copyright 2000 Wizards of the Coast, Inc ("Wizards"). All Rights Reserved.

1. Definitions: (a) "Contributors" means the copyright and/or trademark owners who have contributed Open Game Content; (b) "Derivative Material" means copyrighted material including derivative works and translations (including into other computer languages), potation, modification, correction, addition, extension, upgrade, improvement, compilation, abridgment or other form in which an existing work may be recast, transformed or adapted; (c) "Distribute" means to reproduce, license, rent, lease, sell, broadcast, publicly display, transmit or otherwise distribute; (d) "Open Game Content" means the game mechanic and includes the methods, procedures, processes and routines to the extent such content does not embody the Product Identity and is an enhancement over the prior art and any additional content clearly identified as Open Game Content by the Contributor, and means any work covered by this License, including translations and derivative works under copyright law, but specifically excludes Product Identity. (e) "Product Identity" means product and product line names, logos and identifying marks including trade dress; artifacts; creatures characters; stories, storylines, plots, thematic elements, dialogue, incidents, language, artwork, symbols, designs, depictions, likenesses, formats, poses, concepts, themes and graphic, photographic and other visual or audio representations; names and descriptions of characters, spells, enchantments, personalities, teams, personas, likenesses and special abilities; places, locations, environments, creatures, equipment, magical or supernatural abilities or effects, logos, symbols, or graphic designs; and any other trademark or registered trademark clearly identified as Product Identity by the owner of the Product Identity, and which specifically excludes the Open Game Content; (f) "Trademark" means the logos, names, mark, sign, motto, designs that are used by a Contributor to identify itself or its products or the associated products contributed to the Open Game License by the Contributor (g) "Use", "Used" or "Using" means to use, Distribute, copy, edit, format, modify, translate and otherwise create Derivative Material of Open Game Content. (h) "You" or "Your" means the licensee in terms of this agreement.

2. The License: This License applies to any Open Game Content that contains a notice indicating that the Open Game Content may only be Used under and in terms of this License. You must affix such a notice to any Open Game Content that you Use. No terms may be added to or subtracted from this License except as described by the License itself. No other terms or conditions may be applied to any Open Game Content distributed using this License.

3. Offer and Acceptance: By Using the Open Game Content You indicate Your acceptance of the terms of this License.

4. Grant and Consideration: In consideration for agreeing to use this License, the Contributors grant You a perpetual, worldwide, royalty-free, non-exclusive license with the exact terms of this License to Use, the Open Game Content.

5. Representation of Authority to Contribute: If You are contributing original material as Open Game Content, You represent that Your Contributions are Your original creation and/or You have sufficient rights to grant the rights conveyed by this License.

6. Notice of License Copyright: You must update the COPYRIGHT NOTICE portion of this License to include the exact text of the COPYRIGHT NOTICE of any Open Game Content You are copying, modifying or distributing, and You must add the title, the copyright date, and the copyright holder's name to the COPYRIGHT NOTICE of any original Open Game Content You Distribute.

7. Use of Product Identity: You agree not to Use any Product Identity, including as an indication as to compatibility, except as expressly licensed in another, independent Agreement with the owner of each element of that Product Identity. You agree not to indicate compatibility or co-adaptability with any Trademark or Registered Trademark in conjunction with a work containing Open Game Content except as expressly licensed in another, independent Agreement with the owner of such Trademark or Registered Trademark. The use of any Product Identity in Open Game Content does not constitute a challenge to the ownership of that Product Identity. The owner of any Product Identity used in Open Game Content shall retain all rights, title and interest in and to that Product Identity.

8. Identification: If you distribute Open Game Content You must clearly indicate which portions of the work that you are distributing are Open Game Content.

9. Updating the License: Wizards or its designated Agents may publish updated versions of this License. You may use any authorized version of this License to copy, modify and distribute any Open Game Content originally distributed under any version of this License.

10. Copy of this License: You MUST include a copy of this License with every copy of the Open Game Content You Distribute.

11. Use of Contributor Credits: You may not market or advertise the Open Game Content using the name of any Contributor unless You have written permission from the Contributor to do so.

12. Inability to Comply: If it is impossible for You to comply with any of the terms of this License with respect to some or all of the Open Game Content due to statute, judicial order, or governmental regulation then You may not Use any Open Game Material so affected.

13. Termination: This License will terminate automatically if You fail to comply with all terms herein and fail to cure such breach within 30 days of becoming aware of the breach. All sublicenses shall survive the termination of this License.

14. Reformation: If any provision of this License is held to be unenforceable, such provision shall be reformed only to the extent necessary to make it enforceable.

## 15 COPYRIGHT NOTICE

Open Game License v 1.0 Copyright 2000, Wizards of the Coast, Inc.

System Rules Document Copyright 2000 Wizards of the Coast, Inc.; Authors Jonathan Tweet, Monte Cook, Skip Williams, based on original material by E. Gary Gygax and Dave Arneson.

Dungeon Crawl Classics #3.5: The Haunted Lighthouse, by Dave Arneson, Copyright 2003 Goodman Games (contact goodmangames@mindspring.com, or see www.goodman-games.com)

*Designation of Product Identity: The following items are hereby designated as Product Identity in accordance with Section 1(e) of the Open Game License, version 1.0: Any and all Dungeon Crawl Classics logos and identifying marks and trade dress; all names of characters, areas, factions, and creatures; and all artwork, stories, storylines, plots, thematic elements, symbols, depictions, and illustrations, except such elements that already appear in the System Reference Document.*

*Designation of Open Content: Subject to the Product Identity designation above, the following portions of Dungeon Crawl Classics #3.5: The Haunted Lighthouse are designated as Open Game Content: the sections Introduction and Game Master's Section on pages 2-3, except for such place names and terminology which relates to declared Product Identity.*

*Some of the portions of this book which are delineated OGC originate from the System Reference Document and are copyright © 1999, 2000 Wizards of the Coast, Inc. The remainder of these OGC portions of these book are hereby added to Open Game Content and, if so used, should bear the COPYRIGHT NOTICE "Dungeon Crawl Classics #3.5: The Haunted Lighthouse, by Dave Arneson, Copyright 2003 Goodman Games (contact goodmangames@mindspring.com, or see www.goodman-games.com)"*

*Dungeon Crawl Classics 3.5: The Haunted Lighthouse is copyright © 2003 Goodman Games. Dungeons & Dragons ® and Wizards of the Coast ® are Registered Trademarks of Wizards of the Coast, and are used with Permission. 'd20 System' and the 'd20 System' logo are Trademarks owned by Wizards of the Coast and are used according to the terms of the d20 System License version 1.0. A copy of this license can be found at www.wizards.com. Open game content may only be used under and in the terms of the Open Game License.*

Requires the use of the Dungeons & Dragons® Player's Handbook, Third Edition, published by Wizards of the Coast®

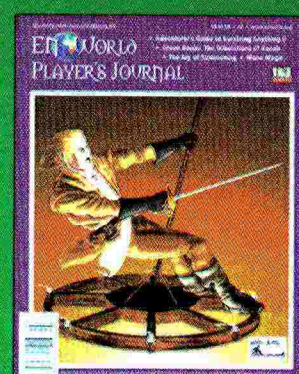
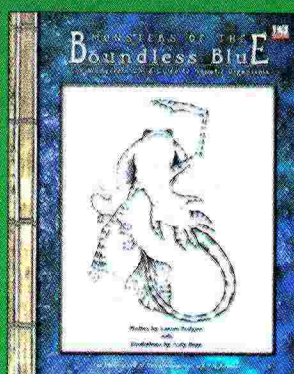
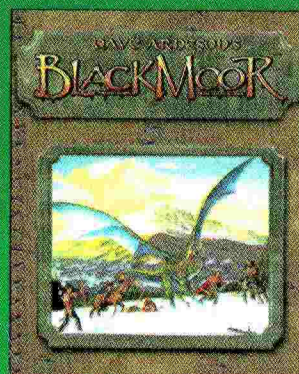
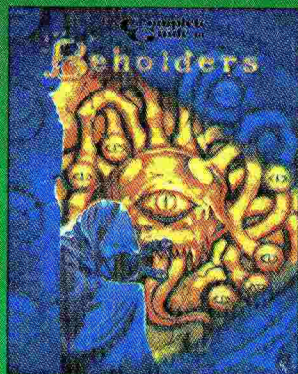

This item is only one of the many popular d20 playing aids published by Goodman Games. Other d20 playing aids currently available or scheduled soon include:

Dave Arneson's Blackmoor

Dungeon Crawl Classics #1: Idylls of the Rat King

Dungeon Crawl Classics #2: Lost Vault of Tsathzar Rho

Dungeon Crawl Classics #3: The Mysterious Tower

EN World Player's Journal

Monsters of the Boundless Blue: Wanderers Guild Guide to Aquatic Organisms

Monsters of the Endless Dark: Wanderers Guild Guide to Subterranean Organisms

Primeval Groves: Wanderers Guild Guide to Mysterious Plant Life

Beyond Monks: the Art of the Fight

Underdark Adventure Guide

Aerial Adventure Guide

Morningstar Campaign Setting

Complete Guide to Beholders

Complete Guide to Liches

Complete Guide to Drow

Complete Guide to Treants

Complete Guide to Wererats

Complete Guide to Doppelgangers

Complete Guide to Velociraptors

Complete Guide to T-Rex

Dinosaurs That Never Were

Dinosaur Planet: Broncosaurus Rex Core Rulebook

Cretasus Adventure Guide



\$10.00 USA

Designed especially for  
Gen Con Indy 2003

[www.goodman-games.com](http://www.goodman-games.com)

Dungeons & Dragons® and Wizards of the Coast® are Registered Trademarks of Wizards of the Coast, and are used with Permission.