

THE AMERICAN ROAD ATLAS

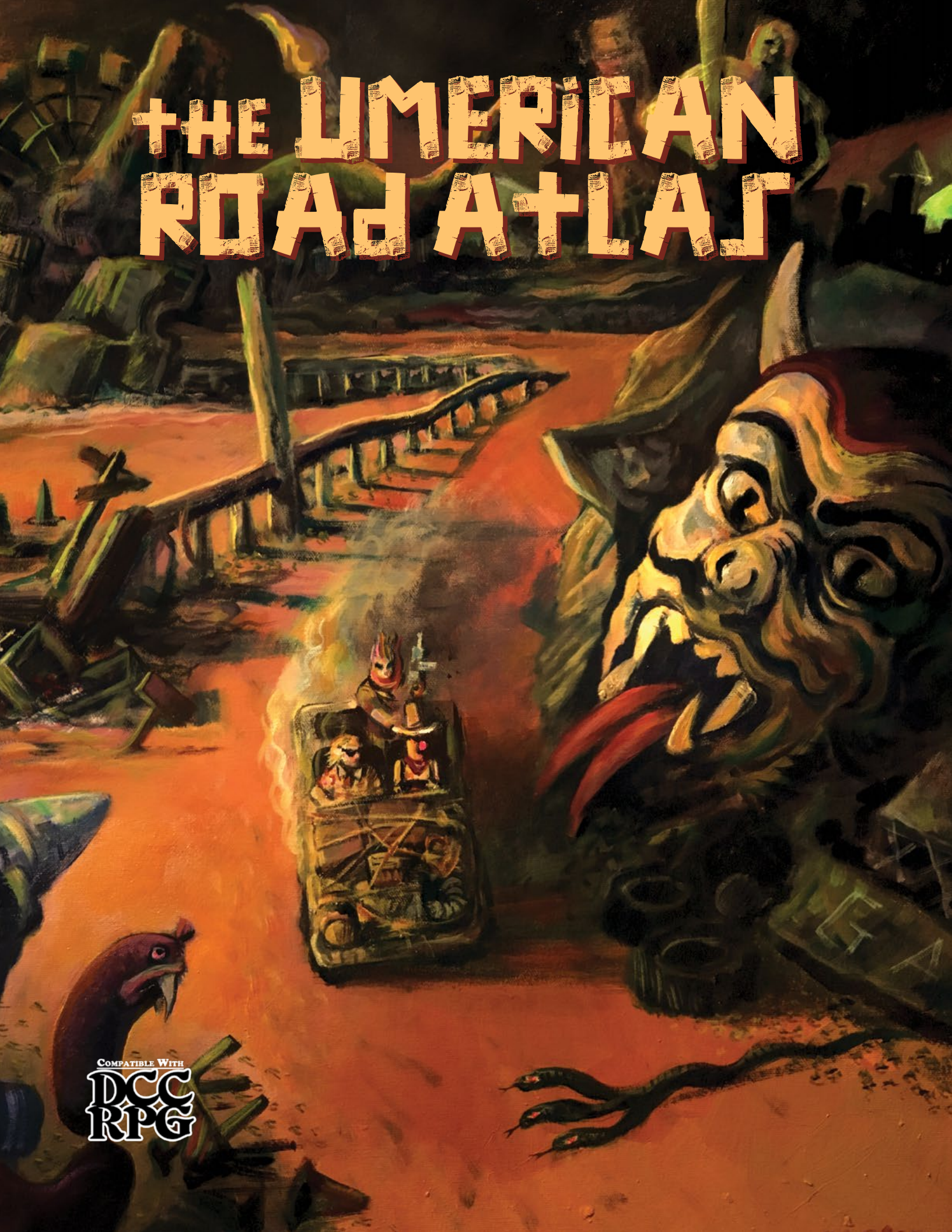

COMPATIBLE WITH
**DCC
RPG**

THE AMERICAN ROAD ATLAS

WRITING

Written by Bob Brinkman & Reid San Filippo

Additional materials written by: Forrest Aguirre, Michael Thompson, & Tim Bruns

ART

Cover: Nate Marcel

Interior: Aaron Robinson, David Coppoletti, Diogo Nogueira,
Karim Gouyette, Matt Hildebrand, Nate Marcel

PROOFREADING

Gilbert Isla

LAYOUT & GRAPHIC DESIGN

Matt Hildebrand

Visit us at <http://crawlingunderabrokenmoon.blogspot.com/>

or

On Facebook: <https://www.facebook.com/ShieldofFaithStudios/>

Copyright © 2020 Shield of Faith Studios, LLC



This product is based on the Dungeon Crawl Classics Role Playing Game, published by Goodman Games LLC. This product is published under license. Dungeon Crawl Classics and DCC RPG are trademarks of Goodman Games LLC. All rights reserved. For additional information, visit www.goodman-games.com or contact info@goodman-games.com

THE LANDS OF UMERICA

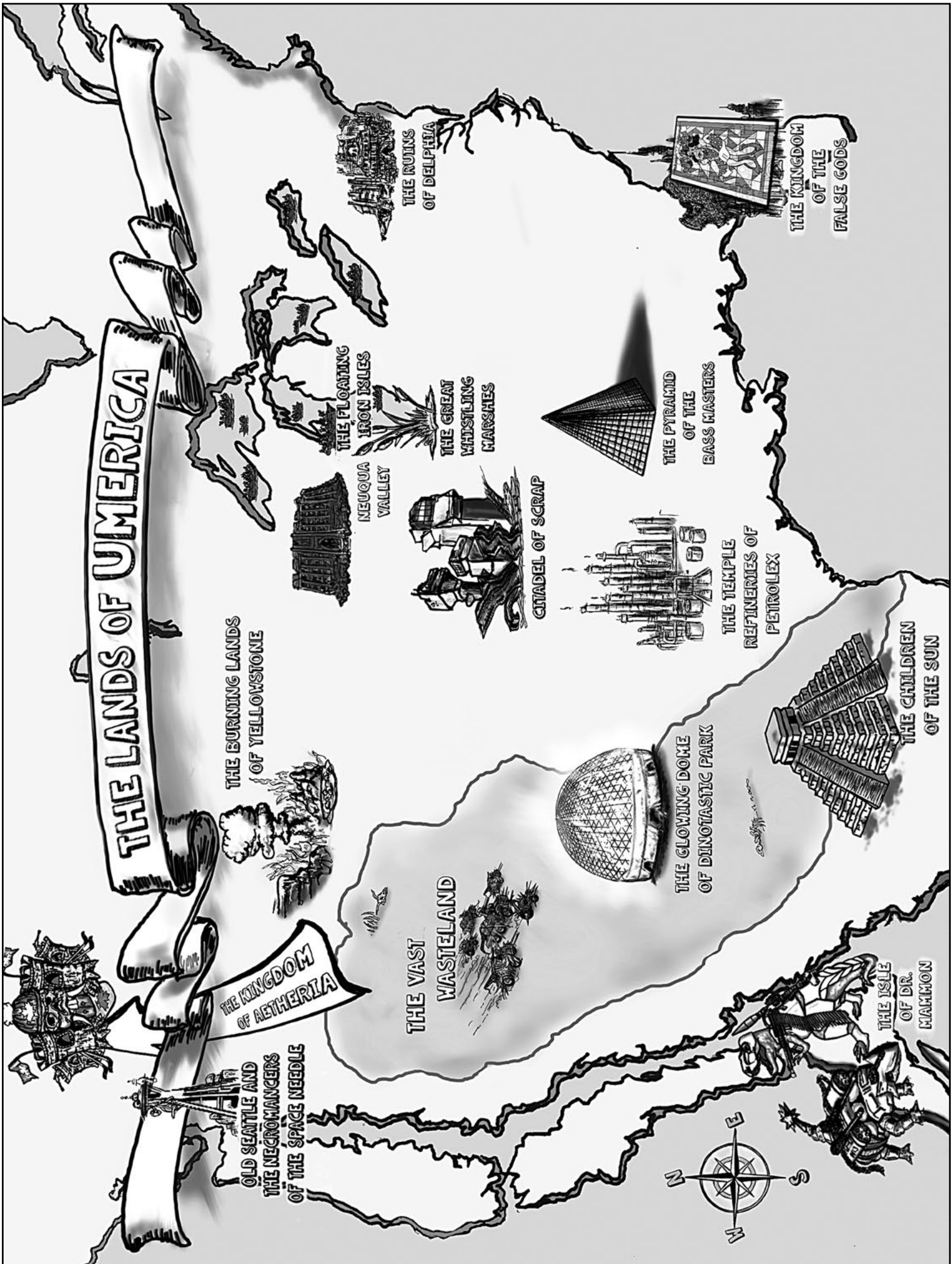

THE KINGDOM OF AETHERIA

OLD SEATTLE AND THE NECROMANCERS OF THE SPACE NEEDLE

THE BURNING LANDS OF YELLOWSTONE

THE VAST WASTELAND

NEUCQUA VALLEY

THE FLOATING IRON ISLES

THE GREAT WHISTLING MARSHES

CITADEL OF SCRAP

THE GLOWING DOME OF DINOTASTIC PARK

THE PYRAMID OF THE BASS MASTERS

THE TEMPLES OF REFINERIES OF PETROLEX

THE ISLE OF DR. MAMMON

THE CHILDREN OF THE SUN

THE RUINS OF DELPHIA

THE KINGDOM OF THE FALSE GODS



THE AMERICAN ROAD ATLAS



TABLE OF CONTENTS

INTERESTING PLACES TO DIE 8

BigRib 'Que & Fuel	8
Doctor Granny's Snake & Sausage Farm	10
Elmos' Worlds	12
Fructose Mines of Iow	15
The Hanging Gardens of Burbankalonia	17
High Temple Nox	19
Junkyard of the Restless Leadsleds	21
Osheana City	24
Snow Down on Ya, Arid Zone "A"	26
The Blessed Singing Sleigh Monastery & Gift Shop	28
The Murmuring Mountain Sages of Dakota	31
The Temple Caverns of the Howling God	33
Tom Stamens – Umerica's Custom Van Dealer	36
Valley of the IceCream Empress	38

ROADSIDE ATTRACTION GENERATOR ... 41

Table I: Roadside Attraction & Hook	43
Table II: Amusement Location	45
Table III: Art Installation	49
Table IV: Hall of Fame	49
Table V: Battlefields	51
Table VI: Memorials	52
Table VII: Museum	54
Table VIII: "Natural" Wonders	55
Table IX: Residential	59

RANDOM ROADTRIP ENCOUNTERS61

Random Roadtrip Encounters Table	63
--	----

WEATHER OF THE WASTELANDS..... 66

Weather Wizardry	68
Weather Conditions	68
Freak Storm Table	70
Outrunning a Storm	72

INFAMOUS GANGS OF THE VAST WASTES & BEYOND73

Regalia	75
Organization	75
Big Dogs (1,000+ members)	76
Komodo Motos	76
Migration Nation	77
Satan's Auditors MC	79
Power Hitters (501-1,000 members)	80
Cenobikes	80
Legions Of The Eye Lord	81
Hissiens	83
Full Brotherhood (251-500 members).....	84
Sons Of Whaaar! MC	84
The Brood	85
Minor Players (51-250 members).....	86
Robo-rollers	86
Untouchable Horde	88
Trailer Park Trash MC	88
Corpse Crew MC	90
Local Yokels (10-50 members)	91
Citadel Scrappers	91
Rad Rats	92
Restless Dead	93
Neighborhood Nuisance (4-10 members).....	94

THE RANDOM GANG GENERATOR 95

Territory	97
Membership Roster	98
Distinctive Regalia	100
Motivations	104

NOTABLE WASTELAND WANDERERS.....107

Carradine	109
James Blacksun	110
Max	110
Taylor	112
The Man & His Best Friend	113

NEW CLASSES 115

Holy Roller117
Hunter.....119
Road Hawg..... 122

AUTOCIDE AND GUNPLAY127

Ace Automotive Annihilation (Aaa) 129
Cockpit Wrestling 130
Cycle Dueling131
Freakin' Laser Beams 132
Scavengra 132
Shotgunnery..... 133
Wall of Lead..... 134

MACHINE SHOP135

New Vehicle Quality Level..... 137
New General Vehicle Traits 137
New Vehicle Types 140
 Construction Vehicles..... 140
 Armored Military Vehicles..... 143
 Aircraft 145

NEW DEITY 148

Demon King of Speed 150

RACE FOR DEATH 154

Introduction..... 155
Background 155
The Race 156
The Teams..... 159
Leg One: The Gomez Express 163
Leg Two: Cross Country Dash 167
Leg Three: One if by Air, Two if by Sea..... 171
The Finish Line 172

LIST OF TABLES173

OGL.....175

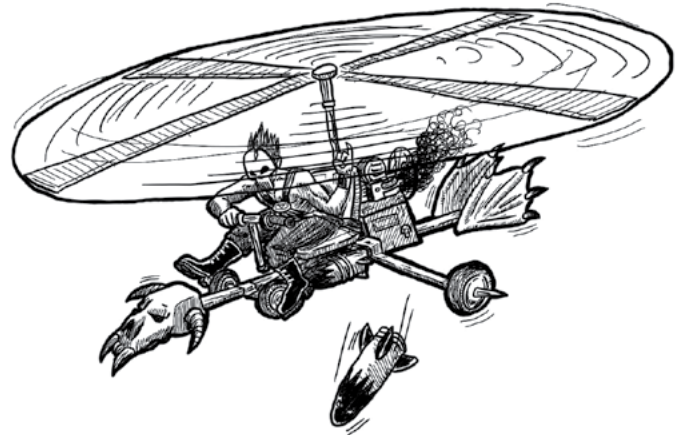



INTERESTING
PLACES
TO DIE



SHOOT THE MOON

CRATER SURFING

FUN FUN FUN

DESERT BEER

MOON

INTERESTING PLACES TO DIE

BIGRIB 'QUE & FUEL

Near the northeastern border of the Vast Wasteland is a crossroads where three ancient highways meet. Since two of them are still in usable shape, traders, travellers, and gangers still make use of them. Next to the crater that destroyed the third highway is a large refurbished truck stop known as the “BigRib ‘Que & Fuel.” The place looks to be in good repair and has several neon signs declaring the name of the place and that it is a “No Fighting Zone.” The pillars for these signs are heavily graffitied with various gang symbols indicating that each gang has chosen to honor the peace treaty around the place. This is mostly due to several facts: everybody likes the place, the owner—Mr. Big—is a charming fellow, and that there are several automated gun turrets around the property that enforce the peace.

Every now and then a group of miscreants will show up and try to cause trouble. Most of the time they seem to be ready to rumble but chicken out once they actually enter the property. Those that do stay focused on violence are dealt with quickly by the gun turrets.

The Truck Stop

At the BigRib ‘Que & Fuel patrons will find cheap fuel, a well-stocked mechanics garage with several bays that can be rented by the hour for making repairs to your ride, and an open-air diner that serves up fresh-cooked BBQ ribs of unusual size (twice as big as beef ribs) with a side of cold beer. In addition, one can purchase clean water and even common automotive parts, including new tires. The odd thing is that no one remembers ever seeing any deliveries being made to the place—it just always has what it needs, when you need it.

Everything is run by Mr. Big, a beefy human with three arms, and his three robotic assistants, so service can be slow when big groups show up. As this place is a melting pot of merchants and marauders, Mr. Big is often in the know about local news and odd jobs. He has even been known to occasionally act as a moderator in deals between gangs not usually on speaking terms. It is known that most gangs around the area are fond of the BigRib and do not take kindly to those who might threaten it.



The Crater

The fact that the BigRib is located next to the old crater is no coincidence. The crater was created when a large spaceship crashed down during the time of the Great Cataclysm. Over a decade ago, Mr. Big was exploring the crater, hoping to find something valuable to sell, when he stumbled upon an exposed hatch of the ship. After much exploration he found some of the ship's systems still functioning, namely its matter replicators and a few robots. Using these, he manufactured everything needed to rebuild and restock the nearby truck-stop ruins. He even figured out how to make robotic gun towers to keep it safe and an empathic broadcast system to lower the aggression levels of anyone on the property, Willpower save (DC 15) vs. passivity.

The robots are not sentient and have been programmed to not speak about the ship or where all of the goods come from. While the passage that Mr. Big uses to enter the ship is very well hidden (DC 25 to spot after a day's search of the property), someone investigating the crater itself may be able to find another way to enter the ship that has not yet been discovered.

INTERESTING PLACES TO DIE

The Ribs

While the replicators have been able to keep up with Mr. Big's various requests, they cannot create edible, organic matter. As Mr. Big continued to explore the ship in hopes of finding a different set of replicators designed for food creation, he discovered the ruins of a control room. Within was the only survivor of the crash, a giant alien mostly trapped under tons of debris. Despite its crushing confinement, it was still quite alive. Mr. Big did try to communicate with the alien but after failing he decided to simply put it out of its misery, not wanting to give up the ship anyways. That is when he found out it could not die and that it rapidly regenerated from any injury. An infinite source of meat that would never run out. Now the BigRib had everything it needed.

The Ship

The crash destroyed a large portion of the spaceship but, due to its original size, there is still a great deal left of it, most of which has not been found by Mr. Big. Below is a list of areas/things that could possibly be found in the ship as the party explores it. This is by no means an exhaustive list and exploring the ship-ruins could easily span an entire campaign, if desired.

It is possible to encounter Mr. Big in areas he has discovered, as he no longer has time to devote to exploring more of the ship. Every 30 minutes spent in one of these areas has a 25% of Mr. Big appearing:

Mr. Big (Mutant): Init +0; Atk raygun +6 missile (2d4+2, range 100/200/300) or vibroknife +6 melee (2d3, ignores non-impervious armor); AC 12; HD 4d8+9; HP 29; Armor Die [1d4](forcefield); MV 30'; Act 2d20; SP regenerates 1hp per round, robot lackeys; SV Fort +5, Ref +2, Will +2; AL N.

The three robots under Mr. Big's control have no combat abilities but will attempt to block any ranged attack made against him. They must make a 1d20+4 roll against the ranged attacker's roll. If successful, they take the damage instead. Each robot has 20hp and an Armor Die [1d4].

Exploring The Ship

- **Passageways** (discovered) - Each searchable area is connected by one or more hallways that are large enough to allow a giant to move around comfortably. There is a 30% chance that each new passage discovered will contain a wall panel

roughly 10' off the ground. Roll 1d6 to determine what is behind the panel: 1 - a hidden cache of 2d4 very large alien snack bars (20% chance of being poisonous), 2 - several pounds of trash waiting to be recycled, 3 - a space suit made to fit an alien giant, 4 - a hull patching kit, 5 - an alien med-kit, 6 - an inactive human sized robot (DC 15 to activate).

- **The Primary Replicators** (discovered) - This area sees a lot of use as Mr. Big and his robots make several trips a day to create new stock. While the controls themselves are difficult to understand (Intelligence check DC 18) without the assistance of the robots, Mr. Big has left several detailed notes on how to use it. Making anything that the BigRib has in stock requires no roll. Attempting to make something else will require the full Intelligence check.
- **The Control Room** (discovered) - The remains of a large room that has mostly collapsed. Some view screens are still active and carry a multitude of warnings about failed systems in an alien language. Trapped under a mountain of rubble is a living alien that seems to have been partially butchered recently. Its wounds are healing at a visible rate. It will attempt to communicate once it realizes that Mr. Big is not with them. An Intelligence check (DC 17) is required to establish communication. Those trying to communicate gain a +2 per serving of BigRibs they have eaten in the past 24 hours. If communication is established, the being will convey it wishes to die. If the party promises to assist it in doing so, it will offer useful, if esoteric, advice on how to use the ship's systems. This will give the party a pool of 20 points of temporary Luck usable on any roll regarding the ship and its functions.

To help the creature, the party must unearth its midsection and disable its regeneration device. This will require 1d4+4 successful Strength checks (DC 10), each attempt taking 30 minutes. Once complete, the alien's body will be reduced to dust. This will make the rubble pile unstable and cause the room to finish collapsing. Everyone still in the room will need to make a Reflex save (DC 10) or be killed in the collapse.
- **Storage Area** - An area designed to hold cargo of some sort. Roll 1d100 to determine its contents:

INTERESTING PLACES TO DIE

Roll	Result
1-40	Empty
41-80	2d20 containers, each 10'x10'x10' in size. All seem to be made of an unidentifiable metal and are thoroughly sealed. To open a container an Intelligence check (DC 16) must be made or a plasma torch, or better, must be used to cut them open. Roll 1d5 to determine the contents of each opened container: 1 - filled with human foodstuffs from the 1980s era in perfect condition, 2 - a cow in suspended animation, 3 - 3d100 BeanBag Babies w/ tags, 4 - 3d4x100 bottles of extra strength hair gel, 5 - 2d3x5 kegs of top shelf beer that are ice cold.
81+	A subterranean creature has entered the area via a crack in the hull and made this place its nest. Roll for initiative.

- **Sleeping Quarters** - This area is filled with bunk beds built into the walls and communal bathing areas, all designed for giants with inhuman physiques. It has a prevalent odor of old cheese and lavender. The bed sheets and clothes are made of highly resistant fabrics that are not cuttable by conventional means.
- **Armory** - This area is full of locked racks holding various alien pistols and blasters, all many sizes too big to be used by normal-sized folk. Each rack has a separate lock, DC 16 to open.
- **Power Plant** - The room has a large glowing sphere floating in the center that is feeding arcs of energy into hundreds of pilons embedded in the walls. Trying to move through the room requires a Reflex save (DC 14) to avoid being struck by an arc (4d10 damage). Any type of batteries left inside the doorway of this area will be fully recharged in a matter of minutes.
- **Mess Hall** - This area is full of tables and chairs all designed for giants with inhuman physiques. Along one wall is a bank of replicators dedicated to food production. The controls are difficult to understand, Intelligence check (DC 18), and failed checks will lead to random foodstuffs being created. All food created by these machines has

a 15% chance of being poisonous to humans due to alien ingredients.

Adventure Hooks

- After a particularly difficult fight, the party needs a good meal and some spare parts to fix up their ride. One of them spots a new sign by an old highway about a neutral rest stop just a few miles down the road ...
- Early in the afternoon, the merchant caravan the party is guarding pulls up to the BigRib to stop for the night. One of the caravan's scavengers remarks that the huge crater over yonder might be a good place to scrounge ...
- The party found some sort of high-tech detector device and has been following its directions hoping for a big score. As they pull over a ridge, they see the BigRib and hear their bellies growl. The detector is also going crazy but is pointing a bit beyond the rest stop towards some sort of crater ...

DOCTOR GRANNY'S SNAKE & SAUSAGE FARM

This is a rest-stop attraction run by a creepy old woman who boasts that she is a real doctor. Visitors to the attraction will find an amazing array of living snake exhibits, a delicious selection of homemade sausages, a wide variety of curative elixirs, and a secretive serpent-god cult looking to recruit new members—by force.

The Snake & Sausage Farm

Located on a sprawling off-road compound, Doctor Granny's Snake & Sausage Farm offers something for everyone, including meeting needs that many folks didn't even know that they might have. Those interested in taking a tour of the grounds will find that tours are free and are led by one of Granny's many kinfolk, who tend to much of the day-to-day upkeep at the farm. The tour includes hundreds of different types of snakes ranging from the mundane run of the mill snakes, such as garter snakes, to exotic and unique creatures such as the mysterious Q, the winged serpent.

In actuality, Q is simply a garter snake with chicken feathers glued to its scales. How visitors react to Q is an important litmus test as to how the kinfolds respond to them. Those who are repulsed or obviously frightened

INTERESTING PLACES TO DIE



receive the “normal” tour—which ends in the “Smoke House” where they will be murdered and made into sausage. Those who show interest receive a decently informative tour and will leave with a pamphlet or two about the farm and about Sssslami. Those who seem genuinely excited are actively recruited by the cult and are given the “full” tour, including the hidden temple of Sssslami.

Granny’s Gift Shop

The central point of Granny’s is a simple wooden shack hosting both the gift shop and the “Surgkal Center.” In the gift shop one may pick up a bewildering array of smoked meats and sausages (including Granny’s world famous serpentine soppressata). There is a near-endless supply of smoked meats brought over from the smokehouse to delight the taste buds of hungry travelers. The rest of the upper level is filled with jars of “genuine pre-disaster delights” including fizzy drinks, crunchy candies, and Granny’s special recipe fudge.

Granny’s Surgkal Center

The shack boasts a subterranean level for Granny’s patients. Those visiting are offered a number of services such as the trimming down of overly large tongues, regrowth of hair and teeth, and a number of various tonics guaranteed to cure whatever ailment may be suffered by the patient. Granny will take virtually anything in barter for a random bottle from her shelves, but she is partial to fresh hen’s eggs.

Smoke House

Officially the “Jim Oliver Memorial Smokehouse,” it is here that Granny’s protégé—Smokin’ Man Mike—cures all the meat with a proprietary blend of woods, spices, and . . . exotic meats. The main area of the smoke house holds a number of large smokers, many large enough to smoke large beasts in. A second room holds the grinders and spice blends for Granny’s famous sausages, and many hard sausages hang here to age.

Behind a locked door is the room that holds carcasses awaiting smoking. Behind the various livestock and game animals are the corpses of travelers who managed to draw the attention of tour guides. That meat goes into the “special sausages” that, despite what some might think, are not sold to the public. Those meats are kept for special rites and offerings to Sssslami.

The Hidden Temple

On the furthestmost portion of the sausage farm is a small, single-room cabin. If asked, guides will state that it is an old guest house that hasn’t been used in living memory and will direct those interested in staying to the newer, much nicer cabins available. Curious eyes peering into the darkness will see nothing to disabuse them of that description. A small rug, and dust-covered furnishing are all that are visible.

The dust is fake, a fine powder blown over clear resin, to create the illusion of undisturbed dust when, in reality, this cabin is fairly heavily trafficked. The small

INTERESTING PLACES TO DIE

Granny's Tonics & Tinctures

Roll 1d5	Tonic Type
1	Snake Oil: Apply directly to burned flesh to heal 2d3 hit points of damage. The resulting flesh regrowth is permanently scaled like a snake. The bottle holds 2d4+1 applications.
2	Pick 'em Up Juice: When imbibed, this hot-pepper infused beverage grants a +2d4 bonus to Stamina for 1 turn, during which they are immune to sleep, sleeplike effects, and even unconsciousness. Afterwards the user lapses into unconsciousness for 1d3 hours. The bottle holds 1d3 doses.
3	Hare Tonic: When rubbed onto bare flesh, fur will grow to cover the area (specifically rabbit fur). This effect is merely cosmetic and will begin to fall out in 1d7 days unless the user receives another application of the formula. The bottle holds 1d6+1 applications.
4	Nerve Tonic: This bottled tonic is really a terribly potent strain of moonshine distilled by Granny herself on certain moonless nights. Drinking the beverage immediately knocks the imbiber out for 12 - Stamina days. Each subsequent drink reduces the number of days spent lying on the floor in a stupor. Those who suffer no ill effects from the tonic (Stamina > 12) find that they are unflappable and gain a +1d bonus on melee attacks made within 12 hours of taking a drink of the tonic. A bottle holds 10 doses of tonic.
5	Face Cream: When rubbed onto the face this cream smooths the skin and clears the complexion, granting a one-time bonus of +1 Personality. Further applications have no effect. The container holds enough for one application of cream.

rug is just large enough to conceal the trapdoor leading down to the temple-inhabited cave below. The temple is of an impressive size, stretching hundreds of feet in all directions. Every surface is covered with thinly sliced sausages, the reddish grease hellishly reflecting any light.

Against the furthest wall is the black altar of Sssslami, carved from a solid block of ancient cured meat. The air is heady with the aromas of meat and spices mixed with the coppery tang of blood. The outline of a humanoid shape can be made out on the surface of the altar—remnants of the last sacrifice.

The Cult of Sssslami

Depicted as a massive serpent made up of sausage links, Sssslami is the god of smoked meats. As deified beings go, Sssslami is rather underwhelming. The meats of his followers never rot, and they always cure to perfection. Still, when one is running a “sausage farm” these are handy traits. The success that this minor godling has brought to Granny and her kin have made them very loyal followers who are always looking for like-minded meat aficionados to join their ministry. Those who are unworthy, or too curious, end up a smoked sacrifice to Sssslami.

Adventure Hooks

- Granny needs a rare spice for a special ceremonial sausage and time is of the essence. The party is hired to collect it from a distant trading post and return it.

- Travelers have been telling tales of people vanishing near Granny's but there is nothing that specifically links the sausage farm (despite its ominous name) to the disappearances.
- In need of immediate medical attention, the party stops at the Surgkal Center for help. Granny will tend to the wounded, but if folks get nosy, any number of terrible things could happen.

ELMOS' WORLDS

Sure, Buddy O'Burgers are everywhere and they supply the best, worst fast food in Umerica. But the same old meat products (what is that stuff, anyway, and where does it come from?) get boring just as fast as it's served. Besides, aren't you a little sick of all the proselyting? Sure, you are!

There is an alternative, you know. You're already starting to see them springing up across the cratered highways from that burger place. But you can ignore those meat-heads; this is where your younglings, mini-mutants, and adolescent androids REALLY want to be!

Elmos' Worlds! Yes, Elmos' Worlds, where you'll find a sweet-tooth's paradise (no “meat” here!) and a barrel of fun times.

Each Elmos' Worlds (yes, that's the singular term, because each location is like a number of worlds in itself) is a uniform standard building in the shape

INTERESTING PLACES TO DIE

of a giant Elmos head (enter through the mouth, of course) guarded—erm, watched over and cared for—by a trio of followers. Which often includes at least one puppet-bot, an elite machine unit capable of heavily-influencing others (whether through persuasion or ... other means) particularly, but not limited to, the young.

Inside each Elmos' Worlds is a plethora of sweet snacks available to trade. You have nothing to trade, you say? Everyone has a soul ...

But the sweets are not the only attraction and may not be the primary attraction at all. Every Elmos' Worlds has a unique feature "out back of the store." It may be a ride, a petting zoo, a swimming pool, or a playground! Everyone is different from the rest. See? Worlds within worlds!

Here are a few examples:

Ride the Pony

Okay, "pony" may be a misnomer. It's actually a dwarf *Spinosaurus* (with half Hit Dice and attack damage). You can ride as long as you like, bareback, like the ancient cowboys! Yeehaw! We guarantee an exhilarating ride that will last until your little dino isn't hungry anymore. Those trying to ride the beast must make a Reflex save (DC 15) each round to stay on. Watch out for those spines! Oh, and did we mention he's hungry? Very, very hungry.

The Ferrous Wheel

Since it requires frequent maintenance and cleaning, The Ferrous Wheel only runs once a day. Walking inside the circular contraption, participants stand against the wall as the cylinder spins faster and faster. Those inside are pressed up against the wall and can lift their feet off the ground without falling down. It's like floating! Wheee! And the fun's just begun. Because two minutes into this spinning frenzy, the hyper-magnetics are turned on. Any metal object on the front side of the riders' body will be magnetically sucked through the rider to the wall. Soft flesh is instantly bored through (The GM determines damage or chance of death) and robots are crushed flat from the combined centripetal force and ultra-powerful magnetics. Maybe the loose screws and blood drains on the floor should have served as a warning for you. Sorry, Elmos' Worlds' liability ends the moment you enter. Elmos' Worlds and affiliates cannot be held liable for unfortunate accidents on any of its rides.



Funtime Mirrorhouse

We all have slightly off-kilter views of ourselves. We probably don't look the way we think we look to others. So, we're here to set things strait or, rather, to set things crooked: to show the many ways that others might see you and to reassure you that no matter how they look at you, you're alright just the way you are! We have all kinds of mirrors here. Some make you look tall and skinny, others round and squat, still others show you in the shape of a pear, or banana, or like a squiggly balloon animal. There are even those that show you from all angles at once! But the one thing you'll notice in each of our mirrors is that you are special in your own special way! And the most special you is the one you see in the reflection with Elmos looming behind you, his hands poised above, holding the strings that make you his special puppet, dancing around with the flames of damnation burning in the background! Dance, dance, dance! You can dance like this forever, if

INTERESTING PLACES TO DIE

you like—or even if you don't like. All who look into the mirrors must make a Willpower save (DC 8) every 20 minutes or become a devotee to the Cult of Elmos.

The Bouncy Room

Bouncing is fun! The bounce room is very large. People love to feel like they are flying! Up and down and up and down we bounce. Only occasionally bumping into someone else (every third round, roll under your Luck or smack into someone else in mid-air for 1d4 hp of damage). With no roof, there's no limit to how high you can bounce! Those walls are 50' high, but I know you can go higher! Each round, roll under Luck or bounce 1d12X10 feet into the air. Those going higher than 50' make another Luck roll or land outside the bouncy room, suffering 1d6 points of falling damage for each 10' fallen.

The Old Swimming Hole

Nothing like stopping in the middle of the Wastelands for a refreshing swim! Yes, that's honest-to-goodness clean water in there. And we like to keep it that way, so no doing you-know-what in the pool.

Resident in the pool is an invisible colony of bowel tyrants (TMM, pg 21) who have a twisted devotion to Elmos. Anyone infected becomes a slave to this particular strain of bowel tyrant and, in turn, slaves to Elmos.

Now, how about those treats?

Subatomic Fireballs

Goodness gracious! These are hot! If eaten, the consumer is immediately dealt 1d6 damage. The eater also has a 35% chance of gaining a mutation (USG, pg 168, -30% to all Detrimental traits rolls) if they are a human or animal-based life form. Each round, the eater may make a Fortitude save (DC 10) to be able to spit the candy out. Those who cannot suffer another 1d3 of damage that round. When spat out, a flameball erupts, causing 2d6 of damage to anyone within a 10' radius of where the candy lands. Subatomic Fireballs must be eaten and spat out for this effect to take place.

Pucker Punch

Drinking this sour-beyond-sour drink causes the eyes to cross and water, plus the face puckers so badly that bones may break. Anyone drinking Pucker punch suffers a -1 Agility score penalty for the next 10 minutes. Those who fail a Fortitude save (DC 10) also suffer a -2 penalty to their Personality score for 24 hours, as their

face puckers inward so much that it bruises and leaves their lips twisted in a rictus of agony.

Sweet Tooth

This may be the sweetest candy you have ever tasted. It's so sweet, in fact, that it will rot your teeth out, right there on the spot. Those who fail a Fortitude save (DC 10) lose all of their teeth at once, suffering 1d3 points of damage from excruciating instant-onset catastrophic tooth decay. They also lose one point of Personality permanently or until they can get all of their teeth replaced. Players are encouraged to speak as if they have no teeth from this time forth.

Sticky Gum

This is handy stuff, if you can ever get it out of your mouth. Those chewing a stick of Sticky Gum make a Reflex save (DC 12) to avoid having 1d3 of their own teeth ripped out for 1 hit point of damage (regardless of the number of teeth ripped out). This must be made each round the gum is chewed. Removing the gum requires a Reflex save (DC 15), even if spitting it out. If removed by hand, the grabber must make a Reflex save (DC 17) or the gum becomes affixed to their hand. While on their hand, a roll under Luck is required to avoid becoming stuck to some random object (GM's discretion as to what the hand becomes stuck to). If one wishes to adhere one thing to another, this requires a Reflex save (DC 19). Things adhered to each other this way are permanently affixed.

Elmos Mini-Zeppelins

It's a balloon, it's a zeppelin, it's Elmos! And it's edible! Fly this stylish balloon proudly as long as you like or until you're hungry for some sweet treats. Eating the balloon not only tastes great, it releases gas into your mouth that causes you to talk just like Elmos for 24 hours—a whole day of Elmos voices, like music to the ears! Those who eat the balloon or breath in its vapors must make a Willpower save (DC 15) or commit one nefarious deed (GM's discretion) on Elmos' behalf within the day.

Adventure Hooks

- It was almost inevitable that Elmos' Worlds and Buddy O'Burger would have a turf dispute! A local outpost's younglings are caught in the crossfire, and the adventurers are hired to bring the children out of danger. Of course, the younglings want ... everything.

INTERESTING PLACES TO DIE

- The party is hired by an eccentric and very wealthy technocrat to accompany his twin children on a tour of the three nearest Elmos' Worlds. The children must return unharmed, but having experienced all that the attractions have to offer.
- It seemed like a regular old delivery of ice and explosives to Elmos' Worlds until the couriers discover that the trio of guards normally present have disappeared, likely into the maze of mirrors behind the main shop. The goods have to be delivered in-person, or the contracts (and possibly the couriers) are void!

FRUCTOSE MINES OF IOW

Scattered about the middle of Umerica are subterranean deposits of fructose crystals. Some settlements form near such deposits to extract them in hopes of the wealth and food the fructose can bring. However, the largest and most legendary deposit of fructose exists in the overturned plains of a place the ancients called Iow, a land claimed by the Beeples.

The Land of Iow

Iow itself is a rather large area, and while the ground has settled, it is clear that long ago there was a great upheaval, inverting much of the land on itself, and burying the ancients and their civilization. Perhaps whatever caused such a great upheaval, or perhaps whatever the ancients produced, made the ground ripe for fructose crystals. Still, many are drawn to Iow due to the land being generally fertile as well as to partake of the fructose crystal trade. The danger lies in dealing with the unpredictable and possibly alien beeples, as well as the Crystal Junkies.

The Beeples of the Fructose Mines

The beeples (a sentient race of large humanoid bees) live the sweet life from the fruits of the mines, where they harvest raw fructose crystals and trade with other neighboring nations. While the beeples venture out with their sweet wares, few folks ever venture into the land of the beeples to see the mines for themselves.

The beeples treasure curious things, and thus have promoted trade for their wares with people hoping the beeples may value something they find meaningless for valuable fructose crystals. The fructose crystals can be

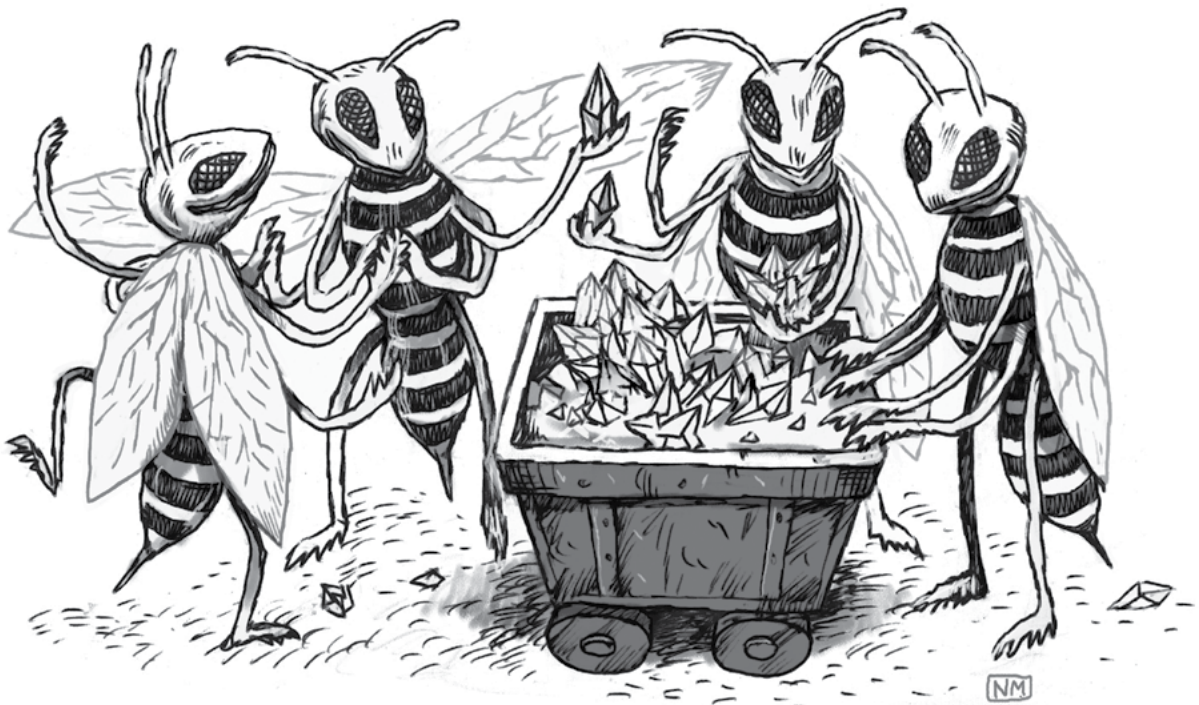

INTERESTING PLACES TO DIE

used to flavor or sustain as food in the harsh Umerican environment and thus are highly valuable. Most villages are willing to overlook a missing villager or two whenever the beeples come by. More enterprising folk find a mine entrance to settle near hoping to reap the profits of trading with the beeples, whose value of the fructose crystals can vary from insignificant to extremely high, and have been known to trade for labor as well as goods.

The beeples have their own language consisting of subtle buzzing, dance-like body movements, plus some level of mild telepathy, though most can also speak in broken Umerican. The beeples live the sweet life of kings and merchants on the backs of the workers or slaves they use to run the mines. The mines are harsh, and non-beeples workers are driven to work long hours sustained only by the crystals they mine, which gives them energy but eventually wreaks havoc on their body from long exposure and overdosing on fructose. Some non-beeples slaves who prove loyal and competent are allowed out of the mines to act as servants for beeples royalty instead, and the Beeples Queen is the center of attention with numerous slaves and attendants at her side. Once a year, the Beeples Queen ventures out of the mines with a large guard contingent and chooses several humanoid “mates,” or at least that’s the closest translation of the word the beeples are aware of. These mates return with her to the mines, and are never seen again. There are no real clues where the beeples came from, if they were aliens stranded in the upheaval, mutants from ancient times, or beings from another dimension who entered through a portal buried in the mines.

Few outsiders have seen the mines and survived. The caverns under Iow spread far and wide, offering places to harvest the fructose crystals, as well as the ruins of ancient Iow. The beeples main hive has salvaged much of this and settled in converted remains of buildings either repaired or moved from the underground while they have salvaged the fructose crystals. Some areas have low-level lighting provided by beeples devices powered by the fructose crystals. The main hive is powered from some unknown source, perhaps an ancient power supply of some kind.

Iow City and Other Settlements

It is a common occurrence in Iow for a new mine entrance to appear and quickly sprout a small settlement. Larger openings establish more permanent

settlements, while smaller ones have been known to be collapsed by the beeples at a moment’s notice. It happens often enough that no one has mapped all of the entrances but they can be found as far as 70 miles out from the largest settlement, a place known as Iow City.

Iow City has turned the mining and processing of fructose crystals into a prosperous trade, though rumors of them dealing in slave labor keep the city from truly flourishing. Through the use of fructose crystals, Iow City has built a manufacturing base of sweet food stuffs that can last for months in the wastes of Umerica. The city also offers the best outlet for outsiders to deal with non-beeples to trade for fructose crystals, which is more appealing to those unfamiliar with the oddities of the beeples. Iow City is something of a renaissance town, featuring secure, controlled borders and housing that would be considered quite safe by Umerican standards.

Still, it is not a paradise, as those who live there work hard trading, manufacturing, building up Iow City, or protecting its borders. It is not unusual for those who don’t contribute to the city to disappear and unfortunate encounters with the beeples are often ignored by the guards in favor of not upsetting the beeples royalty.

Crystal Junkies and Dangers of the Roads

Raiding the countryside of Iow are the Crystal Junkies. A roving gang of raiders who attack caravans, taking fructose goods and prisoners. The Junkies mostly operate around the edge of Iow, and don’t really have a known base of operations, though there are rumors of them having ties to some of the mine entrance villages or even Iow City. Regardless, caravan escort is a profitable business as a result of this and other dangers of the countryside of Iow.

Other road gangs have been known to stray into Iow from time to time as well, as the temptation of sweet salvage is too much for some to ignore. Beyond that, Iow finds itself host to other monsters roaming the area more frequently than other areas of Umerica.

Finally, the overturned ground is rough and unsettled in some areas still. Sinkholes, uneven ground, and the occasional unexploded mine or bomb are not uncommon dangers in the plains of Iow. Plus, as with all flat lands there is often little in the way of cover to

INTERESTING PLACES TO DIE

hide from danger, though it also means such dangers can be spotted from a long way away.

Adventure Hooks

- The Crystal Junkies have raided a caravan from a village outside of Iow. The party has been hired to track down the remains of the caravan and rescue anyone taken prisoner.
- Hired as an escort, the party journeys from outside of Iow to Iow City, where the Beeple Queen is visiting and choosing her “mates.”
- A small village has sprung up around a small fructose mine entrance and is now caught up in a war between the beeples and the Buddy O’Burger (that opened up nearby) over the resources of the village, mainly food and labor.

THE HANGING GARDENS OF BURBANKALONIA

Initial visitors’ comments on first spotting the Hanging Gardens of Burbankalonia usually run something like this:

“How in the ...!?”

The hanging gardens are strange, even by Umerican standards, but like all survivors of interdimensional incursions, we learn to adapt.

So have the gardens.

Viewed from the ground, the gardens appear as just that, a lush, verdant garden shooting hundreds of feet into the air. On closer examination, however, one notices a gap between the trees reaching up to the sky and the vines hanging down from the gardens-proper. One large circular platform, over two miles in diameter, floats several hundred feet in the air, supported by, well, nothing. At five equidistant points are other circular platforms, each about a half mile across, forming a star, at a distance of about 200’ from the edges of the main platform. These are also suspended in the air by unseen forces. They orbit around the main platform in a lazy fashion, but in perfect synchronization, never varying from their relative position vis-à-vis one another.

No one knows how they got there except that they appeared suddenly in the sky over an ancient city, at the moment of the Great Cataclysm. Within moments, the city’s inhabitants (those that survived the other

drastic changes wrought on the area) fled into the desert, there to be eaten by xenomorphic land-sharks from who-knows-where. They didn’t have time to wonder about what was happening above them.

Yet, something was happening. Some observers witnessed (from a great distance, and not in the direction of the xenomorphic land-sharks) what appeared to be seeds shooting forth from several hole-riddled domes on the main platform, literally tons of different kinds of seeds and fruits cascading into a large pile into the remains of the city below. In time, these germinated and grew, inexorably pushing their way up through the plasteel and concrete (not to mention the many bodies and ash that fertilized the area), cracking foundations, infiltrating walls, and effectively consuming the buildings, climbing ever higher toward the platform.

On the main platform, plants were seen growing from the surface of the platform and out of the swiss-cheese-like domed structures. Occasionally, seeds would blow over to the outside platforms, which, in time, also became covered in tiers of lush vegetation.

Even in Umerica, nature hates a vacuum (except in outer space), and it didn’t take long for certain life forms to colonize the Hanging Gardens of Burbankalonia. This was not unimpeded, as certain—things—were already present there, native flora and fauna(?) that weren’t going to cede territory without a fight.

Nevertheless, the hanging gardens are host to a wide variety of strange creatures, including a large colony of beetle apes, more vinacondas per-capita than any other place on Urth, and at least one breeding pair of *Arachmosaurs*. A kaleidoscope of flutter glows frequently visit. A swarm of xeno-locusts is rumored to be travelling across the desert toward the environs. It is also rumored that the Cyberhive has sent a robo-lich to scout the gardens, but no one has been able to confirm this rumor.

Of course, the fauna is far less fearsome than the flora. Carnivorous plants are plentiful and poisonous (but tempting), fruit abounds—mixed in, of course, with some edible fruits (provided they don’t eat you first).

Structurally, the platforms are of uniform thickness—50’ thick and honeycombed with tunnels created either by plant roots pushing through the material or by intelligent design of the garden’s

INTERESTING PLACES TO DIE



inhabitants. They are connected to each other and to the central hub by invisible bridges of force. Yes, some stray vines drape across some points, giving waypoints for the brave or foolhardy traveler to aim for. But attempts to make these bridges visible have altogether failed. They are simply on an invisible wavelength that does not interface with visible light in our dimension. Psychogeographers, spiritualists, or those who have the ability to peer into other dimensions, might be able to see the bridges, should they employ the proper tools (GM's discretion), but other attempts to paint, coat, or otherwise force the bridges into visibility simply fail. Those who cannot see the bridge (which, again, means almost everybody) but who attempt to cross it must make a DC 15 Intelligence check to successfully cross a segment of bridge between the platforms. Failure necessitates a DC 15 Luck check—success indicates that the adventurer has fallen off the platform but, somehow, was able to catch a vine or a treetop. Roll 5d30 to determine how far “down” off the bridge the character has become hung up. Failure, of course, means a plummet to the ground some 500' below.

Catching a vine or treetop does not indicate safety, however, as predators will most definitely be waiting to snatch up any potential prey.

Careful observers will note that each “node” of the array, where an invisible bridge meets a platform-edge, has a half-dome structure present, with the open side of the cutaway section of the dome facing the bridge. If these are investigated, there is a low chance that one might discover a “hopper”—a means of transport that does not require one to walk across the treacherous bridges. Take the Luck score of the party member with the lowest Luck and roll under that score on a d20 to determine if a hopper is potentially present. Rolling below the lowest Luck score indicates that there is the possibility of a hopper being there. Another such roll will indicate whether or not the hopper is in good repair and usable. Again, low rolls indicate success. Still, a good technologist should be able to fix up a hopper in bad repair, in time ... under duress and probably being attacked by carnivorous plants the entire time. But it's not impossible!

INTERESTING PLACES TO DIE

If found or repaired, a hopper will allow up to four passengers to travel to the next platform over. They only work between two specific platforms and can't be caused to travel to a platform other than the one on which it originated and its one, single counterpart. It's a harsh reality, but would you rather walk?

Earlier mention was made of the "native" inhabitants of the central platform. These are wide and varied, but special mention must be made of the Lesser Entity known as The Mold Mother.

The Mold Mother

Deep in the shadowed foliage of The Hanging Gardens of Burbankalonia lurks The Mold Mother, an amalgam of xeno-flesh, circuitry, and eukaryotic organisms akin to a gigantic bio-computer. Her goals and her "mind" are utterly alien, though both organic and mechanical interfaces result in a (very) limited understanding of her desires and the gifts she can present to those who follow her and perform tasks on her behalf, particularly those that serve to integrate artificial intelligence with organic components. She has a particular fondness for cyborgs and others who integrate technology with flesh, wood, or fungi. Her ideal follower would combine elements of all of these at once, though such individuals are rare indeed.

Such integrations do not come without pain, and the Mold Mother rewards her followers who suffer the self-inflicted pains of grafting themselves to her will. Grafting requires the physical carving out of flesh (in the case of fleshy creatures) or circuitry (in the case of mechanical creatures) and the introduction of fungi or plant fiber into the wound. The grafting sacrifice will inflict 2d6 permanent hit points of damage and a drop in Personality score of -2. These may never be regained, and the Personality score may never rise above the newly-determined score brought on by the grafting. Note that this results in a +4 Personality score when dealing with other followers of The Mold Mother. Only a self-inflicted grafting will do—these sacrifices humble the followers of the Mold Mother and show their willingness to be dependent on her. The devotee may not be helped by others, nor may a fortunate accident be considered a willing sacrifice.

Following her is not without rewards! The sacrificing acolyte is rewarded with the "Botanical, Fungi-like" mutation and an oddly specific ability to locate fungi

and molds once per day (as the 30-31 result under the *locate object* spell, but only for fungi and molds). They are also able to cast *summon foulness* with a d16 action die once per week. Spellburn is not allowable for this casting.

Adventure Hooks

- Old Man Mushroom has dreamed a dream—a dream of doom! A dream of a sinister sister mold! He sends dreams out to the party of adventurers, urging them to investigate the lair of the Mold Mother. Of course, there will be rewards! That same night, mysterious messages begin to appear on the party's instruments, in the party robot's head, and so forth. They also promise a reward—for destroying the minions and forest of Old Man Mushroom.
- The xenomorphic land-sharks have returned, raiding desert outposts and eating the inhabitants. Their destination: The Hanging Gardens of Burbankalonia. But what do they smell that attracts them there? Investigators must be sent to find out!
- The Synod of the AstroLiches has taken notice that The Earth Brain of the Cyberhive has introduced a robo-lich to the environs of The Hanging Gardens of Burbankalonia. What fun! They offer a prize to the group of adventurers that can find the robo-lich and defeat it in combat. Of course, there will be meddling by the Synod!

HIGH TEMPLE NOX

The bank temples of \$ can be found scattered around the wastes of Umerica, usually cropping up near civilization, or bringing civilization and trade to them through practices of mediation and oversight in trading, as well as promises of wealth and prosperity. Gracing what legends say was an old military installation, the Head Bank Temple of \$ is the chief repository and dispensary of wealth for the goddess, known to the world as the High Temple Nox.

The Temple Proper

This opulent temple is both rich with wealth and fortified impressively. The high priests of the High Temple Nox are noted to be dressed as the avatars of \$, known from their pictures on old world paper and

INTERESTING PLACES TO DIE

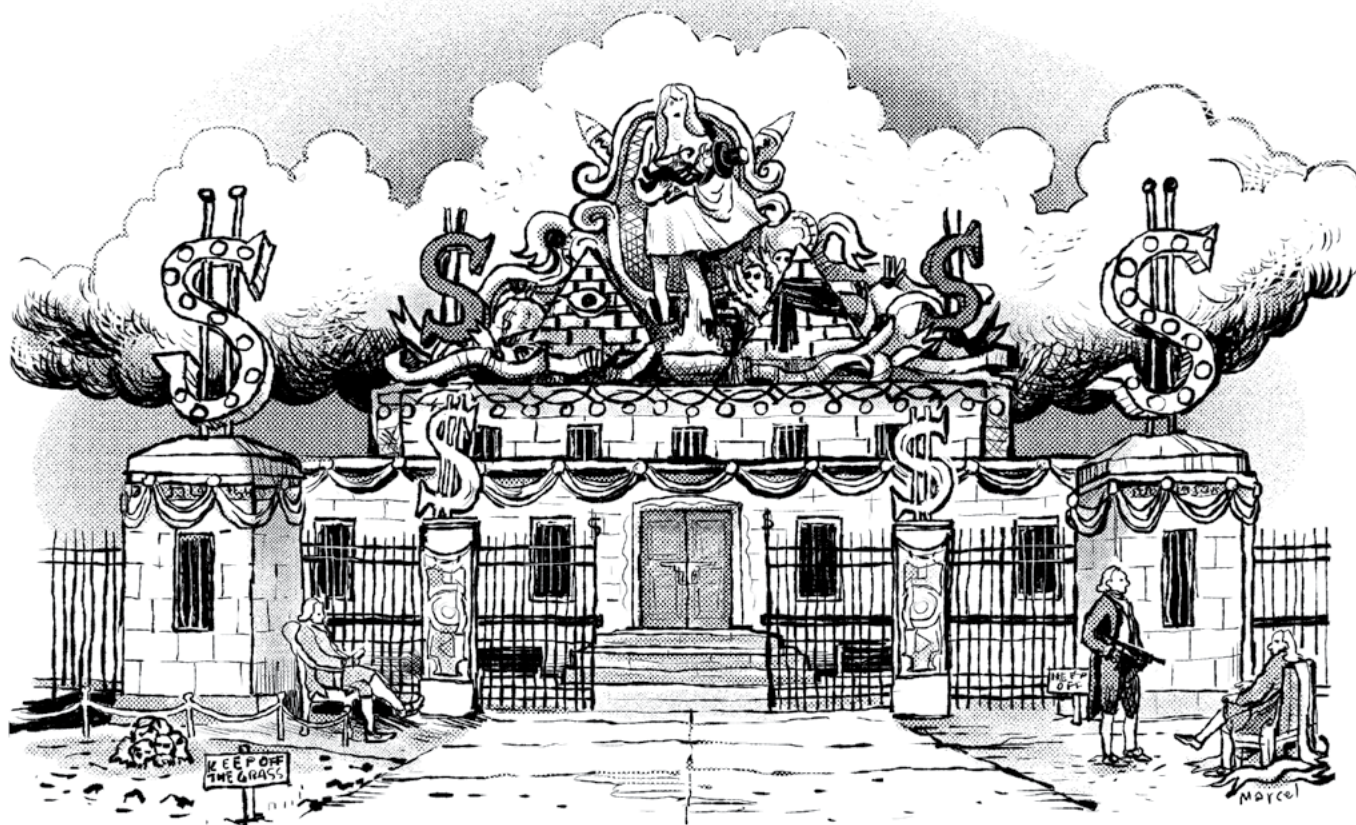

coins used for trade so long ago. While these high priests hold service and manage the goddess's fiscal doctrine, they rarely oversee day to day matters such as overseeing trading or managing the market. However, for trades of great significance to \$, one or more may be coaxed into attendance. Because of their costumed dress, it is not known how many high priests there are, nor if they keep the same costume during their tenure as high priest.

There are several temple services managed by lower priests. Holy actuaries offer protective prayers and contracts known as insurance to those who make a proper tithe, these blessings keep objects, possessions, or people free from harm, or somehow provide financial windfalls if harm does come to these. The process involves complex calculated prayers and few truly understand exactly how it works, but choose to have faith that \$ will bless them appropriately. There are also honored mediators who can oversee trades and agreements by appointment and with a tithe. The most honored mediators work in the high temple, while the lower ranked mediators work the market. There are also general services provided by the lower priests such as blessings sought before negotiations

or simply blessing of trade from the Blessed Business Bureau of the temple.

Soldiers of Fortune

Such a collection of wealth and trade is not without risk, and the High Temple Nox is protected by a well equipped group of guards known as the Soldiers of Fortune. These guards are provided with equipment, training, and luxury few might otherwise experience in the wastes of Umerica, and thus are extremely loyal to the priests of \$. On rare occasions, a few soldiers have been hired out by the temple, but this practice is rare, and the tithes required are rumored to be exorbitant. These soldiers keep the peace both at the temple proper, as well as the market place that has sprung up around the temple, but rarely do they stray further than that. With the soldiers on patrol, the High Temple Nox is one of the safest places in Umerica. At least from violence.

Nox Market

The market that has sprung up around the temple is perhaps the single largest market in Umerica. With \$ priests available to oversee deals for a small tithe, major traders travel here just to make a single

INTERESTING PLACES TO DIE

important trade, while merchants from all over Umerica and beyond gather to sell their wares. With no laws or restrictions from the temple on goods, there is a vast variety of goods such as common foods, exotic weapons, simple vehicles, slave labor, and body parts to name just a few. If it's for sale in Umerica, it's likely been sold in this market at least once. This brings in merchants and buyers from not just Umerica, but from other interdimensional locations Umerica converges on. Thus the market is made up of humans, mutants, aliens, demons, and all sorts of creatures. Even the Lucky Lady rail line has an exclusive station at the edge of the market.

Oversite from the priests keeps all trades made in good faith, but offenders will still try to skirt the system. A trade made in good faith may still have bad products, and does not mean that both sides are getting a fair deal. Such dealings are made in good faith without additional influences outside of bargaining skills, product knowledge, and wit—they are not made with the intent to doublecross later, and have some level of binding to them, depending on the level of service tithed for from the priests. Offenders found may simply find their deals nullified in the eyes of the priests, while repeat or larger violators may be banned from the market, or cursed by the priests. Such curses are often unique and creative, but devastating for traders, such as “May your negotiations always be one sided,” or “May you never break even.” When this is not enough of a deterrent, the Soldiers of Fortune are glad to hunt down offenders who haven't gotten the hint that they're unwelcome.

The Outer Settlement

Outside of the Nox market a settlement has formed, surrounding the market and temple. This settlement is not watched over or managed by the temple in any way, other than the Soldiers of Fortune occasionally passing through on business. This area has attracted some merchants to set up homes or businesses in the area. Trade also happens, but this market is unregulated by the temple, so while cheaper, this market is considered more dangerous. That doesn't mean trade doesn't happen here, and quite often deals are discussed in the many inns and taverns outside the market, only to be consummated in the market itself.

Outside the settlement is a no-man's land filled with thieves, brigands, and other dangers. With the Nox

market being an easy place to sell any goods, that means nearly anything that can be caught in the open can be for sale. Many travelers use the rail line, which has been blessed by Nox and is usually left alone. Others form long caravans to try to stay protected as a group. Some hire guards or find alternative transportation to get to the settlement quickly. Still, tales abound, truthful or not, of those who failed to make it to Nox on their own free will, and serve as either a warning or a simple frightening tale of the dangers of the area.

Adventure Hooks

- A wealthy merchant is looking to travel to the Nox marketplace and hires the party for protection along the way.
- The party has been tasked with finding a rare item, knowing only a merchant's name and that he works out of the Nox marketplace.
- A priest of \$ has cursed a member of the party, “You will be wealthy, many times.” The party must venture to the High Temple Nox to tithe for forgiveness with the high priests before they lose everything. Again.

JUNKYARD OF THE RESTLESS LEADSLEDS

In what once was a mecca of pre-cataclysm car manufacturing sits an expansive, salvage-rich junkyard that is shunned by every settlement remotely near the area. The majority of the citizenry of these settlements are loathe to even talk about it, especially anywhere near a working vehicle. The few that can be convinced to speak, tell tall tales of the junk heap being haunted by sullen spirits that consider the junk to be theirs alone. Others speak of stories where running vehicles start to act odd when close to the junkyard, to the point where the car abandons its owners to seek refuge among the mountainous piles of junk. A few times a year some gangers work up the courage to raid the unholy place in hopes of scoring a fortune in premo vehicle salvage. Those few who do return from such a fool's errand bring new stories of the horrors that await plunderers.

About a Mile Out from the Junkyard

There is a distinct line radiating roughly a mile out from the outer wall of the Jumping Jones Junkyard marked by a sudden stop of any form of encroaching plant life. Indeed, the area around the place is devoid of any

INTERESTING PLACES TO DIE



local life: plant, animal, insect, or otherwise. Any riding, laboring, or companion beasts will refuse to enter the area without some stern coercion by their owners (DC 13, hourly, or they attempt to leave). Spellcasters and artificially intelligent beings (robots) may make an Intelligence check (DC 10) to pick up on the unnatural vibe emanating from the junkyard.

While traveling through this area, there is a 50% chance per hour of seeing 1d3 unmanned vehicles driving around. If approached, they will make every attempt to avoid being caught up to and will lead any pursuers on a merry chase through the hazards of the area. The idea will be to keep the pursuing vehicle in the area as long as possible, without engaging in combat.

Any motor vehicles brought this close to the place have a 33% chance per hour of starting to act “funny.” They may begin to not handle as well—always favoring turning toward the junkyard, begin to develop electrical glitches such as light or wipers turning on and off on their own, or even minor engine problems requiring the driver to stop and check it out. Any such affected vehicle will continue to have intermittent episodes of odd behavior, with increasing intensity, as stray spirits

from the junkyard try to possess it (cumulative 3% chance per hour the vehicle remains within a mile of the place). If the vehicle is removed from the area, all traces of the attempted possession will vanish.

Should the spirits successfully possess the vehicle, they will fully animate it and attempt to bring it within the junkyard. It will also attempt to rid itself of all passengers via opening its doors during tight turns, unlocking seat belts, etc. A Strength of 15 or greater is required to attempt to steer the vehicle and even then all Vehicle Control rolls will be made at -2 die steps. Once any occupants leave the vehicle, it will ignore them other than making efforts to not run them down. A cleric whose religion considers the un-dead to be unholy may try to exorcise the vehicle with a *turn unholy* attempt (DCC, pg 96) as a 2HD creature. Any level of success will free the vehicle.

Should a possessed vehicle somehow leave the possession zone, it will return to normal almost instantly. Note that a vehicle that is already possessed by another type of entity will be completely immune to the areas effects.

INTERESTING PLACES TO DIE

Junkyard Encounters Table

Roll 1d30 Encounter Result

1-5	Carvalanche! One of the towering stacks of wrecked vehicles teeters and falls in the direction of the party. A Reflex Save (DC 10) is required to avoid 10d10 damage.
6-20	Nothing, just seemingly endless paths between the stacked cars.
21-22	Old Construction Robot: Standing among the rows of stacked cars is a 10' tall robot built for heavy labor. It is currently offline but if reactivated (DC 15 with the appropriate ability or skill) it will start up and follow any orders given. The spirits will ignore the robot and it can be ordered to salvage with no consequence.
23-24	Little Jones' Workshed: This garage-sized workshed is made from junkyard scrap but is well built. It is secured by a padlock (DC 13). Inside is a sweet offroad sports car (Custom) and dozens of books, magazines, and posters dedicated to automotive mechanics and speed machines. Also hanging on the wall is a pristine set of mechanics overalls with the name patch "Little Jones." Anyone wearing these overalls will be ignored by all spirits and can loot the place all they want. An Intelligence check (DC 11) will find an otherworldly text dedicated to summoning the Demon King of Speed. There are several pages of notes wedged into the book regarding preparations for the summoning circle. An additional Intelligence check (DC 17) can work out that the Rift opened right where Little Jones was going to build his apparently flawed summoning circle.
25-29	The Crane: There is a large possessed crane wandering about the yard. It seems to like moving the wrecked cars about and making well stacked piles. It will attack anyone interfering with its stacking. Large Possessed Crane (Keeper): Init -4; Atk rundown +8 melee (2d14+Collision damage bonus); AC 7; Armor Die [1d7]; HD 6d20; HP 66; Speed Level cruise 1/ max 1; Act 1d20; SV Fort +13, Ref -3, Will NA; Fuel Tank nil; Guzzle nil. Basic Traits: <i>open, rugged, tracked, hydraulic arm—large.</i>
30-31	The Main Office: Sitting next to several piles of cars is a small building with a "Main Office" sign. It is a three room place: office, bathroom, and break room. Office: This consists of several filing cabinets, a large desk, and several old chairs. The cabinets are full of inventory and sales records. In the bottom drawer of the desk is a bottle of booze and a revolver (fully loaded). Bathroom: A full bathroom with shower. No running water. Under the sink are several bottles of high quality detergent. Hanging on the back of the door is a pristine set of mechanics overalls with the name patch "Big Jones." Anyone wearing these overalls will be ignored by all spirits and can loot the place all they want. Breakroom: A couch, two vending machines, a small refrigerator, and a microwave. Both the fridge and microwave are fully functional and have power. The snacks in the vending machine might still be safe to eat (65% chance for each).
32+	The Rift: In the center of the junkyard is a dimensional breach leading to an afterlife plane dedicated to a techno-organic species. The spirits leaking through into the junkyard view it as something like an afterlife amusement park with occasional interactive adventure events (possessing cars and repelling thieving invaders). Should party members choose to enter the rift, any number of amazing or horrifying things could be encountered. In theory, somehow closing the rift could exorcise the entire junkyard, leaving it open for looting.

Approaching the Junkyard

The junkyard is over a dozen acres in size, surrounded by a 12 foot tall sheet metal fence. The neat piles of cars dwarfs these walls in many places. There appears to be

only one way in and out, a large gate with a lit neon "Jumping Jones Junkyard" sign over the top. The gate itself is wide open. In any lighting condition less than direct sunlight, a faint glow can be seen emanating from within the junkyard.

INTERESTING PLACES TO DIE

Several unmanned vehicles will patrol the outside of the wall and attempt to dissuade any manned/unpossessed vehicles from entering the gate (DC 12 to sneak past on foot). They will do so through threatening movements and sounds but will not actually attack any other vehicle. Any living being discovered attempting to climb the wall or enter the gate on foot will be remorselessly attacked by the possessed patrolling vehicles. Robots will be ignored by the patrolling vehicles.

Anyone making it into the junkyard via climbing the wall or through the gate will no longer be attacked by the patrol vehicles. Should those who enter attempt to leave with any plundered salvage, the patrol vehicles will attack with fervor, gaining a +1 die step to all attacks and damage.

Within the Car Carcass Catacombs

Within the junkyard, ethereal spirits can be seen floating around and through the various wrecks, causing the cars to momentarily show signs of life. Any vehicles brought into the junkyard have a 40% chance per hour of being immediately possessed. This will not cause the vehicle to act threateningly towards its occupants or anyone walking around. The vehicle will just start slowly cruising about the place aimlessly. For every 30 minutes spent in the junkyard, there is a 33% chance of encountering another non-hostile possessed vehicle wandering about.

The spirits will generally avoid interaction with any intruders, unless they start looting the vehicles or other machines in the junkyard. Then, all of the spirits in the local area will attack in mass, usually in a group of 2d4. Robots will be ignored by the spirits.

Junkyard Spirit: Init +2; Atk spectral claws melee +4 (1d3, ignores non-impervious armor); AC 10; Armor Die nil; HD 2d6; MV fly 40'; Act 1d20; SP un-dead traits, immune to non-magical/non-energy weapons; SV Fort +1, Ref +2, Will +3; AL N.

There are many 20' wide pathways that wind through the interior of the junkyard. They do not follow a logical layout and seem to change when one is not looking. For every 20 minutes spent roaming around the junkyard, roll 1d30 on the table below, adding a cumulative +1 for each roll made on the table on page 23.

Adventure Hooks:

- The party has hired on to a motorized merchant caravan as guards. Since they are running behind schedule the caravan takes a shortcut through what the locals call “haunted territory.” No one believes any of that malarkey until several folks spot a few cars moving on their own without drivers.
- A rich train baron has employed the party to track down some parts for his vintage car. So far all lines of inquiry about the parts lead to a supposedly cursed junkyard. How much is this baron paying again?
- The party thought they were goners when they picked up a major biker gang on their trail. After being chased for several hours, the gang just stopped pursuing them and all turned tail. No one asked why until the car started having weird electrical problems and the radio started playing random songs.

OSHEANA CITY

The glitz, glamor, sin, and vice survive and thrive in this city that lies under the old Jersey Shore. A well maintained old highway labeled the Turn-Pike leads into an unnatural parting of the ocean waters. Following the road down between the unnaturally suspended waves and down below the water level leads to Osheana City, a bright and vibrant city surrounded by the ocean. The ocean wall is held back by a mysterious force, yet can be passed through without resistance. There is even a section that's entirely underwater to attract aquatic attendees, as well as provide homes for its mostly aquatic inhabitants, mainly a mix of merfolk, sharkfolk, and octofolk, though aquatic folk of numerous kinds can be found here. Unlike most of Umerica, entertainment and service is the trade of the city, whose gambling, exotic shows, seedy underworld, and famous gladiatorial ring are all wonders to see.

The Big Boss

Osheana City revolves around The Big Boss. Depicted as a whale of a man (quite literally part whale, part man), Di'Capi is billed as a demigod of \$, in charge of gambling, debt collection, and retribution. While not regularly seen, rumors have him running the city from the underground. Regardless, if he's there or

INTERESTING PLACES TO DIE

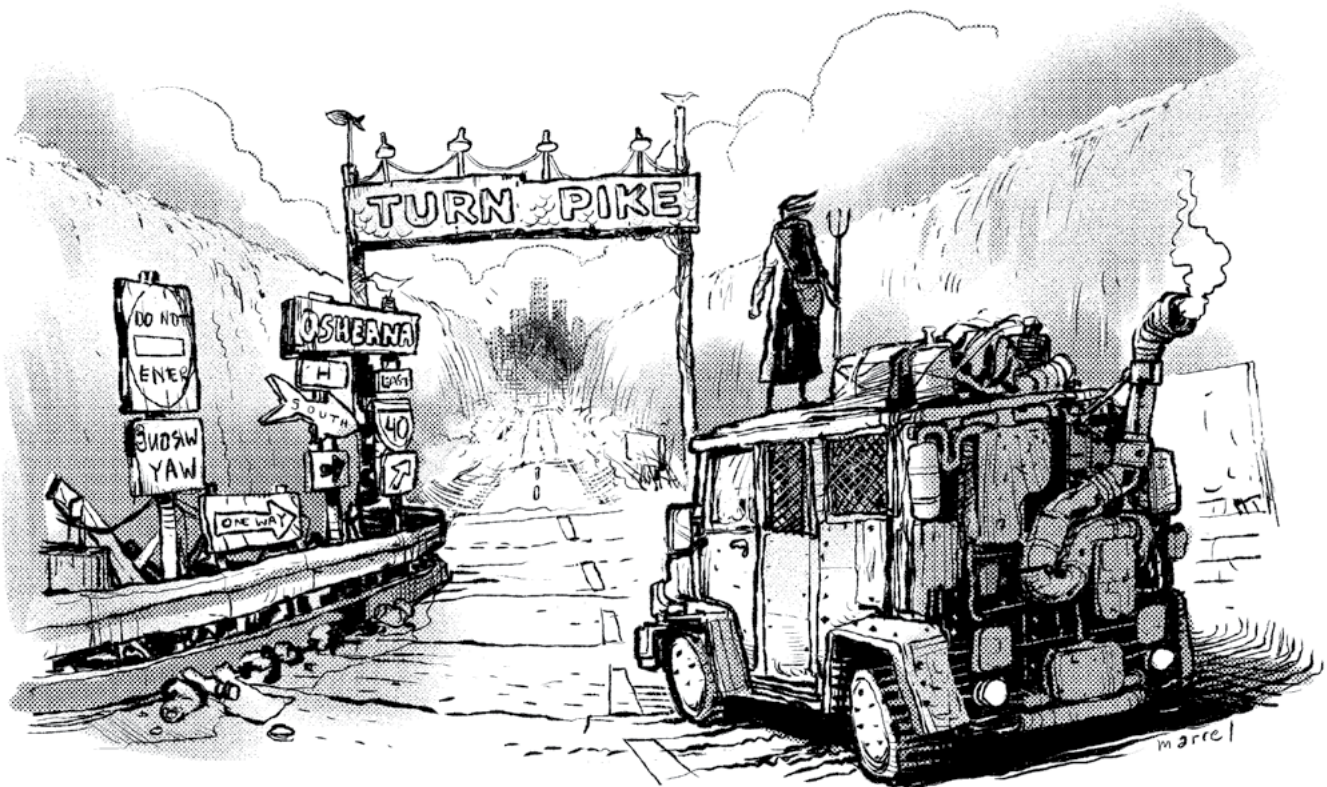

simply worshiped from afar, his ideals are treated with great respect throughout the city. Traditionally, those that visit the city pay respect at his shrine in central Osheana City, a huge fountain with intricate carvings of land and sea creatures throwing money into the center. Di'Capri also has smaller dedicated shrines in most establishments, and donations to the shrine are believed to bring good luck as well as to ward off "collections."

Glitz and Glamor

In the heart of the city are the large hotels and casinos, the most famous and expensive of which are those that line the boardwalk. The boardwalk is at the far end of the dry section of the city, with the wet half starting on the other side of the road. Regardless of which side of the water wall they're on, these opulent casinos are lined with elegant stonework, metalwork, and designs. The casino floors are spectacles of bright lights, loud noises, and tables for various card games. The hotel rooms offer spaces most Umericans could only dream of, with large beds, running water, and in some cases working power. Spaced among these hotels are equally posh dining establishments. All you can eat buffets and high end restaurants serve exotic cuisine from all over Umerica and beyond. High rollers from all over come

to seek out this paradise of excess.

Rivaling the food and drink establishments are the entertainment facilities. From on-broadway theaters featuring such shows as "The Phantom of Oprah," or the longest running act in Osheana City "The Elf Impressly's." Acts of music, dancing, magic, science, and athleticism can all be found here. In some of the less savory parts of the city you can find more rustic entertainment. Places advertising "All Human Review" and other salacious shows provide entertainment to the less discriminating crowds. Not to be outdone, there are street performances scattered throughout the city, as acts from afar travel hoping to make it to the big time in Osheana City.

Under the Shine

Few places can be all glitz and glamor, and Osheana City is not different. It takes money to participate in all the revelry, and there are plenty of ways to get money in the city. Prawn shops are run by crustationfolk who are willing to put anything and everything up for sale and offer immediate money. Prawn shop items are known to range from jewelry, clothing, and small electronics, to weapons, organs, or occasionally loved ones. There are deals to be had for the savvy consumer, but don't expect to sell at top dollar.

INTERESTING PLACES TO DIE

What's not advertised openly in the casinos and entertainment establishments is the city's debtor policy, as is also the penalty for violating any other city laws. Debtors who are unable to pay are put into the gladiatorial pits to recoup money owed. In desperation, some visitors find the prawn shops aren't enough, which has sprung up the loan-shark industry, coined from being almost exclusively run by sharkfolk. These loan-sharks offer high interest loans that come due quickly, and when they come to collect, they're ruthless about throwing those who can't pay into the pits. Loan-sharking is a thriving business in Osheana City—a city designed to squeeze out as much money as it can out of people, especially if they aren't watching their pocketbooks.

The Octo-Dagon

The octofolk run the popular "Octo-Dagon" gladiatorial pit at the south side of the boardwalk. The complex spans the water wall, having one pit on the air side, and one underwater, though both have seating for air and water breathers. These eight-sided pits offer concessions and betting, while willing and unwilling gladiators fight for the audience's entertainment. The gladiator system is quite complex, where willing gladiators get paid and unwilling gladiators get their debts paid off in a similar fashion. Fights are usually till someone yields, but the gladiators get paid for attendance as well as a small part of the take, which puts them on the clock to make matches last longer and appear closer. Unwilling gladiators who yield early may find themselves deemed worthless and sent into death matches, or worse, survivor matches where many enter and only a few leave. Expert gladiators know how to both slowly wound their opponents and show for the crowd to become popular, while rookies and cowards afraid to fight and play to the crowd are eventually disposed of as worthless to those they owe.

Adventure Hooks

- A star entertainer at a large hotel has gone missing. The party is hired to track them down.
- The party wakes up in a hotel room in Osheana City they can't afford, with an outstanding loan-shark debt they need to deal with soon.
- An item found on a great deal at a prawn shop brings trouble when the original owner decides they want it back from the characters.

SNOW DOWN ON YA, ARID ZONE "A"

On a high, conifer-covered mountain overlooking a vast stretch of desert wasteland, sits the resort town of Snow Down On Ya, Arid Zone "A." As the name indicates, there is plenty of snow up there, though very few of the snowflakes are sentient, and some of them are actually flecks of radioactive ash. So be careful what you catch on your tongue!

The town itself is surrounded by a wooden palisade consisting of conifer-trees chained together in five places. Some of the trees are still alive and will creak out a loud warning should anyone be so foolish as to try to scale these 80' tall walls undetected. Trespassers will be violated.

The entrance to the town is guarded by one blue and one red entity that call themselves, respectively, "The Snow Devil" and "The Sun Devil." Above them looms the (in) famous 100' guard tower manned by a contingent of hardened mutants armed with an impressive array of Xenotech, NecroTech, and Forgotten Tech of the Un-Men. Trying to forcefully gain entry is ill-advised.

The admission price is steep, and only the elite can bribe their way in: "You want in? Well, that's a mighty fine lookin' raygun you're totin' there, mister. Or maybe your pet medibot needs a new master? We'll find a good place for 'im ... and maybe let you in!" Needless to say, Snow Down On Ya is reserved for the elite. Paupers need not even visit the front gates, lest they become soup du jour at the Bone Soup Café.

Once inside, "guests" quickly learn that while there are many fine pleasures and entertainments to enjoy here, boundaries and security are strictly-regulated, with flying security drones equipped with stun guns literally every 50' across the nine-square-mile town. Heavily-armed patrols, including a special psi-enforcement and magic-enforcement team, are ever present as the town maintains peace (and pleasure) through superior firepower!

The Clean Baths

Vast hot springs, covered by pillared stone temples, provide the guest the opportunity of an invigorating cleansing bath. Only those that appear "pure" may bathe here, meaning: NO MUTANTS ALLOWED! Those who are deemed "pure," whether they be humans, grays, or even robots, may enter and enjoy. But mutants and

INTERESTING PLACES TO DIE

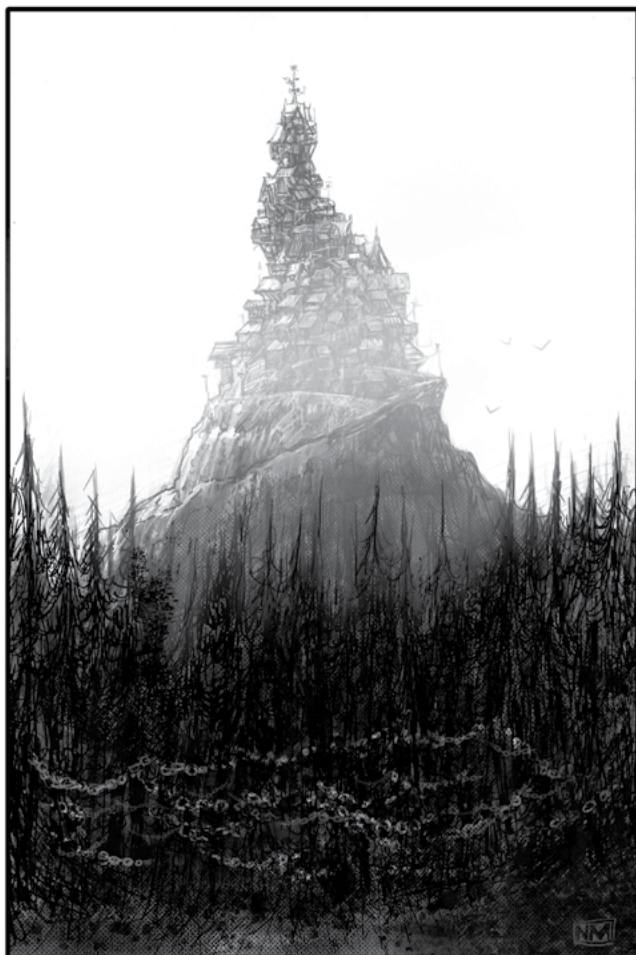

cyborgs, for instance, are barred from entry. To ensure that guests are clean, a fractal-dimension chemical is introduced into the water every hour, whose effect is to cleanse one random mutation from any “disguised” mutants or to permanently and unalterably dislodge one piece of cybernetic hardware, external or internal, by exploding the subatomic fractal dimensional connections between flesh and machine.

The Psilocybin Silo

Actually, a huge building containing dozens of compartments in which psychoactive substances are administered in a controlled environment with “caretakers” who watch over each guest to ensure the most pleasant, uplifting experience possible. Soothing music, sweet odors, and pleasing visuals gently stimulate visions of peace and love and paradise—unless the guest wants something a little ... different. There’s nothing wrong with different. It just might cost a bit more.

The World (and Out of this World) Market

A vast grocer offers the most exotic selection of foods, drinks, and toiletries in Arid Zone “A.” Here, each shopper is offered a set of viewNOculars that are programmed to “delete” anything the viewer might find offensive. For instance, a gray wearing viewNOculars will not see that carton of a dozen grayling eggs, while a psy-mutant chef will be able to spot this delicacy. The viewNOculars can also be programmed for certain predilections, for example, deleting luscious, mouth-watering, rich, yummy, dark chocolate from a chocoholic’s view—but only if they wish!

The Fountain of Youth

Not to be mistaken for “The Fountain of Truth,” just a few steps away, which forces ... er, enables the drinker to say nothing but the blunt truth for 24 hours, The Fountain of Youth is easily recognized by the pile of naked marble statuette babies vomiting water from their mouths. Like many things in Snow Down On Ya, drinking from this fountain is a gamble. Those who do imbibe add or subtract both their Stamina and Luck modifiers from a d24 roll, with results as listed on the opposite page.

The Exorcist’s Gym and Spa

Feeling out of spiritual shape? Want to shed that unwanted wight? Tired of gurus taunting and ancestors haunting? The Exorcist’s Gym and Spa is the resting place for you! Our certified staff of spiritualists will loosen the icy claws of death and help you feel alive again! We’re open 24/7, yes even during the witching hour. You’ll enjoy mana massages, wight-training coaches, rest in peace in our haunt-tub, and our stylists will make your hair stand on end! We are here to serve your everlasting needs.

Unknown Umerica Theatre

Who said that history ended with the Great Cataclysm? Why, it’s just begun! And at Snow Down On Ya, we are proud of our crazy multi-dimensional world! Come enjoy our four-hour-long feature holotheatremagiclantern3Dsmell-o-visionspectacular production of “Unknown Umerica,” where we’ll introduce you to the beauty and sweeping vistas of such grand and mysterious locations as: The Fructose Mines of Iow, The Tower of the Flower of Power, The Valley of the Ice Cream Empress, Aetheria, The Rail Tunnels of the Delphia Beast, and even the (unfairly

INTERESTING PLACES TO DIE

Fountain of Youth Results Table

Result	Effect
1 or under	The drinker instantly ages 10,000 years, possibly leaving a speck of dust or rust in their wake, but probably not.
2	You will live forever. Unfortunately, you will be permanently paralyzed and capable of feeling pain and seeing all around you. You will retain full awareness of everything that might happen to you and be able to do nothing about it but suffer. Forever. As you start to freeze up, you notice the large pile of “stiffs” stacked up in the alley behind the fountain. They are all staring at you. If they could laugh, they would. But they can’t. And neither can you.
3	The drinker instantly ages 100 years. Dead? Not to worry! You will “heal” from this aging at a rate of one year per day, until you return to your “normal” age (well, +100 days). This is true even if aging results in death, with guests effectively resurrecting at an appropriate (though feeble and decrepit) age. If the guest happens to die again while “de-aging” (once they are alive again, of course) the management cannot be held responsible and regrets to inform you that you are now, indeed, permanently dead. “Previously loved” gravestones are available for purchase behind the Bone Soup Café.
4-23	Nothing happens. Maybe you should try drinking some more!
24-26	The drinker becomes 1d4 years younger and gains +1 Sta and +1 Per. Once the drinker returns to the age at which they first drank and experienced this effect, the Sta and Per bonus are lost.
27+	The drinker does not age for the next 1d30 years. Of course, their clothes will go out of fashion.

maligned) Dinotastic Park! It will be like being there, except the Terror-a-Dactyls won’t actually eat you—in fact, you might eat them. In-show catering provided by Buddy O’Burger.

Adventure Hooks

- The party has been hired to protect a film crew for the Unknown Umerica Theatre. The film crew’s equipment is janky and one of their cam bots needs to be convinced that he is not “exploiting the masses” as they journey.
- A cadre of followers of \$ has infiltrated Snow Down On Ya and is attempting to foil any gambling operations. The party has been hired to ferret out these strict traders and stop their efforts.
- A group of radical mutants has hired the party to infiltrate Snow Down On Ya and disable The Clean Baths once and for all.

THE BLESSED SINGING SLEIGH MONASTERY AND GIFT SHOP

Shining brightly on a long stretch of old, lonely highway is a large complex of buildings painted like well-wrapped gifts. An ever-lit neon sign welcomes visitors to “*The Blessed Singing Sleigh Monastery and Gift Shop*” and warns to “Come in peace or don’t come

at all!” Surrounding the compound is a 12 foot tall heavy concrete wall colorfully decorated with lyrics of various hymns of Santa and images of Santa’s ever-watchful all-seeing eye.

The one obvious gate in the wall is painted gold and is embossed with images of cheerful, ever-toiling elves crafting gifts. Those who approach the gate are politely asked their names and their business. Anyone asking for shelter, food, aid, or to shop will be allowed in. Those who seem shifty, are threatening, or are listed on the accursed Naughty List will find the wall is not undefended.

Once inside the compound wall, visitors will find a simple lot to park their vehicle and three buildings facing the lot with large signs: *The Gift Shop of Fine Wares*, *The Temple of Joy*, and *The Monastery Workshop of Toil*. While other buildings can be seen behind these three, no obvious route to access them is visible.

The Gift Shop of Fine Wares

Upon entering the shop the visitor will be serenaded by hymns of Santa playing over the sound system. There are many, well-organized shelves all stocked with new items and refurbished items of all sorts, all in good enough condition to be given as gifts. A monk adorned in traditional fur-lined red robes will welcome them to the shop, give them Santa’s blessing, and help them pick out gifts. The scope of the merchandise consists of

INTERESTING PLACES TO DIE

Gift Shop Wares Table Roll d100, modified by Luck

Result	Item	Cost
1-15	Wind up lantern (20' radius)	5gp
16-40	Survival knife (w/ full kit in the handle)	1gp
41-50	Package of assorted batteries, fully charged	1d4gp
51-60	Solar battery recharger (can recharge one laptop battery in four hours of direct sunlight)	8gp
61-70	Portable burglar alarm (has three sensors that can cover up to a 20' area each, requires batteries)	2gp
71-75	Pair of wind-up shortwave radios	10gp
76-80	Biker jacket with skid plates (2 levels of armor, x3 against vehicle wipeout damage)	5gp
81-85	Lockpicking gun (60% chance to pick normal key entry locks)	10gp
86-90	48 oz. Insulated thermos full of hot cocoa (refills every 24 hours)	10gp
91-95	A 1' sq. plate of ice that will never melt	20gp
96-98	A bright red sack that will hold up to 100 lbs. of goods but never weighs more than 1 lb.	20gp
99+	A Santa hat with attached white beard (+4 to Fort saves vs. cold, regenerates one point of Luck per week worn)	30gp

common tools and items most folks would like to have and a few rare “gems” of high value. Roll 1d4 times on the table above to determine the nature of some of the rarer items. All items are priced a bit on the high side but each purchase comes with exquisite gift wrapping, at no extra charge, and a plastic shopping bag to carry it in.

The Temple of X-mas Joy

Those entering the temple are dazzled by the bewildering array of wall-to-wall decorations. Every inch of it sparkles with gleaming blessed tinsel and iconography of Santa and his legendary stories. Visitors will be welcomed by a monk adorned in traditional fur-lined red robes and beckoned to enter. There, visitors can be regaled by stories of Santa’s fabled adventures, listen to the choir sing hymns of Santa, partake of the cookie feast (given freely), receive medical aid (given freely), or rest in the common room sleeping area (freely offered). Those that require significant beneficence will be asked to return the favor, usually by delivering a particular gift or set of gifts to a location no more than a few days travel from the monastery. Those that refuse or do not properly deliver the gifts risk the Santa’s wrath, the least of which will be to add them to the Naughty List.

The Monastery Workshop of Toil

Those approaching this building will hear the sounds of hundreds of tools being used and then be intercepted by a monk adorned in traditional fur-lined red robes. They will be told the building is off limits to visitors and gently prompted to head into the temple or gift

shop. If one of the visitors is deeply devoted to Santa (a cleric or otherwise) or if a visitor with exceptional craft/technical skills offers their services, the visitors will be escorted to a small section of the workshop and allowed to craft whatever gifts they wish with the materials provided. Good quality food and lodging will be offered to the group for their services. All gifts created will belong to the monastery and most likely end up in the gift shop for purchase. At no time will any visitor be allowed to wander freely in the workshop, outside of the small section they were led too.

The Main Workshop

Anyone sneaking into or otherwise viewing the main sections of the workshop will see hundreds of moaning humanoids with coal-black skin laboring to create gifts and items of all kinds. Each humanoid bears a glowing “NAUGHTY” sign ever-burning on their backs. They are overseen by monks adorned in traditional fur-lined red robes who ply whips and other cruel punishments to keep them working. In addition, there will be at least one tiny, sparkling being walking around that greatly resembles the pictures of one of Santa’s elves. The sparkling elves will be constantly checking off items on a seemingly endless checklist.

If discovered, the trespasser or trespassers will be soundly scolded by the elves, resulting in suffering a -1 die step to all actions for the next 2d3 days, and be ejected from the monastery. Those so ejected may not return and will not receive any gifts from Santa for the next year.

INTERESTING PLACES TO DIE



Should the trespassers become violent, the monks and elves will use force to subdue them. If the trespassers do not escape, they will be converted into coal slaves and forced to work in the factory for 1d5 years plus one year for each person they injured or killed in the fight. Once released, they will have no true memories of being a coal slave, just painful fragments of a horrific existence to haunt them and keep them from being Naughty again.

Monk of Santa: Init +1; Atk tinsel lash +1 melee (1d6, range 10') or candy-cane dart +2 missile (1d4, range 10/20/30); AC 11; Armor Dice: [1d3]; HD 1d8; MV 40'; Act 1d20; SP detect naughty or nice 30', command lightstrings; SV Fort +1, Ref +1, Will +3; AL L.

Command lightstrings - Anywhere within the monastery buildings a monk can use an action to cause some of the numerous strings of festive lights to animate and attempt to entangle a target. The target must make a Reflex save (DC 13) or become Entangled (USG, pg 101). To break free, a target must make a Strength check (DC 11) or be cut loose. A monk does not need to concentrate to maintain the entanglement.

Sparkle Elf Overseer: Init +3; Atk clipboard bash +3 melee (1d3); AC 13; Armor Dice: [1d3]; HD 3d6+3; MV 50' fly; Act 2d20; SP detect naughty or nice 120', scold, coal curse; SV Fort +3, Ref +3, Will +3; AL L.

Coal curse - A subdued or bound victim may be ritually transformed into a coal slave, but only if they are on the Naughty List. This takes a full turn and fails if interrupted. They can also reverse this curse.

Scold - As an action, a glitter elf can berate a target, forcing them to make a Willpower save (DC 14) or suffer crippling guilt inflicting a -1d penalty to all actions for 2d6 hours. The duration can be increased by further scold actions.

Adventure Hooks:

- The party finds an injured pilgrim by the side of an old highway. She says she was attacked and barely got away. She asks to be escorted several miles up the road to a sanctuary (the monastery). If the party does so without requiring payment, they will receive 5d4gp in credit at the gift shop.

INTERESTING PLACES TO DIE

- While traveling, Lawfully aligned members of the party hear the sounds of a Santa hymn that turns into a message: “*Come hither all good boys and girls to aid in the defense of my clergy. Come bar the Naughty from entering the cozy warmth of my hearth!*” Those that hear the message will know how to find the monastery in time to help defend it from a large raider attack.
- Unknowingly (yeah, right), the party has defiled a site belonging to Santa. They are informed by a red robed messenger that they must trek to a nearby monastery dedicated to Santa to be given a quest as penance. Refusal will result in being put on the Naughty List, permanently.

THE MURMURING MOUNTAIN SAGES OF DAKOTA

Tales are told of a place that has answers to every question, if you are patient enough to wait. They tell of a crowd sitting before a strange mountain with four faces that whisper, mutter, and mumble all of the secrets of the universe. The cult there cares for the mountain and collects the questions from all who visit. Then, the visitor needs only to wait until they hear the answer they are longing for, assuming they can discern it from among all of the other answers.

A Tale of a True Believer

“I still recall the first time I laid eyes on the Mountain Oracles. My new wife and I met the Magi of the sages just after we married. I approached the dias and asked ‘How do I best prepare my wife for the future?’ Not moments after I spoke, one of them looked at my wife and said ‘2 pound sugar, 1 quart molasses, 2 quarts vinegar, and 5 pounds salt, mix ingredients in a large container, filling the remainder with water. Marinate for 1-3 days, remove and let dry for 8 hours, slow cook in a sealed container for 24 hours, slice thin and serve with parsley garnish.’ Now, most days I miss my wife, but I use that recipe to this day. The Oracles changed my life. I’m a believer.”

—Donald MacDoogie, Buddy O’Burger Franchise Priest

The Magi

The magi of the Murmuring Mountain Sages, or simply the Murmuring Mountain Magi, are the priesthoods who maintain the area around the sages, collect and process donations, offer assistance interpreting the

wisdom of the sages, and write down everything the sages say for later interpretation. The magi are made up mostly of visitors who chose to stay, and are led by an ageless head magi who is blessed by the Sages. The magi age differently than most, and those that remain longer don’t always experience time the same way. Some magi age decades over the course of a few weeks, while others suffer only the passing of days over the years, or even leave younger than they arrived. The head magi has had time stop affecting them completely, though this only lasts for their tenure, which may last anywhere from days to years.

There are actually four sects of the magi, each believing their chosen sage is the key sage, and that interpreting the murmurings through the words of their sage will lead to true understanding. However, none of the sects discredit the other sages, as their words are wisdom too. There is a mutual respect among the sects, who share supplies and the duties of maintaining the sages, the surrounding area, and the gift shop—though some sects specialize in specific duties based on their core beliefs. The magi together maintain the dias and donation box as well so that any may approach the sages and ask questions. However, each sect writes down the murmurings of the sages, offering a chance to examine them and help interpret them for a small donation.

Each sect has a core belief that revolves around their sage’s sayings, and works into some of the jobs each sect tends towards. The Shing sect focuses on cleaning and maintaining the man-made areas of the sage’s camp, as well as the sages themselves. The Rose sect focuses on maintaining the plants, both farming and gardening, providing food as well as beauty to the camp. The Link sect focuses on promoting unity among the sects as well as producing for the gift shop and managing money, and are the most peaceful sect. The Merson sect focuses on protecting the sages and the magi, and are the most aggressive sect. These core beliefs also tend to color their interpretations of the murmurings of the sages, and it is not unusual to find magi from different sects discussing the murmurings over a meal or while performing other duties.

Those that study the words of the sages have been known to be more drastically affected by time oddities, be they magi or visitors simply reading the murmurs. It is not unheard of for a student to find they have

INTERESTING PLACES TO DIE

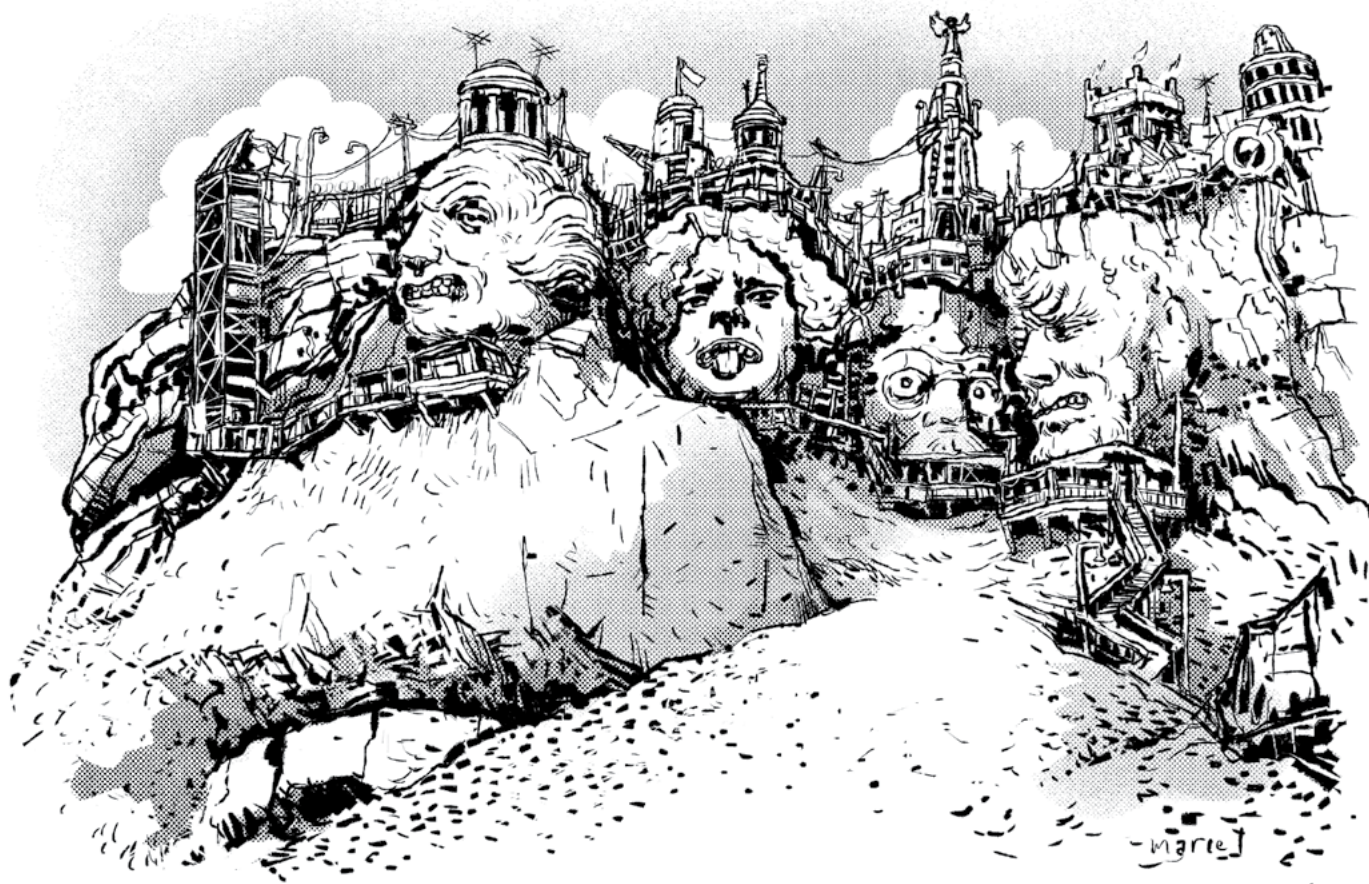

stopped aging entirely. When such a student is found, they are presumed to be blessed by their sage and are christened leader of their magi sect. There are always four ageless magi leaders, and when a new one stops aging, the old one starts aging, often wildly. There seems to be no real pattern to who stops aging, only that the magi will not allow their new blessed leader to leave. The phrase “our leader is tied up right now” is quite literal for the magi; unwilling leaders find they can do little till their time as a blessed leader passes, they accept their new path, or they die from being detained.

The Sages

The Murmuring Mountain Sages stand mounted majestically as a mountainside monolith monitoring the Mountain Magi as they mumble mysterious musings to the meandering masses. These monolithic stone monuments murmur a myriad of musings that magnify off the mountainside to mesmerise the masses of magi and migrants that matriculate to the mountain base. These giant stone heads protrude from the mountainside and project their voices throughout the valley below as they murmur answers to questions

asked throughout the ages. These murmured words of wisdom speak not only to those asking questions, but to each other. To many, it may simply seem like the rambling of old wise men, but the magi believe that time holds no bounds to these sages, and they answer questions asked in their own time. These moving mountainous heads move madly, looking at spaces that are often vacant and answering questions that no one asked. However, not all answers and actions seem random. Occasionally a sage may answer a question directly; or discuss a question with another sage. The magi looking through their recorded murmurs find that they sometimes don't converse in order, and have even been known to answer questions before they have been asked.

Getting too close to the sages is dangerous, as their erratic movements occasionally cause stray rocks to fly, and those who have climbed the sages have been known to get crushed or thrown off by a surprise movement. A small assortment of bones line the basin below the mountain sages, as the magi leave them as offerings for their sage's wisdom, though they will try to clean off the blood and recover valuables for trade

INTERESTING PLACES TO DIE

in the gift shop. Before the sages is a large marble dais, with room for many to approach the sages and shout their questions. Mounted on polls are megaphones used to project questions to the sages, as well as benches to wait for an answer.

The Camp

In the valley below, besides the great dais and gift shop, are the camps of the magi and others who have settled here. Those who wish to study the murmurings of the sages may approach the magi here in hopes of pouring over the musings of the four sages. Donations are collected and pooled by the sects to help pay for supplies plus maintain the dais and surrounding valley. Merson-sect soldiers patrol the camps and the surroundings to keep away many of the dangers of the wastes, as well as to keep order near the sages.

The gift shop is run by the Link sect, who manufactures likenesses of the sages, as well as small recording devices visitors can use to record small parts of what the sages say, t-shirts of some of the more famous proclamations of the sages, and a variety of snacks. It sits above the camp on the stairs just below the dais.

Non-magi who settle in the camp can make lives for themselves as well. The magi accept help in the care of the sages, as well as having need for those who can build and maintain for the families that inevitably end up staying. Fatigue and mental illness is not uncommon for those who settle into the camp, for the constant murmuring of the sages rarely pauses, and the constant noise can take its toll on the less fortunate, as can the oddities of the flow of time which, while not as pronounced, can affect those in camp in strange ways. As a great wonder, there are a lot of visitors, which leads to a lot of trade, but the market of the camp can vary greatly, as few come explicitly just to trade.

Adventure Hooks

- A wealthy trader seeks advice of the Murmuring Mountain Sages and hires the party to bring him and help figure out what they say.
- The party is hired by someone to rescue their significant other, who has been named Blessed Leader of one of the sects.
- One of the party members has drawn the ire of all the sects when one of the sages gazed at them and said, "Death to the Infidel."

THE TEMPLE CAVERNS OF THE HOWLING GOD

In the western parts of Umerica there are a series of mesas that conceal a system of caverns strung throughout the area. The land there is quite rough, so few choose to traverse it but those that have speak of a strange cult that lives within those caves and of their "God" which seems to often fill the mesas with echoing bellows of anger. None of the storytellers have ever reported seeing the god but every one of them will tell a tale of its rageful wails. The only reason some merchants and wanderers choose to go near the place is that the cult is friendly and they grow abundant crops in small farming patches laced throughout the mesas. Plus, the howling scares most monsters out of the area.

The Caverns

While the cave system has many entrances, none of them are more than roughly eight feet wide. Most of the ways in and out have been refined with various crude stairways and climbing paths built by the cult's ancestors. Most of the caves near the entrances are used as living quarters with caves farther in being used for storage. The caves in the center of the system are the god's domain.

There is little-to-no technology in the caves as the cult's ancestors maintain that technology was the cause of the Great Cataclysm. The cultists are not actually technophobic but none of them have had much of any exposure to such things and thus have no desire for it.

The "God"

The "Great Worm God" is actually a sentient, technically advanced, annelid scientist named Fubbdurbub who is from another dimension and is now trapped in these caverns. It was experimenting with an interdimensional gate when there was an accident. It was ripped free from its exo-limb harness and deposited here. Due to its size, it cannot squeeze through any of the cavern system's exits.

Fubbdurbub is best described as a truly massive segmented worm with a multitude of phalanges around its body. As Fubbdurbub's species has advanced beyond the need for physical labor, it is physically unable to do more than crawl around. Its natural regenerative properties render its gigantic orange body relatively immune to terrestrial weaponry.

INTERESTING PLACES TO DIE



Fubbdurbub has attempted many times to telepathically communicate with the humanoid it has encountered but no matter how gentle it is they all just suffer messy cranial explosions. As such, it has resorted to verbal communications with limited success. The cult that now worships Fubbdurbub as a god tries to interpret the universal symbo-speak it uses as best they can but rarely is it correct. Note that Fubbdurbub can easily understand any spoken communication so it is infuriatingly aware that the cult does not understand its words.

While Fubbdurbub's telepathic powers are quite detrimental to all humanoid life, it can use various psychometabolic powers to heal most humanoid diseases, disorders, and injuries. Should it feel threatened or need to defend its inept cult, Fubbdurbub can use its psionic abilities to inflict swaths of catastrophic bodily harm out to a range of 1000' (Fortitude save DC 20 or die).

Should someone find a way to properly communicate with Fubbdurbub, it will be utterly thrilled and offer any amount of advanced scientific expertise in return

for help with gathering materials and assembling a dimensional gate so it can go home.

The Cult

The original inhabitants of the caverns were horrified when Fubbdurbub first appeared in their home. Their attitudes changed quickly and they began to revere it when it used its psionic powers to heal the sick and injured. Their faith was further strengthened when their god destroyed an entire invading raider gang with its mind.

Now they devote themselves to bringing food to their god from their prosperous farm (giant worm poop makes great fertilizer), adhering to ridiculously complex worship rituals, and acting on their god's wishes, as they understand them. The current translation of Fubbdurbub's most recent statement shapes the cult's daily activities and how they interact with anyone they encounter. Roll 1d12 twice, once for what was said and once for how it was interpreted by the cult:

INTERESTING PLACES TO DIE

Worm God Translation Table

Roll	What <i>Fubbdurbub</i> actually said...	How the cult interpretes it...
1	“I’m really tired of eating the vegg and fungi and such you bring before me! Can’t you find some decent processed food? I’d love some cheese burgers!”	The great one must meditate! Everyone be quiet for the next day. Death to anyone in the area that so much as utters a peep!
2	“Look, the natural foods you are bringing me are making me incontinent! That is why I’m pooping all over the place! Stop trying to ‘read omens’ from my droppings and just clean it up!”	The great one is hungry! We must gather the crops and prepare a banquet! We must gather and forage from the land for every natural delicacy! As always, do not bring any of the unholy foods of the cataclysm into the caves!
3	“I understand that you are grateful for my protection and healing but, PLEASE STOP SINGING ALL THE TIME!!!!!!”	The great one mourns for the world and the suffering caused by the Great Cataclysm! We must sing day and night to appease its suffering. All who enter our lands must SING!
4	“Please bring me any technology you can find so I can craft a gate to return home.”	The great one feels the corruption of the cataclysm approaching! Drive all outsiders from the land! Cleanse the land!
5	“I do not want to be worshiped! This is just a mutual exchange of services: I help you survive, you help me go home!”	The great one wishes a great sacrifice! Look throughout the land for something special to bring before our god!
6	“Stop trying to recruit new members from raider gangs you run into! They just end up seeing you as prey and then I have to kill them!”	The great one commands us to proselytize in its name! We must speak to all who travel through the land and get them to join us!
7	“Candy. I miss candy. I would kill for something synthetic and sweet right now!”	The great one wants but we know not what! Mourn and cry for we are unworthy and ignorant.
8	“Wait! I sense some of O’Burger worshipers nearby! Go find them and bring them here so they can cook me something palitalbe to eat!”	A rival cult that wishes to harm the great one approaches! We must shore up our defences and speak to no one!
9	“You know, you all would not need so much daily healing if you bathed regularly and stopped treating my bodily secretions as holy ointments.”	The great one wishes that we anoint ourselves to be more like it! We must go out into the land and crawl to show its greatness!
10	“Oh higher beings of this world, please send me someone competent to help me!”	The great one wails to the heavens for us! Prepare for the blessings that are sure to come soon! Look for the blessings throughout the land!
11	“Leave me alone! I’m sulking!”	The great one is displeased! We must atone for our sins! Let each one of us go into the land and atone in their own way.
12	“I have so much wisdom I could share if you would JUST LISTEN!”	Hark, the great one wishes to share his wisdom with us, its faithful flock! Let us do nothing but listen to its wisdom until the sunrise! No talking, or eating , or anything! JUST LISTEN!

Adventure Hooks

- While settling down for the night near the outcropping of some steep cliffs, the party’s rest is disturbed by resounding howls and roars coming from within the mesas themselves. What giant, horrible beast could be making such sounds!
- The party has come across a merchant caravan limping home from a bad encounter with a roving gang. Since there is strength in numbers,

the merchant offers food in exchange for protection as they take a “safe detour” through a group of nearby mesas.

- The party was told that the answers they seek about a high-tech treasure can be found by seeking an alien sage hiding among a chain of mesas to the west. Also, they must gather an offering of ancient, pre-cataclysmic delicacies as an offering.

INTERESTING PLACES TO DIE

TOM STAMENS – UMERICA'S CUSTOM VAN DEALER

Located directly off the bypass of a winding country road that no one has ever heard of, is Tom Stamens' Custom Vans. A mysterious sales lot that never seems to have any traffic and yet somehow does a steady trade in customized vehicles.

Tom Stamens

Appearing to be some form of twisted hybrid between man and vineconda, Tom Stamens' thorn and flower covered form writhes with unnatural flexibility. His serpentine features lend him a massive, ear-to-ear grin which hardly ever leaves his face as he pontificates on the superiority of his custom vans and the wisdom of buying direct from the manufacturing plant rather than some scrapyard builder.

When waxing on the features of a given vehicle, Stamens repeatedly bangs his fist down on the hood to emphasize his points. Although the hoods will dent from his abusive, if emphatic, soliloquy they always work themselves out moments later. So quickly in fact, that Tom Stamens doesn't even notice—even if the vans themselves do.

In reality, the lot is a breeding ground for autovores, carefully upgraded and trained by Tom Stamens to blend in with their surroundings and to use their "owners" to give them increased opportunities for hunting.

The Manufacturing Plant

Tom Stamens is perfectly happy to give newcomers a tour of the manufacturing plant, the place where the "magic happens." This massive facility is filled with custom vans in various states of assemblage. Most appear to be quite far from completion, although one or two are being lovingly buffed to a factory finish as visitors are shown through.

The workmen here move back and forth, giving the appearance of being hard at work, despite no real work being done here. This location is merely for show, to help sell the idea of Tom Stamens' dream to those who might be seeking to upgrade their ride and travel in comfort. Those looking closely at the vehicles tucked towards the back may notice the dust, cobwebs, and detritus that has built up on the set pieces that aren't up front and center stage.

The completed vehicles though, are ready to roll off the lot—with or without a buyer. These will be 1d3 custom autovores brought in from the lot in advance of the arrival of any outsiders.

The Lot

The sales lot hosts 1d5+10 "vans" (Custom autovores) at any given time. Tom Stamens will proudly show off their features as well as fine appearance—happily giving potential buyers the full sales pitch that he is renowned for (shouting, pounding on the hood, waxing grandiloquent about the van's features) while trying to gauge how much the buyer's can afford. A good judge of character, Tom Stamens' can estimate a price to within 5% of the buyer's total available spending power—which is generally still quite a bargain.

In the case of an attack, Tom will rush to the hatchery and load what young autovores he can into his personal autovoric vehicle and rush them away to safety. Should the worst happen, his backup plan is to reopen in a new location, under a new name, while placing a bounty on the heads of the attackers.

Scrapyard

Tucked in the back of the property, accessible only by a small gravel road that winds through a dense copse of trees and up to a massive pair of locked gates, is the scrapyard. The entirety of the maze-like area is surrounded by a tall wall of corrugated metal, which has large patches on it where it looks as something has tried to eat its way through from the outside.

Feeding young autovores takes a great deal of scrap materials, and this is Tom Stamens' supply for those too young, or feeble, to hunt on their own. Containing well over 50,000sp worth of vehicle chassis and parts, it is rare that outsiders are allowed to know of the scrapyard's existence, let alone go picking for parts. If word were to get out of the quantity of scrap held here, this location would become a major target and could bring more hazard than Tom Stamens and his "associates" could handle. Still, particularly trusted individuals (or those with an incredibly strong working relationship with the lot) have been known to trade large amounts of scrap parts for particularly choice parts. Those individuals guard their knowledge of this secret local quite closely.

The scrapyard is also infested by a small number of miniature autovores, each about twelve-inches long

INTERESTING PLACES TO DIE

and having a long antenna growing from their backs. These reduced capacity (RC for short) autovores are harmless pests, chewing up scrap (and, on occasion, the perimeter wall), posing little threat. Unless cornered, they commonly scatter when approached.

Autovore, RC (scrapyard scavenger): Init +5; Atk bite +3 melee (1d2); AC 11; Armor Die nil; HD 1d4; MV 50'; SP toy camouflage, voracious regeneration, lazy; SV Fort +0, Ref +1, Will NA; AL C.

Toy camouflage: When stationary, RC autovores are indistinguishable from radio-controlled toys (Intelligence check DC 17). Even when moving, their tiny little growls sound much akin to the battery powered motors of ancient toys and for those familiar with such things, are still easily mistaken for their non-living counterparts (Intelligence check DC 12).

These creatures are highly prized by toycubim, and Elmos' demonic servants will offer great rewards in return for the ability to have wheels of their own. Whether or not they deliver on such promises is another matter entirely.

The Hatchery

Behind the manufacturing plant, an outbuilding marked "Private" holds the autovoric hatchery. Sealed with a simple padlock to keep outsiders out while attempting to not raise too much suspicion, there are 1d3 immature autovore vans from each age category, gestating here at any given time. Once fully formed, they are customized and trained before being moved out onto the lot to rest alongside their kindred. Intrusion into this building will bring the full wrath of the lot down upon the interlopers with every vehicle on the lot racing to slay those who threaten the young autovores. Treat immature autovores as standard with the following modifications.

Newborn (0-1 month): Init -5; No attack; AC 8; Armor Die nil; HD 1d4; MV 10'; Act 1d14; SP none; SV Fort +0, Ref +1, Will NA; AL C.

Infant (1-12 months): Init -4; No attack; AC 9; Armor Die: nil; HD 2d5; MV 15'; Act 1d14; SP none; SV Fort +0, Ref +0, Will NA; AL C.

Child (1-2 years): Init -2; Attack bite +2 melee (1d5+1); AC 10; Armor Die: [1d3]; HD 4d7; MV 30'; Act 1d16; SP none; SV Fort +1, Ref +1, Will NA; AL C.



Adolescent (2-4 years): Init -0; rundown +3 melee (1d8+Ram bonus), bite +4 melee (2d5+2), tire slam +3 (2d3+1); AC 11; Armor Die: [1d4]; HD 6d10; MV 40' in melee combat, otherwise Speed Level cruise 2/ max 4; Act 1d20; SV Fort +3, Ref +1, Will NA; AL C.

Customized Autovores

Once reaching maturity, Tom Stamens' customized autovores all appear as 1970's style Custom vans—complete with side art carefully etched and painted into the sides of the creatures.

Autovore, Custom (cannibal car creature): Init +1; Atk rundown +6 melee (2d8+Ram bonus), bite +6 melee (3d5+3), tire slam +6 (3d3+2); AC 12; Armor Die: [1d5]; HD 7d12; MV 40' in melee combat, otherwise Speed Level cruise 4/ max 6; Act 1d20+1d16; SP improved vehicle camouflage, track exhaust, EMP pulse, upgraded, voracious regeneration, lazy; SV Fort +4, Ref +2, Will NA; AL C.

Improved vehicle camouflage: So perfectly adapted

INTERESTING PLACES TO DIE

to their environment are these creatures that it is nearly impossible to discern them from their automotive counterparts. At a casual glance they are indistinguishable and if specifically looking for them, they may only be spotted with great care and scrutiny (Intelligence check DC 20).

Upgraded: In addition to the extra cargo Trait (allowing the autovores to actually carry up to six passengers), Custom autovores may be outfitted with up to two external vehicle Traits (GM's discretion).

Adventure Hooks

- The party has been sent to pick up a customized van, but a third party already has their sight set on claiming the vehicular masterwork for themselves.
- Low on gas and in need of repair, the party finds themselves on a winding road before coming across the lot. The quality of the vehicles beggars belief, but what is the real cost to be paid.
- A badly wounded V.E.T.T. is leaking fluids out onto the road as it expires. It shows signs of having

been brutally attacked by multiple assailants. The only clues as to what fearsome creatures could have done this is a trail of fluids leading back to a strange sales lot in the middle of nowhere.

VALLEY OF THE ICECREAM EMPRESS

Hidden between tall hills, somewhere south of the Ruins of Delpha, lays a wonderland of frozen treats and terrors. Travelers know they are close when an unnaturally cold breeze, scented with rich sweetness, drifts their way. At the border the very ground changes from "normal" to delectable in a matter of a few dozen yards. The land ahead is a chilly wonderland molded from frozen treats. Outcroppings of rock become hard fudge, rivers become flows of various sundae toppings, trees transform from wood to various crunchy cookies, barren dirt becomes ice cream of many flavors, and grass gives way to fields of toasted coconut. All forms of velvety, frigid delights dot the terrain, bewildering the senses. Everything here is quite edible, assuming you can stomach large quantities of sugar. Yet not all that is sweet and scrumptious is safe ...



INTERESTING PLACES TO DIE

Valley Encounter Table

Roll	Result
0-8	No encounter
9-10	Non-hostile Valleyfolk Foragers (# encountered: 2d4) - Will be interested in news from the outside and possibly even trading, if done under cover. Possible trade goods, roll 1d4: 1 - exotic furs; 2 - exotic herbs; 3 - local foraged foods; 4 - roll on Table B4: Umerica Random Equipment (USG pg 50).
11	Ornery Valleyfolk Travelers (# encountered: 2d4) - They want nothing to do with outsiders but will not start hostilities unless threatened. Valleyfolk: Init +0; Atk club +1 melee (1d4+1 cold); AC 10; HD 1d5; Armor Die nil; MV 20'; Act 1d20; SP immune to cold, 2x damage from fire; SV Fort +1, Ref +0, Will +0; AL N.
12	Valleyfolk Village (# encountered: 4d8+4 villagers) - Have the most charismatic character roll a Personality check (DC 10). If successful, the village is non-hostile towards the party, otherwise they are ornery and will call for ranger assistance (three Royal Treat Rangers will arrive in 2d6 turns).
13	Royal Treat Rangers Patrol (# encountered: 3) - Candy shelled warriors loyal to the empress that will attempt to capture any intruders on their land. They travel in groups of three. There is a 30% chance they will be led by a ranger captain. Royal Treat Ranger: Init +2; Atk icypop swords +2 melee (1d6+1d4 cold) or net +3 missile (grapple STR 14); AC 12; HD 1d8; Armor Die 1d4; MV 20'; Act 1d20; SP immune to cold, 2x damage from fire; SV Fort +2, Ref +2, Will +0; AL L. Royal Treat Ranger Captain: Init +4; Atk icypop sword +4 melee (1d6+1d4 cold) or sprinkle scattergun +5 missile (2d6, range 20/40/60); AC 13; HD 2d8; Armor Die 1d5; MV 20'; Act 1d20; SP immune to cold, 2x damage from fire; SV Fort +3, Ref +3, Will +1; AL L.
14-15	Sinksprinkle patch (# encountered: 1) - What looks to be a stretch of ground coated with sprinkles is actually a natural sinking hazard similar to quicksand. Anyone stepping into it will begin sinking 1d3 feet per round until they are fully engulfed. A Strength check (DC 13) is required to break free. Each non-sinking person helping adds +3 to the check. Those that are fully engulfed must make a Fortitude save (DC 10 + # of rounds engulfed) or begin to Drown (USG pg 101).
16	Fruiti-slush Ooze (# encountered: 1) - This predatory protoplasm is hunting for fresh, juicy prey and much prefers outsiders to the locals. For Stat block see TTM pg 83.
17-19	ChocoWolves (# encountered: 1d6) - Ravenous wolflike animals with thick chocolate flake fur. Use of obvious fire may route them, Willpower save DC 10. ChocoWolf: Init +3; Atk bite +2 melee (1d4); AC 12; HD 1d6; Armor Die nil; MV 40'; Act 1d20; SP immune to cold; SV Fort +4, Ref +2, Will +1; AL N.
20+	Gumdrop Owlbear (# encountered: 1) - These hairless predators are brightly colored and emanate the sweet scent of fruity goodness to lure in prey. When possible, it will stealthily climb a tree and drop on its prey, gaining surprise and a +1d to its attack and damage on the first round. Gumdrop Owlbear: Init +1; Atk bite +6 melee (1d6+2) or claw +4 melee (1d4); AC 11; HD 3d8; Armor Die 1d8; MV 20' or climb 10'; Act 2d20; SP spell resistance 25%, immune to cold, ½ damage from bludgeoning weapons; SV Fort +4, Ref +1, Will +8; AL C.

The valley is a wild and savage place. It is also quite cold with temperatures well below freezing year round. Fortitude saves (DC 11) are necessary every 30 minutes for those not properly clothed for winter weather. Also, many hungry beasts roam here looking to devour travelers and locals alike. The difference from other lands is that all of the valley's inhabitants are frozen dessert analogues of beasts and peoples. Their skin looks pale and creamy. Their hair or fur appears to be

one of many sundae toppings. Their eyes are emotive crystal candies. The unusual makeup of their biology seems to have no bearing on their might, vigor, speed, or dietary habits. They are well accustomed to the cold climate, to the point that many creatures here are vulnerable to heat and fire. In fact, all of the local citizenry and many of the beasts will quickly perish from melting should they leave the frosty borders of this land.

INTERESTING PLACES TO DIE

Each hour spent wandering in the valley a random encounter check must be made. Roll 1d20, minus the lowest Luck Mod in the party, and consult the table on the previous page.

This land is ruled by the cruel IceCream Empress, who hates the outside world. For that matter, she hates her own realm as well and oppresses her people for amusement. Luckily, the empress never seems to leave her icy castle, located in the middle of the valley. Most of the citizenry has never seen her and opinions on her appearance are a popular subject of gossip, when her minions are not around. Her Royal Treat Rangers randomly patrol the valley, enforcing the empress' will and many conflicting rules. This leaves the citizenry downtrodden and wary.

This is not to say that the locals are unwilling to show hospitality or trade with their meaty neighbours, as long as such encounters are kept clandestine from their cruel ruler. Long ago the empress decreed that aiding or trading with the meaty folk was punishable by banishment, which means a slow, melty death.

Since most of the landscape is constructed of edible sweets, harvesting uncontaminated foodstuffs from the valley is not difficult at all. The trick is keeping them cold as they all will melt or spoil quickly once removed from the valley, usually within a few hours. This will require refrigeration units or powerful magics.

The greatest danger to any outsider that dares to wander the valley is not the wild beasts, ranger patrols, or even the empress herself. It is the fact that any outsiders or animals that wander too far or long in the Ice Cream Empress' realm risk transforming permanently into a living frosty confection themselves. Each day spent in

the valley requires an outsider to make a Willpower save (DC 12) against the curse. Every day the save is failed, the outsider will take on more features like the local citizenry of the valley. After five failed saves, the being is permanently transformed into a frozen dessert analogue of themselves. The only known cure for those not fully transformed is to spend at least one month away from the valley for every save that failed.

Adventure Hooks:

- The party has been offered a guard job by Sweet Sam, a rich merchant that sells frozen sweet treats along the east coast of Umerica. The pay is good due to the fact they have to swear not to reveal Sam's secret: he leads regular covert expeditions into the Valley of the IceCream Empress to harvest frozen treats. Also, Sam has made one too many ventures into the valley and is on the verge of falling victim to the curse.
- The party is hot on the heels of a new raider gang that has been terrorizing the local communities. They have been well paid to make the new gang "disappear." The chase leads them into a valley that turns strange and cold very quickly as the gang uses their bikes' maneuverability to plunge into a delicious smelling dense forest.
- The church of the most holy Buddy O'Burger has contracted the group to escort one of their clergy members to a "fantastical land of frozen confections" so they can install some "gatestones." Despite the ridiculousness of the job, the pay is too good to pass up. Besides, how bad could it be?





**ROADSIDE
Attraction
GENERATOR**



ROADSIDE ATTRACTION GENERATOR

ROADSIDE ATTRACTION GENERATOR

Umerica is filled with places to visit, both strange and sundry. GMs may use the following tables to generate any number of twisted and unique places for PCs to stumble across in their travels. All of them could be very interesting places to die. To begin, roll once on each column of Table I and then do the same with the linked tables.

TABLE I: ROADSIDE ATTRACTION & HOOK

Table I: Roadside Attraction & Hook			
Roll (d24)	Type of Site	Hook 1	Hook 2
1-3	Amusement (II)	is surrounded by a	off-road rally
4-5	Art Installation (III)	is hosting a	cannibal, chili cook-off
6-8	Hall of Fame (IV)	is under siege by a	Komo-doan gang
9-10	Battlegrounds (V)	is recovering from an attack by a	dimensional rift
11-12	Memorial (VI)	is haunted by a ghostly	alien army
13-16	Museum (VII)	has declared war upon a	neighboring tribe
17-18	Natural Wonder (VIII)	has mistakenly angered a	doomsday cult
19-20	Residential (IX)	needs to relocate a	religious sect
21-23	[Roll twice and merge]	has declared hunting season on a	collapsing city
24	[Roll twice] ___ & ___	[Roll twice] ___ while it ___	kudzu jungle

HOOK 2

Alien army: Roll 1d5 to determine the majority membership of the force: (1) scorpionoid, (2) sharkhana, (3) un-men, (4) xeno-locusts, (5) xenotaur. The army will be made up of a minimum of 1d3 x100 members.

Cannibal, chili cook-off: The cannibals will only eat their own sort and the judges, entrants, and entrees are all human. They will not cook and eat any other intelligent beings as “it would be darned uncivilized don’t you know.” Long pig, its what’s on the menu!

Collapsing city: The city literally crumbles by the second, debris falling everywhere. It is inhabited by 10d100 pitiful residents who have managed to eke out a living amidst the chaotic collapse.

Dimensional rift: The rift glows brightly and leads to one of an infinite number of other dimensions. Those who travel through may find themselves in any number of strange places, planets, or tri-harmonic voids at the GM’s discretion. Of course, travel through such rifts is often one way.

Doomsday cult: While many religious groups are peaceful pilgrims or missionaries, this doomsday cult

is not only awaiting the end of the world, they are actively seeking to bring it about through massive blood sacrifice. The cult numbers 2d3+4 members and will be openly welcoming and friendly towards those who cross their paths—until such time as they can start stealing away individuals for their dark rites.

Cultist: Init +1; Atk holy symbol +1 melee (1d3), sacrificial dagger +1 melee (1d5); AC 10; Armor Die 1d3; HD 2d7; MV 30’; Act 1d20; SP immune to fear; SV Fort +0, Ref +0, Will +4; AL C.

Komo-doan gang: This is not a well-established gang that is feared across the wastelands, but a gang of young komo-doans sating their wanderlust. Gangs of this sort, while dangerous, come and go with great frequency in Umerica and if they get killed, will anyone miss them? Of course someone will! The gang numbers 1d24 x5 young komo-doans.

Kudzu jungle: It is rumored that, in the past, kudzu grew at the rate of one foot per day. If only it had such a relaxed growth rate today. The kudzu jungle expands in all directions at a rate of ten feet per day, allowing anyone spending time observing it to discern the movement of the vines as the plant spreads ever

ROADSIDE ATTRACTION GENERATOR

outwards. While greenery might be initially welcomed in the vast wastes, those who celebrate the coming of the green soon realize that what they are looking out upon is a seething mass of green death, strangling and devouring everything in its path.

When initially encountered, the jungle of verdant greenery will encompass 1d4 square miles. Living creatures entering the jungle will immediately be grasped by the vines, with the intent of crushing the life from them to use as fuel for the jungle's continued growth.

Kudzu Jungle: Init +0; Atk vine +5 melee (1d4 + crush); AC 14; Armor Die nil; HD 1d6 per 5' square; MV 0'; Act 6d16; SP astonishing growth, crushing grasp; SV Fort +2, Ref nil, Will immune; AL N

Astonishing growth: The kudzu jungle's growth rate is nearly unstoppable. Obstacles such as stone walls will be overgrown and crumbled to gravel in 1d3 months, wooden structures last a mere 1d10 days before being rent asunder by the heaving mass of vinery. Additionally, the vine is capable of floating on the surface of most fluid bodies, leaving it unhindered by bodies of water or worse, mutagenic materials (now it grows fast and glows in the dark).

Crushing grasp: Targets caught by an attacking kudzu vine must make a DC 7 Fortitude save or be crushed for one point of Stamina damage. Creatures reduced to 0 Stamina are pulped beyond recognition or restoration.

Neighboring tribe: The nearby tribe numbers 5d20 individuals. If independently approached by the party a successful Personality check (DC 18) by the most personable of the party will ensure a neutral to warm welcome. A failure will immediately initiate hostilities.

Off-road rally: The rally will be made up of 2d4 wasteland gangs. PCs with "wheels" must surpass a DC 12 Willpower save or be drawn into the race as a matter of pride.

Religious sect: Worshipers are not, themselves, inherently dangerous beyond the strictures of their faith. Groups of this sort—smaller sects removed from the primary path of worship of their faith—differ in small ways from the primary religious adherences enough that other worshipers may recognize them as anything from sadly mistaken to raging heretics in need of being cleansed from Umerica through divine nuclear fires.

The body of worshipers has 3d5 members. Roll 1d24 to determine their faith (1)\$; (2) Buddy O' Burger; (3) Classica; (4) The Demon King of Speed; (5) Elmos; (6) Grokk; (7) Kizz; (8) The Lords of Light; (9) Nuka; (10) Petrolex; (11) S'aganoid; (12) Santa; (13) Silk; (14) Technos Discos; (15) Theszolokomodra; (16) The Ultimospark; (17) Whaaar!; (18-19) Yyaallaayy; (20-21) an unknown trans-dimensional being; (22-23) minor local deity (such as Ssslami or others); (24) that rock over there.

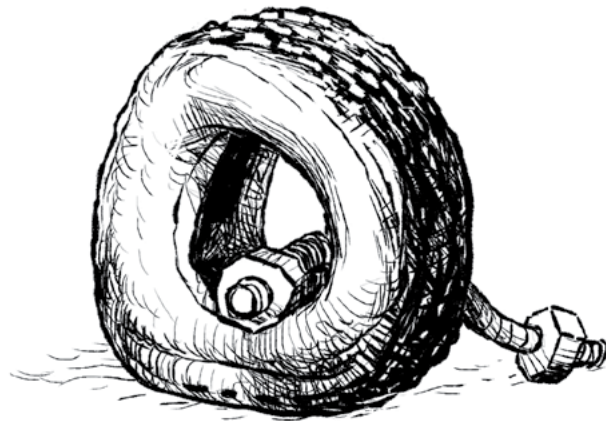

ROADSIDE ATTRACTION GENERATOR

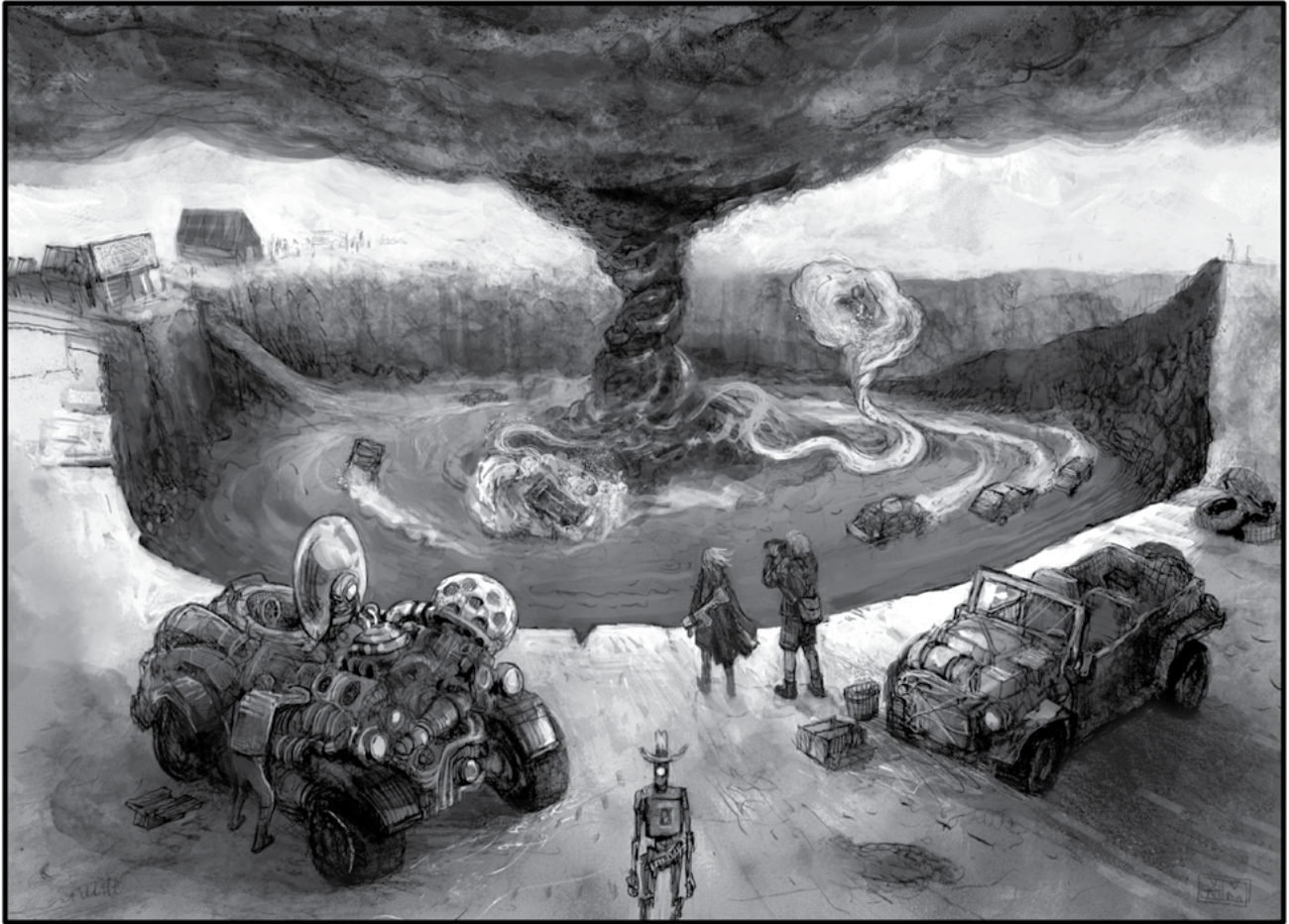

TABLE II: AMUSEMENT LOCATION

Amusement locations are the brightly colored and lit pitcher plants luring traveling families to their economic regret. Seldom living up to the hype, these locations offer a variety of pastimes that provide some level of diversion for the road-weary traveler.

Table II: Amusement Location

Roll (d24)	Name 1	Name 2	Type of Site
1	Spectacular	River	Amusement Park
2-3	Screaming	Merle's	Aquarium
4	Grungetacular	King's	Campgrounds
5-7	Heavenly	Demon's	Carnival
8-9	Whispering	Lake	Circus
10	Splendifous	Imperial	Freakshow
11-13	Sunken	Devil's	Marina
14-15	Worrisome	Mutant	Observatory
16-18	Burning	Queen's	Pleasure Palace
19-20	Hell	Gugleplx	Arcade
21	Ozeptabular	Hole	Resort
22-24	Lightning	Flats	Speedway

ROADSIDE ATTRACTION GENERATOR

TYPE OF SITE

Amusement Park: These rare locations host a number of mechanical ride-based attractions ranging from thrill-rides to simpler children's attractions and shops. Spending a day in a park restores 1HD of health and costs 4d30sp to enter and another 2d20sp for drinks and souvenirs.

Aquarium: Tanks ranging from the miniscule to the gargantuan hold a massive biodiversity of aquatic life. The dark confines of the building are a perfect place to carry out secret meetings, trade contraband, or just look at the pretty fish. Entering an aquarium costs 10sp ("Free on the 3rd Tuesday of every 4th month!").

Arcade: No matter the name of the arcade, they all use the same basic metal tokens emblazoned with the "Laddy's Castle" name and logo (four shiny metal tokens for 1sp). The amusement area is filled with rows of all sorts of wondrous machines. A cacophony of sounds mixes with an assortment of flashing lights, clicking ticket machines, and near zombified patrons. Roll 1d4 to determine the size of the arcade: (1) minor—1d6+4 games; (2) small—2d8+10 games & 1d3 grabbers; (3) large—4d10+20 games, 2d4 grabbers, 1d3 tickies, 1d3-1 mascots; (4) massive—20d10+50 games, 8d4 grabbers, 3d7+5 tickies, 1d4+4 mascots.

Games: These brightly lit arcade games have names such as Wizard of Gor, Pik-man, etc. Playing these games is oddly soothing and restores 1hp per 30 minutes of game play. A single token allows for a Reflex save to determine the number of minutes played.

Grabbers: Unbreakable tanks filled with all number of fascinating and desirable looking items of wildly varying values. Each attempt requires a successful Luck check to pull something from the tank, with most items being worth 1d3sp each. Pulling a major item (worth between 1d10+10sp) out of the grabber requires two successful Luck checks. These games require four tokens to play.

Tickies: These large games of skill involve throwing severed heads through baskets, shooting imitation vermin, bludgeoning small rodents, and other entertainments of the sort. Each 10 minutes of play is worth 1d4 "tickies" which can be spent to purchase a number of "fun" items. A single token wins 1d5 tickies.

10 tickies allows for the purchase of a single item from the Random Housewares table (USG pg 271)—regardless of the quantity normally available if rolling on the table, the winner may choose a single instance of any of those items. Fifty tickies is worth a single pull from the Random Equipment table (USG pg 50). One-hundred tickies is enough to purchase a single trade good (USG pg 48).

Mascots: Found at the larger, well-established arcades, these robotic sentries stand sentinel from their place upon the bandstand. Covered in synth-fur, metallic scales, fiber-optic feathers, or a combination of the three, the comically styled creatures house a variety of lethal countermeasures to deal with those who would attack the arcade or attempt to damage its machinery.

Mascot: Init +3; Atk paw swipe +4 melee (1d8), laser eyes +2 ranged (1d12, Reflex save for half, range 30/60/90); AC 12; Armor Die [1d5]; HD 3d10; MV 20'; Act 2d20; SP mechanical; SV Fort +10, Ref -3, Will n/a; AL L

Mechanical: Mascots are immune to poisons, critical hits, and mind-based attacks. They take double damage from electrical based attacks and suffer full damage from any water-based attacks.

Campgrounds: Simple in amenities, slightly remote in placement, this location is otherwise unremarkable. It is merely a 99% safe place to stay for the night. No dangers will encroach on the campgrounds unless directly led there by the party.

Carnival: Smaller, traveling amusement park-ish locales, carnivals host a small number of mechanical ride-based attractions with varying degrees of safety and a number of crooked midway games. Brave souls boarding one of the mechanical rides must make a Luck check to come out the other side safely (failure results in 1d3 damage, a natural 20 on the Luck check results in death) and regain 1hp. Riding one of the attractions costs 5sp. Playing games allows for prizes from the Random Equipment table (USG pg 50) to be "won" at 10x their normal base cost.

Circus: Beneath the big-top, a full day's worth of enjoyment may be found. Acrobats, fire-breathers, sword-swallowers, animal trainers, and hordes of clowns all spin, caper, and delight audiences. Each day

ROADSIDE ATTRACTION GENERATOR

spent at the circus qualifies as three days of full rest and costs 50sp. The circus will remain in one place for 1d7 days before packing up and moving on to its next stop.

Freakshow: Once a thriving, if underground, business in the long ago freakshows have greatly declined in recent history. In a world filled with mutants, mutants aren't all that interesting. Rather desolate and depressing affairs, freakshows cost a mere 5sp to visit and a Willpower check of 10 to simply remain interested.

Marina: Along the shoreline of an ocean, sea, lake, river, or extremely large pond, a marina is the place to go for all your watercraft needs. All types of Beater watercraft are available for rental at the docks, with a small assortment of Beater and Keeper craft available for purchase, with mechanics standing by to handle any customization. Those seeking to purchase a vehicle for use elsewhere will need to arrive with a way to trailer the vehicle away. Dock rental at a marina for vehicles ranges from 1sp per day for a general slip, 10sp a day for a secured (gated) slip, to 500sp for a heavily guarded slip with round-the-clock armed security.

Observatory: Found atop mountains and other tall peaks, these domed locations offer a rare view into the furthest reaches of Umerica's night sky. Staring into the swirling, chaotic void above requires a DC 18 Willpower save (failure results in a loss of 1d3 Luck) to wrap one's mind around the yawning abyss. Those successful individuals gain a better understanding of the night sky (treat as trained in any navigation type rolls) as well as a one-time bonus of 1 Luck. Looking through the telescope at an observatory costs 7sp.

Pleasure Palace: Catering to every need, want, and dark desire, bypassing a pleasure palace requires a Willpower save (DC 10). Failure inflicts a permanent loss of 1 Stamina, growing ever weaker as the victim gives themselves over and lets their id run wild. Once snared by its lure, the decadent treatment lasts for 1d6 days before the victim is allowed another save. Those finally breaking free gain a permanent bonus of +1d to all future Willpower saves as they have faced the abyss and managed to pass through—forever changed. Those who evade the lure of the pleasure palace gain no bonus.



Resort: A far cry from the basic living of campgrounds, resorts offer luxuries that are otherwise unavailable in the wastelands: non-toxic swimming pools, secure rooms with locks and solid doors, even massages to work out those permanently knotted muscles. A week-long stay provides full healing as well as 20 temporary bonus hp. No benefit is granted for a stay of less than one week while additional weeks add 10 temporary hp to a max of 30. Staying at such places is quite expensive, costing 5d100sp per day.

Speedway: The stench of burning rubber and exhaust, the roar of engines, and the howling of blood-thirsty crowds mark the presence of a permanent speedway. Races are held once a week (on Sunday! Sunday! Sunday!), and vary from place to place from drag races, komo-docross, demolition derbies, and longer lap-based races (often with obstacles). Attending such events costs 10sp + 4d20sp for intoxicating beverages while participating in such events (which encouraged) is solely at the GM's discretion.



ROADSIDE ATTRACTION GENERATOR

TABLE III: ART INSTALLATION

Art is often for the sake of art. There are no modifiers involved based on the work's medium or type. Merely the diversity of American creativity and, in some cases, madness.

Table III: Art Installation

Roll (d24)	Name 1	Name 2	Art Medium
1-2	Martok's Famous	Holy shrine of	Chewing gum
3-5	Beetay's Burnished	Wall of	Toothpaste
6	Glibber's Forbidden	Standing stones	Wrecked autos
7-9	Miglio's megatastic	Giant animal made of	Taxidermy
10-11	Un-Max's Un-men	Miniature city	Ruined alien tech
12-13	Rory's roadside	Sacred playground	Tanned body parts
14	Gotcha'dough's	Fake storefront	Alien skulls
15-16	Nunzio's Nart Umerican	Motorized land-fish	Blood
17	Reibob's classic	Forest of	Spray-paint
18-20	Skullgore's infamous	Zen garden	Toothpicks
21-22	Glphytxll's greemling	Faceless army	Human skulls
23-24	[None]	Maze	Twine

TABLE IV: HALL OF FAME

Whether military leaders, sportsball legends, or hometown heroes everyone is remembered somewhere. While these locals take several forms and are to a variety of activities, those so honored (or their living kin) often take great pride in their inclusion. Mock such places at your own risk. The exhibits found within often have functional materials related to the hall of fame and, if obtained from whatever guardians watch over the collection, they may be quite useful. Due to the often hoarder-level state of these locations, fully searching them takes 1d5x12 hours.

Roll three times on the following table to determine the type and name of the location.

Table IV: Hall of Fame

Roll (d8)	Type	Name 1	Name 2
1	Automotive	Walk of	Fame
2	Aviation	Hall of	Heroes
3	Music	Remembrance Hall of	Icons
4	Sportsball	Memorial Garden of	Sainted Personages
5	Local	Field of	Legends
6	Mutant	Heritage Walk of	the Fallen
7	Road-gang	Wall of	Pioneers
8	Military	Trail of	Failures

TYPE

Automotive: Here may be found 1d4 functional Keeper vehicles (GM's discretion) with a 15% chance of finding a custom vehicle.

Aviation: Amidst the materials here are enough parts to assemble 1d3 functioning Beater gyrocopters. Non-functioning models must be disassembled to collect

these parts, reducing the difficulty of the "repairs" to assemble the gyrocopters by -1.

Local: There is nothing of interest here, but the caretakers will likely be so overjoyed to see outsiders taking an interest in local matters that, in their excitement, they might be willing to give them 2d20sp worth of supplies.

ROADSIDE ATTRACTION GENERATOR

Military: While there are no functional vehicles here, 100gp worth of parts may be gathered here in addition to 1d6 military-grade personal weapons (GM's discretion). While searching, a Luck check is required (from the PC with the highest Luck) so as to not accidentally detonate a forgotten piece of live ordinance.

Music: Hidden amongst the musicians and instruments is an enchanted musical instrument of discord, requiring a natural 1 on a Luck check to discover. The instrument, requiring 2d6 months of practice to functionally learn, deals 1d16 damage (increasing +1d per round to a maximum of 1d30) regardless of Armor Die to all individuals within a 100' radius. Glass shatters, organs liquify, and stone cracks as the infernal instrument releases its cacophonous doom. Playing the instrument while remaining in the acoustic "sweet-

spot" to avoid taking damage oneself requires total concentration (DC 15 Willpower save per round).

Mutant: Filled with mutagenic substances, the collection here requires a DC 13 Fortitude save to avoid mutagenesis. When determining the results of the mutagenesis process, players may choose a result lower than rolled, allowing for some determination in the degree and style of mutation as guided by the ancient wisdom of their mutant forefathers.

Road-gang: A successful Luck check by the party member with the lowest Luck will reveal a Vintage motorcycle, fully tricked out with one more than the normal maximum of Traits.

Sportball: Amidst the ancient equipment may be found +1 equivalents of most mundane melee weapons (GM's discretion) and enough pads and guards to add a total of +5d Armor Dice (split however the party chooses).



ROADSIDE ATTRACTION GENERATOR

TABLE V: BATTLEFIELDS

Throughout the history of Umerica wars have repeatedly been waged, soaking the ground with the blood of the fallen. There were times when mankind merely fought itself, but there were earlier times when prehistoric gods awakened to retake the world, and later points in history where animals rose up in an attempt to throw off the yoke of alien subjugation. Roll twice on the table below and consult the table to reveal what forces fought over this particular patch of ground—and what battlefield artifacts may still remain.

When searching a battlefield, a successful Luck check will unearth one of the listed items from a random participating force.

Table V: Battlefields

Roll (d7)	Force 1	Force 2
1	Human	Alien
2	Mutant	Trans-dimensional beings
3	Alien	Prehistoric gods
4	Trans-dimensional beings	Animals
5	Prehistoric gods	Human
6	Animals	Mutant
7	Roll twice	Roll twice



FORCES

Alien: Coming as mankind's shepherds, or conquerors, aliens have repeatedly visited the earth and come into conflict with its inhabitants. Despite superior technology these creatures often could not match the ferocity of the Earthlings. Roll 1d8 to see what might be left on the battlefield: (1) damaged laser pistol which explodes if fired doing 2d5 damage to all within a 20' radius; (2) 1d4 fusion grenades; (3) 1d3 plasma grenades; (4) functioning laser rifle with four shots remaining; (5) functional blaster pistol with two shots remaining; (6) one MicroNuke; (7) mummified alien corpse entombed with its possessions (GM's discretion); (8) fully charged splice fiend multi-ray.

Animals: When the animal kingdom has risen up it generally has not gone well for the beasts. Simple of thought and tactics, sheer ferocity has failed to overcome superior arms and planning time and again. Armed with crudely made weapons and stolen firearms, the beasts never won their liberation from humanity ... at least until the world ended. Roll 1d6 to see what might be left on the battlefield: (1) broken fangs and claw fragments; (2) stone axe-head, requires a handle; (3) obsidian dagger; (4) blood-spattered war club, 1d5 damage; (5) barely serviceable bolt-action rifle; (6) rotting net, DC 5 Strength check to break free.

Human: The most common combatants in Umerica, having fought since before the dawn of known history

ranging from the stone age to the atomic age. Roll 1d6 to see what might be left on the battlefield: (1) useless weapon bits—arrowheads, shell casings, depleted energy cells; (2) stone knife, 1d5 damage; (3) damaged black-powder rifle, fires 1d3 times before the barrel explodes; (4) old rusty revolver, fumbles on 1-3; (5) stick of sweaty dynamite, Luck check to handle without detonating; (6) laser pistol, two shots remaining.

Mutant: Especially during the initial rise of mutants, humanity and others waged war against the "other" seeking to exterminate them. Despite this, the hardiness of mutants proved to be their saving grace and today the descendants of those early mutant freedom fighters live on. Roll 1d7 to see what might be left on the battlefield: (1) human skeleton encased in unbreakable metal; (2) dormant mutagenic pathogen (DC 10 Fortitude save); (3) rusty chain flail; (4) unstable explosive lance, DC 12 Reflex save to avoid its detonation while in use; (5) saw-blade slinger; (6) 1d6 can grenades; (7) active mutagenic material (DC 18 Fortitude save).

Prehistoric gods: Before humanity was a dream in the mind of a now-dead god, there were those who came before; a race of gods emerged from the raw chaotic fundament of the universe. As oblivious to humanity as an oak tree is to an ant, these beings once dominated the globe. Roll 1d5 to see what might be left

ROADSIDE ATTRACTION GENERATOR

on the battlefield: (1) 8d24 human skulls; (2) sacrificial dagger; (3) star stone, cancel one single incoming spell; (4) strange crystal lens that shows the stars one-billion light years away; (5) 1d3 brain cases occupied with dead, desiccated brains.

Trans-dimensional beings: Humanity has long felt that the world was theirs alone and that no force could force them into retreat. This view is, of course, utterly false. Roll 1d7 to see what might be left on the battlefield: (1) 1d3+1 scrambler grenades; (2) functional xenotaur forcefield generator; (3) functional plasma rifle; (4) 1d6 mutagen grenades; (5) 2d4 grapple grenades; (6) inert xenotaur gauntlet; (7) dormant think tank which will reactivate in 1d4+1 rounds after discovery.

TABLE VI: MEMORIALS

Remembering the fallen is a time-consuming and emotionally-draining task. Whether a lonely marker, a well-maintained statue, or a sprawling cemetery that has been “moved,” leaving marker-less graves behind—the places where the dead are remembered are places that have special properties. Roll once on the following table to determine the type of memorial found.

Table VI: Memorial

Roll (d7)	Memorial Form
1	Desecrated cemetery
2	Military cemetery
3	Obelisk
4	Empty tomb
5	Memorial plaque
6	Statue, mounted
7	Statue, afoot



ROADSIDE ATTRACTION GENERATOR

MEMORIAL

Desecrated cemetery: Long forgotten by the living, these dark places are often rumored to be haunted, despite no one knowing why such a place could possibly be haunted. Restless spirits are trapped in their graves, forgotten and unmourned, awaiting their chance to revenge themselves upon the living. Cemetery contains 2d24 un-dead of mixed types (GM's discretion).

Empty tomb: Perhaps once intended for an honored personage, the intended corpse never arrived and the tomb remained empty, eventually falling into disrepair. Such a place is commonly used as a clubhouse by a small gang.

Memorial plaque: Placed in observance of the deeds of a long-dead Umerican, plaques of these nature are favored drop points for smugglers. By prying the plaque up and creating a space behind it, unsavory types use the memorial as a dead drop. Checking the drop requires a successful Luck check, resulting in the discovery of 1d6 random grenades stashed in the niche behind the marker.

Military cemetery: These highly dangerous locations are commonly surrounded with caution tape, red flags, warning signs, or a combination of each. Observers will note that the ground at these gravesites rises and falls as if the earth itself were preparing to disgorge a foul darkness upon the world—which it is. Approximately once per month, 3d10+10 silver zombies (see TMM pg 212) rise from the ground and wreak havoc through the neighboring countryside. Local caretakers keep a close eye on the goings on so that local residents aren't caught unaware when the restless dead rise.

Obelisk: For reasons wholly unknown, Umerican obelisks attract time travelers (see DCC RPG pg 429) who will lurk nearby, murmuring to themselves about the importance of all of creation. They can normally be found resting against a nearby tree or other feature, nodding knowingly at passers-by.

Statue, afoot: Standing upon its pedestal, the statue looks ready to leap down and enter battle ... because it really is ready to leap down and enter battle. The statue guards the area and will attack strangers coming within 100' of it. Those who grant it respectful clearance are not attacked (treat as living statue, DCC RPG pg 420).

Statue, mounted: As above, but now the living statue is mounted atop another, doubling the potential danger.



ROADSIDE ATTRACTION GENERATOR



TABLE VII: MUSEUM

While time consuming to explore, these locations hold many secrets, both ancient and new, to tempt the unwary. Roll twice on the following table, using the focus to provide depth and additional detail to the museum by broadening the museum description and applying the appropriate bonus to the museum's contents.

Table VII: Museum

Roll (d7)	Focus	Type
1	Natural (-1d on check)	History
2	Modern (+/- 1 bonus in PC's favor)	Art
3	Automotive (DC +/- 1 in PC's favor)	Science
4	Ancient (+1 hours/days)	Entertainment
5	Military/War (+1d on check)	Library
6	Local (-1 hours/days)	Wax
7	None (+0 bonus)	General

TYPE

Art: Art museums are filled with beauty, inspiration, and feed the soul. For every 1d3 hours spent in an art museum characters may make a DC 12 Willpower check. Failing the save indicates that the individual

has been swept up with inspiration, gaining +1 to a non-combat check in the next 24 hours. This effect can stack up to three times for a total of +3.

Entertainment: Throughout the ages, mankind (and mutant-kind) have wrestled with methods of staving

ROADSIDE ATTRACTION GENERATOR

off boredom. These museums preserve artifacts and images from those ancient entertainments. After touring the museum for 1d5 hours players may make a DC 13 Willpower check. Success reflects having their spirits so buoyed that they gain a +1 to all Willpower saves for the next 48 hours.

General: Museums of this type are massive affairs often requiring, at a minimum, several days to explore. The broad nature of the museum's collection allows for the character to research any facet of the museum's focus—selecting the bonus that they wish as it applies to the museum's focus.

History: Browsing the collection of the museum enlightens the searchers to past details and information they are not yet aware of. A successful DC 12 Willpower check indicates that past details pertinent to the museum's focus having been unearthed. The player may ask one historical question about the museum's focus. Digging up the information requires 1d7 hours of research and the bonus may only be obtained twice per week by any given individual.

Library: A search of a library may yield information specific to the needs of the party (shaded through the lens of the library's focus). A successful DC 15

Willpower check indicated that an important piece of pertinent information has been found allowing the player to ask one in-character question (how many bikers are in that gang is fine, how many hit points does that gang member have is not). Digging up the information requires 2d3 hours of research and the bonus may only be obtained once per week by any given individual.

Science: Science and technology are forever intertwined, and these museums lay forth the methodology and techniques of the museum's focus. After spending 1d4+2 hours studying the contents of the museum, researchers may attempt a DC 20 Intelligence check. Success indicates a deeper understanding of technological items and how to recognize them, resulting in a PERMANENT -1 on all Luck checks when searching for technological items related to the museum's focus.

Wax: Silent figures stand in dioramas depicting them in their once living state. It requires a DC 15 Willpower check and 2d4 hours to tour the mausoleum-like museum, and to roam amidst its silent occupants (failure resulting in an uneasy retreat from the location). Successful visitors to the museum gain a +2 to their next untrained skill check used within the next week.

TABLE VIII: "NATURAL" WONDERS

The twisted nature of Umerica has made for a number of truly unnerving "natural" wonders. Roll twice on the following table (or create your own) to determine the type of wonder the party has stumbled across.

Table VIII: "Natural" Wonder

Roll (d6)	Wonder Type	Tourist Trap Type
1	Trans-dimensional Canyon	Gift Shop
2	Floating Cliffs	Tour
3	Sink(black)hole	Scenic Overlook
4	Scintillating Lake	Timeshare
5	Petrified Forest	Hiking Trails
6	Reverse Waterfall	Last Chance Gas

WONDER TYPE

Floating Cliffs: Gravity simply does not apply to these towering rock structures. Laced with an other-worldly element, *absurdium*, the cliffs hover between 1d10x100' in the air. Mining for the con-gravitational element is a dangerous pastime and is rarely attempted due to the frequency with which miners find themselves inhaling enough particulate over time to over-counter

their own weight and slowly float upwards, never to be heard from again. Conversely, by acting with great care, the absurdium, could be freed with a pick (or explosives) to send the floating structure crashing down upon whatever unfortunates are currently below.

Petrified Forest: Unlike ancient petrified forests, these mineralized timberlands have been wholly petrified



ROADSIDE ATTRACTION GENERATOR

by otherworldly energies still active today. All organic matter within the boundaries of the “forest” is being bombarded by forces that gradually turn organic matter into stone. All non-stone lifeforms entering the forest must make a DC 15 Fortitude save each turn within the forest, failure results in the victim losing 2d3 Stamina and 10’ Move as their body begins to literally grind to a halt. Afflicted creatures escaping before death recover Stamina at one point and speed at 1’ per day but once the creature’s Stamina has been reduced to 0, the victim has been irrevocably turned to stone.

Reverse Waterfall: Caused by freak quantum storms, the waters of these breathtaking wonders rise into the air, seeming to flow backwards. The rise is a temporal illusion caused by a quantum reflection allowing observers to watch events play in reverse, but it is only an illusion. While a person leaping from the top will suddenly appear as a battered and lifeless corpse, rising and being seemingly reborn, once exiting the illusory zone, the lifeless corpse will appear at the bottom of the falls and continue floating downriver. The visible chrono-zone of the falls extends 1d100+20’ from the waters themselves, allowing relative concealment (where time flows normally) simply by moving around within the phantasmal region.

Scintillating Lake: Despite their name, not all these features scintillate with brilliant colors. Some eerily glow within a limited range of the spectrum while others are the deepest of black. Anything submerged within these strange aquatic bodies permanently takes on the hues (and glow). While the effect often ranges from cosmetic to useful (such as dipping a stick into a brightly glowing body glowing in the yellow portion of the spectrum), not all spectrums are created equally. Indeed, some of these lakes glow in ways not visible to the naked eye, such as along the ultraviolet or even microwave spectrums. Permanently emitting lethal radiation is often a deal-breaker when trying to travel with others.

Sink(black)hole: Through a twist of non-Euclidean geometry transforming the local laws of physics, a stable black hole has opened here. Ranging in size between 1’-24’ across, these special anomalies inexplicably have event horizons a mere foot beyond their inky circumferences and a reduced pull beyond that. It is wholly safe to stand within 20’ of these marvels, but those who cross that safe-zone find themselves

in mortal peril. Creatures so much as crossing that perimeter must make a DC 20 Strength check to not be pulled forward; a failed roll of 1-14 results in the victim being sucked into oblivion, while 15-19 indicates being pulled 10’ forward allowing for one final DC 25 Strength check the following round.

Individuals attempting to aid their comrade via holding a rope or other method add their Strength bonus (minimum +1) to the attempt but all suffer the results of a failure. Anchoring oneself to the outside of the gravitational pull via various means also increases one’s chance of survival (rope +1d, chain +2d) with any failed result meaning that the anchoring device has snapped under the strain.

Trans-dimensional Canyon: There are places in Umerica where the barriers between neighboring dimensions have not only weakened but have instead completely collapsed. Such a release of trans-dimensional energies rends through the firmament and strata of the region creating a canyon ranging 2d6 miles long. Within the confines of the canyon Umerica has forcibly merged with an alien landscape, transforming flora, fauna, and even the geological makeup. What twisted life lies within such areas is wholly to the GM’s discretion, and those who wander into such places may result in the party being swept away into another world altogether leaving them to desperately search for a way home (or not).

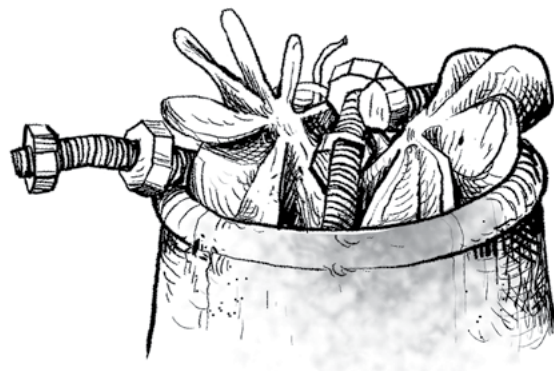



ROADSIDE ATTRACTION GENERATOR

TABLE IX: RESIDENTIAL

Sometimes there are those who call the attraction “Home.” In these cases, strangers may not always be welcome and stumbling upon such a place might mean “knowing too much.” Other times the whole point of the residence is to draw visitors and trade. As with any stranger’s home, one should always enter with caution. Roll twice on the following table to determine the type of residence and size of the population dwelling within. The residence will *normally* appear large enough to house its population but there are always exceptions.

Table IX: Residential

Roll (d10)	Residence Type	Population
1	Alien Enclave	Individual (1)
2	Art Residence	Family (1d3+1)
3	Hippy Commune	Band (1d4+2)
4	Livestock Ranch	Extended family (1d5+3)
5	Displaced Locale	Pack (1d6+4)
6	Ancient Warship	Troop (1d7+5)
7	Crashed Spacecraft	Crew (1d8+10)
8	Cliff Dwellings	Tribe (1d10+15)
9	Vintage Military Compound	Gang (2d10+20)
10	Campground	Clan (3d10+30)

RESIDENCE TYPE

Alien Enclave: Far from home and unable to get home, the aliens here have attempted to recreate their homeworld’s environs here in Umerica. Ranging from a single hut to a bustling “alien alley,” things here are familiar ... and yet not. The chatter of an unearthly language, the smells of strange spices and ingredients, and color-pallets not geared for the human eye blend together into an unsettling combination that puts native Umericans on edge (suffering a -1d penalty to all Willpower rolls while within the immediate vicinity).

Ancient Warship: Once, in the long ago, mighty vessels battled upon the oceans of the world. How one of those ships has ended up ... here? That is a matter of local legend. Ranging from the rusted-out hulk of a WWII submarine to the broken superstructure of a nuclear-powered carrier. While the warship is not functional, its interior may still house any number of dangers such as unexploded ordinance or a faulty reactor. Typically, those dwelling in such a structure are clad in the tattered remains of ancient naval uniforms and sometimes even conform to a crude military hierarchy.

Art Residence: Bewildering the senses while ignoring all rules of decor, architecture, and normalcy, art residences range from simple structures designed to look like something that they are not (a seashell, donkey,

large tree, etc.) to a larger structure housing artistic endeavors or collections (carousel horses, miniature armies, sweaters knitted with still-living snakes, and so forth). While these kooky and free-spirited homes are not overtly threatening, the strange architecture and sometimes crowded confines make it risky to those not familiar with the confines. Unless traversing the interior and themed grounds at half Move a DC 10 Reflex save is required every round of movement lest the visitor suffer 1d3 damage from stumbling, turning an ankle, knocking a pile of artifacts down upon themselves, or the like.

Campgrounds: As in *Amusement Location*, above.

Cliff Dwellings: Not mere caves, these dwellings are bored directly into cliff faces allowing for the additional security of elevated access. Requiring a ladder or the like for entry, these dwellings range from simple five-room affairs to massive Petralike cities capable of concealing entire armies. Often created by expanding on existing cave structures, many have narrow crawl ways and chimneys beyond what is used for living areas. Residents of such areas may attempt to use these areas to evade detection or even escape attackers requiring their pursuers succeed at a Reflex save each round (DC 10 manages to keep up, DC 12 gains 10’ in the chase, failure loses 20’ in the chase, 1 results in being lost).

ROADSIDE ATTRACTION GENERATOR

Crashed Spacecraft: Not all visitors manage to arrive safely. Whether from damage garnered in battle in the skies above Umerica or simple pilot error, the spacecraft crashed and spread wreckage over a 1d3x100 yard area. The exotic materials used to power such craft are highly prized as scrap. If the residents using the craft for shelter can be “persuaded” to “relocate,” the value of the craft is residents x 1000sp—making larger craft more valuable than the wealth of some wasteland strongholds. Of course, finding such wealth and hauling it away with one’s skin still intact is two very different things.

Displaced Locale: Torn through time and space, these places are limited only by the borders of the multiverse. Whether an ancient Germanic village, a Mars habitation dome, or other locale fantastic and extreme, these places have come to rest in Umerica providing a window into life elsewhere across the dimensions. Residents of such places have traveled with their home as it was transported through spacetime and are often distrustful of strangers. Whether bearing advanced technology or capable of wielding strange magics, the displaced are not to be trifled with.

Hippy Commune: Once they were the “flower children” preaching “peace and love” while wearing beads, smelling of patchouli, and practicing pacifism. In modern Umerica, none of that has changed. Whether a solo love child lost in time or a bevy of vegan yogis, the message has remained unchanged while the world around them has transformed.

Hippy: Init +0; Atk special; AC 12; Armor Die [1]; HD 2d8; MV 30'; Act 1d20; SP awkward, flower power, paci-fist; SV Fort +2, Ref +2, Will immune +4; AL N

Awkward: Hippies are so laid back and relaxed that it is difficult to raise the ire to attack them. Attackers suffer a -1d penalty on all attacks until landing a successful blow.

Flower power: Their peaceful nature (not their massive greenhouses filled with recreational “tobacco”) has opened the minds of hippies to secret methods of cultivating plant growth. If the

commune is attacked, a group of 10 or more hippies may raise a protective wall of thorny rose bushes—springing from the soil to a height and thickness of 10' in an instant—to dissuade attackers.

Paci-fist: As they espouse the ideals of pacifism, one could be forgiven for holding the mistaken belief that hippies are harmless. Anyone killing a hippy immediately loses 1d5 Luck, those without Luck are instead struck by an instant karmic backlash (struck by lightning, being entangled and hung while passing through a beaded curtain, choking to death on a lentil, etc.).

Livestock Ranch: This covers a simple meadow with a small flock of animals to miles and miles of fenced-in land (ranchers long ago gave up on simple wooden fences to keep in their livestock and have transitioned to using razor-wire topped concrete walls to keep interlopers out). Additionally, ranchers aren't sitting back and assuming that their herds are safe; they use every means at their disposal from personal weaponry to leveraging their position in the local hierarchy to gain favored treatment for their animals. Small flock or massive herd, there is one thing that is unchanged—ranchers are highly respected in their communities and the residents of the local area are quite protective of them. Attacks on a ranch are dealt with so harshly that many gangs feel it not worth the trouble.

Vintage Military Compound: Ranging from old cavalry forts to decommissioned military bases, these locales share the common trait of being hardened against incursions. More advanced compounds may have functional repair facilities for vehicles and weapons while older ones may simply have a pair of water troughs for horses and a decently dry barn. No matter their origin, these structures have survived the ravages of time, forgotten by most and prized by those who now find safety within their walls, palisades, and fences. There is a 75% chance that any approaching group will have been spotted by the residents of the compound, and if needed, a defense will have been prepared granting the defenders +1d to hit and +2 to damage in the defense of their home.



RANDOM ROADTRIP ENCOUNTERS

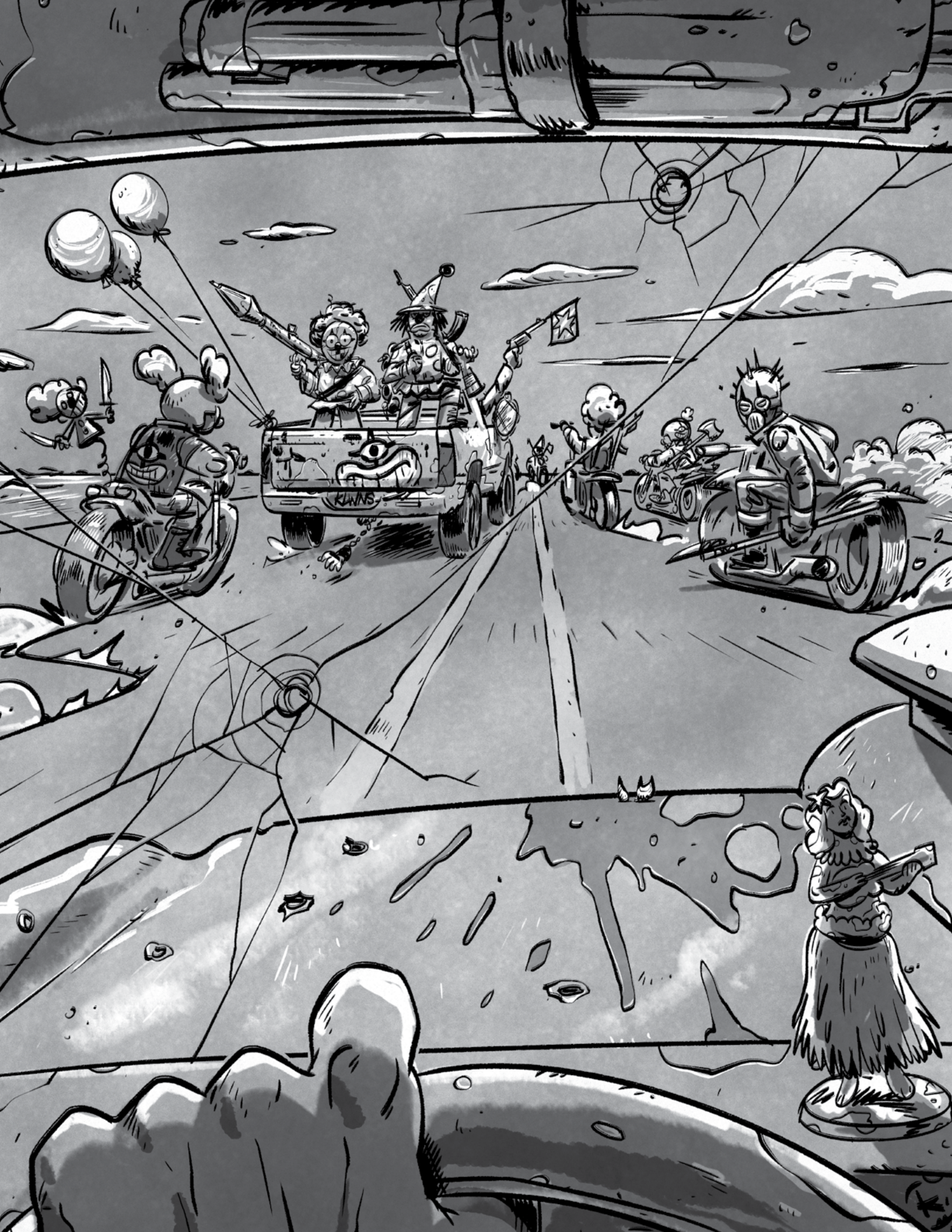

RANDOM ROADTRIP ENCOUNTERS

RANDOM ROADTRIP ENCOUNTERS

Roll 1d100 to determine what might be happened upon while traveling along the remnants of Umerica's remaining roadways. A roll once every three to six hours of travel should keep things interesting.

Random Roadtrip Encounters

Roll	Result
1	A Buddy O'Burger franchise restaurant chapel is currently being built by the roadside. It is mostly complete and open for business while under construction. Lots of friendly clowns beckon you to stop.
2	A bit of roadkill is being eaten by a huge mutant predator. It blocks the road and if left alone will remain for about an hour.
3	A bog is by the side of the road with a semi-submerged car in it that looks like it recently crashed there. It is obvious that one or more creatures live in the bog and are swimming near the car.
4	A burned-out car wreck riddled with bullets and explosive damage entombs several roasted corpses.
5	A burned-out gas station by the roadside is now inhabited by—roll 1d4: 1- animals, 2- bikers, 3- robots, 4- mutants.
6	A burnt-out wreck of a semi-trailer with some goods scattered across the road is found with—roll d4: 1- dead livestock, 2- bags of grain, 3- pallets of building materials, 4- barrels of pickled food.
7	A compound built from wrecked buses and semi trailers on the roadside is inhabited by a tribe of mutants who are cunning traders.
8	A crashed plane wreck is found not too far off the road. There is a 35% chance of something valuable still being on board.
9	A crater with the wreckage of a spaceship escape pod is empty, but there is an obvious trail to follow. There is a 20% chance the whole area is radioactive.
10	A farm tractor is half buried in mud and it looks like it has not been scavenged yet.
11	A few locals are harvesting a large roadkill and setting up for a feast. There is plenty to share and the party is welcome to join in the festivities.
12	A geothermal vent has opened up in the middle of the road. It is violently bubbling with steam and mud, making the road impassable.
13	A group of motorcycles (Beater quality) are parked on the roadside, seemingly abandoned. If investigated, 1d3+1 swarms of colony scorpions (TMM, pg 96) attack. The bikes are all working but have no gas.
14	A group of rotting corpses is strung up in a grove of nearby trees, decorated with obvious gang signs. They have been well picked over by scavenger birds.
15	A grove of nearby trees is strewn with bones. A group of hungry mutants live in the trees and eat anyone who approaches their grove.
16	A herd of wild ox beetles (TMM, pg 59) is crossing the road. It will take them 3d16 minutes to clear the road and will attack if threatened.
17	A holy tanker-truck caravan of Petrolex meets the travelers at a crossroads or onramp. They will allow travelers to join the safety of the caravan for as long as their paths coincide. During rest stops, inexpensive fuel can be purchased.
18	A large creature, that appears dead, is currently blocking the road. When approached, it leaps up and attacks with its final breath. It attacks with a d30 action die and has 1 hp left.
19	A large group of Grokk worshipers are tearing down an old ruin and seeding the area around it. They will look angrily at the vehicle but do not make any hostile moves unless provoked.

RANDOM ROADTRIP ENCOUNTERS

Random Roadtrip Encounters (continued)

Roll	Result
20	A large mobilized road gang is rolling out for a major conflict. If the party pulls off the road and lets them pass, there will be no trouble. The gang has bigger fish to fry. They may be willing to hire some mercs.
21	A large mutant beast runs straight at your car from out of nowhere. Make a Vehicle Control roll (DC 18) or the vehicle suffers 2d8 damage.
22	A massive batch of radiation has left dead animals everywhere. Each person must make a Fort save (DC 13) or lose 1d3 Stamina as they pass through the area.
23	A massive brushfire is running rampant in the area. Visibility is terrible and traveling faster than Speed 1 requires a Vehicle Control roll (DC 6+2d6).
24	A motorcycle is in a tree with the remains of a rider impaled on a branch. It is not apparent how they got there.
25	A motorized merchant caravan is traveling in the opposite direction. They will stop to greet the party and be happy to trade and share local information, for a price.
26	A mutant horror is lurking in the grass using a waving human corpse with a full backpack as bait.
27	A nasty storm front is rolling in from the south. It might be wise to seek some shelter before visibility drops to nil.
28	A pack of hungry falcon wolves (TMM pg 80) are stalking an injured traveler crawling away from the road.
29	A pilgrimage of devout robots traveling to seek the Ultimospark are on the road, singing binary hymns. If approached, they are friendly and interested in trading for electronics.
30	A pre-cataclysmic playground is in near perfect condition. A sizable group of children are playing there with several large animated stuffed animals. Anyone watching them for any length of time will feel a very creepy vibe and not be inclined to approach them.
31	A pre-cataclysmic toll station is being run by an up and coming road gang looking to make a name for themselves; the toll is not cheap.
32	A roadhouse restaurant with a fuel station and a garage is surrounded by a high fence with guards. The prices are cheap but the crowd is rough.
33	A semi trailer is blocking the road. There is a road gang waiting in ambush nearby to extract a toll.
34	A shanty town of nomad merchants with their vehicles in a circle around their tents are reasonably friendly and willing to trade.
35	A strange tentacled mutant corpse nobody can identify is found.
36	A sudden storm produced a flash flood. Now the roadside ditches have swollen into streams, blocking the road. Make a Vehicle Control roll (DC 8+1d5) or wipeout.
37	You find a truck stop with a concrete bunker, diner, showers, and machine gun nests in the towers. It is an expensive place but is quite safe, once you pay.
38	A virulent red weed has overgrown the road and everything else in the area. A Vehicle Control roll (DC 10) is required to get through without the vehicle getting stuck, and maybe overgrown.
39	You spot a wandering huntress and her dog. She is friendly and can offer information about the local area.
40	You stumble upon a wire trap across the road (DC 16 to notice it in time). If not avoided, anyone riding in an open vehicle must make a Reflex save (DC 14) or suffer 5d4 damage. If the driver takes damage, the vehicle immediately wipesout.
41	Along the side of the road is some sort of large barn that is practically shaking due to the loud, repetitive music pumping out of it. The rhythmic cacophony can be heard for miles. In addition, a multitude of flashing and blazing lights are steaming out of every crack and crevice of the building. There are several vehicles parked outside so someone must be in there.
42	An abandoned pickup truck has a corpse in the driver's seat. A deadly spider is living under the dash and will attack anyone entering the vehicle (melee ATK +5; Fort save DC 13 or die; AC 14; hp 1).
43	An ancient church building stands in good repair. It is now inhabited by (roll 1d4: 1- ghosts, 2- cultists, 3- a demon, 4- zombies).

RANDOM ROADTRIP ENCOUNTERS

Random Roadtrip Encounters (continued)

Roll	Result
44	An obviously damaged flying saucer makes a crash landing up ahead and not far from the road. If approached, several voices can be heard yelling at each other in an unknown language. A hatch on the side is attempting to open but it seems to be obstructed by the crash debris.
45	An open mine shaft is found, partly flooded and not too far off the road. It is the lair of (roll 1d4: 1- predatory animals, 2- strange mutants, 3- a road gang, 4- a group of cultists).
46	You see a big aggressive mutant beast that will attack and disembowel anything that approaches. If left alone, it will linger on the road for 3d6 minutes before wandering off.
47	Carnivorous plants around the road will move to block it when they sense a vehicle approaching. A Vehicle Control roll (DC 4+2d8) is required to pass safely.
48	You find dozens of tires of various types dumped in a heap. 2d6 of them are still in OK condition.
49	In the oncoming lane, a blazing, phantasmal semi appears driving wildly down the road. A Vehicle Control roll (DC 14) is required to avoid a collision with the ghost truck. Failure inflicts 1d3 points of temporary Personality damage due to terror.
50-94	Nothing but open road and clear greyish yellow skies. Yawn....
95	Several signs are posted along the road warning that it is the territory of aggressive flying beasts. 1d4+1 flying laser ursines (TMM pg 81) have nested in the area and will harass anyone driving down the road unless they are quiet.
96	The ground begins to shake and buckle. A Vehicle Control roll (DC 15) is required to avoid crashing during the localized quake.
97	The road ahead is filled with smoke leaking up from a burning coal seam in a nearby underground mine. Any attempt to drive through the area at a Speed level greater than 1 requires a Vehicle Control roll (DC 8+2d3).
98	The ruins along the side of the road ahead are heavily graffitied with symbols of WHAAAR! and images of carnage. There are also large smoke plumes in the distance, roughly where you would expect the next roadside settlement to be.
99	This is the scene of a gang fight with 4d12 corpses belonging to several different gangs. There is a 25% chance that there is still loot on them and a 10% chance of finding a working motorcycle (Beater quality, needs repairs).
100	While traveling, you see a truly colossal beast—as tall as a mountain—walking in the distance. Even though it must be miles away, it still feels too close for comfort. It stops suddenly and starts looking in your general direction, as though something has caught its attention.

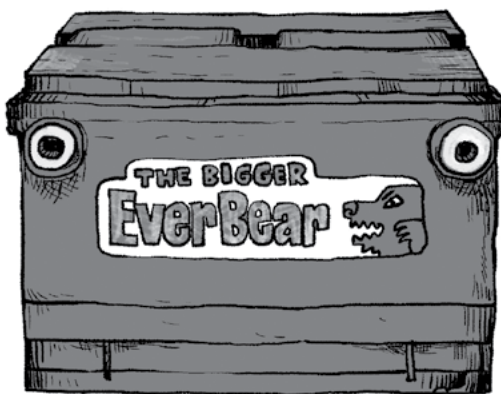



WEATHER OF THE WASTELAND

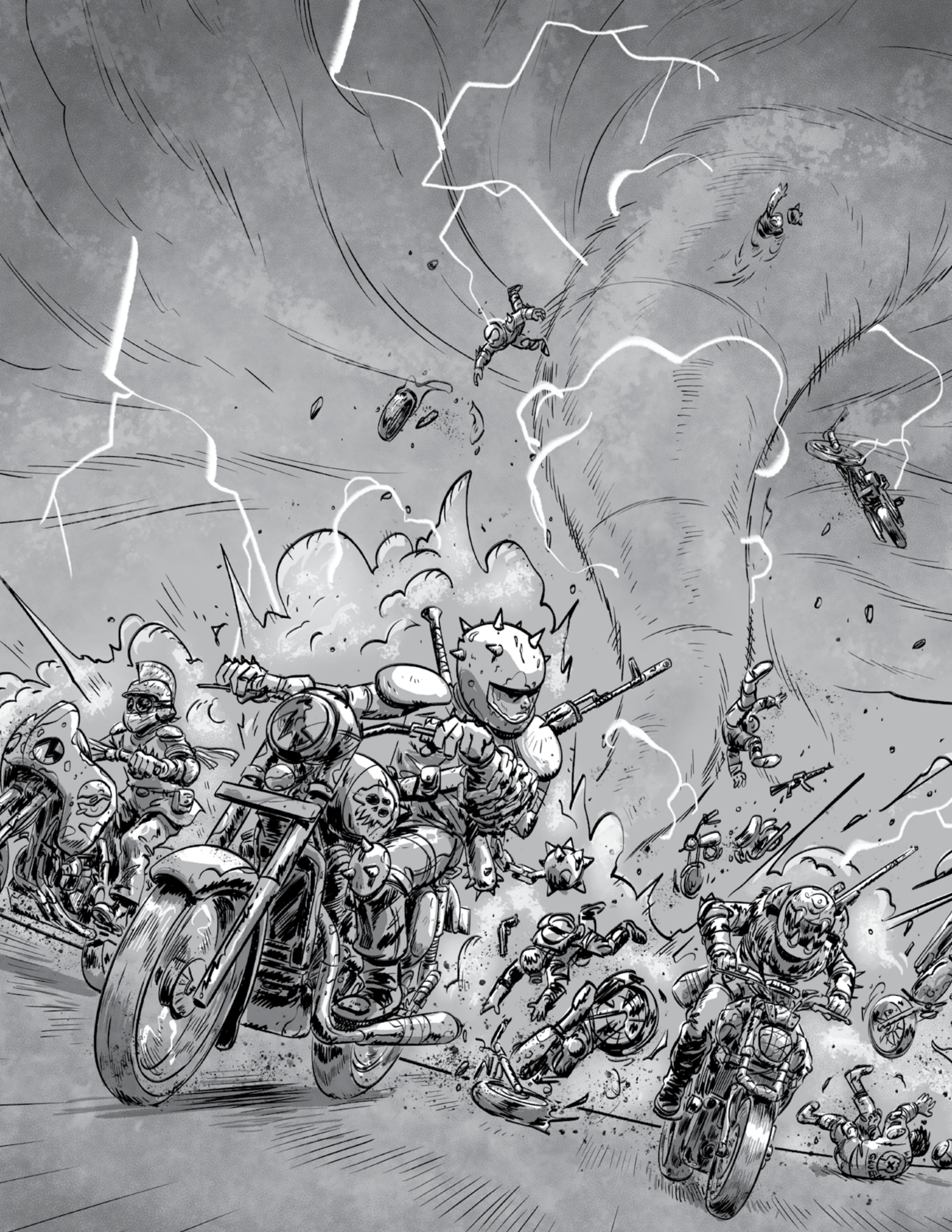

WEATHER OF THE WASTELANDS

WEATHER OF THE WASTELANDS

The weather of Umerica is fickle and cruel at the best of times. When it gets nasty, it swells and ebbs with strange energies that defy the laws of nature. If chaotic weather patterns are desired in an Umerican campaign, here is a system to create some truly memorable atmospheric conditions to spice up any adventure.

WEATHER WIZARDRY

Each day there is a 50% chance that a new weather front will move into the area in a roughly 10 mile radius circle. When one does, use the chart on the next page to plot what happens, starting in the middle Clear Skies space. Every four hours roll 1d4-1d4 twice, producing two numbers ranging from -3 to +3. The first number is for tracking the horizontal movement on the chart, with negative numbers moving left and positive numbers moving right. The second number is used in the same way with negative numbers moving down and positive numbers moving up. This will show the new weather pattern for the next four hours. If, when moving on the chart, the number of moves would fall off the edge, the weather front will disperse during those four hours, returning to a Clear Skies state.

WEATHER CONDITIONS

Burning Mud Storm - Sizzling acidic muck and hard clay pellets rain down from brownish-dark clouds. The air is filled with a wet, earthy smell tinged with an acrid stench.

Visibility: Poor, 20' at best. Windows, windshields, and visors will need constant cleaning to maintain any clarity.

Driving Conditions: +4 to all Vehicle Control rolls assuming the windshield wipers are working, +8 if not. All Wipeout rolls add +1d6.

Exposure Damage: 1d3 points of damage per minute of exposure. Non-Impervious armor will degrade by 1 die step per 10 minutes. Terrestrial Impervious armor will degrade 1 die step per two hours.

Shelter Required: A reinforced building or stone cavern.

Dust Storm - Giant funnel clouds filled with grit swirl hungrily, consuming everything in their path.

Visibility: Terrible, 10' at best. Windows, windshields, and visors will need constant cleaning to maintain any clarity.

Driving Conditions: +3 to all Vehicle Control rolls assuming that the windshield wipers are working, +6 if not. All Wipeout rolls add +1d4.

Exposure Damage: 1 point of damage per minute of exposure plus a Fortitude save (DC 10) to avoid Suffocation (USG pg 101). Non-Impervious armor will degrade by 1 die step per hour.

Shelter Required: A reinforced building with sealed doors and windows.

Freak Storm - Roll once on the Freak Storm Table.

Heavy Storm - Torrential rain and buffeting winds. 15% chance that the rain water is contaminated.

Visibility: Poor, 20' at best. Windows, windshields, and visors will need constant cleaning to maintain any clarity.

Driving Conditions: +3 to all Vehicle Control rolls assuming the windshield wipers are working, +6 if not. All Wipeout rolls add +1d3.

Exposure Damage: 1 point of damage per hour of exposure. If contaminated, once per turn a Fortitude save (DC 12) is required to avoid 1 point of temporary Stamina loss.

Shelter Required: A secured, waterproof shack or cave

Heavy Winds - Buffeting winds and the beginnings of funnel clouds.

Visibility: Good, flying debris occasionally blocks line of sight.

Driving Conditions: +1 to all Vehicle Control rolls for closed vehicles, +3 for open vehicles. All Wipeout rolls add +1.

Exposure Damage: 1 point of damage per hour of exposure due to flying debris.

Shelter Required: A reinforced shack or cave

Light Storm - Gentle rain and winds. 10% chance that the rain water is contaminated.

Visibility: Fair, over 100' with some distortion at farther ranges.

Driving Conditions: +1 to all Vehicle Control rolls assuming the windshield wipers are working, +3 if not. All Wipeout rolls add +1d2.

WEATHER OF THE WASTELANDS

Windy	Overcast	Dust Storm	Light Storm	Light Storm	Light Storm	Heavy Winds	Tornado	Overcast	Overcast	Windy
Overcast	Windy	Heavy Winds	Tornado	Heavy Storm	Heavy Storm	Burning Mud Storm	Heavy Storm	Light Storm	Windy	Overcast
Light Storm	Light Storm	Freak Storm	Super Freak Storm	Freak Storm	Freak Storm	Freak Storm	Super Freak Storm	Freak Storm	Light Storm	Dust Storm
Burning Mud Storm	Heavy Storm	Super Freak Storm	Freak Storm	Tornado	Heavy Storm	Heavy Storm	Freak Storm	Super Freak Storm	Tornado	Heavy Winds
Heavy Winds	Light Storm	Freak Storm	Lightning Storm	Heavy Winds	Overcast	Light Storm	Burning Mud Storm	Freak Storm	Burning Mud Storm	Light Storm
Overcast	Light Storm	Freak Storm	Dust Storm	Windy	Clear skies	Windy	Dust Storm	Freak Storm	Light Storm	Overcast
Light Storm	Burning Mud Storm	Freak Storm	Burning Mud Storm	Light Storm	Overcast	Heavy Winds	Lightning Storm	Freak Storm	Light Storm	Heavy Winds
Heavy Winds	Tornado	Super Freak Storm	Freak Storm	Heavy Storm	Heavy Storm	Tornado	Freak Storm	Super Freak Storm	Heavy Storm	Burning Mud Storm
Dust Storm	Light Storm	Freak Storm	Super Freak Storm	Freak Storm	Freak Storm	Freak Storm	Super Freak Storm	Freak Storm	Light Storm	Light Storm
Overcast	Windy	Light Storm	Heavy Storm	Burning Mud Storm	Heavy Storm	Heavy Storm	Tornado	Heavy Winds	Windy	Overcast
Windy	Overcast	Overcast	Tornado	Heavy Winds	Light Storm	Light Storm	Light Storm	Dust Storm	Overcast	Windy

Example: The first 1d4-1d4 roll is -2 and the second roll is 1. Assuming this is the beginning of the weather front, starting from the center Clear Skies space this moves two spaces to the left and up one space to Lightning Storm.

In four hours, the 1d4-1d4 is rolled twice again generating -3 and -2. This moves from the Lightning Storm space three spaces to the left and two spaces down, landing on Light Storm.

Four hours later the rolls are made again, resulting in -1 and 3. This moves left off the chart, ending the current bout of inclement weather.

WEATHER OF THE WASTELANDS

Exposure Damage: If contaminated, once per turn a Fortitude save (DC 12) is required to avoid 1 point of temporary Stamina loss.

Shelter Required: A waterproof tent or cave

Lightning Storm - A dust storm that generates a massive, static electrical charge rains down lightning throughout the area. Non-shielded electrical equipment has a 1-in-6 chance per hour of exposure of being damaged.

Visibility: Poor, 20' at best. Windows, windshields, and visors will need constant cleaning to maintain any clarity.

Driving Conditions: +3 to all Vehicle Control rolls assuming that the windshield wipers are working, +6 if not. All Wipeout rolls add +1d3.

Exposure Damage: 1 point of damage per turn of exposure plus a Fortitude save (DC 8) to avoid Suffocation (USG pg 101). In addition, there is a 20% chance per turn of being struck by lightning (damage 4d4). Non-Impervious armor will degrade by 1 die step per hour.

Shelter Required: A reinforced building with sealed doors and windows.

Overcast - Reduced visibility.

Visibility: No issues.

Driving Conditions: No modifier.

Exposure Damage: None.

Shelter Required: None required

Super Freak Storm - A legendary tempest of unnatural destruction. Roll twice on the Freak Storm Table and combine the results in the most heinous way possible. May Nuka have mercy on their mutant souls.

Tornado - One or more massive funnel clouds rip through the countryside.

Visibility: Poor, 80' at best. flying debris often blocks line of sight.

Driving Conditions: +2 to all Vehicle Control rolls for closed vehicles, +4 for open vehicles. All Wipeout rolls add +1d3.

Exposure Damage: 1d3 points of damage per minute of exposure due to flying debris. If the vehicle cannot outrun the storm, the driver must make a Luck check every 30 minutes or the vehicle will get sucked into the funnel cloud (10d10 damage to the vehicle and each occupant).

Shelter Required: A cave or underground shelter.

Windy - Kicks up lots of dust and some debris.

Visibility: Good, flying debris occasionally blocks line of sight.

Driving Conditions: +0 to all Vehicle Control rolls for closed vehicles, +2 for open vehicles.

Exposure Damage: None.

Shelter Required: None required.

Freak Storm Table - Roll 1d10

Roll	Result
1	<p>Vermin Storm - Speckled clouds release a torrent of spiders and other poisonous, crawling insects upon the area. They are agitated and ravenous.</p> <p>Visibility: Poor, 20' at best. Windows, windshields, and visors will need constant cleaning to maintain any clarity.</p> <p>Driving Conditions: +3 to all Vehicle Control rolls assuming the windshield wipers are working, +6 if not. Open vehicles suffer an additional +2 modifier. All Wipeout rolls add +1d3.</p> <p>Exposure Damage: 1 point of damage per round of exposure due to dozens of bites.</p> <p>Shelter Required: A sealed building.</p>
2	<p>Seed Storm - Greenish, wispy clouds release a shower of strange seeds. Everything in the area will quickly be entangled in rapidly growing vines.</p> <p>Visibility: Poor, 20' at best. Windows, windshields, and visors will need constant cleaning to maintain any clarity.</p> <p>Driving Conditions: +5 to all Vehicle Control rolls due to clinging vines attempting to entangle the vehicle. All Wipeout rolls add +1d4.</p> <p>Exposure Damage: 1 point of damage per minute of exposure due to seeds attempting to gain root in flesh. Note that devoted followers of Grokk will suffer no damage from the storm seeds.</p> <p>Shelter Required: A sealed building.</p>

WEATHER OF THE WASTELANDS

Freak Storm Table [continued]

Roll	Result
------	--------

- | | |
|---|--|
| 3 | <p>Bone Storm - Cackling ashen clouds forcefully rain down a multitude of dry, skeletal remains of various creatures. There is a 15% chance per hour the storm rages that un-dead skeletal horrors composed of assorted bones will rise to rampage.</p> <p><i>Visibility:</i> Poor, 40' at best.</p> <p><i>Driving Conditions:</i> +3 to all Vehicle Control rolls for closed vehicles, +5 for open vehicles. All Wipeout rolls add +1d5.</p> <p><i>Exposure Damage:</i> 1 point of damage per round of exposure due to falling bone fragments. Windshields, windows, and other glass or fragile objects have a 20% chance of shattering per hour of exposure.</p> <p><i>Shelter Required:</i> A building or cave.</p> |
| 4 | <p>Slime Storm - Bloated gelatinous clouds discharge a downpour of living slime fragments. Every hour that the storm rages, 1d5-1 primeval slimes, each of 1d3 HD in size, (DCC RPG pg 423) will reform from the fragments in each acre the storm covers.</p> <p><i>Visibility:</i> Poor, 20' at best. Windows, windshields, and visors will need constant cleaning to maintain any clarity.</p> <p><i>Driving Conditions:</i> +4 to all Vehicle Control rolls assuming that the windshield wipers are working, +8 if not. Open vehicles suffer an additional +3 modifier. All Wipeout rolls add +1d6.</p> <p><i>Exposure Damage:</i> 1d3 points of damage per minute of exposure. Non-Impervious armor will degrade by 1 die step per turn. Terrestrial Impervious armor will degrade 1 die step per two hours.</p> <p><i>Shelter Required:</i> A reinforced building or stone cavern.</p> |
| 5 | <p>Color Storm - Fluffy, multicolor clouds release a gentle, sweet tasting rain that changes the color of anything it touches. Roll 1d7 to determine the color for each person or object affected: 1- red, 2- orange, 3- yellow, 4- green, 5- blue, 6- indigo, 7- violet. The color change will not wash off by normal means and will last 3d7 weeks.</p> <p><i>Visibility:</i> Fair, over 80' with some distortion at farther ranges.</p> <p><i>Driving Conditions:</i> +1 to all Vehicle Control rolls assuming the windshield wipers are working, +3 if not. All Wipeout rolls add +1d2.</p> <p><i>Exposure Damage:</i> Coloration.</p> <p><i>Shelter Required:</i> A waterproof tent or cave</p> |
| 6 | <p>Hell Storm - The sky is filled with bright, burning clouds. Imps can be seen flying amongst them and laughing at the creatures below. All <i>lay on hands</i> and <i>turn unholy</i> attempts made by non-Chaotic beings during the storm automatically fail.</p> <p><i>Visibility:</i> Good, flaming debris occasionally blocks line of sight.</p> <p><i>Driving Conditions:</i> +1 to all Vehicle Control rolls for closed vehicles, +3 for open vehicles. All Wipeout rolls add +1.</p> <p><i>Exposure Damage:</i> Frequent bolts of flame rain down across the landscape. Unprotected people, beasts, and structures must make a roll under their Luck every 10 minutes that the storm rages or be hit by a fiery bolt for 3d6 damage.</p> <p><i>Shelter Required:</i> A reinforced, fireproof building or cave.</p> |
| 7 | <p>Blessed Storm - Glowing golden clouds release a torrent of glittering rain. All who are caught in the storm heal one HD per hour that the storm lasts. If the rainfall is ritualistically collected before it strikes the earth (requires an Intelligence check (DC 15) by a devout person of Lawful alignment) each gallon collected will act as a healing potion (DCC RPG pg 224) for 2d3 days, after which it will just be 100% pure water.</p> <p><i>Visibility:</i> Fair, over 100' with some distortion at farther ranges.</p> <p><i>Driving Conditions:</i> +1 to all Vehicle Control rolls assuming the windshield wipers are working, +3 if not. All Wipeout rolls add +1d2.</p> <p><i>Exposure Damage:</i> Healing.</p> <p><i>Shelter Required:</i> A waterproof tent or cave.</p> |

WEATHER OF THE WASTELANDS

Freak Storm Table [continued]

Roll	Result
8	<p>Seafood Storm - Swirling purple clouds unleash a downpour of fish, crustaceans, and amphibians upon the area covered by the storm. The bounty that falls is fully edible and untainted but will quickly begin to rot (goes bad in roughly two hours) unless properly stored. Areas not cleared of the rotten mess will have a 20% chance per day to attract many large scavenger type beasts for the next week.</p> <p><i>Visibility:</i> Poor, 40' at best.</p> <p><i>Driving Conditions:</i> +3 to all Vehicle Control rolls for closed vehicles, +5 for open vehicles. All Wipeout rolls add +1d6.</p> <p><i>Exposure Damage:</i> 1 point of damage per round of exposure due to the fleshy torrent. Windshields, windows, and other glass or fragile objects have a 10% chance of shattering per hour of exposure.</p> <p><i>Shelter Required:</i> A building or cave.</p>
9	<p>Rad Storm - Glowing greenish clouds discharge waves of fluffy, incandescent flakes of radioactive ash. This beautiful ashfall covers the area in luminous piles of toxic death.</p> <p><i>Visibility:</i> Poor, 50' at best. Windows, windshields, and visors will need constant cleaning to maintain any clarity.</p> <p><i>Driving Conditions:</i> +1 to all Vehicle Control rolls assuming that the windshield wipers are working, +3 if not. All Wipeout rolls add +1d2.</p> <p><i>Exposure Damage:</i> A Fortitude save (DC 12) must be made each hour to avoid suffering 1 point of temporary Stamina damage. This will remain in effect in the area for 2d5 months. Mutants have a cumulative 10% chance per hour spent in the area to spontaneously mutate (USG pg 168).</p> <p><i>Shelter Required:</i> A rad-proof suit or shelter.</p>
10	<p>Corpsenado - These appear as a purplish tornado with arcs of sickly-green lightning flashing from within. Upon closer inspection onlookers can make out the shapes of hundreds of animated corpses flailing within the twisting funnel cloud while, peering from the center of the whirlwind, are a pair of baleful glowing red eyespots.</p> <p><i>Visibility:</i> Poor, 60' at best. flying debris often blocks line of sight.</p> <p><i>Driving Conditions:</i> +3 to all Vehicle Control rolls for closed vehicles, +6 for open vehicles. All Wipeout rolls add +1d4.</p> <p><i>Exposure Damage:</i> This is an intelligent creature and will attempt to pursue any targets it can (TMM pg 33). In addition, those in the general area suffer 1d3 points of damage per minute of exposure due to flying debris.</p> <p><i>Shelter Required:</i> A cave or underground shelter, maybe. . .</p>

OUTRUNNING A STORM

If a weather front is detected while it is far off, it is possible to drive ahead and or around it. Most storms roll into an area between 20 to 60 miles per hour (Speed levels 2-5, use a 1d4+1 to randomize), and head in a predictable path. To avoid a storm front, a vehicle must travel at least at the Speed level the storm is moving and an Intelligence check (DC 11) is required to gauge the direction it is heading so the vehicle can veer away from it. There is a 10% chance that a front

will change its course, requiring another Intelligence check (DC 13) to determine its new path. As most storms range from 6 to 16 miles in diameter (2d6+4), skirting around a storm may require a long detour.

Another thing to consider is that the stronger the storm, the more likely other folks and/or things will be looking to get away from the front as well. This means the chances of random encounters will double, or possibly triple, when traveling along the edge of a storm, even in the safest of areas.



INFAMOUS GANGS OF THE VAST WASTELAND



INFAMOUS GANGS OF THE VAST WASTES & BEYOND

Roaring engines amidst concealing clouds of dust signal the approach of one of Umerica's many moto-gangs. Ranging from the dread Komodo Motos to local toughs such as the Citadel Scrappers, these bands of adventurous gearheads eat life (and in more than one case—their foes) with shining teeth. Just as in nature, their bright colors warn of the danger to those who approach them without caution. Careless interactions can lead to a quick death, while approaching them openly and in a sense of brotherhood can sometimes have surprising results (just don't expect them to help you change a tire).

REGALIA

Whether handled through the use of actual patches, or via other means such as branding, tattoos, ritual scarification, etc., the regalia of any of these gangs is similar in a style predating the great disaster. This is the accepted form of identification between gangs and a breach of such "uniform" is considered an unworthy act—punishable by death within the gang as frequently as from without.

The "patch/colors" are prominently displayed on the back, bearing the gang's name, logo, and colors. The wearing of the patch by non-members is most often punishable by summary execution while the loss of one's patch is a sign of disgrace. This display can be made up of from one-to-four pieces.

- **Rockers:** Crescent shaped upper and lower patches on the back are known as "rockers." A top rocker will display the name of the gang, while a lower rocker may display things such as a chapter's territory, or a position within the gang.
- **Insignia:** The central portion of the patch displays the chosen logo of the gang.
- **Kutte:** There is much debate over the origin of this small, square patch. Adorned simply with the letters "MC" it is believed to stand for "Murder Club." Placed to the right of the Insignia, the kutte is used by some gangs to denote that they take no prisoners.

Smaller patches are often worn on the front of the colors and can vary wildly. Some bear mottos and

symbols that have meaning for the individual rider (such as gang rallies attended), while others may have defined meanings denoting actions carried out by that particular member both foul and obscene.

ORGANIZATION

Despite their differences, gangs are often organized in a very similar fashion—although the size of a gang will often dictate how organized the group is.

Level 1 – Hangarounds: The pre-entry level to any of the larger gangs, these folks are "friends of the club," showing their interest and hoping for membership. While not officially members of the gang, they are found in solid numbers at any public gathering of the gang and will often be the first to brawl at any perceived slight in hope of garnering favor from the patchholders. While not being "patched" themselves, hangarounds will often wear patches with the gang's colors, to show their affiliation.

Level 2 – Prospects: Having caught the attention of the membership, these individuals are being considered for membership within the gang. The requirements for being "patched" vary from group to group; sometimes a vote of the membership is needed and in other cases some sort of trial or ordeal must be endured. In some of the larger gangs, prospects wear a lower rocker reading "prospect," but without the gang's colors.

Level 3 – Patch Holders/Patches: These members are the rank and file soldiers of any gang. Their loyalties have been made clear and they are expected to uphold the code of the gang, even if that should prove fatal. Devoted to the gang, but generally not fools, they have no qualms about softening up a foe by encouraging a group of hangarounds to lead the charge of battle.

Level 4 – Officers/Lieutenants: There are a number of positions that can be found within gangs (both locally and globally), depending on their size and scope. While the names of the officers may vary from club to club, the general structure often remains the same. Some examples include:

Chaplain/Wise One: The link between the gang and their patron, these members are responsible for the sacred rites of the gang, including funerals. In matters of promoting prospects, it is often the chaplain and the president who make the decision.

Enforcer: If there is trouble, the gang handles it. If

INFAMOUS GANGS OF THE VAST WASTES & BEYOND

there is trouble within the gang, the enforcer handles it. In matters of gang security or reputation, the enforcer has the penultimate word—answering only to the president.

Road Captain: This member plans the route for any mass ride, acting as navigator and enforcer during the run. If the president is not present for the ride, the road captain is the ranking officer and rides at the front of the pack.

Sergeant at Arms: The fist of the officers, they are responsible for the general security of the gang as well as holding the duty of stripping patches and colors from disgraced members. If weapons need to be locked away for any reason, the sergeant at arms handles their safekeeping.

Tail Gunner: The second to the road captain, the tail gunner has the rear-most position on any ride, watching for members who breakdown or crash. This officer is usually one of the most skilled mechanics in the gang, carrying tools and medical supplies.

Level 5 – The top echelon of the gang or chapter, with the rights to ride at the front on any run and often to dispense justice as they see fit.

President/Vice President: All matters between the gang and any outside group (such as local government or rival gangs) are handled by the president. They are the personal representative of the gang and make rulings on anything not covered in the chapter's rules.

Founder: Anyone starting a gang, or chapter, is the founder. They will act as president so long as they are active and, even after, have great sway within the club.

Collected together here for the first time is a wasteland traveler's guide to the gangs of the wastes, detailing their membership.

BIG DOGS (1,000+ MEMBERS)

KOMODO MOTOS

"Change is Truth"

Club Membership: Komo-doan

Total Membership: 1,000+

Territory: Coast to coast

Insignia: Three-headed komo-doan

Chieftain: Friedli

Patron: Theszolokomodra

Regional Chapters: 50 (10-30 members)

Nomad Chapters: 10 (9-12 members)

Allies: Rad Fink, Untouchable Horde

Enemies: The Brood, Hissiens, Migration Nation, Wraths (any)



The largest, and most powerful gang in all of Umerica. The Komodo Motos are the blessed followers of Theszolokomodra and tolerate no rivals. The driving goals of the gang are simple. Kill their enemies, ride far, and party hard (one could almost confuse them for followers of Kizz—if they weren't so often killing members of the Hissiens).

The Komodo Motos are involved in a number of prolonged turf wars with the Hissiens over turf for the sale of Killer Kola. While the beverage itself has no narcotic properties, the difficulty with which it is procured makes it highly sought after and drinking the alien beverage is seen by many as a status symbol. Diet Killer Kola, however, is merely used to remove rust from bumpers and "New" Killer Kola is used as a purgative.

Of particular note is the gang's hatred of wraths, whether gang members or unaffiliated. These un-dead are seen as an affront to the Komodo Moto's patron, as they are seen as "unchanging." This direct challenge to the gang motto is met with full throttle violence in an attempt to eradicate every last wrath from Umerica. So great is their hatred for wraths that the Komodo Motos have abandoned combats where they clearly had the

INFAMOUS GANGS OF THE VAST WASTES & BEYOND

upper hand for the sole purpose of brutally destroying a single wrath.

Initiation: Despite their size and power, the fearsome reputation of the Komodo Motos means that chapters attract only a handful of hangarounds (1d4) and they will generally have an equal number of prospects. There is only one way into the gang, being jumped in by walking the gauntlet. Initiates must take a single, (usually) unarmed blow from each member of the chapter. Those that survive are deemed worthy. Those who fail are roasted on an open spit and devoured by the chapter membership—serving as a warning to all.

Notable Members

Friedli, Chieftain of the Komodo Motos

It is said that three komo-doans rode into the desert and only one returned, born of their merged flesh, to lead the Komodo Motos. This is not legend, it is fact. The three riders, Friedli and two priests sworn to Theszolokomodra, rode out on a vision quest seeking to better serve their great patron. While Friedli does not discuss the specifics, their flesh was merged into a massively powerful body supporting their three monstrous heads.

Having been reshaped by Theszolokomodra, Friedli is followed with slavish devotion of the type generally reserved only for divine beings. Proclaiming himself as the one true prophet of the great Theszolokomodra, he demands total fealty from the membership and even the merest hint of disloyalty is dealt with immediately and brutally.

Friedli (Mutant Komo-doan, TMM pg 228): Init +3; Atk bite (x3) +5 melee (1d8+8, poison Fort DC 18 or death), claws +5 melee (2d6+16), slam +5 melee (1d12+8), tail +4 melee (2d5+8), or laser rifle +3 ranged (1d10, RoF 3); AC 15; Armor Die 1d7; HD 7d8+7; hit points 45; MV 30'/dig 10'; Act 2d24; SP three-headed, chrono-sense, ectothermic, immune to disease, regeneration, wheels, spells (1st level) *choking cloud*, *feather fall*, *magic shield*, *summon foulness*, (2nd level) *invisibility*, *locate object*, *strength*, (3rd level) *fireball*, *planar step*, (4th level) *former glory*, spell check +5; SV Fort +5, Ref +3, Will +3; AL C.

Headstone, Komodo Motos Sgt. at Arms

When members of the Komodo Motos defected to start their own gang, the Migration Nation, Friedli tasked the membership with hunting down and exterminating

the upstart gang. Of those who rose to the challenge, the komo-doan now known only as Headstone, was the most ruthless. Armed only with a chainsaw, he terrorized the membership of the Migration Nation so greatly that even the hint of his being in an area will often cause the migratory gang to steer clear.

While the Migration Nation continued to grow and thrive, Headstone's dedication was rewarded with the position of sgt. at arms. In a ceremony personally overseen by Friedli, the komo-doan's soul was sworn into the eternal service of Theszolokomodra. The patron responded by gifting immortality to the fist of the Komodo Motos. As his legacy of brutality has spread, his fearsome reputation serves as a warning to all who would challenge the Komodo Motos. Clad in "leathers" made from the skins of his prey, Headstone is a terrifying foe indeed.

Headstone (Komo-doan): Init +3; Atk bite +4 melee (1d8+6, poison Fort DC 16 or death), claws +6 melee (2d6+6), tail +4 melee (2d4+6), or chainsaw +5 melee (2d7+6, Crit 18-20); AC 14; Armor Die 1d6; HD 4d8+6; hit points 38; MV 30'/dig 10'; Act 2d20; SP ectothermic, fearsome reputation, immortality, immune to disease, wheels; SV Fort +3, Ref +3, Will +2; AL C.

Fearsome reputation: Upon encountering Headstone, komo-doans not of the Komodo Motos must immediately make a DC 13 Willpower save or flee in terror. Members of the gang fighting alongside Headstone never need to make morale checks.

Immortality: Headstone is virtually unstoppable. If "slain" by ordinary means, he simply rises again in 1d5 rounds, fully restored to full health. In that time, severed limbs crawl back to the body, blood flows back into wounds, and charred flesh is restored. It is rumored that there is a single way to kill Headstone permanently, but if anyone knows that secret, they are keeping quiet.

MIGRATION NATION

"To stop moving is to die"

Club Membership: Komo-doan

Total Membership: 1,000+

Territory: Coast to coast

Insignia: Happy face

President: Hissin' Sam

INFAMOUS GANGS OF THE VAST WASTES & BEYOND

Patron: Yyaallaayy

Regional Chapters: 0

Nomad Chapters: 75 (15-20 members)

Allies: The Brood

Enemies: Komodo Motos

MIGRATION Nation



**TO STOP MOVING
IS TO DIE**

Chief rival of the Komodo Motos, this gang embraces the ever-changing nature of Chaos as a reflection of their migratory habits. This tendency of the gang makes them easier to deal with for locals who, if forewarned, will simply pack up and hide elsewhere for two days before returning home.

With no regional chapters, all bands of this group are nomadic and roam independently of one another save for their annual gathering near the Burning Lands of Yellowstone. This rally is the only time any chapter will remain in one place for greater than 48 hours. The Burning Lands Touring Rally serves as the annual meeting and elections for the gang, with the newly elected club president taking on the title of “Sam” and the outgoing club president being torn to pieces and fed to club prospects as the final step in their initiation.

The gang is allied with its fellow komo-doan gang, the Brood, as a stopgap against the ever-growing power of their common enemy, Friedli and the Komodo Motos. Still, these relations are strained by the gang’s killing and eating their president once a year.

Initiation: Prospective members steal the colors from a member of the Komodo Motos, without killing the biker, to shame both the biker and the gang. Once

accepted for membership, prospects must attend the Burning Lands Touring Rally and partake in the raw flesh of the outgoing Hissin’ Sam to draw in his strength and wisdom—thus earning their patch.

Notable Members

Hissin’ Sam, Club President Chieftain of the Migration Nation

A near perfect example of a young komo-doan in its prime, physically, there is little to distinguish Hissin’ Sam from any other gang member. His skill on a motorcycle though, sets him firmly above the other members of the gang and makes him a feared foe on the roadways of Umerica.

Being dedicated to the service of Yyaallaayy utterly frees Hissin’ Sam from fear. Having accepted an elected position with a terminal retirement, the gang’s president pushes the group to ever greater exploits, despite the toll it might take on membership numbers. There are always more komo-doans, but chances for glory are fleeting.

Hissin’ Sam (komo-doan): Init +4; Atk; claws +2 melee (1d6+4), bite +2 melee (1d8+4, poison DC 14 or die), exploding lance +2 melee (4d6), can grenade +3 ranged (1d5, 10’ blast radius), or saber +2 melee (1d8+4); AC 13; Armor Die 1d6; HD 3d8+5; hit points 20; MV 30’/10’ dig; Act 1d20; SP cycle dueling, ectothermic, immune to disease, immune to fear; SV Fort +0, Ref +3, Will +1; AL C.

Cycle dueling: Hissin’ Sam is proficient in the cycle dueling combat style with a deed die of 1d8.

Tramplin’“T” Terry, Migration Nation Patch Holder

It is not easy to become well known when not staying in one place for more than 48 hours—a challenge that Tramplin’ Terry of the Migration Nation gladly accepted. Easily the most recognized member of the gang, T’s outlandish behavior has earned him notoriety among gangs from coast to coast—and even beyond. No one leaps higher, curses louder, fights better, rides faster, or can party harder than this venerable komo-doan.

His time on the road, and extreme risk-taking, have taken a physical toll—and has also taken his right arm, left eye, and most of his lower jaw. In response, T. has cobbled together jury-rigged replacement parts that, while functional, have an appearance so disturbing that

INFAMOUS GANGS OF THE VAST WASTES & BEYOND

they only add to his legend. Of course, T's tinkering hasn't stopped there, and those picking a fight with this near legendary figure are in for a surprise.

Tramplin' Terry (cyborg komo-doan): Init +2; Atk slam +5 melee (1d12+8), claws +5 melee (1d6+8), bite +5 melee (2d12, poison DC 18 or die), tail +4 melee (2d5+8), plasma pistol +1d3 +3 melee (1d10) or by weapon; AC 15; Armor Die 1d4; HD 5d8+7; hit points 28; MV 30'/10' dig; Act 2d24; SP cyborg, ectothermic, immune to disease, jury rig 1d5, +2 resistance to charm & sleep; SV Fort +5, Ref +2, Will +3; AL C.

Cyborg: Tramplin' Terry has the following home-built cybernetic enhancements:

- Optical enhancement: Infravision 60'
- Spring-loaded jaw: 2d12 damage
- Telescoping arm: 10' reach, +2 for *climbing* checks.
- Weapon port: Plasma pistol (+1d3 to hit, 1d10 damage, range 50')

SATAN'S AUDITORS MC

"Live to die. Die to ride"

Club Membership: Wraths

Total Membership: 1,000+

Territory: Coast to coast

Insignia: Burning skull

Founder: Burnie "Corpse" Grinder

Patron: Whaaar!

Regional Chapters: 0

Nomad Chapters: 75 (15-20 members)

Allies: Sons of Whaaar!

Enemies: Everybody else

The largest known gang of wraths (other gangs including Khan's Killers and the Heathens), Satan's Auditors leave a trail of mangled corpses and devastation in their wake. Easily the most violent of the major gangs, Burnie's Bunch (as they are sometimes called in gang-circles) leave no survivors and, when possible, no structures.

The near Biblical level of destruction and desolation left in their wake is enough to lead most gangs to simply avoid Satan's Auditors, with only the Cenobikes and Komodo Motos challenging them with any regularity. Even these clashes advance the gang's



desire for destruction, the battles leaving entire towns depopulated and having large body counts.

The only gang that Satan's Auditors could call allies are the Sons of Whaaar!. While the gang is made up of living members, the leader of the gang (Jason Meyers) has a connection of some sort to Corpse Grinder—holding his respect.

Initiation: One would think that by merely being a wrath, one could claim membership but such a thought would be incorrect. At any given moment, a chapter will have 2d10 wraths as hangarounds and another 1d5 as prospects. Joining requires a wrath to single-handedly destroy a community of no less than 25 residents, slaying all and razing every last building to the ground.

Notable Members

Burnie "Corpse" Grinder, Satan's Auditors Founder

If terror had a physical form (and perhaps it does), it would be that of "Corpse Grinder." Standing an imposing 7'4", the leather-clad, un-dead biker's form is awash in his signature green hellfire. Said to be the risen form of an ancient warrior from centuries past, there is nothing about the enormous biker that would dissuade from such a conclusion.

Burnie "Corpse" Grinder (wrath): Init +5; Atk sledgehammer +1d7 melee (1d8+Deed), 15' blazing chain +1d7 melee (1d6+Deed+entangle), unarmed +1d7 melee (1d3+Deed); AC 14; Armor Die 1d8; HD 5d12+4; hit points 38; MV 30'; Act 2d20; SP berserker, hellfire, mob tactics, wheels, warrior traits, Will immune; SV

INFAMOUS GANGS OF THE VAST WASTES & BEYOND

Fort +6, Ref +4, Will n/a; AL C.

Berserker: Burnie may add a total of +6d12 in rage damage per day (opposed to the normal +3d12).

“JAG” Petrik, Satan’s Auditors Chaplain

Dedicated to carrying out the sacred rites of Whaaar!, “JAG” is the hooded minister of the gang. Clad entirely in gleaming white leathers the only darkness visible is the empty sockets of JAG’s eyes and the black hellfire within.

“JAG” Petrik (Wrath): Init +5; Atk sledgehammer +1d4 melee (1d8+Deed), 15’ blazing chain +1d4 melee (1d6+Deed+entangle), hellfire blast +1d4 ranged (1d3 Stamina, DC 12 Fort save negates), unarmed +1d4 melee (1d3+Deed); AC 12; Armor Die 1d8; HD 3d12+2; hit points 25; MV 30’; Act 2d20; SP berserker, hellfire, mob tactics, wheels, warrior traits, Will immune, spells (1st level) *blessing, darkness, flaming hands*, (2nd level) *curse, lotus stare*, (3rd level) *bolt from the blue*, spell check +3; SV Fort +6, Ref +4, Will n/a; AL C.

Hellfire blast: JAG is capable of gathering and unleashing massive amounts of black hellfire over distances of up to 500’, draining the very life essence of his targets for 1d3 Stamina. The souls of beings so slain are dedicated to Whaaar! and are forever lost.

POWER HITTERS (501-1,000 MEMBERS)

CENOBIKES

“The Delights We Shall Show You”

Club Membership: Demons

Total Membership: 700+

Territory: Western Umerica

Insignia: Spiked peacock

Founder: Nabroco

Patron: Synod of the Astroliches

Regional Chapters: 30 (15-25 members)

Nomad Chapters: 5 (15-25 members)

Allies: Hissiens

Enemies: Satan’s Auditors

These demon-hordes cruise the byways of Umerica to further the entertainment of the Synod of the Astroliches. Each member rides with a monitor lizard (on his bike, in a sidecar, or simply clinging to its spikes) so as to broadcast their exploits. Of course,

CENOBIKES



keeping the attention of creatures who have seen everything is difficult, and the Cenobikes are known for their ruthless and wicked acts—always attempting to shock those for whom nothing is shocking.

Founded by a relatively minor demon named Nabroco, the creature has risen in profile (if not in power) as its efforts continue to receive the approval of his chosen masters. The continuing war with Satan’s Auditors has provided some of the highest ratings from the Synod and shows no sign of ending. Due to their love of spikes and demonic imagery, the Cenobikes have a passably friendly relationship with the Hissiens and both gangs will aid the other (so long as it is convenient).

Initiation: New members must carry out an on-camera audition for the gang by performing two original monologues and an original act of depravity. Should the auditioner find that a monitor lizard has come to broadcast their activity, they are upgraded to full-patch status. If not, they continue to be hangers on and can attempt to join again at some later date.

Notable Members

Nabroco, Cenobikes Founder

A twisted amalgamation of polar bear and yellow jacket, the multifaceted stare of Nabroco is matched only by that of its ever-present monitor lizard (unit designation WRGB). Nabroco’s skin is pierced by hundreds of needles digging into both itself and its enemies alike when it engages in its popular bear hug.

Formerly a minor demon dedicated to the service of a forgotten lord, Nabroco has now dedicated its very

INFAMOUS GANGS OF THE VAST WASTES & BEYOND

existence to fulfilling the most debased entertainment desires and for some unknown reason, square dancing (which may be THE most debased form of entertainment ever observed by the Synod of the Astroliches).

Nabroco (Type II Demon): Init +4; Atk bearhug +8 melee (3d3+4), claw +8 melee (2d5+4), sting +8 melee (1d6 + poison [agony, DC 10 Fort negates]), or by weapon; AC 13; Armor Die 1d5; HD 7d8+4; hit points 42; MV 30'; Act 2d20; SP demon traits, in the know, needles; SV Fort +6, Ref +4, Will n/a; AL C.

In the know: Nabroco is psychically linked to its personal monitor lizard, which feeds it information it deems important that is found on any Cenobike feed—including information on attackers, locations of enemies, and more. It is through this information that Nabroco has continued to keep the Cenobikes “ratings” with the Astroliches high enough to avoid terminal cancellation.

Needles: The needles in its flesh inflict 3d3+4 points to those it bearhugs, and 1d3+2 damage to itself. With this in mind, Nabroco uses this as a “patented finishing move” which is accompanied by the howling of an unseen spectral audience.

Poison: The poison sting of Nabroco causes unrelenting, ever increasing agony in its victims. Those who succumb to the taint of the sting must make a DC 6 Fort save to take action at any given time. All other time is spent writhing and howling in utter, incessant pain that lasts for the rest of the target’s life (or until the sufferer’s pain ceases to amuse the Synod—generally 2d3 days).

Unit Designation WRGB, Cenobikes Lead Camera

The monitor lizards accompanying the Cenobikes, unlike their brethren, do not act with subtlety. They record clearly in the open, often-times ducking between combatants so as to get the best camera angles. Unit Designation WRGB, beyond its own feed, receives the feeds of all other Cenobike feeds (over 700 separate feeds) and mentally weaves them into a coherent video feed filled with excitement, drama, and lots and lots of bloodshed.

Unit Designation WRGB has far more than the normal number of implants found within a monitor lizard, allowing it to patch in feeds live, crossfade, and even include a “tape” delay should it feel that something is

deserving of extra attention or even a reshoot.

Unit Designation WRGB (monitor lizard): Init +4; Atk bite +2 melee (1d4) or twin head-mounted lasers +5 missile fire (2d12, range 40/80/120); AC 13; Armor Die 1d3; HD 3d8; hit points 18; MV 40', climb 30', or swim 20'; Act 1d20; SP producer, ratings boost, ultimate senses; SV Fort +2, Ref +4, Will +10; AL N.

Producer: Unit Designation WRGB is aware of everything happening to all Cenobike members in real time and passes along any potentially important information to Nabroco.

LEGIONS OF THE EYE LORD

“Nice ride you had there”

Club Membership: Open

Total Membership: 600+

Territory: Coast to coast

Insignia: Glowing eye

Founder: Eye Lord Denbu

Patron: None

Regional Chapters: 30 (10-25 members)

Nomad Chapters: 7 (10-15)

Allies: Corpse Crew

Enemies: Rad Fink, The Restless Dead, Trailer Park Trash

This large gang works towards the singular obsession of their founder, the gathering of rare and well-customized vehicles. Chapters scour Umerica, coast to coast, seeking out the flashiest rides of any sort, stopping at nothing to gain them. Any who fall under the sway of Denbu’s insatiable desire for new vehicles are welcome, and members have been known to ride everything from old construction vehicles to their leader’s recent cast-offs.

Denbu’s obsessive collecting has brought the collective ire of a number of vehicle lovers down upon the gang. Rad Fink in particular will immediately reroute his caravan to destroy any chapters that he should learn of. Since many owners of especially fine custom rides end up dead, the Corpse Crew often allies with the Legions of the Eye Lord so as to absorb the cast-off corpses into their membership.

Initiation: All regional chapters have 2d3 gearhead hangarounds, but there are no prospects. Either one

INFAMOUS GANGS OF THE VAST WASTES & BEYOND



submits to the *cone of control* of the orbus, or one dies. All initiations are carried out by Denbu and the main chapter, with new members traveling back to their respective chapters once fully indoctrinated.

Notable Members

Eye Lord Denbu, Legions of the Eye Lord Founder

Ever since it was a protoplasmic blob, Denbu dreamed and obsessed over Urth vehicles. Prior to reaching maturity it had already amassed a sizeable collection of scale model vehicles and had set about to “improve” them by kit-bashing various models together to create ever wilder and more elaborate customs. Stumbling across an ancient Urth library that held digital copies of ancient hot rod publications, Denbu drove himself further, recreating concept vehicles that had never achieved fruition.

As his efforts began to draw attention, the gearhead orbus began to surround itself with like-minded enthusiasts. Of course, Denbu had the greatest talent for what was being done and so the members of his burgeoning social circle fell under his sway—which was obviously as it should be. Now, with over 600 trained mechanics scouring the Urth for rare and interesting vehicles, Denbu devotes most of his time building his latest masterpiece (often taking several years to complete), showing it off for a relatively brief span of months, before casting it aside and beginning on his next project.

Eye Lord Denbu (Orbus): Init +1; Atk claw +4 melee (1d6+3), psychic lightning +5 missile (1d8+6, range

60/120/180); AC 14; Armor Die 1d5; HD 8d6+8; hit points 36; MV levitation 30'; Act 2d20; SP cone of control, driven, gifted mechanic, obsession, read minds, wheels; SV Fort +6, Ref +4 Will +7; AL C.

Driven: Unlike others of its kind, Denbu does not waste its precious build time by soaking in a nutrient bath, instead slaving away over minute details of body work and custom fabrication. There is a 60% chance that, if encountered unexpectedly, it will be in its workshop. If disturbed, Denbu will fly into a rage, adding +1d to all attack and damage rolls for 1d3 turns (longer if combat occurs during that time).

Gifted Mechanic: So knowledgeable is Denbu, and so gifted at its craft, that the orbus is able to add an additional 1d3 basic Traits (beyond the normal maximum of four additional Traits) to any vehicle that it is devoted to. This means that a number of vehicles used by members of the Legions of the Eye Lord, being cast-off passion projects, also share this benefit.

Obsession: When dealing with the collecting of fine vehicles, Eye Lord Denbu suffers a -1d5 to all Willpower saves attempting to avoid temptation.

Wheels: “Orbus Outlaw”

Custom Large Car: Init +4; Atk rundown +4 melee (2d7+Collision damage bonus), tire blades +4 melee (1d6+ Collision damage bonus, 40% chance of bursting target tire), heavy Gatling gun +4 missile fire (3d16, range 240/480/960); AC 11; Armor Die [1d8]; HD 9d10; Speed Level cruise 5/ max 7; Act 1d20; SV Fort +2, Ref +3, Will NA; Fuel Tank 1d12; Guzzle 2; Wreck check 15.

Basic Traits: *big tank, enhanced handling, fuel efficient, heavily armored, heavy weapon mount* (Gatling gun, heavy), *off road, tire blades* (light).

Bad Boarus, Legions of the Eye Lord Tailgunner

The closest thing that Denbu has to a friend, Bad Boarus is recognized as the second-best mechanic in all of the Legions and serves as Denbu’s tailgunner. The porcine biker found traveling with Denbu to be advantageous, allowing him access to a number of fine custom motorcycle parts and giving him the ability to fabricate his own parts. Unlike every other member of the Legions of the Eye Lord, Bad Boarus is not held under the orbus’ psychic control—he just really likes Denbu and thinks that the whole gang lifestyle is a real snort.

INFAMOUS GANGS OF THE VAST WASTES & BEYOND

Bad Boarus (road hawg): Init +1; Atk wrench +4 melee (1d8+1) or by weapon; AC 14; Armor Die 1d5; HD 6d8+6; hit points 33; MV 30'; Act 1d20+1d16; SP road hawg traits, engineer +5, Ride die 1d8; SV Fort +2, Ref +4 Will +2; AL C.

Wheels: "Pork Chopper"

Custom Motorcycle: Init +5; Atk rundown +1 melee (2d4+Collision damage bonus) or linked machine guns +3 missile fire (2d12); AC 13*; Armor Die: [1d3]; HD d6; Speed cruise 6/ max 11; Act 1d20; SV Fort +0, Ref +5, Will NA; Fuel Tank 1d5; Guzzle 3; Wreck check 15

Basic Traits: *dangerous, enhanced handling, high performance engine (x3), linked weapon mount,* open, off road, trike conversion, very nimble.*

HISSIENS

"Rock on Road All Night"

Club Membership: Komo-doan

Total Membership: 550+

Territory: Coast to coast

Insignia: Skeletal guitarist

Founder: Many-Scale

Patron: Kizz

Regional Chapters: 36 (10-15 members)

Nomad Chapters: 5 (18 members)

Allies: Cenobikes

Enemies: Komodo Motos

Founded a mere ten years ago, the Hissiens exploded onto the moto-gang scene with their hard-partying attitude and slavish devotion to Kizz. Traveling through their turf only by night (and partying every day), the gang's ever-present music is heard for miles, thumping through the air. The gang finances these binges through the sale of illicitly procured Killer Kola, which brings them into frequent conflicts with the Komodo Motos over turf.

Members of the Hissiens are easily recognized, as they all wear the sacred face-paint of their patron and bear metal spikes that have been implanted in their thick lizard hides. Perhaps due to a massive case of mistaken identity caused by their spikes and sinister face-paint, the gang has developed a passably friendly relationship with the demonic Cenobikes. Each gang will aid the



other should the need arise.

The nomadic chapters of the gang always number 18 (6+6+6 is the number of the beats).

Initiation: The popularity of their drug-fueled binges brings with it crowds of 4d10 hangarounds and 1d10 prospects per chapter. New members are expected to create a spectacle worthy of Kizz himself, although the exact spectacle is left up to the prospect's imagination and the chapter president's say-so.

Notable Members

Many-scale, Hissiens Founder

Looking to be more spike than flesh, Many-scale is a devoted priest of Kizz who spreads the gospel of her master through the larger than life actions of the Hissiens. It is her most devout desire to eventually be raised up to rock alongside her master. To this end, Many-scale has modified her motorcycle's exhaust system into a thunderous musical instrument worthy of Kizz himself.

Many-scale (Komo-doan): Init +3; Atk claws +4 melee (1d6+6), bite +4 melee (1d8+6, poison DC 16 or die), tail +4 melee (2d4+6), or by weapon; AC 14; Armor Die 1d5; HD 4d8+8; hit points 28; MV 30'/10' dig; Act 2d20; SP follower of Kizz, ectothermic, immune to disease, wheels, spellcasting (+5 spell check), spells: *Kizz my axe, mosh pit*; SV Fort +3, Ref +2, Will +3; AL C.

Wheels: The exhaust pipes of Many-scales' motorcycle have been worked and tooled so that she may play various notes merely by working the throttle. When

INFAMOUS GANGS OF THE VAST WASTES & BEYOND

casting while upon her motorcycle, Many Scales gains a +1d bonus to spell checks. The komo-doan biker is fond of saying that her bike is her instrument of salvation.

Hiss “Spaced-man” Freely, Hissiens Patchholder

Hiss Freely’s mutation is simultaneously subtle and awe inspiring. While appearing no different from an ordinary komo-doan, his body is able to metabolize virtually any toxic substance without ill-effect. He often can be seen at Hissien rallies, swigging gasoline while snorting powdered scorpionoid venom. His perpetually bloodshot eyes are symptomatic of his long nights of partying rather than any repercussions from his choice of “party fuel.”

Wearing face-paint featuring strange cosmic swirls, Hiss Freely is also often referred to as the “Spaced-man” due to his slow and deliberate speech pattern. His party lifestyle began long before he swore allegiance to Kizz and it has only increased since. He is often cited as an inspiration by hangarounds and prospects alike, although there is a good chance of death among those who attempt to keep up with him.

Hiss Freely (mutant komo-doan): Init +4; Atk claws +2 melee (1d6+4), bite +4 melee (1d8+4, poison DC 14 or die), or by weapon; AC 13; Armor Die 1d6; HD 3d8+5; hit points 19; MV 30’/10’ dig; Act 1d20; SP ectothermic, immune to disease, party harder, wheels; SV Fort +10, Ref +2, Will +1; AL C.

Party harder: When at a rally or other large gathering where his party skills are on full display, Hiss Freely will draw a crowd of 1d10 hangarounds and 1d4 prospects who will join him in his death-defying partying. They will all die. Any PCs attempting to go drink for drink and snort for snort with Hiss Freely must succeed at a DC 25 Fortitude save or die.

FULL-BROTHERHOOD (251-500 MEMBERS)

SONS OF WHAAAR! MC

“Kill, Kill, Kill! Ha-ha-ha!”

Club Membership: Open

Total Membership: 400+

Territory: Coast to coast

Insignia: Bloody hand

Founder: Jason Meyers

Patron: Whaaar!

Regional Chapters: 0

Nomad Chapters: 24 (15-20 members)

Allies: Satan’s Auditors

Enemies: Everybody else

Like an angry swarm of xeno-locusts, the Sons of Whaaar! ride in killing, plundering, and burning. The gang is wholly dedicated to their blood-thirsty patron. Members of the gang favor melee weapons such as chainsaws, cleavers, and meat-hooks while performing their dark devotions.

Once a year, the gang descends on an unsuspecting town or city to celebrate their annual rally—Walpurgis. In a weeklong orgy of bloodshed and horror, the gang leaves nothing alive in their wake—not even plants. They conclude the rally with the ceremonial salting of the earth, using the blood of their victims from the prior year, hauling in tanker trucks filled with crimson gore and coagula to provide the required coverage.

Initiation: Each chapter typically has 2d3 hangarounds and 1d2 prospects at any given time. All prospective members must already be followers of Whaaar!. Those who are not are hacked to bloody gobbets before ever achieving hanground status. To earn their patch, prospects must bring back a grand trophy from a creature Whaaar! deems to be unholy, such as the wings of an angel or the reactor of a powerful robot.

SONS OF WHAAAR!



KILL, KILL, KILL! HA-HA-HA!

INFAMOUS GANGS OF THE VAST WASTES & BEYOND

Notable Members

Jason Meyers, Sons of Whaaar! Founder

Clad in bloodstained mechanic coveralls, the homicidal guru of gore covers his face with a rubber mask of an ancient warrior who killed untold numbers of victims—Payne Greatsky. Through his mask, Jason Meyers channels the primal bloodlust of the forgotten ancients directly into his brain, allowing the spirits of old to possess him and drive him to ever darker acts.

Using his position as a priest of Whaaar!, Jason Meyers calls upon his spells to supplement the carnage he creates—but it is supportive and never his primary method of inflicting horror upon his victims.

Jason Meyers (priest of Whaaar!): Init +2; Atk blessed chainsaw +3 melee (2d7, crit on 17-20), blessed flesh-hooks +3 melee (1d10, crit on a 15-16, dual wielding), blessed saw blade slinger +3 missile (1d6, crit on 18-20, range 15/30/60); AC 11; Armor Die 1d5; HD 5d8+2; hit points 28; MV 20'; Act 1d20 or 2d16; SP wheels, cleric of the Wasteland traits, spell check +6; spells: (1st) *blessing, choking cloud, flaming hands, magic missile, magic shield*, (2nd) *curse, knock, lotus stare, scorching ray, strength*, (3rd) *bolt from the blue, haste*; SV Fort +5, Ref +2, Will +4; AL C.

Jason Meyers rides in an armored pick-up truck, outfitted for all terrain.

Metal-face, Sons of Whaaar! Enforcer

Never speaking, this massive biker wears the faceplate of a robot bolted into his skull—forever hiding his face. Capable of stealth belying his stature, the unforgiving enforcer of the Sons of Whaaar! delivers justice in the most brutal (and terminal) fashion possible. No matter the speed with which his targets flee, he is always there behind them ... inevitable.

Oddly, Metal-face rides a simple bicycle—pedaling across the wastes.

Metal-face (mutant human): Init -1; Atk butcher knife +3 melee (1d6+4), crowbar +3 melee (1d8+4 or 2d8+8 versus robots); AC 10; Armor Die nil; HD 10d12; hit points 120; MV 10'; Act 3d20; SP fast enough, regeneration (5hp/round), wheels; SV Fort +5, Ref +2, Will +4; AL C.

Fast enough: No matter how fast something moves, if Metal-face is in pursuit he is only 1d4x10' behind. Whether following a vehicle on his bicycle or pursuing

a victim on foot, the moment that someone turns their back to look, he spatially transitions forward to be present.

Wheels: Metal-face rides an electric-green children's bicycle, with a white basket attached to the handlebars holding the severed head of a recent victim.

THE BROOD

"In Silk We Trust"

Club Membership: Komo-doan

Total Membership: 325+

Territory: The Vast Wasteland

Insignia: Winged komo-doan skull

President: Fork-tongue

Patron: Silk

Regional Chapters: 10 (20-30 members)

Nomad Chapters: 5 (15-20 members)

Allies: Migration Nation

Enemies: Komodo Motos

As followers of Silk, it is difficult to gather concrete information on this gang. The conflicting information provided and boasted by its members adds an air of confusion to all that surrounds them. They are allies of the Migration Nation, except for when they are not, mostly as a survival tactic. They will come to the aid of their allies when (and if) it suits them—providing wonderfully detailed excuses for the times when they do not.



INFAMOUS GANGS OF THE VAST WASTES & BEYOND

Initiation: There are anywhere from 0-1000 hangarounds and 50-500 prospects at ... yeah, we give up. Nobody knows how many komo-doans are looking to join a chapter at any given time and the tall tales from the gang itself make speculation useless. Even the number of chapters listed above is just a best approximation based on observations as opposed to any information from a gang spokesperson. If stories are to be believed, prospects must show themselves worthy by gaining the colors of a rival gang through subterfuge alone. Of course, that could all be lies as well.

Notable Members

Fork-tongue, The Brood President

According to the claims made by Fork-tongue himself, he is either an ancient komo-doan who has ridden across the wastelands for 1,000 years or a young upstart who first straddled a motorcycle within the past year. While the truth certainly lies somewhere in the middle, where upon the spectrum it is found is anyone's guess.

Fork-tongue (komo-doan): Init +3; Atk claws +4 melee (1d6+6), bite +4 melee (1d8+6, poison DC 16 or die), tail +4 melee (2d4+6), or by weapon; AC 14; Armor Die 1d5; HD 4d8+8; hit points 28; MV 30'/10' dig; Act 2d20; SP opposite day, ectothermic, immune to disease, wheels; SV Fort +3, Ref +2, Will +9; AL C.

Opposite day: So powerful are the lies of Fork-tongue that they have the ability to warp reality. Once per day, the gang leader may make a DC 25 Willpower check to make some statement of deception become fact (GM's discretion). This ability cannot kill the living, raise the dead, or destroy the world. Beyond that is anyone's guess.

Pants, The Brood Chaplain

The subject of a demonstration of Fork-tongue's power to warp reality, both Pants and his motorcycle burn with a never-ending fire (10' radius). While the gang's holy man (and his motorcycle) suffers no damage from the fire, anyone coming into contact with either soon learns just how real the flames are. True to the tenets of Silk, Pants will not enter directly into a combat unless there is no avoiding it.

Truly ancient, Pants is a withered example of a komo-doan long past his prime. If not for his fiery aura he likely would have died long ago. Instead, he seems

near immortal. Slowly riding across the wasteland, the goggle-wearing, near-sighted chaplain would be a comical sight if not so dangerous.

Pants (komo-doan priest of Silk): Init -1; Atk claws +0 melee (1d3+1) or by weapon; AC 10; Armor Die special; HD 5d8+1; hit points 23; MV 15'/5' dig; Act 2d20; SP burning aura, ectothermic, flash-burn, immune to disease, near-sighted, wheels, spell check +7, spells (1st) *charm person*, *Ekim's Magical Mask*, *invoke patron*, (2nd level) *invisibility*, *mirror image*, *phantasm*; SV Fort +5, Ref -4, Will +3; AL C.

Burning aura: The fire surrounding Pants and his ride burn so hotly as to inflict 2d14 damage to anyone coming in contact with his "Liar's Light." Additionally, Armor Dice automatically suffer a -1d loss as even protective armors burn away at the touch of Silk's gift. Anyone attempting a melee attack is considered to have entered the flame.

Flash burn: The flames surrounding Pants and his ride protect them both from harm and burn for as long as the komo-doan lives. Since the flames also extend his natural lifespan indefinitely, only physical harm will end his life. When either Pants or his motorcycle are about to be struck by a successful attack, smoke and flames flare up and negate 20 points of incoming damage.

MINOR PLAYERS (51-250 MEMBERS)

ROBO-ROLLERS

"Farewell to the flesh"

Club Membership: Robot/Cyborg

Total Membership: 250

Territory: The Vast Wasteland

Insignia: Robot on a motorcycle

Prime: 01000001 01001001 0001010 0001010

Regional Chapters: 8 (25 members)

Nomad Chapters: 2 (25 members)

Patron: Ultimospark

Allies: Restless Dead

Enemies: Trailer Park Trash

The Robo-rollers are a militant gang of robots and cyborgs. They travel the wastes, looking for robots in need of rescue, cyborg persecution, or fleshy robo-sympathizers (perhaps wishing to achieve perfection

INFAMOUS GANGS OF THE VAST WASTES & BEYOND



via upgrade). Due to their being easily charmed with platitudes about robot-kind, the Robo-rollers are not among the more feared gangs of the wastelands, although those choosing to pick a fight with them may end up with a different attitude. With those who show no anti-robot bias, they are easygoing and affable. If there is any sign of aggression towards machine-kind they immediately act with extreme force, holding nothing back as they attempt to destroy their foes with a completeness that only a machine can understand.

Under the current leadership of 01000001 01001001 0001010 0001010 the gang has achieved a level of success which it has rarely enjoyed. 01000001 01001001 0001010 0001010's insistence on perfection by maintaining the correct number of members has led to ample hangarounds and prospects being on-hand to immediately fill any vacancies in membership.

Due to their mechanical nature, the Robo-rollers are closely allied with the autogeist gang, the Restless Dead. There is a longstanding feud between the Robo-rollers and Trailer Trash which will only end with the destruction of one (or both) of the gangs. The Robo-rollers will ignore all else if given the opportunity to destroy a Trailer Trash chapter.

Initiation: All 2d6 hangarounds and 2d8 prospects of the gang are followers of the Ultimospark. Induction requires the prospect to prove his computerized worth through a great feat of computation (such as reciting pi to 1,000 places, reciting an ancient battle poem in binary, or other such task). Such initiations only take place

when a chapter has fallen beneath its correct capacity of 25 members. Because of this, half of all prospects have already completed their initiation requirements and can be advanced to full patch immediately should a position open up (including during combat).

Notable Members

01000001 01001001 0001010 0001010, Robo-rollers Prime

A massive constru-bot who became fully self-aware in the early days after the cataclysm. If not for sporadic memory purges (to maintain efficiency), 01000001 01001001 0001010 0001010 would likely be capable of recounting the actual events that lead to the disaster. Alas, it cannot.

Heavy and ponderous, the Robo-rollers prime sets the pace for travel within its chapter—demanding that maximum fuel efficiency be maintained whenever possible.

01000001 01001001 0001010 0001010 (constru-bot): Init -1; Atk dozer blade +6 melee (3d24, Fort save vs. damage or die) or welding lasers +2 ranged (1d10+2, 4 attacks per action die); AC 10; Armor Die 1d30; HD 8d12+10; hit points 62; MV 20'; Act 2d20; SP massive, wheels; SV Fort +8, Ref +0, Will n/a; AL L.

Wheels: 01000001 01001001 0001010 0001010 is his own "ride."

(Stats below reflect vehicle-to-vehicle combat. For attacks on individuals use the stats above.)

Keeper large tractor: Init -1; Atk rundown +8 melee (5d14 + Collision damage bonus), welding lasers +2 ranged (1d10+2, 4 attacks per action die); AC 6; Armor Die: [1d10]; HD d20; Speed Level cruise 1/ max 1; Act 2d20; SV Fort +8, Ref +0, Will +0; Fuel Tank 1d30; Guzzle 9.

Basic Traits: *big tank, dozer blade*—massive, heavily armored, linked weapon mount, rugged, tracked.

01000010 01101111 01100010, Robo-rollers Patchholder

A cyborg who has devoted its life to combating the frailties of the flesh ... in others. Armed with weapons meant to maximize damage to flesh, it methodically enters combat, seeking out the weakest targets first so that it may convert as many "meat-bags" into bloody scrap as possible.

While outwardly showing no emotion, 01000010

INFAMOUS GANGS OF THE VAST WASTES & BEYOND

01101111 01100010 harbors undying hatred towards humans, which drove him to the extremes he has taken to separate himself from their number. His proffered service provider is Dr. Carl Augh in the Citadel of Scrap. The demented doctor often trades his services for the provided severed limbs and flesh scraps.

01000010 01101111 01100010 (cyborg): Init +5; Atk chainsaw +2 melee (2d7, crit 18-20), saw blade slinger +2 missile fire (1d6, crit 19-20), or by weapon; AC 12; Armor Die 1d6; HD 4d8; hit points 18; MV 40'; Act 1d20 + 1d14; SP cyborg traits, jury rig die 1d5, neural interface, rapid response servos, wheels; SV Fort +3, Ref +3, Will +2; AL L

UNTOUCHABLE HORDE

"Flow with the Glow"

Club Membership: Mutant

Total Membership: 150+

Territory: The Vast Wasteland

Insignia: Rad symbol

Founder: Poppa Rad

Patron: Mother Nuka

Regional Chapters: 7 (10-20 members)

Nomad Chapters: 4 (10-15 members)

Allies: N/A

Enemies: Rad Rats

Devoted to the service of the "Untouchable One," the members of this gang are the beloved of Mother Nuka. Less an invading army than a wheeled defense force, the gang does not tolerate anti-mutant behavior or rhetoric by those not "Down with the Glow" (such as the Rad Rats). Anti-mutant bigots are served a beatdown, every member in the area attacking without mercy. If otherwise left to their own devices, the gang members will simply ride, party, and repeat in a relatively harmless fashion. At worst, in most places, the gang is merely a rowdy nuisance.

Initiation: The gang has no hangarounds or prospects; any interested mutant is immediately initiated into the gang and offered into the service of Nuka.

Notable Members

Poppa Rad, Untouchable Horde Founder

Wearing only a loincloth, Poppa Rad leaves all of his

UNTOUCHABLE HORDE



FLOW WITH THE GLOW

mutations on full display. From the horns atop his head, to his additional arms (one centered on his back and one emerging from the side of each hip), and the masses of scar tissue criss-crossing his body, the gang's leader is an unnerving sight for those who despise mutants.

Peaceful, if exhibitionistic, by nature the gang's leader has no interest in petty turf wars or rivalries. Instead, he encourages his members to carouse and enjoy life. However, anti-mutant behavior will enrage the normally placid mutant and, in such cases, he has no compunctions with unleashing the full wrath and power of the gang onto the head of the offending individual.

Poppa Rad (mutant): Init +2; Atk horns +3 melee (1d4+1, 2d4+2 when charging), or by weapon; AC 11; Armor Die 1d4; HD 8d4; hit points 20; MV 30'; Act 4d20; SP mutant traits, extra limbs (+3 arms), horns, survival die 1d6, glow pool 30; wheels; SV Fort +2, Ref +2, Will +1; AL C.

TRAILER PARK TRASH MC

"Leave 'em bleeding"

Club Membership: Wheeler Demon

Total Membership: 100+

Territory: The Vast Wasteland

Insignia: "Bad Sam"

Founder: Azrael Rous

Patron: Demon King of Speed

INFAMOUS GANGS OF THE VAST WASTES & BEYOND

Regional Chapters: 1 (30-50 members)

Nomad Chapters: 2 (25-40 members)

Allies: N/A

Enemies: The Restless Dead, Robo-rollers

There may have once been a gang named after angels in the service of Hell, but this gang takes that role very seriously. Made up of immense wheeler demons, each extruding upwards from the front of an RV, rolling across the Vast Wasteland they find fellow travelers and “put them into need,” often leaving nothing more than corpses in a burned-out car.

Their founder, Azrael Rous, has somehow managed to force members of the gang to diminish their personal competitive displays in order to win greater glory for the Demon King of Speed. That isn't to say that such displays have been abolished though, merely curtailed for ceremonial events. Gang colors are displayed across the back of the rig.

Despite wheeler demons essentially being cyborg demons, the Robo-rollers have declared them to be abominations. This singular exception to the Robo-rollers pro-robo attitudes has led to multiple clashes between the gangs and their supporters.

Initiation: The 2d8 hangarounds that follow each chapter seldom have an opportunity to become full members, as the membership is made up of wheeler demons. That doesn't stop other beings from hoping to join and hangarounds willing to make a bargain with the chapter president may sometimes find themselves bound into service as a wheeler demon. Those favored by such a transformation immediately become prospects. For full patch status, the prospect must defeat a current member in a contest of flame pattern displays.

Those who win find themselves transformed again, this time growing to the enormous size of a full member. These ritualized transformations take place at the Nightnote RV Rally, the annual gathering of the gang and its supporters. The weeklong festival hosts a number of events, including races, gladiatorial battles, and the highly anticipated Burn Out—where the demons compete with ever greater flame displays in hopes of winning the coveted Bad Sam Trident.

Notable Members

Average Trailer Park Trash Patchholder



While the average wheeler demon is a muscle car, the members of this gang are monstrosities of infernal flesh merged with metal. Each demon carries with it an imprisoned pit crew, forced to dwell within the demon's body—emerging only to effect repairs or perform upgrades.

Wheeler Demon RV (recreational fiend): Init +1; Atk rundown +7 melee (2d12 + collision damage bonus) or hellfire lance +8 melee (4d6+4); AC 7; Armor Die: [1d8]; HD 20d14; MV 50' in melee combat, otherwise Speed Level cruise 3/ max 5; Act 3d20; SP dual tires, flame trail, make bargain, pit crew, summon pitimps, car slayer; SV Fort +4, Ref +5, Will +6; AL C.

Pit crew: Residing within the demon's form are 2d4 petrol head slaves. Chained to the demon's frame, with no hope of escape, these tormented souls work to maintain and repair the demon's form without ever again knowing the joy of racing across the wastelands. Often the pit crew is made up of former hangarounds who failed to successfully negotiate their deal to become members.

Pit Crew Member (Satanic mechanic): Init +0; Atk tire iron +0 melee (1d6); AC 10; Armor Die: nil; HD 1d7; hit points 4; MV 20'; Act 1d20; SP petrol head qualities; SV Fort +1, Ref +1, Will +0; AL C.

Azrael Rous, Trailer Park Trash Founder

A believer in the ancient maxim “size is everything,” this wheeler demon devoted its early existence to discovering the arcane means to increase its size. Once it was successful, the response from other wheeler

INFAMOUS GANGS OF THE VAST WASTES & BEYOND

demons was ... lukewarm. Mocked for its lack of maneuverability and low “cool factor,” Azrael Rous finally lashed out, ramming and destroying several of its brethren until the remainder at the rally begged for mercy—and forgiveness.

Understanding that raw power was more than a match for “cool factor,” the surviving wheeler demons became the original members of Trailer Park Trash with Azrael Rous serving as both founder and high priest of the Demon King of Speed.

Azrael Rous (wheeler demon RV): Init +3; Atk rundown +9 melee (3d12 + collision damage bonus) or hellfire lance +8 melee (4d6+4); AC 7; Armor Die 1d10; HD 24d14; hit points 180; MV 50' in melee combat, otherwise Speed Level cruise 3/ max 5; Act 3d20; SP flame trail, make bargain, pit crew, summon pit imps, car slayer; SV Fort +4, Ref +5, Will +10; AL C.

Pit crew: Azrael's pit crew is made up of 10 level 3 petrol heads.

CORPSE CREW MC

“The dead shall ride”

Club Membership: Wraith rider

Total Membership: 75+

Territory: Coast to coast

Insignia: Burning sword

Founder: “Killer Skull”

Patron: N/A

Regional Chapters: N/A

Nomad Chapters: 1 (50-100)

Allies: Legion of the Eye Lord

Enemies: Rad Fink

One of the most ruthless of MCs, thankfully their own level of violence holds them in check. Riding from coast to coast killing every living being that they encounter, the Corpse Crew throws themselves into the task with (w)reckless abandon—sometimes sacrificing as many as five of their own number for every individual slain. With a steady influx of the newly dead, the gang's “tactics” are direct and brutal—not fearing the deletion of their ranks, for there will always be more dead.

The gang doesn't care for the type or quality of its members' rides, and so is the only gang known to be allied with the ride-stealing Legion of the Eye Lord—

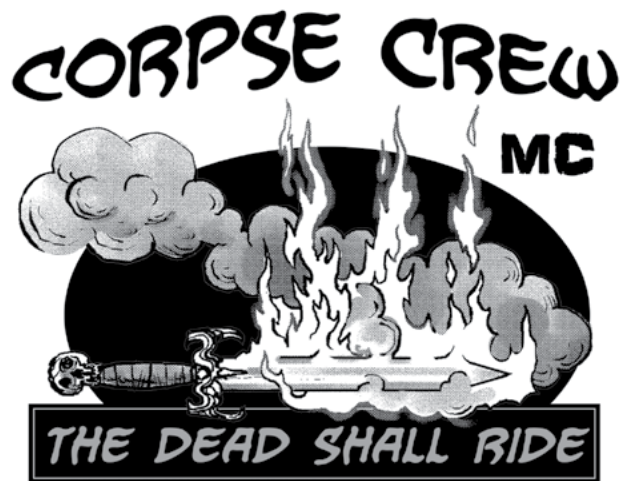

happily aiding the Legion in ambushing and killing riders to add numbers to their ranks while aiding the Eye Lord Denbu in capturing a particularly choice ride.

Initiation: The Corpse Crew “recruits” and indoctrinates any-body they come across to replenish their ever-depleting numbers. Unlike most gangs, there are no membership levels below patch holder, as anyone who would show interest is immediately slain and rises to join the gang.

Notable Members

Killer Skull, Corpse Crew Founder

This all un-dead gang is led by Killer Skull, who wields the sword Deathstorm. The enchanted blade causes anyone it slays to rise anew as one of the un-dead. Standing astride his custom ride, Killer Skull holds fast to Deathstorm, having plunged it through the car's top, using it to control the car when not in combat.

Clad in ragged leathers, the gang founder's regalia is covered in the patches and insignias of other gangs, stripped from those members when they died ... and rose to join the Corpse Crew MC.

Killer Skull (skeleton warrior): Init +2; Atk; *Deathstorm* Deed +1d6+2 melee (1d8 + Deed, slain victims rise as wraith riders in 1 round), touch +1d6+1 (1d3, necromantic touch), or by weapon type; AC 12; Armor Die 1d6; HD 4d10; hit points 27; MV 25'; Act 1d20; SP bound by will, favored weapon—longsword, half damage from piercing and slashing weapons, necromantic touch, wheels, un-dead traits, warrior traits (including deed die); SV Fort +1, Ref +2, Will +2; AL N.

INFAMOUS GANGS OF THE VAST WASTES & BEYOND

Bound by will: If hit points are reduced to zero or below, Killer Skull receives a Willpower save vs. the unmodified attack roll. If successful, he rises the next round with 1d10 hp.

Necromantic touch: The touch of Killer Skull inflicts 1d2 Strength loss.

Deathstorm, artifact, +2 longsword: Int 10; ALN; bane: humans (1d4 Stamina drain), mutants (neutralization); communication: speech; special purpose: to raise an unconquerable army of the un-dead; special powers: detect enemies/hostile intent within 10', 20' globe of darkness, detect bane creatures within 900', flame brand 3/day for 6 rounds (+1d6 damage + burn—DC 15 Ref to avoid), flame tongue 1/day (40'x10' cone, 2d6 + burn—DC 20 to avoid), necromantic (all foes slain by Deathstorm rise as un-dead the following round—un-dead type at GM's discretion).

LOCAL YOKELS (10-50 MEMBERS)

CITADEL SCRAPPERS

"Lookin' for a scrap"

Club Membership: Open

Total Membership: 25+

Territory: Citadel of Scrap

Insignia: Rusty cog

Founder: Brando

Patron: N/A

Regional Chapters: 1 (25-30 members)

Nomad Chapters: 0

Allies: Carl Augh MD

Enemies: N/A

While not the fearsome menace that they hold themselves to be, the Citadel Scrappers are more than merely a dangerous nuisance. Being known to sometimes work as the errand boys of Doctor Augh of Shelley's Surgical Center (see TMM pg 219) has granted a level of protection to the gang. Nobody wants to upset the proprietor of the best "body shop" in town.

Most often, the gang acts simply as bullyboys and toughs, offering protection, dealing in illicit substances, and picking scraps (and thus gathering scraps) with unfortunates who come to their attention.

Citadel Scrappers



Initiation: 1d4 hangarounds and 0-1 prospects join the gang at their local watering hole, "Sanford's Place." Getting patched is merely a matter of the members of the gang liking the prospect and the new member buying the next five rounds. There is no other hazing involved.

Notable Members

Brando, Citadel Scrappers Founder

Unbeknownst to the gang, Brando is one of the creations of the "good doctor" and, while only a lesser power wight, he has been cosmetically altered to be able to pass as a badly scarred human. Wearing durable biker leathers and a distinctive billed leather cap, the bulky biker is a common sight in the rougher areas of the Citadel of Scrap.

Brando (lesser power wight): Init +1; Atk bash +6 melee (1d6+3), bite +6 melee (2d5, heals amount equal to 1/3 damage) or by weapon +5 melee (damage+3); AC 14; Armor Die [1d5]; HD 4d12+4; MV 20'; Act 1d20; SP armor plating, might augment, parts stockpile, speed augment, wheels, un-dead immunities and crits, ignore crit, absorb electricity, wheels; SV Fort +8, Ref +1, Will NA; AL N.

Parts stockpile: Brando knows the whereabouts of a secret stockpile of vintage parts worth 60,000sp. He guards this knowledge most carefully as this is his source for spare parts for "Strabler." Ironically, this makes him one of the wealthiest individuals residing in the citadel of scrap.

Wheels: "Strabler"

INFAMOUS GANGS OF THE VAST WASTES & BEYOND

Brando's pride and joy is Strabler, his vintage Triumph Thunderbird. Lovingly rebuilt from parts found in a pre-cataclysmic cache, the motorcycle is unmistakably vintage and a few of Umerica's collectors (such as Eye Lord Denbu) would give almost anything for it. Only fear of angering the gang's ally, Carl Augh keeps them in check.

Vintage motorcycle: Init +9; Atk rundown +1 melee (2d4 + collision damage bonus); AC 13*; Armor Die [1d3]; HD d6; Speed cruise 4/ max 7; Act 1d20; SV Fort +3, Ref +8, Will NA; Fuel Tank 1d5; Guzzle 1; Wreck check 15.

Basic Traits: *enhanced handling, fog lamps, high-performance engine, off road,* open, very dangerous, very nimble.*

RAD RATS

"Always lucky"

Club Membership: No mutants

Total Membership: 15+

Territory: Last Resort Reststop

Insignia: Glowing rat

Founder: "Big Mickey" Roth Patron: N/A

Regional Chapters: 1 (10-20 members)

Nomad Chapters: 0

Allies: N/A

Enemies: Untouchable Horde

This small but hard rolling crew of bikers has set up shop in the area around the Last Resort Reststop Casino and equally alternates their time between gambling, drinking, riding, and fighting. The Last Resort, located in the western region of the Vast Wastelands, is a well-known stop for travelers heading through the wastes, and the Rad Rats' never-ending poker game is near-legendary.

The Rad Rats, despite their name, have a strict "no mutants" policy, which has put them at odds with the Untouchable Horde from time to time and yet, thanks to their leader's pet luckeater (which he normally keeps hungry), they always come out on top. Due to their propensity to come out on top of their physical conflicts, the Rad Rats are sometimes used by casino owner Ghost Tongue as extra security—because leaving bikers in charge of security never causes

RAD RATS



ALWAYS LUCKY

trouble.

Initiation: 1d3 hangarounds and 0-1 prospects can usually be found in the casino. Getting patched requires winning the casino poker tournament, while playing only against patched gang members. Obviously, no one that Big Mickey doesn't want in, gets in.

Notable Members

"Big Mickey" Roth, Rad Rats Founder

Big Mickey will be quick to point out that he's a xeno, not a mutant. Almost as quickly, he will gut the being who referred to him as a mutant. He spends much of his time at the poker table, leaving only to ride and keep his "territory" secure from interlopers. He will demand tribute from any organized groups smaller than 10 attempting to enter the casino, usually 1d3sp per member but running as high as 1d30sp per member if he is feeling particularly offended by their presence.

"Big Mickey" Roth (xenotaur officer): Init +2; Atk tail flail +5 melee (2d5+3), blaster gauntlet +5 missile (3d4, subdual or lethal), barbed-wire lash +5 melee (2d4 Fort vs. 12 or bleed 1 point for 5 rounds), or by weapon; AC 14; Armor Die 1d5; HD 3d10+2; hit points 26; MV 45'; Act 2d20; SP card cheat, force field, gauntlet, pet luck eater, voice of command, wheels; SV Fort +0, Ref +10, Will -2; AL N.

Card cheat: "Big Mickey" is known for his luck at the tables, because he cheats. This is mostly an open secret at the Last Resort as the gang member doesn't get greedy and generally cheats to win a point of pride as opposed to seeking financial gain. Due to this, the

INFAMOUS GANGS OF THE VAST WASTES & BEYOND

casino staff turns a blind eye. Big Mickey has a 70% chance of winning any given hand of poker.

Charm, Rad Rats Enforcer

Wearing a spiked collar and chained to the gang-leader's belt, is Charm. The fortune-feasting demon is utterly loyal to Big Mickey and serves as the gang's Enforcer—using its confounding abilities to lay low even the toughest of foes. Charm stands 5' tall and is clad in golden leathers, matching the most common shade of exoskeleton, the umber/gold of a hungry luck eater.

Charm (luck eater, TMM pg 108): Init +2; Atk claw +4 melee (1d8); AC 17; Armor Die [1d4]; HD 7d7+7; hit points 31; MV 30'; Act 2d20; SP Luck die (1d4), eat Luck, Luck powers; SV Fort +5, Ref +5, Will +5; AL N.

RESTLESS DEAD

"Crush 'em all, let Petrolex sort 'em out"

Club Membership: Autogeist

Total Membership: 10+

Territory: The Vast Wasteland

Insignia: Flaming car atop piled corpses

Founder: "The Mechanic"

Patron: Petrolex

Regional Chapters: 1 (10-15 members)

Nomad Chapters: 0

Allies: Robo-rollers

Enemies: Trailer Park Trash

While claiming territory in the Vast Wasteland, the Restless Dead are more of an autogeist collective than a traditional gang. Haunting the backroads instead of major thoroughfares, the Restless Dead prey on lone travelers and small bands making their way through the Vast Wasteland. While it is rare that there should be a survivor from an attack by the Restless Dead (the gang avoids opponents that appear strong enough to mount an effective defense), enough motorists have staggered out of the wastes telling tales of the autogeist collective that they have built up a small reputation.

Details of the gang's origins are sketchy at best, but there are a few persistent rumors that have become accepted as truth. The Restless Dead was formed by a powerful autogeist referred to as "The Mechanic," said to be a gearhead killed in a massive pile-up during an

RESTLESS DEAD



CRUSH 'EM ALL

attack by the Trailer Park Trash. Gathering the souls of his slain family into himself, The Mechanic rose as an autogeist fueled by a desire for vengeance. As victims have fallen to its merciless wheels and subsequently risen, they have been recruited into the gang's overall purpose, its war on the Trailer Park Trash.

The gang has an uneasy alliance with the Robo-rollers. Creatures without souls cannot become autogeists after all. Still, they *could* become hosts.

Initiation: Initiation into the gang is as simple as it is terminal. The spirits of those slain by the Restless Dead linger until enough are drawn together to form a new autogeist. So long as one member of the gang exists, the gang will always, slowly and inexorably, return.

Notable Members

"The Mechanic," Restless Dead Founder

Once there was a family of adrenaline-junky gearheads, the Urnhearts, who had the misfortune of falling prey to a gang of wheeler demons. Thinking that the group of parked RVs were simply an encampment, the exhausted travelers made the mistake of parking nearby for safety. In the dead of night, they were ground to paste and scraped beneath the wheels of the Trailer Park Trash. The patriarch of the family, Hill Urnheart, gathered the souls of his family and forged them together into a powerful autogeist, and vowed to draw others to its cause.

INFAMOUS GANGS OF THE VAST WASTES & BEYOND

Decades have passed and whatever fragments of the Urnhearts that remain within the souped-up Fairlane that it currently inhabits are deeply buried. The Mechanic has no pity, it never rests, it simply seeks to bolster its following and bring about a final “wreckoning.”

“The Mechanic” (Custom large car autogiest, TNN pg 14): Init +6; Atk rundown +9 melee (3d6 + ram); AC 11; Armor Die [1d12]; HD 12d10; Hit Points 45; MV 45' in melee combat, otherwise Speed Level cruise 7/ max 9; Act 2d20; SP un-dead, +10 to control checks; SV Fort +6, Ref +7, Will +10: AL C

Basic Traits: *armored, enhanced handling, nimble, off road, rugged, nimble.*

Autogiest special abilities: ghostly presence, hungry, terrifying appearance, unstoppable.

NEIGHBORHOOD NUISANCE (4-10 MEMBERS)

There are no “notable” gangs of this size. Groups of this sort have no impact or recognition outside their home territory. This can be as small as a single clubhouse and as large as a single street.





THE RANDOM GANG GENERATOR



THE RANDOM GANG GENERATOR

THE RANDOM GANG GENERATOR

There are times when a GM needs a gang quickly and might not want to use one of the better-known gangs. Perhaps a new gang is emerging in a territory or has splintered off from another gang. No matter the reasoning, creating a gang needn't be overwhelming or overly time consuming. To begin, roll once on Table RGG-1 for the structure of the gang, its size, chapter make-up, and territory.

Table RGG-1: Road Gang Structure					
Roll (1d24)	Membership Level	# of Chapters	Chapter Size	Territory	Nomad Chapters
1	Neighborhood Nuisance	1	4-10	Clubhouse	No
2	Neighborhood Nuisance	1	4-10	Bar	No
3	Neighborhood Nuisance	1	6-10	Street	No
4	Local Yokels	1-2	10-12	Bar	No
5	Local Yokels	1-3	10-15	Street	No
6	Local Yokels	1-4	10-20	Neighborhood	No
7	Local Yokels	2-3	15-25	Region	No
8	Minor Players	2-10	10-30	Region/Nomad	Exclusively
9	Minor Players	3-12	20-25	City	No
10	Minor Players	3-15	20-30	Region	Yes
11	Minor Players	2-12	20-35	Region	Yes
12	Minor Players	2-10	25-50	Coast to Coast	Yes
13	Full-Brotherhood	12-45	10-20	Region	Yes
14	Full-Brotherhood	12-35	15-20	Region/Nomad	Exclusively
15	Full-Brotherhood	10-35	15-25	Region	Yes
16	Full-Brotherhood	10-45	10-30	Coast to Coast	Yes
17	Full-Brotherhood	10-20	25-30	Coast to Coast	Yes
18	Power Hitters	30-100	10-15	Coast to Coast/Nomad	Exclusively
19	Power Hitters	25-100	10-25	Region	Yes
20	Power Hitters	20-65	15-25	Coast to Coast	Yes
21	Power Hitters	20-50	20-30	Coast to Coast	Yes
22	Big Dogs	50-110	10-20	Coast to Coast	Yes
23	Big Dogs	40-70	15-25	Coast to Coast	Yes
24	Big Dogs	20-60	20-50	Coast to Coast	Yes

TERRITORY

Bar: Having a bar as a primary hangout is the first step towards becoming a “real” gang. Having an openly known location of this sort that is frequented by outsiders as well as the gang is a sign of strength, and the stronger the gang, the fewer outsiders one will find in such a place. For small gangs, this may be the only

real turf held whereas, for larger gangs, there may be many such establishments throughout their territory.

City: Claiming a city as one's territory requires constant vigilance to defend such a claim from up and coming gangs. So frequent are challenges that gangs staking out such a territory tend to be ready for battle at a moment's notice. The cities themselves may

THE RANDOM GANG GENERATOR

seek to root out the gang or in some cases, my look to them as protectors from outside threats, paying a tithe of sorts for the gang's protection. In the case of an overt challenge, gangs of this size may call upon 1d3+1 smaller gangs for support.

Clubhouse: The lowest form of gathering place for a gang, a clubhouse tends to be a space that no one else really wants. Burned out buildings, mildly radioactive caves, and partially collapsed mines are all examples of the sorts of places which the lowest of the low are often forced to occupy. If encountered outside the clubhouse, these gangs tend to be rather lowkey but if threatened within their clubhouse, these gangs will fight to the bitter end. Defeat in the clubhouse is the end of such a gang.

Coast to Coast: While only the strongest gangs can truly claim to hold territory from coast to coast, smaller, widespread gangs also make such claims. When gangs claiming to be coast to coast collide, there is only one outcome—open warfare. These are gangs which, rightfully or no, claim ownership of Umerica and have members scattered across the continent to back that up. Those who tangle with gangs of this sort will be marked as enemies of the gang and killed on sight unless some sort of truce can be reached with the gang's primary leadership.

Neighborhood: Much as a region denotes a notable portion of Umerica as a whole, a neighborhood is a singular section of a town or city. The greater the prestige (or economic value) of the area the more powerful the gang tends to be and the more prestige they hold within the local hierarchy. Such gangs can serve as support for citywide gangs in the case of an outside threat but will always have their eye on stepping up into a bigger role. Examples include the Boardwalk Bravos of Osheana City and the Devil's Dockhands of Pyramid Port City. If acting in defense of the neighborhood as a whole, these gangs may rally 3d5 residents to their side to drive off outsiders.

Region: Gangs not powerful enough to lay claim to coast-to-coast membership often claim a portion of Umerica as their home turf. In many cases, gangs of this nature co-exist in an uneasy truce, each being powerful enough to challenge one rival but none being powerful enough to challenge all of them. Most commonly, gangs claim the Vast Wasteland as their territory, but there are gangs claiming the Misshippy

River Valley, the Land of the Reanimatronic Dead, or even the Rail Wastes that cross Umerica. Gangs of this size have a 15% chance of having another chapter within a single-day's ride and if attacked, will reach out to their fellow chapters for aid—marking their foes for “justice.”

Street: As gangs grow they often move from a clubhouse or bar to carve out a small niche for themselves. Those holding a single street (normally just a choice section) often add the street name to their own, such as the Jones Street Muties or the 8th-balls. Most often, the section of street held ranges 1d4+2 city blocks inhabited by 1d3 clubhouse-dwelling gangs that can be called upon for support.

Nomadic: While nomadic gangs do not have any fixed turf to call their own, such groups will gather 1-4 times per year for massive rallies which include all the membership able (or caring) to attend. Such events typically last for 2-7 days, although some annual gatherings last upwards of two weeks.

STEP 2

Once the gang's structure has been determined, roll three times on Table RGG-2 to breathe life into them and to finish fleshing them out into a varied and unique gang.

Membership Roster

Open: The most common gang membership is that which accepts any interested prospects which meet the gang's requirements. Mutants, humans, aliens, and more all can be found in such a gang.

Autogiest: It is not common for autogiests to band together to seek vengeance upon the living and when they do, there is always a driving cause for them to do so. United in their hatred for a specific target, gangs of this sort take additional victims in order to bolster their numbers and recruit more angry souls to their cause.

Demon: Commonly in service to a more powerful demon or other interdimensional fiend, demons of all types can be found in the wastes. Gang membership of this type tends to be lower-tier demons of a particular bloodline working together in Umerica just as they would in the reaches of the twisted outer realms. Patch holders are Type I demons with the officers of such a

THE RANDOM GANG GENERATOR

Table RGG-2: Gang Nature

Roll (1d24)	Membership Roster	Distinctive Regalia	Motivation
1	Autogiest	Tribal tattoos	Wanderlust
2	Wheeler demon	Space suits	Spread their patron's good word
3	Demon	Ritual mutilation	Criminal endeavors (smuggling)
4	Human (anthrophagi)	Fashionable clothing	Fleeing a powerful enemy
5	Human	Sports uniforms	Speed-freaks
6	Robot/cyborg	Matching clothing	Aiding their fellow travelers
7	Mutant (mixed)	Face paint	Leaving a trail of destruction
8	Open membership	Military uniforms	Building their reputation
9	Open membership	Deely boppers	Party, party, party!
10	Open membership	Ritual scarification	Recruiting
11	Komo-doan	Ancient formalwear	Live to ride, ride to live
12	Komo-doan	Gang "colors"	Live to ride, ride to live
13	Komo-doan	"Period" costuming	Live to ride, ride to live
14	Komo-doan	Androgynous	Recruiting
15	Open membership	Hellbilly chic	Party, party, party!
16	Open membership	Beachwear	Building their reputation
17	Open membership	"Wild West" attire	Leaving a trail of destruction
18	Mutant (beastkin)	Flesh of their foes	Criminal endeavors (murder for hire)
19	Robot/cyborg	Ancient armor	Pursuing a hated enemy
20	Human (militant)	Broken tech gubbins	Criminal endeavors (drug dealing)
21	Human (anti-mutant)	Masks and costumes	Stop, drop, and chop shop
22	Wraith rider	Clergical vestments	Criminal endeavors (drug manufacture)
23	Wrath	Extreme piercings	Locust swarm
24	Special *	Loincloths	Religious pilgrimage

gang ranging from Type II to Type III.

Human: Through turmoil, war, and disaster Homo sapiens have proven that it is they, not the lowly cockroach, that will survive until the bitter end. Almost as common as their komo-doan counterparts, human gangs present challenges and dangers that other intelligent species do not. While some humanocentric gangs are merely exclusive human groups, others are more sinister.

Anti-mutant and anti-robot groups hunt the wastes to stamp their personal visions of "purity" onto the surface of Umerica. These groups not only do not allow non-human members, they attack other groups on sight, hoping to utterly wipe them from the face of

Umerica. While some merely bully and harass targets of opportunity, the larger groups among them actively seek out targets—hunting their prey from coast to coast.

As fearsome as groups such as those are, it is the anthrophagi, the eaters of other intelligent species, that are the most terror-inducing. Often appearing as a group of simple travelers, these gang members relish in the taste of the flesh of intelligent beings. For some it is a matter of religion, for some a learned way of life, and sometimes it is merely general misanthropy taken to the extreme. No matter the inspiration, it is dangerous to lower your guard around a gang of humans in the wastes.

THE RANDOM GANG GENERATOR

Komo-doan: Known for their youthful wanderlust (some might say “rampages”), komo-doans make up a majority of the species-specific gangs. While names such as the Komodo-Motos, Migration Nation, and the Brood strike fear throughout Umerica, there are hundreds of smaller komo-doan gangs which crisscross the wastes.

With colorful names like Leaping Lizards (a gang which carries out logic defying thefts using trick riding to a degree that appears suicidal) to the Draggin’ Dragons (a friendly group devoted to racing) the gangs come in all sizes and purposes. It is not uncommon to find a number of smaller gangs working together for a common goal, but it is just as common to see them working at cross-purposes to one another with murderous abandon.

Mutant: With the large number of mutant types inhabiting the Umerican wastes, it was inevitable that some of them might band together in gangs for both protection as well as profit. The more general, open mutant membership gangs tend towards a collective love for general mayhem. Riding the wastes, bugs in their teeth and exhaust in their eyes, these gangs range from casual riders to true outlaw riding murder clubs.

Standing apart from their more casual brethren are the gangs devoted to a single type of mutant, often referred to as “Beastkin.” Beastkin are mutant strains that have stabilized and breed true, such as bisonmen, serpent people, and the loathsome sluggos. These gangs pose a real danger to outsiders and are often bound together to carry out illicit trade in stolen parts, narcotics, and other contraband. While they are not (always) so aggressive as to attack outsiders on sight, if the gang has strength of numbers the least one can expect is bullyboy behavior while outright murder is not uncommon.

Robot/cyborg: A common thread in the existence of cyborgs and robots, no matter their origin, is that those of the flesh tend to mistrust or fear them. For this reason, there are a number of gangs devoted to robots and cyborgs (one, the other, or both). Having begun as a survival tactic, such gangs have now become a primary path of continued existence for many robotic riders.

Wheeler demon: Wheeler demon gangs are eye-popping collectives of ego run amok. Their peacocklike

displays normally prevent such gangs from growing too large, although the rare exceptions can be near overwhelming in their displays of color, flame, and utter madness. These gangs will often challenge other groups to graphic displays of driving prowess and style, always with some token on the line—to make things “interesting.” Whether competing for a soul or a simple rock, bragging rights are what these gangs live for and those who cannot compete will be forever denigrated in the retold lore of the gang.

Wraith rider: With only a few notable exceptions, wraith rider gangs are normally made up of the members of gangs snuffed out in a singular bout of carnage. These gangs continue to wear the colors of their former selves as they seek to carry out whatever unfinished task it is that keeps them from rest. This need not always be vengeance, there was an instance of a wraith rider gang simply attempting to complete a “poker run” to raise funds to help a member who had lost his wheels—now riding the wastes until such time as they have a worthy ride to bring to the sole surviving member of their former gang.

Wraith rider gangs, if not interfered with, will oft-times simply ride past other groups in their single-minded quest. But woe unto those who would dare interfere with the machinations of the dead.

Wrath: Serving their master, the favored of Whaar!, they forever ride the wastes purging the weak from the roadways with brutal efficiency. Wrath gangs are known for not backing down from stronger foes—for only the strongest deserve to exist and these un-dead bikers “live and die” by that very belief. There is no chance of a peaceful encounter with a wrath gang, only the spray of blood and the crunching of bones.

Special: Gangs of this sort are unique in some fashion or other. For example, while other gangs consisting of wheeler demons exist, the RV-based gang Trailer Park Trash is unlike any other. A horde of time-swept, motorcycle-riding Vikings would also qualify as actual Norsemen are not found in Umerica. If you have a strange or twisted idea—this is the category.

Distinctive Regalia (Optional)

Most gangs dress as one would expect, denim, leather, and spikes. However, some gangs go that “extra mile” to set themselves apart. While the distinctive regalia of



THE RANDOM GANG GENERATOR

a gang still commonly includes the gang's insignia and rockers, how those items are displayed can vary wildly among the gangs of the wasteland.

Ancient Armor: Clad in piecemeal armor made of ancient materials, gang members receive a +1 die step bonus to their Armor Die. If the number of gang members present is greater than 20, the chapter's officers receive a +2 die step bonus to their Armor Die.

Ancient Formalwear: Stylishly dressed for the finest of occasions, gangs clad thusly tend to think themselves superior to the "common" sort, receiving a +2 bonus to morale checks. If the number of gang members present is greater than 20 the bonus increases to +4.

Androgynous: The neutral dress and appearance of these gangs makes them seem simultaneously harmless and disquieting. It requires a DC 12 Willpower save to initiate combat with such groups, and should the gang initiate the combat, their foes are at a -1 penalty to hit. If the number of gang members present is greater than 20 the Willpower save increases to a DC of 15.

Beachwear: Scantily clad and showing a distracting (or in some cases stomach-turning) amount of flesh, foes of these gangs suffer a -2 penalty to melee attacks although the gang members suffer a -1d to their Armor Die. If the number of gang members present is greater than 20, the gang gains the ability beach party bingo.

Beach party bingo: The gang launches into a highly choreographed musical number amidst the combat. At the top of each round, the GM rolls a d20 "bingo" die. Any attack rolls made against the gang that have the same result on the die score a "bingo" and automatically miss as the attacker is drawn into a mystically fueled musical number for 1d3 rounds. Attacks made by the gang that match the bingo roll automatically hit for double damage (regardless of whether the attack would normally hit or not).

Broken Tech Gubbins: Members of these gangs are skilled in confronting mechanical foes. Covering themselves in the remains of their foes, their robo-husk armor grants them a +1d bonus to their Armor Die. Additionally, they receive a +2 bonus when attacking a singular type of technological foe (robots, androids, cyborgs, etc.). If the number of gang members present is greater than 20, the attack bonus applies to all mechanical foes.

Clerical Vestments: Unwaveringly focused on their

faith, members of these gangs receive a +1 die step bonus to all Willpower saves and will always fight to the death. If the number of gang members present is greater than 20, increase the bonus to +2d.

Deely Boppers: Bouncy headbands hold disarmingly out of place shapes upon them, bobbing back and forth as the gang members move. Attackers must make a DC 12 Willpower save or suffer a -4 penalty to ranged attacks due to the near-hypnotic distraction of the deely boppers. If the number of gang members present is greater than 20, foes failing the Willpower save also suffer a -2 to melee attacks as they do battle within a sea of waving antennae.

Extreme Piercings: Their flesh pierced with hundreds of studs, rings, and spikes, these gang members are fueled by combat enhancing drugs which dull their pain response and help them shrug aside the effects of damage. When hit points are reduced to zero, these gang members will continue fighting for an additional round, regardless of any injuries. Headless corpses continue to thrust with knives, while dismembered bodies still manage to pull triggers, etc. If the number of gang members present is greater than 20, the gang's officers will continue fighting for 1d3 rounds past death.

Face Paint: Lead-based paints pit and inundate the skin of these gang members, slowly driving them insane. While their madness grants them a +1d bonus to melee damage, during each round of combat there is a 50% chance that the gang members will turn on one another rather than attacking their foes. If the number of gang members present is greater than 20, the power behind the blows is great enough to halve the effectiveness of their target's Armor Die.

Fashionable Clothing: They look nice. If the number of gang members present is greater than 20, they look *really* nice.

Flesh of their Enemies: The grotesque visages of these gangs is so horrific as to cause sentient creatures of 1HD or less to automatically flee. Those of 2HD or more must succeed at a DC 18 Willpower save to remain and fight, suffering a -1d penalty to all attack rolls. If the number of gang members present is greater than 20, the required Willpower save increases to 20.

Gang Colors: The members of the gang dress in and surround themselves with the gang's chosen color(s). Roll 1d10 to determine the color(s): (1) red; (2) orange;

THE RANDOM GANG GENERATOR

(3) Yellow; (4) green; (5) blue; (6) purple; (7) white; (8) black; (9) stripes, roll 2d8 for colors; (10) checkered, roll 2d8 for colors. Being unified with the gang colors heightens the gang's collective responses, granting +2 to Initiative. If the number of gang members present is greater than 20, increase the bonus to +4.

Hellbilly-Chic: Clad in dungarees, overalls, poorly tanned skins and the like, gangs of this nature favor the ancient music of Molly Hatchet, jacked-up pickup trucks, melee weapons such as axes and machetes, and eat the corpses of their foes. Their vehicles automatically gain the suspension lift kit Trait. If the number of gang members present is greater than 20, their vehicles also gain the vehicle snorkel Trait.

Loincloths: Gangs of this sort are made up of bestial humanoids. These powerful gang members are large and incredibly strong, receiving +2 to all melee attack and damage rolls and a +1d to all Fortitude saves. If the number of gang members present is greater than 20, increase the melee bonus to +1d.

Masks and Costumes: The terror-inducing guises of these gangs force opponents to make a Willpower save vs. DC 8+1d5 or suffer a -1d penalty to all attacks for 2d5 rounds. If the number of gang members present is greater than 20, increase the penalty to -2d.

Matching Clothing: Dressed identically, these gangers have no problem picking out their enemies amidst a melee and suffer no penalty when firing into combat. If the number of gang members present is greater than 20, and at least 10 are active in melee. The gang is well-versed in positioning their foes, granting their snipers a +1 to hit and damage on ranged attacks.

Military Uniforms: Gangs of this sort conform to a military hierarchy and work in a coordinated manner, gaining a +2 bonus to all Stunt rolls in Chase scenes. If the number of gang members present is greater than 20, the Stunt bonus increases to +3.

Period Costuming: Often mocked and derided by their peers, these gangs are dedicated to an ancient way of life (Vikings, pirates, buck-skinners, investment bankers, and the like). Gangs of this sort are highly proficient in arts such as blacksmithing and the manufacture of simple weapons. If befriended, gangs of this type can provide a +1 to all repair rolls and may freely provide simple weapons (clubs, knives, spears, etc.). If the number of gang members present is greater

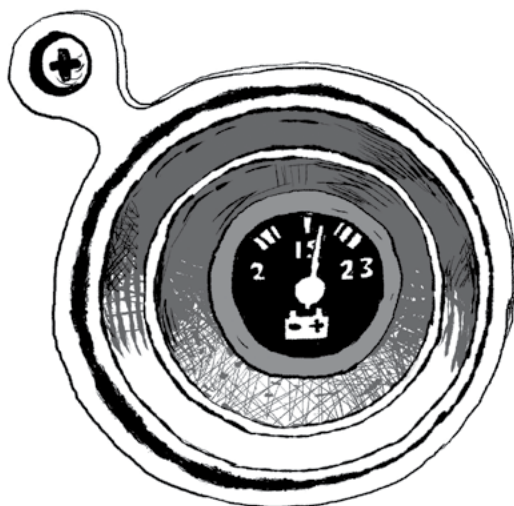

than 20, the bonus increases to +2 and the gang is capable of producing a quality weapon (+1) once per month.

Ritual Mutilation: Missing digits, limbs, or other anatomical portions, these gang members maim themselves in single minded devotion to murder. In combat they become immune to Willpower save-inducing effects, although they remain susceptible outside of combat situations. If the number of gang members present is greater than 20, their foes are struck with a -2 penalty to Willpower saves.

Ritual Scarification: Having ritually scarred their bodies using ancient and forgotten arts, the gang members have forged themselves into a collective. In combat, a chapter uses the collective hit points of its members, rather than individual hit points. So long as the chapter has 1 hit point for each member, none will fall. Once the hit point total falls beneath the number of members, members begin to fall. If the number of gang members present is greater than 20, the mystical forces required are much greater and the gang must have at least 2 hit points for each member standing.

Space Suits: Clad in fully sealed suits containing their own atmospheres, these gang members are immune to exterior effects such as radiation and gasses. Successful attacks with piercing or slashing style attacks negate this ability until repaired. If the number of gang members present is greater than 20, the chapter's officers will be equipped with self-repairing suits. Due to the protective nature of their regalia, gangs of this nature favor the use of toxic gasses (GM's discretion).

Sports Uniforms: These gangs use the uniforms, logos,

THE RANDOM GANG GENERATOR

and identities of ancient sporting teams and favor a weapon “appropriate” to the ancient sport (baseball bats, hurled stones, grenades, etc.). Excelling at working in unison, these gangs receive a +1d3-1 (rolled at the initiation of combat) to all to hit rolls when multiple members work together to attack a single foe. If the number of gang members present is greater than 20, the bonus increases to +1d4.

Tribal Tattoos: As opposed to the markings of ancient tribes, these gangs are emblazoned with deep black and tacky-looking tattoos. While thinking that these markings make them seem fierce, they do not. Those attacking these gang members receive a +1d3 bonus to any morale checks and deal double damage to any declared blows to the face. However, if the number of gang members present is greater than 20, the tattoos are supplemented with the ancient odor of Hatchet Torso Deodorizer, causing those entering melee against the gang to succeed at a DC 12 Fortitude save or suffer a -1 penalty to all attack rolls while gagging on the stench.

Wild West Attire: Beyond a tendency to refer to one another as “Hoss” or “Little Joe,” gang members of this sort favor ancient firearms such as six-shooters and rifles. Gangers are proficient with the quick-draw and gain a +2 bonus to their initiative during the first round of combat. If the number of gang members present is greater than 20, the gang’s officers gain a +4 bonus to their initiative.

Motivations

Aiding their fellow travelers: These helpful gangers are traveling looking for people in need of aid. They will repair any damaged vehicles they come across (short of Vintage vehicles) and will refuse any form of payment.

Building their reputation: Whether having suffered a recent embarrassment or simply up and comers, this gang is out with a chip on their shoulders looking for the “big dawg” to prove themselves against. Of course, a seasoned band of wasteland travelers fits the bill perfectly. Lack of confidence and a need to prove themselves makes these gangs aggressive while also inflicting a -1 penalty to all of their Handling rolls.

Criminal endeavors:

1. Drug dealing: From the small group of pushers to the largest of cartels, two things are true:

drugs turn into wealth and wealth turns into power. While an unaffiliated dealer may just be looking to help folks have a good time, gangs are a wholly different matter. If they feel that their trade is threatened, extreme measures will be taken to make examples of those who have offended them.

2. Drug manufacture: While these groups normally manufacture the drugs that feed the trade in illicit substances, they can (for the right price) sometimes be convinced to manufacture other things such as fuel substitutes, chemical weapons, high explosives, moonshine, etc. Of course, some of these gangs also partake in what they make; approach at your own risk.

3. Murder for hire: When a sniper rifle won’t do, when high explosives just aren’t a big enough statement, a group of gangers thirsting for your foe’s blood may be just what you need. Of course, if they are thirsting for your blood, things can get quite awkward.

4. Smuggling: If a thing needs to get from here to there without anyone knowing, these are the folks to do it. Unfortunately, if someone needs to be taken from here to there without their consent? These are also the folks to do it. Anything can be moved, for a price.

Fleeing a powerful enemy: Whatever is pursuing the gang is far more frightening than they (or the party) could ever possibly hope to achieve. Suggested foes include the Komodo-Motos or a powerful dragon. If prevented from fleeing, the gang will immediately attack those hindering their departure, their fearful frenzy granting them a +1d bonus on melee damage results.

Leaving a trail of destruction: Scorched earth is all that is left behind these gangs. Like a swarm of angry xeno-locusts, they eat, drink, burn, and kill everything they come across. There is no talking to them, there is no mercy, no pity, no remorse. They will scour the world to its bones or die trying.

Live to ride, ride to live: The zen-masters of the road; for these gangers, their way of life is the foundation of their identity. Their devotion to riding as their very lives gives them a +1d bonus to all driving related rolls.

THE RANDOM GANG GENERATOR



Locust swarm: Is there food? They will eat it. Is their booze? They will drink it. Are there parts? They will steal them. This gang is consuming every resource put before them and leaves nothing in their wake but broken bottles, rusted out trash, and speechless survivors. They want it all, and they want it now.

Party, party, party!: The gang is enjoying a bacchanalian rush of booze, drugs, music, and more booze. Anyone coming within 50' of the gang will be encouraged to join in the party and be handed a tankard of "apocalypse punch" (Fortitude save vs. 20 or uncontrollably join the revelry for 3d8 hours with no memory of events afterwards). Threats of violence have no impact on the partygoers, only actual bloodshed will change the mood into that of a rage-fueled rave. In such cases partygoers immediately swarm the offending party (inflicting 1d3 points per round for 2d4 rounds). Once their rage is spent, the party disperses.

Pursuing a hated enemy: The gang is in hot pursuit of their most hated enemy or rival. Those who find themselves between them and their target may sincerely regret their life choices. The gang will attack anyone impeding their pursuit with berserker abandon, gaining a +1d to both attack and damage rolls when using melee weapons.

Religious pilgrimage: Missionary gangs often travel to places deemed to be holy by their beliefs. Gangs of this sort tend to be very devout and less tolerant of outsiders than those who would merely wish to proselytize the "Good Word" to unbelievers. These gangs, sometimes little more than violent cults, are strict adherents to their faith and often see the non-believer as lesser, or unworthy. Because of their unshakeable faith, members of these gangs receive a +3 to their Willpower saves.

THE RANDOM GANG GENERATOR

Speed-freaks: There is nothing like the feel of the wind on your face and bugs in your teeth. The gang will challenge other riders to high-speed races, wagering their vehicles on the outcome. The vehicle used for the race will have the *high performance engine* Trait (taken 1d3 times).

Spread their patron's good word: Have you opened your heart to Elmos? What about our Lord and Master Buddy O'Burger, who gives his sesame seeds so that you may live? These questions and others are among those asked by the gang as they try to indoctrinate the unwary into the worship of their patron through their proselytization power. Creatures with no patron must make a Willpower save (DC 5) with the save DC increasing by +1 for every 10 minutes of proselytizing endured or, in a moment of befuddlement, find themselves earnestly agreeing to follow the patron

and undergoing whatever initiation rites that might be required. The affected target becomes a real follower of the patron but may continue on their own way—hopefully spreading the word to new ears through their newly gained power.

Stop, drop, and chop shop: Always looking for parts to keep their rides maintained, the gang will remorselessly attack and murder other riders so that they can strip their vehicles for parts. No ride? No trouble. If one has so much as a bicycle though, their life may be forfeit.

Wanderlust: These “easy riders” are on a journey from here to there, without caring where “there” is. If offered friendly advice on interesting places to visit, the gang will reciprocate in kind—even offering warnings of dangerous places to avoid or interesting rumors picked up on the road.





NOT+ABLE
WAT+TELAND
WANDERERS

WANTED

VARIOUS OFFENSES AGAINST THE MOST
HOLY CHURCH OF BUDDY O'BURGER

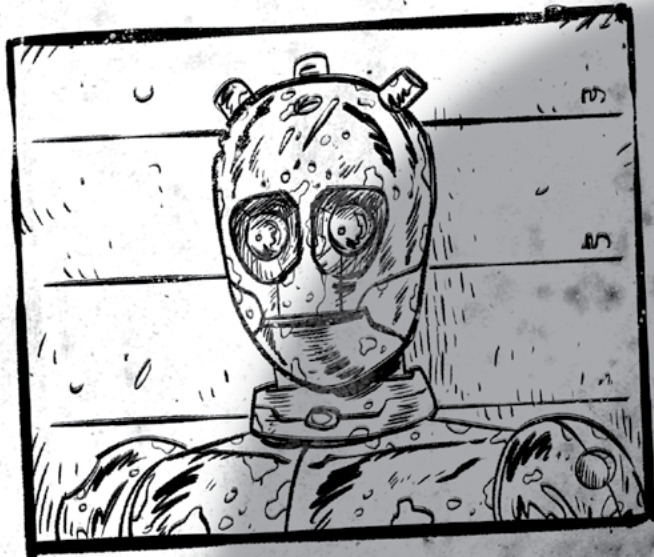
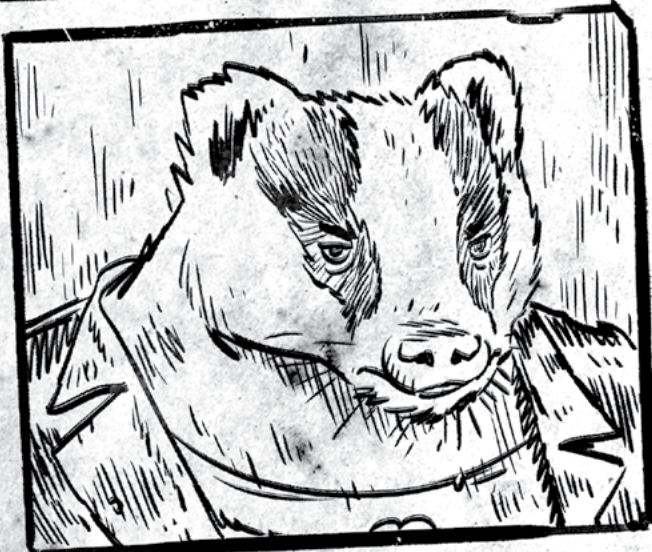

REWARD: 50 JOLLYMEALS



K.

NOTABLE WASTELAND WANDERERS

NOTABLE WASTELAND WANDERERS

While it may be the road gangs that draw the most attention on a regular basis, that isn't to say that there aren't individuals worthy of note that might not instill caution (or outright fear) in those who encounter them. Run-ins with these individuals are understandably rare, as they are the proverbial grain of sand in a desert, but those who do encounter them rarely pay for drinks for the foreseeable future.

CARRADINE

Methodically working his way across the Vast Wastes on foot, the wanderer known as Carradine is a welcome visitor in most places—until he isn't. The emotionless and near-expressionless face of the wandering monk is matched only by the monk's emotionless and near-expressionless voice. Wearing loose fitting clothing and a battered hat, Carradine seems ill-suited to survive in the wastes and yet, somehow, he does so with great ease.

If approached peacefully, Carradine will offer what aid he may: manual labor, strange medicines, and auto repair—all accompanied by a flow of sage advice. If attacked, Carradine's true nature becomes clear. The unique rerun wraith manipulates the flow of local time, slowing it down so that he may take advantage and disarm, defeat, and sometimes humiliate his foes. Carradine prefers to not kill and will only do so if given no other option. In such cases he will do his best to disguise it as an accident such as his foe stumbling over a cliff or tripping onto their own weapon.

Carradine (rerun wraith sage, TNN pg 137): Init +4; Atk palm strike +8 melee (1d4+1), flying kick +8 melee (1d8+1), improvised weapon +8 ranged (1d6, range 10/20/30); AC 15; Armor Die *special*; HD 4d10; hit points 30; MV 30'; Act 1d20 or 2d16 (palm strike); SP do anything, good reception, iron-willed (+10 Will saves), sage wisdom, slow motion; SV Fort +4, Ref +5, Will +10; AL N.

Do anything: Carradine is capable of performing any general task with a mildly proficient skill level. When attempting anything from auto repair to basic medicine, Carradine rolls 1d20 plus any appropriate modifier, versus a difficulty of 14. Actions requiring high levels of training, such as brain surgery, are beyond him.

Good reception: Unlike common rerun wraiths,



Carradine always benefits from good reception and interacts normally, indistinguishable from an ordinary individual.

Sage wisdom: Carradine always seems to know the right course of action while being perhaps a bit obscure in the telling of what needs to be done. If asked, he will offer sagacious advice on any given problem or philosophical question. If understood (DC 20 Willpower save or GM's discretion), following Carradine's advice allows a +d8 to any one non-combat roll related to the task discussed.

Examples of his advice include:

- "If a man dwells on the past, then he robs the present. But if a man ignores the past, he may rob the future."
- "Be nothing, and you will have everything to give to others."
- "Because a man can see, he does not look."
- "Be like the sun, and what is within you will warm the earth."
- "Because our soul does not keep time—it merely records growth."

Slow motion: In combat, Carradine slows the passage of time, leaving his foes to struggle while he maneuvers through the altered time-flow expertly. The armor classes of his foes immediately drops to 9 and Carradine immediately gains a Reflex save versus incoming attacks (of difficulty equal to the attack roll

NOTABLE WASTELAND WANDERERS

without any bonuses or Deeds) to simply evade the attack. Carradine is allowed two rolls to evade any ranged attacks.

JAMES BLACKSUN

James Blacksun was swept through a temporal portal and crash landed his spacecraft in Aetheria several decades ago. Lacking memories of his former life, he joined Aetherian society and was appalled at the conditions of the common man. Using a power sword and harness, he led a small contingent of freemen as a revolutionary, seeking to overthrow the Aetherian dictatorship once and for all. This plan ended in disaster with his fledgling army broken and scattered, leaving the once would-be savior of Aetheria as an outcast in the skies above the Umerican wastes where he hopes to raise a force to one day make another attempt at freeing his adopted people.

When encountered Blacksun is commonly dressed in barbarian furs, his once-handsome countenance having an olive complexion, his long black hair snarled into rude dreadlocks. Unless threatened, Blacksun is genial and if given the chance, will launch into a lengthy recruitment pitch in hopes of seeding a new core for his resistance army. If rebuffed, he is visibly disappointed but not aggressive.

In hopes of proving himself to any potential recruits, he will leap to the defense of the downtrodden without hesitation (or stopping to consider who is really in the right). His rash behavior has prevented him from keeping any allies for any length of time, although he will simply complain of the faithlessness of those Umericans he has encountered so far.

Only his winged dragon-horse mount Shaman has not abandoned him—yet.

Blacksun (human warrior): Init:+1; Atk melee power sword +7 (2d4+6) or ranged + 6 (1d4+2, range 30/60/90); AC 11; Armor Die [d10]; hit points 34; MV 30'; Act 1d20+1d14; SP: power sword, power harness; SV Fort 2, Ref 1, Will 1; AL L.

Power harness: Appearing as a rather gaudy, golden, and glowing necklace, Blacksun's power harness grants a +2 bonus to Strength, helping to boost his strength to superhuman levels. It also provides a forcefield that surrounds him, providing a d10 Armor Die.

Power sword: Appearing as a jagged, glowing sliver of



metal, the power sword grants a +2 bonus to Strength and may be used to fire bolts of energy every two rounds.

Shaman (dragon-horse): Init +2; Atk bite +8 melee (1d14) or claw +4 melee (1d8); AC 15; Armor Die 1d3; HD 10d8; hit points 45; MV 40' or fly 80'; Act 1d20; SP screech; SV Fort +6, Ref +7, Will +2; AL N.

Screech: Once per combat, Shaman may release a powerful sonic screech capable of damaging flesh, bone, and metal. Targeting a foe within 100', the sonic wave reduces the target's Armor Die by 1d3-1 and victims failing a DC 12 Fortitude save suffer 1d6 points of damage.

MAX

Rumors abound about this figure who alternately drives or limps across the wastes, clad in leathers and with a shotgun across his shoulders. "Just Max," he insists. "Rumors of my mental health are exaggerated." Whether or not that is the case, he has been sighted across the Wasteland so many times that it almost seems that he must be two people.

Dismissing mutants to a point that borders on mutaphobic hysteria, Max will actively rant about his hatred of mutants, how they are to blame for all

NOTABLE WASTELAND WANDERERS



of America's ills, and suspiciously demand to know if humans he speaks with are secretly mutants. "You can never be sure" he rants. He will never accompany or aid mutants and will not make any attempt to conceal his utter disdain and contempt from them.

If one gets past (or simply avoids) his xenophobic rantings, Max is a decently capable Wasteland warrior and a somewhat loyal companion—at least until he decides to end his involvement and wander on his merry way.

Having some sort of background in law enforcement, Max lives by a personal code of ethics that is mercurially mutable when it suits him. Under normal circumstances, Max is a defender of women and children and upholds societal norms against theft and murder. Should he be angered, that code gets tossed aside and he will actively pursue, capture, torture, and kill those who have earned his wrath—sometimes leaving them the horrid choice between self-mutilation and death (often not really a choice so much as an illusion that the self-mutilation might make escape possible in cases where it will not).

Max (wasteland warrior): Init +4; Atk dagger +2+deed die melee (1d4+deed die), full-auto pistol +1+deed die ranged (1d7+deed die, RoF 3), double barreled shotgun +1+deed die ranged (1d10 or 2d10+deed die, crit on 19-

20); AC 12; Armor Die 1d4; HD 4d12+4; hit points 30; MV 20'; Act 1d20; SP wheels, wasteland warrior traits, deed die +d6; SV Fort +2, Ref +2, Will +1; AL L.

Wheels: "Sceptor"

Max's sometimes ride is a black, Vintage muscle car of indeterminate origin. Carefully maintained (and booby-trapped), the growl of the car's engine roars across the wastelands.

Vintage small car: Init +3; Atk rundown +3 melee (2d6+Collision damage bonus); AC 12; Armor Die [1d7]; HD 6d8; hit points 48; Speed cruise 7/ max 9; Act 1d20; SP booby trapped; SV Fort +2, Ref +2, Will NA; Fuel Tank 1d10; Guzzle 2; Wreck Check 15.

Basic Traits: *big tank, nitrous tank, off road, rugged.*

Booby trapped: Max's ride is riddled with explosives set to trigger if anyone attempts to pry open the gas tank or to start the car without properly deactivating the charges. The driver's compartment trap releases a ball of fire inflicting 4d6 points of damage to anyone inside the car. The flash is so quick that it does no damage to the car itself and provides no save against the damage.

The charge connected to the fuel tank is less kind, detonating if the gas cap is forced open rather than unlocked (DC 14 to pick). The charge sends fire and

NOTABLE WASTELAND WANDERERS

shrapnel into the would-be thief (DC 20 Reflex save for half) inflicting 2d20 points of damage and damaging the car itself for 2d10 (bypassing the car's Armor Die).

TAYLOR

Wearing the shredded remains of an ancient military uniform, this grizzled quantum ape crosses Umerica on horseback, complaining of the evils done by his kind to have warped the world into one mostly run by hairless simians. If directly questioned, Taylor mumbles something about being from an alternate timeline "Quantum Ape Prime"—whatever that may be.

If approached peacefully, he will offer aid to those who need it, while audibly cursing the fates that have left him stranded in this "deviant timeline." If travelers who encounter him can put up with his ramblings, he will provide food, what little medical care he can, as well as what safety he can provide. If asked, he may accompany a party of travelers (60% chance) until they reach the next outpost of civilization.

Being from a different timeline, Taylor's powers differ from a common quantum ape, in some cases quite drastically.

Taylor (time-tossed quantum ape, TNN pg 129): Init +1; Atk bite +12 melee (2d6+10) or slam +14 melee (2d8+10); AC 14; Armor Die 1d4; HD 6d8+10; hit points 46; MV 40' or climb 30'; Act 3d20; SP chrono-howl, flash forward, rend, temporal stutter; SV Fort +14, Ref +8, Will +8; AL N.

Chrono-howl: Channeling raw temporal energy through his form, Taylor releases a blast of chromatic energies that warp the chronosphere of his chosen target. The target must make a Fortitude save (DC 18) or immediately revert to an earlier self, losing 1d3 HD (and appropriate hit points) and being left Stunned for 1d3 rounds. This power is extremely draining for Taylor, inflicting 1d12 in damage to Taylor anytime it is used. Victims reduced to less than 0 HD regress to a zygote, drop to the ground, and expire.



NOTABLE WASTELAND WANDERERS



Flash forward: Taylor can manipulate his own temporal vine to change the relative passage of time versus the flow of local space/time. Taylor may take up to 1d12 rounds worth of actions in a single round but afterwards is helpless for the same number of rounds as time suddenly catches up with him.

Rend: Taylor does +2d8 damage if more than two slam attacks hit the same target in one round.

Temporal stutter: In times of great personal danger, Taylor may bring duplicates of himself into local time/space. The effort of wrenching a duplicate from nearby in his personal timeline and crossing them over causes 1d3 points of chrono-damage (per duplicate). The duplicate is near-identical to the original (including the damage taken when bringing in the duplicate) however, there is a 10% chance (cumulative per duplicate) that the duplicate is pulled from Quantum Ape Prime and (ignoring all else) will immediately seek to kill Taylor.

THE MAN & HIS BEST FRIEND

Clad in simple clothing, the once probably handsome man trudges across the wastes accompanied by his “faithful” dog. It is unknown just how long this pair have wandered the wastes, and on the few occasions where someone has dealt with them and lived, they speak of whispers of World War IV. It is uncertain if the duo originates from this reality or another war-torn landscape, existing alongside Umerica.

Victor

Victor is an ancient human, his body wracked with disease, who simply refuses to die. Wholly omnivorous, he has no compunctions about killing and eating those he encounters, one might say he almost seems to prefer it. When sated and well supplied, Victor has been known to accompany folks just for someone to talk to “other than the mutt.”

NOTABLE WASTELAND WANDERERS

Whether or not Victor is wholly sane is another subject altogether. He is often seen having one-sided conversations with his dog, at times heatedly arguing over whether or not to kill someone that they have just encountered.

Victor (human-“ish” wasteland warrior): Init +10; Atk knife + Deed melee (1d5+Deed), bolt action rifle + Deed ranged (1d10+Deed), micronuke + Deed ranged (1d24+Deed, 40’ radius); AC 14; Armor Die 1d5; HD 10d12; hit points 55; MV 30’; Act 2d20+1d16; SP wasteland warrior traits, d10+4 deed die, disease wracked, immune to radiation, regeneration; SV Fort N/A, Ref +4, Will +10; AL C.

Disease wracked: The truth is that Victor died some time ago. His body is kept in motion by the collective bacterial, viral, and fungal infections that riddle his corpse to the point of having achieved sentience. Unless the entirety of his body is destroyed, he simply will not die, regenerating and rising again and again to wander the wastes. As such, acids, poisons, and the like that would normally require a Fortitude save are simply purged from the corpse and do no damage.

Regeneration: The diseases within Victor’s corpse act swiftly to repair damage to their vessel, regenerating 5 hit points per round.

Hemoglobin

The “mutt” in question, the aptly named Hemoglobin, is a genetically modified dog gifted with limited telepathy, standing 4’ high at the shoulders. It accompanies Victor and tolerates his presence while not actually “obeying” him. The massive mutt’s gummy fur is the same rusty brown as dried blood and swarms with fleas and other parasites.

Hemoglobin (genetically modified dog): Init +7; Atk bite +6 melee (1d10+4) or claws +6 melee (2d6+4); AC 14; Armor Die 1d3; HD 6d8+6; hit points 33; MV 50’; Act 2d20; SP parasitic swarm, immortality, immune to radiation, telepathic; SV Fort +3, Ref +3, Will +2; AL C.

Parasitic swarm: Hemoglobin is surrounded by a cloud of biting/stinging insects. Individuals in melee with the beast automatically suffer 1d3 points of damage per round.

Immortality: Hemoglobin is immortal, although not indestructible. He continues to age, without ever dying. It makes him a rather cranky old cuss. If slain, Hemoglobin’s corpse will likely become another host for the infections animating Victor. Hemoglobin isn’t all that fond of that plan.

Telepathic: When he chooses, Hemoglobin can telepathically converse with individuals within 100’. Blocking his gravelly, psychic voice requires a DC 30 Willpower save (although he can do no damage with his communication, he can be really infuriating at times).



NEW CLATTER



NEW CLASSES



HOLY ROLLER

NEW CLASSES

HOLY ROLLER

While the wandering priests of the various Umerican gods are known to most of the common folk, there are a rarer breed of the devout that are much more mendicant and militant. They proclaim their faith through inspiring actions rather than miracles and pomp.

Hit points: A holy roller gains 1d8 hit points at each level.

Weapon training: A holy roller is trained in using common tools and objects as weapons without penalty (*treat as one- and two-handed clubs*) and unarmed combat. Employing normal weapons prevents them from performing Smitey Deeds. Holy rollers may not wear any type of armor or shields that gives them an armor check penalty.

Alignment: Regardless of which god, gods, or patron they revere, most holy rollers take a Neutral view on life as they seek to understand the cosmic balance of all things mortal and immortal. Those of Lawful or Chaotic alignments are often too zealous or disturbed to achieve the enlightenment required to become a holy roller.

Turn unholy: as per a neutral cleric (DCC rulebook pg 30). Note, a holy roller only uses a d16 instead of a d20 on turn unholy attempts.

Lay on hands: Works similarly to the standard cleric (DCC rulebook pg 30) other than the conditions that may be healed, see below. Note, a holy roller only uses a d16 instead of a d20 on lay on hand attempts.

- 1 die - Mend a broken bone.
- 2 dice - Repair specific organ damage, heal a mundane disease, or heal minor radiation poisoning.
- 3 dice - Neutralize mundane poisons, heal major radiation poisoning, heal food poisoning, restore maimed limb, or heal starvation/dehydration.
- 4 dice - Heal blindness, heal deafness, neutralize xeno/alien poisons, or regrow limb.
- 5 dice - Reverse mutation less than CL days old.

Disapproval: Holy rollers build up disapproval with failed lay on hands and turn unholy attempts, just as clerics do. A natural 1, or rolling under their current disapproval level means they suffer penalties as per the standard cleric (DCC rulebook pg 29). If a disapproval result refers to the loss of divine aid or spellcasting, the holy roller loses their ability to perform Smitey Deeds instead.

Austerity: Holy rollers believe in living a life free from materialism and can never own or carry more than double their Strength Attribute in pounds of possessions. Anything they earn or gain in excess of this must be given away to those in need within 24 hours or they lose the ability to perform Deeds until they do. They also lose their ability to perform Deeds if they are encumbered in any way.

The only exceptions to this are owning a mount, pet, or vehicle. These may be kept as long as they are shared or used to aid those in need (*i.e. giving rides in your truck to peaceful travelers, using a pet frog ox to plow a farmer's field to spend the night in his barn, delivering packages to the next settlement over with your riding beetle, etc.*).

Unencumbered: Due to their freedom from bulky armors and rigorous training, they gain a bonus to their AC and movement rates based on their level. These abilities are lost if the holy roller has a check penalty due to worn armor.

Smitey Deeds: Similar to a warrior, a holy roller can perform Mighty Deeds powered by their faith and physical training. Prior to any attack roll, they can declare they are attempting to perform a Deed.

The holy roller's deed die determines the Deed's success. This is the same die used as an attack and damage modifier each round. If the deed die is a 3 or higher, and the attack lands (e.g., the total attack roll exceeds the target's AC), the Deed succeeds. If the deed die is a 2 or less, or the overall attack fails, the Deed fails as well.

Signature Move: Many holy rollers like to use one specific Deed often in combat and may claim it as their signature move. Should they score a 3 or higher on the deed die without previously calling what kind of Deed they were attempting, the Deed is assumed to be their signature move Deed.

Unarmed Mastery: In addition to the standard unarmed combat rules (DCC rulebook pg 96), the

NEW CLASSES

holy roller can choose to deal normal damage (1d3 + Strength modifier) with unarmed attacks as well as subdual. They can also choose to add their Smitey Deeds die result as a bonus to hit and damage.

In addition, holy rollers can employ their unarmed attacks using the two-weapon fighting abilities of a halfling (DCC rulebook pg 60). Note that this only works when making two unarmed attacks and only one Smitey Deed may be attempted during the double attack. Also, the Smitey Deeds die bonus to hit and damage must be split between the two attacks, but it

does not need to be split evenly. (i.e. Zuul rolls 2d16 for her whirlwind Deed double kick and 1d3 for her Smitey Deeds die. The results of the d16s are: 9 and 13; the deed die result is 3. Her foe's AC is 11 so she adds a full value of the Smitey Deed roll, +3, to the 9 so both attacks hit and the whirlwind Deed is successful.)

Luck: If a holy roller has a positive Luck Mod, they can add it to their Smitey Deeds die result of 3+ when determining the effect level of a Deed. This bonus does not affect the attack and damage bonus of the deed die.

Table HR-1: Holy Roller

Level	Smitey Deed Die	Crit Die/Table	Action Dice	Ref	Fort	Will	AC Bonus	Move Bonus
1	+d3	1d8/III	1d20	+1	+1	+1	+1	+5'
2	+d4	1d8/III	1d20	+1	+1	+1	+1	+10'
3	+d5	1d10/III	1d20	+2	+1	+2	+2	+10'
4	+d6	1d10/III	1d20	+2	+2	+2	+2	+15'
5	+d7	1d12/III	1d20+1d14	+3	+2	+3	+3	+15'
6	+d8	1d12/III	1d20+1d16	+4	+2	+4	+3	+20'
7	+d10	1d14/III	1d20+1d16	+4	+3	+4	+4	+20'
8	+d10	1d14/III	1d20+1d20	+5	+3	+5	+4	+25'
9	+d12	1d16/III	1d20+1d20	+5	+3	+5	+5	+25'
10	+d12	1d16/III	1d20+1d20	+6	+4	+6	+5	+30'

HUNTER

Lone wanderers that generally prefer the wastes and wilds to the company others, hunters are a rare breed of folk. Their wilderness skills allow them to have some measure of safety in traveling far from the few civilized areas of Umerica.

Hit Points: A hunter gains 1d8 hit points at each level.

Weapon Training: Hunters tend to favor ranged combat whenever possible and are proficient in all ranged or thrown weapons. They can also employ any one-handed melee weapons. They cannot wear armor with a fumble die greater than d8 but tend to avoid heavy armor that impairs their stealth. Hunters rarely use shields.

Alignment: Most hunters tend towards a Neutral outlook, adopting the laws of nature as their guide. It is not unheard of for a hunter to be Chaotic due to their disdain for community or company. Lawful hunters

are the rarest breed as the alignment is usually too confining for their tastes.

Hunter Skills: A hunter learns essential skills that aid their pursuits: *hide, sneak, sniper, survival, track, and trapping.*

To use a hunter skill, the player rolls a d20 and adds the appropriate Attribute modifier. They must beat a DC assigned to the task at hand. An easy task is DC 5, while an extremely difficult task is DC 20.

Success when using a hunter's skill means the following:

Hide (Agility): A successful hide check means the hunter cannot be seen. As with sneaking, this check is never opposed but is a roll versus a set DC. The base DC for sneaking through an area with moderate cover (large rubble, cars, nooks and crannies, alcoves, etc.) is DC 10. Hiding at night or in a shaded or dimly lit area is DC 5; hiding under a full moon is DC 10; hiding in daylight but in a dark shadow or behind a solid object

NEW CLASSES



HUNTER

NEW CLASSES

is DC 15; and hiding in broad daylight with minimal obstruction is DC 20.

Sneak (Agility): A hunter never makes an opposed check to sneak; that is, the check is never made against the target's attempt to listen. The hunter rolls against a hard DC, as noted below, and success means the hunter did indeed sneak silently. With the exception of advanced technology or extraordinary magic, the scavenger's movement cannot be heard. The base DC for moving across solid surfaces is DC 10. Cushioned surfaces, such as grass or moldy carpet are DC 5; moderately noisy surfaces, such as rotting wooden boards are DC 15; and extremely noisy surfaces, like crackling leaves, still water, or crumbling debris are DC 20.

Sniper (Ranged Attack): The most cunning hunters can kill without their victims ever being aware of the threat. When attacking a target from a distance (minimum of 80') with a properly sighted or scope-equipped ranged weapon, the hunter receives the indicated attack bonus to their attack roll. To set up a sniper shot, the hunter must aim at their target for 2 full rounds to receive the bonus. For firearms, this also counts as an aimed shot (USG pg 101). In addition, if they hit, the hunter automatically achieves a critical hit, rolling on the Crit table as per their level. Sniper shot attempts can only be made against creatures with clear anatomical vulnerabilities who are unaware of the hunter.

Survival (Intelligence): Hunters learn to avoid environmental hazards, unsound structures, and toxic edibles. Figuring out which canned goods are still safe or if a bridge is safe to cross would require a DC 10. Identifying a building that will collapse at any moment,

determining if a strange new fruit is poisonous, or spotting a radzone can range between DC 15-20.

Track (Intelligence): By examining the local area, a hunter can find out what has passed through there recently and possibly follow its path. In normal conditions, a DC 10 will suffice for identifying and following a trail. If the weather or terrain is troublesome, the difficulty can increase to DC 15-20. Those actively trying to hide their tracks inflict a -5 penalty to the roll to follow them.

Trapping (Intelligence): Hunters are capable of crafting simple traps from found materials. This usually takes 1d3 turns (10-30 minutes) and has a DC of 10. Setting up a trap in a matter of 2d3 rounds would increase the difficulty to DC 15-20. The damage caused by these traps is a number of d4 equal to their class level divided by 2 (round down) plus 1d4 (i.e. a 4th level hunter can cause 3d4 damage with their traps). Finding and disabling traps set up by others ranges from DC 10 for simple traps, DC 15 for subtle or complex traps, and hightech or magical traps might require a DC 20+.

Survivor's Fortune: Unlike other classes, the hunter recovers lost Luck on a daily basis. The hunter's Luck score is restored each night by a number of points equal to twice their level. This process cannot take their Luck score past its natural maximum.

Herbalism: Traveling alone in the wastes and wilds, you have to be your own doctor, and the flora of the area is your medicine cabinet. In 2d3 turns (20-60 minutes) a hunter can whip up a local remedy from foraged herbs that will heal 1d3 + the hunter's level in hit points for a number of people equal to 1d6 plus their Intelligence

Table HUN-1: Hunter

Level	Attack	Crit Die/Table	Action Dice	Ref	Fort	Will
1	+1	1d10/II	1d20	+1	+1	+0
2	+2	1d12/II	1d20	+1	+1	+0
3	+3	1d14/II	1d20	+2	+2	+1
4	+4	1d16/II	1d20	+2	+2	+1
5	+5	1d20/II	1d20	+3	+3	+1
6	+6	1d24/II	1d20+1d14	+4	+4	+2
7	+7	1d30/II	1d20+1d16	+4	+4	+2
8	+8	1d30+2/II	1d20+1d20	+5	+5	+2
9	+9	1d30+4/II	1d20+1d20	+5	+5	+3
10	+10	1d30+6/II	1d20+1d20	+6	+4	+4

NEW CLASSES

Table HUN-2: Hunter Skills

Hunter Level	1	2	3	4	5	6	7	8	9	10
Hide (Agility)	+1	+3	+5	+7	+8	+9	+10	+11	+12	+13
Sniper (Ranged Attack)	+2	+2	+3	+3	+4	+4	+5	+5	+6	+7
Sneak (Agility)	+3	+5	+7	+8	+9	+11	+12	+13	+14	+15
Survival (Intelligence)	+1	+3	+5	+7	+8	+9	+10	+11	+12	+13
Track (Intelligence)	+2	+3	+4	+5	+6	+7	+8	+9	+10	+11
Trapping (Intelligence)	+0	+1	+2	+3	+4	+5	+6	+7	+8	+9

Mod. A person can only benefit from one hunter remedy per day and the remedy must be imbibed hot and fresh. A hunter can only scrounge enough materials from an area to create 1d4+Intelligence Mod batches of remedy before the area's herbs are depleted, requiring 1d4 weeks to replenish.

At 4th level, a hunter can create a different remedy that can cure most normal diseases instead of healing.

At 8th level, the healing properties of their remedy increases to restore one point of temporary Attribute damage as well as healing.

ROAD HAWG

Riding is your life. Nothing beats the thrill of combat on your favorite hog. Whether riding for your swine boss or as a solo excursion, you live for the thrill. Nevermind how disgusted most other wastelanders are by you. They just don't understand.

Hit Points: A road hawg gains 1d8 hit points at each level.

Weapon Training: Road hawgs can use one-handed melee weapons, pistols, grenades, and any other guns that are affixed to their motorcycle. They can wear any armor with a fumble die of d7 or less. They do not use shields. They are silly things.

Alignment: Most road hawgs tend to be lawful. Their biker gangs that rove the wastelands are typically more structured than most other gangs. Chaotic road hawgs are not uncommon. Sometimes the thrill of the ride is too strong and warps the mind of the pure pigs into reckless killing machines. Neutral road hawgs are virtually unheard of.

Pig Men: Every road hawg is a portly humanoid pig. Their mere presence can be disturbing for other

wastelanders. They can eat almost any organic material they come across and do so in a sickening manner. Their stomachs can digest all but the most poisonous or radioactive material.

Ride or Die: Motorcycles are more important than family. Due to this connection with their bikes, road hawgs are capable of performing stunts that would make the legendary daredevils of the pre-disaster world blush. The ride die works similar to a warrior's deed die. The player adds the ride die to all of their Vehicle Control rolls. When the ride die is a 3 or higher they perform some sort of exciting stunt. The higher the roll, the better a stunt can be. If the ride die succeeds but the total roll is still not enough for the control roll to succeed, the roll is still failed and the stunt is lost. Furthermore, they may add the ride die to all repair or salvage rolls when working on some sort of motorcycle. An example of Ride or Die is included after Table CX: Road Hawg.

Hawg: All road hawgs start with a motorcycle. The bike has the *weapon mount* Trait.

Bike Mods: At first level the road hawg has already begun to modify their bike in extraordinary ways. They start with 1 bike mod and receive more at levels 4, 7, and 10. If a road hawg gets a new bike, they already know how to equip these mods and may apply them to the new bike. The mods may not be used by other characters. They don't have the experience needed to utilise the road hawg's mods.

Roll 1d12

- 1 Turbo engines - You have modified your bike's engines for a little more excitement. It gains the *high performance engine* Trait. USG pg 136.
- 2 Trike conversion - You convert your bike into a 3 wheeled trike. The bike replaces the *very*

NEW CLASSES



ROAD HAWG

NEW CLASSES

- dangerous* Trait with *dangerous*. It also gains the *extra cargo* Trait.
- 3 Linked weapon mount - You add a second weapon to your weapon mount. Now both will fire simultaneously at the same target. Only 1 attack roll is made to fire the linked weapons. Both expend ammo as normal. If you roll a 20, they both crit and roll separate crit dice on the appropriate Crit chart. Fumbles are resolved the same way.
 - 4 Armored chopper - Your bike gains the *armored* Trait. Your bike's Armor Die increases to a d5. Rolling this additional times increases the Armor Die by +1d.
 - 5 Custom sidecar - You equip your bike with a sidecar that another passenger can ride along in. It can be equipped with a single support class weapon but does not start with one. Furthermore, the bike's max Speed is decreased by 1 and you gain +1 to all control rolls.
 - 6 Blast shield - A large metal plate is affixed to the front of your bike much like a windshield. It grants the rider a +2 armor class when something is attacking from the front.
 - 7 Nitrous tanks - Your bike now has the *nitrous tank x2* Trait, USG pg 136.
 - 8 Heavy tire blades - Your bike now has the *tire blade, heavy* Trait, USG pg 137.
 - 9 Inferno dropper - Your bike is fitted with a napalm launcher on the back end. As an action it creates a wall of fire behind your bike. It is 5' wide as long as you moved in the round used. Anybody in the inferno or that comes into contact with it takes 2d6 damage and must make a Ref save DC 14 or be lit on fire. It burns for 1 minute or until extinguished. Ammo capacity 5; requires refueling.
 - 10 Gyrocopter - A propeller folds out of your bike that allows it to fly. Its movement is reduced to Cruise 1 max 2 and has a height Cruise of 1 and max of 2. A successful Vehicle Control roll DC 15 and a successful stunt are required to deploy the propeller while in motion. Failure results in a wipeout. The handling modifier for your Speed level applies to this roll. While in flight, the bike's Guzzle is increased by 2.
 - 11 Splatter plow - Your bike now has the *ram plate* Trait, USG pg 136.
 - 12 Grapple claw - With a successful attack roll, your grapple claw will prevent other vehicles from gaining distance away from you in a chase. Furthermore, if an individual is grabbed by the claw, it can be used to drag them behind your bike with a DC 10 control roll and a successful stunt. Further modifiers still apply. They take damage equal to 1d6 per Speed level that your bike is moving. It takes 3 rounds to reel the claw back in. Range 30/60/90.
- Hawg Engineering:** Life on the Wasteland is hard. Being able to construct useful items from what is scavenged in the ruins of the old world is a valuable skill. The road hawg is able to construct a number of useful items. At levels 2, 4, 6, 8, and 10 the road hawg learns how to create another useful tool or gains a new talent. They must make an *engineering* skill roll and have sufficient materials to use these abilities. This skill uses the Intelligence ability score.

Roll 1d12

- 1 You have learned how to maintain other vehicles. You can now repair other land vehicles.
- 2 You can make ammunition for slug throwing firearms: DC 10 for 5 rounds, DC 15 for 10 rounds, and DC 20 for 20 rounds.
- 3 An *engineering* skill roll DC 16 creates one piece of retread armor.
- 4 An *engineering* skill roll DC 12 creates one piece of ablative armor.
- 5 You have a fondness for all things that go boom. An *engineering* skill roll DC 15 creates 1 can grenade. A DC 20 produces a single grill tank bomb.
- 6 Firearms are your thing. You can create a scrap gun with an *engineering* skill roll DC 16.
- 7 You have turned your tools into a weapon. An *engineering* skill roll DC 16 creates a saw blade slinger.
- 8 It is best to always be armed when in the wasteland. You are able to create a simple melee weapon out of scrap with a DC 12 *engineering* roll. It does 1d7 damage.

NEW CLASSES

Table CX: Road Hawg

Level	Attack	Crit Die/Table	Action Dice	Ref	Fort	Will	Engineer	Ride Die
1	+1	1d8/III	1d20	+0	+1	+0	+0	1d3
2	+2	1d8/III	1d20	+0	+1	+0	+1	1d4
3	+2	1d10/III	1d20	+1	+2	+1	+2	1d5
4	+3	1d10/III	1d20	+1	+2	+1	+3	1d6
5	+4	1d12/III	1d20	+1	+3	+1	+4	1d7
6	+4	1d12/III	1d20+1d14	+2	+4	+2	+5	1d8
7	+5	1d14/III	1d20+1d16	+2	+4	+2	+6	1d10
8	+6	1d14/III	1d20+1d20	+2	+5	+2	+7	1d10+1
9	+6	1d16/III	1d20+1d20	+3	+5	+3	+8	1d10+2
10	+7	1d16/III	1d20+1d20	+3	+6	+3	+9	1d10+3

9 Scrapping expertise: You are able to strip random machinery from around the wasteland for use on vehicles.

10 Breaking and entering: Your ability with machines lends well to getting into places you normally couldn't. You are able to break into locked or secured places in an unconventional manner. Sometimes it's easier to go around a lock, than to pick it.

11 Shiner: You are able to distill biofuel from plants and other similar things with a DC 12 *engineering* roll.

12 Jury rig: You have no problem fixing things on the fly with available scrap. Unfortunately without proper parts, your "fixes" don't usually last long. With a minimum DC 15 roll. You are able to jury rig broken tech back together for a short amount of time. It usually works just as long as you need ... usually.

RIDE DIE EXAMPLE

Ride and Fly

The road hawg is able to use chunks of rubble or other obstacles to make jumps that would normally require some sort of ramp.

3 The road hawg is able to make a 20' jump with ease (min Speed 2).

4 The road hawg is able to make a 50' jump with ease (min Speed 3).

5 The road hawg is able to make a 100' jump with ease (min Speed 4).

6 The road hawg is able to make a jump of 160' with ease (min Speed 5). Furthermore, the road hawg is now able to easily land on hazardous surfaces such as a moving vehicle or a floor that is ready to collapse.

7 The road hawg is able to jump 240' with ease (min Speed 6). The road hawg is now able to land anywhere with extreme accuracy. They could accurately land on another bike or on a steel girder.

Smoke Screen

When the road hawg begins their movement, they burn out and create a smokescreen behind them that obscures the view from behind.

3 The road hawg creates a cloud of smoke behind their bike in a 5' radius. Anything shooting through it is at -1d.

4 The road hawg creates a cloud of smoke behind their bike in a 10' radius. Anything shooting through it is at -1d.

5 The road hawg creates a cloud of smoke behind their bike in a 10' radius. Anything shooting through it is at -2d.

6 The road hawg creates a cloud of smoke behind their bike in a 20' radius. Anything shooting through it is at -2d.

7 The road hawg creates a thick black cloud of smoke in a 30' radius. Anything with normal sight cannot see through it and shoot through it as if they were blind.

NEW CLASSES

180 Reversal

Sometimes the enemy is behind you. Firing your weapons at these foes can be difficult. The road hawg spins their bike around and continues their movement, now in reverse, and fires upon his foe.

- 3 The road hawg spins their bike around in a single fluid movement and continues to move in the direction they were going. Movement Speed decreases by 2. If this reduces Speed to 0 they stop. They can now use any available held or mounted weapons.
- 4 The road hawg spins their bike around in a single fluid movement and continues to move in the direction they were going. Movement Speed decreases by 1. If this reduces Speed to 0 they stop. They can now use any available held or mounted weapons.
- 5 The road hawg spins their bike around in a single fluid movement and continues to move in the direction they were going. They can now use any available held or mounted weapons.
- 6 The road hawg spins their bike around in a single fluid movement and continues to move in the direction they were going. They can now use any available held or mounted weapons. The Vehicle Control roll modifier for driving in reverse is reduced to +2.
- 7 The road hawg spins their bike around in a single fluid movement and continues to move in the direction they were going. They can now use any available held or mounted weapons. The Vehicle Control roll modifier for driving in reverse is reduced to 0.

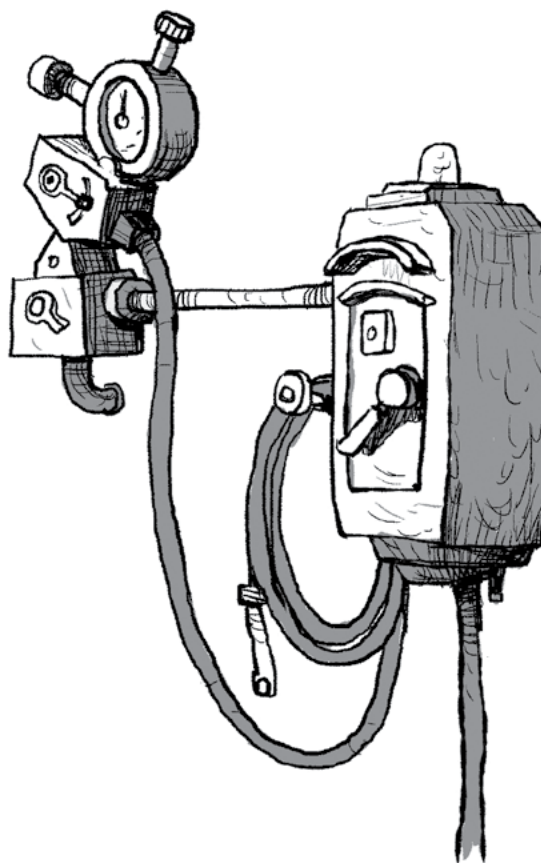



ALTOCIDIE AND GUNPLAY

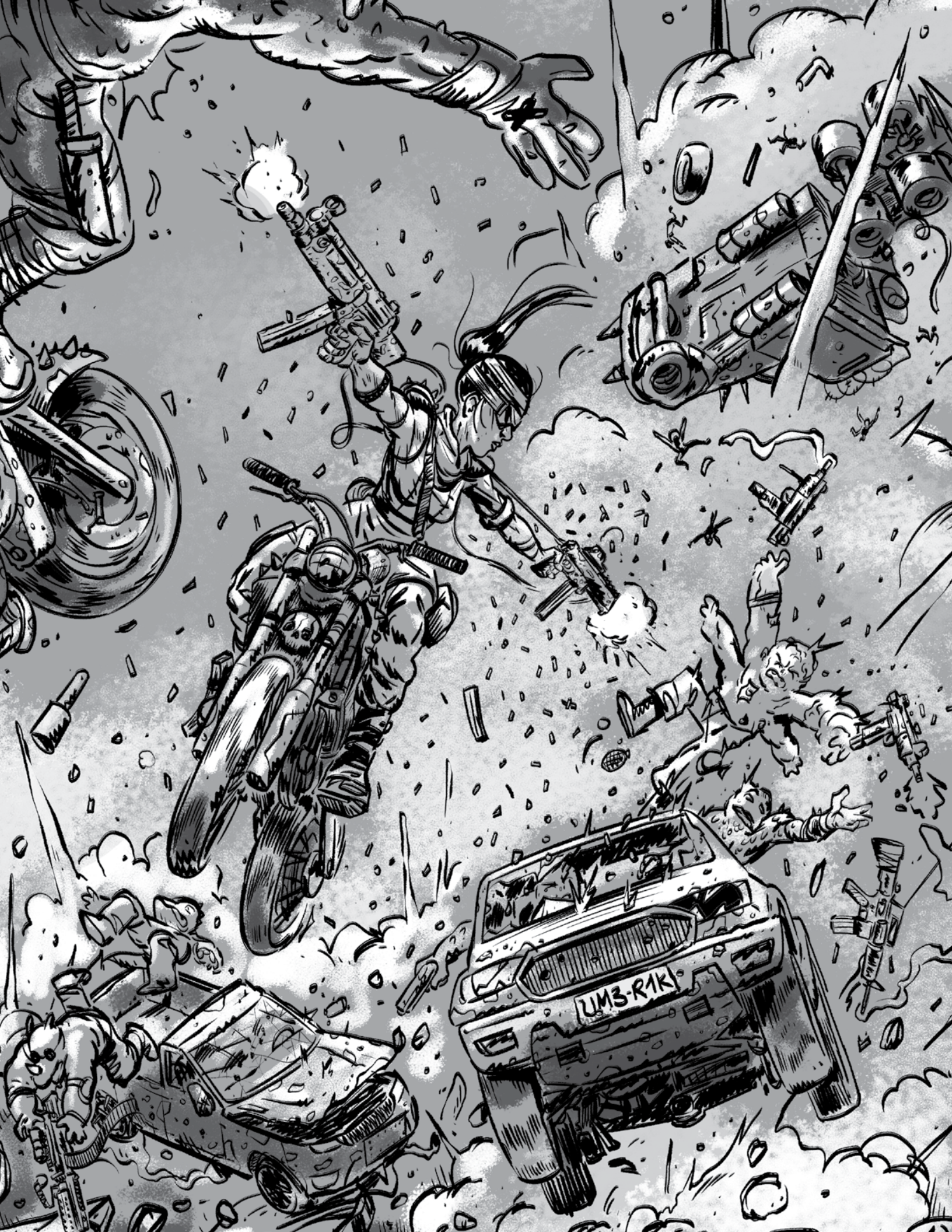

AUTOCIDE AND GUNPLAY

AUTOCIDE AND GUNPLAY

The fighting styles of Umerica have slowly evolved (or in some cases, devolved) from both the unique needs of a post-apocalyptic wasteland and the drive to bring combat and conflict to all new levels. Mighty warriors, steadfast fossorians, roving holy rollers, or anyone with a deed die may find reason to use these mighty combat Deeds of the wasteland, while some simply rest on older forms passed down from days before the broken moon.

These new Deed lists are suggestions of fighting styles that can be used in Umerica and can be used as is, or to simply offer a guide to possible combat maneuvers

that can be performed using the deed die in Umerica. These are but a sample of possible new-age fighting styles that have sprung up in the wastes of Umerica.

Mighty Crits and Mighty Fumbles are optional rules that can add some additional chaos to battle. A Mighty Fumble occurs when you fumble both on the action die and roll a 1 on the deed die. A Mighty Crit happens when you roll a crit on the action die, and roll the max on the deed die. The effects of these fumbles or crits go above and beyond a normal fumble or crit, as they are mighty indeed. The GM may rule how they wish, but the Deeds below offer suggestions and ideas that can be tailored to the Deed style.

ACE AUTOMOTIVE ANNIHILATION (AAA)

Warriors of the wasteland don't just specialize in killing creatures, they often have to disable or destroy vehicles. AAA brings roadside vehicle destruction to a new artistry level that can decimate many of the vehicles that roam the wasteland. This form is generally practiced with vehicle-mounted ranged weapons but can be used with hand-held ranged weapons fired against vehicles instead. Regardless of how good the Deed may be, it is only effective with weapons that are a threat to the vehicle in the first place.

Deeds:

Roll	Effect
Mighty Fumble	The vehicle the warrior is currently in must make an immediate Vehicle Control roll. If not in a vehicle, the weapon fired jams (DC 10 to clear).
3	<i>Tire Ripper</i> - There is a 5x the deed die result +10% chance of a tire popping.
4	<i>Compromised Steering</i> - The targeted vehicle's handling suffers a -1d3 penalty until the steering can be repaired. The driver must make an immediate Vehicle Control roll.
5	<i>Bypass Armor</i> - The deed die result is subtracted from the vehicle's Armor Die roll versus this attack.
6	<i>Engine Damage</i> - Vehicle's max Speed is reduced by 1 and handling suffers a -1 penalty until both are repaired.
7+	<i>Smoking</i> - Damage causes smoke to billow out of the engine and fill the vehicle, Blinding (USG pg 101) the driver and all passengers until they exit the vehicle.
Mighty Crit	<i>Thread the Needle</i> - When firing at armored vehicles, shot may instead hit a target in the vehicle that would otherwise have near-complete cover. Not viable if the target is totally enclosed.

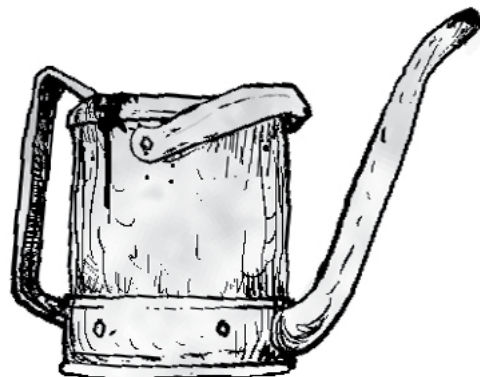

AUTOCIDE AND GUNPLAY



COCKPIT WRESTLING

The age-old art of fighting over the driver's seat or fighting in any car for that matter. Wrestling for control of a vehicle while not crashing is an important part of taking control of a vehicle. While this can be done unarmed, small hand-held weapons such as knives or pistols can be used as well.

Deeds:

Roll	Effect
Mighty Fumble	<i>Stuck</i> - Weapon or appendage gets stuck somewhere in the cockpit, requiring an action to free, or be Entangled (USG pg 101) until the appendage is freed.
3	<i>Steering Wheel Strangle</i> - Target is choked against the steering wheel or other part of the cockpit. Deal an additional +1d4 damage and make a Vehicle Control roll (at -2 if the driver is being choked) if using the actual steering wheel or choking the driver.
4	<i>Lose Control</i> - Force current driver to make a Vehicle Control roll with the deed die as a penalty.
5	<i>Hit the Gas/Break Slam</i> - Force vehicle to accelerate +1 Speed, or decelerate up to 2 Speed. The driver must make an immediate Vehicle Control roll to maintain control of the vehicle.
6	<i>Door Slam</i> - Slam appendage in the door, doing an additional +1d6 damage plus the target suffers a -2 penalty to all checks using that appendage for one turn.
7+	<i>Assume Control</i> - Gain control of the vehicle from its current driver. Make an immediate Vehicle Control roll adding half your deed die.
Mighty Crit	<i>Forced Dismount</i> - As Assume Control and the target is thrown out of the vehicle.

AUTOCIDE AND GUNPLAY



CYCLE DUELING

Like mounted knights of yore, this venerable combat technique is popular with warriors who fight atop the steel horses that are the motorcycles of Umerica. Called Cycle Sabat, Motorcycle Kickboxing, or even Vicious Cycle, this style specializes in warriors on top of motorcycles fighting others on mounts or vehicles (either the same cycle or an adjacent mount or vehicle), though some of the Deeds are viable to be used against non-mounted targets.

Deeds:

Roll	Effect
Mighty Fumble	Warrior must make an immediate Reflex save DC 12 + current Speed or fall off the bike. If successful, a Vehicle Control roll is required to retain control of the vehicle.
3	<i>Balance</i> - Allows rider to add half their deed die to control checks while driving and fighting.
4	<i>Distracted Driving</i> - Forces a Vehicle Control roll with the deed die result as a penalty.
5	<i>Eat My Dust</i> - The warrior may increase or decrease their current Speed by 1 without making a Vehicle Control roll.
6	<i>Velocity Blow</i> - Add Speed x d3 to the damage inflicted by the attack.
7+	<i>Forced Dismount</i> - Pull/push an unsecured target out of the enemy vehicle or off your vehicle. Must make a Vehicle Control roll if the warrior was NOT the driver of the vehicle and dismounted the driver.
Mighty Crit	<i>Drop and Drag</i> - As Forced Dismount but bonus dragging damage of 1d6 per Speed rating, all 6s indicating a broken bone. Target will be dragged for 1d3 rounds or until they extract themselves from the situation.

AUTOCIDE AND GUNPLAY

FREAKIN' LASER BEAMS

Originally designed to be mounted on sharks, laser beams have been a staple of high-tech weaponry for some time. While an untrained welder may simply point and shoot, expert warriors know how to adjust the beam to get even more desirable and deadly effects. This Deed only works with lasers and other high-energy beam weapons that rely on energy or heat to cause damage.

Deeds:

Roll	Effect
Mighty Fumble	<i>Overload</i> - Take 1d4 damage from weapon overloading. The weapon can not be used for 1d3 rounds.
3	<i>Slow Burn</i> - Attack does an additional +1d4 damage.
4	<i>Distract/Disorient</i> - Target is -1 to all actions for 1d3 rounds.
5	<i>Disarm</i> - Target's weapon becomes too hot to handle and drops out of the target's hands, or target suffers 1d3 damage per round. It remains too hot to handle for 1d3 rounds.
6	<i>Disarmorment</i> - Attack damages armor by 1 step automatically after normal Armor roll is resolved. Impervious armor takes temporary damage until healed or repaired.
7+	<i>Vital Burn</i> - Target takes 1d3 temporary Stamina damage.
Mighty Crit	<i>Ignite</i> - Target will catch target on fire, causing 1d6 damage per round for 1d5 rounds or till put out. Target is also at -1d to all actions while on fire.

SCAVENGRA

This unique martial art practiced by scavenging warriors is used unarmed in the presence of junk or scrap. It is the art of using scavenged materials to attack and wound an opponent. While its damage output can vary depending on the items found, it makes use of hazardous terrain well, and lets the practitioner keep their hands free to help climb, escape, or loot while fighting. Best done in areas with lots of loose items.

Deeds:

Roll	Effect
Mighty Fumble	<i>Wrong End</i> - Take 1d3 damage from grabbing the wrong end of a sharp or otherwise dangerous item.
3	<i>Thrown Loot</i> - Melee attack does normal damage at a range of 5' times the deed die result.
4	<i>Slippery Footing</i> - Target must make a Ref save DC 10 + deed die result or fall prone.
5	<i>Dangerous Scavenging</i> - Using the environment and scraps, do an additional 2d4 damage.
6	<i>In the Eyes</i> - Target is blinded for 1d4 rounds.
7+	<i>Caustic</i> - Target takes 1d3 points of damage for the next 1d5 rounds of a random damage type (roll 1d4: 1- cold, 2- heat, 3- acid, 4- radiation).
Mighty Crit	<i>Keeper</i> - In addition to activating one of the above Deeds, the practitioner finds an item worth scavenging of some value and is able to pocket it. Value is up to GM's discretion (something worth up to deed die result x10 SP is a good guideline).

AUTOCIDE AND GUNPLAY

SHOTGUNNERY

When these warriors cry “Shotgun!” they don’t mean the other front seat. Warriors who use this Deed excel at the use of shotguns, blunderbusses, and other fragment projectile weapons.

Deeds:

Roll	Effect
Mighty Fumble	<i>Right in the Foot</i> - Take 1d4 damage and suffer 5’ Move penalty (5’ minimum) till healed.
3	<i>Cloud of Dust</i> - Shot also stirs up a disorientating cloud of dust, causing target to take a -2 penalty on all actions for the next round.
4	<i>Something Cool</i> - This deed is so cool, it has yet to be described!
5	<i>Crippling Blow</i> - Target loses 10’ of Move rate (minimum 5’) and has a -2 penalty on Reflex save bonus till healed.
6	<i>Splatter</i> - Target and anyone within 5’ make a Reflex save DC 10 + deed die result or be blinded by blood and gore splatter; 10’ if shot killed target.
7+	<i>Penetrating Shot</i> - Can do half damage to additional target behind current target.
Mighty Crit	<i>Second Pull</i> - May trigger the second barrel on a double barrel if it was loaded and not fired originally (roll an extra attack and damage, use the same deed die).

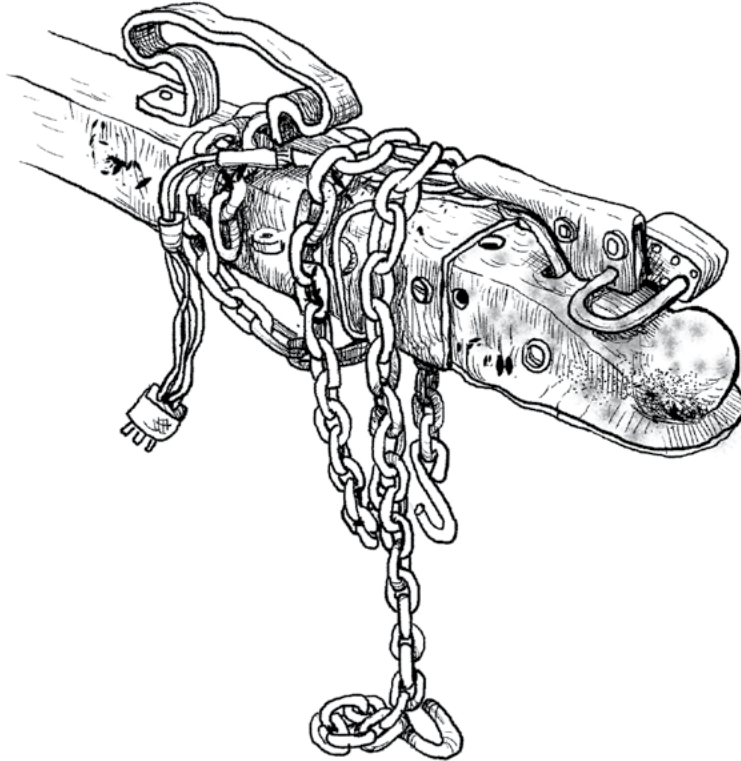

AUTOCIDE AND GUNPLAY



WALL OF LEAD

This Deed is for the impressive art of effectively filling the sky with lead. Automatic weapons, already fearsome in Umerica, gain a deadly elegance in the hands of a warrior. Anyone can empty a clip, but a true warrior can rain hell down upon their target to great effect. These deeds allow the warrior to help control the battlefield while mowing down their enemies. This Deed can only be activated by weapons firing in full auto mode.

Deeds:

Roll	Effect
Mighty Fumble	<i>Friendly Fire</i> - Random friendly target in firing arc takes half damage from weapon.
3	<i>Collateral Damage</i> - An item within 5' of the target may also sustain damage. Damage may be minor or major depending on damage done and targets in the area.
4	<i>Suppressing Fire</i> - Target will be unable to move this round or automatically suffer the weapon's normal damage.
5	<i>Cover Fire</i> - Anyone within 10' of the target are -2 to attack rolls for the next round.
6	<i>Extra Hit</i> - Hit with more bullets than usual. Raise all damage dice by +1d.
7+	<i>Additional Target</i> - Stray fire does half damage to an additional target within 10' of the current target.
Mighty Crit	<i>Efficient Trigger Pull</i> - In addition to activating a Deed as above, warrior uses half as much ammo as they would have normally used (minimum 3).



MACHINE SHOP

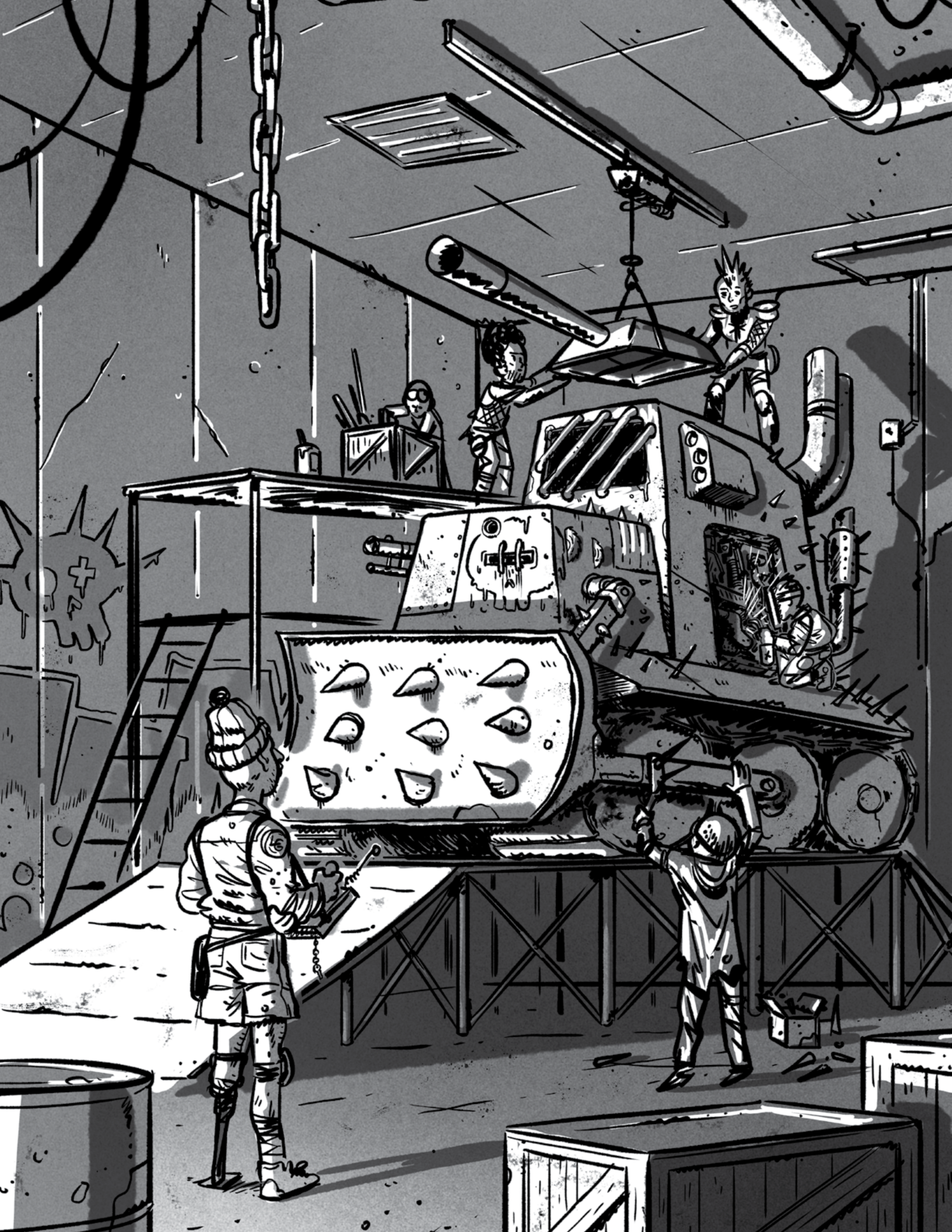

MACHINE SHOP

NEW VEHICLE QUALITY LEVEL

Vintage: The rarest of all vehicles, these are either pre-cataclysmic vehicles that somehow survived the ravages of time or those which have been painstakingly restored using pre-cataclysm parts. While not always as immediately eye-catching as custom jobs, Vintage vehicles are a class all to themselves. These vehicles have 6HD (maxed) and add the following Stat bumps: +4 to init or +3 die steps to the Armor Die; +3 to Speed cruise & max or Fortitude & Reflex saves. They have 2 additional Traits and with a DC 20 vehicle repair check a third (or even fourth) Trait may be added. They have a Wreck check of 15.

Due to the scarcity of such vehicles, and the difficulty in obtaining parts for maintenance, it requires 10d6 repair checks (DC 20, each failure costing 500sp in additional parts) taking 10d30 x10 hours of labour and (4d30)d100 x 10sp worth of parts (averaging 31,000sp) to assemble such a vehicle—they are never for sale in the open market.

Basic maintenance to Vintage vehicles is DC 10. Repairs of minor damage is DC 15, major damage requires DC 20, while near totaled vehicles damaged beyond 90% require DC 30 to repair. The cost for repair parts for all damage levels is consistent at 10d30sp per hit point repaired. Parts for Vintage vehicles cannot be salvaged from common scrap yards.

NEW GENERAL VEHICLE TRAITS

Alarm System - This vehicle has a hidden trigger that, if not activated, will sound a piercing siren if tampered with. In addition, the ignition switch will not work until the alarm is deactivated. Disabling or deactivating the alarm (assuming the trigger is not known) requires a DC 15 mechanic roll and the proper tools. It is DC 20 if the proper tools are not available.

For those who prefer a pyrrhic victory, the alarm can trigger an explosive attached to the gas tank, inflicting 5x the vehicle's current Fuel die in damage to anyone within 10' of the vehicle and half that damage to anyone within 50'. Needless to say, the explosion destroys the vehicle. If the vehicle is inspected before any tampering occurs, It is a DC 12 Intelligence check to notice the fuel tank is rigged to blow.

Built-in Lavatory (cargo van or larger) - A portion of this vehicle's storage or passenger area is dedicated to a rudimentary restroom that allows at least a modicum of privacy while washing up or using the toilet. The system must be resupplied daily with a few gallons of reasonably clean water to function. Many vehicles with this Trait employ a few buckets or barrels attached to the exterior to catch rainwater to serve this purpose.

Built-in Still (pickup truck or larger) - The vehicle has a five-gallon distillery system (output: 1-2 gallons) attached to the vehicle. If the vehicle suffers 50% or more of its hit points in damage there is a 50% chance that the still will explode. The effects are:

- If the still is attached to the outside of the vehicle, the explosion causes 2d3 damage to the vehicle and requires an immediate Vehicle Control roll (DC 10 base). If the vehicle wipesout, add an additional +1 to the Wipeout roll total.
- If the still is attached to the inside of the vehicle the explosion causes 2d3 damage to the driver and passengers, 1d3 damage to the vehicle, and requires an immediate Vehicle Control roll (DC 13 base). If the vehicle wipesout, add an additional +1d3 to the Wipeout roll total.

Booster Rockets (pickup truck or smaller, cannot be put on tracked vehicles) - The vehicle is equipped with hazardously explosive rockets that can greatly increase its speed for a short amount of time. When activated, these rockets will increase the vehicle's Speed by +2 each round until it reaches Speed 10 and then maintains this Speed level for 3d4 rounds. A Vehicle Control roll must be made each round to avoid wiping out. Also, the vehicle must make a Fortitude save each round (DC 14) or suffer 2d6 damage, ignoring any armor. Once the rockets are expended, it will take several hours and 4d4gp worth of volatile materials to recharge them (DC 15).

Anytime the vehicle suffers damage from an attack, the vehicle must make a Fortitude save (DC 12) to avoid the rockets misfiring. If the damage was fire or heat based, the DC is 18. If there is a misfire, see below:

- **Rockets are fully charged** - the rocket system will immediately activate and all Vehicle Control rolls are made at -1d. If the save to avoid misfire comes up a natural "1" the rockets explode, inflicting 8d8 damage to the vehicle, ignoring any armor. If it

MACHINE SHOP

is an open vehicle, the driver and passenger also suffer the full damage from the rocket explosion. If it is closed, the driver and passengers only suffer ½ damage. In addition, the vehicle is out of control and must roll on Table WO-1: Wipeout Results, USG pg 128, and add +1d4 to the result.

- **Rockets have been used** - the rocket system will sputter into life for one round, increasing the vehicle's Speed by 1, and the Vehicle Control roll is made at -1d. If the save to avoid misfire comes up a natural "1" the rockets explode, inflicting 4d4 damage to the vehicle, ignoring any armor. If it is an open vehicle, the driver and passenger also suffer the full damage from the rocket explosion. If it is closed, the driver and passengers only suffer ½ damage. In addition, the vehicle is out of control and must roll on Table WO-1: Wipeout Results, USG pg 128.

Cold Storage (pickup truck or larger) - This represents a large portion of the vehicles' storage or passenger space being occupied by a refrigeration unit capable of maintaining temperatures as low as 0° F (-18° C). If the vehicle suffers 50% or more of its hit points in damage, there is a 60% chance per hour that the refrigeration unit will fail and need repair.

Fearsome (Custom quality vehicles only) - The exterior of the vehicle has been artistically crafted to look as threatening and savage as possible. While in this vehicle, the driver and passengers gain a +3 to all Personality checks when attempting to intimidate. In addition, anyone considering attacking this vehicle that has not done so before must make a Willpower save (DC 10) or chicken out and avoid combat. If added to a large vehicle (semi-trucks, most construction vehicles and military vehicles) these bonuses may be greater (GM's decision).

The downside is that all repairs to this vehicle cost triple the normal amount, and if it is damaged below 50% of its normal hit point total, it loses its fearsomeness until properly repaired. If any other Traits modify repair costs, the multipliers are added together (e.i. double [x2] and triple [x3] combine to quintuple [x5]).

Heavy Winch (large or heavier construction vehicles and military vehicles) - Similar to the winch Trait, this is an industrial/military grade version capable of pulling a maximum of 40 tons and tow cable length of roughly 150'.

Hell Dropper (cannot be put on motorcycles) - As an action, the vehicle can drop a roughly 15'x15' field of burning oil and scrap caltrops. Any autos following this vehicle must make a Vehicle Control roll (DC 12 base) or drive through the field. Any vehicle driving through the field has a 35% chance for each tire to blow out and a 25% chance of the vehicle itself catching fire (1d4 damage per round, ignores all armor). The field will continue to be a flaming hazard for 1d6x10 minutes.

If this vehicle wipesout and has any dropper ammo left, add an additional +1d3 to the Wipeout roll total. The dropper has an ammo capacity based on the vehicle's HD type:

HD #	of drops
d7-d8	1
d10-d12	2
d14	3
d16+	4

Mini-Kitchen(cargo van or larger) - This represents a sizable portion of the vehicle's storage or passenger space being occupied by a small, full service kitchen area. Many times this will also include a serving window in the side of the vehicle and collapsible awning. This kitchen area only requires minimal setup time to use (a few minutes) and does not impede the vehicle if used while driving. If combined with the cold storage Trait it creates a perfect food truck.

Portable Repair Shop (pickup truck or larger) - This represents a large portion of the vehicle's storage or passenger space being occupied by compactly organized automotive tools. Setting up the shop takes roughly 30 minutes and allows general vehicle repairs. Specialized repairs may require tools not normally included, based on GM's choice.

Radio Communications System - A radio receiver, transmitter, and antenna capable of wide-band pick up. The effective communications range will vary wildly based on background interference caused by radiation, magical energies, and dimensional distortions.

Robo Control - This vehicle has a robotic virtual intelligence installed that can control all of the vehicle's functions. Its effective Agility for Vehicle Control rolls or other vehicle functions is 14 (+1). Otherwise, all of its mental attributes are 10 (+0). It can speak and will take verbal directions. Roll 1d10 to determine

MACHINE SHOP

the robot's personality trait: (1) condescending; (2) despondent; (3) very perky; (4) gruff; (5) domineering; (6) sniveling; (7) cowardly; (8) hyper; (9) contrary; (10) roll again twice, combining both results. All repairs to this vehicle cost double the normal amount. If any other Traits modify repair costs, the multipliers are added together (e.i. double [x2] and triple [x3] combine to quintuple [x5]).

Tailgate Grill (pickup truck or larger) - The vehicle has a retractable/collapsible camp stove or grill plus food prep station attaching to its exterior. Setting up the stove/grill takes roughly 30 minutes and allows preparation of simple hot meals. The vehicle suffers -3 to all Vehicle Control rolls if the stove/grill is not properly stowed away before driving.

Targeting System (requires a support or artillery class weapon) - Grants one vehicle mounted weapon system a +2d3 to all ranged attacks and increases critical threat range by 1. Removes penalties for calculating indirect fire.

Towing Rig (pickup truck or larger) - This is either a *boom winch* or *flatbed winch* style towing apparatus designed to move damaged or otherwise immobile vehicles of a like size or smaller. When in use, the towing vehicle's Speed max is reduced by 1 and it's Reflex save is reduced by 2.

Tracked (cannot be put on motorcycles) - The vehicle's wheels have been partially or completely replaced with continuous track, also called tank tread. This grants the vehicle exceptional grip on most surfaces (+1d4+2 to all Vehicle Control rolls and -1d to all Wipeout dice). Also, the vehicle ignores all chances of tire blowout. If attacked directly, each track can suffer 20hp of damage (Armor Die [1d3]) before it ceases to function. Any Trait that increases the vehicle's Armor Die will also increase the track's Armor Die. The cost of this stability is speed, reducing cruise by -2 and max by -3 if the vehicle was not initially designed to use a continuous track (not listed as a base vehicle Trait).

Sound System - A tricked-out audio system capable of playing any terrestrial audio media at high volume and excessive bass. If pushed to the max, it can cause temporary deafness (1d3 hours) to all within 20' Fortitude save (DC 12) to avoid. Repeated, long term exposure can cause permanent deafness.

Storage Pods - The vehicle has a cargo compartment

attached to its exterior, usually the top or rear of the vehicle. Most vehicles cannot have more than two storage pods attached (GM's decision).

Anytime the vehicle is struck in combat there is a 20% chance that the pod is struck instead. The pod can be targeted specifically at no penalty. A pod has hit points equal to one full Hit Die of the vehicle's type (HD d8 = 8hp) and Armor Die [1d3]. When reduced to 0 hit points, the pod either detaches from the vehicle or is ripped open, spilling out its contents. Either way, any object stored in the pod has a chance to be destroyed equal to 15% times the vehicle's current Speed (i.e. at Speed 5 [~55mph] objects have a 75% of being destroyed), modified by what it is made of (GM's decision).

This pod has a storage capacity based on the vehicle's HD type:

HD	Storage
d6	2 cu ft
d7-d8	4 cu ft
d10-d12	6 cu ft
d14	10 cu ft
d16+	16 cu ft

Suspension Lift Kit (cannot be put on motorcycles) - This vehicle has a modification to drastically raise the ride height, improving its off-road performance and allowing it to utilize larger wheels and tires. While similar to the *off-road* Trait (no penalties for traveling off-road), this allows the vehicle to traverse normally impassable terrain and cross deeper water hazards without the risk of engine stalls or electrical damage. In addition, during potential collisions with shorter vehicles, a Vehicle Control roll (DC 13 base) can be made to instead drive over the other vehicle, inflicting the normal rundown damage without taking damage in return. At Speed 2 or greater, this vehicle must make a Fortitude save (DC 5+Speed) for each tire when attempting a car-crash to avoid a blowout.

The downsides of this Trait are poor high-speed handling, poor gas mileage, and expensive maintenance:

- Attempting anything other than a slight turn at Speed 3 or higher invokes a -2 to the Vehicle Control roll.
- This vehicle's Guzzle rating is increased by +1.
- All repairs to this vehicle cost double the normal amount. If any other Traits modify repair costs,

MACHINE SHOP

the multipliers are added together (e.i. double [x2] and triple [x3] combine to quintuple [x5]).

Vehicle Snorkel (cannot be put on motorcycles) - This vehicle has all of its air intake parts inside the engine bay and all wiring sealed. A large tube device, typically routed out through one of the front fenders or directly through the hood, feeds the engine a steady supply of air. This allows the vehicle to wade through deep waters without fear of water entering the engine or damaging the wiring. Note that the interior cabin of most vehicles are not water tight and will flood while fording a water hazard.

Winch (pickup truck or larger) - An electrically or hydraulically powered winch with a spool of high-test towing cable attached to the vehicle's chassis. This winch has a maximum pull weight of roughly four tons and a tow cable length of roughly 80'. Note, attempting to winch an object heavier than the vehicle can be an issue.

NEW VEHICLE TYPES

Construction Vehicles

While rarer than general-use vehicles, many specialized vehicles designed primarily for construction work have survived due to their inherent rugged nature. Agricultural (farming) vehicles also fall under this category as many times the main differences between the two is the color of the paint job.

Note: Due to their unique designs, finding or adapting replacement parts for construction vehicles is more difficult than normal vehicles, meaning all repair DC's are increased by +5. On the plus side, construction vehicles are easier to modify and can be equipped with up to +2 extra vehicle Traits more than their quality level would normally allow.

Mini Tractor - These tiny construction vehicles are barely the size of a small car and yet are powerful utilitarian workhorses.

Mini Tractor: Init -1; Atk rundown +4 melee (2d7+Collision damage bonus); AC 9; Armor Die [1d5]; HD d10; Speed Level cruise 1/ max 2; Act 1d20; SV Fort +8, Ref -1, Will NA; Fuel Tank 1d12; Guzzle 4.

Basic Traits: *nimble, open, rugged*, either *dual wheeled* or *tracked*, pick one of the following (*hydraulic arm - small, dozer blade - light, roller-compact - light, or agricultural equipment*).

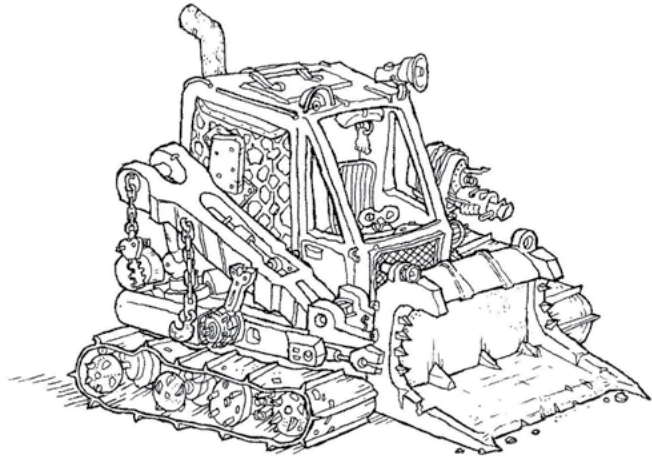

Small Tractor - These vehicles were commonly employed for road and small worksite construction.

Small Tractor: Init -3; Atk rundown +6 melee (2d10+Collision damage bonus); AC 7; Armor Die [1d6]; HD d14; Speed Level cruise 1/ max 2; Act 1d20; SV Fort +10, Ref -3, Will NA; Fuel Tank 1d16; Guzzle 6.

Basic Traits: *open, rugged*, either *dual wheeled* or *tracked*, pick one of the following (*hydraulic arm - medium, dozer blade - heavy, roller-compact - heavy, or agricultural equipment*).

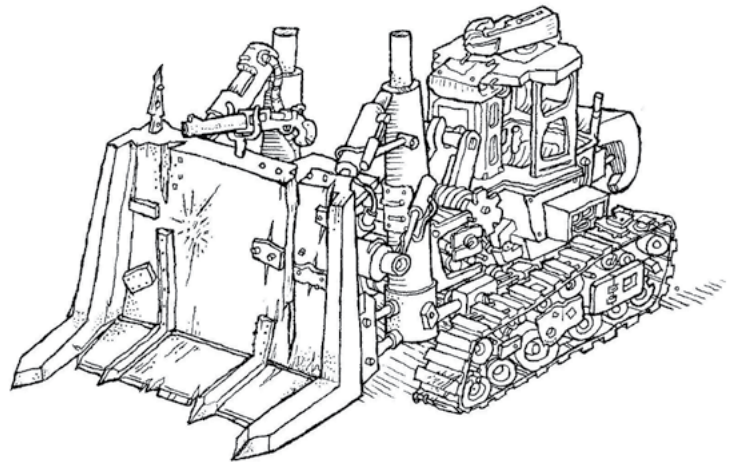

Large Tractor - Construction vehicles of this size are only used for major construction sites. They are large enough that they can barely fit down a two-lane road and require a lot of maneuvering room.

Large Tractor: Init -5; Atk rundown +8 melee (2d14+Collision damage bonus); AC 6; Armor Die [1d7]; HD d20; Speed Level cruise 1/ max 1; Act 1d20; SV Fort +12, Ref -4, Will NA; Fuel Tank 1d20; Guzzle 8.

MACHINE SHOP

Basic Traits: *open, rugged*, either *dual wheeled* or *tracked*, pick one of the following (*hydraulic arm - large, dozer blade - heavy, roller-compact - heavy, or agricultural equipment*).

Massive Tractor - The rarest of construction vehicles,

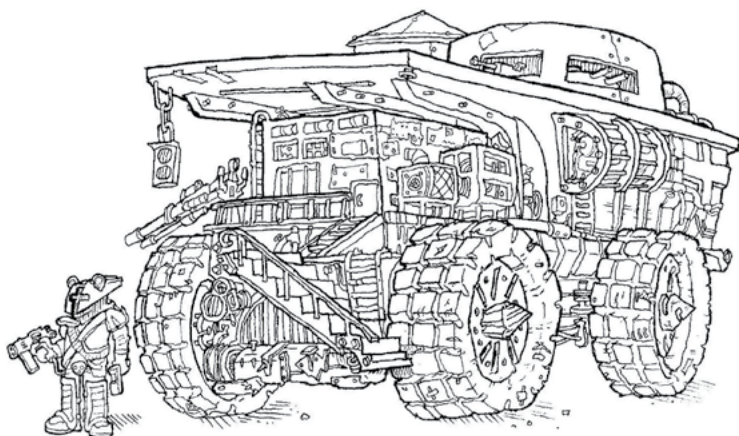

these are only found in gigantic terraforming or mining worksites. These towering behemoths can barely fit down a four-lane road and require enormous room to maneuver.

Massive Tractor: Init -7; Atk rundown +10 melee (2d16+Collision damage bonus); AC 6; Armor Die [1d8]; HD d30; Speed Level cruise ½ / max 1; Act 1d20; SV Fort +14, Ref -5, Will NA; Fuel Tank 1d30; Guzzle 12.

Basic Traits: *rugged*, either *dual wheeled* or *tracked*, pick one of the following (*hydraulic arm - massive, dozer blade - massive, roller-compact - heavy, or agricultural equipment*).

Construction Vehicle Traits

The following normal Vehicle Traits cannot be applied to construction vehicles: *high performance engine, nimble*, and *nitrous tank*.

New Traits

Agricultural Equipment (construction vehicles only)

- This Trait covers a multitude of various vehicular farming tools (multi-row plows, seeders, harvesters, bailers, etc.). While most of these are ill designed to be truly weaponized, they are extremely useful for raising and harvesting crops, granting +2 to +6 to such rolls. Attempting to attack with these tools will inflict the normal rundown damage but will break on an attack roll result of 5 or less.

Dozer Blade - light (pickup trucks or larger civilian vehicles and construction vehicles only) - Similar to a ram plate, this equips the vehicle with a substantial metal plate (known as a blade) used to push large quantities of soil, sand, rubble, snow, or other such materials. If used in combat, this either increases all rundown damage from 2 dice to 3 dice (i.e. 2d6 becomes 3d6) or acts as a shield (+2 AC) versus all front facing attackers. Also, all front end collision damage suffered by the vehicle is reduced by 50% and it gains +5 to all Vehicle Control rolls after colliding with hard or soft targets.

Dozer Blade - heavy (small or large construction vehicles only) - As the *light dozer blade* except it is much larger and can move greater quantities of soil, sand, rubble, snow, or other such materials. If used in combat, this either increases all rundown damage from 2 dice to 4 dice (i.e. 2d6 becomes 4d6) or acts as a shield (+4 AC) versus all front facing attackers. Also, all front end collision damage suffered by the vehicle is reduced by 60% and it gains +7 to all Vehicle Control rolls after colliding with hard or soft targets.

Dozer Blade - massive (massive construction vehicles only) - As the *heavy dozer blade* except it is enormous and can move titanic quantities of soil, sand, rubble, snow, or other such materials. If used in combat, this either increases all rundown damage from 2 dice to 5 dice (i.e. 2d6 becomes 5d6) or acts as a shield (+6 AC) versus all front facing attackers. Also, all front end collision damage suffered by the vehicle is reduced by 70% and it gains +10 to all Vehicle Control rolls after colliding with hard or soft targets.

Hydraulic Arm - small (cannot be put on motorcycles)

- The vehicle has a four-to-six foot hydraulically powered machine arm that can be equipped with several different types of tools or weapon attachments. The arm must be controlled manually or by a computer component. Attacks with this arm are considered to have an ATK +3 (2d4+3 damage) and can lift up to 500lbs. If the arm is attacked directly, it can suffer 10hp of damage (Armor Die [1d4]) before it ceases to function. Any Trait that increases the vehicle's Armor Die will also increase the arm's Armor Die. When the hydraulic system is running, the vehicle's Speed is reduced by cruise -1/ max -2 due to engine strain. Construction vehicles are immune to this effect.

MACHINE SHOP

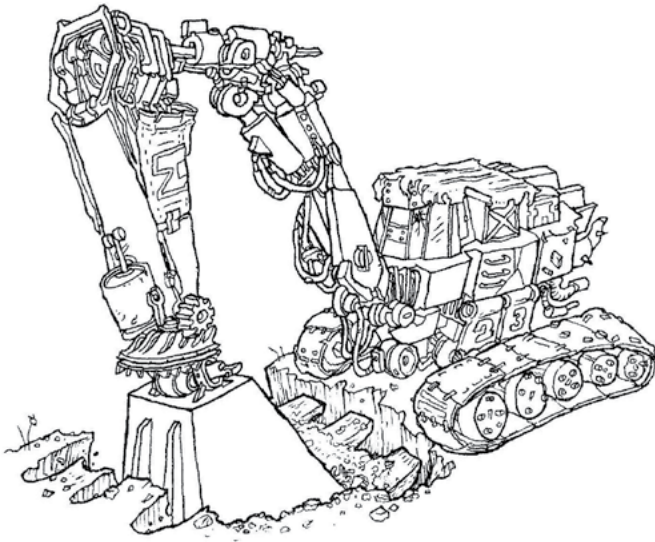

Hydraulic Arm - medium (pickup trucks or larger civilian vehicles and construction vehicles only) - The vehicle has an 8-to-10 foot hydraulically powered machine arm that can be equipped with several different types of tools or weapon attachments. The arm must be controlled manually or by a computer component. Attacks with this arm are considered to have an ATK +3 (2d8+5 damage) and can lift up to one ton. If the arm is attacked directly, it can suffer 20hp of damage (Armor Die [1d5]) before it ceases to function. Any Trait that increases the vehicle's Armor Die will also increase the arm's Armor Die. When the hydraulic system is running, the vehicle's Speed is reduced by cruise -2/ max -3 and it suffers -2d to Vehicle Control rolls due to being off balance. Construction vehicles are immune to this effect.

Hydraulic Arm - large (buses, semi trailers, and large construction vehicles only) - The vehicle has a sizeable hydraulically-powered machine arm that can be equipped with several different types of tools or weapon attachments. The arm must be controlled manually or by a computer component. Attacks with this arm are considered to have an ATK +3 (2d12+6 damage) and can lift up to five tons. If the arm is attacked directly, it can suffer 30hp of damage (Armor Die [1d6]) before it ceases to function. Any Trait that increases the vehicle's Armor Die will also increase the arm's Armor Die. When the hydraulic system is running, the vehicle's Speed is reduced by cruise -2/ max -3 and it suffers -2d to Vehicle Control rolls due to being off balance. Construction vehicles are immune to this effect.

Hydraulic Arm - massive (massive construction vehicles only) - The construction vehicle has an immense hydraulically-powered machine arm that can be equipped with several different types of large tools or weapon attachments. The arm must be controlled manually or by a computer component. Attacks with this arm are considered to have an ATK +3 (2d20+10 damage) and can lift up to 20 tons. If the arm is attacked directly, it can suffer 40hp of damage (Armor Die [1d8]) before it ceases to function. Any Trait that increases the vehicle's Armor Die will also increase the arm's Armor Die.

Roller-Compactor - light (pickup trucks or larger civilian vehicles and construction vehicles only) - These heavy barrel-like rollers were intended to compact small areas of soil, gravel, concrete, or asphalt, usually patching existing smoothed areas. If used in combat, this increases the rundown damage dice of the vehicle by +1 step (i.e. 2d6 becomes 2d7). It also increases the rundown attack's critical hit range to 18-20 and deals double damage in addition to the critical effects. Also, all front-end collision damage suffered by the vehicle is reduced by 50% and it gains +5 to all Vehicle Control rolls after colliding with hard or soft targets. Vehicles employing a roller-compactor are reduced to a cruise and max speed of 1, but it acts as the vehicle's front wheels and cannot be destroyed independently of the vehicle.

Roller-Compactor - heavy (small or large construction vehicles only) - These solid-metal cylinders were intended to compact soil, gravel, concrete, or asphalt, usually in road laying or foundation construction. If used in combat, this increases the rundown damage dice of the vehicle by +3 steps (i.e. 2d6 becomes 2d9). It also increases the rundown attack's critical hit range to 18-20 and deals double damage in addition to the critical effects. Also, all front-end collision damage suffered by the vehicle is reduced by 50% and it gains +5 to all Vehicle Control rolls after colliding with hard or soft targets. Vehicles employing a roller-compactor are reduced to a cruise and max speed of 1 but it acts as the vehicle's front wheels and cannot be destroyed independently of the vehicle.

Driving Construction Vehicles and Petrol Heads

Unlike other ground vehicles, construction vehicles require both driving and technical skills. Driving a construction vehicle is only slightly more difficult than a normal vehicle, meaning an untrained driver makes

MACHINE SHOP

Construction Grade Hydraulic Arm Tools/Weapons

Name	Damage	Size*	Notes
Auger	1d4 x size	Any	Can bore through materials no harder than concrete or average stone without significant tool wear.
Bucket scoop	1d5 x size	Medium or bigger	Can hold/lift up ~500lbs x size.
Claw	1d5 x size	Medium or bigger	Can hold/lift up ~750lbs x size.
Jackhammer	2d3 x size	Large or smaller	Inflicts double damage to mineral or crystalline based targets.
Rotary Saw	2d4 x size	any	Can cut through materials no harder than rebar or hard stone without significant tool wear.
Wrecking ball	1d10 x size	Medium or bigger	Requires significant space to employ this tool.

* For tools that deal damage by size, small is x1, medium is x2, large is x4, and massive is x8.

Vehicle Control rolls with an action die reduced to 1d14. The learning process requires 2d30+10 hours of practice to become a trained driver. Petrol heads are always considered trained on construction vehicles.

Running the tool end of a construction vehicle is a different matter, although petrol heads do get a +1d to do so (1d12) if they are untrained. Techie types and some occupations are considered trained on construction vehicle tool operation.

Armored Military Vehicles

While a majority of these types of vehicles were destroyed during or shortly after the Great Cataclysm, enough have survived that their existence is known and anyone in power or seeking power wants them. These vehicles have been constructed to endure a lot of punishment and abuse, much more so than any other vehicle type. The down side of this is the fact that they are built from specialized parts that generally cannot be found in civilian repair facilities or storehouses, meaning all repair DC's are increased by +10. Some

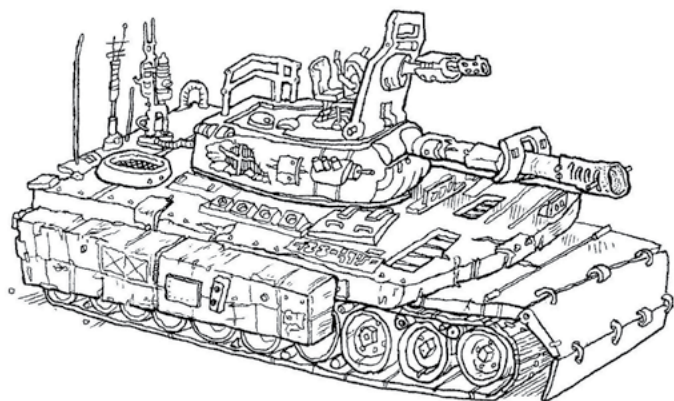

construction vehicle parts can be retrofitted to work, lowering the DC modifier to only +5.

Light Tank - This combat vehicle was used for rapid deployment and scouting purposes, employing lighter armor and weaponry to increase maneuverability and speed. Max crew 4.

Light Tank: Init 0; Atk rundown +8 melee (3d8+Collision damage bonus); AC 10; Armor Die [1d10]; HD d16; Speed Level cruise 2/ max 3; Act 1d20; SV Fort +12, Ref 0, Will NA; Fuel Tank 1d20; Guzzle 7.

Basic Traits: *off road, rugged, tracked* (30hp, Armor Die [1d5]), *weapon mount, turret* - support weapon.

Heavy Tank - Designed to be mobile artillery platforms, these vehicles are loaded with armor and carry a massive main weapon. Max crew 6.

Heavy Tank: Init -3; Atk rundown +8 melee (3d10+Collision damage bonus); AC 7; Armor Die [1d14]; HD d24; Speed Level cruise 1/ max 2; Act 1d20; SV Fort +14, Ref -3, Will NA; Fuel Tank 1d30; Guzzle 9.

Basic Traits: *off road, rugged, tracked* (30hp, Armor Die [1d5]), *weapon mount, heavy weapon mount, turret* - artillery weapon.

Armored Personnel Carrier (APC) - These combat vehicles were responsible for delivering troops through heavy fire directly to key locations. Max crew 3 plus 12 passengers.

Armored Personnel Carrier: Init 0; Atk rundown +6 melee (2d10+Collision damage bonus); AC 10;

MACHINE SHOP

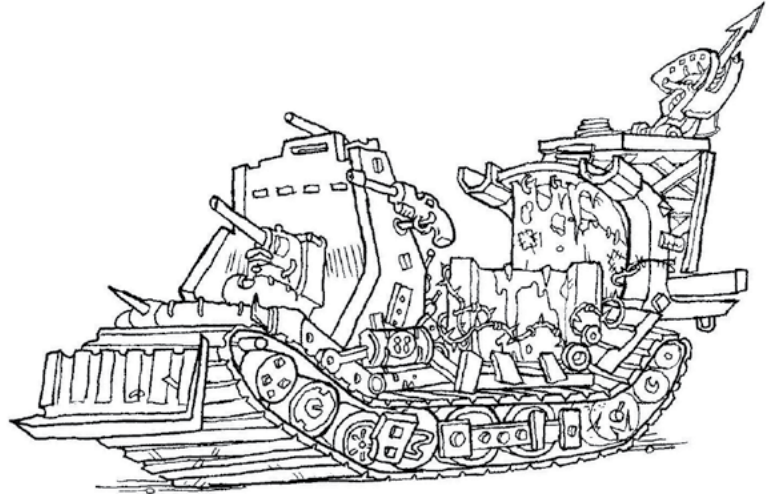
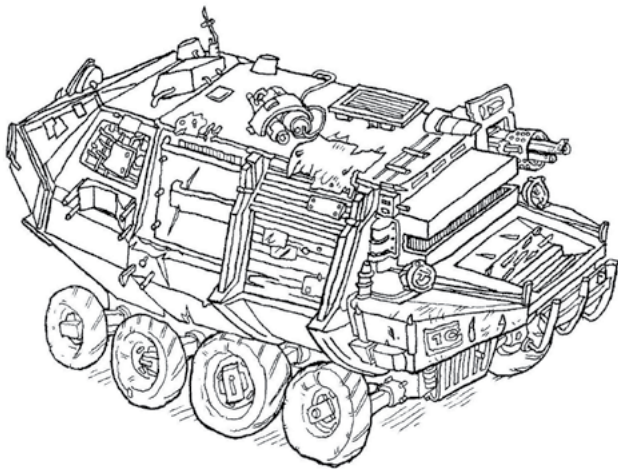

Armor Die [1d10]; HD d14; Speed Level cruise 3/ max 4; Act 1d20; SV Fort +12, Ref 0, Will NA; Fuel Tank 1d16; Guzzle 6.

Basic Traits: *off road, rugged, weapon mount x2, heavy weapon mount.*

Armored Recovery Vehicle (ARV) - typically a tank chassis modified for use during combat for towing or repair of battle-damaged, stuck, and/or inoperable armoured fighting vehicles. ARVs may have winches, jibs, cranes, and/or bulldozer blades to aid in tank recovery. Max crew 3.

Armored Recovery Vehicle: Init -3; Atk rundown +6 melee (2d10+Collision damage bonus); AC 7; Armor Die [1d12]; HD d20; Speed Level cruise 2/ max 3; Act 1d20; SV Fort +12, Ref -3, Will NA; Fuel Tank 1d30; Guzzle 8.

Basic Traits: *off road, rugged, tracked* (30hp, armor die [1d5]), *weapon mount, heavy winch, portable repair shop*, pick one of the following (*hydraulic arm - large* {Armor Die: [1d10]}, *dozer blade - heavy*, or *towing rig*).

Military Vehicle Traits

The following normal Vehicle Traits cannot be applied to military vehicles: *armored, heavily armored, high performance engine, nimble*, and *nitrous tank*.

New Traits

Turret - Support Weapon (semi trailers, large or heavier construction vehicles, and military vehicles only) - This is a swivel mounted turret with a 360° range of fire. It can mount one Support Class Weapon (USG pg 137) and requires a crew of two to properly function.

Turret - Artillery Weapon (heavy tank only) - This is a swivel mounted turret with a 360° range of fire. It can mount one Artillery Class Weapon and requires a crew of two to properly function.

Artillery Class Weapons

These military armaments are even more devastating than Support Class Weapons and as such can only be installed in properly large and structurally reinforced vehicles.

Driving Military Vehicles and Petrol Heads

Driving a military vehicle is a bit more difficult than a normal vehicle, meaning an untrained driver makes Vehicle Control rolls with an action die reduced to 1d12. The learning process requires 2d30+10 hours of practice to become a trained driver. Petrol heads are always considered trained on military vehicles.

Artillery Class Weapons					
Weapon	Damage	RoF	Range	Ammo	Notes
Missile Launcher	1d20	1	30/60/90	8 launch tubes	Cannot be fired while moving. Blast Radius 50'
Cannon, Massive	12d12	1/2	2 miles/4 miles/6 miles	18 shells	Cannot be fired while moving. Ignores all terrestrial armor

MACHINE SHOP

Aircraft

Very few pre-cataclysm aircraft are still functional. The most common aircraft seen are small one- to two-man craft built from recycled wrecks or scrap. They follow all of the rules for vehicles (including Quality levels and control rolls) with the following exceptions:

- In addition to speed, aircraft have Height Cruise/Max rating that determines how high they can fly, see Table HGT-1.
- Aircraft use their own Wipeout table, Table AWO-1.
- Even minor Wipeouts can result in fatal crashes.

Please note that some of this information was actually published in the *Umerican Survival Guide* under the heading “Gyrocopters and Ultralights” but some vital parts were somehow not included. As such, here is the entirety of the rules reprinted here with updates. -Reid

The Vehicle Control roll (aircraft edition)

In addition to the normal modifiers an aircraft has the following additional modifier to the roll:

Changing altitude by more than 1 level of Height in a round +2 per level.

Table HGT-1: HGT Levels

Height Level	Handling Modifier	Rough Height	Penalty to Hit Ground Targets	Chance of Bad Turbulence per Hour	Crash Damage
1	0	100'	-1 (+1 AC vs. Ground attacks)	30% (-1d8 Handle Mod)	3d6
2	-1	200'	-2 (+2 AC vs. Ground)	30% (-1d7 Handle Mod)	5d6
3	-2	600'	-3 (+4 AC vs. Ground)	25% (-1d6 Handle Mod)	7d6
4	-3	1200'	-6 (+8 AC vs. Ground)	25% (-1d5 Handle Mod)	9d6
5	-4	3600'	-9 (+12 AC vs. Ground)	20% (-1d4 Handle Mod)	11d6
6	-5	7200'	-12 (+16 AC vs. Ground)	15% (-1d3 Handle Mod)	13d6
7	-6	12000'	-15 (+24 AC vs. Ground)	10% (-1d3 Handle Mod)	15d6
8	-7	15000'	-18 (+30 AC vs. Ground)	10% (-1d3 Handle Mod)	20d6

Table AWO-1: Aerial Wipeout Results

Roll the Wipeout die appropriate to the Speed rating of the aircraft (determined on Table SPD-1) and subtract the pilot's Luck Mod. Luck may be burned to affect this result. If a drop in height would cause the craft to make contact with the ground (Height level 0) they suffer the Crash damage listed for the height level they lost control at plus the Collision Damage Bonus for the speed they were traveling at.

Roll	Effect
1-3	Just a little lurch! Speed and Height are reduced by 1 and all Vehicle Control checks next round are at -1 to the roll.
4-6	That was close! Speed and Height are reduced by 1 and craft must make a Fortitude save (DC 10) or all actions are taken at -1d until repaired.
7-9	Hold onto your butts! Speed and Height are reduced by 2 and craft must make a Fortitude save (DC 15) or all actions are taken at -1d until repaired.
10-12	Major Fail. Control is lost for 1d3+1 rounds plus Speed and Height are reduced by 2 and must make a Fortitude save (DC 15) or all actions are taken at -2d until repaired..
13-15	We are going down! Control is lost and Speed and Height are reduced by 2 and there is a 35% chance of control damage causing all future Vehicle Control checks to be made at -1d. Attempts may be made to land safely but the craft must land or crash. If this results in a crash, there is a 40% chance that the fuel system catches fire and explodes in 1d5 rounds.
16+	SPLAT! Control is lost and craft plummets to the ground. Height is reduced by 2 per round until craft reaches the ground. Speed increases by 1 per round. One Vehicle Control roll may be made to control the crash. Success indicates all crash damage is reduced by 5% for every point the roll succeeded by. A failed roll means the pilot and passengers must make a Fortitude save (DC 12) or be killed upon impact. After the crash there is a 60% chance that the fuel system catches fire and explodes in 1d5 rounds.

MACHINE SHOP

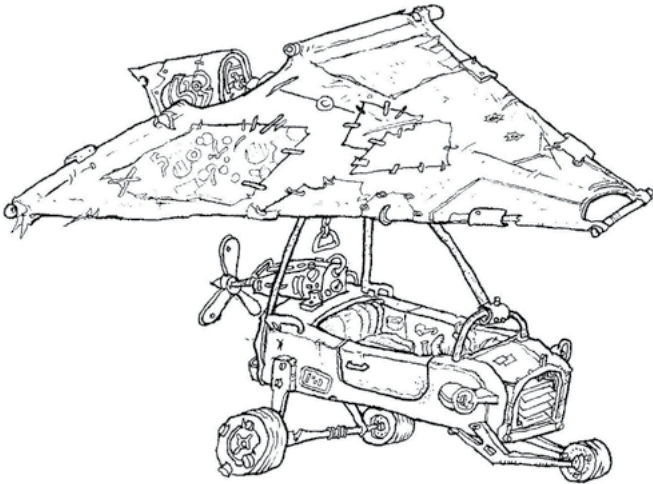

Aircraft types

Gyrocopter - These are small rotorcraft capable of carrying one pilot and one-to-two passengers.

Gyrocopter: Init +1; Atk weights +1 missile (weights 1d5); AC 11; Armor Die [1d3]; HD d5; Speed Level cruise 2/ max 5; Height cruise 3/ max 7; Act 1d20; SV Fort -2, Ref +1, Will NA; Fuel Tank 1d8; Guzzle 2.

Basic Traits: *open, auto rotate.*

Ultralight - These aircraft are light, fixed-winged vehicles capable of carrying a pilot and possibly one passenger.

Ultralight: Init +2; Atk weights +1 missile (weights 1d5); AC 13; Armor Die: nil; HD d4; Speed Level cruise 3/ max 6; Height cruise 4/ max 6; Act 1d20; SV Fort -3, Ref +3, Will NA; Fuel Tank 1d5; Guzzle 1.

Basic Traits: *open, dangerous, glider.*

Helicopter - These rotorcraft rely solely on rotors to provide all of the lift and thrust necessary for flight. They are able to take off and land vertically, to hover, and to fly forward, backward, and laterally. The cabin can seat one pilot and one-to-three passengers.

Helicopter: Init +2; Atk weights +1 missile (weights 1d5); AC 12; Armor Die [1d3]; HD d7; Speed Level cruise 3/ max 5; Height cruise 4/ max 7; Act 1d20; SV Fort +0, Ref +2, Will NA; Fuel Tank 1d10; Guzzle 4.

Basic Traits: *auto rotate.*

Single Engine Prop Plane - These are small turboprop aircraft capable of carrying one pilot, one-to-two passengers, and a small amount of cargo.

Single Engine Prop Plane: Init 0; Atk weights +1



missile (weights 1d5); AC 10; Armor Die [1d3]; HD d6; Speed Level cruise 2/ max 6; Height cruise 3/ max 8; Act 1d20; SV Fort 0, Ref 0, Will NA; Fuel Tank 1d12; Guzzle 4.

Basic Traits: none.

Small Dual Engine Prop Plane - These turboprop aircraft can carry six-to-eight passengers and/or a sizeable load of cargo.

Small Dual Engine Prop Plane: Init -1; Atk weights +1 missile (weights 1d5); AC 10; Armor Die [1d4]; HD d8; Speed Level cruise 3/ max 6; Height cruise 3/ max 8; Act 1d20; SV Fort +1, Ref 0, Will NA; Fuel Tank 1d16; Guzzle 6.

Basic Traits: *extra cargo.*

Aircraft Vehicle Traits

The following normal Vehicle Traits can be applied to aircraft: *armored, big tank, dangerous, enhanced handling, extra cargo* (not on ultralight), *fuel efficient, open, possessed, reserve tank, very dangerous, weapon mount.*

New Traits

Auto Rotate - This gyrocraft's main propeller will allow the craft to glide and drop at a slower pace when control is lost. -1 to all Wipeout tests and all crash damage is reduced by 33%.

Bomb Rack - Holds five grenade-class explosives rigged to detonate on impact.

Bombing Sights - Adds +1d3 to all dropped-weapon attack rolls.

Good Instruments - Adds +1d3 to navigation checks and -1 to Guzzle on long flights.

MACHINE SHOP

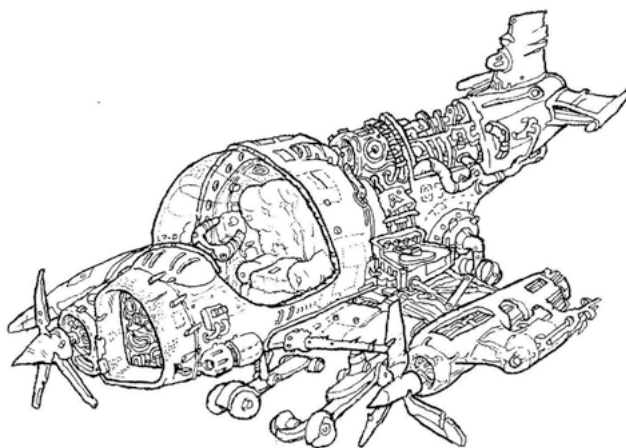
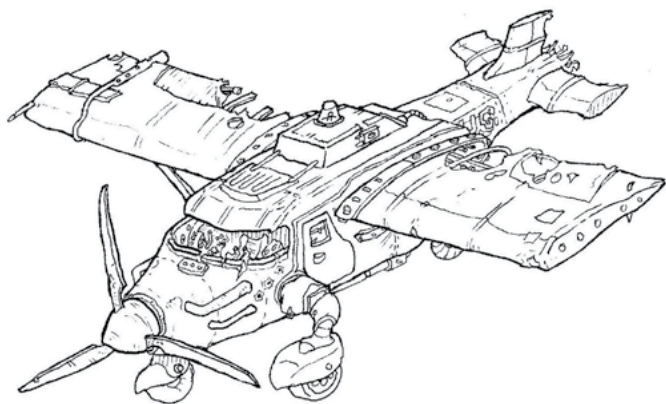

Glider - This craft can remain aloft by gliding when the engine is not running. The craft will drop 1 level of Height for every two miles of gliding. Control rolls are made at -1d when gliding.

Superior Glider - This craft will only drop 1 level of Height for a number of miles traveled equal to its current height, with a minimum of two miles. i.e. five miles at Height 5 then four miles at Height 4, etc.

Piloting Aircraft and Petrol Heads

Unlike ground vehicles, aircraft are not very easy to pilot. Until one is accustomed to flying them, all action dice are reduced to 1d10 (1d16 for petrol heads). This learning process requires 3d30+10 hours of practice to be a trained pilot. A petrol head can use all of their normal vehicular abilities with aircraft once they get accustomed to them.

Support and Artillery Class Weapon Critical Hit Table

Roll	Result
0 or less	Something was a bit off on that shot and the weapon system requires 1d4+1 rounds of maintenance to fire again.
1-4	A well aimed shot that inflicts an extra 1d30 damage to all targets.
5-8	All targets suffer an additional 1d30 damage and surviving foes are stunned for 2d6 rounds.
9-12	All targets suffer an additional 1d30 damage and surviving foes are knocked prone and dazed for 2d6 rounds.
13-16	Surviving foes will die in 1d5 hours due to internal bleeding unless they receive medical attention.
17-20	All targets suffer an additional 2d30 damage. Anyone within 20' of the strike is knocked prone and dazed for 2d6 rounds.
21-23	All targets suffer an additional 3d30 damage. Anyone within 30' of the strike suffers 2d6 damage and is knocked prone and dazed for 1d4+1 minutes.
24+	All who were struck by the weapon are instantly killed in a messy explosion of gore. Any vehicles or buildings targeted will likewise be utterly shredded and explode in a cinematic fireball, inflicting 5d6 damage to anyone within 50' and knocking them prone. Anyone witnessing these results (range 200') are automatically turned (DCC RPG, pg 97) and must flee the scene for 3d10 minutes. In addition, they must make a Willpower save (DC 15) or suffer 1d3 points of temporary Int and Per damage, each rolled separately.



NEW DEITY



NEW DEITY

DEMON KING OF SPEED

Infernal King of Umerican roadways (Chaotic)

It is said “those who attempt to make a deal at a crossroads risk being run-down from four directions.” The adage carries more than a kernel of truth. The Demon King of Speed traverses the roads of Umerica answering the cries of supplicants by grinding them to paste beneath its mighty wheels and transforms the remains into wheeler demons. While one might think that this might make such worship understandably rare, his cult has grown in recent years due to the proselytizing efforts of the Trailer Park Trash.

As master of Umerica’s highways, the Demon King of Speed favors the bold—adrenaline junkies pushing their vehicles ever-faster and performing ever more outrageous stunts in its name. Its centers of worship are not openly marked as such, but those in the know can find them easily—looking for well-stocked filling stations (referred to as “Hell Stations”) with supplies of the high octane, leaded fuel with the special additive ≠55. Even though covert, a hell stations’ ample supply of quality fuels draws a steady crowd of petrol heads and gang members—ripe for conversion.

Followers of the Demon King of Speed have given themselves wholly over to the thrill only found at high speeds. Casual worshipers include petrol heads and road hawks praying to accomplish faster rides or longer jumps, with the lay clergy made up of stunt-drivers, gang members, and professional rally racers. Its true priests are the wheeler demons (chief among them, Azrael Rous). Those who offend the Demon King of Speed (by committing such offenses as driving slow in the left lane, tampering with gasoline, or damaging high-performance vehicles—to name a few sins) may find themselves visited by a wheeler demon sent to claim vengeance.

The Demon King of Speed’s holy festival is the Nightnote RV Rally, hosted by the Trailer Park Trash. Among other smaller festivals and gearhead gatherings held in his name include: The Soggy City Swamp Meet (Whistling Marshes), The Smoking Valley Classic (Vast Wastelands), The Petrolex Invitational Road Rally (Temple Refineries of Petrolex), and countless others.

Despite what one might think, with the priests of the

Demon King of Speed encouraging the use of fuel additives that could be seen as “tainting” the blessing of Petrolex, the followers of the Demon King of Speed get along well with their Petrolex counterparts. As the highest performance requires the purest of fuels, the Demon King of Speed’s priests insist on using only fuel acquired from Petrolex (when available).

For their part, the priests of Petrolex are uneasy around, but accepting of, the wheeler demons and others who follow the Demon King of Speed. While normally maintaining that “fuel is love” and that “fuel is for the worthy,” it is hard to argue that those who squeeze extra power from fuel are anything but worthy ... and they sure do love their fuel. Even so, the uneasiness felt by the priests of Petrolex towards those who follow the Demon King of Speed may be based upon the fact that it is a trans-dimensional being from the exhaust-fouled hellscape of the Plane of Chrome, Brutality, and Pain. Petrolex, being native to Umerica, accepts the presence of the automotive latecomer for now, and this may also explain the strange truce between Petrolex and Grokk. With both knowing that they may someday be forced to unite against the ever-more powerful Demon King of Speed, it is best not to engage in actions that may weaken them against that future battle.

The Tenets of the Demon King of Speed

- Let thy foot always be on the floor, the pedal always to the metal.
- Drop the hammer, but don’t feed the bears.
- Suffer not the smokey, be always the bandit.
- Keep thy shiny side up and thy dirty side down.
- Always move aside for a meat wagon.
- Fill the road with fury.

Special Rules

The vehicles of the Demon King of Speed’s priests gain +1 to max speed as well as +1d to Vehicle Control rolls, while those of the lay clergy gain +1 to Vehicle Control rolls.

Special additive ≠55

This special fuel additive concentrates the gasoline’s potency and increases mileage—giving a +1d bonus to Fuel Tank size. It is only sold at hell stations. There is a 5% chance that any vehicle so fueled transforms into a wheeler demon.

NEW DEITY



Weapons of Choice

Ram plates, wheel spikes, and other devices of such vehicular mayhem are the favored weapons of the Demon King of Speed. When not driving, its followers often wield items such as tire irons and motorcycle chains.

Unholy Creatures

Mundane animals (rabbits, deer, and other soon-to-be roadkill), car thieves, slow drivers, and plants.

Flaming Thunder

Worshippers of the Demon King of Speed show their fealty through outrageous acts of motoring. The most dangerous feat, offering the highest praise, is “burning rubber.” Imitating the actions of wheeler demons, followers set their tires ablaze and perform a series of dangerous maneuvers at high-speeds, trailing fire and molten rubber in their wake. The vehicle is normally destroyed in the process with the value of the sacrifice being judged on both the relative value of the vehicle and the showmanship with which it was destroyed.







RACE FOR DEATH

A 2ND LEVEL UMERICA ADVENTURE

RACE FOR DEATH

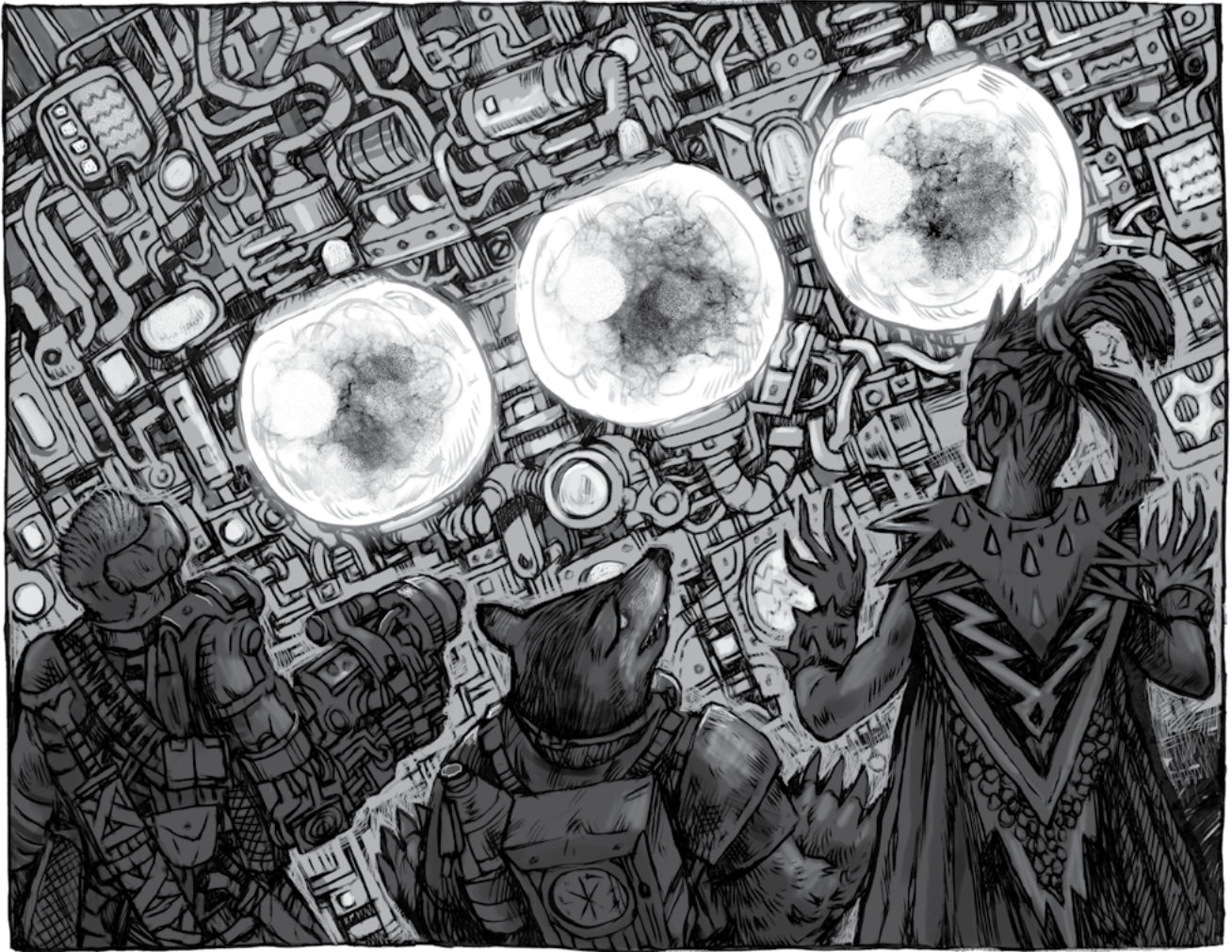

RACE FOR DEATH

INTRODUCTION

Race for Death is an Umerica adventure designed for a team of four 2nd level characters. It is intended to be run for an established group of adventurers.

Following up on a lead for what sounded like a promising job has placed the party under the power of one of the Royals of the Citadel of Scrap, Casio. Their souls torn from their bodies, they are left in a state of un-life, with only victory granting them a chance to regain their souls—and perhaps a prize as well.

BACKGROUND

The Royals wield complete control over the Citadel of Scrap, using magic (as well as brute authoritarian might) to weave the life-threads of their subjects into a tapestry for their own secretive purposes. Engaged in a cold war between themselves, the Royals play

their mysterious long game on a level that none but themselves will ever understand. They are mysterious, ineffable, and they are also...

...easily bored.

To keep themselves amused amidst their Byzantine struggle for power, the Royals engage in numerous wagers and contests. This particular match-up is a race to collect the Ruby Spear, which the winner will likely put in a corner and promptly forget about. It is winning that is important to the Royals, not the prize. Of course, techno-wizards as powerful as the Royals do not compete against one another directly, that would subject the whole of reality to techno-phlogistic forces powerful enough to sunder the universe. Instead, they play “games” and the “Race for Death” is one of their favorites.

Participants are placed in a state of un-life, their souls held in glowing techno-phylacteries, while they race

RACE FOR DEATH

across the wastelands in a cutthroat, but never fatal, competition. Each leg of the competition has its own starting and checkpoint finish line—much like the famed Tour de Morte—as well as its own advantage for the winner of the round. Getting to each checkpoint can be quite challenging, getting beyond each starting line even more so as each team does its best to eliminate (or at least egregiously impair) their rivals.

The first leg of the race entails catching up to a moving (and armed) train. Aboard the train is an advantage for anyone who can collect it, a route guide to the second leg—detailing the quickest route to the checkpoint for those bold enough. The second leg is a cross-country challenge that tests the teams' courage as well as navigational skills with the winner receiving bonus firepower for the final leg of the race. The third leg is a battle-royal rush to the teleporter back to the Citadel of Scrap—and victory.

Being unable to die, injury is merely an inconvenience for the participants. Of course, the agonies of life can rapidly outweigh the benefits of being unkillable—which is part of the entertainment for the dark desires of the Royals. After all, what is a game without a little suffering?

The Soulless and Un-living

While the racers are not immediately aware of the impact of having no soul, those around them notice. The un-living suffer a -1 penalty to their Personality from the moment that their soul is removed. After that, the next change doesn't become apparent until they are "killed." While still alive, treat reduction to 0 hit points as normal with the exception that the body cannot be rolled, a character who bleeds out is "dead." The un-living must expend a temporary point of Personality to rise again, having 1 hit point. When they can no longer "get by on their looks," replace Personality with a permanent point of Luck. Unlike characters who have had their bodies rolled, the un-living suffer no dice penalties from their ordeal, but they no longer may be healed through normal means; instead the un-living simply tape, glue, or suture themselves back together, using materials provided by the Royals (see team descriptions). Each turn spent repairing the body grants up to 10 hit points of healing.

THE RACE

Drivers on Your Marks

It seriously seemed like a good idea at the time. A job at the Citadel of Scrap that would allow you to make some money while catching your breath after your last adventure, it was too good to be true.

Seriously...it was too good to be true.

You showed up to talk to the person offering the job and found yourself surrounded, outnumbered, and ill-prepared. The fact that they used some sort of knockout drug didn't help matters. Regaining consciousness, there is a strange feeling and a strange mental stillness—your internal monologue suddenly silent.

Against the far wall are several glowing canisters, with each of them having medical-style hoses running to the now stirring forms of your companions as well as yourself. As if detecting the communal consciousness of your group, the hoses go slack and drop to the floor as the canisters are mechanically raised higher on the wall and slide into small cubbies. A protective barrier shimmers into being in front of them, sealing the canisters away. Unseen fingers play a complex and haunting tune on a synthesizer and a techno-wizard glides into sight, seated at his flying keyboard.

Allow the PCs time to react, ask questions, examine the room, etc. before Casio deigns to speak to them.

"Welcome, my brave volunteers, it is your pleasure to be here!" His fingers dance across the keyboard, synthing dramatically, "and what a pleasure here is." Pointing towards the glowing canisters he gives a sly grin, "with your souls in cyber-phylacteries, you cannot die. You literally un-live to serve ... and serve you will."

Casio pauses for effect there, and the PCs may well interject, argue, or otherwise seek to decline the job which they have been volun-told to perform. Casio will have none of it. Any attempts at hostility directed towards him are immediately stilled with a few notes on his enchanted keyboard.

"Today it is your great honor to be my team in the Race for Death," the Royal holds up a hand. "I know, I know, you don't feel that you deserve this honor. Well, I've been watching you for a while now and I disagree." The techno-wizard's eyes narrow meaningfully. He twiddles out another tune on his mystical-synth and a swirling rift opens in the air; the roar of engines can be heard on the other side.

RACE FOR DEATH

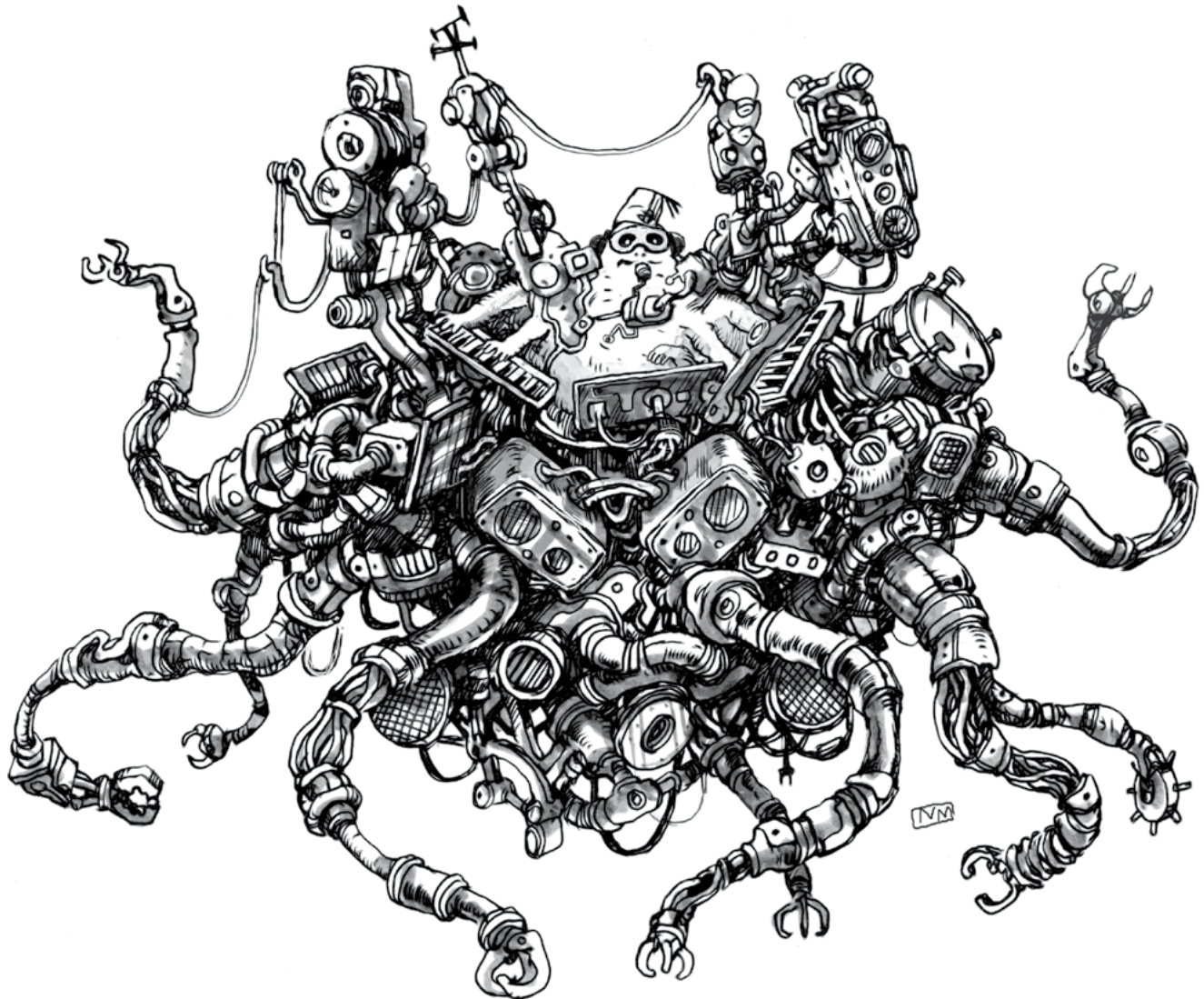

“The long and the short of it is that I have your souls, so you cannot die. Pain is still a thing though. In the back seat you’ll find a duffle bag with a few handy items for you to use, and the trunk of the car is packed with bits to patch you up should something unfortunate happen. Win the race and I’ll grant you the return of your souls plus a super big prize!”

Casio pauses here, waiting to see if the party hops to as ordered. If they do not, his smile will turn to a scowl as he adds, “Don’t make me show you what I can do with your souls.” He will then shoo the party through the portal.

Get Set

Give the characters a few minutes to scope out their car (the sullen and currently silent Mock V) and check out their supplies. Inside the trunk of the Mock V is a stained cardboard box with “Med Kit” scrawled across it in black crayon. The box contains duct tape, a staple

gun, plastic cling wrap, twine, and a pair of seven-inch trussing needles. These supplies make up the team’s 15 med kits (10hp each)—useful only once the subject is truly un-living as opposed to merely soulless. An injured PC may regain 10hp after a round of stapling, stitching, and taping.

The PCs may notice that the other teams have piles of spare parts for their vehicles (SP reserve) while they themselves have none. Let them stew on that while hurrying to get ready.

In the backseat is a threadbare duffle bag of average size. It is anything but average. It holds a number of varied items in a pan-dimensional space, extending its opening to unleash the largest of items when withdrawn. Each player may make two pulls from the bag before it is depleted.

The Duffle Bag of Holding

Roll	Result	Roll	Result
01	Six-pack of Olde Fishman Lager (1d4, 10/20/30)	51	Pair of beaded seat cushions
02	Full-sized Port-o-Loo (major hazard, VCM 11)	52	Functional smoke detector
03	A dozen hedgehog skulls (1d2, 10/20/30)	53	Bottle of Old Purplefoot wine (+1d3 hp)
04	Small cactus (1d2)	54	Motorcycle helmet
05	1 gallon of windshield wiper fluid	55	Microscope
06	1 fertilizer bomb (4d5, 20' radius)	56	10' pole (1d4)
07	100' of coiled rope	57	Pair of leather gloves
08	Novel: Love's Four-Cylinder Folly (Fort 8 or sleep)	58	Potted geranium (1d5, 10/20/30)
09	1 oz bottle of <i>Eau de Skunk</i> (DC 10 Fort or stun)	59	5 lbs. lard, (minor hazard, VCM 6)
10	An apple, glowing and delicious (+1d16 hp)	60	Sniper rifle and 4 rounds
11	A pointy wooden stick (1d3, 1 use)	61	Corkscrew (1d3)
12	Lever action rifle and 20 rounds	62	75' long network cable
13	Snakeskin boots, size 18	63	Titanium spork (1d2)
14	Purple and silver fidget spinner	64	Bag of marshmallows
15	Box of 50 envelopes	65	Titanium loincloth (+1 Armor Die step)
16	Bag of plastic dinosaurs (minor hazard, VCM 5)	66	Dead rabbit (1d2)
17	Library of Alexandria library card	67	Sledgehammer (1d8)
18	Disposable 1-shot rocket launcher (2d20, 100/200/300)	68	8-track tape, <i>Casio's Greatest Hits</i>
19	Box of 100 paper clips	69	Box of colored chalk (3 pieces)
20	50 lb. bag of potting soil (minor hazard, VCM 7)	70	"World's Best Mutant" coffee mug
21	Handful of gravel (DC 12 Ref or blinded 1 round)	71	Bicycle pump
22	1 case (20) of Starvin' Dude freezer meals	72	Plastic explosives pack (1d24, 40' radius)
23	Barbarian and witch-woman lunchbox	73	Canteen full of gin (+1 Fort for 1 hour)
24	Chainsaw (2d7, Crit 18-20)	74	Empty 5 lb. container of lard
25	17' long feather	75	Black cat (+2 Luck)
26	Bag of 250 marbles (1 point, 5/10/15)	76	Shortwave radio transmitter
27	Severed human head (-2 to foe morale)	77	Pine tree car air freshener
28	Stapler and box of 1,000 staples	78	One dart (1d4)
29	Roll of Mutiny brand paper towels	79	Jar of instant coffee, 40 servings (+1 Ref)
30	Combat knife (1d5)	80	Lucky horseshoe (+1 Luck)
31	Keyring with 2d5 random keys (1d2)	81	Self-inflating 8-person rubber raft
32	Deck of cards (missing the Queen of Clubs)	82	Chocolate chip cookie (+1 hp)
33	Live rabbit (minor hazard, VCM 8)	83	Gideon's Bible
34	26 lb. bag of kitty litter (1d24, ranged STR-10')	84	Micronuke (1d24 + 13 DC Fort or 1d5 Sta)
35	Fishing pole and lure (1d4, range 10')	85	Suitcase containing 2 silver suits
36	Belt of 6 smoke grenades (major hazard, VCM 14)	86	5-gallon jerry can of gas
37	Subscription form for Wasteland Weekly	87	Functional ultralight
38	Shortwave radio receiver	88	Outboard motor
39	Fish tank and 6 live fish (minor hazard, VCM 5)	89	Gallon jug of camel milk, melee (1d5)
40	4-way cross lug wrench (1d4)	90	Bundle of dynamite (1d12, Fumble 1-3)
41	Flashlight (no batteries)	91	Taxidermy alligator (minor hazard, VCM 9)
42	Revolver and six rounds	92	Citadel of Scrap souvenir keychain
43	Scavenger of the Year trophy (1d14)	93	Fireman's helmet (+1 step to Armor Die)
44	Case of 1,000 plastic forks (minor hazard, VCM 6)	94	"I need Reid" campaign button (+1 Per)
45	10-gallon hat (+2 Per)	95	"Lucky" rabbit's foot (-1 Luck)
46	Money belt (empty)	96	Plasma rifle
47	Genuine imitation vinyl jacket (XXXXXXXL)	97	Chill-Tone's Guide to the 3047 Nebula
48	Flamethrower	98	Crawling Under a Broken Moon Omnibus
49	Box of white chalk, 6 pieces	99	Un-living rabbit (major hazard, VCM 12)
50	Bag of 10 Buddy-o-Burgers	100	6 empty cans of Olde Fishman Lager

RACE FOR DEATH

THE TEAMS

TEAM 1 (ROYAL: WARNER)

Harvested from a still-functional cryo-storage in an abandoned military base, the members of this five-man team are time-tossed soldiers with no way home and have embraced their new lifestyle as wasteland warriors. Well trained and used to functioning as a unit, these are dangerous men indeed. Unlike the other two teams, these soldiers still have their souls and can die as normal.

Black Berets (wasteland warriors): Init +4; Atk assault rifle +(1+deed) ranged (1d10, RoF 3, range 100/200/300), semi-auto pistol +(1+deed) ranged (1d8, RoF 2, 60/120/180), or combat knife +(2+deed) melee (1d8); AC 11; Armor Die 1d12; HD 3d12+3; hit points 30; MV 30'; Act 1d20; SP infantry armor (d6 fumble die, Armor Die x2 versus projectile damage), mighty Deeds (d5), critical range 19-20; SV Fort +2, Ref +3, Will +2; AL N.

The Waste-landmaster MK IV (unique custom vehicle): Init 1; Atk rundown +7 melee (2d12+Damage Bonus), heavy cannon +4 ranged (8d8, range 1000/2000/3000); AC 8; Armor Die [1d8]; HD 9d20; hit points 120; Speed Level cruise 5/ max 7 (cruise 2/max 3 in water); Act 1d20; SV Fort +6 (d30), Ref +0, Will NA; Fuel Tank 1d20; Guzzle 8.

Basic Traits: *dual tires, enhanced handling, heavy weapon mount, hell dropper, off road, portable repair shop, reserve tank (1d14), rugged, vehicle snorkel.*

Wreck Check: 15 SP: 500 Fuel Reserve: special
Medical Supplies: 12 healing potions (2d6hp each)

The Waste-landmaster MK IV uses a custom-designed 12-wheel rotational system as part of its off-road capabilities. Additionally, this allows the vehicle to turn at its midpoint, being capable of even rotating in place.

TEAM 2 (ROYAL: TOEI)

Toeï's team are members of a minor komo-doan gang, the Animaulers. Clad in bright colors and wearing helmets with up-swept, antennaelike horns, these young bikers are cut-off from the rest of their gang hierarchy and know that winning will truly allow them to make names for themselves. Like the PCs, the Animaulers are soulless and will become un-living upon death (see pg 156).

Animaulers Ganger (komo-doan): Init +2; Atk bite +2 melee (1d8+4, poison Fort DC 14 or death), claws +2 melee (1d6+4), or hi-power pistol +4 ranged (1d10, range 50/100/150); AC 13; Armor Die 1d6; HD 3d8+5; hit points 19; MV 30'/dig 10'; Act 1d20; SP ectothermic, fearsome reputation, soulless, immune to disease, wheels; SV Fort +1, Ref +3, Will +1; AL C.

Wheels: Revolt-a-tron (unique custom vehicle): Init +6; Atk rundown +1 melee (2d4+Damage Bonus), tire blades +1 melee (2d6+Damage Bonus, 80% chance of bursting tire on successful hit); AC 13; Armor Die [1d5]; HD 9d30; hit points 125; Speed cruise 6/ max 10; Act 1d20; SV Fort +1, Ref +3, Will NA; Fuel Tank 1d24; Guzzle 3.

Basic Traits: *big tank, dual tires, high performance engine x2, off road, reconfigure, reserve tank (d12), tire blades (heavy), very dangerous, very nimble.*

Wreck Check: 15 SP: see below Fuel Reserve: see below
Body Repair Materials: see below

Reconfigure: The Revolt-a-tron is constructed of the chassis of five mechanically fused motorcycles. It takes two full rounds for the motorcycles to separate and the main vehicle may only be formed if all five vehicles are present. Damage taken in this form is distributed equally to all component vehicles.

Revolt-a-tron Cycles (unique keeper vehicles): Init +6; Atk rundown +1 melee (2d4+Damage Bonus), tire blades +1 melee (1d6+Damage Bonus, 40% chance of bursting tire on successful hit); AC 13*; Armor Die [1d3]; HD 6d6; hit points 25; Speed cruise 5/ max 7; Act 1d20; SV Fort +0, Ref +3, Will NA; Fuel Tank 1d7; Guzzle 2.

Basic Traits: *big tank, high performance engine, off road, *open, reconfigure, tire blades (light), very dangerous, very nimble.*

Wreck Check: 10 SP: 100 Fuel Reserve: 4
Body Repair Materials: 4 kits (10hp each)

Reconfigure: The five motorcycles (crimson, ebony, olive, mustard, and cobalt) are able to join together to form the Revolt-a-tron. This process requires two rounds and may only be accomplished if all five motorcycles are present.

RACE FOR DEATH

TEAM 3 (ROYAL: CASIO)

Unlike the vehicles of the other two teams, the PC's vehicle is actually a team member, with the same un-living state as the rest of the team. Mock V has no need to feed, and so will not bother to speak to the PCs or reveal itself to them unless their driving causes it great damage. At that point, Mock V will address the team (referring to them as Michael #s 1-4) and take autonomous control. The V.E.T.T. is open to suggestions from the rest of the team but would prefer not to get blown to scrap and be faced with the need to ooze back together.

Mock V (un-living V.E.T.T.): Init +3; Atk rundown +8 melee (2d6+collision damage bonus), melee weapon +8 (2d5+3), or blaster +8 ranged (3d4, 100/200/300); AC 13; Armor Die: [1d7]; HD 10d10; hit points 100; MV 60' in melee combat, otherwise Speed cruise 6/ max 10; Act 2d20; SV Fort +10, Ref +6, Will +8; Fuel Tank n/a; Guzzle n/a.

Basic Traits: *biomechanical, in control, no fuel tank, reconfigure, trap feeding, vehicle form.*

Wreck Check: n/a SP: n/a Fuel Reserve: n/a
Body Repair Materials: 15 kits (10hp each)

Biomechanical: As an alien living machine-based lifeform, all V.E.T.T.s are immune to all terrestrial poisons, toxins, and diseases. In addition, their lifespans are so long they are nigh immortal, making them relatively immune to aging effects.

In control: At the beginning of the race, the Mock V will sullenly keep quiet and let the PCs dictate where to go and how quickly. However, if the choices of the team inflict 40hp of damage or more, the car will inform "Michaels" 1-4 that it is taking over since they are useless. When driving itself, instead of being under the control of someone else, the Mock V rolls Vehicle Control rolls on a d24 and has a +12 bonus to the roll.

No fuel tank: As the PCs race across the wasteland, their travel time is determined by their traveling speed. However, while the V.E.T.T. doesn't need to worry about fuel, it still cannot travel at greater than cruising speed for prolonged periods without strain. After each hour of travel at greater than cruising speed (6), Mock V must make a Fortitude save vs. 10 + speed or drop to speed 3 for the next hour (rolling to a stop for an hour on a 1). Such an event triggers Mock V to address the PCs, as noted above.

Reconfigure: As one or more actions, a V.E.T.T. may take an action to reconfigure their modular physiology to do one of the following:

- **Change appearance** (2 actions): The V.E.T.T. can scan and duplicate the appearance of any vehicle of their size category. An Intelligence check (DC 20) is required to tell the difference between the two.
- **Revert to true form** (1 action): This allows the V.E.T.T. to transform from its vehicle form to its normal humanoid form, allowing it to utilize its melee and blaster attack options.
- **Repair** (1+ actions): By activating redundant systems and moving damaged components into rapid maintenance nodes, a V.E.T.T. may heal 1d3 damage for each action spent.
- **Rearm** (1 action): If disarmed, a V.E.T.T. can utilize spare components to form a new weapon.
- **Upgrade** (2 actions): A V.E.T.T. can temporarily increase their action dice for one specific type of action (melee combat, ranged combat, saves, Armor Dice, skill checks, etc.) by +1 die step. This lasts for 5 rounds and all other types of actions taken suffer a -1 penalty to the rolls.

Trap feeding: Despite the Mock V not needing to feed (due to being un-live) it is still capable of carrying out the feeding actions of a V.E.T.T. Should it choose, it may lock its doors, which may withstand a total of 15hp damage before being forced open. The interior of the V.E.T.T. shares the same Armor Die as the exterior. The Mock V may then flood the compartment with corrosive digestive juices causing drowning (USG, pg 101) and 1d4+1 acid damage per round to all occupants. As the car has no need to feed, once all of the victims are broken down, it will open the doors and the resulting soup will pour out onto the ground.

RACE FOR DEATH

GO

The air at the starting line is thick with blue-gray exhaust fumes as the other teams perform last minute inspections before piling into their vehicles. The rides of the rival teams look outlandish. One is a massive, twelve-wheeled RV-like behemoth that looks absolutely ponderous while the other is a garish collection of parts that seem held together with clamps, straps, and tape.

The crowd howls their approval as the three Royals float over the starting line, eyeing one another closely to ensure no last-minute trickery. At long last, a massive mutant, standing 15' tall strides out onto the road—flag in hand. The thunder of the crowd becomes deafening as the flag is raised in the air...

At this point, before continuing, allow for any single last-second actions by the party such as drawing weapons, hurling insults, consulting maps, etc. One quick action each (including trying to get the jump on the other cars) followed by:

... and drops. The race has officially begun. The three Royals vanish in a swirl of music and lights and the other two teams lurch forward!

The mutant is standing in the road and is in a great deal of peril.

Splat (mutant flagger): Init +1; Atk bash +8 melee (1d6+6) or large maul +8 melee (2d5+6); AC 13; Armor Die [1d3]; HD 4d4+2; hit points 12; MV 20'; Act 1d20; SP gigantism (STR 24), remote detonation; SV Fort +1, Ref +1 (d16), Will -1; AL C.

Remote detonation: Lord Toei secretly fitted the flagger with an explosive belt, linked to Splat's heartbeat. If he dies, his heartbeat stops...and the belt explodes doing 4d7 damage with a 15' blast radius.

As the race begins, use the Chase rules (USG pg 83) as the teams struggle for the lead. Here is a summary of those rules: Every vehicle makes a Vehicle Control roll once per round in initiative order; a success lets them adjust the distance from a pursued/pursuing vehicle by one step, plus one per level of speed greater than the other vehicle/group (who can negate some or all of this if they also succeed); if the distance between the fleeing vehicle and its nearest pursuers exceeds 12 steps (use a d12 for each vehicle to track their position in the race),

the team in the lead has garnered a large enough lead to enable them to win the race.

In addition to racing, drivers can attempt to pull stunts and any passengers can make attacks. To pull a stunt, describe the maneuver and decide how much risk to wager, from between 1 and 15. This is the penalty to the Vehicle Control roll and how many die steps higher the Wipeout die will be on a failure. If successful, the same penalty is applied to the Vehicle Control roll of every other vehicle/group involved with the stunt.

Teams 1 and 2 will push just past their cruising speed to start, allowing the PCs to set the pace for the race. Both teams prefer to stay just behind the leader, using the lead vehicle to reveal any road hazards along the way, but neither team wants to be last. Weapons will be fired, and it is possible that the first "deaths" will occur in the initial crush.

Projected travel times and damage are plotted for each leg of the race. Depending on their fuel situation, or damage taken in the initial rush, either of the other teams might choose to deviate from the below results at the Judge's discretion.

It is approximately 300 miles to the train rendezvous (it is moving after all). Break the distance up into 50 mile segments for travel. The time required to complete a segment is as follows. Speed: (3) 1.5 hours, (4) 1 hour, (5) 55 minutes, (6) 40 minutes, (7) 35 minutes, (8) 30 minutes, (9) 25 minutes, (10) 20 minutes.

After traveling 50, 150, and 200 miles, have the player with the lowest Luck make a Luck check. On a failure, make a roll on the following random encounter table.

RACE FOR DEATH

Random Encounter Table

Roll (1d12)	Result
1	<p><i>Ox Beetle Roadblock:</i> The entire way through is blocked by a herd of massive ox beetles. The creatures are fairly docile, but are impassable without taking action of some sort.</p> <p>Ox Beetles (20): Init -3; Atk bite +3 melee (1d4+5); AC 8; Armor Die 1d6; HD 3d8; hit points 17; MV 30'; Act 1d20; SP very strong (STR checks on 1d30); SV Fort +3, Ref +3, Will +1; AL N.</p>
2	<p><i>Damaged Think Tank:</i> Rolling on the road ahead is a heavily damaged but still formidable, think tank. Its atomic weaponry disabled, its once unbreachable armor rent in numerous places, the pain ravaged brain within is not interested in peaceful discussion.</p> <p>Think Tank: Init +2; Atk claw +12 melee (1d16+4), mini-guns +2 ranged (2d6, range 100'), or grenade launcher +10 ranged (3d8 damage in 50' radius, DC 12 Ref save for half damage, range 100'); AC 12; Armor Die 1d10 (chassis)/1d24 (brain case); HD 12d10+12; hit points 50; MV 40'; Act 3d20; SP grenades, trans-dimensional imaging; SV Fort N/A, Ref -2, Will +10; AL L</p>
3	<p><i>Haunted Gas Station:</i> A small glowing building next to the road offers the promise of fuel (for those running low) and ammo (for those with plenty of fuel who want to keep it). Stopping at the station stirs up a pair of rerun wraith buddies who will try to be helpful, without really knowing how ("washing" windows with an oily rag, pumping gas into the car's trunk, helpfully heating ammo in the station's microwave, etc).</p> <p>Rerun Wraith Buddies (2): Init +1; Atk fist +1 melee (1d3); AC 10; Armor Die 1d3; HD 1d8; hit points 5; MV 30'; Act 1d20; SP friendly, reception (good/bad); SV Fort +0, Ref -2, Will -2; AL C.</p>
4	<p><i>Elemental Ambush:</i> Moving from behind an old billboard alongside the road, a hulking, gun covered figure comes into view before raining down hell. The creature was placed here by Warner and will never fire on Team 1.</p> <p>Gun Elemental (lesser): Init +4; Atk +8 melee (4d4) or bullet barrage +10 ranged (4d8, range 200/400/600); AC 14; Armor Die [1d4]; HD 8d8; hit points 36; MV 40'; Act 1d20; SP friendly, reception (good/bad); SV Fort +10, Ref +4, Will +8; AL N.</p>
5	<p><i>A Stretch of Rough Road:</i> The road here is more crater than pavement. Drivers must make a Vehicle Control roll versus 9.</p>
6	<p><i>Hot Pursuit:</i> Team #1 has caught up, opens fire, and gives chase.</p>
7	<p><i>Road Train:</i> This mammoth vehicle is an otherworldly fusion of automotive and locomotive and seeks to overtake and crush other vehicles under its massive treads.</p> <p>Road Train: Init -3; Atk rundown +6 melee (4d14 + Damage Bonus); AC 8; Armor Die [1d10]; HD 6d20; HP 66; Speed Level cruise 2/max 5; Act 1d20; SV Fort +9 (d30), Ref 2, Will NA; Fuel Tank 1d30; Guzzle 10.</p> <p>Basic Traits: <i>offroad, possessed, rugged, superior ram plate, ultra hauler.</i></p>
8	<p><i>Komodo Motos Nomads (10):</i> A nomad chapter of the infamous gang attacks the team, looking to raise some hell and have some fun. They will fall back if either three members are killed or one of their rides is destroyed.</p> <p>Komo-doan Bikers: Init +2; Atk bite +2 melee (1d8+4, poison Fort DC 14 or death), claws +2 melee (1d6+4), or hi-power pistol +4 ranged (1d10, 50/100/150); AC 13; Armor Die 1d6; HD 3d8+5; hit points 19; MV 30'/dig 10'; Act 1d20; SP ectothermic, fearsome reputation, immune to disease, wheels; SV Fort +1, Ref +3, Will +1; AL C.</p> <p>Wheels: Init +4; Atk rundown +1 melee (2d4+Damage Bonus); AC 13*; Armor Die: [1d3]; HD 4d6; hit points 15; Speed cruise 4/ max 3; Act 1d20; SV Fort +0, Ref +3, Will NA; Fuel Tank 1d5; Guzzle 2.</p> <p>Basic Traits: <i>off road, *open, very dangerous, very nimble.</i></p>
9	<p><i>Hot Pursuit:</i> Team #2 has caught up, opens fire, and gives chase.</p>
10	<p><i>Strafing Run:</i> A small plane flies over the race, firing upon the team. It makes four passes before flying off.</p> <p>Single Engine Prop Plane: Init 0; Atk light gatling gun +1 ranged (3d12, 180/360/540); AC 10; Armor Die [1d3]; HD d6; Speed Level cruise 2/ max 6; Height cruise 3/ max 8; Act 1d20; SV Fort 0, Ref 0, Will NA; Fuel Tank 1d12; Guzzle 4.</p> <p>Basic Traits: <i>weapon mount.</i></p>
11	<p><i>Radiation Cloud:</i> A large, crackling cloud of radiation blocks your way. Rerouting adds 1 hour to drive time. All who enter the cloud must make a DC 12 Fort save or lose 1d4 hit points permanently as their flesh boils away.</p>
12	<p><i>Hot Pursuit:</i> Team #3 has caught up? Doppelgangers of the PCs and Mock V catch up, open fire, and give chase.</p>

RACE FOR DEATH

Leg One: Travel Times & Remaining Reserve Levels

	Hazard #1	Hazard #2	Random Encounter	Train	Checkpoint	Total	SP Reserve
Team #1	2 hours	1 hour	2 hours	2 hours	2 hours	2 hours	2 hours
Team #2	1 hour	1 hour	1 hour	1 hour	1 hour	1 hour	1 hour

LEG ONE: THE GOMEZ EXPRESS

The goal of the first leg of the race is to gain control of the compass pointing to the shortest route for the second leg. Depending on how the start of the race worked out and the speed at which the team is traveling, it is possible that another team will have beaten them to the train. In such a case they will be parked on Car #4 and that guard will be dead, replaced with a gunner by a member of that team as they prepare to leave with their prize.

Road Hazard #1 (100 miles)

Cresting a hill, directly before the Mock V is the wreckage of an alien battle-platform (either that or a really large vending machine). The top of the vehicle looks to have been stove in by some massive wasteland creature. Broken bits of metal are scattered about and the main body of the wreck is blocking the road entirely.

Avoiding plowing head-on into the obstruction requires a Vehicle Control roll. If the PCs are traveling at their cruise speed or slower, the DC is 12—DC 14 if traveling faster than cruising speed (consult table SPD-1, USG pg 79).

Lying behind the log are a trio of rad-crazed scavengers looking to collect a new ride. Regardless of whether the vehicle hits the log, they will pop up from concealment and open fire in an attempt to kill the crew. After all, who expects near-immortal road racers to be driving through the wasteland?

Rad Scavs (3): Init +1; Atk dagger +1 melee (1d4) or bolt-action rifle +2 ranged (1d10, range 120/240/360) and revolver +2 ranged (1d8, range 60/120/180); AC 11; Armor Die [1d4]; HD 1d8+2; hit points 7; MV 30'; Act 1d20 + 1d16; SP 3-armed; SV Fort +1, Ref +1, Will +6; AL C

3-armed: During ranged combat, the rad scavs use their third hand to wildly fire their revolver (thus the reduction to 1d16 to attack), while focusing on doing damage with their rifles.

Road Hazard #2 (250 miles)

The roar of dozens of motorcycles grows louder and louder as a horde of komo-doan bikers appears in the rearview mirror. What looks like a large nomad chapter has crossed into the race and the bikers seem intent on closing the distance between themselves and the car.

This nomad chapter is part of the Migration Nation. Their bloodlust is relatively sated at the moment and any vehicles that simply pull over and give them right of way will be passed and left alone. Those who impede their travels, however, will rapidly find themselves taking fire from a score of angry (and armed) bikers.

Migration Nation Bikers (20): Init +2; Atk; claws +2 melee (1d4+6), bite +2 melee (1d8+4, poison DC 14 or die), or shotgun +1 ranged (1d8, range 50/100/*); AC 13; Armor Die 1d6; HD 3d8+5; hit points 18; MV 30'/10' dig; Act 1d20; SP ectothermic, immune to disease, wheels; SV Fort +1, Ref +2, Will +1; AL C.

Motorcycle (Beater): Init +5; Atk rundown +1 melee (2d4+Damage Bonus); AC 13*; Armor Die [1d3]; HD 3d6; hit points 10; Speed cruise 3/ max 5; Act 1d20; SV Fort +0, Ref +3, Will NA; Fuel Tank 1d5; Guzzle 1.

Basic Traits: *very nimble, very dangerous, *open, off road.*

Sighting the train

Up ahead, tearing down the track at breakneck speeds, is a massive black locomotive trailing three train-cars. Fire licks from around the front of the engine and the air around the engineer's compartment has a visible heat shimmer. The rearmost car is an empty flatcar, merely a platform with wheels; beyond that is a box car, as wide as it is tall; finally, behind the engine is a long passenger car.

Car #1—The Engine

A locomotive straight from the pits of hades roars across the wastes. A massive cattle-catcher adorns the front of the engine, the carcasses of several cars fused to the blade. The scraping wreckage throws up a sheet of sparks and flame licks at the windshield while the screeching of the protesting metal is akin

RACE FOR DEATH

to the tormented groaning of the damned. Through the grim covered windows of the doors, the vague figure of the engineer can be seen.

“The Gomez Express” (Keeper, large engine): Init 3; Atk rundown +6 melee (4d14+Damage Bonus); AC 8; Armor Die [1d20]; HD 6d20; hit points 120; Speed Level cruise 5/ max 9; Act 1d20; SV Fort +9, Ref 2, Will NA; Fuel Tank 1d30; Guzzle NA.

Basic Traits: *heavily armored, high performance engine, superior ram plate, ultra hauler.*

Car #2—Passenger Car

The sides of the passenger car have been armored; thick metal plates have been riveted over the once inviting windows. On either end of the railcar a small platform, ringed with a simple railing, provides access to the car’s entrance.

Passenger Car: Init *; Atk *; AC 8; Armor Die [1d7]; HD 6d10; hit points 35; Speed Level *; Act *; SV Fort +6, Ref *, Will NA. Passenger capacity: 50 passengers and luggage.

Basic Traits: *heavily armored.*

Car #3—Box Car

A scarce few flakes of red paint are the only bits of color remaining on this now almost barren metal boxcar. The massive side doors leading into this box car are welded shut, thick beads of metal forever sealing them. On the front and back ends of the car, narrow ladders ascend to the roof where, presumably, one might enter through the rooftop hatchways.

Box Car: Init *; Atk *; AC 8; Armor Die [1d3]; HD 6d12; hit points 40; Speed Level *; Act *; SV Fort +7, Ref *, Will NA.

Basic Traits: *extra cargo x100.*

Car #4—Flat Car

Essentially a sixty-foot-long platform, the car jostles along the track. The rear 10 feet of the car bounce with a bit of independence as if the platform of the car is not one solid piece. The front of the flat car is equipped with dual-mounted heavy Gatling guns, ready to be used to clear off foes approaching the rear of the train. The gunner stands in a metal copula, at least partially protected from any incoming fire that may come their way.

Flatcar: Init *; Atk *; AC 8; Armor Die [1d3]; HD 6d10; hit points 35; Speed Level *; Act *; SV Fort +5, Ref *, Will NA.

Basic Traits: *boarding ramp, heavy weapon mount x2, open, rugged.*

Car #1-1—Engineer’s Compartment

Visible through the front windshield, the tracks wind ever deeper into the Umerican wastes. Flames lick at the windshield, emanating from the visible wreckage of several cars crushed against the front of the engine.

Lining the walls of this compartment are dials, switches, levers, indicator lights, and a number of other mechanical controls—far more than one would expect to see. Standing in the center of the compartment, seemingly wholly unaffected by things such as ... inertia, is the oddly clad, grayscale, and very mustachioed engineer. Wearing a black suit with white pinstripes and puffing on a large cigar he watches the world rushing at him with utter glee. Without turning his head, he speaks “You know, you should not be in here old bean.”

Gomez is a mostly harmless and benevolent rerun wraith who simply adores trains—hence him accepting the position as engineer. Of course, he also enjoys crashing trains, hence him being offered the position for this race. Unlike others of his kind, so long as he is within the engineer’s compartment he suffers from no good/bad reception issues and seems as real as anyone else. He will not attack unless the train’s controls are tampered with, or he himself is attacked.

Gomez (Powerful Rerun Wraith): Init +1; Atk epee +6 melee (1d6+1) or by weapon; AC 10; Armor Die 1d3; HD 8d8; HP 64; MV 30’; Act 1d20 +1d16; SP friendly, smoker, total control, zany; SV Fort +1, Ref +2, Will +2; AL C

Friendly: Gomez is so dashing, charming, and polite that a DC 15 Willpower save is required by any creature wishing to engage him in combat. Those failing are under the sway of Gomez’s charm and will actively attempt to interrupt and intercede in any hostile actions taken against him in non-lethal fashion (a PC wouldn’t attack a comrade but might “accidentally” trip an attacker).

Smoker: Gomez is fond of cigars and the pocket of his immaculately tailored jacket houses as many cigars as he should require, allowing him to draw them (already

RACE FOR DEATH

lit). As an action, he is able to puff on a cigar and fill the engineer's compartment with smoke, causing a -1d penalty on all attacks made against him.

Total Control: Gomez enjoys utter mental control over the train (almost as if he were looking down on it from above with a remote control in his hand). He may cause sudden changes to the train's speed at will, once per round, suddenly accelerating or decelerating to throw his foes off balance (or through the front windshield—which can take 20 points of damage).

Zany: The outlandish actions of Gomez allow him to do all number of strange things. As an action he may do any of the following:

- Ignore all damage from any one attack (while looking comedically affected: frizzed hair, doubled over and flailing wildly, launched airborne and somersaulting across the ground upon impact).
- Take another full movement.
- Redirect any incoming attack towards another adjacent individual (DC 12 Reflex check required).

Car #2-1—Forward Guard Room

Bare, armored walls make up this chamber within the passenger car. Sitting around a card table are six burly men with large holstered pistols and really big combat knives strapped to their hips. The table before them is covered with cards and chips; the men look up as the door opens, back to the chips, back to the door, back to the table ... before shrugging and looking back at their cards.

The men in this room have no specific loyalty to any of the Royals and would prefer to finish their poker game in peace. If undisturbed, they will simply allow anyone to pass through the room, muttering “should’a paid us better” as they do. If attacked they will throw their cards down in disgust and launch into a relentless offensive until they or those interrupting their game, are dead.

The door to the central vault is locked and requires a DC 13 pick lock check to open and can withstand 50 points of damage.

Royal Railway Guards (6): Init +2; Atk high power pistol +4 ranged (1d10, range 50/100/150), large knife +3 melee (1d6+1), punch +3 melee (1d3, strike twice), kick +3 melee (1d5), or bite +3 melee (1d2+1); AC 11; Armor Die 1d5; HD 2d12; hit points 18; MV 30'; Act 1d20; SP final rage; SV Fort +3, Ref +2, Will +0; AL N.

If questioned Gomez has a number of ready quips on a variety of subjects.

- The Royals: “I love wizards with integrity; I wish I knew one.”
- The flaming wreckage on the engine: “Did I run into those cars? Of course, why else would a grown man play with trains?”
- On why he won't leave the engine: “I'm a wallflower.”
- Team #1: “The behavior of Warner's team has me agog. Did I say agog? More like aghast!”
- Team #2: “In the Amazon, no racing victory is complete without the traditional shower of lizards' teeth.”
- Team #3: “You folks are as cute as a bat's ear.”
- On becoming an engineer: “You fall asleep on a park bench one time and they carry you off to the morgue by mistake.”
- The Train: “If it weren't for me, this place would be a madhouse.”
- Umerica: “When the blazing sun has turned to mud, And the moon lies dead in a pool of blood, And the tom-tom beat of eternity starts, Where will I love in my heart of hearts? Umerica.”

Final rage: When struck by what would be a mortal blow, the guard goes into a berserk death rage for 1d3 rounds. During this time, he will stab, bludgeon, punch, kick, or bite any foe within range before finally expiring. Certain forms of death (such as disintegration) bypass this ability at the Judge's discretion.

Car #2-2—The Vault

Looking through the doorway reveals that the dividing walls are several feet thick, and this vault is notably smaller than the guardroom, likely due to the additional reinforcement. In the center of the room is a small table with what appears to be a single sheet of paper upon it. A voice from above calmly states “Oh, you certainly shouldn't be in there. Now, if you'll observe, operating a loco-motive is a combination of TWO things: balance, timing, peripheral vision, superb coordination, and a killer's instinct!”

The voice is that of the Engineer, Gomez. As he speaks,

RACE FOR DEATH

the train will noticeably pick up speed. Gomez has the train speeding towards a collision, to prevent the information on the paper from being stolen. In six rounds the train will come to a singularly cataclysmic halt resulting in a Total Disaster (as result 16+ on Table LWO-1: Locomotive Wipeout Results, USG, pg 138) for both the Gomez Express and the unlucky train that it plows headlong into.

The paper holds the information on which is the quickest route to the next checkpoint (Route #2).

Car #2-3—Rear Guard Room

Bare, armored walls make up this chamber within the passenger car. Standing attentively in the room are six burly men with large holstered pistols and really big combat knives strapped to their hips.

The guards immediately attack anyone attempting to enter this room from the outside. Those exiting into this room from the vault are given a snappy salute and a crisp “sir” as they pass.

The door to the central vault is locked and requires a DC 13 pick lock check to open and can withstand 50 points of damage.

Royal Railway Guards (6): Init +2; Atk high power pistol +4 ranged (1d10, range 50/100/150), large knife +3 melee (1d6+1), punch +3 melee (1d3, strike twice), kick +3 melee (1d5), or bite +3 melee (1d2+1); AC 11; Armor Die 1d5; HD 2d12; hit points 18; MV 30'; Act 1d20; SP final rage; SV Fort +3, Ref +2, Will +0; AL N.

Final rage: When struck by what would be a mortal blow, the guard goes into a berserk death rage for 1d3 rounds. During this time, he will stab, bludgeon, punch, kick, or bite any foe within range before finally expiring. Certain forms of death (such as disintegration) bypass this ability at the GM's discretion.

Car #3—Boxcar

Light spills in through the open hatch and into the gloomy interior of the boxcar below. The rising air is musty, smelling of dust, stale cigarettes, and BO. A scattering of straw can be seen on the wooden floor sixteen feet below. Just outside the circle of light, several figures can be seen moving in the gloom.

A boxcar with the doors welded shut certainly looks like it might be hauling something important. Rebuilt from its own wreckage, this car carries the angry spirits of the victims of a horrific train wreck. The tragically

slain rose again as rail wraiths, anchored forever to this box car and eager to share their suffering with anyone foolish enough to enter their domain. Prior to their attacking, Gomez interjects:

A cheerful voice fills the darkness surrounding you. “Ah yes, the satisfied passengers of the Gomez Express. For being satisfied they always seem so angry. There is just no understanding some people. By all means, forget you are locked in this cage and just act like one of the family. Oh well, I'm certain that you will all get along famously.”

Of course, when death doesn't claim their victims, the rail wraiths will be puzzled and will take no further hostile action against the interlopers. At that point a successful DC 12 Personality check will convince the rail wraiths that the speaker is truly one of their number. If the PC will remain with them for one hour, they will teach them how to perform their songs of the railway, granting the PC their haunting dirge ability.

Rail Wraiths (15): Init +3; Atk railroad spike +4 melee (1d8+rust); AC 15; Armor Die nil; HD 3d12; HP 20; MV 20' flight; Act 1d20; SP rusty railroad spike, light vulnerability, incorporeal, haunting dirge, never dead; SV Fort +6, Ref +3, Wil +10; AL N.

Car #4-1—Gun-mount

Situated at the front of the car, this massive weapons mount sports a pair of heavy Gatling guns, bolted together to rain efficient destruction upon a single target. The guns rise from a metal copula, protecting the gunner and are large enough to store a small ammunition supply for reloading.

The gunner will open fire on any vehicle coming into range, resorting to his personal weapon should he run out of ammunition or be attacked from a location he cannot spray with the guns. A pair of boxes at his feet each hold a single reload belt for one of the guns. Due to his extreme familiarity with the weapons, it requires only a single round for the guard to retrieve a belt and load it into one of the guns (still requiring two rounds if he reloads both weapons at once).

Royal Railway Guard (1): Init +2; Atk twin heavy Gatling guns +4 ranged (3d16x2, range 180/360/540), high power pistol +4 ranged (1d10, range 50/100/150), large knife +3 melee (1d6+1), punch +3 melee (1d3, strike twice), kick +3 melee (1d5), or bite +3 melee (1d2+1); AC 11; Armor Die 1d5; HD 2d12; hit points 18; MV 30'; Act 1d20; SP final rage; SV Fort +3, Ref +2, Will +0; AL N.

RACE FOR DEATH

Leg Two: Travel Times & Remaining Reserve Levels

	Route	Segment Number							Total	SP Reserve
		#1	#2	#3	#4	#5	#6	#7		
Team #1	1	30 min	45 min.	1 hour	2 hours	1 hour	1 hour	1 hour	7.25 hours	453 points
Team #2	2	15 min	1 hour	15 min	1 hour	N/A	1 hour	N/A	4.5 hours	180 points

If one of the players enters the copula and takes control of the guns, Gomez responds with glee. *“That’s the spirit! Crush your enemies, make them drive behind you, and hear the lamentations of their mechanics!”*

Car #4-2—Loading Ramp

The decking here is divided from the main bed of the flatcar and is capable of being lowered to allow easier access. The ramp can be lowered and operated by means of a lever on the right-hand side of the car that controls the automation. A cheerful voice emanates from somewhere nearby, “You are so cold, I’m sure you can do better. Come on old man, give it that old college try! Go fighting cephalopods!”

The lever to work the ramp sticks, requiring a DC 10 Strength check to lower it and a DC 12 Strength check to raise it. Safely driving either on or off the ramp requires a Vehicle Control roll.

Checkpoint #1

Wherever the train wrecks is the checkpoint. Each team will be allowed 30 minutes to make repairs as needed before the next leg of the race.

As the dust settles and the fires die down, an “enthusiastic” throng shimmers into view, along with a squad of sullen guardsmen on site to keep them cheering and rooting for “their” team. Many of them listlessly wave colored pennants in the air, each bearing a single letter (C, T, or W) on a field of royal blue. The effect is unnerving, a resentful crowd all waving the same color pennants while staring at you and emotionlessly cheering.

LEG TWO: CROSS COUNTRY DASH

The three routes to the second checkpoint are marked by hot air balloons hovering over their starting lines. Driving from the train to the second leg routes requires a check for a random encounter prior to arrival. The teams once more line up in position, with the team which won the first leg choosing where in the starting position they wish to be. The teams depart an hour apart from one another. Each team is free to follow

another team (perhaps attempting to overtake them) or to choose their own route. Of the routes, #2 is the quickest, but if the players listen to the directions from the Mock V and shortcut between routes, they will be able to get there even more quickly. The Mock V’s navigation system allows for the team to change routes after completing a segment and the V.E.T.T. is able to detect segments with no hazards upon a successful Luck check by the “driver.”

Like the first leg, this one is approximately 300 miles long and the time required to complete each segment is as follows. Each segment on the following table represents 50 miles of travel and each encounter adds 15 minutes to the travel time of the racers. Speed: (3) 1.5 hours, (4) 1 hour, (5) 55 minutes, (6) 40 minutes, (7) 35 minutes, (8) 30 minutes, (9) 25 minutes, (10) 20 minutes. Keep in mind that, beyond the listed hazards, it is quite possible for one team to catch up with another and engage in battle.

The other two Royals have designed one of the obstacles each and their team will bypass it with no challenge. Team #2 has great difficulty with this leg of the race, wiping out repeatedly before finally slowing down. They are near out of reserves going into the final leg of the race.

Obstacle #1—The Burning Jungle

Ahead, the road goes straight into a growth of interdimensional jungle, lit by massive flames that jet towards the sky. Circling above the otherworldly, asbestosine flora, alien horrors ride the massive thermals. The road ahead seems clear, although the burning trees form a tunnel of fire.

The roadway through the burning jungle is relatively clear, but the inhabitants of the jungle pose a serious threat to the drivers. The creatures above are pterror-dons, small alien cousins to Umerican dragons. Due to all of the magma that has cooled upon the roadway all Vehicle Control checks made in the forest suffer a +2 in difficulty. Once the pterror-dons are exhausted or slain,

RACE FOR DEATH

Route 1	Route 2	Route 3
Obstacle #1	Obstacle #1	Obstacle #2
Random Encounter	XXX	Random Encounter
Obstacle #2	XXX	Obstacle #3
Random Encounter	Random Encounter	Random Encounter
Obstacle #3	Obstacle #3	XXX
Obstacle #4	Obstacle #4	Obstacle #4

there are no further dangers within the burning jungle.

This obstacle was crafted by Warner and, as such, team #1's Waste-landmaster MK IV rolls through, utterly immune to the flames and magma.

Pterror-dons (4): Init +6; Atk bite +3 melee (2d4), wing buffet +3 melee (1d8); AC 14; Armor Die 1d3; HD 4d10; hit points 22; MV special; Act 1d20; SP breath weapon, combustible, explosive speed; SV Fort +4, Ref +7, Will +0; AL C.

Breath weapon: As an action, pterror-dons can use their breath weapon each round, spewing forth a torrent of interdimensional magma that inflicts 1d6 points of damage (successful Vehicle Control roll, or a DC 13 Reflex save from pedestrians, negates). The volcanic stream extends to a range of 500' and is 30' wide at its zenith. Further, to prevent the lava from building up, pterror-dons must release magma at least once every 10 rounds.

Combustible: Serving as interdimensional conduits for alien lava poses an additional risk when the creature is no longer able to vent. When slain, magma begins to build up, and in 10 rounds (reduced by the number of rounds since the creature last employed its breath weapon) the pterror-don explodes in a geyser of fire and molten rock doing 1d60 damage to all creatures within 300'.

Explosive speed: Leaving trails of fire and burning gasses in their wake, the pterror-don is a match for the speed of virtually any vehicle (at least in the short run). The creatures are capable of moving at vehicular speeds for short periods (treat as Speed cruise 5/ max 10). The beast must make a Fortitude save each round vs. a DC of 5 + current speed or drop out of any chase due to exhaustion. Consult Table SPD-1: Speed Levels on pg 79 of the Umerican Survival Guide to determine how many breath weapon attacks an exhausted pterror-don may unleash before a vehicle is out of range.

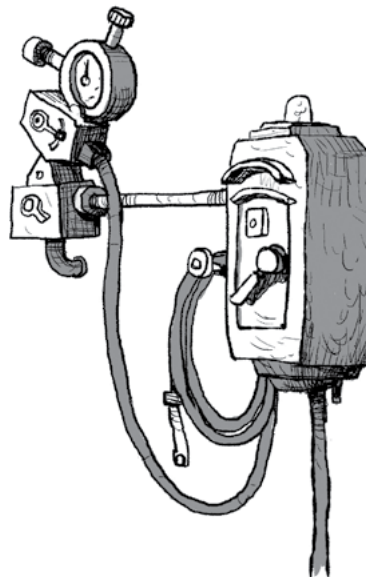

RACE FOR DEATH

Obstacle #2—Sinister Sinkhole

Rising above the road is a gigantic clown head, the mouth of which the road directly enters. Twenty-foot-tall eyes crackle with blue energy, moving from side to side before locking their gaze onto the approaching car. The corners of the titanic mouth curl into a grin and a booming laugh rends the air around you like summer's thunder.

The freakish cackling spreads out with a visible shockwave and the ground ahead, behind, and beneath you begins to lurch. With no real warning, the roadway around the car begins to fall away into an abyssal sinkhole. The mammoth crater is rapidly devouring everything in the area.

Escaping the devouring maw of the sinkhole requires a trio of Vehicle Control rolls (base difficulty 14) over a course of rounds as the car careens across near impossible gaps and seems to almost defy physics. Disciples of Kizz who play their sacred instruments (and thus make the challenge awesome) while the driver is attempting to navigate the collapsing roadway grant a +1d bonus to the driver's Vehicle Control checks.

In addition to the damage taken and any needed repair time, crashing to the bottom leaves the drivers trapped for two hours as they seek to find a way back up while dodging the debris raining down all around them.

Obstacle #3—Certain Death Gorge

Following your route, you come to a massive gorge, a graven wound in the Umerican earth. A crude ramp has been built up towards the lip of the chasm making jumping it possible—even if horrifyingly unlikely. A sign next to the ramp reads “Certain Death Gorge – Good Luck Sucker!”

Looking across at the far canyon wall the remains of an antique red, white, and blue skycycle are embedded in the stone. Tattered shreds of a parachute bleached by the sun and torn by time flutter limply. An ancient statue of a man, only missing its head, stands next to the handmade ramp.

Drivers slowing to examine the canyon floor immediately note piles of wreckage littering the area—cars, trucks, and even boats and trains, all lie broken, smashed like the toys of an ill-tempered giant. A small sign, unreadable from the top of the canyon, sticks out among the wreckage. If closely examined, the sign reads “You are never a failure until you refuse to get back up.”

The gap is nearly 50' across requiring a Vehicle Control roll of base 18 + any additional situational modifiers (as per USG pgs 79-80). Those fortunate enough to make it across continue unimpeded, but those who fail face a 100' drop to certain destruction and quasi-death.

On a successful jump across the canyon read the following:

	Succeed	Fail
1st Roll	<i>The wheels of the car scream and smoke as the front end of the car rises crazily. The upper portion of the crust drops, giving the car purchase and sending you sailing across the gap. The tires bounce as the car reaches relatively solid ground, at least for the moment.</i>	<i>The wheels of the car scream and smoke as the front end of the car rises crazily. This is followed by the sinking sensation of the car inexorably sliding backwards into the darkness and dropping into the void.</i> (Roll on Wipeout Table)
2nd Roll	<i>The ground suddenly slants left, sloping down sideways towards the darkness. The engine roars as the Mock V manages, against all odds, to cling to the surface as a hate-fueled blur that jumps the gap to the last relatively sound bridge of land.</i>	<i>The ground suddenly slants left, sloping down sideways towards the darkness. The engine roars as the Mock V struggles to maintain forward motion. The hate-fueled car loses that battle, sliding sideways, and dropping hard onto a nearby ledge.</i> (Roll on Wipeout Table)
3rd Roll	<i>The Mock V tears across the remaining land bridge, ramping into the air and over the remaining gap, landing on solid ground once more. In the rearview, the last of the ground crumbles away, leaving nothing but an impassable crater.</i>	<i>The Mock V tears across the remaining land bridge, speeding towards the remaining gap. A massive spar of stone forms a mammoth ramp and the Mock V shoots high into the air over the gap, crashing down hard on the other side. Finally, the car is on solid ground.</i> (Roll on Wipeout Table)

RACE FOR DEATH

The Mock V is hurled skyward, launching off the ramp. Rockets and pyrotechnics explode in the air all around the car, jetting from the sides of the ramp. Reaching the apex of the jump, the car seems to hang in the air for a moment. The sun glints through the windshield, flickering like a living thing. Then, as quickly as it began, the moment is over. The Mock V lands on the ramp—hard—bouncing in the air once, twice, three times as the suspension screeches from the abuse. Looking back, it seems impossible to have made that leap, and only a madman would ever have tried.

In the event of failure to jump across the canyon read the following:

The engine of the Mock V roars as the needle on the speedometer is buried. There is a small “bump” prior to the car being launched and hurled skyward. Rockets and pyrotechnics explode in the air all around the car, jetting from the sides of the ramp. Reaching the apex of the jump, the car seems to hang in the air for a moment. The sun glints through the windshield, flickering like a living thing. Then, as quickly as it began, the moment is over. The Mock V is going to make it, going to make it, going to ... it isn't going to make it.

Your ride turns end over end as it plummets into the canyon and towards the rocky ground below. The fall comes to an immediate stop, crashing to a halt that breaks bones and tears metal. You distantly hear the bouncing of the tires as they careen away. The dust settles, and all is still.

All PCs suffer 10d6 points of bone-crunching damage with any 6s reflecting broken arms and/or legs, making un-life generally difficult. The Mock V suffers 99 points of damage and is nearly destroyed. Able to regenerate 1d3 points per action, the team (and V.E.T.T.) will need to prioritize repairs.

- Engine trouble: reduce speeds to 40', cruise 4/max 8 – 40 hp to repair.
- Ruptured tires: -1 Reflex and +2 Vehicle Control modifier per tire – 2 rounds to recover tires, 6 hit points (each) to repair.
- Smashed windshield: +4 Vehicle Control modifier – 5 hit points to repair.
- Roof crushed: vehicle gains open trait. Passengers gain no armor benefit from the vehicle and 50% of damage done to the vehicle is also suffered by the passengers – 15 hit points to repair.
- No doors: AC reduced to 11, Armor Die reduced

to [1d5] – 8 hit points to repair.

- No trunk lid: on a failed Vehicle Control roll, all supplies fly out of the trunk – 6 hit points to repair.
- No cigarette lighter: 1 hit point to repair

No matter the state of those who fail, it will take an additional hour to extricate themselves from the gorge using an ancient burro trail.

This obstacle was crafted by Toei. When the Revolt-a-tron approaches it will break into its component cycles as the ramp extends both outwards and upwards. The cycles clear the jump without any issue and without need for a Vehicle Control roll.

Obstacle #4—RACSAN Raceway

Ahead, the three routes merge back into one as they enter the final hazard of this course, a stadium filled with drunk members of RACSAN (“Ragingly Angry Competitively Single-minded Attack Nihilists”). The murderous cult centers around the belief that the expression of drunken rage at racing events is tantamount to being bathed in the spirit of the divine. As you prepare to enter the stadium a sign reads “5 laps” with “or death” scrawled beneath it. The roar of the crowd is deafening, even over the roar of the engine.

During the five laps, small groups of RACSAN cultists will charge onto the track. Avoiding the groups requires a Vehicle Control roll each lap; running them down in a death race-fueled rampage inflicts 1d5 points to the car each round. Additionally, the racers are subjected to small arms fire, taking 3d3 points per lap.

Should the racers simply drive through the arena and out the other side, there is no penalty. Attentive racers (Intelligence vs. DC 13) will notice that the additional message on the arena sign was written by the cultists and is not official or reflective of the outcome of driving straight through.

Checkpoint

Ahead you can make out the throngs of excited political prisoners who cheer for the winning teams with mock gaiety. Guards patrol behind them, pushing banners into their hands and prodding those who are not enthusiastic enough for their liking. Driving clear of the ambivalent throngs reveals a large lake with a finish line on the far side. Near the shoreline are a number of jet-skis and gyrocopters.

RACE FOR DEATH

LEG THREE: ONE IF BY AIR, TWO IF BY SEA

The crowd finally begins to show some interest as the teams move towards the starting line of what looks to be the beginning of a foot race to get to the water and aircraft. Sporadic, but genuine cheers emerge from the gathered crowd pressed into service to witness the game of the Royals. The other teams eye the shoreline, obviously sizing up the competition for the individual vehicles. No one wants to swim across that lake. Standing next to their vehicles, the other teams brace themselves for the starter's gun.

One of the crowd screams and clutches his chest as the starter's gun fatally shoots him. Toei's team begins a mad dash towards the shore, obviously seeking out the watercraft but Warner's team rushes back into their Waste-lander and the ponderous vehicle roars to life and begins rolling towards the water.

The final leg of the race is a chase, using the Chase rules (USG pg 83). Team #1 remains in their amphibious vehicle while Team #2 races to a mixture of jet-skis and gyrocopters. The players have the choice of whether to remain with the Mock V (which can take the shape of other vehicles) or to split up to improve their chances of winning.

These are the participants of the race:

Team #1

Team #1 begins the race with a two-step lead and uses their head start to fire upon anyone coming up behind them, specifically whomever is closest to them. They will switch back and forth between targets with both the heavy cannon and small arms fire.

Black Berets (wasteland warriors): Init +4; Atk assault rifle +(1+deed) ranged (1d10, RoF 3, range 100/200/300), semi-auto pistol + (1+deed) ranged (1d8, RoF 2, range 60/120/180), or combat knife +(2+deed) melee (1d8); AC 11; Armor Die 1d12; HD 3d12+3; hit points 30; MV 30'; Act 1d20; SP infantry armor (d6 fumble die, Armor Die x2 versus projectile damage), mighty deeds (d5), critical range 19-20; SV Fort +2, Ref +3, Will +2; AL N.

The Waste-Landmaster MK IV (unique custom vehicle): Init +1; Atk rundown +7 melee (2d12+Damage Bonus), heavy cannon +4 ranged (8d8, range 1000/2000/3000); AC 8; Armor Die [1d8]; HD 9d20; hit points 120; Speed Level cruise 5/ max 7 (cruise 2/ max 3 in water); Act 1d20; SV Fort +6 (d30), Ref +0, Will NA; Fuel Tank 1d20; Guzzle 8.

Basic Traits: *dual tires, enhanced handling, heavy weapon mount, hell dropper, off road, portable repair shop, reserve tank (1d14), rugged, vehicle snorkel.*

Team #2

The gyrocopter carries its pilot and two passengers, but their unfamiliarity with the copter makes the pilot very tentative and requires the use of a d12 for Vehicle Control rolls while flying.

Animaulers Ganger (5): Init +2; Atk bite +2 melee (1d8+4, poison Fort DC 14 or death), claws +2 melee (1d6+4), or hi-power pistol +4 ranged (1d10, range 50/100/150); AC 13; Armor Die 1d6; HD 3d8+5; hit points 19; MV 30'/dig 10'; Act 1d20; SP ectothermic, fearsome reputation, soulless, immune to disease, wheels; SV Fort +1, Ref +3, Will +1; AL C.

Lakecycles (2): Init +5; Atk rundown +1 melee (2d4+Damage Bonus); AC 13*; Armor Die [1d3]; HD 3d6; hit points 10; Speed cruise 1/ max 5; Act 1d20; SV Fort +0, Ref +3, Will NA; Fuel Tank 1d5; Guzzle 1.

Basic Traits: *very nimble, very dangerous, *open.*

Gyrocopter: Init +1; Atk weights +1 missile (weights 1d5); AC 11*; Armor Die [1d3]; HD 3d5; hit points 9; Speed Level cruise 2/ max 5; Height cruise 3/ max 7; Act 1d20; SV Fort 2, Ref +1, Will NA; Fuel Tank 1d8; Guzzle 2.

Basic Traits: **open, auto rotate.*

Auto rotate: This gyrocraft's main propeller will allow the craft to glide and drop at a slower pace when control is lost. +1 to all Wipeout tests and all crash damage is reduced by 33%

There are two gyrocopters and six lakecycles remaining should the players choose to use them instead of having the Mock V transform into something more appropriate for this last leg. Of course, their V.E.T.T. teammate refuses to be left behind.

Mock Twain (transformed V.E.T.T. Bowrider): Init +3; Atk rundown +4 melee (2d6+collision damage bonus), melee weapon +8 (2d5+3), or blaster ranged +8 (3d4, range 100/200/300); AC 11; Armor Die [1d3]; HD 10d10; hit points 100; MV 20' in melee combat, otherwise Speed cruise 2/ max 3; Act 2d20; SV Fort +10, Ref +6, Will +8; Fuel Tank n/a; Guzzle n/a.

Basic Traits: *biomechanical, in control, no fuel tank, reconfigure, trap feeding, vehicle form.*

RACE FOR DEATH

THE FINISH LINE

Embedded in the ground on the far shore is the Ruby Spear. The crystalline shaft glows with its own inner light, bathing the area around it in crimson. Whichever team grabs the spear, opening the portal back to the citadel of scrap, has technically won the race. If the PCs haven't gotten the spear, it might be worth reminding them that there is no rule against them taking the spear and going through the portal themselves.

There are a number of possible outcomes. Regardless of winning or losing, the Mock V will have paid its debt to Casio and will race off with its soul returned.

- The players lose. Casio is understandably upset at the team coming up short and quietly seethes. The characters have made a powerful enemy, one that still holds their souls in a cyber-phylactery. Of course, if the team wants their souls back, they need to succeed at a task for Casio. The Judge is encouraged to come up with an unpleasant task for the party to carry out to earn their freedom from Casio.
- The players win. As promised, Casio will offer to return the team's souls. Of course, depending on how badly damaged their bodies are the pain caused by their soul's return will be excruciating (Fortitude save vs. DC 20 - current hit points or permanently lose 1d3 Stamina). Casio will be well pleased with the victory and his opportunity to lord it over the other Royals and so will offer to keep the team on "part time" to run other jobs for him. As a special reward for winning, he will offer the team their choice of the loser's vehicles, restored to their pre-race condition, or 1000gp of trade goods.
- The players win. Being un-living has its advantages and the team may have no interest in regaining their souls for the time being. Of course, leaving their souls in Casio's care ensures that their paths will cross again. As a show of good faith, in addition to their vehicular reward above, Casio will send the team to see Dr. Carl Augh at Shelley's Surgical Centre. He will return them to full health and provide them each with 20 hit points worth of "medical" supplies.

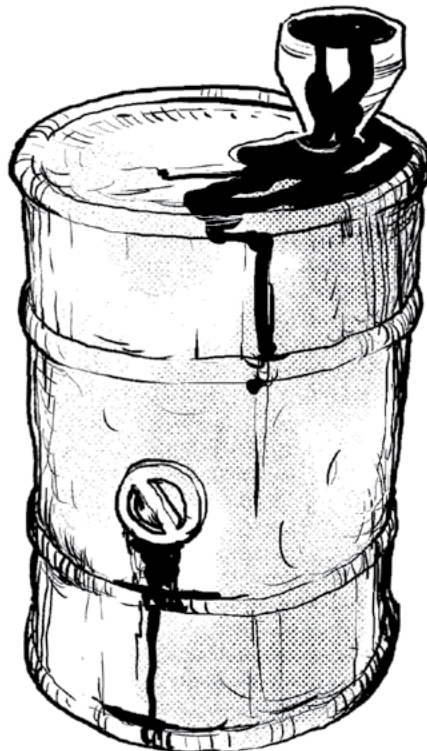

LIST OF TABLES

Granny's Tonics and Tinctures	12	Table HUN-2: Hunter Skills	122
Junkyard Encounters Table	23	Table CX: Road Hawg	125
Fountain of Youth Results Table	28	Ace Automotive Annihilation (AAA)	129
Gift Shop Wares Table	29	Cockpit Wrestling	130
Worm God Translation Table	35	Cycle Dueling	131
Valley Encounter Table	39	Freakin' Laser Beams	132
Table I: Roadside Attraction & Hook	43	Scavengra	132
Table II: Amusement Location	45	Shotgunnery	133
Table III: Art Installation	49	Wall of Lead	134
Table IV: Hall of Fame	49	Construction Grade Hydraulic Arm Tools/Weapons	143
Table V: Battlefields	51	Artillery Class Weapons	144
Table VI: Memorials	52	Table HGT-1: HGT Levels	145
Table VII: Museums	54	Table AWO-1: Aerial Wipeout Results	145
Table VIII: "Natural" Wonders	55	Support and Artillery Class Weapon Critical Hit Table	147
Table IX: Residential	59	The Duffle Bag of Holding	158
Random Roadtrip Encounters	63	Random Encounter Table	162
Weather Chart	69	Leg One: Travel Times & Remaining Reserve Levels	163
Freak Storm Table	70	Leg Two: Travel Times & Remaining Reserve Levels	167
Table RGG-1: Road Gang Structure	97		
Table RGG-2: Gang Nature	99		
Table HR-1: Holy Roller	119		
Table HUN-1: Hunter	121		

THE AMERICAN ROAD ATLAS

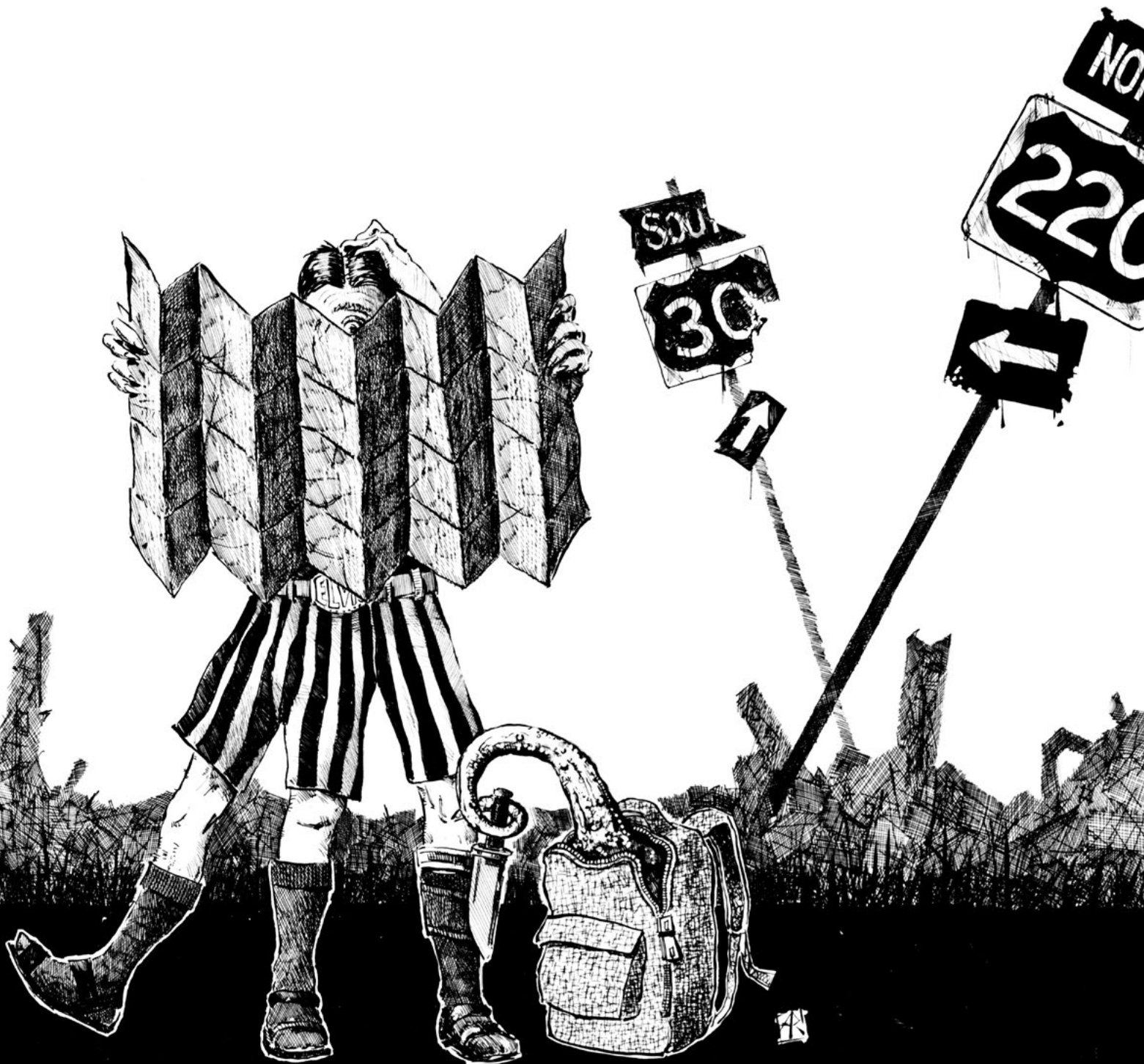

Product Identity: The following items are hereby identified as Product Identity, as defined in the Open Game License 1.0a, Section 1(e), and are not Open Content: All trademarks, registered trademarks, proper names (characters, deities, etc.), dialogue, plots, storylines, locations, characters, artworks, and trade dress. (Elements that have previously been designated as Open Game Content are not included in this declaration.)

Open Content: Except for material designated as Product Identity (see above), the game mechanics of this fanzine are Open Game Content, as defined in the Open Game License version 1.0a Section 1(d). No portion of this work other than the material designated as Open Game Content may be reproduced in any form without written permission.

OPEN GAME LICENSE Version 1.0a

The following text is the property of Wizards of the Coast, Inc. and is Copyright 2000 Wizards of the Coast, Inc ("Wizards"). All Rights Reserved.

1. Definitions: (a) "Contributors" means the copyright and/or trademark owners who have contributed Open Game Content; (b) "Derivative Material" means copyrighted material including derivative works and translations (including into other computer languages), potation, modification, correction, addition, extension, upgrade, improvement, compilation, abridgment or other form in which an existing work may be recast, transformed or adapted; (c) "Distribute" means to reproduce, license, rent, lease, sell, broadcast, publicly display, transmit or otherwise distribute; (d) "Open Game Content" means the game mechanic and includes the methods, procedures, processes and routines to the extent such content does not embody the Product Identity and is an enhancement over the prior art and any additional content clearly identified as Open Game Content by the Contributor, and means any work covered by this License, including translations and derivative works under copyright law, but specifically excludes Product Identity. (e) "Product Identity" means product and product line names, logos and identifying marks including trade dress; artifacts, creatures, characters, stories, storylines, plots, thematic elements, dialogue, incidents, language, artwork, symbols, designs, depictions, likenesses, formats, poses, concepts, themes and graphic, photographic and other visual or audio representations; names and descriptions of characters, spells, enchantments, personalities, teams, personas, likenesses and special abilities; places, locations, environments, creatures, equipment, magical or supernatural abilities or effects, logos, symbols, or graphic designs; and any other trademark or registered trademark clearly identified as Product identity by the owner of the Product Identity, and which specifically excludes the Open Game Content; (f) "Trademark" means the logos, names, mark, sign, motto, designs that are used by a Contributor to identify itself or its products or the associated products contributed to the Open Game License by the Contributor (g) "Use", "Used" or "Using" means to use, Distribute, copy, edit, format, modify, translate and otherwise create Derivative Material of Open Game Content. (h) "You" or "Your" means the licensee in terms of this agreement.

2. The License: This License applies to any Open Game Content that contains a notice indicating that the Open Game Content may only be Used under and in terms of this License. You must affix such a notice to any Open Game Content that you Use. No terms may be added to or subtracted from this License except as described by the License itself. No other terms or conditions may be applied to any Open Game Content distributed using this License.

3. Offer and Acceptance: By Using the Open Game Content You indicate Your acceptance of the terms of this License.

4. Grant and Consideration: In consideration for agreeing to use this License, the Contributors grant You a perpetual, worldwide, royalty-free, non-exclusive license with the exact terms of this License to Use, the Open Game Content.

5. Representation of Authority to Contribute: If You are contributing original material as Open Game Content, You represent that Your Contributions are Your original creation and/or You have sufficient rights to grant the rights conveyed by this License.

6. NOTICE of License Copyright: You must update the COPYRIGHT NOTICE portion of this License to include the exact text of the COPYRIGHT NOTICE of any Open Game Content You are copying, modifying or distributing, and You must add the title, the copyright date, and the copyright holder's name to the COPYRIGHT NOTICE of any original Open Game Content you Distribute.

7. Use of Product Identity: You agree not to Use any Product Identity, including as an indication as to compatibility, except as expressly licensed in another, independent Agreement with the owner of each element of that Product Identity. You agree not to indicate compatibility or co-adaptability with any Trademark or Registered Trademark in conjunction with a work containing Open Game Content except as expressly licensed in another, independent Agreement with the owner of such Trademark or Registered Trademark. The use of any Product Identity in Open Game Content does not constitute a challenge to the ownership of that Product Identity. The owner of any Product Identity used in Open Game Content shall retain all rights, title and interest in and to that Product Identity.

8. Identification: If you distribute Open Game Content You must clearly indicate which portions of the work that you are distributing are Open Game Content.

9. Updating the License: Wizards or its designated Agents may publish updated versions of this License. You may use any authorized version of this License to copy, modify and distribute any Open Game Content originally distributed under any version of this License.

10. Copy of this License: You MUST include a copy of this License with every copy of the Open Game Content You distribute.

11. Use of Contributor Credits: You may not market or advertise the Open Game Content using the name of any Contributor unless You have written permission from the Contributor to do so.

12. Inability to Comply: If it is impossible for You to comply with any of the terms of this License with respect to some or all of the Open Game Content due to statute, judicial order, or governmental regulation then You may not Use any Open Game Material so affected.

13. Termination: This License will terminate automatically if You fail to comply with all terms herein and fail to cure such breach within 30 days of becoming aware of the breach. All sublicenses shall survive the termination of this License.

14. Reformation: If any provision of this License is held to be unenforceable, such provision shall be reformed only to the extent necessary to make it enforceable.

15. COPYRIGHT NOTICE

Open Game License v 1.0a Copyright 2000, Wizards of the Coast, Inc.

Dungeon Crawl Classics Role Playing Game Copyright 2012, Goodman Games

American Survival Guide Copyright 2017, Shield of Faith Studios, LLC

Twisted Menagerie Manual Copyright 2018, Shield of Faith Studios, LLC

American Road Atlas Copyright 2020, Shield of Faith Studios, LLC

Crawling Under a Broken Moon issue #1 - #18 Copyright 2014-2017, Shield of Faith Studios, LLC

Join us as we explore the glowing highways and byways of Umerica and those that ride upon them.

Within these irradiated pages you will find:

- Over a baker's dozen of new Interesting Places to Die for you to inflict upon your players.
- The amusing Roadside Attraction Generator, useful for creating truly terrifying tourist traps.
- The helpful Random Roadtrip Encounters table, just in case you're not sure exactly what is over the next hill.
- Wild weather rules for brewing up an American style storm to make your PC's lives interesting.
- A treatise on the most infamous gangs of the wastelands.
- The Random Gang Generator, for all of your on-the-fly raider ambush needs.
- Three new character classes: Holy Roller, Hunter, and Road Hawg.
- A slew of new Mighty Deeds dedicated to modern weapons and vehicular mayhem.
- A whole section dedicated to new vehicle types and traits.
- And last but not least, Race for Death — a road rally adventure to die for.

This product is compatible with the Dungeon Crawl Classics Role Playing Game

\$24.99 CUBM5004

**CRAWLING
UNDER A
BROKEN MOON**



COMPATIBLE WITH
**DCC
RPG**



crawlingunderabrokenmoon.blogspot.com