

CRAWLJAMMER PRESENTS

THE VAULT OF ASH



MOON DICE
GAMES

COMPATIBLE WITH
**DCC
RPG**

A 5TH LEVEL ADVENTURE BY **DANIEL BISHOP**

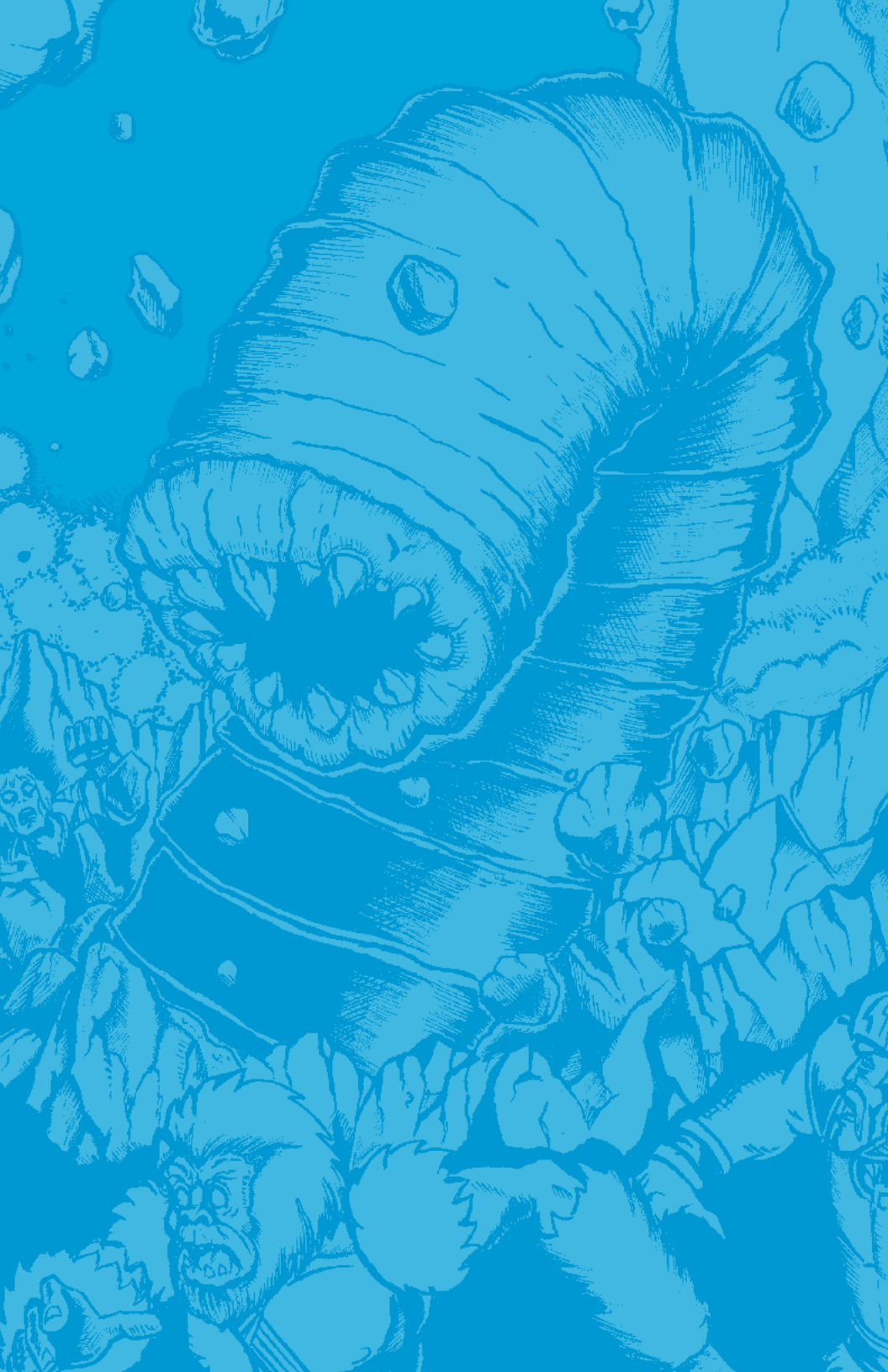

— CRAWLJAMMER —
THE VAULT OF ASH

ASHES AND WORMWOOD PART TWO
AN ADVENTURE FOR 5TH LEVEL CRAWLJAMMERS

Daniel J. Bishop

WRITER

Tim Callahan

EDITOR

Fred Dailey

INTERIOR ARTWORK & BACK COVER

Matt Hildebrand

LAYOUT & FRONT COVER

Special thanks to Emily Hakkinen
for proofreading assistance.

For information about Crawljammer or Moon Dice Games products,
please email us at crawljammerzine@gmail.com



This product is based on the Dungeon Crawl Classics Role Playing Game published by Goodman Games. This product is published under license. Dungeon Crawl Classics and DCC RPG are trademarks of Goodman Games. All rights reserved. For additional information, visit www.goodman-games.com or contact info@goodman-games.com.



INTRODUCTION

This adventure follows *The Weird Worm-Ways of Saturn*, also published by Moon Dice Games. Judges without access to that adventure can set the Vault anywhere they wish; this module accommodates a standard campaign setting as well as it does *Crawljammer*, with a few adjustments.

Saturn was home to a great demon-worshipping civilization in eons past, around the time of the Devonian era on Earth. Whatever cataclysm wrought the end of their culture also caused the weird energies of Saturn's magnetic core, drawing many of their ruins and artifacts deep into the planet, where they do not trouble the solar system of today. This field fluctuates, allowing ships to safely approach once every several thousand years.

One particular necromancer, Zin the Meticulous, devised a way to survive beyond death. With the aid of the demon-god Tsathoggua, he housed his spirit in a black Onyx Ring. In addition, he devised a living idol of the demon-god, which can consume souls to power the magician's survival and eventual return. The un-dead technomancer, and Zin's ancient lover, Satrampa, dwelling upon the frozen ocean-moon Tethys, has been sending adventurers to try their luck in the Vault for millennia. She is well aware that Zin's consciousness still retains its vitality, and can attempt to possess the living body of any who dares place Zin's Onyx Ring upon a finger.

For more background, and for information on Saturn's magnetic flux, see *The Weird Worm-Ways of Saturn*.

SKELETON MEN OF MARS

Thought to be extinct for over 500 years, the Skeleton Men of Mars look very much like greyish-blue skeletons, although their enlarged skulls are translucent, revealing a pulsing phosphorescent shadow of the potent brain within. Close examination shows their stringy, near-transparent flesh and organs clinging to the visible bones. Their name is an omen of fear, as they raided and consumed other races, without differentiating between the sentient and beasts. The Skeleton Men are genderless, reproducing by budding. The bones of the new Skeleton Man begin to acquire opacity only when the budding creature reaches about 1 foot in length, about half-way through the budding cycle. When budding, Skeleton Men are forced into hibernation.

When deprived of food or air, Skeleton Men can hibernate to survive. Those in this adventure entered hibernation within days of being trapped here, never making it beyond the first level of the Vault. Like most that came to

seek the Vault of Zin, they were enticed by Satrampa, who looked no different then than she does now.

The judge may use the Skeleton Men as adversaries or allies, a source of (limited) information, or even as replacement PCs. Hidden enclaves of hibernating Skeleton Men may be encountered in later adventures, either on Mars or elsewhere. In the planetary romances of Edgar Rice Burroughs, Michael Moorcock, and other Appendix N authors, strange creatures learn to value the mostly-human protagonists. If the judge desires, a Skeleton Man – perhaps more enlightened or philosophical than its comrades — could be used as a replacement PC. To this end, a complete Skeleton Man class is included in this adventure.

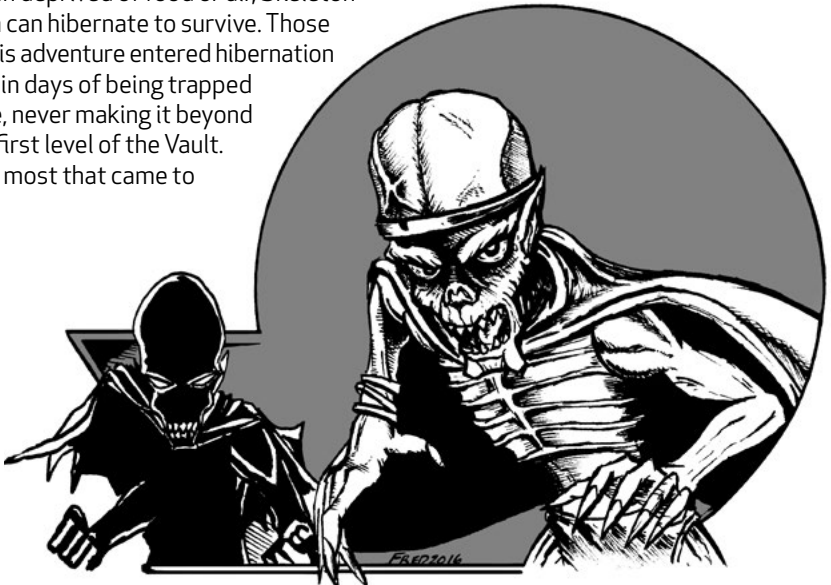

USING MAGIC IN THE VAULT

The power of Tsathoggua permeates the Vault. When a wizard spell is cast, have the caster roll 1d14 + Luck modifier, and consult the following table. If a cleric spell is cast (not

including turning the unholy or laying hands), have the caster roll 1d12 + Luck modifier. If the Icon of Tsathoggua (**Area 2-6**) is destroyed, magic may be cast normally in the Vault thereafter.

1d14 or 1d2 + Luck Modifier	Effect
0 or less	The spell fails, but the spell energy is used to summon 1d3-1 demons of Tsathoggua (see below), which arrive 1d3 x 10' away from the caster. If the caster is Chaotic, there is a 10% chance that they will offer to serve her. Otherwise, they immediately attack.
1-2	The spell is treated as though one step worse on the Spell Chart, which means that any normal failure on a wizard spell is treated as though a natural "1" were rolled. Disapproval is not affected.
3-4	The spell goes off as normal, but the caster takes 1d3 damage each round for 1 round per spell level, as thousands of tiny invisible mouths latch onto him. These mouths can be Turned by a Lawful or Neutral cleric (20+ roll), but are otherwise impervious to mortal hindrance. Examining the wounds shows the bites come from needle-sharp teeth on mouths no more than an inch across.
5-6	As 3-4, above, but the invisible bites occur for 1 round only.
7-9	The area dims as the spell is cast (light sources only half effective), and the manifestation is altered to reflect toads, bats, or corpulence (as determined by the judge).
10-12	The power of Tsathoggua compels you. Gain a +2 bonus to the spell check result, but thereafter for the next 1d3 rounds your mind wanders on distant planes, and you can take no action here. When your mind returns, your body bears the Mark of Tsathoggua in some hidden location. Choose to serve Him now, and gain +1 to a randomly determined ability score.
13-16	As 10-12, above, but the spell check is increased by +4, and the character's mind wanders for 1d5 minutes. Further, the character can choose which ability score gains a +1 bonus, should she choose to declare allegiance to Tsathoggua. If the character chooses to serve the demon, the mark of the demon appears on his face. If the character is a cleric, he thereafter gains his spells from Tsathoggua, and is treated as Chaotic regardless of his professed alignment. Whatever god the cleric formerly served forsakes him completely.
17 or higher	As 13-16, above, but the spell check is increased by +8. The character's mind wanders for 1d7 x 10 minutes. Finally, should the character choose to serve Tsathoggua, she gains +1 to a random ability, and +1 to an ability score of her choice. She is immediately aware of Tsathoggua's desire to have one companion bear the Ring of Zin (thus reviving Tsathoggua's trusted servant), and having all other PCs present sacrificed to the Icon of Tsathoggua in Area 2-6 . For every PC sacrificed to the Icon, the PC servant of Tsathoggua permanently increases her maximum hit points by 1d3.

DEMONS OF TSATHOGGUA

Demons of Tsathoggua appear as grossly overweight toad-like humanoids covered in coarse black hair. They have bat wings, but can only fly clumsily, and for no more than 1d3 rounds, due to their corpulence. Their faces are toad-like, with sharp teeth and multi-faceted eyes. Demons of Tsathoggua also have a scorpion-like poisonous sting, which grows from their heads, and can reach targets up to 10 feet away. The venom of the demons' stings causes 1d4 damage as the victim is aged 1d8 years. If the victim fails a

DC 15 Fort save, he instead ages 3d8 years and takes 1 hp damage per year aged. Neutralizing the poison does not reverse the aging effect.

The judge should be familiar with the demon traits listed on page 401 of the *core rulebook*.

Demon of Tsathoggua (type II demon): Init +4; Atk bite +8 melee (1d5+2) or sting +6 melee (1d7+2 plus poison); AC 13; HD 6d12; MV 30' or fly 10'; Act 2d20; SP demon traits, poison; SV Fort +10, Ref +4, Will +8; AL C.



ADVENTURE START

The great stone mouth of the enormous statue — an unholy, corpulent admixture of bat, toad, and some loathsome thing you cannot name — opens with an audible groan. The Ape-Men of Duggabask flee in all directions, scattering in irrational fear. You can see neither hinge nor seam allowing the mouth to open, but within there is worked stone, and beyond three wide steps a great set of stone double doors. Surely, this must be the fabled Vault of Zin!

When using this adventure in conjunction with *The Weird Worm-Ways of Saturn*, none of these Ape-Man will hinder the PCs either entering, or (if they do) exiting the Vault. Surviving PCs will be met with superstitious awe, having been swallowed and returned whole from the maw of Tsothoggua. The adventure begins when the PCs open the stone double doors; **Area 1-1** is beyond.

LEVEL ONE:

SKELETON MEN FROM MARS!

A dozen Martian Skeleton Men entered the Vault over 1,000 years ago. They have been hibernating all this time, awakened by the opening of the colossal statue's maw. The statistics below represent the Skeleton Men at -2d on the dice chain due to having recently awoken from hibernation. The six most powerful Skeleton Men are specifically placed; the judge may

have the remaining six move about as desired. The mobile six are 5th level, and one or more may be suitable as a replacement PC. The Skeleton Men were not strong enough to make the elevator in **Area 1-12** work. They are hungry, but cunning.

These Skeleton Men have a d14 Action Die for the first d24 hours, a d16 Action Die for the next d12 hours, and then have a full d20 Action Die. Damage and Psionics Die also rise by +1d with each step. If the PCs take a long time exploring the Vault, their surviving enemies become more powerful!

Wandering Martian Skeleton Men

(6): Init +0 on 1d14; Atk bite or claw +2 melee (1); AC 15; HD 5d6; hp 17, 21, 23, 16, 22, 25; MV 30; Act 1d14; SP hibernation, water vulnerability, psionics (1d3 Psionics Die); SV (d14) Fort +4, Ref +2, Will +3; AL N.

This level contains a coating of fine ash over the floor, 3 inches deep. Violent motion stirs it up in a choking cloud (Fort DC 5 or take a -1d penalty to all rolls each round); this can be prevented by breathing through a moistened cloth. Skeleton Men gain a +4 bonus to this save, and demons are unaffected.

Worse, there is a 1 in 10 chance per round of violent action that ash will affect any open flame, such as a torch or candle (but not a lantern), causing a flare-up that does 1d3 damage to the character holding the flame.

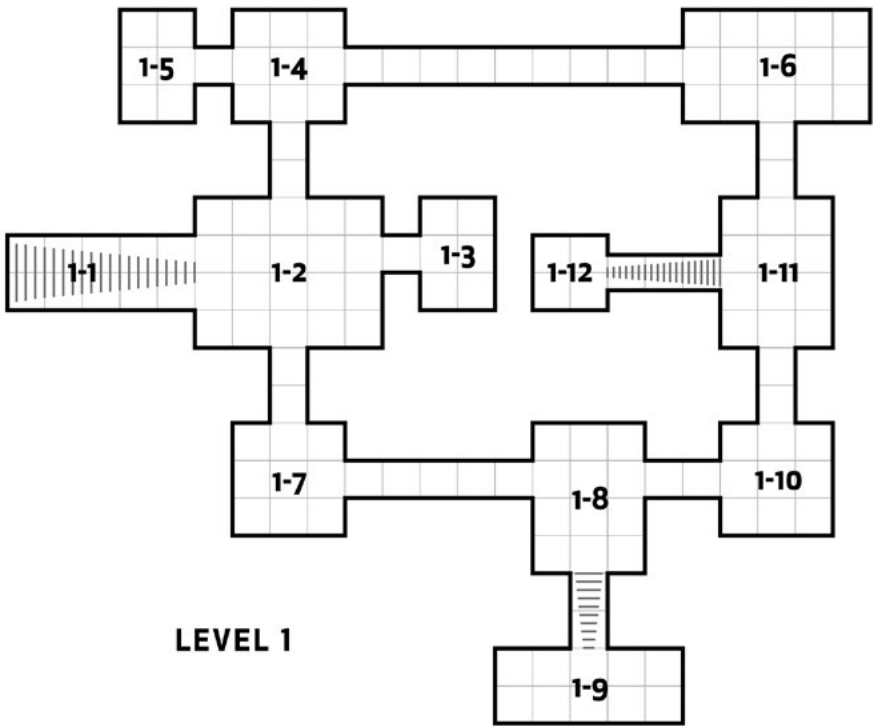

1-1 - Entrance Stairway: *As you pull the stone double doors open, a great rush of stale air comes from within, bearing with it a cloud of grey-white ash. As the air settles, you can see wide stone steps leading into the darkness beyond. The air smells dry, and there is a sense of incredible age, distorting the straight lines of walls, ceiling, and even steps.*

The stairs go downward for 50' at a 90° angle, so that the length of the staircase itself is just over 70'. If the characters are quiet, the Martian Skeleton Men in **Area 1-2** are still hibernating, and may be found in their apparently mummified state. If the PCs are loud, the Skeleton Men will

have revived. If the PCs are loud, and take a long time to act, the Skeleton Men will take positions on either side of the stairway along the western wall, ambushing them with automatic surprise when they enter.

1-2 - Entry Hall: *At the end of the stairs is a 40' wide vaulted hall whose stone floor is coated with a layer of fine ash. If the PCs have been quiet: You can see four mummified forms, skeletally thin, huddled in the dust. They must have been trapped here when the stone idol last opened, long ages ago.*

The creatures here are four **Martian Skeleton Men**. Skeleton Men are

helpless while hibernating, but automatically awaken if damaged, or after 1d3 rounds if food or air becomes available. Skeleton Men are at -2d on the dice chain to all rolls for the first d24 hours after being awakened, and -1d on the dice chain for the next d12 hours thereafter.

Advanced Martian Skeleton Men (4):

Init +1 on 1d14; Atk bite or claw +3 melee (1); AC 16; HD 6d6; hp; MV 30'; Act 1d14; SP hibernation, water vulnerability, psionics (1d4 Psionics Die); SV (d14) Fort +5, Ref +4, Will +3; AL N.

1-3 - Dead End: *After 10', the passage enters a room some 30' wide and 20' deep. There are no obvious exits here, but the far wall is covered with an ancient peeling fresco of the creature whose enormous mouth you have entered – an unholy mixture of bat and toad with some nameless thing beyond your comprehension. It seems to be swallowing some great earthworm, while tiny pale green men and women look on in horror. The toad-thing in the fresco is larger than the idol outside, so great that the worm's struggles destroy buildings and crush individuals to death.*

Close examination of the fresco shows that, among more human-looking figures, antecedents of the Saturnian Ape-Men seem to form a servant class. Some of the Ape-Men look upon the enormous worm with apparent awe. Others regard its consumption with dismay. A title written in Demonic reads, "Tsathoggua Consumes the Worm".

1-4 - Demonic Runes: *The hallway leads into a square room, some 30' to a side, with an arched passage in the center of every wall but the northern. To the north, large runes are deeply carved into the wall. The letters themselves are disturbing, and seem to change whenever you are not looking directly at them, although you can see no specific alteration when you check.*

The runes are written in a form of Demonic, and read:

To the Vault of Zin, Greetings!

Thou Provest Thy Worth Going Ever Downward

**Wisest Only May Touch the Black Idol
Strongest Only May Wear the Black Ring**

In the Name of Tsathoggua, Go Thou Forth!

1-5 - Failed Trap: *After 10', the passage opens into a chamber about 30' wide and 20' deep. The far wall is dominated by a carved relief sculpture of a toad-like creature with great bat wings and thick woolly fur. Tentacles and strange appendages sprout from it in odd places. One of its large eyes appears to be a red gemstone twice the size of a man's head; the other is missing. The one-eyed visage stares at you open-mouthed. Its thick lips are lined with sharp stone fangs.*

If anyone steps into this room, there is a loud click underfoot, followed by a slow grinding noise from the far wall. There is an acrid smell, and a thin smoke wafts upward from the relief's stony maw. A pressure plate (DC 15 to

locate under the ashes) once triggered a fire trap. For all his care, Zin didn't fully understand the extent of Saturn's magnetic flux following the collapse of his civilization. Over long aeons, the moving parts shifted, so that the trap no longer works.

The gemstone is made of paste, and has no value.

1-6 – Skeleton Man Commander: Any character approaching this room is attacked by the **commander** of the Martian Skeleton Men:

Skeleton Men Commander: Init +2 on 1d14; Atk bite or claw +4 melee (1); AC 20; HD 8d6; hp; MV 30'; Act 1d14 + 1d14; SP hibernation, water vulnerability, psionics (1d5 Psionics Die); SV (d14) Fort +4, Ref +7, Will +5; AL N.

This chamber is some 50' east to west, and some 30' north to south, with passages in the center of the south and west walls. The walls are covered with mutated frescos of social scenes that make the chamber seem as though it were the center of a party extending for miles. The people seem human, but with pale green skin, and their servants remind you of the Ape-Men you have encountered on Saturn. There is something sly about the way the humans are depicted. The more you see of them, the more certain you are that they hide depravities with the positions of their bodies, which would be hideous if you could see them.

Anyone who studies the fresco may roll a Luck check to locate a figure that seems eerily similar to Satrampa, although surely she cannot be so

old. She is accompanied by a tall man wearing muted red robes with commanding eyes. His face looks vaguely like that of a warrior in the party. He raises a glass of pale wine, and a black onyx ring can be seen on his finger.

The mural is not magical, but it is the result of Zin's unimaginable foresight and pre-planning. Further examination shows dozens, nay hundreds, of other burgundy-robed men raising wine glasses in the crowd. The men all wear black rings, but have different faces. Only the eyes are the same, and the woman at his side.

Searching under the ash in the northeast corner reveals a large red paste gemstone, the mate to the one in **Area 1-5**.

1-7 – Demonic Runes: *The hallway leads into a square room, some 30' to a side, with an arched passage in the center of the north and east walls. To the south, large runes are deeply carved into the wall. The letters themselves are disturbing, and seem to change whenever you are not looking directly at them, although you can see no specific alteration when you check.*

The runes are written in a form of Demonic, and are the same as in **Area 1-4**.

1-8 – Budding Skeleton Man: *The passage enters a room 30' deep and 50' from north to south. There is an archway opposite where you entered, and another to the south. The passage*



to the south has letters carved over the archway. A bundle, like a mummified man, lies unmoving in the northeast corner.

The bundle to the north is the last of the Martian Skeleton Men. It began the process of budding long ago, and three imps hang from its forehead, about 20% formed. Sealed in the Vault of Zin, the Skeleton Man and its progeny died of starvation. If touched, the thing drags itself to its feet as an **un-dead Skeleton Man**. Each time the un-dead creature is hit, one of the **imps** drops from its forehead and becomes an independent un-dead monster. If any creature falls, each un-dead must succeed in a DC 10 Will save or spend 1d3 rounds consuming it. Each round of consumption decreases the chance of successfully recovering the body by 1, or the rounds that the creature can be saved by magical healing by 1. These effects are cumulative by round, by creature.

Un-dead Skeleton Man: Init +0; Atk bite or claw +3 melee (1d3); AC 14; HD 4d12; hp 30; MV 30'; Act 2d20; SP un-dead traits, consume, critical range 19-20; SV Fort +7, Ref +3, Will +8; AL C.

Un-dead Imps (3): Init +4; Atk bite +5 melee (1); AC 16; HD 1d6; hp 4, 5, 6; MV 20'; Act 1d16; SP un-dead traits, consume; SV Fort +4, Ref +8, Will +10; AL C.

The letters on the archway to the south are in a form of Demonic, and read "Occult Secrets, O Seeker, For Your Eyes Alone". Stairs lead downward beyond the arch. These steps go downward at a 90° angle for an apparent length of almost 30'.

1-9 - Wizard Trap: At the end of the stairs is a chamber with green stone walls, some 50' wide and 20' deep. Runes are inscribed in columns on the walls, forming what appear to be discrete formulae for various spells — two on the south wall, one each to west and east, and two to the north, flanking the arch where the steps enter the room.

Zin knew well that wizards would be attracted to his Vault, but he desired a new body that was young, handsome, strong, and easily dominated. To this end, he devised a chamber to attract and destroy wizards. There are six

spell formulae here, and each one, once examined, requires a DC 20 Will save to avoid reading aloud and casting, as the magic of the writing compels the caster. A character without knowledge of arcane spells must still make this save, but casts using only 1d10 + Intelligence modifier (Thieves use their “cast spell from scroll” die).

The spells are:

- East Wall: *Choking cloud* (p. 134): The cloud is an explosion of ash, and the caster is always the target.
- South Wall (Eastern): *Magic missile* (p. 144-145): Beams of black energy target the caster.
- South Wall (Western): *Sleep* (p. 155-156): The manifestation is a cloud of glowing ash surrounding the target, which is always the caster. The caster always awakens on the condition that another character dons the onyx ring (see **Area 4-2**).
- West Wall: *Turn to stone* (p. 233-234): The spell manifests as ashes rising from the ground, coating the target, and transforming him to stone. The caster is always targeted; other characters in range may also be targeted depending upon the spell check result.
- North Wall (Western): *Ray of enfeeblement* (p. 190): This spell requires a point of spellburn, causing the caster to cut a rune sacred to Tsathoggua into the palm of his hand. While this may eventually heal, the scar will always be visible. The manifestation is a sickly grey necrotic ray, and the target is always the caster, who

does not gain any Strength as a result of this spell. Keep track of the Strength that the caster would gain; this becomes a penalty to the Will save to resist the Idol of Tsathoggua in **Area 2-6**. The first time a creature successfully saves, this penalty goes away.

- North Wall (Eastern): *Lightning bolt* (p. 222-223): The first target is always the caster; if there are other PCs in the room, they are targeted on the basis of Luck (i.e., lowest Luck first).

The effects of the “Using Magic in the Vault” section apply to these spell checks. Note that a wizard who survives examining (and/or casting) a spell may use the experience to attempt to learn it, as per the **core rulebook**, pp. 314-316. The manifestation will always be as indicated above, unless the judge determines otherwise. Determine mercurial magic normally.

1-10 – Silver Coins: *This square chamber is about 30’ to a side, with an archway to the north and the west. You can see that there were once frescos painted on the walls, but they have largely peeled off, and it is not at all certain what they once depicted.*

A scattering of 536 blackened silver coins are probably hidden under the ashes in the southeast corner, brought here by explorers long ago. They were once in leather bags, but these were eaten by the Martian Skeleton Men when they became trapped here. The coins themselves had forced their

way through the leather, and there are marks in the stone where the floor resisted Saturn's magnetic pull upon each coin. Depending upon when this room is encountered, it is possible that the coins are on the ceiling due to the magnetic flux.

Examining the frescos shows that they were clawed off the walls; the Skeleton Men also experimented here, unsuccessfully trying to use the fresco material for sustenance. The other frescos on this level would have been clawed off as well had this worked.

1-11 – Bare Chamber: *The passage enters into a vaulted chamber some 30' across. You can see another archway on the western wall. The room otherwise appears to be empty.*

Brilliantly colored tiles celebrating the depravities of Tsathoggua (and several other equally disgusting lesser Saturnian gods) cover the floor, but it is unlikely that the PCs will ever discover them under the layer of ash.

The stairs to the west go down at a 90° angle for just over 40' before emerging into **Area 1-12**.

1-12 – Elevator Room: *At the end of the stairs is a 20' square room. There is a heavy iron wheel built into the western wall, its shape deformed by ages of Saturn's normal constant magnetic pull. The wheel is on a red metal rod or axle which goes into the wall, and which strangely seems not to be deformed. The ashes are deeper in this room than*

above, being almost half a foot deep.

The red metal axle on the wheel is a late creation of Zin's. Although Saturn's magnetism affects all other metals, even if they are non-ferrous, it does not affect the red metal, *Zinnium*. Thus, while the magnetism and flux has affected some of the wizard's mechanisms and traps, others still function. *Zinnium* can be used to create a connection to Saturn — Tsathoggua provided at least one terrestrial wizard with a red metal door that would take him to Saturn if he was forced to flee the world of his birth. The wizard, and a cleric who followed him, had great influence on several strange civilizations far to the south of the Weird Wormways of Saturn.

If the wheel is turned counter-clockwise (Strength DC 20), the floor begins to grind downward at a rate of 1 foot per minute. Turning the wheel clockwise (Strength DC 15) stops the floor from moving, but the wheel doesn't move with the floor, and each minute that passes increases the DC by 1, until the PCs can no longer reach the wheel. The floor drops down a full 60' over the course of an hour. The floor of the elevator becomes the floor of **Area 2-1**. After the elevator has been down for an hour, the floor begins to grind back upward over the course of 2 hours (6 inches per minute), resetting the wheel when it reaches the top.

The walls here are smooth, but can be climbed with a DC 15 check per 20'.

LEVEL TWO:**THE EMPTY HALLS**

This ash on this level is 6 inches deep. If stirred up, by violent motion, PCs take a -1d penalty to all rolls unless a DC 10 Fort save is made each round. As before, this can be prevented by breathing through a moistened cloth. Skeleton Men gain a +4 bonus to this save, and demons are unaffected.

The chance of a flare up with open flame is 1 in 8 per round of violent action, causing 1d5 damage to all within 5' of the character holding the flame (Ref DC 10 for half damage, rounded up).

The doors on this level are all made of stone with hidden hinges. They require a DC 5 Strength check to open, but mysteriously close after 1d5 rounds unless held open (with spikes, etc.).

2-1 – Elevator Room: *As the floor slowly grinds downward, you eventually become aware of the top of an archway beginning to show to the south. Slowly, minute by minute, the size of the archway becomes larger, until eventually it is large enough to pass through on your belly, sliding downward into the area beyond. The opening gets ever larger, taking 6 minutes before the arch is fully revealed, and the floor comes to a rest.*

The “ceiling height” in this area depends upon where the floor is. When the floor comes to rest, the ceiling is a full 70' overhead, lost in darkness. Once the floor begins to rise, the ceiling height is likely to be the distance that the block

is overhead. The stone floor is 5' thick, so that, when it is raised, there is a 5' drop into this area. Searching the area reveals a red Zinnium plate upright in the center of the floor, approximately 2' square and raised to a height of 8". Pressing this down (by standing on it) causes the elevator to grind its way slowly down once more.

2-2 – Empty Room: *This chamber is 30' square, with an arched passage in the middle of the north and south wall, and a stone door to the west. The eastern wall is decorated with a worn fresco depicting evil-looking folk conducting sacrifices to various demonic creatures with blasphemous forms. Chief among them are a man and a woman, but they are faced away from you, and you cannot identify them with any certainty. The woman has many rings, and the man wears burgundy robes.*

There is nothing of interest here.

2-3 – The Angelic Door: *This area is 30' square, with a passage to the north and west. To the east, there is a stone door inscribed with runes glowing with their own pale yellow light. The south wall seems to have been covered with frescos, but these were scraped off long ago.*

The runes on the door are in the language of Angels, and read, “Only the Holy May Pass Herein/A Test of Faith for the Servants of the Gods”. A cleric who spends time studying the runes

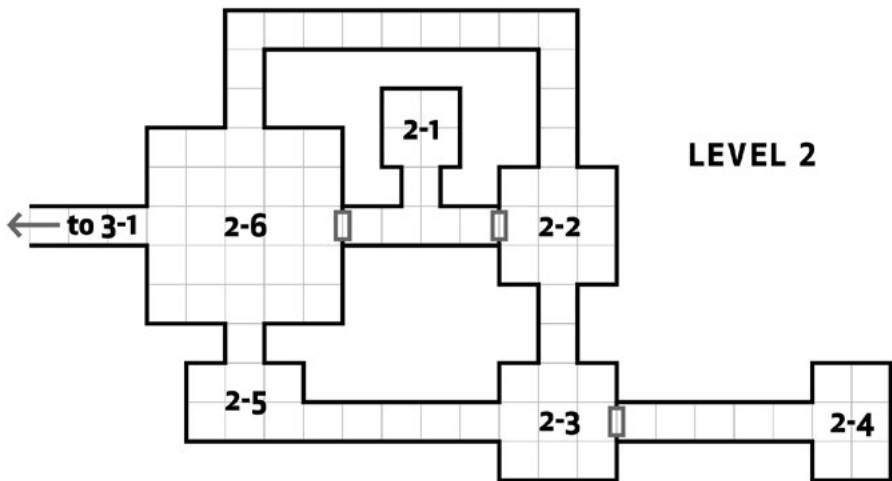

has a chance equal to their level on 1d10 of becoming uneasy looking at them, as though they were not exactly as they seemed. This is the case; the demon who inscribed these words could not help but reveal its nature to some degree.

Beyond the door is a dark hallway, leading to **Area 2-4**. The darkness is magical; no light reveals more than 10' within it.

2-4 - Lair of the Klarashton: This chamber is the lair of a demon, known as the Klarashton, which has lurked here for ages devouring those foolish enough to pass the "angelic" door in **Area 2-3**. Once a character passes 30' down the hallway, the door slams shut and cannot be opened without a DC 20 Strength check until either the Klarashton is dead, or 30 minutes have passed.

The Klarashton is bored more than anything, and plays with its victims.

"Only fools may pass herein", the demon chortles with a voice like breaking glass. "A test of stupidity for the slaves of the gods!" Engaging the demon in conversation, or challenging it to a game or contest (riddles, chess, etc.), can cause the creature to halt its attacks and buy the PCs time.

The Klarashton is a Type IV Demon appearing as a desiccated mummy with burning coals for eyes and great fangs, its humanoid torso mounted on a 20' long ophidian tail. It has telekinetic powers, used largely to hold the door once on or more PCs have come far enough down the hallway. On a successful bite attack it drains blood causing an additional 1d3 points of Strength or Stamina damage (player's choice, Fort DC 22 negates).

The Klarashton has been here for a long time, and it has made it bored and slow-witted. If the players are clever enough to try to outwit the demon, the judge is advised to let any plan work at



least reasonably well. The demon will not easily let them go; if beaten, it will demand “two out of three”. If beaten twice, it will demand “three out of five”, and so on.

The Klarashton (Type IV demon): Init +6; Atk bite +12 melee (1d3) or claw +12 melee (1d5); AC 21; HD 10d8+10; hp 60; MV 30; Act 2d20; SP infravision, telepathy, *darkness* (+16 check), immune to weapons of less than +3 enchantment or natural attacks from creatures of 7 HD or less, immunities (fire, cold, electricity, and gas), half damage from acid, critical range 17-20, limited telekinesis, blood drain, death throes; SV Fort +12, Ref +12, Will +10; AL C

If the demon is slain, there is a loud roll of thunder, and the ground appears to fall away. The demon’s body falls into darkness. All within 20’ must succeed in a DC 10 Reflex save or tumble into the demon world as well. They take no falling damage — physics are different there — but are forever lost unless a quest is undertaken to recover them. A kind judge might allow the lost PCs an opportunity to fight their way out of the demon world in a special adventure.

So long as the Klarashton survives, this room appears to be a gore-drenched nest of darkness, smelling strongly of old blood. Once the demon is gone, the room appears empty, save for half a foot of ash (which is not present,

and does not have an effect, while the Klarashton is present).

2-5 - Empty Room: *This area is 30' from east to west, and 20' north to south. The walls are decorated with ancient frescos. These show various people — pale green humans and Ape-Man alike — but what it is that they are doing is uncertain. Strangely, none of the painted figures looks into this room; at best they offer only a one-quarter profile, as their attention is drawn by something you cannot see.*

There is nothing of interest here.

2-6 - The Icon of Tsathoggua: *This large chamber is 50' to a side, rising up well over 30' to vaulting lost in the darkness. The walls are painted with frescos of vice and debauchery, the figures both human and clearly non-human. Many of the humans have pale green skin, but not all — you can see primitive versions of the peoples of many worlds. Among them are strange beings are dark stone cacti and stranger beings that seem to be made entirely of flexible minerals, spherical monstrosities with grotesquely elongated arms and legs, and humanoid beings whose faces are part of their headless torsos. All of these beings are depicted killing, sacrificing, and mating with each other, nor are these the only vices which engage them. In the center of this temple-chamber is a bloated black idol of the same toad-bat-thing which was depicted in the Ape-Man village above you. The air around it seems palpably darker and more perilous.*

Characters that ignore this idol are in no danger, so long as they leave this chamber quickly. Those who interact with it discover that it has a malignant spirit capable of consuming souls. Souls consumed by the idol power Zin the Meticulous in his repose, allowing his spirit to survive within the Onyx Ring (which is linked to this idol; see **Areas 4-2** and **4-3**).

Anyone who touches the idol takes 1d5 damage and must succeed in a DC 15 Will save or suffer 1d3 points of temporary ability score damage (roll 1d5 to determine ability score for each point; Luck is never targeted; events in **Area 1-9** may cause a penalty to this save). The idol may strike with a shadowy tongue (+3 to hit, ignores armor) once per round. Anyone hit by this attack is drawn 10' closer to the idol each round unless a Will save (DC 20) is made. If the character is adjacent to the idol, he is forced into contact with it. The tongue disappears with a successful save (it is illusory), and the idol may have any number of active tongues.

The idol may also make a targeted sonic attack once per round, causing a PC who fails a DC 15 Fort save to lose its next Action Die. Typically, the idol will attempt to destroy casters and immobilize warriors or handsome thieves, which may become suitable replacement bodies for Zin. It is unlikely that the PCs will be able to destroy the idol, but they are welcome to die trying.

The judge should keep careful track of who is injured by the idol, and how many ability score points are drained,

as it will impact the encounter with the revenant in **Area 4-3**.

Note: If the Idol is destroyed, the “Using Magic in the Vault” section ceases to be in effect. Whatever weapon was used to destroy the icon becomes a +3 Lawful weapon, which may develop other powers as the judge sees fit. If destroyed by an arcane spell, the caster may reroll the mercurial effect and choose the better of the two results. If destroyed by divine power, the cleric thereafter casts that spell with a +1d bonus on the dice chain.

Icon of Tsothoggua: Init +3; Atk illusory tongue +3 melee or ranged; AC 25; HD 20d8+40; hp 140; MV 0; Act 1d20; SP half damage from non-bludgeoning weapons and spells, immunities (piercing weapons, cold, fire, electricity, poison, disease, gas, biology-dependent attacks, mind-affecting), illusory tongues, draw closer, sonic attack; SV Fort +20, Ref -10, Will +30; AL C.

The hallway to the west is on a slight slant, running 60’ down to **Area 3-1**. A dwarf, miner, or similar character notices the slant immediately. As a character passes this way, the ashes become ever thicker, until they are 1’ deep in **Area 3-1**. Level 3 is 20’ below Level 2.

LEVEL THREE: WORMS OF DUST

This level has been infiltrated by cast-offs of the Wormgod, strange creatures capable of burrowing through stone, and which can consume ash. Like the

hydra worm of the surface, their bodies grow gem-like biological nodules called sequins, which may be violet (1 sp value), green (1 gp), or red (1 ep). Dust worms have 1d6 violet sequins per HD, 1d3 green sequins per HD, and a chance of 1d3 red sequins equal to HD or less on 1d30. Sequins are non-metallic.

There are any number of **dust worms** here. The judge may have the PCs encounter groups of 1d5 of them whenever desired. A dust worm is 1’ long per Hit Die. Even the longest dust worm is only 8 inches in diameter; their tunnels are not generally passable by PCs. Bite damage is determined by HD: 1 HD = 1, 2 HD = 1d3, 3 HD = 1d4, 4 HD = 1d5; 5 HD = 1d7; 6 HD = 1d10. To determine the Hit Dice of a dust worm, roll 1d12-1 (minimum 1 HD). Dust worms are blind, but can sense movement and creatures within 120’.

Dust Worm: Init +0; Atk bite +0 melee (by Hit Die); AC 9; HD 1-6d8; MV 20’ or burrow 5’; Act 1d20; SP blindsense 120’, immune to mind-affecting; SV Fort +5, Ref +2, Will +0; AL N.

This level contains a coating of fine ash over the floor, 1’ deep on average. Violent motion stirs it up in a choking cloud (Fort DC 15 or take a -1d penalty to all rolls each round); this can be prevented by breathing through a moistened cloth, but the cloth must be frequently moistened to remain effective. A dry cloth grants a +2 bonus to the save. Skeleton Men gain a +4 bonus to this save, and demons are unaffected.

There is a 1 in 3 chance per round of violent action that ash will affect any

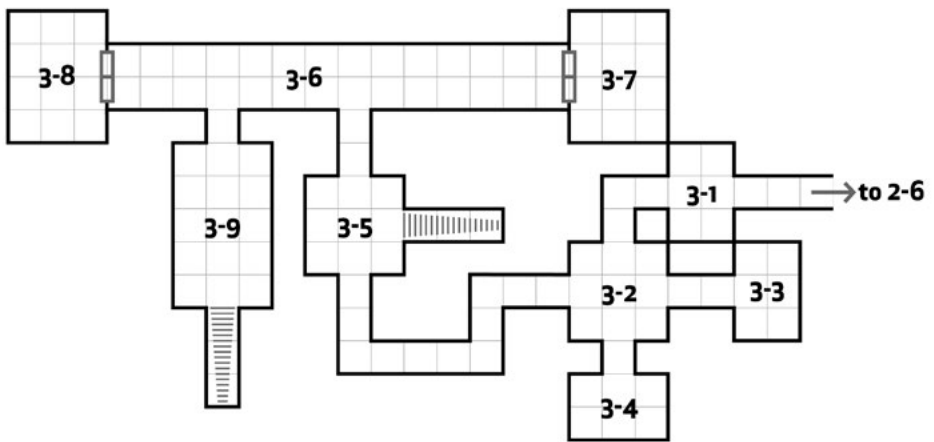

open flame, such as a torch or candle (but not a lantern), causing a flare-up that does 1d6 damage to all within 5' of the character holding the flame (Ref DC 10 for half). Any character who takes 6 damage catches on fire, and takes another 1d6 each round until a DC 10 Reflex save succeeds. This character can also cause a flare-up for additional damage, and attempting to put the flames out counts as violent action. These ashes are deep enough that a halfling carrying an open flame risks a flare-up simply by moving.

The doors on this level are all made of stone with hidden hinges, and all are locked. They require a DC 15 Pick locks check to open, or a DC 25 Strength check to force. The keys to these doors may be found in **Area 4-3**.

As a result of the dust worms, all walls on this level are pocked with holes from 3 to 8 inches in diameter.

3-1 - Entry to Level Three: *The passage gives way to a room some 30' wide and 20' deep. Runes are carved onto the archway of an exit directly opposite this passage.*

The runes are in the Demonic tongue, and read "For the Glory of Tsathoggua" and, under that, "That I Who Fall May Rise Again".

3-2 - Intersection and Worms: *This is a 30' square room, with an arched passageway leading outward from the center of each wall. The walls and ceiling, you note, are riddled with small holes, most of them no more than 3 inches in diameter. Even the largest is closer to half a foot than a foot. You cannot tell what the floor is like, because of the thick coating of ash.*

Characters entering this room for the first time are attacked by 5 three-foot-long dust worms hiding beneath the ashes. After three rounds of combat, another 1d5 enter through the ceiling

holes each round, until a total of 10 dust worms attack. The first time worms drop from the ceiling, they gain a free attack due to surprise, unless the PCs take extraordinary precautions. Thereafter, determine who any new dust worms attack, and those characters gain a roll under Luck or Intelligence (whichever is better) to avoid a free attack.

Dust Worms (10): Init +0; Atk bite +0 melee (1d4); AC 9; HD 3d8; hp 13 each; MV 20' or burrow 5'; Act 1d20; SP blindsense 120'; immune to mind-affecting; SV Fort +5, Ref +2, Will +0; AL N.

3-3 – Hot Bathing Chamber: *This area appears to be empty, apart from the holes riddling its walls. It is 30' wide and 20' deep. You can see shreds of frescos in predominantly blue or green, but whatever they once depicted is impossible to tell.*

This room was once filled with hot water from spigots now hidden beneath the ash. The floor level is 3' below that of the hallway, so that any character entering here drops suddenly (Ref DC 5 or drop any held item; check for each item). A character holding an open flame automatically causes a flare-up, which has a 1 in 3 chance of causing another each round until the chance fails.

An item dropped is lost under 4' of ash, so that there is only a percentage chance (equal to Luck) of finding a relatively large object (such as a shield or sword) each round of searching. Smaller items have only ½ to ¼ of this chance of recovery. Searching has a 1

in 3 chance of causing a flare-up each round an open flame is used for light.

Smaller characters, such as halflings and dwarves, run a risk of drowning in the ash. If they succeed in a DC 15 Reflex save, they can last Stamina rounds before needing to breath. Otherwise, they did not get a good breath, and can only last half that long. A natural "1" indicates that a character begins to drown immediately. Likewise, any round of activity consumes two rounds' worth of held breath. When a character has no more held breath, he begins to drown.

Each round, a drowning character must make a DC 10 Fort save or temporarily lose 1 point of Stamina. The save DC increases by 1 each round after the first. A drowning PC can take no actions and must be rescued by another character. When a PC's Stamina reaches 0, he dies. If the PC is rescued, the lost Stamina is restored with 1d5 minutes of rest.

A character in the ash can attempt to climb out again with a DC 10 check. Each failure increases the DC by 2 to a maximum of DC 15. Another character can aid a fallen character from the outside, using a rope, spear, pole, or similar device, with a percentage chance equal to both characters' combined Luck scores of success. Once a character is drowning, though, he no longer adds his own Luck score to this chance.

3-4 – Cold Bathing Chamber: *This area appears to be empty, apart from the holes riddling its walls. It is 30' wide and 20' deep. You can see shreds of frescos in predominantly blue or green,*

but whatever they once depicted is impossible to tell.

This is exactly like **Area 3-3**, above, except that it was once a cold water bathing chamber, and that stairs in the one-time pool make it easier to climb out (DC 5 base check).

3-5 - The Way Down: *The passage leads into a 30' square chamber. There is an archway in the wall opposite you, and one in the center of the wall to your right. The walls are carved here with images of toad-faced demons, Saturn ring bats, and similar creatures, but the carvings are riddled with the same holes that the rest of the walls are — this makes them both more grotesque and less menacing than they might otherwise seem.*

The way to the right is the stairway which goes down 30' at a 90° angle, seeming to be about 40' long. At the bottom is a pressure plate of red *Zinnium* that causes the steps to rotate, creating a flat slide. At the same time, six *Zinnium* spears extend 5' from the east wall. The area at the bottom is only 10' square, so that a character who triggers the trap is safe from the spears unless other characters on the stairs slide down, causing one or more PCs to be impaled (1d8 damage, Ref DC 15 negates). Climbing back up requires two DC 10 climbing checks; if the second fails, the PC must succeed in a Reflex save to avoid being impaled. The stairs return to normal 1d6 x 10 minutes after there is 50 lbs weight or less on the pressure

plate. The spears are strongly affixed, and cannot be removed.

Going to the north has a 1 in 5 chance of triggering a pressure plate that causes a spear of red *Zinnium* to shoot out of the keystone of the arch (+4 to hit, 1d8 damage). The spear can be removed and used as a weapon. If not removed, it withdraws into the arch after 1d5 rounds. There is a 1 in 6 chance each time it should move that the mechanism fails, and the spear doesn't attack or withdraw. This trap is DC 15 to find (largely due to the ash and the wormholes), but only DC 5 to disable.

3-6 - The Hall of Frescos: *The passage enters a 20' wide hall, running east to west, vaulted to a height of 20'. The walls are covered with flaking, faded frescos, whose once-bright colors have been peppered with wormholes. The subject of the murals appears to alternate between gatherings of cruel-faced pale green folk and corpulent bat-toad-demon things conquering and consuming worms of various types.*

This hallway is now home to the largest of the **dust worms**, a monster 8' long and 1' in diameter. When PCs approach the eastern double doors to **Area 3-7**, it bursts out of the southern wall near the floor, surprising on a 3 in 5 chance. (A PC may burn a point of Luck to negate surprise for that PC only.)

Monstrous Dust Worm: Init +2; Atk bite +2 melee (1d14); AC 12; HD 8d8+8; hp 45; MV 30' or burrow 10'; Act 2d20; SP blindsense 120'; immune to mind-affecting; SV Fort +7, Ref +3, Will +0; AL N.



3-7 – Eastern Treasure Vault: The double doors to this chamber are not only locked, but are trapped with a prominent magical glyph that summons a Type II demon of Tsathoggua if the name “Zin” is not spoken, while touching the door, before opening it. The demon appears 30’ away from the doors to the west, and is instructed to slay and devour those who attempt to steal from the treasure vault.

Beyond the double doors is a room 40’ wide and 30’ deep. Within is a jumble of broken pottery sherds, coins, metal bars, and ingots. The ceiling and walls all appear to have been battered, and some of the metal is deformed by having smashed into the ceiling and floor many times over the aeons. You can imagine that the floor must look similarly damaged under the thick coating of ash.

Scattered throughout this vault are 83 ingots of raw copper (2 lbs. each, worth 4 gp), 28 ingots of raw gold (10 lbs. each, worth 50 gp), 121 bars of silver (164 lbs. each, worth 20 gp), 102 bars of gold

(300 lbs. each, worth 1,500 gp), 146 bars of iron (110 lbs., worth 25 gp.), 10 bars of Zinnium (130 lbs each, worth 3,000 gp), and coins to the value of 51,531 cp, 4,838 sp, and 643 gp. All of the coins are of strange, asymmetrical shapes, and marked with evil-looking runes. All of the metal bars are 1 ft. x ½ ft. x ½ ft. This is an enormous treasure, but trying to carry it all off during Saturn’s magnetic flux is likely to be the death of anyone foolish enough to attempt it. Even attempting to sort through it all might take enough time for Saturn’s magnetic pull to normalize...

3-8 – Western Treasure Vault: As with Area 3-7, this door is guarded with an obvious magical glyph. This causes a burst of cold in a 30’ radius (3d6 damage, Fort save DC 15 for half) unless “Satrampa” is said by someone touching the door before it is opened.

This room is otherwise a mirror of **Area 3-7**, except in its total contents: 92 ingots of raw copper, 19 ingots of raw

gold, 123 bars of silver, 97 bars of gold, 155 bars of iron, 15 bars of Zinnium, and coins to the value of 23,798 cp, 4,746 sp, and 765 gp.

3-9 – Riddle of the Guardians: *This vaulted chamber is 30' wide and 50' long. At the far end, a pair of six-armed stone ape-men 10' high flank an arched passage.*

When a PC passes halfway through this room, a hollow voice intones a riddle. Each character present hears the riddle in his native tongue:

*I can be held, but not for long
Once taken in, I demand release
If gone for long, thou art undone
Without me, there is no speech
Or lover's sigh
Who am I?*

The stone ape guardians are placed here, not to prevent dullards from entering the lowest level, but to prevent those intelligent enough to parse the riddle. Thus, they attack only if the correct answer ("breath") is given! PCs that choose the wrong answer, or do not answer at all, are safe from attack. Even if they aid targeted PCs, the guardians ignore them. Although the guardians are slow, the judge should remember that Action Dice can be used for extra moves.

Stone Ape-Man Guardians (2): Init -4; Atk slam +6 melee (1d5+4); AC 19; HD 5d12; hp 40 each; MV 10; Act 6d20; SP construct, immune to mind-affecting; SV Fort +12, Ref -4, Will +0; AL N.

LEVEL FOUR: THE VAULT OF ZIN

4-1 – The Pit of Yagzarrid: *The stairs are uneven, seemingly cut following a path which already existed, meandering through the rock. Unlike the areas above, this passage seems free from ashes and dust. After about 200' of twisting narrow steps, you come to a great gulf, at least 120' across, around the inside of which the stairs continue for another 200' before entering another passage, about 100' below where you stand. Where the stairs follow the passage around the inside of the chasm, they are open to one side, without any rail or handholds. The bottom of the drop cannot be seen.*

The gulf continues upward farther than can be seen, and drops 500' to the great web of Yagzarrid, the Spider-God of ancient Saturn. Although the air within the region of the stairs is lit by floating motes, the areas immediately above and below are as dark as pitch. PCs passing towards **Area 4-2** are ignored, but characters passing back towards **Level Three** without a character wearing the Onyx Ring are attacked from below by three waves of the Spawn of Yagzarrid. Any creature damaged on the unprotected steps must make a Reflex save (DC equal to damage taken) or fall. Any creature moving more than its standard move must succeed in a DC 10 Reflex save to avoid falling.

Each wave of the Spawn of Yagzarrid consists of 3d7 creatures, which may come out of the pit at any point in the chasm. It is recommended that the

judge drop 3d7, using the way the die “points” to indicate initial placement, and the number to indicate how many Spawn appear in that location. When the Spawn first appear, they are 40’ below the lower stair level. Each wave occurs 1d5 rounds after the last.

The Spawn of Yagzarrid are dull black spider-like creatures with too many legs and dozens of pale green glowing eyes. They are 2’ long each. Their bites are poisonous (Fort DC 10 or take an additional 1d5 damage), and poison damage counts when determining the Reflex save to avoid falling from the steps. If a PC is reduced to 0 hp and does not fall to the great web, all Spawn within 100’ converge on the character, devouring him completely over the course of 2d7 rounds. A devoured character’s body cannot be recovered, although his equipment possibly can. The Spawn will continue to pursue and attack so long as even one remains with a clear route to the PCs.

Spawn of Yagzarrid (variable number): Init +6; Atk bite +3 melee (1d3 plus poison); AC 14; HD 2d6; hp 7 each; MV 40’ or climb 40’; Act 2d20; SP infravision 100’, poison; SV Fort +2, Ref +8, Will +5; AL C.

A character falling into the great web takes only 3d6 damage (as the web breaks his fall), but needs to succeed in a DC 20 Strength check to pull himself free. Yagzarrid itself is there, a great bloated shadow that no mortal attacks can affect, with thousands of its Spawn. If the judge wishes to expand this section, the Spider-God may send fallen PCs into deeper regions to carry messages to other, stranger gods long

forgotten on the surface of the ringed planet. If not, Yagzarrid’s Spawn feed while the Spider-God watches on.

4-2 - Catacombs of the Faithful:

The walls of this passage are carved with niches, each of which contains a mummified corpse wrapped in whitish-green cloth or webbing. The floor is rough and uneven, broken as though by seismic activity over the long aeons.

These bodies are the servants of Zin the Meticulous, which were entombed with him to serve in the Lands of the Dead until the wizard’s consciousness once more dwells in a living body. Although seemingly human, any who examines them will note a greenish tinge to their skin.

Halfway down the passage, a desiccated body with faded lemon-yellow skin sprawls, the skull cracked when its owner tripped over a broken length of stone in the passage floor. These are the remains of Kal Hannatim, once a famous Venusian thief who was tempted to the Vault by Satrampa’s elaborate promises. He won the Onyx Ring from Zin’s finger, and it can be found in a cracked leather pouch at his belt.

Anyone touching the black Onyx Ring is telepathically given a false idea of what putting the Ring on will do. The Ring can read minds, and chooses the temptation most likely to sway whoever touches it, but can only choose from among five possibilities. If the judge is in doubt, roll 1d5: (1) invisibility, (2) the strength of giants, (3) eternal life, (4) knowledge of arcane spells, or (5) mastery over Saturn’s peoples. The

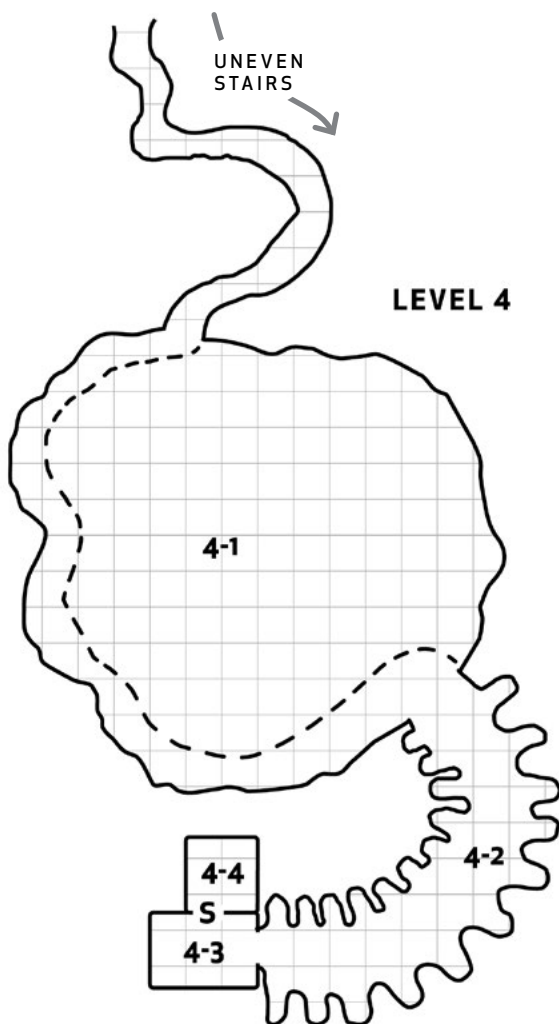

Onyx Ring houses a tie to the spirit of Zin the Meticulous, and placing it willingly upon the finger allows Zin to possess the body of the Ring's wearer. If placed unwillingly on a finger, a DC 20 Will save negates (and reveals) the attempted possession.

A possessed character retains his or her original Strength, Agility, Stamina, hit points, Fort save, and Reflex save. Zin's Intelligence and Personality are 18 and 17 respectively; he cannot burn Luck but has an 8 Luck. Zin has a +4 attack modifier, Action Dice of 1d20+1d20+1d14, a Will save modifier

of +8, and the ability to cast the following spells with a +13 bonus to the spell check: *Charm person*, *choking cloud*, *comprehend languages*, *detect magic*, *find familiar*, *invoke patron* (Tsathoggua), *magic shield*, *patron bond*, *read magic*, *invisible companion*, *magic mouth*, *monster summoning*, *phantasm*, *wizard staff*, *consult spirit*, *demon summoning*, *dispel magic*, *planar step*, *wizard sense*, and *mind purge*.

The first round of possession, Zin is at -2d on the dice chain to all die rolls. The second round, he is at -1d. From the third round onward, he is in full control of the body. If the Onyx Ring is somehow removed or destroyed, the original character is allowed a DC 15 Will save to overcome the wizard's evil spirit; if this save fails, possession is permanent (barring extraordinary measures, or an exorcise spell with a spell check of 32+, which **will** provoke a spell duel).

Zin's primary goals are to gather his magical accoutrements from **Area 4-4** and escape. The Onyx Ring cannot be destroyed.

4-3 – Burial Vault of Zin: *The passage gives way to a chamber some 20' wide and 30' long. Four pillars line both the right and left walls, supporting the ribbed vaulting of the room's ceiling. In the center of the area is a sarcophagus made of black stone. Its lid has been pulled aside, a large crack running through the carven image of an evil bat-toad-thing that leers out from the stone.*

Since the Onyx Ring was taken by Kal Hannatim, the energy drained by the



idol of Tsathoggua in **Area 2-6** has animated the wizard's corpse without Zin's controlling spirit. The un-dead revenant appears as a withered green-skinned body with blackened teeth and claw-like fingers. It attacks the victims of the idol by preference, hungering for their remaining life energy.

The revenant has 1d3 bonus hit points per ability score point drained in **Area 2-6**. Anyone who has taken this damage in **Area 2-6** will instinctively recognize that her own life force is powering the un-dead creature here. If the creature succeeds in a bite attack, the victim

must succeed in a DC 10 Will save or suffer 1d3 points of temporary ability score damage (roll 1d5 to determine ability drained per point; Luck is never targeted). The revenant gains 1 bonus hit point per ability point drained in this way.

Revenant of Zin: Init +0; Atk bite +2 melee (1d3 plus ability drain) or claw +4 melee (1d5); AC 12; HD 4d6; hp 16 plus bonus points; MV 30'; Act 2d20; SP un-dead traits, bonus hit points, ability score drain; SV Fort +4, Ref +1, Will +6; AL C.

The secret door is opened by pressing a small stone imprinted with the image of Tsathoggua. It grinds slowly down, over the course of a minute. After 10 minutes, it grinds back up, closing in 10 rounds. After 4 rounds, a DC 5 Agility check is required to exit the door. After 6 rounds, this check increases to DC 15 (DC 20 at 8 rounds; thereafter impossible). The secret door cannot be opened from within **Area 4-4**.

4-4 - The Magic of Zin: *Beyond the secret door is a room approximately 20' square. This room, like those above, is thick with ashes and dust. Dusty stone shelves hold the crumbling remnants of ancient scrolls. A black stone block holds an ages-old leather-bound book clasped with red metal and a fist-sized polished white crystal shot through with gold flecks. A black wooden staff with a strange horned skull leans in one corner. To the right, a red metal door is set into the stone wall, three feet above the floor.*

The dust and ashes here are only about a foot thick. The stone shelves are

covered with many scrolls, but most crumble when their seals are broken or they are unfurled. The judge should carefully track the time, remembering that characters have only a limited chance to examine this room before the secret door begins to close. Clever players may leave one PC outside the room to reopen the door, and thus remove the time restriction.

A character spending 1 minute to search through the scrolls may roll on the table to the right. Each special scroll can be found but once.

The book is entitled *The Treader in Dust*, and describes an ancient god that most fear to call upon, for he is a master of the time's swift passing. Studying the book allows a character to attempt to learn each of the following spells: *Chill touch, choking cloud, sleep, forget, phantasm, ray of enfeeblement, shatter*, and *Emirikol's entropic maelstrom*. Each spell studied requires a Will save (DC 10 + twice spell level) or the studier ages 2d3 years for a 1st level spell, 1d5 decades for a 2nd level spell, or 1d3 centuries for a 3rd level spell. The judge is encouraged to reduce physical statistics based on aging, possibly consulting earlier editions of the World's Most Popular Fantasy RPG for ideas.

The crystal was hewn from the living heart of the Fifth World, and stood in a place of honor in its chief temple to the Lords of Chaos before that world was destroyed, forming the asteroid belt. The Auric Crystal is a potent item, allowing a wizard or elf to focus spells, effectively gaining a +5 bonus to the spell check in return for a permanent loss of one random ability score point

D%	Result
01-90	Only ruined scrolls that fall into dust, or whose ink has long ago faded to nothingness.
91	Scroll of <i>eldritch hound</i> , cast at the user's normal spell check, stored in scroll tube of dark alien twisted glass which form runes warning against its use in the tongue of Chaos. It can be used only once.
92	Scroll of <i>chill touch</i> , <i>choking cloud</i> , <i>patron bond</i> , and <i>ray of enfeeblement</i> , stored in a cracked leather tube. It is cast at the user's normal spell check, and is signed by Zin the Meticulous. Each spell can be used only once.
93	Scroll of <i>planar step</i> , cast at the user's normal spell check, which is only capable of taking the targets to a preset location of the judge's choosing. A DC 10 Intelligence check when examining the scroll discovers the limitation; if the check is 20 or more, it also notes a second spell entwined with the first, which releases a Type III demon to hunt the caster. The demon initially appears 1d100 miles away, and may make several attempts at the caster's life over the course of more than one adventure. The scroll is in a bone case. Once used, it is consumed by black flames.
94	Scroll of <i>invisibility</i> , using the caster's normal spell check, in an ivory scroll case (value: 5 sp). Whenever the scroll is read, all non-magical flames within 1d100 miles are instantly snuffed out. The scroll can be read any number of times, but each time it is read there is a cumulative 5% chance that a powerful invisible demon bears the caster away to a cold and lightless planet. If this happens, the scroll is lost, but a rescue may be attempted...
95	Scroll of <i>invisible companion</i> , <i>knock</i> , and <i>scorching ray</i> . The spells use the caster's normal spell check, and fade from the parchment when each is cast. The bone scroll tube is sealed with wax imprinted with the sigil of Obitu-Que. When each spell is used, roll 3d24 to determine mercurial effect.
96	Scroll of <i>magic mouth</i> and <i>wizard staff</i> , signed by Zin the Meticulous, who further notes that any other using the scroll will be cursed (Will DC 15 or permanently lose 1d3 points of Luck). Each spell uses the caster's normal spell check, and the spells can be reused. However, on a roll of "1", in addition to all other effects, the scroll crumbles to ash.
97	Scroll of <i>magic shield</i> , written in the language of serpent men. The scroll starts with a spell check using 1d20, but with each subsequent casting the check is reduced by a cumulative -1d on the dice chain. If the spell check ever fails, the scroll is destroyed.
98	Scroll of <i>tadpole transformation</i> , which is always cast at a result of 24-27. Once used, it disappears as soon as it is not being actively looked after (until that time, it can be used more than once). If the caster is not bonded to Bobugbubilz, a minor toadfiend (core rules , p. 402) is sent to demand allegiance to the demon lord of amphibians or slay the transgressor.
99	Scroll of <i>arcane affinity</i> , <i>fire resistance</i> , <i>levitate</i> , and <i>shatter</i> . Each spell can be used but once before fading from the page. The bone scroll tube is signed with the mark of the Scarlet Hand, a conclave of wizards and libertines in the ancient days of Saturn.
00	This scroll is in an ivory tube made from the tooth of an enormous (but unknown) creature and is written upon vellum made from the greenish skin of the folk of ancient Saturn. The reader may choose to become forever after a servant of Malotoch (or another powerful demon-god of the judge's choosing) and gain permanent a +1 bonus to Strength, Stamina, and Intelligence (to a maximum of 18). The scroll exists until a character agrees to the bargain, and then crumbles to dust. If a character reads the scroll and demurs, her maximum hit points are permanently reduced by 1d3.

(except Luck). The second time the crystal is used, the caster automatically gains one minor corruption. The third time it is used, the caster gains one major corruption. Thereafter, each use has a 50% chance of causing major or greater corruption.

Hidden in the dust near the black stone (or possibly not, depending upon the magnetic flux) is a much-battered gold cup worth 25 gp. The life's blood of a living, sentient creature drained into the Sacrificial Chalice, if immediately consumed, heals up to 1 HD per level or Hit Die of the sacrificed creature. The cup heals nothing if the sacrifice is not slain, and cannot heal special conditions. If the blood is not consumed from the Chalice within 7 minutes of the sacrifice's completion, it turns into a primeval slime (*core rulebook*, pp. 423-4), which boils up out of the cup. The slime has 1 HD per Hit Die or level of the victim, and is most definitely **not** under the control of the Chalice's owner.

The staff is Zin's Wizard Staff, made of a dark ebony wood and topped with the skull of a demonkin, somewhat like a ram-horned cat's skull. If the staff is destroyed, Zin immediately takes 6d4 damage; if still within the Onyx Ring, he

is destroyed. The staff is a +1 weapon that does 1d4+7 damage. It grants a +2 bonus to AC and saving throws. In Zin's hands, the staff can also create light within a 20' radius, grants a +2 bonus to attempts to cast *choking cloud*, *magic shield*, and *planar step*. The staff contains two charges of *choking cloud* and three charges of *magic shield*, usable only by Zin.

The red *Zinnium* door is a planetary portal, leading to another door on another world (which may be made of the same or a different metal). The portal only remains passable for 5 minutes once the door has been opened; thereafter it forever becomes nothing more than a blank wall. Anyone touching the door knows about this limitation, although they do not know whence it leads. At the judge's discretion, it may bring PCs to any world within the *Crawljammer* solar system, or even far reaching planets beyond! If there is an adventure the judge wishes the PCs to tackle, that is where the door leads to.

This door may act as a final option for PCs desperate to escape Saturn once the magnetic flux ends, or if they become trapped by the secret door.



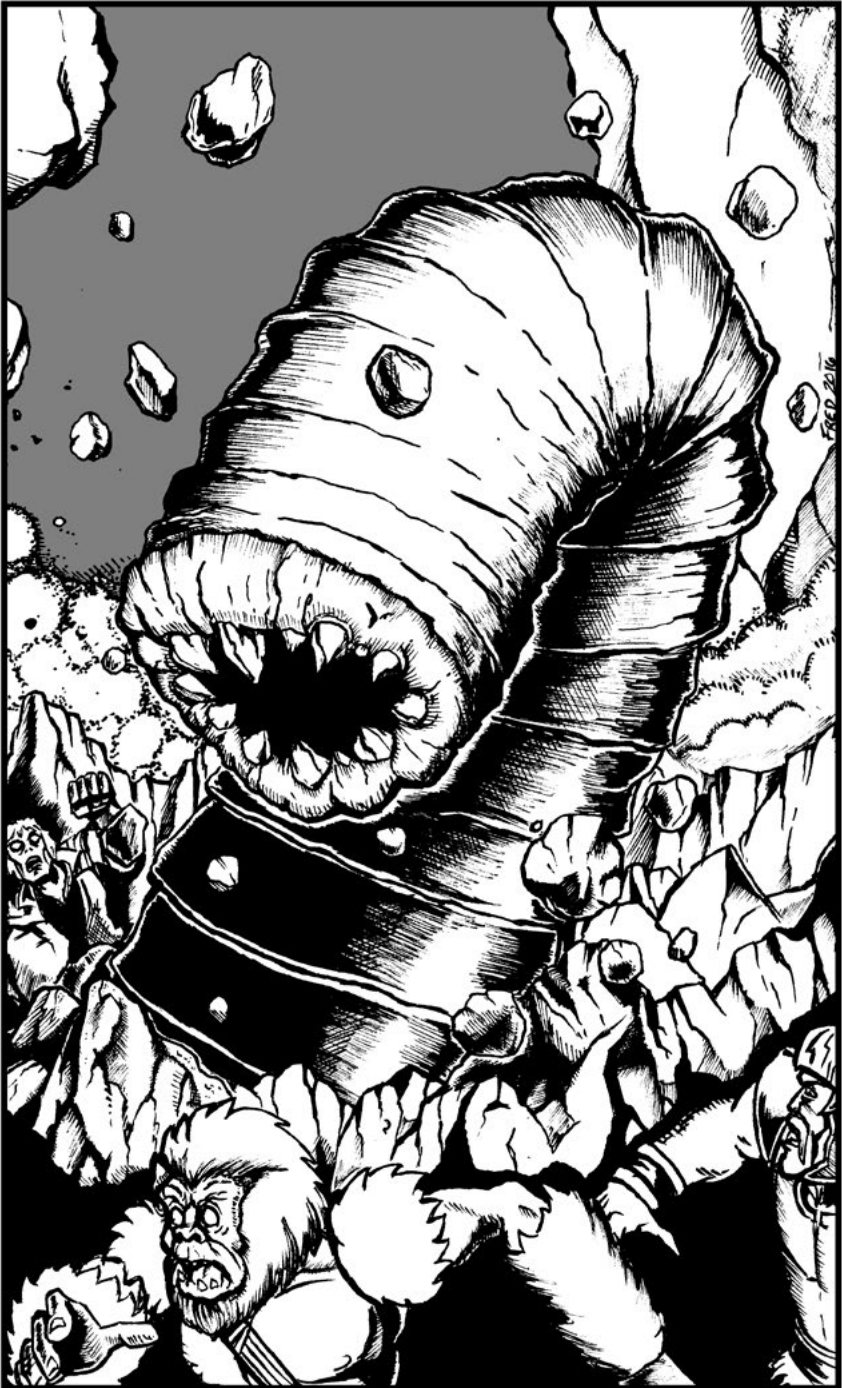

THE WORMGOD STRIKES!

At a suitably dramatic moment, the Wormgod itself acts to cleanse Saturn from Tsathoggua's unclean presence. The judge should add these events to achieve the pacing desired. If the players are engaged, feel free to skip these events. Otherwise, use them to heighten tension, enforce a time limit, refocus the players, or force the PCs to stop dithering.

- A shudder causes the entire complex to tremble. Roll under Agility on 1d16 or fall prone. This may happen during combat. Note that creatures like dust worms are already prone, and therefore at no risk. Otherwise, assume creatures have an Agility score of 10.
- A quake shakes the entire complex, knocking all characters prone and creating a chasm 1d20' wide. 1d16' down the chasm, a moist pinkish-red surface can be seen sliding through the planet's crust. This is part of the Wormgod, an entity over a mile long and more than 100' in diameter. This event can happen more than once. If an alternative route is available, the judge may consider making one or more chasms 2d20' wide and 2d16' deep. Or more.
- As characters leave **Area 2-6**, the floor collapses into a pit hundreds of feet deep, where something smelling of moist earth moves in the blackness. All PCs must make a DC 15 Reflex save to keep their feet. If they fail this save, the last PCs out of the room must succeed in a DC 10 Luck check or slide into the pit, disappearing forever.
- As the elevator rises (**Areas 1-12** and **2-1**), something strikes it violently, jamming it in the shaft. 1d10 minutes later, it is struck again, forcing it rapidly to the top of the shaft. Everyone on the elevator must make a Luck check or take 1d3 damage. If every Luck check fails, the elevator then drops 60' to **Area 2-1**, causing 6d6 falling damage to all aboard. Regardless of which area the elevator stops at, it never moves again.
- As the PCs leave the Vault, the Ape-Man village of Duggabask experiences tremors, collapsing buildings and causing the Ape-Men to fall quivering to the ground. They regard the PCs with superstitious awe, and shrink from them in fear. After some minutes, there is a great rumbling and the Wormgod thrusts upward from beneath the Vault, swallowing the image of Tsathoggua before disappearing again into the planet's crust. Any Ape-Man PC witnessing the event gains a permanent +1 bonus to Luck.



ENDING THE ADVENTURE

If PCs have not escaped using the Zinnium door in **Area 4-4**, they will need to find their way back to their ship. If they do not escape before Saturn's magnetic field returns to normal, they may find themselves trapped on the ringed planet for many further adventures. *The Weird Worm-Ways of Saturn* describes a very small part of a vast world, but can be used as an initial source of ideas. Most *Dungeon Crawl Classics* adventures can be reskinned to take place on Saturn.

Assuming that the PCs manage to escape Saturn, Zin the Meticulous

(if he gained a new body) and/or Satrampa can be used as recurring villains. Certainly, the PCs will want to confront Satrampa after realizing how she set them up.

Saturn's magnetic field makes travel to the ringed planet almost impossible by crawljamming ship for thousands of years. If the judge wishes to set further adventures on Saturn, Zinnium doors leading there can be placed in other adventure locations. Saturn is vast, and largely unexplored. Have fun with it.



FRED 2016

APPENDIX: MARTIAN SKELETON MAN CHARACTERS

You are a skeletally thin, genderless cannibalistic creature from the dry plains of Mars' ancient past. You have honed your mind and body to a single purpose — survival! Where other creatures falter and die, you will find a way to continue. You have a great resiliency, and your mental powers both protect you and aid you in capturing your prey.

Unlike other skeleton men, you have discovered that there is a benefit to the companionship of others. The survival of your companions actually means nearly as much to you as your own survival. With time, you may even come to understand the concept of "friendship".

Hit Points: A Skeleton Man gets 1d6 hit points at each level.

Weapon training: A Skeleton Man is trained in the use of dagger, longsword, short sword, and spear. They can also bite or claw (1d3) for lethal damage. They are trained in the use of shields, but do not normally wear armor. A Skeleton Man wearing armor increases its Fumble Die by two steps on the dice chain and loses its class-based AC bonus (see below).

Alignment: Martian Skeleton Men are usually Neutral, caring nothing about the greater battles between Law and Chaos. PC Skeleton Men may be of any alignment, however.

Genderless: Despite their name,

Martian Skeleton Men are all asexual, and reproduce by budding. When a Skeleton Man is ready to reproduce, it enters a hibernation cycle for 2d6 weeks. During this time, a protruding bud develops from the parent's forehead. When the bud is about two feet long, it drops off, becoming a juvenile Skeleton Man imp. A Skeleton Man parent may have as many as three buds at a time (1d6-3, minimum 1). Skeleton Men, whether parents or imps, have no true loyalty to each other. It is the imps attempting to eat their parent that wakes the parent from its hibernation, after sustaining 1d3 damage per imp. Skeleton Men reproduce once every 2d10 years, if there is sufficient food, water, and air available to produce imps. This process is beyond their control.

Hibernation: A Skeleton Man bereft of food and/or air can enter a hibernation cycle. The Skeleton Man is helpless while hibernating, but automatically awakens if damaged, or after 1d3 rounds if food or air become available. The Skeleton Man is at -2d on the dice chain to all rolls for the first d24 hours after being awakened, and -1d on the dice chain for the next d12 hours thereafter.

AC Bonus: A Skeleton Man gains an AC bonus equal to his level when not wearing armor or using a shield only.

Durability: Skeleton Men are incredibly durable. They take only 1d3

damage per 10' fallen, with no chance of a broken bone. They can eat almost any form of food or creature, raw or cooked, without harm, and gain a +4 bonus to all saves vs. poisons.

My Mind is My Strength: Skeleton Men use 1d16 when making Strength checks. When making non-combat skill rolls, they use 1d16 if trained in a particular skill, or 1d8 otherwise.

Water Vulnerability: Although they can consume blood or liquids, water damages Skeleton Men if it strikes their skins. A Skeleton Man takes 1 hp damage from a splash of water equal to a pint or more. If caught outside during rain, the Skeleton Man takes 1d3 to 1d7 damage per round depending upon the severity of the rain (1d3 for a light sprinkle or heavy fog, 1d4 for light rain, 1d5 for normal rain, 1d6 for heavy rain, and 1d7 for a downpour — treat snow as two steps lower for this purpose, so that light

snow causes no damage). Complete immersion causes 1d10 damage per round.

Action Dice: A Skeleton Man can use its Action Dice for attacks or Psionics Rolls. Extra Action Dice can only be used for attacks or Psionics Rolls.

Luck: A Skeleton Man's current Luck modifier is applied to its hit points when they are rolled at each level. In addition, when reduced to 0 hp, a Skeleton Man can spend 3 points of Luck to determine whether or not it survived, as though its body had been recovered. If the check fails, a Skeleton Man may spend 2 points of Luck to check again.

Psionics: Skeleton Men gain a Psionics Die. They roll this die when making a Psionics Roll, and can choose any effect equal to the result of the roll or less from the following table. This takes the place of a normal Action Die.

Die Roll	Result
2 or less	No effect
3	Distract: A target within 30' must succeed in a DC 10 Will save or lose its next action.
4	Psychic Dagger: A target within 60' must succeed in a DC 15 Will save or take 1d3 damage. Each round the same target is damaged by this effect, damage is increased by +1d on the dice chain. Any round the target is not damaged by the psychic dagger restarts the damage at 1d3.
5	Telekinetic Shield: The Skeleton Man gains a +2 bonus to AC vs. melee weapons (+4 vs. ranged weapons) for 1d3 rounds. Energy weapons or non-physical attacks are not affected.
6	Telekinetic Thrust: A single target within 100' must make a DC 20 Strength check or be pushed back 1d5 x 10', directly away from the Skeleton Man.
7	Psychic Blast: All non-Skeleton Man creatures within 30' take 2d6 damage (Will DC 10 for half). The Skeleton Man can exclude one or more creatures, but doing so reduces range to 20' and damage to 1d6.
8	Psionic Overwhelm: One target must make a DC 20 Will save or be rendered unconscious for 3d6 minutes. At the end of this time, the target must make a DC 15 Fort save or die.

Zero-level Skeleton Men: A 0-level Skeleton Man begins with the ability to hibernate and generate imps via budding. They also have the Water Vulnerability and My Mind is My Strength traits. To determine starting occupation, roll 1d14: (1-10) cannibal raider (weapon: short sword; trade good: collection of 2d5 body parts

[roll 1d5: 1 = ears, 2 = eyes, 3 = noses, 4 = hands, 5 = feet]); (11-12) cannibal warrior (weapon: long sword; trade good: shield); (13) stealthy cannibal (weapon: spear; trade good: 50' coil of rope); or (14) cannibal with an actual job skill (roll again on normal Occupations table, disregarding race).

Level	Attack	Crit Die/Table	Action Dice	Psionics Die	Ref	Fort	Will
1	+1	1d3/III	1d20	1d3	+1	+1	+1
2	+1	1d4/III	1d20	1d4	+1	+2	+1
3	+2	1d5/III	1d20	1d4	+1	+2	+1
4	+2	1d6/III	1d20	1d5	+1	+2	+2
5	+2	1d7/III	1d20	1d5	+2	+4	+3
6	+3	1d8/III	1d20+1d14	1d6	+3	+5	+3
7	+3	1d10/III	1d20+1d16	1d6	+3	+5	+3
8	+4	1d12/III	1d20+1d20	1d7	+4	+5	+3
9	+5	1d14/III	1d20+1d20	1d8	+4	+6	+4
10	+6	1d8/IV	1d20+1d20+1d14	1d10	+4	+7	+5

SKELETON MAN LEVEL TITLES

Level	Title
1	Hungering One
2	Waste Hunter
3	Mind Cannibal
4	Superior Mind
5	Overmind

LEGAL STUFF: This printing of *Crawljammer: The Vault of Ash* is done under version 1.0 of the Open Gaming License, and the System Reference Document by permission from Wizards of the Coast, Inc. Designation of Product Identity: The following items are hereby designated as Product Identity in accordance with Section 1e of the Open Game License, version 1.0: *Crawljammer*, all proper nouns, capitalized terms, artwork, maps, symbols, depictions, and illustrations except such elements that already appear in the System Reference Document.

Designation of Open Content: Subject to the Product Identity designation above, such sections of *Crawljammer: The Vault of Ash* as derive from the SRD are designated as Open Gaming Content.

OPEN GAME LICENSE Version 1.0a

The following text is the property of Wizards of the Coast, Inc. and is Copyright 2000 Wizards of the Coast, Inc. ("Wizards"). All Rights Reserved.

- Definitions: (a) "Contributors" means the copyright and/or trademark owners who have contributed Open Game Content; (b) "Derivative Material" means copyrighted material including derivative works and translations (including into other computer languages), potation, modification, correction, addition, extension, upgrade, improvement, compilation, abridgment or other form in which an existing work may be recast, transformed or adapted; (c) "Distribute" means to reproduce, license, rent, lease, sell, broadcast, publicly display, transmit or otherwise distribute; (d) "Open Game Content" means the game mechanic and includes the methods, procedures, processes and routines to the extent such content does not embody the Product Identity and is an enhancement over the prior art and any additional content clearly identified as Open Game Content by the Contributor, and means any work covered by this License, including translations and derivative works under copyright law, but specifically excludes Product Identity. (e) "Product Identity" means product and product line names, logos and identifying marks including trade dress; artifacts; creatures characters; stories, storylines, plots, thematic elements, dialogue, incidents, language, artwork, symbols, designs, depictions, likenesses, formats, poses, concepts, themes and graphic, photographic and other visual or audio representations; names and descriptions of characters, spells, enchantments, personalities, teams, personas, likenesses and special abilities; places, locations, environments, creatures, equipment, magical or supernatural abilities or effects, logos, symbols, or graphic designs; and any other trademark or registered trademark clearly identified as Product Identity by the owner of the Product Identity, and which specifically excludes the Open Game Content; (f) "Trademark" means the logos, names, mark, sign, motto, designs that are used by a Contributor to identify itself or its products or the associated products contributed to the Open Game License by the Contributor (g) "Use," "Used" or "Using" means to use, Distribute, copy, edit, format, modify, translate and otherwise create Derivative Material of Open Game Content. (h) "You" or "Your" means the licensee in terms of this agreement.
- The License: This License applies to any Open Game Content that contains a notice indicating that the Open Game Content may only be Used under and in terms of this License. You must affix such a notice to any Open Game Content that you Use. No terms may be added to or subtracted from this License except as described by the License itself. No other terms or conditions may be applied to any Open Game Content distributed using this License.
- Offer and Acceptance: By Using the Open Game Content You indicate Your acceptance of the terms of this License.
- Grant and Consideration: In consideration for agreeing to use this License, the Contributors grant You a perpetual, worldwide, royalty-free, non-exclusive license with the exact terms of this License to Use, the Open Game Content.
- Representation of Authority to Contribute: If You are contributing original material as Open Game Content, You represent that Your Contributions are Your original creation and/or You have sufficient rights to grant the rights conveyed by this License.
- Notice of License Copyright: You must update the COPYRIGHT NOTICE portion of this License to include the exact text of the COPYRIGHT NOTICE of any Open Game Content You are copying, modifying or distributing, and You must add the title, the copyright date, and the copyright holder's name to the COPYRIGHT NOTICE of any original Open Game Content you Distribute.
- Use of Product Identity: You agree not to Use any Product Identity, including as an indication as to compatibility, except as expressly licensed in another, independent Agreement with the owner of each element of that Product Identity. You agree not to indicate compatibility or co-adaptability with any Trademark or Registered Trademark in conjunction with a work containing Open Game Content except as expressly licensed in another, independent Agreement with the owner of such Trademark or Registered Trademark. The use of any Product Identity in Open Game Content does not constitute a challenge to the ownership of that Product Identity. The owner of any Product Identity used in Open Game Content shall retain all rights, title and interest in and to that Product Identity.
- Identification: If you distribute Open Game Content You must clearly indicate which portions of the work that you are distributing are Open Game Content.
- Updating the License: Wizards or its designated Agents may publish updated versions of this License. You may use any authorized version of this License to copy, modify and distribute any Open Game Content originally distributed under any version of this License.
- Copy of this License: You MUST include a copy of this License with every copy of the Open Game Content You Distribute.
- Use of Contributor Credits: You may not market or advertise the Open Game Content using the name of any Contributor unless You have written permission from the Contributor to do so.
- Inability to Comply: If it is impossible for You to comply with any of the terms of this License with respect to some or all of the Open Game Content due to statute, judicial order, or governmental regulation then You may not Use any Open Game Material so affected.
- Termination: This License will terminate automatically if You fail to comply with all terms herein and fail to cure such breach within 30 days of becoming aware of the breach. All sublicenses shall survive the termination of this License.
- Reformation: If any provision of this License is held to be unenforceable, such provision shall be reformed only to the extent necessary to make it enforceable.

15. COPYRIGHT NOTICE

Open Game License v 1.0a Copyright 2000, Wizards of the Coast, Inc.

System Reference Document Copyright 2000-2003, Wizards of the Coast, Inc.; Authors Jonathan Tweet, Monte Cook, Skip Williams, Rich Baker, Andy Collins, David Noonan, Rich Redman, Bruce R. Cordell, John D. Rateliff, Thomas Reid, James Wyatt, based on original material by E. Gary Gygax and Dave Arneson.

DCC RPG, copyright 2012 Goodman Games, all rights reserved, visit www.goodman-games.com or contact info@goodman-games.com.

Crawljammer: The Vault of Ash, copyright 2016 Daniel Bishop.

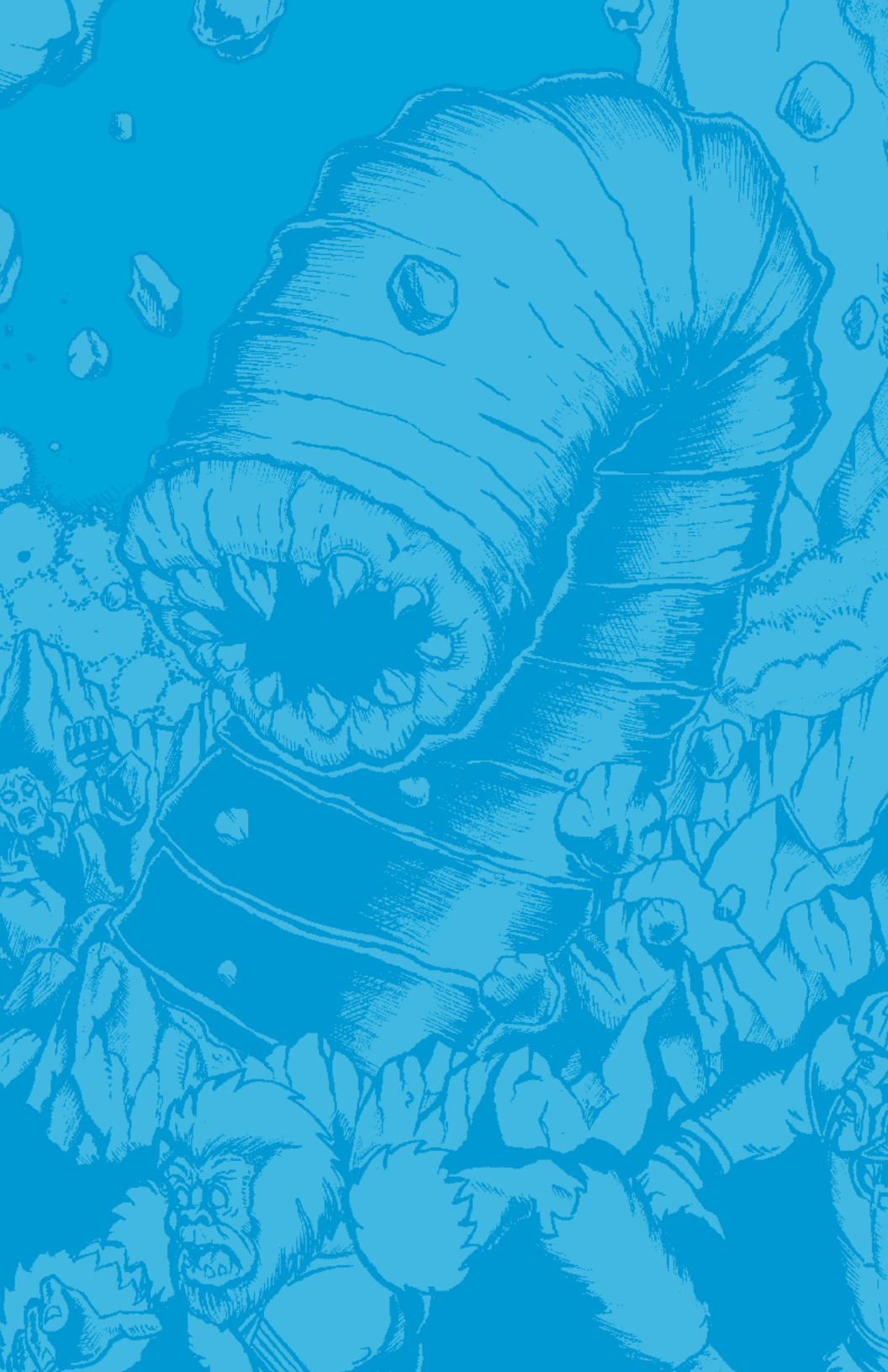

— CRAWLJAMMER —

DCC RPG'S GREATEST SCIENCE FANTASY ZINE
PRESENTS



THE VAULT OF ASH



MOON DICE
GAMES

\$5.99

COMPATIBLE WITH
**DCC
RPG**