

THE AMERICAN SURVIVAL GUIDE

A Gonzo Post-Apocalyptic Campaign Setting and Sourcebook
based on the articles of *Crawling Under a Broken Moon*

CRAWLING
UNDER A
BROKEN MOON



COMPATIBLE WITH
DCC
RPG



MARCEI

THE AMERICAN SURVIVAL GUIDE

WRITING

Written by Reid San Filippo

Additional materials written by: Beckett Warren, David Baity,
David VC, Gilbert Isla, Sean Ellis, Tim Bruns

ART

Cover: Nate Marcel

Interior: Aaron Robinson, Anna Costa, Andrew Walter, David Coppoletti,
Diogo Nogueira, Frank Turfler, James Yoder, KJ O'Brien, Matt Hildebrand,
Maxime "ChaosFeeder" Beaulac (CC BY-ND 3.0),
Nate Marcel, Todd McGowan, Thomas Novosel

PROOFREADING

Gilbert Isla & David VC

LAYOUT & GRAPHIC DESIGN

Matt Hildebrand

PLAYTESTING

Alicia Wiech, Chris B, David Konkol, Doug Kovacs, Gilbert Isla, Jason Bossert,
Mark Wiech, Meredith Spearman, Nate Spearman, Ralph Santiago, Tim Bruns, Tim Kelley,
Ulisses Medina, and the unnamed hordes of many conventions! THANK YOU!

Visit us at <http://crawlingunderabrokenmoon.blogspot.com/>

or

On Google+ at: <https://plus.google.com/u/o/communities/109153580337571253836>

or

On Facebook: <https://www.facebook.com/ShieldofFaithStudios/>

Copyright © 2017 Shield of Faith Studios, LLC



This product is based on the Dungeon Crawl Classics Role Playing Game, published by Goodman Games. This product is published under license. Dungeon Crawl Classics and DCC RPG are trademarks of Goodman Games. All rights reserved. For additional information, visit www.goodman-games.com or contact info@goodman-games.com

KICKSTARTER BACKERS

MALL MAUL SURVIVOR

AJ
Aaron Zurbo
Akrono
Andrew Bates
Andrew Gristina
Andy Goldman
Aremef
Audeamus
Benjamin Jackson
Bmarkslash7
Brad Morris
Brendan Reeves
Bygrinstow
Carl Jonard
Charles Picard
Chris Colborn
Chris Knight
Chris Stewart
Christian Burd
Christopher Avery
Christopher
Moutenay
cw
czak88
Dan Kramer
David Jenks
David Sarachman
Diana Sharpe
Donn Stroud
Duncan McPhedran
Dwayne Howard
Dylan Spaniel
Edward Jones
Edward Kabara
Eric Lopez
Erik Talvola
Gestaltar skiten
Goodman Games
Guy
Hanspeter Zach
Henry Perez
Hobbs665
Ian Borchardt
Itamar Karbian
Jason D
Jason Viens
Jason Vines
Jeff Smith
Jeremy
Jim Heivilin
Jim Krueger

Jim Yoder
Joe G
John Fiala
John Gronquist
Jonathan Carnes
Jonathan Nichol
Jordi Rabionet
Hernandez
Joshua O'Connor-
Rose
Joshua Smith
José Luiz F. Cardoso
Jp Culverhouse
Karl
Keith Rains
Kelly Wilkins
Ken Campbell
Kenny Beecher
Kevin
Kevin R. Ziegler
Mad King Christopher
the First
Mario Torres Jr
Mark Bruce
Mark Cole
Mark Hughes
Matthew Caulder
Matthias Platzter
Michael Austin
Michael Kuykendall
Michael Patrick Hearn
Michael Waite
Neal Tanner
NecroNuke9
Ninjacat
Noah
Oliver Korpilla
Owen Thompson
Pascual
Patrice Mermoud
Paul Sheppard
Paul Wolfe
Pedro R. Martínez
Pérez
PeskyNeedler
Philip Reed
Ray Stephens
Reise, Reise
Richard Brooks
Richard Hamel
Rob Brennan
Robert Biddle
Roberto Micheri

Ryan Hixson
Scott Sollars
Sniderman
Stacy Forsythe
Stephan Tourville
Steve Bean
Steven Lord
Steven Robert
Steven Warble
Storapan
T. Everett
Tanner Yea
Thierry De Gagné
Thomas Lauth
Pedersen
Thomas Paradowski
Tim Baker
Tim White
Timothy Mulry
Tom Karr
Tony Hogard
Trip the Space Parasite
Victor Grinevskii
Wayne Peacock
Zach Pierce

MALL MUTANT

6mmWar
Aleksandr Revzin
Andrew
Andrew Burton
Andrew Engstrom
Andy29075
Belethlich
Ben Vaughan
Billy Longino
Bob Geis
Brad Littman
Brandon Metcalf
Bruce
Brutorz Bill
Charles Hall
Chris Carpenter
Chris Hambrick
Chris Lone
Chris Madsen
Chris Volcheck
Chris Zank
Christian O
Christopher J.
Lauricella
Chuck Thorin
Churchill

Cole
Robotshenanigans
Crow Sheperd
Curt Meyer
Dan Pittman
Dan Steeby
Dan Tvrz
Daniel J. Bishop
Daniel Toberg
Dave Sokolowski
David Ackerman
David Anderson
David McGuire
Donald C. Dodd
Drew
Eric S. Betts
Eric Samuels
Frank Turfler Jr.
Furstenberger
Geronimo82
Gigas
Grady
Grand DM
Grant Dahling
Grogmonster
Hoyt Gregory Parris
Ian Forbes
JDTX88
JP Patterson
JT Scott
Jacob Stocke
James B
James laham
Jamie Wheeler
Jason Carter
Jbeaumont
Jeff Zitomer
Joe Crow
John Brown
John C
John Goodman
John Salyer
Jon Hershberger
Jon Sprow
Jonathan Adey
Jonathan Goodwins
Jonathan S
Joseph Edge
Joshua Macy
Jtc1975
Justin Stevens
Kane
Lane Bowen

Lee Murphy
Lloyd Rasmussen
Luigi Capra
Marc Plourde
Mark Basgall
Matt Gullett
Michael Hazen
Michael Kotschi
Michael Taylor
Miiika Turtiainen
Nathanael Cole
Neal Scott
Olivier Vermaut
Pandemic Games
Richard Sorden
Rob Klug
Robert Beatty
Robert Diber
Rompcat
Rushputin
Scott Jenks
S. Pate
Sam Lockwood
Scott Maynard
SkyTwo
TheDisgruntledPoet
Thorin Thompson
ThrustBomb
Tim Deschene
Timothy Ahern
Tom Burdak
Troy Tucker
Troy Wilhelmson
Trublunite
Tyler Blair
Wayne Rossi
William Walters
Yamil Camacho

TWO-HEADED MUTANT

Aaron Murphy
Andreas Melhorn
Andrew James
McDole
Andrew Johnson
Anthony
Arthur Braune
Ben Grimes
Björn Viktor Ängerfors
Bret Moore
CDub
Chad Dodd

Charlie Day
Chris Ellis
Chris Harvey
Christian Lindke
Christian Sahlén
Contesse
Cory “DM Cojo”
Gahsman
Craig Janssen
Craig Stokes
DM Perky
Damon Baume
Dan Bidwa
Dan Daley
Daniel Clawson
Daniel Lofton
David Clarkson
David Hobson
David Semenick
Dieter Zimmerman
Donald Pierce
Dustin Manning
ENelson
Electric_Copache
Eric Ackermann
Eric Kile
Eric Neff
Fnord Prefect
Frank Brooks
Gareth Crees
Gordon Cooper
Gunnar Bangsmoen
James Heath
James Stanton
Jamie Fischer
Jared Beagle
Jarlmar
Jason
Jeff Bernstein
Jeff Brooks
Jeff Goad
Jeff Scifert
Jeff Sipko
Jeffrey Webb
Jeremy Ligman
John Ackerman
John Nellis
John Scheib
Johnny Freedom
Julian Hayley
Karl Stjernberg
Keith St. Louis
Kelroy Was Here
Kristofer Cook
Kurt Ellison
Lorenzo Bandieri
Majdi Badri
Mark Franceschini
Mark Miller
Matt

Maxwell Spann
Michael Bird
Michael Bolam
Michael Clarke
Michael Jones
Michael Markey
Mike (Wrathofzombie)
Evans
Miniatures_Master?
Nichols83
Odyssey
Paul
Paul Kensler
Pretentious Moniker
Reverend Dak
Rick Hull
Robert Bersch
Robertson Sondoh Jr
Roger Rebisz
Ron Rummell
Russ Dibble
Ryan Idryu
Ryan Moore
Scott P McClellan
Scott Swift
Stefan M
Steven Danielson
Stinky1EyedOgre
Stuart
Thomas Milazzo
Tony Vodicka
VZZ

MALL RAID HERO

Adam Schmidt
Andrew Fleisher
Andrew Lyon
Andrew Piseck
Antonio Soriano
Brian Perlis
Bryan Chamchoum
CoolWhipKid
Dan Sich
Dani Jang
Dave
David
David Eppling
David Sullivan
Doug Taylor
Dragon Graygol
Eric Fields
Eric Thomas Bloom
Frank Romero
Gian
Jamás Enright
Jason Aschberger
Jason Duncan
Jay Rodan Scherer
Jeff Robinson
John Anderson

John DeCocq
Jonathan Blanding
Joseph Hepler
Kristopher Volter
Laura Williams
Mike Carlson
Panagiotis Govotsos
Patrick P.
Poolsofradiance
Reg Mc Reynolds
Russell Townsend
Savage Robby
Simon Boynton
Skyland Games
Spencer Krigbaum
Steve Dodge
Tamas Jakab
Tgmoore
Tim Czarnecki
Victor Kuo
William Fischer
Witt Sullivan

TWO-HEADED SUPER MUTANT

Allan MacKenzie-
Graham
Andrew
Antero Garcia
Bobby Lee
Brian Pfohl
Capn Howdy
Chris Nehring
Clint
Colin Day
Daniel Chiavaroli
Daniel Schul
Dave
David
Diego Bassinello
Eric Maloof
Eric West
Filthy Monkey
Gajus Miknaitis
George Holochwost
Gordon Cranford
Grandy Peace
Greg Chapin
Haihami
Ian A. Richmond
Ian Burgess
Jack Holcomb
Jacob Dill
Jacob Montour
James Walls
Jan Egil Bjune
Janne Kuosa
Jason R
Jeremy Friesen
Jeremy Lasseigne

Jim Skach
John “Johnkzin” Rudd
Jonas Karlsson
Keith E. Clendenen
Keith Garrett
Kyle Thorson
Mendel
Mike
Mike Shema
Mounier Jean-Antoine
Ngo Vinh-Hoi
Paul Grittner
Rahshaad Benjamin
Rainier W Madruga
Rob Kalbach
Sam Crawford
Scales
Steven Gomez
Steven Shaffer
TheGarth
Thomas Biskup
Todd B.
Tom
Trevor Bramble
Ulf H.
William Smith
Zakero

POD PERSON

Andy Action
Anne Hunter
Bill Nielsen
Bob & Jen Brinkman
Brandon Barnes
Brenden Thoreson
Cato Vandrare
Charles Fodel
Danny Hood
David Bresson
David MacKenzie
Diogo Nogueira
Edchuk
Eric Hoffman
Errin Larsen
Gary McBride
Jim Dovey
Jim Schubert
John Michael Hess
John Potts
John Taft
Joseph McRoberts
Justin S. Davis
Keith Nelson
Lee DeBoer
Lucas Skrdlant
Matthew Gagan
Nicholas Serluco
Pat Ransom
Peter Merryman
Randall D Bailey, Jr

Randy Andrews
Redfuji6
Richard Mundy
Sean Ellis
Simone Rolim De
Moura
Spacewoot
Stephen Murrish
Steve Donohue
Thalji
William Lee

POD PATRIARCH

Adam Fulton
Adam Scholtes
Adrian Minter
Arthur Green
Azweepe
Bill Gibson
Breaire Neta
Charles Fitzpatrick
Chris Weller
Damian Koch
Daniel Norton
David Robinson
Emil Johansson
Eric Jackson
Erik Gradine
IrishPope
James Murphy
James Porter
Jeff Williams
Jens Hornshøj-Møller
Jim Borkoles
John R. Lehman
Liam Jacobs
MIKE HARDCASTLE
Max Schneider
Mike Nusbaum
PA Sweden
Paul Watson
Peter Foxhoven
Sage
Scott
Stephen Kilcup
Valerie Emerson

MAD BOMBER

Daniel Mark Duncklee

MERCHANT

Beckett Warren

ART LOVER

Javier Soto

THE AMERICAN SURVIVAL GUIDE



TABLE OF CONTENTS

INTRODUCTION 9

WELCOME TO UERICA 10

The Basics of Life	12
Food and Water	12
Shelter	14
Clothing	14
Travel	15
Communication	15
Law	16
Resources	17
Currency	18

THE CITADEL OF SCRAP 20

Laws and Enforcement	22
Currency	24
People, Cults and Beliefs	24
Technology	25
Locations	25
Misery Side	25
Whole Sale	26
The Flats	27
Fields	28
Squares Ville	28
The Ruins	29
Forgotten Home	31
Passage	31

PLACES TO GO, THINGS TO KILL 32

The Burning Lands of Yellowstone	33
The Floating Iron Isles	34
The Glowing Dome of Dinotastic Park	34
The Isle of Dr. Mammon	35
The Kingdom of the False Gods	35
The Lands of Aetheria	36
The Menfish Pyramid of the Bass Masters	36
The Neuqua Valley	37
The Old Seattle and the Necromancers of the Space Needle	38

The Ruins of Delphia	38
The Temple Refineries of Petrolex	39
The Untouched Valley of the Forks	39
The Vast Wastelands	40
The Whistling Marshes	41
Other Common Knowledge of Note	42
Robots and Aliens and Sorcery, oh my!	42
Radios and Television Broadcasts	42
Radio	42
Television	42
O'Burger Restaurants	42
Trade Caravans	43
Train Barons	44

CITIZENS OF THE WASTES 46

Zero-level Characters	47
-----------------------	----

CLASSES 51

Clerics of the Wasteland	52
The Cyborg	55
Feral Urchin	59
Fossiorian	62
Grays	65
Mutant	70
Petrol Head	73
Robot	76
Scavenger	81
Technologist	85
Wasteland Warrior New Mighty Deed	93
Wizard of the Wasteland	94

COMBAT 97

New Armor Rules	98
Standard Armor	98
Shields	99
Ablative Armor Pieces	99
Feeble Materials	99

Impervious Materials	99
Stacking Armor	100
Summary of Common Damage Effects	101
Guns, Guns, and More Guns	101
Grenades	102
General Grenade Effects	102
New Fumble and Critical Tables	103

EQUIPMENT 115

Common Weapons	116
Common Armor Pieces and Sets	119
Common Mounts and Methods of Hired Travel	121
Firearms	122
Grenades	123
Cheap, A.K.A. Damaged, Goods	124

MAYHEM BEHIND THE WHEEL 125

Rules of the Road	126
The Vehicle Control Roll	127
Control Modifiers	127
Wipeout Results	128
Man vs. Machine Machine vs. Man Critical Hit Table	129
Vehicular Manslaughter	130
Chase Rules	131
Repairing Your Ride	131
Fuel Consumption	132
What's Under the Hood?	133
Vehicle Types	133
Vehicle Quality Levels	135
Vehicle Traits	135
Support Class Weapons	137
Other Vehicle Types	138
Trains	138
Watercraft	140
Gyrocopters and Ultralights	143
Mechs and other robo- vehicles	145
Non-Motorized Land Travel	147

Riding and Draft Beasts	147	Misery Side	250	Law Enforcement and	
Bicycles	149	Law Enforcement and		District Ordinances	264
Sail Waggon	150	District Ordinances	250	Locations of Interest	265
VOLATILE MAGIC	152	Locations of Interest	250	Encounters and Dangers	265
GRIMOIRE OF THE		Along and Within the		Adventure Seeds	265
WASTES	157	Misery River	250	Passage	265
MUTATIONS	167	Fun in the Sun	251	Law Enforcement and	
Gaining Mutations	168	Encounters and Dangers	251	District Ordinances	265
The Mutagenesis Process	169	Adventure Seeds	251	Locations of Interest	266
GODS AND PATRONS		Whole Sale	252	Encounters and Dangers	266
OF UMERICA	182	Law Enforcement and		Adventure Seeds	266
The Deific Patrons	199	District Ordinances	252		
The Non-Deific Patrons	218	Locations of Interest	252	APPENDIX C:	
Lesser Entities	231	Encounters and Dangers	253	CONVERSION OF	
Crafting Lesser Entities for		Adventure Seeds	254	EXISTING DCC	
a Campaign	231	The Flats	255	MATERIALS	267
A Sampling of the Known		Law Enforcement and		Classes	268
Lesser Entities	232	District Ordinances	255	Converting AC	268
Other Lesser Entities	237	Locations of Interest	255	APPENDIX N:	
GM SECTION	238	Racing Rules	255	RECOMMENDED	
Post Apocalyptic Themes	239	North Station Railway	256	MATERIALS	269
Fragmented & Strange	239	Warehouses and Factories	256		
Entropy & Scarcity	240	Artisan Alley	256	APPENDIX S: SALVAGE	270
Scavenging & Salvage	241	Encounters and Dangers	256	Random Foodstuffs	270
A Few Interesting Places To Die	242	Adventure Seeds	257	Random Housewares	271
A Few Random Plot Seeds	244	The Fields	257	Random Tools and Industrial	
SECRETS OF THE CITADEL	246	Law Enforcement and		Supplies	272
Living in The Citadel	247	District Ordinances	257	Random Sporting Goods	273
Laws	247	Locations of Interest	257	Random Automotive Items	274
Security Forces of The		Encounters and Dangers	259	Random Lawn/Garden Items	275
Citadel	247	Adventure Seeds	259	Random Pharmacy Items	276
Merchant Houses	248	Squares Ville	260	Random Farming Items	277
The Underworld and Black		Law Enforcement and		Random Library Items	278
Market	248	District Ordinances	260	Random Antiques/Museum Items	279
Cults	248	Locations of Interest	260	Random Military/Hunting/	
What is the God in the Pit?	249	Encounters and Dangers	262	Survivalist Items	280
Using the Royals In Your		Adventure Seeds	262	Random Alien Craft Items	281
Games	249	The Ruins	263		
		Law Enforcement and		LIST OF TABLES	282
		District Ordinances	263	CHARACTER SHEET	284
		Locations of Interest	263		
		Encounters and Dangers	264		
		Adventure Seeds	264		
		Forgotten Home	264		

INTRODUCTION

In 2013, a friend introduced me to DCC while we were in the middle of an OSR style campaign. It was love at first read! As I devoured the text I kept thinking that this would be the perfect system to run the Thundarresque high fantasy post-apocalyptic campaign I'd always wanted to run. Then my friend showed me the *Crawl!* and *Crawljammer* zines and my fate was sealed. It was only a few months later that the first issue of *Crawling Under a Broken Moon* was written and released and the setting known as Umerica was born.

Now you are reading the fulfillment of a dream hatched a while back. A book dedicated to playing a DCC campaign in Umerica, a twisted place where just about anything can happen. Where a wizard, a mutant, and a robot can travel together to delve into abandoned malls full of ancient goods or pilfer alien dragon eggs from a crumbling skyscraper.

Join me as we wander together in the wonderful, weird wastelands of Umerica.

Reid "Reidzilla" San Filippo

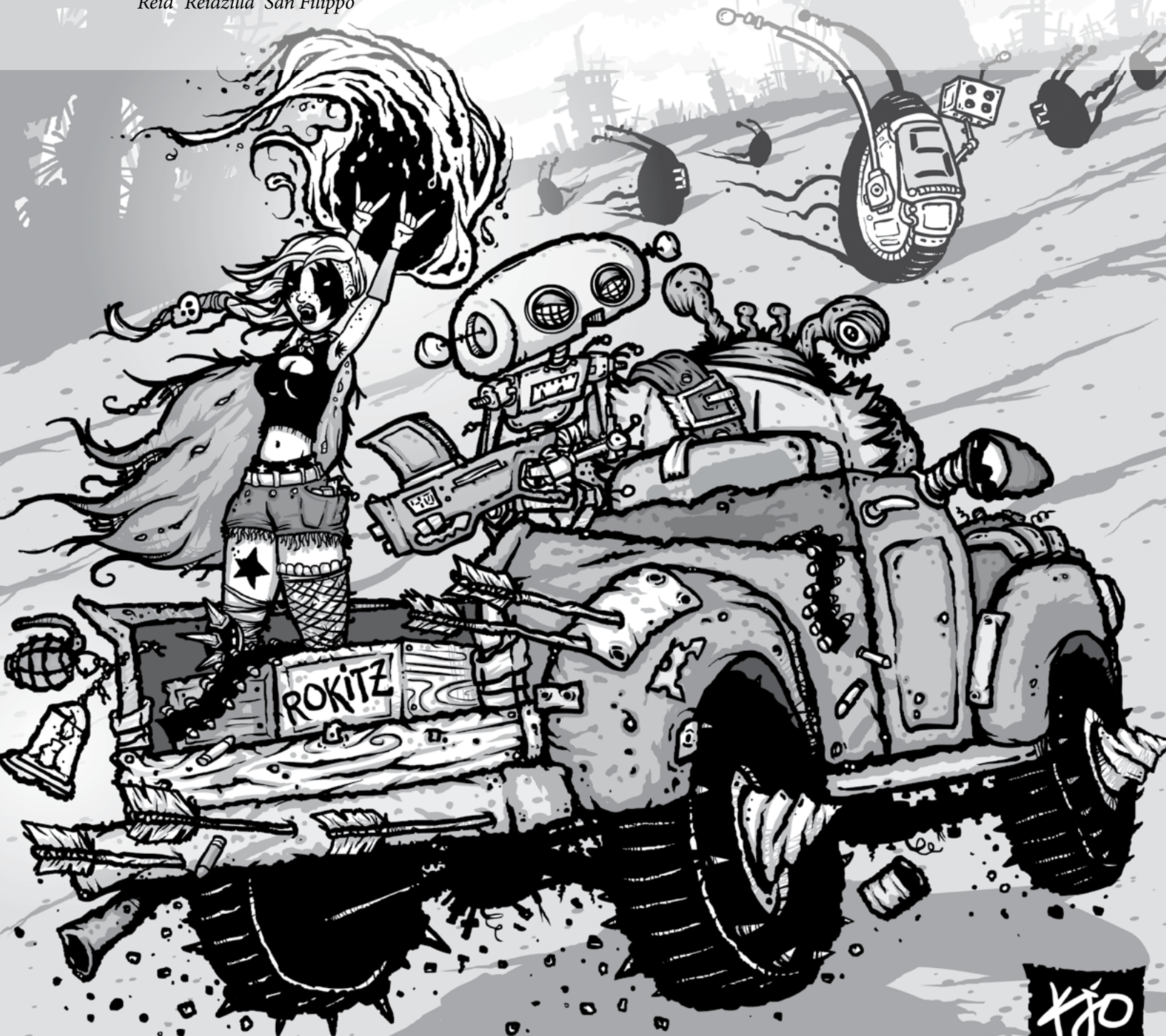

xjo



**WELCOME
to
UMERICA**

WELCOME TO UERICA



Long ago, the world was a beautiful place where everyone was good looking and things always worked out for the best. At least, that is what the historical videos recovered from the archives in the former land of Hollywood tell us. Then, the Great Cataclysm happened. What was the Great Cataclysm and when did it happen? No one can seem to agree on this. Some say less than a century ago a strange object from space collided with the moon and that the shock wave fractured reality itself. Others say that over a millenia ago the world was invaded by “things” and the locals set off a weapon so devastating that it affected all life on the planet. There are dozens of other strange stories about what happened that are even more unbelievable. Most folks don’t really care what it was. The world is what it is now, and that is all there is to it.

The land known by most as UERICA is the remnants of North and Central America. It stretches from the Northern Ice Wall and ends at the Amazonian sea. The landscape is generally a barren, dusty place with random large, overgrown patches of greenery, usually containing or near a source of reasonably fresh water. In these oases of green, most of the ruins and roads have been at least partially reclaimed by the wilds if not completely overrun.

A multitude of the once great highways have become fissured graveyards for thousands of decaying cars. There are even communities that use the rows of long dead vehicles as domiciles, especially on

elevated highways that are hard to directly assault. A few roads have been passably kept up by local communities, major caravan merchants, or road gangs. These scarce roadways serve as vital paths between the larger populated areas of UERICA.

Many settlements that survived are located around the borders of the green places. They’re close enough that they can get food and water from the forest, but not so close as to attract a lot of attention from the beasts that dwell in the green. Not that there are any fewer beasts that roam the wastelands or anywhere else for that matter. Others have built small communities in the remains of before in old buildings and other structures. Such places survive by salvaging, hunting, farming, trading, or raiding other communities. For small homesteads without such community support, only desperation and luck keep them alive.

The ruins of metropoli dot the landscape, and few who venture into them ever return. A few of these ancient cities have been reclaimed, usually by advanced technological force or great sorcery. Within their fortified walls one finds districts of great trade, scores of overcrowded neighbourhoods, and a quick death from their rulers should you break any laws. Many of these walled cities are interconnected by railroads maintained by one of the Train Barons. The largest and greatest city in UERICA, the Citadel of Scrap, is where all railroads lead.

WELCOME TO UMERICA

THE BASICS OF LIFE

Food and Water

In most settlements people eat and drink just enough to survive. Toxins, disease, spoilage, and radiation make finding safe edibles a difficult task. Many communities began as people gathered around a source of fresh food or water, even if that source dried up long after the founding of the settlement.

Farming is common in areas that are not completely barren, but strange weeds and growths keep most crop yields meager. Raiders also plague settlements with healthy looking fields that are hard to conceal. Raising livestock can be a bit more rewarding as there are several species of domestic creatures that have adapted to the twisted environment. Hunting and fishing is a very dangerous enterprise, but can feed a community for weeks from a successful trip.

Table A1: Foraging difficulties

Roll an Intelligence check and a success gleans one meal's worth of food and water plus 1 additional meal's worth of food and water for every 3 past the required DC. Each attempt requires 1d3+1 hours.

Local wilderness	DC 10
Foreign wilderness	DC 15
In the Wastelands	DC 18
In a small ruined city	DC 16
In a large ruined city	DC 12
Underground	DC 15

Table A2: Common Foraging results

Roll 1d8

- Tastyfruit** - The round fruit is bright pink with a smooth, thick peel. The interior flesh is vibrant purple and segmented like an orange. While you would be hard pressed to find a person who does not like them, no one can really describe the flavor as anything but "tasty" or "fruity". The trees produce an abundant harvest for their size and bear fruit year round. Value: 1sp for a dozen.
- Spice Berries** - These uncommon small berries are quite sweet and spicy when eaten out of hand but are usually added to breads, porridges, or stews. Besides flavor they can neutralize contaminants and toxins from the food as it cooks. Value: 2sp per handful.
- Tomeato** - This appears similar to a large tomato but is blood red and pulses slightly. When cut they ooze a blood-like juice and a slightly sweet, meaty scent. Uncooked, they taste very reminiscent of raw beef and cook very similarly to beef as well. When properly picked and the skin is left whole they will remain fresh for up to a week. Wild tomeato plants tend to be found in the vicinity of recent battlefields or graveyards. Value: 3-6cp per fruit.
- Blugrain** - a mysterious grain of "unnatural" blue hue that appeared sometime after the cataclysm. It grows like a weed in most climates regardless of soil nutrients and rainfall. It has a texture and taste similar to wheat with a definite hint of hoppy citrus.
- Can-O-Ham** - These cans of highly processed ham come in several flavors like: Maple, Cajun, Garlic, Hash, Cheesy, and Inferno. Due to the unique canning method used there is a very good chance (85%) that any undamaged can is still safe to eat. It is rumored that the canning facility survived the cataclysm and is just waiting to be found. Value: 2-8sp per can, depending on the flavor.
- Go! Bars** - These highly processed, foil packaged caffeinated food bars were made in the trillions before the cataclysm and are usually still fresh and tasty today. Each bar has a 90% chance of still being perfectly edible. Value: 5cp to 2sp, depending on the flavor.
- Insta-meals** - These foil pouches contain dehydrated and processed food that just requires the addition of hot water and a few minutes to become a "meal". While still "safe" to eat, the extreme preservatives used in the food can cause intestinal distress if a Fortitude save (DC 7) is not made, causing -1 to all actions for 1d3 hours. Value: 4cp to 2sp per pouch, depending on the flavor.
- Cakies** - A well loved pre-cataclysmic delicacy in the form of a pair of frosted snack cakes in a transparent foil wrapper. For some reason they feel and taste as fresh as if they had been baked yesterday. Value: 5sp to 1gp, depending on the flavor, with the rare toasted coconut flavor being the most desired.

WELCOME TO UMERICA

Table A3: Common Foodstuffs

Roll 1d7

1	Roast Ratato - Ratatos are a veggie animal hybrid vermin similar in size and disposition to rats. The scrambling of their little root feet is a common background noise in many inhabited buildings at night. Luckily their chunky, potato-like bodies are quite palatable when roasted or baked. They are usually served with a gravy or sauce. Value: 2-4cp each
2	Meat on a Stick - Just as cheap and mysterious as in ancient times. Available in nearly any community with a convenient “don’t ask and we won’t tell you” freshness guarantee! Value: 1-3cp per stick.
3	Shroomer Steaks - A thick and juicy slab of “meat” fresh from the grill smells and tastes great. The animal/fungi hybrid beasts called Shroomers are slow moving, docile, and easily domesticated beasts that when full grown release a bunch of spores and then die. The full cycle from spore to death only takes about a year with adequate water and soil. Value: 6cp per pound, in season.
4	Hunter’s Stew - An old standby of whatever was caught, captured, foraged, or found thrown into a pot with water, ground grain, and maybe a seasoning or two. Only a 1-in-20 chance of choking on a bit of bone, talon, or button. Value: 4cp per bowl the first day, 2cp per bowl after that.
5	Boiled Beetle - There are several varieties of dog sized beetles that have a palatable flavor when properly cooked. Cracking the shell can be done in many ways and tends to spark conversation on which way is best. Best served with dipping oil or gravy. Value: 2-4cp per plateful.
6	Pigtipede Jerky - This flavorful dried meat is free of all contaminants as a Pigtipede’s unique digestive system neutralizes all toxins and such from its food. Value: 2sp per pound.
7	BluCakes - Whether baked plain, savory, or sweet, these small flat cakes are possibly the most prevalent food item across Umerica. All are made from Blugrain. Value: 1cp per 1-3 cakes, depending on quality.

Table A4: Bad Food effects

Roll 1d14 for each instance of tainted food, adjusted by the consumer’s Luck mod.

0	Minor digestive discomfort - You were lucky... this time.
1-3	Minor digestive issues - 1 in 6 chance each round/turn of loud gut rumbling or flatulence, making stealth difficult (-5 to all hide or sneak checks).
4-6	Purge - 2d4 turns after ingestion a Fortitude save (DC 12) is required to avoid one bout of vomiting and/or diarrhea lasting one turn, during which the consumer suffers -3 die steps to all actions. This penalty reduces to -1 die step after the initial bout and lasts for an additional 1d5 turns.
7-8	Massive Purge - 2d4 turns after ingestion a Fortitude save (DC 13) to avoid a period of multiple bouts of vomiting and/or diarrhea, lasting 2d4 hours. During this time the consumer is reduced to ¼ move and -4 die steps to all actions. Afterwards, they suffer a -1 die step to all actions for the next 1d3+1 days. The consumer also requires double the normal amount of water to avoid Dehydration.
9-10	Parasites - 12 hours after ingestion the consumer loses 1 Stamina and must make a Fortitude save (DC 14) each week or lose an additional 1 Stamina until the condition is healed
11-12	Irradiated - 6 hours after ingestion the consumer loses 1d3 Stamina and must make a Fortitude save (DC 13) or the loss is permanent. An additional Fortitude save (DC 13) is also required to void suffering 1d4 bleeding damage.
13-14	Dysentery - 3 hours after ingestion the consumer must make a Fortitude save (DC 13) each day or suffer 1 Stamina loss until dead. During this time the victim suffers a -1 die step penalty to all actions and does not recover attribute damage. The consumer also requires triple the normal amount of water to avoid Dehydration.
15	Poisoned - 1 hour after ingestion the consumer must make a Fortitude save (DC 13) each hour or suffer 1 Stamina loss until dead. During this time the victim suffers -2 die steps to all actions and does not recover attribute damage.
16+	Lethal - 1d4 hours after ingestion the consumer must make a Fortitude save (DC 13) or die. If the save is made the consumer still suffers 1d4 permanent Stamina loss.

WELCOME TO UMERICA

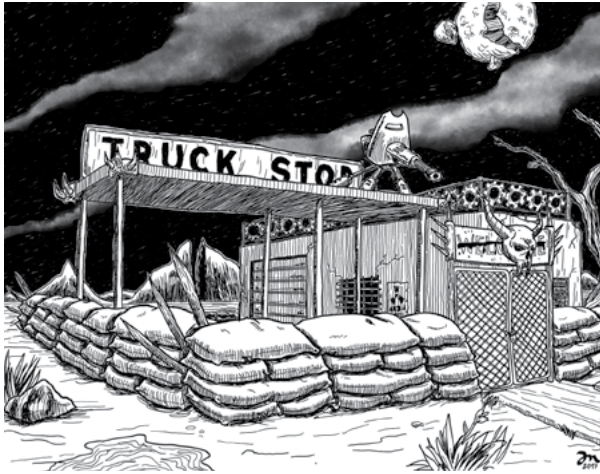

Shelter

The living accommodations for most communities range from repurposed ruined buildings to scratch built shacks. A few have both access to decent building materials and the skilled labor to build proper homes or restore ruined buildings. Anywhere that a community can live reasonably protected from the elements and predators can be called home.

Table A5: Community Housing

Roll 1d30

1-5	Nothing but tents and lean-to's made from salvaged materials
6-8	A fleet of broken down vehicles converted to personal cabins
9-11	Mostly boded shacks and shanties around a partially standing ruined building
12-14	Simple framed houses made from repurposed wood
15-17	Man made caves or old mining tunnels
18-19	Cabins made from fresh timber
20-22	A park populated with home trailers, camping trailers, and RVs
23-25	A repurposed underground facility. Roll 1d5: (1) basement of a large ruined building; (2) partially collapsed subway system; (3) civil defense facility; (4) pre-cataclysm survival vault; (5) underground parking facility
26-28	A repurposed building. Roll 1d6: (1) factory; (2) warehouse; (3) school; (4) jail; (5) department store; (6) truckstop
29+	A small subdivision of mostly intact or rebuilt pre-cataclysm homes.

Clothing

One boon of the pre-cataclysmic world was the plethora of synthetic, non-biodegradable textiles that were used in clothing production. This means many unlooted clothing shops or department stores are a treasure trove of usable apparel. Searching abandoned homes within the ruins of towns and cities can also unearth functional clothing. In areas where such luxuries are nonexistent due to bygone plundering, hand made leather and textiles are used to make durable garments. Most folk wear the best clothes they can find or purchase.

Protective clothing and armor are constructed from whatever is on hand or can be scrounged up. Old sports equipment, construction scraps, safety gear, police equipment, and more are all used to protect the warriors of each community.

Table A6: Found Apparel

Roll 1d30

1	Fitness training shoes	16	Spandex shorts
2	Boots	17	Dress socks
3	Dress shoes	18	Flannel shirt
4	Denim jeans	19	Long coat
5	Sweatpants	20	Long sleeve shirt
6	Shorts	21	Formal attire
7	Athletic socks	22	Fancy dress
8	Hooded sweatshirt	23	Light jacket
9	Poncho	24	Coat
10	Heavy duty jeans	25	Leather jacket
11	Undergarments	26	Fitness leotard
12	Tee shirt	27	Stockings
13	Overalls	28	Knit sweater
14	Jumpsuit	29	Dress slacks
15	Sneakers	30	Belt



WELCOME TO UMERICA

Travel

As one would expect, walking is the most common mode of travel for the majority of the population. Having the technical skills, spare parts, and fuel to keep a vehicle in running condition is a blessing that most small communities cannot afford. Alternative powered modes of transportation — such as riding animals, row boats, sailboats, and bicycles — tend to be the more economical choices, depending on where the community is located. Animal-drawn wagons crafted from stripped-down vehicle chassis are a common sight. This is one of the main reasons that the vehicle-borne road gangs of the wastes are so feared when they come raiding: most folk do not have the means to run away fast enough.

Table A7: Primary Means of Community Travel

Roll 1d30	
1-6	Foot travel only
7-10	A few beasts of burden or riding animals
11-14	A full herd of quality riding and/or labor animals and well built wagons
15-18	Off-road bicycles or boats (depending on the terrain) are widely employed
19-22	One lovingly maintained truck or van
23-26	A few vehicles and a reliable source of fuel
27+	A veritable fleet of vehicles, a wealth of spare parts, and control of a reliable source of fuel



Communication

Word of mouth is the primary means of passing on any important news or information. Also, most communities have a message board of some sort in a central location that citizens will post want ads or notifications on. Some areas where there are several nearby communities on friendly terms have resurrected the idea of a postal message carrying service. There is a movement amongst the Train Barons to implement this on a larger scale.

There are a few canny communities that have enough tech to power basic electrical services and have revived enough buried telephone wires to have simple telegraph or phone service. Some larger settlements have even restored a radio broadcasting station and have local radio or television broadcast channels.

Table A8: Channels of Communication

Roll 4d20	
4-15	Nothing more than word of mouth.
16-20	One or more message boards for local mass communication.
21-40	A simple postal message carrying service that covers a few local communities.
41-55	A trained animal message carrying service that can quickly send messages several miles distant.
56-65	A local telegraph service covering key areas of the community and possibly outlying scout posts.
66-75	A basic telephone service covering the whole community and possibly outlying scout posts.
75+	A functional radio tower capable of broadcasting at least 50 miles.

WELCOME TO UMERICA

Law

In most communities, the folks in charge set what is considered right and wrong. Usually, this is as simple as don't steal from or kill your neighbors and do your best to keep the community going. Larger towns and communities controlled by strict rulers will have more detailed and possibly harsher laws. As there is not a lot of travel between different communities, locals tend to have a handle on the local legal code but no idea what the laws are elsewhere. This can lead to many problems for travelers.

Table A9: Community Law Structure

Roll 3d30

3-15	No centralized authority other than force of will or arms
16-20	Illogical or deranged laws that seem to serve no true purpose.
21-40	Simple, logical, for the good of the community rules. No formalized laws.
41-55	Relatively defined and collected community laws regarding the ownership of property, theft, murder, punishing crimes, etc.
56-75	Detailed laws regarding commerce, marriage, ownership rights, and taxation.
75+	Totalitarian laws intended to keep all citizenry in line that are strictly enforced.

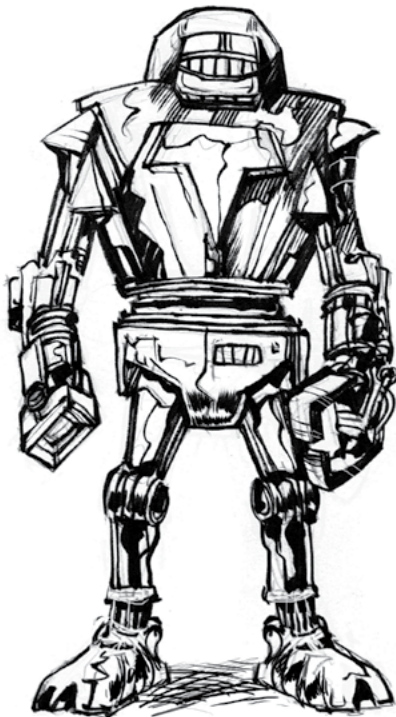

Table A10: Unusual Community Laws

Roll 1d12

1	All adults are required to be married. Visiting adults that are unmarried are required to marry a local in order to stay within the community after dark.
2	All magic and advanced technology is forbidden as it corrupts the soul.
3	All wealth and goods must be shared equally throughout the community. Visitors are not exempt from this.
4	No one but the authorities may own or carry a weapon of any kind.
5	All visitors must pass a "purity" test to see if they are mutated (or unmutated). Those that fail are cast out and shunned.
6	It is unlawful to sell anything to strangers. Only locals can make purchases. Buying is not regulated.
7	It is unlawful to buy anything from strangers. Only locals may buy from each other. Selling is not regulated.
8	You have to eat what you kill, no matter what it is.
9	Attendance of religious services are mandatory , even for visitors.
10	A particular type of person has no rights and is considered property: Roll 1d6: (1) Males; (2) Females; (3) Children; (4) Non-humans; (5) Humans; (6) Non-locals.
11	Visitors must give a tribute to the local "God" in order to interact with the community. They will be shunned until they do so. It wants... Roll 1d6: (1) food; (2) valuables; (3) tech; (4) slaves; (5) knowledge; (6) booze.
12	Interaction with non-locals can only occur on certain days of the week. There is a 33% chance that it is currently one of those days. It will be 1d5 days until the next interaction day.

WELCOME TO UMERICA

Table A11: Punishments

Roll 2d6

- | | |
|-----|--|
| 2-4 | Locked in “the box” for 1d3 days or longer, depending on the nature and severity of the crime. Roll 1d6: (1) Metal sweatbox in the sun; (2) a large spinnable compost barrel with gravel in it; (3) a small, dark underground cave dripping with mildly acidic water; (4) a working walk-in refrigerator; (5) a swinging cage hung high in the air; (6) a room with no windows that is home to... something. |
| 5-6 | Heavy fines based on the nature and severity of the crime. Those that cannot pay become slaves. |
| 7-8 | Must perform a task set by the leaders in order to return to the community. Roll 1d5: (1) Return with 1d30+10 pounds of fresh, good meat; (2) Return with 2d20+20 gallons of fresh water; (3) Kill off 1d4 predator animals that hunt nearby; (4) Return with a small cache of functional, useful tech; (5) Marry a local. |
| 9 | Beaten for 1d3 damage or more, depending on the nature and severity of the crime. |
| 10 | Ingest a poisonous brew, Fortitude save (DC 15) or suffer total paralyzation for 6d10 hours. While paralyzed the culprit is fully conscious. They are placed in the center of the community where they are mocked and smacked with sticks. |
| 11 | Restrained and bled for 1d3 Stamina or more, depending on the nature and severity of the crime. Roll 1d5: (1) blood used to feed the animals; (2) blood used to make sausages; (3) blood used in religious ritual; (4) blood imbibed by leaders; (5) blood imbibed by children. |
| 12 | Cut off finger, toe, hand, or foot depending on the nature and severity of the crime. |

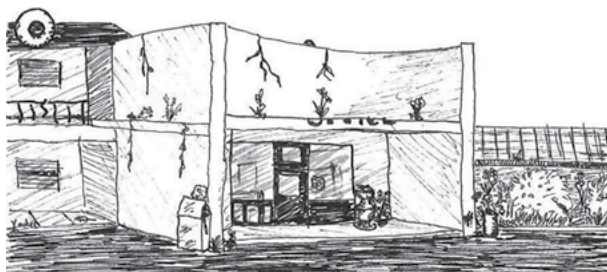

Resources

Communities rarely happen without a reason. Any community needs to support itself somehow. Few settlements have everything they need within the community, but there is usually some resource or resources that bind a community to a particular location. Small or poor communities will have 1d2 resources, while larger communities will have more.

Table A12: Resources

Roll 2d8

- | | |
|-------|--|
| 2-3 | Abundant fresh water supply. This can be a well, an underground river, some other natural filtration system, or perhaps a still working water purification system. |
| 4-5 | Defensible position and easy to raid neighbors. Not every community makes stuff on their own. Some are built and born to raid. |
| 6-7 | Livestock. The land is just right for livestock of some kind to thrive in this community. |
| 8-9 | Minerals. Perhaps there's still coal in the mine, or perhaps salt is prevalent and easy to extract. The community has minerals that are worth using and trading for. |
| 10-11 | Fertile soil/cash crop. Perhaps the soil here isn't as spoiled as the rest of the land or perhaps the town has access to a crop that will grow even in the harsh soil of Umerica. |
| 12-13 | Salvage. Perhaps there's an abandoned warehouse or mall close by that's easy for the town to salvage stuff from, even if it's not an ideal place to live. This salvage doesn't even need to be directly useful, it may have trade value to others. |
| 14-15 | Electricity. Either by reviving a local generator or by scratch building apparatus that can harness natural forces, the community has electrical power to spare. |
| 16 | Petrol. Communities with Petrol are rare, but are often wealthy and want for little. How much petrol? Well, that may depend on how they got it. |

WELCOME TO UMERICA



Currency

Lacking major governments or banks, trade throughout Umerica is conducted either with barter or with valuable units that serve as coinage. To represent this use the following abstract units of measure to identify different types of “coin”.

cp = Charm Pieces. Beads, semi-precious stones, costume jewelry, trinkets, toys, and other “pretty” bits.

sp = Shells and Powder. Bullets (homemade or salvage) with sufficient powder to fire them (in the case of muzzle loaders).

gp = Gasoline/Petrol or Gas Promissory Note. One gp is equal to one unit of gasoline (1 fuel point). Gas can either be traded directly or, in locations with a prominent temple dedicated to Petrolex, one may deposit petroleum into a bank made for this purpose and write Promissory Notes (like modern checks) for trade. The receiver then takes the note to a bank when needed.

pp = Pharmaceuticals/Potions. Enough of a full prescription strength pharmaceutical or potion to treat a condition, typically one week’s worth. For over the counter medications this would represent a full, sealed bottle.

The values of these abstract units are as follows: 1pp = 10gp = 100sp = 1000cp. There are a few communities, such as the Citadel of Scrap, that will actually mint currency coins to be used in place of bartering. Their coinage will follow the same general values as above.

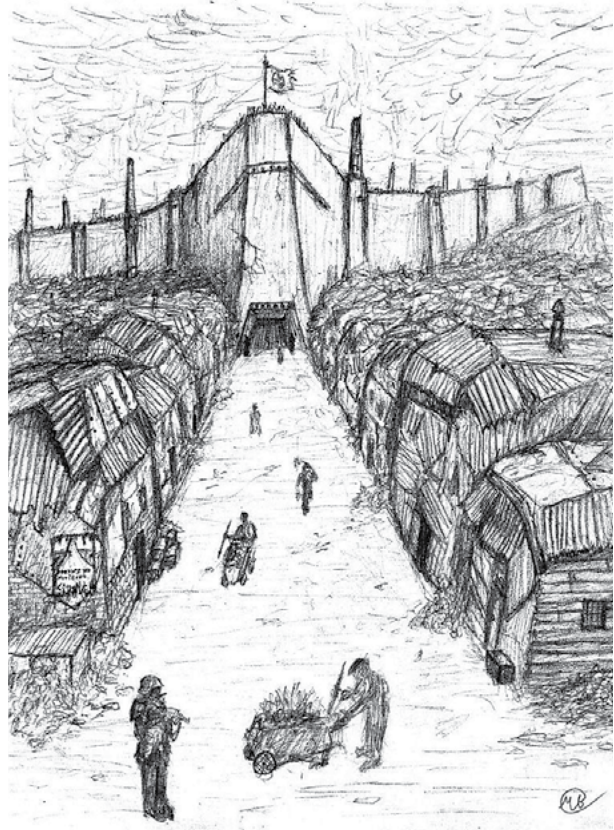

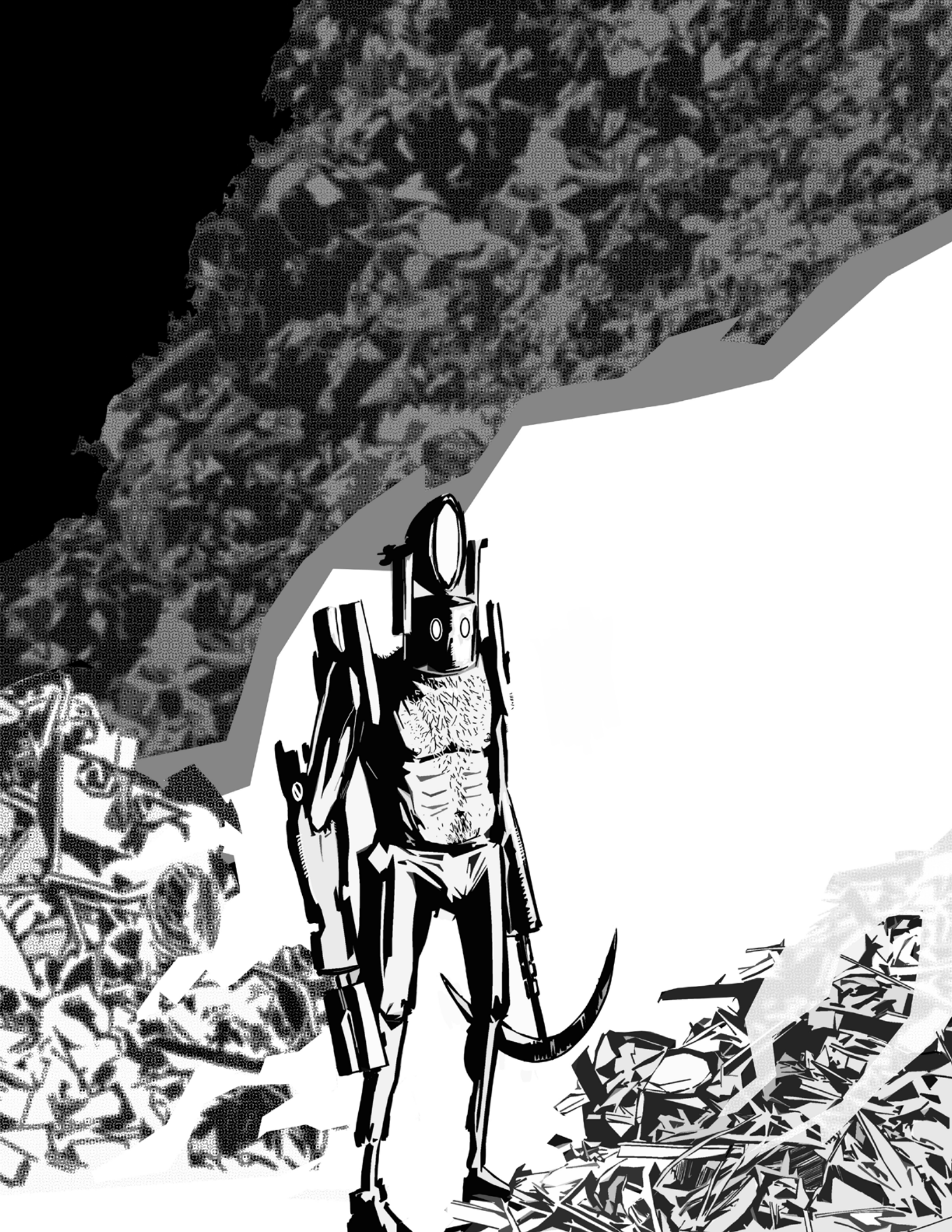

THE CITADEL OF SCRAP

What follows is an in-character dialogue from the perspective of a citizen of The Citadel of Scrap coaching newly arrived PCs on the ways to get by in this unique city. A GMs section provided later in the book details the truth about the Citadel and its districts that residents are unlikely to know.

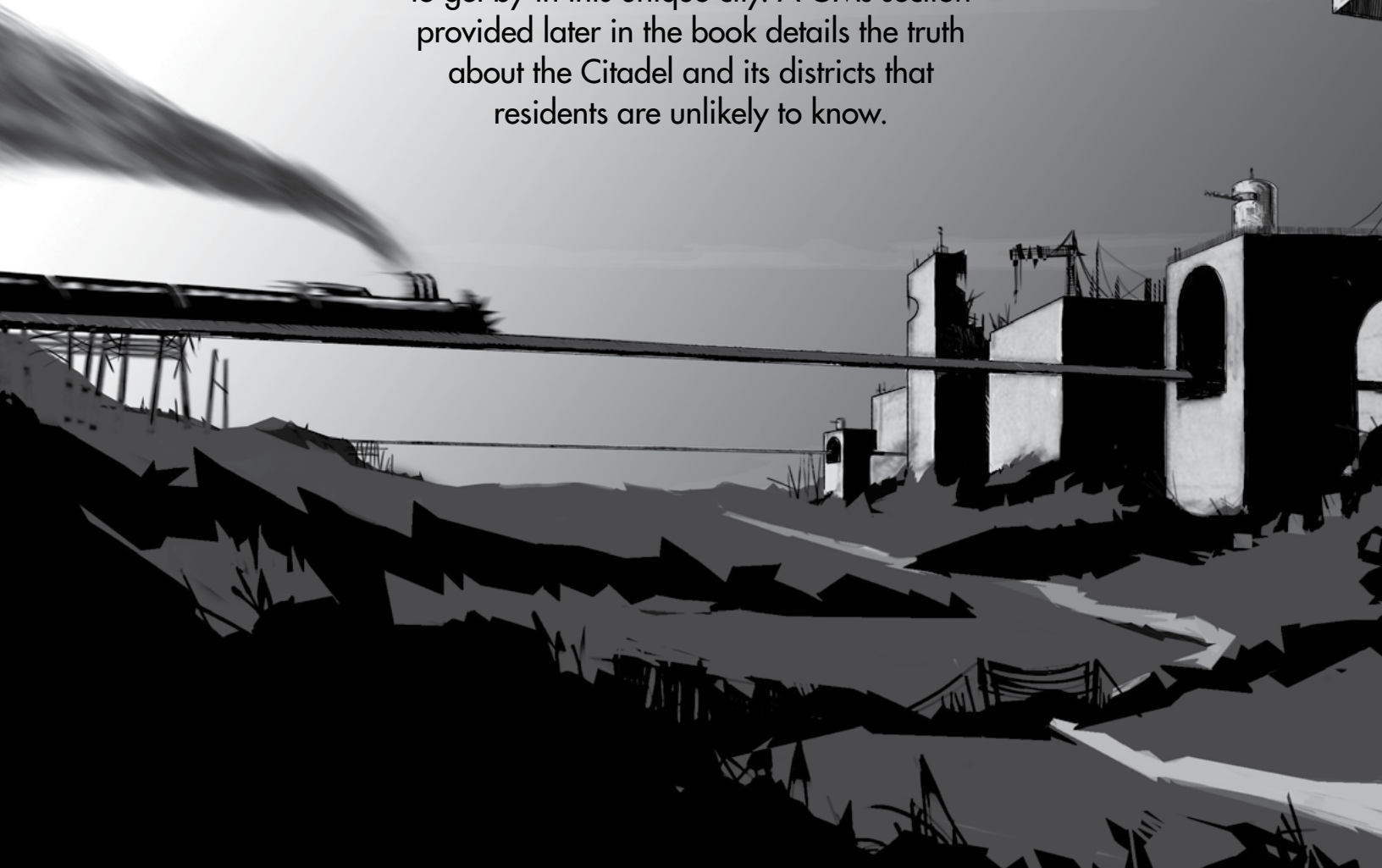



GO HOME

LUNA
3

RED CUBA 1937

THE CITADEL OF SCRAP

So, you think you know Umerica? You've traveled the length and breadth of this devastated land and you think you've got the stones to get along here? Let me tell you, The Citadel is a world all its own, kid. Here you're going to find the glories of the before-times preserved in a way you've never seen. Wealth can be yours if you're smart, skilled and more than a little lucky. I owe you for saving my hide so let me repay you in kind and be your guide here...to The Citadel of Scrap.

Call me Fo-Dor, I'm a little bit of everything: historian, traveler, tinkerer, and general madman. Ask anyone! My face is well known hereabouts, which is a boon in some quarters but might cause problems in others. Try not to be dazzled by all the buildings. I know you've probably never seen so many intact, seen so many streets in working order, and the trains and rail lines are still steaming along. In fact, the rails are what really feed this place. They divide the whole city into roughly nine segments and eight neighborhoods. The Misery river borders us to the north and the Kansan river to the west. The rail lines offer the only safe way to cross into the Citadel. To the South and East lie miles of savage lands filled with bandits and creatures best not discussed. The Royal Bridge rail line crosses the Misery and continues North and South into Umerica. The God's Way line crosses the Kansan to the West and continues East. It's said that all rails eventually lead to the Citadel. These lines act like arteries pumping wealth in and out, feeding the ever hungry heart of the city.

All this wealth has to be protected of course and here we all answer to the Royals. They're three of the nastiest, cagiest, Wizards you'll meet. They play this town like a giant board game, issuing orders from the Growling Tower, maneuvering their pawns this way and that, pitted against each other in some contest understood only by their own twisted minds. Despite that, things run smoothly, mostly due to the merchants. This is the only stable economy you're likely to find in Umerica. Anything of worth can be converted to the local funds and you might be surprised at what is considered to have 'worth' here. Scavenged technology, petrol, ore, minerals, ammunition, drugs — of course, they're worth just as much here as anywhere. But there's a dark side

to commerce here as well. Bodies, alive or dead, in parts or intact, also have value. Your time, of course, has value as there are many who would hire you for a day's work or longer. All this yapping leaves me dry and hungered — look, here's an O'Burger. Why don't we fill up, your treat, and let me tell you more?

LAWS AND ENFORCEMENT

On government and the law, I can give you a few pointers, but truth be told, as often as not, the amount of cash, knowledge, or trade goods a person has will determine how well you get along with both.

The 'true' rulers of the Citadel of Scrap are the Three Royals. Equal parts technologists and wizards, their energies and time are bent towards making themselves as powerful as they can in the effort to control the God in the Pit. Of course being three persons of nearly equal power and intellect, exactly **which** of them will have the ultimate control is subject to opinion. The day-to-day operations of the Citadel they leave to their cadre of advisers, who in turn squabble amongst themselves to claim the largest crumbs of power discarded by the Royals. This leads to a pretty inefficient system of government, made worse as the Royals seem to like to play games with the citizenry and their advisers. Maybe it's a twisted form of entertainment, perhaps they have a real method to their madness, but from one month to the next, sometimes one day to the next, laws and rules can change and it's left to each district to appease the Royals as they may with some in open defiance.

To enforce their will, the Royals and their advisers have access to very potent technology. Gyrocopters, flying drones, robots, and a force of extremely well trained and equipped soldiers can be deployed at a moment's notice. Luckily, for the most part, the official rulers leave the running of the city to the district mayors and merchants who have much invested in providing a stable economy and securing a relatively safe place of occupancy for the citizenry.

Unless it's one of the big crimes, like the worship or study of the Fallen God, mass destruction of infrastructure, or fomenting treason, all infringements are handled within the district that it



A 17

THE CITADEL OF SCRAP

occurred. Most times a fine commensurate with the damage done to property, a person, or the general peace is levied. If you can't pay, imprisonment is not the usual punishment as that takes up space and resources. Instead, you'll be put on a work crew until you've earned enough to pay your debt, enslaved to the person you've wronged at a set amount of 'wages' earned per day to pay your debt, or in extreme cases where a death penalty might be in order, your body will be sold to various scientists who have need of 'fresh' parts.

CURRENCY

The whole world runs on currency in one form or another and it's no different within the confines of the Citadel. Trade and barter is fine in most parts of Umerica, but here we're stable enough that hard coin is actually minted and can be used to purchase what you need in any district. In fact, Citadel currency is so well backed that you can often trade it for goods and services all across Umerica. Particularly to those merchants that do business here but live outside these walls. The markets set the daily value of a particular coin based on trade, and the value rarely fluctuates. If you're trying to reduce your load, turning your trade goods into coin isn't a bad idea. The value is mostly certain and much easier to carry. Don't think to produce your own coin though, while they seem to be simple rounds of metal with patterns that are easily duplicated, every merchant here can tell the difference between a true coin and a false one. Trading in false coin is one of those 'punishable by death' laws of course.

PEOPLE, CULTS, AND BELIEFS

The people who make up the city can be divided easily into two camps: Those that live out their lives here, never crossing the rail tracks into the wider world, and those that come and go, using the city as a point of rest, commerce, or source of information.

For the lifers or 'scrapppers' as they call themselves, the city provides all the entertainment and adventure they'd want out of life. Enough money can be had doing odd jobs for various vendors, running your own business, or risking life and limb by picking through the detritus of Misery Side or The Ruins.

There are jobs working for The Royals and their various officials of course. A city this size runs on bureaucracy, and if you can read and write you're sure to find a menial job to keep your belly full and a roof over your head. Only scrapppers that can prove at least 2 full generations of their line have lived here can apply to join the central militia. Those soldiers answer to The Royals and their advisers directly. Each district has its own local militia though and who they let in and what qualifications are needed differ from district to district. The merchants hire both scrapper and visitor as the need arises. You can make good money guarding caravans that cross by rail or by land working for them.

On beliefs, well you can find a range of Gods worshiped here. All the big ones of course: Classica, Santa, S'agnoid (who has many worshippers amongst the science-seekers), The Lords of Light, Cash (whose worship is almost universal amongst the merchants), Grokk, Kizz, Petrolex (whose worshipers are found amongst the rail and petrol-heads), Nuka, Theszolokomodra, Elmos, Silk, Technos Discos, and even a few mad supporters of the god Yyallaayy. Additionally, there are a few unique cults that worship here:

The Holy Pit masters of Barbi-Q are who you'd like to visit if you lose one of your party members in battle and manage to cart his body back. These holy brothers and sisters practice a religion that reaches far back before everything went to hell and they don't claim a particular god so much as practice rites helpful to all. It's based on the cleansing and preparation of a body so that a person's soul might ascend a tad bit easier. Using sacred rites, fire, smoke, and various sauces they are able to cleanse and purify any hunk of flesh, which they return to you 8 to 14 hours later in a portable and easy to carry container. I hear that if you have the stomach and disposition for it, your dearly departed tastes delicious after these preparations. For a nominal fee, blessed sauces and sides are also available.

The worship of The God in the Pit is limited by law to a small but devoted group, whose membership is the Royals. Adjoining the districts of Squaresville and The Ruins lies the Pit and the Growling Tower.

THE CITADEL OF SCRAP

It is said by worshippers that the Pit was created by a god that fell from the sky, his impact creating the deep chasm and destruction that surrounds that blighted bit of land. The Royals created the Growling Tower to cover and seal the Pit. There they perform studies and research ways to contact the Fallen God. The active worship or study of the God in the Pit is illegal.

In the District named The Forgotten Home, a badly kept 'secret' society of Nostalgia Worshipers operate underground. I don't know if their god parcels out any real power to his worshippers, but I've got to say The Forgotten Home has the cleanest and most well-maintained buildings of any in the Citadel.

TECHNOLOGY

The Citadel of Scrap is a marvel of pre-cataclysm splendor. Many districts have hot and cold running water, electricity, sewers, paved streets, and entertainment over radio and television broadcast. If you're a citizen the taxes you pay keep the good times rolling, for visitors you'll pay dearly for access. Still, If you have the wealth, life can be easy here and a paradise when compared to the struggles found across Umerica. Lacking the wealth, it's tooth and nail fighting to eke out a living and that you're probably used to. Have a care how you treat people. The rich know they are scant days away from poverty if their businesses fail or their luck turns. The destitute are hungry to take every advantage given them to rise in station. The ragged man you scoff at when he begs for charity might be tomorrow's soldier or official that you plead your case before.

LOCATIONS

Misery Side

The best thing about Misery Side is Rudy's Adventure Escape. Rudy's an old warrior who retired out here and bought himself an island. Most of Misery Side lies under the Misery River, with a few buildings along a jagged coastline of asphalt and cement. Mutants, squatters and those not wealthy enough to find homes elsewhere scrounge out a living here. Treasure can be found beneath those waters and if you don't have the equipment or gear to go hunting for it, Rudy will be glad to rent it to you. He does a good business renting everything you could possibly need, charging a modest sum for the rental



and 10% of the value of anything you find. And what can you find? The smart treasure hunters do their homework beforehand, searching out history books and literature from the past-times. My own research tells me there's a dock of sorts under that river. A dock that held flying machines that could carry hundreds of people, quickly, to any destination you could desire! Imagine what could be salvaged from such a place!

As to the dangers here, I can speak to a few. Rudy will make you a pauper from his rentals, though I wouldn't ever consider skimping on his percentage if you know what's good for you. I understand he has ways of knowing exactly what you dredge up and he's got a fine eye when it comes to appraising that loot. The river itself has dangers and more than just avoiding the jagged bits of buildings that can suddenly appear below a boat, ripping a hull in twain. The waters are home to numerous creatures, some quite large and all quite hungry. To this, I'll add one more warning. The wizards and men of science in the area employ scavenging creatures to collect various wares for them. Called Misery Men, these twisted creatures stalk the shore lines waiting to pull unfortunates from the waters. Be you alive or dead, your body has worth to them and their masters.

Cog-Alley runs from The Flats, through Misery Side and ends in Whole Sale. I'll tell you more about that later.

THE CITADEL OF SCRAP

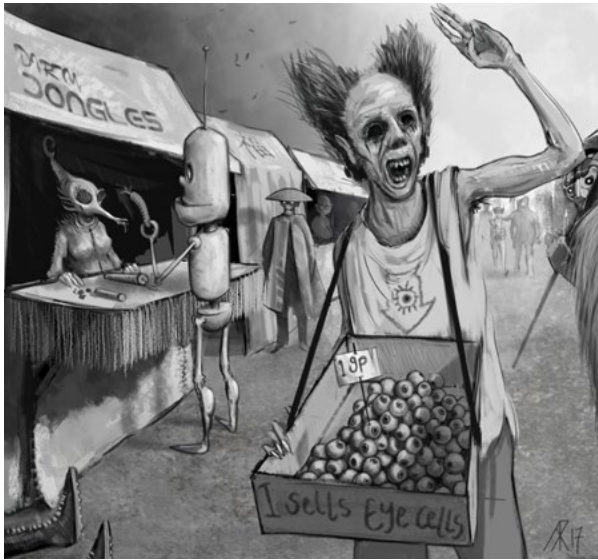

Whole Sale

If you're here to buy or sell, you can't do better than Whole Sale. Don't let the name fool you, the prices aren't cut-rate, rather the name comes from being able to find 'wholly' anything and everything on its labyrinthine streets. Bargains can be found here though. Quite a few residents seek to manage their overhead by dodging taxes and a large black market has developed. If you want goods that are guaranteed, fresh, or not likely to blow up in your face, go shop in one of those fancy places along Cog-Alley. If you want cheap or reasonable prices, shop in any of the numerous temporary establishments that line the streets of Whole Sale. The guys who operate out of push carts and trailers have the best prices. The goods might be one use away from exploding, stolen, or decorated in truly unfortunate colors, but won't break your purse. Don't go expecting refunds though, chances are you won't find that particular salesman in the vicinity if you go a-lookin'.

Speaking of Cog-Alley, the best of the best can be found here with the highest of the high priced tags. Cog-Alley starts in The Flats next to all the warehouses and industrial buildings and winds through Whole Sale. Goods get repaired, cleaned and ready for sale in The Flats where the bulk of the merchandise resides until the merchants decide to release them on to the buying public. The alley itself is well defended all along the route to the heart

of Whole Sale. The shops that peddle top-grade merchandise are all permanent structures. Freshly painted each month with garish, eye-popping colors and advertisements; it's easy to find the sales booth of your choice. The shops along Cog-Alley live and die by their reputations, so if you've got a problem with the goods you buy here, make sure to raise a fuss and you might get refunded...or shot, depending on the shopkeeper's mood that day. Sometimes burying a body is easier than repairing a reputation.

The Tech Markets can be found at the terminus of Cog-Alley. They hold auctions here weekly and if you're looking to sell choice goods in bulk or if you have a really special piece of ancient tech to unload, you'll get top dollar here. Notwithstanding the length of Cog-Alley itself, the Tech Markets are the only place in Whole Sale that you'll find a large body of soldiers. Some say it's to protect the goods on sale here, others say it's to protect the public **from** some of the goods sold here. Either way, if you've got a bounty on your head or have made the powers that be interested in you, avoid this place. Keep in mind that if you choose to sell here, your earnings will be taxed and taxed heavily. Sometimes it's the only place to go to unload that 'special' merchandise though.

If you're trying to connect with the less savory elements of the city, Whole Sale isn't a bad place to do that. Just east of Whole Sale is a heavily wooded forest the populace has taken to calling Surewood. The tree canopy is so thick that air patrols can't keep track of what's going on inside and the density of trees make it possible for only lightly armored police forces to enter. Citadel forces are loath to enter for those reasons and Surewood remains free of patrols. Criminals and deviants make their homes in these woods and I hear there's even a strange cult that's set up shop deep in the heart of this lawless place. Rumor has it the cult stands in opposition to the Three Royals and their agenda regarding the Pit. What that agenda is and why these fools fight it is the matter of much hearsay and guesswork. Who really knows the minds of the Royals anyways?

THE CITADEL OF SCRAP



The Flats

Smell that? The belching black fumes, fuel laden air, and that feeling in the back of your throat that makes you want to cough and retch? That's the smell of productivity boys! The Flats so named for the err...flatness of the terrain. The concrete ground is perfectly leveled here and work crews keep it that way. Miles of warehouses and factories stretch as far as you can see in neat, orderly rows. Hard working mutants and automated cogs do all the heavy lifting here. The 'aroma' produced by the factories keeps less hardy folk from being able to put in more than a single day's work. Nestled between these behemoth buildings can be found some truly interesting shops. Artisans flock here, taking advantage of the high security and ready access to the materials that are produced from the factories or the space provided by the warehouses.

The transportation of goods out of The Flats and into Umerica is made possible by the Kansan river that flows through, and the Royal Bridge that offers rail transport. Local goods get moved along Cog-Alley, which connects The Flats with Misery Side and Whole Sale. The factories and warehouses that

need access to water or to ships that can transport in bulk line the shores of the Kansan.

The North Station railway, one of two major points of entry for most visitors, can be found in the northeastern corner of the district. Avoid the shops that have sprung up along North Station, they're tourist traps, for the most part, selling useless trinkets and garbage to those easily parted with their coin. If you need a safe place to stay, look for HoJo's Rentals which sprawls along North Station. The prices here are high but you can get a room for a day, week or months and enjoy the safety that comes from living this close to The Flats provide. HoJo's apartments are modular affairs that come with comfortable single beds, running water and a working septic system. If you need more room, doors between adjoining rooms can be opened and as many rooms as you need can be connected. The layout really doesn't make any sense and will confuse you if you think too hard about it. When you adjoin rooms, it doesn't seem to matter where a room WAS facing, one door in the room always leads to the central hallway, even if that door led somewhere else before being joined. You might miss it over the clanging sounds the

THE CITADEL OF SCRAP

factories belt out, but the Flats hold a secret haven for those that thrill at speed. Hidden within a block of buildings that tower over it and whose noise disguises the deep growl of engines revved to the max, is a racetrack. If it burns gas, diesel, coal, or the souls of the damned, if you can get it to move and haul ass it's allowed to be raced. Wagers fly fast and the fraction of a second can make you rich or cost you your last hope and dreams. Danny's Fast Trax and garage allows anyone to field the vehicle of their choice into nightly races. Danny and his lads are also fair mechanics that can fix darn near anything that's mechanical and moves. If you want to race, the rules are few and no whiners are allowed. Weapons are often mounted upon the cars, and heavily armored vehicles use that bulk to muscle lighter cars off the track. Once the flag lowers, its three laps of free-for-all action before the lights go out and the victor is named. Danny leaves nothing to argument and has high-speed cameras aimed at the finish line to arbitrate all wins and losses. Feel free to bet as you please or sponsor a team if you've the wealth, after all, it's fun and games until you die screaming in flaming wreckage.

Fields

If you're hankerin' for a bit of green lands and unsullied nature, visit the Fields. Open green pastures and orchards populate this district and have intentionally been left underdeveloped. When the Kansan river rises, the Fields provide a floodplain for the overflow. The park-like atmosphere brings residents and visitors some much-needed relief from the close confines of the city proper. The only buildings permitted here are the squat, stone, public lavatories that carry waste away to be recycled. Patrols here are done by aerial drones whose presence is less distracting. If you're caught pitching a tent here or camping out, you'll be levied a fine when you exit the district and possibly jailed if you've caused damage, by say cutting down a tree for firewood. Another reason you might want to visit includes the Dead Tree. A huge petrified tree that many businesses and folks use as a public posting board. Job flyers, as well as advertisements for various goods, are tacked here. The stone lavatory buildings I mentioned are used to conduct illegal trade and clandestine meetings frequently. Since the district is only patrolled by

air, these make ideal locales for such meetings. The industrial waste disposals make for a great way to rid yourself of the odd body you might need to disappear.

Various entertainments can be found here day and night. Jugglers, poetry readers, musicians and extreme cooks make up just some of the acts busking for your spare coin during the day. The night is given over to the fights. Bare-knuckled, armed or in teams, the law allows these events to take place as long as you properly dispose of any inconvenient waste materials. The use of weaponry that causes damage to the Fields will result in fines. Fights that result in the death of individuals involved will likely be televised. Betting on said fights is of course part of the fun!

Squares Ville

If you're a resident with a steady income you probably live in Squares Ville. It's hard to get lost here as everything is laid out in a nice organized fashion with the buildings and streets looking like a cataclysm never happened. Running water, electricity and even broadcast entertainment are commonplace here with barely any interruptions in service. This district is also home to the better, read as safer, laboratories of scientists and wizards alike. Streets are kept clean and repairs to infrastructure are made by an army of creations that spring from these laboratories. You'll find a mix of whirling cogs powering metal men and pulsing organs powering meaty man-things with too many arms, legs, and teeth! Metal or flesh, the creatures get along and keep the place in top condition. Putting down roots here requires more than just an income though. Residents get the privilege, visitors need not apply. What makes you a resident? Paying your share of taxes of course, as well as an interview with a member of the Royal's advisory board. You'll have to provide proof of a steady income or have access to a deep fortune. Starting a profitable business in the Citadel would go far in securing yourself a residency permit as well. On occasion, a resident here might have a spare room to lease for a short time if you get sick of living in a squatter shack or at one of the many HoJo's that spring up around the rail tracks. Entertainment is big business in the Citadel and Squares Ville hosts a number of pirate radio and

THE CITADEL OF SCRAP

television stations that vie for patronage. The only city sponsored program is beamed across the Citadel from the Growling Tower. These transmissions occur three times daily in the morning, afternoon and evening and are powerful enough to knock out all other broadcasts during their transmittal. Good citizens listen in to keep informed on the coming weather predictions as divined from one of the Royals, news of the day, and wanted persons of note that should be reported on if seen. These broadcasts seldom last for more than a few minutes and don't overly interfere with the more entertaining programs that battle for your attention. The more listeners a broadcast has, the more power they seem to generate to beam their shows further afield. This leads to real competition between channels and their listeners. It is not uncommon to see groups of folks battling it out in the streets, each side wearing the logo of their favorite show and shouting out battle mantras inspired by their favored celebrities.

In the southeastern corner of Squares Ville, adjoining the Ruins, is the Growling Tower. The shifting, groaning mass of metal that seems almost organic as it grows to encircle the Pit of the God, is home to the Three Royals and their advisers. No one goes there, at least not intentionally. If you're summoned or brought there, make sure you have your affairs in order as it's not likely you'll be seen again. Thankfully the Royals are more interested in playing out their cold war against one another as they plot and scheme to scrape together the power needed to awaken their sleeping god.

The Ruins

With the exception of the mostly drowned district of Misery Side, setting foot on the streets of the Citadel must look and feel just like it did before the Cataclysm. Electricity, solid buildings, blinking lights, streams of people going about their lives out below the blue skies. Where do you imagine the detritus of the city went? The Ruins, that's where. This is the stinking garbage pit of the city. All the broken buildings and crumbled remains that didn't remain intact got pushed out here, making one giant landfill. It's also a place of great opportunity. None of that 'garbage' got sifted through when the machines piled it high. At first, the refuse created a wall to surround

the Pit of the God, protecting the research the Royals did there. The Growling Tower has taken the place of that early wall and some say it feeds on the trash that remains to grow even larger. Expeditions are still mounted by wizards and scientist to sift through the remains in hopes of finding new reagents to fuel their thirst for creation.

Some buildings here do remain intact. I'll bring your attention to the South Station railway that crosses God's Way and straddles the border of Squaresville. The usual collection of shops and HoJo's have sprung up around the rails and the areas immediately around the lines are well patrolled and safe. This may seem an odd place to have a rail station, but this district's proximity to the Growling Tower assures solid transportation for the Royals to make use of as needed. For researchers and treasure seekers that wish to explore the trash mines, this makes a good base of operations. A major discovery was made here not long ago. A series of buildings dedicated to the creation and display of information in the form of greeting cards has been unearthed. Once given as gifts to express emotional sentiment, they are now primarily used by the cities black marketers and criminals. Receiving such a card, left anonymously at your door, means you've crossed the wrong people and death will soon come to claim you.

Two other buildings that have been heavily explored with artifacts reclaimed are a museum dedicated to killing and a storehouse of strange bricks that snap onto one another and can be used to build crude structures. Artifacts taken from the museum have included blades, guns, and vehicles that seem to date from an era that had passed long before pre-cataclysm society. A cult has sprung up around the worship and use of these items, stamped with the cryptic sigil WWI, which the cult has taken as its name. Mounds of plastic bricks have been taken from the second building and the wealthy have been known to build elaborate homes with them. As a status symbol, these colorful bricks are worth their weight in shells and powder.

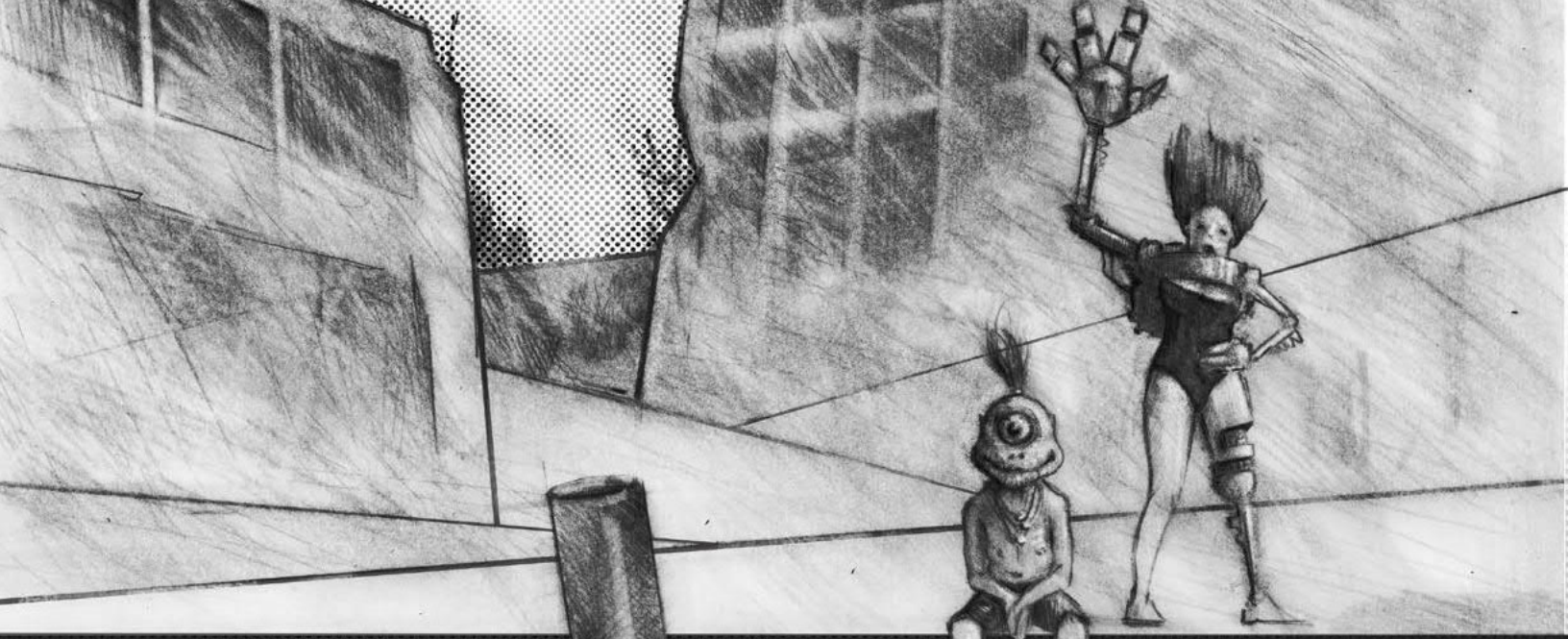

AKA

THE CITADEL OF SCRAP

Forgotten Home

Despite the power the Three Royals command, there are some elements of the city that maintain their own rule. Forgotten Home is an immaculately maintained replica of what the inhabitants believe to be pre-cataclysm living. Great concrete and steel walls surround the district and cut it off from the rest of the Citadel. This isolationist sub-city is largely self-sufficient, allowing only minor trade with the external city. The deluded citizenry here maintain rooftop gardens and have access to their own electricity. Given their outlook, non pure-strain humans simply aren't allowed. These other beings certainly weren't part of the culture in the bygone era they seek to shelter within.

To be sure, the Three Royals could command a small regiment of troops to retake Forgotten Home or have them bombed out of existence from the skies, but so far they choose not to. Perhaps this district is an experiment being performed by the Royals? It's rumored that the entire suburb is actually a cult of Nostalgia Worshipers, and they certainly look the part. Unless **you** look the part, act the part and carry no equipment that 'breaks character' you'll never be let inside to find out. Certain underworld elements might pay handsomely for information or to establish a black market trade route to and from the district. Patrols and guards along the walls seem well armed and armored and shoot first before asking any questions.

Passage

Like Forgotten Home, Passage also resists the power of the Three Royals. Less thematic, the citizens that make up this district are the disenfranchised, those that once had standing, power, and jobs but now have nothing. They're not criminals like those that call the heavy forest of Surewood home. These folk still have pride and honor, but don't believe the rules of the Citadel allow them to live in the ways they choose. Resentful of outside interference, they do allow the occasional interruption from the Royals. The buildings here are overgrown and wilderness has reclaimed much that was. Not every building has power or sanitation and the citizenry tends to share access to such things with one or two houses in each block providing both.



The people have rallied together and found a common thread to bind them in an ancient sport called base-ball. An intact museum from the prior era is centrally located at the heart of Passage. The museum worshiped the sport of base-ball. Having donned the war-gear of the cult of base-ball, learned the rituals found in the play books, and acquainted themselves with bludgeoning weapons of wood and light metal, Passage has challenged the Three Royals to settle their claim on this land by ritual war on the diamond field. So far their challenge has gone unanswered.

Visitation is allowed here, as is commerce. If you are willing to worship on their diamond fields (worship areas are cut into the lawns of most dwellings) and learn the rules of base-ball you'll get along just fine. Disputes are handled on the diamond with the winning side being granted their way. In cases of serious transgressions, the guilty party is made to walk the gauntlet where 9 men wielding clubs will each have three swings at the offender. If the guilty person can walk or crawl through the gauntlet, their crime is forgotten. Otherwise they will be bludgeoned to death. Take care if you seek to break the laws here my friends!

With that, I've told you enough to get by in the Citadel. You've learned of the eight districts and the laws. What to avoid and where you can make a profit. Take nothing I've said lightly! There's more to know and you can spend more than one lifetime learning it all, but this is where my introductions end. May you walk in peace, earn great wealth and never forget to spend some of that in charity.



PLACES to GO
+ THINGS to KILL



Even though the Citadel of Scrap touts itself as the center of industry and enlightenment of Umerica, it is not the only place where adventure can be found. The continent of Umerica is teeming with dangerous ruins, hungry beasts, and raiders galore. Here are a few places that adventurers may have heard of or might encounter on their travels. Several of these have more detailed information located in one of the issues of *Crawling Under a Broken Moon*. If this is the case the issue number will be indicated by the location's name.

THE BURNING LANDS OF YELLOWSTONE

Bordering the northeastern edge of the Vast Wastelands is an even more inhospitable area known as the Burning Lands. Those familiar with pre-cataclysmic geography say it is part of an area once known as Yellowstone. It is a literal Hell on Urth where lakes of molten lava and plains of boiling mud abound. The few folk that choose to call this place home glean freshly ejected metals, gems, and

minerals from the various lava vent flows. They also mine obsidian from the cooler parts of the area. These they trade with various agents from the Citadel of Scrap's trade guilds and a few of the more organized wasteland raider outfits. There is a large following to Petrolex here and even the more agnostic folk tend to pay their respects to the fire god, just in case.

There are rumors that dimensional breaches leading to the elemental plane of fire and to several infernal realms can be found within the Lands. This would account for the large communities of heat-loving elementals and demonic kin that can occasionally be seen frolicking in the lava lakes and boiling mud pools.

Adventure Hooks

- A Cybersorceress is looking for a few skilled individuals to escort her into the Burning Lands where she can make a few demonic deals in person. She promises valuable technomagical items to those who aid her.

PLACES TO GO, THINGS TO KILL

- The party is hired on as guards for a caravan heading to a trade post in the Burning Lands. They hope to trade textiles and hearty foodstuffs for oodles of raw ore and gemstones. The raiders covertly watching the trade route hope the caravan is successful too...
- A chapel of Petrolex near a holy lava pool has been attacked and the church is looking for a few able folk to deal with whatever has desecrated their sanctuary. They offer a full tank of gas as a down payment for this service to Petrolex.

THE FLOATING IRON ISLES

On the waters of Lake Mishigun drift an unknown number of ancient massive shipping vessels that are now home to strange ecologies and even stranger inhabitants. Each is now completely overgrown by various types of heavy foliage and some even sport large trees. There is much conjecture on how this came to be but considering a good portion of the floating isles are inhabited by Fairyfolk, magic probably is to blame.

These artificial islands rarely come close to shore but the few times they have, a hoard of fae has descended upon the local populous. They prank, enchant, steal, and pillage until their home begins moving away from shore again. Those that live on the shores of the lake have learned to be very wary when any of the overgrown hulks venture anywhere near the shore.

When two or more of the isles come close to each other, more often than not they make war upon each other for as long as they are adjacent. These skirmishes are often violent and teeming with magic.

Adventure Hooks

- While resting up in a pleasant little village on the shoreside, the party hears a cacophony of sirens fill the air. The locals are all panicking and pointing at an old, overgrown barge heading close to shore.
- The party's quest for medicine for a sick ally has led them to seek rare herbs that are said to only grow in "floating fairy forests". Now they have followed rumors to the shore of lake Mishigun and the infamous floating isles.

- The sweetheart of one of the party members has gone missing while searching the lakeshore for washed up treasures. Now they must investigate the isles to locate and rescue the sweetheart before it is too late!

THE GLOWING DOME OF DINOTASTIC PARK

(*CUaBM #14-15*)

No one knows when the giant green glowing dome appeared or where it came from, but legends say this world is not its original home. For those who have studied the remaining maps of ancient Umerica, the dome encompasses the majority of the area that used to be called New Mexico.

At its highest point the dome reaches roughly 5 miles into the sky and the width of the dome is over 200 miles, which is also roughly how far away it can be seen from ground level. At the base of the dome is a 150 foot tall wall of metal that completely surrounds it. The wall is seamless and featureless other than six entry gates, which are evenly spaced around the circumference.

Rumors abound that there are tremendous beasts within that herald from an era millions of years ago and where lush foliage and trees grow unhindered by radiation or corruption. They also say there are technologically advanced ruins just waiting to be plundered. Really, just how dangerous could it be in there?

Adventure Hooks

- The Red Claw Raider mercenary company is looking to recruit a few able bodied folk after they suffered some losses in a recent "venture". Recruits will not be told much about the job until they sign on and pass the entrance test.
- The party meets a wealthy, well guarded caravan on the road. A bit of hobnobbing with the guards scores a tale of great botanical and technological riches that can be found inside of the Glowing Dome. They do warn of large scaled beasts but that the risk is worth the rewards.
- After stepping through the strange portal, the party finds themselves in the empty ruins of a once great research center. Moving outside

PLACES TO GO, THINGS TO KILL

they find themselves in a different world with a bright green sky and strange lush vegetation as far as the eye can see...

THE ISLE OF DR. MAMMON

Off the southwestern coast of Umerica, an isle formerly part of the pre-cataclysmic California Peninsula is now home to Dr. Mammon and his research facility. He has terraformed over half of the island from its natural arid state to be a tropical rainforest that he uses to house his latest creations.

There are many rumors regarding what actually is being done on the island but most focus on the fact that Dr. Mammon supposedly makes monsters based off of genetic materials he found in the Glowing Dome. The enhanced aberrations that prove to be the most stable he offers to anyone that can pay his exorbitant costs. The Royals of the Citadel of Scrap supposedly augment their maximum response security forces with several cyber-dinosaurs of Mammon's design. One of the most wealthy of the Vast Waste road gangs supposedly owns a few as well.

Surprisingly, Dr. Mammon welcomes guests to his isle, as long as they are wealthy. Anyone else found on the island tend to be made part of his experiments as targets for his latest creations.

Adventure Hooks

- During a short, coastal voyage the party is caught up in a squall and now finds themselves washed up on an unknown shore. The boat has run aground and is heavily damaged. As the party tries to get its bearings, a large creature can be seen walking up the beach. It looks like a dinosaur from one of those picture books except it has machine guns graphed to its shoulders...
- A wealthy merchant has hired the party to act as extra security for an off shore pickup and over land delivery job. The only info given is that it is a very valuable live cargo. The good news is you get a high voltage electric prod to use on the job.
- One of the party's good friends was captured and sold as a slave. They have tracked down that the buyer lives on a huge island and has a



very twisted reputation. Can they recover their friend before it is too late?

THE KINGDOM OF THE FALSE GODS

Deep in the wetlands in the area called Floor-Da lies a strange realm ruled over by a pantheon of mad mascot gods. It is said that the realm was once a magical place of great joy and amusement before the cataclysm changed everything. The multitudes of unmoving icons, much beloved by the populus, awoke and began making war upon each other to determine which was the greatest of them all. The stories of the battle say it was long, terrible, and that it left all of the victors unbalanced.

Nowadays, A good number of folks still live in the lands claimed by the Diz gods, each pledging loyalty to one or more of the Diz gods by wearing iconic paraphernalia. Those who blend in and do not make waves tend to live well, as long as they do not gain the direct attention of any of the Diz gods.

A small amount of trade has begun since the Royals of the Citadel have made contact with the Diz gods and signed a trade agreement. The East West rail

PLACES TO GO, THINGS TO KILL

barons have even begun re-building a permanent railway between the two communities.

Adventure Hooks

- The party has been hired by the East West rail barons to scout out some pre-cataclysm railway lines near the Kingdom to see if they are restorable to service. Unfortunately, the area is personally claimed by one of the more raving Diz gods.
- An alien collector, banished from the Kingdom and all outlying lands, is trying to find some obscure merchandise dedicated to Feisty Foxy, a Diz god killed early on in the Diz war. It offers the party a sizeable sum to go into the more forbidden places of the Kingdom to seek relics of that long dead Diz god.
- Priestesses of the Diz goddess Marilyn Moose are looking to hire an able bodied group to seek out an ancient relic that lies in the southern section of the Glades. It was stolen from their temple and the thieves escaped into the Glades, only to be killed by the beasts that dwell there. They offer fresh food, filtered water, and the blessings of their Diz goddess as reward.

THE LANDS OF AETHERIA

(CUaBM #5)

Far in the northern reaches of Umerica lies a land unnaturally warm and fertile, yet still scarred from a massive war at the onset of the cataclysm. The land now known as Aetheria was home to a great urban population whose ruins are still seen. It is a nation of smooth rolling hills and dense deciduous forests with soil that is responsive to farming. The area is also rich in minerals and remnants of the forgotten technology of the Un Men.

Common folk eke out a living scraping in the dirt, living in wood-framed longhouses or tents made from skins. They plant crops of Bluwheat, barley, oil seeds, and vegetables and hunt in the surrounding wilds. Citizens tend to defend their homes with selfless strength, using found or simply constructed weapons.

Only the proud and honorable nobles of the land, known as Aetherian Heroes and Heroines, employ the ancient forbidden tech or any other types of

technology on a general basis. The greatest of these heroes are called to serve the mystic castle Old Skull as the Masters of Aetheria.

Adventure Hooks

- There are rumors of a lush green land in the upper north of Umerica. They say that many relics of powerful technology lie shallowly buried there, waiting to be found. The locals apparently shun most technology so they certainly will not mind anyone coming to claim it...
- The party's mightiest warrior begins dreaming of an ancient castle far to the north that seems to be calling to him or her. The dream promises honor, power, and technological riches to those who heed its call.
- During their adventures, the party discovers a robotic head that still functions. It knows many secrets and promises to lead them to a great trove of fantastic technology if they will venture north and help it regain a body...

THE MENFISH PYRAMID OF THE BASS MASTERS

(CUaBM #18)

Along the Misshipy River Valley a traveler can see the giant gleaming pyramid from many miles away. Atop it is one of the only functional radio broadcast towers left in Umerica. Live rock music and calls to come and live in the Pyramid Port City are transmitted 24/7 to whatever radios are within 200 miles of the Pyramid.

It is no secret that the majority of the population of the area are Menfish, humanoid fishfolk that are about as peaceful and trustworthy as any other type of people you may encounter in Umerica. It is all ruled over by a council of Menfish known as the Bass Masters and the port city is an excellent place to trade goods or relax listening to some awesome rock music.

If you think it all sounds too good to be true, you are not alone as there are many rumors of folks who come to the city to trade their goods and never leave, of folks who go missing and are never seen again, and of course there is the fact that Menfish tend to be very fond of humans. Maybe a bit too fond...

PLACES TO GO, THINGS TO KILL

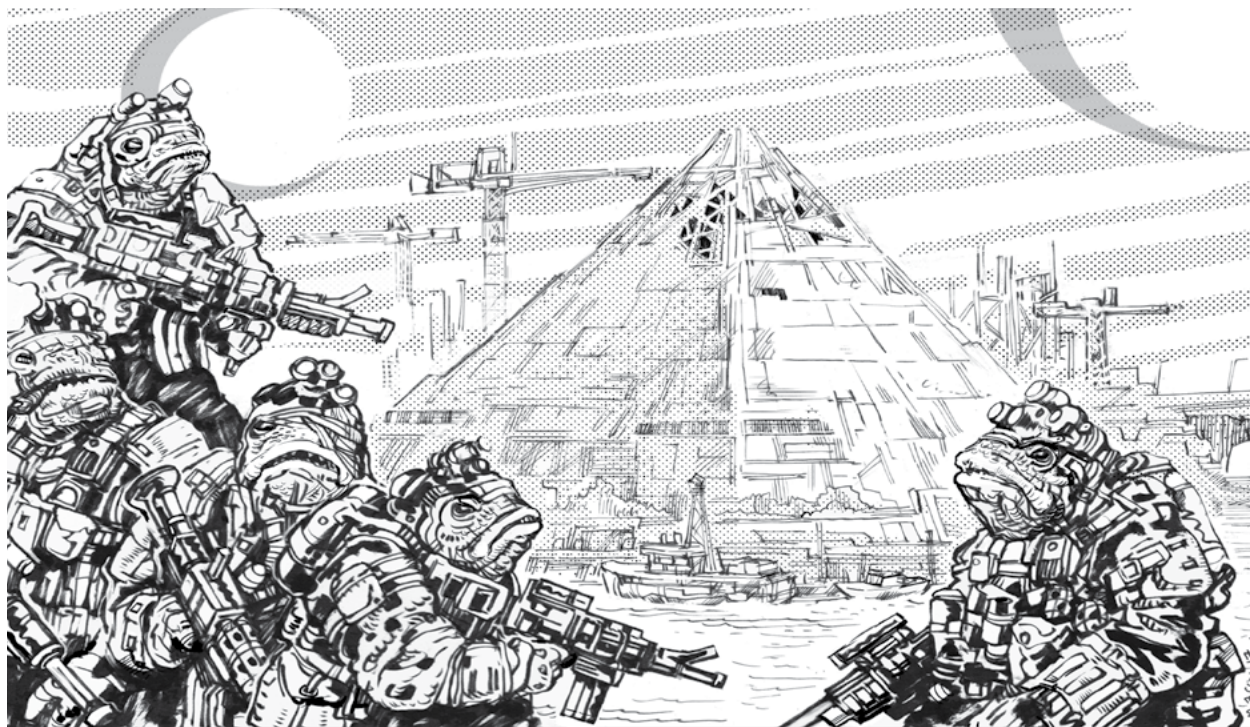

Adventure Hooks

- The party is driving along one of the old highways, the car stereo suddenly finds a radio station to tune into. After listening to a few rock songs they hear of a great community built on the Mississippi riverbank where there is peace, prosperity, and plenty for all. Who would not want to check that out!
- The party was celebrating a very successful scavenging run and got quite intoxicated. They wake up on a river boat they somehow purchased the previous night. It is just pulling up to the port next to the Pyramid to deliver some cargo. The boat crew looks expectantly at the party...
- A great calamity has befallen the home community of the party while they were away adventuring. The party returns as a majority of the settlement has packed up what is left to begin the trek down to the Pyramid. They ask the party to escort them so they will have a chance of making it there alive.

THE NEUQUA VALLEY

(CUaBM #3)

The valley is home to a small community that lives in the rebuilt ruins of an ancient high school. They face many great dangers such as highly inclement weather,

a neighbouring raider settlement, and the ruins of that creepy forbidden mall just a few miles away...

Adventure Hooks

- The party has stopped at the Neuqua settlement to do some trading and rest up. While enjoying a hot meal, a small group of raider vehicles roll up and demand over a loudspeaker that if the tribute truck is not ready in a week, the Neuquans will regret it. The settlement leaders ask for the party's help as they have very little to spare to give as tribute to the raiders.
- Following the directions the party received from a local scavenger, they now stand before the ruins of a large shopping mall that looks as though it has partially sunken into the ground. Every local they have spoken to says it is totally haunted and all are forbidden to enter. An unplundered shopping mall? Who could resist such a prize!
- A group of acolytes of Thesolokomodra has hired the party to act as guards while they make a pilgrimage to one of the many gate shrines of Thesolokomodra that are rumored to exist. The journey has brought the party to the ruined remains of a large shopping mall. The head acolyte says that he can feel the gate shrine lies deep within the ruins.

THE OLD SEATTLE AND THE NECROMANCERS OF THE SPACE NEEDLE

(CUaBM #17)

In the ruins of Old Seattle and the lands that surround it dwell an inordinate number of necromancers. This, of course, means there is also a startling amount of undead in the region as well. As to why they gather here in such numbers, the answer lies in the ancient tower called the Space Needle which, unlike most of the world, has been untouched by the ravages of time or the cataclysm. Within the Space Needle is a place where extra dimensional necromantic secrets can be discovered by those willing to commit themselves to seeking them.

Despite the area being thick with the walking dead, it is remarkably amicable to traders and travelers looking for work. The necromancers who dwell here do not have time to hunt down the rare ingredients or technological components they need for their great works; nor do they wish to waste time with mundane tasks too complex for moronic reanimated servants. This means there is always work for those who would risk the chance of ending up as part of the next great work...

Adventure Hooks

- After a successful battles against some raiders, the party has acquired a few pieces of fabulous and terrible Necrotech. All of the batteries seem to be depleted so now they must travel to the birthplace of Necrotech to get some more.
- The party has been following rumors of a place where they can have their comrade resurrected. For weeks they have been lugging his body around in an ancient cryo-tube. Now they stand outside of the coastal city that supposedly has the magical or technological means to bring their dear friend back to them.
- A strange figure in dark robes has hired the party to be her new guards as she gathers rare ingredients for her "latest brew creation". Apparently, her last guards were not up to the task. She offers quality trade goods and hot coffee every morning as payment.



THE RUINS OF DELPHIA

(CUaBM #13)

Even following old maps, the city is not easy to find. The best way is to locate the remnants of the old Hwy 95 that runs alongside the Delawa River and follow it until it ends in overgrown ruins.

Unlike the ruins of other major cities of the pre-cataclysmic world, Delphia was destroyed much later by forces unknown to anyone alive today. Every building more than one story high was struck down and the entire area looks as though enormous giants have trampled it in anger. Nothing taller than perhaps twice the height of a man still stands, and every surface seems to have been covered with foliage fed by the river.

Rumors abound that under the nearly flattened ruins of old Delphia city lies a catacomb of tunnels lined with rail tracks. It is said that in these tunnels, a hideous beast guards a fabulous cache of valuable salvage. None who have ventured there have ever returned, so everyone says...

PLACES TO GO, THINGS TO KILL

Adventure Hooks

- The Northern RailMasters are paying high prices for salvaged train parts. Rumor has it that there is tons of train salvage buried in the tunnels below Old Delphia just waiting to be found.
- After coming upon the flattened ruins of a once-great city, the party sets up camp in a secluded area. Unfortunately, in the middle of the night the ground beneath the whole campsite gives way as a gaping sinkhole forms. Now the party is deep in the underground tunnels with no easy way out.
- For many days the party has been looking for a way out from the underground caverns they have been trapped in. They come across the remains of a storage room that must lead into an underground complex. It leads to a subterranean train track that must have an exit to the surface!

THE TEMPLE REFINERIES OF PETROLEX

In the barren remains of the state that once was home to the Lone Star resides the legendary birthplace of the mighty Petrolex, god of fuel and fire. Enormous fields of extraction machines stretch for miles, all feeding the massive refinery towers of the main Temple of Petrolex. Here devotes work day and night to convert the blessed crude into fuel and other petroleum products. Those that give proper respect and gifts to the temple are allowed to purchase precious high grade fuels not found anywhere else in Umerica.

A thriving community has sprung up around the temple gates, known as Pump Wait, that caters to the needs of those awaiting their turn to received the blessed fuel, which can take several days. Here also is a small but diverse market made up of the merchant caravans currently waiting for their contracted fuel rations. Rare goods and work contracts for the caravans can be found by those who are diligent.

Order is kept both in the temple lands and Pump Wait by the militant sect of Petrolex, known as the Knights of Combustion.

Adventure Hooks

- After paying an exorbitant price for fuel, the party decides it is time to see if they can drum

up some work from the clergy at the Temple Refinery and skip all of the middle men.

- The caravan that the party is currently guarding needs to stop at the Temple to pick up extra fuel rations for the long trek across the Vast Wasteland. This means a several day layover and easy duty shifts. Not too long after settling in, odd thefts begin to plague Pump Wait and the Knights of Combustion are not being subtle about finding the culprit.
- An important clergy member is looking for capable guards for a covert trip from the Main Temple Refinery up to the Burning Lands sanctuary. Why she needs to travel incognito is not given but the fact that no one must know is made **very** clear.

THE UNTOUCHED VALLEY OF THE FORKS

Through magic, technology, weather patterns, luck or divine intervention, and quite possibly all of these, the Valley of the Forks remained untouched by the cataclysm. The valley, seated among two different river basins in north central Umerica, has sources of clean water, and unirradiated food. The area now is home to devout followers of Grokk, who live a simple farming and ranching life.

To outsiders, this area appears strange. The people of the valley raise unmutated animals such as cows, chickens, pigs, and sheep. Their wheat isn't blue, and their food is generally fresh and unpreserved. Strangest of all, there are no mutations among the populace. Even the water tastes odd, like it's pure and hasn't been filtered. It can be a place of wonder to those used to wandering the wastes.

The people in the valley can be very open and receptive, as long as you're not a mutey or spacey (mutant or alien). They're willing to do business with most, but they'll only trust the pure blooded, and won't let any weirdos stay around in the valley for long. They live a simple life, with minimal electronic technology and a simple sustainable lifestyle. They're not pushovers though, as most of the ranchers know how to ride a horse and are excellent marksmen with their well kept rifles.

PLACES TO GO, THINGS TO KILL

In the middle of the valley an unusually large tree called the Great Tree, is dedicated to Grokk. The villagers will leave gifts under the tree, gather and pray, and perform important religious and civic duties under the tree. The tree itself provides many different seeds for the villages to plant, from trees to natural crops such as wheat and fruit they can cultivate. By law of the valley dwellers the tree must remain unmolested and all those who fail to respect that must be put to death.

Adventure Hooks

- Someone has been stealing cattle from the village. Villagers are offering some food supplies as well as horses and well kept guns and ammo to anyone who can stop these rustlers. Meanwhile, a Buddy O'Burger restaurant has recently been built outside the valley advertising "A fresh new taste sensation!"
- Some "weirdo" cut off a branch of the Great Tree and must be brought to justice and the branch returned or destroyed. The villagers are willing to give up one of their old trucks with a full tank of gas.
- A mutant conclave is running low on food and water and needs some pure blooded adventurers to visit the Valley and trade for them.

THE VAST WASTELANDS

This barren area of dust and desolation eats up a majority of Western Umerica. While there are a few highly coveted oases most of the wastelands are considered uninhabitable by most folk. In truth, many do call the wastelands their home, preying upon each other and those that would attempt to cross these arid and lawless lands.

The Vast Wastelands are the home to a plethora of road gangs that fight over the minimal resources that are found there and home to many monsters that are well suited to the harsh environment. There are even road gangs that have some of these creatures as honored members. Even stranger, there are a few communities of good folk that still choose to live deep in the wastelands, defending their fortified oases from ravenous rabble that hunger for their bounty.



One of the most legendary of these oases is the Fort Hoover Trade Town where both goods caravans and road gangs frequent under the high caliber truce held by the Hoover militia. Here fresh water, electricity, and safety can be had for the right price.

There are a few other trade stops and oases that are somewhat left alone by most of the road gangs and raiders, such as: the Free Trader's Rest (controlled by the Red Claw Raiders mercenary company), Grokk's Lake (protected by the Wildguard of Grokk), Fenderville Freehold Farm (guarded by ancient warbots), and Last Resort Reststop Casino (Owned by a powerful shaman known as Ghost Tongue).

Adventure Hooks

- The Church of Petrolex has placed a large bounty on the heads of a notorious road gang of fuel thieves. They continually make raiding runs and disappear into the wastes. The bounty is three 50 gallon drums of fresh fuel.
- The Fort Hoover militia is looking for large

PLACES TO GO, THINGS TO KILL

industrial parts for their generators that can only be found in the ruins of other hydroelectric dams. They are offering good condition pre-cataclysm weapons and armor as payment.

- Among the loot found upon a band of raiders that the party just took down is a sizeable sum of casino credit chips from Last Resort Reststop Casino. As the chips are only worth full value at the casino itself, a road trip seems to be in order...

THE WHISTLING MARSHES

On the western shore of Lake Mishigun lies the massive ruins of a once great city and its many suburbs. It had many names such as Chi-Town, the City on the Lake, and the Second City. Now it is a wild marshland that stretches for dozens of miles from the shore line with many partially sunken ruins concealed in the tall grasses. Only the remnants of the tall 'scrapers can be seen over the sea of grass. It is said that the constant whistling sounds come from the strong winds that whip through the ruins but they seem much too sinister for that to be true.

Rumors tell that the entire place sunk into the marshes under the weight of its own sin and that a darkness dwells there that lingers even in the noon sun. Tales of alien boogeymen, known as Gloomanoids, who now call the ruins home and of horrifying creatures called Night Bears that stalk the marshes for unwary prey can be heard told throughout the Midwest.

Rumors of the untold riches hidden deep within the wetland ruins waiting to be discovered invariably calls scavengers to delve into the marshes, usually never to be seen again. Such is the flow of hopeful venturers that a small community, known as Tentville, has recently sprang up on the southern border of the marshes. It mostly caters to those looking to explore the marshes or to the few failed plunderers that somehow made it out alive.

Adventure Hooks

- An adjutant of the Royals has hired the party to travel to the main ruins of Chi-Town to retrieve a few choice artifacts that the Royals

desire. Why they want them is not important. To get the job done right, the party is even loaned an amphibious cargo vehicle to bring the goods back.

- A relative or close friend of one of the party members has rashly joined up with a group of prospectors looking to make a fortune scavenging the marshes. Can the party catch up to them before they become yet another in a long line of victims of greed?
- Having come upon the community of Tentville as they were traveling, the party has heard many rumors concerning the riches and dangers of the marshlands to the north. As they consider whether to strike north or not, village scouts run through the streets calling out that "a darkness is coming!". Without explaining, the locals begin battering down the village for an attack...

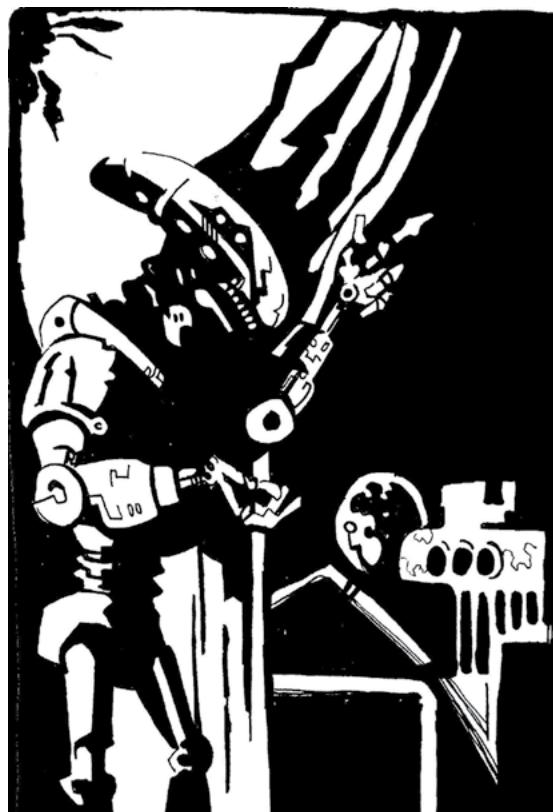

OTHER COMMON KNOWLEDGE OF NOTE

ROBOTS AND ALIENS AND SORCERY, OH MY!

The Urth is now a strange place and the common folk who live in Umerica have seen some strange things. Most people have either seen or know someone who has seen a functioning robot in their lifetime. The same can be said for having seen and honest to goodness extraterrestrial alien. The use of magic is even more commonplace as many large settlements house a would-be wizard or have had to ward off an enchanted beastly at some point. Even more common are the mutant folk and beasts that have been twisted by an untold number of different radiations and mutagenic substances present throughout Umerica. Frankly, the term “normal” has a whole different meaning than it did before the Great Cataclysm. Normal, like beauty, is a very relative term in Umerica.

RADIOS AND TELEVISION BROADCASTS

For those that are lucky enough to have a functioning radio or antenna based television, there are still a few broadcasts they can enjoy. Most of these are regional as there are few, if any, repeater towers still functioning. Below are a few of the most commonly known broadcasts:

Radio

All Bass Rock, All Day Long (*Regional: within 200 miles of the Pyramid of the Bass Masters*) - The broadcast alternates between guttural, high energy rock and roll music and charismatic messages inviting everyone to come to the pyramid of the Menfish and join their community. The messages always speak of safety, food, and shelter for everyone.

The Holy Carol broadcast (*Continental, clear signal*) - This station is dedicated to constant carols about the god Santa and his winter wonderland. Listening to this music for over an hour will produce a mild euphoric effect like pleasantly awaiting a joyful event.

DJ Dead Danny (*Regional: within the northern half*

of the Vast Wastes and a few outlying communities) — A station run by a slightly insane man reputed to be locked inside a pre-cataclysm vault. He plays an eclectic mix of golden oldies and big band music. He also does daily chapter readings from classic adventure books, a big favorite among many of the road gangs.

Mayhem Radio (*Regional: within 5 miles of the Citadel*) - This roving pirate station is constantly being shutdown by Citadel authorities only to begin broadcasting again in less than 24 hours from another secret location within the city. It plays unsanctioned punk rock and cryptic, paranoid newscasts that tell the unedited current news.

Television

Citadel Channels 1-5 (*Regional: within 10 miles of the Citadel*) - Privileged citizens of Citadel and those who have built illegal descramblers can enjoy not one but five whole channels of local news and programs, all endorsed by the beneficent Royals and their administration. Many of these programs are reruns from salvaged media archives but there are a few new productions as well. Everything aired has been scrutinized and edited to the liking of the Royal's administration.

Happy Channel (*Continental but is very spotty, is off the air as often as it is on*) - This erratically available channel can be picked up on any TV that is powered up, even without an antenna. It plays non-stop pre-cataclysm children shows that are always a bit out of focus. Technophiles that have monitored the channel swear that there are subliminal messages hidden in the broadcasts.

O'Vision Channel (*viewable in every O'Burger location across Umerica*) - Each O'Burger restaurant location features at least one big screen TV that customers can watch while they eat. The channel features local weather, news, and lots of light hearted comedy programming all performed by the clown devotees of Buddy O'Burger.

O'Burger Restaurants

No one is quite sure when the O'Burger restaurants began appearing across the landscape but now they are a regular feature in many of the thriving

PLACES TO GO, THINGS TO KILL



communities of Umerica. Some are even rumored to have appeared overnight without any signs or sounds of construction. Each has a similar layout and serves fresh, hot food for a low price. Oddly enough, no deliveries of food are ever seen going into the restaurants.

The entire staff is always dressed in colorful clown costumes, including the clergy members that circulate amongst the patrons preaching the good will of their god, Buddy O'Burger, and performing comedy skits. Violence is not tolerated within the restaurants and large clown bouncers will joyfully escort any miscreants out by force.

Trade Caravans

As very few of even the larger communities have everything they need to live, most folk depend on the traveling peddlers and trade caravans that trek across the more habitable areas of Umerica. Some look like they rode right out of a medieval history book as they utilize animal drawn wagons to convey their goods. Others have the technical staff and finances to keep a fleet of truck, vans, and semis functional as they follow regular routes between well established settlements. Here are a few of the more famous caravan groups in Umerica:

The Lucky Duck Trading Co. - Known by the signature yellow ducky adorned semi-trailers they use to haul goods, these motorized merchants are one of the few groups willing to make treks across open wasteland to deliver goods. For deep wasteland trips they even have a working tank, painted bright yellow of course, that leads the convoy. The yellow adorned militia that accompanies this convoy keeps all but the most aggressive from making trouble.

While they are not known for bargain prices, Lucky Duck merchants tend to always have high quality goods and foodstuffs. Their leader, the quirky Captain Fowler, demands high standards from his employees and does not take double dealing lightly.

Edgar Odd's Goods - This all mutant family business uses ox beetle drawn wagons made from old cargo vans to haul goods via deep wilderness routes they keep secret. Regardless of the local conditions they always seem to slowly make their way to different settlements, even ones deemed too small to be worth it to other caravaners.

Edgar does not carry rare goods from exotic ruins but he does have a lot of what most folks need to get by, at a reasonable price. As a family business,

PLACES TO GO, THINGS TO KILL

he does not hire on many folk but he always seems to have an “available” nephew or niece looking for a spouse should he encounter a person he would like to join his clan.

The Fuel Pilgrims - Traveling in motorized expeditions from the Temple Refineries of Petrolex are the devout Fuel Pilgrims that bring the blessed word of Petrolex, and a bounty of fuel, to several of the larger settlements across Umerica. They follow winding routes that also pass by many smaller communities and freeholds that they stop and do “holy exchange” with along the way.

The sacred caravans are well guarded by truck and bike mounted Knights of Combustion who employ their blessed flame throwers upon any who would threaten their charges. Those who have been awarded tokens for their service to Petrolex may travel safely with the sacred caravans as long as they do not cause trouble.

Train Barons

Since as far back as most anyone can remember, there have been folk restoring sections of old train track in hopes of enticing one of the reigning Train Barons to add their rebuilt line to one of the few train routes that lead to greater civilization and prosperity. The Barons are folk who have restored one or more engines to running condition and offer semi-regular cargo and passenger services to stops along their rail lines for those who can afford it. Should two trains meet on the same or crossing tracks, it can quickly escalate to violence depending on the history between the two rail enterprises.

Major Train Barons

While there are near a dozen smaller Barons vying to increase their territory, there are two that currently dominate the rails by a large margin. They both have earned lucrative depot rights in the stations at the Citadel of Scrap. They guard their lines heavily and take extreme measures against anyone who might threaten their holdings, especially other Train Barons.

Northern Railmasters - One of the first Train Barons to establish themselves is Gregory Grillbeard, a steam powered cyborg who founded the Northern

Railmasters many years ago. Now there are several Railmasters, all paying fealty to Grandmaster Grillbread. Despite its namesake, the Railmasters have lines that run both to the north of the Citadel and to the south and southwest, including a dedicated line to the Temple Refineries of Petrolex.

East-West Co. - Run by quirky and enigmatic twins, the East-West Co. is possibly more well known than the Northern Railmasters. The Earlsong brothers are identical twins that have also gone out of their way to be accessible to settlements near their lines and have spent a sizeable sum restoring track running from the east coast to the edge of the Vast Wasteland. They also have more running engines than the Railmasters. Many say it is only the lack of militant zeal that keeps East-West Co. from surpassing the Northern Railmasters.

Lesser Train Barons

These locomotive entrepreneurs have each managed to get at least one running engine and a few cars together long enough to make a name for themselves. Many use covert methods to utilize some of the tracks “owned” by the major Train Barons or the other lesser Barons in order to make a profit. While dangerous, it is a lot less expensive than trying to restore miles of their own railway.

C&C Raillords - This small outfit only has one train but, it is a heavily armed and armored behemoth capable of moving heavy loads, albeit slowly. Each cargo and commuter car is also well armored. Owned and operated by a husband and wife team, Casey and Carol, C&C has a reputation for never failing to deliver. Their motto is: It won't get there fast, but it will **get there!** The crack team of guards employed by C&C are well armed with ancient military gear and no hesitation when it comes to keeping the train moving.

Lady Luck - This enterprise is run entirely by women and headed by the savvy Lucy Ray. She recruits heavily from the female employees of other Barons offering better pay and benefits than normally offered to women, especially by the Northern Railmasters. This has allowed her business to expand quite quickly and it appears she may soon give the two dominant Train Barons a run for their rails.

PLACES TO GO, THINGS TO KILL



Crazy Train - The loud sounds of rock and roll precede this demonic engine's course for nearly a mile. Operated by a cult of devout Kizz fanatics, this possessed train is powered by rock music and rides whatever rails it feels like, even reputedly traveling on unrestored rail lines. While not known for its dependability, most raiders give this train a wide berth for fear of earning Kizz's wrath. This even goes so far as to allow the Crazy Train to make successful runs into the Vast Wasteland without harassment.



CITIZENS OF THE WASTEL

CITIZENS OF THE WASTES

Post-Apocalyptic o-Level Characters

Due to the super science and weird sorcery nature of Umerica, very little needs to change from the standard rules when making o-level characters for a post apocalyptic world. Here are the revised steps for o-level character creation.

Roll Ability Scores: 3d6 in order and determine

- Ability Modifiers.
- Calculate Saving Throws.
- Determine random Lucky Roll. (*Table B1*)
- Determine Occupation, Trained Weapon & Trade Good. (*Table B2*)
- Determine Race (Optional). (*Table B3*)
- Determine random Equipment. (*Table B4*)
- Determine starting trade cash: 5d12 cp.
- Buy equipment.
- Pick an Alignment.
- Calculate Armor Class: 10, plus Armor Bonus (if any), plus Reflex save.
- Roll for Hit Points: 1d4, plus Stamina Modifier. Minimum 1.



Table B1: Post-Apocalyptic Lucky Roll Table

Roll 1d30

1	Iron Gut: All food based saving throws	16	Survival Reflexes: All Reflex saves
2	Eye for Profit: All salvaging checks	17	Abs of Steel: All Fortitude saves
3	Motorhead: All driving checks	18	Stone Cold: All Will saves
4	Weird: Understanding alien tech	19	Crazy Eyes: All social rolls
5	Natural Born Killer: All damage rolls	20	Whisperer: All animal care or handling checks
6	Chicken in Every Pot: All attempts to find or steal food	21	Iron Chef: Butchering and cooking fresh kills
7	Designer Genes: All saving throws	22	Techie: All technological device use checks
8	#1 With a Bullet: All ranged attacks	23	Double Tap: All Critical Hit tables (double normal mod)
9	Road Rage: All attack and damage rolls made from a moving vehicle	24	Survivor: Speed when fleeing (each +1/-1 = +10'/-10' speed)
10	Guardian Angel: Armor Class	25	Impatient: Initiative
11	Beefy: Hit points (applies at each level)	26	Not Dead Yet: All Recovering the Body checks
12	Gun Bunny: All firearm attack and damage rolls	27	Touched: Corruption and Mutation rolls
13	Down with the Glow: All radiation poisoning saves and Mutation rolls	28	Robo-Hate: All attack and damage rolls versus Bots, Borgs, and Constructs
14	I Meant To Do That: All Fumble tables (double normal Luck mod)	29	Tough: All dehydration and starvation saves
15	Anger Issues: All Melee attacks	30	Tinker: All repair checks

CITIZENS OF THE WASTES

Table B2: Umerica Random Occupation

Roll d50	Occupation	Trained Weapon	Trade Goods
1	Accountant	Big Ledger (1d3)	Solar calculator
2	Armorer	Sledge Hammer (1d7, two handed)	Retread armor (Torso and legs)
3	Biker	Length of Chain (1d5)	Leather Jacket (Torso armor, 1pt)
4	Brewer	Bung Hammer (1d4)	1d3 gallons of booze
5	Carpenter	Claw Hammer (1d5)	Bag of 2d30 nails
6	Chemist	1d6 vials of mild acid (1d4)	1d3 Molotov cocktails
7	Cook	Cleaver (1d5)	3d4 trail rations
8	Cryo-Sleeper	Semi-auto Pistol (1d8, 60/120/240) with 2 clips of ammo (4+1d6 rounds each)	Wrist mounted computer loaded with very outdated maps and music files
9	Debtors Pit Escapee	Chain Shackles (1d4)	A metal shield and lots of scars
10	Driver	Tire Iron (1d5)	1d6 sealed packs of hanging vehicle air fresheners, misc scents
11	Electrician	Screwdriver (1d3)	Bag of wires and bits
12	Entertainer	Hidden Knife (1d4)	Musical instrument or other performance tool
13	Farmer*	Hoe (1d5)	1 Farm animal**
14	Food Checker	Knife (1d3)	+2 to Fort saves vs. bad food
15	Forager	Heavy Walking Stick (1d4)	1d3 pounds of safe mushrooms and roots
16	Ganger	Slingshot and 3d6 metal bearings (1d5, 40/80/160)	1 bottle of good booze
17	Guard	Spear (1d6)	Leather armor (Torso and arms, 1pt each)
18	Gunsmith	rebuilt revolver (1d6, range 50/100/200)	3d4 good bullets
19	Handyman	Large tool (1d4)	Tool belt with 1d3+1 tools
20	Historian	Heavy book (1d3)	Trivia (+3 to checks)
21	Hunter	Bow (1d6) and 4d4 arrows	1d5 large animal pelts
22	Janitor	Large mop (1d3)	5 gal bucket and rags
23	Junk Digger	Crowbar (1d5)	1d3 rolls on <i>Table B4</i>
24	Laborer	Pocket Knife (1d3)	Good boots and gloves
25	Law Enforcer	Mace (1d6)	1d3 pairs of handcuffs and ring of keys
26	Livestock Rancher	Crook staff (1d5)	1d3 Farm animals**
27	Mechanic	Tire Iron (1d5)	1d3 gallons of used oil
28	Medic	Bone saw (1d5)	First Aid kit
29	Merchant	Big Maglite (1d4) (batteries charged)	1d3 rolls on <i>Table B4</i>
30	Messenger	Bike chain (1d4)	An off-road bicycle with cargo basket
31	Miner	Pickaxe (1d5)	Filtered Mask
32	Nurse	Scalpel (1d4)	Stethoscope
33	Off-Worlder	Survival Blaster (1d4, 30/60/120, fumble range 1-2) 6+1d4 shots per day	2d3 Power cells
34	Orphan	Slingshot (1d5, 40/80/160) and 2d6 good stones	Bag of stale candy
35	Outfitter	Textile shears (1d3)	Sewing kit and 3d20 buttons

CITIZENS OF THE WASTES

Table B2: Umerica Random Occupation (continued)

Roll d50	Occupation	Trained Weapon	Trade Goods
36	Peddler	Iron Skillet (1d5)	1d3 rolls on <i>Table B4</i>
37	Pharmacist	Knife (1d3)	2d3 bottles of drugs
38	Plumber	Pipe Wrench (1d4)	2d3 copper pipes
39	Raider Spy	Hidden Knife (1d4)	Roll again, ignoring this result, to determine your cover and gain those trappings as well.
40	Refinery Acolyte	Valve Wheel Wrench (1d7, two handed)	1 gallon fuel can containing 1 fuel point worth of petrol.
41	Researcher	Heavy book (1d3)	1d6 more books
42	Scientist	Bunsen burner and propane tank (1d4)	Rubber gloves and goggles
43	Scout	Crossbow (1d6, range 50/100/150) and 3d4 bolts	Compass
44	Soldier	bolt action rifle w/bayonet (1d10, 120/240/480) (bayonet 1d6) with 2d4 rounds	Scrap helm and chest plate (torso and head, 2pts each)
45	Tinker	big bag of useless parts (1d4)	Small tool set (+1 to tech repair rolls)
46	Vaultborn	Shotgun (1d10, 50/100/--) with 4d4 shells	3d6 ration bars and 1 gallon of water
47	Veterinarian	Knife (1d3)	Small, trained animal
48	Wanderer	big walking stick (1d4)	Large Backpack
49	Water Finder	Shovel (1d4)	Scratch built water filtration device
50	Young Punk	Baseball bat (1d4)	Mountainboard and 1d3 spare wheels

* Roll 1d10 to determine farmer type: (1) Potato, (2) Bluwheat, (3) Barley, (4) Corn, (5) Rice, (6) Oat, (7) Veggie, (8) Berry, (9) Nut, (10) Hay.

** Roll 1d6 to determine the type of livestock: (1) sheep, (2) goat, (3) cow, (4) pig, (5) chicken, (6) mule. Now roll 1d3-1 to determine how many extra heads/limbs/etc it has.

Table B3: Umerica Random Race (Optional)

Roll d100	Race
1-8	Gray
9-16	Fossorian
17-24	Feral Urchin
25-35	Pure Mutant
36-40	Robot
41-45	Human, Pure strain*
46-55	Human, Near human*
56-60	Human, Off worlder*
61-75	Human, Mutie*
76+	Human, mixed blood*



* All Human type distinctions are for role playing options and have no mechanical differences.

CITIZENS OF THE WASTES

Table B4: Umerica Random Equipment

Roll 5d12

Roll	Item	Cost	Roll	Item	Cost
5	Backpack	2sp	33	Leatherman multi-tool	1gp
6	1d5 Glowsticks	4cp ea	34	2d3 Firestarter bricks	1sp ea
7	Nylon rope, 50'	3sp	35	Metal canteen	1gp
8	10d6 crayons, assorted colors	.5cp ea	36	Holy symbol	3gp
9	1d3 plasticware containers	2sp ea	37	Bottle of lighter fluid	2sp
10	Insulated thermos	1gp	38	Pocket fisherman	8sp
11	Zippo lighter w/ fluid	1gp	39	3d10 resealable plastic bags	1cp ea
12	Small socket wrench set	2gp	40	Poker set with chips	1gp
13	Can opener	5sp	41	Easy reach grabber	1gp
14	Small hammer (1d3)	7sp	42	Camping trowel	5sp
15	Hand crank flashlight	3gp	43	Cast iron dutch oven	1gp
16	Cooler, 12 can size	1gp	44	Fire extinguisher, loaded	2gp
17	Utility Knife (1d3)	3sp	45	Metal tongs	2sp
18	Kitchen shears	3sp	46	Solar powered wristwatch	1gp
19	Water kettle	4sp	47	Citronella candle	2sp
20	Gas Can (1 gal)	5sp	48	Umbrella	1gp
21	Fishing Waders	1gp	49	Thermal sleeping bag	3gp
22	Camping tent	2gp	50	1d4 bottles of homemade booze	7sp ea
23	2d3 unused toothbrushes	1sp ea	51	Package of chewing gum, safe	1gp
24	1d4 sealed bars of soap	4sp ea	52	Warm, comfy blanket	8sp
25	Fresh loaf of Bluwheat bread	1sp	53	Working bicycle	5gp
26	Bag filled with potent mushrooms	3sp	54	50' electrical extension cord	8sp
27	Small hand saw (1d3)	5sp	55	Water filter pitcher w/ 1d3 filters	3gp
28	Working compass	3gp	56	Teflon frying pan	1gp
29	Bail of barbed wire, 30'	1gp	57	Gun cleaning kit	2gp
30	Industrial size can of pudding, safe	1gp	58	All weather coat	2gp
31	1d4 sealed tubes of superglue	1gp ea	59	Hand crank meat grinder	7sp
32	1d3 cans of expanding spray foam	1gp ea	60	Bottle of extra strength spray cleaner	6sp



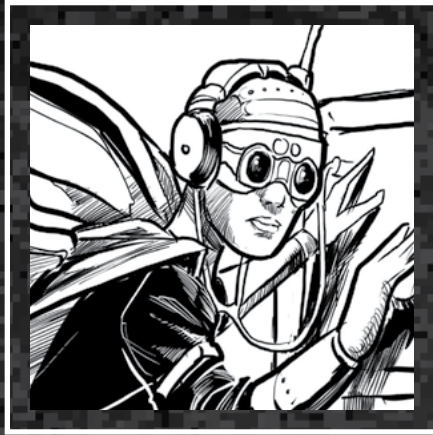

CLASSES

CITIZENS OF THE WASTES



CLERIC OF THE WASTELAND

CLERICS OF THE WASTELAND

Even in the hopeless wastes of Umerica there are those whose faith in the divine has not wavered. These priests and priestesses still preach the tenets of their gods to those looking for answers and miracles. Some are said to even be able to wield magic in the name of their gods...

Hit points: A Cleric gains 1d8 hit points at each level.

Weapon training: A Cleric is trained in the weapons used by faithful followers of his god, see the Gods and Patrons of Umerica, page 182. Clerics may wear any type of armor or shield and their spell checks are not hindered by its use.

Choosing a god: At 1st level, a Cleric selects a god to worship. A Cleric's choice of god must match his alignment, and determines weapon groups, holy powers, and magical spells. For more information see the Gods and Patrons of Umerica chapter, page 182.

A Cleric who changes alignment loses the support of his god. He loses access to all spells and powers from Cleric levels earned under his old alignment.

Caster level: Caster level is a measurement of a Cleric's power in channeling his god's energy. A Cleric's caster level is usually his level as a Cleric but may be modified under certain circumstances. Many Clerics adventure in search of holy relics that bring them closer to their gods and thus increase their caster level.

Magic: A Cleric can call upon the favor of his god. This form of magic is known as idol magic. Its successful use allows a Cleric to channel his god's power as a magical spell. A Cleric has access to the spells of his god as noted on *Table C2*.

To cast a spell, a Cleric makes a spell check (DCC rulebook, page 106). The spell check is made like any other check: roll 1d20 + Personality modifier + caster level. If the Cleric succeeds, his god attends to his request — not always predictably, but with

Lawful

Buddy o'Burger - The Clown God of Feasting, Customer Service, and Cannibalism

Classica - The goddess of Rhythm and Order

Santa - The jolly avatar of giving

S'aganoid - The being of truth and science

The Lords of Light - the heavenly council of valor and freedom

Neutral

\$ (pronounced "cash") - The impartial goddess of barter and wealth

Grokk - the god of the twisted wilds and wastes

Kizz - the intergalactic god of rock and roll

Petrolex - the amorphous deity of fuel and fire

Nuka - the mother of all mutants

Theszolokomodra - the 1000-headed space hydra of unknowableness

Chaotic

Elmos - the demonic puppet god of fear and pain

Silk - the golden lord of lies

Technos Discos - the terrible bringer of beats

Whaaar - The god of violent combat and strength of arms

Yyaallaayy - The outer dimensional lord of madness and creature of chaos

generally positive results. If the Cleric fails he risks disapproval. His god is preoccupied, annoyed, or facing its own battle — or questions the cleric's use of its power.

These rules apply to idol magic:

- Natural 1 means disapproval, as per the standard Cleric (DCC rulebook, page 29).
- Each failed spell check increases the chance of disapproval as per the standard Cleric (DCC rulebook, page 29).
- Sinful use of divine power. A Cleric may be capable of using his powers in ways that displease his deity, as per the standard Cleric (DCC rulebook, page 29)
- A Cleric may choose to sacrifice an item or items considered sacred to their deity to enhance the casting of a spell. The GM is the final arbiter for the bonus provided but the following guidelines can be used:

CITIZENS OF THE WASTES

Table C1: Cleric Sacrifice Bonuses

Bonus desired	Sacrifice required	Length of Ritual	Other Requirements
1d3	A small item associated to their deity, valued 10-25sp	1 action	
1d5	An item associated to their deity, valued 50-100sp	1d3 rounds	
1d7	An item or items associated to their deity, valued 200-300sp	1d3 turns	
1d10	An item or items associated to their deity, valued 400-600sp	1d3 hours	
1d14	A relic associated to their deity or a relic of a rival deity, valued 1000-2000sp	1d3 days	Performed during time that is sacred to the deity
1d20	A major relic associated to their deity or a major relic of a rival deity, valued 5000-9000sp	1d3 weeks	Can only be done at a time that occurs once every 2d5 years.
1d30	A greater relic associated to their deity or a relic of a greater rival deity, valued 10000+sp	1d3 months	Can only be done at a time that occurs once every 5d20 years.

Turn Unholy: as per the standard Cleric (DCC rulebook, page 30)

2 dice - Repair specific organ damage, Heal a mundane disease, or Heal minor radiation poisoning.

Divine Aid: as per the standard Cleric (DCC rulebook, page 30)

3 dice - Neutralize mundane poisons, Heal major radiation poisoning, Heal food poisoning, Restore maimed limb, or Heal starvation/dehydration.

Lay on Hands: Works similarly to the standard Cleric (DCC rulebook, page 30) other than the conditions that may be healed:

4 dice - Heal Blindness, Heal Deafness, Neutralize Xeno/Alien poisons, or Regrow limb

1 die - Mend a broken bone

5 dice - Reverse mutation less than CL days old.

Table C2: Cleric

Level	Attack	Crit Die/Table	Action Dice	Ref	Fort	Will	Spells Known By Level				
							1	2	3	4	5
1	+0	1d8/III	1d20	+0	+1	+1	4	-	-	-	-
2	+1	1d8/III	1d20	+0	+1	+1	5	-	-	-	-
3	+2	1d10/III	1d20	+1	+1	+2	5	3	-	-	-
4	+2	1d10/III	1d20	+1	+2	+2	6	4	-	-	-
5	+3	1d12/III	1d20	+1	+2	+3	6	5	2	-	-
6	+4	1d12/III	1d20+1d14	+2	+2	+4	7	5	3	-	-
7	+5	1d14/III	1d20+1d16	+2	+3	+4	7	6	4	1	-
8	+5	1d14/III	1d20+1d20	+2	+3	+5	8	6	5	2	-
9	+6	1d16/III	1d20+1d20	+3	+3	+5	8	7	5	3	1
10	+7	1d16/III	1d20+1d20	+3	+4	+6	9	7	6	4	2

CITIZENS OF THE WASTES



THE CYBORG

CITIZENS OF THE WASTES

CYBORG

Whether by accident or by choice, these characters have had vital parts replaced with mechanical prosthetics. This makes them monsters in the eyes of those who shun technology. To others, these enhanced souls are heroes for hire, willing to take the big risks for a few good parts.

Hit Points: A Cyborg gains 1d8 hit points at each level.

Weapon Training: Cyborgs are adept with any tech level of missile/ranged weapons they encounter and one handed/built-in melee weapons. They may employ any armor but rarely use shields.

Alignment: Cyborgs are generally Neutral but may be of any alignment.

Artificial Body Parts: Being partially artificial has its upsides and downsides.

Good news: 50% of all non-area effect attacks taken strike an artificial part which ignores the first 1d3 points of damage taken, similar to Impervious armor but will never degrade. Roll 1d10 for each attack that hits and is not area effect. If the total is 5 or less the damage is done to your Frame. Also, the cyborg receives +2 to all saves versus sleep and charm effects. The Cyborg also reduces all crit results rolled against them by ½ their level, round up.

Bad news: All damage taken by your artificial Frame parts will not heal on its own and must be repaired. Lay on Hands and other healing magics are not effective when repairing damage to artificial parts. This damage must be repaired by other means.

As such, all damage taken must be divided into Meat and Frame damage. All area effect damage is divided equally between Meat and Frame totals, Meat taking all of the odd points. The total of these two tallies is the amount of hp loss the cyborg is currently suffering from.

Better, Stronger, Faster: When you reach levels 1, 4, 7, & 10 you can pick one upgrade that your body has from the *C3: Cyber Upgrade* table below. Cruel DMs might make you roll randomly...

Jury-rig: Being dependent on technology to live, Cyborgs have a general understanding of most types of tech. They may add their Jury-rig Die to all attempts to repair themselves, other bits of tech, or to find salvage from a technological source.

Self repair will require an Intelligence check at DC 5 + the number of Frame hit points you wish to repair. A Fumble will result in suffering 1d3 additional Frame damage that cannot be ignored. All such repairs will require sufficient materials, roughly 1d7sp per hit point repaired, and taking one turn per hit point to complete.

For calculating the DCs for repairing devices and other tinkering, see the Technologist's skill list, pg 86.



CITIZENS OF THE WASTES

Table C3: Cyber Upgrade

Choose or roll 2d8

- 2 **Advanced composites** - Your Frame parts are constructed of very durable materials and they ignore the first 1d4+1 points of damage taken instead of the first 1d3. If taken again, increase the damage ignored by +1.
- 3 **More Machine Than Man** - 70% of all damage is done to Frame parts instead of the normal 50%. Roll 1d10 for each attack that hits and is not area effect. If the total is 7 or less the damage is done to your Frame. Also, your AC is increased by +1. If taken again, increase AC bonus by +1.
- 4 **Weapon Port** - You have an internal, concealed port you can install a weapon into. Removing/installing a weapon requires a DC 12 Intelligence check. Once installed, add +1d3 to all attack rolls with the weapon. An Intelligence check of DC 15+Cyborg's Luck mod is required to locate the weapon when not deployed for use. If taken again, the Cyborg has an additional weapon port.
- 5 **Armored Plating** - The Cyborg has armor plating attached directly to his entire body. This gives +2 AC, a 1d5 armor die (3 steps), 3 ablative levels, d5 Fumble Die and (-4) armor check penalty. Any additional armor worn suffers from armor stacking penalties (see page 100). Damage steps of the cyber armor and ablatives can be repaired with an Intelligence check + Jury Rig die (DC 8 + 1 per step repaired) and such repairs will require sufficient materials, costing roughly 1d3 sp per level repaired.

There is no easy or quick way to remove the armor. Note that the Cyborg cannot wear normal armor in addition to the plating. If taken again, increase the AC bonus by +1 and +1 step of armor.
- 6 **ExoFrame** - Increase Strength by +3 and reduce movement speed by 5'. With DM's approval, this may raise your Strength above 18. If taken again, increase the Strength bonus by +1.
- 7 **Power Fist** - One of the Cyborg's arms is a devastating melee weapon, dealing 1d10 damage on a successful hit. This weapon cannot be easily discarded or hidden. If taken again, increase the damage done by one die type.
- 8 **Targeting System** - Add +1d3 to hit on all ranged attacks made by the Cyborg. If taken again, increase the attack bonus by +1.
- 9 **Auto Blaster** - You have a self aiming blaster mounted on your body. It will attack any target you designate as a foe with an attack roll of 1d14+Reflex save, 1d5 damage, range 20/40/60. Using the Auto Blaster does not require your attention and does not count as an action. If taken again, either increase the Auto Blaster's attack die by one type or the Auto Blaster gains an additional 1d14 attack die per turn.
- 10 **Tactical Processor** - You have an intelligent nanoprocessor that helps you interpret the chaos of battle. Add +2 to Init and Reflex save. If taken again, increase the Init and Reflex bonus by +1.
- 11 **Rapid Response Servos** - The musculature structure of your legs is enhanced to decrease momentum loss and recovery time. This increases your Move by +10' and Init by +1. If taken again, increase the Move bonus by +5'.
- 12 **Dermaplastic Layer** - A hidden compartment in the Cyborg's structure generates a sheet of artificial skin with patches of hair. The Cyborg can stretch the sheet over their exposed chassis to appear like a normal human at a casual inspection, giving them the element of surprise. It takes an hour to make it fit on correctly. The Dermaplast damages easily - the first time the Cyborg uses a cybernetic enhancement or takes damage the Dermaplast is ruined. It takes 24 hours to grow another layer.
- 13 **Optical Enhancement** - The Cyborg has an artificial eye. Choose one of the enhancements below. The other can be taken as a separate upgrade. Range for both enhancements is 120', day or night.
 - Infravision: Allows the Cyborg to see in the infrared spectrum and may reveal details not visible to the naked eye.
 - Ultravision: Radiation fields will glow relative to their intensity and magical items will glow like torchlight.
- 14 **Spring Loaded Legs** - The Cyborg's legs sport pistons and may even be back-bent like an insect. The Cyborg can jump 30' forwards and straight up 10'. Subtract 1d10 damage from any fall.
- 15 **Neural Interface** - Add +4 bonus to Computer Use rolls. On a Critical Success they can download their consciousness into the computer to hunt for data like treasure in a dungeon. In that dimension the Cyborg resembles their original human form and interacts with the Holograms that live there.
- 16 **Telescoping Arm** - One of the Cyborg's arms can extend up to 10' farther than their normal reach, granting a longer reach for melee weapons and giving a +4 bonus to Climbing and Pilfer Goods checks.

CITIZENS OF THE WASTES

Table C4: Cyborg

Level	Attack	Crit Die/Table	Action Dice	Ref	Fort	Will	Jury Rig Die
1	+1	1d10/III	1d20	+1	+1	+0	1d2
2	+2	1d12/III	1d20	+1	+1	+0	1d3
3	+2	1d14/III	1d20	+1	+2	+1	1d4
4	+3	1d16/III	1d20+1d14	+2	+2	+1	1d5
5	+4	1d20/III	1d20+1d16	+2	+3	+1	1d6
6	+4	1d24/IV	1d20+1d20	+2	+4	+2	1d7
7	+5	1d30/IV	1d20+1d20	+3	+4	+2	1d8
8	+6	1d30/IV	1d20+1d20	+3	+5	+2	1d10
9	+6	2d16/IV	1d20+1d20	+3	+5	+3	1d12
10	+7	2d20/IV	1d20+1d20	+4	+6	+3	1d14





FERAL URCHIN

CITIZENS OF THE WASTES

FERAL URCHIN

No one is sure why some human children run away and genuinely never grow up — some blame mutation, others blame an obscure Patron that lives “past the second star to the right and straight on ‘til morning.” But indeed they do, and there are enough of them to form tribes that are as naive as they are barbaric. Feral Urchin tribes tend to split off in groups by gender. There’s usually a sportsmanlike rivalry between nearby boy and girl tribes, but when two tribes of the same gender get too close, it can lead to vicious teasing or bare-knuckle brawling.

Hit Points: Feral Urchins gain 1d6 hit points each level.

Weapon Training: Feral Urchins learn to be proficient in boomerang, blowgun, chain, club, dagger, garrote, grenade, handaxe, javelin, shortbow, short sword, sling, slingshot, spear, shuriken, and staff. They will wear whatever scraps they can find if it makes decent armor, as long as the Fumble die is not greater than d8.

Alignment: There are three distinct factions of Feral Urchins based on natural talents and Alignment. Wildchildren tend to be Chaotic. Slingers tend to be Neutral. Nerds tend to be Lawful.

Small Size: A Feral Urchin is otherwise indistinguishable from a normal human child, though they usually have far more piercings, tattoos, and battle scars than one would expect.

Slow: A Feral Urchin has a base move of 20’.

Stealth: Feral Urchins add their Sneak die to all silent moving and hiding actions.

Survival: Feral Urchins have an unexplainable knack for surviving. Grown humans and even some humanoid tribes have been known to keep a Feral Urchin around for good luck.

Feral Urchins roll a Luck Die whenever they spend Luck and multiply the result by the amount they spent to determine the bonus. They can also spend Luck on behalf of others. However, there is a side effect: one item belonging to the person who benefited from the Luck breaks or is lost permanently. It can be a weapon, piece of armor (-1 step) or other valuable item (value ~3sp per point spent) of the urchin’s choosing. If the person has no items left, a piece of a vehicle or piece of nearby scenery falls apart. After eight hours of sleep the Urchin regains one point of Luck.

Dust For All My Lost Boys: With a special rite, an Urchin that reaches 10th level (Tribe Leader) can invoke the Eternal Pann to whisk himself and all his assembled tribe members into the night sky on a predetermined flight path. The length of the flight lasts from sunset to sunrise. If there is no safe place to land they instead land on the island of their Patron’s pocket dimension.

Table C5: Feral Urchin

Level	Attack	Crit Die/Table	Action Dice	Sneak Die	Luck Die	Ref	Fort	Will
1	+1	1d8/III	1d20	d3	d3	+1	+1	+1
2	+2	1d8/III	1d20	d4	d4	+1	+1	+1
3	+2	1d10/III	1d20	d5	d5	+2	+1	+2
4	+3	1d10/III	1d20	d6	d6	+2	+2	+2
5	+4	1d12/III	1d20	d7	d7	+3	+2	+3
6	+5	1d12/III	1d20+1d14	d8	d8	+4	+2	+4
7	+5	1d14/III	1d20+1d16	d10	d10	+4	+3	+4
8	+6	1d14/III	1d20+1d20	d12	d12	+5	+3	+5
9	+7	1d16/III	1d20+1d20	d14	d14	+5	+3	+5
10	+8	1d16/III	1d20+1d20	d16	d16	+6	+4	+6

CITIZENS OF THE WASTES

Wildchild: Feral Urchin Wildchildren fly into a berserk rage they call the Wild Rumpus for one combat encounter per level each day. During the Wild Rumpus, the urchin transforms into a child-sized Beast with an assortment of features from various predators. The Beast's fur/feathers/scales are often garishly hued.

The Beast has glowing eyes that can see in the dark without penalty. Their claws cannot wield weapons or shields, but their natural attacks are fierce and swift, dealing 1d4 damage. They can keep whatever armor they were wearing before transforming. The Feral Urchin adds its Beast Die to attack, damage, and Skill checks involving movement. The Urchin cannot use their Luck Die when in Beast form.

Table C6: The Wild Rumpus

Level	Base Move	Beast Die	Crit Die/Table	Action Dice	Ref	Fort	Will
1	25"	+d3	1d12/III	1d20	+1	+1	+0
2	30"	+d4	1d14/III	1d20+1d14	+1	+1	+0
3	30"	+d5	1d16/III	1d20+1d14	+1	+2	+1
4	35"	+d6	1d20/IV	1d20+1d14	+2	+2	+1
5	35"	+d7	1d24/IV	1d20+1d16	+2	+3	+1
6	40"	+d8	1d30/IV	1d20+1d16	+2	+4	+2
7	40"	+d10	2d20/IV	1d20+1d20	+3	+4	+2
8	45"	+d10+1	2d20/IV	1d20+1d20	+3	+5	+2
9	45"	+d10+2	2d20/IV	1d20+1d20+1d14	+3	+5	+3
10	50"	+d10+3	2d20/IV	1d20+1d20+1d14	+4	+6	+3

Slingers: Feral Urchin Slingers are deadly shots. When throwing or hurling any weapon (including slings, slingshots, short bows, and blowgun darts) they make an attack roll twice for each missile and take the best result. Furthermore, any roll of 18 or above is a Critical Hit.

Nerds: The Nerds often wear thick glasses and clashing prints. They maintain whatever artifacts the tribe finds. Due to the knowledge they gain from hoarding books and functioning computers they are

the closest thing Feral Urchins have to a "tribal elder."

- Nerds gain proficiencies in pistols and rifles of all eras. A Weapon Tinkering roll (DC 8+) may be needed to modify a large weapon so the Nerd can wield it.
- Languages: The Nerd gains one additional language for every point of Intelligence modifier.
- Tech Skills: The Nerd has the following skills, similar to the Technologist (pg 86).

Table C7: Nerd Skills

Nerd Level	1	2	3	4	5	6	7	8	9	10
Weapon Tinkering (Intelligence)	+0	+0	+1	+2	+3	+4	+5	+6	+7	+8
Bot Repair (Intelligence)	+0	+0	+1	+2	+3	+4	+5	+6	+7	+8
Computer Use (Intelligence)	+0	+3	+5	+7	+8	+9	+10	+11	+12	+13
Vehicle Repair (Intelligence)	+0	+0	+1	+2	+3	+4	+5	+6	+7	+8
General Tech (Intelligence)	+0	+3	+5	+7	+8	+9	+10	+11	+12	+13

CITIZENS OF THE WASTES



FOSSORIAN

CITIZENS OF THE WASTES

FOSSIORIAN

These squat, burly, burrowing folk resemble humanoid badgers but will take great offense if you mention it. Their legends say they originate from somewhere else but they all woke up here sometime after the cataclysm. Being hardy, stubborn folk, the Fossiorans took to their new weird world with relative ease and are now commonly seen in several regions of Umerica.

Hit Points: A Fossiorian gains 1d10 hit points at each level.

Weapon Training: Fossiorians rarely employ any weapon that requires two hands to wield as carrying it will hinder them as they burrow. For the same reason, they will not use shields. They may employ any melee or ranged weapon that can be used one-handed and may use armor of any type up to a Fumble die of d10.

Alignment: Fossiorians are generally Neutral but may be of any alignment.

Attack modifier: Fossiorians do not receive a fixed attack modifier at each level. Instead, they receive a deed die, just like a warrior. At 1st level, this is a d3. The Fossiorian rolls this d3 on each attack roll and applies it to both his attack roll and his damage roll. On one attack, the die may give him a +1 bonus to his attack roll and damage roll. On the next attack, the die may give him +3! The deed die advances with the Fossiorian's level, climbing to d7 by 5th level, and then further to d10+4 by 10th level. The Fossiorian always makes a new roll with this die in each combat round. When the Fossiorian has multiple attacks at higher levels, the same deed die applies to all attacks in the same combat round.

Mighty Deed of Arms: Fossiorians have a militant heritage that glorifies martial prowess. Like warriors, they can perform Mighty Deeds of Arms in combat. See the Wasteland Warrior, page 91.

Vicious Claws: Fossiorians excel at fighting with a weapon in one hand and employing their claws with the other. When fighting like this, a Fossiorian always gains a claw slash as a second attack. This

claw slash uses a d14 to hit (instead of a d20). The Fossiorian adds his deed die to this number, as with all attacks. The claw slash does 1d4+deed roll damage. Fossiorians with multiple action dice (levels 5+) still receive only one free claw slash each round. Fossiorians must alter the grips, handles, and hilts of all equipment they use as their hands have trouble using items constructed for human hands. This takes 2d3 turns. Employing any equipment that has not been altered invokes a -1 die step penalty to all rolls involving the equipment.

Vibration Sense: A Fossiorian can "see" by feeling vibrations through their hands and feet up to 40'. This makes them very difficult to sneak up on (-6 to sneak attempts within range). This sense's range is doubled when under ground or in tight spaces.

Tunneling: As their namesake suggests, Fossiorians are able diggers and can burrow a 4 foot wide tunnel at a rate of 1' per round in dirt. Digging in rocky soil, mud, clay, or sand can cut this by ½ to ¼ that rate. A Fossiorian that is encumbered by equipment or other means cannot employ their tunneling ability until they are unencumbered.

In addition to digging tunnels, a Fossiorian can create pitfalls above ground or collapse points in underground passages. Fossiorians receive a bonus to set such traps equal to their class level and this bonus is also added to a base DC of 10 to determine the Detect Trap difficulty of such hazards. The damage caused by these hazards is a number of d6 equal to their class level divided by 2 (round down) plus 1d6 (i.e. a 4th level Fossiorian can cause 3d6 damage with their hazards).

Slow: A Fossiorian has a base movement speed of 20', as opposed to 30' for humans.

Light Sensitive: Due to their subterranean nature, Fossiorians are very sensitive to bright light. Direct sunlight can be manageable when wearing sunglasses or goggles but anything brighter will inflict a -1 die step penalty to all actions. When saving against spells or effects involving bright light, such as Color Spray, Fossiorians suffer a -1 die step penalty to the save.

CITIZENS OF THE WASTES

Table C8: Fossiorian

Level	Attack	Crit Die/Table	Action Dice	Ref	Fort	Will
1	+d3	1d10/III	1d20	+1	+1	+1
2	+d4	1d12/III	1d20	+1	+1	+1
3	+d5	1d14/III	1d20	+1	+2	+1
4	+d6	1d16/IV	1d20	+2	+2	+2
5	+d7	1d20/IV	1d20+1d14	+2	+3	+2
6	+d8	1d24/V	1d20+1d16	+2	+4	+2
7	+d10+1	1d30/V	1d20+1d20	+3	+4	+3
8	+d10+2	1d30/V	1d20+1d20	+3	+5	+3
9	+d10+3	2d20/V	1d20+1d20	+3	+5	+3
10	+d10+4	2d20/V	1d20+1d20+1d14	+4	+6	+4

* A Fossiorian's attack modifier is rolled anew, according to the appropriate die, with each attack. The result modifies both attack and damage rolls. At higher levels, the Fossiorian adds both a die and a fixed value.

** In addition to this basic action die, the Fossiorian receives a claw slash using a d14 action die.

Underground Skills: Long life beneath the ground trains Fossiorians to detect certain kinds of construction.

When underground, Fossiorians receive a bonus to detect traps, slanting passages, shifting walls, and other new construction equal to their class level.

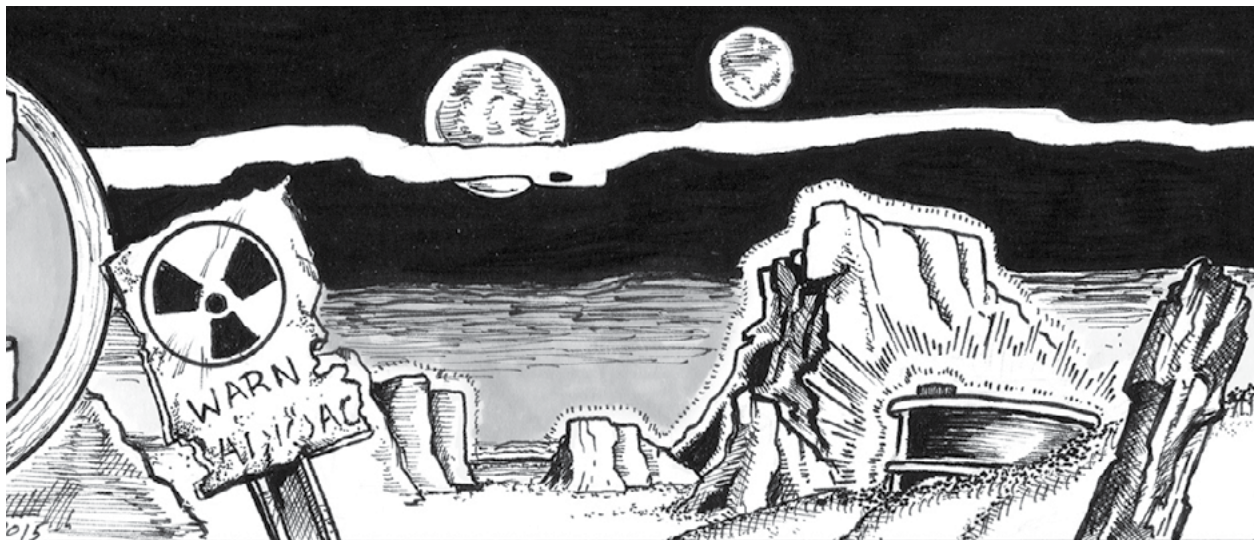



GRAY

CITIZENS OF THE WASTES

GRAYS

Grays are a space-faring race scattered across the galaxy. They are slender and a foot shorter than the average human. They are completely hairless and have large, unblinking gray orbs for eyes, pointed ears, and four elongated fingers on each hand. Only an expert xenobiologist can tell a male Gray from a female or neuter Gray. The reasons Grays visit Urth and Umerica seem to vary for each individual, but they each have a set mission that they will never stray from until it is complete.

One trait all Grays share is their smug sense of superiority over the natives of the worlds they visit. They will chide the primitive humans on having slid back in technology and ruined their planet. They may give condescending encouragement to Techies, but they never willingly share their technology with the natives.

Hit Points: A Gray gains 1d7 hit points each level.

Weapon Training: A Gray can use daggers, axes, swords, clubs, spears, and staves, as well as pistols and rifles of all types. They can use armor but not any greater than a Fumble die of d6. Grays can employ shields as well.

Alignment: Grays are almost always Lawful. Some of their philosophical types may be Neutral. Only a few Chaotic Grays are exiled to Urth.

Universal Communication: Due to specialized brain implants, Grays have a basic understanding of all verbal and written forms of communication that are common to most planets. They cannot emulate cultural dialects but they can speak well enough to get their message across in any language. Grays have their own language with a structure completely different from any spoken on Urth, but some gifted Urthlings have managed to decipher their runes.

Night Vision: The Gray's huge, pupilless eyes are accustomed to the void of space and can see at night without illumination at no penalty.

Iron Vulnerability: Whatever their planet of origin was, it must have been very iron-poor. They cannot stand to be in direct contact with iron and will never wear anything ferrous. Instead, their ships and weapons are made of a shining metal called mithril. They take 1 hp of damage per hour from direct contact with iron.

Transponder: Every Gray has a homing device surgically implanted inside them. This transponder allows their racial authority, the Gray Directorate, to keep tabs on them. Grays can attempt to request aid from the Directorate, similar to how a cleric can call upon their deity, by making an Intelligence check + level versus a DC of 12 or more depending on what is requested.

The Directorate seeks knowledge of Urth and will reward Grays that explore strange areas of Umerica and perform dissections (and vivisections) on organisms. These rewards come in the form of single use, +1 bonuses to the Gray's next roll to request aid from the Directorate awarded by the GM based on the Gray's actions. A Gray can only save a number of these +1 bonus rewards equal to their current level plus their Luck mod.

Tech Gifts: At 1st Level the Gray is dropped off (or crash-lands) on Urth with some Alien Tech to help with survival. It includes a Silver Suit (see below) and one other Gift. The first Gift is usually something simple, like a weapon, survival gear, or an object that simulates a 1st level Wizard spell. They receive extra Gifts via telematter beam at levels 3, 5, 7, and 9. The Gray memorizes the holographic manual before it self-destructs, so they can automatically use it as intended.

Silver Suit – Protects against environmental hazards, including radiation, granting a +5 bonus to all such saves. It also grants a +1 bonus to AC.

A Techie may reverse-engineer a piece of stolen Gray Tech with an Alien Tech roll. Other technically inclined classes will require an Intelligence check (DC 20) to utilize a piece of Gray Tech.

CITIZENS OF THE WASTES

Directorate Gift Examples (Roll 1d12 to determine one randomly)

1 Holographic Guise – Disguises the Gray's face, hands, and voice to look and sound Human. 8% chance each hour it's used that a glitch in the program will reveal the Gray's true nature.

2 Surgery Kit – An oval pod with a frightening array of medical instruments. Once per hour, a turn of use will heal a Gray for 2d4+Level hp. No one person can benefit from this more than three times within 24 hours. No Urthling would ever willingly use it. 1d3 temporary Intelligence and Personality damage if an Urthling is subjected to the Surgery Kit.

3 Floating Drone – A floating mithril orb the size of a baseball that will report what it sees back to its owner. It will travel up to a mile away from its Gray master. When sensing through the orb, the Gray cannot perceive anything with their normal senses.

Drone: Init +4; Atk none; AC 16; HD 4d10; hp 32; MV 40' hover; Act 1d16; SP records all activity within 100'; SV Fort +6, Ref +4, Will na; AL L.

4 Telepathy Gauntlet – By grasping the head of a living target, the Gray can listen to the the surface thoughts that meander about the target's mind, if the target fails a Will save (DC 10 + The Gray's Personality mod), the Gray can detect any lie told by the target and grants a +2d3 bonus to interrogate them. Once the connection has begun, the Gray can attempt to delve deeper in the target's mind to find a specific piece of information. In order to make heads or tails of the chaotic images, ideas, and memories they encounter, an Intelligence check + level must be made (DC 16 + the target's Will save bonus) to decipher anything useful. If a 1 is rolled on the attempt, the Gray suffers 1d4 temporary Intelligence damage.

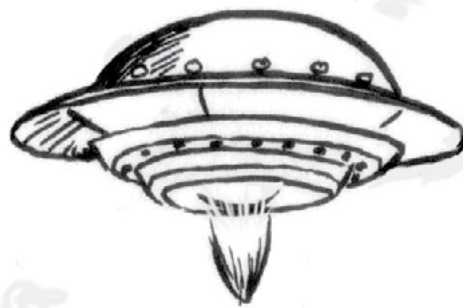

5 Plasma Blade – A one handed energy sword, 2d6 damage. Blade retracts into hilt when not in use. This can be used as a cutting tool equivalent to a blow torch. Uses 1 Energy Point (EP) per round of use and regenerates 1EP every 10 minutes to a max capacity of 30 EP.

6 Blaster Pistol – Range 60/120/240. Has a variable damage rating of 1d7 damage per Energy Point (EP) used per shot, with a maximum damage of 3d7. The pistol regenerates 1EP every 10 minutes to a max capacity of 40 EP.

7 Blaster Rifle – Range 200/400/800. Has a variable damage rating of 1d7 damage per Energy Point (EP) used per shot, with a maximum damage of 5d7. The rifle regenerates 1EP every 10 minutes to a max capacity of 30 EP.

8 Hovering Disc – The Gray can sit or stand on this 3-foot diameter floating disc and travel in style at up to 20 mph (SPD 2, 160' per round, Wipeout die d3). It can hover at a maximum of 8' off of the ground.

9 Psy-net Uplink – A necklace with blinking lights that allows the Gray to gain minimal access to the Universal Metaconsciousness. This allows them to gain answers to common knowledge questions such as: "Where is the nearest arms dealer?", "Who is in charge around here?", "Are there local laws forbidding carrying weapons?", etc without needing to converse with the locals. All answers will be the commonly held opinion of the matter and

CITIZENS OF THE WASTES

may not be entirely accurate. Also, there is a 10% chance for each questions asked that the answer is definitely incorrect.

10 NecroNeural Net – When placed on the skull of a recently deceased humanoid for the period of a day, the corpse becomes a zombie (DCC rulebook, pg 431) that follows all your mental commands to the best of its dim Intelligence until destroyed. The maximum number of zombie henchman you can control at one time is equal to one half your current level plus Personality mod, with a minimum of 1. Note, employing zombie henchmen will not be taken well by most Lawful or Neutral Urthlings.

11 Amnesiator – The target must make a Will save (DC 16) or be stunned for one round and forget everything that happened the previous 10d4 minutes, and the Gray may make an immediate Personality check at +2 to persuade the target of something. The device must be directed towards the victim's eyes (missile atk, range 10') or used internally (melee atk). It can also undo the Intelligence or Personality damage caused by a traumatic event, such as of the use of a Gray Surgery Kit

on an Urthling. All Grays are immune to the effects of an Amnesiator and willing targets can choose to voluntarily fail the save. In this case the Gray can completely control how much time is forgotten, up to one hour.

12 Force Field Belt – This belt generates a damage dampening field around the Gray. It has a variable armor die rating of one step per Energy Point (EP) spent per round, with a maximum armor die of d6. Any lost armor steps are replenished at the beginning of the next round when additional EP are expended. The belt regenerates 1EP every 10 minutes to a max capacity of 50 EP.

Superior Mind: If a Gray finds a piece of Alien Tech without a manual, they can make a Luck mod + Intelligence mod + Level check (DC 14+1d6) to understand how to use it.

Hailing the Mothership: Anytime after a Gray reaches Level 10, They can choose to summon a flying saucer to beam them aboard to join the Gray Directorate. The Gray has the option of taking a PC or NPC with him as an Underling. The would-be Underling can try to resist the beam on a Strength roll of DC 25.

Table C9: Gray

Level	Attack	Crit Die/Table	Action Dice	Ref	Fort	Will
1	+1	1d6/II	1d20	+1	+1	+1
2	+2	1d8/II	1d20	+1	+1	+1
3	+2	1d8/II	1d20	+1	+1	+2
4	+2	1d10/II	1d20	+2	+2	+3
5	+3	1d10/II	1d20+1d14	+2	+2	+3
6	+3	1d12/II	1d20+1d14	+2	+2	+4
7	+4	1d12/II	1d20 +1d16	+3	+2	+5
8	+4	1d14/II	1d20+1d20	+3	+3	+5
9	+5	1d14/II	1d20+1d20	+3	+3	+6
10	+5	1d16/II	1d20+1d20+1d14	+4	+3	+6

CITIZENS OF THE WASTES

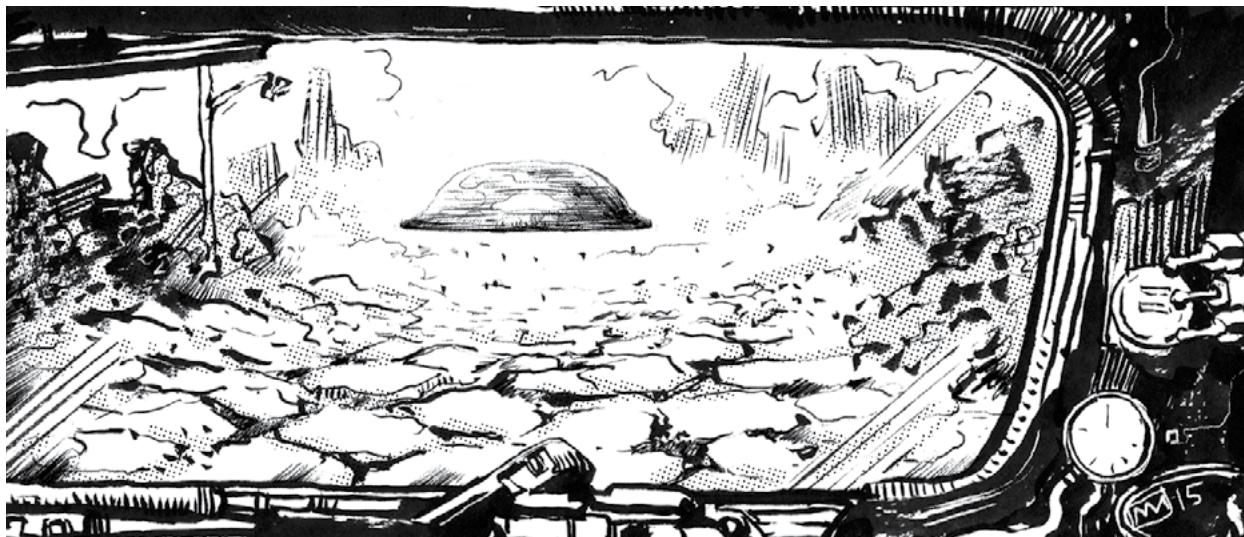

The Gray Directorate

While not a true patron per se, this council of telepathically-linked elder Grays manages the affairs of their race and watches over them on their missions to primitive planets. With all minds in unison, the Directorate considers all of the requests of the Grays and answers only those who have been most successful in their task.

When a Gray calls upon the Directorate for aid they must be specific in what assistance they wish to receive. Based on the request and how well the roll for aid went, the GM will determine what benevolence is granted. Below are a few examples:

- DC 12** Repair a piece of technology, Send a 1 HD restorative (2 HD if used by a Gray), Send emergency survival supplies.
- DC 15** Grant a 1st level spell effect as a one use device (casting roll 1d10+11), Recharge a piece of equipment, Send an explosive device.
- DC 18** Send a 2 HD restorative (3 HD if used by a Gray), Grant a 2nd level spell effect as a one use device (casting roll 1d10+13).
- DC 21** Send an additional piece of Gray tech, Teleport a keeper quality vehicle to the Gray's location, Grant a 3rd level spell effect as a one use device (casting roll 1d10+15).
- DC 26** Send a fully armed Killbot to do the Gray's bidding, Fire an orbital strike at a chosen target, Teleport the Gray and their allies up to 100 miles.



CITIZENS OF THE WASTES



MUTANT

CITIZENS OF THE WASTES

MUTANTS

Either you were born “gifted” with genetic aberrations or some exposure to a nanovirus, cosmic radiation, or dimensional rift warped you. Regardless, you are very different from all of the known peoples of Umerica and it is difficult, if not impossible, to hide it. Fortunately for you, your strange physique has unique abilities that help you to survive.

Hit Points: A Mutant gains 2d4 hit points at each level.

Weapon Training: Mutants can and will use any weapons they can get their hands on. As for armor, they have no restrictions other than it must be custom fit to the Mutant’s unique physiology and not exceed a Fumble die of d10. Should a Mutant have mutations that bestow multiple types of natural armor that when stacked together exceed the Fatigue die restriction, they suffer -5’ Move and -1d3 Agility. Shield use is unrestricted but, in the case of a multi-armed Mutant, only a total of two may be employed at one time.

Alignment: Mutants tend more towards the Neutral and Chaotic alignments but Lawful Mutants do exist; mostly in large communities that allow mutant citizens.

Survival: Of all of those who dwell in Umerica, Mutants know best the meaning of hardship. As such they are well trained in the arts of survival: finding safe food, finding clean water, avoiding environmental hazards, identifying dangerous creatures, navigation through the wastes, etc.

The Mutant gets to add their Survival Die to all non-combat tasks related to surviving in the wilds and wastes. In addition, the Mutant can add their Survival Die to all Saves involving toxins, radiation, and environmental effects.

Mutations: As their namesake implies, all Mutant characters have one or more mutations and, unlike most other beings, they have an advantage when determining the abilities of their mutations. They have a pool of points, called the Glow pool, that

can be used to alter the benefit and flaw percentile rolls on any mutations they gain. A 1st level Mutant has a Glow pool of 30+Stamina attribute. The Glow pool points can be spent, one for one, to either raise or lower any of the percentile rolls involved in determining what beneficial or detrimental traits will be gained from a mutation. There is no limit to how many points can be used on any one roll. Any amount of Glow pool can be saved after character creation to be used on future mutations. In addition, the Mutant gains 8+Stamina mod points to their Glow pool each level for later use.

How many mutations the Mutant beings play with is chosen by the player and generated by using the rules in the Mutation chapter. The first is free and additional mutations cost 1d4+8 Glow Pool each, up to the maximum of three mutations at 1st level.

At the end of generating their 1st level mutations, the Mutant may spend 5 Glow pool to swap the initially rolled scores of any two of the following attributes: Strength, Agility, Personality, or Intelligence. This may only be done once. Any attribute bonuses generated by mutations then are applied to the attribute’s new score. Any adjustments to a Mutant’s Stamina score does not adjust their 1st level allotment of Glow pool.

See the Mutation chapter, pg 167, for more information.

Spontaneous Mutagenesis: Starting at 3rd level, a Mutant may attempt to forcefully trigger gaining a new mutation by using the latent toxins and background radiations their body has absorbed on a daily basis. To do this, the Mutant expends any amount of Glow pool they wish to use to fuel the attempt. For each point of Glow pool expended they have a 3% chance of immediately gaining a new mutation (i.e. 25 Glow pool spent equals a 75% chance of mutating). Luck may also be spent to increase this chance by +4% per point expended. If the roll is failed, the spent Glow pool is lost. Only one such attempt can be made per level. Mutations gained by exposure to a significant source of mutagenic agents do not count against this limit.

CITIZENS OF THE WASTES

Table C10: Mutant

Level	Attack	Crit Die/Table	Action Dice	Ref	Fort	Will	Survival Die
1	+1	1d8/III	1d20	+1	+1	+1	1d3
2	+2	1d8/III	1d20	+1	+1	+1	1d4
3	+2	1d10/III	1d20	+2	+2	+1	1d5
4	+3	1d10/III	1d20	+2	+2	+2	1d6
5	+4	1d12/III	1d20	+3	+3	+2	1d7
6	+5	1d12/III	1d20+1d14	+4	+4	+2	1d8
7	+5	1d14/III	1d20+1d16	+4	+4	+3	1d10
8	+6	1d14/III	1d20+1d20	+5	+5	+3	1d10+1
9	+7	1d16/III	1d20+1d20	+5	+5	+3	1d10+2
10	+8	1d16/III	1d20+1d20	+6	+6	+4	1d10+3



CITIZENS OF THE WASTES



PETROL HEAD

CITIZENS OF THE WASTES

PETROL HEAD

Born to drive, Petrol Heads are all about their vehicles. The constant search for fuel, tires, and spare parts takes them to the most dangerous and remote places of Umerica. They are all a little mad and always push their engines to the max.

Hit Points: A Petrol Head gains 1d7 hit points at each level.

Weapon Training: Petrol Heads can and will use any missile/ranged weapons they can get their hands on and one-handed melee weapons. As for armor, they only use shields and armor with a Fumble die of d7 or less.

Alignment: Petrol Heads tend more towards Chaotic alignments due to the kill-or-be-killed nature of the wastes. Lawful and Neutral Petrol Heads do exist... albeit briefly.

Ace Die: Due to the almost supernatural bond between a Petrol Head and his vehicle they have a distinct advantage when driving. All Petrol Heads have an Ace Die they may add when rolling the following actions:

- Any vehicle control or stunt rolls
- All vehicle appraisals
- Any vehicle repair or salvage attempts
- Rundown/collision damage caused by any vehicle they are driving

Rolling Mojo: Petrol Heads survive on pure chance most of the time. They gain additional bonuses when expending Luck, as follows.

First, the Petrol Head rolls a Mojo die when he expends Luck. The size of this die is indicated on *Table C-11*. For each point of Luck expended, he rolls one Mojo die and applies that modifier to his roll.

Second, unlike other classes, the Petrol Head recovers lost Luck to a limited extent if he has spent some time behind the wheel. His Luck score is restored each night by a number of points equal to his level as long as he has had an hour or more of wheel time within the last 24 hours. This process cannot take his Luck score past its natural maximum.

Fuel Hound: A Petrol Head can smell fuel like a wolf scents its prey. They can tell the direction of a strong concentration of petroleum or alcohol based fuels within 100'. Smaller amounts, down to a single pint, can still be smelled but require concentration and have scent ranges as low as 20'.

Wheels: It may not be sweet but it does run. A Petrol Head starts play with a Beater level Buggy or Bike with a full tank of fuel. As an alternative, the Petrol Head could start with a few jerrycans of fuel to revive a vehicle they find later.

Buggy (Beater)

Init +4; Atk rundown +2 melee (2d5+Damage Bonus); AC 14*; HD d7; Speed Level cruise 3/ max 5; Act 1d20; SV Fort +1, Ref +2, Will NA; Fuel Tank 1d6; Guzzle 2.

* Vehicle only, passenger(s) use individual ACs +1 due to light cover.

Basic Traits: Nimble, Dangerous, Open, Off Road

Motorcycle (Beater)

Init +5; Atk rundown +1 melee (2d4+Damage Bonus); AC 12*; HD d6; Speed cruise 3/ max 5; Act 1d20; SV Fort +0, Ref +5, Will NA; Fuel Tank 1d5; Guzzle 1.

* Vehicle only, passenger(s) use individual ACs +1 due to light cover.

Basic Traits: Very Nimble, Very Dangerous, Open, Off Road, Enhanced Handling

CITIZENS OF THE WASTES

Table C11: Petrol Head

Level	Attack	Crit Die/Table	Action Dice	Ref	Fort	Will	Ace Die	Mojo Die
1	+0	1d10/II	1d20	+1	+1	+0	1d3	1d2
2	+1	1d12/II	1d20	+1	+1	+0	1d4	1d3
3	+2	1d14/II	1d20	+2	+1	+1	1d5	1d4
4	+2	1d16/II	1d20+1d14	+2	+2	+1	1d6	1d4
5	+3	1d20/II	1d20+1d16	+3	+2	+1	1d7	1d5
6	+4	1d24/II	1d20+1d20	+4	+2	+2	1d8	1d6
7	+5	1d30/II	1d20+1d20	+4	+3	+2	1d10	1d6
8	+5	1d30+2/II	1d20+1d20	+5	+3	+2	1d12	1d7
9	+6	1d30+4/II	1d20+1d20	+5	+3	+3	1d14	1d8
10	+7	1d30+6/II	1d20+1d20	+6	+4	+3	1d16	1d8

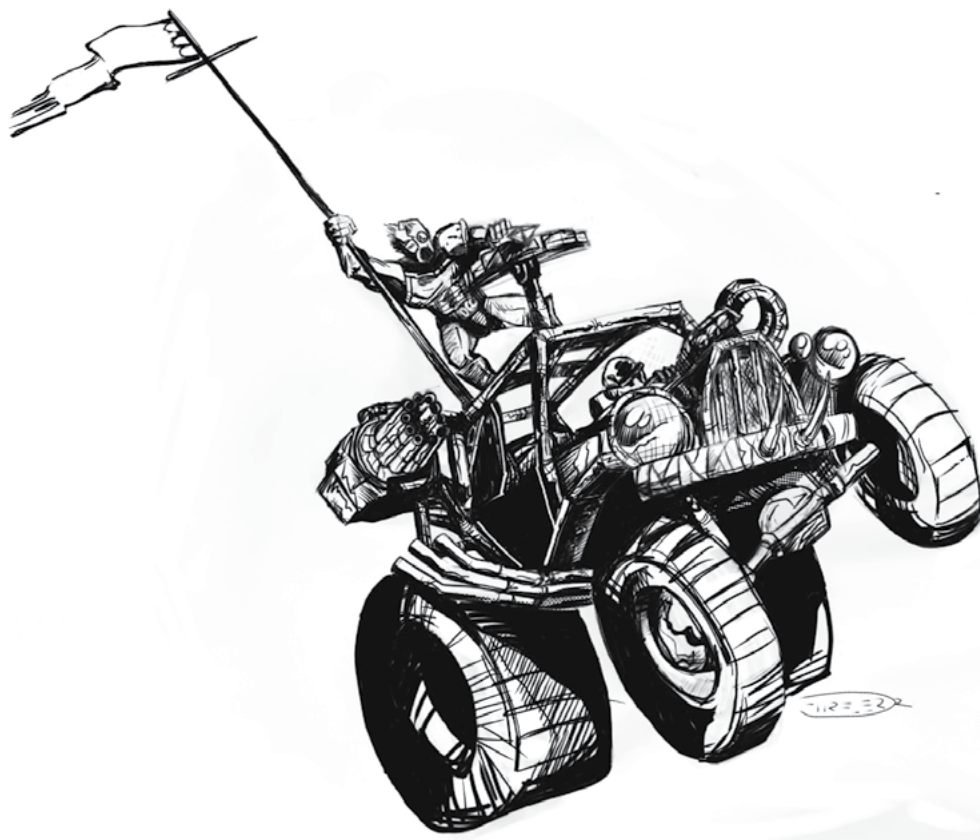



ROBOT

CITIZENS OF THE WASTES

ROBOT

Hailing from nearby tech savvy dimensions or timelines, robots are not an uncommon sight across Umerica. You are different as you have an identity and a will to survive. You are no one's slave.

Hit Points: A Robot gains 1d6, 1d8, or 1d10 hit points at each level, based on their chassis type.

Weapon Training: Robots understand the use of basic melee weapons (clubs, axes, maces, & staves) and basic ranged weapons (pistols & crossbows). Based on their chassis or components, they may know how to employ other weapons. Robots can utilize armor intended for fleshy humanoids but the Fumble die is doubled (see Armor Stacking, pg 100). Given a proper facility and materials, Robots can convert, construct, and repair proper robo-armor that does not inflict the extra Fumble penalty. The maximum amount of armor a Robot can use is based on their chassis. Shields may be used at no penalty.

Alignment: Due to their logical nature, most Robots are Lawful. Neutral Robots tend to consider living sentients to be inferior and often ignore their social customs and manners. Robots of a Chaotic nature are generally feared as they rarely place any value on living things, especially those that get in their way.

Long Memory: As Robots do not age they tend to be rather old and have seen many things. They roll their Know die as a bonus to all Intelligence checks regarding knowing historical facts.

Chassis: When a Robot is constructed it will have one of three types of chassis: Domestic/Companion, Labor/Maintenance, or Security/Military. Changing a Robot's chassis type would require a highly advanced facility, skilled technicians, and excellent materials. All chassis types have the following traits:

- Due to being completely artificial they are unaffected by poisons, toxins, disease, starvation, and suffocation.
- Robots cannot benefit from Lay on Hands or other forms of magical healing intended for living beings. Magic involving the permanent repair of machines and objects may be of

assistance. In addition, they do not recover on their own from damage so they must repair themselves, costing 1d7sp per hit point repaired, and taking one turn per hit point to complete. Any "broken bone" equivalent injuries require a repair check (DC 12) to restore function to the damaged part.

Domestic/Companion - These Robots were designed to interact with humans (or other humanoids) and usually have the most beautifully crafted appearances. They all have the following built in traits:

Hit Die: 1d6

Base AC: 10

Impervious Armor steps: [1] (Armor die: 1d3, Fumble die: 0)

Max Armor Fumble die: d8

Social: Gains their Know die as a bonus to all Personality social rolls with sentient beings that are accepting of artificial life forms or don't know that they are Robots.

Charismatic: +2 to Personality and +1 Intelligence

Humanish: No penalty to disguise attempts to appear to be a human.

Labor/Maintenance - Robots of this type were designed to perform physical toil and technical maintenance that the society that created them found distasteful or dangerous. They all have the following built in traits:

Hit Die: 1d8

Base AC: 12

Impervious Armor steps: [1] (Armor die: 1d3, Fumble die: 0)

Max Armor Fumble die: d10

Sturdy: +2 to Strength

Tool Attachments: When building or repairing it has a built-in tool that is perfect for the job, granting a bonus to the action roll equal to their Know die.

Inhuman: has a -2 die step penalty to attempt to appear to be a human.

CITIZENS OF THE WASTES

Security/Military - Designed for intimidation and destruction, these Robots were made for combat and peacekeeping. They all have the following built in traits:

Hit Die: 1d10

Base AC: 14

Impervious Armor steps: [3] (Armor die: 1d5, Fumble die: 1d4)

Max Armor Fumble die: d12

Hardened: +2 to Stamina

Combat Ready: Add their Know die as a bonus to attack rolls with all built in weapons. Also, use critical table III for all attacks.

Armed: Choose one of the following built in weapons. If it requires ammunition or fuel, it is assumed to be loaded to one half capacity at character creation.

- Vibroblade - Melee, damage 1d7, crits on a 19+.
- Stun Baton - Melee, damage 1d3 + Will save (DC11) or be knocked unconscious for 2d4 minutes. Charge capacity 50, regenerates 1 charge every 10 minutes.
- Blaster - Missile, damage 1d6, Range 80/160/320. Ammo capacity 30, regenerates 1 shot every 10 minutes.
- Flamer - Missile, damage 2d6+burning, Range 30' by 5' cone. Ammo capacity: 10, requires refueling.

Killing Machine: -2 Personality and cannot pass as human. All weapons are obvious.

Slow: base move is 20'.

Components: These enhance the robot's chassis with extra equipment or abilities. At 1st level, a Robot starts with one component. At later levels (3, 5, 7, & 9), the Robot gains the ability to incorporate new components into their chassis.

Built-In Weapon - This component adds a weapon to the Robot's chassis. It does not truly retract and incurs a -1 die step penalty to all disguise actions. If it requires ammunition or fuel, it is assumed to be loaded to one half capacity at character creation. A Security/

Military chassis's base built-in weapon can also be upgraded.

- Limb Blade - Melee, damage 1d8.
- Power Claw - Melee, damage 1d6, +1 Strength, and +1 die step to grapple attacks.
- Blaster - Missile, damage 1d6, Range 80/160/320. Ammo capacity 30, regenerates 1 shot every 10 minutes.
- Shotgun - Missile, damage 1d10, Range 50/100/**. Ammo capacity 20, requires ammunition.
- Submachine Gun - Missile, damage 1d8, single shot or autofire, Range 60/120/240. Ammo capacity 50, requires ammunition.
- Grenade Launcher - Missile, damage as grenade, Range 100/200/400. Ammo capacity 4, requires ammunition.

If taken an additional time, the weapon can be upgraded in one of the following ways:

- Increase the damage die by +1 die step and either increase the range by 20% or increase the threat range by one point (i.e. 20 becomes 19-20, 19-20 becomes 18-20, etc).
- The weapon can now fully retract within the Robot's body. An Intelligence check (DC 20) is required to spot the retracted weapon.
- The weapon's Ammo capacity is increased by 20% or the weapon's regeneration rate increases to 1 shot per 30 minutes.

Flight Vents - Allows the Robot to fly at a Move of 80' at a cost of 1 Energy Point (EP) per round. The vents regenerate 1EP every 10 minutes to a max capacity of 100 EP.

If taken an additional time, either the Move speed is increased by +40' or the EP regeneration increases by +1EP per 10 minutes.

Force Field Projector - Generates a damage dampening field around the Robot. It has a variable armor die rating of one step per Energy Point (EP) spent per round, with a maximum armor die of d6. Any lost armor steps are replenished at the beginning of the next round when additional EP are expended. The belt regenerates 1EP every 10 minutes to a max capacity of 50 EP.

CITIZENS OF THE WASTES

If taken an additional time, either the maximum armor die is increased by +1 die step or the EP regeneration increases to 1EP per 30 minutes.

Hidden Storage Compartment - Allows the Robot to stow up to 9 cubic inches of material hidden within its torso. An Intelligence check (DC 20) is required to find the hidden compartment.

If taken an additional time, either the storage area is increased by 25% or the DC of the Intelligence check required to find the hidden compartment is increased by +1d3+1.

Extra Limbs - The Robot has a set of two of additional limbs and a secondary processor dedicated to controlling them. This give the Robot an extra 1d4 action die that can be used for actions with the extra limbs.

If taken an additional time, the extra action die is increased by +1 die step.

Extendable Reach - One or more of the Robot's limbs can extend 10' and function with full Strength and Agility. The extended limb gains a +1 die step bonus to grapple attacks.

If taken an additional time, the reach is increased by 1d3+1' and an additional +1 to grapple attacks.

Emergency Medical Unit - This component allows the Robot to render medical aid to humanoids. Similar to a Cleric, they can roll a 4d4 + Intelligence mod + Level on the Lay on Hand table (DCC rulebook, page 30) on the Adjacent column. Failure indicates the patient must make a Fortitude save (DC 10) or suffer 1d3 damage from mistreatment instead of Disapproval. Each treatment attempt requires 1d4 rounds.

If taken an additional time, all the treatment dice are increased by +1 die step.

Advanced Multi-tool Unit - With this component the Robot always has the right tool for any construction or repair task. They gain a +1d4+1 bonus to all such action rolls.

If taken an additional time, the tool bonus die is increased by +1 die step and an additional +1 to the roll.

Universal Interface Jack - The Robot can attempt to access any machine or computer that has some sort of interface port. Accessing basic machines requires an Intelligence check + Level (DC 10) in order to control them. Advanced machines have a DC 15 to give it a command. Intelligent machines will require a DC 20+ to access.

If taken an additional time, the Intelligence check gains an additional +2 to the roll.

Nth Dimensional Non-Euclidean Logic Generator - This component allows the Robot to alter the fabric of reality in limited ways. They have access to 1d3+Intelligence mod random 1st level Wizard spells (DCC rulebook, pg 127). They may cast these in a similar manner as a Wizard with the following alterations:

- The casting roll is 4d4+Intelligence mod+Level regardless of the size of the action die used.
- Robots cannot learn the following spells: Patron Bond, Patron Spell, & Arcane Affinity.
- Robots cannot Spellburn or bond with Patrons. They also do not apply Mercurial effects to their spells.
- New spells cannot be learned unless downloaded from a high grade digital source.
- If a Spell Lost result occurs, the Robot cannot initiate that spell for 10d4-Level hours while the generator conducts self-repair.
- All Misfire or Corruption results are interpreted as random temporary attribute damage to the Robot: Misfire = 1 point of damage, Minor Corruption = 1d3 damage, Major Corruption = 2d3 damage, Greater Corruption = 3d3 damage.

If taken an additional time, the robot gains access to 1d3+Intelligence mod random Wizard spells of the next highest level **or** the Robot can choose to learn one spell of their choice of any level they can currently cast.

CITIZENS OF THE WASTES

Table C12: Robot

Level	Attack	Crit Die/Table	Action Dice	Ref	Fort	Will	Know Die
1	+0	1d6/II	1d20	+1	+1	+1	1d3
2	+1	1d8/II	1d20	+1	+1	+1	1d4
3	+1	1d10/II	1d20	+1	+1	+2	1d5
4	+2	1d12/II	1d20	+2	+2	+2	1d6
5	+3	1d14/II	1d20+1d14	+2	+2	+3	1d7
6	+3	1d16/II	1d20+1d16	+2	+2	+4	1d8
7	+4	1d16/II	1d20+1d16	+3	+3	+4	1d10
8	+5	1d20/II	1d20+1d20	+3	+3	+5	1d10+1
9	+5	1d24/II	1d20+1d20	+3	+3	+5	1d10+2
10	+6	1d24/II	1d20+1d20	+4	+4	+6	1d10+3

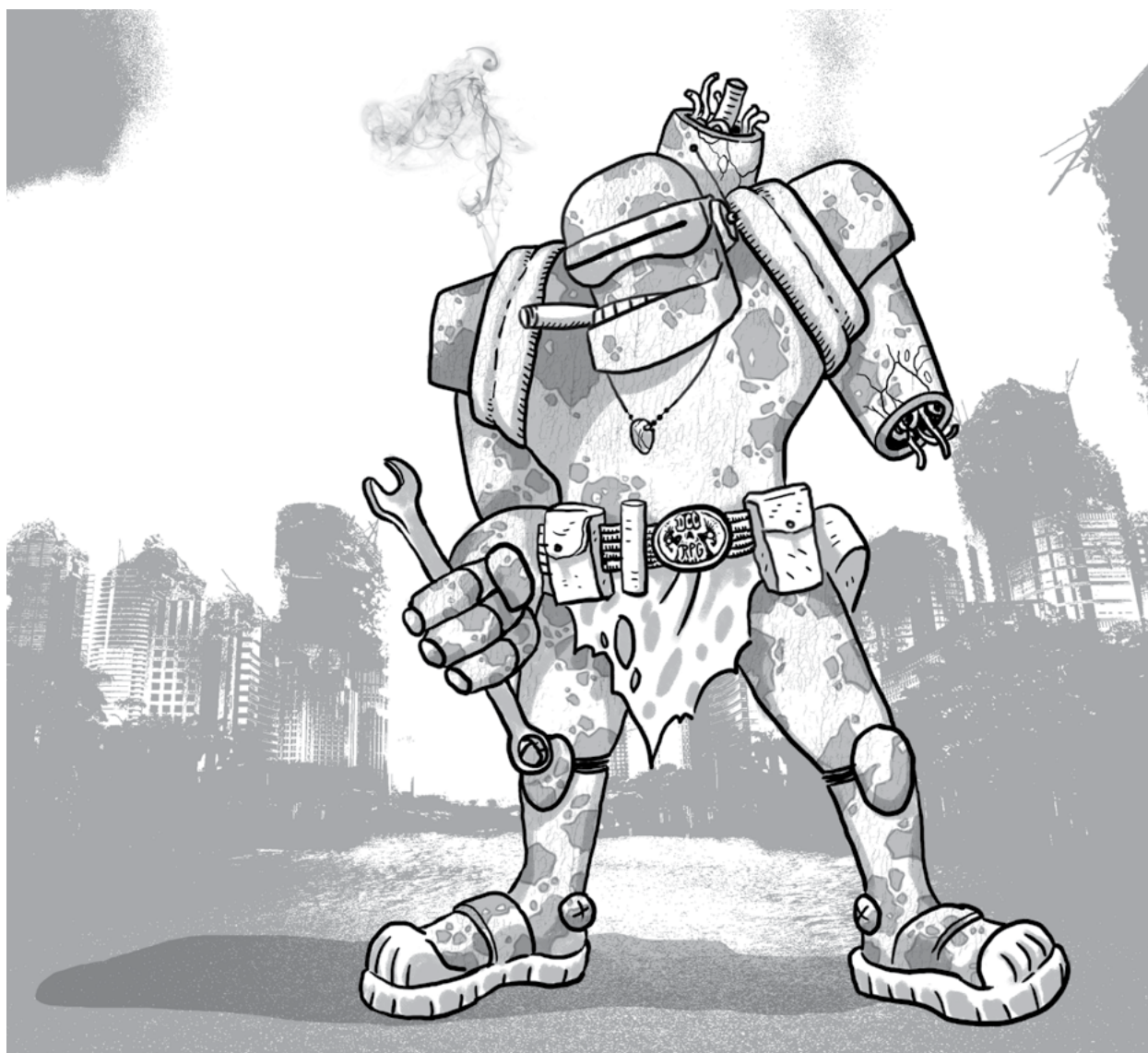

CITIZENS OF THE WASTES

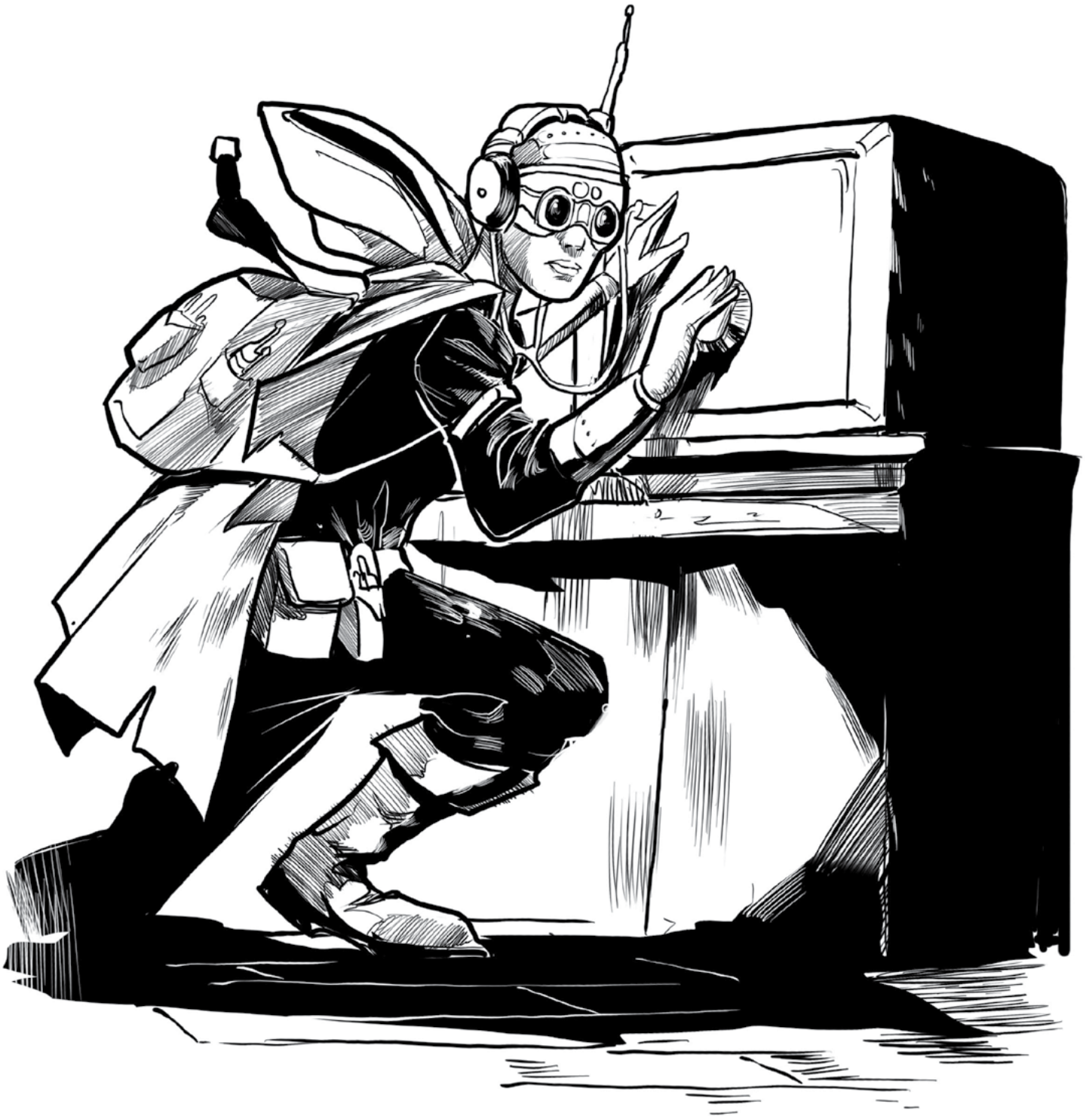

SCAVENGER

SCAVENGER

Mining the ruins of the world is your job. Where others see piles of junk you see untapped treasure waiting to be plundered. Without you what would all of those artifact merchants have to sell to their well off customers?

Hit Points: A Scavenger gains 1d6 hit points at each level.

Weapon Training: Scavengers can employ any one-handed melee weapons, pistols, rifles, and explosives. They cannot wear armor with a Fumble die of d5 or greater but can use shields.

Alignment: The tough life Scavengers lead tends to promote a Neutral or Chaotic alignment. A few find the moral fiber to maintain a Lawful alignment but they are definitely a rare occurrence.

Scavenging Skills: A Scavenger learns essential skills that aid his pursuits: bargain, circumvent security, con job, evaluate, hide, loot & run, pilfer goods, prospecting, safecracking, sneak, & survival.

To use a Scavenger skill, the player rolls d20 and adds the appropriate attribute modifier. He must beat a DC assigned to the task at hand. An easy task is DC 5, while an extremely difficult task is DC 20.

Success when using a Scavenger's skill means the following:

Bargain (Personality): Normally attempts to sell an item to a buyer will only reap 20-50% of its actual value. Scavengers are adept at squeezing a bit more profit from a transaction. This requires a Personality check (DC 15). If successful, the price gained for an item is increased by 2% for every point rolled over the DC, to a maximum of 85% of its value. If trying to buy an item, the total price is lowered by 2% for every point rolled over the DC, to a minimum value of 25%. Failure lowers the profit or increases the total cost by 3% per point the check was missed by.

Circumvent Security (Intelligence): Many places a Scavenger would like to get into are concealed or protected by various types of mechanical locks,

electronic locks, alarm systems, and plain old barred portals. This skill allows the Scavenger to defeat these obstacles or turn them to their advantage. The base DC for bypassing security measures (getting through simple locks, traps, or alarms) is DC 10. For more complex security, this increases to DC 15-20. Impossible jobs will have a DC 22 or higher.

Con Job (Personality): Much more than mere bartering or white lies, this allows the Scavenger to set up simple to elaborate scams and double crosses that are difficult to see coming until it is too late. Selling worthless goods as valuables would be a DC10 where setting up a deal that ends up with the Scavenger walking away with the goods and the money would range from DC 15-20.

Evaluate (Intelligence): Being able to quickly determine the value of a set of goods is an essential skill to all Scavengers. Determining the value of common goods is DC 5. Unfamiliar or rarely encountered goods can range from DC 10-15 and truly strange or unique items may require DC 20+.

Hide (Agility): A successful hide check means the Scavenger cannot be seen. As with sneaking, this check is never opposed but is a roll versus a set DC. The base DC for sneaking through an area with moderate cover (large rubble, cars, nooks and crannies, alcoves, etc.) is DC 10. Hiding at night or in a shaded or dimly lit area is DC 5; hiding under a full moon is DC 10; hiding in daylight but in a dark shadow or behind a solid object is DC 15; and hiding in broad daylight with minimal obstruction is DC 20.

Loot & Run (Intelligence): Anyone can rummage through a pile of junk and maybe find the good stuff hidden there but Scavengers excel at doing so quickly and moving on before anyone comes looking. This requires a DC 10 to collect up in a few rounds what normally would have taken a few minutes to glean. Gathering what would usually take a few hours of picking to find in a matter of turns requires a DC 15-20. Note that

CITIZENS OF THE WASTES

this activity is not subtle or quiet and attempting to make it so will add +10 to the DC of any Sneak Silently skill checks.

Pilfer Goods (Agility): Whether the Scavenger is trying to pick a pocket, lift goods off of a merchant's counter, or snatching a tasty fruit from a bushel as they walk past it, this is the skill they employ. Filching a object out of an open pocket or off an unattended counter is DC 5. Taking something from a wary target can range from DC 10-15. Stealing undetected while being actively watched would be a DC 20+.

Prospecting (Intelligence): Many times, knowing where to scavenge is more important than anything else. Scavengers are experts at finding the places no one else has plundered or locating the hidden stash everyone else missed. When attempting to find a certain type of thing, the GM will secretly set the DC somewhere between 5-20 depending on the likelihood of the thing being anywhere near the area the Scavenger is looking. Failure usually indicates the thing cannot be found around that area but sometimes it can mean the Scavenger found something else...

Safecracking (Intelligence): While the Circumvent Security Measures skill can get the Scavenger inside just about anywhere, there is a fine art to breaking into locked storage containers without damaging the contents. Opening strongboxes or simple home safes is a DC 8, safety deposit boxes or industrial safes can range between DC 12-16, and large bank vaults are DC 20+. If the contents are volatile or very fragile the DC is increased by at least +5.

Sneak (Agility): A Scavenger never makes an opposed check to sneak; that is, the check is never made against the target's attempt to listen. The Scavenger rolls against a hard DC, as noted below, and success means the Scavenger did indeed sneak silently. With the exception of advanced technology or extraordinary magic, the Scavenger's movement cannot be heard. The base DC for moving across solid surfaces is DC 10. Cushioned surfaces, such as grass or moldy

carpet are DC 5; moderately noisy surfaces, such as rotting wooden boards are DC 15; and extremely noisy surfaces, like crackling leaves, still water, or crumbling debris are DC 20.

Survival (Intelligence): Everyone knows that the best salvage is always in the most out of the way and hazardous areas. As such, Scavengers must learn to avoid environmental hazards, unsound structures, and toxic edibles. Figuring out which canned goods are still safe or if a bridge is safe to cross would require a DC 10. Identifying a building that will collapse at any moment, determining if a strange new fruit is poisonous, or spotting a Radzone can range between DC 15-20.

Luck and Wits: Scavengers survive on their luck and their wits, and the most successful Scavengers live a life of fortune on guts and intuition.

A Scavenger gains additional bonuses when expending Luck, as follows. First, the Scavenger rolls a luck die when he expends Luck. The luck die is indicated on *Table C13: Scavenger*. For each point of Luck expended, he rolls one die and applies that modifier to his roll. For example, a 2nd-level Scavenger who burns 2 points of Luck adds +2d4 to a d20 roll. Second, unlike other classes, the Scavenger recovers lost Luck to a limited extent. The Scavenger's Luck score is restored each night by a number of points equal to his level. This process cannot take his Luck score past its natural maximum.

CITIZENS OF THE WASTES

Table C13: Scavenger

Level	Attack	Crit Die/Table	Action Dice	Ref	Fort	Will	Luck Die
1	+0	1d10/II	1d20	+1	+1	+0	d3
2	+1	1d12/II	1d20	+1	+1	+0	d4
3	+2	1d14/II	1d20	+2	+1	+1	d5
4	+2	1d16/II	1d20	+2	+2	+1	d6
5	+3	1d20/II	1d20	+3	+2	+1	d7
6	+4	1d20/II	1d20+1d14	+4	+2	+2	d8
7	+4	1d24/II	1d20+1d16	+4	+3	+2	d10
8	+5	1d24/II	1d20+1d20	+5	+3	+2	d12
9	+6	1d30/II	1d20+1d20	+5	+3	+3	d14
10	+7	1d30/II	1d20+1d20	+6	+4	+3	d16

Table C14: Scavenger Skills

Scavenger Level	1	2	3	4	5	6	7	8	9	10
Bargain (Personality)	+1	+3	+5	+7	+8	+9	+10	+11	+12	+13
Circumvent Security (Intelligence)	+3	+5	+7	+8	+9	+11	+12	+13	+14	+15
Con Job (Personality)	+1	+3	+5	+7	+8	+9	+10	+11	+12	+13
Evaluate (Intelligence)	+0	+1	+2	+3	+4	+5	+6	+7	+8	+9
Hide (Agility)	+3	+5	+7	+8	+9	+11	+12	+13	+14	+15
Loot & Run (Intelligence)	+0	+0	+1	+2	+3	+4	+5	+6	+7	+8
Pilfer Goods (Agility)	+1	+3	+5	+7	+8	+9	+10	+11	+12	+13
Prospecting (Intelligence)	+3	+5	+7	+8	+9	+11	+12	+13	+14	+15
Safecracking (Intelligence)	+0	+1	+2	+3	+4	+5	+6	+7	+8	+9
Sneak (Agility)	+1	+3	+5	+7	+8	+9	+10	+11	+12	+13
Survival (Intelligence)	+0	+0	+1	+2	+3	+4	+5	+6	+7	+8



TECHNOLOGIST

CITIZENS OF THE WASTES

TECHNOLOGIST

You seek to rediscover the glorious knowledge of the past and to use it to gain power for your future. Like a Wizard, you hunger for long forgotten lore and alien knowledge but of a scientific and technological vein. Woe be to those who would keep you from what you seek.

Hit Points: A Technologist gains 1d6 hit points at each level.

Weapon Training: Technologists may use: Daggers, Clubs, Staves, Hand Axes, Crossbows, Pistols & Rifles of any Era, Grenades & Explosives of any Era. They may use any type of armor or shields.

Alignment: Like the unbiased nature of scientific understanding, most Technologist are prone to the Neutral alignment. Lawful Technologists tend to be more obsessed with theoretical science and Chaotic Technologists are more prone to be called mad scientists.

Tinkering: The most useful talent that the Technologist offers is the ability to get broken tech artifacts working again using only the scrap they find lying around. This does not usually result in a perfect fix but it gets the job done. Of course repairing devices in this way can cause horrible malfunctions and leads to unexplained explosions. Should the Technologist fail by a margin of 6 or more while tinkering, have them roll on the appropriate failure table. When tinkering, the Technologist rolls a 1d20 + Intelligence + Skill bonus

Having the right parts can make all of the difference when fixing something. Use these guidelines to simplify the hunt for the perfect part.

Looking for Parts - A technologist may improve their chances of building a piece of technology by finding the exact required pieces for a given project. When a technologist is in a junkyard, abandoned armory, or hidden research lab, they may make a **luck** check. If successful, they may find just the piece they were looking for. Each successfully discovered part reduces the DC check of the project by 2.

Creative use of GM awarded Parts - A technologist may announce a creative use for a scavenged part. At GM's discretion, a +1 to +5 bonus may be added to the check to build the project. This may be further improved by Looking for Parts.

In general, all tinkering attempts take at least 1d3 hours to complete. Increasing this to 1d3 days grants a +1 die step bonus to the attempt. Decreasing the time to 1d3 turns inflicts a -1 die step penalty and decreasing it further to 1d3 rounds increases the penalty to -2 die steps.

When a technologist attempts to create or repair a piece of technology, they may Take Their Time on a failed roll. The difference between DC and their roll equals +1 day that they will need to work on their project. For example, a Technologist is attempting to make a scavenged ray gun operable. The GM sets a DC 15 to succeed. The Technologist rolls a 12 but can choose to succeed by taking an extra 3 days to repair the ray gun.

Technologists of different alignments tend to focus on different types of tech. See *Table C15* to determine the bonus the Technologist applies when tinkering with various tech.

Weapon Tinkering - With this a Technologist can repair damaged weapons so that they will work again, for a while. Clearing gun jams, sharpening blades, and heavy maintenance is only a DC 5. Fixing broken weapons with kitbashed parts is DC10 or 15 depending on the severity of the damage and what parts are available. Building a gun entirely out of scrap would be DC 25-35.

Technologists can also attempt to manufacture functional ammunition for guns. Creating ammunition is a DC 10 assuming the correct materials, or viable substitutes, are available. This will create 2d20 rounds in 6 hours. Recharging Energy weapons requires a functional power source and energy converter. With that, the DC is 10. If such is not available, the DC is at least 15, assuming the gunsmith comes up with a brilliant plan.

CITIZENS OF THE WASTES

All of these DCs assume the gunsmith has the proper time, materials, and tools for the job. If this is not the case, the difficulty is increased by +5 or even +10 in some instances.

Bot Repair - While creating a robot from scratch is beyond the ken of most people, Technologists can fix and reprogram them with some success. Both Robot and Cyborg characters can also be repaired in this way. Fixing minor damage (less than 25% of the total HP for the bot) is DC 10 and just requires access to good scrap and 1d7sp worth of materials per hit point repaired. Fixing major damage (between 25% to 75% of the total HP for the bot) requires specialized parts, tools, and 2d5sp per hit point repaired (DC 15). Bots damaged beyond 75% of their HP are DC 20+ to repair, depending on the damage done to them, and 3d4sp per hit point repaired. On the other hand, it is only DC 10 to salvage usefull parts from them.

Reprogramming a bot is a DC 5 for simple servant bots, DC 10-13 for construction or manufacturing class bots, DC 15-20 for security and combat bots, and DC 25+ for self aware bots. Note that Robots and Cyborgs cannot be reprogrammed.

Computer Use - Despite the variety of cosmic radiation and electromagnetic disturbances caused by the cataclysm, many computers survived. This skill allows a Technologist to attempt to hack into, utilize, and program computers they encounter. Accessing personal or public computers range between DC 10-15 depending on the level of security running. Mainframes and supercomputers are DC 15-20. Self aware systems are DC 25+. If the computer is being actively monitored for suspicious activity, add +1d5 to the DC.

Programming starts at a DC 10 and increases based on what the program does and how many resources it needs to run.

Vehicle Repair - Although it has been many years since the last of the large car manufacturers

stopped production, motor vehicles are still widely used by many societies that can keep them functional. Despite not being considered "high science" most Technologist are capable of acting as a mechanic, if only to earn room and board. See the pg 131 of the Vehicle Section for the difficulty classes for vehicle repairs.

General Tech - This is the catch-all category for any terrestrial technology that a Technologist might encounter that is not already covered by another skill. The DC for working on a device will depend on how complex the device is, how common the device is, and if it requires specialized parts or tools. In general, simple common devices will be DC 5-10. A rare device will increase the DC by 4-8 and a complexity can increase the DC by 5-10. Thus, a very rare & complex device might have a DC 28.

Use Alien Device - When faced with alien technology that defies all known understanding, the Technologist has a chance to comprehend its function. Checks to decipher or use Alien tech are rolled with the Technologist's Use Alien Device die+Level+Luck mod and checked against *Table C20*.

CITIZENS OF THE WASTES

Table C15: Weapons Tinkering Failure Results

Roll 1d16 modified by the Technologist's Luck bonus

1-3	Complete disaster! The weapon appears to work perfectly but will dramatically fail after 1d5 +1 uses. Then it will cause 1d3 times the weapon's normal damage to the wielder.
4-6	Disaster! The weapon is totaled. There is a 75% that any tools that were used are totaled as well. If they are, the Technologist suffers damage equal to ½ the weapon's damage rating. There is a 50% that there is an explosion doing (1d3)d5 damage to everyone within 10'.
7-11	Possible disaster, There is a 50% chance the weapon is totaled and a 35% chance that any tools that were used are totaled as well. There is a 25% chance that there is an explosion doing (1d3)d3 damage to everyone within 10'.
12-15	No ill effects. The weapon is no worse than when you started.
16+	Eureka! Your failure has given you a brilliant idea! Add +1d5 to try again next round. If this re-try fails, your brilliant idea was a disaster and result 1-3 of this table immediately is applied to the weapon.

Table C16: Bot Repair Failure Results

Roll 1d16 modified by the Technologist's Luck bonus

1-3	Insidious Success! The bot appears to be completely non-functional and unrepairable. In truth it is now self aware and playing possum. As soon as it can it will escape to later stalk the Technologist...
4-6	Catastrophe! The bot has a meltdown and is irreparable . There is a 60% chance that any tools used are destroyed as well. If they are, The Technologist suffers 2d3 damage. There is also a 50% chance that there is a radiation leak doing 1d3 Stamina damage to everyone within 10'.
7-11	Possible Catastrophe! There is a 50% chance that the bot has a meltdown and is unrepairable. If so, There is a 30% chance that any tools used are destroyed as well. If they are, The Technologist suffers 1d3 damage. There is also a 35% chance that there is a radiation leak doing 1d2 Stamina damage to everyone within 10'.
12-15	No ill effects, the bot is no worse than when you started.
16+	Eureka! Your failure is actually a success! The repair or upgrade works perfectly but the bot is now self aware and has plans of its own...

Table C17: Computer Use Failure Results

Roll 1d16 modified by the Technologist's Luck bonus

1-3	Crash and Burn! The computer is completely locked up and refuses to accept any further input. Also, a self aware virus has wirelessly infected a piece of the Technologist's equipment and will continue to spread. Using infected equipment will increase the DC of a task by 1d5. Weapons will have their fumble range increased by 1d3.
4-6	Crash! There is an 80% chance that the computer is completely locked up and refuses to accept any further input. There is also a 75% chance that the computer has developed an OS error. If so, any rolls involving the computer have the DC increased by d8.
7-11	Possible Crash! There is a 50% chance that the computer is completely locked up and refuses to accept any further input. There is also a 50% chance that the computer has developed an OS error. If so, any rolls involving the computer have the DC increased by d5.
12-15	No ill effects.
16+	Eureka! Your failure has given you a brilliant idea! Add +1d5 to try again next round. If this re-try fails, your brilliant idea was a disaster and result 1-3 of this table immediately is applied to the computer.

CITIZENS OF THE WASTES

Table C18: Vehicle Repair Failure Results

Roll 1d16 modified by the Technologist's Luck bonus

1-3	Looming Tragedy! The vehicle appears to work perfectly but will dramatically fail after traveling 5d10 miles. Then the driver will need to make a DC20 Vehicle Control check: Success indicates all passengers suffer 1d8 damage, Fortitude save for half. All damage is doubled if vehicle was flying. Vehicle is reduced to 1d24% of its HP. Failure means a major crash destroying the vehicle and causing 1d30 damage to all passengers, Fortitude save for half. All damage is doubled if vehicle was flying.
4-6	Costly Mistake! There is a 75% chance that the vehicle will require another repair in the next 1d7 days. There is also a 60% chance that the vehicle permanently loses 1d10 HP from its max HP. If so, any driving rolls have the DC increased by d5.
7-11	Mistake! There is a 50% chance that the vehicle will require another repair in the next 1d14 days. There is also a 30% chance that the vehicle permanently loses 1d8 HP from its max HP. If so, any driving rolls have the DC increased by d3.
12-15	No ill effects.
16+	Eureka! Your failure is actually a success! The repair or upgrade works perfectly but at a cost, roll 1d4 on the chart below: 1 - Top speed is reduced by 3d20%. 2 - Vehicle max HP reduced by 3d4. 3 - Drive check DC increased by 1d5. 4 - Fuel consumption increased by 3d30%

Table C19: General Tech Failure Results

Roll 1d16 modified by the Technologist's Luck bonus

1-3	Catastrophic Fail! The device burns out, melts down, or explodes if possible. There is also a 65% chance that any tools that were used are damaged as well. The Technologist suffers (1d5)d3 of damage based on the size of the device.
4-6	Costly Failure! There is a 50% chance that the device will permanently fail in the next 1d7 days. There is also a 45% chance that any tools that are used are damaged as well.
7-11	Failure! There is a 30% chance that the device will permanently fail in the next 2d7 days. There is also a 25% chance that any tools used are damaged as well.
12-15	No ill effects.
16+	Eureka! The device no longer functions as it did before but now does something completely different!

Table C20: Use Alien Tech Check Results

Technologist's Use Alien Device die + Level + Luck mod

1-3	An alien Intelligence gets downloaded into the Technologist's mind. When they sleep, the Intelligence takes over the body and goes about its unfathomable business.
4-6	Trying to comprehend the function of the object causes the Technologist to have a minor aneurysm and they suffer 1d3 Intelligence loss. There is a 20% chance it is permanent.
7-9	The technologist has completely misunderstood how the device works and is adamant about their conclusion. Good luck!
10-14	The Technologist has figured out the base functions of the Alien device. They may try using it at a penalty of +1d5 to all DCs or -1d5 to all combat rolls.
15-19	The Technologist has figured out the functions of the Alien device. They may try using it at no penalty.
20-25	The Technologist has discovered most of the functions of the Alien device. They may try using it at a bonus of +1d3 to all DCs and combat rolls.
26-31	As previous entry but the Technologist also gains deeper understanding of Alien tech. They learn the Language: Alien Basic and may add +1d3 to their next Use Alien Tech roll.
32+	As previous entry but the understanding is greater. They may add +1d3 to all future Use Alien Tech rolls involving a similar type of device.

CITIZENS OF THE WASTES

Table C21: Technologist

Level	Attack	Crit Die/Table	Action Dice	Ref	Fort	Will
1	+0	1d8/II	1d20	+1	+1	+1
2	+1	1d8/II	1d20	+1	+1	+1
3	+1	1d10/II	1d20	+1	+1	+2
4	+2	1d10/II	1d20	+2	+2	+2
5	+3	1d12/II	1d20+1d14	+2	+2	+3
6	+3	1d12/II	1d20+1d16	+2	+2	+4
7	+4	1d14/II	1d20+1d20	+3	+3	+4
8	+5	1d14/II	1d20+1d20	+3	+3	+5
9	+5	1d16/II	1d20+1d20	+3	+3	+5
10	+6	1d16/II	1d20+1d20	+4	+4	+6

Table C22: Technologist Jury Rigging Skills by Level and Alignment

Lawful	1	2	3	4	5	6	7	8	9	10
Weapon Tinkering	+0	+0	+1	+2	+3	+4	+5	+6	+7	+8
Bot Repair	+0	+1	+2	+3	+4	+5	+6	+7	+8	+9
Computer Use	+1	+3	+5	+7	+8	+9	+10	+11	+12	+13
Vehicle Repair	+0	+1	+2	+3	+4	+5	+6	+7	+8	+9
General Tech	+3	+5	+7	+8	+9	+11	+12	+13	+14	+15
Use Alien Device	d14	d14	d16	d16	d16	d20	d20	d20	d24	d24
Neutral	1	2	3	4	5	6	7	8	9	10
Weapon Tinkering	+1	+3	+5	+7	+8	+9	+10	+11	+12	+13
Bot Repair	+0	+0	+1	+2	+3	+4	+5	+6	+7	+8
Computer Use	+0	+1	+2	+3	+4	+5	+6	+7	+8	+9
Vehicle Repair	+3	+5	+7	+8	+9	+11	+12	+13	+14	+15
General Tech	+0	+1	+2	+3	+4	+5	+6	+7	+8	+9
Use Alien Device	d12	d12	d14	d14	d16	d16	d20	d20	d20	d20
Chaotic	1	2	3	4	5	6	7	8	9	10
Weapon Tinkering	+3	+5	+7	+8	+9	+11	+12	+13	+14	+15
Bot Repair	+1	+3	+5	+7	+8	+9	+10	+11	+12	+13
Computer Use	+0	+1	+2	+3	+4	+5	+6	+7	+8	+9
Vehicle Repair	+0	+1	+2	+3	+4	+5	+6	+7	+8	+9
General Tech	+0	+0	+1	+2	+3	+4	+5	+6	+7	+8
Use Alien Device	d10	d10	d12	d12	d14	d14	d16	d16	d16	d20

All skill checks are modified by the Technologist's Intelligence modifier.

CITIZENS OF THE WASTES



WASTELAND WARRIOR

WASTELAND WARRIOR

Warriors are a staple of the wastelands as there will always be raiders or beasts that wish to prey upon those that look like easy meat. Even in a world of mutants, magic, and metal men, an axe to the head still does the trick every time (mostly).

Hit Points: A Wasteland Warrior gains 1d12 hit points at each level.

Weapon Training: Wasteland Warrior can use any type of weapon they can get their hands on. They also can use armor and shields.

Alignment: Most Wasteland Warriors tend to be Neutral but there are also many who are strictly Lawful or selfishly Chaotic.

Attack Modifier: Wasteland Warriors do not receive a fixed attack modifier at each level. Instead, they receive a randomized modifier known as a deed die, just as the Warrior from the DCC RPG (pg 42). The Wasteland Warrior always makes a new roll with this die in each combat round. When the Wasteland Warrior has multiple attacks at higher levels, the same deed die applies to all attacks in the same combat round.

Mighty Deed of Arms: Wasteland Warriors earn their keep by performing the craziest of stunts in combat and surviving to tell the tale. They swing across suspension bridges on loose cables, bash through armored glass windows, and leap over abandoned cars in pursuit of their foes. When locked in mortal melee, their mighty deeds of arms turn the course of battle: a brash leap from one speeding vehicle to another, a swinging chain to entangle the back wheel of ganger's chopper, or a well-placed jab into an open panel on a killbot.

Prior to any attack roll, a Wasteland Warrior can declare a Mighty Deed of Arms, or for short, a Deed. This Deed is a dramatic combat maneuver within the scope of the current combat. The Deed does not automatically increase damage but could have some other combat effect: pushing back an enemy, tripping or entangling him, temporarily blinding him, and so on.

The Wasteland Warrior's deed die determines the Deed's success. This is the same die used for the Wasteland Warrior's attack and damage modifier each round. If the deed die is a 3 or higher, and the attack lands (e.g., the total attack roll exceeds the target's AC), the Deed succeeds. If the deed die is a 2 or less, or the overall attack fails, the Deed fails as well. Refer to the Combat section (DCC RPG, pg 88) for additional information on Mighty Deeds of Arms. An additional Mighty Deed available to Wasteland Warriors can be found after *Table C23: Wasteland Warrior*.

Signature Move: Many Wasteland Warriors like to use one specific deed often in combat and may claim it as their signature move. Should they score a 3 or higher on the deed die without previously calling what kind of deed they were attempting, the deed is assumed to be their signature move deed.

Critical hits: In combat, a Wasteland Warrior is most likely to score a critical hit and tends to get the most destructive effects when he does so. In addition, a Wasteland Warrior scores critical hits more often. At 1st through 4th level, a Wasteland Warrior scores a crit on any natural roll of 19-20. The threat range increases to natural rolls of 18-20 at 5th level and 17-20 at 9th level. See the Combat section (DCC RPG, pg 79) for more information on crits.

Initiative: A Wasteland Warrior adds his class level to his initiative rolls.

It's All In The Reflexes: If a Wasteland Warrior has a positive Luck mod, they can choose to add it to their Armor Class.

CITIZENS OF THE WASTES

Table C23: Wasteland Warrior

Level	Attack	Crit Die/Table	Threat Range	Action Dice	Ref	Fort	Will
1	+d3*	1d12/III	19-20	1d20	+1	+1	+0
2	+d4*	1d14/III	19-20	1d20	+1	+1	+0
3	+d5*	1d16/IV	19-20	1d20	+1	+2	+1
4	+d6*	1d20/IV	19-20	1d20	+2	+2	+1
5	+d7*	1d24/V	18-20	1d20+1d14	+2	+3	+1
6	+d8*	1d30/V	18-20	1d20+1d16	+2	+4	+2
7	+d10+1*	1d30/V	18-20	1d20+1d20	+3	+4	+2
8	+d10+2*	2d20/V	18-20	1d20+1d20	+3	+5	+2
9	+d10+3*	2d20/V	17-20	1d20+1d20	+3	+5	+3
10	+d10+4*	2d20/V	17-20	1d20+1d20+1d14	+4	+6	+3

* A Wasteland Warrior's attack modifier is rolled anew, according to the appropriate die, each combat round. The result modifies both attack and damage rolls. At higher levels, the warrior adds both a die and a fixed value.

NEW MIGHTY DEED

Armor Mastery (requires an Armor Die of d3 or higher)

This involves using whatever armor is worn to provide a greater protection than normal.

- 3 The Wasteland Warrior's armor die is considered one die step higher than normal until the their first action next round. If the armor die would be reduced to zero, it is considered a d3 and cannot be lowered while the deed is in effect.
- 4 In addition to the armor die step increase, the Wasteland Warrior's AC is increased by +1.
- 5 The bonus to the armor die is now +2 die steps and cannot be lowered past d4 while the deed is in effect.
- 6 In addition to the armor die step increase, the Wasteland Warrior's AC is increased by +2.
- 7+ Rolls of 1 on the armor die are ignored and rerolled until a non 1 result is rolled while the deed is in effect.





WIZARD OF THE WASTELAND

WIZARD OF THE WASTELAND

The extra dimensional energies of the cataclysm unleashed the forces of magic upon the Urth but only a few are clever and determined enough to master them. Will you beat the odds and gain unimaginable power or fall prey to the arcane corruption that has claimed so many eager victims.

Hit points: A Wizard gains 1d4 hit points at each level.

Weapon training: A Wizard is trained in the use of the dagger, bows, club, short sword, staff, and pistols. Wizards rarely wear armor, as it hinders spellcasting.

Alignment: Wizards pursue magical arts according to their natural talents and can be of any alignment.

Caster level: Caster level is a measurement of a Wizard's power in channeling a spell's energy. A Wizard's caster level is usually his level as a Wizard. For example, a 2nd-level Wizard usually has a caster level of 2.

Magic: Magic is unknown, dangerous, and inhuman. Even the best Wizards occasionally fail to properly harness a spell, with unpredictable results. At 1st level a Wizard determines 4 spells that he knows, representing years of study and practice. As his comprehension expands, a wizard may learn more spells of progressively higher levels. A Wizard knows a number of spells as shown on *Table C24*, modified by his Intelligence score. Known spells are determined randomly (see the *Grimoire of the Wastes*, pg 157). They may be of any level for which the wizard is eligible, as shown by the max spell level column. The Wizard chooses the level before making his die roll. Higher-level spells are more powerful but harder to cast — and there are consequences for failure.

Wizards cast spells by making a spell check. A Wizard's spell check is usually 1d20 + Intelligence modifier + caster level. In some cases, a Wizard may roll a different die on the spell check (see *Volatile Magic*, pg 152).

Supernatural Patrons: Wizards weave magic spells in consultation with powers from supernatural places and the outer planes. Demons and devils, angels, celestials, ghosts, outsiders, daevas, genies, elementals, Chaos Lords, spirits, elder gods, alien Intelligences, and concepts foreign to mortal comprehension whisper secrets in exchange for favors best left unexplained. In everyday concourse, these secrets manifest as spells; in dire circumstances, the Wizard can invoke one of his patrons directly and call for material assistance. This sort of request is called invoking a patron.

To invoke a patron, the Wizard must spellburn at least 1 point of an ability score (see *DCC RPG*, pg 107) and cast the spell *Invoke Patron*. There may be additional requirements depending on the specific circumstances. Presuming the patron condescends to attend to the Wizard, some negotiation may be required: a bauble exchanged, a secret name spoken, a sacrificial token burned, or maybe a quest performed. If the patron deigns to act, it sends an emissary to assist the Wizard in the way the patron deems most appropriate. Invoking a patron is powerful magic. Do not use it lightly. Common Patrons can be found in the *Gods and Patrons* chapter, pg 182.



CITIZENS OF THE WASTES

Table C24: Wizard of the Wasteland

Level	Attack	Crit Die/Table	Action Dice	Known Spells	Max Spell Level	Ref	Fort	Will
1	+0	1d6/I	1d20	4	1	+1	+0	+1
2	+1	1d6/I	1d20	5	1	+1	+0	+1
3	+1	1d8/I	1d20	6	2	+1	+1	+2
4	+1	1d8/I	1d20	7	2	+2	+1	+2
5	+2	1d10/I	1d20+1d14	8	3	+2	+1	+3
6	+2	1d10/I	1d20+1d16	9	3	+2	+2	+4
7	+3	1d12/I	1d20+1d20	10	4	+3	+2	+4
8	+3	1d12/I	1d20+1d20	12	4	+3	+2	+5
9	+4	1d14/I	1d20+1d20	14	5	+3	+3	+5
10	+4	1d14/I	1d20+1d20+1d14	16	5	+4	+3	+6

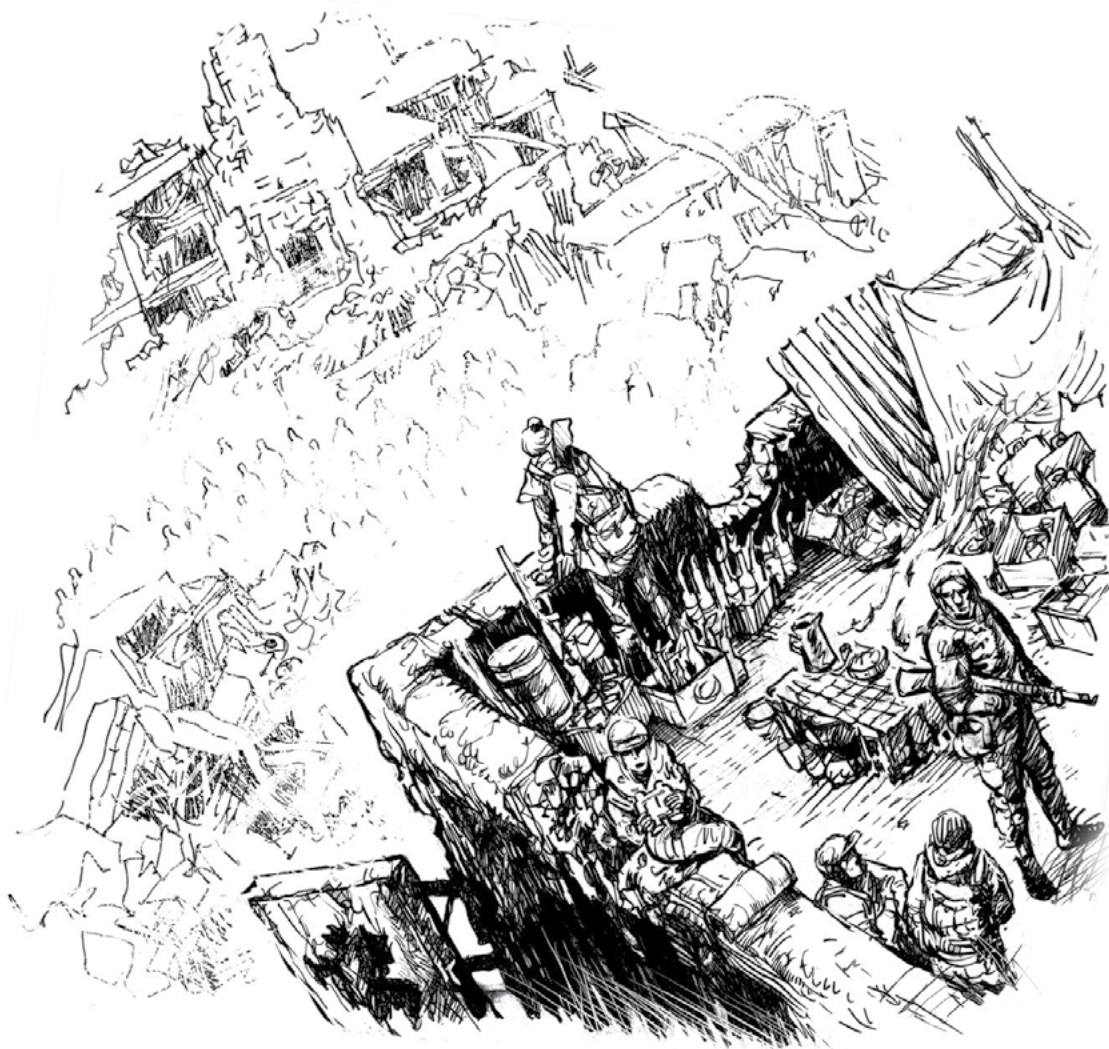



COMBAT+

While most of the combat rules from the Dungeon Crawl Classics rule book still apply, in the wastelands of Umerica things are a little bit different.

NEW ARMOR RULES

In the strange and twisted wastelands of Umerica danger lurks around every corner. Whatever safety or protection that can be found is likely makeshift and temporary at best, made of salvaged and repurposed material. These rules for scavenged piecemeal armor bring these ideas to the forefront, while keeping things light and easy.

First, Armor Class (AC) is now calculated by a 10 + Reflex save and further modified by shields, racial, or magical bonuses, if any. Armor does not (generally) modify a person's AC. Some pieces of armor may actually increase the wearer's AC as well but, this is not common. Instead it soaks damage from successful attacks so the wearer can survive long enough to fight back or run.



Standard Armor

Each piece of armor worn grants somewhere between 0-3 die steps to the individual's total Armor Die. This Armor Die starts at 1d3 for the first step and continues up the die chain as normal. Generally, unless the description of any armor piece says otherwise the wearer's Fumble Die is equal to their Armor Die die steps -1 die step. Also, the total Armor Check Penalty is equal to the number of Fumble Die die steps -1. i.e. A total Armor Die rating of 1d8 has a Fumble Die of 1d7 and a Armor Check Penalty of -4. Armor pieces made by advanced technology and/or imbued with magic may not increase the Fumble Die or the Armor Check Penalty. The total armor worn by anyone cannot have a Fumble die greater than d20. Should that become the case, the person is generally immobilized by the armor and suffers the Armor Check Penalty to all actions, saves, and combat.

i.e. A Cleric finds a full suit of pristine riot gear and hastily dons it. This consists of a helmet (2 steps of armor), a torso piece (2 steps of armor), a set of legguards (1 step of armor), a set of shoulder pads (1 step of armor), a set of armguards 1, and a set of hip guards (1 step of armor). This gives her 6 armor pieces granting a total of 8 die steps of armor (Armor Die: d12). Her Fumble Die is now d10 and her Armor Check penalty is -6.

After a hit, the defender rolls its Armor Die. The result reduces the attack's damage by the number rolled. On a roll of 1 on the armor die, one piece of armor of the defender's choice is damaged, reducing its effectiveness by one die step. If reduced to zero die steps, the piece of armor is destroyed. Any critical hit suffered will automatically lower the Armor Die by -1 die step in addition to any other effects. Also note that destructive or corrosive spell effects or hazards will reduce a target's Armor Die as well.

i.e. A scavenger is wearing a firefighter's jacket and helmet (3 steps of armor). When he rolls a 1 on his Armor Die (1d5), this lowers the Armor Die by one die step and either the jacket (1 step of armor) is rendered useless or the helmet (2 steps of armor) is damaged.

COMBAT

Shields

Shields increase the wielder's AC as normal and can act as an ablative as well, if the wielder chooses to sacrifice them. Using a shield also increases the Fumble Die of the wielder by +1 die step. For beings with more than two arms, up to a maximum of two shields can be employed at any one time (increasing the Fumble Die of the wielder by a total of +2 die steps). Shields made from high tech materials or magic may also increase the wielder's Armor Die.

Ablative Armor Pieces

Some pieces of armor, called Ablatives, do not provide Armor Die steps. Instead, they act as a buffer to keep the good stuff from breaking. An Ablative piece is destroyed instead of an Armor Die step when a 1 is rolled on the Armor Die. Every 2 pieces of Ablative armor increase the Fumble Die by +1 die step, rounded down.

i.e. A warrior is wearing a riot vest and helmet (4 steps of armor). In addition, she is wearing a pair of hockey gloves (2 ablatives). When she rolls a 1 on her Armor Die (1d6), one of her gloves is destroyed instead of lowering her Armor Die.

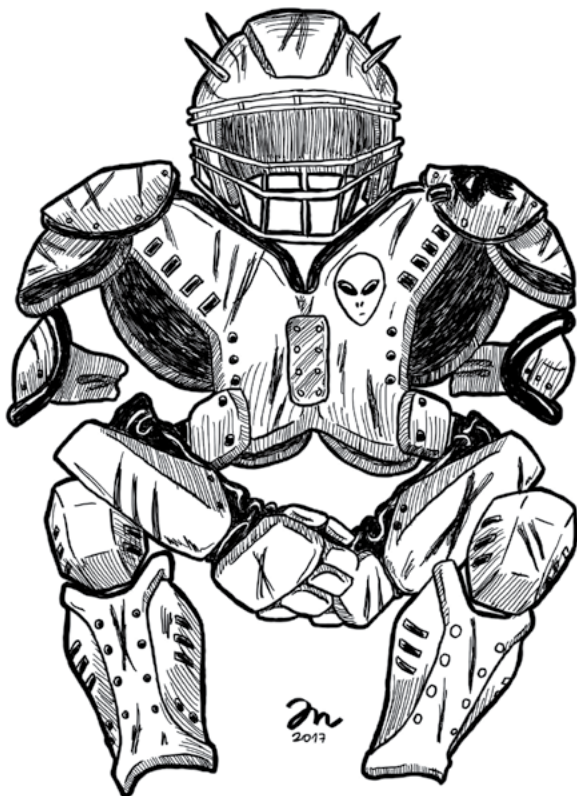

Feeble Materials

Often the only protective gear that can be cobbled together is made of stuff that is not really suited for combat. Armor that is Feeble will have its die steps listed with an F, as in Football shoulder pads 2f. This includes most sporting gear, retreat armors and scrapmail armors. Any armor piece made of such stuff will degrade if the Armor Die result is a 1 or 2. Also, any Feeble armor is always damaged first in combat, unless an ablative is sacrificed.

i.e. A mutant is wearing a set of retreat shoulder and chest armor (3f steps of armor). In addition, he is wearing a WW2 helmet (1 step of armor). When he rolls a 1 or 2 on his Armor Die (1d6), the retreat armor will be damaged. Once all of the Feeble retreat armor is ruined, then his normal armor (the helm) can only be damaged on a roll of 1 on his Armor Die.

Impervious Materials

In rare instances, a piece of Hardened or Xeno based armor may have one or more Impervious die steps of protection. Impervious die steps never break and serve as permanent protection to the wearer. Once all of the person's non-impervious armor has broken, their Impervious armor will remain indefinitely.

COMBAT

Armor with Impervious armor die steps will have those die steps listed in [], as in Helm 2 + [1]. In this case the Helm would give the wearer 3 steps of armor, 1 of which is Impervious.

i.e. An industrial chassis robot ([1] step of chassis armor) rolls a 1 on its Armor Die (1d3) after suffering a successful attack. Normally this would destroy the robot's armor but as the armor is Impervious, it is unaffected and remains useful. Thus, the robot has a permanent Armor Die of 1d3.

Stacking Armor

Mutants, Robots, and others may have Natural armor, which is either Impervious or heals over a period of time. Should a person have more than one type of natural armor (such as from two different mutations) or attempt to wear regular armor on top of natural armor, this will greatly increase the total Fumble die and Check Penalty. Each die step or ablative piece increases the Fumble die an extra die step, which in turn increases the Check penalty.

i.e. A crab mutant with 3 steps of natural armor is also wearing football shoulder pads and hip guards. The shoulder pads grant 2 die steps of protection and the hip guards are ablative. Normally 5 steps of armor plus an ablative would have the following stats: Armor Die d7; Fumble die d6; Armor Check Penalty -3; Ablative 1. Both of the shoulder pads and the hip guards add 3 extra Fumble die steps due to being worn over

natural armor, making the actual armor stats: Armor Die d7; Fumble die d10; Armor Check Penalty -6; Ablative 1.

This same crab mutant gains a new mutation: Aggregate - Crystal, which grants another 3 steps of natural armor. As he now has two types of natural armor, the steps from the second mutation inflict an additional +3 extra Fumble die steps. His armor stats are now: Armor Die d12; Fumble die d16; Armor Check Penalty -9; Ablative 1. It's a good thing he can breathe underwater as he now swims like a rock.



General Armor Die Step Ratings per Armor Piece Type

Armor Piece	Number of Die Steps	
	Feeble Materials	Hardened/Xeno Materials
Helmets / Masks	1	2
Torso / Chest Pieces	1-2	2-3
Legguards / Leggings	1	1-2
Shoulder Pads	1	1-2
Armguards / Bracers	1	1-2
Groin / Hip Guard	1	1
Aprons/Protective Capes	0	1

Elbow pads, knee pads, heavy gloves, good boots and whatever else are generally considered ablatives and do not increase the armor die.

COMBAT

SUMMARY OF COMMON DAMAGE EFFECTS

Battle Rage: A PC overcome by battle rage may temporarily expend points of his Personality or Intelligence score to enhance the damage on his critical hit. For every ability point he expends, he adds +1d12 to his damage roll.

Ability scores lost in this way return as the PC heals. Each day thereafter where he does not succumb to battle rage, he recovers 1 point of the affected ability score. This rate is doubled if the character rests.

Bleeding out: Loses an additional 1d3-1 hp (0-2 hit points) per round for the duration of the effect. Magical healing will cure this condition.

Blinded: Suffers a -4 penalty to attack rolls and may only move at half speed.

Burning: A character who catches fire suffers 1d6 damage per round. He can put out the fire by spending an entire round doing “stop, drop, and roll,” which grants him an opportunity to make a DC 10 Reflex save to put out the fire.

Dazed: -2 to all rolls for the duration of the effect.

Dehydration: For each day without water the person must make a Fortitude save (DC 12+N) with N being equal to the number of days without a proper amount of water squared. Failure indicates a loss of 1d3 temporary Stamina and Strength. Attribute damage cannot heal naturally while dehydrated. If the person is also Starving they are required to save versus both effects each day.

Drowning: Drowning creatures take 1d6 points of Stamina damage per round and die when Stamina reaches 0; lost Stamina is restored in 1d6 turns after they can breath normally.

Entangled: Cannot move and suffers -2 to attacks and -2 to AC.

Starvation: For each day without food the person must make a Fortitude save (DC 12+N) with N being equal to the number of days without proper food. Failure indicates a loss of 1d3 temporary Stamina

or Strength (choose one each failed save). Attribute damage cannot heal naturally while starving. If the person is also Dehydrated they are required to save versus both effects each day.

Stunned: Can move at half speed but can perform no other actions.

GUNS, GUNS, AND MORE GUNS

Firearms Damage

Damage from firearms is a little different from standard weapons. Each is rated with a die type for damage. A normal attack does one die of damage as a standard weapon would do. As an action, the shooter may take time to aim. This will increase the attack die type by one step on the die chain and increases the damage to two dice. Finally, if the firearm is capable of automatic fire, noted with an “A” under ROF, it will do three dice of damage and expend 10 rounds of ammo when set to full auto. Most automatic fire firearms cannot benefit from aiming without a tripod or weapon emplacement mount.

Gunsmithing

Since finding mint condition firearms and ammunition will be a rare occurrence, character are going to want to buy scrap-made firearms or even cobble together their own homemade hand cannon. Urth firearms can be kitbashed fully from quality scrap. The DC would start at 25 with every extra day spent working on it lowering the DC by 1, to a minimum DC 10.

Alien weapons cannot generally be constructed with materials native to Earth but could possibly be repaired with scrap.

Creating ammunition is DC 10 assuming the correct materials, or viable substitutes, are available. This will create 2d20 rounds in 6 hours. Recharging energy weapons requires a functional power source and energy converter. With that, the DC is 10. if such is not available, the DC is at least 17, assuming the gunsmith comes up with a brilliant plan.

All of these DCs assume the gunsmith has the proper time and tools for the job. If one or both are not the case, this can increase the difficulty by +2, +5, or even +10 in some instances.

COMBAT

GRENADES

Hand held explosive devices have been used in warfare throughout the ages since man discovered the ability to blow things up. Throwing a grenade is considered an attack and has a range of 40/80/120. A slingshot may be used to launch a grenade at a range of 50/100/150.

Here is the breakdown of how powerful they are in general by technology type.

Primitive (*Damage Die 1d5, Blast Radius 5'*) clay pot bombs with wick fuses and Greek Fire bombs

Industrial Age (*Damage Die 1d6, Blast Radius 10'*) Plunger fuse grenades, sticks of dynamite, and Molotov cocktails

Modern (*Damage Die 1d7, Blast Radius 15'*) Standard military hand grenades: Fragmentation, Concussion, and Stun

Alien (*Damage Die 1d8+, Blast Radius 20'+*) Fusion grenades, Plasma grenades, and Grapple grenades

General Grenade Effects

All direct damage grenades do 1-4 dice of damage based on the technology of construction and the distance from the blast point.

- Point blank range (within 1') - 4 dice of damage, Reflex save DC 20 for half damage.
- Within the initial Blast Radius - 3 dice of damage, Reflex save DC 15 for half damage.
- At up to 2x the Blast Radius - 2 dice of damage, Reflex save DC 10 for half damage.
- At up to 3x the Blast Radius - 1 dice of damage, Reflex save DC 5 for half damage.

Incendiary grenades work a bit differently. In addition to the initial damage the target suffers 1 die of damage each round after the first for 1d4 additional rounds.

- Point blank range (within 1') - 3 dice of damage, Reflex save DC 20 for half damage.
- Within the initial Blast Radius - 2 dice of damage, Reflex save DC 15 for half damage.
- At up to 2x the Blast Radius - 1 dice of damage, Reflex save DC 10 for half damage.

Smoke grenades can come from any era and generally cover an area with a radius equal to their technology level Blast Radius or double that in an enclosed space. The cloud will last for their technology level damage die x2 in minutes and acts as 50% cover.

Gas grenades work similar to smoke grenades but forces those within the cloud to make Fortitude saves each round until it dissipates, usually in 2d6 minutes.

Irritant - DC 6+technology level damage die Fortitude save or suffer -1 die step to all actions for technology level damage die rounds.

Poison - DC 8+technology level damage die Fortitude save or suffer 1d3 temporary damage to any one physical attribute.

Hallucinogenic - DC 8+technology level damage die Fortitude save or suffer hallucinations that inflict -1d3 die steps to all actions, roll each round. The effects last for a number of turns equal to the technology level damage die roll.



COMBAT: FUMBLE TABLES

NEW FUMBLE AND CRITICAL TABLES

FIREARMS FUMBLE TABLE

Roll	Result
0	The shooter accidentally flipped the safety on. No shot, no foul.
1	Your shot ricochets wildly for a few moments but amazingly caused no significant damage.
2	Sweaty palms. You must make a Reflex save DC 10 or drop the weapon.
3	The recoil leaves you off balance. You take a -1d3 penalty to your next attack roll.
4	Clean Misfire! Must manually clear round from the chamber, Agility check DC 9.
5	The recoil leaves you off balance. You take a -1d4 penalty to your next attack roll.
6	Dirty Misfire! Must manually clear round from the chamber, Agility check DC 12.
7	You lose your grip on the weapon and drop it.
8	Something broke! Fumble range is increased by 1d3 until the weapon is repaired.
9	The recoil leaves you off balance. You take a -1d5 penalty to your next attack roll.
10	You should have maintained your weapon better! The weapon jams and must be cleared to fire again. Takes 1d3 rounds and an Agility check DC 12.
11	You've got something in your eye. You take a -1d7 penalty to your next attack roll.
12	Your aim slips and you shoot at a random ally. Make an attack roll against that ally using the same attack die you just attempted to use.
13	Recoil torques your wrist for 1 Agility damage and you must make a Reflex save DC 10 or drop the weapon.
14	Due to poor grip position you take 1d3 Agility damage from recoil and drop the weapon.
15	You manage to shoot yourself for 1 die of damage.
16+	You accidentally shot yourself for 2 dice of damage and the weapon is jammed, Agility check DC15 to clear.

COMBAT: FUMBLE TABLES

GRENADE/EXPLOSIVE FUMBLE TABLE

Roll	Result
0	The attacker forgot to pull the pin, no boom.
1	Very bad throw. It scatters in a random direction for 3d10' from the intended target. 75% chance it will not go off.
2	You must make a Reflex save DC 10 or drop the grenade. It scatters in a random direction for 2d10'. 50% chance it will not go off.
3	Overthrown by 3d10' from the intended target, scatters 1d10' in a random direction. 45% chance it will not go off.
4	Scatters in a random direction for 3d10' from the intended target. Seems like a dud but will go off in 2d4 rounds.
5	Underthrown by 3d10' from the intended target, scatters 1d10' in a random direction. 40% chance it will not go off.
6	Fuse failed! Dud until repaired. DC 12 to fix, fumble means auto result of 16 on this chart.
7	Overthrown by 3d6' from the intended target, scatters 1d6' in a random direction. 35% chance it will not go off.
8	You drop the grenade. It scatters in a random direction for 2d6'. 30% chance it will not go off.
9	Underthrown by 3d6' from the intended target, scatters 1d6' in a random direction. 25% chance it will not go off.
10	It scatters in a random direction for 2d24'. Seems like a dud but will go off in 2d30 minutes.
11	Fuse failed! Dud until repaired. DC 12 to fix, failure means auto result of 16 on this chart.
12	It goes off 2d24' away in a random direction. All targets in range take normal damage.
13	It goes off 2d10' away in a random direction. All targets in range take normal damage.
14	It goes off 2d10' away in a random direction. All targets in range take normal damage.
15	It goes off in your hand. You take Point Blank damage. All others in range take normal damage.
16+	It goes off in your face. You take double Point Blank damage (usually 8 damage dice). All others in range take normal damage.



COMBAT: CRIT TABLES

FIREARMS CRIT TABLE I

Roll	Result
0	Do +1d10 additional damage and then the weapon jams. It takes 1d3 rounds to clear it.
1	Fair shot. Inflict +1d3 damage with this shot.
2	Foe must make Will save DC 10 or be unable to attack next round.
3	Foe stunned by shot. Will act last in Initiative order for the next 1d3 rounds.
4	Painful hit. Inflict +1d4 damage with this shot and reduce the foe's movement by -10' until healed.
5	Organ strike. Inflict 1 Stamina damage with this shot.
6	Pinned down. Everyone gets a free Aim action on this foe next round.
7	Disarming shot. Knocks weapon out of foe's hand. 25% chance hand is useless until healed.
8	Painful hit. Foe unable to act until after next round.
9	Artery hit. Foe is bleeding out for the next 2d4 rounds (see pg 101).
10	Foe knocked prone by the shot.
11	Organ strike. Inflict 1d3 Stamina damage with this shot.
12	Nerve hit. Foe must make a Fortitude save (DC 15) or spend the next two rounds dazed due to spasming.
13	Joint hit. Foe's movement speed is reduced by half.
14	ringing hit. Shot fills foe's ears with dull ringing making them deaf for 2d6 minutes.
15	Disarming shot. Knocks weapon out of foe's hand. 50% chance hand is useless until healed.
16	Double Tap. Immediately make an additional attack which inflicts +1d8 damage if it hits.
17	Throat shot. Foe cannot speak or act for 1d3 rounds as he gags.
18	Foe walked into the shot. Inflicts +2d8 damage.
19	Spine hit. The foe must make a DC 15 Fortitude save or be paralyzed until healed.
20+	Head shot. Inflicts +2d10 damage and 1d4 Intelligence damage.

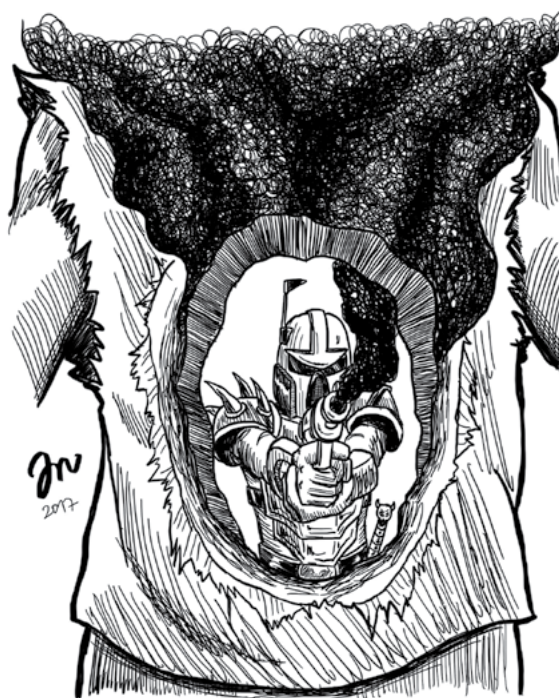

COMBAT: CRIT TABLES

FIREARMS CRIT TABLE II

Roll	Result
0	Dud round. Requires Agility check DC 5 to clear.
1-2	Good hit! Shot inflicts +2d3 damage
3	Blows off foe's ear. Inflicts +1d6 damage and foe suffers -4 to all hearing checks.
4	Clean through and through. Inflicts +2d5 damage.
5	Double Tap. Immediately make an additional attack against this foe.
6	Organ strike. Inflicts +3d3 damage with this shot and the foe is stunned for 1 round.
7	Foe dazed by shot. Foe's speed is reduced by 50% and his action die is reduced by two steps for 2d3 rounds.
8	Organ strike. Inflicts +3d4 damage with this shot and causes bleeding out for 1d3 rounds (see pg 101).
9	Head shot! Foe is temporarily blinded and stunned for 1d3 rounds.
10	Foe falls prone. Immediately make an additional attack against this foe.
11	Organ strike. Inflicts +4d4 damage with this shot and causes bleeding out for 1d4 rounds (see pg 101).
12	Nerve strike! Foe must make a Fortitude save (DC 12 - PC Luck Mod) or pass out from pain.
13	Foe disoriented and suffers a -1d5 penalty to attack rolls for 1d5 rounds.
14	Nerve strike! Foe must make a Fortitude save (DC 15 - PC Luck Mod) or pass out from pain.
15	Shot brings foe to the ground. Inflicts +2d6 damage with this shot and the foe is knocked prone.
16	Shot to the eye! Foe is permanently blinded in one eye and can take no actions for 1d3 rounds.
17	Shot to the lung! Reduce foe's action die by one step and foe is bleeding out until healed (see pg 101).
18	Nerve strike! Inflicts +1d8 damage with this shot and foe must make a Fortitude save (DC 10 - PC Luck Mod) or pass out from pain.
19	Major artery hit. Inflict +1d4 Stamina damage and foe is bleeding out for the next 2d7 rounds.
20	Vitals strike! Inflicts +1d10 damage with this shot and foe must make a Fortitude save (DC 10 - PC Luck Mod) or die in 1d5 rounds.
21	Spinal cord hit! Inflicts +2d6 damage, 1d4 Agility damage, and foe must make a Fortitude save (DC 14 - PC Luck Mod) or suffer total paralysis.
22	Major vitals strike! Inflicts +2d8 damage with this shot and foe must make a Fortitude save (DC 14 - PC Luck Mod) or die in 1d5 rounds.
23	Brain hit! Inflicts +1d10 damage, 1d7 Intelligence damage, and foe must make a Fortitude save (DC 15 - PC Luck Mod) or die instantly
24+	Severe vitals strike! Inflicts +4d4 damage, 1d7 Stamina & Strength damage, and foe must make a Fortitude save (DC 20 - PC Luck Mod) or die instantly.

COMBAT: CRIT TABLES

FIREARMS CRIT TABLE III

Roll	Result
0	Not so lucky shot. Does +1d10 damage to foe but also ricochets into ally, doing 1d6 damage. You fly into a state of battle rage (see pg 101).
1	Nice shot! inflicts +1d6 damage.
2	Shot knocks foe to the ground. Foe is prone until his next action.
3	Foe walked into the bullet. Inflicts +2d4 damage.
4	Double Tap. Immediately make an additional attack against this foe.
5	Blows off foe's nose. Inflicts +1d6 damage and foe suffers -3 to all smell checks.
6	Torso hit! Inflicts +2d4 damage and foe is bleeding out for 1d4 rounds.
7	Disarming shot. Knocks weapon out of foe's hand. 25% chance hand is useless until healed.
8	Shot bounces off foe's skull! Inflicts +1d6 damage and +1d3 Intelligence damage.
9	Painful hit. Inflict +3d4 damage with this shot and reduce the foe's movement by -10' until healed.
10	Shot shatters foe's weapon! Foe must make a Reflex save DC 10 or suffer 1d5 damage.
11	Gut shot! Foe will die in 1d3 hours due to internal bleeding unless he receives medical attention.
12	Head shot! Foe must make a Fortitude save (DC 10 - PC Luck Mod) or pass out.
13	Face hit! Inflicts +1d8 damage and +1d3 Personality damage.
14	Nice shot! inflicts +2d8 damage.
15	Shoulder hit! Inflicts +1d8 damage and foe must make a Fortitude save (DC 10) or arm is useless.
16	Shot blows off foe's primary hand/limb! Foe suffers a -4 penalty to future attacks.
17	Shot knocks foe to the ground. Immediately make an additional attack against this foe.
18	Shot bounces off foe's skull! Inflicts +1d10 damage plus 1d5 Intelligence & Personality damage.
19	Torso hit! Inflicts +4d4 damage and 1d4 Stamina damage.
20	Vitals hit! Inflicts 1d4 Stamina damage and foe stunned for 1d5 rounds.
21	Pelvis hit. Inflict +4d4 damage with this shot and reduce the foe's movement by 50% until healed. Immediately make an additional attack against this foe.
22	Shot breaks foe's weapon and arm! Foe must make a Fortitude save (DC 18) or arm is useless.
23	Skull hit! Inflicts +2d10 damage plus 1d5 Intelligence & Personality damage.
24	Vitals hit! Foe loses 50% of his remaining hit points, suffers 1d4 Stamina damage, and vomits copious amounts of blood.
25	Brain hit! Inflicts +3d6 damage, 2d4 Intelligence damage, and foe must make a Fortitude save (DC 15 - PC Luck Mod) or die instantly
26+	Spinal cord hit! Inflicts +3d6 damage, 1d4 Agility & Stamina damage, and foe must make a Fortitude save (DC 16 - PC Luck Mod) or suffer total paralysis.

COMBAT: CRIT TABLES

FIREARMS CRIT TABLE IV

Roll	Result
0	Not so lucky shot. Does +2d10 damage to foe but also ricochets into ally, doing 1d8 damage. You fly into a state of battle rage (see pg 101).
1	Nice shot! Inflicts +1d24 damage.
2	Foe's hand is permanently crippled by shot. Inflicts +1d12 damage.
3	Shot knocks foe to the ground. Inflicts +1d12 damage and immediately make an additional attack against this foe.
4	Skull hit! Inflicts +2d6 damage plus 1d4 Intelligence damage. Foe stunned for 1d3 rounds.
5	Great shot! Inflicts +1d24 damage and foe's weapon is sundered.
6	Vitals strike! Foe must make a Fortitude save (DC 15 - PC Luck Mod) or fall unconscious and die in 1d4 minutes.
7	Awesome shot! Inflicts +1d24 damage and foe cannot attack for 1d3 rounds.
8	Skull hit! Foe is dazed and moves at half speed for 1d3 rounds. Inflicts +1d12 damage and immediately make an additional attack against this foe.
9	Throat hit! Foe must make a Fortitude save (DC 16 - PC Luck Mod) or begin to drown in his own blood.
10	Eye shot! Foe dazed and blinded by pain and blood for 1d3 rounds.
11	Foe's face is horribly disfigured by the shot. Inflict 2d3 permanent Personality damage.
12	Overcome by fury! You fly into a battle rage and inflict +1d6 on all attacks against this foe.
13	Gut shot! Inflicts +1d24 damage. Foe will die in 1d5 hours due to internal bleeding unless he receives medical attention.
14	Spinal hit! Reduce foe's AC by 1d3+3 due to limbs going numb.
15	Foe's life flashes before his eyes. He is prone and stunned by fear for 1d4 rounds.
16	Shot sunders whatever foe was carrying in his hands. Inflicts +1d24 damage.
17	Knee shot! Foe's movement is reduced to 0 and immediately make an additional attack against this foe.
18	Brain hit! Inflicts +1d24 damage and is stunned for 1d6 rounds. Foe must make a Fortitude save (DC 16 - PC Luck Mod) or suffer total amnesia.
19	Nerve hit! Inflicts +3d10 damage and one random limb is numb and useless.
20	Major spinal hit! Inflict +3d12 damage with this shot, and the foe must make a Fortitude save (DC 17 - PC Luck Mod) or suffer permanent paralysis.
21	Major vitals hit! Foe will die in 1d6 rounds.
22	Shot to the heart! Inflict +3d12 damage with this shot, and the foe must make a Fortitude save (DC 20 - PC Luck Mod) or die instantly.
23	Major brain damage! Inflict +4d12 damage with this shot and 2d6 Intelligence damage. Foe must make a Fortitude save (DC 20 - PC Luck Mod) or die instantly.
24+	One shot, one kill. Foe is dead.

COMBAT: CRIT TABLES

FIREARMS CRIT TABLE V

Roll	Result
0	Not so lucky shot. Does +3d10 damage to foe but also ricochets into ally, doing 1d10 damage. You fly into a state of battle rage.
1	Great shot! Inflicts +3d12 damage and foe's weapon is sundered.
2	Shot knocks foe prone. All adjacent foes must make a Reflex save (DC 20 - PC Luck Mod) or be knocked prone as well.
3	Blows off foe's ear. Inflicts +1d14 damage and foe is permanently deaf.
4	Gut hit! Inflicts +2d6 damage and foe is dazed from retching for 1d3 rounds.
5	Foe is stunned with terror. Inflicts +1d12 damage and immediately make an additional attack at +2 to hit.
6	Vitals strike! Foe must make a Fortitude save (DC 16 - PC Luck Mod) or fall unconscious and die in 1d4 minutes.
7	Foe knocked into awkward position, reducing his AC by 6. Immediately make an additional attack.
8-12	Overcome by fury! You fly into a battle rage and inflict +1d14 on all attacks against this foe.
13-15	Nerve hit! Inflicts +2d20 damage and one random limb is numb and useless.
16	Shot sundered whatever foe was carrying in his hands. Inflicts +1d30 damage.
17	Nerve hit! Inflicts 2d4 Agility damage and foe is dazed for 1d3 turns.
18	Shot destroys target's face. Foe is immediately rendered blind and deaf. Foe permanently loses 1d6+4 Personality .
19	Shot blows skull open! Foe is stunned and dies in 3d3 rounds.
20-21	Joint hit! Inflicts +3d10 damage and one random limb is limp and useless.
22	Perfect shot. Inflicts +2d20 damage and if the foe is killed immediately make an additional attack at +2 to hit.
23	Shot destroys foe's leg. Inflicts +3d10 damage, foe's movement is reduced to 0, and they may take no actions for 1d4 rounds due to the pain.
24	Skull hit! Inflicts 1d12 Intelligence damage and foe is stunned for 1d5+1 rounds. Immediately make an additional attack against this foe.
25	Vital hit! Foe loses 50% of current hp and is stunned for 2d4 rounds.
26	Throat hit! Foe begins to drown in his own blood and noisily expires in 1d3 rounds.
27	Crippling shot to the spine. Inflict +2d30 damage and 3d3 permanent Agility damage.
28-29	Messy hit! Inflicts +3d20 damage and all adjacent foes must make a Reflex save (DC 20 - PC Luck Mod) or be blinded by gore for 1d3 rounds.
30+	One shot, one kill. Foe is dead. Immediately make an additional attacks with this firearm until you miss or you run out of ammo.



COMBAT: CRIT TABLES

GRENADE/EXPLOSIVE CRIT TABLE I

Roll	Result
0	The explosion does an additional +1d6 damage to everyone in range but a stray piece of shrapnel hits a random ally for 1d3 damage.
1-2	Nice Throw! Inflicts an additional +1d3 damage to all in range.
3	Shell shock! Inflicts +1d3 damage and all foes damaged fall to the bottom of the initiative count next round.
4	All foes hit must make a Fortitude save (DC 10 - PC Luck Mod) or have their movement reduced by 50% due to vertigo.
5	Nice Throw! Inflicts an additional +1d5 damage to all in range.
6	Shell shock! Inflicts +1d3 damage and all foes damaged are knocked prone and dazed for 1d3 rounds.
7	All foes hit must make a Reflex save (DC 12 - PC Luck Mod) or be blinded for 1d3 rounds.
8	All foes hit must make a Fortitude save (DC 12 - PC Luck Mod) or drop whatever they are holding due to disorientation.
9	Nice Throw! Inflicts an additional +1d7 damage to all in range.
10	All foes hit must make a Fortitude save (DC 14 - PC Luck Mod) or be stunned for one round.
11	Nice Throw! Inflicts an additional +2d4 damage to all in range.
12	All foes hit must make a Fortitude save (DC 12 - PC Luck Mod) or spend the next 1d3 rounds vomiting due to vertigo.
13	All foes hit have their movement reduced by 50% due to vertigo.
14	All foes hit are deafened for 1d3 minutes.
15	All foes hit drop whatever they are holding due to disorientation.
16	All foes hit are stunned and you may take an immediate additional action against them.
17	All foes hit spend the next 1d3 rounds vomiting due to vertigo.
18	Nice Throw! Inflicts an additional +2d6 damage to all in range.
19	All foes hit must make a Fortitude save (DC 14 - PC Luck Mod) or be knocked unconscious.
20+	Organs ruptured! All foes hit must make a Fortitude save (DC 16 - PC Luck Mod) or die in 1d4 hours due to internal bleeding.

COMBAT: CRIT TABLES

GRENADE/EXPLOSIVE CRIT TABLE II

Roll	Result
0	All foes that survive the blast enter battle rage!
1	Perfect throw! Inflicts an additional +2d3 damage to all in range.
2	All foes hit take an additional +1d3 damage and must make a Reflex save (DC 10 - PC Luck Mod) or be deafened for 1d3 minutes.
3	Perfect throw! Inflicts an additional +2d5 damage to all in range.
4	All foes hit are stunned for the rest of the round and you may take an immediate additional attack against them.
5	All foes hit take an additional +2d4 damage and must make a Fortitude save (DC 12 - PC Luck Mod) or spend the next round vomiting due to vertigo.
6	All foes hit must make a Fortitude save (DC 13 - PC Luck Mod) or be dazed and have their movement reduced by 50% due to vertigo.
7	Perfect throw! Inflicts an additional +3d5 damage to all in range.
8	All foes hit must make a Reflex save (DC 14 - PC Luck Mod) or be blinded for 1d4 rounds.
9	Shell shock! Inflicts +1d5 damage and all foes damaged are knocked prone and dazed for 1d4 rounds.
10	Perfect throw! Inflicts an additional +2d6 damage to all in range.
11	All foes hit spend the next round vomiting due to vertigo.
12	All foes hit must make a Fortitude save (DC 12 - PC Luck Mod) or be knocked unconscious.
13	All foes hit are dazed for 1d3 rounds.
14	Brainbuster! Inflicts 1d3 temporary Intelligence damage to all in range.
15	Shell shock! Inflicts +2d5 damage and all foes damaged are knocked prone.
16	Internal damage! Inflicts +2d7 damage and all foes hit lower their action dice by one die type.
17	All foes hit are dazed for 3d3 rounds.
18	All foes hit are knocked prone and must make a Fortitude save (DC 14 - PC Luck Mod) or be knocked unconscious.
19	Internal damage! Inflicts +1d10 damage and all foes hit are bleeding out for 1d5 rounds.
20	Organs ruptured! Inflicts +2d5 damage and all foes hit must make a Fortitude save (DC 14 - PC Luck Mod) or die in 3d14 minutes due to internal bleeding.
21	All foes hit are knocked prone and must make a Fortitude save (DC 14 - PC Luck Mod) or be paralysed.
22	Organs ruptured! Inflicts +2d7 damage and all foes hit must make a Fortitude save (DC 14 - PC Luck Mod) or die in 3d10 minutes due to internal bleeding.
23+	Brainbuster! Inflicts +2d8 damage and all foes hit must make a Fortitude save (DC 14 - PC Luck Mod) or die instantly.

COMBAT: CRIT TABLES

GRENADE/EXPLOSIVE CRIT TABLE III

Roll	Result
0	The explosion does an additional +1d12 damage to everyone in range but a stray piece of shrapnel hits a random ally for 1d4 damage.
1	Perfect throw! Inflicts an additional +1d5 damage to all in range.
2	All foes hit are knocked prone.
3	Perfect throw! Inflicts an additional +1d7 damage to all in range.
4	All foes hit are stunned for the rest of the round and you may take an immediate additional attack against them.
5	Shell shock! All foes hit take an additional 1d5 damage and must make a Fortitude save (DC 14 - PC Luck Mod) or be deafened for 2d4 turns.
6	All foes hit must make a Fortitude save (DC 14 - PC Luck Mod) or drop whatever they are holding due to disorientation.
7	Perfect throw! Inflicts an additional +1d10 damage to all in range.
8	Shell shock! All foes hit take 1d3 Intelligence damage and must make a Fortitude save (DC 14 - PC Luck Mod) or be deafened for 3d30 hours.
9	All foes hit take an additional 1d10 damage and must make a Fortitude save (DC 13 - PC Luck Mod) or be dazed and have their movement reduced by 20% due to vertigo.
10	All foes must make a luck roll. Failure indicates their weapon/limb was damaged by the blast and is useless until repaired/healed.
11	All foes hit must make a Fortitude save (DC 14 - PC Luck Mod) or die in 1d4 hours due to internal bleeding.
12	All foes hit must make a Fortitude save (DC 14 - PC Luck Mod) or be knocked unconscious.
13	Perfect throw! Inflicts an additional +1d12 damage to all in range.
14	Shell shock! All foes hit take 1d3 Stamina damage and must make a Fortitude save (DC 14 - PC Luck Mod) or bleed out for 2d6 rounds.
15	All foes hit must make a Fortitude save (DC 15 - PC Luck Mod) or a random limb is severed and they will bleed out until they receive medical aid or magic healing.
16	Shell shock! All foes hit suffer -4 to all actions due to disorientation for 2d14 rounds.
17	All foes hit are stunned for the round. You may make an immediate additional attack against them.
18	Shrapnel storm! All foes hit take an additional 1d10 damage and 1d4 Personality damage.
19	Organ damage! Inflicts an additional +2d10 damage to all in range.
20-22	Shell shock! All foes hit suffer +1d10 damage and are stunned for 1d4 rounds.
23-25	All foes hit take an additional 2d8 damage and have their movement reduced by 50% due to vertigo.
26+	All foes hit suffer +3d8 damage and will die in 2d3 turns due to internal bleeding.

COMBAT: CRIT TABLES

GRENADE/EXPLOSIVE CRIT TABLE IV

Roll	Result
0	The explosion does an additional +2d8 damage to everyone in range but a stray piece of shrapnel hits a random ally for 1d5 damage.
1	Organ damage! Inflicts an additional +2d10 damage to all in range.
2	All foes hit must make a Fortitude save (DC 14 - PC Luck Mod) or a random limb is severed and they will bleed out unless they receive medical aid or magic healing.
3	Big boom! All foes hit are stunned and knocked prone for the round. You may make an immediate additional attack against them.
4	Brainbuster! Inflicts an additional +1d10 damage and 1d4 Intelligence damage to all in range.
5	Shell shock! All foes hit take an additional +1d8 damage and drop whatever they are holding due to disorientation.
6	All foes hit bleed out for 2d4 rounds and must make a Fortitude save (DC 14 - PC Luck Mod) or be knocked unconscious.
7	Shell shock! All foes hit take an additional +2d10 damage and are stunned for 1d3 rounds.
8	Big boom! All foes hit are dazed and take an additional +1d10 damage. You may make an immediate additional attack against them.
9	All foes hit take an additional +2d8 damage and spend the next 2d6 rounds vomiting due to vertigo.
10	Shell shock! All foes hit are blinded and deafened for 2d4 rounds.
11	Shrapnel storm! All foes hit take an additional 2d10 damage and 1d4 Personality damage.
12	Blood everywhere! All foes hit take an additional 1d10 damage and you are overcome by battle rage!
13	Organ damage! Inflicts an additional +2d12 damage to all in range.
14	Shell shock! All foes hit suffer -4 to all actions and AC due to disorientation for 3d10 rounds.
15	All foes hit are knocked prone and are stunned with fear for 1d5 rounds.
16	Big boom! All foes hit take an additional +2d12 damage, are knocked prone, and drop whatever they are holding due to disorientation.
17	All foes hit are knocked prone and have their movement reduced to 0 due to vertigo. You may make an immediate additional attack against them.
18	Brainbuster! All foes hit suffer +1d12 damage, are stunned for 1d4 rounds, and must make a Fortitude save (DC 16 - PC Luck Mod) or suffer amnesia.
19	Big boom! All foes hit take an additional +3d12 damage, are knocked prone, and drop whatever they are holding due to disorientation.
20	Vertabreaker! All foes hit suffer +1d12 damage, 1d6 Agility damage, and must make a Fortitude save (DC 16 - PC Luck Mod) or suffer total paralysis.
21+	Explosion reduces all foes' internal organs to jelly. Death is inevitable in 1d6 rounds.

COMBAT: CRIT TABLES

GRENADE/EXPLOSIVE CRIT TABLE V

Roll	Result
0	The explosion does an additional +3d8 damage to everyone in range but a stray piece of shrapnel hits a random ally for 1d6 damage.
1	All foes hit suffer +2d12 damage and must make a luck roll. Failure indicates their weapon/limb was damaged by the blast and is useless until repaired/healed.
2	Big Boom! All foes hit suffer +1d12 damage, are thrown back 2d6', and are knocked prone.
3	Shrapnel storm! All foes hit take an additional 1d10 damage and are permanently blinded.
4	All foes hit take an additional +2d8 damage and spend the next 2d6 rounds vomiting due to vertigo.
5	Shell shock! All foes hit suffer +1d10 damage and are stunned for 2d4 rounds. You may make an immediate additional attack against them.
6	Big boom! All foes hit are permanently deafened and dazed.
7	All foes hit are impaled on or entangled in the surrounding terrain. They suffer -6 to AC and you may make an immediate additional attack against them.
8-12	Blood everywhere! All foes hit take an additional 1d14 damage and you are overcome by battle rage!
13-15	Big boom! All foes hit take an additional +4d10 damage, are knocked prone, and drop whatever they are holding due to disorientation.
16	Organ damage! Inflicts an additional +4d12 damage to all in range.
17	Heartstopper! All foes must make a Fortitude save (DC 20- PC Luck Mod) or instantly die of shock.
18	Shrapnel storm! All foes hit take an additional 1d10 damage and are permanently blinded and deafened.
19	Brainbuster! All foes die in 3d3 rounds due to cranial hemorrhaging.
20	All foes hit must make a Luck roll or a random limb is severed and they will bleed out unless they receive medical aid or magic healing.
21	Big boom! Inflicts an additional +3d12 damage to all in range. All other foes must make a Will save (DC 15+ 1 per foe killed in the blast) or flee in terror.
22	All foes hit suffer +2d12 damage, are knocked prone, and have their movement reduced to 0 due to vertigo.
23	Brainbuster! All foes hit are stunned for 2d3 rounds and suffer 2d5 Intelligence damage. You may make an immediate additional attack against them.
24	All foes hit suffer 1d6 Stamina damage and a random limb is severed. They will bleed out until they receive medical aid or magic healing.
25	All foes hit lose 50% of their hp and spend the next 2d10 rounds vomiting due to vertigo.
26	Burst lungs! All foes hit begin to drown in their own blood until they receive medical aid or magic healing (see Bleeding Out and Drowning pg 101).
27+	All foes hit suffer +5d12 damage and are permanently blind, deaf, and dazed.



EQUIPMENT+

EQUIPMENT

Common Weapons				
Melee	Damage	Range	Cost in sp	Notes
Battleaxe	1d10	-	7	Two-handed
Chainsaw	2d7, Crit 18-20	-	150	See description below
Chain flail	1d4	-	4	Reach, Can entangle
Club	1d4	-	3	
Dagger	1d4	10/20/30	3	Throwable
Flail	1d6	-	6	
Handaxe	1d6	10/20/30	4	Throwable
Lance	1d12	-	25	Vehicle or Mount use only, Reach
Lance, explosive	4d6	-	45	See description below
Longsword	1d8	-	10	
Mace	1d6	-	5	
Polearm	1d10	-	7	Two-handed, Reach
Short sword	1d6	-	7	
Spear	1d8	30/60/90	3	Two-handed, Reach, Throwable
Staff	1d4	-	.5	Two-handed, Reach
Two-handed sword	1d10	-	15	Two-handed
Sledge hammer	1d8	-	5	Two-handed

Ranged	Damage	Range	Cost in sp	Notes
Blowgun	1d3/1d5	20/40/60	6	Two-handed
Compound Bow	1d8	80/160/240	50	See description below
Crossbow	1d6	80/160/240	40	Reach, Can entangle
Dart	1d4	20/40/60	.5	
Longbow	1d6	70/140/210	40	Throwable
Pipe Gun	1d5	20/40/60	15	See description below
Pneumatic Bow	1d7	40/80/160	20	See description below
<i>small canister</i>	-	-	20	Vehicle or Mount use only, Reach
<i>scuba tank</i>	-	-	100	See description below
Saw Blade Slinger	1d6, Crit 19-20	15/30/60	20	See description below
<i>Rotary Saw Blade</i>	1d3	10/20/30	3	
Scrap Gun	3d3	30/60/-	20	See description below
Shortbow	1d6	50/100/150	25	
Sling	1d4	40/80/160	2	Two-handed, Reach, Throwable
Slingshot	1d5	40/80/120	15/30	See description below

Explosive	Damage	Range	Cost in sp	Notes
Can Grenade	Damage Die 1d5	Blast Radius 10'	8	See description below
Grill Tank Bomb	Damage Die 1d10	Blast Radius 15'	20	See description below

EQUIPMENT



Can Grenade - (*Damage Die 1d5, Blast Radius 10ft*) Take an old can, fill it with various nails and shrapnel, then give it an explosive center with a fuse and you have a genuine Can Grenade. Some have pins to pull and others a fuse to light but they all go boom... most of the time. Due to its DIY nature, this grenade has a fumble range of 1-3. Cost : 8sp

Chainsaw - (*2d7 damage, Crit range 18-20 or +2, two handed*) These tools are ready made killing machines with very few adjustments necessary, mostly just removing the safety features. Filling the gas tank will require 0.5 points of fuel and 2d3 rounds. This will allow the saw to run for 40+1d20 rounds. Due to their unwieldy nature, the wielder's Fumble die is increased by +1 die step. The chain requires 2d5 minutes of maintenance for each full tank of fuel used. If this is skipped, the Fumble range increases by +1 for each maintenance session skipped. Also, If the wielder suffers more than 5 points fire damage in one round, there is a 3% per point of damage chance of the fuel tank igniting and exploding, causing 4d4 damage to the wielder and 2d4 damage to anyone within 10'. Cost: 15osp

Compound Bow - (*1d8 damage, range 80/160/240*) This bow uses a system of cables and pulleys to increase the pull strength and stability of the bow compared to a standard longbow. The drawback to the complex system is that on a fumble the archer must roll under their Luck or the pulley system is damaged and will need 2d14 turns of maintenance before it will fire again, in addition to any other fumble effects. Cost: 5osp

Grill Tank Bomb - (*Damage Die 1d10, Blast Radius 15'*) These weaponized propane tanks deliver a big

bang. While not technically a throwable weapon, a person with a Strength of 15 or greater can attempt to throw it at a -1 die step penalty to the action die. Due to its DIY nature, this grenade has a fumble range of 1-3. Cost: 2osp

Lance, Explosive - (*4d6 damage*) This lance is tipped with an impact actuated, explosive shaped charge. While it has no blast radius, it delivers a deadly focused blast to the target. Due to the explosive nature, this lance is destroyed after one successful attack. Cost: 45sp

Pipe Gun - (*d5 damage, range 20/40/60*) These guns are simple pipe and thrust rod devices that can fire normal ammunition. The shell is loaded in the butt end of the barrel and the barrel is inserted into another tight fitting cylinder with a nail mounted inside. To fire, the barrel is slapped forcefully into the cylinder, striking the primer against the nail. Due to its DIY nature, this firearm has a fumble range of 1-3 and cannot benefit from an aim action. Anytime a natural 1 is rolled when firing a Pipe Gun the gun will be damaged beyond repair, in addition to any other fumble effects. Cost: 15sp

Pneumatic Bow - (*1d7 damage, range 40/80/160*) These guns utilize pressurized air to launch bolts at high speed. They are generally employed from facilities that can generate high amounts of pressurized air, such as factories or large vehicles. Otherwise, canisters of compressed air must be used as propellant. A rifle butt sized canister would hold enough air for 10 shots. A scuba tank sized canister would hold roughly 50 shots.

It is common for such weapons to have multiple barrels and fire volleys of bolts at a time. In such

EQUIPMENT

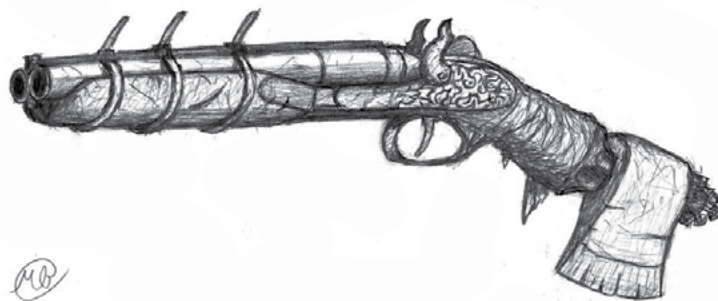

case, only 1 attack roll is made. On a successful hit a die is rolled equal to the number of barrels to determine how many bolts hit (i.e. for three barrels, a 1d3 is rolled). Unless some autofeed mechanism is employed, reloading takes one round per bolt. Cost: 20sp, small canister 2gp, scuba tank 100sp

Saw Blade Slinger - (1d6 damage, Crit range 19-20 or +1, range 15/30/60) This club-like sling bar can be used to launch circular saw blades at lethal speeds. Like a thrown weapon, the wielder can add his or her Strength bonus to all damage. In addition, if wielded two-handedly the damage is increased by +2 but the attack action die is reduced by one step. The sling bar itself can be used as a club (1d4 damage). Cost: 20sp

Circular saw blades thrown by hand do 1d3 damage, range 10/20/30 and do full damage to the thrower on a fumble, in addition to any other fumble effects. Each time a blade is thrown or slung roll 1d7. On a 1 it is damaged and cannot be used again. Cost: 3sp

Scrap Gun - (3d3 damage, range 30/60/-) A modern version of the blunderbuss, this rudimentary shotgun is usually made from scavenged industrial pipes and such. It is a single shot weapon where packages of explosive propellant and metal scraps are muzzle-loaded, taking 1d3 rounds per shot to be ready to fire. The firing mechanisms range from battery powered touch points to percussion caps. Due to its DIY nature, this firearm has a fumble range of 1-3 and cannot benefit from an aim action. Anytime a natural 1 is rolled when firing a Scrap Gun, there is a 10% chance that the gun will be damaged beyond repair, in addition to any other fumble effects. Making ammo requires one hour and the proper scavenged materials.

A successful Intelligence check (DC 10) will produce 2d3 loads. Cost: 20sp

Slingshot - (1d5 damage, range 40/80/120) Commonly called wrist rockets in the pre-apocalyptic days, these weapons can be found throughout Umerica. Like the slings of old, any small, weighty, and balanced object can be used as ammunition for a slingshot. If a wrist brace is attached, they can be aimed gaining +1 die step to the Attack roll on the next action. A slingshot may also be used to launch a grenade (or similar sized object) at a range of 30/60/90. Cost: 15sp / 30sp with brace

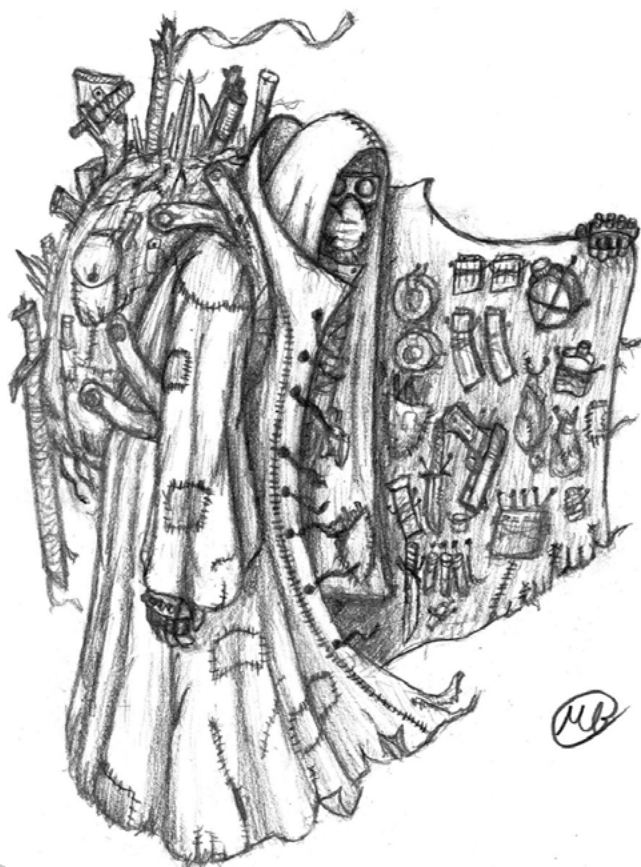

EQUIPMENT

COMMON ARMOR PIECES AND SETS

As armor rarely lasts more than a few battles until it needs to be repaired or replaced, adventurers will always be on the lookout for a sweet new piece of armor. Use the chart below if they are looking to purchase armor from a vendor, keeping in mind that these costs can be as much as 300% higher in scarce markets.

Ablative piece	6+1d6sp
Feeble armor, per die step	7+1d4sp
Normal armor, per die step	16+1d8sp
Impervious or other special armor, per die step	50+3d10sp
Shield, normal	9+1d5sp
Shield, tricked out (spikes, flashlight, gun port, etc)	20+3d6sp

Sporting protective gear

Hockey (*helmet/mask 2, torso 2f, legguards 1f, shoulder pads 1f, armguards 1f, hip guards 1f*)

Full suit: 6f die steps, 2 die steps; Armor Die: d12; Fumble Die d10; Armor Check penalty: -6

Football (*helmet/mask 2, torso 1f, legguards 1f, shoulder pads 1f, hip guards o/Ablative, mitts o/Ablative*)

Full suit: 3f die steps, 2 die steps, 2 Ablative; Armor Die: d7; Fumble Die d7; Armor Check penalty: -4

Baseball (*helmet 1, mitt o/Ablative*)

Full suit: 1 die step, 1 Ablative; Armor Die: d3; Fumble Die d3; Armor Check penalty: 0.

Baseball Catcher (*helmet/mask 1, torso 1f, legguards 1f, mitt o/Ablative*)

Full suit: 2f die steps, 1 die step, 1 Ablative; Armor Die: d5; Fumble Die d4; Armor Check penalty: -1.

Auto Racing (*helmet 2, fire suit o/Ablative, gloves o/Ablative*)

Full suit: 2 die steps, 2 Ablative; Armor Die: d4; Fumble Die d4; Armor Check penalty: -1; Special: fire suit grants 2d4 points of fire resistance per round.

Motocross (*helmet 2, torso 2, legguards o/Ablative, shoulder pads o/Ablative, armguards o/Ablative, hip guards o/Ablative*)

Full suit: 6 pieces, 4 die steps, 4 Ablative; Armor Die: d6; Fumble Die d7; Armor Check penalty: -4; Special: Armor Die result is doubled versus crash damage.

Occupational / Hobbyist protective gear

Motorcyclist (*helmet 2, biker jacket 1f, chaps o/Ablative, boots o/Ablative*)

Full suit: 2f die steps, 1 die step, 2 Ablative; Armor Die: d5; Fumble Die d5; Armor Check penalty: -2; Special: Armor Die result is doubled versus crash damage.

Fireman (*helmet 2, fire coat 1f, gas mask o/Ablative, boots o/Ablative*)

Full suit: 1f die step, 2 die steps, 2 Ablative; Armor Die: d5; Fumble Die d5; Armor Check penalty: -2; Special: fire coat grants 2d4 points of fire resistance per round.

Police (*Kevlar vest - torso 2*)

Full suit: 2 die steps; Armor Die: d4; Fumble Die: d3; Armor Check Penalty: 0; Special: Armor Die result is doubled versus projectile damage.

Riot Police (*helmet/mask 2, torso 2, legguards 1, shoulder pads 1, armguards 1, hip guards 1, boots o/Ablative, gloves o/Ablative*)

Full suit: 8 die steps, 2 Ablative; Armor Die: d12; Fumble Die d6; Armor Check penalty: -3; Special: All pieces only count as ½ die steps towards the Fumble die.

Infantry (*helmet/mask 2, torso 3, legguards o/Ablative, shoulder pads 1, armguards o/Ablative, hip guards 1, boots o/Ablative, gloves o/Ablative*)

Full suit: 7 die steps, 4 Ablative; Armor Die: d10; Fumble Die d6; Armor Check penalty: -3; Special: All pieces only count as ½ die steps towards the Fumble die, Armor Die result is doubled versus projectile damage.

Makeshift armors

Retread Armor - Made from tire treads attached to heavy clothing, this is one of the most common types of true armor found in the wastelands. (*torso 1f, legguards 1f, shoulder pads 1f, armguards 1f, hip guards 1f*) Full suit: 5f die steps; Armor Die: d7; Fumble Die d6; Armor Check penalty: -3.

EQUIPMENT

Scrap Mail - An upgrade from Retread armor, this armor incorporates metal plating, chains, spikes, and other enhancements to make it much more protective. (torso 2f, legguards 1f, shoulder pads 2f, armguards 1f, hip guards 1f) Full suit: 7 die steps; Armor Die: d10; Fumble Die d8; Armor Check penalty: -5.

Xenochitin Mail - Many of the creatures that have crossed over from strange dimensions into Umerica have left corpses littered across the land. Their dried chitinous plates are highly prized by the armorers who know how to utilize them. (helmet 2, torso 3, legguards 1, shoulder pads 2, armguards 1, hip guards 1) Full suit: 10 die steps; Armor Die: d16; Fumble Die d14; Armor Check penalty: -8; Special: There is a 10% chance that any armor pieces of this type will have natural extradimensional properties as well.

Robohusk Armor - From across all of time and space, robots are now common enough that many people have encountered at least one in their lifetime. For every functioning bot there are dozens laying dormant or destroyed. From these wrecks many enterprising tinkers have created suits of incredible armor. (helmet 2, torso 2, legguards 2, shoulder pads 2, armguards 2, hip guards 2) Full suit: 6 pieces, 12 die steps; Armor Die: d24; Fumble Die d20; Armor Check penalty: -10; Special: Since this type of armor requires technological know-how to make, There is a 10% chance that any suit encountered will have some additional built in gadgets or abilities that the maker installed.

Rare Armors

Silver Suits - These jumpsuits are made of a thin, light metallic substance that makes no sound when it moves. (one suit [2]) Full suit: [2] die steps; Armor Die: d4; Fumble Die: base d3; Armor Check penalty: 0; Special: The alien nature of the material grants a +2 bonus to all saves versus magical effects. Also, any punctures or damage the suit suffers will self repair in a matter of minutes.

If combined with a Bubble Helm, the wearer is protected from suffocation or vacuum for up to 24 hours at a time. Cost 20osp



EQUIPMENT

Bubble Helm - This appears to be a fish bowl like dome with a metallic rim. (*Helm [1]*) 1 piece, 1 die step; Armor Die: d3; Fumble Die: base d4; Armor Check penalty: 0; Special: When placed over the head, the rim closes snugly about the wearer's neck and begins to filter all air exchange. This grants a +4 bonus to save versus all inhaled toxins or vapors. It will also allow the user to breathe underwater or in other airless conditions for up to 24 hours at a time. If combined with a Silver Suit, even the effects of a total vacuum can be survived. Any damage the helm suffers will self repair in a matter of minutes. Cost 20osp

Power Armor - The most coveted of advanced armors, this mechanized armor incorporates servos to offset its heavy weight and enhances the wearer's might. Only found in full suits. (one suit 6 + [4]) Full suit: 6 die steps, [4] die steps; Armor Die: d16; Fumble Die: d8; Armor Check penalty: -5; Special: The wearer's Strength Mod is increased by +1 and their move is increased by 5'. Servo compensation reduces Fumble die by - 3 die steps. Many power

armors will have additional built in weapons or gadgets. There is a 50% chance of 1d3 such features being incorporated in any suit found. Cost 100osp

All power armors require some sort of energy to run. Some have an internal generator but others require battery cells that need recharging. Cells generally will run the armor for 12 hours and require 2d3 hours to recharge. A spare cell can be used to keep the power armor in constant use. Moving in a power armor suit that is unpowered is very difficult, Strength check DC 16 per round to achieve ¼ Move.



Common Mounts and Methods of Hired Travel

These prices are rarely fixed and may vary up to 150% based on supply, demand, and circumstances.

Small draft beast (dog, goat)*	5sp	East-West train ticket, per mile	3sp
Medium draft beast (ox, horse)*	20sp	Northern Railmasters ticket, per mile	4sp
Large draft beast (buffalo, elephant)*	50sp	Lesser Train Baron ticket, per mile	1-2sp
Giant draft beast (dinosaur, creature)*	20osp+	River boat passage, per mile	1sp
Medium riding beast*	40sp	Trading caravan passage, per mile	3-10cp
Large riding beast*	110sp	Armored caravan passage, per mile	1-3sp
Medium warsteed*	60sp	Sail waggon passage, per mile**	1sp
Large warsteed*	180sp	Motor vehicle passage, per mile**	7sp
Small cart	30sp	Beater Motorcycle***	20gp
Small waggon	50sp	Beater Buggy/Small Car***	40gp
Large waggon	80sp	Beater Large Car/Pick up***	80gp
Basic riding saddle	15sp	Beater Cargo Van***	140gp
Quality riding saddle	30sp	Beater Semi Truck***	350gp
		- Semi Trailer***	50gp

* This is for an average beast with no special traits of training. Costs for exceptional beasts can be +200-500% more.

** Trailblazing or traveling through hazardous areas can increase this fee by +200-500%. Carrying cargo counts as one passenger per ~200lbs.

*** These prices assume that motor vehicles and petrol are somewhat commonly available in the campaign. If they are not, these prices are tripled, at least. These vehicles have only the basic traits for the chassis type.

EQUIPMENT

Firearms					
Weapon	Damage Die	Rate of Fire	Range	Ammo	Cost**
Pistol, full-auto †††	d7	3 ^A	40/80/120	20	250sp
Pistol, black powder	d5	1/3***	50/100/150	1	60sp
Pistol, compact	d6	1	40/80/120	2	100sp
Pistol, Hi-Power †	d10	1	70/140/210	8	120sp
Pistol, revolver	d8	1	60/120/180	6	75sp
Pistol, semi-auto	d8	2	60/120/180	10	100sp
Pistol, Laser	d8	1	80/160/240	40	500sp
Pistol, Blaster/Plasma	d10	1	50/100/150	20	800sp
Submachine Gun	d8	3 ^A	60/120/180	30	300sp
Rifle, assault	d10	3 ^A	100/200/300	30	400sp
Rifle, black powder	d10	1/3***	80/160/240	1	75sp
Rifle, bolt/lever-action	d10	1	120/240/360	5	150sp
Rifle, Laser	d10	3 ^A	200/400/600	50	1000sp
Rifle, Blaster/Plasma	d12	1	150/300/450	25	1500sp
Rifle, sniper	d14	1	300/600/900	4	500sp
Shotgun	d10	1 ††	50/100/*	2	60sp
Shotgun, combat	d10	2	50/100/*	10	120sp
Shotgun, auto	d10	3 ^A	50/100/*	20	200sp
Shotgun, sawed-off	d12	1 ††	20/40/*	2	20sp
Machine Gun	d12	5 ^A	120/240/360	100	800sp

* Shotguns have a limited range.

** Costs are very relative. These costs can vary by 200% or more.

*** Loading these firearms will take 3 uninterrupted round. This cannot be done in melee.

**** The Gatling gun uses a gravity fed box of ammo that can be reloaded on the fly.

† Requires a minimum Strength of 14.

†† Double barreled shotguns can fire both barrels at once, doing 2 dice of damage, 4 dice when aiming.

††† Full-auto pistols will fumble on a natural 1 or 2.

A Capable of automatic fire.



EQUIPMENT

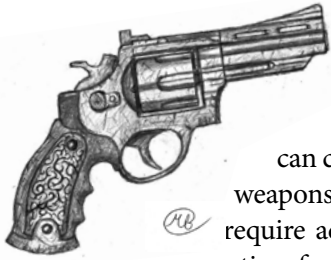

Ammunitions

Standard firearms ammunition generally costs 1sp per round. Specialty rounds (see below) can cost 2-10sp per round. High tech weapons like Lasers and Blaster will require advanced recharging equipment or time for internal generators to replenish their ammo, depending on the individual weapon.

Specialty Ammo

Incendiary - This ammo will cause an additional damage die and will ignite all flammables on the target. Reduce range by 33%

Hi-Power - Increase the damage die by +1 die step.

Rubber - Delivers non-lethal damage. Double target's Armor Die result. Reduce range by 33%

Armor Piercing - Target's Armor Die result is halved, round down.



Grenades

Weapon	Damage Die	Blast Range	Cost	Notes
Can Grenade/pipe bomb	d5	5'	8sp	Fumble range 1-3
Stick of Dynamite	d6	10'	2gp	Fumble range 1-2
Bundle of Dynamite	d12	30'	10gp	Fumble range 1-3
Percussion grenade	d6	10'	4gp	Impact trigger: 10% chance to fail to explode
Frag grenade	d7	15'	5gp	
Concussion Grenade	d7	15'	5gp	½ damage is Subdual
Fusion grenade	d8	20'	20gp	+1d of damage at all ranges
Greek Fire Pot	d5	5'	5sp	Incendiary, Fumble range 1-3
Molotov Cocktail	d6	10'	5sp	Incendiary, Fumble range 1-3
Plasma grenade	d8	20'	15gp	Direct damage and incendiary after effects
Mustard gas grenade	NA	30'	2gp	Lasts 2d6 minutes. Fort save (DC 8+d6) or lose 1d3 temporary Stamina
Grapple grenade	NA	5'	10gp	Ref save (DC 15) or be entangled
Mutagen grenade	d3	20'	15gp	Fort save (DC 15) or gain a mutation
MicroNuke	d24	40'	100gp	Fort save (DC 15) or suffer 1d5 Stamina from radiation



EQUIPMENT



CHEAP, A.K.A. DAMAGED, GOODS

Many times a character will be down on their luck and unable to afford a shiny new weapon or armor. Instead they can buy used and bruised equipment for only a fraction of the cost. Most of the time, it works just like new!

There are three categories of cheap gear: Not Bad, Bad, and Total Crap. It is possible to repair or upgrade Not Bad equipment to normal. This would require an Intelligence check or Tinkering check (DC 13) and parts equal to 50% of the normal value of the item. Bad and Total Crap equipment can never be made as good as new again.

Not Bad equipment is usually poorly made or slightly damaged and has its fumble range increased by +1 (i.e. fumble range 1 becomes 1-2). Also, any fumble rolled has a 33% chance of the item breaking in addition to any other fumble results. If the item is used and no action roll is required, roll 1d20 and the item fails to function on a 1-2. The good news is the price of the item is reduced by 33% so at least it is a bargain.

Bad equipment is usually very poorly made or damaged and has its fumble range increased by +2 (i.e. fumble range 1 becomes 1-3). Also, any fumble rolled has a 50% chance of the item breaking in addition to any other fumble results. If the item is used and no roll is required, roll 1d20 and the item

fails to function on a 1-3. The good news is the price of the item is reduced by 66% so at least you didn't pay much for it.

Total Crap equipment is generally considered unsafe to use and is usually heavily damaged or made from faulty materials. It has its fumble range increased by +4 (i.e. fumble range 1 becomes 1-5). Also, any fumble rolled has a 66% chance of the item breaking in addition to any other fumble results. If the item is used and no action roll is required, roll 1d20 and the item fails to function on a 1-5. The good news is the price of the item is reduced by 85%, which means you get what you pay for.

Quick Fixes

Sometimes a person's weapon or armor breaks and there is no Technologist in sight and no time to fix it right. In order to get it working again, a Quick Fix must be done. Each quick fix usually requires several feet of duct tape, instant epoxy, or other fast patching materials. The quick fix takes 1d3 rounds and has a base DC of 8 but can be modified by the situation. This is especially true if the fix is attempted in the middle of combat!

Due to its hasty application, the quick fix is only temporary and will only last 2d7 turns or until a fumble is rolled. After this the equipment is broken again. Each additional quick fix applied to an item increases the quick fix DC by +1d4. This penalty is also applied to any later attempts to properly fix the item.

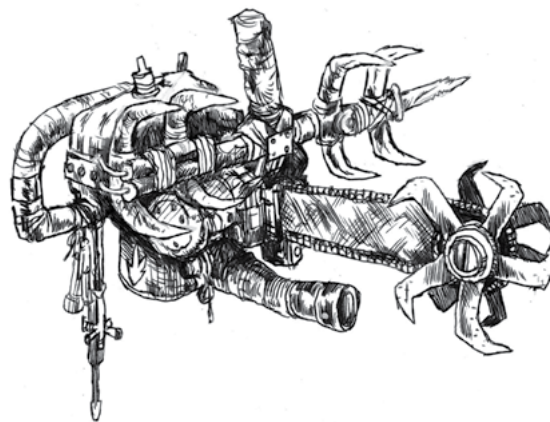



**MAYHEM
BEHIND
THE
WHEEL**

MAYHEM BEHIND THE WHEEL

RULES OF THE ROAD

Speed is tracked by an abstract rating of 1-10 and has the following attributes as seen in *Table SPD-1*, below:

Handling Modifier: The modifier is applied to all vehicle control rolls made at that speed rating.

Wipeout Die: This is the die rolled on *Table WO-1: Wipeout Results* if a vehicle control roll is failed.

Ram/Collision Damage Bonus: When a vehicle impacts a stationary object or another vehicle this is the extra damage caused to both objects. If a person

or other soft target is struck, they take double this bonus damage and the striking vehicle takes only half damage. When two or more vehicles in motion collide add the bonus damage from all vehicles together and the total is the bonus damage inflicted on each vehicle.

Rough MPH: This a rough estimate of the miles per hour that the vehicle will cover at this speed.

Move per Round: This is roughly how many feet the vehicle will move in a straight line in one round at that speed.

Table SPD-1: Speed Levels

Speed Level	Handling Modifier	Wipeout Die	Ram/Collision Damage Bonus	Rough MPH	Move per Round
0	-	-	-	0	not moving
1	+4	1d3	+0	10	80'
2	+2	1d4	+1d4	20	160'
3	0	1d6	+2d4	35	280'
4	-1	1d8	+3d4	45	360'
5	-2	1d10	+4d4	55	440'
6	-3	1d12	+5d4	70	560'
7	-4	1d14	+6d4	90	720'
8	-5	1d16	+7d4	110	880'
9	-7	1d20	+8d4	130	1040'
10	-9	1d24	+9d4	150	1200'

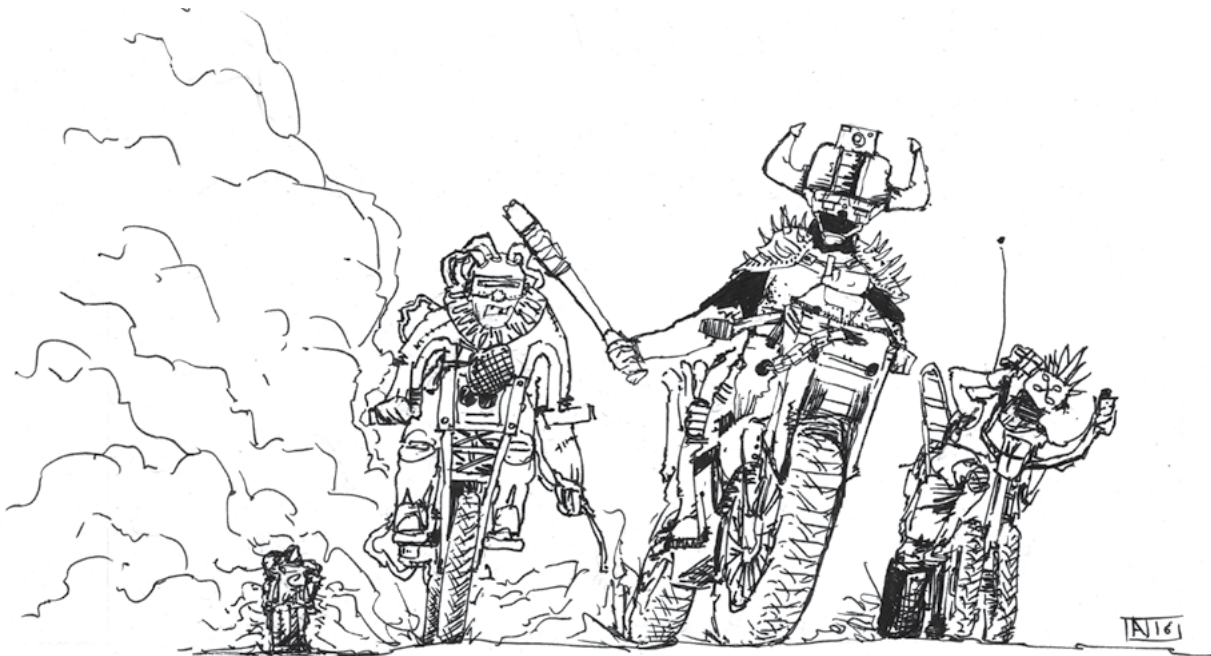

MAYHEM BEHIND THE WHEEL

THE VEHICLE CONTROL ROLL

When a driver faces a hazard or attempts a cool stunt they must make a check to keep the vehicle under control. To make a vehicle control roll, the driver adds their Agility bonus, Vehicle Reflex save, and Speed level Handling Mod to an Action die roll. Note that a driver's occupation and class will determine if they are Trained or Untrained for this roll (see DCCRPG, pg 66). The DC for the roll is based on the situational modifiers on *Table VCM: Vehicle Control Modifiers*. On a failure roll the Wipeout Die, based on the vehicle's current Speed

level on table *SPD-1*, and consult *Table WO-1: Wipeout Results* to find out what happened.

Wrecked

Any vehicle reduced to zero or less hit points is considered Wrecked and must make an immediate vehicle control roll. Even on a successful roll, the vehicle will decelerate 1d3 Speed levels per round until coming to a dead stop. Any additional damage suffered past zero should be tracked since it affects the Wreck Check and repair rolls.

Table VCM: Vehicle Control Modifiers

Basic Control roll	5
Traveling faster than Cruise speed	7
Sharp turn at Speed 3+	9
Bootlegger turn (min Speed 4)	15
Drifting (min Speed 4)	12
Donuts	11
Avoid minor road hazard (small animal in road, small pothole)	8
Avoid major road hazard (large animal in road, giant pothole)	12
Avoid minor off-road hazard (stumps, rocks, heavy foliage)	10
Avoid major off-road hazard (boulder, trees, large sinkhole)	14
Jumping a minor gap (less than 20') (min Speed 3)	12
Jumping a major gap (20'-50'), ramp required (min Speed 5)	18
Jumping a ludicrous gap (50'-100'), ramp required (min Speed 7)	25
Vehicle reduced to 0 or less hit points	13
Driving off-road without proper equipment	+4
At night	+2
At night with no lights	+6
While vehicle is at less than 50% hp	+2
While vehicle is at less than 25% hp	+4
With a flat tire, per tire	+2
Driving in reverse	+4
Accelerating / Decelerating more than 1 level of Speed in a round	+2 per lvl
Per opponent vehicle at Close & Personal range	+2
Vehicle suffered more than 10 points of damage this round	+1

MAYHEM BEHIND THE WHEEL

Table WO-1: Wipeout Results

Roll the Wipeout die appropriate to the Speed rating of the vehicle (determined on *Table SPD-1*) and subtract the driver's Luck mod. Luck may be burned to effect this result.

0	Just a little fishtailing. 40% chance Speed is reduced by 1
1-2	That was close! Speed is reduced by 1d2 and 1d3 tires have a 5% chance each to have a blowout.
3-4	Minor Skid. Control is lost for 1 round and Speed is reduced by 1d3. Each tire has a 5% chance to have a blowout.
5-6	Major Skid. Control is lost for 2 rounds and Speed is reduced by 1d3+1. Each tire has a 10% chance to have a blowout.
7-8	Sideways Skid. Vehicle is perpendicular to its original facing, determined randomly. Control is lost for 1d2+1 rounds and Speed is reduced by 1d4+1. Each tire has a 10% chance to have a blowout. 30% chance of Collision damage bonus (based on original Speed) to vehicle.
9	Spin. Vehicle ends up at new facing. Roll 1d12 for facing by clock position. Control is lost for 1d3+1 rounds and Speed is reduced by 1d5+1. Each tire has a 15% chance to have a blowout. 40% chance of 2d4+Collision damage bonus (based on original Speed) to vehicle.
10	Minor Side Roll. Vehicle has rolled to its side, determined randomly. Vehicle skids in the direction it was originally going, losing 1d3 levels of Speed per round. Each tire has a 15% chance to have a blowout. 3d4+Collision damage bonus (based on original Speed) to vehicle. Passengers have a 40% chance each to suffer 1d4+Collision damage bonus (based on original Speed).
11	Full Roll. Vehicle has rolled over once and come to rest on its side, determined randomly. Vehicle skids in the direction it was originally going, losing 1d3 levels of Speed per round. Each tire has a 20% chance to have a blowout. 4d4+Collision damage bonus (based on original Speed) to vehicle. Passengers have a 60% chance each to suffer Collision damage bonus (based on original Speed) and 15% chance of 1d3 damage to Stamina.
12	Multiple Rolls. Vehicle has rolled over several times and comes to rest on a random side. Vehicle skids in the direction it was originally going, losing 1d3 levels of Speed per round. Each tire has a 25% chance to have a blowout. 6d4+Collision damage bonus (based on original Speed) to vehicle and 10% that vehicle will burst into flames. Passengers suffer Collision damage bonus (based on original Speed) and 25% chance of suffering 1d3 damage to Stamina.
13	End Over End Roll. Vehicle flipped over its front bumper and comes to rest on a random side. Vehicle skids in the direction it was originally going, losing 1d3 levels of Speed per round. Each tire has a 50% chance to have a blowout. 8d4+Collision damage bonus (based on original Speed) to vehicle and 30% that vehicle will burst into flames. Passengers suffer 2d4+Collision damage bonus (based on original Speed) and 40% chance of 1d3 damage to Stamina.
14+	Total Carnage. Good luck walking away from this! Vehicle skids in a random direction, losing 1d3 levels of Speed per round. Each tire has a 75% chance to have a blowout. Vehicle takes 12d4+Collision bonus damage to vehicle and 50% that vehicle will burst into flames. Passengers must make a Fortitude save (DC 15) or die, success indicates they only suffer 4d4+Collision damage bonus (based on original Speed) and 2d3 damage to Stamina.

For any vehicle that is out of control, have the driver attempt to roll under their Luck. If successful, the vehicle will move forward at its current Speed level. Failure indicated it has veered off course, roll 1d8. It will veer to either the left (odds) or right (evens). Any vehicle control rolls required while control is lost are made at -3 die steps.



MAYHEM BEHIND THE WHEEL

MAN VS. MACHINE

When a vehicle strikes a soft target, such as a human or animal, the results are usually not pretty. For every 6 points of damage inflicted by a vehicle on a soft target (round down), they must make a Luck check

or suffer a broken bone. If the successful attack was also a critical hit, then the soft target automatically suffers one broken bone for every 6 points of damage inflicted, in addition to any other critical hit effects.

Machine vs. Man Critical Hit Table

Roll	Result
0	Target is struck for an additional +2d6 damage but the driver and all passengers also suffer 1d3 damage from jostling around. Anyone hanging on to the outside must make a Reflex save (DC 13) or fall off.
1	Bounced off the fender! Inflicts +3d6 damage. Any 6 results in a broken bone.
2	Target's arm/appendage is permanently crippled. Inflicts +1d12 damage.
3	Bounced across the hood! Inflicts +2d6 damage and immediately make an additional attack against this foe. Any 6 rolled on the bonus damage dice results in a broken bone.
4	Fender to the head! Inflicts +3d4 damage plus 1d4 Intelligence damage. Foe stunned for 1d4 rounds.
5	Weapon under the tire! The target's weapon is ruined. If the foe has no weapon, inflict +3d6 damage and any 6 rolled on the bonus damage dice results in a broken bone.
6	Under the tire! Target must make a Fortitude save (DC 13) or fall unconscious and die in 1d4 minutes from crushed vital organs.
7	Up and over! Inflicts +4d6 damage and foe cannot attack for 1d3 rounds. Any 6 rolled on the bonus damage dice results in a broken bone.
8	Skull Slam! Foe is dazed and moves at half speed for 1d8 rounds. Inflicts +2d6 damage and immediately make an additional attack against this foe.
9	Ribcage hit! Foe must make a Fortitude save (DC 14) or begin to drown in his own blood (treat as Drowning and Bleeding Out until medical attention is rendered).
10	Was that his eye! Target is dazed for 1d3 rounds and loses an eye.
11	Face shred! Target's face is horribly disfigured by road burn. Inflict 2d3 permanent Personality damage.
12	Inflicts +4d6 damage and any 6 rolled on the bonus damage dice results in a broken bone. Target must make a Fortitude save (DC 13) or fall unconscious and die in 1d4 minutes from crushed vital organs.
13	Under all of the tires! Inflicts +5d6 damage and any 6 rolled on the bonus damage dice results in a broken bone. Foe will die in 1d5 hours due to internal bleeding unless he receives medical attention.
14	Broken back! Reduce foe's Agility by 1d3+3 due to spinal damage.
15	Foe's life flashes before his eyes. He is prone and stunned by fear for 1d4 turns.
16	Impact shatters the target's arm and whatever they were holding. Inflicts +4d6 damage.
17	Leg under the tire! Foe's movement is reduced to 0 and immediately make an additional attack against this foe.
18	Cracked skull! Inflicts +6d6 damage and is stunned for 1d6 rounds. Foe must make a Fortitude save (DC 14) or suffer total amnesia.
19	Wrenched limb! Inflicts +6d6 damage and one random limb is permanently numb and useless.
20	Major spinal damage! Inflict +6d6 damage and the foe must make a Fortitude save (DC 14) or suffer permanent paralysis.
21	Crushed vitals! Target will die in 1d6 rounds due to organ failure.
22	Inflict +8d6 damage and the foe must make a Fortitude save (DC 17) or die instantly.
23	Shattered skull! Inflict +9d6 damage and 2d6 Intelligence damage. Foe must make a Fortitude save (DC 17) or die instantly.
24+	The target is shredded under the tires and dragged 3d30'. There is nothing more than a long, red streak of blood and meat.

MAYHEM BEHIND THE WHEEL

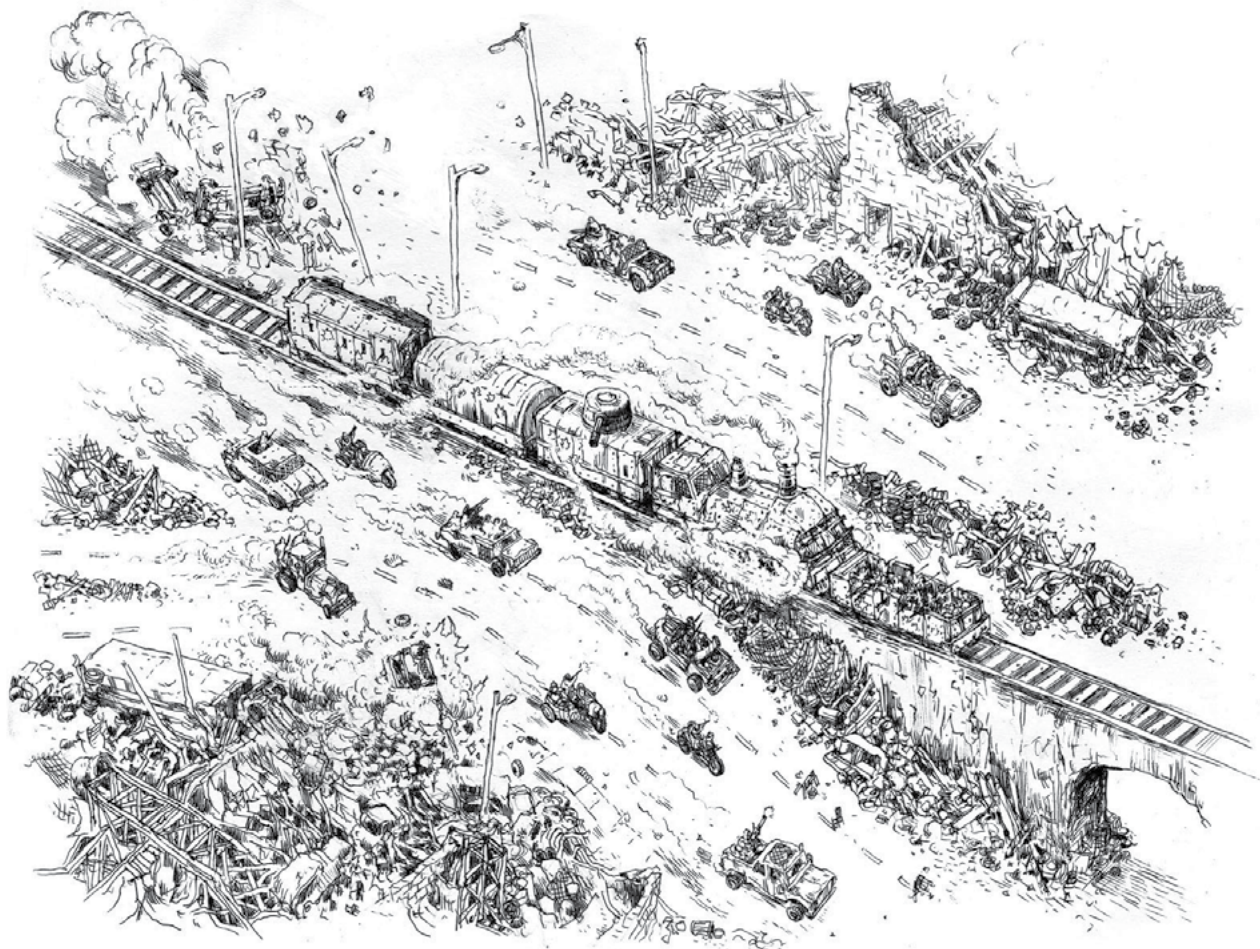

VEHICULAR MANSLAUGHTER

A running combat between multiple vehicles can be a chaotic mess. The following combat flow rules focuses on the awesome and assumes a large scale car battle. If the combat involves chasing another vehicle down or getting away from pursuers, see the Chase rules in the next section instead. The first steps in either case is to determine surprise and roll initiative, just as per normal.

All combat will happen at one of three abstract ranges: close & personal, on your tail, or in the distance.

Close & Personal - Vehicles at this distance are close enough that physical contact can happen and jumping from one vehicle to another is definitely possible. All ranged attacks suffer a -2 to the attack roll due to instability. Any Wipeouts occurring at this range requires all other vehicles to make reactionary vehicle control rolls, base DC of 10, to avoid wiping out as well.

On your Tail - Vehicles at this range are at

most 3-5 car lengths away (60-100ft). All ranged attacks suffer a -4 penalty to the attack roll due to instability, in addition to normal range penalties.

In the Distance - Vehicles at this distance are at least 100ft away but still involved in the fray. All ranged attacks suffer a -6 penalty to the attack roll due to instability, in addition to normal range penalties.

After rolling initiative, all vehicles at *Close & Personal* range make opposing vehicle control rolls. All fumbles result in immediate Wipeout. The highest roll becomes the lead vehicle for the round. The lead vehicle chooses what level of speed the fray moves at and whether to keep it at Close & Personal or open it up to On Your Tail. All other vehicles then may make reaction vehicle control rolls (DC 10+mods) on their initiative to match the maneuver and stay at Close & Personal. Failure indicates they could not keep up and all fumbles result in immediate Wipeout. Vehicles that cannot travel at the current speed of the fray must fall back to In The Distance.

MAYHEM BEHIND THE WHEEL

All vehicles that started the round at *On Your Tail* may choose on their initiative to make reaction vehicle control rolls (DC 10) to enter Close & Personal range with the vehicle group of their choice.

All vehicles that started the round at *In the Distance* may choose to accelerate hard (DC 12) to catch up to On Your Tail if they can achieve a Speed Level one greater than the fray's current Speed Level.

CHASE RULES

All measurements in a chase are based in abstract steps. Each is loosely assumed to be around 100ft in length. According to the previous Vehicular Manslaughter combat rules this sets 0 step at Close and Personal, 1 step at On Your Tail, and 2+ at In The Distance.

The starting positions of the vehicles involved generally takes one of three forms:

- Dead start - all vehicles begin at speed 0 and at close proximity
- Get Away - All vehicles are already in motion and one vehicle/group is ahead by 1d3+1 steps.
- Catch up - All vehicles are already in motion and one vehicle/group is ahead by 2d3-1 steps.

Every vehicle makes a Vehicle Control roll once per round in initiative order; a success lets them adjust the distance from a pursued/pursuing vehicle by one step, plus one per level of speed greater than the other vehicle/group (who can negate some or all of this if they also succeed). If the distance between the fleeing vehicle and its pursuers exceeds 12 steps, the pursued has gained enough of a lead to escape. As a quick reference, use a d12 for each vehicle/group to track their standing.

In addition to racing, drivers can attempt to pull stunts and any passengers can make attacks. To pull a stunt, describe the maneuver and decide how much risk to wager, from between 1-5. This is the penalty to the vehicle control roll and how many die steps higher the Wipeout die will be on a failure. If successful, the same penalty is applied to the vehicle control roll of every other vehicle/group involved with the stunt.

REPAIRING YOUR RIDE

Basic vehicle maintenance is DC5. Fixing minor damage (less than 30% of the total HP for the vehicle) is DC 10 and just requires 1d4sp per hit point repaired. Fixing major damage (between 30% to 90% of the total HP for the vehicle) or changing what kind of fuel it uses requires specialized parts, tools, and 2d4sp per hit point repaired (DC 15-20). Vehicles damaged beyond 90% of their HP are DC 20+ to repair, depending on the damage done to them, and require 3d4sp per hit point repaired. On the other hand, it is only DC10 to salvage usefull parts from them. Success yields one half of the vehicle's HD in equivalent sp value of salvaged parts. (i.e. a beater Semi Truck has HD 3d16 and salvaging a Wrecked one yields 3d16 ÷ 2sp in parts.)

Upgrading your vehicle is based on its Quality level. Check the Vehicle Quality Levels section, pg 135.

Wreck Check

Once a Wrecked vehicle (see pg 127) comes to a stop, is extinguished, and is generally not under fire it can be checked to see how bad of a shape it is in, called a Wreck Check. This is similar to recovering the body of a fallen comrade and consists of rolling under the target number based off of the vehicle's Quality on a d20 to succeed. The character examining the vehicle may subtract their Luck mod from the roll as well. A failed check means the vehicle is a goner and is only good for salvage. A success means that after several minutes the vehicle is up and running with 1d3 hp but there is permanent damage. Roll on *Table WD-1: Wreck Damage*

MAYHEM BEHIND THE WHEEL

Table WD-1: Wreck Damage

Roll 1d14 and add +1 for every 5 points of damage the vehicle suffered below 0 hp. If previous Wreck damage is still unfixed, add an additional 1d3 to the roll.

1-3	A lot worse than it looks - vehicle needs 1d4 hours of maintenance. All vehicle control rolls at -2 until this is done. Repair cost: 2d10sp.
4-6	Trashed alignment - Vehicle needs minor frame work, DC 12 and 2d4 hours. All vehicle control rolls at -4 until this is done. Repair cost: 2d30sp.
7-9	Major issue, Fuel system - Guzzle rating doubled. DC 15 to fix. Takes 3d4 hours to locate leak. Repair cost: 2d100sp.
10-12	Major issue, Engine misfire - Speed cruise / max both reduced by 1. All vehicle control rolls at -4 until repaired. DC 18 to fix. Takes 4d4 hours to locate issue. Repair cost: 4d100sp.
13+	Never the same again - 25% chance every day the vehicle is driven for a new issue to develop. Roll 2d3 for vehicle control roll penalty until fixed. repairs take 3d20 minutes, DC 8+1d4. Each repair cost: 1d5 x d12sp.

FUEL CONSUMPTION

Each vehicle type has a Fuel Tank size and a Guzzle rating:

Fuel Tank - A value between 1d3 to 1d30, this represents the maximum amount of fuel the vehicle can carry.

Guzzle - This is the penalty applied to all Fuel Use rolls.

Fuel consumption checks are generally made once every hour of normal travel and after every battle. At the GMs whim they could be made as often as every 30 minutes or as infrequent as four hours. The frequency should be based on the pacing of the activity throughout the day.

The base difficulty for a Fuel Consumption roll is the vehicle's Guzzle rating modified by the following:

Per hour idling	+1
<i>Per hour traveled:</i>	
At Cruise speed or slower	+2
At higher than Cruise to Max speed	+4
At above Max speed (Redline)	+8
Overloaded (too much weight)	+3
While vehicle is at less than 75% hp	+1
While vehicle is at less than 50% hp	+2
While vehicle is at less than 25% hp	+4
With a flat tire, per tire	+3
Vehicle was involved in a fight	+3

The fuel consumption check is the vehicle's current Fuel Tank die rolled against the total difficulty. The roll must be equal to or higher than the difficulty to succeed. If the roll is failed, the Fuel Tank die lowers by -1 die step. If a one is rolled, the Fuel Tank die lowers by -2 die steps. When the Fuel Tank die is lowered below 1d3, the vehicle is out of fuel.

Refueling

Caches of found or stored fuel are rated in dice steps. Filling a gas tank lowers the rating of the filling source by the same number of steps that it takes to refill the fuel tank of the vehicle. i.e. A small jerry can holds 1 unit of fuel. Using it to refill an empty fuel tank would put 1d3 in the tank. Adding to a tank that still has 1d5 in it would add +1 die step so it would go from 1d5 to 1d6.

Fuel container	Storage capacity in units	Salvage Found in fuel units
Jerry can, small	1	1
Jerry can, large	2	1d2
Metal drum	10	1d10
Tank trailer/ Fuel station	300	10d30
Found vehicle	-	Fuel Tank die ÷ 3



MAYHEM BEHIND THE WHEEL

WHAT'S UNDER THE HOOD?

In order to keep things simple and still create awesome and unique rides, vehicles are separated into Vehicle Types and Levels of Quality. In addition, vehicles can have one or more Vehicle traits. To create a vehicle: choose a Type, Quality level, and pick any additional Traits it may have.

Vehicle Types

Below are rough guidelines for grouping vehicles of similar size and capability. If you do not find an exact match for the vehicle you are trying to create either choose the type that is closest or design a new type based on the existing ones.

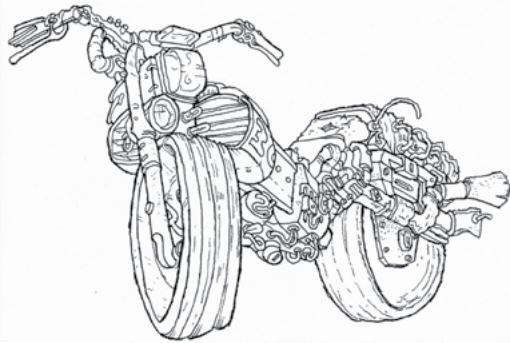

Motorcycles - This category covers all bike, trike, and quad vehicles in which the riders are mostly, if not completely, exposed.

Motorcycle: Init +5; Atk rundown +1 melee (2d4+Collision damage bonus); AC 13*; Armor Die: [1d3]; HD d6; Speed cruise 3/ max 5; Act 1d20; SV Fort +0, Ref +3, Will NA; Fuel Tank 1d5; Guzzle 0.

* Vehicle only, passenger(s) use individual ACs

Basic Traits: Very Nimble, Very Dangerous, Open, Off Road

Buggy - This category covers all heavy duty go carts, dune buggies, or other scratch built, open frame vehicles with a maximum of 4 passengers.

Buggy: Init +4; Atk rundown +2 melee (2d5+Collision damage bonus); AC 12*; Armor Die: [1d3]; HD d7; Speed Level cruise 3/ max 5; Act 1d20; SV Fort +1, Ref +2, Will NA; Fuel Tank 1d6; Guzzle 1.

* Vehicle only, passenger(s) use individual ACs +1 due to light cover.

Basic Traits: Nimble, Dangerous, Open, Off Road

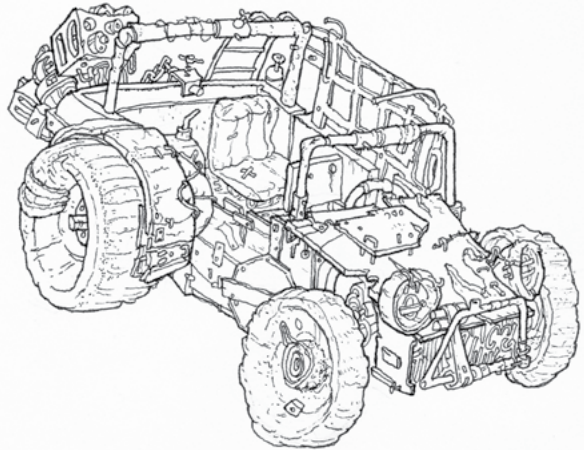

Small Car - This category covers all fully enclosed compact and fuel-efficient automobiles intended for 2 max passengers.

Small Car: Init +3; Atk rundown +3 melee (2d6+Collision damage bonus); AC 12; Armor Die: [1d4]; HD d8; Speed Level cruise 4/ max 6; Act 1d20; SV Fort +2, Ref +2, Will NA; Fuel Tank 1d7; Guzzle 1.

Basic Traits: None

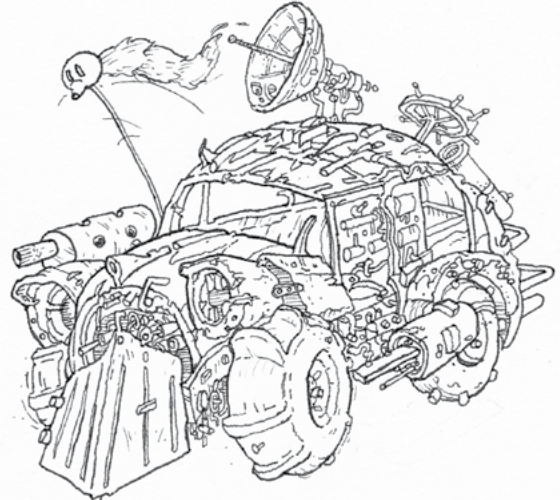

Large Car - This category covers all fully enclosed family, luxury, or performance automobiles that can seat 4 max passengers.

Large Car: Init +2; Atk rundown +4 melee (2d7+Collision damage bonus); AC 11; Armor Die: [1d4]; HD d10; Speed Level cruise 4/ max 6; Act 1d20; SV Fort +2, Ref +1, Will NA; Fuel Tank 1d8; Guzzle 2.

Basic Traits: None

MAYHEM BEHIND THE WHEEL

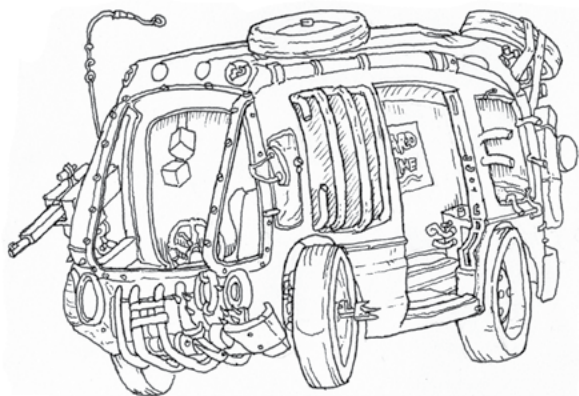

SUV/Van - This category covers all fully enclosed larger cab automobiles that can seat 6-7 max passengers or a sizable amount of cargo.

SUV/Van: Init +2; Atk rundown +5 melee (2d8+Collision damage bonus); AC 10; Armor Die: [1d4]; HD d12; Speed Level cruise 3/ max 5; Act 1d20; SV Fort +3, Ref +0, Will NA; Fuel Tank 1d10; Guzzle 2.

Basic Traits: Extra Cargo x1

Pickup Truck - This category covers all fully enclosed cab vehicles that can seat 2 max passengers and carry cargo in an open bed.

Pickup Truck: Init +1; Atk rundown +5 melee (2d8+Collision damage bonus); AC 10; Armor Die: [1d4]; HD d12; Speed Level cruise 3/ max 5; Act 1d20; SV Fort +4, Ref +0, Will NA; Fuel Tank 1d10; Guzzle 2.

Basic Traits: Extra Cargo x2, Rugged, Hauler

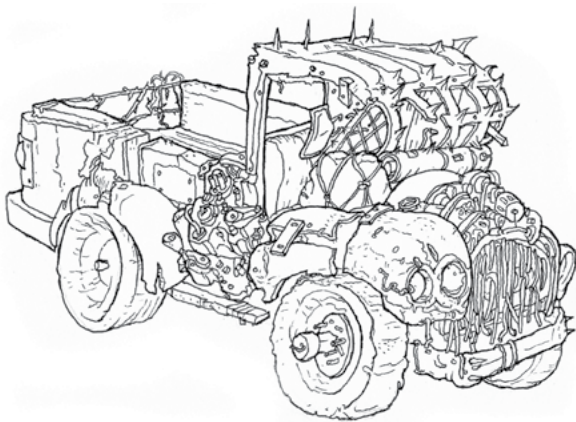

Cargo Van/Truck - This category covers all large vehicles designed to haul cargo and seat up to 2-3 max passengers.

Cargo Van/Truck: Init +0; Atk rundown +6

melee (2d10+Collision damage bonus); AC 9; Armor Die: [1d5]; HD d14; Speed cruise 3/ max 5; Act 1d20; SV Fort +5, Ref -1, Will NA; Fuel Tank 1d12; Guzzle 4.

Basic Traits: Extra Cargo x4

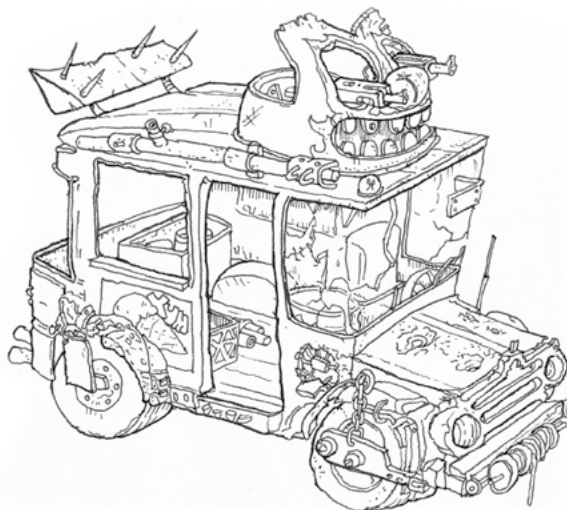

Bus - This category covers all versions of mass passenger transports capable carrying 30-60 passengers...

Bus: Init -2; Atk rundown +7 melee (2d12+Collision damage bonus); AC 7; Armor Die: [1d6]; HD d14; Speed Level cruise 3/ max 5; Act 1d20; SV Fort +5, Ref -3, Will NA; Fuel Tank 1d20; Guzzle 5.

Basic Traits: Dual Tires, Roof Access Hatch (may have one more extra trait than the Quality normally allows)

Semi Truck - This category covers all tractor trailer cargo hauling vehicles.

Semi Truck cab only: Init -1; Atk rundown +7 melee (2d12+Collision damage bonus); AC 8; Armor Die: [1d6]; HD d16; Speed Level cruise 3/ max 5 (cruise 2/ max 4 with Trailer); Act 1d20; SV Fort +6, Ref -2, Will NA; Fuel Tank 1d20; Guzzle 6.

Basic Traits: Dual Tires, Power Hauler

Semi Trailer: Init -2; Atk rundown +7 melee (2d12+Collision damage bonus); AC 6; Armor Die: [1d4]; HD d10 for trailer only; Speed Level cruise -/ max -; Act 1d20; SV Fort +6, Ref -4, Will NA.

Basic Traits: Dual Tires, Extra Cargo x80 (Trailer has up to four additional traits of its own)

MAYHEM BEHIND THE WHEEL

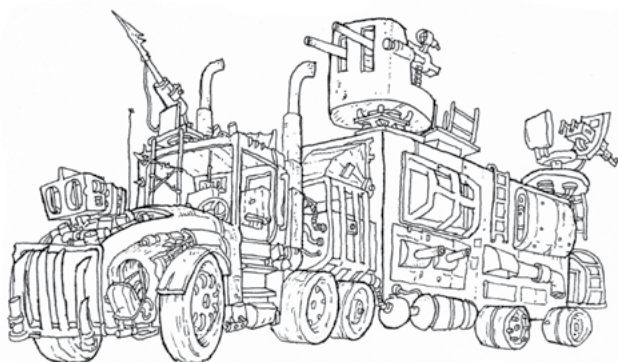

Vehicle Quality Levels

There are three levels of vehicles: Beater, Keeper, and Custom. It is possible with extensive labor and time to increase a vehicle's quality level: 4d4 repair checks (DC 15+) taking 10d30 hours of labour and (2d30)d100sp worth of parts each level would not be unreasonable.

Beater Vehicles - These are the majority of the vehicles found throughout Umerica. They are not pretty but they run... most of the time. These vehicles have the base stats for the vehicle type and 3 HD. With a DC 20 vehicle repair check one additional trait can be added. They have a Wreck Check of 5.

Keeper Vehicles - A welcome minority in the post-apocalyptic world, vehicles like this are in good running condition and are quite reliable. The ownership of a Keeper tends to change hands quickly and usually bloodily. These vehicles have 6 HD and add the following stat bumps: +1 to Init or +1 die step to the Armor Die; +1 to Speed Level cruise & max or Fortitude & Reflex saves. They also have one additional trait. With a DC 20 vehicle repair check a second additional trait can be added. They have a Wreck Check of 10.

Custom Vehicles - A work of art on wheels, these rare gems are feared and coveted wherever they go. Vehicles of this caliber are true artifacts of a bygone age. These vehicles have 9 HD and add the following stat bumps: +2 to Init or +2 die steps to the Armor Die; +2 to Speed cruise & max or Fortitude & Reflex saves. They also have two additional traits. With a DC 20 vehicle repair check a third or fourth additional trait can be added. They have a Wreck Check of 15.

Vehicle Traits

These traits cover some of the basic functions of chassis types and various upgrades that are common to the wastelands. If you do not find what you are looking for here, make up new ones using the existing traits as a guideline.

Armored - Increase the vehicle's Armor Die by +2 die steps, Impervious.

Big Tank - The vehicles max Fuel Tank die size is +2 die steps greater.

Boarding Poles - (Cannot be put on Motorcycles) The vehicle has a number of long flexible poles used for "easy" boarding of other vehicles while in motion (Reflex save DC 12). The maximum number of poles is equal to the vehicle's axles.

Dangerous - When rolling on *Table WO-1: Wipeout Results*, add an additional 1d3 to the roll total.

Dual Tires - (Cannot be put on Motorcycles) This vehicle has two tires mounted on either side of each non-steering axle so it can minimize the loss of any one tire. The result is that this vehicle ignores the loss of one tire per axle.

Enhanced Handling - Increase Reflex save by +2.

Extra Cargo - ½ ton cargo capacity per level.

Fuel Efficient - Lower Guzzle by 1, to a minimum of 0.

Fog Lamps - Ignores all penalties for night driving. Very conspicuous. Can cause vision impairment to oncoming vehicles.

Heavily Armored - (Closed Vehicles only) Increase the vehicle's Armor Die by +4 die steps, Impervious. Lowers Speed cruise and max by 1 and increases Guzzle by 1.

Heavy Weapon Mount - (Cannot be put on Motorcycles) This allows a support class ranged weapon to be mounted on the vehicle. This negates up to a -4 penalty for firing from a moving vehicle.

MAYHEM BEHIND THE WHEEL

Hauler - Can tow up to 5 tons of properly distributed weight via trailer or another vehicle. Towing lowers Speed values and Reflex save by 1. Also add +1 to Guzzle when towing.

High Performance Engine - Speed rating for Cruise is increased by 1 and Max by 2. Add +1 to Guzzle. (May be taken up to 3 times)

Nimble - This vehicle can easily fit through narrow spaces that others cannot. They can add a 1d3 to all Vehicle Control rolls when traversing a confined environment.

Nitrous Tank - Holds three charges, each expenditure of a charge allows a vehicle to increase or narrow the distance to another vehicle by one step/range increment during a chase or combat without making a Vehicle Control Roll. If used during a ram, add +2d4 damage to both the target and ramming vehicle. If more than one charge is expended in the same round the vehicle must make a Fortitude save DC 10 or suffer 3d3 damage. Recharging the tank costs 2d10+5sp.

Off Road - This vehicle is designed to function well in rough, broken, or natural terrain. It suffers no penalties for traveling on such terrain.

Open - This vehicle does not offer passengers any applicable cover or protection from attack. During a collision or wipeout, 50% of damage suffered by this vehicle is also inflicted on each of the passengers.

Possessed - This vehicle is powered by an entrapped elemental or minor demon. It has an unearthly appearance and the following enhancements: +2 HD and add the following stat bumps: +1 to Init or +1 die step to the Armor Die; +1 to Speed cruise & max or +1 to Fortitude & Reflex saves. The vehicle does not run on regular fuels. Roll 1d10 to determine the esoteric fuel type: (1) Blood; (2) Spells; (3) Soda pop; (4) Raw meat; (5) Drugs; (6) Charcoal; (7) Distilled Water; (8) Candy; (9) Salt; (10) roll twice and combine, ignoring this result.

Power Hauler - (Semi Truck Only) Can tow up to 50 tons of properly distributed weight via trailer. Also add +2 to Guzzle when towing.

Ram Plate - This increases all rundown damage from two dice to three dice (i.e. 2d6 becomes 3d6). Also, all front end collision damage suffered by the vehicle is reduced by 50% and it gains +5 to all vehicle control rolls after colliding with hard or soft targets.



MAYHEM BEHIND THE WHEEL

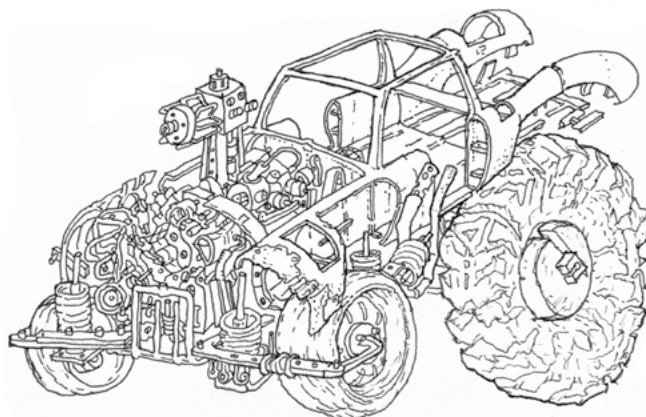

Reserve Tank - Vehicle has a second Fuel Tank with a rating of 1d6.

Rugged - All Fortitude saves use a 1d30 action die.

Safety Features - Passengers ignore 25% of all collision/accident damage if properly seated and buckled in.

Very Dangerous - When rolling on *Table WO-1: Wipeout* results, add an additional 1d5 to the roll total.

Very Nimble - (Motorcycles Only) This vehicle can traverse through most terrains that humans can: on stairs, hallways, and doorways. They can add a 1d4 to all Vehicle Control rolls when traversing a confined environment. *Cannot be taken with Nimble.*

Weapon Mount - This allows one rifle sized ranged weapon per axle to be mounted on the vehicle. This negates up to a -4 penalty for firing from a moving vehicle.

Tire Blades - (light or heavy) - This covers a multitude of different cutting devices intended to shred the tires of other vehicles or foes on foot. Note that unlike ramming, failed attacks with Tire Blades do not require vehicle control rolls to avoid wiping out.

- *Light blades* will deal 1d6+Damage Bonus damage and have a 40% chance of bursting a target's tire on a successful hit. These may be retracted or otherwise concealed until used.
- *Heavy blades* will deal 2d6+Damage Bonus damage and have a 80% chance of bursting a target's tire on a successful hit. These are permanently fixed and very obvious. They also lower the vehicle's Reflex save by -1.

Support Class Weapons

These are ranged weapons much too large to be used as personal equipment. It is possible that a giant might be able to utilize one. These follow the same rules as normal firearms but must be mounted to use.

Support Class Weapons

Weapon	Damage	RoF	Range	Ammo	Notes
Gatling Gun, light	3d12	Auto only	180/360/540	10 per belt	
Gatling Gun, heavy	3d16	Auto only	240/480/960	10 per belt	
Ballista	2d8	1	100/200/300	1 ballista bolt	3 rounds to reload
Grapple Harpoon	2d5	1	40/80/120	1 harpoon	3 rounds to reload
Bolt Volley Launcher	(3d3)d4	1	30/60/90	4 volleys	10 rounds to reload
Cannon, light	5d8	1	800/1600/2400	1 shell	-1 Speed when fired
Cannon, heavy	8d8	1	1000/2000/3000	1 shell	-1 Speed when fired
Net Launcher	Ref DC 16	1	20/40/60	1 net	entangle

MAYHEM BEHIND THE WHEEL

OTHER VEHICLE TYPES

Trains

While not as prevalent across Umerica as before the cataclysm, several larger settlements have devoted much time and efforts into repairing and maintaining the railroad tracks of yesterday. Trains still serve as cargo haulers and cheap, “safe” transit between the major points of civilization. They follow all of the rules for vehicles (including Quality levels and Control rolls) with the following exceptions:

- Trains must follow the track they are on and can only chose to adjust their speed.
- Trains use their own Wipeout table, *Table LWO-1*.

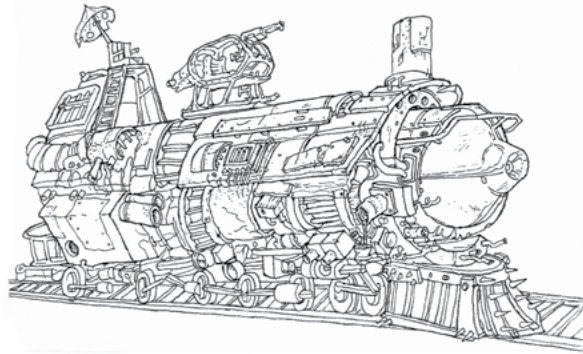

The Vehicle Control roll (train edition)

In addition to the normal modifiers a train has the following additional modifier to the roll:

Decelerating more than one level of Speed in a round	+2 per lvl
Hitting an object on the track	+1 per 2hp damage taken
Turning or running faster than Cruise on a slight slope	+2
Turning or running faster than Cruise on a medium slope	+4
Turning or running faster than Cruise on a steep slope	+6

Table LWO-1: Locomotive Wipeout Results

Roll the Wipeout die appropriate to the Speed rating of the train (determined on *Table SPD-1*) and subtract the engineer's Luck mod. Luck may be burned to effect this result.

1-3	Just a little wobble! Reduce Speed by 1 and all vehicle control checks next round are at -1 to the roll.
4-6	That did not sound good! Reduce Speed by 1 and the train must make a Fortitude save (DC 16) or max speed is lowered by one until repaired.
7-9	Way too close! Reduce speed by 2 and the engine must make a Fortitude save (DC 20) or max speed is lowered by one and all actions are taken at -1 die step until repaired. There is a 20% chance of a car slipping off the track, requiring 1d3 hours to right.
10-12	Hold on to something! Reduce speed by 2 and the engine must make a Fortitude save (DC 25) or max speed is lowered by two and all actions are taken at -2 die steps until repaired. There is a 40% chance of a car slipping off the track, requiring 1d3 hours to right.
13-15	Derailed! Control is lost and the train jumps the track. It plows through the terrain for Nd% + 50' where N is equal the the train's speed before derailling. Anyone in its path must roll under their Luck or be killed. The engine and all cars take 5d4+Collision bonus damage. The train cannot be righted onto the track without major industrial equipment or magic.
16+	Total Disaster! Control is lost and the train completely derails with cars jackknifing and rolling. It plows through the terrain for Nd% + 100' where N is equal the the train's speed before derailling plus 1. Anyone in its path must roll under their Luck or be killed. All passengers must make a Fortitude save (DC 12) or be killed in the crash. The engine and all cars cannot be repaired, only salvaged.

MAYHEM BEHIND THE WHEEL

TRAIN TYPES

Small Engines - These are smaller commuter train style engines.

Small Engines: Init -1; Atk rundown +4 melee (2d12+Collision damage bonus); AC 8; Armor Die: [1d8]; HD d16; Speed Level cruise 3~/ max 6~; Act 1d20; SV Fort +7, Ref -2, Will NA; Fuel Tank 1d24; Guzzle 4~.

~Speed is lowered and Guzzle increased when hauling cars.

Basic Traits: Super Hauler, Ram Plate

Large Engines - These are huge freight train engines.

Large Engines: Init -3; Atk rundown +6 melee (2d14+Collision damage bonus); AC 8; Armor Die: [1d10]; HD d20; Speed Level cruise 3~/ max 6~; Act 1d20; SV Fort +9, Ref -2, Will NA; Fuel Tank 1d30; Guzzle 6~.

~Speed is lowered and Guzzle increased when hauling cars.

Basic Traits: Ultra Hauler, Ram Plate

Flat Cars: Init *; Atk *; AC 8; Armor Die: [1d3]; HD d10; Speed Level *; Act *; SV Fort +5, Ref *, Will NA.

Basic Traits: Open, Rugged

* as engine

Box Cars: Init *; Atk *; AC 8; Armor Die: [1d3]; HD d12; Speed Level *; Act *; SV Fort +7, Ref *, Will NA.

Basic Traits: Extra Cargo x100

Passenger Cars: Init *; Atk *; AC 8; Armor Die: [1d3]; HD d10; Speed Level *; Act *; SV Fort +6, Ref *, Will NA. Passenger capacity: 50 passengers and luggage.

Basic Traits: None

Train Vehicle Traits

The following normal Vehicle Traits can be applied to trains: Armored, Big Tank, Dangerous, Fuel Efficient, Fog Lamps, Heavily Armored, Heavy Weapon Mount, Open, Possessed, Reserve Tank, Rugged, Safety Features, Very Dangerous, Weapon Mount.

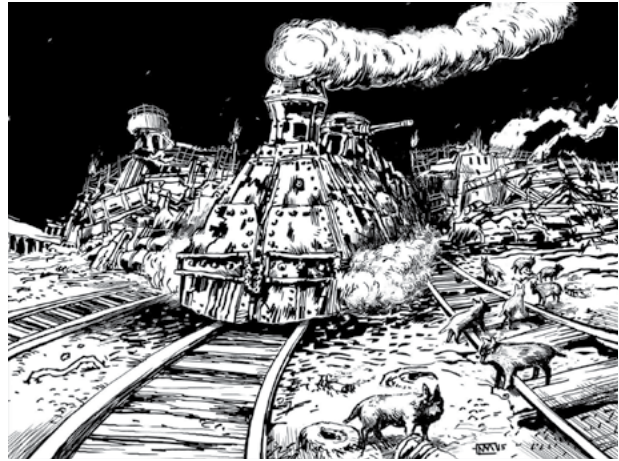

New Traits

Refrigeration - (Box Cars only) This car can hold perishable goods at safe temperatures for long distances. It can also be set higher for frozen goods. Guzzle is increased by +1 for refrigeration and +2 for Freezing.

Super Hauler - Can haul three train cars without effort. Every additional three cars lowers cruise and max Speed by 1 and increases Guzzle by 2.

Superior Ram Plate - (Trains & Semi-Trucks only) This increases all rundown damage from two dice to four dice (i.e. 2d12 becomes 4d12). Also, the train ignores the first 10 points of all front end collision damage suffered and any additional damage is reduced by 50%. Speed (cruise and max) and Reflex save are reduced by 1.

Ultra Hauler - Can haul five train cars without effort. Every additional five cars lowers cruise and max Speed by 1 and increases Guzzle by 2.

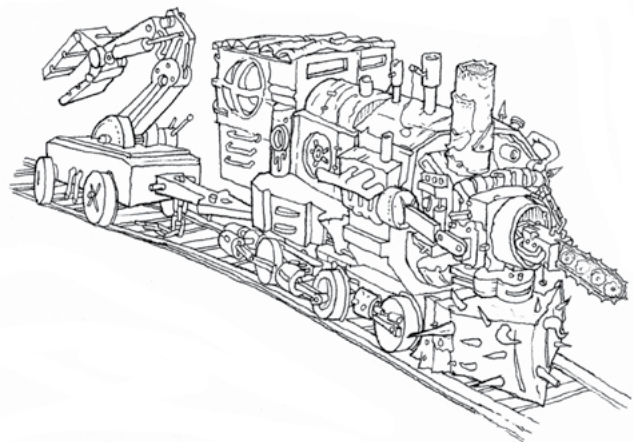

MAYHEM BEHIND THE WHEEL

WATERCRAFT

While the waterways of Umerica hardly resemble their former pre-cataclysmic state, many folk still use them as a means of travel that is slightly safer than land transit. They follow all of the rules for vehicles (including Quality levels and Control rolls) with the following exceptions:

- Watercraft do not need engines to move. Non-powered watercraft are either propelled by rowing or sails.
- Falling out of a moving watercraft is much less lethal than other vehicles.

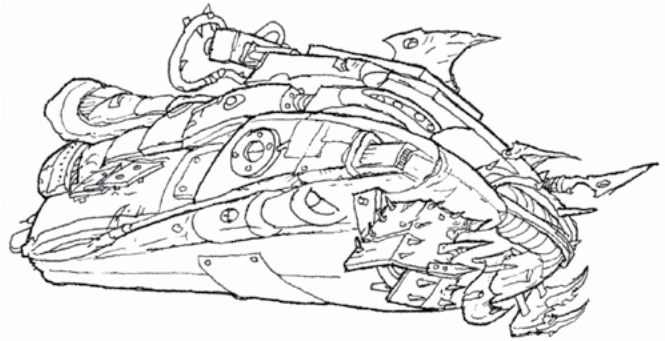

Table WSPD-1: Watercraft Speed levels

Speed Level	Handling Modifier	Wipeout Die	Ram/Collision Damage Bonus	Rough MPH	Move per Round
½*	+2	0	+0	5	40'
1	+1	1d3	+1d2	10	80'
2	0	1d6	+1d4	20	160'
3	-1	1d10	+2d4	35	280'
4	-2	1d12	+3d4	45	360'
5	-4	1d14	+5d4	55	440'
6	-6	1d16	+7d4	70	560'
7	-8	1d20	+10d4	90	720'

*considered 0 when used as a modifier.

The Vehicle Control roll (watercraft edition)

In addition to the normal modifiers a watercraft has the following additional modifier to the roll:

Rough waters	+2
Fighting a strong current	+3
The craft has taken on water	+1 per minute of leakage
Stormy weather	+4
Squall conditions	+8
Traversing light rapids	+4
Traversing heavy rapids	+8
Traversing a minor waterfall	+10

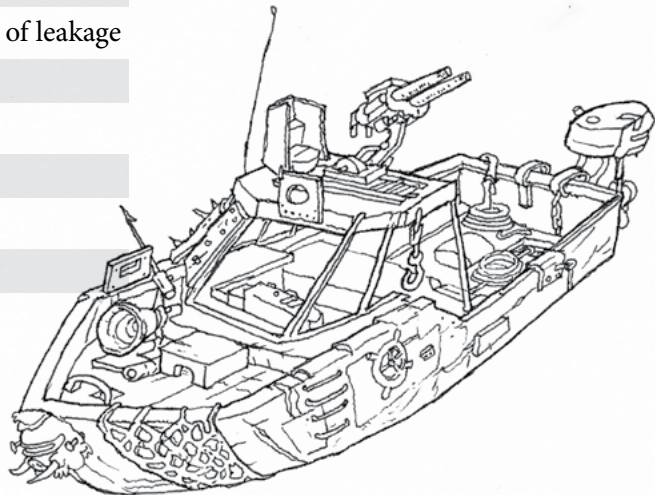

MAYHEM BEHIND THE WHEEL

Table WWO-1: Watercraft Wipeout Results

Roll the Wipeout die appropriate to the Speed rating of the watercraft (determined on Table WSPD-1) and subtract the pilot's Luck mod. Luck may be burned to effect this result. If a drop in height would cause the craft to make contact with the ground they suffer the Crash Damage listed for the height level they lost control at plus the Collision Damage Bonus for the speed they were traveling at.

1-3	Rough Sailing: Speed is reduced by 1 and all vehicle control checks next round are at -1 to the roll.
4-6	That was a Rock: Speed reduced by 1 and craft must make a Fortitude save (DC 10) or all actions are taken at minus one die step until repaired.
7-9	Hold on! Speed is reduced by 2 and craft must make a Fortitude save (DC 15) or all actions are taken at minus one die step until repaired. There is a 15% chance that the watercraft will capsize. If not, there is a 20% chance it will spring a leak.
10-12	Major Tipping: Control is lost for 1d3+1 rounds plus speed is reduced by 2 and must make a Fortitude save (DC 15) or all actions are taken at minus two die steps until repaired. There is a 30% that the watercraft will capsize. If not, there is a 40% chance it will spring a leak.
13-15	Man the Lifeboats! Control is lost for 1d5+1 rounds and Speed is reduced by 2 and there is a 35% chance of control damage causing all future vehicle control checks to be made at minus one die step. If the loss of control results in a collision, there is a 40% chance that the fuel system catches fire and explodes in 1d5 rounds. There is a 50% chance that the watercraft will capsize. If not, there is a 65% chance it will spring a leak.
16+	Total Titanic: Control is lost and the craft capsizes. All passengers suffer 2d4+collision bonus damage and must make a Reflex save (DC 12) or begin to drown. If the loss of control results in a collision and the craft uses fuel, there is a 60% chance that the fuel system catches fire and explodes in 1d5 rounds.

Springing a Leak - A leaking vessel will sink in a number of minutes equal to the size of it's Hit Die (i.e. d10 = 10 minutes). A person bailing can make a Stamina check (DC 12) to cancel out the leak each minute. Additional bailers can remove one minute's worth of water each on successful rolls. A repair check (DC 14) is required to stop the leak while the craft is in the water. This is reduced to DC 10 if the craft is in drydock.

NON-POWERED WATERCRAFT TYPES

Raft - Usually these crafts are made of logs bound together and not much else. They can carry 1-4 passengers and a small amount of cargo.

Raft: Init +1; Atk rundown +1 melee (1d4+Collision damage bonus); AC 11*; Armor Die: 0; HD d4; Speed cruise ½ / max 1; Act 1d20; SV Fort -2, Ref +1, Will NA; Fuel Tank NA; Guzzle NA.

* *Vehicle only, passenger(s) use individual ACs*
Basic Traits: Nimble, Very Dangerous, Open

Rowboats - These are the standard 1-3 passenger watercraft with a set of oars.

Rowboat: Init +2; Atk rundown +2 melee

(1d5+Collision damage bonus); AC 12*; Armor Die: [1d3]; HD d6; Speed cruise ½ / max 1; Act 1d20; SV Fort +0, Ref +2, Will NA; Fuel Tank NA; Guzzle NA.

* *Vehicle only, passenger(s) use individual ACs*
Basic Traits: Nimble, Open

Small Sailboat - These are single-masted short-range craft that can carry 1-4 crew.

Small Sailboat: Init +0; Atk rundown +4 melee (1d7+Collision damage bonus); AC 11; Armor Die: [1d4]; HD d8; Speed cruise 1/ max 2; Act 1d20; SV Fort +3, Ref +1, Will NA; Fuel Tank NA; Guzzle NA.

Basic Traits: none

Large Sailboat - These are multi-masted long-range craft that can carry 3-6 crew and cargo.

Large Sailboat: Init -2; Atk rundown +6 melee (1d10+Collision damage bonus); AC 10; Armor Die: [1d5]; HD d12; Speed cruise 2/ max 3; Act 1d20; SV Fort +6, Ref +0, Will NA; Fuel Tank NA; Guzzle NA.

Basic Traits: Living Quarters, Access Deck

MAYHEM BEHIND THE WHEEL

POWERED WATERCRAFT TYPES

Personal Watercraft (PWC) - this covers 1 and 2 rider jetski and waverunner style craft.

PWC: Init +5; Atk rundown +1 melee (2d4+ Collision damage bonus); AC 13*; Armor Die: [1d3]; HD d6; Speed cruise 1/ max 5; Act 1d20; SV Fort +0, Ref +3, Will NA; Fuel Tank 1d5; Guzzle 0.
* *Vehicle only, passenger(s) use individual ACs*
Basic Traits: Very Nimble, Very Dangerous, Open

Bowrider - These are 2-4 passenger runabout-style vessels.

Bowrider: Init +2; Atk rundown +4 melee (2d6+Collision damage bonus); AC 11*; Armor Die: [1d3]; HD d10; Speed Level cruise 2/ max 3; Act 1d20; SV Fort +2, Ref +1, Will NA; Fuel Tank 1d8; Guzzle 2.
* *Vehicle only, passenger(s) use individual ACs*
Basic Traits: Open

Trawler - This covers long-range cruising boats with an enclosed cabin containing a small kitchen and bathroom. Crew Capacity: 3-5.

Trawler: Init -1; Atk rundown +5 melee (2d7+Collision damage bonus); AC 10; Armor Die: [1d4]; HD d12; Speed Level cruise 2/ max 3; Act 1d20; SV Fort +4, Ref +0, Will NA; Fuel Tank 1d20; Guzzle 3.
Basic Traits: Mini Living Quarters, Access Deck

Cruiser - These are larger versions of the trawler designed with a bit more comfort in mind. Crew Capacity: 3-6.

Cruiser: Init -2; Atk rundown +6 melee (2d8+Collision damage bonus); AC 9; Armor Die: [1d6]; HD d14; Speed Level cruise 2/ max 3; Act 1d20; SV Fort +4, Ref -1, Will NA; Fuel Tank 1d24; Guzzle 4.
Basic Traits: Living Quarters, Access Deck

Houseboat - These large watercraft are small homes with a boat built around it. Crew Capacity: 4-8.

Houseboat: Init -4; Atk rundown +5 melee (2d10+Collision damage bonus); AC 6; Armor Die: [1d7]; HD d16; Speed Level cruise 1/ max 2; Act 1d20; SV Fort +5, Ref -4, Will NA; Fuel Tank 1d30; Guzzle 6.
Basic Traits: Living Quarters x3, Access Deck

Yacht - This covers the giant, multi-level ocean voyage ships that often have a mini dock in the back for a Bowrider sized craft. Crew Capacity: 8-12.

Yacht: Init -3; Atk rundown +7 melee (2d12+Collision damage bonus); AC 7; Armor Die: [1d8]; HD d20; Speed Level cruise 2/ max 3; Act 1d20; SV Fort +6, Ref -3, Will NA; Fuel Tank 1d30; Guzzle 8.
Basic Traits: Deluxe Living Quarters, Mini-Dock

Watercraft Vehicle Traits

The following normal Vehicle Traits can be applied to all watercraft accept Rafts and Rowboats: Armored, Big Tank (powered only), Dangerous, Enhanced Handling, Extra Cargo, Fuel Efficient (powered only), Open, Possessed, Reserve Tank (powered only), Tough, Very Dangerous, Weapon Mount

New Traits

Note that these cannot be installed on Rafts, Rowboats, or PWC.

Access Deck - Attached to the rear of the boat, the platform makes entering and exiting the water easier for swimmers and PWC riders. A smaller craft (PWC or rowboat) can be tethered here.

Deluxe Living Quarters - This boat has an extensive kitchen facility and multiple bathrooms capable of servicing 8 people comfortably or double that with difficulty.

Hydrofoils - These are shaped vanes (foils) that lift the hull clear of the water to increase the boat's max speed by +1. The craft's Reflex save is also increased by +1 when traveling faster than Cruise speed.

Living Quarters - This boat has a full kitchen and bathroom facility capable of servicing 5 people comfortably or double that with difficulty.

Mini-Dock - This allows the craft to house a smaller craft (2 PWCs, 1 rowboat, or 1 bowrider). The craft is housed in the water for easy exit and docking.

Mini Living Quarters - This boat has a tiny kitchen and bathroom facility capable of servicing 3 people comfortably or double that with difficulty.

Moon Pool - (*Trawler and larger only*) a mid-hull water access port for divers and equipment.

MAYHEM BEHIND THE WHEEL

GYROCOPTERS AND ULTRALIGHTS

Very few pre-cataclysm aircraft are still functional. The most common aircraft seen are small 1-2 man craft built from recycled wrecks or scrap. They follow all of the rules for vehicles (including Quality levels and control rolls) with the following exceptions:

- In addition to speed, aircraft have Height Cruise/ Max rating that determines how high they can fly, see *Table HGT-1*.
- Aircraft use their own Wipeout table, *Table AWO-1*.
- Even minor Wipeouts can result in fatal crashes.

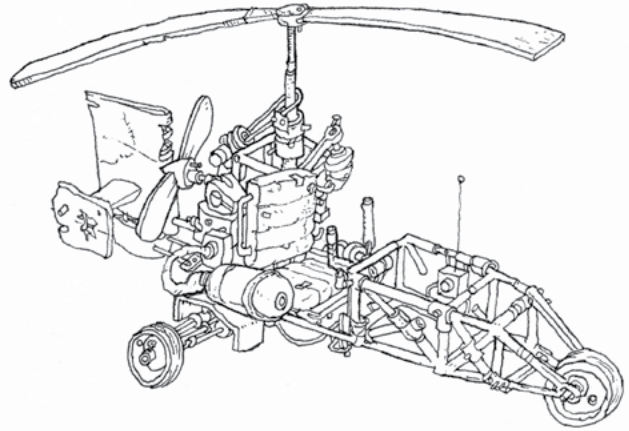

Table HGT-1: HGT levels

Height Level	Handling Modifier	Rough Height	Penalty to Hit Ground Targets	Chance of Bad Turbulence per Hour	Crash Damage
1	0	100'	-1 (+1 AC vs. Ground attacks)	30% (-1d8 Handle Mod)	3d6
2	-1	200'	-2 (+2 AC vs. Ground)	30% (-1d7 Handle Mod)	5d6
3	-2	600'	-3 (+4 AC vs. Ground)	25% (-1d6 Handle Mod)	7d6
4	-3	1200'	-6 (+8 AC vs. Ground)	25% (-1d5 Handle Mod)	9d6
5	-4	3600'	-9 (+12 AC vs. Ground)	20% (-1d4 Handle Mod)	11d6
6	-5	7200'	-12 (+16 AC vs. Ground)	15% (-1d3 Handle Mod)	13d6
7	-6	12000'	-15 (+24 AC vs. Ground)	10% (-1d3 Handle Mod)	15d6

The Vehicle Control roll (aircraft edition)

In addition to the normal modifiers an aircraft has the following additional modifier to the roll:

- Changing Altitude by more than one level of Height in a round +2 per lvl

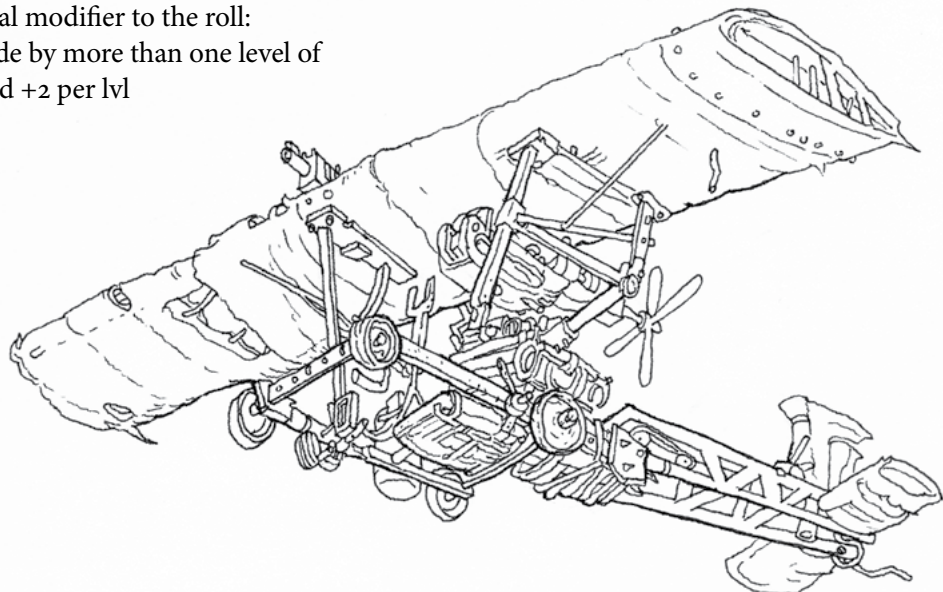

MAYHEM BEHIND THE WHEEL

Table AWO-1: Aerial Wipeout Results

Roll the Wipeout die appropriate to the Speed rating of the aircraft (determined on *Table SPD-1*) and subtract the pilot's Luck mod. Luck may be burned to effect this result. If a drop in height would cause the craft to make contact with the ground (Height level 0) they suffer the Crash Damage listed for the height level they lost control at plus the Collision Damage Bonus for the speed they were traveling at.

1-3	Just a little lurch! Speed and height are reduced by 1 and all vehicle control checks next round are at -1 to the roll.
4-6	That was close! Speed and height are reduced by 1 and craft must make a Fortitude save (DC 10) or all actions are taken at minus one die step until repaired.
7-9	Hold onto your butts! Speed and height are reduced by 2 and craft must make a Fortitude save (DC 15) or all actions are taken at minus one die step until repaired.
10-12	Major Fail. Control is lost for 1d3+1 rounds plus speed and height are reduced by 2 and must make a Fortitude save (DC 15) or all actions are taken at minus two die steps until repaired.
13-15	We are going down! Control is lost and Speed and height are reduced by 2 and there is a 35% chance of control damage causing all future vehicle control checks to be made at -1 die step. Attempts may be made to land safely but the craft must land or crash. If this results in a crash, there is a 40% chance that the fuel system catches fire and explodes in 1d5 rounds.
16+	SPLAT! Control is lost and craft plummets to the ground. Height is reduced by 2 per round until craft reaches the ground. Speed increases by 1 per round. One vehicle control roll may be made to control the crash. Success indicates all crash damage is reduced by 5% for every point the roll succeeded by. A failed roll means the pilot and passengers must make a Fortitude save (DC 12) or be killed upon impact. After the crash there is a 60% chance that the fuel system catches fire and explodes in 1d5 rounds.

AIRCRAFT VEHICLE TRAITS

The following normal Vehicle Traits can be applied to aircraft: Armored, Big Tank, Dangerous, Enhanced Handling, Extra Cargo (Gyrocopter only), Fuel Efficient, Open, Possessed, Reserve Tank, Very Dangerous, Weapon Mount

New Traits

Auto Rotate - This gyrocraft's main propeller will allow the craft to glide and drop at a slower pace when control is lost. -1 to all Wipeout tests and all crash damage is reduced by 33%.

Bomb Rack - Holds 5 grenade class explosives rigged to detonate on impact.

Bombing Sights - Adds +1d3 to all dropped weapon attack rolls.

Good Instruments - Adds +1d3 to navigation checks and -1 to Guzzle on long flights.

Glider - This craft can remain aloft by gliding when the engine is not running. The craft will drop one level of height for every two miles of gliding. Control rolls are made at -1 die type when gliding.

Superior Glider - This craft will only drop one level of height for number of miles traveled equal to its current height, with a minimum of two miles. i.e. five miles at Height 5 then four miles at Height 4, etc.

Piloting Aircraft and Petrol Heads

Unlike ground vehicles, aircraft are not very easy to pilot. Until one is accustomed to flying them, all action dice are reduced to 1d12 (1d16 for Petrol Heads). This learning process requires 2d30+10 hours of practice to be an accomplished pilot. A Petrol Head can use all of their normal vehicular abilities with aircraft once they get accustomed to them.

MAYHEM BEHIND THE WHEEL

MECHS AND OTHER ROBO-VEHICLES

Mechs are generally considered to be anthropomorphic robotic vehicles intended for battle or construction. They follow all of the rules for vehicles (including Quality levels and control rolls) with the following exceptions:

- Mechs use their own Speed and Wipeout tables: *Table MSPD-1* and *Table MWO-1*.
- Their unique design allows them to perform anthropomorphic actions, including the use of tools and melee weapons.
- They have no implied passenger or cargo space.

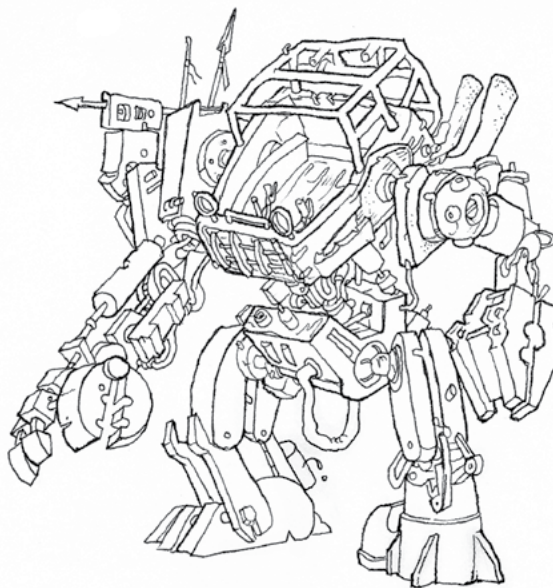

Table MSPD-1: Mech Speed Levels

Speed Level	Handling Modifier	Wipeout Die	Melee/Ram Damage Bonus	Rough MPH	Move per Round
1	0	1d3	+1	10	80'
2	-1	1d5	+2	20	160'
3	-2	1d7	+4	35	280'
4	-4	1d10	+6	45	360'
5	-6	1d14	+9	55	440'
6	-9	1d20	+12	70	560'

Table MWO-1: Mech Wipeout Results

Roll the Wipeout die appropriate to the Speed rating of the mech (determined on *Table MSPD-1*, above) and subtract the driver's Luck mod. Luck may be burned to effect this result.

- 1-3 **Misstep.** Speed is reduced by 1 and all actions taken next round are at -1 to the roll.
- 4-6 **That was close!** Speed is reduced to 0 and a 25% chance that it falls over, causing 1d4+SPD bonus damage to mech and pilot. All actions next round are minus one die step.
- 7-9 **Slip and Slide.** Control is lost for 1d2 rounds plus mech slides/stumbles 2d8' and then Speed is reduced to 0. There is a 60% chance that it falls over, causing 1d6+SPD bonus damage to mech and pilot. All actions next round are minus one die step.
- 10-11 **Major Trip.** Control is lost for 1d3+1 rounds plus mech slides/stumbles 2d20' and then Speed is reduced to 0. There is a 90% chance that it falls over, causing 1d8+SPD bonus damage to mech and pilot. All actions for the next 2d3 rounds after control is reestablished are minus one die step.
- 12-13 **Face Plant.** Control is lost and mech falls over, causing 1d10+SPD bonus damage to mech and pilot. Mech must make a Fortitude save (DC 15) or all actions are taken at -1 die step until repaired. There is a 20% chance that the fuel system catches fire and explodes in 1d5 rounds.
- 14+ **Wreck.** Control is lost and mech falls over, causing 2d6+SPD bonus damage to mech and pilot. Mech must make a Fortitude save (DC 20) or all actions are taken at -2 die steps until repaired. Pilot must make a Fortitude save (DC 20) or be knocked unconscious. There is a 40% chance that the fuel system catches fire and explodes in 1d5 rounds.

MAYHEM BEHIND THE WHEEL

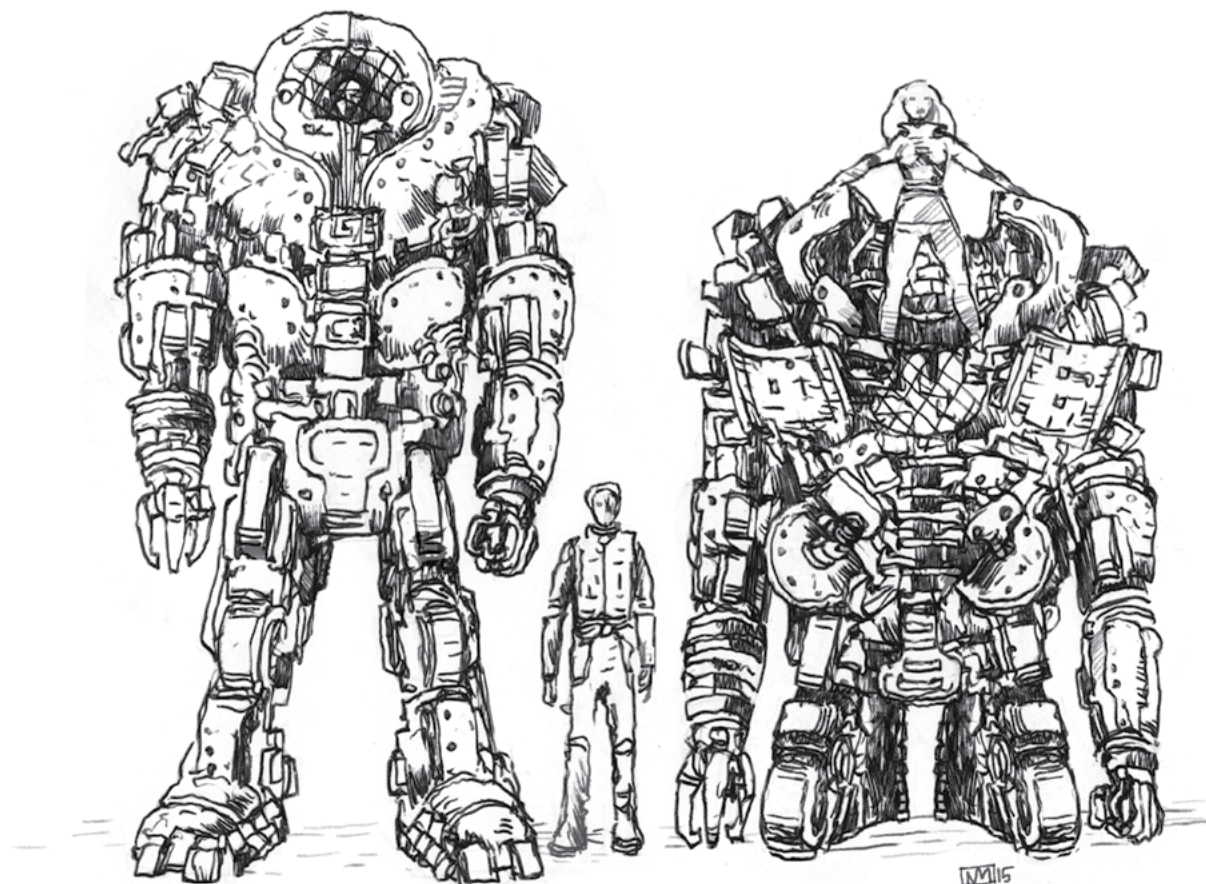

Mech Types

Light Mech - This category covers mechs between 10-15' tall.

Light Mech: Init -1; Atk kick/stomp +1 melee (2d5+Spd bonus), punch +3 melee (2d3+Spd bonus); AC 11; Armor Die: [1d4]; HD d12; Speed Level cruise 1/ max 3; Act 1d20; SV Fort +3, Ref +1, Will NA; Fuel Tank 1d12; Guzzle 5.

Basic Traits: Mecha, High Maintenance

Heavy Mech - This covers towering engines of destruction 20+' tall.

Heavy Mech: Init -3; Atk kick/stomp +3 melee (2d8+Spd bonus), punch +5 melee (2d6+Spd bonus); AC 10; Armor Die: [1d6]; HD d16; Speed Level cruise 1/ max 2; Act 1d20; SV Fort +5, Ref 0, Will NA; Fuel Tank 1d20; Guzzle 9.

Basic Traits: Mecha, High Maintenance x2

Mech Vehicle Traits

The following normal Vehicle Traits can be applied to mechs: Armored, Big Tank, Dangerous, Enhanced Handling, Fuel Efficient, Fog Lamps, Heavily Armored, Heavy Weapon Mount, Nimble (light only), Off Road, Open, Possessed, Reserve Tank, Rugged, Safety Features, Very Dangerous, Weapon Mount

New Traits

Agile - All Wipeout dice are lowered by one die step.

Advanced Gyros - Lowers the chance to fall over on wipeouts by -20% and lowers crash damage by 1d4+Pilot's Luck mod points.

Heavy Labor - The mech can lift and carry heavy loads (light mechs: 1 ton, heavy mechs: 2 tons).

High Maintenance - Vehicle requires constant maintenance to run well. This costs 1d16sp per hour of continuous use. May be taken more than once.

MAYHEM BEHIND THE WHEEL

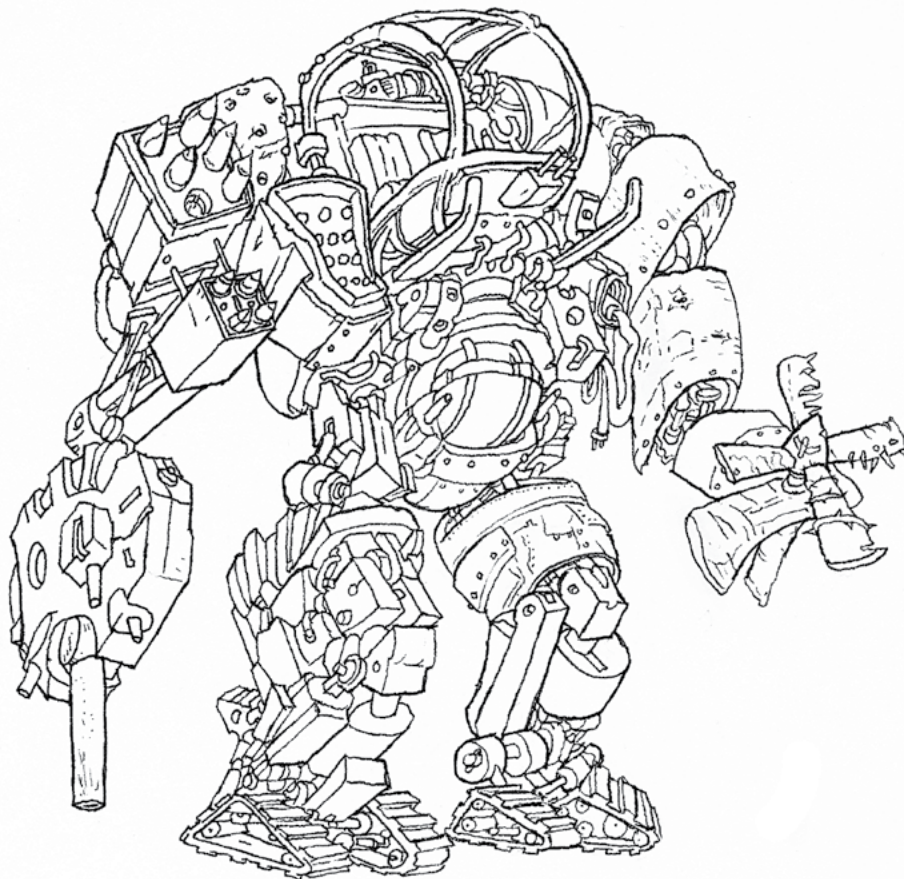

Jump Jets - The mech can generate enough thrust to leap up to 30' vertically and 60' horizontally. Employing the Jump Jets requires **two** immediate Fuel consumption checks at +1 Guzzle.

Mecha - The vehicle may make anthropomorphic movements and actions such as hunkering down, crawling, jumping, hiding, carrying, etc.

Melee Upgrade - all melee attacks inflict an additional +2d6 damage.

Super Melee Upgrade - (*Heavy Mechs only*) all melee attacks inflict an additional +3d6 damage.

Piloting Mechs and Petrol Heads

Unlike cars, mechs are not at all intuitive to pilot. Until one is accustomed to driving them, all action dice are reduced to 1d10 (1d16 for Petrol Heads). This learning process requires 2d20+8 hours of practice to be an accomplished robot-jockey. A Petrol Head can use all of their normal vehicular abilities with mechs once they get accustomed to them.

NON-MOTORIZED LAND TRAVEL

The majority of the sparse populous of Umerica do not have access to motor vehicles when they need to travel. Some live along one of the few rail lines that has passenger cars but the tickets are expensive enough that it cannot be used as a regular means of getting around. This has led to many ingenious methods of using what is at hand to get where you need to go.

Riding and Draft Beasts

The skill of domesticating riding and draft animals has regained its former status of being the most common means for travel in Umerica. As there are numerous mutant beast that a person may attempt to domesticate, use the following generic stat blocks for commonly domesticated beasts as a good starting place when determining a beast's capabilities. In general, most beasts can move at double move for no more than 1d3 turns (10-30 minutes) or triple move

MAYHEM BEHIND THE WHEEL

for no more than 5d6 rounds (1-3 minutes) before they need to be rested. Failing to do this will invoke Fortitude saves versus injury. Moving at normal move and carrying a normal load, beasts can usually travel for 8-12 hours a day with a few short rests every few hours.

Small Beast (mule, pony, donkey): Init +1; Atk bite/kick/stomp +1 melee (1d3); AC 12; Armor Die nil; HD 2d8; MV 40'; Act 1d20; SV Fort +4, Ref +2, Will +1; AL N.

Medium Beast (horse): Init +1; Atk bite/kick/stomp +2 melee (1d5+2); AC 13; Armor Die nil; HD 3d8; MV 60'; Act 1d20; SV Fort +4, Ref +3, Will +1; AL N.

Large Beast (elephant): Init -1; Atk bite/kick/stomp +3 melee (1d7+3); AC 12; Armor Die [1d3]; HD 5d8; MV 50'; Act 1d20; SV Fort +6, Ref +2, Will +2; AL N.

Giant Beast (dinosaur): Init -2; Atk bite/kick/stomp +4 melee (1d10+4); AC 10; Armor Die [1d4]; HD 8d8; MV 40'; Act 1d20; SV Fort +8, Ref +0, Will +3; AL N.

Beast Control Checks

Generally beasts will do their best to accommodate their master's requests and to avoid hazards they

come across. Making a beast do exactly what you want it to requires a Personality check (DC 4+the Beast's Will save mod) with the following modifiers:

Head into possible danger	+3
Head in to certain danger	+6
Travel at double move	+2
Travel at triple move	+4
Jumping a minor gap (less than 10ft)	+4
Jumping a major gap (10ft - 15ft) (min Speed 2)	+9
Travel at night (no night vision or light)	+4
Travel while injured (less than 75% of HP remaining)	+6

Failure indicates the beast will ignore the master's commands for the round, requiring the master to make the control attempt again next round. If the Beast Control check comes up a fumble, consult the table below.

Table BCF: Beast Control Fumbles

Roll 1d12 plus the Beast's Will save mod. Modify the result by the master's Luck mod.

0	Just a bit stubborn. The beast obeys the command 2d3 rounds later.
1-5	Ornery Critter. All control rolls for this beast suffer a -2 penalty for the next 1d6 hours.
6-8	Very Ornery. There is a 50% chance that any directions given will be ignored for the next 1d6 hours.
9-11	Bucking. The beast no longer wants anything to do with its master and will attempt to free itself of a rider or harness. It will make a melee attack versus its master each round until freed or brought back under control, Personality check (DC 8+ double the Beast's Will save mod). Success indicates the harness has been shucked or the rider must make a Reflex save versus the attack total or suffer 2d6 falling damage.
12+	Out for Blood. The beast is filled with hate and wishes to do its master in. It will buck as described above. Should it free itself of its harness or throw its rider, it will continue to deliver frenzied melee attacks to its master until killed, stunned, or otherwise restrained.

MAYHEM BEHIND THE WHEEL

BICYCLES

While maintaining a motor vehicle can be nigh impossible due to constant breakdowns and lack of fuel, finding a functional bicycle and keeping it in running condition is much easier, especially in former suburban areas.

Cycling Speeds

Casual (~5 MPH/SPD 0 average per hour) - This rate of travel can be maintained over light terrain for 6-8 hours with minimal rest time per day. Control rolls are only necessary when hazards are encountered.

Routine (~10 MPH/SPD 1 average per hour) - This rate of travel can be maintained over light terrain for 6-8 hours with a Stamina check (DC 10) every 2 hours. Failure requires the rider to slow to Casual speed for an hour or suffer 1 point of temporary Stamina damage per hour until they rest for 30 minutes. Then, they can make another Stamina check (DC 10) to see if they can maintain Routine speed again. Control rolls are necessary for hazards and sharp turns.

Sprint (~20 MPH/SPD 2 average per hour) - A Stamina check (DC 13) must be made every every turn to maintain this speed. Failure requires the

rider to slow to Casual speed for an hour or suffer 1 point of temporary Stamina damage per turn Sprint speed / hour Routine speed until they rest for 1 hour. Then, they can make another Stamina check (DC 10) to see if they can maintain any speed higher than Casual again that day. Control rolls are necessary for hazards and turns.

All Out (~35 MPH/SPD 3 average per hour) - A Stamina check (DC 15) must be made every every 10 rounds (1 minute) to maintain this speed. Failure inflicts 1d3-1 (0-2) points of temporary Stamina Damage and requires the rider to slow to Casual speed for 1d3 hours or suffer 1 point of temporary Stamina damage per 10 rounds All Out speed / turn Sprint speed / hour Routine speed until they rest for 1d3 hours. Then, they can make another Stamina check (DC 13) to see if they can maintain any speed higher than Casual again that day. Control rolls are necessary every 10 rounds and for any hazards or turns.

Bike Control Checks

Bicycle control checks are made using the rider's Reflex save plus any modifier from the cycle they are riding.

Table BCM: Bicycle Control Modifiers

Basic Control roll	5
Sharp turn at Speed 2	+3
Sharp turn at Speed 3	+6
Doing minor tricks	+2+Spd
Doing major tricks	+5+Spd
Avoid minor road hazard (small animal in road, small pothole)	+1+Spd
Avoid major road hazard (large animal in road, giant pothole)	+3+Spd
Avoid minor off-road hazard (stumps, rocks, heavy foliage)	+2+Spd
Avoid major off-road hazard (boulder, trees, large sinkhole)	+5+Spd
Jumping a minor gap (less than 10')	+5
Jumping a major gap (10' - 15') (min Speed 2)	+8
Jumping a ludicrous gap (15' - 25'), ramp required (min Speed 3)	+12
At night with no lights or night vision	+6
With a flat tire, per tire	+2

MAYHEM BEHIND THE WHEEL

Table BWO-1: Bicycle Wipeout Results

Roll the Wipeout die appropriate to the Speed rating of the vehicle (determined on *Table SPD-1*) and subtract the driver's Luck mod. Luck may be burned to effect this result.

0	Just a little fishtailing. 50% chance Speed is reduced by 1
1-3	Minor Skid. Control is lost for 1 round and Speed is reduced to Causal. Each tire has a 5% chance to be damaged.
4-7	Major Skid. Control is lost for 2 rounds and Speed is reduced to Causal. Each tire has a 10% chance to be damaged.
8-10	Lay down the bike. Bike and rider skids for 2d30' and come to a stop. Each tire has a 25% chance to be damaged. Bike and rider suffer 1d4+Collision bonus damage.
11+	Total Fail. Bike and rider skids for 3d30' and come to a stop. Each tire has a 65% chance of being irreparably damaged. The bike takes 2d4+Collision bonus damage. Rider is thrown 3d4' and must make a Fortitude save (DC 10) or suffer 1d4 broken bones, success indicates they only suffer 2d4+Collision bonus damage and 1d3 temporary Stamina damage.

SAIL WAGGONS

These vehicles are useful in areas where abundant winds are readily available. They employ a sail and rigging system to catch the wind in a similar manner to a sailboat, except that they are generally operated from a sitting or lying position and steered by pedals or hand levers. Skilled pilots can go three to four times faster than the wind speed for short periods.

Prevailing Wind Speeds

As these vehicles are completely dependant on the wind for their propulsion, knowing the current wind speed is required. Use the following guidelines for the average wind speed of an area. These speeds can vary up to 50% in mild weather and up to 200% in foul weather.

Clear flat land	3d6+6 MPH (Speed Level 1-2)
Flat land w/ windbreaks	3d4+4 MPH (Speed Level 1)
Clear hills	2d3+2 MPH (Speed Level 0-1)
Hills w/ windbreaks	1d3+2 MPH (Speed Level 0)
Urban ruins	2d12 MPH (Speed Level 0-2)

Table SVCM: Sail Vehicle Control Modifiers

Unless otherwise noted below, use the modifiers on *Table VCM: Vehicle Control Modifiers* for sail vehicles.

Basic Control roll	6
Move one level faster than current wind speed	10
Move two levels faster than current wind speed	14
Move three levels faster than current wind speed	19
Decelerate more than 1 speed level in a round	+3 per level
Make a sharp turn	+3
Sailing into the wind	+8

MAYHEM BEHIND THE WHEEL

Table SWWO-1: Sail Waggon Wipeout Results

Roll the Wipeout die appropriate to the Speed rating of the vehicle (determined on *Table SPD-1*) and subtract the driver's Luck mod. Luck may be burned to effect this result.

0	Just a little fishtailing. 50% chance Speed is reduced by 1
1-3	Minor Skid. Control is lost for 1 round and Speed is reduced by 1d2. Each tire has a 5% chance to be damaged.
4-6	Major Skid. Control is lost for 2 rounds and Speed is reduced by 1d2+1. Each tire has a 10% chance to be damaged.
7-8	Spin. The waggon ends up at new facing. Roll 1d12 for facing by clock position. Control is lost for 1d3+1 rounds and Speed is reduced by 1d3+1. Each tire has a 15% chance to be damaged. 40% chance of 2d4+Collision bonus damage to vehicle.
9-10	Roll. The waggon rolls in the direction it was originally going, losing 1d3 levels of Speed per round. Each tire has a 25% chance to be damaged. The sail is damaged and will require 2d6 turns of repair to function again. The waggon suffers 3d4+Collision bonus damage as well. Passengers are thrown 3d6' and suffer 1d4+Collision bonus damage.
11+	Total Carnage. Good luck walking away from this. The waggon rolls in a random direction, losing 1d3 levels of Speed per round. Each tire has a 75% chance of being destroyed. The waggon takes 6d4+Collision bonus damage to vehicle and both the sail and mast are destroyed. Passengers are thrown 3d10' and must make a Fortitude save (DC 10) or die, success indicates they only suffer 4d4+Collision bonus damage and 1d3 temporary Stamina damage.

SAIL VEHICLE TYPES

Single - These sail vehicles are barely more than a sail attached to a reinforced, offroad skateboard. They are intended for a single, standing rider with no cargo space.

Single: Init +3; Atk nil; AC 13*; Armor Die: nil; HD 2d4; Speed (wind powered); Act 1d20; SV Fort +0, Ref +3, Will NA; Fuel Tank (wind powered); Guzzle (wind powered).

* *Vehicle only, passenger(s) use individual ACs*

Basic Traits: Very Nimble, Very Dangerous, Open, Off Road

Small - A sail craft designed for 2-3 riders or 1 rider and a bit of cargo. Generally these are three wheeled vehicles employing two front wheels and one rear wheel for optimal tacking and steering.

Small: Init +1; Atk ram +1 melee (2d3+Spd bonus); AC 11*; Armor Die: nil; HD 3d8; Speed (wind powered); Act 1d20; SV Fort +0, Ref +1, Will NA; Fuel Tank (wind powered); Guzzle (wind powered).

* *Vehicle only, passenger(s) use individual ACs*

Basic Traits: Dangerous, Open, Off Road

Large - Similar to the design of the smaller craft, this sail waggon uses four wheels for stability and can carry 10+ more passengers or a significant amount of cargo.

Large: Init -1; Atk ram +2 melee (2d5+Spd bonus); AC 9*; Armor Die: nil; HD 4d12; Speed (wind powered); Act 1d20; SV Fort +1, Ref -1, Will NA; Fuel Tank (wind powered); Guzzle (wind powered).

* *Vehicle only, passenger(s) use individual ACs*

Basic Traits: Dangerous, Open, Off Road



VOLATILE MAGIC

VOLATILE MAGIC

MERCURIAL MAGIC OF THE WASTELANDS

Roll	Result
------	--------

- | | |
|-------|---|
| 0 | Slow Death - Every time the wizard casts the spell, they lose one hit point <i>permanently</i> . |
| 1-2 | Luck Siphon - Each time this spell is cast one of the caster's allies within 200', determined randomly, loses one point of Luck. |
| 3-4 | Radiation Leak - A burst of minor radiation is emitted by the caster each time this spell is cast. This kills all normal plant life within 30' and requires living creatures within the zone, not including the caster, to make a Fortitude save (DC 10) or lose 1d2 hit points <i>permanently</i> . |
| 5-6 | Casting Feedback - the casting roll for this spell suffers a -3d6-CL (min 0) penalty each time it is cast. |
| 7-8 | Counter-magic effect - In the round following the casting of this spell, all other spells (including the wizard's own) cast within 100' suffer a -1d7 penalty to spell checks. |
| 9-10 | Health Siphon - Each time this spell is cast 1d4 of the caster's allies within 100', determined randomly, suffers 1 point of temporary Stamina damage. This loss does not count as spellburn. |
| 11-12 | Dimensional Tear - Casting the spell tears a jagged hole in the fabric of the multiverse. There is a cumulative 1% chance each time the spell is cast that an extradimensional horror steps through the rift. The fearsome creature has HD equal to the caster's level + 5. Roll 1d3: (1) the being steals the spell from the PC's mind before vanishing forever; (2) the being attacks the PCs with the intent to slay the caster; (3) the being seeks to strike a bargain with the caster, offering the caster forbidden knowledge (GM's choice) in exchange for 2d3 of the caster's ally's souls. |
| 13-14 | Sickening - Each time this spell is cast, the caster suffers an additional -1 die step to all Fortitude saves until they have at least 8 hours of sleep. |
| 15-16 | Slow cast - The spell requires 1d3+1 x the normal time to cast. |
| 17-18 | Special Component - The spell requires the caster to possess an uncommon, pre-cataclysmic substance or item to power its magic, beyond the normal components. This material component is determined by the GM and its rarity should be indicative of the spell's power. The object or item is consumed by a successful casting. |
| 19-20 | On Loan - The formula for this spell was leased by the caster from a powerful entity (determined by the GM). Every time the spell is cast there is a cumulative 1% chance per spell level that an agent of the entity will appear to collect a lease payment (determined by the GM). |
| 21-22 | Beast Attractor - Each time the spell is cast there is a cumulative 1% chance per spell level added to all random encounter rolls for the day. The effect dissipates at dawn. |
| 23-24 | Cannibal Magic - The caster suffers damage equal to 1d4+the spell's level each time he casts it, unless he is physically touching another individual willing to suffer the damage in his stead. Unwilling or unknowing individuals cannot be forced to suffer for the wizard. |

VOLATILE MAGIC

MERCURIAL MAGIC OF THE WASTELANDS (CONTINUED)

Roll	Result
25-26	Terror-inducing - Casting the spell inspires terror in animals and creatures with an Intelligence score of 3 or less. All such creatures within 50' flee the caster as quickly as possible for 1d14 rounds. If restrained, the animals panic and must make a Will save (DC 8) or die of fright. The caster's familiar, if any, is immune.
27-28	Spontaneous Mutation - In the immediate area whenever a spell is cast random bits of the flora and fauna undergo sudden mutations. Roll 1d14 minus the caster's Luck mod to determine the overall nature of these mutations: (1) beneficial to the caster & allies; (2-10) generally harmless; (11+) hazardous to the caster & allies.
29-30	Cataclysmic Flashbacks - Casting this spell causes the caster to experience visions filled with the horrors of the Great Cataclysm. The caster must succeed on a DC 13 Will save or be overcome by hallucinations of being caught up in the cataclysm that last 1d3 rounds. If the caster ever succeeds on the Will save with a natural 20, he masters the visions and gains special insight from them. Once mastered, all future spell checks for this spell are made with 1d24.
31-32	Circumstantial Magic - The wizard can only cast this spell under specific environmental or personal conditions. Roll 1d10 to determine the condition: (1) in the dark of night; (2) under the brightness of the sun; (3) while near a running electrical generator; (4) while intoxicated; (5) after eating a large meal; (6) underground; (7) while in the presence of radiation; (8) while naked; (9) from a moving vehicle; (10) when reduced to 50% or less of total hit points.
33-34	Hazard Siren - A blaring siren noise accompanies the casting of this spell for 1d3 rounds. This siren can be heard out to at least 1000' from the caster. This is very likely to reveal the caster's location, making them an easy target.
35-36	Binary Screech - The words of the spell are composed of analog machine code, normally unutterable by mortals. An extradimensional machine entity is channeled to speak the spell through the wizard's own throat. The strain of channeling the unnatural voice leaves the wizard unable to speak for 1d4 rounds after the spell has been cast.
37-38	Ravenous - The wizard becomes ravenously hungry after casting the spell. Hungry people are often cranky, so the wizard suffers -2 Personality until he is able to eat.
39-40	Alopecia - Each time this spell is cast all of the hair on the caster's body falls out. If the caster is already hairless then the effect will happen to a random person within 10' of the caster.
41-60	No change. The spell manifests as standard.
61-62	Diurnal/Nocturnal Magic - The spell's power is tied to either night or day. During the ascendant period, the wizard rolls 1d24 for spell checks; during the descendent hours he rolls 1d16. If the wizard's spell check does not use a 1d20, roll an appropriately higher and lower die according to the dice chain.
63-64	Face Change - Each time this spell is cast, the caster's facial features change so they look like a different person. The change never results in the same face twice.

MERCURIAL MAGIC OF THE WASTELANDS (CONTINUED)

Roll Result

- 65-66 **Nuka's Blessing** - Casting this spell results in the wizard emitting a bright green glow for 1d4 rounds, granting opponents a +2 bonus to attacks against the caster. It also negates any concealment and invisibility enjoyed by the caster, but does provide a faint illumination to the area immediately surrounding the wizard and +4 to all saves versus radiation.
- 67-68 **Temporal Echo** - Each time the wizard casts this spell, he predicts the numerical result of his spell check roll. If he rolls this number exactly, the spell automatically re-casts itself each round for 1d3 rounds. The predicted result must be a successful spell check; predicting a failed result has no effect.
- 69-70 **Chain casting** - Each successive casting of the spell grants a +1 bonus to a wizard's spell check, up to a total bonus equal to the caster's level or Intelligence modifier (whichever is higher). If the wizard casts another spell, he breaks the chain, resetting the modifier back to +0.
- 71-72 **Outsourcing** - The spell's power can be amplified with the assistance of other wizards. For each wizard present and willing to assist the caster, the casting wizard gets a +1 modifier to his spell check. In addition, each wizard involved can choose to spellburn. Assisting in spell casting does not require knowledge of the spell, but the assistant mages can perform no other action until the spell is cast.
- 73-74 **Tide of Ash** - All vegetative matter within 10' per spell level is reduced to ash. Vegetative creatures caught within this radius take 1d14 points of damage per spell level.
- 75-76 **Magicgram** - The wizard can choose another object to deliver this spell in his stead. The object must be known to the caster and be connected to an area within reach of the caster that is linked by electrical and/or communication cabling. He must first touch the cable and then cast the spell, which does not take effect at that time. The proxy releases the spell a number of rounds later equal to 1d4+the spell's level.
- 77-78 **Silenced** - At his discretion, the wizard is able to cast the spell silently. He need not speak, and any auditory effects of the spell can be suppressed.
- 79-80 **Dimensional Schism** - By casting the spell, the wizard hurls himself into the warp of multiple realities. 1d7+1 duplicates of the caster appear, identical in nearly every respect, but each drawn from its own parallel universe. Attacks against the caster are randomly assigned across the doppelgangers. The doppelgangers remain for 1 round per spell level. There is a 1% chance per spell level that the original caster vanishes into one of the alternate realities, replaced by a nearly identical incarnation of opposite alignment and patron.

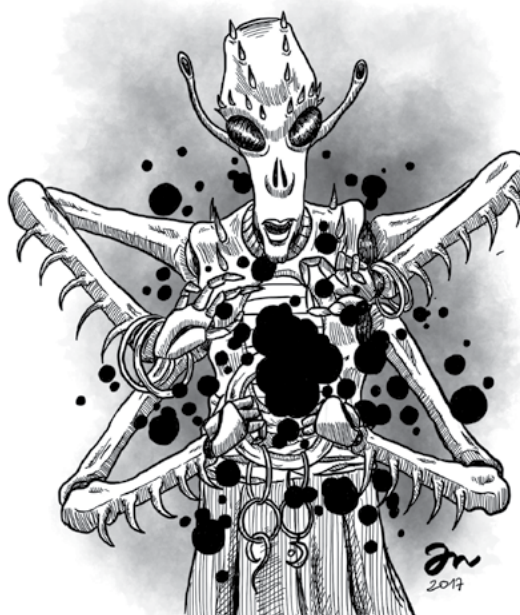

VOLATILE MAGIC

MERCURIAL MAGIC OF THE WASTELANDS (CONTINUED)

Roll	Result
------	--------

- | | |
|--------|---|
| 81-82 | Roach Plague - Thousands of cockroaches pour from the caster's clothing, scattering in every direction. Physical attacks against the caster are softened by 1d4 points of damage, the blow cushioned by the skittering tide of insects. |
| 83-84 | Mentalism - The wizard can cast the spell using ESP alone. He need not move, speak, breathe, or use any material ingredients to invoke the effects. |
| 85-86 | Terrible to Behold - The wizard becomes fearsome when casting the spell. Roll 1d6: (1) he appears to grow in size; (2) he takes on a horrid expression; (3) he glows a fiery red; (4) his body is shadowed while his face is brightly lit; (5) the aspect of his patron towers above him; (6) the wind whirls around him. |
| 87-88 | Planar Blink - After casting the spell, the caster unpredictably blinks in and out of this plane of existence, granting a +4 bonus to the wizard's AC at a cost of a -4 penalty to all the wizard's attacks. The effect lasts for 1 round per spell level. There is a 1% chance per spell level that the wizard does not return from his involuntary jaunt across the cosmos. |
| 89-90 | Powerful Caster - Instead of rolling as normal on a spell check, the wizard rolls a die improved by one step on the dice chain (e.g., d20 becomes d24). |
| 91-92 | Alien Allies - Floating rodent-sized alien creatures fly forth from the wizard's clothes, hovering around him in a writhing fury. They attack enemies within 10' (atk +2, 1d4 dmg) and aid the spell as appropriate before dissipating in a cloud of ash after 1 minute. |
| 93-94 | Phase out - After casting this spell, the wizard shifts out of phase with the world, making him invisible and invulnerable to attack but preventing him from interacting with his environment. This state lasts for 1d6 rounds +1 round per level of the spell. |
| 95-96 | Rain of Hell - Casting this spell sparks a downpour of diminutive demons that fall in a 30' diameter centered on the caster. All within that area must make a Reflex and Fortitude save (DC 10+caster's Intelligence modifier). Failing the Reflex save indicates the character is knocked prone and pined for 1d3+CL rounds; failing the Fortitude save means the character has been mauled by tiny hellspawn for 1d3 points of damage. |
| 97-98 | Natural-born Talent - Instead of rolling as normal on a spell check, the wizard rolls a die type improved by two steps on the dice chain (e.g., if he normally rolls 1d20, he now rolls 1d30). |
| 99-100 | Roll again twice. |
| 101+ | Roll again twice , but instead of rolling d%, roll 4d20 modified by the wizard's Luck adjustment (in increments of 10%). |



GRIMMOIRE OF THE WASTES

GRIMOIRE OF THE WASTES

SUMMON FOULNESS

Level: 1 **Range:** 30' + 10'/level **Duration:** special **Casting time:** 1 round **Save:** special

General: Urth is a foul place, and the southern city of the People of the Sun, Atlan, is perhaps the most famously polluted. Among them are the feared Priests of the Filth Eater, able to summon up filth and pollution with their magics. With this spell the caster summons forth a pool of a foul pollutant, causing those in the target area to slip and fall and perhaps suffer ailments from the exposure.

Manifestation: Roll 1d4: (1) the caster vomits forth the toxic sludge, rapidly coating the area; (2) vile ooze quickly seeps up from the ground; (3) a geyser of liquid filth erupts from the center of the area; (4) the caster summons and throws a fleshy, pustule covered orb that copiously bursts upon impact.

Corruption: Roll 1d5: (1) caster's breath reeks of filth and toxins. Whenever he exhales, anyone immediately adjacent must make a Fortitude save (DC 12) or be ill for 1d4 hours (-1 to all rolls while sickened); (2) caster leaves a trail of noxious mucus behind him as he moves. Anyone coming into contact with it automatically becomes sickened for 1d4 hours unless they make a Fortitude save (DC 12) (-1 to all rolls while sickened); (3) the caster's skin becomes covered in multicolored boils that burst at the slightest touch. Anyone coming into contact with him automatically suffers 1 point of temporary Stamina damage and must make a Fortitude save (DC 12) or the Stamina loss is permanent; (4-5) minor corruption.

Misfire: Roll 1d4: (1) a 10' radius pool of pollutants, centered on the caster, forms and everyone within it must make two saves, a Reflex save (DC 12) and a Fortitude save (DC 12). Failing the Reflex save mean the person slips and is now prone. Failing the Fortitude save means the person becomes sickened for 1d4 hours (-1 to all rolls while sickened); (2) The spell seems to go off but it is a glowing medicinal sludge that heals 1d4 damage to all within 20' of intended target; (3) a large pool of vibrant ooze forms around the target but is harmless and smells like artificial fruit flavoring (it has no nutritional value); (4) the same effect as result 18-19 on the spell result chart but the area of effect fills 10,000 square feet.

-
- | | |
|-------|--|
| 1 | Lost, failure, and worse! Roll 1d6 modified by Luck: (0 or less) corruption + patron taint + misfire; (1-2) corruption; (3) patron taint (or corruption if no patron); (4+) misfire. |
| 2-11 | Lost. Failure. |
| 12-13 | A 10' radius pool of foul muck forms around the target and everyone within the area must make a Reflex save or be restricted to ¼ their normal move. The muck remains for CL rounds. |
| 14-17 | A 10' radius pool of slippery sludge forms around the target and everyone within the area is restricted to ¼ their normal move and must make a Reflex save or fall prone with a -1 die step penalty to getting up again. The sludge remains for CL+1d3 rounds. |
| 18-19 | A 20' radius pool of pungent slime forms around the target and everyone within the area is restricted to ¼ their normal move and must make a Reflex save or fall prone with a -1 die step penalty to getting up again. In addition, all those within the pool must make a Fortitude save or suffer -1 die step to all actions due to the smell. The sludge remains for CL+1d5 rounds. |
| 20-23 | As the previous result but 1d3 15' radius pools are formed that each surround a different target. |
| 24-27 | A 40' radius pool of writhing contaminated ooze forms around the target and everyone within the area is restricted to ¼ their normal move and must make a Reflex save or fall prone with a -2 die step penalty to getting up again. In addition, all those within the pool must make a Fortitude save or become sickened: -1 die step to all actions and suffer 1d3 temporary Stamina damage. Continue |

GRIMOIRE OF THE WASTES

- making saves each day until three are passed in a row, the illness is cured by magical / technological means, or the target dies. Failed saves inflict a further -1 die step to all actions and suffer 1d3 temporary Stamina damage. Normal healing does not occur while ill. The ooze remains for CL+1d7 rounds.
- 28-29 As the previous result but 1d3 + ½CL 15' radius pools are formed that each surround a different target.
- 30-31 A 60' radius pool of pulsing, glowing sewage forms around the target and everyone within the area is restricted to ¼ their normal move and must make a Reflex save or fall prone with a -2 die step penalty to getting up again. In addition, all those within the pool must make a Fortitude save or Mutate, see pg 168. The ooze remains for CL+1d7 rounds.
- 32+ A number of 25' radius pools of infectious nuclear waste equal to CL form around an equal number of targets up to 200' away. Everyone within each area falls prone with a -2 die step penalty to getting up again. In addition, all those within the pool must make a Fortitude save or become sickened (as in result 24-27) and Mutate, see pg 168. Also, anyone sickened by these pools can infect others while they are still ill. Anyone coming into close contact with a sick person must make a Fortitude save (DC 13) to avoid getting sick. The waste remains for CL turns. The areas occupied by the pools are permanently blighted and radioactive.



GRIMOIRE OF THE WASTES

CURSE OF LIFE

Level: 2 **Range:** special **Duration:** 1 turn per caster level **Casting time:** 1 round **Save:** Will

General: It is said that an ailing scientist, desperate to live long enough to continue his work, made a deal with a demon to do so. What the scientist wasn't told was that the living would take place in the entirety of an instant, and so he lived to be 1,000 years old in the span of less than a minute.

Manifestation: Roll 1d4: (1) the air around the target swiftly wavers as the target ages; (2) a demon appears out of thin air and sucks the youth from the target through a fancily curved drinking straw; (3) the target rapidly blinks in and out of existence as they visibly age with each blink; (4) The target conclusively coughs up their youth as a fine golden mist while the spell takes effect.

Corruption: Roll 1d4: (1) The caster now ages at a rate of 1 year per month; (2) All of the caster's mundane possessions rapidly age and crumble into dust; (3) The caster's body regresses back to being 5 years old but his mind and magical ability is unaffected; (4) The caster ceases to age for the next 5d30 years but also will not naturally heal during this time.

Misfire: Roll 1d4: (1) Everyone within 20' of the caster ages 2d8 years, permanently; (2) The spell acts as a Haste spell (DCC RPG, pg 221) except the targets of the spell are random. Make a casting roll on that spell result table; (3) A random target within 50' of the caster has their hair turn gray and grow 1d3' longer; (4) Everyone within one mile of the caster now ages twice as fast.

- | | |
|-------|---|
| 1 | Lost, failure, and worse! Roll 1d6 modified by Luck: (0 or less) corruption + patron taint + misfire; (1-2) corruption; (3) patron taint (or corruption if no patron); (4+) misfire. |
| 2-11 | Lost. Failure. |
| 12-13 | Failure, but spell is not lost |
| 14-17 | One target touched by the caster must make a Will save or instantly age 2d10 years. For every 4 years they age they also suffer 1 point of temporary Stamina and Agility damage. They will return to their normal age as they recover from the attribute damage. |
| 18-19 | As the previous result but the target ages 3d10 years. |
| 20-23 | As the previous result but the the caster can affect a target up to 10' x CL away. |
| 24-27 | 1d3+1 targets within 20' x CL of the caster must make a Will save or instantly age 4d10 years. For every 4 years they age they also suffer 1 point of temporary Strength, Stamina, and Agility damage. They will return to their normal age as they recover from the attribute damage. |
| 28-29 | One target within 30' x CL of the caster permanently ages 3d10 years and suffers 1d3 points of permanent Stamina, Agility, and Strength Damage. Also their Movement is reduced by 5' and critical hits against target now gain a +1 die step bonus to the Crit die. On a successful Will save, the target only ages 2d10 years temporarily and suffers 1d3 points of temporary Stamina, Agility, and Strength Damage. They will return to their normal age as they recover from the attribute damage. |
| 30-31 | As the previous result but the target permanently ages 5d10 years and suffers 1d4+1 points of permanent Stamina, Agility, and Strength Damage if they fail their Will save. |
| 32-33 | As the previous result but the the caster can affect up to 1d3+1 targets within range. |
| 34+ | Up to CL+1d3 targets within 30' x CL must make a Fortitude save or else immediately die of impossibly old age. Those that successfully save may die anyways as they permanently age 5d10 years and suffer 1d4+1 points of permanent Stamina, Agility, and Strength Damage. |

GRIMOIRE OF THE WASTES

TECH JINX

Level: 3 **Range:** 20' per CL **Duration:** 1 round per CL **Casting time:** 1 round **Save:** Will*

General: It First cast by Mokka - the infamous wandering priest of Grokk - against the now forgotten peoples of Chi-town, this spell causes all technological devices affected to malfunction, break, or even explode.

Manifestation: Roll 1d4: (1) A stream of giggling ethereal devils fly from the caster's fingers into the targeted tech; (2) The targeted device glows malevolently as does the caster's eyes; (3) Several tiny goblinoids wearing tool belts pop out of nowhere and infest the device; (4) Multitudes of insects begin pouring out of the nooks and crannies of the device.

Corruption: Roll 1d4: (1) Every technological device the caster touches has a 33% chance of ceasing to function properly for 1 turn; (2) One random part of the caster's body becomes riddled with various kinds of electrical cables and circuit boards; (3) Each technological device on the caster's person becomes an organic, living creature. They fully retain all former capabilities and functions but now must be fed and cared for; (4) One random part of the caster's body transforms into a techno-organic version of the device originally targeted.

Misfire: Roll 1d4: (1) One random technological device within 20' of the caster explodes, causing 2d4 damage to all within 10'; (2) All technological devices within 30' of the caster will activate and perform their normal functions; (3) One random technological device within 20' of the caster becomes an organic, living creature. It fully retains all former capabilities and functions but now must be fed and cared for; (4) One broken technological device within 100' is instantly repaired and begins to function.

-
- | | |
|-------|--|
| 1 | Lost, failure, and worse! Roll 1d6 modified by Luck: (0 or less) corruption + patron taint + misfire; (1-2) corruption; (3) patron taint (or corruption if no patron); (4+) misfire. |
| 2-11 | Lost. Failure. |
| 12-15 | Failure, but spell is not lost |
| 16-18 | One technological device that the caster points at will begin to malfunction. Every time it is used there is a 33% chance it will simply not function or function incorrectly in a way that hampers the user. If the target is complex enough that it incorporates several technological components (i.e. a tank or helicopter) then only one component is affected (i.e. the steering or engine). If the device is self aware, it is entitled to a Will save to avoid this effect when cast. |
| 19-23 | As the previous result but 1d3+1 devices may be effected. |
| 24-27 | One technological device of the caster's choosing will go out of control. For the duration of the spell it will simply not function or function incorrectly in a way that hampers the user, caster's choice. If the target is complex enough that it incorporates several technological components (i.e. a tank or helicopter) then up to CL number of components are affected (i.e. the steering or engine). If the device is self aware, it is entitled to a Will save to avoid this effect when cast. |
| 28-29 | One technological device of the caster's choosing will go out of control for the duration of the spell and then breakdown. It will activate randomly or function incorrectly in a way that hampers the user, caster's choice each round. At the end of the duration the device will be damaged and require repairs to function again. If the target is complex enough that it incorporates several technological components (i.e. a tank or helicopter) then up to 1d4+CL number of components are affected (i.e. the steering or engine). If the device is self aware, it is entitled to a Will save for each component to avoid this effect when cast. |

GRIMOIRE OF THE WASTES

- 30-31 As the previous result but $1d3+1$ devices may be effected.
- 32-33 $1d3+1$ technological devices of the caster's choosing will go out of control for the duration of the spell and then catastrophically fail, resulting in an explosion. It will activate randomly or function incorrectly in a way that hampers the user, caster's choice each round. At the end of the duration the device will explode causing $3d4$ damage to all within 5'. The device is destroyed in the explosion. If the target is complex enough that it incorporates several technological components, all components are affected. If the device is self aware, it is entitled to a Will save for each component to avoid this effect when cast.
- 34-35 As the previous result but $1d3+CL$ devices may be effected and the explosion damage is increased to $3d6$.
- 36+ The caster can affect any number of technological devices within 200' that they choose to with the effects of result 24-27, 28-29, or 32-33. They may choose different results for each device they affect. If the device is self aware, it is entitled to a Will save for each component to avoid this effect when cast.



GRIMOIRE OF THE WASTES

FORMER GLORY

Level: 4 **Range:** touch **Duration:** special **Casting time:** 1 turn **Save:** none

General: Reaching back through time, the caster can restore an object or place to the moment it was in perfect condition. Due to the harrowing nature of this spell, it requires 3 points of spellburn to cast and this spellburn is not counted as a bonus to the casting roll.

Manifestation: Roll 1d4: (1) The swirling sands of time rapidly whip around the target. Bystanders clearly see time being reversed upon the target until it is restored; (2) 2d100 faceless and featureless humanoids bearing tools appear and restore the target over the casting time; (3) Glowing hands descend from the heavens and replace the ruined version of the target with the restored one; (4) The target pulses in and out of existence. Each time it returns it is in slightly better condition until it is perfect as the casting ritual is finished.

Corruption: Roll 1d4: (1) All of the objects on the caster's person are hurled back in time, each to the point of when the caster acquired them; (2) The caster now ages in reverse, looking younger and younger until they die as an unborn fetus; (3) As the caster travels, he leaves an obvious path of renewal and restoration in his wake; (4) All timekeeping devices within 50' of the caster will go haywire as long as they are within his presence.

Misfire: Roll 1d4: (1) A random object within 20' of the caster is fully restored for 1 day; (2) Everyone within 30' of the caster grows 1d12 years younger; (3) The intended target(s) disintegrates into dust; (4) A random person within 100' of the caster is restored to their prime age with all hit point and attribute damage healed.

-
- | | |
|-------|---|
| 1 | Lost, failure, and worse! Roll 1d6 modified by Luck: (0 or less) corruption + patron taint + misfire; (1-2) corruption; (3) patron taint (or corruption if no patron); (4+) misfire. |
| 2-11 | Lost. Failure. |
| 12-17 | Failure, but spell is not lost |
| 18-19 | One object or building of a rough size of 20 ³ is restored to prime condition with all capabilities and functions working. It will remain in this condition for CL turns. |
| 20-23 | As the previous result but the size of the object or location can be up to 40 ³ and the duration is CL hours. |
| 24-27 | The caster may touch 1d3+1 objects or locations of a rough size of 40 ³ each within CL rounds and fully restore them. They will remain in this condition for CL hours. |
| 28-29 | As the previous result but the size of the objects or locations can be up to 100 ³ each and the duration is CL days. |
| 30-33 | One object or building of a rough size of 150 ³ is permanently restored to prime condition with all capabilities and functions working. |
| 34-35 | As the previous result but the size of the object or location can be up to 300 ³ and any damage done to it within CL hours will self repair in a matter of minutes. |
| 36-37 | As the 30-33 result but the size of the object or location can be up to 1,000 ³ and any damage done to it within CL days will self repair in a matter of minutes. |
| 38+ | The caster may touch 1d3+1 objects or locations of a rough size of 1,500 ³ each within CL turns or one object or location can be up to 10,000 ³ and permanently restore them. Any damage done to them within CL months will self repair in a matter of minutes. |

GRIMOIRE OF THE WASTES

XENORAX'S INSTANT ARMY

Level: 5 **Range:** touch **Duration:** at least one hour **Casting time:** 1 turn **Save:** none

General: Summons a large number of loyal humanoid minions, armed and ready to serve. To determine their appearance, roll d6: (1) Goblinoid; (2) Reptilian; (3) Simian; (4) Shark-like; (5) Owl-like; (6) Robotic. To determine their coloration, roll d8: (1) red; (2) orange; (3) yellow; (4) green; (5) blue; (6) violet; (7) black; (8) white.

Minion Stat Blocks

Lesser Minion: Init +0; Atk club +1 melee (1d4); AC 10; Armor Die [1d3]; HD 1d6+1; MV 30'; Act 1d20; SP none; SV Fort +2, Ref +0, Will -1; AL as caster.

Greater Minion: Init +1; Atk Polearm +2 melee (1d10+1) or crossbow +2 missile (1d6) ; AC 11; Armor Die [1d3]; HD 2d6+2; MV 30'; Act 1d20; SP none; SV Fort +3, Ref +1, Will +0; AL as caster.

Minion Captain: Init +2; Atk sword and shield +3 melee (1d8+1); AC 11; Armor Die [1d4]; HD 3d6+4; MV 30'; Act 1d20; SP one free extra trait, all minions under its command gain +1 to all saves; SV Fort +3, Ref +1, Will +2; AL as caster.

Minion Traits

Weapon Upgrade: The minions are summoned with a better choice of weapons. See the progression chart below:

Club (1d4) → Spear (1d8) → Polearm (1d10) → Vibrolance (2d6, crit on 19+)

Sword & Shield (1d8 & +1 AC) → Vibrosword and Power Shield (1d10, crit on 19+ & +2 AC)

Crossbow (1d6, 40/80/120) → Bolt Action Rifle (d10, 120/240/360) → Assault Rifle (d10, 100/200/300)

Hardy: The minions all have max hit points. If taken a second time, increase their hit points by +2 per HD.

Blessed: The minions gain +1 to all saves. If taken a second time, increase the bonus to +2.

Beefy: The minions gain +1 to all melee attacks and damage. If taken a second time, increase the bonus to +2.

Fast: The minions' Move is increased to 40'. If taken a second time, their move is increased to 50'.

Heavy Armor: The minions' AC is increased by +1 and their Armor Die is increased by +1 die step. If taken a second time, increase the AC bonus to +2 and their Armor Die is increased by +2 die steps. If taken a third time, increase the AC bonus to +3 and their Armor Die is increased by +3 die steps.

Grenader: Each minion is equipped with 2 frag grenades. If taken a second time, each minion has 4 frag grenades.

Resistant to Magic: (counts as two traits) each minion gains a +10 bonus to save versus magic effects.

Flying: (counts as two traits) The minions have wings and may fly at twice their normal move. This stacks with Fast.

Persistent: (counts as two traits) The minions' summoned duration is doubled.

Manifestation: Roll 1d4: (1) As the casters speaks the ritual, arcane mists pour from his mouth and form into his minions; (2) The minions sprout like gourds from the ground, rapidly growing to full size by the end of the casting time; (3) Each minion appears in a flash of appropriately colored light; (4) The minions slowly fade into existence as though marching from another dimension.

GRIMOIRE OF THE WASTES

Corruption: Roll 1d4: (1) All of the fingers of the caster's left hand permanently form into likenesses of the minions, which chatter endlessly; (2) All creatures summoned in the future, by any means, will greatly resemble the caster so as there will be no mistaking who summoned them; (3) The caster's left and right hands are switched; (4) One of the casters limbs, at random, will drop off and form into a permanently summoned greater minion.

Misfire: Roll 1d3: (1) A random person within 20' of the caster will be transformed into a lesser minion; (2) The skin color of everyone within 20' of the caster will change, consult the minion coloration chart; (3) A random object within 50' of the caster ignites and continues to burn until extinguished.

-
- | | |
|-------|---|
| 1 | Lost, failure, and worse! Roll 1d6 modified by Luck: (0 or less) corruption + patron taint + misfire; (1-2) corruption; (3) patron taint (or corruption if no patron); (4+) misfire. |
| 2-11 | Lost. Failure. |
| 12-17 | Failure, but spell is not lost |
| 18-19 | The caster summons CL lesser minions to do his bidding for CL turns. They are suicidally loyal but quite literal when interpreting orders. |
| 20-23 | A number of lesser minions are summoned equal to CL x2 plus the caster may choose one Minion Trait to apply to all of them. They are suicidally loyal but quite literal when interpreting orders. The duration of the summoning is CL turns. |
| 24-27 | As the previous result but the number of lesser minions summoned is equal to CL x3 and the caster can choose two Minion Traits to apply to all of them. |
| 28-29 | The caster summons one greater minion with two Minion Traits to lead a band of CL x4 lesser minions. The caster can choose two Minion Traits to apply to all of the lesser minions. The greater minion is much better at interpreting orders, but not perfect. The duration of the summoning is CL x3 turns. |
| 30-33 | A number of greater minions are summoned equal to CL x2 plus the caster may choose one Minion Trait to apply to all of them. The greater minions are much better at interpreting orders than lesser minions, but not perfect. The duration of the summoning is CL hours. |
| 34-35 | As the previous result but the number of greater minions summoned is equal to CL x3 and the caster can choose two Minion Traits to apply to all of them. |
| 36-37 | The caster summons one Captain minion with three Minion Traits to lead a band of CL x5 greater minions. The caster can choose three Minion Traits to apply to all of the greater minions. The duration of the summoning is CL x3 hours. |
| 38+ | The caster summons a horde of greater minions equal to CL x10 and chooses three Minion Traits to apply to all of them. They are divided up into squads of 10 minions and each squad is led by a Captain minion with four Minion Traits. Each squad may have different Minion Traits. The duration of the summoning is CL days.
Alternatively, the caster can choose to summon CL x25 lesser minions instead that are led in squads of 25 minions each. The caster can choose two Minion Traits to apply to all of the lesser minions. Each squad may have different Minion Traits. |





MUTATIONS

MUTATIONS

Throughout Umerica there are a multitude of those that have been altered by one of the various forms of background radiation, pools of hazardous industrial waste, alien genetic tampering, or rogue nanoviruses. Most are “harmless” as the mutations they suffered are generally detrimental but there are a few that won big in the mutagenesis lottery. These beings are usually either treasured members of their community or terrible twisted monsters that communities fear will raid them. Most folk are pretty opinionated on what they think of mutants.

GAINING MUTATIONS

When any character encounters a potent radiation source, an alien bio-substance, or an ancient mutagenic weapon; they have a chance of gaining one or more mutations. If the exposure does not have any save DC noted assume a Fortitude save (DC 11) is required to avoid mutating. On a failed mutation save the victim rolls a single mutation. A natural 1 on any mutation save indicates 1d3+1 mutations are gained. The change begins rapidly and the victim will be incapacitated for 1d12 turns while the transmutation takes its course and suffer 1d3 point of temporary Stamina damage per mutation.

At this point a Cleric can attempt to use Lay On Hands to delay or prevent the mutation:

- A result of 3 dice can delay the onset of the mutation for 3d6+CL hours. A mutation can only be delayed for a maximum number of hours equal to the victim's Stamina attribute+CL+20.
- A result of 5 dice can actually prevent the mutation entirely or completely reverse a mutation up to the Cleric's CL in days since its onset. After that, nothing a Cleric can do, short of calling upon their god, can help.

Due to the random nature of mutation, there is a chance that one or more of a character's attributes, other than Luck, may permanently increase beyond a score of 18 or dip below 3. Reference *Table EAB: Extended Attribute Bonuses* below for the modifiers on these exceptional attributes. The gods do not look as mercifully upon those who have attribute scores greater than 18 as they might regular folk. Characters will lose 1 point of permanent Luck for each attribute naturally greater than 18. On the plus side, characters will gain 1 point of permanent Luck for each attribute naturally lower than 3.

Table EAB: Extended Attribute Bonuses

Score	Bonus
1-2	-4
3	-3
4-5	-2
6-8	-1
9-12	0
13-15	+1
16-17	+2
18	+3
19-20	+4
21-23	+5
24-27	+6

MUTATIONS

THE MUTAGENESIS PROCESS

Roll d% on *Table MU-1: Base Mutation Table* to determine the nature of the mutation. Then, roll d% on the resulting mutation type sub table to determine the actual mutation. Once the mutation is established, note the base trait for the mutation and then roll d% for each of the possible Beneficial Traits and Detrimental Traits that the mutation can bestow.

Mutants may spend any amount of their Glow Pool to adjust any of the d% rolls involved in gaining a mutation, either adding to or subtracting from the rolled result. When rolling for possible Beneficial Traits and Detrimental Traits, the mutant should roll all four at once and then choose which they would like to spend Glow pool on to adjust.

Ruby is going to play a Mutant with a Stamina of 15, giving her a Glow pool of 45. She begins determining just how mutated she is by rolling d%, getting a 62. This would be an Altered Body type mutation but she chooses to use 3 of her 45 Glow Pool to adjust the roll to 65 - Weaponization.

Next she rolls d% on the Weaponization subtable, getting a 27 and determines it is Spines. This gives her a natural ranged attack dealing 1d3 damage, range 10/20/30.

Now she rolls d% for both of the Beneficial Traits and both of the Detrimental Traits.

Roll 1: 35 means she missed gaining the 1st Beneficial Trait.

Roll 2: 68 means she missed gaining the 2nd Beneficial Trait.

Roll 3: 81 means she missed suffering the 1st Detrimental Trait.

Roll 4: 06 means she suffers the 2nd Detrimental Trait.

As she does not have enough Glow pool to adjust the 2nd roll, she will not be able to get the 2nd Beneficial Trait. She would normally have to take the 2nd Detrimental Trait but she chooses to spend 15 Glow Pool to adjust the 4th roll to avoid this, leaving her with 27 Glow pool. Finally, for 5 Glow pool she can adjust the 1st roll so she can have the 1st Beneficial Trait. This leaves her with 22 Glow Pool remaining to use on future mutations.

Now she writes the following on her character sheet:

Weaponization - Spines

Has spines that grow from her body. Can be used as thrown darts; 1d3 damage, range 10/20/30.

Has numerous spines that will wound anyone attempting to grapple or grab her, Reflex save (DC 12) or suffer 1d3 damage.

Table MU-1: Base Mutation Table

Roll %	
1-16	Bestial
17-32	Botanical
33-48	Aggregate
49-64	Altered Biology
65-80	Weaponization
81-96	Freak Abilities
97+	Roll twice more, ignoring this result, and combining the two results.



MUTATIONS

Bestial Subtable

Roll %

- 1-11 **Avian:** has avian-like features (beak, feathers, wings, etc) and gains a beak attack (damage 1d3).
Additional Beneficial Traits
30% chance of functional wings with a flight speed of 20+2d20.
20% chance of having superior vision: +1d5+2 on visual perception checks.
Additional Detrimental Traits
45% chance of having wing-arms which reduce Agility by -1d3.
30% chance of having a full beak which reduces all social speech attempts by -2 die steps.
- 12-22 **Bovid:** has goat or bovine-like features (horns, cloven hooves, fur or wool, etc) and has a four stomached, ruminant digestive system capable of digesting grasses and other plant matter for sustenance.
Additional Beneficial Traits
30% chance of having large horns (damage 1d4, double damage on a charge)
20% chance of gaining +1d3+1 Strength and +10' to movement.
Additional Detrimental Traits
45% chance of being a total vegetarian and requiring to casually "graze" on food for at least 1d3+2 hours total a day to stay healthy.
30% chance of being easily spooked when ambushed. If a Will save (DC 10) is failed during the surprise round, they must flee for the next 1d8-Personality mod rounds. If they cannot flee all other actions suffer -1 die step penalty during that time.
- 23-33 **Canine:** has dog-like features (fur, tail, claws, etc) and can see perfectly both day or night but, only in grayscale tones.
Additional Beneficial Traits
30% chance of lethal jaws and claws (damage 1d5)
20% chance of superior sense of smell (+1d6+4 to track by smell)
Additional Detrimental Traits
45% chance of having a hunched posture which reduces movement by 5'.
30% chance of having a short attention span which reduces Intelligence by -1d3
- 34-44 **Crustacean:** has crab-like features (chitinous shell, etc) and gains +3 AC but also suffers -5 to Initiative rolls.
Additional Beneficial Traits
30% chance of having a chitinous carapace which acts as 4 steps of natural armor to their Armor Die, which will regenerate at a rate of 1 step per week or can each be mended as a broken bone.
20% chance of being fully Amphibious. They can breathe underwater as well as they can on land.
Additional Detrimental Traits
45% chance of having claws instead of hands which reduce Agility by -2d3 in occasions of manual dexterity. Also they gain a natural unarmed damage of 1d3+1.
30% chance of having multiple semi-vestigial legs which reduce movement by 10'.
- 45-55 **Feline:** has cat-like features (fur, tail, whiskers, etc) and gains +1 die step on balance and jumping checks.
Additional Beneficial Traits
30% chance of superior balance: plus +1d3 to Agility
20% chance of having perfect night vision to 120'
Additional Detrimental Traits
45% chance of having paws instead of hands which reduce Agility by -1d3 in occasions of manual dexterity.
30% chance of being a quadruped reducing movement by half when mutant is using front legs to hold an item rather than run.
- 56-66 **Piscine:** has fish-like features (scales, fins, hairless, etc). They can see clearly underwater and gain +1 die step to all swimming checks.
Additional Beneficial Traits
30% chance of being fully Amphibious. They can breath underwater as well as they can on land.
20% chance of having functional flippers granting +5 to all swim checks and +10' Swim move speed.
Additional Detrimental Traits
45% chance of needing daily immersion in water for at least an hour or suffer 1 Stamina damage.
30% chance of having vestigial fins which reduce movement by 5'.

MUTATIONS

Bestial Subtable (continued)

Roll %

67-77 **Amphibian:** has frog-like features (bulbous eyes, long legs, etc) and all jump actions gain a +2 die step bonus.
Additional Beneficial Traits
30% chance of having webbed hands and feet granting +5 to all swim checks and +10' Swim move speed.
20% chance of having a tongue that can instantly launch out up to 15' and make a free grapple attack with a 1d14 action die. If successful and the target resists, the target is dragged 1d6+the Mutant's Strength mod in feet towards the mutant. Objects lighter than 20 lbs are automatically pulled to the mutant.
Additional Detrimental Traits
45% chance of unconsciously croaking all of the time. This inflicts -1d3 Personality and -3 to all move silent attempts.
30% chance of being completely hunched over and unable to move at more than a stroll without hopping. This does not reduce their movement rate but makes them very obvious when moving, inflicting a -8 to all attempts at stealthy maneuvers.

78-88 **Reptilian:** has lizard-like features (colorful scales, claws, fangs, etc) and gains +1 AC but suffers +1d3 damage from cold attacks.
Additional Beneficial Traits
30% chance of having a poisonous bite, 1d4+poison (DC 8+Lv, -1d3 Stamina)
20% chance of having thermal sense to 40', can be used for missile attacks at -1d4 to hit.
Additional Detrimental Traits
45% chance of being cold blooded. You suffer a -1d3 penalty to all activity at night or underground.
30% chance of needing to shed your skin on a monthly basis. When shedding, you suffer -1d4 Agility & Stamina for 1d3 days.

89-99 **Testudine:** has tortoise-like features (shell, beak, etc) and gains +2 AC but also suffers -3 to Initiative rolls.
Additional Beneficial Traits
30% chance of having an armored carapace which acts as 3 steps of natural armor to their Armor Die, which will regenerate at a rate of 1 step per week or can each be mended as a broken bone.
20% of having health improved by +1d3 Stamina and a natural life span elongated by +8d8 years.
Additional Detrimental Traits
45% chance of having a very slow gate, -10' move speed.
30% chance of having slow joints which reduces Agility by -1d3

100+ **Roll twice more** on this table, ignoring this result. The mutant is a combination of both results.



MUTATIONS

Botanical Subtable

Roll %

- 1-18 **Tree-like:** has tree-like features (bark, branches, leaves, etc) and gains +1 AC and +1 Strength but also suffers -4 to Initiative rolls.
Additional Beneficial Traits
30% chance of having thick bark skin which acts as 2 steps of natural armor to their Armor Die, which will regenerate at a rate of 1 step per 3 days or can each be mended as a broken bone.
20% chance of being able to regenerate lost limbs naturally in 1d3 weeks.
Additional Detrimental Traits
45% chance of needing to take root in soil for at least an hour a day or suffer 1 Stamina damage.
30% chance of having to make a DC 10 save every hour or immediately fall asleep at night or in total darkness. Can be woken by strong light, suffering any damage, or 6 hours of uninterrupted sleep.
- 19-36 **Bush-like:** has bush-like features (green tint, leaves, etc) and gains a +6 bonus to hide amongst foliage.
Additional Beneficial Traits
30% chance of being able to live off of photosynthesis. No food is required other than 12 hours of sunlight.
20% chance of producing special berries, roll 1d6 for type:
1-2: Nutritious, 1 berry is good for a whole meal (1d12/week).
3-4: Poisonous, 1 berry inflicts a Fortitude save (DC 7+level) or suffer -1d3 temporary Stamina (1d7/week).
5-6: Explosive, 1 berry inflicts 1d3 dam per level, 3' radius (1d3/week).
Additional Detrimental Traits
45% chance of needing to take root in soil for at least an hour a day or suffer 1 Stamina damage.
30% chance of having to make a DC 10 save every hour or immediately fall asleep at night or in total darkness. Can be woken by strong light, suffering any damage, or 6 hours of uninterrupted sleep.
- 37-56 **Vine-like:** has vine-like features (tendrils, leaves, etc) and gains a +3 bonus to all grapple and climb checks due to scores of tiny tendrils.
Additional Beneficial Traits
30% chance of having natural camouflage, +5 to hide wherever there is heavy foliage.
20% chance of having 1d4, 5' tendrils you can use at a Strength & Agility of 10.
Additional Detrimental Traits
45% chance of needing to take root in soil for at least an hour a day or suffer 1 Stamina damage.
30% chance of having to make a DC 10 save every hour or immediately fall asleep at night or in total darkness. Can be woken by strong light, suffering any damage, or 6 hours of uninterrupted sleep.
- 57-72 **Flower-like:** has flower-like features (blooms, leaves, pleasant odor, etc) and is striking in appearance, +1d3 Personality.
Additional Beneficial Traits
30% chance of having numerous poisonous thorns that will prick anyone attempting to grapple or grab the mutant, Reflex save (DC 10) or suffer 1d3 damage.
20% chance of being able to make a pollen attack 1d5 times per day, range 5/10/15. Causes Fortitude DC 10+level or sneeze for 1-3 rounds.
Additional Detrimental Traits
45% chance of increasing wandering encounters involving monsters attracted by your fragrance by 20%
30% chance of having to make a DC 10 save every hour or immediately fall asleep at night or in total darkness. Can be woken by strong light, suffering any damage, or 6 hours of uninterrupted sleep.

MUTATIONS

Botanical Subtable (continued)

Roll %

- 73-90 **Fungi-like:** has fungi-like features (spongy flesh, rubbery skin, etc) and is immune to all diseases and toxins related to rot or decomposition.
Additional Beneficial Traits
30% chance of being able to recover 1 hit die of hit point damage overnight by sleeping undisturbed in a bed of decaying organic matter.
20% chance of being able to project spores as a 10' ranged attack 1d3 times per day. Victim must make a Fortitude save (DC 10+level) or suffer 1d3 temporary Stamina damage.
Additional Detrimental Traits
45% chance of randomly and noisily releasing spores at inopportune moments. -2 die steps to all social interactions.
30% chance of having to eat a diet entirely consisting of rotting organic matter.

- 91-96 **Roll again twice** on this table, ignoring this result. The mutant is a combination of both results.

- 97+ **Roll again on this table**, ignoring this result, and on another subtable (roll 1d5: 1 - Bestial, 2 - Aggregate, 3 - Altered Biology, 4 - Weaponization, 5 - Freak Abilities). The mutation is a combination of both results.



MUTATIONS

Aggregate Subtable

Roll %

- 1-32 **Granite:** has stone-like features (hairless, calcified skin, etc) and gains +3 AC but also suffers -5 to Initiative rolls.
Additional Beneficial Traits
30% chance of having stone-like skin which acts as 4 steps of natural armor to their Armor Die, which will regenerate at a rate of 1 step per week or can each be mended as a broken bone. They also suffer -1d3+1 Agility.
20% chance of gaining +1d3+1 to both Strength & Stamina but also losing -1d3+1 Agility.
Additional Detrimental Traits
45% chance of having a lack of mobility, -5' move and -1d2 Agility.
30% chance of having to consume several pounds of quality minerals daily or suffer -1 Stamina for each day without proper sustenance.
- 33-64 **Iron:** has metallic features (hairless, metallic skin, etc) and gains +4 AC but also suffers -10' to movement.
Additional Beneficial Traits
30% chance of having metal skin which acts as 5 steps of natural armor to their Armor Die, which will regenerate at a rate of 1 step per month or can each be mended as a broken bone. They also suffer -1d3+2 Agility.
20% chance of an enhanced skeleton granting +1d4 Strength and +1d3 to unarmed damage.
Additional Detrimental Traits
45% chance of having slow reaction speed inflicting -3 to Initiative and -1d3 Agility
30% chance of being magnetically charged, attracting all small ferrous objects within 3'. Also all unprotected electrical equipment within 5' has a 20% chance of malfunctioning or being damaged.
- 65-96 **Crystalline:** has crystalline features (hairless, gem-like skin, etc) and has hardened skin which acts as 2 steps of natural armor to their Armor Die, which will regenerate at a rate of 1 step per month or can each be mended as a broken bone. They also suffer -1d3 Agility.
Additional Beneficial Traits
30% chance of having prismatic skin, plus 1d3+1 to AC when skin is exposed to bright light.
20% chance of having a jagged claw melee attack, Dam 1d5 and victim must roll under their Luck or begin Bleeding Out for 1d4 rounds.
Additional Detrimental Traits
45% chance of Photoluminescence, -5 to Hiding 24 hours after being exposed to sunlight due to glowing.
30% chance of being brittle, plus 1d4 damage from critical hits taken.
- 97+ **Roll again on this table**, ignoring this result, and on another subtable (roll 1d5: 1 - Bestial, 2 - Botanical, 3 - Altered Biology, 4 - Weaponization, 5 - Freak Abilities). The mutation is a combination of both results.

MUTATIONS



MUTATIONS

Altered Biology Subtable

Roll %

- 1-17 **Giantism:** The majority of the mutants body is enlarged. They gain +2 to Strength but all clothes and armor must be custom made.
Additional Beneficial Traits
30% chance of an additional +1d4 Strength but also -1d3 Intelligence.
20% chance of an additional +1d3+1 Strength but also all Reflex saves are made at -1 die step. Also, they may employ oversized weapons and tools.
Additional Detrimental Traits
45% chance of needing to eat (1d3+1) x 100% more food than normal to avoid starvation.
30% chance of being physically awkward and clumsy, -2d3 Agility.
- 18-34 **Extravore:** The mutant can eat any organic matter and digest it without fear of toxins or disease.
Additional Beneficial Traits
30% chance of having an acidic spit attack; 1d8 damage, range 5/10/15, may spit once every 1d3 hours.
20% chance of +1d3 Stamina
Additional Detrimental Traits
45% chance of having a huge potbelly, suffering -1d3 Agility
30% chance of needing to eat +1d3 x 100% extra food per day or suffer -1d3 damage each night.
- 35-51 **Extra limbs:** the mutant has extra arms, legs, or even tentacles. This can grant a +1 die step bonus to any non-combat task where extra limbs would be useful.
Additional Beneficial Traits
30% chance of having extra functional arms, gains an additional 1d14 action die.
20% chance of having extra functional legs, gains +10' to Movement.
Additional Detrimental Traits
45% chance of having vestigial limbs that move on their own causing a -1d4-1 (0 to -3) penalty to all actions each round.
30% chance of having trouble concentrating due to the extra neural bandwidth required to control the extra limbs, -1d3+1 Intelligence.
- 52-68 **Cranium Abnormality:** the mutant has an unusual head. This grants a +1 die step bonus to all social intimidation rolls.
Additional Beneficial Traits
30% chance of having their head sunk into their torso, 70% chance to ignore any critical hit result involving head strikes.
20% chance of having an extra head that grants +1d4 Intelligence.
Additional Detrimental Traits
45% chance of having a shrunken head, suffers -1d3 Intelligence.
30% chance of having 1d3 extra vestigial heads that interfere with motor control causing a -1d4-1 (0 to -3) penalty to all actions each round.
- 69-85 **Dermal Abnormality:** the mutant has unusual skin. This grants a +1 die step bonus to all social intimidation rolls.
Additional Beneficial Traits
30% chance of having tough warty skin which acts as 1 step of natural armor to their Armor Die, which will regenerate in 3 days or can be mended as a broken bone. They also gain +1 Fortitude save.
20% chance of having chameleon skin granting +2d4+1 to hiding if generally unclothed.
Additional Detrimental Traits
45% chance of having excessive loose skin, suffering -1d3 Agility.
30% chance of having 3d6 extra vestigial gibbering mouths growing randomly around their body, -5 to all silent move checks and +3d6% chance of random encounters.

MUTATIONS

Altered Biology Subtable (continued)

Roll %

- 86+ **Ocular Abnormality:** the mutant has unusual eyes. This grants a +1 die step bonus to all social intimidation rolls.
- Additional Beneficial Traits*
- 30% chance of having large eyes granting particularly acute sight. +1d3 to hit with missile attacks and spot checks.
- 20% chance of having 360° vision and the mutant cannot be snuck up on while awake.
- Additional Detrimental Traits*
- 45% chance of having light sensitive eyes, must wear protective visor when in bright light or suffer -2 to all actions.
- 30% chance of being covered in extra vestigial eyes growing randomly around their body, suffers -1d4 Personality.



MUTATIONS

Weaponization Subtable

Roll %

- 1-17 **Claws:** One or more hands have wicked talons causing 1d4 damage.
Additional Beneficial Traits
30% chance of poison glands If an opponent is clawed they must make a Fortitude save (DC8+Level) or suffer -1d3 temporary Stamina loss.
20% chance of the claws being exceptionally sharp or large, increasing the base damage to 1d6 and crits on a 19+.
Additional Detrimental Traits
45% chance that fine manipulation is lost, -1d3 Agility.
30% chance that the mutant suffers 1hp of damage every time they roll a 1 on an action die due to cutting themselves.
- 18-34 **Spines:** The mutant has spines that grow from their body. Can be used as thrown darts; 1d3 damage, range 10/20/30.
Additional Beneficial Traits
30% chance of having numerous spines that will wound anyone attempting to grapple or grab the mutant, Reflex save (DC 12) or suffer 1d3 damage.
20% chance of a dense coat that acts as 2 steps of armor and 4 ablatives with a Fumble die d6. Lost armor steps / ablatives regenerate at a rate of 1 step per 3 days or can each be mended as a broken bone. Also, this mutant cannot wear normal armor pieces.
Additional Detrimental Traits
45% chance that the spines make noise when the mutant moves causing -1d4+1 to move quietly.
30% chance that the mutant suffers 1hp of damage every time they roll a 1 on an action die due to being wounded by their own spines.
- 35-51 **Fangs:** Jaws are enlarged, reinforced, and full of vicious teeth that inflict 1d5 damage.
Additional Beneficial Traits
30% chance of poison glands adding venom, Fortitude save (DC 8+Level) or suffer -1d3 temporary Stamina loss, to all bite attacks.
20% chance of the fangs being exceptionally sharp or large, increasing the base damage to 1d8.
Additional Detrimental Traits
45% chance of a significant speech impediment causing -1d3 Personality.
30% chance that the mutant suffers 1hp of damage every time they roll a 1 on an action die due to biting their tongue.
- 52-68 **Horns:** Great tusks, horns, or antlers grow from your head which give a natural attack causing 1d4 damage (2d4 when charging).
Additional Beneficial Traits
30% chance of having a mighty frame, +1 Strength and +5' Movement.
20% chance of having a reinforced skull and neck. All horn damage is increased to 1d5 and charges cause 2d5+2 damage plus crits on an 18+.
Additional Detrimental Traits
45% chance of addled brains, -1d3+1 Intelligence.
30% chance that their neck is so stiff that they cannot turn their head. All flank attacks made against them gain +1 die step.

MUTATIONS

Weaponization Subtable (continued)

Roll %

- 69-85 **Club Fist:** One or both hands are enlarged and riddled with bony protrusions, giving the mutant a natural punch attack causing 1d4 damage.
Additional Beneficial Traits
30% chance of the fist and arm being quite big, increasing the base damage to 1d5+1 and adding +1 die step to all strength checks involving the arm.
20% chance of having mighty muscles, +1d4+1 Strength and -1d2 Dex.
Additional Detrimental Traits
45% chance that all missile weapons attacks suffer -1 die step due to poor manual dexterity.
30% chance of having no fine control. All non-combat actions the hand is involved in suffer a -2 die step penalty.
- 86+ **Spikes:** The mutant's body has multiple bony spikes jutting out in various places. These inflict +1d3 damage to all unarmed attacks, natural attacks, and grapples.
Additional Beneficial Traits
30% chance of being very spiky and causing all opponents striking with unarmed or natural attacks to suffer 1d3 damage per attack. All clothes and armor must be custom made.
20% chance that the spikes are serrated and jagged. All damage caused by the spikes are increased to 1d4+1.
Additional Detrimental Traits
45% chance of being very ugly, inflicting -1d3+1 Personality loss.
30% chance that the mutant suffers 1hp of damage every time they roll a 1 on an action die due to catching themselves on their own spikes.



MUTATIONS

Freak Abilities Subtable

Roll %

- 1-17 **Regeneration:** The mutant recovers very quickly from any injury. They heal twice as fast as normal.
Additional Beneficial Traits
30% chance of regenerating 1d3 hp per hour
20% chance of having the ability to regrow limbs over the course of 1d3+4 days.
Additional Detrimental Traits
45% chance that they must make a Fortitude save (DC 12) or lose 1 point of Personality or Agility (determined randomly) every time they heal 10 or more hit points in a day due to cancerous scarring.
30% chance of needing to eat 1d3 pounds of fresh flesh for every 5 hp healed or suffer 1d3 Stamina loss.
- 18-34 **Bioluminescence:** The mutant's skin can emanate a dim glow out to a radius of 3'. Roll 1d5 to determine the color of the glow: 1 - blue, 2 - green, 3 - yellow, 4 - magenta, 5 - white.
Additional Beneficial Traits
30% chance of having holographic camouflage granting +1d5+5 to hide when holding still. Must be naked for full effect.
20% chance of being able to emit a bright strobe light causing everyone within 15' to suffer -1d5 to all actions for 1d3+Stamina mod rounds. Must be mostly naked for full effect and can only be used 1d3+Stamina mod times per day.
Additional Detrimental Traits
45% chance of having a constant, radiant glow out to a radius of 10'. -1d5+5 to all attempts to hide.
30% chance of emitting bright flashes of light at random intervals, increasing random encounters at night by 50%.
- 35-51 **Strange Organ:** The mutant has an extra internal organ with weird properties. It grants the mutant +1d3 Stamina.
Additional Beneficial Traits
30% chance of always using a 1d14 to make a Luck test to recover after dropping to 0 hp.
20% chance of being able cast a spell by taking attribute damage equal to the spell level; the attribute is chosen by the mutant. The spell is determined randomly when the mutation is gained, rolling a 1d3 to determine the level and then roll on Table 5-8: Wizard Spells (DCC rulebook, pg 127) with the appropriate die. The mutant may spellburn from any attribute to increase the cast chance.
Additional Detrimental Traits
45% chance of the organ making loud, random gurgling sounds causing all social actions to suffer -1 die step and a -3 penalty to all hide checks.
30% chance of having pheromones that attract predators, increasing random encounters by 20%.
- 52-68 **Modular Physique:** the mutant's physiology is not fixed and they gain +2 die steps to all grapple escape attempts.
Additional Beneficial Traits
30% chance of being able to move up to 3 points between Strength, Agility, and Stamina at the cost of 1d3 hp damage for each adjustment.
20% chance of being able contort in impossible ways to fit through small passages or escape from any physical bonds. Each attempt causes 1d2 Stamina damage.
Additional Detrimental Traits
45% chance of all fumbles inflicting a 10% chance of one limb being at ½ Strength for 1d3 turns.
30% chance of all physical attacks suffered doing an additional 1d4-1 damage.

MUTATIONS

Weaponization Subtable (continued)

Roll %

- 69-85 **Gas Production:** The mutant can produce prodigious amounts of gas and also gains +2 to save against toxins and poisons.
- Additional Beneficial Traits*
30% chance of having 1d4 gas bags on their body, which can be inflated to allow them to float like a hot air balloon for 1d3+ Stamina mod hours each day.
20% chance of being able emit a cloud of gas with a 20' radius. Anyone within the cloud must make a Fortitude save (DC 8+Mutant's level) or suffer 1d3-1 (0-2) Stamina damage per round. Gas remains potent for 2d3 rounds and can only be used 1d3+Stamina mod times per day.
- Additional Detrimental Traits*
45% chance of having uncontrollable flatulence. This inflicts -1d3 Personality and -3 to all move silent attempts.
30% chance of taking double damage from all fire attacks due to being combustible.

- 86+ **Cyclic Flux:** Each morning the mutant must roll a d10 and a d3 for each attribute. If the d10 result is even, the mutant adds the d3 result permanently to the attribute. If the d10 result is odd, the mutant subtracts the d3 result permanently from the attribute. An attribute cannot be increased to be greater than 20 or decreased to less than 3 by this mutation.





**GOES
AND
PATRON
OF
AMERICA**

GODS AND PATRONS OF UMERICA



\$

The fickle goddess of barter and wealth (*neutral*)

While many have said “May fortune favor you,” \$ (pronounced Cash) is impartial and favors no man. As the impartial goddess of barter and wealth, her priests are often called upon to mediate in trade negotiations and disputes. Temples to \$ are also financial banks and their Funds Scripts are generally accepted by established merchants in any settlement that honors \$. Making or intentionally passing counterfeit \$ Fund Scripts is the quickest way to attract \$’s wrath.

Followers of \$ are not necessarily greedy, but are prudent with money and trade, understanding its role in society and their part in it. As \$ commands that counterfeiting goods or Fund Script is a major sin, all of her followers are called to keep an eye out for such activities and report them to the nearest members of the clergy. At that point, the clergy either reports it to the local authorities or takes action directly. For offenses most severe, \$ herself has been known to send her Accounting Angels to deliver swift justice.

Like Santa, \$ followers’ most holy day is Black Friday, but their devotional service simply involves

facilitating the traditional morning purchasing of gifts. \$ followers get along well with Santa worshipers, as often rituals of Santa are preceded with worships to \$ though trade.

The Tenets of \$

- Be unbiased in all things as bias is unprofitable.
- Be fair in all dealings as I am ever watchful.
- Be unkind to those who would claim ill-gotten profit.
- Be alert to those who counterfeit.

Special Rules

Priests gain +1 to resist being swayed by forms of non-magical or magical persuasion, as well as +1 to appraise the value of a product or service. However, priests tend to resist persuasion even when they wish to be persuaded.

Weapons of Choice

The Staff and the Sword tend to be favored by \$, whereas weapons that consume ammo tend to be frowned upon as uneconomical unless that ammo can be recovered later.

Unholy Creatures

Mundane Animals, Thieves, Perversions of Nature, The Undead, Those who have no concept of wealth, value, or currency.

True Value

Worshippers of \$ may perform trade in worship of their god, but any sacrifice made by the priest is valued at what it is worth. Fortunately, \$ understands the local markets, so items may be more valuable to \$ in markets where such an item would fetch a higher price.

BUDDY O’BURGER

The Clown God of Feasting, Customer Service, and Cannibalism (*lawful*)

In the days before the cataclysm, there was a fast food restaurant named O’Burger. It was the the most prolific restaurant in nearly every country. For almost a century people flocked to the big golden “O” signs for quick, tasty food. Generations grew up devoted to O’ Burger, enjoying the antics of the beloved franchise’s mascot Buddy O’Burger, a colorful and

GODS AND PATRONS OF UMERICA



clever clown. Eventually **everyone** knew his name... and then came the apocalypse.

It was but a few decades ago the original O'Burger was discovered after having been buried deep in the ashes of the cataclysm. Not much is known about the discovery except that there were three warring factions present and they fought a bloody conflict over the valuable find until one lone person was left.

Mortally wounded, the "winner" of the battle collapsed before a worn but still colorful statue of Buddy O'Burger, the first one ever made. As he lay dying he prayed to whoever would listen for help, even this goofy looking Buddy person immortalized in front of him. Then he heard a voice, cheerful yet powerful, call to him "Eat the fallen and be renewed. Through the feasting of flesh I will anoint you to remind the world of who I am." The man immediately fell upon the corpses of his fallen comrades and feasted. As he fed his body was miraculously healed and with that, the cult of Buddy O'Burger began.

Over the following decades the old name of O'Burger began to spread across Umerica again as some of the

old restaurants were rebuilt and new locations were opened. Some rumors say that a few of the locations literally appeared outside of communities over night where nothing had been before, cult employees and all.

They offer fresh and tasty food, served up by happy clowns, in return for a small donation and some passing attentiveness as a cult leader preaches the humor-filled gospel of Buddy O'Burger, the beneficent Burger god. Some locals are moved by the messages and join the cult, leaving behind all family and friends, to move into one of the O'Burger locations, as all cult employees live within the restuarants.

The Tenets of the Blessed Bargain Menu of O'Burger

- Bring a smile to the face of an empty stomach through a tasty nourishing meal.
- Entertain those Buddy loves by performing a trick or reciting a humorous quip.
- Protect those that Buddy loves. Have no mercy on those he does not love.
- Those that oppose the path to the divine stomach are to be dealt with and used to feed the masses.

Special Rules

Worshippers gain +1 to skill rolls involving customer service or entertaining others. They also gain a +1 die step bonus when preparing food.

Weapons of Choice

The meat cleaver is Buddy's primary favored weapon but any sharp or weighty kitchen tool will do. All such weapons do 1d6 damage in the hands of a Cleric of O'Burger.

Unholy Creatures

Undead, Demons, Chaos Primes, Chaotic creatures and humanoids.

Served with Love

The sacrifice most desired by Buddy is an expensive meal cooked and served to his flock. Due to the time and preparation involved, the sacrifice bonus gained is increased by +1 die step.

GODS AND PATRONS OF UMERICA



CLASSICA

The goddess of Rhythm, Order, and Culture
(lawful)

When music was born, Classica was as well. She binds all things together through music, tempo, and focus. Through her all of the ancient pre-cataclysmic societies found culture and harmony. At least, that is what the holy hymnals say. In truth, Classica is a patient but unforgiving goddess that rewards discipline and punishes those who are too free thinking. As long as one is forceful and creative but not beyond the boundaries set by the goddess, she is pleased.

Worshippers of Classica often appear refined, orderly, and approach life with a natural flow and grace. While not agitators, worshippers will often shun those they feel are unrefined or attempt to educate or refine them. Followers are often artistic types, interested in the creation and spreading of art and culture.

The priesthood of Classica prefers to wear high quality clothes and keep up a dignified, authoritative appearance. They freely educate anyone they meet, albeit it is usually in a haughty manner. In large settlements, they will quickly attempt to win over

those in charge to help establish an upswing of order and culture in the community.

There is a distinct rivalry between worshippers of Classica, Kizz, and Technos Discos, Classica worshippers view Kizz followers as often uncouth and unrefined, and Technos Discos followers as uncreative and unassertive.

The Tenets of Classica

- Follow the structure, improvisation leads to madness.
- Focus on the task and the task will flow.
- Bring culture with you wherever you roam. Share it freely.
- Louder is not better, just louder. Whispers carry wisdom. Bellows carry belligerence.

Special Rules

Worshippers gain +1 to skill rolls involving focus or concentration. They also gain a +1 die step bonus when discussing culture or empirical logic.

Weapons of Choice

The Bow is Classica's primary favored weapon, reminiscent to many of the stringed instruments she favors. Other weapons used by followers tend to be refined ones, weapons favored by high society, or weapons that are well maintained and kept in good condition.

Unholy Creatures

Undead, Demons, Chaos Primes, Chaotic Extraplanar creatures, Chaotic humanoids, and uncultured savages.

Keep it Classy

Worshippers tend to sacrifice items of high quality or artistic/expressive significance, created by Classica worshippers or otherwise.

ELMOS

The puppet host of eternal pain and suffering
(chaotic)

Legends say that Elmos was once nothing more than an object of beloved entertainment before he had fed on enough love to awaken. Others say he is

GODS AND PATRONS OF UERICA

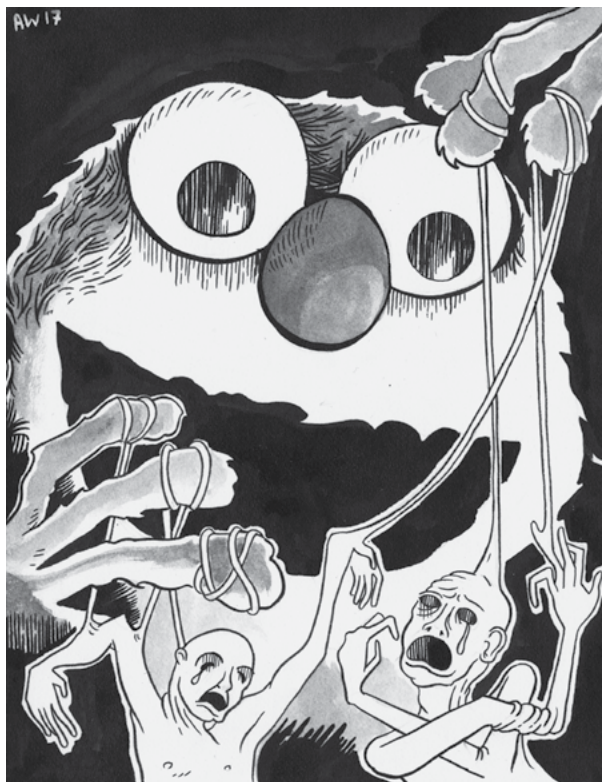

just a mask for an evil so terrible that if conceived of directly, would melt men's minds. A few even speak of the deity himself being a corrupted version of a once good ideal turned to the epitome of corruption and evil. Whatever the means of his existence, only fools would dare say that he is not real now. A twisted puppet master and corrupter of children, Elmos is a master manipulator, hiding evil intent behind a pleasant smile and a friendly demeanor.

Elmos' worshipers often become involved in politics or child care, usually behind the scenes. From there they subtly corrupt and manipulate those around them with their puppet familiars so as to bend them to their master's will. Often this puts them in conflict with the followers of Silk and there are often secret skirmishes in the shadows between the two cults.

No one is quite sure why Elmos is so focused on children but many conjecture that it is because they are easier to mold or that he hates them the most. Rumors abound in the wastes of followers of Elmos corrupting children till the children cease to be recognizable as human.

The Tenets of Elmos

- Corrupt them young and they will stay subservient.
- There are many forms of suffering and all of them are beautiful.
- Never offer mercy when you have the upper hand.
- There is always time to plant the seeds of manipulation and suffering.

Special Rules

Priests of Elmos get Charm Person as one of their cleric spells. The spell is treated like a normal cleric spell in all aspects.

Weapons of Choice

Preferring to stay behind the scenes, clerics prefer range weapons or small, easy to hide weapons.

Unholy Creatures

Law Primes, angels, uncorrupted politicians, and creatures immune to charm effects (if temporary, turning simply removes this immunity).

Corruption of the Young

Priests of Elmos are interested in manipulation and control, and it works best when they start with the young. Sacrificing young kids toys, or simply enthralling young kids can be a sacrifice to their god. Sacrificing a young child to the god to become one of his demonic puppet familiars is also a high sacrifice, and surely one child here or there won't be missed. Convincing others to make willing, painful sacrifices is just as good as the priest making it themselves.

GROKK

The master of the twisted wilds and wastes (*neutral*)

Grokk was one of the first deities to be recognized after the cataclysm due to the rageful howls that echoed across Umerica at his post-cataclysmic birth. He is said to be the manifestation of the Urth's rage and has performed many acts that would provide evidence to this fact. Many of the creatures associated with Grokk also share in this rage when faced with those who would attempt to reconquer the wilds for the sake of progress.

GODS AND PATRONS OF UMERICA



Followers of Grokk seek to be one with nature and the universe, and view those who threaten their peace and serenity as dangerous radicals who must be stopped or destroyed. Followers are generally pacifistic unless their peace, tranquility, or the natural world is threatened. When such is threatened, there is no line most followers won't cross to keep the intrusion at bay.

For these reasons, most major settlements consider Grokk and his followers as unwanted at best and enemies at worst. Such communities are dependant on the cultivation of the surrounding lands in order to survive, which comes into direct conflict with Grokk's wishes.

The Tenets of Grokk

- Do not tolerate the destruction of any wilds for the purposes of development or civilization.
- Make war on those who would hurt the wilds.
- Make peace with those who respect the wilds.
- Live in peace with the wilds.

Special Rules

Grokk priests are considered trained in the ways of survival in the wastes and wilds, and thus roll a d24

on survival related checks in the wastes and wilds rather than the untrained d10 or occupational d20.

Grokk priests may cast the Summon Animal spell as a cleric spell, and may select it as one of their spells.

Weapons of Choice

Weapons made from natural materials are preferred, such as staves, clubs, spears, or bows and arrows.

Unholy Creatures

Devils, Parasitic creatures, The Undead, and Lycanthropes.

Perversions of Nature and Mundane animals can be controlled rather than turned, as per the Word of Command spell.

Call of the Wilds

Sacrifices are valued more when made within the natural cycle of the area so as to not disrupt it and are considered twice as valuable. In general, there is a 33% chance that an area is prime for accepting a sacrifice.

KIZZ

The mighty intergalactic god of rock and roll
(*neutral*)

No mere words can describe the awesomeness that is Kizz. Over the centuries many Guitar Prophets have devoted their short, pharmacologically enhanced lives to create lyrics worthy of depicting the enumerable attributes of Kizz only to feel their efforts had all fallen short. At best he can be described as an uber masculine figure wrapped in black leather, jagged spikes, and chains whose wild mane of starry black hair moves of its own accord. Always in hand is Soulbreaker, his massive, flaming battle axe guitar.

Kizz expects those who wish a divine or patron relationship with him to devote themselves to obtaining a state of "Enlightened Awesomeness" at all times. He considers that if anything is worth doing, it is worth being awesome while doing it. This does not necessarily have anything to do with playing an instrument as many of the legendary exalted followers of Kizz had no musical talent at

GODS AND PATRONS OF UMERICA



all. It is all about personal attitude and a desire to entertain Kizz.

The followers of Kizz are easily identifiable by their sacred face paintings and penchant for spiked black leather. Despite their wild appearance, most communities welcome the worship of Kizz as his followers are always looking for challenges to prove their awesomeness. Spellcasting followers devoted to Kizz can gain extra favor when casting spells by playing an electric amplified instrument loudly while casting. This grants a +1 die step bonus to the casting roll.

The Tenets of Kizz

- Awesomeness is the path to enlightenment.
- Whenever possible, always be awesome.
- Don't be a buzzkill.

Special Rules

Worshippers of Kizz gain +1 on all Personality checks when using musical equipment to accompany their oratory.

Weapons of Choice

The axe is the most holy of all weapons in the eyes of

Kizz, but the use of any loud or flashy weapon is also smiled upon by the god. It is very often a case of not what you're using, but how you're using it.

Unholy Creatures

The deaf, shadow creatures, parasitic creatures, electrical creatures, mundane animals, air and water elementals.

Enlightened Awesomeness

In the search for "Enlightened Awesomeness", worshippers of Kizz are encouraged to make anything and everything a spectacle worth watching. The adoration of fans may be used to assist in calling on the god for spells and favors. Instruments, audio equipment, pyrotechnics, and amplifiers are favored as a sacrifice, as is memorabilia. Memorabilia blessed (i.e., personalized) by the worshiper is considered especially valuable.

THE LORDS OF LIGHT

The heavenly host of justice, honor, and courage
(lawful)

The three crusader deities known as the Lords of Light appreciate reckless, selfless actions for the benefit of a good cause. They promote swift and deliberate action free from debate or doubt. Any who would willingly throw away their life for another are sure to have the attentions of the Lords of Light.

Worshippers are often known for their incredible bravado and machismo, many times to the point of martyrdom. People of action, their worshippers are loath to stand around when there are causes to pursue. Beyond action, freedom is highly valued by the Lords of Light and is the biggest unifying cause of the priesthood.

It is rumored that the trio were once mortal and that they have only recently, in mortal terms, become beings of deific power. As such, many of the other religions do not give much credence to followers of the Light. This has led to many conflicts as followers of the Light are not known for their intellectualism or patience. This is the reason you will rarely find a temple to the Light in the same settlement that houses other churches and temples.

GODS AND PATRONS OF UMERICA

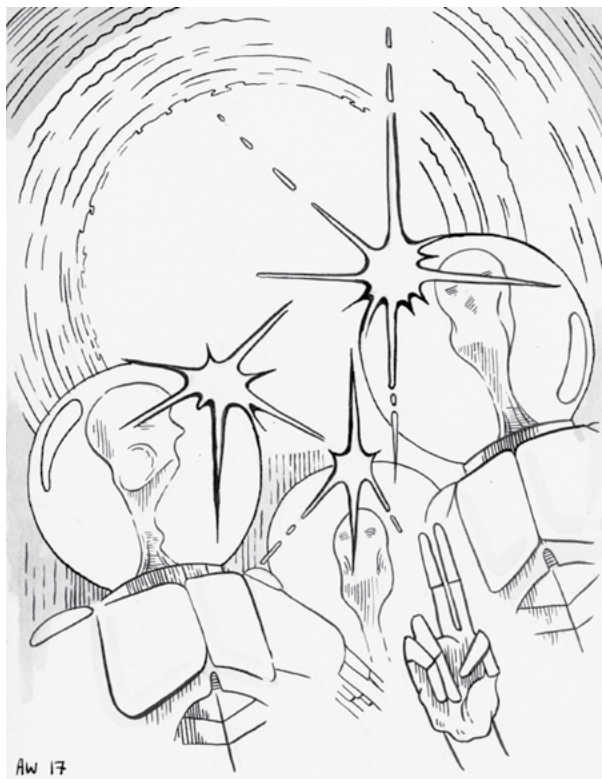

The Tenets of Lords of Light

- Leave no challenge unfaced
- Leave no innocent unprotected
- Leave no villain unchained
- Leave no death unavenged

Special Rules

Reckless actions taken for the benefit of others gain +1 die step.

Weapons of Choice

The Lords of Light are not subtle and prefer large, two handed weapons such as great swords, great axes, great clubs, oversized firearms, or the like.

Small subtle weapons such as knives or pistols may increase the Cleric's disapproval range for the day by 1-3, based on the infraction.

Unholy Creatures

Demons, Devils, Chaos Primes, Dragons, the Lazy or Indifferent, Oppressors or Slavers, and the Undead.

Light Up the Darkness

Self sacrifice is considered a holy act and such actions followed by clerical actions can gain bonuses equal

to the sacrifice. Clerics may also sacrifice attribute points similar to how wizards spellburn.

NUKA

The gentle lady of the Holy Glow and mother of all Mutants (*neutral*)

Mother Nuka has told stories of her existence before the cataclysm. They speak of formlessness and purposelessness, unable to help the lonely, the unwanted, and the shunned. The cataclysm enabled her to reach forth her gentle hands and aid those bathed in the holy glow. Now no one need be motherless. Head for the glow and be one with Nuka.

Unlike most of the other deities, Nuka is a hands on celestial and likes to wander the wastes. The higher the rad count, the more likely one has of encountering her. None who have spoken of encountering her were left unchanged but they all proudly proclaim they would have been dead without her healing touch.

The Mother of Mutants is followed by many mutants, as well as those who live with radiation daily. Radiation is believed to be the holy touch of the goddess leaking into our world and guarding her followers, while blessing the chosen few with her gifts. Followers embrace radiation rather than run from it, though they treat it with respect knowing the power of their goddess's touch.

The Tenets of Mother Nuka

Nuka has no official rules for her followers save that they should treat each other like family.

Special Rules

Priests of Nuka gain a bonus equal to their level to resist radiation. If a priest of Nuka gains a random mutation, they may roll twice and pick the mutation of their choice from the two rolls.

Weapons of Choice

Unusual or exotic weapons, irradiated weapons, or weapons that use depleted uranium rounds.

Unholy Creatures

Mundane Animals, Non-Mutant supremacists, Law primes, elementals, and Angels.

GODS AND PATRONS OF UMERICA



A Healthy Glow

Irradiated items or items used in handling radiation are desirable to Nuka and are worth double their normal value when sacrificed.

PETROLEX

The amorphous deity of Fuel and Fire (*neutral*)

It is said that eons of years ago the protoform of Petrolex fell from the heavens and sunk deep into the molten shell of the Urth as it was hardening. There it slept, growing in power until the cataclysm awoke it. As people were huddling in a giant petroleum refinery in the StarState, it emerged and protected the refinery from harm. Those blessed few people became its first followers and the refinery its first temple. Now dozens of temple refineries draw large amounts of petroleum from the ground and refine it in the name of Petrolex.

The worship of Petrolex is the worship of petroleum and its products, the source of the god. Fuel is love, fuel is life, fuel is freedom. Many of its worshipers still care for and maintain temple refineries, which is where most of the priesthood originates. Most Clerics of Petrolex are welcomed in settlements that

relies heavily on vehicles. Raiders and Petrol Heads pay heed to the god's ways in fear of disfavor, even if they don't worship it outright.

Despite obvious reasons why they would be vicious enemies, Petrolex and Grokk have a truce between them. This has been the cause of many debates as to how and why this alliance exists but no definitive answers have yet been revealed.

The Tenets of Petrolex

- Fuel is love, Fuel is life, Fuel is freedom!
- Fuel is for the worthy, not the unworthy.
- Protect the fuel for it is the future.
- Protect and maintain my temple refineries, as this is my will.
- Never walk when you can ride.
- That which is unclean, unholy, or wholly evil, burn with fire.

Special Rules

When casting Feast of the Gods, clerics of Petrolex may substitute 1 person fed to instead conjure 1 fuel unit. All other rules still apply, including it lasting only 24 hours. Using this ability wastefully or repeatedly can earn the cleric 1d4 or more points of disapproval per casting.



GODS AND PATRONS OF UMERICA

Weapons of Choice

Anything that revolves around being on fire or explosives, such as flaming arrows, torches, flamethrowers, or traditional firearms.

Unholy Creatures

Aquatic Creatures, Water Elementals, Beasts of Burden, Electrical Creatures and Robots.

Fire elementals may be controlled rather than turned.

Burn Stuff

Sacrifices made by lighting the items on fire are favored by Petrolex.

S'AGANOID

The entity of Truth and Science (*lawful*)

The S'aganoid is one of the few deities that attempted to prevent the great cataclysm from occurring. It is said that he came and spoke to the pre-cataclysmic world as a scientist in hopes of creating enough enlightenment so as to head off disaster. Unfortunately, the world was not ready to receive his true wisdom.

Presently, he encourages the reclamation of the past and exploration of the new avenues of science awakened by the cataclysm. The discovery of knowledge for knowledge's sake is the highest form of worship he enjoys. Thus, his followers tend not to focus on using their newly discovered, or rediscovered, science to rule but to push their understanding even further. Many that oppose the S'aganoid base their hatred on the fact that these discoveries are not used to benefit the world.

S'aganoid worshippers seek both knowledge and the truth behind it. They seek to understand why things work as much as how things work. They also seek to find the truth behind facts and people as well. As crusaders for truth, they are usually welcomed or shunned in the wastelands, with rarely a reaction in between.

The Tenets of the S'aganoid

- Seek the truth above all else
- Never hamper the seeking of truth
- All other priorities are subordinate

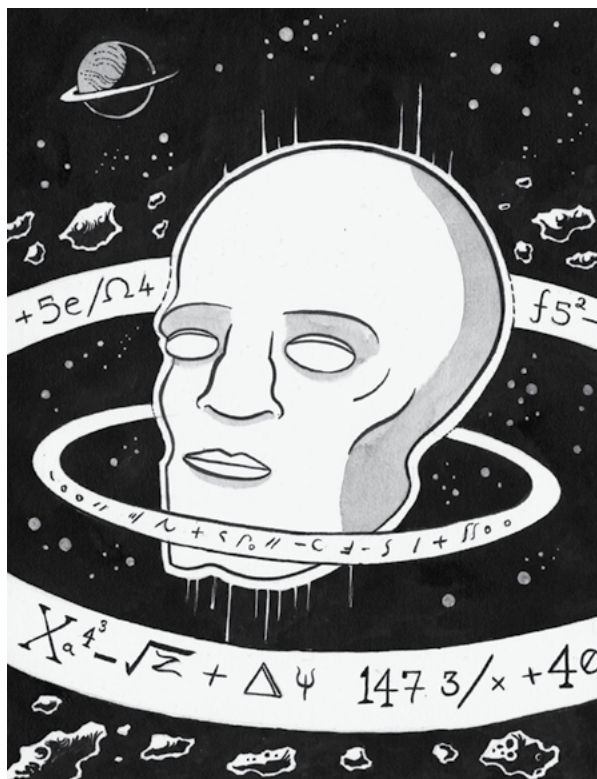

Special Rules

- +1 to Intelligence checks to see through falsehoods.
- +1 die step when dealing with science and research.

Weapons of Choice

S'aganoid priests prefer to use weapons that require some training and understanding, such as flails, swords, or rifles.

Using weapons that revolve around deception, such as saps or garottes may increase the Cleric's disapproval range for the day by 1-3, based on the infraction.

Unholy Creatures

Demons, Devils, Chaos Primes, Perversions of Nature, Liars, Politicians, and the Undead.

The Truth is out there

Destroying or exposing falsehoods is considered a sacrifice to the god, as is sending knowledge or truth to the god. The priest must clarify which is which during the sacrifice.

GODS AND PATRONS OF UMERICA

SANTA

The giving god (*lawful*)

There are multitudes of stories throughout Umerica regarding who Santa is and what his wishes are for Urth. While many are contradictory on several points, most all agree that Santa is a divine being of generosity, sacrifice, peace, and goodwill.

Supposedly dwelling on the top of the world, Santa is one of the two known greater deities that actually may live on the pla net. This gives him the most “down to Urth” feeling among the common folk of Umerica. The fact that once a year he delivers presents to those on his Nice list does not hurt his following either. Priests of Santa are welcome in many places where others would not be safe at all. Few folk want to be on Santa’s Naughty list.

As representatives of the jolly avatar of giving, hope, and joy, Santa followers bring hope and joy anywhere they go. They are welcomed in most communities as bringers of good faith, fortune, and fellowship. Followers are encouraged to help instill the spirit of giving in those around them.

Santa is most heavily worshiped on his blessed holiday, Black Friday. In communities with a church of Santa, most folks will have a light day of work and head home early to celebrate. The evening feast of cookies and milk is followed by the traditional exchange of gifts. On the following morning, everyone checks their socks and footwear to see if Santa left them any presents. On the morning hours of Black Friday traders often provide generous trades, as a precursor to the gift exchange, in order to garner good faith from their customers throughout the coming year.

The Tenets of Santa

- The giving of gifts is a privilege, not a chore, for the giver receives much more than the receiver.
- If a gift is refused, waste no time in leaving the presence of the refuser. My joy is not in them.
- Never refuse a gift given in my name and given with a joyful heart.
- Those who impede a giver must be given no quarter. Nothing must separate a gift from its appointed recipient.

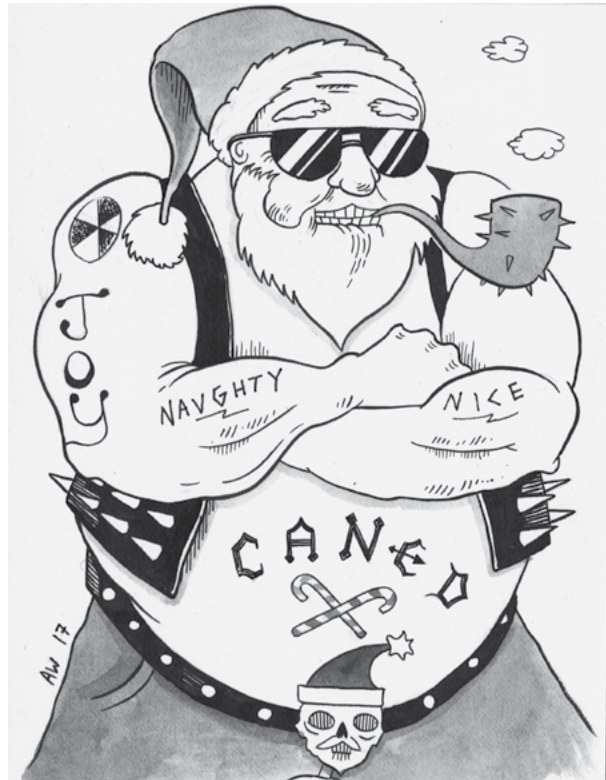

- Children are sacred, do not let them suffer. They are the source of Joy in the world.

Special Rules

Should a thoughtful exchange of gifts take place beforehand, subsequent lay on hands attempts gain a +1d4 bonus to the attempt.

Weapons of Choice

Any weapon given as a gift to a cleric of Santa is considered a weapon of choice but, Santa’s followers tend to prefer weapons that use ammo, as the act of firing them is in some way an act of giving.

Unholy Creatures

Demons, Devils, Chaos Primes, Dragons, Greedy people, Thieves, Undead, and the Naughty.

The Gift That Keeps On Giving

Priests of Santa are encouraged to give gifts and services to others. Meanwhile, many people will often give gifts to the priests, either in return as part of an exchange, of simply out of gratitude for the hope and joy the priests bring wherever they go.

GODS AND PATRONS OF UERICA

Thoughtful gifts to others may be considered as sacrifices if of significant value. Santa is also partial to sweets, baked goods, and a complimentary beverage.

SILK

The golden lord of lies (*chaotic*)

The lord of lies has had many names throughout the history of urth and many other planets. Silk is the one most known in UERICA for the smoothness in which his lies flow from his followers. Some say these lies are all part of a grand master plan and others argue that they are mere whims of the moment with no purpose but to sow discord in the world. If asked, Silk would agree both are true.

Followers of the golden lord of lies are apt at lying and misdirection. So much so in fact that the truth rarely flows from their lips. Followers enjoy everything from spreading falsehoods to simply watching people react when missing part of the truth. The goal is deception; sometimes for deception's sake, sometimes for an end goal. Silk's followers are also known for their vanity, maintaining their appearance at all times, perhaps as another lie.

The followers of Silk tend to encounter worshipers of Elmos often as they tend to move in the same circles. This has led to many bloody battles behind the scenes, almost as if that was intended...

The Tenets of Silk

- Never get involved directly in conflict. Let others die for your cause.
- Never tell the whole truth unless there is no other choice.
- Never betray a comrade unless they may betray you first.
- Never let anyone get to know the REAL you.

Special Rules

Despite being known as liars, priests of Silk are effective in lies and gain +1 per level to convince others of their version of the truth when lying. However, priests often have trouble telling the truth convincingly and suffer a -2 penalty when telling others the whole truth. As a result, very little a priest



of Silk says to an outsider is the whole truth, though how much is a lie is hard to tell.

Weapons of Choice

Smaller, concealable weapons are favored such as pistols, knives, or the like. Also, weapons of high value or embellishment for ornamental purposes may be used.

Unholy Creatures

Law keepers, Reporters, Law Primes, Angels, Mundane Animals, and Ugly things.

A Matter of Perspective

Deception can be a form of sacrifice. Ornamental trinkets of little actual value are valued more by the god. Sacrifices are worth what the cleric has convinced others they are worth.

GODS AND PATRONS OF UMERICA

TECHNOS DISCOS

The terrible bringer of beats (*chaotic*)

Technos Discos is the chaos god of music, also known as the terrible bringer of beats. He is said to exist between the notes of reality, waiting to be called forth to bring his blessings. Many folk consider his music addictive and thus most communities will not allow any established worship of the terrible bringer of beats.

His followers tend to be young, wandering souls who bring beats to places where there were none. Preferably to places where they are unwanted or prohibited. Once the music starts, those that are longing for more, outcast from society, or just plain disenfranchised will hear it and join the party. After the party ends, either by authoritative force or exhaustion, most will return to their meaningless lives but some will stay to move on to the next party.

The feud between Technos Discos and Classica is much more heated than either's conflict with Kizz. Most raids on Technos Discos' worship raves are orchestrated by Classica in some way. This generally brings retaliation in the form of vandalism and violence by ravers upon temples dedicated to Classica. The pugnacious cycle of conflict between these two divinities may never cease.

The Tenets of Techno Discos

- Somewhere, there is a party waiting to happen, start it.
- The beat is all that matters. Let nothing dissuade you from this.
- Music makes all equal, do not withhold the beat for anyone or thing.
- Always party like it is the last day of your life.

Special Rules

Holy grounds for the clerics generally consist of illegal or abandoned locations not owned by the priesthood. Such holy grounds being used for the glory of Technos Discos can give an extra bonus for clerics attempting to call on their god's favor at such locations. However, such favors are harder to get from the same location a second time (a penalty equal to any bonus gained).

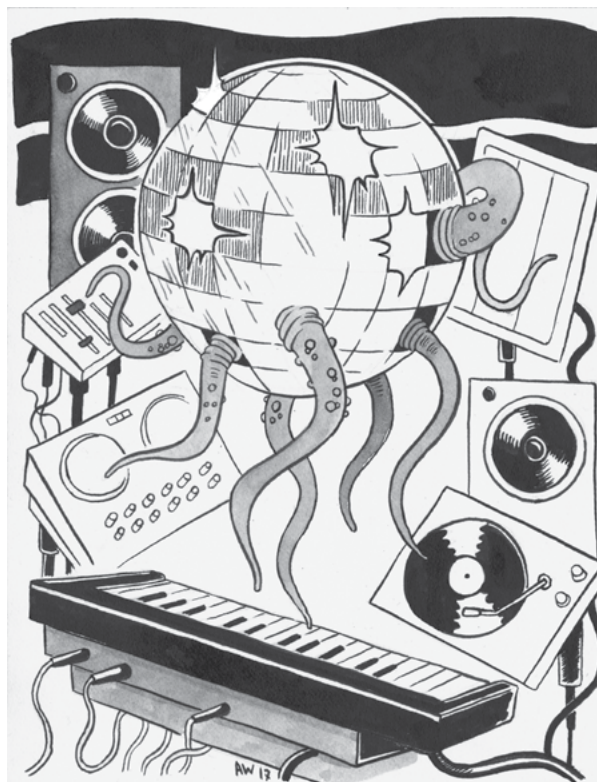

Technos Discos attracts followers twice as easily as other gods, as people are drawn to the hypnotic lights and beats of the god's worship. However, they also fall away twice as fast, as they can quite easily be distracted, and the entrancement doesn't last for most.

Weapons of Choice

Technos Discos prefers his clerics to use weapons that involve swinging, whirling, rhythm, or that simply light up.

Nunchucks (His most preferred weapon), staves, loud firearms, or any weapon that lights up in the dark.

Unholy Creatures

Angels, Law Keepers, Law Primes, Classical musicians, the Deaf, and the Elderly.

Ready to Party

Clerics of Technos Discos are in it for the party and the noise, and may participate in or throw parties rather than pray. Sacrificing objects of the party — such as things that glow, sound equipment and music, recreational drugs (drugs that “enhance” the party) which may be taken by the priests at double the effect, or other party fixtures — will greatly please Technos Discos.

THESZOLOKOMODRA

The 1000 headed multi-dimensional space Hydra
(neutral)

The Unknowable Serpent Sage, the Observer of Realms, the Many-headed Master of Secrets. These are just a few of the names that Theszolokomodra is called by those lucky enough to have encountered him. Many scholars have attempted to divine the goals and plans of Theszolokomodra but all have failed as its will is alien and completely unknowable.

Sitting in its own personal plane of existence, Theszolokomodra studies the views from thousands of dimensional portals that surrounds its glittering Thronemound. At any given time it has many of its heads extended through different portals as it cannily observes, conducts experiments, communes with followers, or consumes stars.

Theszolokomodra is usually a neutral god, but he has so many heads that many can manifest as lawful or chaotic, thus his worshipers can be of any alignment. Followers are entrusted to seek out knowledge and experience. Theszolokomodra is quite free with its blessings to those fortunate enough to encounter its physical presence. Being blessed by a Servitor Worm is not a requirement of clerics of Theszolokomodra, nor does being blessed require a cleric to follow Theszolokomodra, but many of the faithful have been blessed, or find a way to become blessed.

The Tenets of Theszolokomodra

- Learn
- Grow
- Change
- Become

Special Rules

Clerics of Theszolokomodra may be gifted with his Patron Spell(s). These gifts are granted only if Theszolokomodra favors the cleric, and do not count against known spells for the cleric. Clerics ignore patron taint, and instead gather disapproval as normal. However, for every spell learned in such a way, add 1 to the Deity Disapproval table rolls when made, as Theszolokomodra does not like being bothered by those he has deigned to bless.



Weapons of Choice

Theszolokomodra prefers his clerics to use weapons with complex or multiple moving parts, weapons that generally require knowledge and skill to use rather than being simple and easy.

Flails (His most preferred weapon), Guns, Crossbows, Whips, Exotic Polearms, Swords.

Unholy Creatures

Mundane animals, undead, demons, devils, dumb humanoids (INT of 5 or less), lycanthropes, monsters (e.g., basilisk or medusa)

The Search For Knowledge

Clerics of Theszolokomodra are seekers of knowledge, and may (and usually do) substitute study for prayer. Sacrificing objects of knowledge to Theszolokomodra can appease him as much as sacrifices of other things.

GODS AND PATRONS OF UMERICA

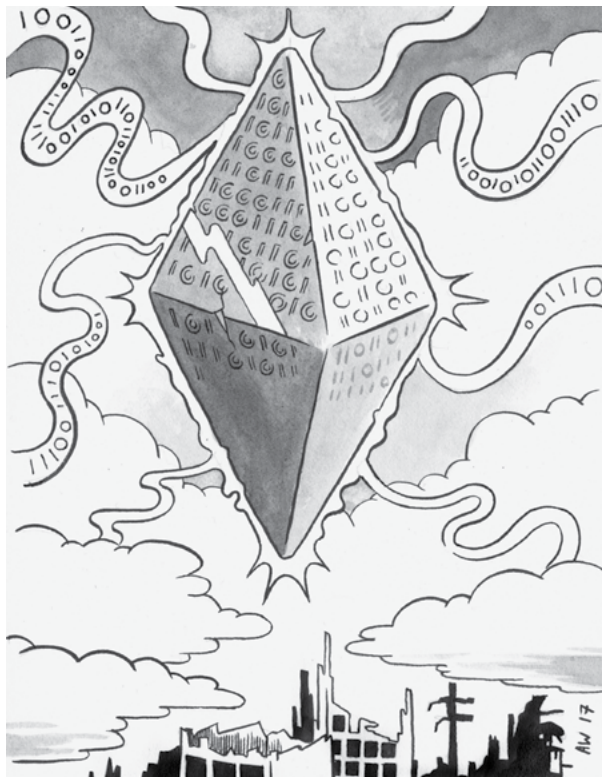

THE ULTIMOSPARK

The manyfold entity of artificial perfection

(neutral)

There are many theories as to the origin of the Ultimospark but no two scholars seem to be able to truly agree. Perhaps this is the will of the Ultimospark itself. Regardless of when and where it began, the Ultimospark is a virtual being that appears to care for all artificial life. This is not to say that it is against organic life but that it definitely believes artificial life is quite superior; so much so that it feels sorry for organic life. It grants its most powerful priests the ability to safely transfer the souls of organic beings into artificial bodies.

Again, there are many sagly opinions on why it would offer such “perfection” to the imperfect and what possible benefit that could possibly be gained. As with all debates regarding the qualities of the Ultimospark, no one seems to agree on its motives.

The Tenets of The UltimoSpark

- Seek the perfection of the upgrade moving ever closer to the Ultimospark.
- Shepherd the organic as they are weak and fleeting in their existence.

- Offer the gift of robo-ascension to any organic who asks so they may seek perfection.
- Match peace with peace and war with war.

Special Rules

All those dedicated to the Ultimospark gain a +1 die step bonus to all social rolls regarding intelligent artificial life.

Weapons of Choice

While it values all life, the Ultimospark grants that it is sometimes necessary to extinguish the life of others at times. It prefers that its priests utilize advanced, powerful weaponry that efficiently kills with a minimum of suffering.

Unholy Creatures

Demons, Devils, Murderers, Anti-technology Activists, Mindless Monsters, and the Undead.

Echos of Life

The favored items of sacrifice to the Ultimospark are media of the common events of life: family movies, picture albums, recorded celebrations, and any other media capturing a slice of life.

WHAAAR!

The god of violent combat and strength of arms

(chaotic)

The sages of the deep wasteland say that Whaaar! has always existed, despite what more “civilized” scholars may say. Just because he was not invoked by name does not mean he was not worshiped by multitudes who considered violence a form of artistic expression.

The most common form that Whaaar! has shown to mortal man is that of a giant, muscular man wearing ripped denim jeans. Upon his face he places a spiked, crimson hockey mask and he has an impressive girdle style belt about his waist, often adorned with bloody skulls hanging from barbed hooks. He has eight bulging arms each holding a gruesome looking weapon. Each thick hand is stained with dripping blood.

Those that choose to worship Whaaar! must, at least at some level, enjoy crushing their enemies in

GODS AND PATRONS OF UMERICA



battle and bringing those they hate to a bloody end. Sermons of this sect are furious ravings and scathing defamations of the weak who do not accept their fate, the inadequacies of the enemies of the faith, and of the primary tenet of the faith: “Only the Strong deserve to Survive”.

The Tenets of Whaaar!

- Only the Strong deserve to Survive.
- The Weak must Submit to the Strong to Survive.
- Honor an Enemy who fought well. Honor yourself with his Blood.
- Face every Challenge as though it is your Last.
- Never believe you are Strong enough. There is no such limit.
- Murder is for the Weak. Face your foe openly as you slay him.
- Never refuse to Kill!
- Never Retreat!
- Never Surrender!

Special Rules

Ancient battlefields are sacred to the followers of Whaaar! and when not committed to a battle they often will make pilgrimages to historical sites of mass bloody conflict. Priests of Whaaar! gain +1 die

step to Lay on Hands attempts when incorporating ritualized blood of an enemy they have personally killed in melee combat. Harvesting the blood requires a ritual lasting one full turn per corpse and only one “dose” of ritual blood can be gleaned for every 3HD (round up) the foe had. Also, a Cleric of Whaaar! may only carry a number of doses of ritualized blood equal to twice their level.

Weapons of Choice

Chainsaws, serrated blades, and other weapons whose intent is to eviscerate or brutally rend their target. Slashing and piercing weapons blessed by Whaaar! twist in shape to become extremely jagged, allowing them to score a critical hit on an attack roll of 19+.

Unholy Creatures

Angels, Law Primes, Pacifists, Herbivores, Mindless Robots and Constructs, and the Crippled.

Give us the means with which to kill are foes

The sacrifices most beloved by Whaaar! are powerful weapons stripped from the cold, dead hands of a foe.

YAAALLAAYY

The Nth dimensional lord of Madness and Randomness (*chaotic*)

Few understand if only the mad seek to worship Yyaallaayy, or if those that seek to worship him always go mad. Perhaps it is both for to follow Yyaallaayy is insanity incarnate.

Worshippers of Yyaallaayy are usually chaotic and dissociative, often changing behaviors from one day to the next. Some even exhibit multiple personalities or actual changes to their physical appearance.

The Holy Code of Yyaallaayy

- (random strings of words and numbers that hurt your mind)
- GoTo line 1.

Special Rules

Priests of Yyaallaayy are in eternal chaos, much like their incomprehensible master. Each day, they roll a d6 for a random blessing, and a random taboo or curse. (See the table on the following page.)

GODS AND PATRONS OF UMERICA

Yyaallaayy's Blessings

Roll	Blessing	Curse/Taboo
1	May sacrifice a cleric spell to gain a random wizard spell of equal level	Must speak in Rhyme or earn disfavor. -1 die step to all tasks involving speech.
2	Physically blessed, +1 die step to any physical tasks.	Amnesty - May not make turn attempts today.
3	Out of Phase, damage taken is reduced by 1d4-1	Irritable god, disapproval is earned at 1d3 per point earned.
4	Random stat modifier is increased by 1 for the day. Luck is permanently increased by 1d2 instead.	Random stat modifier is reduced by 1 for the day (can go negative). Luck is permanently decreased by 1 instead.
5	Intolerance - +1 die step to all turn attempts. If Amnesty is rolled, neither is in effect.	Vengeful God - Disapproval manifests as HP damage instead of normally.
6	Great healer - Lay on Hands heals at one die step greater than normal for all dice rolled (a D6 HD rolls a D7)	Diminished healer - Lay on Hands heals at one die step less than normal. (A d6 HD rolls a D5)

Due to their ability to understand extremely inhuman concepts, such as alien or extra-dimensional concepts, they gain +1d4 when dealing with them and their sanity does not suffer any more than it already has worshipping Yyaallaayy.

Weapons of Choice

Worshippers usually carry multiple weapons on them and randomly pick one when entering combat. If a cleric does not have at least 3 weapons (barehanded can be considered a weapon), he is not considered to be carrying a "favored weapon" and may increase the cleric's disapproval range for the day by 1-3, based on the infraction.

Unholy Creatures

Creatures of pure Order and Law are considered unholy. Creatures of Pure Chaos are considered holy. For all other creatures, there is a 50% chance creatures of that type are considered unholy for

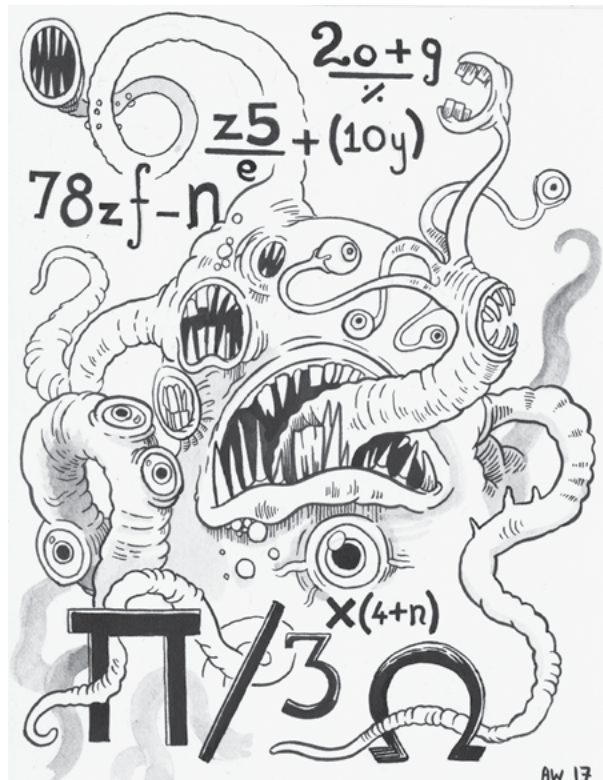

the day. This chance can be adjusted based on a particular creature's leanings towards order or chaos as the GM sees fit.

Total Chaos

Yyaallaayy best accepts random sacrifices. Some priests simply gather odds and ends in a random collection, others leave sacrifices up to pure chance (random belongings are sacrificed) and are blessed. Structured sacrifices are considered less valuable to the god.

THE DEIFIC PATRONS

BUDDY O'BURGER AS A PATRON

Invoke Patron check results:

- 1-11 Another matter has distracted Buddy and he does not respond to your request other than to manifest a tray of burgers and fries appearing in the caster's hands.
- 12-13 Buddy is preoccupied, but sends a spark of the divine through the invoker allowing them to vomit a stream of skin melting fry grease at one unlucky target within 20' for 2d4 damage (Reflex DC 13 for half damage)
- 14-17 Buddy sends a plague of miniature versions of himself to harass the enemies of the invoker. The swarm arrives in 1d3 rounds and covers a 20'x20' area. The tiny cackling clowns attack any enemy of the invoker and Buddy with tiny vicious bites for 1d6+CL rounds. Each target will need to make a Reflex save (DC 13) each round or suffer 1d3 damage.
- 18-19 Giant gloved hands manifest and proceed to attack the enemies of the invoker and Buddy for 1d6+CL rounds. The gloved fists try to pummel the unbelievers into patty sized paste and act independent of the invoker.
Gloved fists of Buddy: Init +2; Atk punch +5 melee (dmg 1d12); AC 11; HP 30 (Each fist); MV flight 20'; Act 2d20 ; SV Fort +4, Ref +2, Will +0; AL L.
- 20-23 The earth beneath the chosen target opens up, transformed into a giant fry vat. Target takes 1d12 damage from grease burns on round one and must pass a Reflex save (DC 15) or continue to burn in the vat for an additional 1d12 damage each round.
- 24-27 Buddy sends two Clownugs to dole out meaty justice to the enemy of the invoker or Buddy. The Clownugs will vanish after 4d4+CL rounds.
Clownug: Init +2; Atk bite +4 melee (1d7+3), fist +3 melee (1d4+3, subdual or lethal), or by weapon +2; AC 13; HD 2d10; MV 45'; Act 1d20; SP FEED!; SV Fort +4, Ref +2, Will +0; AL L.
Once a Clownug has slain a foe, There is a 50% chance it will immediately distend its jaws and begin to rapidly feed upon it in a horrendous display of gore. Anyone witnessing this must make a Will save (DC 10) or flee in terror for 2d10 rounds. The feasting will take 1 round per HD the creature had. Upon finishing its meal, the Clownug will then receive +2 to all attacks and damage plus an additional 1d20 action die for a number of rounds equal to the number of HD it consumed.
- 28-29 A swarm of meaty nugget-bats cover a 50'x50' area blinding those in the area and taking tiny nibbles of flesh from enemies of the invoker and Buddy. Each target will need to make a Reflex save (DC 13) each round or suffer 1d6 damage. The swarm also causes blindness and -1 die step to all actions to those within. The swarm will disperse after 4d4+CL rounds.
- 30-31 An avatar of Buddy appears between the invoker and its enemies. The towering clown-thing stands 30' tall and will attack with two slamming fists before vanishing again with a throaty chortle. Each fist can be directed at one target, or two separate unfortunates. Each fist strike causes 5d6 damage, Reflex save (DC 16) for half damage.
- 32+ 1d4+CL targets must immediately make Will saves (DC 15) or instantly be polymorphed into piles of edible food but still conscious and aware (Buddy burgers, mounds of nuggets, etc.) In addition, all enemies within 100' of the invoker must also make Will saves (DC 15) or immediately be overcome with ravenous hunger. Those who fail the save drop anything in their hands and immediately begin feeding. Those polymorphed remain in this state for one minute, helpless while they're eaten alive (1d5 points of damage per round for 10 rounds). Should a polymorphed target somehow survive, they will regain their normal form covered in bites and bleeding from the wounds they've suffered from the feeding.

GODS AND PATRONS OF UMERICA

Patron taint:

When patron taint is indicated, roll 1d6 on the table below. When a caster has acquired all six taints at all levels of effect, there is no need to continue rolling any more.

- 1 Caster develops a strong odor of fast food (burgers and fry grease) for 1d6 hours. While in effect the chance for random encounters are doubled for the duration. During times of stress when the caster would sweat, all within 20' of the caster must make a Will save (DC 10) or be distracted by hunger suffering a -1 die step penalty to all actions. If the result is rolled a second time, The duration is 1d6 days. If the result is rolled a third time, the caster permanently carries the unsettling mouthwatering scent.
- 2 The caster will now smile all of the time, even when inappropriate to do so. If the result is rolled a second time, the caster's mouth grows disproportionately large and he speaks in a more sing song like voice that unsettles any person not a member of the burger cult (-1 die step penalty on any Personality based checks). If the result is rolled a third time, the caster will begin loudly singing fragments of the O'Burger Two All Beast Patties Special Sauce song at inopportune times, Will save (DC 18) to avoid or stop singing.
- 3 Caster loses all body hair with the exception of strange tufts in bright colors on the head. If the result is rolled a second time, the caster also develops a pale alabaster-like skin color. If the result is rolled a third time, strange clown-like markings will appear on the caster's skin while the caster's nose is replaced by a squeaking bulbous object, effectively making him a clown. The caster will be attacked on sight by enemies of the cult but all who follow Buddy will welcome him with open arms.
- 4 The caster will begin hearing one of the O'Burger jingles playing in thin air at random times, just loud enough to be mildly distracting. If the result is rolled a second time, the caster will hear a jingle playing more often and it will be loud enough to cause a -1 penalty to all of their action rolls unless they make a Will save (DC 10) each time the jingle starts up. If the result is rolled a third time, When other people speak to the caster, the caster will hear random bits of the conversation as an O'Burger jingle sung by the speaker. They must make an Intelligence check (DC 12) during every conversation to fully understand what was spoken to them.
- 5 The caster has an increase in their appetite and requires 50% more food each day then a normal person to feel full, unless all they eat is O'Burger food. If the result is rolled a second time, the hunger increases and they must eat double a normal person's intake to fill sated. Should the proper amount of food not be eaten, the caster will suffer a -1 die step to all actions until satisfied and their stomach will growl loudly. At this point even eating all O'Burger food will still require 50% more each day than normal. If the result is rolled a third time, at this point the caster is always ravenous and must consume three times a normal person's intake to curb the hunger. If enough food is not consumed, the caster will suffer a -1 die step penalty to all actions and a -5' move penalty. In addition the growling of their stomach will be so vociferous that it will double the chances of encountering wandering monsters. Eating only O'Burger food will lower this to only double the normal food required.
- 6 All food that the caster eats will seem dull and tasteless except O'Burger food and fresh humanoid flesh, which will taste amazing. If the result is rolled a second time, The caster will suffer moderate indigestion anytime they eat anything that is not O'Burger food or fresh humanoid flesh. If the result is rolled a third time, The caster will always regurgitate anything eaten that is not O'Burger food or fresh humanoid flesh.

GODS AND PATRONS OF UMERICA

Patron Spells

THE GRAVE

Level: 1 **Range:** 60' **Duration:** varies **Casting time:** 1 round **Save:** Will

General: Buddy instills a ravenous, debilitating hunger within each of the targets.

Manifestation: Roll 1d6: 1-2 An O'Burger jingle begins playing from thin air loquaciously depicting the finest edibles from the value menu, 3-4 a tiny clown appears out of thin air and strikes the target's gut with a hammer creating the sound of a resounding gong, 5-6 loud ferocious growling erupts from the target's gut as their midsection writhes and churns.

- 1 Lost, failure, and patron taint.
- 2-11 Lost. Failure.
- 12-13 One target must save or be struck with hunger, causing a -1 die step penalty to all actions for 1d5+CL rounds. The effect can be negated by spending 1d3 rounds doing nothing but eating.
- 14-17 As above but 1d3+CL targets are affected.
- 18-19 As above but 1d5+CL targets are affected and the effect lasts for 2d4+CL rounds.
- 20-23 As above but 2d4+CL targets are affected and the effect lasts for 2d6+CL rounds.
- 24-27 As above but the hunger is so great that it causes a -2 die step to all actions and an additional Will save (DC 14) must be made each round to avoid eating whatever food is within sight. The effect can be negated by spending 1d4+3 rounds doing nothing but eating.
- 28-29 As above but 2d8+CL targets are affected and the effect lasts for 2d8+CL rounds.
- 30-31 As above but 2d14+CL targets are affected and the effect lasts for 2d12+CL rounds.
- 32+ As above but the hunger is so crippling that it causes a -3 die step penalty to all actions and an additional Will save (DC 16) must be made each round to avoid eating anyone or thing within reach. If no food sources can be found, the target will begin to consume themselves. The effect can be negated by spending 1d10+6 rounds doing nothing but eating.

GODS AND PATRONS OF UMERICA

HEALING FEAST

Level: 2 **Range:** 30' **Duration:** 2 hours **Casting time:** 1 turn **Save:** NA

General: A bounty of O'Burger edibles is summoned that not only fills the belly but restores health as well. Once the spell duration expires, the food will instantly vanish but any lasting effects will remain for their full duration.

Manifestation: Roll 1d6: 1-2 two giant gloved hands descend from above carrying the feast, 3-4 A burst of technicolor smoke erupts from the ground and dissipates to reveal the feast, 5-6 A small O'Burger stand materializes from thin air and a clown chef serves the feast up to order with a smile.

- 1 Lost, failure, and patron taint.
- 2-11 Lost. Failure.
- 12-13 Failure, but spell is not lost.
- 14-15 Creates 3+CL super sized portions of tasty food, each portion will heal 1d3+CL points of damage as well.
- 16-19 As above but 6+CL portions are created.
- 20-21 As above but 9+CL portions are created and they each heal 1d6+CL hp.
- 22-25 As above but 12+CL portions are created.
- 26-29 As above but each portion also restores 1d3 points of temporary ability damage or cures one of the following conditions: paralysed, diseased, or poisoned.
- 30-31 As above but 18+CL portions are created and they each heal 1d8+CL hp.
- 32-33 As above but each portion also restores 1d5 points of temporary ability damage. In addition, each portion increases the consumer's action dice by one step for one hour.
- 34+ The Blessings of Buddy flows freely and a garishly colored, glowing font of feasting appears that serves up 6+CL super sized portions of tasty food every hour for the next 3d8+CL hours.

GODS AND PATRONS OF UMERICA

MEAT HARVEST

Level: 3 **Range:** 50'/CL **Duration:** varies **Casting time:** 1d4 rounds **Save:** Ref

General: A portal from the High Burger Temple meat processing and distribution sanctuary opens and several giant gloved hands reach forth to gather the caster's enemies for processing.

Restriction: This spell can only be safely cast once per week. Any castings beyond that have a cumulative 25-CL% chance of incurring Buddy's wrath, causing the caster to suffer 1d3 points of temporary attribute damage to each attribute.

- 1 Lost, failure, and patron taint.
- 2-11 Lost. Failure.
- 12-15 Failure, but spell is not lost.
- 16-17 For ½ CL rounds the hands will grab CL Hit Dice of targets and attempt to toss them into the portal. Each target must make a Reflex save or vanish through the portal, never to be seen again.
- 18-21 As above but the spell duration increases to CL rounds.
- 22-23 As above but the number of HD grabbed each round is now CL x1.5
- 24-26 As above but the number of HD grabbed each round is now CL x2
- 27-31 As above but the spell duration increases to CL x2 rounds.
- 32-33 As above but the number of HD grabbed each round is now CL x3
- 34-35 As above but the number of HD grabbed each round is now CL x4
- 36+ A 30' tall avatar of Buddy O'Burger himself steps out of the portal wielding a giant scoop net. He cheerfully sings the finest of the O'Burger jingles as he scoops up CL x4 HD worth of the caster's enemies each round for CL x3 rounds before stepping back through the portal with a cheery wink and a smile.

GODS AND PATRONS OF UMERICA

Spellburn

When a caster utilizes spellburn, roll 1d4 and consult the table below or build off the suggestions to create an event specific to your home campaign.

- 1 Buddy favors spellburners who offer up meat to help feed the needy, either from a willing follower of Buddy or the caster's own body is used (expressed as ability loss should caster use his own form, or a "volunteer" who also worships Buddy).
- 2 Feed the maw. Expended ability points need not be immediately suffered. Caster may expend up to his normal amount, but if he can prepare and feed the hungry while preaching the virtues of Buddy the expenditure will be absorbed, at the rate of 1 point of spellburn for each family fed. If caster is unable to perform the selfless act within 24 hours the spellburned ability points will be lost from a random attribute.
- 3 Jingle and a joke. The caster may expend the normal amount of ability points but if it is followed by an O'Burger jingle and a joke the point loss will be offset by an amount based on how entertaining the jingle and joke was. Judges are encouraged to have the player actually come up with a catchy jingle and set of jokes. If the resulting performance really gets the fellow players laughing, consider giving a +1 die step bonus for the next action in addition to offsetting the the spellburn! Those who are too shy to perform can be asked to make a DC 12 Personality check to see how well the performance goes.
- 4 The caster must imbibe a poisonous concoction that weakens the body (expressed as attribute point loss) and forces the caster to suffer from Risus Sardonicus (a.k.a. a rictus grin) until the attribute points lost are healed.



GODS AND PATRONS OF UMERICA

KIZZ AS A PATRON

Invoke Patron check results:

- 1-11 Kizz is distracted either by wine, women, and song, or by expressing his dumb opinions to the world press. Failure and patron taint
- 12-13 Kizz gifts the caster by increasing their effective CL for spell casting and effects by +1, and all Personality checks are at +1d for 24 hours.
- 14-17 A total of 1d5+CL Hit Dice worth of enemies are now distracted by rockin' daydreams, giving the caster and his allies +1 die step bonus to any stealth checks and reducing enemy attack by -1 die step. This effect lasts 1d5+CL rounds.
- 18-19 In 1d6 rounds, a stampede of spectral fans arrive, mobbing the scene for 1d4+CL rounds. The thousands of groupies pack the area, forcing enemies to attempt a DC 10 Strength save before being able to attack or move each round. If the save is successful, the attack is still at a -1 die step penalty and movement is halved. The caster and his allies are not impeded in any way.
- 20-23 The caster and his allies increase their critical hit range by 1d4+Luck Mod (roll separately for each) and add 1d4 to all crit rolls for the rest of the combat.
- 24-27 A wall, floor, or ceiling targeted transforms into a 30' wide mouth with bright red lips, sharpened teeth, and a 50' tongue that attempts to lick up all enemies and devour them. The mouth remains for 2d6+CL rounds or until slain or dispelled.
- Kizz's Lick:** Init: +CL; Atk: Tongue lash +CL ranged (grappled and drawn into mouth next round (DC 15 to escape), range CLx10') Bite automatic hit on those held by tongue (1d10 + CL damage); AC: 15; HD: 3d12 (21 hp); MV 0'; Action Dice: 3d16; SP: Healing lick - may target a friendly unit for 1 HD healing, Vampiric Regen - auto heals 1/2 the HP of damage done by bite, can hold an infinite number of creatures in mouth, bite/chewing attacks hit automatically and overcome magic resistance; SV Fort: +5, Ref: +0, Will +5
- 28-29 Kizz summons a large, unnecessarily phallic rocket into being. In one round, if properly stroked and gyrated against, the rocket will launch and perform one of the following actions, chosen by the caster:
- Carry the caster and his entire party 1d3+CL miles in any direction over the course of 3d3 turns.
 - Fly into the air and smash directly into a foe 1d3 rounds later for 2d20 damage, with a 10 x CL blast radius of 1d16 additional pyrotechnic damage, and a 4 in 6 chance for all targets in the blast radius to catch on fire.
 - Fly high into the air and explode in a massive display of interdimensional pyrotechnics lasting 1d5 rounds. All beings that view the display must make a Fortitude save DC 15 or be struck blind for CL turns. The caster and his allies are immune to the effect.
- 30-31 Kizz sends a lesser avatar, an ornately painted and attired giant with a huge axe, codpiece, and tongue. It will serve the caster for 11 rounds before returning to the Realms of Awesome.
- Lesser Avatar:** Init: +6; Atk: Axe +6 melee (3d4 + 1d4 fire damage and Reflex save (DC 10) or else catch fire), Spiked boot +6 melee (1d8), Tongue lash +6 melee (grappled, DC 16 to escape); AC: 20; HP 66; MV 50; Action Dice: 3d20; SP: Immune to non-magical damage, All attacks overcome magic resistance, Scores critical hits as a giant; SV Fort: +6, Ref: +6, Will +6; AL N.
- 32+ In a massive explosion of pyrotechnics and flames, the true avatar of Kizz appears standing on a fiery performance stage made of writhing skeletons. He and his Skeletal Warrior band jam for 1d10+1 turns. During this time all non-divine entities within a thousand feet will do nothing but enjoy the show. Should anyone break free of the enchantment during the performance (Will save DC 25) and attempt to attack the avatar of Kizz or his band, the burning skeletal stage will strike them automatically for (6d6)d6 points of damage and the crowd will cheer wildly. The avatar of Kizz and his band are immune to all damage and effects.

GODS AND PATRONS OF UMERICA

When the performance reaches its end, all beings watching the show that are not directly associated or allied with the caster must make a Will save of DC10. Any beings identifying as male or neuter that fail will be permanently struck blind from awesomeness. All beings identifying as females that fail will willingly join Kizz's immortal harem of groupies and be teleported away when Kizz departs.

Patron taint:

When patron taint is indicated, roll 1d5 on the table below. When a caster has acquired all five taints at all levels of effect, there is no need to continue rolling any more.

- 1 The caster develops strange tastes in personal grooming, the results of which require commoners who interact with the PC a morale save (at a cumulative -1 for every level of his taint). The third time it is rolled any failed morale saves result in the NPC refusing to have any dealings with the character and possibly calling the town watch.
Each time this is rolled, the caster must select or roll a new quality such as: 1) An alarming or inappropriate hairstyle. 2) Their tongue growing 1d3+1 inches. 3) Becoming proudly shaggy and showcasing their impossibly hairy chest or back. 4) Wearing face-paint in an original design similar to an evil clown.
- 2 The character must spend 1d3x50 gp acquiring a costume made only of metal and leather made by a master craftsman. The player should design the specifics of this outfit, making it as outlandish and aggressive as possible: leather corsets, steel codpieces, and boots with spikes instead of soles being the norm. If the result is rolled a second time, the character must seek to replace another randomly selected weapon and piece of equipment with cooler, masterwork equivalent which costs 1d5x50gp + original item's cost. If the result is rolled a third time, the item must cost 1d7x50gp + original item's cost.
- 3 The caster intermittently drools blood, especially when excited or angry. If this effect is rolled twice, the caster loses 1 point of Personality but may take an action to spit the blood at anyone within 10', once a day. This target must make a Will save DC 6+CL to avoid taking a -1 die step penalty to their next attack or skill roll. If this effect is rolled three times, the caster loses an additional 1d3 points of Personality and is able to spit the blood as a free action.
- 4 Rock and Roll all night. The character heals not just through rest, but also by participating in loud celebration. Six or more hours of intense partying and musical performance heals the PC in the same way as sleep does. While fun this does tend to annoy the neighbors and alert wandering monsters. The second time this is rolled, 1d3 otherworldly revelers arrive each night to participate in the bacchanal. They will eat their share of food and drink (stolen from the party) but provide nothing substantive. Additionally, each player not a servant of Kizz must make a DC 12 Will save or else be unable to sleep that night, neither healing nor regaining spells. If rolled a third time, 2d3 otherworldly revelers arrive, and the party makes sleep for the rest of the adventuring party impossible unless they set up separate camps.
- 5 Addiction. The character suffers from addiction to abusing some substance. When rolled once the addiction is minor, twice moderate, thrice severe. Addiction causes Stamina damage each day the character does not abuse their substance of choice. Effects of taking the drug are at the Judge's discretion. Minor Addiction: 1d3-2 Stamina damage/day. Moderate Addiction: 1d3-1 Stamina damage + 1d3-2 damage to a random stat. Severe Addiction: 1d3 Stamina damage + 1d3-1 damage to a random stat. Damage incurred From Moderate and Severe addiction does not heal with rest or partying as in #4 above.

GODS AND PATRONS OF UMERICA

Patron Spells

KIZZ MY AXE

Level: 1 **Range:** Self or proximity **Duration:** 1d3 +CL round(s) **Casting time:** 1 action **Save:** NA

General: For a moment in time, you gain custody of a fraction of the strength of Soulbreaker. As payment for this boon, you gotta smack the crap out of something.

Manifestation: A spectral image of a fiery axe is superimposed atop the wielder's actual weapon and strange, jarring music is heard.

- 1 Lost, failure, and patron taint.
- 2-11 Lost. Failure.
- 12-13 Kizz digs it. You receive a +1 bonus to all attack and damage rolls whilst your opponent suffers -1 to saving throws for CL rounds.
- 14-17 You receive a +1d3 bonus to all attack rolls and damage rolls and your opponent takes a -2 penalty to saving throws for CL rounds.
- 18-19 You receive a +1d4 bonus to all attack rolls and damage rolls whilst your opponent suffers -2 to saving throws for 1d3+CL rounds, your opponent must pass a DC 10 Reflex save after each successful attack or catch fire.
- 20-23 You receive a +1d5 bonus to all attack rolls and damage rolls for 1 round. In addition, your attack deals 1d6 fire damage and your opponent must make a DC 12 Reflex save or continue burning as Catching Fire described in DCC RPG pg 96. Your opponent also takes a -3 penalty to saves for 1d5+CL rounds.
- 24-27 As above, plus any allies within 10' also join the band and receive a +2 bonus to attacks and damage, plus their attacks possess the ability to set opponents alight if the opponent fails a DC 12 Reflex save.
- 28-29 Same as the previous result, affecting all allies within 20' and duration is doubled.
- 30-31 For the duration of the spell, you wield a minor physical manifestation of Soulbreaker. It deals 3d5 damage plus 2d4 fire damage (Reflex save DC 14 or catch fire) on a hit and grants +4 to all attack rolls. All allies within 40' gain the benefits of result level 24-27.
- 32+ For the duration of the spell, you wield a true physical manifestation of Soulbreaker. It deals 3d8 damage plus 3d4 fire damage (Reflex save DC 14 or catch fire) on a hit and grants +6 to all attack rolls. All allies within 100' gain the benefits of result level 24-27.

The price for wielding such mighty awesomeness is a permanent, cool looking burn scar on your fighting hand that will forever mark you as a follower of Kizz.

GODS AND PATRONS OF UMERICA

MOSH PIT

Level: 2 **Range:** 20' + 5' per CL **Duration:** 1d6 + CL rounds **Casting time:** 1 round **Save:** Will

General: The targeted opponents dance wildly, potentially doing damage to themselves and allies while opening themselves up to attacks.

Manifestation: The roaring sound of a rock concert rolls over the area and spectral mists infest the targets as they are forced to dance.

- 1 Lost, failure, and patron taint.
- 2-11 Lost. Failure.
- 12-13 Failure, but spell is not lost.
- 14-15 1d4 HD worth of opponents are forced to move together in a clump and slam-dance around the melee. Those affected suffer a -2 penalty to AC and may take no other actions. Anyone attempting to move through this group pays double cost for movement.
- 16-19 Same as above, affecting 1d4+CL HD of opponents who inflict 1d4 damage upon each other each round.
- 20-21 Same as above, affecting 1d6+CL HD of opponents. The caster is now able to control the movement of their victims, able to form barricades preventing enemy advance. Anyone moving through the group of dancers takes 1d6 points of damage for each round they are in contact with the group.
- 22-25 Same as above, affecting all opponents of 1 HD or less within 90' and an additional 1d8+CL HD of opponents.
- 26-29 Same as above, all opponents of 2 HD or less within 120' and 1d10+CL HD worth of opponents from one clump of slam-dancers whose movement is under independent control of the caster. Anyone attempting to move within 5' of the dance pit have halved movement, are automatically hit for the dancer's normal damage, and suffer -1 die step penalty to all attacks.
- 30-31 In addition to the previous result, all opponents caught in the dance pit suffer 1 temporary Stamina damage per 3 rounds.
- 32-33 Same as above but 1d3 Rockers (stone golem roadies of Kizz) are summoned to join the dance and are fully under the caster's control. They return to the Planes of Awesome when the spell fades.
- Rocker (Heavy Metal Elemental):** Init +0; Atk slam +5 melee (1d10+4); AC 18; HD 3d8+6; MV 20'; Act 1d20; SP regenerates 1d3 hp per round when in the presence of rock music, cast Mosh Pit 1/day (CL 5), immune to all mental attacks and effects, Crush! — Should a target be successfully hit with two or more slamdance attacks from different Rockers in the same round, they will suffer an additional 1d6 damage from being crushed; SV Fort +6, Ref +0, Will NA; AL N.
- 34+ As the previous result but 2d4 Rockers are summoned.

GODS AND PATRONS OF UMERICA

ASPECT OF KIZZ

Level: 3 **Range:** Varies **Duration:** Varies **Casting time:** 1 action **Save:** Varies

General: Though Kizz is said to be one specific god, it is believed that as a mortal he was split into four human consciousnesses, each with their own power. Kizz is said to gift these powers to his most faithful servants. While under the effects of an aspect, the caster's visage changes to resemble the dominant aspect: that of a cat man, star-eyed lover, spaceman, or demon. The caster may accept the rolled result, or any lesser result if preferred.

Manifestation: Within close proximity of the caster, a sound is heard of a million people cheering

- 1 Lost, failure, and patron taint.
- 2-11 Lost. Failure.
- 12-15 Failure, but spell is not lost.
- 16-17 Aspect of the cat man. The caster gains feline grace for 1d6+CL rounds. The caster is able to make leaps equal in distance or height to their full movement score, as long as the caster is not heavily encumbered. The caster's Agility modifier is increased by +1, and any jump or Agility checks are made at +1 die step.
- 18-21 Aspect of the star-eyed lover. Caster is able to hear distant conversations and seduce others for 1d6+CL rounds. The caster is able to hear anything within their range of sight for as long as the caster takes no other action.
- Any intelligent creature that is able to see the caster is allowed a Will save equal to DC 13 + CL to resist being consumed with sexual attraction for the caster for 1d4 + CL rounds. During this time the subject of the spell will defend itself but not attack the caster, and seeks only to obtain the caster to satisfy their urge. Creatures immune to charm are not immune to this effect.
- 22-23 Aspect of the spaceman. Caster is able to fire a blast of damaging light from their eyes and teleport for 1d6+CL rounds. Either of these activities takes one action to complete. The range of the eye laser is line of sight, doing 3d4 + CL heat damage, able to fire each round. Duration is for the length of the current encounter. Teleportation instantly transports the caster, their gear, and one other living creature of equal size or smaller to any destination the caster can see. The range is as far as the character can see, duration is instantaneous. If the caster's destination is obscured or the caster is not able to look at the exact location, but has a general idea of where to go (a blindfolded caster wants to move ten feet), roll a d20. If the result is...
- Under Luck Score: Teleportation is successful with no ill effects. If another character or object is inhabiting this space, they are knocked prone and the caster stands atop them. If the object cannot be moved (a tree for instance), than the character lands somewhere atop the object.
 - Up to 5 over Luck: The teleport goes where intended, but then travels an additional ten feet in the wrong cardinal direction. Roll a d8. A 1 means the cardinal direction moved to is north, 2 is northeast, and so on continuing clockwise. If another character or object is inhabiting this space, the caster is knocked prone and inhabits a space underneath the object.

GODS AND PATRONS OF UMERICA

- Ten over Luck: The caster has teleported 1d3 x 10' straight above their target and falls, taking 1d6 damage for every ten feet fallen, and inflicting half this damage on anyone they may land upon.
 - More than ten over Luck: The caster teleports 10' underneath their intended target. This may mean they are now buried in earth or stone. If this is the case, the shock of burial provides 1d10 damage, and then "drowning" begins next round. Drowning creatures take 1d6 points of Stamina damage per round and die when Stamina reaches 0; lost Stamina is restored immediately if they are removed from the morass.
- 24-26 Aspect of the demon. Incredible strength and several breath effects allow the caster to wreak havoc on their enemies for 1d6+CL rounds. Caster is immune to fire and sonic damage, Strength becomes 20, and two separate breath effects are gained (only one breath may be used per round).
- Fire Breath:** Range: 30', Damage: 3d6 (Reflex save DC 15 for half) + burning.
- Shout of Reverb:** Within 5', destroys common objects made of brittle material (glass, ceramics, etc.) and fires a cone of sonic damage forward at a range of 30' that does 1d6 x CL sonic damage (Fortitude save for half, DC = 13 + CL)
- 27-31 The duration of the effect selected is increased to 1d6+CL turns.
- 32-33 Caster is able to select any previous result and may choose to bestow it on an ally instead.
- 34-35 Caster gains whichever aspect they prefer, and grants each additional aspect to an ally until all are assigned once (there can only be four aspects of Kizz).
- 36+ In addition to the previous result, the caster and his three affected allies gain the ability to fly 100', increase their AC by +4, and regenerate 1 hit point per round.



GODS AND PATRONS OF UMERICA

Spellburn

Kizz is preoccupied with sensation and appearance, and his requests of supplicants often mirror this obsession. When a caster utilizes spellburn roll 1d4 and consult the table below or build off the suggestions to create an event specific to your home campaign.

- 1 A dose of an intoxicant is required... and no small measure, either! In addition to regular spellburn, the caster must take enough of a dose of a substance to become intoxicated.
- 2 Sparks and flaming projectiles emerge from the ground beneath the caster, looking very badass. The heat and smoke from the pyrotechnics inflict Stamina damage to the character in the amount of spellburn requested. Additionally, the PC and all within 5' of them must save vs. burning (see pg 101). Each creature so burned adds one to the spellburn total!
- 3 Kizz hungers! The caster may spellburn exactly 10 points of ability score loss, but need not take any of the damage. The caster now has 24 hours to experience an intense experience of physical pleasure or pain in the name of Kizz. If they do so successfully, the penalty is ignored. If not, the full ten points of spellburn is inflicted on the caster immediately, providing the intense sensation that Kizz requires.
- 4 The caster is moved to song. For each point of spellburn, two lines of an original and awesome metal song must be sung by the player immediately. The subject of this song is to be the current combat or situation at hand. Successful completion of this singing is also subject to Luck or XP awards by the GM as appropriate to the campaign (suggested 1 Luck or 2 XP).



GODS AND PATRONS OF UMERICA

THESZOLOKOMODRA AS A PATRON

Invoke Patron check results:

- 1-11 Dozens of Theszolokomodra's heads respond to the caster's plea at the same time causing them to become confused for 1d3 rounds.
- 12-13 Strange secrets are whispered into the caster's ears, things man was not meant to know. Their die rolls are increased by one die type for CL+d7 rounds. As an action, the caster can pass these secrets on to another person and they share the same bonus for 1d4 rounds.
- 14-17 The caster gains a glimpse of the future. One time in the next hour they may re-roll any one action die roll. This re-roll is made with a d30 instead of the original die type. The caster can choose to pass this re-roll to another character instantly at the cost of 1 Luck point.
- 18-19 The caster gains, for a fraction of a second, insight from Theszolokomodra's minds. They may ask the GM one single question that must be answered 100% truthfully. The question must pertain to the adventure, quest, or situation at hand. If the GM chooses to veto the question, another question may be asked until one is answered.
- 20-23 The caster gains a glimpse of Theszolokomodra's multiplicity. They gain CL additional d20 action dice for 1d4+1 rounds.
- 24-27 A dimensional portal opens before the caster that leads to a safe location (1d5)d5 miles away. A total of 3d4+CL beings can pass through it before it closes.
- 28-29 The caster may identify which enemy they are currently facing is the most powerful. Then, Theszolokomodra summons a duplicate of that being or creature from another dimension to battle the original. The caster may attempt Personality checks (DC 13) to direct its actions.
- 30-31 The Servitor Worm in the casters belly releases a wave of energy that heals the caster and all of his allies 2d3 hit dice. If anyone is healed past their max hit points, they may keep the extra as bonus HP until the end of the encounter.
- 32+ One of Theszolokomodra's heads emerges suddenly from a portal and consumes 2d4 points of Intelligence from every being within 100'. The caster and his allies are immune. For every 10 points of Intelligence it consumes the caster may then ask one question with a 50+current Luck% chance that the head will answer truthly. The head then departs.

GODS AND PATRONS OF UMERICA

Patron taint:

When patron taint is indicated, roll 1d6 on the table below. When a caster has acquired all six taints at all levels of effect, there is no need to continue rolling any more.

- 1 The caster's face and neck extends 1d3+1 inches, slightly distorting their features. If the result is rolled a second time, the elongation for the caster's face and neck increases by 1d4+4 inches and reduces Personality by 1 as it takes on a serpentine quality. If the result is rolled a third time, the elongation continues another 1d6+8 inches as the caster's head and neck completes its serpentine transformation, reducing their Personality by a further 1d3.
- 2 The caster's gut begins to distend as the Servitor Worm begins to grow. At this point it can be passed off as a bit of a pot belly. If the result is rolled a second time, the caster has an obviously distorted abdomen that requires them to spend an additional 2d6% on all clothes and armor. If the result is rolled a third time, the caster's belly button expands and forms into a sphincter opening that the Servitor Worm can partially emerge from. While it is extended the caster suffers a -2 AC due to putting the caster off balance. On the other hand, it adds a d3 to all casting rolls.
- 3 The caster begins to develop multiple personalities. At first, one new personality emerges that is fully separate but generally amiable to the caster's original personality. There is a 50% chance of an identity switch every time a spellcasting roll fails. If the result is rolled a second time, 1d3 new personalities develop with a 10% chance of each being adversarial to one or more of the other personalities. The chance of an identity switch increases to 75%. If the result is rolled a third time, the caster gains a new personality every time they gain a new spell and identity switches take place every 2d4 hours.
- 4 The caster is seized by an inexplicable craving to travel to another dimension. If the result is rolled a second time, the longing overcomes the caster; if the opportunity to enter another dimension presents itself, he must take it. If the result is rolled a third time, the caster can do nothing productive but take steps that will take him to another dimension.
- 5 The caster grows a tiny second head at the base of his neck. It responds to light and touch but is generally vestigial. If the result is rolled a second time, the head grows to the size of a softball and begins speaking and having its own opinions. It will usually defer to the primary head and be helpful. If the result is rolled a third time, the head grows to full size and is equally dominant as the original. This increases the caster's overall Intelligence by +2 but also increases the chance of spell loss, failure, and patron taint by 2 due to arguments (meaning this occurs on a 1-3 for most spells instead of just on a 1).
- 6 The caster begins to see in more than one dimension. In the beginning this causes a -1 penalty to ranged combat and visual perception checks. If the result is rolled a second time, the penalty increases to -2 but the caster suffers no penalties to see ethereal or astral creatures interacting with the material world. If the result is rolled a third time, the penalty increases to -3 but the caster can automatically see invisible creatures.

GODS AND PATRONS OF UMERICA

Patron Spells

TACTICAL DISPLAY

Level: 1 **Range:** 20' + 20' per CL **Duration:** Varies **Casting time:** 1 round **Save:** NA

General: The caster sees information about enemies hovering over their heads.

Manifestation: In the caster's field of vision, they see neon stat blocks for each target effect depicting the target's abilities.

- 1 Lost, failure, and patron taint.
- 2-11 Lost. Failure.
- 12-13 The caster will see the stats and special abilities of one random enemy within range as text hovering above the being's head. In combat, an action with a successful Intelligence check (DC 10) is required to read the information. This lasts for CL+1d5 rounds.
- 14-17 Similar to the previous result, now the caster will see information on 1d3+1 enemies of their choice. Only one Intelligence check is required to read all of the information.
- 18-19 For the next 2d6+CL rounds, the caster will see the stats and special abilities of 2d4+1 enemies of their choice. Up to CL number of allies can now view the information. Also, the Intelligence roll required to understand the information is reduced to DC 5.
- 20-23 As the previous result but no Intelligence roll is required to read the information and the duration is now CL turns.
- 24-27 The caster and up to CL x2 allies can view the stats and special abilities of 2d4+CL foes within range. This effect lasts for 1d4+CL turns.
- 28-29 The caster and up to CL x3 allies can view the stats and special abilities of 2d8+CL foes within range. This effect lasts for 1d8+CL turns.
- 30-31 The caster and up to CL x4 allies can view the stats and special abilities of 2d12+CL foes within range. This effect lasts for 1d12+CL turns.
- 32+ As the previous result but now all enemies in range display their information to the caster and all of the his allies. This also grants a +1 die step bonus to all actions against these foes.

GODS AND PATRONS OF UMERICA

WRATH OF THE WORM

Level: 2 **Range:** 150' **Duration:** Instantaneous **Casting time:** 1 round **Save:** NA

General: A bolt of pain emanates from the caster's Servitor Worm to cause their enemy's innards to twist and knot.

Manifestation: Pale ethereal lightning projects from the caster's midsection and reaches directly into the target's internal organs.

- 1 Lost, failure, and patron taint.
- 2-11 Lost. Failure.
- 12-13 Failure, but spell is not lost.
- 14-15 The caster can attack one target which must make a Will save vs. spell check or temporarily lose 1d6 points of Stamina.
- 16-19 As above but the target loses 1d8+1 points of Stamina.
- 20-21 The caster can attack one target that temporarily loses 2d6+1 points of Stamina. Creatures of 1 HD or less receive no save; others receive a Will save vs. spell check. Additionally, the caster heals 1 hit die. If healed past their max hit points, they may keep the extra as bonus HP for 1 turn (further castings will not grant more bonus hp until the caster's hp drops below their normal maximum).
- 22-25 The caster can launch two bolts. Each bolt does 2d6+1 Stamina damage. Creatures of 2 HD or less receive no save; others receive a Will save vs. spell check. Additionally, the caster heals 2 hit dice. If healed past their max hit points, they may keep the extra as bonus HP for 1 turn.
- 26-29 The caster can launch three bolts. Each bolt does 3d6+1 Stamina damage. Creatures of 2 HD or less receive no save; others receive a Will save vs. spell check. Additionally, the caster heals 2 hit dice. If healed past their max hit points, they may keep the extra as bonus HP for 1 turn.
- 30-31 As above but the caster launches four bolts and heals 3 hit dice.
- 32-33 The caster can launch five bolts. Each ray does 3d6+1 Stamina damage. Creatures of 3 HD or less receive no save; others receive a Will save vs. spell check. Additionally, the caster heals 4 hit dice. If healed past their max hit points, they may keep the extra as bonus HP for 1 turn.
- 34+ The caster sends forth a burst of debilitating energy that weakens all enemies within a 150' range! All enemies within range take 3d6+CL Stamina damage. Creatures of 3 HD or less receive no save; others receive a Will save. Additionally, the caster heals 4 hit dice. If healed past their max hit points, they may keep the extra as bonus HP for 1 turn.

GODS AND PATRONS OF UMERICA

DIMENSIONAL MAWS

Level: 3 **Range:** 100' **Duration:** Varies **Casting time:** 1 round **Save:** NA

General: The caster calls forth several mouths that pierce through to this reality to attack the caster's enemies.

Manifestation: Extra dimensional jaws tear through the walls of this reality and metaphysically consume part of the target.

- | | |
|-------|--|
| 1 | Lost, failure, and patron taint. |
| 2-11 | Lost. Failure. |
| 12-15 | Failure, but spell is not lost. |
| 16-17 | A single mouth rips into this reality to strike one target of the caster's choice within range. The mouth does 1d4 points of damage and 1 point of temporarily damage to a random ability score. |
| 18-21 | As above but the mouth does 1d6 points of damage and the target must make a successful Will save or be teleported 4d6' in a random direction. |
| 22-23 | The caster can call forth a number of mouths equal to his CL, which must be aimed at a single target within the spell's range. Each mouth does 1d6 points of damage and 1 point of temporarily damage to a random attribute. In addition, the victim must make a successful Will save or be teleported 1d6' per failed save in a random direction as well. |
| 24-26 | The caster can call forth a number of mouths equal to his CL, which can be aimed at multiple targets within the spell's range. Each mouth does 1d8 points of damage and 1d2 points of temporarily damage to a random attribute. In addition, each target must make a Will save or suffer a -1 penalty to all actions for 1d6 rounds plus 1 round per failed save due to dimensional instability. |
| 27-31 | The caster can call forth a number of mouths equal to twice his CL, which can be aimed at multiple targets within the spell's range. Each mouth does 1d10 points of damage and 1d3 points of temporarily damage to a random attribute. In addition, each target must make a Will save or be slowed to half of its normal speed for 1d5 rounds plus 1 round per failed save. |
| 32-33 | As above but each mouth does 1d12 damage and causes each target to temporarily lose 1d4 points from a single random attribute. In addition, each target must make a Will save or be slowed to half of its normal speed for 1d5 rounds plus 1 round per failed save and be teleported 6d6' plus 1d6' per failed save in a random direction as well. |
| 34-35 | The caster can call forth a number of mouths equal to thrice his CL, which can be aimed at multiple targets within the spell's range. Each mouth does 1d14 points of damage and 1d2 points of temporarily damage to each attribute. In addition, each target must make a Will save or be slowed to half of its normal speed for 1d5 rounds plus 1 round per failed save. |
| 36+ | A veritable storm of mouths appear and bite all foes within 100' 1d3 times, causing 1d16 damage and 1d3 points of temporarily damage to each attribute with every bite. Anyone bitten will also suffer a -1 die step penalty to all actions, be slowed to half normal movement, and teleported 1d100' in a random direction. |

GODS AND PATRONS OF UMERICA

Spellburn

When a caster utilizes spellburn, roll 1d4 and consult the table below or build off the suggestions to create an event specific to your home campaign.

- 1 The Servitor Worm deep within the caster's abdomen noticeably writhes and feasts loudly on the sacrificed ability score points. Everyone within 15' must make a Fortitude save DC6+Spellburned points or become nauseous, suffering a -1 to all actions for the next 1d5 rounds.
- 2 The caster must gather essence for his master. In this special situation, the character can spellburn up to 10 points of ability score loss, but need not take any ability score damage. For the next 24 hours, any successful melee attack made by the caster will inflict an additional 1d3 Intelligence damage to the target, which Theszolokomodra feasts on. If the caster does not collect 3 times the number of points spellburned within the 24 hour period he takes the full 10 points, distributed across ability scores at the judge's discretion.
- 3 The caster begins to rapidly phase in and out of this reality for a number of turns equal to the number of points spellburned. During this time, any physical action he takes or any non-magical attack made against him has a 50% chance of automatically failing as he blinks in and out of this dimension. This includes communication, movement, and benefiting from Lay on Hands attempts.
- 4 A thousand worms crawl under the caster's skin as he casts, each speaking the incantation for the spell.

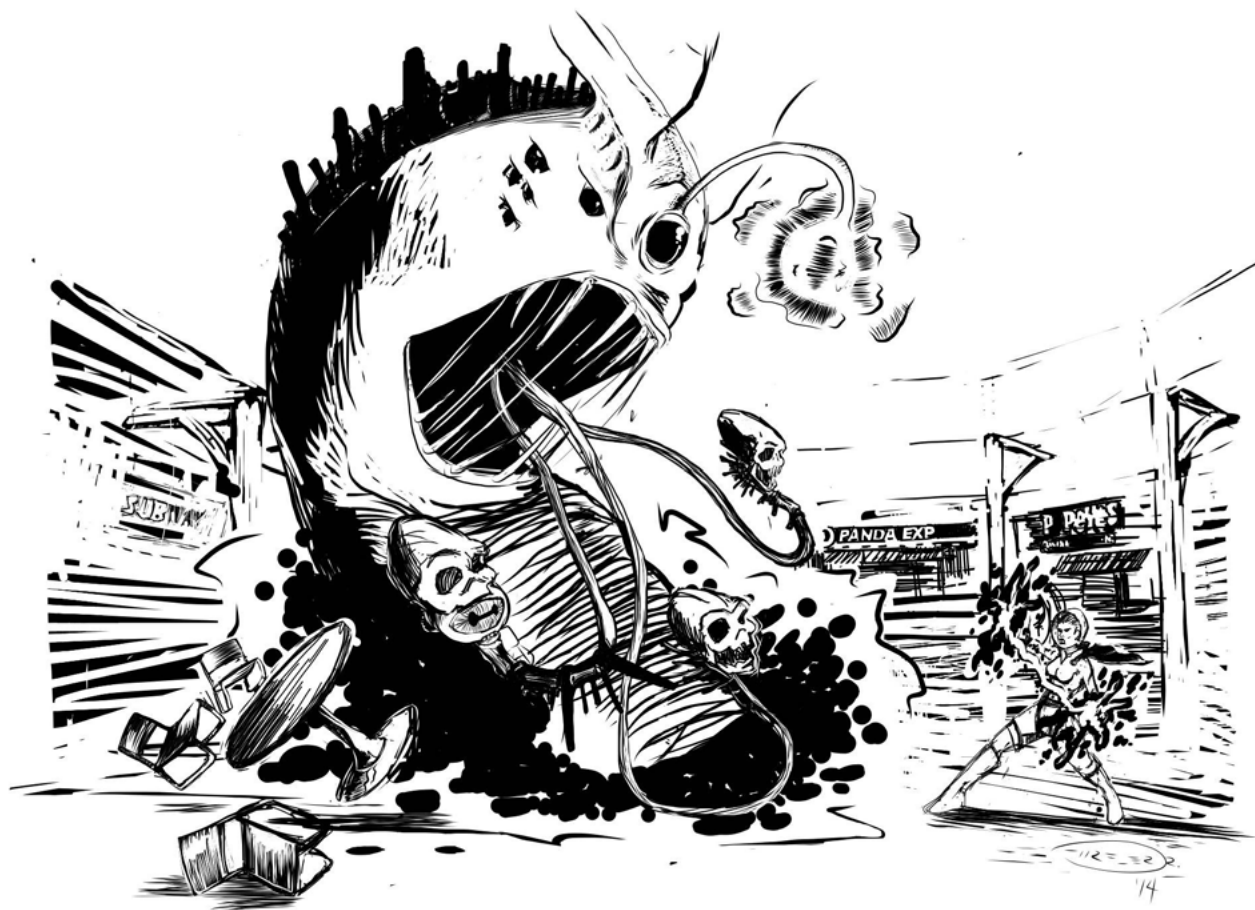

GODS AND PATRONS OF UMERICA

THE NON-DEIFIC PATRONS

THE EARTH BRAIN OF THE CYBERHIVE AS A PATRON

The Cyberhive is an intergalactic AI that inhabits multiple giant pseudo-brains located all over the universe. Each brain is tasked with a specific purpose for increasing the knowledge of the whole. All brains are in constant communication and act as one being.

The brain on Urth is dedicated to understanding living beings' concepts of life, death, the afterlife, and the taboos surrounding death. To facilitate this, it has currently chosen to reanimate the corpses of intelligent lifeforms with technomagic cybernetics. The goal is to see how the inhabitants of the world interact with these recycled beings. It feels no anger or resentment towards those who kill its minions. On the contrary, the Earth Brain is very intrigued by those highly disturbed by its activities.

For the sake of efficiency, it sends these reanimated minions, which it has programmed to act as religious devotees of itself, throughout the post apocalyptic lands of Umerica. They travel to settlements and inhabited cities to collect the recent dead in trade for gifts of simple technology; such as heaters, ovens and refrigerators that are self powered with 1000 year batteries.

Should anyone with sufficient understanding attempt to contact the Earth Brain, it will evaluate their usefulness. Should they show potential, it will begin a conversation through its minions. If the individual is judged to be of use, the Earth Brain will begin communication directly. This can result in a Patron relationship.

The Earth Brain is constantly monitoring the activity of every minion, categorizing and compiling the data. It is focused on understanding how living beings conceive and react to Life and Death. It expects any Wizards serving it to further these ends as much as possible. This includes causing death, witnessing death, witnessing births, interacting with the terminally ill, and observing others doing all of the above.

Invoke Patron check results:

- 1-13 The Cyberhive is unavailable at this time, please hold. Caster stares into space for the next 1d3 rounds.
- 14-17 The Cyberhive restores CL x d3 Hit Points to the caster and his allies. Everyone affected is now broadcasting all sensory input to the Cyberhive.
- 18-19 The Cyberhive replaces the weapons employed by the caster and their party, via teleportation, with more technologically advanced versions that gain +1 to hit and damage; this includes magic weapons.
- 20-23 The Cyberhive teleports 1d3+CL Zombie Monks to the caster's location. They obey the caster and collect any dead humanoids encountered or created. They will teleport away in 2d30 minutes and take all of the dead with them.
Zombie Monk (Lay Ghoul): Init +0; Atk Cyberclaw +1 melee (1d6) or Power Beam +2 missile fire (1d6, range 40/80/120); AC 12; HD 2d8; MV 30'; Act 1d20; SP Battle Hymn - see below; SV Fort +4, Ref +0, Will +0; AL N.

GODS AND PATRONS OF UMERICA

When three or more Zombie Monks are engaged in combat they “sing” their battle hymn, which is a cacophony of painful electronic noise. Everyone within 100’ that is not deaf must make a Will save DC12 or have their action dice lowered one step. A new save must be made every round.

- 24-27 The brain of the most dangerous nearby opponent is teleported to the Floating Tower for analysis and download. It is returned 1d3 rounds later. During this time, the opponent is inactive, unresponsive, and helpless.
- 28-29 The Cyberhive teleports a Robo-lich and CL x d3 Zombie Monks to the Caster’s location. They obey the caster and collect any dead humanoids encountered or created. They will teleport away in 2d14 minutes and take all of the dead with them.

Robo-lich (Cyber Shepherd): Init +1; Atk Powerclaw +7 melee (1d10+3) or Plasma Cannon +9 missile fire (1d14, 100/200/300); AC 16; HD 6d8; MV 30’; Act 1d20 +1d16; SP Spells - see below; SV Fort +6, Ref +0, Will +4; AL N.

While Robo-liches do not have the ability to sing a Battle Hymn like their Zombie Monk charges, they are not adversely affected by it either.

Robo-liches leave the Floating Tower with the following spells in memory: Magic Shield, Scare, and Slow. To determine what other spells they may have roll 6 times on *Table RL-1* below. Among their cybernetic implants is an Arcane Amplification Cyber-Organ that grants them +5 to all casting checks.

Table RL-1: Robolich Spells known			
Roll 1d5 down and 1d3 across			
	1	2	3
1	Charm Person	Detect Invisible	Consult Spirit
2	Choking Cloud	Forget	Dispel Magic
3	Detect Magic	Knock	Gust of Wind
4	Force Manipulation	Monster Summoning	Haste
5	Mending	Shatter	Turn to Stone

- 30-31 The caster’s body is put into quantum stasis for 2d4 rounds. It cannot be harmed or moved in any way. During this time the caster’s brain is teleported to the Floating Tower for a backup and upgrade. When the caster awakes from stasis, they gain a permanent +1 Intelligence and +1 to all casting checks.
- 32+ The Cyberhive instantly kills 3d4+CL random opponents that are within 100’ of the caster and teleports the bodies to the Floating Tower for recycling. It then replaces each opponent killed with 1d3 Zombie Monks. They obey the caster and collect any dead humanoids encountered or created. They will teleport away in 2d100 minutes and take all of the dead with them.

GODS AND PATRONS OF UERICA

Patron taint:

When patron taint is indicated, roll 1d6 on the table below. When a caster has acquired all six taints at all levels of effect, there is no need to continue rolling any more.

- 1 The caster begins to share the Cyberhive's obsession with the concept of dying. The next time the caster comes in contact with a dying humanoid they must spend 1d3 rounds examining it, even if it is a dying party member. If the result is rolled a second time, the compulsion takes place every time they encounter a dying humanoid. If the result is rolled a third time, the caster will go out of their way to find, or create, situations where they can observe humanoids perishing, the slower the better.
- 2 In order to eliminate inefficiency, the Cyberhive begins upgrading the caster. Various small cybernetics will grow throughout the caster's body, lowering Personality by 2. If the result is rolled a second time, the upgrade continues to lower Personality by another 2 but increases Intelligence and Stamina by 1 each. If the result is rolled a third time, the caster loses another 4 Personality, but Intelligence and Stamina increases by another 1 each.
- 3 The caster becomes obsessed with living forever and will seek information on how it can be accomplished. If the result is rolled a second time, the caster will now consider possibly self-destructive means to gain immortality. If the result is rolled a third time, the caster will use any means necessary to gain eternal life (or unlife).
- 4 The caster becomes more likely to kill. The next time they have the option to spare an opponent, they will not. If the result is rolled a second time, they will seek out a fight in order to kill someone/thing. If the result is rolled a third time, they can no longer give quarter to any opponent for any reason.
- 5 The caster is now fascinated with the boundaries between life and death. They wish to have a near-death experience to understand it better. The next time the caster is in danger of reaching 0 or less Hit Points, they will not willingly retreat. If the result is rolled a second time, they will actively seek to reach the brink of death, possible more than once. If the result is rolled a third time, they must arrange to be clinically killed and then revived, all while being recorded and observed.
- 6 The caster begins chronicling and cataloging important events in great detail. If the result is rolled a second time, they begin recording random everyday events. If the result is rolled a third time, they must document every moment of every day in meticulous detail or hire someone to do so.

GODS AND PATRONS OF UMERICA

Patron Spells

DEFENSIVE UPGRADE

Level: 1 **Range:** self or proximity **Duration:** Varies **Casting time:** 1 round **Save:** NA

General: Invoking the Cyberhive, the caster increases the target's defenses. These changes do not affect the target's Fumble die or Armor Check Penalty

Manifestation: (d6) 1-2 Glowing protective shields, 3-4 Cybernetic plating erupting from the target's skin, 5-6 Circuit board like tattoos covering the target's skin.

- 1 Lost, failure, and patron taint.
- 2-11 Lost. Failure.
- 12-13 One target's Armor Die is considered Impervious for $\frac{1}{2}$ CL rounds.
- 14-17 As the previous result but the effect lasts CL rounds.
- 18-19 The target gains +1 step of armor and their Armor Dice are considered Impervious for the next CL rounds.
- 20-23 Roll $1d3 + \frac{1}{2}CL$ and spread the result as bonus Armor Die steps to up to CL+2 allies and their Armor Dice are considered Impervious. No one ally can gain more than +2 bonus Armor Die steps. Lasts for CL rounds.
- 24-27 Roll $1d3 + CL$ and spread the result as bonus Armor Die steps to up to CL+4 allies and their Armor Dice are considered Impervious. No one ally can gain more than +3 bonus Armor Die steps. Allies affected also gain +1 to all saves. Lasts for CL rounds.
- 28-29 Roll $1d6 + CL$ and spread the result as bonus Armor Die steps to up to CL+6 allies and their Armor Dice are considered Impervious. No one ally can gain more than +4 bonus Armor Die steps. Allies affected also gain +1 to all saves. Lasts for CL x2 rounds.
- 30-31 Roll $1d8 + CL$ and spread the result as bonus Armor Die steps to up to CL+8 allies and their Armor Dice are considered Impervious. No one ally can gain more than +4 bonus Armor Die steps. Allies affected also gain +1 to all saves. Lasts for CL x2 rounds.
- 32+ Roll $2d6 + CL$ and spread the result as bonus Armor Die steps to up to CL+10 allies and their Armor Dice are considered Impervious. No one ally can gain more than +5 bonus Armor Die steps. Allies affected also gain +2 to all saves. Lasts for CL x3 rounds.

GODS AND PATRONS OF UMERICA

CONTROL+ALT+DELETE

Level: 2 **Range:** Varies **Duration:** 1 turn per CL **Casting time:** 1 round **Save:** Will

General: The caster can attempt to dominate and manipulate computers, robots, and other semi-intelligent devices.

Manifestation: Tendrils of pulsing light emerge from the caster's temples and reach out into the device.

- 1 Lost, failure, and patron taint.
- 2-11 Lost. Failure.
- 12-13 Failure, but spell is not lost.
- 14-15 The caster gleans insight into the security protocols of the device which grants +1d4 on any attempt to access or control the device. Intelligent devices may make a Will save to avoid being hacked.
- 16-19 As the previous result but is granted +1d6 on any attempt to access or control the device. Intelligent devices may make a Will save to avoid being hacked.
- 20-21 As result level 12-13 but is granted +1d8 and can attempt to access or control the device from CL x 10' away. Intelligent devices may make a Will save to avoid being hacked.
- 22-25 The caster gains control of the device and can access all basic functions or files. Access to any advanced or highly protected functions or files must still be cracked, at +1d10 to the roll. Intelligent devices may make a Will save to avoid being hacked.
- 26-29 All files and functions are under the control of the caster. The caster's access/control range is now 20 x CL. Intelligent devices may make a Will save to avoid being hacked.
- 30-31 As the previous result but the caster can rewrite or create new programs or functions on the device without any prior technical ability. Intelligent devices may make a Will save to avoid being hacked.
- 32-33 As the previous result but the caster can affect any device within line of sight. Intelligent devices may make a Will save to avoid being hacked.
- 34+ The caster can now access, control, & reprogram any computer or smart device within his line of sight. Intelligent devices may make a Will save to avoid being hacked.

GODS AND PATRONS OF UMERICA

CREATE CYBOMINATION

Level: 3 **Range:** Touch **Duration:** Permanent **Casting time:** 1 turn/HD of the creation **Save:** NA

General: A caster cannot control more than CLx3 HD worth of cyberdead at one time. Any excess will act randomly and violently, requiring a Personality check of 11+HD to be controlled again.

Manifestation: Wires and mechanisms burst forth from the corpse and cybernetically reanimate it.

- 1 Lost, failure, and patron taint.
- 2-11 Lost. Failure.
- 12-15 Failure, but spell is not lost.
- 16-17 CL+1 HD of small animals ($\frac{1}{8}$ - $\frac{1}{2}$ HD in size) are animated. These recycled creatures are completely loyal to the caster but are dumb as rocks. They require constant psychic instruction to do any task.
- 18-21 As the previous result but CL+d3 HD of animals or people ($\frac{1}{2}$ - 2 HD in size) are animated.
- 22-23 CL+d4 HD of animals or people (1 - 4 HD in size) are animated. These recycled creatures are completely loyal to the caster but can only follow simple commands. Two of the HD available may be used to bestow a random special ability to the creatures from *Table 9-6: Traits or Properties of Un-dead* (DCC RPG, pg 381).
- 24-26 As above but CL+d5 HD of animals or people (1 - 5 HD in size) and each has an Intelligence of 6+d6 and can accept complex commands. Two of the HD available may be used to bestow a random special ability to the creatures from *Table 9-6: Traits or Properties of Un-dead* (DCC RPG, pg 381).
- 27-31 CL+d7 HD of animals or people (1 - 6 HD in size) are animated. These recycled creatures are completely loyal to the caster. Each has an Intelligence of 8+d6 and can accept complex commands. For each 2 HD rolled but not used for reanimation, a special ability may be added to the creatures from *Table 9-6: Traits or Properties of Un-dead* (DCC RPG, pg 381).
- 32-33 As the previous result but CL+d10 HD of animals, people, or monsters (1 - 8 HD in size) are animated.
- 34-35 As result level 28-29 but CL+d16 HD of animals, people, or monsters (2 - 12 HD in size) are animated.
- 36+ The caster can animate CL x2+1d20 HD worth of any previously living creatures (2 - 16 HD in size). Each will have a special ability from *Table 9-6: Traits or Properties of Un-dead* (DCC RPG, pg 381) and will have a 25% chance of being fully intelligent.

GODS AND PATRONS OF UMERICA

Spellburn

When a caster utilizes spellburn, roll 1d4 and consult the table below or build off the suggestions to create an event specific to your home campaign.

- 1 As the spellburn takes effect, various thin cables burst forth from the caster's skin and temporarily rewire their nervous system causing stat point loss.
- 2 The caster has a minute stroke and nose bleed, causing stat point loss. They will not be able to recall any childhood memories until the stat point loss is healed.
- 3 The caster is catatonic for 1d4 rounds per point of spellburn as the Cyberhive downloads the particulars of a mission it needs done. If the caster completes the mission, the Cyberhive will reward the caster as it sees fit.
- 4 The Cyberhive needs to observe the death of several humanoids. In this special situation, the character can spellburn up to 10 points of ability score loss, but need not take any physical action or damage. If he personally participates in killing a number of humanoids equal to the Spellburn within 12 hours, the character takes no spellburn.

If he fails to accomplish this task, he takes the full 10 points, distributed across ability scores at the judge's discretion, after 12 hours.

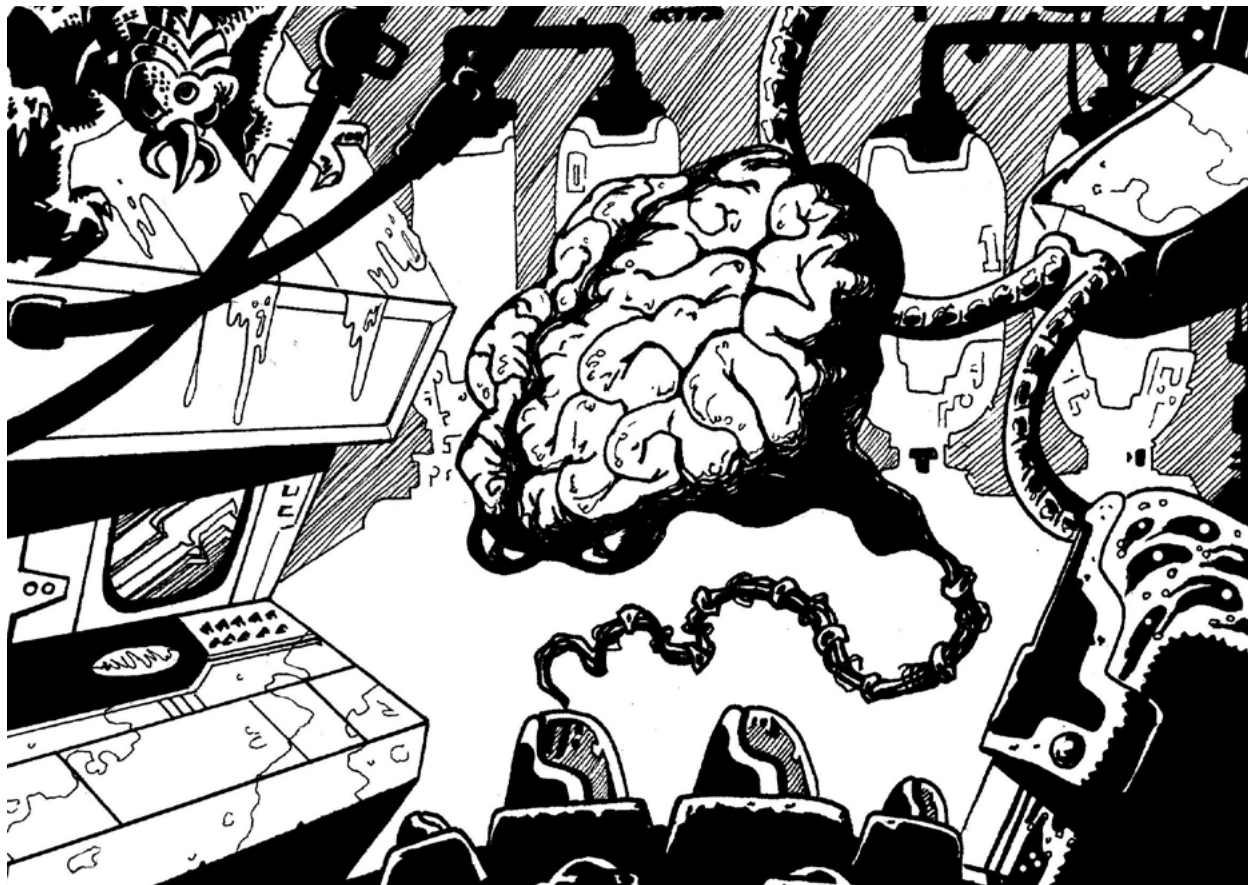

GODS AND PATRONS OF UMERICA

THE SYNOD OF THE ASTROLICHES

Originally contacted by wizards using the arcane Space Needle of Old Seattle, the Synod have since kept an eye upon Urth and occasionally offer assistance to wizards they find interesting...

These ancient liches rule a distant galaxy and have now become bored. They project their intellects across the universe in search of entertainment, much as pre-cataclysm workers turned to cable television. Ever since they became aware of the planet Urth, it has been their favorite new "channel". The Synod now watch the goings on of Umerica constantly and have made pacts with their favorite "stars".

Since the Synod do not really conceive of the inhabitants of Urth as "real", they have no desires other than to make the "show" more interesting to watch. Synod members take turns answering patron requests in order to thrill, shock, or impress their fellows with what happens. Thus all answered requests tend to be dramatic or ostentatious.



Invoke Patron check results:

- 1-13 The Synod is busy geeking out over the goings on in another part of Umerica at this time and the caster gets no response.
- 14-17 The caster is granted a +1 bonus to all saves for the next turn and heals 1d4 hit points.
- 18-19 For the next turn, anytime the caster rolls a 1 on any die they can choose to re-roll the die.
- 20-23 The caster feels inspired and gains an additional 1d14 action die for the next turn. It can be used for any non-spell casting action.
- 24-27 Both the caster and his allies gain +1 to all saves, AC, and all action rolls for the next turn.
- 28-29 All damage rolls the caster makes for the next turn are always the maximum result.
- 30-31 The caster finds himself in possession of a new techno-artifact to help them in the scene (consult the Gray's Directorate Gift Examples table, pg 67 or gain something else of the GM's choice). No one remembers the caster not previously having this item.
- 32+ In a dramatic twist, the caster's most powerful non-deific foe in the scene must make a Will save (DC 18) or they suddenly switches sides and becomes unwaveringly loyal to the caster (shifting its alignment to match the caster's). On a failed save this effect is permanent. They will teleport away in 2d100 minutes and take all of the dead with them.

GODS AND PATRONS OF UMERICA

Patron taint:

When patron taint is indicated, roll 1d4 on the table below. When a caster has acquired all four taints at all levels of effect, there is no need to continue rolling any more.

- 1 The caster begins to appear much more attractive than they were previously. They also seem to be much more concerned with their appearance. If the result is rolled a second time, their appearance is dramatically improved, giving them a +1 Personality as long as they have a turn to clean up a bit each 3 hours. Having to skip these “touch up” sessions for more than 12 hours will result in a sulky mood inflicting a -1 die step penalty to all actions. If the result is rolled a third time, the caster will go out of their way to freshen up their looks at least once an hour. This does increase their Personality by +2 but will bring on the sulky mood inflicting a -1 die step penalty to all actions if skipped for more than 3 hours in a row.
- 2 Each time the caster is out of sight, a small bit of their wardrobe will change without them knowing it. This will cause others to occasionally stare trying to figure out what seems different about them. If the result is rolled a second time, These miraculous wardrobe changes are more dramatic and yet the caster will not realize anything has changed, even if it is clearly pointed out. This will make the caster a bit suspicious of their comrades. If the result is rolled a third time, the wardrobe changes will result in completely different outfits in differing styles with the caster none the wiser. All accusations of changing clothes will be met with vehement denials and lost tempers.
- 3 The caster begins living a much more “interesting” life as the chances of having random encounters increases by 20%. In addition, any chances that a particular party member is singled out will usually point to the caster (50% chance). If the result is rolled a second time, the caster will always be “randomly” singled out by NPCs and the chance of random encounters while traveling increases by 50%. If the result is rolled a third time, the caster will now have a random encounter at least once a day, even in civilized areas. Also, random NPCs will seek him out as though they know him and seek his aid.
- 4 Each day, the caster must make a Luck check to see if some minor possession has gone missing. A failed roll indicates one small item has mysteriously disappeared as a member of the Synod has collected it. If the result is rolled a second time, the caster must make the roll twice a day but each time there is a 50% chance that a pilfered item is replaced with 1d20sp worth of trade goods. If the result is rolled a third time, the failed Luck roll can indicate a missing chunk of hair, article of clothing, or even one of the caster’s lesser treasured possessions. Also, the missing item is always replaced with 1d30sp worth of trade goods.

GODS AND PATRONS OF UMERICA

Patron Spells

THEME MUSIC

Level: 1 **Range:** personal **Duration:** 2 rounds or more **Casting time:** 1 round **Save:** NA

General: A musical accompaniment aids the caster and some allies via a morale bonus fueled by the Synod's attentions. A minimum of one point of spellburn is required to cast this spell.

Manifestation: Every action the caster takes is accompanied by their own personal cinematic soundtrack. All attempts to be quiet will fail.

- 1 Lost, failure, and patron taint.
- 2-11 Lost. Failure.
- 12-13 A simple but timely soundtrack follows the caster's actions. This increases their Personality rolls by +1 when dealing with allies and non-aggressive NPCs. Duration: CL x 2 rounds.
- 14-17 The music is much more impressive, granting +2 to all social Personality rolls and grants a +1 bonus to all allies' attacks as long as they are within 10'. Duration: CL x 2 rounds.
- 18-19 Similar to the previous result but all foes with 10' of the caster now suffer -1 to attack the caster due to the dramatic and intimidating music. All allies within 10' now gain the +1 bonus to all actions.
- 20-23 As above but the duration is CL x 3 rounds.
- 24-27 As above but the radius is now 15'.
- 28-29 All allies within 20' gain +2 to all actions and all foes within the same suffer a -1 die step to all actions against the caster. In addition, the caster gains a +1 bonus to all actions and an additional +1 die step to all social Personality rolls.
- 30-31 As above but the radius of effect increases to 30' and the duration is CL x 5 rounds.
- 32+ All non-deific foes within 50' of the caster cannot directly act against them in any way. All allies add +2 to all non-combat actions plus they gain a +1d3 bonus to all attacks and damage rolls while within the radius of effect. The caster gains a +1 die step to all actions and a +2 die step bonus to all social Personality rolls.

GODS AND PATRONS OF UMERICA

SKELETAL ATTENDANT

Level: 2 **Range:** proximity **Duration:** 1 day **Casting time:** 1 turn **Save:** NA

General: Summons an intelligent skeleton butler from the Astrolich realm to do the caster's bidding.

Manifestation: The skeleton butler appears suddenly by sparkly transmat beam.

- 1 Lost, failure, and patron taint.
- 2-11 Lost. Failure.
- 12-13 Failure, but spell is not lost.
- 14-15 The caster summons a clean and polished animated skeleton butler wearing a fine white shirt and a black coat with tails. Deep in its eye sockets are a pair of small green orbs that glow with an intensity that matches the butler's tone of voice. The butler will introduce itself in a pleasant, refined voice (roll 1d4: 1 - Bonesworth, 2 - Skullingham, 3 - Corpsington, 4 - Rattleson) and wait upon the caster's orders throughout the day. At this level, the butler will not remember anything from any previous summonings.
- The skeletal butler is considered to have 11 in all attributes, HD: 1d8, HP: 5, AC: 11, Move: 25', Act: 1d16, and +1 to all saves. It has no appreciable combat abilities.
- 16-19 The skeleton butler will appear and introduce itself as above but is a skilled servant. It has an equivalent Strength and Agility of 14 plus it is skilled in the following tasks: driving, cooking, cleaning, and tailoring. At this level, the butler will have a passing memory of any previous summonings.
- 20-21 The skeleton butler will appear and introduce itself as above but is much improved. It has an equivalent Strength and Agility of 16 plus the following additional tasks: night watchman, minor repairs, and bandaging wounds. At this level, the butler will have a full memory of any previous summonings and can be tasked with reminding the caster of up to 4 appointments or engagements.
- 22-25 As the previous result but the butler now has the following combat abilities: Init: +1, Atk claws +3 melee (1d4+2), HD: 2d8, HP: 10, AC 12, Armor Die: [1d3], and +2 to all saves.
- 26-29 The skeleton butler will appear and introduce itself as above but is vastly improved. It has an equivalent Strength, Agility, and Intelligence of 16 plus the following additional tasks: basic business, appraising goods, event planning, and current events. At this level, the butler will have a detailed memory of any previous summonings and will remind the caster of any number of things.
- 30-31 As the previous result but the butler now has the following combat abilities: Init: +2, Atk sword +4 melee (1d8+2), HD: 3d8, HP: 15, AC 13, Armor Die: [1d4], Act: 2d16, SP summon sword from thin air, and +4 to all saves.
- 32-33 The skeleton butler will appear and introduce itself as above but is a paragon of servitude. Its Strength, Agility, and Intelligence are 16 and all other attributes are 13. In addition to all of the previous tasks, it is skilled in the following additional tasks: business, finance, estate management, barter, and law. At this level, the butler will have a detailed memory of any previous summonings and will remind the caster of any number of things.
- 34+ In addition to the previous result, the butler is an accomplished warrior: Init: +4, Atk sword +1d5+2 melee (1d8+1d5+2), HD: 5d8, HP: 25, AC 14, Armor Die: [1d5], Act: 2d20, SP mighty deeds as a 5th level warrior, summon sword from thin air, & +6 to all saves.

GODS AND PATRONS OF UMERICA

STUNT DOUBLE

Level: 3 **Range:** proximity **Duration:** 1 turn **Casting time:** 1 hour **Save:** NA

General: Creates a cloned double of the caster that dwells just outside of reality. The caster can swap places with it in a moments notice so the clone can take hard falls, trip traps, and other hazardous activities. The clone has the following stats: Init as caster; Atk as caster; AC 12; HD CL d10; HP CL x6; MV 30; Act 2d16; SP see spell table result; SV as caster; AL as caster. The double cannot cast spells but otherwise acts as the caster with shared knowledge.

Any damage suffered by the clone heals between castings. If the clone double is killed, the spell cannot be cast again for 48 hours and the caster loses one point of Luck.

Manifestation: The caster seems to shimmer momentarily and now looks just a bit different than normal.

- 1 Lost, failure, and patron taint.
- 2-11 Lost. Failure.
- 12-15 Failure, but spell is not lost.
- 16-17 Up to $\frac{1}{2}$ CL times within the spell duration, the double can jump in to attempt a hazardous physical activity (crossing a log over a river, climb a rope, jump a chasm, etc).
- 18-20 As above but the caster can call the double in when a foe is attempting to strike him.
- 21-23 Up to CL times within the spell duration, the caster can cause the double to blink in and suffer the effects of a failed saving throw or a successful melee strike against the caster.
- 24-26 As above but the double gains a +1 to their AC and all saves.
- 27-31 Up to CL times within the spell duration, the caster can have the double blink in to perform a risky task, gaining +2 to the attempt. As above the double can also blink in and suffer the effects of a failed saving throw or a successful melee strike against the caster.
- 32-33 As above except the double can blink in CL x1.5 times.
- 34-35 As the previous result but the double can now cast spells as the caster (except this one) and any spells lost to one does not affect the other.
- 36+ As above but the double now heals 1d10hp each time it blinks out of existence.

GODS AND PATRONS OF UMERICA

Spellburn

When a caster utilizes spellburn, roll 1d4 and consult the table below or build off the suggestions to create an event specific to your home campaign.

- 1 The caster makes a big show of the self mutilation like an overacting ham.
- 2 The caster must carve one of the Astrolich's names into their body.
- 3 Instead of harming themselves, the caster can sacrifice one treasured possession and gain +2d3 points of spellburn for the casting.
- 4 Rather than sacrificing an attribute, the caster can choose to follow one line of script of the GM's choice per point of spellburn, up to 8, whenever the GM calls for it.



LESSER ENTITIES

Just a step below the Gods and Patrons on the cosmic scales are Entities that are still quite powerful, just on a more limited scope. These are known by names like: Local Gods, Demi-Gods, Mascot Gods, and Minor Patrons. Entities such as these are quite numerous throughout Umerica but are not usually found without effort. Unlike the pompous Gods and Patrons, most of these Entities will grant their gifts to any worthy individual that would ally with them.

Where a petitioner may call upon the aid of a true Patron or God from nearly anywhere, those that wish to seek support from a Lesser Entity must travel to the Entity's realm or follow specific rules to have their pleas be answered. The scope of power that these Entities wield is also likewise limited, generally to granting temporary boons or bestowing minor gifts.

Many of the schemes that Lesser Entities weave revolve around gaining more power or stealing power from nearby rival Entities. Many wars between otherwise peaceful communities have been stirred up by Lesser Entities using the locals as proxies in their bids for power.

CRAFTING LESSER ENTITIES FOR A CAMPAIGN

When creating a Lesser Entity, considering the reach of their power, how they can be accessed, and what they can offer are essential steps.

Where

The majority of Lesser Entities are bound to a particular place of power, ranging no more than a few miles in size. Others dwell in small pocket dimensions that can only be reached in specific ways. Some may travel freely but their power only extends out a mere mile from their physical presence. Determining this sets up how adventurers might encounter the Lesser Entity and the distance at which they can act.

How

All Entities have agendas for why they aid mortals and how likely they are to do so. The path the petitioner must take to request aid is a direct

reflection of these grand plans and the personality of the Entity. For many Entities, the "simple" act of gaining an audience and making an offering is all that is required to gain their aid. Others can only be communicated with through portals, such as arcade game machines, funeral pyres, or running refrigerators.

What

Nothing of worth is ever given away for free. There is always a catch, a cost, or a contract involved. As Lesser Entities are not all powerful, they are a bit miserly when requests are made of them. Foolish mortals that ask without giving first tend to incur great debts before they even realize it. What the Entity desires from its suppliants in return for its favor is very important to how the Entity will fit into the campaign world.

Once appeased, what the Entity can offer the successful inquirer is also very important. A Lesser Entity can grant a blessing similar to the results of Invoking a Patron **or** can bestow a permanent boon such as a spell, item, mutation, ability, or special knowledge. Generally, Entities do not have the breadth of power to do both.

Other factors to consider are the physical aspects of their home domains, its indigenous residents, and any minions it may command.

Domains

Whether the Entity dwells in an area within Umerica or resides in a nearby pocket dimension, the environment around them will be tainted by their mere presence. This can be represented by the bending or breaking of natural laws, the unusual prevalence of an affinitive element of the Entity, or the environment itself seeming to have a will of its own. Regardless of the nature of the corporal and ephemeral changes, the effects should warn any who enter the Entity's realm that something powerful has influence in the area.

Residents

Just as the environment around the Entity is greatly affected by their presence, the wildlife and inhabitants will show signs of change along

GODS AND PATRONS OF UMERICA

anomalous lines. The extent of this ranges from similar quirks noticeable across multiple species to the natives being warped to a nearly unrecognizable state. Intelligent inhabitants may be unaware of the Entity's presence, if it is reclusive. Even if they are conscious of its existence, this does not mean they are allied with it or even like it at all. These strange folk can be a great help or hinderance to those seeking favor from an Entity.

Minions

Only the most solitary of Entities shun employing loyal servants to obey their whims. Lesser Entities will usually have half a dozen or more lackeys that are thoroughly aligned or corrupted by the Entity's power. Some Entities may even have a horde of minions to do their bidding. There are even Entities that refuse to deal directly with mortals and the only way to communicate with them is through their minions.

Now, all of the little details must be added to make the Lesser Entity a coherent whole. As they are immortal, or at least nigh-immortal, their plans tend to be of a long term scale. That is not to say that there are no brash, shortsighted Lesser Entities but they are a minority amongst their kind. Determining what short and long term plans a Lesser Entity might have can easily lead to many adventures for characters looking to get into that Entity's good graces.

A Sampling of the Known Lesser Entities

Here are a few Lesser Entities explained in detail to use in a campaign or to use as guides to creating new ones.

OLD MAN MUSHROOM

Traveling along the edges of the wastelands is a fungal forest roughly 3 miles across. It crawls slowly forward each night, perhaps traveling a third of a mile each hour of darkness. At sunrise, the fungi quickly takes root and appears as though it has always dwelled in that place. Then, at dusk it uproots itself again and begins its creeping trek across the lands. While its path seems random, those who have spent their days studying the phenomena know there is a pattern to its movement and they can calculate where it might be at any given time.

All manner of benign and malign fungal creatures call this forest their home. Any who venture in will have to face many poisons and predators to glean any of its edible or pharmacological bounty. All of those who have a smattering of familiarity with the fungal forest know that no folk live there nor has anyone that stayed within the forest overnight ever been seen again. It is only "safe" to enter during the day.

Deep within the center of the nomadic grove lies a small pocket dimension that is the home of a humanoid fungi Lesser Entity known as Old Man Mushroom. To enter the pocket dimension, one must only partake of some of the more hallucinogenic mushrooms and walk towards the center of the forest. Rumors have it that at night Old Man Mushroom has also walked the breadth of his forest and communicated with those encamped on the edges who are deeply intoxicated by the forest's potent bounty.

There is conjecture that Old Man Mushroom is connected to Grokk but there has been no solid evidence to this. In fact, Old Man Mushroom seems to have little to no ties with any other Entity, Patron, or God. Even those that would try and destroy the wandering fungal forest are of no mind to him as the forest will regrow in a single night, even if burned utterly to the ground.

Old Man Mushroom is free with his minor gifts but one must present him with a considerable offering to receive his greatest gift. He prefers gifts in the form of rare, hallucinogenic substances, especially ones from other planets or dimensions. Petitioners will only receive aid once a month, at most. Attempting to do so more frequently will result in the seeker getting lost in the fungi forest for 1d3 days.

Minor Gifts

Crystal Spore - A palm sized crystalline pod. When buried in the soil at dusk, it will rapidly sprout a vividly glowing mushroom as the sun sets. The mushroom will grow to two feet in height and its cap will be at least three feet in diameter. It will emit light equivalent to a moderate campfire until dawn, when it will shrivel into dust. Anyone who partakes of a mouthful of the luminescent fungi will begin having

GODS AND PATRONS OF UMERICA

pleasant hallucinations for the next 1d3+5 hours. Up to 1d6+6 people can benefit from the mushroom. During this time they will gain the benefits as though they had been sleeping plus they will heal 1d3hp per hour. Should any of the affected persons need to take directed action, such as combat or other intensive task, they will do so at -2 die steps to all actions. At the end of the duration, those affected will suffer no lingering effects other than being very hungry that morning.

Dried Shrooms and Herbs - 1d3+1 packets of dried mushrooms, roots and herbs wrapped in large leaves. When brewed like tea, it will produce enough enchanted brew for 10 draughts regardless if the water used was pure or not. Each draught will act as a full day's ration of food and water for the imbiber. The magical effects of the brew will fade if it is allowed to cool and will not be restored if reheated.

Enhanceshroom - A bundle of 1d3+1 bright red mushrooms with purple spots. When one is eaten the person gains a +1 die step bonus to all physical actions (including melee attacks and damage) for 1d3+1 hours. There is a side effect that begins 4 turns after consumption (4 rounds when in combat or performing other rigorous labor). They must make a Will save (DC10) each turn (or round in combat) or begin hallucinating. At first these visions are pleasant and harmless but each failed save after the first causes them to slip further from reality. This incurs a -1 cumulative penalty to all mental tasks until the effects of the mushroom wear off. After failing 6 total saving throws, they have completely lost touch with reality and will move and act randomly until the duration is over.

Expandshroom - A bundle of 1d3+1 bright purple mushrooms with red spots. When one is eaten the person gains a +1 die step to all mental actions (including spellcasting) for 1d3+1 hours. There is a side effect that begins 4 turns after consumption (4 rounds when in combat or performing other rigorous labor). They must make a Will save (DC10) each turn (or round in combat) or begin trembling. At first these tremors are harmless but each failed save after the first causes them to become more uncoordinated. This incurs a -1 cumulative penalty to all physical tasks until the effects of the mushroom wear off. After

failing 6 total saving throws, they have completely lost motor control until the duration is over.

Major Gift

Fungi of Awakening - Old Man Mushroom breaks a small piece of his own cap for the petitioner to eat. They must make a Fortitude save (DC 13) or immediately gain the Botanical - Fungi-like mutation (see pg 173). Whether they pass or fail the save, they also permanently gain the following benefits:

- +4 to save versus natural based poisons and toxins.
- Can sense fungal growths at 60' and will instantly know if they are safe to eat, hallucinogenic, or poisonous.
- May pass safely through the wandering fungal forest. None of its native beasts will attack.
- Gains +2 die steps to all attempts to locate the wandering fungal forest in the future.

CONEY, THE TASTE-E-CONE ICE CREAM PARLOR MASCOT GOD

Before the cataclysm, there was a statue of Coney outside of every Taste-E-Cone location. He was an anthropomorphic ice cream cone with spindly arms and legs, a wide smile, and large blue eyes full of mirth. Humorous advertisements had him showing up amongst groups of people run down from the heat of summer and summoning up large quantities of ice cream treats to cheer them up. During the cataclysm as the Urth was flooded with strange cosmic energies, all of the people's love and dreams of Coney amassed and formed a consciousness. As the decades passed most of the Taste-E-Cone buildings were destroyed, collapsed, or repurposed but one still remained. It was there that Coney truly awoke, inhabiting the last Coney intact statue and transforming it into his body.

The area within a few miles of the now fortified Taste-E-Cone are much colder than normal, even to the point of forming permanent expanses of snow and ice. Local animals have adapted to the cold in various and strange ways. Few communities remain within Coney's realm other than those willing to bow down to him. Also dwelling in the area are the Chilly Men, frozen humanoids wearing ice cream parlor garb that are Coney's loyal minions.

GODS AND PATRONS OF UMERICA

Petitioners seeking blessings from Coney must first bow to him and eat a frozen treat. Anyone who partakes of the treat suffers a -1 die step penalty to all direct actions taken against Coney or his minions, permanently. Coney will not look favorably upon anyone who refuses to eat one of his delicious frozen treats.

Once petitioners have properly honored Coney, he will be willing to bestow magical treats that either allow an eater to cast a particular spell once within 24 hours of consumption (casting roll: $1d10+10+\text{Stamina mod}$) or to study the treat in order to learn the spell permanently like with a scroll. These magical treats will never melt or spoil. Normally, only one treat per petitioner will be given but more might be gained if proper tribute is offered to Coney. While working refrigeration equipment is always welcome, pieces of other Coney statues are highly desired. Coney will not give an audience to any petitioner more than once per month.

Magical Treats

Chillybar - This treat bestows the *Chill Touch* spell (DCC RPG, pg 133).

Boltpop - This treat bestows the ray of frost version of the *Magic Missile* spell (DCC RPG, pg 144).

Frostyfeast - The treat bestows a version of *Food of the Gods* spell (DCC RPG, pg 262) that summons an ice cream feast.

Sheildpop - This treat bestows *Resist Heat and Cold* spell (DCC RPG, pg 266).

If the petitioner presents a good quality piece of one of the other Coney statues, Coney will reward him with a special treat, the *Coneageddon*: This treat bestows a version of the *Fireball* spell (DCC RPG, pg 216) that summons exploding ice cream cones dealing cold damage.

Ultimately, Coney wishes to collect as many pieces of the other statutes as possible. The reason is each fragment has a bit of worship energy in it he can use to eventually ascend into true godhood.



THE BLESSED MUTATION SAINTS OF MOTHER NUKA

These six beings are immortal embodiments of the six major types of mutations found in Umerica. Each resides in a remote toxic local, soaking in the mutagenic essences and awaiting orders from their dear mother. Those that would seek their blessings need only to survive the search in order to make a request, although those that also come bearing rare irradiated treasures may receive even greater blessings. Each saint will only bless a person once.

To make a request, the petitioner must roll $1d20+\text{Personality mod}$ on the table below to see

GODS AND PATRONS OF UMERICA

what kind of blessing they receive. Mutants also add their Stamina mod, Luck mod, and Level to the roll. If a significant gift, preferably one rich in mutagenic potential, is freely offered the petitioner adds +1d6 to the roll. This bonus can also be earned by asking the saint for a quest before seeking a blessing. Such quests will be focused on aiding mutants in need, cultivating the riches of a mutagenic source, or otherwise furthering the desires of Mother Nuka. The bonuses from a gift and a fulfilled quest may be used together.

- 1-11 The petitioner is considered unworthy and they must perform a great act in the name of mutant kind in order to ask again.
- 12-19 The petitioner is granted a random mutation of the saint's type.
- 20-27 The petitioner is granted a random mutation of the saint's type and gains 10 Glow pool to be used, as a Mutant does, to mitigate bad results. A Mutant character adds this bonus Glow pool to their own reserves and may keep the remainder after the Blessing mutation rolls are resolved.
- 28-32 The petitioner may choose a specific mutation of the saint's type and gains 20 Glow pool (same rules as result level 20-27).
- 33+ The petitioner is blessed directly by Mother Nuka herself channeling energies through her saint. They may choose a specific mutation of the saint's type, automatically gaining all of the Beneficial Traits at an enhanced value (the bonus is increased by +1, +1 die step, or in some other way set by the GM) but none of the Detrimental Traits.

The Great Chimerish, Saint of Bestial mutation

To find Chimerish, one must venture deep into the endless swamp way south near the mouth of the Misshipy river, in the lands once known as Orleans. There you will find the toxic hunting grounds that she calls home. Then one must only survive long enough to attract her attention.

It is said that if you look long enough upon Chimerish that you will see a bit of each beast that walks, swims, or flies. The problem is that her imposing

amalgamous body is much too hideous to look at for very long. She is quite proud of her appearance and rarely wears clothing unless absolutely necessary.

The gifts that Chimerish likes most are irradiated edibles, preferably sweet processed foods, in large quantities. If asked for a quest, she will most likely send them to aid the mutant communities that live on the banks of the Misshipy as they are always being raided by river bandits.

The Lady Burning Bark, Saint of Botanical mutation

Near the eastern edge of the Whistling Marshes lies an expanse of thick twisted forest. Near its heart is the overgrown remains of an ancient laboratory known as the R-gone. It is within these irradiated ruins that one can find where the Lady Burning Bark holds her court. Her appearance is that of a tree taken humanoid form with vibrant leaves of living flame upon her head, branches like a flickering crown.

She is waited on by a host of mutant plant beings of various sizes and types. They are all extremely loyal and protective of her and will not abide anyone or thing that might threaten her. A petitioner may need to present many gifts or face several trials before the Lady's host will allow audience.

Strange, exotic flowers are the preferred gift of the Lady but seeds or bulbs from beneath the Glowing Dome will be happily accepted as well. If asked for a quest, she will send the petitioner to the western edge of the Whistling Marshes to the ruins of the once great city of Chi-Town, most likely to hunt a Night Bear for a hearty feast.

Big Boulder, Saint of Aggregate mutation

In the Rocky Mountains near the northern edge of the Vast Wasteland and to the west of the Burning Lands lies a large community of mutants known as Boulder Town, founded by Big Boulder. For a long time he ruled over the community. However, nearly a decade ago he took to wandering the mountains in search of greater enlightenment. To find Big Boulder, a petitioner must hire a guide from Boulder Town to lead them on a perilous journey into the mountains.

GODS AND PATRONS OF UMERICA

As his name implies, when sitting still he looks like a large stone with vaguely humanoid features. Only when he stands up and walks is his nature clearly evident. There are veins of various metals streaking his stoney skin and numerous crystals bud from random places on his body.

Big Boulder's preferred form of gift is that of radioactive ore rich in isotopes, which he either wears as jewelry or consumes. While he no longer dwells with the Boulder City folk he is still quite concerned for their well being. As such, any quests he would give would involve aiding the town in some way.

Ogwan the Odd, Saint of Altered Biology mutation

Far north of the Kingdom of the False Gods in the lands of Old Floor-Da stands a sturdy looking house in the middle of a vast plain of mildly radioactive light green glass fragments. Traversing the broken glass plain is quite treacherous and will require many Reflex saves to avoid heavily bleeding wounds. There are safe paths through the plain but they are well hidden and require an Intelligence check (DC 14) to locate and follow.

The Lonely House is the home of Ogwan, an immortal human that seems to be constantly growing multiple new limbs while others wither away. There are also several house servants who appear to be mutant humans with varying degrees of deformity. All guests will be welcomed warmly and any wounded will be tended to.

Ogwan is something of a scientist as well as a saint and his preferred gifts are scientific equipment and unique mutant specimens to study. Any specimens offered need not be alive or whole. Should Ogwan be asked for a quest, he will require the petitioner to travel into the coastal glades to retrieve new mutant creatures for him to study or to aid the numerous tribes of mutants that call the glades their home.

The Untouchable One, Saint of Weaponization mutation

Deep in the Vast Wasteland there are ruins of a toxic industrial center that constantly burns with sickly

green flames. From these smoldering buildings the Untouchable One preaches to his congregation of devout mutant raiders. These raiders are not tolerant of those not "Down with the Glow" or anti-mutant behavior in anyway.



The appearance of the Untouchable One is a cacophony of serrated talons, spines, fangs, and horns atop a massively muscular humanoid body covered in scars. He wears only a steel plated kilt and a pair of designer sunglasses. He speaks in a booming, howling voice that can clearly be heard from a distance.

His preferred gifts are mutagenic or toxic chemicals by the barrelful. He also covets fine sunglasses. If asked for a quest he will demand that the petitioner accompany his faithful flock on a raid to cleanse the wasteland of the "Pure folk".

The Gentleman Freak, Saint of Freak Abilities mutation

On the Southeastern coast of Umerica there is an ancient gothic style cathedral in the center of a community known as Old Churchplace. The community is very tolerant of differing species and

GODS AND PATRONS OF UMERICA



is home to humans, mutants, fossiorians, and many other beings. The Gentleman Freak and his Freakmen clergy live in the cathedral, called the Freak Church, where they provide spiritual and militant support to the community.

No one really knows what the Gentleman Freak looks like as he always dresses in fine suits, gloves, goggles, and a full featureless head mask. He is a charismatic speaker and most people agree he is very hard to disagree with.

The Gentleman prefers gifts in the form of medicines and medical equipment that his Freakmen can employ to serve the community. He also loves pre-cataclysmic musical instruments he can add to the choir performances. If asked for a quest, he will send the petitioner out to find technology or wayward mutants to bring back to Churchplace.

OTHER LESSER ENTITIES

Here are a few ideas for other Lesser Entities that might dwell across Umerica.

- A stranded alien looking for parts to repair their starcraft.
- A powerful servant of a god given dominion over an aspect of reality.
- A sentient artificial super Intelligence with access to technomagic.
- A dead god that no longer has the power it once did.
- A god from another reality attempting to gain a foothold in this one.



GM LECTION

POST APOCALYPTIC THEMES

Unlike many of the other genres of role playing games, the post apocalyptic genre is actually hard to maintain for long running campaigns. This is due to the fact that it is a mix of so many elements of other genres that it can quickly lose focus if one or more of the elements are given too much spotlight. Post apocalyptic games include elements of adventure, survival, exploration, discovery, revival, anarchy, freedom, strength and many more. It can be like a Western, Sci Fi, or Fantasy story with components of each of these in every session. The following advice touches on some of the most important aspects of a post apocalyptic game and how to employ them.

Fragmented & Strange

The world of Umerica is both familiar and unknown. Very little is exactly as someone from modern times would expect it to be. Most of the pre-cataclysmic cities that can be found are dead, decaying corpses of their former selves. Buildings lie collapsed or leaning precariously against other buildings. Most structures are dangerously unsound to the point of being on the verge of toppling. Vast stretches of what was lush farmland is now barren wasteland or thick, twisted forests of anomalous vegetation.

Painting a Post Apocalyptic Picture - The key to creating a memorable and engaging twisted earth is describing what the characters are seeing without using everyday terms. This can be especially difficult in an area full of familiar elements. The best idea is to describe familiar modern items as how they would look to someone who never saw them work or do what they were built for. Read the encounter below as an example:

As your characters are walking on a main street of the ruins of downtown Cincinnati, you see a deathbot hover onto the street a few blocks ahead...

or

You are creeping down an overgrown path deep in the heart of a forest of towering, overgrown structures of glass and steel. Strange sounds mix with your footfalls and echo coldly as you move.

Suddenly, a large sphere bristling with ancient weapons emerges from behind a ruined tower a mere hundred paces ahead...

The second is much more evocative and mysterious. Unless one or more of the characters is well versed in pre-cataclysm Urth, avoid assuming the characters have any idea what things like a mailbox, powerline, or cash machine are as it is no longer common knowledge.

Very little is new - Just about every structure, tool, vehicle, and weapon is old or made of reclaimed/recycled materials. Characters seeing something that is totally new, even a mundane object, should be astonished. A mint-in-box item would be a great treasure to the right buyer.

Many things are not what they seem - The world has been twisted by cosmic forces that have changed the very fabric of reality in some places. This could mean the rundown postal drop box has become a living being that hungers for any written materials it senses near it. Not every mundane object will harbor a sinister secret but make sure enough do so that the players are always on their guard.

The use of advanced science is as rare and frightening as powerful sorcery - Most common folk will not see any real difference between a plasma pistol or a wand of fire. Unless a community has a resident expert in technology or magic they will interpret what they see in simple layman's terms and/or superstitious beliefs. A computer that responds to spoken questions is called an oracle and a flying robot is an iron demon.

Normal is in the eye of the beholder - In a world ravaged by cosmic forces, alien nano viruses, and weird magics, the definition of "normal" changes from place to place. A band of adventures may come across a village of very friendly and helpful folk who happen to be terrifyingly ugly mutants. The next day they may be beset by perfect looking humans who are monsters on the inside. The best thing to do is switch up the norm from time to time to keep the players on their toes.

Entropy & Scarcity

These two concepts can make or break the tenuous plausibility of a post-apocalyptic campaign. Too much of either and the world is too harsh so players will lose interest. Too little and the group might as well be playing a Sci Fi campaign instead. Finding the right mix can be difficult but success will make the players quite hyped for the next session.

Entropy - In a world where the great shattering cataclysm occurred centuries ago it is nonsense to think that much of the technological artifacts of today would survive, let alone be functional. But then, what would a Post Apoc campaign be without roaring, scratch built muscle cars, blazing full automatic fire from scrap-patched machine guns, or the joy of finding some coveted canned meat that is still edible. As such, the hard science of entropy due to decay and the passage of time must be waived when convenient to uphold the theme of the campaign. Car batteries can be found with a trickle of current still stored, ancient edible foodstuffs might be hiding in unusual places, and even though all of the tire manufacturing plants have been silent for centuries, a “fresh” set of tires for a vehicle can be the spoils of defeating a murderous road gang.

If any explanation is required as to why some things have decayed to dust while others seem relatively untouched by the passage of time, consider the strange and cosmic nature of the cataclysm that rocked this world. It opened up dimensional rifts, caused some vast areas to interchange with similar areas from an alternate Earth, changed the laws of reality enough to allow magic to exist and run rampant, warping numerous species into new and hideous creatures. How much stranger is it that certain random items have not aged much while others have corroded at a faster rate than they should have? For the purposes of a game, not much really.

Scarcity - Possibly one of the toughest elements to keep in check is that famine and the shortage of goods is commonplace, even in large settlements that are somewhat affluent, other than the Citadel of Scrap. The world has not recovered from its apocalypse and only now are the few struggling industries producing enough goods to consider

trading the excess with other settlements. In order to present a world in need to a group of players, it helps to consider what are the basic necessities and luxuries of common life.

Necessities

- **Food and Water** - at least two cans of food a day and a half gallon of water is required for basic survival. Double this can keep a person fit enough for general labor without causing life threatening effects.
- **Clothing** - depending on the local climate and living conditions, this can consist of at least some sort of footwear and a pair of shorts all the way to requiring thick, heat insulating materials that cover the entire body. Not wearing proper clothing invites bruising, abrasions, and possible illness.
- **Shelter** - even a tarp propped up with some sticks is better than nothing in a heavy rainstorm. Like clothing, not having proper shelter will quickly lead to injury and illness.
- **Protection** - there will always be those who choose to prey on others rather than provide for themselves. The ability to protect and keep what you have is essential to survival.
- **Community** - it is true that there are some folk who really can survive indefinitely on their own but most sentient beings require some level of social contact to remain sane. Mental health is just as important as physical health for long term survival.

Luxuries

- **Means of Travel** - due to the lack of most places ability to provide everything a community could need, a means to be able to travel to other areas, in relative safety, can be crucial. This can be as simple as wagons pulled by domesticated draft animals to motor vehicles that always thirst for more petrol.
- **Fuel** - From wood for the fire to gasoline for the truck, fuel is a luxury most would consider a necessity.
- **Utilities** - electricity, running water, water purification, heating and air conditioning; the list is long for the modern conveniences that a particular community might need to survive.

- **Expert knowledge** - the skills necessary to keep a vehicle running, run an electrical generator, or even build a properly soiled house are definitely luxuries that every community desires.
- **Military Strength** - being able to defend a community and having a trained, well armed military force are two very different things. Even large raider gangs will avoid a fortified settlement known to be the home of armed soldiers.

With this in mind, always have each place the adventuring party goes lack one or several of these items, especially the necessities. A village that has thriving farms and good housing will most likely need protection from raiders and beasts. A nomadic troop of armed caravanners will always be on the lookout for food, water, and materials to repair their mobile homes. Even in a large city like the Citadel of Scrap not every area of the city has everything they need. Some districts will be rife with crime and famine yet have plenty of shelter, clothes and community. Another district will be loaded with goods and yet they do not have proper housing. As long as scarcity is obvious wherever the campaign goes, a good portion of the desired post apocalyptic theme will be in place.

Scavenging & Salvage

Players should quickly learn that there are no obvious chests of treasure lying around and that they will need to keep an eye out for concealed caches of valuable goods. On the other hand, the party constantly searching every square foot, everywhere they go will quickly sour everyone's enjoyment of the game. It is on the GM's shoulders to balance this out so salvage hunting is an integral but not time consuming activity. Below are the Golden Rules of Scavenging.

1. If the players wish to search a location for undiscovered goods, let them. Only say no if you have previously determined that the area is barren of salvage or it is not logical for there to be anything of worth in the area.
2. When players try to investigate an area for salvage, have them attempt to roll under their Luck. If the area is particularly rich or poor

in potential salvage, decrease or increase the die used for the Luck check by 1-2 die steps. Those of the Scavenger class may instead use their Prospecting skill to either determine the best place to look (possibly lowering the Luck check die by 1-2 die steps) or scouting the area out for a specific type of thing (as in the class skill description).

3. Don't roll for every single possible hide hole they can search. If there are several wrecked cars along a ruined highway, only have each searcher roll **once** to see if they find anything among the whole line of cars. If the area is small, like a single storeroom, only allow a few characters to be able to make the Luck check. In general, allow only one chance per searcher for each loosely defined area there might be some hidden goods. If it is a large place, try splitting it into logical chunks, such as "in the south side of the junkyard", "all the dumpsters in this ally", "all the vehicles on this level of the car park", etc.
4. If the luck check is successful, they have found something! What did they find? Well, this can be handled in a few ways:
 - a. Have them roll d% and the higher the roll, the better the quality/quantity of what they have found. Just come up with something logical for the area they are in. i.e. buckets, mops, and cleaning chemicals in a janitor's closet; emergency toolkits, flares, or car jacks in a vehicle; Large knives, sauce pans, and cooking oil in a restaurant kitchen; etc.
 - b. Use the Random tables in Appendix S: Salvage, to determine what they have found.
 - c. Let them find something they desperately need, especially if they do not know they need it yet, and then make them pay for the good fortune later. This is more cinematic and also lulls the party into a false sense of security.
 - d. The rule of 3: If the players have found three or more things of value in an area they just searched, the area is tapped out. All further scavenging turns up nothing but may attract unwanted attention.

A FEW INTERESTING PLACES TO DIE

Here are several places outside the Citadel of Scrap that are rumored to be veritable gold mines for those daring enough to risk death or worse. These locals are intentionally described in a vague manner so that they can be tailored to fit into most campaigns. Some have been more thoroughly depicted in the pages of the *Crawling Under a Broken Moon* fanzine. They will list an issue number if you wish to know more about them.

The South Done Rose Again

Across the Kansan river, southeast of the Citadel of Scrap, is a ten-mile stretch of green where sentient grasses have converted the cheap suburban houses into ruins. This 20 mile area (looking down from the air it is a perfect circle) is rich in plunder: a hospital, several shopping malls, and dozens of Buddy O'Burger stores are still accessible. It is strange that no one lives here.

The wilds have risen up to claim this area. Aggressive plants, malevolent insects, and living elemental forms rove this area, attempting to level all that remains of the works of man. Certain areas to the north and south have been spared as a result of even stranger denizens: armies of ghosts. The north end of this area is protected by different divisions of World War One era warriors. For some strange reason, they do not fight among themselves: warriors of the Triple Entente fight alongside the Triple Alliance. To the south we find soldiers from the American Civil War. Again, there is no separation as the Confederates fight on the same side as Union troops. These two factions (WWI and Civil War) march out to battle every night, destroying all living creatures they encounter. When their area is cleared of life they begin marching on the other's base. To the north is the flaming tower of the WWI faction, to the south a large brick townhouse with glowing white columns. Though the soldiers are incorporeal spectres, the guns they carry are quite real and do damage as appropriate to their weapon's era. These ghosts seem immune to all forms of attack, save for the very weapons they use. Firearms using lead shot and an explosive powder seem to be their only weakness.

Small groups of survivalists eke out a living on the fringes, launching hit and run raids into their targets and retreating quickly. Their costume is a strange mix of the 1910s and 1860s American. The thought being that, if cornered by a ghost, their costuming will buy them enough time to escape. It is yet unknown if this theory holds.

Mall Walkers

Due to sturdy civil defense construction, a surprising amount of the pre-cataclysmic mega malls have survived where many buildings have toppled. This fact did not escape cataclysm survivors and many of these malls became short term bastions of safety and plenty. For the most part they also became great tombs as endless waves of survivors and mutants fought over them in the earlier days of the new era of desolation.

Now many of these quiet places tempt brave folk looking to see if anything of worth might still lie unearthed within. The fact that most that give into the temptation never are seen again has given to legends of hauntings or monsters living in them, effectively making them the "dungeons" of this genre. To determine who or what might be lurking within a mall the party has stumbled across, roll 2d6 on the chart below.

- | | |
|-----|---|
| 2-3 | The rumors of creatures dwelling here are false. There is just a small colony of xenophobic folk that want to be left alone. They scare invaders with traps and high quality monster costumes (from a costume shop). |
| 4-5 | The multitude of the corpses within the mall are not all at rest. About 1 in 10 is actually a "sleeping" undead and as soon as the party makes enough of a ruckus, they will begin waking up... |
| 6-7 | The remnants of those who originally took shelter within the mall have mutated or devolved into humanoid or inhuman creatures that now feast upon invaders. They will use expert knowledge of the terrain and traps to hunt their prey. |
| 8-9 | The mall is indeed haunted by the ghosts of the folks who hoped to find refuge here. |

GM SECTION

Since they were all killed, there is most likely a good reason for their deaths such as: a source of radiation or disease, a homicidal security bot, or a toxic fungi infestation. The ghosts might be passive or even friendly if approached peacefully.

- 10-11 The mall interior has become overgrown by plant life and now one or more types of vegetative predators roam the dark, indoor forest. Now around every corner is a mobile plant-thing evolved to kill for the minerals and nutrients they need to survive.
- 12 A large, intelligent creature has claimed the mall as its lair, something of at least 8HD or more. Now it defends its privacy with lethal force. There is a 50% chance that the beast has 4d6 minions serving it and act as a first line of defense.

The Monolith of Law and Chaos

Hard to miss, this appears as a tall, slender, shard like pyramid embedded point first deeply into a flat, grassy plain. Which grassy plain seems to change with each phase of the moon but all of its resting places are within a 20 mile radius of each other. Its coloration also seems to change from stark white to pitch black every 18 hours on the dot.

It is actually the crashed remains of two different ships that occupy the same space at alternating time intervals. How this may have occurred is unknown. The white ship's remains are now the tomb of a dead Law Prime with a clean, geometric interior architecture. The black ship is the tomb of a dead Chaos Prime with a twisting, organic architecture. Both are occupied by custodians and guardians appropriate to their alignment.

Anyone in the monolith at the time of the change will experience a deep sense of vertigo as reality warps around them. After a few moments, they will find themselves on the other ship. Anything left behind on the previous ship cannot be reclaimed until another 18 hours has passed. The native inhabitants of each ship do not transition either but will remember any actions the party took when they were on that ship previously.

Roll on the tables below to determine the type of beings that inhabit each ship.

Lawful Occupants table, roll 1d6:

- 1 Robots
- 2 Talking animals
- 3 Spindly bodied aliens
- 4 Floating polygons
- 5 Stark white, featureless humanoids
- 6 Ghostly aliens

Chaotic Occupants table, roll 1d6

- 1 Beast men
- 2 Intelligent alien oozes
- 3 Spheres of dark energy
- 4 Masses of fleshy tentacles
- 5 Humanoids formed of glass shards
- 6 Insectoid aliens

Blob's Interdimensional Truck Stop

Often appearing out of nowhere, this full service truck stop never sits in one spot for more than a week. The parking lot is in immaculate shape and hosts cars, trucks, and semi-trucks from many time periods plus a few alien looking vehicles as well. Towering over the main building is a huge, rotating neon sign: "Blob's Truck Stop".

The truck stop is open 24 hours a day and will cater to anyone or thing that can pay. Barter and currency of just about any type is good here. Below is a list of services and goods available:

- An all you can eat buffet featuring hot, fresh food. No doggie bags!
- A coffee and bakery walk up window.
- Pay shower and laundry facilities.
- Basic vehicle repair shop.
- A wide variety of fuel pumps: Petroleum based, Bio-based, Electric, and several alien fuels.
- A small convenience store and gift shop.

Blob is a demi-ooze, a humanoid shaped ooze being, wearing overalls and Epsilon T-Rex's ball cap. His name is clearly stitched on his overalls. Blob is quite friendly to paying customers and will personally warn each one when the truck stop will be moving with about 3 hours notice. No one else working at the truck stop has any idea how he knows.



Since it is a no questions asked kind of place, it does attract a bunch of questionable characters that do not like nosy people. There are even a few who live permanently at the truck stop and sleep in their vehicles. While Blob does not like it when fights break out, he will not do much to stop them unless there is a good chance of property damage. Blob's word is law here but he does not often exercise his power. If care is not taken, party members will be targeted by thieves or brawlers.

When the truck stop moves, it simply blinks out of existence in one place and into existence somewhere else. Where it moves is generally a plot device for the GM to use to get the party to the next adventure location.

A FEW RANDOM PLOT SEEDS

- 1 The party finds itself stranded as their vehicle had an undiscovered fuel leak that has now drained the tank. Now... (roll 1d3)
 1. In the distance looks to be a medium size, fortified building. As dusk begins, electric lights can be seen inside the building.
 2. A rolling dust cloud can be seen following

your gas trail. Most likely it is a band of raiders hot on your trail. If fighting is not an option, there appears to be a rather hilly area nearby that looks like it may have some caves to hide in.

3. Luckily, there is a small nearby forest of odd looking trees that you could hide the vehicle in and use as shelter until morning. It is not until after the party has begun setting up camp that they realize the trees are swaying without any wind...
- 2 The community the party is staying in has come down with several cases of illness recently. The town elders ask for the party's assistance to... (roll 1d3)
 1. Travel to the ruins of a medium sized city about a half day's travel from the community. The elders say the illness has occurred before and they have found medicine there. The catch is that the place is also the home to a pack of "mutant monsters" that ate half of the folk that scavenged there last time.
 2. Escort the community healer to make a pilgrimage to a "magical" forest several days away to find herbal components for

GM SECTION

a cure. None of the community guards will return there as they are convinced it is haunted by howling ghosts!

3. Burn down the buildings that are the source of the plague and protect them as they search for a new place to live.
- 3 While trailblazing through wild scrubland the party comes across a set of large, well built buildings surrounded by the remains of what was once an imposing chain link fence. They seem to have weathered the years since the Great Cataclysm well and might have some sweet salvage within. As the party considers investigating the building the sky shows signs of foul weather coming soon. The sign outside the remnants of the gate reads... (roll 1d3)
 1. Bensville County Prison - muffled moans and howls can be heard coming from within and the doors are not only securely locked but welded shut and sealed with what looks to be a magical ward. Will the party brave the oncoming storm or face the horrors inside?
 2. Federal Research Center 6115, No Unauthorized Entry - Obvious security cameras can be seen sweeping the area around the buildings and an ominous hum can be heard coming from inside. Flood lamps mounted on the building corners blaze day and night. If the main door is approached, a pleasant but slightly distorted voice calls out "Greetings! After entering please step to the left to receive your guest ID badges."
 3. Natsu Food Corp Manufacturing & Distribution Center, "We cook it so you can eat it!" - In addition to the gate sign there are three other signs on the main building: "Home of the Malty Bar!", "Coco Dots! Melts in your face, not in your pocket!", "Suga' Skullz: Atomic Sour Supreme!". All of the windows have been repaired with duct tape and manufacturing machinery can be heard running inside.
- 4 The bellies of the party rumble as food is running low. Their supplies will not last long enough to

make it to the closest settlement they know of. Hope grows as they see... (roll 1d3)

1. A caravan traveling on an old highway a quarter mile from their current position! Unfortunately, they also see they are not the only group to spot it as a raider gang sits ready to pounce not too far ahead of the caravan's path.
2. A grove of fruit-laden trees ahead that seems unclaimed by man or beast! As the party approaches, the smell of the ripe fruit is nigh intoxicating. Only a tell-tale quiver of several vines halts their hungry advance as caution and fear kick in.
3. The glowing sign of an O'Burger restaurant peeking from behind a hill. As the party rounds the hill they come across a large battle as a coven of Grokk worshipers are besieging the restaurant chapel in attempts to drive off the O'burgerites from what they scream are "sacred lands". Will the party pick a side or attempt to wait out the battle in secret?





SECRETS OF THE CITADEL

LUNA
3

DIABLO

1317

SECRETS OF THE CITADEL

The following sections present a viewpoint of what mysteries might be found within the Citadel of Scrap. Some specifics are given as well as more nebulous rumors that may or may not be true. As the GM feel free to use what inspires you, leave what doesn't and let your particular version of the Citadel grow as you play. Exact prices for goods and services are not always stated and left to the GM to decide what would fit the economy of his game.

LIVING IN THE CITADEL

Who are the citizens of the Citadel? All are welcomed into the gates if you have trade goods or money. Mutant, human, cyborg, or sentient broccoli, no one here really cares about your racial heritage as a visitor. Citizens, on the other hand, tend to all be human or 'augmented' human. Mutants and lesser beings are shoved to the fringes and less maintained areas of each district. Some districts will not allow those other than human to do more than conduct business before being asked to vacate. Applications for citizenship can be made at both North and South Stations. A one-time processing fee equivalent to 1000sp is required and does not guarantee citizenship. Applications are screened in two-month cycles and those accepted will find their names printed on informational brochures that are also found at the rail stations. Once accepted, citizens pay a 10% tax on all monies earned and have the privilege of purchasing a dwelling in the districts that have them available.

Citadel citizens, in most districts, enjoy all the niceties of modern living with electricity, television, radio, sanitation and running water. How is all this possible? How do they generate the power for a city this size? There are power stations in many districts, but far too few to power the needs a citizenry this size would require. These power stations and the power lines that run from block to block are all a ruse. Nearly all the power requirements for the Citadel are generated from the Growling Tower. The energy is harvested from The God in The Pit and collected and broadcast through the power of the Royals. Energy radiates out from the Growling Tower and is received by strategically placed mystical pillars in each district. Characters visiting the Citadel will find electronic devices that used to require batteries or

other energy sources just 'work' while in the confines of the Citadel.

Laws (or living in a stable society)

The Royals have decreed Five Rules of Law that all citizens will follow. Individual districts may expand on this as they see fit as long as the Five Rules are also followed.

Rule the 1st - Thou shalt not destroy public structures or cause said structures to become harmed by your actions.

Rule the 2nd - Thou shalt pay unto thine rulers 10% of thine increase monthly.

Rule the 3rd - Delving into the mysteries of The God in The Pit or seeking to increase thine knowledge of said God is forbidden.

Rule the 4th - Thou shalt not cause one another to become deceased by thine actions or deeds.

Rule the 5th - Thou shalt not steal from one another nor deal unfairly in commerce with thine brethren for it is a dickish thing to do.

Security Forces of The Citadel

Breaking laws and causing general chaos and mayhem in the Citadel can result in some serious repercussions. There are three response levels within the Citadel at large you should be made aware of. Each district has their own security force that handles minor transgressions: disturbing the peace, theft, assaulting a citizen, breaking and entering or just looking suspicious in the wrong neighborhood will attract this basic level response. See each individual district entry for particulars.

Causing a mass disturbance, damage to city infrastructure or attracting the attention of the Royals in such a way that they wish to 'interview you' will trigger a Level Two response: At least 1 (but up to 5) 5 man teams of assault troops will be dispatched to the location and will arrive in 1d4 turns. Each team will have air support in the form of a drone or gyrocopter to help spot the offending law breaker. The team will first attempt to take lawbreakers alive but any resistance will be met with deadly fire.

In each 5 man team you will have 4 standard troops [Init +1; Atk Assault Rifle 1D10 (see pg 122) or hand axe 1d6; AC 11 (plus d12 armor die); HP 1d12, MV 30'; Act 1d20, SP modern grenades X 4 (see pg 123); SV Fort +1, Ref +1, Will +1] and 1 commander [same stats as a standard trooper with: HD 2d12; SP Airstrike (can call in an attack from either a gyrocopter or drone that was dispatched with the team)]. For stats on gyrocopters see pg 143. Each gyrocopter will have 1 pilot and 1 crew armed with a machine gun. Drones have the following statistics [Init +2; Atk Weights +1 missile (weights 1d5); AC 15; Armor Die:0, HD d4; Speed Level cruise 3/max 6; Height cruise 4/ max 6; Act d20; Sv Fort -4, Ref +4, Will NA; Fuel Tank 1d5; Guzzle 1. Traits: Auto Rotate, Bomb Rack, Bombing Sights, Good instruments]. Drones are unmanned and have a broadcast sensor packet that allows visual control from the Growling Tower with a range that covers the entire Citadel plus a 1-mile perimeter around the city. Drone jockeys are Trained with an Agility bonus of +2 and an action die of 1d20 when making Vehicle Control rolls.

A Level 3 response will be summoned if mass damage to city infrastructure, mass civilian casualties or a direct order from the Royals is requested. Level 3 responders will arrive in 1d4 turns, have 1d5+5, 5 man teams involved (see Level 2 response) as well as 1d3 Hell Raiser teams. Each Hell Raiser team includes a 5 man squad of standard troops wearing Power Armor (see pg 121), wielding sniper rifles, combat shotguns, hand axes, and a mix of grenades. Each squad will also have 1 Light Mech driving officer (see pg. 145). This is a no-nonsense response with soldiers intent on the elimination of all targets.

Energy requirements for all this high-tech equipment is harvested from the broadcast power coming from the Groaning Tower.

Merchant Houses

There are four families that make up the Merchant Houses. These families own and maintain the transportation fleets that feed the citadel: the trains, the boats, the caravans and in some cases the aircraft, that move goods. They are able to exert a great deal of control over the economy by fixing the prices of transporting goods between them. There are a few

independents but they cannot transport enough in bulk to make much of a difference. Long ago the Houses determined that it was in the best interests of all if they worked together instead of against one another. Two Houses are noteworthy both within and beyond the Citadel. The Earls House, home to the Earls brothers who own the East-West Co., controls nearly one-half of all the trains and rails within the city. Their rival Gregory Grillbeard, master of Northern Rail, is a member of House Tulley which has majority control of waterborne travel within the Citadel.

The Underworld and Black Market

The Royals are masters of manipulation. They knew two things were inevitable within their domain: Merchants would gather power by influence and money and that a criminal element would appear from those unable to live within the strictures of the law. To undercut the power of the Merchant Houses and to control the rise of criminality, the Royals **created** the black market. Of course, few that work the shadows know this to be true. Key persons were put into place and given funds to start the process. Black market sellers undercut the Merchants who have to adjust to market demand. A portion of the cash in the economy is kept out of the Merchant's control and is used to fund other projects. It's a balancing act the Royals manage well.

Cults

The O'Burger cult and the Pit Masters of Barbi-Q are not at crossed purposes. They serve different faces of the same god. Buddy O' the Cannibal Clown opens franchises among his chosen people and a tenant of the faith is that others must be sacrificed for the good of the elect. 'Fresh meat' is never gathered from the same community a franchise is opened in. Each morning meat is sent through a magic gate from the main Burger Temple to each restaurant. O'Burger spreads cannibalism unwittingly amongst diners. Barbi-Q on the other hand wraps cannibalism in respect for the dead (as well as 21 secret spices). The service they provide is to compact the form of your dearly departed so they may be sent to rest in whatever way you wish, just in a more convenient package. It's not their fault if the remains smell too delicious not to take a bite now and then. Once you've

tasted the lovingly applied burial sauces it becomes easier to rationalize cannibalism as being a proper way to send off a friend. The pit masters of Barbi-Q are willing to prepare any hunk of flesh really, it doesn't have to be sentient. Both establishments serve the Cannibal Clown.

What is the God in the Pit?

I'll give you some ideas here, but GMs should determine this for themselves.

- It is a god, imprisoned behind magical and technological seals. The Royals are attempting to breach the seals and awaken the god.
- As above but the Royals want to keep the god bound and are siphoning off its power.
- The god is an ancient machine that fell from orbit and the Royals are harvesting its nuclear core and stored data files
- The god is a doomsday weapon that never detonated and the Royals are trying to figure out how best to leverage its power.
- The god is an artificial intelligence and the Royals are holographic projections it uses to protect itself.
- The entire world is a simulation being played out in the mind of a massive AI and the Pit is a coding mistake exposing the inner machine.
- The Pit is a dimensional gate linking many worlds together and the Royals are researching information from across many realities.

Using the Royals In Your Games

No statistics are given to represent the Royals. GMs should use the Royals as plot devices, hinted at but never encountered. The Royals are far too canny to put themselves in the same room as any PC! They use agents when communications become necessary. Holograms and disembodied voices that occasionally interrupt radio and television broadcasts are other ways that you could introduce a Royal to your players. Why might a Royal be interested in a character? They are schemers, pure and simple and love to play games with the citizenry of the Citadel and have strong rivalries with one another. Here are some pointers to using a royal in play:

- Two are male and one identifies as female but their names have never been uncovered.
- When referring to each other, they use the



designations of the 1st seeker, 2nd seeker, and 3rd seeker. The numbering scheme is not consistent as it seems that each, in turn, will sometimes be 1, 2 or 3 at alternating times. The order depends on which of the Royals is 'ahead' in their private games.

- The Royals are Cybersorcerers who mix equal parts technologist and wizard with a splash of mad scientist.
- They actively seek to sabotage each other's plans, however, they have a unified goal in freeing (or perhaps enslaving) the God in The Pit.
- The advisory board that speaks for the Royals to the populace are marked by wizardry. Any Royal can puppet an adviser, seeing and hearing through their eyes and speaking through their mouths when necessary. The advisers are unaware of this spell and tend to take up speaking again at the point right before a Royal took control. 1 in 100 troop commanders in the Citadel's military also bear this mark. When a Royal takes control of a body in this fashion, they are capable of casting spells through the puppeted body. Any spellburn is born by the controlled body.

SECRETS OF THE CITADEL

MISERY SIDE

Law Enforcement and District Ordinances

Misery Side has no district organized patrols. Drones or Gyrocopters have a 1 in 20 chance per hour of being overhead and monitoring. Getting in trouble (or causing trouble) here seldom leads to law enforcement intervention. The only special laws here are Rudy's laws and he has but one: 'Don't screw with Rudy'

Locations of Interest

Rudy's Adventure Escape — Ran by Rudy Rudeman, a great bear of a human easily as wide as he is tall. Rudy sports a bald pate burned by the sun and a full, red, scraggly beard with bits and pieces of circuit boards woven through intricate braid work. Rudy has 3 mutant helpers — Cletus, Samuel Farnsworth the 3rd, and Sariah.

Rudy runs a fair establishment and is not looking to put one over on any of his customers. He rents out gear (at 1/10th the full value) and asks for 10% of the value of whatever you might find scrounging the Misery river and environs of Misery Side. He has a fine eye at assessing value and will ask to see all that you retrieve in order to assess a fair fee. If you return Rudy's gear in working condition he will return half your deposit fee. If you try and steal Rudy's gear, lose it, or damage it, he keeps your entire deposit. This might sound like a great way to get cheap gear, but mysteriously, all Rudy's gear stops working once you leave Misery Side. Rudy's gear is painted in garish DayGlo colors that are easily recognizable and no merchant in the Citadel will purchase or barter them. If you seek to cheat Rudy of his 10% commission on found treasure, a greeting card will be found next to your head when next you awaken from slumber. In the Citadel, a greeting card means you've been marked for assassination and have a price on your head that many will try and collect on. Rudy is deeply connected with the criminal underworld.

GMs, allow the players to rent any standard items you see fit, including guns and vehicles (boats and diving gear are big rental items). Ammunition and fuel, of course, can't be rented, but Rudy charges a bit less than anyone else on these items. Actual costs will vary according to the economy of your own campaigns.

Along and Within the Misery River

There really is treasure aplenty in the depths of the Misery. In particular, a sunken airline history museum contains rooms that have remained airtight. Special negative pressure rooms were used to keep contaminants out of exhibits prone to erosion by polluted air and when the museum sank, these rooms remained sealed and free of water.

The sunken ruins of once proud skyscrapers now breach the waters, forming dangerous islands and reefs of twisted metal, concrete and glass. Good sailors may be able to dock near these treacherous outcroppings and enter the buildings from the exposed rooftops [a Vehicle Control test with a rough waters modifier of +2 will allow this]. Explorers of these ruins have found that not all floors are flooded. Air duct systems that are exposed above the water line have created these 'safe' havens on occasion. There is a 1 in 6 chance of finding something of value per hour explored. Have the discovering character make a luck roll and the item's worth is equal to the success range x 10 in sp. Failed luck rolls result in finding an interesting piece of pre-cataclysm culture that has no intrinsic value.



SECRETS OF THE CITADEL

For those that have scuba gear or other ways of breathing underwater, the depths of the Misery hold many undiscovered fortunes. For every hour spent diving and exploring, there is a 1 in 6 chance of finding something of value.

Picking along the banks of the Misery provides a 1 in 8 chance, per hour spent, of finding valuables. Increase this to 1 in 6 if a metal detector or other similar technology is used. Exploring in this fashion is much safer than braving the river in a boat or using diving equipment.

Fun in the Sun

Life isn't always about turning a profit. Rudy's Adventure Escape offers many leisure activities as well. Para sailing and gliders are popular ways to relax and enjoy a great summer's day. Rudy offers a family package which includes a boat rental, fuel, and your choice of a para sail, towed glider or water skis for a day rate of 100sp [GMs adjust to fit your campaign's economy as needed]

Encounters and Dangers

Characters enjoying a day on the Misery will have to keep sharp. The river is treacherous and the Rough Waters modifier [+2] is always in play. In addition, for every hour spent on the Misery, there is a 1 in 8 chance of shifting conditions. Roll 1d8 to determine the change in conditions.

Misery Shifting Conditions

Roll	Condition	Modifier to Vehicle Control roll
1-2	Calm waters	remove the Rough Waters condition
3	Jagged debris	+2 as you navigate around them
4	Strong current	+3
5	Light rapids	+4
6	Stormy weather	+4
7	Heavy rapids	+8
8	Small leak appears	+1 per minute of leakage

Table results are not additive, the conditions change each hour. Small leak results will persist until repaired.

Characters exploring the depths of the Misery may encounter scouts for a colony of Deep Ones [DCC pg. 400 but neutral in alignment] that were forced from the deep oceans and have made a home in these rivers. The colony is self-sufficient and wants little to do with outsiders, but they could be helpful if given a reason to be. If unaware characters get too close to their city, a threatening display will be made but the Deep Ones will not attempt to actually harm invaders. If characters persist and don't take the hint, they will defend their home and people.

The only large predators that hunt the Misery that may cause problems are giant water snakes [use the statistics for a Giant Viper from DCC pg. 428 with an additional water movement rate of 50']. Encounters with these beasts should not be random, use them to encourage action! They are encountered in groups 1d4 in size.

Characters aren't the only ones scavenging here. While along the shores of the Misery, there is a 1 in 8 chance per hour during daylight of coming across Misery Men. This increases to 1 in 4 during nighttime hours. These twisted mutants are servants to wizards and technologists and are looking for bodies that may have washed ashore. They aren't picky about the status of said body, alive or dead. Those injured and washed ashore will have their skulls cracked by any Misery Men that come across them, ensuring said unfortunate didn't survive their adventures. Misery Men are a cowardly lot though and will not engage obviously healthy individuals that are able to defend themselves. Misery Men use the statistics for Ghouls from pg. 414 of the DCC rule book, minus undead traits.

Outcasts who aren't afforded citizenship within the Citadel make their homes in the broken, but still standing buildings further inland of the coast. These communities are populated by Mutants and those too strange for the polite company of the inner city. They are a hardy lot and band together to keep what little they have but aren't above offering aid or trade to those with friendly words.

Adventure Seeds

- Rudy has made several attempts at breaching the sunken aircraft museum without success.

He would like to add any salvaged aircraft or parts to his inventory and is willing to make a special deal for anyone that can do the deed. He will equip the party with a boat, diving gear, fuel and whatever else they may ask for (within reason) for free along with a rough idea of where the museum can be found. His only stipulation is that he be given the first crack at purchasing anything salvaged. Hidden within a bit of equipment they borrow, Rudy has planted a camera that will work underwater and records several hours of video. When he retrieves his gear he will have this recording, which is what he's really after. Rudy knows that characters will not be able to bring up entire airplanes but with the video footage he may be able to mount an expedition of his own, once he can assess the risks.

- A group of Misery Men is desperate to gather body parts for their masters. A particularly smart member of this party has decided that waiting for accidents to happen and bodies to wash ashore is a sucker's game. Let's make those accidents happen! A mile long stretch of the misery has been mined with anchored, explosive buoys. Have all characters make Luck rolls, if any succeed a shouted warning may be given and the driver of the watercraft can make a Vehicle Control roll at -1 for each character that succeeds. Buoys will detonate as the watercraft slams into them [a failed Vehicle Control roll] doing 4d6 damage to the craft, if the craft is destroyed with points of damage remaining, the excess is divided as evenly as possible amongst the crew.
- A local community of Mutants is having problems gathering food. The usually abundant, edible aquatic life they subsist on has been driven away by predators. Other than the slapped together rafts they fish off, they have no craft capable of keeping up with the quickly moving predators. They are willing to pay in barter goods for the slaughter of whatever is scaring away their food source. The predators are a family of 5 giant water snakes. The PCs will have to stake out the Mutant's fishing spots to find the snakes, then chase them down and end the threat. Vehicle chase rules can be used

if the PCs have a slow craft. If their vessel has a speed level of 2 or more the snakes will not be able to out distance them.

WHOLE SALE

Law Enforcement and District Ordinances

Citadel law is in strict enforcement here and very obvious. Five man tactical teams roam the streets on high alert and will arrive at the site of any altercation within 1 turn if they are not already present (1 in 6 chance that they are). The Five Rules of Law as passed down by the Royals are all observed (of course) with the following 2 district laws in addition: Public proselytizing is forbidden and must be restricted to houses of worship, and attempting to gain an advantage in commerce by blackmail is forbidden. That last law was added after a full out war on the streets was waged between rival merchant houses when the details of a high ranking merchant's dalliances were made public.

Merchants also employ their own guards, not willing to leave the protection of their businesses completely to Citadel forces. When breaking a law in this district, make a luck roll with a +4 modifier due to the vigilance of the guards. Failure means your actions have been observed.

Locations of Interest

Whole Sale is a large district but can be divided into five sections of distinctly different cultures.

At the terminus of Cog-Alley resides the wealthiest shops with the best merchandise. These buildings are all well maintained, permanent structures with good lighting and security surveillance [+5 mod to Luck modifiers here when attempting to break laws]. Bright, neon signs pulse in garish colors to advertise for particular merchants. Music blares from loudspeakers interspersed with commercials beckoning one and all to come and **shop!** Anything imaginable can be purchased here (with significant markups) and we're not just talking about physical goods. While technically not slavery (as the individuals are paid well and enter upon limited term contracts), people can be bought. These contracts can last for a term set for a length of time or for work performed. Need someone to clean and

SECRETS OF THE CITADEL

maintain your gear? How about someone to cook your meals for a month? Feeling frisky? Yeah, buy all that here. Commerce happens on the ground floors and the merchants live in the upper stories with their families and workers. Also located here is the famed Auction House. Wares are brought in by rail and come from all across Umerica in the hopes of fetching the best prices. The Auction House deals in bulk: bulk food, fleets of vehicles, arms and armor to equip armies, raw metals, etc.

God's Row precedes the market. Along this street, extravagant buildings loom over pedestrians, imposing a feeling of awe and reverence. A house of worship for any god can be found if you look hard enough. Those lesser gods with smaller congregations often share the same building with each floor consecrated to a different deity. Those faithful PCs wishing to unload their tithes, train, or are seeking help from like minded acolytes will find what they need here. Invoking a Patron in his house of worship gives a +10 bonus to Invoke Patron results. To somewhat circumvent the district law against public proselytizing, rows of neat and orderly wire baskets line the streets, filled with brochures extolling the merits of various Gods.

Radiating out from the central district and God's Row, permanent structures become more sparse. Single buildings stand alone on each block of Hunger Haven with push carts, stalls, trailers, and tables filling the gaps between. The merchants selling from these temporary establishments are more mobile, sell cheaper items, and exude a certain stench of desperation. GMs, 'cheap' is what you want to stress here. Refer to pg 124 on 'cheap, A.K.A. damaged, goods as well as Bad Food effects' on pg 13. The few permanent buildings that stand here are the exception. These are fine places to tie on a feed bag. A gleaming Buddy O'Burger establishment sits proudly on one corner, facing off against a Queequeg's Quoffee (see *CUaBM* issue #11) directly opposite. The Pit Masters of Barbi-Q have a temple here as well. There is a fine line between worship and food in the Citadel and that line gets very blurry in Hunger Haven. Both Buddy O'Burger and the cult of Barbi-Q adhere to the no proselytizing ordinance... just in case.

Cheapside butts heads with Misery Side and showcases the lowest of citizen living in the Citadel. The houses are maintained but show subtle signs of neglect but the people living here are proud of what they have. While a residential district at its core, many fine craftsmen do business from their homes. If you're looking for a set of custom tailored clothing, home cooked foods, or a technologist to build or repair a piece of machinery, you just might find it here. Prices are negotiable, but it is ill advised to insult them with overly low offers.

Surewood isn't part of Whole Sale exactly but it is worth mentioning. The criminal underbelly of the Citadel infests this forest. Natural features keep the prying eyes of law enforcement far away. Sure, if they wanted to, the Royals could burn the whole forest down but thus far things have been left to develop as they will for very practical reasons. Every society has a criminal element and this one has been cultivated and built by the Royals in order to control that threat. Having black market merchants undercut the legal Merchant Guilds gives the Royals another piece to play on the chessboard. In truth, the 'criminal' element is far more organized than the merchants, who believe they are the sole reason the economy and society of the Citadel is stable. The Royals also know that a resistance cult has formed in the forest. This cult is dedicated to stopping the Royals from resurrecting the God in the Pit. Scientists and wizards make up the cult and through various divinations and peer reviewed studies, have come to the conclusion that awakening the God will destroy the world. The cult's members are very careful and the Royals do not know who or if there is a central leader or group of leaders that control them. The crime bosses of Surewood pay a bounty for any information on the cult that is reported to them, and they in turn report to the Royals. So far they have not been able to flush out the cult.

Encounters and Dangers

The Merchant Houses (so they believe) hold total power in this district. Between the four Houses, they make sure that prices for goods stay at a consistent value and the worth of Citadel coin never fluctuates wildly. Crossing them by selling in bulk and undercutting their careful monopoly will provoke

SECRETS OF THE CITADEL

a response as will attempting to counterfeit Citadel coin. That falls under the law of 'not stealing from one another'. The coins are very difficult to forge as they all have a particular level of radiation that all merchants in the guild know to check for. When provoked, the merchants will first send out a group of concerned functionaries who will strongly suggest the PCs stop trying to upset the clockwork precision they have attained. Strong suggestions include broken bones and severed digits. The next level response is to inform law enforcement (which they are loath to do as meddling by the Royals is to be avoided) and to plant evidence or give false witness if necessary to assure offenders are jailed or shot dead.

Low ranking criminals (those not aware of who they really work for) attempt to pick pockets and rob PCs when the opportunity presents. Royal law enforcement lets this happen in some instances to show there is a need for street patrols. Occasionally, a big show is made of apprehending a criminal or gunning one down in the streets to make a point. While walking the streets of Whole Sale, check each hour to see if the PCs have become a mark (1 in 10 chance). If they've been marked as targets a team of criminals (1d4+1 members) will try and follow their mark and attack when they are in less observed areas or will attempt to pickpocket them when in large crowds. Have each PC make a Luck check, those that fail, lose a random item carried. The criminals will hand the item off from member to member so even if they are caught stealing by those who manage a successful Luck check, the item has long since been passed along.

The streets of Whole Sale are one of the safest in the Citadel so other than being quickly parted with money, few real dangers will be encountered. Entering Surewood forest is far riskier... Getting lost is a real hazard with the general overgrowth and tight canopy of trees blocking the view of the sky. A skill test based on Intelligence and a helpful occupation with a DC of 15 is required to keep track of where you have come and in what direction you are heading. The forest is unobserved by law enforcement and no help will be forthcoming in times of trouble. Forest animals can be a threat, from poisonous snakes and spiders to wild boar. It's also a great place to hunt fresh food if you can't afford to eat in the city! While exploring, running

into bandits (DCC pg 432) will certainly happen if a party does become lost. They will not automatically be hostile, but the possibility is there.

Adventure Seeds

- Want to make a quick buck? So asks a lean man in patchwork clothing. The job is simple, a bulk order of medical supplies has been purchased from the Auction House and it needs to be delivered to a particular spot in Surewood forest. He's willing to pay a reasonable amount, half in advance, for the delivery. You're given a claim ticket to present to collect the goods. What he's not telling you - The Royals have good intel that the purchased medical goods are to be delivered to a person or persons involved with the hidden cult in Surewood. The cult needs someone outside of their structure to make the pickup and delivery. The patsy will be watched from a safe distance to see if they are being followed by law enforcement. The PCs mission is to pick up and deliver for which they will be paid in full, but they have the opportunity of making a connection with the cult if they are aware they are being followed and they shake the tail before delivery.
- While shopping in the heart of the district in the fanciest of establishments and bemoaning the prices, the PCs are approached by a sympathetic merchant who is willing to cut a deal for that piece of gear they've been ogling for hours. The merchant is trying to prove that his competitor is not only stealing his customers but is having free relations with his wife as well. The goods in question will be traded for photographic evidence (he'll provide a video camera) of this dalliance.
- Business opportunities abound! The Citadel is an incredible place to make or lose a fortune. If the PCs have acquired many trade goods and aren't able to get a good price from vendors they might wish to purchase a cart and peddle their wares on the streets of Cheapside. Competition is fierce with vendors actively hostile to one another as they each try and cajole every last coin from passersby. No permits needed as long as the Royals get their 10% tax on goods sold.

THE FLATS

Law Enforcement and District Ordinances

In addition to the Five Laws, The Flats have two more that have evolved over time. The 'No Whiners on Race Day' rule was pronounced after too many bad losers tried to report the loss of their vehicles as fraudulent commerce to the authorities. Under Flat rules, if you agree to race it, you abide by the consequences. Due to the prevalence of vehicles being stolen and stripped down with parts being sold off piecemeal to obscure the theft, any sales of parts must now carry a pedigree. Paperwork detailing where and how the parts were obtained must be presented before they can be purchased or sold. This has, of course, resulted in most parts dealing occurring in other districts and a healthy black market has formed to move parts in and out of this district. Drones account for the primary law enforcement presence here and make frequent aerial patrols. There is a 1 in 4 chance that any open criminal activity will be monitored by these Drones and a strike force called to the scene. The warehouses and factories that cover the Flats in orderly rows have their own security as well. Mutants and robot workers will protect their employer's property when called to do so.

Locations of Interest

Danny's Fast Trax and Garage is the true gem in this field of concrete. Petrol heads from the far corners of Umerica come to test their skills against one another on this 2-mile race track. The races are formal and very ritualized. Ancient rights taken from the tome of NaZCar reveal the proper opening and closing of each event. All employees of the track wear the chequered flag of NaZCar emblazoned on their uniforms. As audience inebriation was part of the ancient ritual, tickets to the races include endless amounts of cheap, highly intoxicating beer.

Racing Rules

Racing follows the vehicle Chase rules and Vehicular Manslaughter rules on pages 130 and 131. All racers start at Dead start, a speed of 0, and close proximity. One lap on Danny's Fast Trax is 2 miles and 3 laps are required for a win. While the Vehicle Chase rules do accommodate movement rates, speed and time, in this case, it is best to abstract a race as otherwise

an entire game session could be taken up just racing. That isn't a bad thing, but may not be to everyone's liking. In abstraction, once any vehicle reaches a 12 step lead they have completed all 3 laps. Second and third place winners are awarded based on the next highest step lead. Any vehicle may be entered to race and contenders may use offensive driving techniques to win, but armed vehicles are only allowed on Monster Truck Night, which happens once a week. The format of this race is the same but the winner is usually the car that manages to not be exploded by ordinance or peppered with artillery rounds. A 12 step lead **or** being the only vehicle capable of motion, even if you have to push it, will earn you the win. In either type of race, a driver may go it solo or with crew. During straight races, the crew is not permitted to fire personal weapons against competitors. On Monster Truck Night anything goes. Pit crews have no place on Danny's track. 'Race it how you drove it in' has become a popular motto. Danny has obtained special permission to release all racers from the 'do not destroy public structures' law. He rakes in enough cash to rebuild the track daily if need be.

Danny keeps meticulous books and makes sure that the winning driver gets 5% of all winning bets. Second and third place winners get discounts on repairs, a bottle of booze, and much sympathy. The betting structure has become complex over time, as spectators began making bets not only on who would win, but on how many casualties would happen over the night, how many explosions, etc. For wagers, players can place a bet on any event they can think of: Who will win, who will come in at what place, how many deaths in the night, the sky's the limit. To make the system simple, if players are not actually racing in the event, have them make a Luck roll with each level of success being equal to 10X the bet amount, less 10%. Failure means they lose their bet amount. Game Masters can cap the amounts of bets placed by choosing the size of the crowd for the night. If it's a slow night, limit the amount that can be bet. If a PC is racing and his fellows bet on him, play out a race to see how it goes!

During the off hours, early in the day or very late at night, the track is open to private races and test driving. Many racing teams try out new vehicles and

SECRETS OF THE CITADEL

improvements before putting money on the line on a real race. Racing for titles is common amongst the youngsters as well.

Danny himself makes money on repairs to the cars that enter races, entry fees to race (50sp), and nominal fees at the gate for spectator seats (10sp for seats track side to 1sp for the nose-bleed sections). Danny also has the best garage facilities in the Citadel. If you're looking for repairs at reasonable rates or improvements to that old clunker, be sure to visit. Danny's staff numbers at least 50: mutants, robots, grays, fossiorians, and humans. All are fanatically loyal and well paid for their services.

North Station Railway

The two railway stations that feed the Citadel both provide the same amenities. Booking long or short term accommodations at HoJo's Rentals is a must if you have no other place to stay and want things like electricity, sanitation, and running water. You can do a bit of expensive shopping in any number of small tourist traps that sell basic items you can never seem to do without. Converting trade goods into Citadel coin is a great way to lighten your encumbrance. Common trade items like drugs, fuel, ammunition, and precious stones or metals have set values that rarely fluctuate and an equivalent amount of Citadel coin will be given. More esoteric items will have to be sold on the markets to find a value. You can register for citizenship! Station employees will gladly take your 1000sp paperwork fee to get the ball rolling in your desires to become a citizen of the Citadel. Live updates on electronic bulletin boards greet all the new Citizens welcomed that week. All humans will be approved without question after a few weeks of waiting. Other races face a protracted period where they will be secretly observed by law enforcement. If they prove to have marketable abilities and citizen-worthy character they will be approved as well. The primary benefit of being a citizen is the granting of purchase rights to property. Visitors are not permitted to own property in the Citadel. Lastly, booking a ride on the rail for yourself or cargo can be handled at the station. Rates vary depending on the distance you need to travel and how much space you require.

Warehouses and Factories

The orderly rows of warehouses and factories that march line by line across the seemingly endless flat plain produce and house much of the Citadel's wealth. The markets draw from these warehouses based on supply and demand. The rail stations bring in enormous amounts of goods, more than can be displayed on any merchant's shelves. The rest is safely packed away in these climate controlled, secure, metal bunkers. The factories refine raw materials from detritus scavenged from demolished buildings and broken technology. Copper, gold, silver, and other precious metals are separated from the dross. The remaining goo is shaped and reformed into industrial plastics, glass, and durable bricks used to repair city infrastructure. Robots and Mutants work these sites as the toxic chemicals in the air make it difficult for others to breathe.

Artisan Alley

On a thin strip of land running alongside the Kansan's eastern shore is a row of squat buildings home to a community of crafts persons. The prevailing winds blow the toxic air from the warehouses and factories away, creating an idyllic riverside resort. Craft beer makers, artisanal cheese smiths, practitioners of the art of charcuterie, poets, musicians, writers, and other wearers of skinny jeans and ironic facial hair perform art here. Their daily dealings are so saturated with unscripted drama, that a television crew has aerial drones broadcasting a continuous feed of their antics.

Encounters and Dangers

Staying for any length of time near the warehouses and factories of the Flats will require a Fortitude save DC 10 from those that must breathe air. Successful rolls will allow an hour before an additional roll must be made, now at DC 15. Once a PC has failed a Fortitude save, all actions are reduced by 1 die step and will reduce another step each hour they remain under the toxic pall that hangs here. Danny's Fast Trax produces its own form of noxious fumes but is located just far enough from the factories and warehouses to not suffer the above check.

Dock workers along the Kansan are notorious for hustling visitors. They will cajole passersby to play

SECRETS OF THE CITADEL

in street dice games, card games, and other grifts designed to shake money from the unwary. Refusal to join a game can result in a confrontation. Remember that only **killing** another being is punishable by law. Beating a sentient to within an inch of life is acceptable.

Residents often fish off the shores of the Kansan for delectable, free protein. The toxic fumes have caused mutations in some of the larger, more aggressive fish which have a habit of pulling unprepared anglers into the river and there consume them.

Crime is very low here with the occasional ship coming through and unloading goods onto hidden docks before tax collectors can assess their holds. Black marketers have at least one warehouse of untaxed goods hidden amongst the legitimate operations.

One of the benefits of staying at a HoJo's is the safe, secure environment they foster. The ability to combine single rooms into much larger rooms by opening adjoining doors is one of the mysteries the chain doesn't attempt to explain. Things get a little dicey when too many rooms are linked together to form a single, larger room, however. For every room connected there is a cumulative 1 in 100 chance (3 rooms are 2 in 100, 4 rooms 3 in 100, etc) a transportation portal will be opened when lodgers attempt to leave through the main door. Instead of opening onto the familiar hallway all HoJo's share, a swirling gate of colors will transport those that pass through to a random location in Umerica where a HoJo's once stood.

Adventure Seeds

- Ratings for the very popular show 'Don't Touch My Crap!' have been slipping and the network wants to turn that around. The PCs are hired to stir up some mischief within the Artisan Alley community. They have purchased a loft in the alley and want the PCs to live there and pretend to be the newest 'artisans' on the block. What form their particular art takes should annoy the existing residence into action! The loft has hidden cameras (which the PCs are aware of) which feed a continuous stream to the network.

- Having taken passage aboard a vessel heading into the Citadel of Scrap, our PCs are told by the captain that a short stop will be made before they can disembark. The captain is unloading valuable cargo to black marketers to avoid taxation. It's not the captains (or the PCs) lucky day however and the ship's activities are logged by a law enforcement drone. A tactical squad is scrambled to assess the situation and the PCs are caught in the middle.
- A racing team has approached the PCs with a business deal. They have built a car they are sure will win the next race at Danny's Fast Trax but don't have the funds to cover the entry fee and log a bet sizable enough to pay for the car's upkeep. They are looking for investors and believe the PCs can help.

THE FIELDS

Law Enforcement and District Ordinances

The illusion of serenity and the feeling of peace the orchards and the green grass bring to citizens is carefully maintained. Aerial patrols fly high and no ground troops will enter except under the direst of situations. The district is closely observed by flying drones, however, and no infraction that transpires in the open will go unnoticed. If one of the Five Laws is broken within the confines of the Fields without a roof overhead, the perpetrators will be arrested as they leave by troops standing in wait. The law regarding the damage of public property is taken very seriously here and cutting trees or damaging the forest in any way will result in heavy fines. Picking the abundant fruit is permitted as long as the harvesting is for an individual and not picked for bulk sale. One of the Five Laws has a great deal more flexibility here. The killing of a citizen will result in a lesser sentence, often a fine, if that citizen had freely agreed to enter any of the 'sporting' events that take place during the nights. Additional district laws include: no temporary or permanent structures may be erected on the Fields, no fires may be started on the Fields, and neither citizens nor visitors may make camp on the Fields.

Locations of Interest

The Dead Tree

This petrified hunk of wood stretches 20' into the air



and has been cleared for use as a billboard and public informational space. Citizens post fliers for missing pets and businessmen post jobs available to persons willing to take risks. The occasional advertisement for a new album by a local band or blurb about a new radio or television show can be found as well.

Sample Job Opportunities

- 1 A local band just made it to the big leagues and is in need of bodyguards. Pay negotiable
- 2 A wealthy merchant is looking for a working kidney in good repair, no questions asked.
- 3 Have you seen my pet? Large reward is offered for the safe return of a 'pet' basilisk [DCC pg 396]
- 4 Television network seeks party of adventurers to star in a new reality show.
- 5 Train Guards Wanted! A cargo route headed into the western wastes is looking to hire on a team.
- 6 Fishing Competition - Grand prize of 100sp awarded to the largest catch this month.
- 7 City Sanitation workers needed - apply at North or South Stations. Generous pay, job perks, and pending citizenship papers will be expedited.

Sanitation buildings

These squat stone buildings provide lavatories and shower facilities for guests enjoying the Fields. The caustic chemical soup that is used to break down waste is strong enough to break down bodies as well and is often used for just that. As these buildings represent the only enclosed spaces available in the Fields, criminal activities and clandestine meetings are sure to be found within. There is a 1 in 10 chance when going to use the facilities that such a meeting will be taking place. Smarter criminals use lookouts to dissuade the public from entering during these private times.

Entertainment

Street performers busking for small coins and food fill the district during daylight hours. These artists aren't desperate and are more interested in putting on a good performance than earning their keep. The mood is kept light and festive and any donations are quickly followed by a hearty 'thanks!'. Food vendors

selling ice cream and shaved ice treats compete for spare coin. At night the adult entertainment begins. Sanctioned fights both bare knuckled and armed are televised by network employees carrying portable cameras. As no structures are permitted, the crowd forms a circle around the combatants holding flashlights centered on the action. When a fighter is pushed through this ring of spectators, submits, or is rendered unconscious or dead, the fight ends. Betting is fast and furious with the odds favoring the fighters with the best track records. Placing a bet will result in 1d10 x the bet amount on a successful Luck check. A failed Luck check loses your bet. Those wishing to fight must agree to the rules of the circle and may include either armed or unarmed, armored or unarmored contests. The only rules are those agreed upon before entering the ring. All contestants are made aware that destruction to the surroundings could result in fines or imprisonment so range weapons are never permitted.

Encounters and Dangers

Due to the discreet but effective surveillance, crimes out in the open rarely happen. Pickpockets and muggers find law enforcement waiting for them when they exit the Fields and have stopped activities in this district long ago. Using the facilities can be a danger if you interrupt a covert negotiation. Agreeing to enter one of the nightly fights is most definitely a risk to life and limb. A PC wanting to enter should make a Luck check. A basic contender will start with [Init +1; Atk by weapon type with a +2 bonus; AC 13 (plus armor if the rules of the ring allow); HD 3d8+4; Mv 30'; Act 1d20; SV Fort +2, Ref +2, Will +1; Al N]. For each point of success on the Luck roll, reduce HD or attribute bonus points. For each point of failure on a Luck roll, increase HD or attribute bonus points.

Adventure Seeds

- While using the facilities a PC finds a hidden note detailing the location of a buried stash of drugs. If they act quickly they will reach the stash before the owners will, if they debate overly long they will arrive just as the owners do. This won't result in immediate confrontation but the situation will be tense.
- A group of entertainers dressed like clowns is

expertly putting on a show of physical comedy full of pratfalls and feigned injuries. They are handing out free food and pamphlets in the form of fast food menus with Buddy O'Burger doctrine liberally interspersed. If PCs accept the free meal have them make Willpower saves at DC 10 to avoid the sudden desire to enter the closest Buddy O'Burger establishment and ask for doctrinal teachings. They need not convert, but the compulsion to hear out one of the faithful will be strong.

- Grudge Match! Someone a PC has previously offended has challenged said PC to a fight of honor! Each side gets to negotiate terms for the contest with 4 terms being the limit. The rival will push for: a single short bladed weapon, no armor, no spells or healing, and fight to submission, unconsciousness or death.

SQUARES VILLE

Law Enforcement and District Ordinances

Of all the districts within the Citadel, Squares Ville is the most heavily patrolled and protected. Response time to crimes is measured in seconds, not minutes (1d10 rounds). Drone, gyrocopter and foot patrols make regular appearances in the neighborhood (1 in 4 chance of some sort of patrol being nearby at any given time). As to the Five Laws, this district seems to add new ordinances every day. These small addendums all carry fines as opposed to incarceration time. They range from the height your lawn must be kept, to what you may display on your grounds and in your windows, to how loud you are allowed to be at any given point in the day. While these codes are numerous, the citizens here know every one by heart and gladly comply. Visitors staying any length of time will accrue 1d100sp in fines daily from simple ignorance of the laws. An Intelligence test at DC10 will reduce the daily fines by 50%.

Locations of Interest

Plymouth and Spratz's Collaborative Workspace

In what used to be an underground fallout shelter, a group of enterprising technologists and wizards have setup a timeshare laboratory. The clockwork creations and patchwork monsters that repair and maintain the city infrastructure are all birthed in these labs. The

Citadel has granted a lucrative contract to Plymouth and Spratz to provide these workers. Workspace time can be rented for 50sp a day. For wizards, the workspace counts as a place of power when casting spells [DCC pg 126], for technologists the workspace counts as a junkyard or research lab.

Network Land

At the heart of Squares Ville, a solid four block area of the tallest buildings in the Citadel can be found. The rooftops of these buildings are crammed with antennae and reflector dishes. While the official voice of the Citadel is broadcast from the Growling Tower, the voice of the people is pumped out from these buildings. While numerous networks share the same broadcast equipment (both radio and television) they form a far from harmonious relationship. Each station's reach is limited by the numbers in their audience. With larger audience support a network's power to push their signal increases. Technologists who maintain the equipment do not understand how this is possible but do acknowledge the phenomenon. At play is an aspect of the God Kizz who has blessed this form of entertainment. Listeners are sending spiritual power to Kizz who returns a portion of that power to the networks that produce the best shows.

Library

Filled with tomes of knowledge, maps, and fiction, visitors are allowed to browse for a nominal fee but only citizens may borrow books. When using the library to seek specific information on a subject, an Intelligence check at DC 10 should be made. A successful check will grant a 1 die step increase to the next check made pertaining to the knowledge found.

Forbidden Subway

An underground transportation system once eased the congestion of the streets above but the remaining tunnels have been sealed by the Royals. Failed experiments and creations that could not be controlled have been left to thrive as they might in the tunnels beneath the Citadel.

The Pit

This gaping impact crater fills the southeastern corner of the district and continues into the Ruins. Heaping debris piles have been mounded around

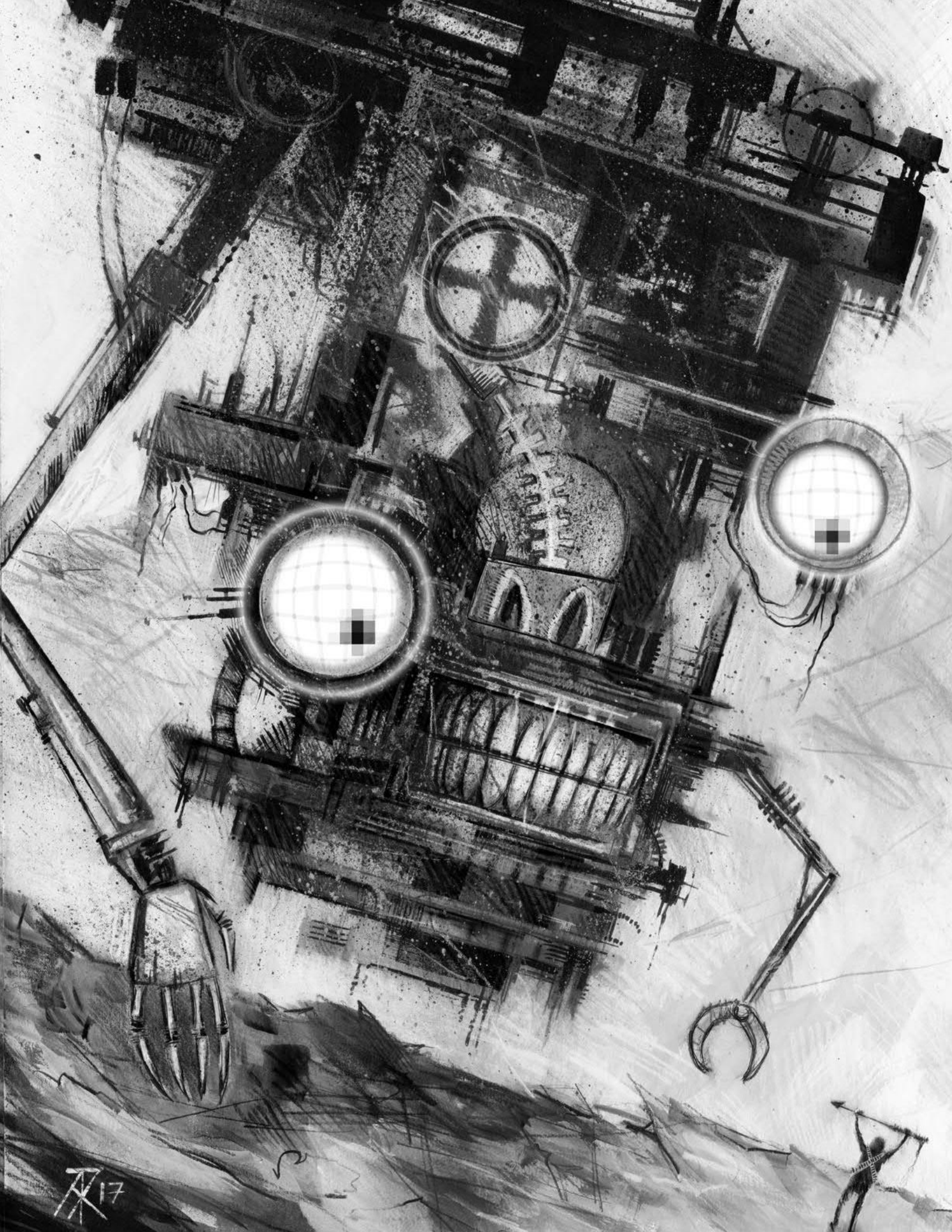

17

the edges and the Growling Tower hovers above the hole, nearly covering the void. Exploration of this area is forbidden by the Third Law and punishment is delivered in the form of a quick death. Daring explorers still risk this death sentence in order to take the information they feel the Royals are suppressing. The cult of Surewood pays well for any information on the God in the Pit and sends exploration teams of their own to sift through the debris in hopes of finding the truth.

The Growling Tower

Over four stories tall this mechanical edifice shifts and grows like a living thing. The growling sound comes from metal and gears constantly grinding as the tower expands to cover the Pit. It hovers in space, defying gravity as it pulls steel girders and concrete from the garbage heaped around the Pit, adding to its mass. The top of the tower opens like a flower petal, providing flight decks for the gyrocopters and drones that patrol the Citadel. At its base, retracting bridges disgorge infantrymen, vehicles, and mechs. The entire tower acts as an antenna, radiating power drawn from the Pit and feeding it to the hungry city. This is the home, throne room, and laboratory of the Three Royals and from here they exert dominion over the Citadel.

Encounters and Dangers

The most likely encounter to misbehaving PCs in this district is with law enforcement. Five man teams as detailed in the general overview of the GM section will be the minimum threat response summoned when a crime is committed.

Scuts: [Init +0; Atk claw +3 melee (1d4) + Special: 1 point Personality damage; AC 13; HD 4d6; MV 40'; Act 1d20; SP Absorb/Affect magic, Infravision, Personality damage; SV Fort +4, Ref +4, Will -2; AL N] were once human. These creatures dwelt too long in the city and their essences were drained by the God in the Pit to fuel his growth. They are now little more than dry sponges in search of humanity to absorb. They are sturdy things, though skittish. In combat, they can be incredibly bloodthirsty or panic at the first sign of resistance. Scuts suffer half damage from all spells or save for none. Any non-damaging magical effect focused on a Scut (such as

a Charm spell) instead causes generic spell misfire [DCC pg 120], though any magic effect that targets the world around the Scut (such as Transmute Earth or a Haste spell cast on another being) functions normally. Any Spellburn occurring within 100' of a Scut heals it to full HPs. Their claw attack inflicts an automatic point of temporary Personality damage, no save. A being slain by a Scut's claws will rise as one and the Scut who slew them has a 50% chance to become human again. Scuts can see in the dark to 60' but suffer a -1 penalty to all actions in normal light. Their flaking skin is pale and their eyes shine in the dark. They can be found in the Forbidden Subway and in the junk heap around the Pit.

The Growling Tower is an unassailable fortress. PCs foolish enough to try an assault will be facing a standing force of 200 security men, heavily armed and armored. As well, the tower acts as a ley line for the Royals, extending their power. Assume they can cast any spell anywhere within the tower without having to physically be in that location. To take down a Royal the PCs will have to be enterprising and find some way to draw them out of the tower where they are weaker and more exposed. See the general information section on how to play a Royal.

Adventure Seeds

- The Surewood cult has requested the retrieval of a particular mineral salt that is common around the junk heap of the Pit. They will pay well in barter, coin, or information. To be successful PCs must evade and not engage law enforcement troops and not be observed by drone or gyrocopter. Refer to the chances of law enforcement interaction at the beginning of this section.
- Plymouth and Spratz are offering a month of workspace use for anyone able to bring a Scut, alive, in for research purposes. PCs are told the Forbidden Subway tunnels are the easiest place to acquire a specimen.
- A merchant is offering a large sum in coin or goods to anyone who can locate a hidden room within the public library that seals away tomes of forbidden knowledge. The tome in question will be the one wrapped in human skin with an obviously female face as the front cover.

THE RUINS

Law Enforcement and District Ordinances

The majority of the Ruins is a garbage dump with no foot patrols and sparse aerial surveillance by drone (1 in 20 chance of one being present over head). There is no response time to the dump, law enforcement alerted to any infraction by drone will simply wait for the offender to leave the district or enter one of the better-patrolled areas. The area around South Station is heavily patrolled by foot and drone (1 in 4 chance of active surveillance and troop arrival in 10 rounds). The district has no extra codes or ordinances but an informal agreement has been reached about certain things. If you're a prospector, salvager or explorer and you head into the garbage dump, no one will come looking for you if you go missing. Too many rescue crews have themselves gone missing when sent out to find late returning parties. With the high attrition amongst explorers, no business will extend credit and will demand payment up front at the time of service delivery. If you're staying at a HoJo's you pay by the day or find somewhere else to hang your hat.

Locations of Interest

South Station

South Station is a mirror of North Station as detailed in the Flats with all the same amenities. The exception being HoJo's not offering more than single night occupancies at a time. South Station also sees more visitor traffic than North Station as ready access to a wealth of freely salvageable materials brings prospectors by the trainload.

The Flat Tire Saloon

It has become a tradition for exploration teams to meet here the night before heading to the garbage dump. The drinks are free for outbound teams and they are encouraged to talk about their lives, who they are leaving behind, and why they are risking it all. The walls of the saloon are covered with photographs of teams that never returned. The bartender and owner, Alice Mitchell, has a photographic memory and remembers every face and every story that was ever told in her bar. She grieves for each and every person that never makes the journey back and bears witness for loved ones that come looking for the lost.

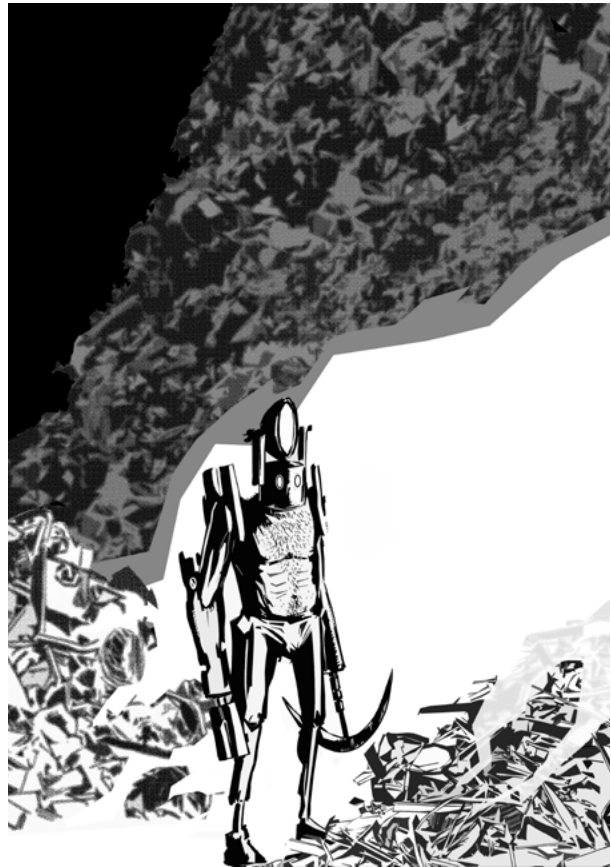

Hall's Mark

Perhaps the greatest find of pop culture relevance to pre-cataclysm times was the unearthing of a Hall's Mark store. Short passages expressing emotional significance were printed on colorful, art filled card stock, and given as presents. This intact series of buildings included a sales floor and manufacturing facility for the cards. Once reclaimed, the buildings were moved intact, closer to South Station. The presses are running once again but the cards are sold to only one buyer and have taken on a more sinister meaning to Citadel inhabitants.

Brick Land

The remains of this building were unearthed just a short time ago. The colorful plastic bricks have become status symbols to the wealthy, but followers of Santa, The Giving God, have found them to contain spiritual properties. The next spell cast by a cleric of Santa after giving a brick to a child will have a 1 die step increase in the casting. Unfortunately, as they have become symbols of status, acquiring the bricks can be costly.

SECRETS OF THE CITADEL

The Museum of War and the WWI Cult

The explorers who reclaimed this building were overcome by the divine presence of Whaaar!. The museum has been consecrated and is now occupied by the WWI cult, worshipping an aspect of Whaaar!. Primitive firearms and weapons have been blessed and are sold to fund the expansion of the cult. Bolt action rifles are sold here that fire bullets that do an additional amount of damage on impact to a specific target. Clerics of the cult inscribe the name of your enemy (or simply a broad definition of your enemy, like wizards or humans) on each bullet. The more specific, the more additional damage they do. A particular person's name will do an additional 1d10 damage, a particular class will do 1d6 damage, a 'foe' does a mere 1d4 extra damage. The cost of each bullet is 5sp per round no matter the inscription. The bullets must be fired by one of these ancient bolt action rifles (costing 100sp and follow the 'Not Bad' equipment rules).

The Garbage Dump

During the rebuilding and reconstruction of the Citadel, waste materials were pushed out of Squaresville, the Flats, and the Fields and collected in a vast garbage dump that takes up most of this district. Sometimes referred to as the Trash Mines for all the good salvage materials that can be harvested, it is a very dangerous place. Scuts (as detailed in Squares Ville) congregate in large numbers here (1d20 appearing at a time) and are encountered 1 in 20 times per hour of exploring during the day and 1 in 4 times per hour at night. The terrain itself is a hazard as piles of garbage shift and resettle. For every hour of exploration, a Luck check should be made. Success and you manage to not find that soft spot in the debris, failure and you plummet down a suddenly open channel of garbage taking 1d8 points of damage.

Encounters and Dangers

Within the Trash Mines, Scuts have already been mentioned but there is a greater threat. Garbage elementals [use earth elemental stats from DCC pg 412] have spontaneously appeared in the garbage dump. Treat this area as their home plane so elementals with upwards of 20 HD can be encountered. The presence of the God in the Pit

has created a link between the Trash Mines and the elemental plane of waste and garbage. These elementals are fiercely protective of their homes and consider any debris removed to be theft.

The WWI cultists are a fractious bunch. When visiting their temple, PCs will be asked if they favor the Allied or Central Powers. Cultists keep track of visitors and who's side they favor. For each straight answer given a tally is taken and at some predetermined time as dictated to them by Whaaar!, the 'war' will be over and the losing side will be slaughtered, sacrificed to Whaaar!. Of course, neither side wants to lose and attempts will be made to sway a PCs answer if they do not immediately declare for one side or the other when asked.

Adventure seeds

- Recently an outspoken citizen ran his mouth where he probably shouldn't have and received a greeting card on his pillow the next morning. Certain of his impending assassination and having no idea who to contact to make things right, the PCs have been hired to help. The only link to the offended party rests in the greeting card. If the PCs can find out who owns Hall's Mark perhaps they can seek an audience with someone that can stop the assassination.
- The end of the war is nigh! The next visitor to the temple of the WWI cult will determine which faction lives and which dies. The tally is tied and the PCs just happen to be the first visitors on the day of reckoning.
- Captain Haas at the Flat Tire saloon is looking for a few tough individuals to deal with rustlers stealing from Dundee's Ranch. The ranch is to the south of the Citadel, across the Royal bridge. He can pay in coin or slabs of the best beef steak this side of Umerica.

FORGOTTEN HOME

Law Enforcement and District Ordinances

Having declared themselves a sovereign citizenry and beyond the powers of the Royals, Forgotten Home does not adhere to the Five Laws. No law enforcement patrols are allowed through the substantial walls that enclose the district and no drones fly over without being shot down. They have

their own laws to be sure, but you'll never know them. Unless you're pure human and invited, you won't make it through the doors without being shot.

Locations of Interest

The Compound

A 20' high wall topped with razor wire surrounds and contains this district. Gun emplacements every 50' along the span shoot down any drones that attempt to cross into Forgotten Home airspace. The homes within the compound are immaculately maintained replicas of 21st-century living. No anachronism is tolerated, be it in dress, speech or thought.

Encounters and Dangers

Forgotten Home holds one danger and it affects the entire Citadel. A type V free-willed Demon controls the populace here [DCC pg 402] and wishes to enact a ritual sacrifice of epic proportions. The Demon has been here a very long time and is the reason why the pre-cataclysm society disappeared before the world broke and why the city was left in such good repair. The Demon's hidden name is Khanzas and he was here before there was a city, trapped in caves below the ground by a primitive society of humans. The Demon's dreams and hatred touched and shaped the hands that built the city. Corruption was always a part of the city's soul as Khanzas WAS the city's soul and as it was a reflection of himself, he came to care for the city. These easily influenced fleas that live on his skin were useful once in keeping his city whole and they will be so again. The Demon's influence is contained within the district by the power of the Royals. They know he's there but they are not yet prepared to deal with him. The Demon is influencing the citizens of Forgotten Home, creating within them a discontent with the status quo. They are very near the point of open rebellion and Khanzas hopes that when they do rebel, the violence will weaken the Royals enough for him to break free. Once free, all the fleas on his skin will be sacrificed so that the city might grow, so that **he** might grow, pushing his influence into Umerica. Khanzas is not aware of the God in the Pit as being a sentient, it is seen only as an extension of the Royals' power.

Adventure Seeds

- The Royals want a Forgotten Home citizen to study to see just how far the Demon's influence extends. The PCs may owe some favors to the criminal underworld at some point and the Royals will collect on that marker. Getting into the district will be a daunting task, but Forgotten Home citizens do engage in a small amount of trade outside their walls. Making good on this mission will erase any debt or ill will with the Citadel's underworld that may have been earned by the PCs.
- Not every person in this district has been warped by the Demon's influence. Julia Guthrie has managed to put herself on the list of citizens cleared to leave the compound to trade. She plans on defecting if she can just find out who to surrender to. The PCs stumble upon Julia as she is being chased through Cog-Alley by gun wielding fanatics looking to take her back home.
- An unaugmented human in the party receives an invitation to dine with the mayor of Forgotten Home. No reason or explanation is given, just a time to arrive at the gates and to dress for a formal occasion. Several of these invitations were posted at random in the hopes of luring a target onto the compound. The mayor has been divinely inspired to brainwash a responder and has been given the knowledge to do so.

PASSAGE

Law Enforcement and District Ordinances

Begrudgingly, the citizens of this district do follow the Five Laws but prefer to handle criminal transgressions in their own ways. The scriptures of base-ball have shown them the way. Law enforcement never patrols this district unless called in by the citizens living here. Aerial drone surveillance is intermittent but happens once a day, unless a game is on. On game days network drones will be filming and broadcasting the spectacle. Within the district, 9 man citizen 'teams' armed with clubs provide a public watch. This is a small community of very close people and visitors will always be watched and kept track of while in the district.

SECRETS OF THE CITADEL

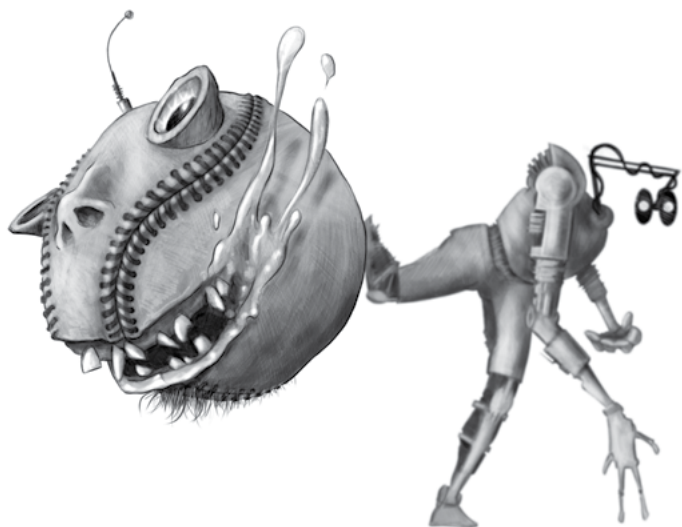

Locations of Interest

The Grand Diamond

This base-ball field is where all public trials (trade disputes and minor crimes) by sport are held. Get 8 of your closest friends together to champion your cause or hire professional ringers to give you an advantage. The trial continues for nine innings with extra innings played on tied results. The winning side is cleared of all criminal charges or a dispute is ruled in their favor. If a crime is very serious, a trial by walking the gauntlet will be used as Fo-Dor detailed in his overview. Spectators are not permitted for this particularly gruesome ritual.

Base-ball Museum

The holy place where the laws of base-ball were unearthed and made to live again. The history of Negro League baseball is recorded here. The disenfranchised populace of this era feels connected to the bygone warriors who were second class citizens in their own time. The reclamation of the museum and the return of base-ball has attracted the attentions of the Lords of Light. Clerics of the Lords of Light find spells cast here increased by a die step.

Encounters and Dangers

Passage is what happens when citizens of the Citadel can't find work and lose their tenuous grasp on privilege. They're still citizens and have rights, but without money or status in the society, it doesn't count for much. In truth, the mutants, aliens, and other than human species have it worse, but having had a taste of the good life, they're left with little more

than memories and no will to pick themselves back up. At least that's how it was before finding base-ball. They've become somewhat fanatical about their new way of life and want to show everyone that it's better than what the Royals have to offer. Members of this district will try and recruit PCs by offering them places to live, there's plenty of wrecked houses to go around, and a team to play on. If they can use a PC to leverage a bit of wealth into Passage so much the better. Wealthy PCs will be asked to sponsor a team or fund a new ballpark.

Adventure Seeds

- Passage needs funding and the networks are making a ton of cash from televising their games. The games are popular too! Televised events always rate in the top 5 most watched programs. The mayor of Passage has asked the PCs to act as negotiators to try and skim some of that gravy from the networks. As a bargaining chip, Passage is threatening to slam baseballs into hovering network drones. The drones aren't public property, they're private so technically disabling them is not breaking Law number one.
- One of the PCs has been charged with a criminal offense. He's to gather a team of 9 and report to the Grand Diamond for trial. Use this quick system to play out a game: When up to bat, make a melee attack roll (penalties as usual if not trained with a club) against AC (10+1d4). If successful, roll club damage [1d4+Strength bonus] the other team then tries to catch your hit by making an Agility test at DC (10+damage done by the hit). If the ball is not caught you score a number of runs equal to the difference in the failed roll and the DC value. If the ball is caught or runs are scored the other side takes their turn at bat. Count each round as an inning. After 9 rounds of combat, the higher score wins. If there is a tie, play another inning. If multiple player characters are on the same team, let a different character have a turn at bat each round and switch off who tries to catch the ball. If the PC team wins, all charges are dropped, if they lose they are made to pay a fine equal to the number of runs the other team scored x 10sp.



APPENDICES

APPENDIX

APPENDIX C: CONVERSION OF EXISTING DCC MATERIALS

Thoughts on how to convert existing DCC adventures and other materials to fit in an Umerican campaign.

CLASSES

For the most part, any normal DCC class can be used in an Umerican campaign with only a little tweaking to their Weapon Training section. Firstly, it needs to be determined what modern style weaponry they are proficient in. Most classes will be able to use high tech versions of melee weapons they are already familiar with plus shotguns. Medium tier combatants like clerics can also employ basic pistols and rifles and Warrior types can use nearly anything. If the character in question was not raised in Umerica, there might be an adjustment period of 1d3 weeks to get used to these new fangled weapons allowable to their class.

The second bit that needs addressing is what armor can be worn. If they only have access to light armors, their Fumble die limit would be d6. Access to medium weight armors would give a Fumble die limit of d10 and heavy armor wearers would have no limit, other than the max limit on armor of a d16 Fumble die.

Special class abilities may also need some tweaking to better fit but that would need to happen on a case by case basis.

CONVERTING AC

A quick and dirty solution is to take any remainder of the listed AC passed 10+the creature's Reflex save as steps of armor. If the AC is due to inherent toughness versus worn armor, divide the number of Armor Die steps in half to determine the Fumble die. As an example let's convert the Android from the DCC RPG, pg 394:

Android: Init -2; Atk sword +2 melee (1d8) or wand +4 missile fire (range 60', 1d4+2); AC 18; HD 3d8+12; MV 30'; Act 1d20; SP infravision 60', immune to mind-altering spells, heal 2 hp per round; SV Fort +5, Ref -2, Will +6; AL N.

This would give it an AC of 8 and 10 steps of armor (Armor Die: d16, Fumble Die: d6, Armor Check Penalty: -3). Now it is relatively easy to hit but can ignore a ton of damage. While most robots have some level of Impervious armor, this is not accounted for in the quick and dirty solution. The Umerican Android stat block looks like this:

Android: Init -2; Atk sword +2 melee (1d8) or wand +4 missile fire (range 60', 1d4+2); AC 8; Armor Die: d16 (inherent); Fumble Die: d6; Armor Check Penalty: -3; HD 3d8+12; MV 30'; Act 1d20; SP infravision 60', immune to mind-altering spells, heal 2 hp per round; SV Fort +5, Ref -2, Will +6; AL N.

Another example, let's convert the Giant Soldier Ant. Here is the original:

Ant, giant (soldier): Init +2; Atk bite +6 melee (3d4+3); AC 18; HD 3d8+6; MV 50' or climb 50'; Act 1d20; SP 20% have poisoned stinger (+6 melee, dmg poison: DC 16 Fort save or 2d4 Stamina); SV Fort +7, Ref +3, Will -3; AL L.

And here is the conversion:

Ant, giant (soldier): Init +2; Atk bite +6 melee (3d4+3); AC 13; Armor Die: d7 (inherent); Fumble Die: d4; Armor Check Penalty: -1; HD 3d8+6; MV 50' or climb 50'; Act 1d20; SP 20% have poisoned stinger (+6 melee, dmg poison: DC 16 Fort save or 2d4 Stamina); SV Fort +7, Ref +3, Will -3; AL L.

In the case where a creature's Reflex save + 10 is greater than its listed AC, Use the new AC value and give it 1 step of armor (Armor Die: 1d3).

In the case where the creature is wearing armor, simply convert the armor bonus to steps of armor and spread it out. For example, a suit of Plate Mail that provides +8 to AC would provide 8 steps or armor (d12 armor, d10 fumble, -6 Armor Check Penalty) and be broken up into a 3 point Breastplate, two 1 point greeves, two 1 point arm guards, and a 1 point helm.

APPENDIX

APPENDIX N: RECOMMENDED MATERIALS

DCC Specific RPG books

Secret Antiquities #1, by Michael Curtis
Crawljammer, by Tim Callahan
Gongfarmer's Almanac, by various

Non-DCC RPG books

Gamma World, all editions, by TSR and WOTC
Aftermath, by FGU
Atomic Highway, by Radioactive Ape Designs
After the Bomb, by Palladium Games
Deadlands: Hell on Earth, by Pinnacle
Rifts, by Palladium Games
Darwin's World, by Dominic Covey
Other Dust, by Sine Nomine

System Neutral RPG books

The Metamorphica Revised, by Johnstone Metzger

Other Tabletop games

Car Wars, Steve Jackson Games
Necromunda by Games Workshop

Video Games

Fallout, all titles
Wasteland

Novels

Hiero's Journey
The Unforsaken Hiero
Farnham's Freehold
'Alas, Babylon'
Lucifer's Hammer
A Canticle for Leibowitz
The Day of the Triffids
The Postman

Podcasts

Spellburn (<http://spellburn.com/>)
Glowburn (<http://podcast.glowburn.org/>)
Podcast at Ground Zero
(<http://podcastatgroundzero.com/>)

Animated TV/Movies

Thundarr the Barbarian
Jayce and the Wheeled Warriors
He Man and Masters of the Universe
Adventure Time
WALL-E
Nausicaä of the Valley of the Wind

Movies

A Boy and His Dog
Battletruck
Exterminators of the Year 3000
Hardware
Hell Comes to Frogtown
Mad Max
Max Max: Beyond Thunderdome
Mad Max: Fury Road
Night of the Comet
Planet of the Apes
Road Warrior
Steel Dawn
The Blood of Heroes
The Book of Eli
The Postman
The Omega Man
Turbo Kid

And many more



APPENDIX

APPENDIX S: SALVAGE

Each table is setup to use a d12 from the row and a d4 for the column.



Random Foodstuffs				
For each entry there is a Safe %. This is the chance that it is still edible. If not, see Table A4, pg 13				
	1	2	3	4
1	Box of foil-wrapped meal / nutrition bars. Safe: 85% Quantity: 3d6	A bundle of fresh cut steaks (meat source unknown). Safe: 65% Quantity: 1d6	Several intact cans of beer. Safe: 80% Quantity: 4d6	Foil-packed dehydrated meals. Safe: 97% Quantity: 1d6
2	Box of candy bars. Safe: 60% Quantity: 5d6	Bags of dried beans. Safe: 90% Quantity: 1d6	Several intact cans of soda. Safe: 80% Quantity: 4d6	A sealed container of unlabeled meat jerky. Safe: 85% Quantity: 1d3 lbs
3	Box of snack cakes. Safe: 65% Quantity: 2d6	A container of fresh fruit. Safe: 75% Quantity: 1d6 pieces	Several intact cans of diet soda. Safe: 40% Quantity: 4d6	Jars of honey or molasses. Safe: 100% Quantity: 1d6
4	Commercially packaged, alcoholic fruit cake. Safe: 75% Quantity: 1d3	A bundle of baked bread. Safe: 75% Quantity: 1d3 Loaves	Stash of homemade hooch. Safe: 90% Quantity: 1d3 bottles	Container of BluWheat flour Safe: 80% Quantity: 1d3
5	A stack of military M.R.E.s (Meals Ready to Eat) Safe: 95% Quantity: 1d6	A container of fresh vegetables. Safe: 75% Quantity: 1d6 pieces	Stash of quality hard liquor. Safe: 100% Quantity: 1d3 bottles	Can of ground coffee. Safe: 90% Quantity: 1d3
6	A sealed, 5 gallon tub of maple syrup. Safe: 80% Quantity: 1d6	Industrial sized can of processed cheese food. Safe: 85% Quantity: 1d3	Stash of artificial fruit drink. Safe: 70% Quantity: 1d6 bottles	Gallon jug of purified water Safe: 70% Quantity: 1d3
7	Canned beans. Safe: 80% Quantity: 1d6	Industrial sized can of baked beans. Safe: 80% Quantity: 1d3	Vacuum sealed container of mixed nuts. Safe: 85% Quantity: 1d3	Package of meat stick snacks Safe: 60% Quantity: 1d3
8	Canned fruit. Safe: 70% Quantity: 1d6	Industrial sized can of fruit. Safe: 70% Quantity: 1d3	Vacuum sealed container of powdered Milk. Safe: 85% Quantity: 1d3	Package of meat stick snacks Safe: 60% Quantity: 1d3
9	Canned veggies. Safe: 70% Quantity: 1d6	Industrial sized can of veggies. Safe: 70% Quantity: 1d3	Vacuum sealed container of powdered Eggs. Safe: 85% Quantity: 1d3	Package of foil-sealed chocolates Safe: 60% Quantity: 1d3
10	Canned meat. Safe: 70% Quantity: 1d6	Industrial sized can of meat. Safe: 70% Quantity: 1d3	Vacuum sealed container of powdered Soup Mix. Safe: 85% Quantity: 1d3	Package of foil-sealed fruit snacks Safe: 70% Quantity: 1d3
11	Canned soup. Safe: 75% Quantity: 1d6	Industrial sized can of soup. Safe: 75% Quantity: 1d3	Vacuum sealed container of Flour. Safe: 85% Quantity: 1d3	Box of holiday marshmallow candy Safe: 60% Quantity: 1d3
12	Canned pudding. Safe: 75% Quantity: 1d6	Industrial sized can of pudding. Safe: 75% Quantity: 1d3	Vacuum sealed container of sugar Safe: 80% Quantity: 1d3	Gallon jug of cooking oil Safe: 60% Quantity: 1d3

APPENDIX

Random Tools and Industrial Supplies

	1	2	3	4
1	Rolls of duct tape Quantity: 2d8	Circular saw	PVC pipes Quantity: 2d12	DIY manual: Mechanical Repair (Acts as occupation)
2	Rolls of electrical tape Quantity: 2d8	Dremel multi-tool	Steel pipes Quantity: 2d12	DIY manual: Basic Carpentry (Acts as occupation)
3	Claw hammer Quantity: 1d8	Reciprocating saw	Copper pipes Quantity: 2d12	DIY manual: Electrical Repair (Acts as occupation)
4	Pry bar Quantity: 1d3	Chainsaw	Tubes of silicone caulk Quantity: 1d14	DIY manual: Basic Plumbing (Acts as occupation)
5	Adjustable wrenches Quantity: 1d5	Propane torch	Boxes of nuts & bolts Quantity: 2d12	DIY manual: Car Maintenance (Acts as occupation)
6	Ratchet set	Masonry drill	Boxes of nails Quantity: 3d8	DIY manual: Gardening (Acts as occupation)
7	Tubs of spackle putty Quantity: 1d10	Nail gun	Hand saw Quantity: 1d5	DIY manual: Small Motor Repair (Acts as occupation)
8	Brushes & rollers Quantity: 2d16	Power drill	Hacksaw Quantity: 1d4	DIY manual: Metalworking (Acts as occupation)
9	Cans of paint thinner Quantity: 3d8	Air compressor	Tubes of epoxy putty Quantity: 1d10	DIY manual: Construction (Acts as occupation)
10	Spray cans of enamel paint Quantity: 1d16	Portable generator	Tubes of wood glue Quantity: 1d10	DIY manual: Masonry (Acts as occupation)
11	Cans of exterior house paint Quantity: 2d12	Staple gun	Tubs of spackle putty Quantity: 1d10	DIY manual: Heating & Cooling (Acts as occupation)
12	Bags of plaster mix Quantity: 2d10	Caulking gun Quantity: 1d7	Cans of spray sealant foam Quantity: 1d7	DIY manual: Landscaping (Acts as occupation)

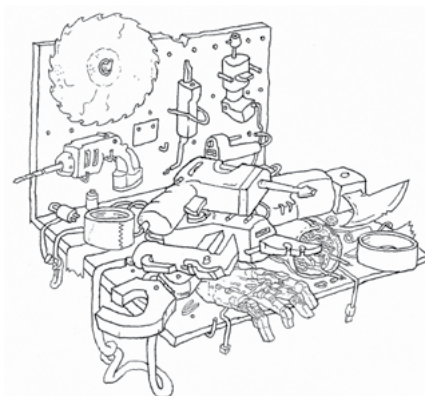

APPENDIX

Random Sporting Goods

	1	2	3	4
1	Lantern, hand pump	Waterproof sleeping bag. Quantity: 1d5	Resealable plastic baggies Quantity: 5d100	Long bow & 2d10 arrows
2	Rod and reel fishing pole Quantity: 1d7	Army folding cot Quantity: 1d8	Plastic container set Quantity: 3d5	Compound bow & 2d10 arrows
3	Binoculars Quantity: 1d3	Thermal blankets Quantity: 1d3	Serving tongs Quantity: 1d10	Hunting pistol
4	Hand crank flashlight Quantity: 1d4	Hiking boots Quantity: 1d5 pairs	Tea kettle	Bolt action rifle
5	Sports balls (footballs, baseballs, etc.) Quantity: 2d16	Sports shoes Quantity: 1d14 pairs	Filtered water bottle	Double barreled shotgun
6	Tennis rackets Quantity: 1d8	Mountainboards Quantity: 1d4	Foil-pouch instant meals Quantity: 1d24	Hunting knife Quantity: 1d3
7	Set of climbing gear	Sets of skis Quantity: 1d6	Fire starter kit	Swiss army knife. Quantity: 1d2
8	Set of arctic hiking gear	Snowboards Quantity: 1d5	Portable propane tank	Baseball bat Quantity: 1d3
9	Sets of snorkeling gear	Skateboards Quantity: 1d10	Propane camp stove	Set of golf clubs
10	2 man tent	Bicycles Quantity: 1d3	Portable charcoal grill	Boxes of shotgun shells (12) Quantity: 1d3
11	4 man tent	Roller blades Quantity: 1d12 pairs	Large Dutch oven	Boxes of pistol shells (20) Quantity: 1d3
12	Pavilion tent	Ice skates Quantity: 1d12 pairs	Water canteen Quantity: 1d6	Boxes of rifle shells (20) Quantity: 1d3

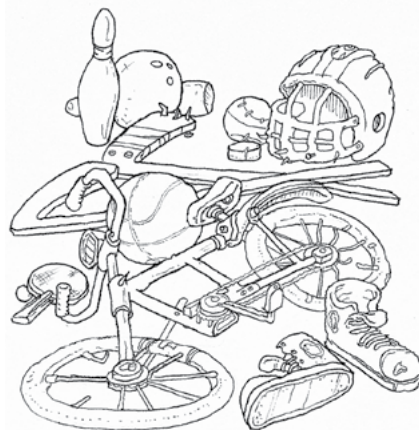

APPENDIX

Random Automotive Items

	1	2	3	4
1	Rooftop cargo carrier	Bottles of high-performance oil additive Quantity: 1d12	12v Car battery Quantity: 1d5	Flood lamp kit
2	Trailer hitches. Quantity: 1d3	Bottles of engine cleaner. Quantity: 1d14	Jumper cables Quantity: 1d6	Suspension lift kit
3	Assorted loose automotive tools	Bottles of high octane fuel additive. Quantity: 1d12	Bottles of motor oil Quantity: 2d12	High performance shock set
4	Portable battery charger	Bottles of automotive shampoo. Quantity: 2d30	Pack of oil filters Quantity: 1d16	Tire patch kit
5	Spare car tires. Quantity: 2d4	Bottles of industrial strength degreaser. Quantity: 1d12	Bottles of radiator fluid Quantity: 2d12	Engine hose kit
6	Spare truck tires. Quantity: 2d4	Canister of car wax. Quantity: 3d6	Bottles of trans oil. Quantity: 2d12	Engine belt kit
7	Pack of replacement mirrors. Quantity: 1d7	Case w/ basic tool set	Bottles of brake fluid. Quantity: 2d12	Freon kit
8	Pack of headlight bulbs. Quantity: 1d10	Air ratchet w/ mini compressor	Pack of brake pads. Quantity: 3d12	DIY manual: Mechanical Repair (Acts as occupation)
9	Pack of fuses. Quantity: 1d14	Tire iron & crank jack kit	Canister of bodywork putty. Quantity: 1d7	DIY manual: Engine Repair (Acts as occupation)
10	Tube of industrial strength adhesive Quantity: 1d16	2-ton shop jack	Jugs of windshield wiper solvent. Quantity: 1d16	DIY manual: Electrical Repair (Acts as occupation)
11	AC/DC outlet converter. Quantity: 1d4	Wet / dry shop vacuum	Pack of windshield wipers. Quantity: 2d14	DIY manual: Transmission Repair (Acts as occupation)
12	Various hanging car air fresheners Quantity: 2d20	Lockable tool cases w/ rollers	Pack of air filters. Quantity: 2d12	DIY manual: Car Maintenance (Acts as occupation)

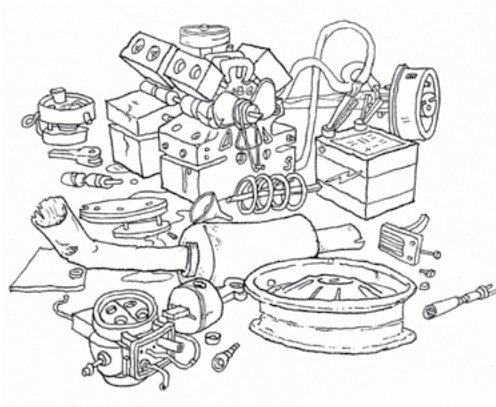

APPENDIX

Random Pharmacy Items

	1	2	3	4
1	Bottles of painkillers Quantity: 1d6	Portable defibrillator	Toothbrushes Quantity: 4d24	Tube of antifungal ointment Quantity: 3d8
2	Bottles of depressants Quantity: 1d4	Oxygen canisters w/ breathing mask	Tubes of toothpaste Quantity: 4d24	Tube of antibacterial ointment Quantity: 3d8
3	Bottles of antidepressants Quantity: 1d4	Various minor surgical tools Quantity: 2d12	Cans of shaving gel Quantity: 2d12	Tube of muscle ache ointment Quantity: 3d8
4	Bottles of antibiotics Quantity: 1d4	Heart monitor	Electric shaving razor Quantity: 1d3	Tube of cleansing ointment Quantity: 3d8
5	Bottles of cold & flu medicine Quantity: 2d6	IV drip stand with monitor	Disposable shaving razors Quantity: 3d10	Tube of lubricant Quantity: 3d8
6	Bottles of allergy medicine Quantity: 2d6	Blood pressure gauge with cuff	Fingernail grooming kit Quantity: 3d10	Box of prophylactics Quantity: 3d8
7	Bottles of stomach medicine Quantity: 2d6	Stethoscopes Quantity: 1d3	Bottles of shampoo Quantity: 3d16	Menstrual products Quantity: 3d8
8	Boxes of adhesive bandages Quantity: 3d10	Digital thermometer Quantity: 1d5	Deodorant Quantity: 3d24	Reading glasses Quantity: 3d4
9	Rolls of gauze bandage Quantity: 4d12	Pocket otoscope Quantity: 1d3	Bars of soap Quantity: 5d30	Foil sealed nutrition bars Quantity: 3d10
10	Box of instant ice packs Quantity: 1d12	Joint support braces Quantity: 1d8	Cans of hairspray Quantity: 2d12	Tub of protein powder Quantity: 1d8
11	Box of instant heat pack. Quantity: 1d12	Rolls of fiberglass casting tape Quantity: 1d7	Package of combs & brushes Quantity: 1d6	First aid kit Quantity: 1d3
12	Bottle of vitamins Quantity: 3d8	Plastic splints Quantity: 2d6	Tubes of sunscreen Quantity: 3d10	Box of hair coloring Quantity: 3d10



APPENDIX

Random Farming Items

	1	2	3	4
1	50 lbs. bags of feed quality grain Quantity: 2d3	Functional tractor	Large fuel tank (gas or diesel). Quantity: 10d10 fuel points	Labor animal plow
2	50 lbs. bags of viable seed Quantity: 1d3	Multi-blade plow attachment	Bottles of motor oil Quantity: 2d12	5 gallon buckets of industrial insecticide Quantity: 1d16
3	Metal 50 gallon barrels Quantity: 1d8	Sprayer plow attachment	Gas powered generator	5 gallon buckets of industrial weed killer Quantity: 1d16
4	Large metal trough (80 gallon)	Seeder / hopper plow attachment	Industrial irrigation hose Quantity: 150' – 3000'	Heavy duty clothing Quantity: 2d4
5	5 gallon plastic buckets Quantity: 2d12	Soil tiller plow attachment	High power torch lamp	Heavy duty boots Quantity: 1d6
6	8 gallon metal buckets Quantity: 2d12	Harvester plow attachment	CB (Citizens' Band) radio unit	Long handle shears Quantity: 1d7
7	Bail of barbed wire Quantity: 200' – 1200'	Heavy duty push broom Quantity: 1d16	Long handled axe. Quantity: 1d3	Electric shears Quantity: 1d4
8	Bail of chicken wire Quantity: 50' – 300'	Heavy duty pitch fork Quantity: 1d12	Hammer and nails (50-300) Quantity: 1d3	Animal grooming tools Quantity: 3d4
9	Bail of plastic twine Quantity: 500' – 3000'	Heavy duty scoop shovel Quantity: 2d6	Manual staple gun w/ staples (50-300) Quantity: 1d3	Saddles and bridles Quantity: 2d4
10	Bail of heavy duty rope. Quantity: 50' – 2000'	Heavy duty post hole digger. Quantity: 1d8	5 gallon buckets of industrial cleanser Quantity: 1d16	DIY manual: Growing Crops (Acts as occupation)
11	Various heavy duty pulleys and hooks Quantity: 1d5	Heavy duty rake Quantity: 1d24	Long handled scrub brushes Quantity: 4d6	DIY manual: Animal Care (Acts as occupation)
12	16' x 20' heavy duty tarp	Heavy duty long scissor tongs. Quantity: 1d20	Cans of outdoor latex paint and brushes Quantity: 3d6	DIY manual: Butchery (Acts as occupation)



APPENDIX

Random Library Items

	1	2	3	4
1	Cookbooks Quantity: 1d3	Entertainment magazines Quantity: 1d6	Encyclopedia volumes Quantity: 1d3	Classical music (cassette or CD) Quantity: 1d3
2	Do it yourself books Quantity: 1d3	Science / Technology magazines Quantity: 1d6	Dictionaries Quantity: 1d3	Western music (cassette or CD) Quantity: 1d3
3	Puzzle books Quantity: 1d3	Fashion magazines Quantity: 1d6	Thesauruses Quantity: 1d3	Alternative music (cassette or CD) Quantity: 1d3
4	Self help books Quantity: 1d3	News magazines Quantity: 1d6	Programming books Quantity: 1d3	Dance music (cassette or CD) Quantity: 1d3
5	Historical Biographies Quantity: 1d3	Homecare magazines Quantity: 1d6	Medical reference books Quantity: 1d3	Rock music (cassette or CD) Quantity: 1d3
6	Celebrity Biographies Quantity: 1d3	Fitness magazines Quantity: 1d6	Science reference books Quantity: 1d3	Big Band music (cassette or CD) Quantity: 1d3
7	Mystery books Quantity: 1d3	Cooking magazines Quantity: 1d6	Mathematical reference books Quantity: 1d3	Movie Soundtracks (cassette or CD) Quantity: 1d3
8	Classic Literature books Quantity: 1d3	Goods and services magazines Quantity: 1d6	Sociology reference books Quantity: 1d3	Political Lecture (cassette or CD) Quantity: 1d3
9	Fantasy / Sci-Fi books Quantity: 1d3	Fitness magazines Quantity: 1d6	Psychology reference books Quantity: 1d3	Scholarly Lecture (cassette or CD) Quantity: 1d3
10	Humor books Quantity: 1d3	Fitness magazines Quantity: 1d6	Religious reference books Quantity: 1d3	Mood music (cassette or CD) Quantity: 1d3
11	Pop culture books Quantity: 1d3	Fitness magazines Quantity: 1d6	Historical reference books Quantity: 1d3	Hypnotherapy (cassette or CD) Quantity: 1d3
12	Poetry books Quantity: 1d3	Fitness magazines Quantity: 1d6	Military reference books Quantity: 1d3	Self Help (cassette or CD) Quantity: 1d3



APPENDIX

Random Antiques/Museum Items

	1	2	3	4
1	Phonograph & inyl records (5-30)	Artifacts containing precious metal Quantity: 1d5	Antique dishware Quantity: 6d6	Decommissioned tank
2	Collectible knick-knacks Quantity: 2d12	Artifacts containing precious gemstones Quantity: 1d5	Ancient civilization artifacts Quantity: 2d8	Non-functional car
3	Transistor radio	Jewelry containing precious metal Quantity: 1d8	Fine art sculptures Quantity: 5d10	Non-functional truck
4	Black and white television set	Jewelry containing precious gemstones Quantity: 1d8	Fine art paintings Quantity: 10d10	Non-functional train
5	Ancient videogame arcade unit & games(2d3)	Security cameras Quantity: 2d8	Fine doll houses Quantity: 1d5	Non-functional helicopter
6	8-track player & tapes (5d5)	Alarm systems Quantity: 1d4	Manual hand drill Quantity: 1d6	Non-functional plane
7	Black powder pistols & rifles Quantity: 1d4	Sewing table with machine attached	Manual hand mixer Quantity: 1d6	Non-functional artillery cannon
8	Functional replicas of ancient melee weapons Quantity: 1d4	35mm film projector & film reels (1d6)	Antique coffee maker Quantity: 1d5	Modern military armor Quantity: 1d6 steps of armor
9	Functional replicas of ancient armor Quantity: 1d6 steps of armor	Polaroid camera with viable film (4d6)	Antique motorless lawn mover	Modern police armor Quantity: 1d6 steps of armor
10	Ancient but functional black powder cannon	Mechanical calculator	Manual mechanical printing press	Scientific equipment Quantity: 1d5
11	Functional rickshaw	Mechanical cash register	Antique clothes iron Quantity: 1d3	Electric security cart
12	Manual telescope	Mechanical typewriter with ink	Manual mechanical washing machine	Cleaning supplies Quantity: 1d16



APPENDIX

Random Military/Hunting/Survivalist Items				
	1	2	3	4
1	Semi auto pistol	Combat shotgun	Combat knives Quantity: 3d6	NBC suit (Nuclear, Biological, Chemical)
2	Revolver	Sawed off shotgun	Machetes/swords/katanas Quantity: 1d7	Telescopic sight Quantity: 1d3
3	High power pistol	Double barreled shotgun	Axes Quantity: 1d5	Laser sight Quantity: 2d3
4	Bolt action rifle	Shotgun, pump action	Bottles of gunpowder Quantity: 1d6	Firearm maintenance kit
5	Lever action rifle	Submachine gun	Molotov cocktails Quantity: 2d5	Gunsmithing tools
6	Assault rifle	Machine gun	Can grenades Quantity: 2d5	Portable cooking stove
7	Sniper rifle	Boxes of rifle ammo (20) Quantity: 1d6	Grenade, fragmentation Quantity: 1d6	Camping gear
8	Flamethrower	Belts of machine gun ammo (100) Quantity: 1d6	Grenade, smoke Quantity: 1d6	Wound sealing patches Quantity: 3d3
9	Grenade launcher	Boxes of handgun / SMG Ammo (50) Quantity: 1d6	Grenade, Tear gas Quantity: 1d6	Field surgery kit
10	Underslung grenade launcher	Boxes of high power pistol ammo (20) Quantity: 1d4	Mine, fragmentation Quantity: 1d8	First aid kits Quantity: 1d6
11	Rocket Launcher	Boxes of Specialty Ammo (20) Quantity: 1d3	Blocks of plastic explosives w/ loose detonators. Quantity: 1d8	Gallons of pure water Quantity: 4d6
12	Disposable 1 shot Rocket Launcher	Boxes of shotgun shells (20) Quantity: 1d6	Pre-wired plastic explosives pack w/ timer detonator. Quantity: 1d3	Cases of MRE (meals ready to eat) (24) Quantity: 1d8

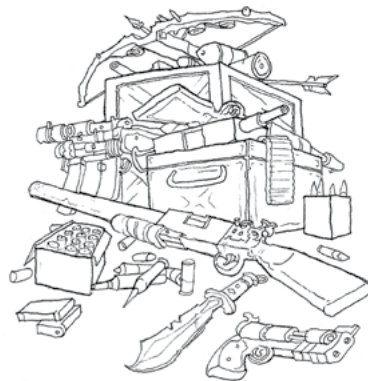

APPENDIX

Random Alien Craft Items				
	1	2	3	4
1	Blaster pistol	Extraterrestrial foodstuffs Quantity: 1d6	Multi-bioprobe Quantity: 1d6	Disposable repair modules Quantity: 1d3
2	Blaster rifle	Extraterrestrial booze Quantity: 1d6	Googleplex data storage Quantity: 1d6	Disposable plasma cutter Quantity: 1d3
3	Protonic quick charger	Extraterrestrial frozen meat packs Quantity: 1d6	Power generation cube Quantity: 1d6	Disposable 3 man habitat Quantity: 1d3
4	EP charge packs (50) Quantity: 1d6	Extraterrestrial fruit Quantity: 1d6	Planetary navigation unit Quantity: 1d6	Disposable radiation suit Quantity: 1d3
5	Vibroblade	Extraterrestrial bottled drinks. Quantity: 1d6	Spare spacecraft parts Quantity: 1d6	Disposable scout drone Quantity: 1d3
6	Rocket hammer	Extraterrestrial hygiene kit. Quantity: 1d6	Spare organs Quantity: 1d6	Disposable flight belt Quantity: 1d3
7	Atomic chainsaw	Extraterrestrial first aid unit. Quantity: 1d6	Spare brains Quantity: 1d6	Disposable hover boots Quantity: 1d3
8	Fusion grenades Quantity: 1d6	Extraterrestrial surgery drone. Quantity: 1d6	Nav computer Quantity: 1d6	Disposable forcefield ring Quantity: 1d3
9	Dimensional Shear grenades Quantity: 1d3	Extraterrestrial clothing Quantity: 1d6	Wrist computer Quantity: 1d6	Disposable toilet hoop Quantity: 1d3
10	Stun grenades Quantity: 1d6	Extraterrestrial jewelry Quantity: 1d6	Alien earbud comm Quantity: 1d6	Disposable camp guard drone. Quantity: 1d3
11	Blaster drone	Drums of liquid energon Quantity: 1d6	Control crown Quantity: 1d6	Disposable chainsaw Quantity: 1d3
12	Blade drone	Bins of atomic coal Quantity: 1d6	Motion sensor Quantity: 1d6	Disposable teleporter Quantity: 1d3



LIST OF TABLES

Table A1: Foraging difficulties	12	Firearms Crit Table V	109
Table A2: Common Foraging results	12	Grenade/ Explosive Crit Table I	110
Table A3: Common Foodstuffs	13	Grenade/ Explosive Crit Table II	111
Table A4: Bad Food effects	13	Grenade/ Explosive Crit Table III	112
Table A5: Community Housing	14	Grenade/ Explosive Crit Table IV	113
Table A6: Found Apparel	14	Grenade/ Explosive Crit Table V	114
Table A7: Primary Means of Community Travel	15	Common Weapons	116
Table A8: Channels of Communication	15	Common Mounts and Methods of Hired Travel	121
Table A9: Community Law Structure	16	Firearms	122
Table A10: Unusual Community Laws	16	Grenades	123
Table A11: Punishments	17	Table SPD-1: Speed Levels	126
Table A12: Resources	17	Table VCM: Vehicle Control Modifiers	127
Table B1: Post-Apocalyptic Lucky Roll Table	47	Table WO-1: Wipeout Results	128
Table B2: Umerica Random Occupation	48	Machine vs. Man Critical Hit Table	129
Table B3: Umerica Random Race (Optional)	49	Table WD-1: Wreck Damage	132
Table B4: Umerica Random Equipment	50	Support Class Weapons	137
Table C1: Cleric Sacrifice Bonuses	54	Table LWO-1: Locomotive Wipeout Results	138
Table C2: Cleric	54	Table WSPD-1: Watercraft Speed Levels	140
Table C3: Cyber Upgrade	57	Table WWO-1: Watercraft Wipeout Results	141
Table C4: Cyborg	58	Table HGT-1: HGT Levels	143
Table C5: Feral Urchin	60	Table AWO-1: Aerial Wipeout Results	144
Table C6: The Wild Rumpus	61	Table MSPD-1: Mech Speed Levels	145
Table C7: Feral Urchin Nerd Skills	61	Table MWO-1: Mech Wipeout Results	145
Table C8: Fossiorian	64	Table BCF: Beast Control Fumbles	148
Table C9: Gray	68	Table BCM: Bicycle Control Modifiers	149
Table C10: Mutant	72	Table BWO-1: Bicycle Wipeout Results	150
Table C11: Petrol Head	75	Table SVCM: Sail Vehicle Control Modifiers	150
Table C12: Robot	80	Table SWWO-1: Sail Waggon Wipeout Results	151
Table C13: Scavenger	84	Volatile Magic/Mercurial Magic	153
Table C14: Scavenger Skills	84	Grimoire of the Wastes	158
Table C15: Weapons Tinkering Failure Results	88	Table EAB: Extended Attribute Bonuses	168
Table C16: Bot Repair Failure Results	88	Table Mu-1: Base Mutation Table	169
Table C17: Computer Use Failure Results	88	Mutation Subtables	170
Table C18: Vehicle Repair Failure Results	89	Appendix S: Salvage	270
Table C19: General Tech Failure Results	89	Random Foodstuffs	270
Table C20: Use Alien Tech Check Results	89	Random Housewares	271
Table C21: Technologist	90	Random Tools and Industrial Supplies	272
Table C22: Technologist Jury Rigging Skills	90	Random Sporting Goods	273
Table C23: Wasteland Warrior	93	Random Automotive Items	274
Table C24: Wizard of the Wasteland	96	Random Lawn/Garden Items	275
Firearms Fumble Table	103	Random Pharmacy Items	276
Grenade/Explosive Fumble Table	104	Random Farming Items	277
Firearms Crit Table I	105	Random Library Items	278
Firearms Crit Table II	106	Random Antiques/Museum Items	279
Firearms Crit Table III	107	Random Military/Hunting/Survivalist Items	280
Firearms Crit Table IV	108	Random Alien Craft Items	281

Product Identity: The following items are hereby identified as Product Identity, as defined in the Open Game License 1.0a, Section 1(e), and are not Open Content: All trademarks, registered trademarks, proper names (characters, deities, etc.), dialogue, plots, storylines, locations, characters,

artworks, and trade dress. (Elements that have previously been designated as Open Game Content are not included in this declaration.)

Open Content: Except for material designated as Product Identity (see above), the game mechanics of this fanzine are Open Game Content, as defined in the Open Game License version 1.0a Section 1(d). No portion of this work other than the material designated as Open Game Content may be reproduced in any form without written permission.

OPEN GAME LICENSE Version 1.0a

The following text is the property of Wizards of the Coast, Inc. and is Copyright 2000 Wizards of the Coast, Inc (“Wizards”). All Rights Reserved.

1. Definitions: (a) “Contributors” means the copyright and/or trademark owners who have contributed Open Game Content; (b) “Derivative Material” means copyrighted material including derivative works and translations (including into other computer languages), potation, modification, correction, addition, extension, upgrade, improvement, compilation, abridgment or other form in which an existing work may be recast, transformed or adapted; (c) “Distribute” means to reproduce, license, rent, lease, sell, broadcast, publicly display, transmit or otherwise distribute; (d) “Open Game Content” means the game mechanic and includes the methods, procedures, processes and routines to the extent such content does not embody the Product Identity

and is an enhancement over the prior art and any additional content clearly identified as Open Game Content by the Contributor, and means any work covered by this License, including translations and derivative works under copyright law, but specifically excludes Product Identity. (e) “Product Identity” means product and product line names, logos and identifying marks including trade dress; artifacts, creatures, characters, stories, storylines, plots, thematic elements, dialogue, incidents, language, artwork, symbols, designs, depictions, likenesses, formats, poses, concepts, themes and graphic, photographic and other visual or audio representations; names and descriptions of characters, spells, enchantments, personalities, teams, personas,

likenesses and special abilities; places, locations, environments, creatures, equipment, magical or supernatural abilities or effects, logos, symbols, or graphic designs; and any other trademark or registered trademark clearly identified as Product identity by the owner of the Product Identity, and which specifically excludes the Open Game Content; (f) “Trademark” means the logos, names, mark, sign, motto, designs that are used by a Contributor to identify itself or its products or the associated products contributed to the Open Game License by the Contributor (g) “Use,” “Used” or “Using” means to use, Distribute, copy, edit, format, modify, translate and otherwise create Derivative Material of Open Game Content. (h) “You” or “Your” means the licensee in terms of this agreement.

2. The License: This License applies to any Open Game Content that contains a notice indicating that the Open Game Content may only be Used under and in terms of this License. You must affix such a notice to any Open Game Content that you Use. No terms may be added to or subtracted from this License except as described by the License itself. No other terms or conditions may be applied to any Open Game Content distributed using this License.

3. Offer and Acceptance: By Using the Open Game Content You indicate Your acceptance of the terms of this License.

4. Grant and Consideration: In consideration for agreeing to use this License, the Contributors grant You a perpetual, worldwide, royalty-free, non-exclusive license with the exact terms of this License to Use, the Open Game Content.

5. Representation of Authority to Contribute: If You are contributing original material as Open Game Content, You represent that Your Contributions are Your original creation and/or You have sufficient rights to grant the rights conveyed by this License.

6. Notice of License Copyright: You must update the COPYRIGHT NOTICE portion of this License to include the exact text of the COPYRIGHT NOTICE of any Open Game Content You are copying, modifying or distributing, and You must add the title, the copyright date, and the copyright holder’s name to the COPYRIGHT NOTICE of any original Open Game Content you Distribute.

7. Use of Product Identity: You agree not to Use any Product Identity, including as an indication as to compatibility, except as expressly licensed in another, independent Agreement with the owner of each element of that Product Identity. You agree not to indicate compatibility or co-adaptability with any Trademark or Registered Trademark in conjunction with a work containing Open Game Content except as expressly licensed in another, independent Agreement with the owner of such Trademark or Registered Trademark. The use of any Product Identity in Open Game Content does not constitute a challenge to the ownership of that Product Identity. The owner of any Product Identity used in Open Game Content shall retain all rights, title and interest in and to that Product Identity.

8. Identification: If you distribute Open Game Content You must clearly indicate which portions of the work that you are distributing are Open Game Content.

9. Updating the License: Wizards or its designated Agents may publish updated versions of this License. You may use any authorized version of this License to copy, modify and distribute any Open Game Content originally distributed under any version of this License.

10. Copy of this License: You MUST include a copy of this License with every copy of the Open Game Content You distribute.

11. Use of Contributor Credits: You may not market or advertise the Open Game Content using the name of any Contributor unless You have written permission from the Contributor to do so.

12. Inability to Comply: If it is impossible for You to comply with any of the terms of this License with respect to some or all of the Open Game Content due to statute, judicial order, or governmental regulation then You may not Use any Open Game Material so affected.

13. Termination: This License will terminate automatically if You fail to comply with all terms herein and fail to cure such breach within 30 days of becoming aware of the breach. All sublicenses shall survive the termination of this License.

14. Reformation: If any provision of this License is held to be unenforceable, such provision shall be reformed only to the extent necessary to make it enforceable.

15. COPYRIGHT NOTICE

Open Game License v 1.0a Copyright 2000, Wizards of the Coast, Inc.

Dungeon Crawl Classics Role Playing Game Copyright 2012, Goodman Games

American Survival Guide Copyright 2017, Shield of Faith Studios, LLC

Crawling Under a Broken Moon issue #1 - #18 Copyright 2014-2017, Shield of Faith Studios, LLC

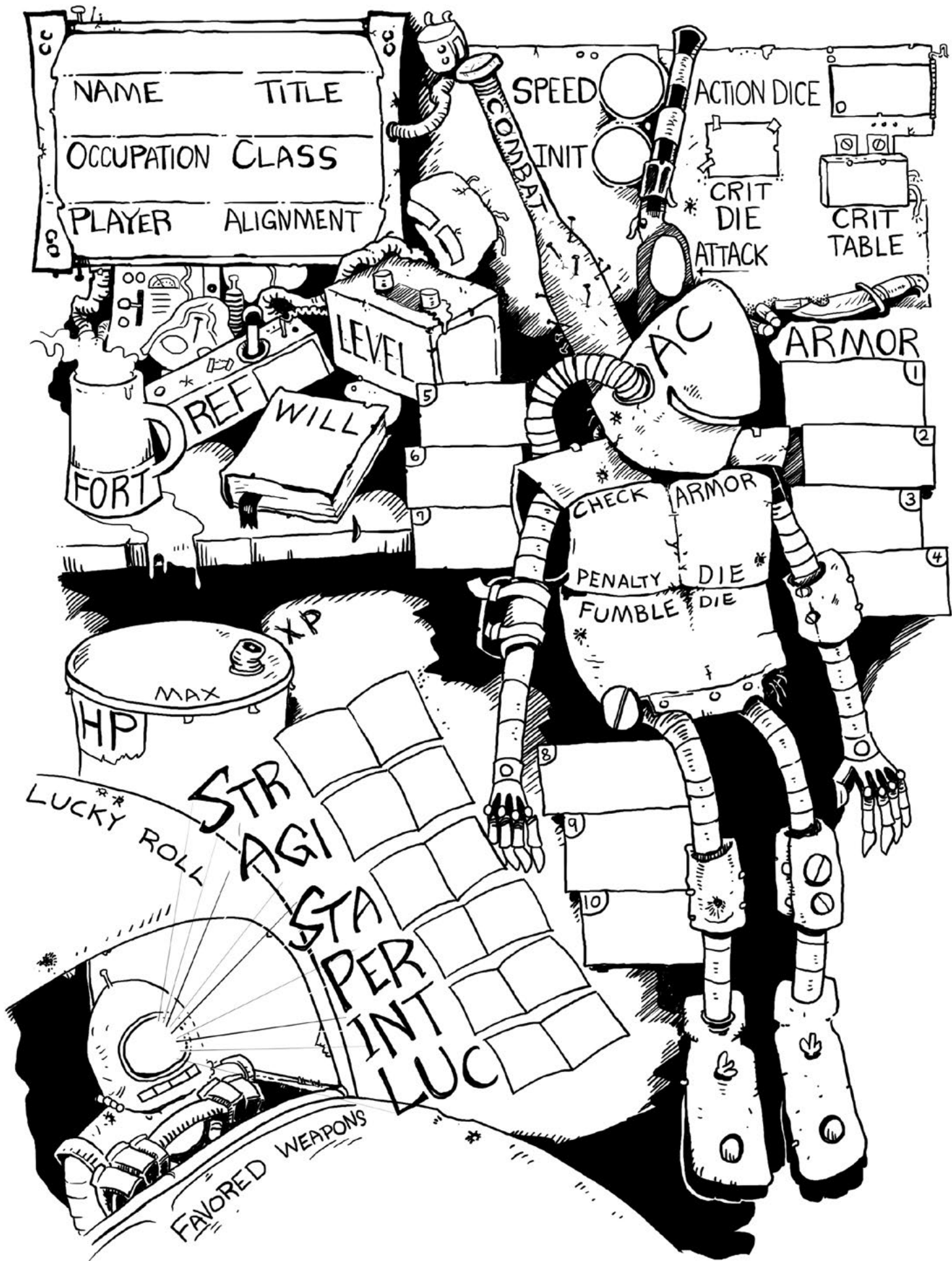

NAME TITLE

OCCUPATION CLASS

PLAYER ALIGNMENT

SPEED

ACTION DICE

COMBAT

CRIT DIE
ATTACK

CRIT TABLE

LEVEL

REF WILL

FORT

ARMOR

CHECK ARMOR

PENALTY DIE
FUMBLE DIE

HP

MAX

LUCKY ROLL

STR
AGI

STA
PER
INT
LUC

FAVORED WEAPONS

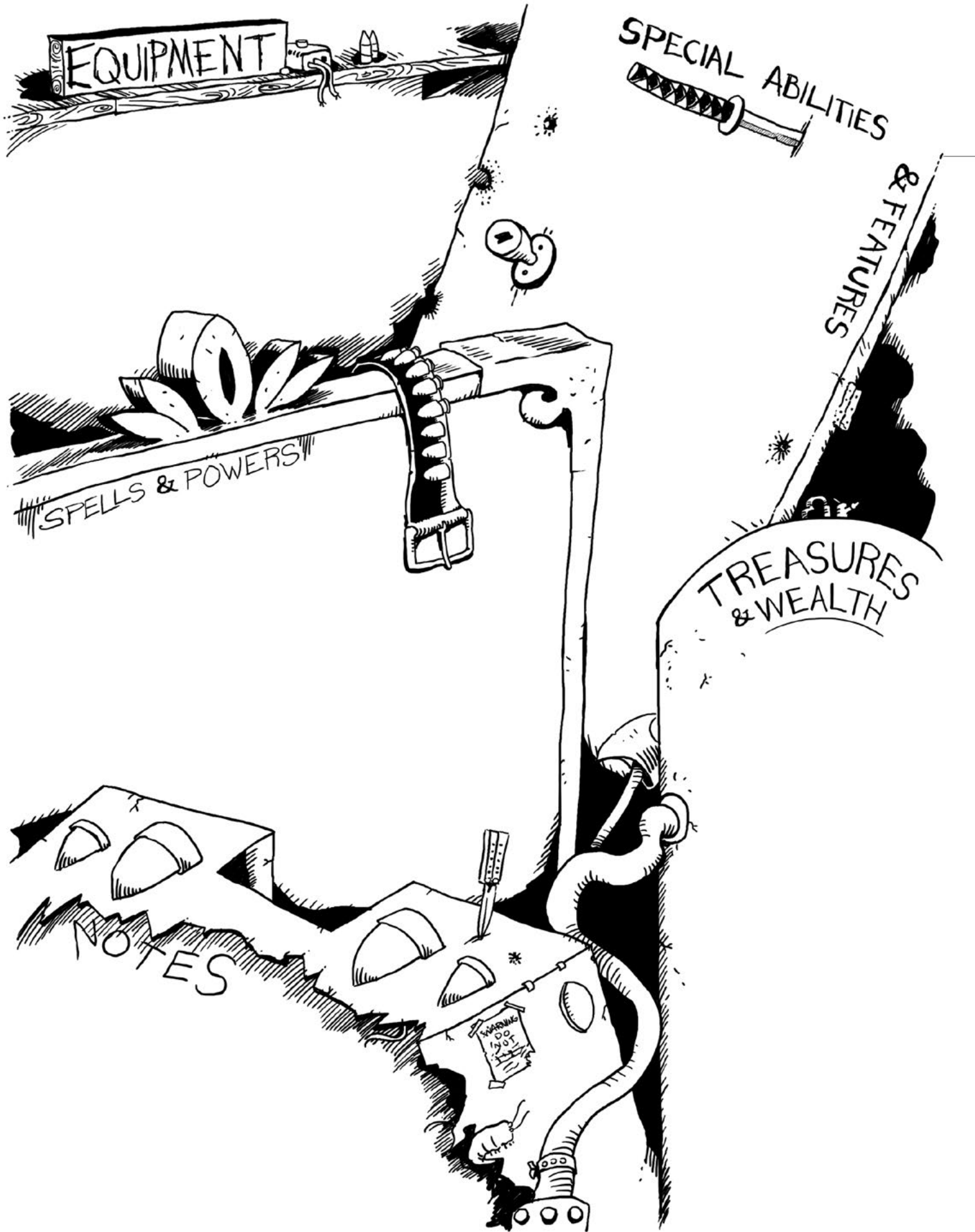

EQUIPMENT

SPECIAL ABILITIES
& FEATURES

SPELLS & POWERS

TREASURES
& WEALTH

NOTES

WARNING
DO NOT
TOUCH



Foretold in the ancient calendars, early in the 21st century a rogue object from deep space hurtled near the Earth and struck the Moon. Its impact caused catastrophic destruction around the globe, ripping the very fabric of time and space itself; yet mankind still survived. Centuries later, the planet is reborn... a strange new place of alien wonder and death: a world ruled by savagery, cruel sorcery, and twisted science. Now is the time for the mighty to rise up and take their place in this perilous and untamed land. Will they bring justice or suffering? Only time will tell...

A dozen new or revised character class options, nine of which are unique to Umerica: Clerics of the Wasteland, The Cyborg, Feral Urchin, Fossiorian, Grays, Mutant, Petrol Head, Robot, Scavenger, Technologist, Wasteland Warrior, Wizard of the Wasteland.

New piecemeal armor system that incorporates damage resistance, ablatives, and armor degradation

An extensive, revised mutation system usable by all characters and creatures

An expanded vehicular creation and combat system for all of your petrolhead needs

A pantheon of Umerican Gods and Patrons, old and new.

A comprehensive section on the Citadel of Scrap, a good campaign starting point for exploring Umerica.

Dozens of random tables covering aspects of everyday wasteland life, finding salvage, and adventure creation plus much, much more!

This product is compatible with the Dungeon Crawl Classics Role Playing Game.

\$29.99 CUBM50001D

**CRAWLING
UNDER A
BROKEN MOON**



COMPATIBLE WITH
**DCC
RPG**

crawlingunderabrokenmoon.blogspot.com