

# DUNGEON CRAWL CLASSICS

## GRIMTOOTH'S MUSEUM OF DEATH

#87.5: A LEVEL 1 ADVENTURE  
BY JOBE BITTMAN WITH  
STEVE CROMPTON

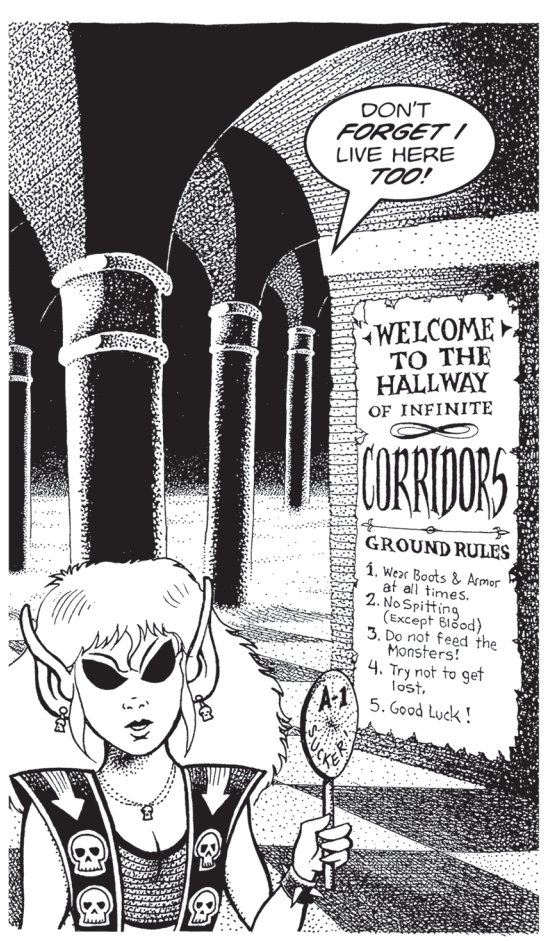

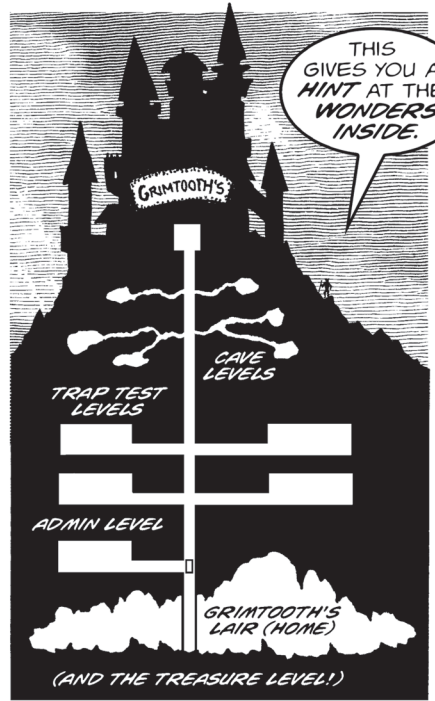

Grim

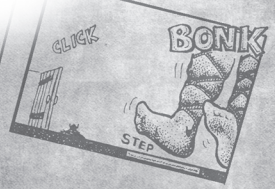

# GRIMTOOTH'S MUSEUM OF DEATH



**By Jobe Bittman with Steven S. Crompton**  
**Editor: Jen Brinkman; Layout: Opus Graphics**  
**Cover artist: Doug Kovacs Cartographer: S.S. Crompton**  
**Interior Artists: S.S. Crompton, Stefan Poag, and Brad McDevitt**

Playtesters: Bennett Hansen, Bart Staker, Dylan Martin, Jason Hobbs,  
Lindsay Carvalho, Meegan Kauffman;  
(Garycon VII) Bob Brinkman, David Baity, Kathy Heatherly, Scott Hobbs,  
Doug Kovacs, Adam Muszkiewicz, Kathryn Muszkiewicz,  
Hilary Perrino, Jon Perrino, Jeff Sipko.

DCC RPG and this adventure are copyright © 2015 Goodman Games. Dungeon Crawl Classics is a trademark of Goodman Games. Grimtooth's Traps, Grimtooth, Grimtina and related characters and material are TM & Copyright © 1981-2015 Flying Buffalo Inc. All rights reserved. DCC RPG is published under the Open Game License. Refer to the OGL in this work for additional information.

**[www.goodman-games.com](http://www.goodman-games.com)**

# INTRODUCTION

**R**emember the good old days, when adventures were underground, NPCs were there to be killed, and the finale of every dungeon was the dragon on the 20th level? Those days are back. Dungeon Crawl Classics adventures don't waste your time with long-winded speeches, weird campaign settings, or NPCs who aren't meant to be killed. Each adventure is 100% good, solid dungeon crawl, with the monsters you know, the traps you remember, and the secret doors you know are there somewhere.

After three decades, the wait is nearly over. In *Grimtooth's Museum of Death*, you and your players finally get the chance to delve into the evil troll's base of operations first detailed in the pages of Grimtooth's Trap Comics. Deadly traps old and new are waiting to be sprung, from Castle Grimtooth down to the lower treasure levels. You just might see a few familiar faces on your journey, too.

This adventure is designed for 20 to 30 twenty-seventh-level characters accompanied by a host of 50 seasoned mercenaries, 200 hirelings, 3 ox-drawn carts loaded with chickens, wooden poles cut to varying lengths, and several siege weapons. In playtests, the group that lived the longest brought several backpacks stuffed with scrolls and a ring of three wishes. It is also feasible for an adventuring party as low as level zero to best Grimtooth's traps and reach the Great Troll's treasure hoard, but they must keep their wits about them at all times lest they be ground up as monster chow in Grimtooth's blood chutes.

## ADVENTURE BACKGROUND

**S**ince before the year of the Bitter Wyvern, the Great Troll has observed the dealings of mortals... and he has judged them harshly. The once war-like tribes have beaten their swords into plowshares, built mighty cities filled with exquisite architecture, and produced works of art unrivaled by any age in a celebration of life. Nonsense and puffery! Life's beauty cannot be captured by inane doodles trapped beneath a picture frame or beatific self-congratulation. It can only be truly appreciated at the point of the sword as one's precious red ink pools on the earth—either end of the blade will do.

Calling himself Grimtooth, the Great Troll descended on Aereth to spread his oeuvre of pain to the undeserving masses. Upon a high bluff, the troll erected a majestic castle that could be seen for many miles, and packed its vast subterranean galleries with his nefarious art installations—masterfully crafted death traps bedecked with oiled springs, razor blades, telescoping bone saws, and contact poison. At the very bottom level, Grimtooth deposited a

vast hoard of treasure and sent invitations to all far and wide to share his wealth. To this day, the Great Troll sits upon a massive pile of gold coins diagramming his intricate trap designs in leather-bound volumes, waiting for art lovers to arrive.



## A WORD ABOUT GRIMTOOTH'S TRAPS

The traps cataloged in Grimtooth's many grimoires and detailed in this adventure heavily depend on the location and actions of the PCs. While running this adventure, the judge should constantly poll the players about their characters positions and actions. The players should also indicate marching order and, if desired, standard operating procedures when approaching a new door or corridor. This will avoid the inevitable arguments about who intended to stand where.

The maps contain several mystery rooms keyed with question marks. These rooms are supplied for judges to insert their own traps or favorite traps from the Grimtooth trap series. Adding traps is optional. Judges can choose to treat mystery rooms as empty rooms, or roll on Appendix D or Appendix F to add a small trap.

Grimtooth's traps are easy to adapt for DCC RPG by reading the trap carefully and using common sense. If you need a difficulty class for a skill check, use Grimtooth's deadliness rating as a gauge: 1-2 skulls (DC 15), 3-4 skulls (DC 20), 5 skulls (DC 25). Likewise, an average damage output for a trap can be determined by multiplying the deadliness rating by 10 and round up or down. For example, 2 skulls  $\times$  10 = 20 average damage;  $20 \div 3.5$  (the average damage of a d6) rounds to 6 for 6d6 damage. After overcoming a trap, award experience points equal to the trap's deadliness rating (e.g., 2 skulls equals 2 XP).



# ADVENTURE START

**W**ord has spread of a sadistic troll with a vast treasure horde living in a castle to the east. The troll, obviously mad, has invited all comers to collect a share of his wealth. The adventure starts as the PCs arrive within a bowshot of Castle Grimtooth. Read or paraphrase the following:

*Emerging from the dense forest tree line, you reach a clearing with a wide vista. A gloomy castle stands upon a verdant butte, its forlorn parapets and spires silhouetted against the sky. The chimneys are all cold, and no light or movement can be seen on the walls. While the castle appears to have fallen into disuse, freshly painted wooden signs have been sparsely planted throughout the glade with messages of greeting: "Delvers Welcome", "Vacancy - Apply Within", and "Help Wanted".*

The grounds are littered with additional greetings encouraging travelers to approach Castle Grimtooth. A wide gradual path slopes around the butte leading to the castle's entrance. Ascending the steep pitch of the butte is slower and takes more effort, but can be achieved without resorting to calls for climbing checks. The grounds are quite lovely, but hold little of interest or danger. If the adventurers overcautiously insist on searching the grounds during their approach, roll 1d7 on the following list of interesting sights: (1) a fluttering butterfly; (2) a sleeping baby bunny; (3) 1d4 sp or 1 gp; (4) a bee collecting pollen from a flower; (5) a pretty rock; (6) a chipmunk nibbling a berry; (7) a small patch of fresh-tilled earth (contains a buried bone).

## LEVEL 6: CASTLE GRIMTOOTH

**C**astle Grimtooth has a commanding view of the surrounding lands making it difficult to approach without being spotted. The castle is completely devoid of furnishings or signs of habitation as Grimtooth prefers to lair in a cavern far below, protected by the traps in his museum of death.

As the reach the top of the butte, read the following:

*You stand before a foreboding castle surrounded by buttressed stone walls. Up close, the stronghold appears even more uninviting and shabby. Missing shingles pockmark the conical roofs capping the fortification's weather-beaten towers. All the windows are either shuttered or blocked by drawn curtains. An arched sign emblazoned with the word "Grimtooth's" stands over the gatehouse's raised portcullis, ostensibly the moniker of the keep's absentee lord. In the courtyard beyond, the massive ironbound castle doors are slightly ajar. No light escapes from the darkened hall beyond.*

Allow the adventurers to enter the castle by any means they choose. The windows and doors are unlocked. Map A(##) shows the general layout of the castle. All rooms appear to have been vacated except the ballroom (Area G-1).

### ACCIDENTAL DEATH & DISMEMBERMENT

*Grimtooth's Museum of Death* is extremely hazardous and completely unfair. Weak-hearted judges may temper the lethality of the traps by using the optional "Accidental Death & Dismemberment" rule. If a trap outright kills a delver, the player can opt to instead take a permanent -1 penalty to Luck and -1 to Strength, Agility, or Stamina (determine randomly) and survive with 1 hit point. Then, roll on the table below.

Roll d 14	Result
1	Empties bladder, but is otherwise healthy.
2	Lose an eye: First eye (-2 to ranged attack rolls); second eye (permanent blindness).
3	Severed hand. Lose ability to hold shield or second hand item.
4	Sprained ankle. -10' penalty to speed for 1d3 days.
5	Severed ear. Permanent -1 to Listen checks.
6	Broken spine. PC is uncontrollable from the waist down. Movement reduced to 0'.
7	Cut-off nose. Permanent loss of 1d3 Personality.
8	Broken ear drum. -2 to Reflex saves and Agility checks for 1d3 weeks.
9	Blow to head causes amnesia. PC loses long-term memory for 1 week. Casters cannot recall spells.
10	Impaled by an object. The object inflicts 1d8 damage when removed.
11	Shattered jaw. Cannot speak (or cast spells) until condition is healed (3 dice).
12	Disemboweled. Death in 1d4 turns unless the condition is healed (3 dice).
13	Throat slashed. PC takes 20 damage in next round unless healed.
14	Internal bleeding. PC seems fine, but after 1d6 hours must make a DC 20 Fort save or die instantly.

# Grimtooth's Castle

Level G 1 & 2



= 10 Feet

E = Elevator



**Level 2**  
Second Floor

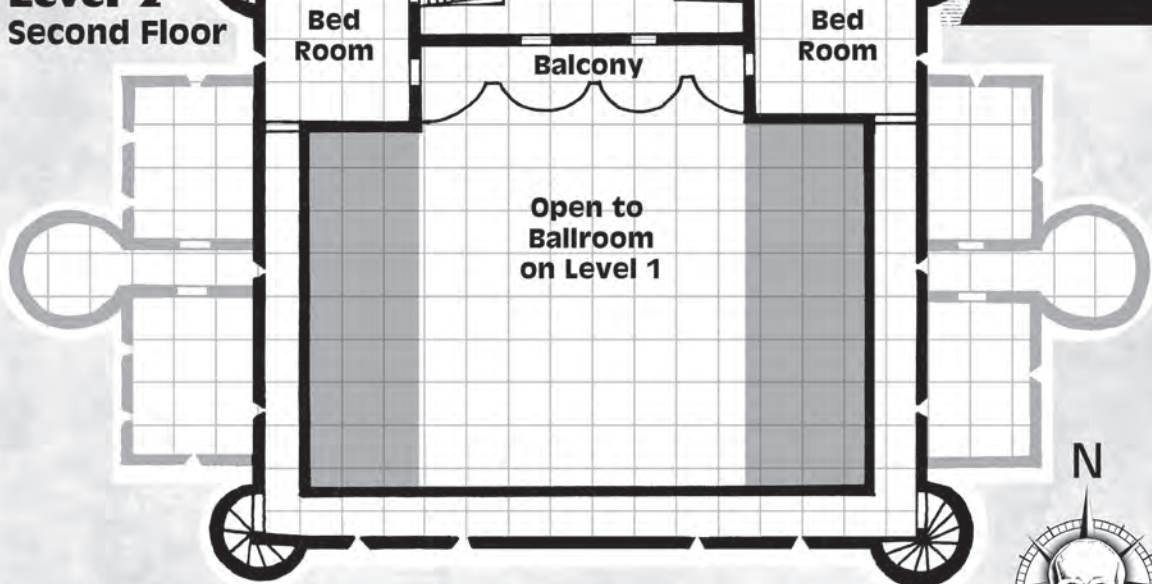

N



**Level 1**  
Ground Floor

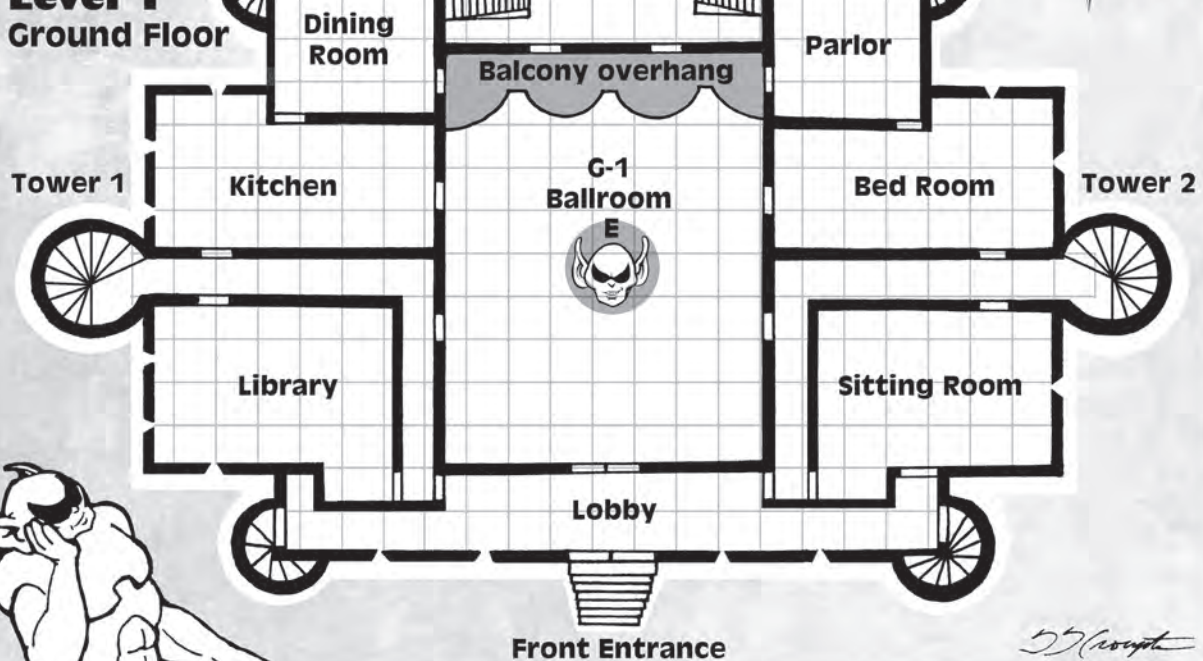

Front Entrance

*55/croquet*

The judge should extemporize the contents of other rooms. Months of dust coat every surface. Canvas tarps are draped over all furnishings, and the dressers and cupboards are bare.

**Area G-1 – Ballroom:** The entrance to Grimtooth's lair is located in the ballroom. Pushing a callbox button opens an elevator shaft leading to the lower levels. If the adventurers wish to accept Grimtooth's challenge, the elevator will transport them to Level 4: Cave Level.

When the characters reach the ballroom, read the following:

*You stand before a high-ceilinged chamber at least 100' long surrounded by balconies. Chairs and other covered furnishings have been pushed against the walls. Light filters into the dusty room through tall, narrow windows in the south wall illuminating a strange fixture at the room's center, a metal disc 20' in diameter pocketed within a metal ring. The metal disc is embossed with a grinning, pointy-eared creature with large eyes. Beside, a waist-height pole juts from the floor topped by a small box.*

The metal disc is constructed from a thick, unbreakable alloy, and bisected by a single hairline seam in which no crowbar can find purchase. A door in the small, unlocked box conceals a red elevator call button.

When the PCs push the button, read the following:

*A bell toll echoes through the hall. Bing Bong! A staccato, disembodied voice resounds through the chamber. "Ah, fresh meat – ahem, I mean – new visitors. Greetings, mortals, and welcome to my humble abode. If it is gold you seek, you shall have that and more, but first you must prove your worth. Overcome my challenges and you shall be rewarded handsomely. Failure means your doom. Before you die, please shout out a number between 1 and 10 rating how agonizing your death is, 10 being the most painful. Thank you."*

*The metal disc slowly slides open with a grating sound revealing a dazzling sight below: a 20' round vertical shaft descending into the earth, choked with whirling sword blades, spinning drill bits, and articulated buzzsaws. The deathly apparatuses suddenly shrink back as an elevator platform protected by an ethereal blue orb ascends to ground level. Within the sphere, a riveted metal box is covered with rows of holes. An entrance slides open in the glowing orb, allowing access.*

The elevator shaft from top to bottom is clogged with hundreds of traps, thrusting spears, poison darts, laser beams, and scissoring scythes. Disarming each of the thousands of traps would take several lifetimes. However, the magic shield around the elevator makes the traps retract briefly. The traps quickly close the gap once the elevator passes.

On the elevator platform, a rectangular metal control panel is covered with keyholes numbered 1-100 and has a single unilluminated button labeled "EXIT". The angled panel is roughly 2' tall by 4' wide and 4" thick, mounted on a sturdy metal post. The exit button does not function presently.

There is also a single keyhole on the underside labeled #101,

but an adventurer must specifically look up from below the control panel to see it. A single key, labeled #4, has already been inserted in keyhole #4 (for Level 4: Cave Level). The keys are used to open the entrances to the various levels of Grimtooth's Museum of Death. A Pick Lock check or using a key in a keyhole with a mismatched number causes a powerful electric shock to jolt anyone touching the panel (2d6 damage). Turning a numbered key in a matching keyhole makes the elevator travel to the numbered level.

## LEVEL 4: CAVE LEVEL



Grimtooth has populated this level with some of his minions and larger traps. Unless otherwise noted, the ceilings in the sprawling complex of caverns are 40' high and hang with hoary stalactites. Each time the adventurers arrive at a door trap or floor trap as indicated on the map, roll on Appendix D: Door Traps or Appendix F: Floor Traps to determine the type of trap. Grimtina (Area 4-5) holds the elevator key to the next level.

**Area 4-1 – In A Fog:** The floor is covered in a thick mist that conceals several pit traps.

*The whirling blades and stabbing spears retreat as the elevator shaft becomes a thick glass tube opening into a large cavern. The lift shudders to a halt at ground level as a hatch on the tube swings open. The air is cool and damp with thick, obscuring fog clinging to the floor. Passages run north and south from the chamber.*

Walking toward either exit without feeling ahead or somehow clearing the mist will cause a fall into an acid pool. The pools are 10' deep and filled to the brim with an extremely caustic acid that causes 6d6 damage per round. Delvers within 5' when someone falls in make a DC 15 Reflex save or take 1d6 damage from splashing acid. A 1'-wide walkway around each pool allows PCs to exit safely.

**Awards:** Avoiding pits (1 XP)

**Area 4-2 – The Bigger They Are:** A rocky outcropping is rigged to fall.

*The passage ends into a vaulted chamber. The way forward is blocked by 30'-high cliff wall with a protruding rocky promontory. Something atop the cliff glimmers with a white glow, reflecting off the glistening wet walls.*

The cliff wall is chossy and difficult to climb (DC 20 Strength or Agility check; thieves subtract their Climb Sheer Surfaces bonus from the DC). A 1-ton rock slab falls if the slightest weight is put on the rocky outcropping at the center of the cliff. When the slab falls everyone at the bottom in a 10'x10' area must make a DC 20 Reflex check or be crushed to death. Anyone standing on the outcropping when it falls must make a DC 15 Reflex check to get off or take 3d6 damage from the fall.

The white light is shed by a *glowmerang*, a magical boomerang that sheds as much light as a torch. The glowmerang does 1d3/1d5 damage (thieves get better damage with a backstab) and ranges 20/40/60. Each time the weapon is

# CAVE LEVEL 4

□ = 10 Feet E = Elevator

FT = Floor Trap ☙ = Door Trap

? = Mystery Room 🏹 = Archer

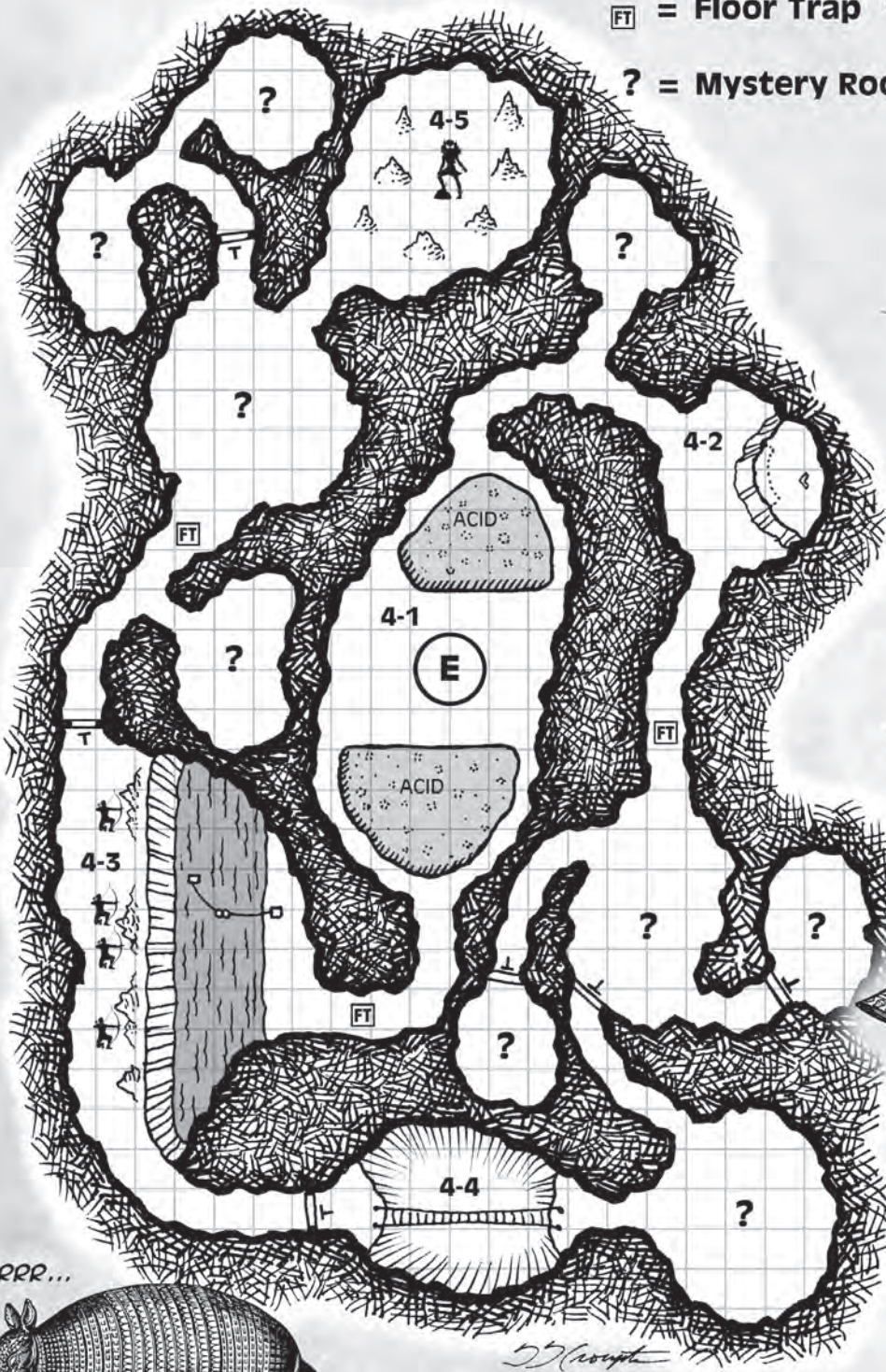

HI YA.  
WHATCHA  
DOING?

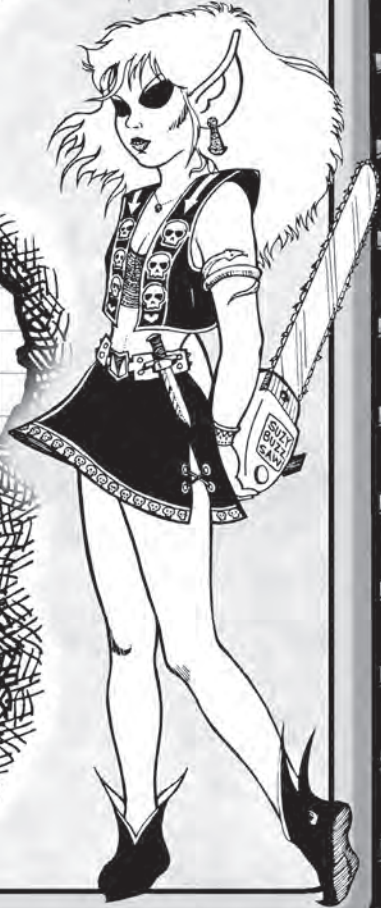

GRRR...

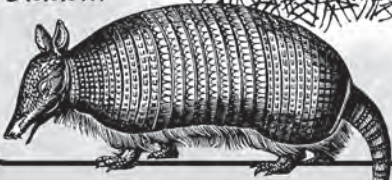

*W. Wright*



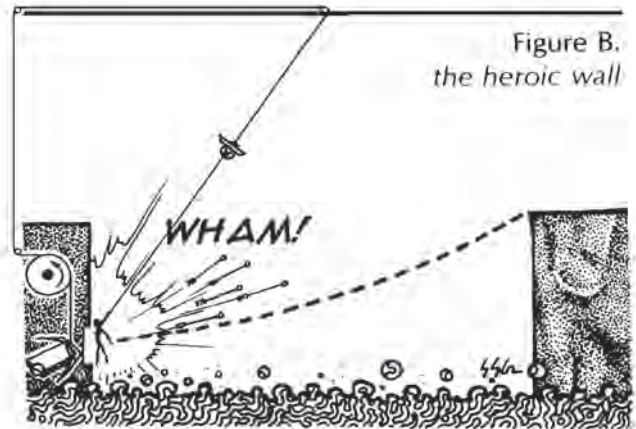
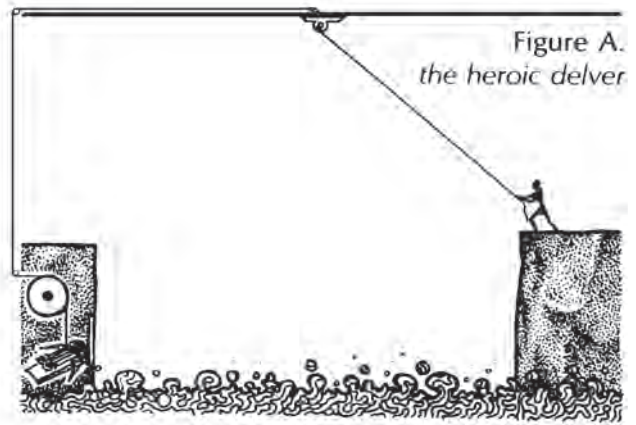
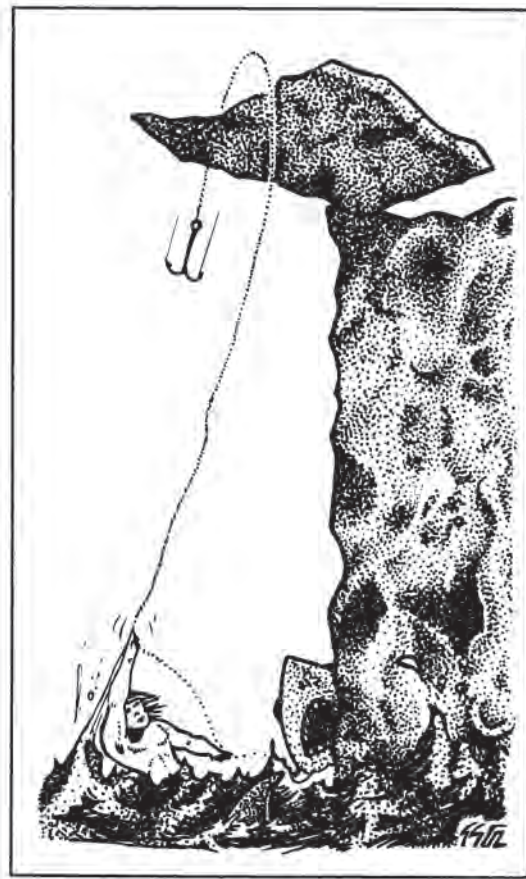

thrown, the wielder makes a DC 10 Will save to have the weapon return to his hand. Otherwise, the wielder must expend an action to order the boomerang to return.

**Awards:** Not dying (2 XP)

**Area 4-3 – The Greystoke Memorial:** A rope swing is used to cross scalding hot water springs.

*Hot humid air causes you to break out in a sweat. Steam fills the air with haze across the entire cavern. A 30'-wide chasm bisecting the room is filled with bubbling liquid, cutting you off from the cave's only other exit. A thick rope anchored to the midpoint of the ceiling has been tied to a post at the chasm's edge. The twang of a bow string interrupts your observation, and then you hear an arrow sail over your head. Green-skinned creatures with piggish noses crouch behind rocks on the far side of the chasm, nocking arrows in bows.*

Swinging on the rope would seem to be a good way to quickly cross the chasm, but it is trapped. The anchor point is connected to a pulley that gives when too much weight is applied. The rope feels secure when tugged on, but if anyone larger than a lightly-armored halfling attempts to swing across the chasm, the pulley gives up the slack, sending the swinger crashing into the far chasm wall (2d6 damage) and into the water. The best ways to cross the chasm are by spell or tossing a grappling hook across and tying it off on one of the many large rock formations.

The steaming chasm is hundreds of feet deep and filled with boiling water fed by a hydrothermal vent. The surface

of the water is roughly 20' below the rocky chasm ledge. Anyone who falls into the water takes 1d6 damage per round. Scale mail and heavier armor will sink a swimmer like a stone, requiring a DC 15 Strength or Agility check to remove. The chasm walls have been worked smooth. A swimmer has little chance to escape unless he has the ability to climb sheer surfaces or is thrown a rope.

The orcs make no attempt to cross the chasm. They prefer to take potshots from behind cover. The archers wear studded leather and quivers holding 10 arrows.

**Orcs (4):** Init +1; Atk dagger +1 melee (1d4) or shortbow +1 missile fire (1d6); AC 14; HD 1d8+1; hp 6; MV 30'; Act 1d20; SV Fort +2, Ref +0, Will -1; AL C.

**Awards:** Defeat orcs (judge's discretion), crossing the chasm (3 XP)

**Area 4-4 – Beware Flash Flood:** Crossing a rope bridge might trigger a flood trap.

*A rickety rope bridge is strung across a lightless black pit nearly 50' across. The air is damp and stinks of guano. The sound of a splashing water droplet echoes through the chamber every few seconds.*

A colony of vampiric bats roosts amongst the calciferous icicles on the cave roof. Having recently fed, the bats are in a state of torpor. Bells have been tied to the undercarriage of the bridge. Running across the bridge makes them ring, automatically waking the bats. The PCs must move quietly through this area moving at half speed (each PC makes a

DC 15 Reflex check; thieves and halflings reduce the DC by their Sneak Silently modifier) to prevent the bats from flying into a blood fury.

However, there are a few more obstacles to overcome. The bridge is weak and will break if more than 3 delvers attempt to cross at once; they can maintain their grip on the bridge with a DC 15 Strength or Agility check to avoid falling 30' into a spiked pit (5d6 damage). The ceiling of the cave is also filled with a large reservoir of water. Each time a character fires a missile weapon or casts an offensive spell into the bat swarm, there is a 50% chance of poking a hole in the ceiling and triggering a flash flood from above; all targets on the bridge must succeed in a DC 20 Fortitude or Reflex save or be washed into the spiked pit (5d6 damage).

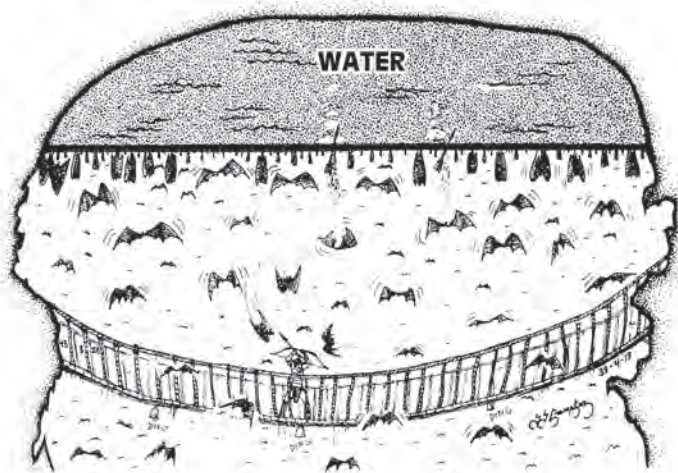

**Bat swarm, vampiric:** Init +6; Atk swarming bite +3 melee (1d4 plus disease and vampiric drain); AC 12; HD 4d8; hp 18; MV fly 40'; Act special; SP bite all targets within 20'x20' space, half damage from non-area attacks, vampiric drain (any target wounded by the swarm takes an additional 1 point of damage per round until entire swarm is killed), disease (DC 14 Fort save or terrible stomach pains, additional 1d4 damage, and unable to heal normal damage for one week); SV Fort +1, Ref +10, Will -2; AL L.

**Awards:** Defeat bats (judge's discretion), crossing bridge (3 XP)

**Area 4-5 – Trollettes Rule:** Grimtooth's sister, Grimtina, toys with the delvers.

*You hear the sound of shifting rubble as a shadowy figure leaps to the ground behind you, blocking the exit. The creature appears to be a female nearly 8' in height with tall pointy ears, a mangy mop of white hair, skin of ashen grey with a tinge of purple, and large almond-shaped eyes, jet black and soulless like a shark's. Her armor is black with two vicious shoulder spikes. A metal key hangs from a loop on her belt. The creature strikes a pose and flashes a toothy grin – a gesture that may be coquettish among her race, but under the circumstances is horrifying. The vile thing speaks in a chirpy voice. "Hiya. Whatcha doing?"*

The creature introduces herself as Grimtina. She engages in light conversation with the party, but she responds to all questions in the vaguest manner possible or with outright misdirection. Grimtina's personality is much like a kid sis-

ter or flighty teen. She is invulnerable to all attacks, possesses inhuman strength, and splits anyone who touches her from skull to groin with her chainsaw. Save versus moron always fails. In combat, Grimtina stays her hand until attacked, and then metes out harsh retribution. Her attacks are always delivered with a quip or pun.

After a couple exchanges, Grimtina says, "This is boring. Let's play a game. If you solve my riddle, I'll let you go. If not, you all die." The characters have one chance to answer the following riddle:

*What is the creature that walks on five legs in the morning, three hands at noon, and tolls bells of three in the evening?*

The riddle has no solution. Grimtina keeps pestering the characters for an answer while revving her chainsaw. When the delvers arrive at a solution, she asks, "Is that your final answer?" Whatever the answer, Grimtina responds, "Eh? Close enough. Take this." The trollette tosses the adventurers a key imprinted with the number 24. "Tell my brother he's a dweeb."

**Grimtina:** Init SP (delays until attacked); Atk chainsaw +21 melee (10d10); AC 41; HD 10d30+100; hp 255; MV 30'; Act 1d20; SP invulnerable to damage, immune to magic; SV Fort +17, Ref +25, Will +15; AL C.

**Awards:** Obtaining the key to Level 24 (4 XP)



## LEVEL 24: ADMINISTRATIVE LEVEL



ataloging and maintaining Grimtooth's enormous collection of death traps is an overwhelming task. It takes a staff of hundreds to keep the operation running smoothly. Level 24 is home base to the administrators who keep the steady supply of blood greasing the wheels of the Great Troll's grand death machine.

**Area 24-1 – Lobby:** This room is merely the foyer to evil.

*The endlessly gyrating trap machinery retreats as the elevator comes to rest before metal double doors. A brass plaque over the doors reads "ADMIN LEVEL 24". The door gently slides open. A bespectacled demonic creature with small horns on a balding pate sits behind a mahogany desk. Filing cabinets overstuffed with paperwork fill every available space between the doors on each wall. To your right, you see a large room with neat rows of chairs.*

*The demon looks flabbergasted. "How did you get here? You aren't supposed to be here," he sputters. He stands and you see he wears a butler's livery and holds a key in one hand.*

Sludgeworth, Grimtooth's majordomo, oversees the operations of the museum from this level. The demon wears a butler's livery and has a calm demeanor. Sludgeworth speaks briefly with the delvers, then hands them a ticket labeled #5,345. He instructs them to go to the waiting room until their number is called.

If attacked, Sludgeworth hits an emergency lockdown switch and screams, "Security!" Iron gates swing down over all doors except the elevator. A group of trollish security guards arrive in 1d3+1 rounds.

**Sludgeworth:** Init +3; Atk claw +12 melee (1d8+4 plus dis-

ease) or spell (below); AC 17; HD 11d12; hp 72; MV 30'; Act 2d20; SP disease (DC 18 Fort save or temporarily lose 1d4 Strength), infravision, *darkness* (+12 spell check), immune to weapons of less than +2 enchantment, half damage from magic, teleport to home plane at will, crit range 18-20; SV Fort +8, Ref +9, Will +7; AL C.

**Trollish security guards (4):** Init +4; Atk longsword +12 melee (1d8+6) or longbow +10 missile fire (1d6+4); AC 18; HD 4d8; hp 18; MV 20'; Act 1d20; SV Fort +8, Ref +4, Will +4; AL N.

**Area 24-2 – Waiting Room:** This is the actual antechamber to evil.

*This square room is filled with four rows of uncomfortable-looking chairs facing the lobby. A water cooler and trashcan are positioned in the corner. A chime sounds and you hear the demonic butler's voice over a loudspeaker. "Now serving delver #47. Delves #47."*

Sludgeworth does his best to delay and frustrate the PCs as long as possible. The party needs to come up with some way to steal his key (labeled #13) by creating some kind of diversion. Sludgeworth will leave his key on his desk while investigating the disturbance.

The water cooler in the corner has a cup dispenser and appears to be filled with potable water. This is actually a trap (DC 25 Find Trap check) filled with acid that is waiting to be moved to Level 37. If a character tries to use it, the water bottle explodes causing 3d6 damage to all targets within a 20' radius (DC 20 Reflex save for half damage) including Sludgeworth. The angry demon will race into the waiting room and go on a tirade. This would be a good time to try and grab his key.

**Awards:** Obtaining the key to Level 13 (3 XP)



# LEVEL 24: ADMIN

□ = 5 Feet E = Elevator

⌘ = Chair 🍃 = Brazier

📚 = bookcase

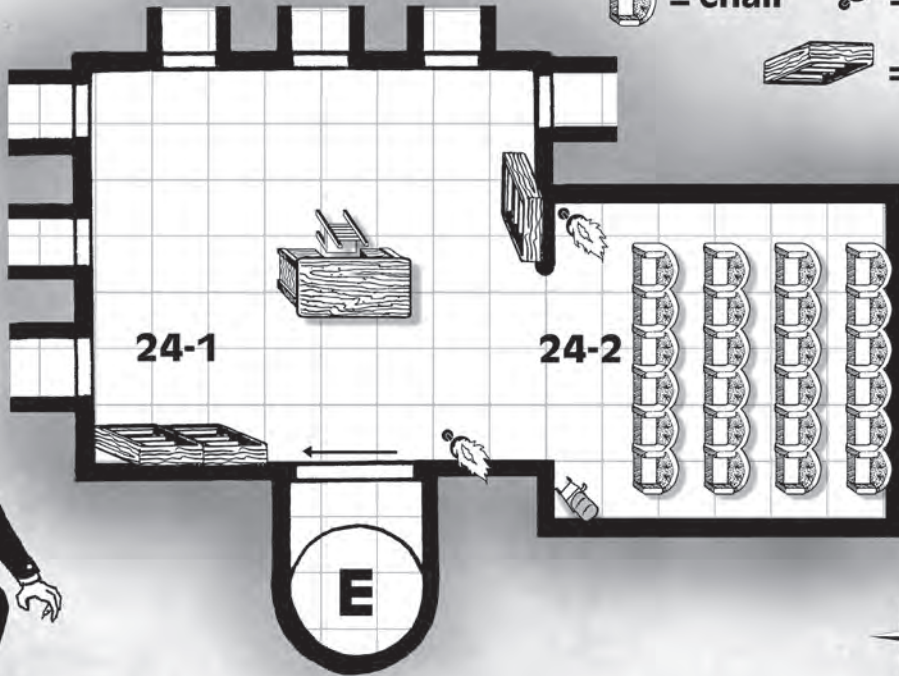

**Admin...**

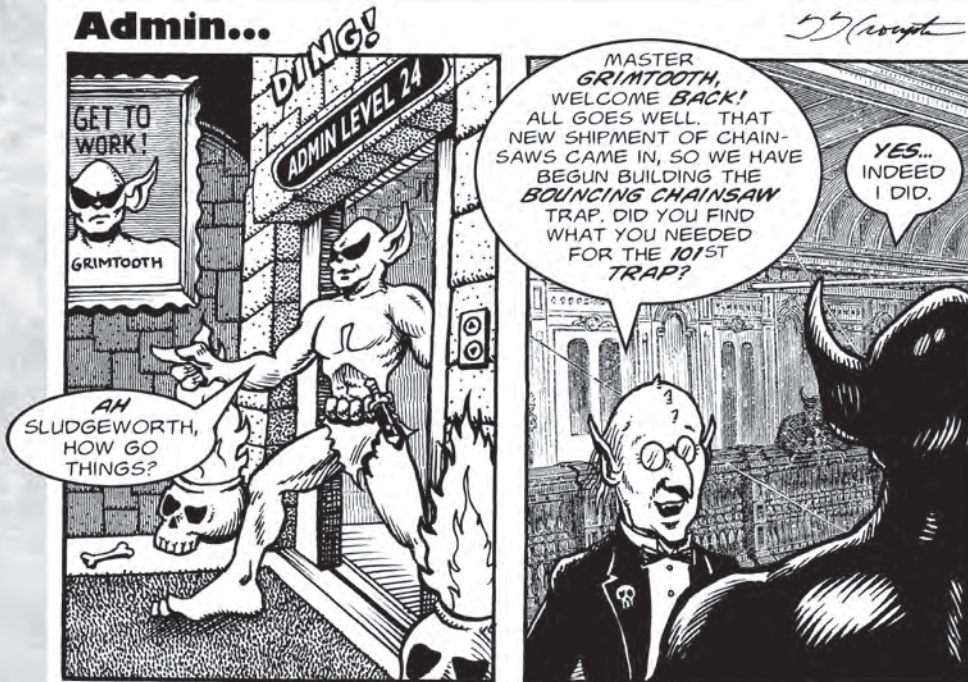

# LEVEL 13: TRAP TEST LEVEL



rimtooth's nastiest traps are located on this level. The entire wing has a sterile feeling. The floors and ceiling are constructed from stone brick and tile. There are few furnishings or decorations. Each time the adventurers arrive at a door trap or floor trap as indicated on the map, roll on Appendix D: Door Traps or Appendix F: Floor Traps to determine the type of trap. All secret doors are simple revolving walls triggered by pressing a loose brick. Spike the Grimdog (Area 13-11) holds the key to the next area.

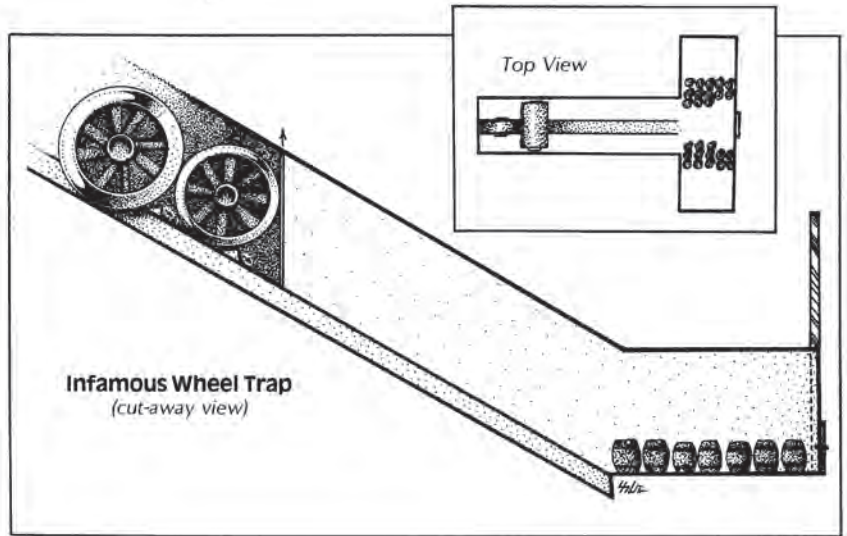

**Area 13-1 – Landing:** The elevator is located in this area.

The elevator platform stops at a door with a brass plaque over it reading "LEVEL 13". The door slides open to reveal a square room. The walls and floor are built from worked stone brick and tile. In the far left corner, a sawhorse with a note reading "UNDER CONSTRUCTION" has been placed in front of a hole. A door stands in the middle of the wall directly in front of you.

The sawhorse marks a 15'-deep pit trap. The bottom is lined with poisoned punji sticks. Falling into the pit causes 2d6 damage plus a random poison from Appendix P in the core rulebook. This pit trap is provided to increase the adventurers' paranoia level and can also be linked to one of the teleport traps from the *Grimtooth's Traps* series if desired. The door leading deeper into the level may be trapped; roll on the table in Appendix D: Door Traps to find out. Don't forget to roll on the trap appendix tables each time the map indicates a trap.

**Area 13-2 – Infamous Wheel Trap:** A deadly wheel and acid trap is set here.

You stand at the head of a T-shaped junction. Wooden barrels are arranged on each side of the door blocking the way into the alcoves. The corridor ahead is 15' wide and ramps up a steep pitch to a door. A 5' trench is dug in the center of the ramping corridor.

The barrels are sealed tightly and cannot be opened short of breaking (20 hp each). Rocking a barrel from side to side reveals the sloshing sound of some liquid. The door at the top of the ramp is a false wall hiding 2 large crushing wheels. A nearly invisible trip wire halfway up the ramp triggers the trap (DC 25 Find Trap check).

When the trap is sprung, the false wall at top of the stair raises to the ceiling as a metal portcullis slams shut over the entrance, blocking exit. An enormous cylinder that fills the entire corridor speeds down the incline. To run this trap, call for initiative and roll for the cylinder (Init +2). The trench can be used to avoid the rolling cylinder. Delvers with higher initiative than the cylinder can leap into the trench with a DC 15 Reflex check. The cylinder speeds down the incline on its turn crushing anyone on the incline

or at the base (5d10 damage; DC 20 Reflex save for half damage) and shatters the barrels, spraying acid in all directions. All targets within 20' of a shattered barrel take 2d6 splash damage, including those in a straight line beyond the portcullis.

**Awards:** Not dying (4 XP)

**Area 13-3 – Illusions:** An illusory pit trap fools characters into making a wrong step.

A 10'-deep spike-filled pit takes up most of the floor area of this room. A 2'-wide ledge runs around the entire perimeter of the room. A wooden door is located at the far end of the room.

Should a delver poke or reach into the spiked pit, they will discover an invisible barrier that prevents reaching into it, but that's no barrier. It's solid floor. The pit is actually an illusion (that can be banished by a *dispel magic* spell). The safe path through this room is to stroll across the center of the room. The ledges on either side are spring loaded. Half-way across the ledge, anyone over the weight of a lightly-armored halfling triggers the trap, and is flung into invisible spikes on the ceiling for 4d8 damage.

**Awards:** Not dying (3 XP)

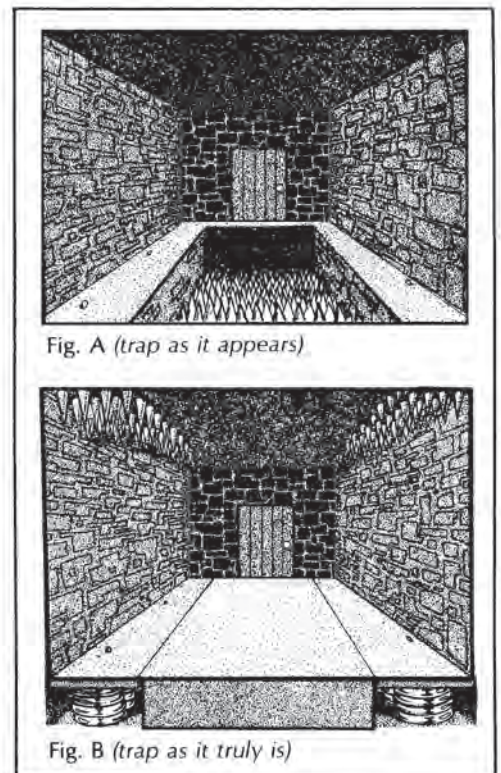

# LEVEL 13: TRAP TEST LEVEL

□ = 10 Feet E = Elevator

T = Trapped Door

SD = Secret Door

FD = False Door

FT = Floor Trap

? = Mystery Room

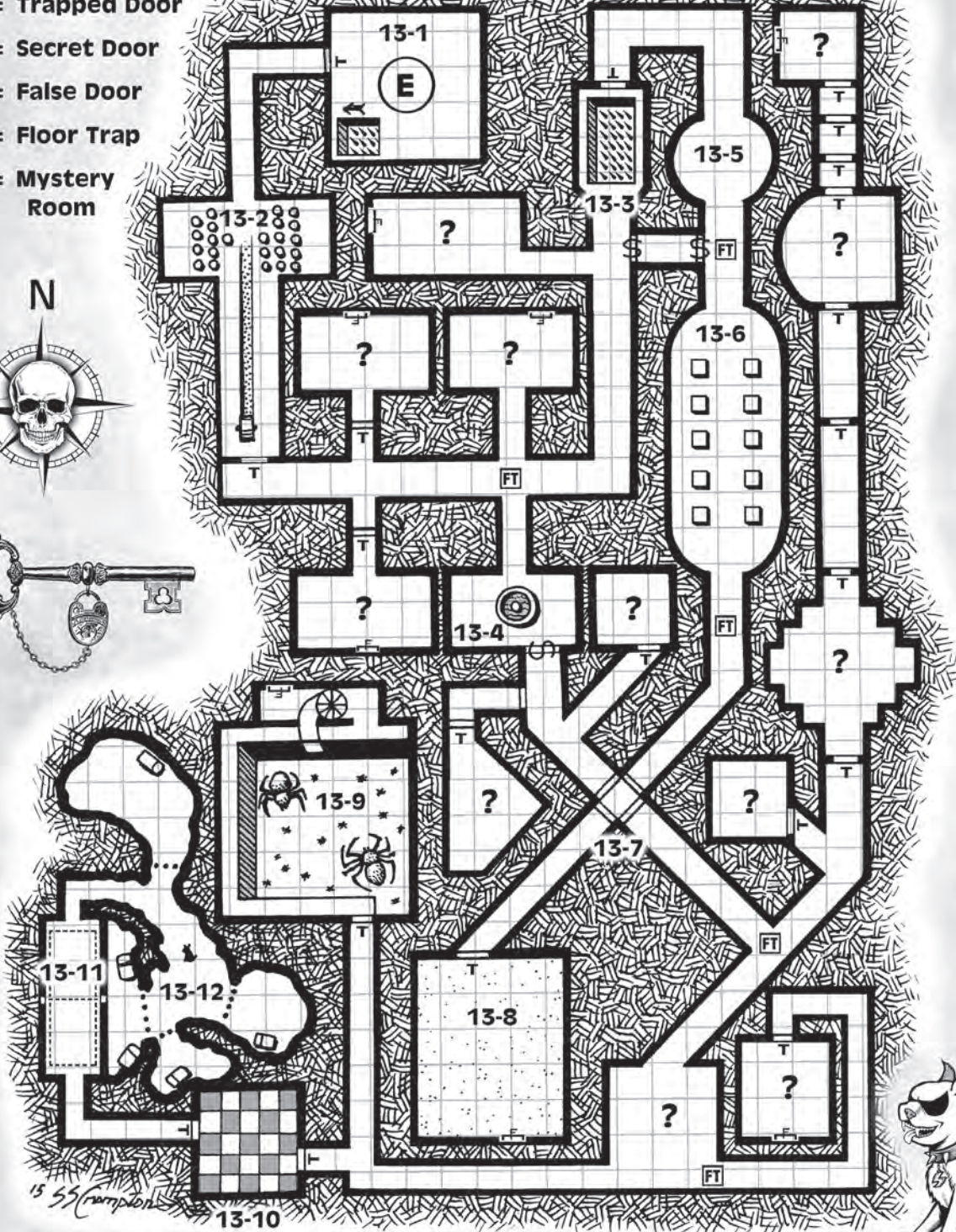

15 SS Crampson



**Area 13-4 – Fountain Trap:** This wishing well comes straight from hell.

*The sound of gently gurgling water alights upon your ear. A white marble fountain and basin splashes in the center of the room. The silvery glint of platinum coins shimmers beneath the cool refreshing waters.*

The fountain is imbued with the same enchantment that grants animation to gargoyles. It remains motionless until someone disturbs its waters. A character who reaches into the water to retrieve the 5 platinum coins must make a DC 20 Reflex save or a stone manacle clamps around his or her wrist and the marble basin quickly contracts, causing 1d6 damage and submerging the character's upper body beneath the water. If a character instead tries to remove the coins using an implement or a spell, the fountain snaps closed to either prevent the removal of its precious coinage or to smack a character leaning too close to the fountain's edge (DC 15 Reflex save or 1d6 damage from the fountain's blow).

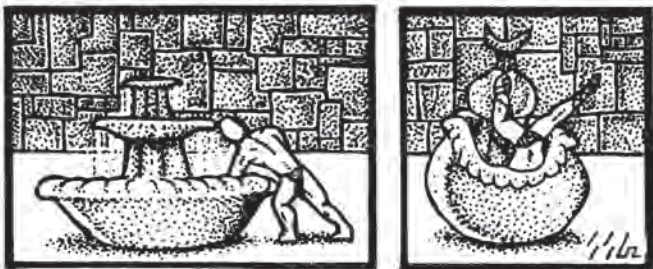

Each round, a manacled delver takes an additional 1d6 damage from drowning and constriction until they escape (DC 25 Strength check). The fountain can also be smashed open. For destruction purposes, the fountain has AC 10, 50 hp, damage resistance 3, and takes half damage from edged weapons.

**Awards:** Retrieving the coins (1 XP)

**Area 13-5 – The Weirdness:** A strange sound follows the party.

*The stone tiles here continue from the floor up the walls to the vaulted ceiling. A high-pitched tone suddenly beeps in empty air somewhere above your head. Then, all is silent.*

The beeping sound is maddening, but otherwise harmless. The phantom beep follows the party around, always floating in the air above, and makes a sound every 30 seconds. When the beep is near, monsters receive a +5 bonus to initiative due to hearing the warning. Fortunately, the phantom beep is slow moving (30' per round). If the characters run more than 100' away, the phantom beep stops making sounds and stays in place until another adventurer crosses its path.

**Area 13-6 – Hall of Wonders:** This exhibit lures the greedy into a gas trap.

*A grand hallway with a high arched ceiling stretches before you. Glass display boxes 2' square and 5' tall are arranged in neat rows, five on each side of the hall. Each display case holds various*

*items: swords, pieces of armor, and jewelry. A passageway can be seen at the other end of the hall.*

The glass cases purport to display an array of fabulous items. A hand-drawn card inside each case notes the items' names: Flame Tongue, Holy Avenger, Mace of Smiting, Ioun Stone, Helm of Telepathy, Necklace of Fireballs, Staff of the Magi, and Deck of Many Things. These items are actually powerless replicas gilded with gold leaf and decorated with jewels of cut glass.

The display cases do not have hinges, locks, or any obvious method of opening. They are sealed airtight. Breaking the glass is the only means of gaining entry, but this sets off the trap. The displays are pressurized with clear poison gas. When the glass is breached, a hissing noise and strange sulfur odor emit from the base of the case as the gas fills the hall. Roll initiative. In the first and second round, each PC in the hall must make a DC 15 Fort save or fall asleep – a second failed save causes death. Even worse, the poison gas is flammable. At the end of the second round, the gas ignites if there are any open flames (torches, lanterns, etc.), triggering an explosion that does 10d6 damage to targets in the hall and tossing anyone in the adjacent passages 1d3x10' by the explosive force.

**Awards:** Triggering the trap and surviving (3 XP)

**Area 13-7 – Mapper Maddener:** The walls in the junction reconfigure each time the characters pass through. The first time the PCs traverse this area, all 4 walls are retracted. Once the party has passed out of sight range, roll a d3 for each wall; on a 1, the wall is toggled either up or down. Thieves can detect and retract the walls (DC 10 Find/Disable Trap checks). Elves' heightened senses also allow them to detect the nature of the walls as if they were secret doors.

**Awards:** Finding and disabling trick walls (1 XP)

**Area 13-8 – Floor Creature:** The floor is actually a monster.

*The room is rectangular, barren, and unremarkable except that the tile floor glistens with dampness. The only other point of egress is a wooden door across the room.*

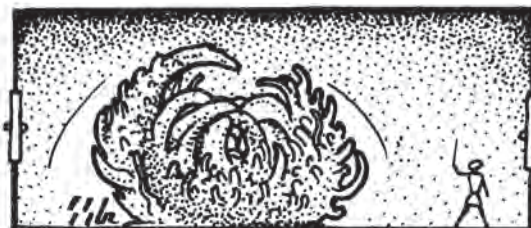
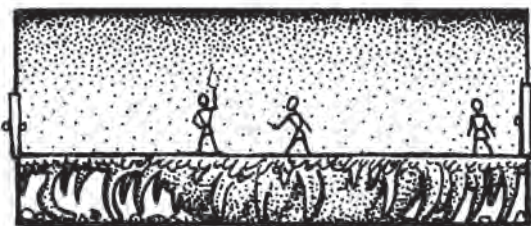

A character walking through the room will immediately notice the floor has a springy feel to it as if it is not solid beneath. As a character reaches the midway point of the room, the subfloor lurker surprises the party by springing to life and enveloping everyone in the room. PCs near the floor's edge can make a DC 15 Reflex save to avoid being trapped, but they will take 1d6 damage from falling 10' to the room's real floor. Enveloped characters are immobilized, silenced, cannot cast spells, and only do half damage with melee weapons. The lurker has sharp fangs attached to pseudopods that it can fire to impale a target up to 20' away and drag them into its mouth. Enveloped characters cannot escape until the creature is slain.

The door at the other end of the room is a false door. It will not budge. Smashing the door (15 hp) reveals the stone wall behind it.

**Subfloor lurker:** Init +4; Atk dentopod +6 melee (20' range, 1d8 plus drag and envelop); AC 13; HD 5d8; hp 23; MV 10' or climb 10'; Act 3d20; SP drag (DC 15 Fort save or target is enveloped), envelop (1d3 damage, see text for additional effects); SV Fort +10, Ref +2, Will -6; AL N.

**Area 13-9 - Door Lover's Room:** A deep pit holds a cluster of spiders.

*Old cobwebs hang from the ceiling above the 50'-wide pit that dominates this room. A 2'-wide walkway stretches along one side of the pit to an arched portal on the opposite wall. Hundreds of tiny points reflect light from the furthest recesses of the black pit.*

This room contains a pit full of spiders and a chute trap. A lantern will reveal shadowy movement in the 60'-deep pit. Dropping a lit torch down will reveal the hundreds of spiders and 2 giant spiders lurking below. The spiders silently follow the party with their eyes as they cross the room, waiting in anticipation for fresh meat to eject from the blood chute. If attacked, the giant spiders defend the cluster while the spider swarms retreat to the safety of deep cracks in the pit walls.

The archway leads to a stone spiral staircase with a door on a 5'x15' landing above. The door is fake. Any attempt to pick or open the door (DC 25 Find Trap check to avoid) causes the landing to swing open sending anyone on the landing into a blood chute (DC 20 Reflex check to avoid falling). The chute is lined with razor blades that slice and bloody victims (4d3 damage), and then jettison them out a hole 30' from the bottom of the pit (3d6 falling damage and prone). The ravenous spiders find fresh blood irresistible and immediately swarm over any downed adventurers.

**Spiders, giant (2):** Init +3; Atk bite +7 melee (1d8+2 plus poison) or web +6 missile fire (2/day); AC 18; HD 10d10+5; hp 60; MV 50' or climb 50'; Act 2d20; SP poison (DC 15 Fort save or 2d20 damage in following round); web (shoots 20'x20' spider web within 30', DC 20 Strength or Agility check to escape web, or hack free with an edged weapon [AC 15, hp 5], misfired webs land in random direction); SV Fort +3, Ref +8, Will -3; AL N.



**Spider swarm:** Init +6; Atk swarming bite +3 melee (2 plus poison); AC 11; HD 4d8; hp 18; MV 35' or climb 35'; Act special; SP bite all targets within 20'x20' space, half damage from non-area attacks, poison (DC 12 Fort save or additional 1d3 damage and slowed 1d3 rounds); SV Fort +2, Ref +12, Will +0; AL N.

**Awards:** Defeating spiders (judge's discretion), triggering the trap and surviving (2 XP)

**Area 13-10 - G-Whiz:** An antigravity trap that ends with a bang.

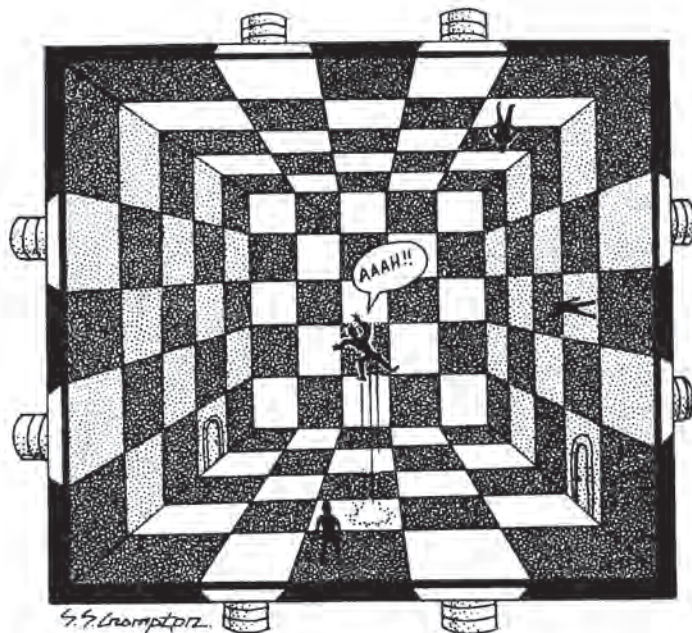



The room beyond this door is a perfect cube tiled from floor to ceiling with 5' square white and black metal plates. The only other door is an arched metal door positioned over a white tile on the other side of the room.

The white and black plates are positive and negative anti-gravity zones. The white plates start out aligned with normal gravity. The black plates reverse gravity so that stepping on it causes a 25' fall (2d6 damage) to the "ceiling". Only the plates on the ceiling and floor are currently active. Once the characters discover the nature of the tiles, it is a simple matter (a single DC 10 Reflex check) to leap diagonally from white square to white square to reach the other door. However, the last white square is trapped (DC 15 Find/Disable Trap checks). Jumping onto this square causes an explosive charge to detonate (3d10 damage) and the gravitational polarity of the white and black squares reverses. The white tiles' "ceiling" suddenly becomes its "floor". All occupants in the room fall upwards taking 2d6 damage when hitting the new floor.

**Awards:** Exiting room by opposite door (3 XP)

**Area 13-11 - Teeter-Totter Room:** Spike the Grimdog taunts the adventurers into a trap.



The ceiling in this long, featureless hall is much higher than the rest of the complex – at least 40'. From the end of the hall, you hear growling coming from the archway opposite. A small dog wearing a spiked leather collar slowly pads into hall. The canine glowers with hellish black pits for eyes, a large metal key clutched in its slavering maw. The beast suddenly turns tail, and disappears through the archway.

Grimtooth's dog, Spike, followed the scent of an intruder to this area. His master often tasks him with retrieving the keys

scattered around the complex by dead delvers. Spike bolts down the stairs to the jail cells below, hoping the adventurers will give chase and fall victim to the trap in the hall.

The floor in this room is rigged to tip like a seesaw. Metal supports brace the floor at the entrance side. Once half of the weight passes the pivot point, the entire floor swings forward and dumps its victims into a chute that empties to a locked jail cell below (Area 13-12).

**Area 13-12 - Grimtooth's Prison:** Spike the Grimdog is holding the key to the next level here.

The rock floors are slicked with slippery slime, and moldy, wet air assails your nose. Unlike the complex above, this room is carved directly into the rock. Several jail cells are set in the cave walls. Hearing your approach, the small dog squeezes through the bars of one cell and growls menacingly from safety. The key is still clutched in its bared teeth. Stairs carved in the rock lead up.

All cells in this area are locked with masterwork locks (DC 25 Pick Lock check). Each cell contains a rotted cot anchored to the wall with a rusty chain and some dented bowls and plates. PCs that fell from Area 13-11 end up locked in a cell here. In addition to picking the lock, the cell bars can be bent open with a DC 20 Strength check (though the bars are wide enough for an unarmored halfling to squeeze through).

Spike really wants to protect his master's key, but the dog is also famished. Spike can be coaxed out of the cell with food or drink. The characters need to work slowly and appear non-threatening. Any attempt to grab or attack Spike causes him to retreat to the back of the cell. Placing rations, a hunk of flesh, or a bowl filled with blood in the center of the room and retreating draws the hungry dog out. Spike drops the key and eats voraciously. A PC that moves slowly will be able to pick up the key. Spike growls and glares, but doesn't stop eating or pursue the character. The key is imprinted with the number 100.

Using violence or spells to separate Spike from his master's key is another feasible (albeit dangerous) option. Stress-induced adrenaline triggers a fantastic transformation in the Grimdog. The dog grows to a height of 10', bulging with rosy muscles of absurd proportions. Spike flies into a rabid rage and relentlessly pursues the party until they are either dead or exit the level via the elevator. It takes Spike 1d3 rounds to bash through the bars. Afterwards, he races after the party. Each time Spike downs a party member, he spends 1 minute ripping the PC to shreds (giving the rest of the characters a chance to escape).

**Spike the Grimdog:** Init +15; Atk bite +10 melee (8d10+8) or pounce (Fort DC 15 or fall prone); AC 23; HD 20d8+10; hp 65; MV 50'; Act 2d20; SP immune to magic; SV Fort +15, Ref +17, Will +14; AL L.

**Awards:** Obtaining key to Level 100 (3 XP)

# LEVEL 100-101: GRIMTOOTH'S LAIR



Grimtooth built his castle for the very infrequent entertaining he does, but the evil troll much prefers to lair on the 100th level, protected by his traps. Grimtooth awaits in his false treasure room, ready to try one last trick on the adventurers. Should the characters decipher the solution to Grimtooth's last ruse, they might reach his real treasure horde on the 101st level.

**Area 100-1 – Throne Room:** Grimtooth's false treasure room lies on this level.

*The elevator shaft's endlessly churning traps retreat and you see a glorious golden light. The platform slowly descends a massive cavern of cathedral proportions. Blazing torches illuminate mountains of gold and jewels. As the elevator comes to rest, the "EXIT" button on the elevator control panel suddenly illuminates. Before you, a pointed-eared, hairless creature the size of a hill giant reclines on a high-backed throne atop a mound of gold coins. The imposing, pale grey figure stands and regards you with large eyes black as midnight, wearing nothing but a filthy animal hide as a loincloth.*

*"Well met, delvers. I am Grimtooth and this is my home." The evil troll chortles hardily, causing the floor to shake and coins to roll from their piles. "You have bested my traps. Now I offer you this: You may have as much gold as you can carry on your person and you may name one object of your heart's desire. Should I have the item, I will make a gift of it."*

Grimtooth is indeed true to his word. The PCs may exit with as much gold as they can carry bodily. Several large bags are scattered around, free for the taking. The average character can drag roughly 150 gp in additional to their worn gear; add an additional 100 gp per Strength modifier point. Grimtooth has magic weapons, scrolls, wands, and rings aplenty that the Great Troll gleefully hands over if requested. If the item is too far-fetched, such as a ring of troll obliteration, Grimtooth will politely decline saying the item does not exist in his stores. If a PC asks for key #101, Grimtooth will frown momentarily then reach into his loincloth and hand it over. This key takes the elevator down one level to the true treasure hoard (Area 101-1).

Of course, all the treasure on this level is false. The gold crumbles to dust when exposed to sunlight, and the magic items are all cursed. After leaving the castle, the magic items become stuck in hand and cannot be removed. Any spells cast target the wielder, and any weapon bonuses become negative penalties. The item can only be removed by a 27+ *remove curse* spell check.

Attacking the evil troll is futile. Grimtooth chuckles while casually extinguishing the life of puny mortals like candles. He only exercises retribution on those who attack him, though. Once the PCs have collected their "rewards", they may return to the elevator and hit the exit button to leave. Grimtooth smiles and waves a fond farewell as the elevator rises.



**Grimtooth:** Init +25; Atk spear +30 melee (10d8+20) or chaos bolt (special); AC 50; HD 20d30+100; hp 420; MV 50'; Act 4d20; SP invulnerable to damage, immune to magic, chaos bolt (100' range, DC 25 Reflex save or disintegration); SV Fort +39, Ref +34, Will +31; AL C.

**Awards:** Obtaining the key to level 101 (5 XP)

**Area 101-1 – Treasure Room:** A dragon protects Grimtooth's real hoard on this level.

*The elevator descends into a even larger cavern than Grimtooth's throne room. You are overjoyed to find a sea of gold specked by glittering jewels in every color of the rainbow. The platform comes to rest on a circular dais. Wide marble stairs descend 20' down to the fabulous hoard below.*

Grimtooth's actual treasure hoard resides here. The party can leave with as much lucre as they can pack into the elevator. Gold can be acquired at the bottom of the stairs. Delvers can look for any sort of item they wish (e.g., sword, wand, ring, etc.). The desired item is located 1d20x10' from the bottom of the stairs. Use Chapter 8: Magic Items rules in the core rulebook to randomly determine magic item powers after the characters escape Castle Grimtooth.

After a few minutes, Grimtina's pet wyrm, Grimscale, bursts from her hiding spot beneath a pile of coins and attacks. The dragon is arrayed in oily purple scales and has the same ebon eyes as her mistress.

**Grimscale:** Init +9; Atk 2 claws +12 melee (1d8), bite +12 melee (1d12), tail slap +12 melee (1d20), and spell (see below); AC 27; HD 9d12; hp 81; MV 60' or fly 120'; Act 4d20+1d20(spell); SP spells, breath weapon, frightful presence, damage reduction, *darkness*, *ventriloquism*, *neutralize poison*, telepathic (see below for all); SV Fort +9, Ref +9, Will +9; AL C.

# GRIMTOOTH'S LAIR

KEEP OUT!

□ = 20 Feet

E = Elevator



**Throne Room  
100-1**

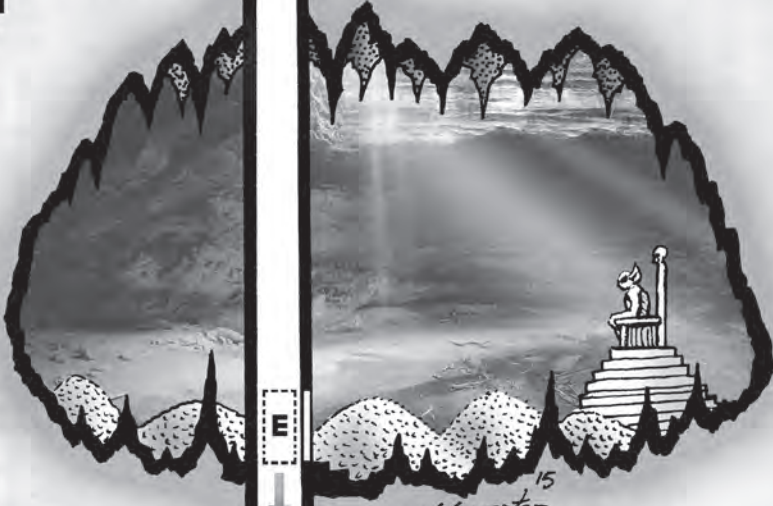

E



*15  
of Comptar*

Up



Down

**Treasure Room  
101-1**

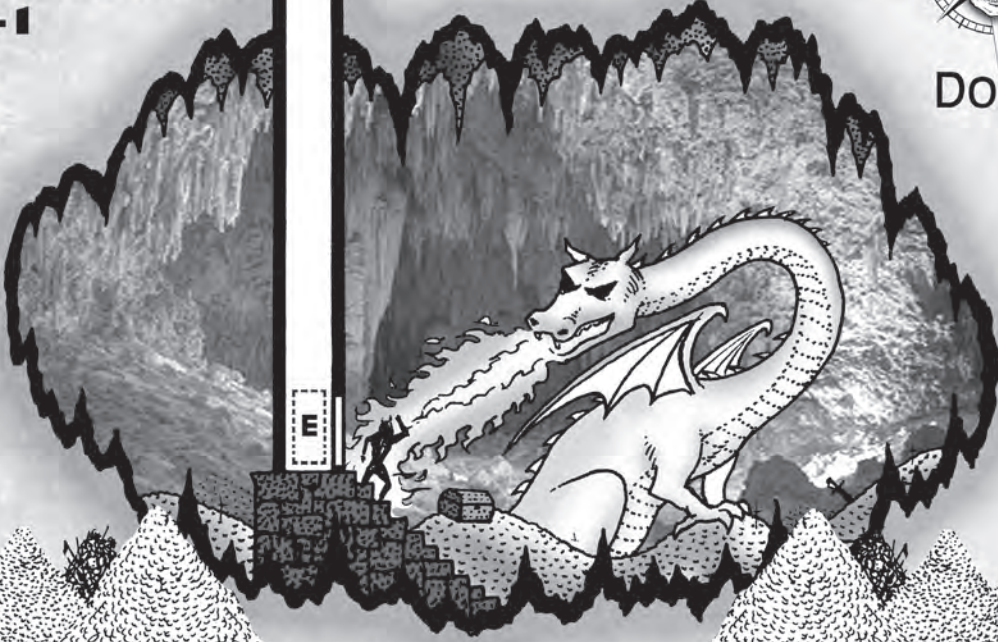

E

**The Good Stuff!**

Spells (+8 spell check); Level 1: *charm person, magic shield, flaming hands*; Level 2: *detect invisible, mirror image*.

Breath Weapon (3/day): Electricity (1-4 line forks, width 5', total length 80'); 81 hp damage (DC 19 Fort save for half).

*Frightful presence*: The dragon's visage and sheer mass are absolutely terrifying. All who look upon it must make a Will save (DC 19) or flee in terror (duration 1d4 turns or until reach a safe distance).

*Damage reduction*: The dragon's tough hide reduces the damage of all blows against it by 2 points.

*Darkness (at will)*: The dragon can cloak an area of 30' radius into absolute darkness. Target any spot within 100'.

*Ventriloquism (at will)*: The dragon can throw its voice to any point within 200'.

*Neutralize poison (1/day)*: The dragon can cancel the effects of any one poison by touching the affected creature.

*Telepathic (1/hour)*: The dragon can read the surface thoughts of one creature within line of sight.

**Awards**: Escaping with real treasure (4 XP)



## OPEN GAME LICENSE

This printing of DCC #87.5: Grimtooth's Museum of Death is done under version 1.0 of the Open Gaming License, and the System Reference Document by permission from Wizards of the Coast, Inc. Designation of Product Identity: The following items are hereby designated as Product Identity in accordance with Section 1(e) of the Open Game License, version 1.0: Dungeon Crawl Classics, DCC RPG, Mighty Deed of Arms, spell check, Luck check, spellburn, mercurial magic, corruption, disapproval, all spell names, all proper nouns, capitalized terms, italicized terms, artwork, maps, symbols, depictions, and illustrations, except such elements that already appear in the System Reference Document.

Designation of Open Content: Subject to the Product Identity designation above, such sections of creature statistics as derive from the SRD are designated as Open Game Content. Some of the portions of this book which are delineated OGC originate from the System Reference Document and are copyright © 1999, 2000 Wizards of the Coast, Inc. The remainder of these OGC portions of these book are hereby added to Open Game Content and, if so used, should bear the COPYRIGHT NOTICE "DCC #87.5: Grimtooth's Museum of Death, copyright © 2015 Goodman Games, all rights reserved, visit [www.goodman-games.com](http://www.goodman-games.com) or contact [info@goodman-games.com](mailto:info@goodman-games.com)" DCC #87.5: Grimtooth's Museum of Death is copyright © 2015 Goodman Games. Open game content may only be used under and in the terms of the Open Game License.

### OPEN GAME LICENSE Version 1.0a

The following text is the property of Wizards of the Coast, Inc. and is Copyright 2000 Wizards of the Coast, Inc ("Wizards"). All Rights Reserved.

**1. Definitions:** (a) "Contributors" means the copyright and/or trademark owners who have contributed Open Game Content; (b) "Derivative Material" means copyrighted material including derivative works and translations (including into other computer languages), potation, modification, correction, addition, extension, upgrade, improvement, compilation, abridgment or other form in which an existing work may be recast, transformed or adapted; (c) "Distribute" means to reproduce, license, rent, lease, sell, broadcast, publicly display, transmit or otherwise distribute; (d) "Open Game Content" means the game mechanic and includes the methods, procedures, processes and routines to the extent such content does not embody the Product Identity and is an enhancement over the prior art and any additional content clearly identified as Open Game Content by the Contributor, and means any work covered by this License, including translations and derivative works under copyright law, but specifically excludes Product Identity. (e) "Product Identity" means product and product line names, logos and identifying marks including trade dress; artifacts; creatures characters; stories, storylines, plots, thematic elements, dialogue, incidents, language, artwork, symbols, designs, depictions, likenesses, formats, poses, concepts, themes and graphic, photographic and other visual or audio representations; names and descriptions of characters, spells, enchantments, personalities, teams, personas, likenesses and special abilities; places, locations, environments, creatures, equipment, magical or supernatural abilities or effects, logos, symbols, or graphic designs; and any other trademark or registered trademark clearly identified as Product Identity by the owner of the Product Identity, and which specifically excludes the Open Game Content; (f) "Trademark" means the logos, names, mark, sign, motto, designs that are used by a Contributor to identify itself or its products or the associated products contributed to the Open Game License by the Contributor (g) "Use", "Used" or "Using" means to use, Distribute, copy, edit, format, modify, translate and otherwise create Derivative Material of Open Game Content. (h) "You" or "Your" means the licensee in terms of this agreement.

**2. The License:** This License applies to any Open Game Content that contains a notice indicating that the Open Game Content may only be Used under and in terms of this License. You must affix such a notice to any Open Game Content that you Use. No terms may be added to or subtracted from this License except as described by the License itself. No other terms or conditions may be applied to any Open Game Content distributed using this License.

**3. Offer and Acceptance:** By Using the Open Game Content You indicate Your acceptance of the terms of this License.

**4. Grant and Consideration:** In consideration for agreeing to use this License, the Contributors grant You a perpetual, worldwide, royalty-free, non-exclusive license with the exact terms of this License to Use, the Open Game Content.

**5. Representation of Authority to Contribute:** If You are contributing original material as Open Game Content, You represent that Your Contributions are Your original creation and/or You have sufficient rights to grant the rights conveyed by this License.

**6. Notice of License Copyright:** You must update the COPYRIGHT NOTICE portion of this License to include the exact text of the COPYRIGHT NOTICE of any Open Game Content You are copying, modifying or distributing, and You must add the title, the copyright date, and the copyright holder's name to the COPYRIGHT NOTICE of any original Open Game Content you Distribute.

**7. Use of Product Identity:** You agree not to Use any Product Identity, including as an indication as to compatibility, except as expressly licensed in another, independent Agreement with the owner of each element of that Product Identity.

You agree not to indicate compatibility or co-adaptability with any Trademark or Registered Trademark in conjunction with a work containing Open Game Content except as expressly licensed in another, independent Agreement with the owner of such Trademark or Registered Trademark. The use of any Product Identity in Open Game Content does not constitute a challenge to the ownership of that Product Identity. The owner of any Product Identity used in Open Game Content shall retain all rights, title and interest in and to that Product Identity.

**8. Identification:** If you distribute Open Game Content You must clearly indicate which portions of the work that you are distributing are Open Game Content.

**9. Updating the License:** Wizards or its designated Agents may publish updated versions of this License. You may use any authorized version of this License to copy, modify and distribute any Open Game Content originally distributed under any version of this License.

**10. Copy of this License:** You MUST include a copy of this License with every copy of the Open Game Content You Distribute.

**11. Use of Contributor Credits:** You may not market or advertise the Open Game Content using the name of any Contributor unless You have written permission from the Contributor to do so.

**12. Inability to Comply:** If it is impossible for You to comply with any of the terms of this License with respect to some or all of the Open Game Content due to statute, judicial order, or governmental regulation then You may not Use any Open Game Material so affected.

**13. Termination:** This License will terminate automatically if You fail to comply with all terms herein and fail to cure such breach within 30 days of becoming aware of the breach. All sublicenses shall survive the termination of this License.

**14. Reformation:** If any provision of this License is held to be unenforceable, such provision shall be reformed only to the extent necessary to make it enforceable.

### 15. COPYRIGHT NOTICE

Open Game License v 1.0 Copyright 2000, Wizards of the Coast, Inc. System Rules Document Copyright 2000 Wizards of the Coast, Inc.; Authors Jonathan Tweet, Monte Cook, Skip Williams, based on original material by E. Gary Gygax and Dave Arneson. DCC #87.5: Grimtooth's Museum of Death, copyright © 2015 Goodman Games, all rights reserved, visit [www.goodman-games.com](http://www.goodman-games.com) or contact [info@goodman-games.com](mailto:info@goodman-games.com)

# ESCAPING CASTLE GRIMTOOTH



**G**rimtooth has one last trick up his sleeve. After the party hits the exit button, the elevator ascends slowly at first, but soon begins to rapidly increase in velocity upwards of 100 miles an hour. Roll initiative. Give the characters one round to plot a course of action. If a character jumps off the platform when it reaches ground level, he takes 6d6 damage (DC 20 Reflex save for half damage) and escapes only with carried items. No! You can't jump off a speeding elevator dragging a large bag laden with gold coins. Otherwise, the elevator catapults into the

sky at height of 100' feet per round. Jumpers from this height take 1d6 damage per 10' fallen and cannot reduce damage with a Reflex save. Each round, 20% of the gold and items fall off the platform and scatter across the countryside. The platform reaches its zenith at 500' and begins falling back to earth. After this point, characters that do not escape by some means will take 50d6 damage when the elevator craters 3 miles away in a random direction.

Characters can return to Castle Grimtooth to recover some of their lost loot. Up to 1d4 percent of the coins remain scattered in the ballroom. Pressing the elevator call button brings the familiar toll of the bell, but no one answers. Perhaps Grimtooth has stepped out for a bit...

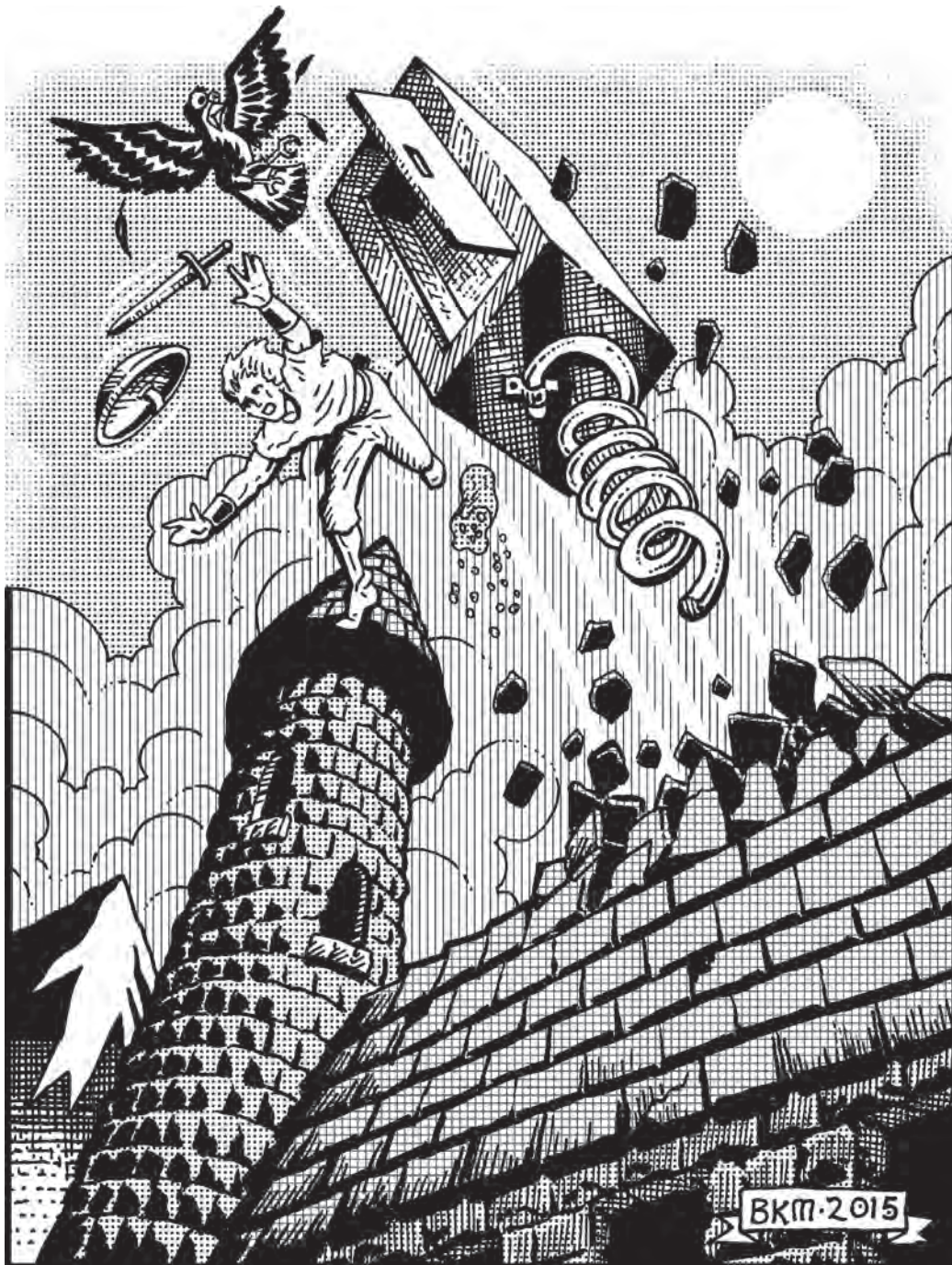

# GRIMTOOTH



f the origins of Grimtooth the Great Troll, little is known with absolute certainty. While he purports to be of the trollish race, the entity bears little resemblance to the mindless, green-skinned namesakes. Over 12' tall, the muscular ashen giant sneers with eyes like black pools of tar that seem to leech light from the air. The sage, Phondidlus, champions the theory that Grimtooth is not a troll at all, but rather an intergalactic alien traveller or the mischievous alter ego of another patron or deity.

Grimtooth has a reputation for being a master trapsmith. While the evil troll eschews the weapons and armor of modern warfare for a simple loincloth and spear, his deathtraps exhibit a level of craftsmanship and genius that approaches art. Some mechanisms even incorporate technology only seen in advanced civilizations. Grimtooth's obsession with traps hints at his murky nihilist philosophy: All mortals are insignificant and should be exterminated for a chuckle.

Those who ally themselves with the Great Troll are usually aligned with chaos. Grimtooth has no concern for the safety and wellbeing of sycophants and hangers-on. In fact, the Great Troll finds the whining pleas of puny mortals insufferably boring. Anytime Grimtooth is invoked, there is a 25% chance that the evil troll ignores the invocation even if the spell check is successful. However, Grimtooth can't resist a good joke. Uttering a pun ensures Grimtooth will not ignore the invocation.

---

## Invoke Patron check results:

- 12-13 A dart fires from a hidden mechanism, striking one target of the caster's choosing within 60'. The dart inflicts 1d4 damage and is coated in a random type of poison (roll 1d16 on Appendix P, DCC RPG, pg 446).
- 14-17 1d3+1 darts fire from hidden mechanisms, each striking a target of the caster's choosing within 60'. Each dart inflicts 1d4 damage and is coated in a random type of poison (roll 1d16 on Appendix P, DCC RPG, pg 446).
- 18-19 Like a puppet master with a marionette, Grimtooth seizes control of the caster's body with invisible strings and goes on a bloody rampage. The caster gains a +4 bonus to attack and damage rolls for 1d4+1 rounds. If the caster wields a spear, the bonus increases by +1.
- 20-23 A bowling ball drops from the ceiling over the head of a random foe within 100'. The target must make a DC 20 Reflex save, or take 2d10 damage and be knocked unconscious for 1d4 rounds.

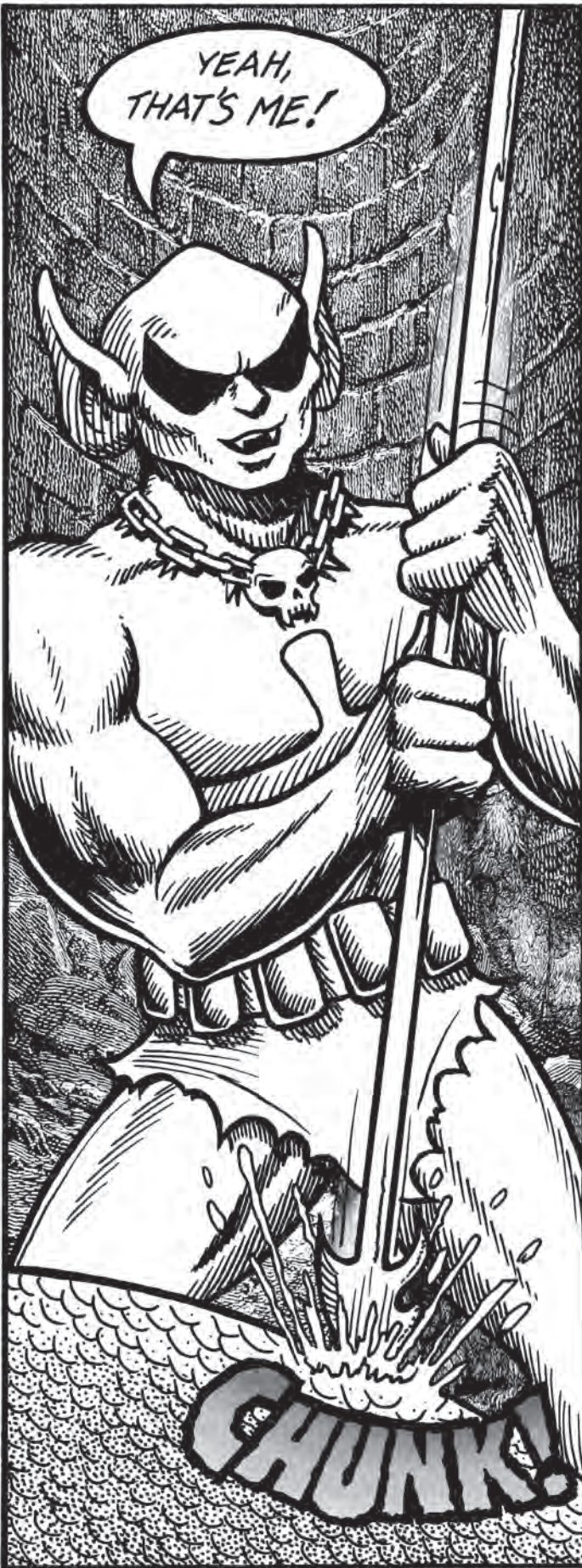

- 24-27 The caster feels Grimtooth's mischievous presence. The Great Troll causes 1d4+2 traps to spontaneously arm themselves with a Find/Disable Trap DC equal to the spell check. Each trap occupies a 5'x5' section of floor. The caster has no knowledge of the traps' placement. The judge should position the traps wherever they are most likely to crack up the evil troll. Roll 1d6 to determine trap type: (1) spike pit (10' deep), DC 20 Reflex save or 1d6+1 damage plus poison (DC 15 Fort save or death, 1d12 hp + 1d4 Str damage on successful save); (2) pressure plate launches 1d4 tranquilizer darts at random targets (DC 20 Reflex save or sleep 1d3 rounds); (3) choking gas trap, DC 20 Fort save or 1d6 damage and blinded for 1d4 rounds; (4) falling block, DC 20 Reflex save or 3d6 damage; (5) flame jet, DC 20 Reflex save or 2d6 damage plus 50% chance of bursting into flames; (6) pressure plate triggers slicing scythe from ceiling, targets in a 15' line make DC 20 Reflex save or struck by blade for 2d8 damage.
- 28-29 Same as previous, but 1d6+2 traps are created and caster knows their locations.
- 30-31 Same as previous, but 1d10+2 traps are created and the caster may choose the placement of the traps (but not type).
- 32+ The Great Troll's sister, Grimtina, drops from a trapdoor in the ceiling. The trollish killing machine, nearly 8' in height with black eyes and long flowing hair, revs a growling chainsaw. Grimtina attacks the caster's foes for 2d6 rounds. However, Grimtina's chainsaw is thirsty. Should her favored weapon not taste enough blood (75 hp) by the end of the spell's duration, Grimtina turns on the nearest creature with her chainsaw (even the adventurers) until her blood tax has been paid.

**Grimtina:** Init +9; Atk chainsaw +21 melee (10d10); AC 41; HD 10d30+100; hp 255; MV 30'; Act 1d20; SP invulnerable to damage, immune to magic; SV Fort +17, Ref +25, Will +15; AL C.



## PATRON TAINT: GRIMTOOTH

The Great Troll is a cruel and sadistic patron. Puny mortals hold no use for him outside of the pleasure he receives from tormenting them. When patron taint is indicated, roll 1d6 on the table below to find out what torture strikes Grimtooth's fancy. When a caster has exhausted all levels of effect, continue rolling on result 1.

Roll	Result
1	Through an invisible assailant, Grimtooth gives the puny caster a token of his affection. Roll 1d6: (1) kick to the groin (1d4 damage, -10' speed for 1 turn); (2) box ears (deafened 1d3 rounds, -1 penalty to spell checks); (3) uppercut (1d3 damage and bite tongue, causing -2 penalty to spell checks); (4) gut punch (1d3 damage and DC 15 Fortitude check or immobilized 1d3 rounds); (5) close shave (cuts off a wad of hair or beard); (6) leg sweep (1d3 damage and fall prone),
2	The caster has stared into the abyss of the Great Troll's ebon eyes and now the abyss has taken root. The sclera and pupil of the caster's eyes turn black. The caster's eyesight is reduced to a distance of 50' for 1 week. Everything beyond is a blur. If the result is rolled a second time, the caster's eyes double in size. If the result is rolled a third time, the caster's eyes grow even larger and more sinister, taking on the appearance of Grimtooth's. The caster gains infravision 60' and loses 2 Personality.
3	Grimtooth has laid a trap for the caster. The caster knows there is a trap, but does not know when it will strike and cannot avoid it. The judge should cause the trap to strike when least expected or most inopportune. The first time the result is rolled, a rattrap snaps the caster for 1d3 damage. The second time the result is rolled, a rope snare grabs the caster's leg, suspending the caster upside down, and immobilized until cut down. The third time the result is rolled, a bear trap crushes the caster's leg for 2d6 damage, and the caster is immobilized until freed (DC 15 Strength check).
4	The caster hears Grimtooth's maniacal laugh even when covering his or her ears. The howling laughter goes on for 1 turn, during which time the caster has trouble concentrating. All spell checks, ability checks, and saves incur a -2 penalty. If the result is rolled a second time, the incessant cackling goes on for 1 day. In addition to the previous effect, the caster's sleep is disturbed. The caster is unable to rest, regain lost spells, or recover from spellburn. If the result is rolled a third time, loud insults and mocking chortles continue for an entire week, during

Roll	Result
4 cntd.	which time the caster suffers from all previous effects. At the week's end, the caster must roll under each ability score, or permanently lose 1 point of that ability from exhaustion.
5	An object suddenly falls from the ceiling or sky over the caster's head. The caster can make an immediate DC 15 Reflex save to avoid being hit by a falling brick (1d6 damage). If this result is rolled a second time, the object is a frying pan (1d8 damage). If this result is rolled a third time, the object is an anvil (4d10 damage and unconscious 1d6 turns).
6	Darts rocket at the caster from unseen holes. The caster can make an immediate DC 15 Reflex save to avoid being hit by a poison dart (1d4 damage plus jellyfish poison). If this result is rolled a second time, the dart injects giant wasp poison. If this result is rolled a third time, the dart injects black lotus poison. Poison effects are detailed in Appendix P: Poisons in the core rulebook (page 446).



## PATRON SPELLS: GRIMTOOTH

Grimtooth grants three unique spells, as follows:

Level 1: *Detect Trap*

Level 3: *Make Poison*

Level 5: *Chaos Bolt*

## SPELLBURN: GRIMTOOTH

Grimtooth has no love for this stinking mud ball planet and its population of simpering weaklings. Followers of the Great Troll learn the easiest way to curry favor is by appealing to the master's sense of humor. Unfortunately, Grimtooth is most amused by the suffering of mortals. When a caster uses spellburn, roll 1d4 and consult the table below or build off the suggestions to create an event specific to your home campaign.



Roll	Spellburn Result
1	The caster headbutts the nearest creature, resulting in 1d4 damage to the caster and the target in addition to the normal Stamina, Strength, or Agility loss.
2	Grimtooth scoffs at the caster's flaccid pleas. The caster gets an immediate melee or missile fire attack against a creature within movement range. If the blow draws blood, Grimtooth grants the spellburned ability points plus an additional 5 points in aid. Otherwise, the caster gains no benefit from the spellburn.
3	The caster causes grievous injury to himself to draw the Great Troll's attention. In addition to ability point loss, the caster must self-inflict even greater damage. Roll 1d3: (1) poke self in eyes (blinded 1d3 rounds); (2) punch self in face (1d4 damage); (3) open vein (1d3 damage plus bleeding; DC 15 Fortitude save to staunch bleeding, or suffer additional 1d3 damage per round until save).
4	Grimtooth is unmoved by the caster's demands. The caster must make a pun or only receive half the benefit of the spellburned ability points (round down).



---

---

## Detect Trap

---

<b>Level: 1 (Grimtooth)</b>	Range: 20' or more Duration: 2 turns Casting time: 2 actions Save: None
<b>General</b>	The caster senses the location on triggers, traps, and snares within range.
<b>Manifestation</b>	See below.
<b>1</b>	Lost, failure, and patron taint.
<b>2-11</b>	Lost. Failure.
<b>12-13</b>	The caster has an unfocused sense of danger when approaching traps with a Find Trap DC of 10 or less within range. This sense can manifest as hair rising on the back of the neck, ringing in the ears, or a tingling sensation on the forehead. Traps behind 3' of wood, 1" of solid metal, or 1' of stone are not detected.
<b>14-17</b>	The caster has an unfocused sense of danger when approaching traps with a Find Trap DC of 15 or less within range. This sense can manifest as hair rising on the back of the neck, ringing in the ears, or a tingling sensation on the forehead. Traps behind 3' of wood, 1" of solid metal, or 1' of stone are not detected.
<b>18-19</b>	The caster has a directional sense of danger when approaching traps with a Find Trap DC of 15 or less within range. This directional sense extends in a cone from the caster's head, 20' long and 20' wide. Outlines of an eye-shaped symbol appear floating at the caster's forehead. Traps behind 3' of wood, 1" of solid metal, or 1' of stone are not detected.
<b>20-23</b>	The caster has a directional sense of danger when approaching traps with a Find Trap DC of 20 or less within range. This directional sense extends in a cone from the caster's head, 20' long and 20' wide. Outlines of an eye-shaped symbol appear floating at the caster's forehead. Traps behind 3' of wood, 1" of solid metal, or 1' of stone are not detected.
<b>24-27</b>	The caster has a directional sense of danger when approaching traps with a Find Trap DC of 20 or less within range. This directional sense extends in a cone from the caster's head, 30' long and 10' wide. The caster can describe the trap in enough detail for an ally to gain a +1 bonus to a Find/Disable Trap check against the trap. A spectral eye-shaped symbol appears floating at the caster's forehead.
<b>28-29</b>	The caster has a directional sense of danger when approaching traps with a Find Trap DC of 25 or less within range. This directional sense extends in a cone from the caster's head, 40' long and 5' wide. To the caster, the trap's triggering mechanism is limned in radiant light within line of sight. The caster can describe one trap in enough detail for an ally to gain a +3 bonus to a Find/Disable Trap check against the trap. A glowing eye-shaped symbol appears at the caster's forehead.
<b>30-31</b>	The caster can determine the exact location of traps with a Find Trap DC of 25 or less within an 80' radius. To the caster, trap mechanisms are limned in radiant light within line of sight. The caster can describe one trap in enough detail for an ally to gain a +5 bonus to a Find/Disable Trap check against the trap. A glowing eye-shaped symbol appears at the caster's forehead.
<b>32+</b>	The caster has perfect awareness of the exact location of traps within a 120' radius. To the caster, trap mechanisms are limned in radiant light, even through walls. The caster can describe one trap in enough detail for an ally to gain a +10 bonus to a Find/Disable Trap check against the trap. The caster also knows the safest position to be in when the trap is triggered. A glorious eye-shaped symbol hovers above the caster, radiating light in a 60' radius.

---

---

## Make Poison

---

**Level: 2 (Grimtooth)** Range: Self Duration: Permanent Casting time: 1 round Save: None

---

### General

The caster distills powerful poisons from the glands of venomous creatures. The caster must first obtain the proper material components to create extracts; at least 1 venom extract is required to make a poison. Then, the caster picks a poison from the Poison Brewing List (below) to obtain the base DC. The base DC is further modified by the Poison Delivery Method table. Additional materials needed to complete the process cost half the target DC (rounded down) x10 gp. Once the target DC is calculated, the caster makes the spell check against that number.

Unlike most spell checks, when creating poison the caster makes a spell check against a target DC. A spell check that would reflect successful casting (14+) but fails to meet the target DC consumes the extract components, but does not create a viable poison.

Each successfully created poison grants one use of the poison attack.

Poison effects are detailed in Appendix P: Poisons in the core rulebook. However, the judge shouldn't feel limited to these poisons. The venom sac of any creature with a poison attack can be used to make extracts. The base DC for brewing purposes is equivalent to the attack's saving throw DC +5. Giant creatures add +4 to the target DC, and demonic creatures add +8. Both yield 3 extracts per creature.

---

### Manifestation

Roll 1d4: (1) Poof! A cloud of smoke mushrooms from the concoction; (2) the brew roils as it changes from one color to another; (3) the air is thick with a cloying sweet aroma; (4) the liquid's surface rises into the shape of a cobra. It hisses and strikes at the air then melts back into the cauldron.

### Corruption

Roll 1d4: (1) the joints of the caster's hand become stiff and inflamed with rheumatism; (2) acidic spray from a bad reaction leaves permanent burn marks on the caster's face or body; (3) the poison taints the caster's humors and exudes from the pores for 1 week. Anyone touching the caster must make a DC 10 Fort save or suffer effects of the poison; (4) dark colored buboes swell at the neck and armpits.

### Misfire

Roll 1d4: (1) the poison becomes volatile and explodes resulting in 1d10 damage to everyone within 10'; (2) the poison smokes, creating a 20'x20' poisonous cloud (DC 15 Fort save against target poison or suffer effect); (3) the poison splashes up into caster's eyes and mouth, resulting in an immediate save against the intended poison's effect; (4) the poison is weak (re-roll a normal result, and reduce the DC of all effects by 10).

---

1	Misfire and corruption!
2-11	Lost. Failure.
12-13	Failure, but spell is not lost.
14-15	Per poison brewing list.
16-19	Per poison brewing list.
20-21	Per poison brewing list.
22-25	Per poison brewing list.
26-29	Per poison brewing list.
30-31	Per poison brewing list.
32-33	Per poison brewing list.
34+	Per poison brewing list.

## Poison Brewing List

Poison	Base DC	Extraction
Toxic ooze	15	Toxic ooze (1 flask)
Mummy rot	17	Mummy heart
Tarantula	17	3 tarantula venom sacs, or harvest 1/3 extract/week per live tarantula
Giant centipede	18	Giant centipede venom sac (yields 2 extracts)
Black widow	19	2 black widow venom sacs, or harvest 1/2 extract/week per live black widow
Giant wasp	20	Giant wasp venom sac (yields 2 extracts)
Jellyfish	21	Jellyfish poison gland
Manticore	21	Severed manticore stinger (yields 3 extracts)
Medusa	21	Milk snake hair venom (yields 2d6 extracts per medusa)
Scorpion	21	Severed giant scorpion stinger (yields 3 extracts)
Viper	21	Viper venom sac, or harvest 1 extract/day per live viper
Cobra	23	Cobra venom sac, or harvest 1 extract/day per live cobra
Asp	25	Asp venom sac, or harvest 1 extract/day per live asp
Adder	27	Adder venom sac, or harvest 1 extract/day per live adder
Black lotus	29	2 pounds lotus bulbs

## Poison Delivery Method

Delivery	DC Modifier	Description
Balm (wound)	+0	Consumes 1 extract. Balm is pressed inside a piece of folded cloth that can be applied to weapons without making a Handle Poison check.
Contact (touch)	+2	Consumes 2 extracts. Can be applied to gloves, weapons, or any item that target may handle (e.g., applied to letter and mailed to target).
Volatile powder (area)	+5	Consumes 1 extract per 5'x5' of coverage. Additional material cost increases to target DC x10 gp. The final product is contained within a stoppered glass phial. When thrown, the glass breaks and a poisonous cloud fills the coverage area. All targets within cloud must save versus poison effect.

## Chaos Bolt

<b>Level: 3 (Grimtooth)</b>	Range: 50' or more Duration: Instantaneous Casting time: 1 action Save: Reflex vs. spell check
<b>General</b>	A bolt of chaos energy shoots from the caster's finger, causing mayhem on the battlefield.
<b>Manifestation</b>	Roll 1d4: (1) purple crackling lightning bolts; (2) ray of crimson light; (3) silvery zigzag bolt; (4) wavy arcs of spectral blue-black energy.
<b>1</b>	Lost, failure, and patron taint.
<b>2-11</b>	Lost. Failure.
<b>12-15</b>	Failure, but spell is not lost.
<b>16-17</b>	The caster releases a single chaos bolt aimed at one target within 50'. The target takes 2d6 damage and must make a Reflex save opposed by the spell check or be paralyzed 1d3 rounds.

---

---

## Chaos Bolt (continued)

---

- 18-21** The caster releases a single chaos bolt aimed at one target within 50'. The target is hurled 1d3x10' backwards (taking 1d6 damage per 10' thrown if a solid object is struck) and falls prone. If the target strikes another creature, the creature must make a Reflex save opposed by the spell check, or take half the target's damage and fall prone.
- 22-23** The caster releases a single chaos bolt aimed at one target within 50'. The target is hurled 1d4x10' in a direction of the caster's choosing (taking 1d6 damage per 10' thrown if a solid object is struck), bursts into flames, and falls prone. If the target strikes another creature, the creature must make a Reflex save opposed by the spell check, or take half the target's damage, burst into flames, and fall prone.
- 24-26** The caster fires two chaos bolts aimed at targets within 75'. Targets are hurled 1d4+1x10' in a direction of the caster's choosing (taking 1d6 damage per 10' thrown if a solid object is struck) and fall prone. If a target strikes another creature, the creature must make a Reflex save opposed by the spell check, or take half the target's damage and fall prone. Any target of the spell must make a DC 15 Fort save or all carried weapons shatter immediately. Otherwise, the weapons become brittle (-2 penalty to attack and damage rolls).
- 27-31** The caster fires two chaos bolts aimed at targets within 75'. Targets are hurled 1d4+2x10' in a direction of the caster's choosing (taking 1d6 damage per 10' thrown if a solid object is struck), afflicted by a random condition for 1d3 rounds, and fall prone. If a target strikes another creature, the creature must make a Reflex save opposed by the spell check, or take half the target's damage, become afflicted by a random condition for 1d3 rounds, and fall prone. Roll 1d5 for condition: (1) petrification (permanent); (2) paralysis; (3) unconscious; (4) blindness; (5) shrink by half (-5' speed).
- 32-33** The caster fires two chaos bolts aimed at targets within 75'. Each bolt can strike another target within 50' for a total of 4 primary targets. Targets are hurled 2d4x10' in a direction of the caster's choosing (taking 1d6 damage per 10' thrown if a solid object is struck) and fall prone. If a target strikes another creature, the creature must make a Reflex save opposed by the spell check, or take half the target's damage and fall prone. Additionally, all primary and secondary targets must make a Fortitude save opposed by the spell check or be partially polymorphed for 1d6 rounds. Roll on each of the following tables:
- Roll 1d5 for body part: (1) right arm; (2) left arm; (3) right leg; (4) left leg; (5) head.
- Roll 1d6: (1) octopus; (2) gorilla; (3) chicken; (4) cat; (5) bear; (6) owl.
- The judge decides the effects of the transformation. For example, a character whose arm becomes an owl's wing might drop their weapon.
- 34-35** The caster fires two chaos bolts aimed at targets within 75'. Each bolt can strike 3 additional targets within 50' for a total of 6 primary targets. Targets are hurled 2d4x10' in a direction of the caster's choosing (taking 1d6 damage per 10' thrown if a solid object is struck). If a target strikes another creature, the creature must make a Reflex save opposed by the spell check, or share in the target's fate. All primary and secondary targets fall upwards up to 100' (taking 1d6 falling damage for each 10' traveled if they strike the ceiling), then drop from the height to the ground in the following round for additional falling damage.
- 36+** A storm of crackling chaos erupts around the caster in a dome with a 100' radius for 2d6 turns. Cascades of frenetic dancing purple lightning electrify targets within range. The caster cannot move the storm, but can walk through it without suffering ill effects. All others must succeed in a DC 20 Fortitude or Reflex check, or suffer the effects of pure chaos. Roll 1d22: (1) thrown 2d4x10' in random direction (taking 1d6 damage per 10' thrown if a solid object is struck); (2) weapon animates and attacks wielder (AC 14, MV 30', hp 20); (3) increases 50% in size (cumulative), +2 bonus to attacks, damage, and AC; (4) shrinks 50% in size (cumulative), -2 to attacks and -5' speed; (5) corruption, roll 1d3: [1] minor, [2] major, [3] greater; (6) heal 2 hit die of damage; (7) random appendage becomes a tentacle; (8) hot soup; (9) polymorphed, then reduce hit points by half and attack nearest creature; roll 1d6: [1] giant rat, [2] cave octopus, [3] cat, [4] kobold, [5] killer bee, [6] insect swarm; (10) immune to one kind of attack, roll 1d5: [1] fire, [2] cold, [3] acid, [4] lightning, [5] force energy; (11) teleports 2d4x10' random direction; (12) disappears, then reappears when storm dissipates; (13) turns to stone then explodes into smoking chunks of concentrated evil (instant death); (14-15) nothing happens; (16) fall asleep for 1d4 rounds; (17) 1d3 mirror images blink into existence, 75% chance attacks against caster will target a mirror duplicate (destroys image); (18) body melds with nearest creature, roll 1d6: [1-5] incapacitated permanently, [6] forms a single creature with combined stats, hit points, and action die of individual creatures; (19) armor melts, negates AC bonus and inflicts 2d6 damage; (20) bucket appears over head, blinded; (21) sliced by invisible force for 12d6 damage; (22) spontaneous decapitation (instant death).

# APPENDIX D: Door Traps

## Door Traps (Roll 1d12)

1-5: No trap.

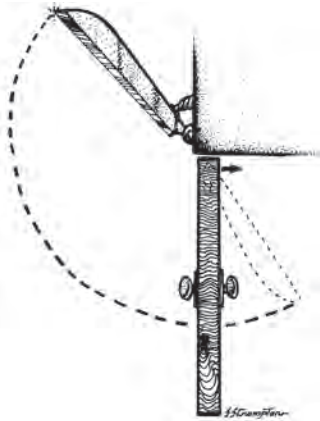

**6:** Undetectable. Strikes person in front of door. DC 20 Ref save or 4d8 damage. (GT 32)

**7:** Triggered by pressure plate 5' in front of door (DC 20 Find/Disable Trap checks). Fires in straight line. DC 20 Ref save or 3d4 damage. (TT 39)



**8:** DC 15 Find/Disable Trap checks, or touching handle releases 20'x20' poison cloud. DC 20 Fort save or poisoned. Poison is aerosolized version of a random poison from Appendix P in the core rulebook. (GT 33)

**9:** DC 30 Find/Disable Trap checks or detect magic spell. Opening door causes monsters to teleport into room. Roll 1d12: (1) mummy; (2) 2d4 giant rats; (3) ogre; (4) type III demon; (5) minotaur; (6) 2d6 orcs; (7) primeval slime; (8) 2 owlbears; (9) 2d3 hobgoblins; (10) 2d8 zombies; (11) air elemental; (12) 2d12 kobolds. (GT 34)

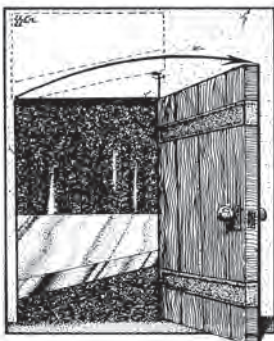

**10:** Door itself is unlocked and not trapped. Pressure plate (DC 15 Find/Disable Trap checks) beyond threshold drops guillotine blade on first to pass through door; DC 20 Ref save or 2d12 damage. (GT 33)

**11:** Heavy iron portcullis with a winch on opposite side. DC 25 Strength check to partially lift (-5 to DC for each additional lifter). Pressure plate on opposite side causes guillotine to drop. DC 25 Ref save or 3d20 damage. (TA 45)

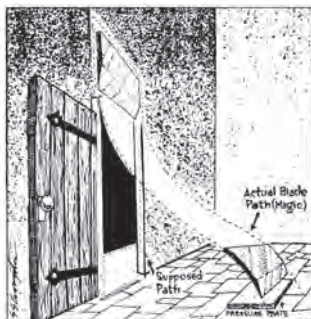

**12:** Door is open and guillotine trap clearly visible. Pressure plate 5' in front of door triggers trap (DC 15 Find/Disable Trap checks). DC 25 Ref save or 4d10 damage. (TA 44)

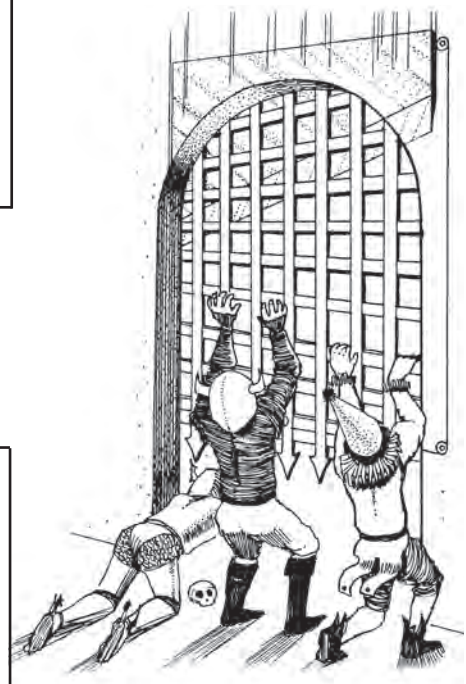

# APPENDIX F: Floor Traps

Floor Traps (Roll 1d12)

1-6: No trap.

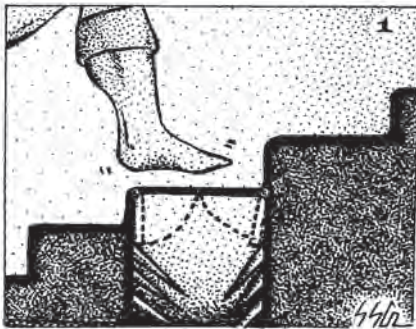

7: Undetectable without touching. A jump across a 5'-wide spiked pit looks easy (DC 10 Agility check). However, the other edge is illusory. The character takes 1d4 damage from hidden spikes, and then must succeed in a DC 20 Reflex check or fall into a 20'-deep spike-filled pit (2d6 falling damage plus 1d8 damage from spikes). (TT 33)

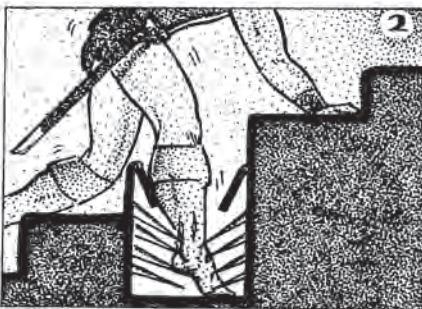

8: A trick stair (DC 15 Find/Disable Trap checks) ensnares the delver's leg with angled spear tips as a giant cobra falls from a hatch in the ceiling. The target is immobilized until 5 minutes can be spent safely extracting leg. Otherwise, the delver can rip out foot for 3d4 damage. (GT 29)

Cobra, giant: Init +8; Atk bite +6 melee (2d4 plus poison); AC 14; HD 3d8; hp 14; MV 40'; SP 25% chance of spitting, poison (DC 20 Fort save or death); Act 1d20; SV Fort +3, Ref +8, Will +2; AL N.

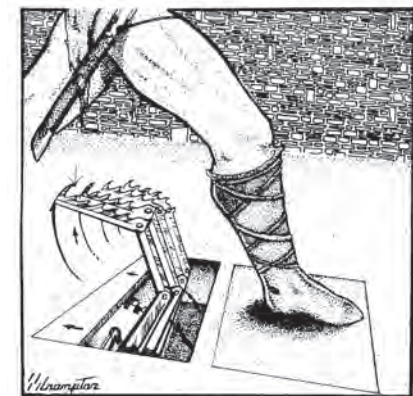

9: Weight-sensitive plate (DC 15 Find/Disable Trap checks) drops down as a razor-sharp blade slices across the depression. DC 25 Reflex save or 2d6 damage and the delver's foot is amputated. (TA 26)



10: Pressure plate (DC 15 Find/Disable Trap checks) triggers a swing arm loaded with barbs to rake the delver's calf. DC 20 Reflex save or 2d6 damage and -5' movement for 1d3 days. (GT 29)

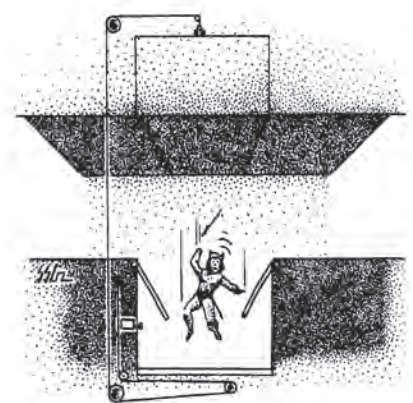

11: A 10'x10' section of floor breaks away (DC 15 Find/Disable Trap checks) dropping delvers into 10'-deep pit. DC 25 Reflex save or targets fall in, setting off a pressure sensitive switch that drops a 2-ton stone block. Delvers and all their equipment are pulverized. (GT 17)

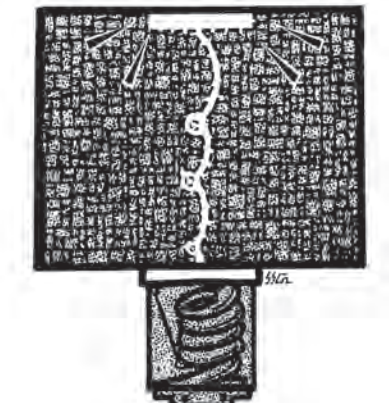

12: A 5'x5' spring-loaded floor tile (DC 15 Find/Disable Trap checks) launches a delver into the ceiling for 2d6 damage or 1d6 for each 10' of ceiling height, whichever is greater. (GT 28)

# We're with the band.



**The band of adventurers, that is. Join us in the pages of Dungeon Crawl Classics adventure modules. Stand-alone, world-neutral, all new, and inspired by Appendix N. Learn more at [www.goodman-games.com](http://www.goodman-games.com).**



# DCC RPG

# DUNGEON CRAWL CLASSICS

## GRIMTOOTH'S MUSEUM OF DEATH

#87.5: A LEVEL 1 ADVENTURE  
BY JOBE BITTMAN WITH  
STEVE CROMPTON

**After three decades of preparation, the evil troll Grimtooth has finally thrown wide the gates of his abode to all comers. The troll has sent ravens far and wide inviting delvers to share in the vast wealth of his treasure room. Of course, there is a catch. The adventurers must wend their way through a maze of traps in Grimtooth's Museum of Death, a curated collection of the deadliest and most devious traps ever assembled in one place. Along the way, they might even cross paths with a few of Grimtooth's allies: Grimtina, Spike the Grimdog, and Sludgeworth. Tread lightly, delver. There are no refunds for this tour.**



**\$9.99**  
**GMG50875**