

TACTICAL COMBAT RULES

HEAVY GEAR



THE INTERPOLAR WAR BEGINS

TACTICAL COMBAT

THE SCIENCE FICTION TACTICAL GAME

WELCOME TO TERRA NOVA •
RATINGS, SKILLS AND SK
NEW SKILLS • WEAPONS •
SYSTEMS • TURNING • TERR
EFFECTS • STEALTH EFFEC
CALLED SHOTS • INDIRE
INFANTRY RULES • INFANT

REGIONS OF TERRA NOVA • A HISTORY OF WARFARE • HEAVY GEARS • DICE AND DIE ROLLING
SUCCESS/FAILURE • COMBAT UNITS AND COMBAT GROUPS • MAPBOARDS • VEHICLE RECORD SHEET •
TYPES OF ACTIONS • MOVEMENT AND TERRAIN • COMBAT SPEED • TOP SPEED • MULTIPLE MOVEMENT
HIDDEN & OBSCUREMENT • CONCEALMENT • DETECTION RATING • ACTIVE SENSOR LOSS • ECM AND ECCM
ATTACKER MODIFIERS • DEFENDER MODIFIERS • PHYSICAL ATTACKS • EVASIVE MANEUVERS
AREA EFFECT WEAPONS • DAMAGE • SYSTEMS DAMAGE • DAMAGE TO ARMOR • DAMAGE TO ARMS •
MOUNT • SENSORS • INFANTRY ACTIONS • ATTACKS VS INFANTRY • INFANTRY TV • PERKS • FLAWS



DREAM POD 9



1.1 WELCOME TO TERRA NOVA	2	1.12.5 STEALTH EFFECTS	12
1.1.1 EARTH AND ITS COLONIES	2	1.12.6 FIRING ARCS	12
1.1.2 REGIONS OF TERRA NOVA	2	1.13 ATTACKS	12
1.1.3 A HISTORY OF WARFARE	3	1.13.1 ATTACHER MODIFIERS	12
1.2 HEAVY GEARS	4	1.13.2 DEFENDER MODIFIERS	13
1.2.1 COCHPIT AND CONTROLS	4	1.13.3 PHYSICAL ATTACKS	14
1.2.2 CENTRAL PROCESSING UNIT	4	1.13.4 EVASIVE MANEUVERS	15
1.2.3 SENSOR SYSTEM	4	1.13.5 CALLED SHOTS	15
1.2.4 POWERPLANT	5	1.13.6 INDIRECT FIRE	15
1.2.5 TRANSMISSION	5	1.13.7 BURST FIRE	15
1.2.6 SECONDARY MOVEMENT SYSTEM	5	1.13.8 AREA EFFECT WEAPONS	16
1.2.7 WEAPONS	5	1.14 DAMAGE	17
1.2.8 ARMOR	5	1.14.1 SYSTEMS DAMAGE	17
1.3 DICE AND DIE ROLLING	6	1.14.2 DAMAGE TO ARMOR	18
1.4 RATINGS, SKILLS AND SKILL TESTS	6	1.14.3 DAMAGE TO ARMS	18
1.5 MARGIN OF SUCCESS/FAILURE	6	1.15 INFANTRY RULES	18
1.6 COMBAT UNITS AND COMBAT GROUPS	6	1.15.1 INFANTRY RECORD SHEET	18
1.7 MAPBOARDS	6	1.15.2 MOVEMENT	19
1.8 VEHICLE RECORD SHEET	6	1.15.3 SENSORS	19
1.8.1 CREW SKILLS	7	1.15.4 INFANTRY ACTIONS	19
1.8.2 WEAPONS	7	1.15.5 ATTACKS VERSUS INFANTRY	20
1.9 THE COMBAT ROUND	8	1.15.6 INFANTRY THREAT VALUE	20
1.10 NUMBER OF ACTIONS	9	1.16 PERKS	21
1.11 MOVEMENT AND TERRAIN	9	1.17 FLAWS	21
1.11.1 COMBAT SPEED	9	CHEETAH	22
1.11.2 TOP SPEED	9	HUNTER	23
1.11.3 MULTIPLE MOVEMENT SYSTEMS	9	JAGUAR	24
1.11.4 TURNING	10	GRIZZLY	25
1.11.5 TERRAIN EFFECTS	10	IGUANA	26
1.11.6 STACKING	10	JÄGER	27
1.12 LINE OF SIGHT & OBSCUREMENT	10	BLACH MAMBA	28
1.12.1 CONCEALMENT	10	SPITTING COBRA	29
1.12.2 DETECTION RATING	11	BADGER APC	30
1.12.3 ACTIVE SENSOR LOS	11	CAIMAN APC	31
1.12.4 ECM AND ECCM EFFECTS	11	INFANTRY RECORD SHEETS	32

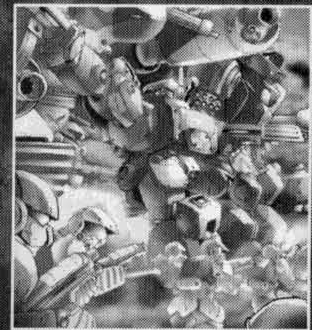

Dream Pod 9 Team

WRITING JEAN CARRIÈRES, MARC-ALEXANDRE VÉZINA,
 PHILIPPE A BOULLE

PRODUCTION PIERRE OUELLETTE, JEAN-FRANÇOIS FORTIER,
 GHISLAIN BARBE, NORMAND BILDOERU, CHARLES-
 EMMANUEL OUELLETTE

ADMINISTRATION ROBERT DUBOIS, STÉPHANE BROCHU

Produced and Published by



5000 Iberville, Suite 332
Montréal, Québec, Canada, H2H 2S6

Art & designs © 1998, Dream Pod 9, Inc.
Dream Pod 9, Terra Nova, Heavy Gear, Silhouette and other names,
specific game terms, vehicle names and logos are © 1998, Dream
Pod 9, Inc. All rights reserved.

Silhouette is a trademark of Dream Pod 9, Inc.
Heavy Gear is a registered trademark of Dream Pod 9, Inc.
No part of this book may be reproduced without written permission
from the publisher, except for short excerpts for review purposes.
Any similarities to actual characters, situations, institutions,
corporations, etc. (without satirical intent) are strictly coincidental.

The use of the male gender throughout this manual should in no way
imply the exclusion of the female gender or suggest that the game is
intended exclusively for a male audience. It is our hope that female
gamers will find this product just as interesting as their male
counterparts.
Dream Pod 9 can be reached through the internet. Check out our web site
at www.dp9.com. We can also be reached through the newsgroups
rec.games.mech and alt.games.dp9. Your feedback is welcome.

Legal Deposit: April 1998
Bibliothèque Nationale du Québec
National Library of Canada

Stock DP9-043
Printed in Canada



THE RULES

1

1.1 - WELCOME TO TERRA NOVA

Heavy Gear takes place in the year A.D. 6134 on a distant planet called Terra Nova, a world colonized during the 52nd century by Terrans from Earth. Terra Nova is one of the nine inhabitable planets discovered by Mankind outside the solar system during its dynamic renaissance after a terrible ice age. While the new world resembles Earth in many respects, it features indigenous life forms (of no more than animal intelligence) that represent an all-too-real threat to the unprepared colonist. Still, much of the Terran flora and fauna are edible, and make survival of the human race in this inhospitable world possible. After so many centuries on this world, part of humanity has indeed found a new home.

Despite its similarities to Earth, the former colony has a very different calendar. Days last 36 hours, not 24, and a complete year (called a "cycle" on Terra Nova) is around 168 days. One Terran year is equal to roughly 1.4 cycles. Tougher living conditions have slightly shortened the average Terran lifespan and forced people to mature much faster than on Earth. The term teenager, while referring to someone younger on Terra Nova than on Earth, is still someone between 12 and 18, but in cycles rather than in years. An young adult is still someone between 20 and 30. An elderly person is still someone above 70.

The year A.D. 6134 is equivalent to the Terran cycle TN 1936.

1.1.1 - EARTH AND ITS COLONIES

It began on Earth during the 47th century. After recovering from a terrible ice age and under the guidance of a global government, the Human Concordat, Earth discovered the existence of so-called "Tannhauser Anomalies," which paved the way to the Tannhauser Gate technology and opened the doors to distant worlds. Earth slowly discovered a web of gates connecting a series of inhabitable planets. The first was Caprice. Only marginally inhabitable, it became known as the "gate world" because of the numerous space-time anomalies in its star system. In the 48th century, Terra Nova — a rich planet just waiting for colonization — was discovered. Settlement began in earnest.

Various corporations and government agencies set up shop on Terra Nova, staking claims on continent sized regions of the new planet. Terra Nova was more arid than Earth — its equator was a harsh desert and most of its water flowed underground — but the temperate and polar regions were teeming with life and the whole planet was rich in minerals. As colonization continued, settlers decided to stay beyond their corporate mandates and independent communities emerged. Some corporation even sold lands to their workers. Over the centuries, a thriving native population developed, made up of independent-minded settlers.

Terra Nova was not the only colony, however. Seven other planets were discovered and settled.

Atlantis was a rich water world. Eden was a lush garden planet. Home became the corporate headquarters of its settlers and developed a strong economy. New Jerusalem became the new home of the Catholic Church. Utopia was the most successful colony, even challenging Earth's status.

The insular Jotenheim and the prison planet of Botany Bay were less successful. All these worlds had inhabitants and all were thrown into chaos in A.D. 5790 (or TN 1454), when an anti-colonial movement swept Earth and the global political-economic structure collapsed.

Isolationists rose to power and the Concordat suddenly cut off its colonies.

Millions fled back to Earth, but many more were stranded (or chose to stay) and forced to begin a new life without contact with the home world. On Terra

Nova, the rugged spirit of independence would serve the people well and build a thriving and diverse world — but one that knew far too much bloodshed.



1.1.2 - REGIONS OF TERRA NOVA

Because Terra Nova is so arid, there are no seas to separate nations. Rather the planet is divided into three regions: the mountainous and temperate northern hemisphere, the luxuriant and tropical southern hemisphere; and the Badlands, which stretch out as a thick desert band about 1000 kilometers north and south of the equator. While Terranovans first grouped into city-states and then into leagues, each hemisphere is now dominated by a super confederacy. The Badlands is the battlefield between them.



◆ The North

The northern hemisphere is united under the Confederated Northern City-States (CNCS), a relatively equal partnership between three nations: the Northern Lights Confederacy (NLC), United Mercantile Federation (UMF), and Western Frontier Protectorate (WFP). Although conflicts between these nations do occur, they generally cooperate. They are bonded by a mutual dislike (and fear) of the aggressive South and by an undercurrent of religious sentiment. Indeed, most Northerners are members of the Revisionist Church — a faith born on Terra Nova right after Earth abandoned the planet. In TN 1936, both these sentiments are running high because the South appears increasingly dangerous and an assassination has put the church into turmoil.

The military interests of the North are defended by the Northern Guard, a professional army with recruits from all three leagues.



◆ The South

The southern hemisphere is ruled by the Allied Southern Territories (AST), but this is nothing but a puppet regime for the powerful Southern Republic (SR). Through the AST, the Republic dominates the various city-states of the Mekong Dominion (MD), Eastern Sun Emirates (ESE) and Humanist Alliance (HA). In TN 1936, this domination is less than certain. Several cities are in open revolt and Republican troops are busy keeping the peace in many others. All the while, tensions with the North are growing as it becomes involved in conflicts within the AST. The Republic was built on an imperialist agenda of conquest and this philosophy seems to be leading it toward war once more.

The military interests of the South are currently in the hands of the Southern MILICIA, a conscript army drawn from all Southern leagues.



◆ The Badlands

The Badlands, unlike the polar confederations, are fractious, and form no political entities to speak of. Only one city-state in the Badlands is truly respected by the polar confederation for its power and prestige: Peace River, a city built around Paxton Arms, the planet's most important weapons manufacturer. Paxton Arms remains neutral in the North-South conflicts, providing equipment to everyone indiscriminately. Almost on the other side of the planet, around the equator, a new coalition (NuCoal) of small city-states has recently been formed around Port Arthur and Prince Gable, the seat of the NuCoal Council of Trade. While NuCoal does not have a military component, the Arthurian Korps ensures that it comes to no harm and that its territory is respected by the polar confederations.

There are several other city-states in the Badlands, most of which serve as refuge for renegade soldiers or simple civilians fleeing the constraints of life in the hemispheres. Notorious among those cities, Khayr ad-Din — often referred to as the "City of Trash" because it was built in the middle of a trash dumping area in the Badlands — is where ex-Gear pilots go to become Duelists in the arenas. The rest of the Badlands is populated by nomadic traders, rovers, hard-boiled homesteaders and the mysterious Sand Riders who live in the acidic sands of the Great White Desert.

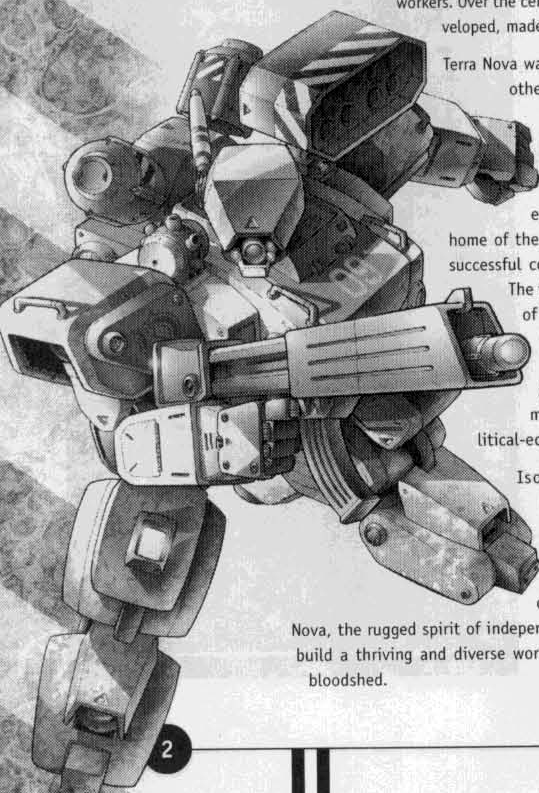

2



1.1.3 - A HISTORY OF WARFARE

With only rare exceptions, Terranovans have been busy warring with each other ever since Earth abandoned them. In the cycles following Earth's departure, desperation led many to raid their neighbors. Bands of "rover bandits" (simply called "Rovers") turned into outlaw armies led by vicious warlords. Communities became fortified city-states to defend themselves against these attackers.

Folklore has it that one day, a certain Badlander had had enough of the pillaging and constant harassment of the Rovers, and welded some armor plates and machine guns to a construction walker. When the Rovers returned to harass his family and take over his homestead, he taught them a lesson in survival and they never returned. Thus was presumably born the first Gear. Over the centuries that followed, it became a recognized tool of war and was perfected by several militaries to eventually take its rightful place on the battlefield.

◆ Wars of Unification

As the city-states grew, they came into conflict with each other and warfare began on a greater scale. Soon enough, cities began to conquer each other. In the South, the city-state of Marabou conquered its neighbors and founded the Southern Republic. In the North, cities allied by religious outlook conquered those afraid of the new Revisionist faith. Other cities entered alliances peacefully, often to defend themselves against aggressive neighbors. During the late 16th century-early 17th century, North and South respectively formed the Confederated Northern City-States and the Allied Southern Territories.

◆ Interpolar Warfare

Ever since the founding of the AST, the two hemispheres have been in a state of near-constant conflict. The Badlands have become an endless battlefield, site of countless skirmishes for mineral wealth and tactical positions. The TN 1720s saw St. Vincent's War, the worst global conflict yet. A Badlands skirmish released a deadly biological agent that killed millions of children across the globe and maimed others. Polar governments dealt with the tragedy by blaming their enemies and the public called for blood. For six cycles, the planet was caught in an all-out war that ended only when the global economy collapsed under the strain. After a period of reconstruction, however, the old skirmishes of the "cold war" began anew.

◆ The War of the Alliance

It took the sudden reappearance of Earth to bring North and South together. In TN 1913, Terra Nova was on the verge of war when the Colonial Expeditionary Force (CEF) arrived, an invasion force from a newly imperialist Earth. Faced with an enemy wielding 400,000 highly trained men and supersoldiers (the GREs) and cutting edge technology, Terranovans rallied together and fought a desperate battle for freedom. The CEF thought the defenders would buckle rapidly, little realizing that they had been training for war for generations. It was hard fought battle, that cost many lives and saw much territory in enemy hands, but in TN 1917 the CEF was kicked off Terra Nova. The unified planetary forces celebrated; they had defeated a powerful enemy and put aside their own differences — or so they thought.

◆ The Brink of War

The post-war period was supposed to rebuild Terra Nova, but old tensions have ground away all hopes of peace. In TN 1936, the Northern Guard and Southern MILICIA are just waiting for an excuse to go to war. Every day brings more political rhetoric and more calls for blood. The recent assassination of Thor Hutchison, leader of the Revisionist Church, has the North looking for a scapegoat while many in the South call for a final push to global domination.

On both sides, the Gears are ready to enter battle. These walking armored vehicles are credited with the victory over the CEF and both sides expect them to win the coming war. Near the small Badlands city-state of Elayu, the first shots are about to be fired...

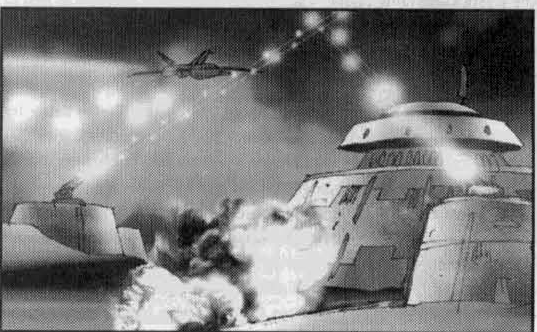
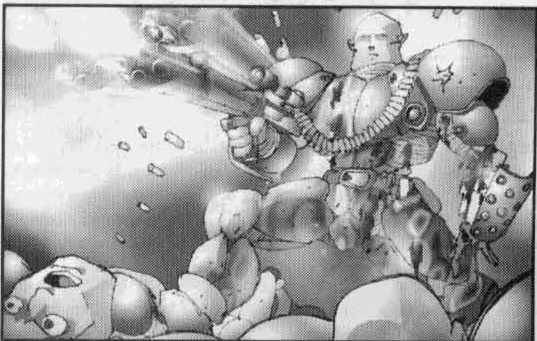
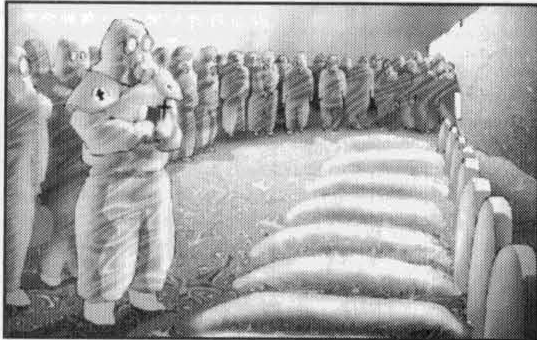
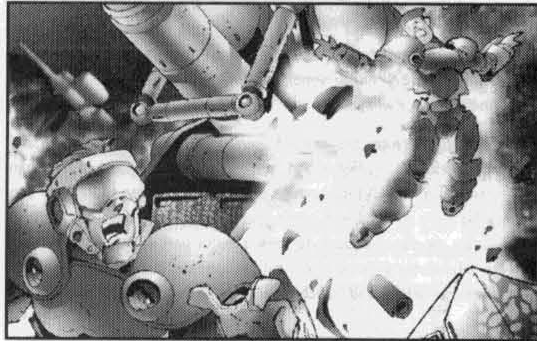
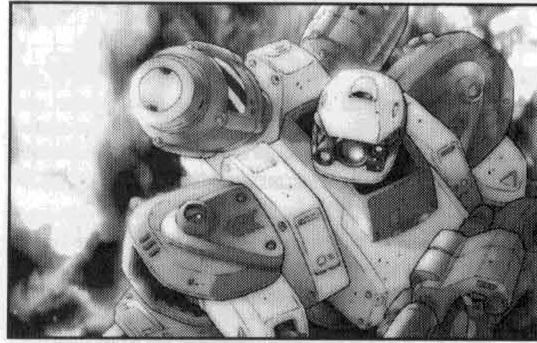

THE RULES



1

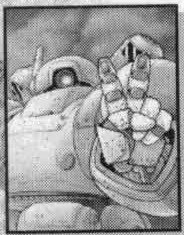

1.2 - HEAVY GEARS

Heavy Gears are one of the most significant advances in the field of military technology in the past millennium. Although combat walkers were used as far back as the early third millennium, they were always cumbersome and too easily targeted enough to survive the high tech battlefield, relegating them to support and engineering duties. This changed with the development of the Heavy Gear.

The Battle of Pioneer of TN 1669, during which the Northern Lights Confederacy and Western Frontier Protectorate tried to put an end to expansionism on the part of the United Mercantile Federation, saw the birth of the combat walker on Terra Nova. Heavy Gears (often called Gears or HGs for short) have participated in every major conflict on the planet since then. They played an especially critical role in the War of the Alliance, when combined Terranovan forces defeated the invading Colonial Expeditionary Force from Earth. Tacticians point out, however, that Gears still depend on support from infantry, heavy armor, artillery and air support — they are not invincible super-weapons.

The Gear is actually a compromise between an infantryman's flexibility and an armored vehicle's resilience and firepower. It is, in effect, a one-man IFV (Infantry Fighting Vehicle) which protects the soldier and allows him to carry far more payload and armor than an ordinary trooper. Mass-produced, Gears are cheap enough to form a major part of the modern army. They are extensively covered in the first volumes of the **Vehicle Compendiums** series (**North 1** and **South 1**) and in the **Technical Manual**.

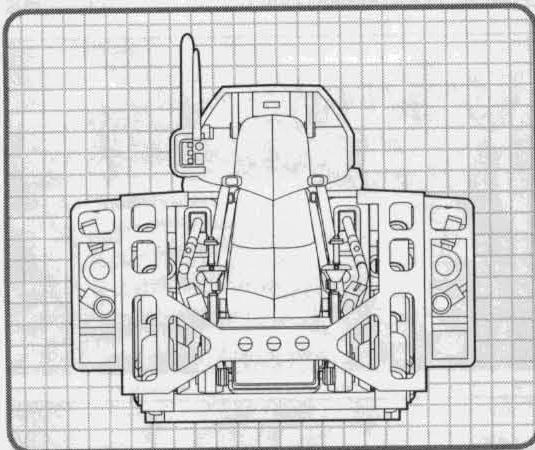

1.2.1 - COCKPIT AND CONTROLS

All Gears can carry one man in a cockpit located in the torso. Because of the space required by the machine's internal mechanisms, all Gear cockpits are cramped, some even limiting the size of the pilot. A sturdy seat occupies the center of the torso. Most of the spare space is used for electronic systems, leaving little to no room for an ejection mechanism.

The configuration of the instruments depends on the designers of the machine. All are equipped with two joysticks and two foot pedals, but buttons and readouts vary immensely, even between variants of the same model. The joysticks are fairly complex, sporting several thumb switches as well as finger-activated triggers. Combinations of switch, trigger and stick movements are converted into body motion routines called **Macromoves** (or simply "Macros") by the CPU, much like a combat video game.

Early Gear designs had holographic screens and HUD to display battle information. Newer models use Virtual Reality technology instead. With special laser-crystal screens mounted inside a slightly enlarged helmet, the VR system relays information treated by the CPU and its visual sub-processor to the pilot. For all intents and purposes, the trooper can see as if the cockpit were open to the outside. Relevant tactical and battle readouts are superimposed over the landscape by order of priority. Small movement indicators and ID tags enable the pilot to keep track of many targets and can even identify mission objectives and navigation waypoints.

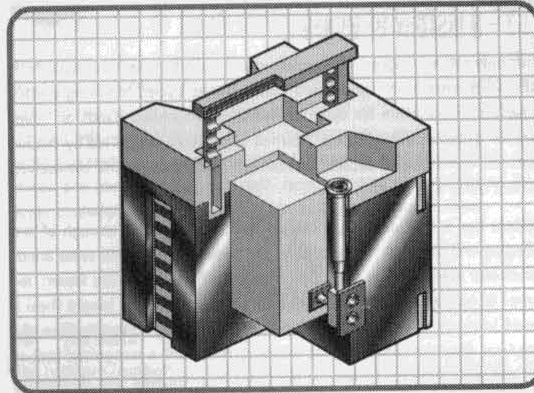

1.2.2 - CENTRAL PROCESSING UNIT

The "brain" of the Gear is the Central Processing Unit, or CPU for short. It is a small, semi-transparent cube (15 cm³) filled with an intricate molecule-sized neural network. This network is so complex it cannot be repaired if damaged and must be replaced by a new unit. It is encased in a special shockproof polymer or composite case which is normally installed under the pilot seat. It can be easily removed by reaching under the seat and releasing the connections and is always the first piece of equipment salvaged when a Gear is destroyed or damaged beyond repair.

The CPU's neural network is able to learn and establish new connections within itself. This allows non-linear logic processing, as new parallel paths are created to handle computing tasks. This ability for "fuzzy," or open-ended, logic makes the CPU much better at handling the complex body motions of the humanoid Gear it controls than other "standard" neural network/computers. A standard Gear CPU is not self-aware, although it often gives the illusion that it is.

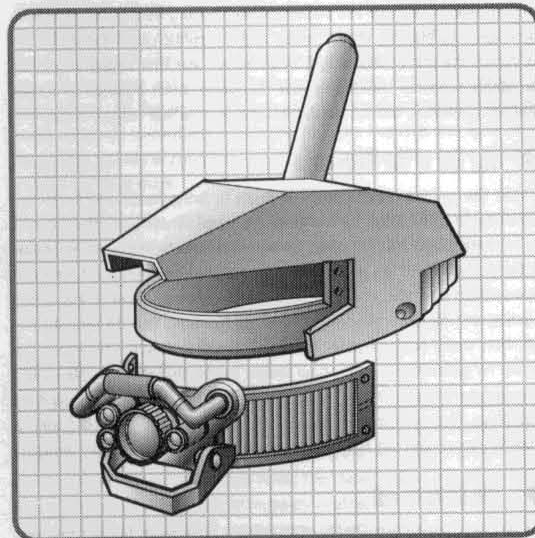

1.2.3 - SENSOR SYSTEM

Gears carry a variety of sensor systems to allow the CPU to relate to its environment and help the pilot in battle. Since Gears are supposed to be inexpensive and easy to maintain, most designs have only a minimal sensor package. The primary sensor system is a small cluster of digital omnicameras, often placed in the Gear's head. Most models use only one main camera, relying on laser rangefinders and "dumb" stereoscopic cameras for range and depth measurements. The data is processed by the CPU's visual sub-processor, then the CPU combines this information with that from the other sensory systems and uses it all to maintain the Gear's balance and perform the action required by the pilot.

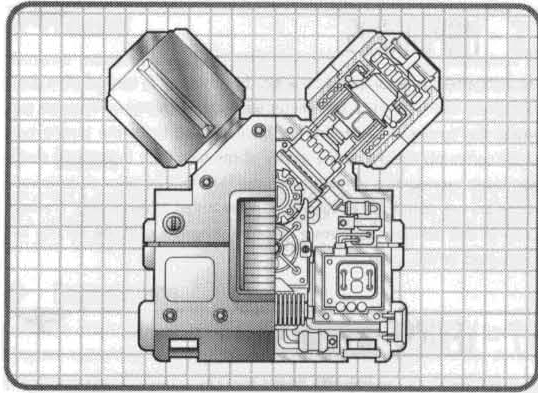

1.2.4 - POWERPLANT

Most Gears use a very compact, internal combustion engine called a V-engine. So named because of its shape, it is a twin drive, air-cooled, highly efficient powerplant with minimal moving parts. The core of the V-engine is a support axle made out of high-strength alloy steel. It is in fact only a bent bar of metal and is the strongest part of the engine. Two combustion chambers are slipped over this support axle. These chambers, thanks to their peculiar internal shape, serve as piston housing, distributor cap, lubrication system, and cooling fan — all in one. The engine configuration thus provides two drive shafts, each delivering equal horsepower. The end result is a fairly compact engine which is rugged, easy to manufacture, and easy to repair. The V-engine's ability to run on a variety of fuels and its small number of moving parts make it perfectly suited for Gears.

A few rare Gears models are powered by electrical engines fed by a bank of ambient-temperature superconductive coils. However, the high cost of such a system and its inherent limitations makes it unpopular except in specialized stealth units or as a backup system. The short operation range is also a problem which has yet to be solved.

1.2.5 - TRANSMISSION

Transmission is a catch-all term covering the various pistons and motors that move the machine around. All Gears use a combination of hydraulic and electrical power to move their limbs. They also use two types of actuators, hydraulic pistons and rotors. The hydraulic system is fed by one main pump connected to the engine through a computer-controlled gearbox to maximize efficiency. The second drive shaft of the engine is used for an electrical generator that powers booster pumps placed in the lower body. Since the pump and the generator extend above the shoulders of the Gear, they are heavily armored. Valves, overflow reservoirs and heat exchangers are also part of the circuit and are attached to the basic frame of the Gear. The fluid used to transmit the motive power is a highly advanced polymer compound which is much better than oil for transmitting load. It is distributed throughout the Gear's body by feed lines made of duraplast, a composite plastic that can contain high pressures.

1.2.6 - SECONDARY MOVEMENT SYSTEM

Many Gears have more than one transmission system. This Secondary Movement System, or SMS for short, usually takes the form of wheels or treads placed under the feet of the machine. Although the basic concept may sound ridiculous, one cannot deny the immense increase in mobility, speed and efficiency — not to mention versatility — this brings to the Heavy Gear weapon system.

Most often, the wheels (or treads) use small electric motors powered by a generator attached to one of the V-engine's drive shafts. Special software built into the CPU changes the equilibrium equations to handle high speed "skating" motions. This function can be retrofitted, but is usually less efficient than a built-in software. Because of the low ground clearance of the wheels, the SMS is only useful on flat, hard ground like packed sand or concrete. Some SMS have larger wheels which can be used over broken terrain, but the price of this increased versatility is a bigger, thus more vulnerable, movement system.

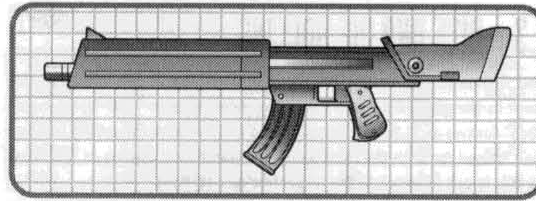

1.2.7 - WEAPONS

Gears are rarely designed with built-in weaponry. Its humanoid shape, complete with grasping manipulators, makes the Gear a very versatile tool which can support a variety of offensive systems. Nonetheless, it is an accepted practice to standardize a Gear's armament for ease of maintenance, going as far as altering the unit's identification code to reflect its current payload.

The typical Gear armament consists of one main weapon, usually hand-held in a rifle or pistol-like form. Rapid-firing, self-loading projectile weapons are preferred. All Gears possess hardpoints on various parts of their body to accept additional equipment and armament. This often takes the form of either support items (smoke launchers, ECM generators, etc.) or a limited use, hard hitting weapon for a one-shot-kill capacity such as an unguided rocket pack. This equipment can be simply bolted on, with control and power wiring being routed either through the armor or alongside it.

1.2.8 - ARMOR

The average Gear carries several centimeters of composite armor. This affords them the same general level of protection as an armored infantry fighting vehicle, which is more or less what the Gear is: a one-man Infantry Fighting Vehicle.

Gears use the same composite armor as all other war vehicles in the 62nd Century. Unfortunately, their humanoid shape, so versatile and maneuverable, here plays against them. Because the limbs of the Gear must have flexibility, mobile armor plates are unavoidable. Some clearance is necessary, meaning that one cannot just heap on plates or simply add on thickness. All this reduces the potential stopping power of the material used for the armor, leaving weak points which can be exploited by a skilled gunner.

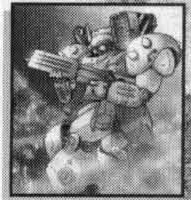
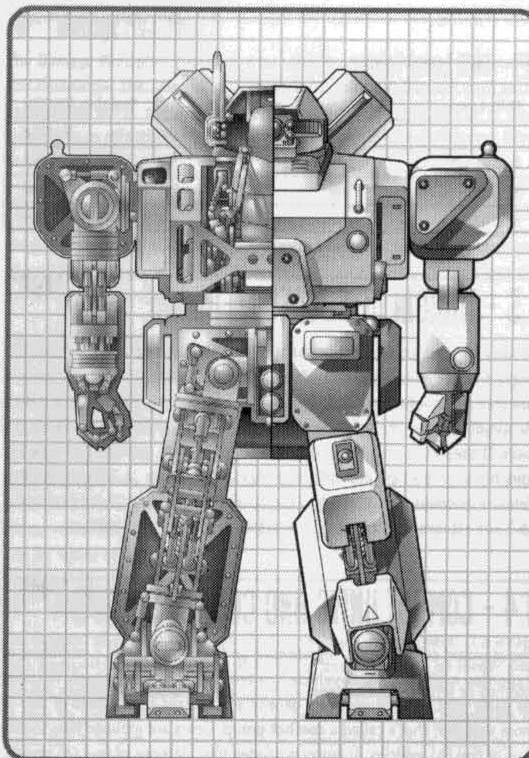



1

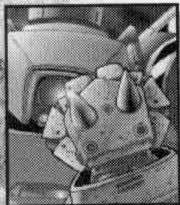

1.3 - DICE AND DIE ROLLING

The Silhouette system uses everyday six-sided dice to add a random element to the game. These are sometimes referred to as "1d6" in the rules, "2d6" for two dice, 3d6 for three, and so on. The same die rolling convention is used for both the roleplaying and wargaming aspects of the rules, so this is not repeated in the respective rule sections.

When two or more dice are rolled simultaneously, their results are not added together. **Instead, the highest result is considered to be the outcome of the die roll. If more than one "6" is rolled, each extra "6" adds one (1) to the total.** If every die rolled turns up "1," the die roll is a Fumble and counts as an overall result of zero and no modifiers may change this value. Unless specifically mentioned otherwise, all die rolls work in this way.

The totals of die rolls are often influenced by modifiers. Modifiers are added to the total of a die roll. If negative modifiers lower the total below zero, the final result is always zero and cannot go any lower. **Modifiers are not applied to Fumbles.**

Die Rolling Examples

Example 1: Player A rolls two dice. The dice read 3 and 5. The total of the die roll is 5 (the highest individual die result).

Example 2: Player B rolls five dice. The dice read 1, 6, 4, 6, and 6. The total of this die roll is 8 (the highest roll + 2 for the two extra sixes).

Example 3: Player C rolls three dice. All three dice read 1. He has fumbled the die roll. The total is considered to be 0.

Example 4: Player D rolls two dice and has a +2 modifier. The dice read 1 and 5. The total of the die roll is 7 (highest roll + 2).

1.4 - RATINGS, SKILLS, AND SKILL TESTS

In Heavy Gear, pilots are rated in terms of their Skills. A Skill is a learned talent or ability which is often improved with practical experience. There are only five important Skills in the tactical game: Piloting, Gunnery, Electronic Warfare, Leadership and Tactics. It is a common practice to rate a pilot in terms of his general training. For example, a pilot rated as Veteran is assumed to have an average Skill level of 3 in the basic tactical game Skills (Piloting and Gunnery); see the *Crew Skill* table on the next page.

Skill Level Values

Skill Level	Training Quality
1	Rookie
2	Qualified
3	Veteran
4	Elite

1.5 - MARGIN OF SUCCESS/FAILURE

Combat involves an element of chance. Most attacks and tactical actions in heavy Gear require Skill Tests. They consist of a die roll whose result is compared to another die roll. The difference between both rolls is called Margin of Success (MoS) for the winner and Margin of Failure (MoF) for the loser. If the roll is a tie, the MoS is zero. For instance, an Qualified attacker uses his Gunnery Skill and rolls two dice: a "1" and a "4." The defending Veteran defender rolls three dice for his Piloting Skill: a "2," a "3," and a "6." The attacker has a MoF of 2 and fails to hit his opponent.

1.6 - COMBAT UNITS AND COMBAT GROUPS

The standard **combat unit**, represented on the mapboard by a miniature or a counter, is either a single vehicle or a ten-person infantry squad. To speed up game play, combat units are generally organized into groups of two or more vehicles; that's called a **combat group**. Gears are grouped into squads of five (5) vehicles. Infantry is divided into platoons of four (4) squads.

1.6 - MAPBOARDS

The battlefield is represented by a hex-based map for ease of play. Each battlefield hex represents a 50-meter wide area of terrain. For game purposes, the terrain of the entire hex is considered to be the terrain type which surrounds the dot in the center of the hex. Each increase in elevation levels represents a 50-meter increase in height (smaller altitude variations are not significant enough to be represented at this scale). The back cover of this rulebook features a color representation of the various hex types used in this game.

1.7 - VEHICLE RECORD SHEET

Each vehicle has an appropriate record sheet (p. 22 to 31) that details the necessary statistics for game play. These sheets allow clear tally of damage and other important information. The information is broken down into five parts: Vehicle Attributes, Crew Skills, Weapons, Perks and Flaws and Battle Damage. The infantry record sheet is discussed in the infantry section, page 18. We also provide a squadron/cadre record sheet (p. 32) to keep track of their unit's damage and respective speeds during each round.

Vehicle Attributes

Vehicle Attributes define a vehicle. The numbers show the strength and prowess of each machine. Variations in the numbers between vehicles indicate various design objectives. There are nine Vehicle Attributes: Threat Value, Size, Number of Crew, Speed, Maneuver, Sensors, Communication, Fire Control and Armor.

Threat Value

Threat values are a good measure of a vehicle's value in combat. Everything on the battlefield has a Threat Value. It reflects a combat unit's offensive, defensive and miscellaneous abilities. The higher the number, the more powerful the unit is in that particular field. Games can be easily balanced by allocating an equal amount of points to each side. These amounts are then used to purchase vehicles according to their Threat Values.

Size

Every vehicle is assigned a Size value based upon its mass. Size values are primarily used to determine the outcome of physical attacks like ramming attempts. The following table lists the mass range that each Size value roughly represents.

Size to Mass Chart

Size	Mass in Tons	Size	Mass in Tons
1	0-0.08	6	4.5-7.3
2	0.09-0.3	7	7.4-10
3	0.4-1.1	8	11-16
4	1.2-2.4	9	17-22
5	2.5-4.4	10	23-30

Crew

Combat vehicles always carry a crew. In high-tech vehicles, robotic systems replace live crew members, but they are considered crew nonetheless. Additional personnel increases the number of actions a vehicle can perform during a combat round. Large vehicles generally need many crewmen to function at all.

Speed

A vehicle's speed is translated directly into Movement Points (MP). Entering a map area denoted by a hex costs a certain number of movement points. Each vehicle can move at two different rates, or "speeds." The first one, called **Combat Speed**, is the highest speed a vehicle can achieve and still participate efficiently in combat. The second one, **Top Speed**, is twice as fast as Combat Speed, but the vehicle's finesse in combat is strongly impaired and it is limited in its maneuvering.





◆ Maneuver

Maneuver indicates a vehicle's ease of control and its responsiveness to sudden changes of direction. The value is a zero-average value and is used as a modifier to all Piloting Skill rolls.

◆ Sensors

Sensors is a generalized rating of the quality and sophistication of a vehicle's detection systems. This number covers the various sensor systems installed in the vehicle, regardless of their actual nature.

◆ Communication

Communication systems combine radios and laser transmission devices. They are especially important to allow units to talk to each other during battle and to coordinate their fire, or to transmit enemy coordinates to friendly artillery fire.

◆ Fire Control

Fire Control is a catch-all category for targeting devices and weaponry. These can vary between expensive combat computers to primitive mechanical sights. The value is used as a modifier to all attack rolls.

◆ Armor

Armor represents the toughness of the vehicle's protective hide and general structure. Three values are listed: Light damage, Heavy damage, and Overkill. They are equal to one, two, and three times the base armor value, respectively. When a vehicle is hit, the attacker's damage is compared to each of the vehicle's Armor values in turn. The attack's effect is the last armor stage it has exceeded (see *Damage*, page 17).

1.7.1 - CREW SKILLS

Skills indicate the quality of a vehicle's crew. Skills are rated by experience: higher Skill indicates greater ability. As mentioned earlier, Skill 2 is considered average.

◆ Piloting

The Skill of piloting and maneuvering a walker vehicle. Piloting is required to evade attacks, initiate physical attacks and perform difficult maneuvers. Driving and Naval Piloting are used for ground and naval vehicles respectively, but they serve the same purpose.

◆ Gunnery

The Skill of aiming vehicle-mounted weapons or using fire control mechanisms. Gunnery is crucial to all ranged attacks.

◆ Electronic Warfare (EW)

The Skill of using sensors, jamming equipment and other electronic packages in combat vehicles. This Skill is used when calculating a vehicle's Detection value (see *Detection Rating*, page 11) and for checking the position of an object using the vehicle's sensor systems.

◆ Leadership

The commanding officer's Skill at leading troops and planning tactics. Leadership Skill is used to check for combat initiative. It is normally one level below the Electronic Warfare Skill.

◆ Tactics

This represents the pilot's expertise in small-unit tactics and the proper positioning and ordering of troops while engaged with an enemy force. This is useful to gain a general tactical advantage throughout the game.

◆ Standard Crew

We provide below a selection of sample Heavy Gear pilots which you can use in tactical scenarios. They are listed with a corresponding Threat Value modifier; multiply the Gear's TV by this value to determine the final Threat Value of the pilot/Gear team. By default, most tactical games should be played with Qualified pilots.

□ Standard Crew Skills

Type	Pilot.	Gunn.	Elect. War.	Leader.	Tactics	TV Mult.
Rookie	1/0	1/+1	0/0	0/0	0/0	x0.25
Qualified	2/0	2/+1	1/0	1/0	1/0	x1
Veteran	3/+1	3/+1	2/0	2/0	2/0	x2.25
Elite	4/+1	4/+2	3/+1	3/0	3/+1	x4

1.7.2 - WEAPONS

Most military vehicles carry weapons of some kind. Regardless of their performance, these weapons all share similar characteristics, such as Accuracy, Damage Multiplier, Range, Rate of Fire (ROF) and Ammunition.

◆ Fire Arcs

Firing arcs determine whether or not a given weapon can be aimed at a target. There are six standard arcs: Forward (F), Right (Rt), Left (L), Rear (Rr), Fixed Forward (FF) and Turreted (T). For a visual representation of the fire arcs, turn to page 12.

◆ Base Range

Each weapon has four ranges: Short (S), Medium (M), Long (L) and Extreme (Ex). The Short Range is also called the Base Range of the weapon; the Medium, Long and Extreme ranges are equal to twice, four times and eight times the Base Range, respectively. All vehicular weapon ranges are listed in hexes.

Modern weapons are extremely powerful. They have theoretical ranges that often extend to many kilometers. Life, however, is not a firing range. Obscurement, the movements of both attacker and defender along with the limitations of targeting system all reduce the effective range of weapons. The Range Bands given represents the effective combat range.

◆ Accuracy

In addition to the effects of the vehicle's main fire control systems (the Fire Control rating), the Accuracy (Acc) of each individual weapon affects the odds of successfully damaging opponents. It is applied as a modifier to each attack roll made with the weapon. Accuracy can drop because of damage (see *System Damage*, page 17).

◆ Damage Multiplier

The Damage Multiplier (Dam) of a weapon is a rating of how devastating and destructive the weapon's attack is. The Damage Multipliers work on an exponential scale, not a linear one. A Damage Multiplier of x10 is more than twice as effective as a Damage Multiplier of x5: in fact, it is four times as effective.

◆ Quantity

Many vehicles carry more than one weapon, and sometimes more than one of a given weapon. This column lists the number of that particular weapon which the vehicle carries.

◆ Rate of Fire

The Rate of Fire (ROF) of a weapon is listed in its own column. A weapon with an ROF of 0 fires a single shot and is then reloaded; it expends one round of ammunition per attack. Weapons with ROF of 1 or more are rapid-loading and can fire many more shots during the same interval of time. They can lay down a hail of fire to saturate an area with firepower or hit more than one target at once, but expend considerable amounts of ammunition while doing so. Rapid-fire rules, along with various attack options, can be found on page 15.

◆ Ammunition

The amount of ammunition loaded into a weapon is listed here. If a weapon's ammunition drops to zero, it is out of ammo and can no longer fire. Players should be careful of how much ammunition they spend in combat. It may be nice and efficient to spread your fire on several opponents at once, but it is also extremely costly in ammunition. Some attack types, such as physical attacks, do not expend ammunition.

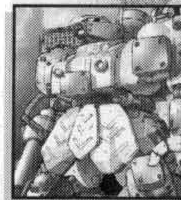



1.8 - THE COMBAT ROUND

A tactical game is subdivided into combat rounds that simulate approximately 30 seconds of real life events. Players normally get one action during that round, which can be used to shoot, communicate important information or scan the area. While the fact that shooting once every thirty seconds may appear unrealistic to some Players, we must point out that Player Characters involved in tactical combat are only shooting when they get an opportunity. In a computer simulation, everything can be adjusted every thousandth of a second, so simultaneous combat and repetitive shooting are a possibility. For a pen-and-paper-and-miniatures-and-hex maps simulation, combat has to be broken down into "chunks" of time and distances in order to be manageable.

If Players truly want to have the opportunity to make several attacks during the round, they can still do so, but at a cost in accuracy since the crew will be trying to get more things done in the same amount of time and will thus be less careful. It is possible to declare several actions instead of just one for the round, but this will cause a penalty to each action.

During each combat round, the following four steps occur in order, except Step Zero, which only occurs at the beginning of the game.

◆ Step Zero: Set-up Phase

A battle always begins with the Set-up Phase, which occurs only once. An overall Commander must be chosen for each side, with a Second in Command. Their identities can remain secret, but must be noted down for future reference. The Commander's Leadership and Tactics Skills are one level above normal. The Second in Command's Leadership Skill is one level above normal. If the Commander becomes a casualty, he or she is replaced by the Second in Command. If both are put out of action, all future Leadership Skills are rolled at the Skill level of the pilot with the highest Leadership Skill.

A Tactics Skill test is made by each side based upon the Skill level of the Commander. Fumbles count as a die result of one. Reroll ties. The winner chooses which Player will begin placing his or her combat groups upon the map. Players should alternate, each placing one combat group at a time on the mapboard. After placing a unit, the Player must declare what speed (stationary, Combat, or Top Speed) it is moving at. Pre-designed scenarios have clearly defined set-up locations for each faction. When not using pre-designed scenarios, the Players should agree on which mapboards to use and set up on the first three rows of hexes on opposite sides.

If, during the first round, a unit is attacked before it has been moved, it is treated as if it were moving at the maximum number of hexes possible for its speed for the purpose of defense rolls.

Each Player should record the result of the Tactics roll. Each point represents one Tactical Command Point (TCP) that can be played at any time during the game. Command points represent an action reserve for unexpected situations; they are fully explained further on.

◆ Step One: Declaration Phase

Both sides declare any extra actions and individual evasive maneuvers for the round. Use one or more counters to mark extra actions taken to avoid confusion during game play. This token can be placed either near the playing piece or on the record sheet, whichever the Player finds more suitable.

◆ Step Two: Initiative Phase

Initiative determines which side has the advantage during the present round of combat. Each side rolls an action test based on their commander's Leadership Skill. If only two machines are facing each other, the Piloting Skill is used instead of the Leadership Skill. The highest result wins. Draws are rerolled.

Record the MoS of the Initiative roll. The Winner receives a number of Initiative Command Points (ICP) equal to that MoS. The Loser receives no ICPs this combat round, but may use Tactical Command Points if he wants. If there are more than two sides to the battle, only the Winner gets ICPs.

The side with the least number of combat groups decides which side will play first. If both sides have the same number of combat groups, the winner of the Leadership roll makes the decision.

◆ Step Three: Activation Phase

The side whose turn it is to play may move any or all units in one of their combat groups. Units that shift speeds (Combat to Top and vice-versa) must declare so immediately after movement (the new movement will only be applicable next round). Actions, such as firing or activating a system, may be resolved at any time before, during or after the movement. Attack penalties are based on the unit's total movement; for example, if Combat Speed is announced, the unit cannot spend more than Combat MPs.

Each unit moves and takes its actions before another unit is activated. If a unit does not move or act when its combat group is activated, it *cannot* do so at a later point in the round.

At any time during the activated unit's movement, any enemy unit that has not already been activated may use one (or more) of its actions to fire or perform a task against the moving unit (and only against the moving unit). This is called "snap fire." Attacks may be directed at any point along the moving unit's path, but the unit's full movement counts towards the Defense roll. The total MP allocation of the target is used to determine the defense speed modifier, even though the actual displacement may be shorter, because this is a hurried reaction for the attacker. Snap firing does not cost Command Points (unless the firing unit needs to turn around to fire), but it reduces by 1 the total number of attacks which the snap firing unit has for the round. The defender must spend at least one MP or end its movement before each of the attacker's actions if more than one action is used. Forward observers (units that spend an action feeding enemy coordinates to their people) must always act before the firing unit(s).

Once every unit in the combat group has moved and acted (or forfeited its chance to do either), the other side activates one of his own combat groups, which may move and take action. This exchange goes back and forth until all groups have moved and acted.

A combat group may only move once per combat round. If one Player no longer has any combat groups left to use, the opponents activates their remaining combat groups one by one until they all have been moved.

◆ Step Four: Miscellaneous Events Phase

During this phase, any unusual events, such as long-range artillery and bombing attacks, are resolved. These are optional rules which are not covered in this box. Initiative Command points go back to zero. Any action not spent at this point is lost.

Repeat Steps 1 to 4 until the battle is resolved or pre-planned objectives are met. A combat group may only move once per combat round.

◆ Command Points

Command points represent the commander reacting to or anticipating the enemy's actions. There are two types of Command points: Tactical Command Points (TCPs) and Initiative Command Points (ICPs). TCPs are available throughout the game, but cannot be regained once spent. ICPs are valid for one round only, but are refreshed during each new Initiative roll. Other than this, there is no difference between the two.

Command Points may be used by any unit with a functional Communication system. They can be used as an additional regular action incurring no penalty. One Command Point can be used to buy a +2 modifier to a single Defense roll (representing a warning shout). A Command Point can be used to activate a unit out of sequence — to get out of harm's way, for example. In the latter case, the unit must not have been activated (i.e., moved) previously, and it cannot be moved again when its combat group is activated (though it may act if it has any actions left). Finally, a Command Point may be used to turn a unit around by up to 180 degrees, even if it has been activated before (and thus has no MP left).

□ Using Command Points

•	Extra action (no penalty)
•	Defensive maneuvering (+2 to single defense roll)
•	Activate a unit out of sequence (if it hasn't been activated already)
•	About-face (change facing 180°)

1.9 - NUMBER OF ACTIONS

A vehicle's actions are limited by the total number of crewmen. All vehicles automatically get one action. Vehicles with two or more crewmen get additional actions at no cost. This is listed on the vehicle record sheet. Some or all of these additional actions can be lost when crew casualties occur. It takes two crewmen to have a total of two actions each round. It takes four crewmembers to have four actions. If the number of crewmembers goes below that minimum, one action is lost. A crewless unit cannot perform actions. It is possible to take more actions than allowed during a combat round, but each additional action causes a -1 penalty on all actions.

Action Examples

•	fire one weapon once
•	fire one set of linked weapons once
•	perform a single physical attack (ramming, kicking, punching, etc.)
•	activate an auxiliary system (ECM, active sensors, communication, etc.)
•	embark/disembark one crewman
•	embark/disembark a number of passengers equal to the Size of the vehicle

Number of Actions Examples

Example 1: A Hunter Gear has a crew of one person. This vehicle gets its one automatic action and no free additional actions. If the Hunter needed to perform three actions in a single turn (2 more than its normal allocation), it would receive a -2 penalty on all three actions.

Example 2: A tank has a crew of four people. This vehicle gets its one automatic and two additional actions due to its crew complement, for a total of three actions per turn (without penalty). If the tank needed to perform four actions, it would suffer a -1 penalty on all four actions. No benefit is gained from performing less than three actions.

Example 3: If the tank's crew were injured and one crewmember was incapacitated, the vehicle would have an effective crew of 3, giving it only one additional action (instead of 2). The short-handed tank would now be able to perform up to 2 actions without penalty.

1.10 - MOVEMENT AND TERRAIN

A vehicle can cross a certain number of areas based on its movement points (MPs). The vehicle record sheet contains the values for Combat Speed and Top Speed. Combat Speed allows a vehicle to engage in offensive actions unhindered. Top Speed is twice as fast as Combat Speed, but severely impairs offensive actions.

Speeds are listed in MPs; one MP equals movement across one clear mapboard hex or about 6 kph across clear terrain. Thus a vehicle with a Combat Speed of 12 MPs moves at about 72 kph. Every turn, each vehicle receives as many Movement Points as its current speed (Combat or Top).

1.10.1 - COMBAT SPEED

A vehicle normally receives a number of movement points equal to its Combat Speed value. If the vehicle expends none of these movement points to move, it is considered stationary. Otherwise, the vehicle is said to be traveling at Combat Speed. Attacks can be made normally at this rate of movement. Vehicles moving at half their Combat Speed or less gain an additional +1 to their attack rolls due to the additional stability provided by lower speeds (see *Movement Modifiers*, page 13).

Reverse Movement

A vehicle moving at up to half Combat Speed can opt to move backward instead of forward. Reverse movement is not possible at higher speeds. Half the Combat Speed means an extra +1 modifier to the attack roll for extra stability. This is particularly efficient when using several vehicles in a combat group that is retreating from the field; enemy units will think twice before attacking them.

1.10.2 - TOP SPEED

A vehicle that expends its full Combat Speed MPs can shift to Top Speed in the next round. This shift must be declared by the Player immediately after moving the unit. The vehicle is considered to be at Top Speed for attack and defense purposes for the rest of the combat round.

In subsequent combat rounds, the vehicle receives movement points equal to its Top Speed value. The vehicle must expend a number of movement points **greater** than its Combat Speed while moving at Top Speed. A vehicle may return to Combat Speed after any number of rounds of Top Speed movement. The Player declares the return to Combat Speed immediately after moving the unit.

Players should put a Top Speed counters (marked "T") beside the vehicles moving at Top Speed. This helps to prevent disputes over the speed at which a vehicle is moving.

Speed Examples

Example: A Hunter Gear is rolling at Combat Speed (6 MPs). It may spend anywhere between 0 and 6 MPs. If it spends zero, it is considered to have stopped moving and is immobile. If it spends the full 6 MPs, it has the option to shift to Top Speed. The Hunter's Player opts to do this and declares the speed shift immediately after moving the Hunter. To making record keeping easy, the Player puts down a "Top Speed" marker beside his or her unit counter on the mapboard.

1.10.3 - MULTIPLE MOVEMENT SYSTEMS

Vehicles with multiple movement systems, such as walking and rolling, are able to switch modes during combat. **A vehicle may ONLY switch modes while at Combat Speed, not at Top Speed.** During the switching round, the initial movement mode is used to determine the available MPs. The vehicle expends MPs as its original movement mode until the switch is declared. The remaining MPs are expended at the terrain cost of the new movement mode. If the vehicle has already spent more MPs in movement than it would have in the system it switches to, then it stops moving after the switch.

A vehicle with multiple movement systems may only switch modes once per round. This option must be announced during the movement phase.

Movement System Examples

Example: A Hunter pilot is currently moving at Combat Speed with his Ground Secondary Movement System (6 MPs). After moving 4 hexes, he decides to switch to Walker mode. His Walker Combat Speed is 4 MPs; having already reached this limit, his movement ends. If he had only moved 2 hexes before switching, he would have had 2 more MPs to spend.

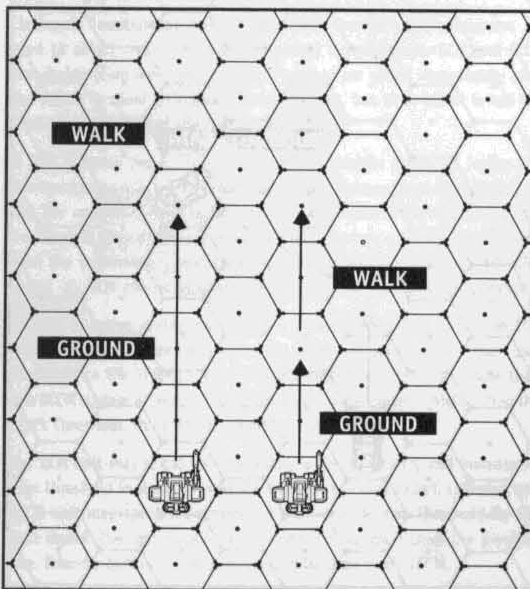



1.10.4 - TURNING

A vehicle which wants to make a facing change (a 60-degree turn right or left) may do so at no MP expense **after** entering a hex. If it wants to do turn 120 degrees or **before** entering a hex, it will cost 1 MP. Any turn above 120 degrees costs no more extra MPs. A vehicle could spin on itself 360 degrees, it would still cost 1 MP.

Any vehicle that turns more than two hex facings (180+ degrees) while moving at Top Speed requires a Piloting Skill roll versus a Threshold of 3 plus the terrain MP cost (this does not count as an action). If the roll succeeds or is a draw, the turn occurs without complications. If the roll fails, the vehicle skids forward 1 hex before taking the turn (if something is already in the hex, the pilot may attempt ramming if he wants). If the roll Fumbles, the vehicle skids forward 1 hex, then crashes. This ends the vehicle's movement, even if it has MPs left to spend. If a vehicle crashes, roll one die and assign either a Light (1 to 3) or Heavy (4 to 6) damage effect, depending upon the number rolled (see *Damage*, page 17).

1.10.5 - TERRAIN EFFECTS

Various terrain types negatively affect locomotion methods. The chart on the back of this rulebook lists the MP cost to traverse different types of terrain. Certain types of terrain also reduce visibility. This is represented by the Obscurement of the terrain (Obscurement will be explained later on). Although no vehicles in this box has a hover mode, they do exist in the universe of Heavy Gear and the terrain costs for these is listed as well.

◆ Dots and Hexes

The dot in the center of each hex on the mapboards is there to help you determine what the terrain type of the hex is. The terrain of the hex is whatever mapboard feature the dot is on top of. If a little bit of the drawing representing broken terrain spills over into a primarily clear hex, the dot will be on clear terrain, indicating that the terrain type is clear. If one or more terrain elevation contour lines cross through a hex, the elevation level of the hex is the elevation level the dot resides in.

▣ Movement & Terrain Example

Example: An Armored Personnel Carrier (APC) is moving at Combat Speed (10 MPs). It begins in a Clear hex. It travels forward two hexes across Clear terrain (expending 2 MPs) and then turns one hex-facing clockwise (expending 0 MPs). The APC then moves forward 3 hexes across Rough terrain (expending 6 MPs), turns two hex facings counterclockwise (expending 1 MP), and ends its movement. The remaining 1 MP is not enough to enter Rough terrain (which would cost 2 MPs) and is lost.

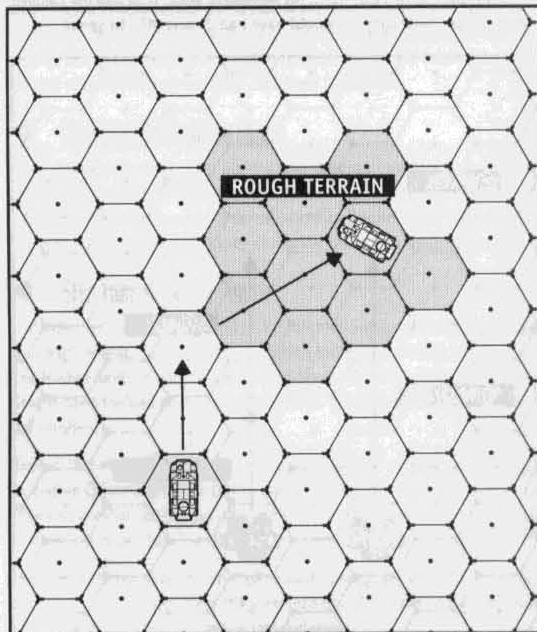

1.10.6 - STACKING

The term "stacking" refers to how many units can reside in a single mapboard hex. While the standard hexes are fifty meters wide, a certain security margin must be observed during the chaos of combat lest accidents happen. For this reason, the number of units allowed in a single hex is limited by stacking.

Each 50-meter hex can take up to a total of 30 Size points worth of vehicle and other units. The Size of each vehicle is always noted on its record sheet. Five or less infantrymen count as the equivalent of a Size 3 vehicle for stacking purposes (an entire squad of ten would thus take up 6 points). Range is measured from the attacker's closest target's hex: if combat occurs between units in the same hex, the range is considered to be Point Blank (0).

1.11 - LINE OF SIGHT & OBSCUREMENT

It is a requirement for a unit to "see" its target to fire. The ability to detect and target an opposing unit is called, for simplicity, having a Line of Sight (LOS). This does not necessarily imply that the target is within human visual sight, merely that it can be acquired and locked on by the sensors and fire control computers available to the detecting unit. Units are considered to have a Line of Sight to their target unless one of the following conditions exists:

▣ Blocked Line of Sight

•	The target is beyond the detecting unit's Sensor range.
•	Any terrain between the two units is one or more elevation levels higher than both the units.
•	Either unit is within the dead zone of an intervening elevation level. A unit is within a dead zone if it is adjacent to an interceding elevation increase.
•	The Concealment value between the vehicle and the target is greater than the vehicle's Detection rating (see page 11).

1.11.1 - CONCEALMENT

The Concealment value is equal to the Obscurement score of all terrain directly between the two units plus the Obscurement score of the terrain the defender is in. If one of the two vehicles is on a higher elevation level than the other, only the terrain at the higher elevation level and the terrain of the defender's hex are counted for concealment purposes.

The Terrain table on the back of this rulebook indicates the Obscurement values for each type of terrain. Obscurement makes a target more difficult to detect and cause penalties that are applied to the attacker's roll.

▣ Line of Sight Examples

Example 1: Gear Alpha is faced with a Hunter and has taken shelter in jungle vegetation. Two Jungle hexes (Obscurement 2) intervene in addition to the Jungle hex Alpha is in, for a total Concealment value of 6. This is greater than the Hunter's Detection score of 4, so Alpha remains hidden.

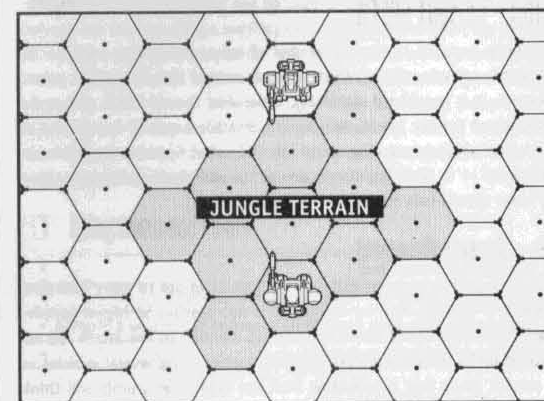

Example 2: If either unit is in a dead zone, line of sight is obscured. Gear Beta is within range of an enemy APC (6 hexes) but both units are just behind ridges. The APC is hidden and cannot be fired upon. If the Gear was to climb on the nearest ridge, it would still not be able to see the APC because the vehicle is located in the dead zone at the base of the elevation level. If the Gear moves to the other ridge, it will then see the APC.

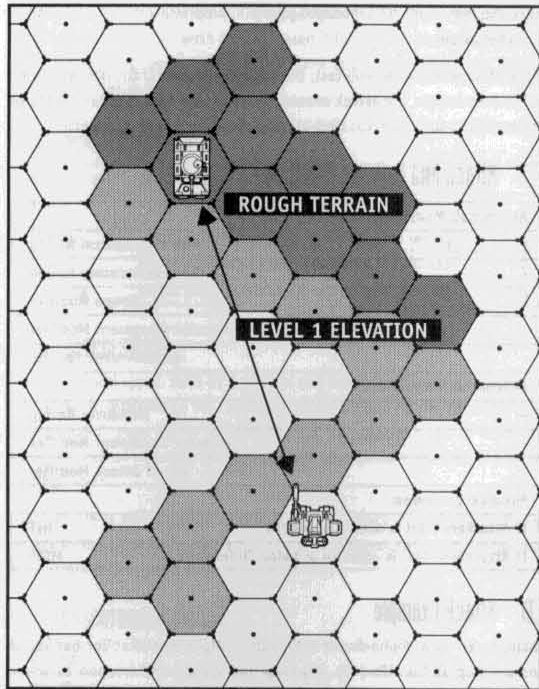

1.11.2 - DETECTION RATING

Sensors and crews are always on the lookout for enemy units. Every vehicle has a passive Detection Rating: this value is used to calculate whether a unit can gain line of sight to its target. All units, including infantry, get a Base Detection rating of 4 in daylight (2 at night) from unassisted vision. A vehicle also has a Passive Sensor value equal to its Sensor rating plus its crew's Electronic Warfare Skill level. The final Detection Rating is either the Base Detection Rating or the Passive Sensor value, whichever is higher. This represents how much Concealment a vehicle can see through before having to do an Active Sensor sweep. Unassisted vision has a range of 1 kilometer (20 hexes); if sensors are available, their range is used instead.

1.11.3 - ACTIVE SENSOR LOS

Most of the 62nd century combat vehicles carry sophisticated sensor suites to locate enemy units lurking nearby: radar, motion detectors, IR and UV cameras, etc. By performing an active sensor sweep, these systems can be used to obtain a combat lock-on on an enemy unit even when visual or passive sensor LOS is blocked.

An Electronic Warfare Skill test is rolled against a Concealment Threshold (see table below). A success gives the detecting unit a LOS to the defender. A draw, failure, or fumble does not grant LOS. Vehicles with no sensors cannot perform an Active Sensor detection. Active Sensor sweeps, unlike passive or visual detection, require a full action to complete.

Concealment Threshold

•	Base Threshold = Concealment value
•	plus defender vehicle's Stealth rating
•	minus attacker vehicle's Sensor rating
•	minus defender's movement penalty
•	-1 for every weapon fired by the defender

Active Sensor Example

Example 1: Gear Alpha cannot normally detect Gear Beta, since the total Obscurement value of the hexes between the two machines is greater than the Detection Rating of Alpha (which is 4). Three Jungle hexes intervene between the two and Beta is in a Swamp hex. This produces a Concealment value of $(2+2+2+1)=7$. Alpha's unit leader, however, is expecting trouble and orders the Gear to do an active sensor sweep to try to lock-on to the faint readings from Beta's direction. The Concealment value of 7 is the base Threshold for Alpha's sensor Skill test.

Example 2: Beta last moved two hexes. This reduces the Threshold by 2 points, down to 5. Beta did not fire any weapons this round. To add to Alpha's difficulties, Gear Beta is an experimental combat model with the Stealth Perk at a rating of 3. This is added to the Threshold, producing a final Threshold of 8.

Example 3: Alpha's Sensors are rated at +1. Alpha's pilot spends an action and rolls his EW Skill test, obtaining a 6. He adds his Sensor rating (+1) to the roll and obtains a final score of 7. This is not enough to detect Beta — Alpha needed to get a higher score (9 or better) than the Threshold of 8 to detect the enemy Gear.

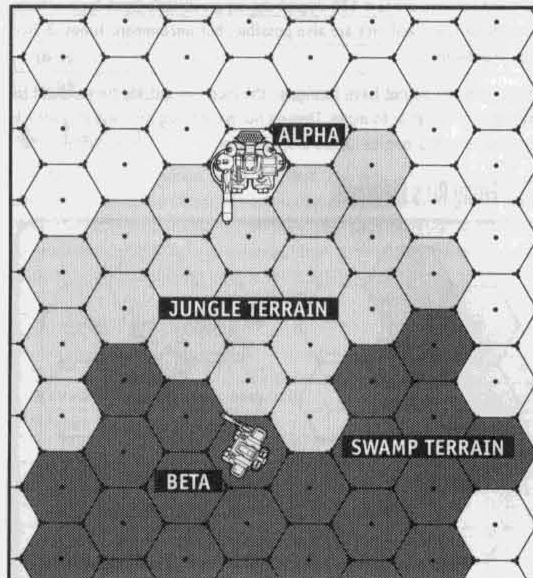

1.11.3 - ECM AND ECCM EFFECTS

Electronic Countermeasures and Electronic Counter Countermeasures are used to affect communication and sensor transmissions. ECM and ECCM Thresholds (Electronic Warfare Skill + rating) are rolled immediately after the action is spent to activate these systems, but their effect is not felt until the beginning of the next round.

If ECM is active and functional during the initiative phase, all Sensor and Communication rolls for the round are affected and must beat the ECM Threshold. The unit which is using either of these systems is the one testing, not the receiver. Transferring Command Points requires a Communication test from the commanding unit (if an infantry squad, use Infantry Skill with Comm -2). ECM affects all enemy units within the emitter's Sensor range.

If ECCM is active during the initiative phase of the turn, all active ECM systems within the Sensor range of the ECCM unit must compare their own Threshold to the ECCM's Threshold (or Thresholds, if there are more than one ECCM system active). If the ECCM Threshold is equal or higher than the ECM's Threshold, the ECM has no effect that turn.

The ECM unit may spend an action during the turn to try and increase its own Threshold in order to beat the ECCM in the next round. Likewise, the ECCM unit may spend an action to try to raise its own Threshold for the next round. The new result stands, even if it is lower than the previous one. Friendly ECM units are not affected by their side's ECCM.

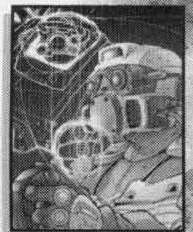



1.11.4 - STEALTH EFFECTS

Some vehicles are equipped with special systems that reduce their overall sensor signature: these are grouped under the Perk "Stealth." During daytime, the rating of a Stealth system is added to the Concealment total only when there is Obscurement between the attacker and the defender — Stealth does not confer invisibility.

Stealth systems are always added to the defender's Concealment at night, since most stealth vehicles are painted in dark shades and feature silent running drive trains, making it hard to locate them with human senses and sensors alike.



1.11.5 - FIRING ARCS

Vehicles may only target opponents that are within their weapons' firing arcs. Each weapon is mounted within a certain arc and can only fire in it; targets which lie outside the arc cannot be targeted.

There are six common firing arcs: Forward (F), Right (Rt), Left (L), Rear (Rr), Fixed Forward (FF) and Turreted (T). The first four are 180-degree arcs on their respective sides. Side arcs include directly forward and backward. The fixed forward arc is a 120-degree arc on a vehicle's front facing. Note that side or rear fixed arcs are also possible, but uncommon. Turreted arcs span 360 degrees.

Infantry squads do not have facing, as the men can quickly turn around to respond to a threat or to move. They do not have firing arcs and may attack anything in a 360-degree radius around them.

□ Firing Arcs Diagrams

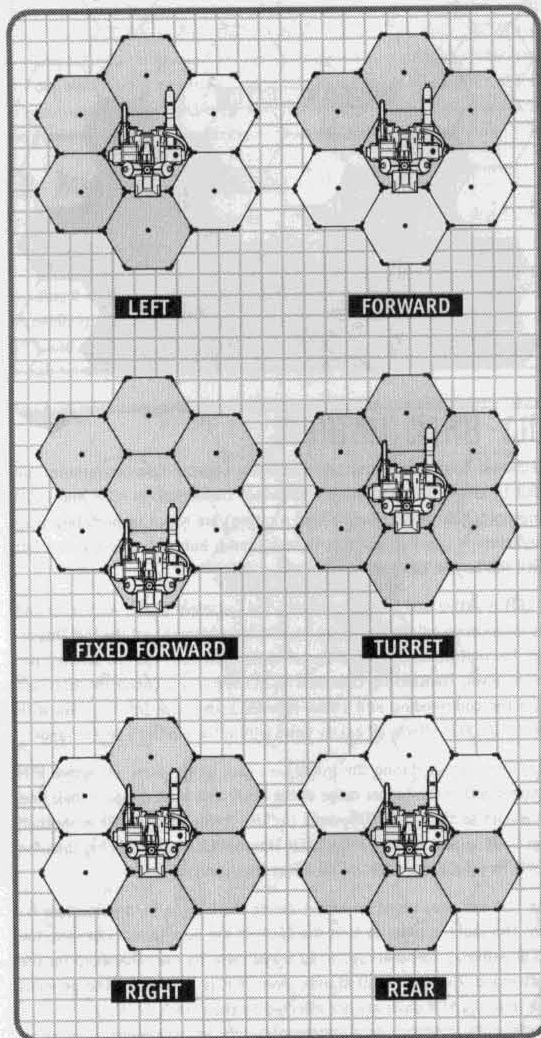

1.12 - ATTACKS

If a unit has a Line of Sight to a target within its weapon's firing arc and range, it can attack that target. When an attack occurs, an opposed Skill test is required to determine the success of the attack. The attacker uses his unit's Gunnery Skill and the defender uses his unit's Piloting Skill to make the test, both rolls modified by the appropriate Attributes and situation modifiers.

If the attacker wins the Skill test, the attack succeeds. If the defender wins or if a draw occurs, the attack misses. The following table contains a list of the modifiers to both rolls; they are explained further in the text.

□ Attack And Defense Modifiers

Attack Roll Modifiers:	
-	Targeting System Rating
-	Weapon Accuracy Rating
-	Range Modifier
-	Attacker Movement Modifier
-	Obscurement Penalty
Defense Roll Modifiers:	
-	Maneuver Rating
-	Defender Movement Modifier
-	Arc of Attack Modifier
Possible Outcomes:	
If Attackers total is above Defender's	HIT
If Attacker's total is equal to or below Defender's	MISS

■ Attack Example

Example 1: Gear Alpha shoots at Gear Beta. Alpha moved at Combat Speed and used up all his MPs (+0). His targeting system and weapon accuracy are both rated at +0. He is attacking within the "Short" range band (2 hexes) of his weapon (+0). There is no obscuring terrain. Alpha's pilot rolls his Gunnery Skill roll and obtains a total of 6. Since Alpha's modifiers total up to +0, his final attack roll is 6.

Beta must now make his defense roll. On his last move, Beta traveled 7 hexes (+1). Beta's Maneuver rating is +1. Alpha's attack occurs in Beta's forward defense arc (+0). Beta's pilot rolls his Piloting Skill test and obtains a score of 5. This is modified by the situation bonuses to yield a final total of 7. Since 7 is definitely greater than or equal to 6, Beta avoids Alpha's attack.

Example 2: Later, Gear Alpha is again shooting at Gear Beta. Alpha moved at Top Speed (-3). His fire control system was damaged during the battle and Alpha now receives a -1 modifier to all attacks. He is 5 hexes away from Beta, and is therefore at Long range with his weapon (-2). In addition, two hexes of Woodlands terrain (Obscurement 1 each) lay between the two (-2). Alpha rolls his Gunnery Skill test and obtains the remarkable roll of 10. Unfortunately, after the total -8 penalty is applied, the final total is only 2.

Beta attempts to avoid this attack. On his last move, Beta only traveled 2 hexes (-2). In addition, Alpha now lies in Beta's rear defense arc (-2). Fortunately, Beta still has his good Maneuver (+1). Beta rolls his Piloting Skill test and obtain a lowly 3. After the situation modifiers are applied, this is reduced to a final total of 0. Since Alpha's total of 2 is greater than Beta's total of 0, Alpha has successfully attacked Beta with a Margin of Success of 2.

1.12.1 - ATTACKER MODIFIERS

Life is not a firing range; combat is always harder under certain conditions, easier under others. Modifiers resolve this by introducing penalties and bonuses to each and every combat roll.

Apart from the quality of the vehicle's Fire Control computer and the accuracy of the weapon, three other factors apply: the range to the target, the obscurement (or cover) between the attacker and defender and the attacker's own movement.



◆ Range

Every ranged weapon is rated by a value known as its Base Range. The Base Range is further expanded into four Range Bands, each one doubling the maximum distance of the preceding band. The further away the target, the harder it is to hit and damage it.

Although there is no theoretical limit on certain weapons' ranges, such as lasers and particle accelerators, the ranges given are practical combat ranges that take into account both the increased difficulty of aiming and the loss of energy caused by distance. Point Blank is the range band for attacks that occur within the same map hex.

□ Range Modifiers

Point Blank	Special range (same hex)	+1
Short	(from 1 hex to base range)	0
Medium	(from previous to two (2) times base range)	-1
Long	(from previous to four (4) times base range)	-2
Extreme	(from previous to eight (8) times base range)	-3

◆ Obscurement

Various terrain types, such as swamped and wooded areas, obscure a target and make it difficult to hit. The Concealment value of the defender (see *Line of Sight*, page 10) is subtracted from the attacker's roll to represent both the lack of accuracy and the damage absorption caused by the intervening cover.

Indirect fire is an exception to this. Since the attack is arcing through the air above the intervening terrain, some of the Obscurement may be ignored (see *Indirect Fire*, page 15).

□ Obscurement Modifiers

Swamp	1
Woodlands	1
Jungle	2
Water	2*

* Only produces Obscurement in the defender's hex and only if defender is not a Hover, Naval or Amphibious vehicle.

◆ Attacker Movement

A moving gun platform has a higher chance of missing than a stationary one. Conversely, a unit that is moving slowly generally have less trouble keeping their weapons trained on a target. Stationary attackers (i.e., that have spent no MP) are the best firing platforms.

Since the penalty for moving slowly are higher than the attack benefits gained, Players must be careful to place their slow-moving units in a position where return fire is least likely.

□ Movement Modifiers

Stationary	+2
Half Combat Speed or less	+1
Combat Speed	+0
Top Speed	-3

1.12.2 - DEFENDER MODIFIERS

The Defense roll is an actual dodging of the attack, but is rather an abstract representation of the target's attempts at evasion and its use of any available cover (both impossible to properly represent at the fifty-meter ground scale). Targets rely on the following modifiers to help them avoid shots and blows. In general, the only defense of large and ungainly vehicles is their speed, as their poor Maneuver rating will often severely hamper their defense.

Attacks coming from the rear are much more dangerous than attacks from the front, both because the armor is thinner there and because the crew's attention is much more focused on the front arc.

◆ Maneuver Value

Each vehicle has a set maneuver value by design. Negative maneuver values are for slow ponderous vehicles like battleships and large tanks. Positive maneuver values are for fast and agile vehicles like motorcycles, combat helicopters and Gears.

◆ Target Speed

An enemy platform's speed affects how easy it is to hit. Speed modifiers are determined according to the following ever-increasing scale. If the target has yet to move in the round, its last recorded movement is used to determine its modifier. On the first round of combat, assume that the vehicle has moved the maximum number of hexes for its current speed in its current terrain.

◆ Target Speed Modifiers

Hexes Moved	Defense Modifier
0	-3
1-2	-2
3-4	-1
5-6	+0
7-9	+1
10-19	+2
20-99	+3

◆ Defense Arc

The defender's orientation, when attacked, can reduce his chances of successfully escaping the attack, either because of inattention or thinner armor. Most combat vehicles carry less armor on their back than on the front, due to unavoidable engineering concerns. More importantly, however, pilots cannot dodge attacks they cannot see coming.

□ Defense Arc Modifiers

If attack is in the defender's Front	0
If attack is from defender's Rear Flank	-1
If attack is from defender's Rear	-2

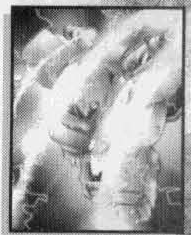
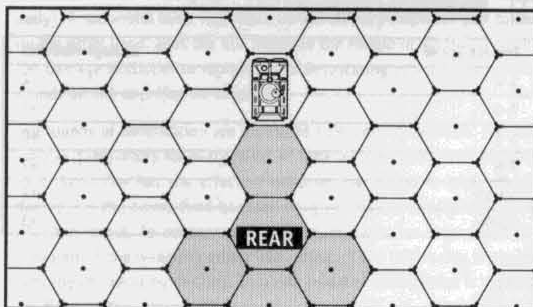
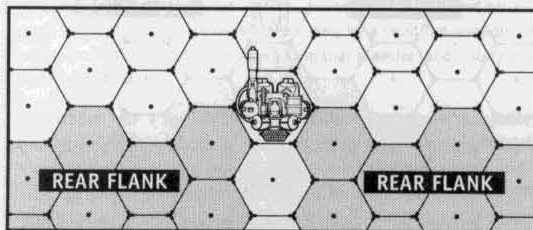
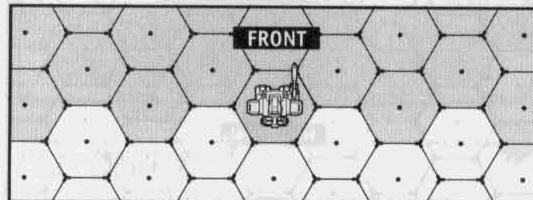



1



1.12.3 - PHYSICAL ATTACKS

There are few vehicles that can make effective physical attacks. Ground vehicles are capable of ramming, but few commanders exercise the option. With humanoid Heavy Gears, the old-fashioned close-in attacks have become common. Ramming, punching, kicking, stomping and all manner of melee weapons are being used on the battlefield when ammo runs out. All physical attacks use the attacker's Piloting Skill instead of his or her Gunnery Skill, except when an arm or a melee weapon is used (see the description of each maneuver in the column at right).

◆ Ramming

Impact at high speeds can be devastating. Frontal collisions are almost always deadly, while impacts from either side or from the rear are slightly less dangerous. Ramming is a standard Opposed Skill roll. Unlike other attack forms, ramming inflicts collision damage on both the attacker and the defender.

When checking for ramming damage, impact speed is first determined based upon the direction of the incoming ram. Head on collisions add the speeds of the attacker and defender. Side impacts take the attacker's speed, and rear collisions take the difference between the two speeds.

Once the impact speed has been established, a damage modifier is determined using the Impact Speed Table (below). This damage modifier is added to the Size of each vehicle involved in the collision to determine its actual Damage Multiplier. Each vehicle will take an amount of damage equal to the Margin of Success of the Attack multiplied by its opponent's Impact Damage Multiplier (see *Damage*, page 17). The larger the unit, the more damage it will inflict on the other unit involved in the collision. If the attacker gets a MoF and still had MPs to spend, he moves one hex forward and stops there; otherwise, he stops in the collision hex.

◆ Ramming Speed

Ramming Direction	Impact Speed
Head On	Attacker Speed + Defender Speed
Side	Attacker Speed
Rear	Attacker Speed - Defender Speed

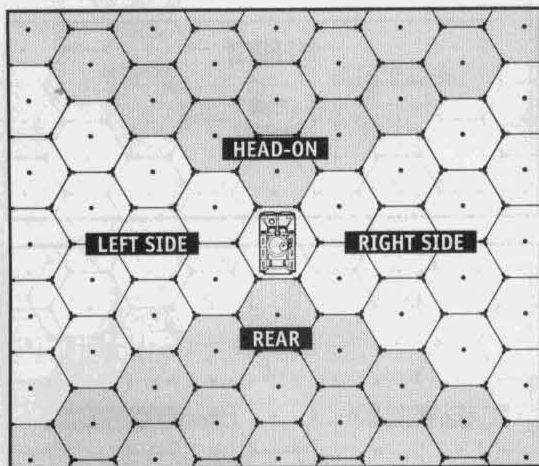

□ Impact Speed Modifiers

Impact Speed	Damage Modifier
1-2	-2
3-4	-1
5-6	+0
7-9	+1
10-19	+2
20-99	+3

■ Ramming Example

Example: Gear Alpha (Size 6) rams tank Beta (Size 12) in the side. Alpha traveled 8 hexes that round. Beta had last moved 7 hexes. Since this is a side impact, the impact speed is equal to the attacker's movement, or 8. A quick glance at the Impact Speed Table shows this to produce a +1 damage modifier. Thus, Alpha's impact Damage Multiplier is $(6 + 1 =) 7$ and Beta's impact Damage Multiplier is $(12 + 1 =) 13$. If Alpha has a Margin of Success of 2 for the ramming attack, then Alpha will take $(13 \times 2 =) 26$ in damage and Beta will take $(7 \times 2 =) 14$ in damage. Maybe Gear Alpha's pilot should reconsider this course of action!

■ Physical Attack Example

Example: Out of ammunition, Gear Omicron (Size 6) decides to run up to the light tank it disabled last turn and finish it off with a well-placed kick. The damaged tank is not very maneuverable and rolls a low 2 as defense. With modifiers, Omicron's pilot rolls a 6, for a MoS of 4. The final damage is $(4 \times 6 =) 24$ points of damage. The Gear jumps on the hapless tank's hull and kicks the turret clean off.

◆ Punching

An arm or an equivalent appendage is required to punch. The Gears are the most common punching vehicles, but construction machines equipped with hydraulic arms can achieve a similar effect if the latter are sturdy enough to withstand the impact (this is noted in the Perk's description on the vehicle sheet). Punch attacks require a Gunnery Skill roll (modified by the Fire Control rating) versus the defender's own Piloting (or Infantry Skill, if attacking infantry units). The Damage Multiplier of a vehicle's punch is normally equal to the rating of the punching arm, but the pilot may elect to "pull" the punch to lower the DM and thus reduce the damage.

◆ Kicking and Stomping

Kicking other vehicles and stomping infantry squads are both valid attacks for a Walker vehicle. Kick attacks require a Piloting Skill roll (modified by the Maneuver rating) versus the defender's own Piloting (or Infantry Skill, if attacking infantry units). If successful, the Margin of Success is worked out and the damage calculated as normal. The Damage Multiplier of a kick is equal to the Size of the vehicle. If the vehicle is capable of putting its full weight upon the target, the damage is doubled.

◆ Throwing

Throwing is the attack used to hurl items, such as rocks or grenades. At least one arm is required for throwing. Battle and Tool Arms may not be used to throw objects, unless they have been specifically designed to do so. They may not be used for another function, and the Battle Arm cannot pick up the projectile by itself.

The base throwing range (in meters) of the arm is equal to twice its rating. This total is reduced by the Size of the object being thrown, which is subtracted from the throwing arm's rating before doubling it. If the object being thrown is larger than half the Size of the throwing vehicle, half the rating of another arm can be added to the effort. Weapons' Sizes are equal to their Minimum Size requirement minus one.

The base range calculated above is doubled for each additional range band, as for any other weapon. When playing on a hex board, both the attacker and defender are considered to be in the middle of their respective hexes when determining the range.

When an object is thrown, a Gunnery Skill roll, modified as normal for range and movement, is made. If the modified die roll is equal or higher than the defense roll, the object thrown lands right on target. If the dice roll is failed, the shot will deviate from its intended destination by a number of meters equal to twice the Margin of Failure. One die is rolled for the direction of the deviation. When using hexes, the deviated projectile is placed in the nearest possible hex, considering the target point as the center of the target hex.

If the attack roll was Fumbled, the shot deviates as normal, but toward the throwing unit. Sometimes, a Fumble will land a projectile right on top of another unit anyway. The attack is resolved as normal if the defense roll of the new target is failed.



◆ Melee Weapons

Much like punching, attacking with various handheld weapons is a Gear battle signature. The pilot attacks the target using his Gunnery Skill, applying the Fire Control as a modifier. If successful, the Margin of Success is worked out and the damage calculated as normal. A melee weapon's Damage Multiplier is listed in the Weapon section of the vehicle record sheet, along with any special effect or rule.

1.12.4 - EVASIVE MANEUVERS

Evasive maneuvers allow the pilot to avoid incoming attacks. An evasive maneuver counts as an action and **MUST** be declared at the beginning of the combat round (units may not "abort" to evasive maneuvers later in the round). Performing evasive actions adds a +3 bonus to all defense rolls for the combat round, but forbids the vehicle from attacking or performing ANY other action that round. Multiple "evasive actions" cannot be performed to accumulate defensive bonuses.

1.12.5 - CALLED SHOTS

A gunner may elect to perform a called shot versus a specific component of a vehicle rather than aim for the center of mass. Possible targets are Fire Control, Structure, Crew Compartments, Movement Systems, and Auxiliary Systems. These locations are represented by 1 to 5 on the Systems Damage Table (see *Damage*, page 17). Called shots take a -1 modifier on their attack. If the called shot hits, the odds of hitting the specific component are increased: result 6 now also correspond to the desired location (see *Damage*, page 17).

For scenario purposes, high precision shots versus tiny targets (headlights, for example) are possible. The shot must be aimed (-1 Accuracy) and a Margin of Success of at least 3 is required to hit. If the MoS is lower than 3 but above 0, the attack hits the targeted location but not the tiny target. For example, a gunner wishing to blow out a headlight on the Gear's structure would make a precision shot; if the MoS is under 3, he hits the Structure instead. Small targets and their locations are mentioned in the scenario when this option is available.

Called shots, being less likely to hit than other attacks, are usually best used for specific objectives. For example, destroying a vehicle's movement system helps to capture it, while specifically targeting the fragile antennae array of the Gear providing ECM cover to the opponent is more likely to silence it than a random hit to the structure.

◆ Called Shot Example

Example: Gear Alpha's pilot holds a grudge against Gear Beta's pilot and performs an aimed shot towards Beta's crew compartment. Alpha takes a -1 on his attack roll, but if he hits Beta, his odds of hitting the crew compartment are slightly increased. When Alpha's Player rolls on the Systems Damage Table, either a "3" or a "6" result will hit the crew compartment. Normally, only the "3" is a crew compartment hit — a "6" usually results in a "Roll twice on this table" result.

1.12.6 - INDIRECT FIRE

Indirect fire is used by artillery batteries and other vehicles that have weapons capable of indirect fire. Indirect fire is primarily used for long range fire support, though it is also useful to attack targets that are out of visual line of sight. Only weapons that are specifically designated as indirect firing weapons may use this form of attack.

To fire indirectly, an allied unit must be designated as the forward observer. The forward observer must have a valid LOS to the target. Being a forward observer takes up one action (and possibly a Communication roll to beat ECM, if any is present). However, a single forward observer can relay firing coordinates to multiple indirect fire units.

Indirect attacks can be performed over obstacles, including interfering elevation levels, because the attacks are angled over the obstructions. The attack receives the forward observer's Obscurement modifier to attack instead of his own. If the attack is successful, however, only the target hex's Obscurement counts, thus increasing the MoS. If the attack fails, the shot scatters in a random direction by a number of hexes equal to the MoF.

□ Indirect Fire Example

Example 1: Gears Alpha and Beta are allies. Gear Gamma is their enemy. Gears Alpha and Gamma cannot see each other due to an obstructing hill. However, Gear Alpha has an indirect fire weapon. Beta has a line-of-sight with Gamma and can serve as a forward observer for Gear Alpha. If Beta expends one action to serve as a forward observer, Alpha may fire indirectly at Gear Gamma using the Obscurement between Gears Beta and Gamma as his own Obscurement modifier.

Example 2: The total Obscurement between Beta and Gamma is 0, because only Beta's own hex has any Obscurement. Beta can then transfer the information (at the cost of one action) to Alpha, who fires with Beta's Obscurement penalty, but its own range and Accuracy modifiers. If it hits, the MoS is increased by removing all Obscurement except Gamma's own hex. If it misses, the shot scatters randomly by a distance equal to the Margin of Failure.

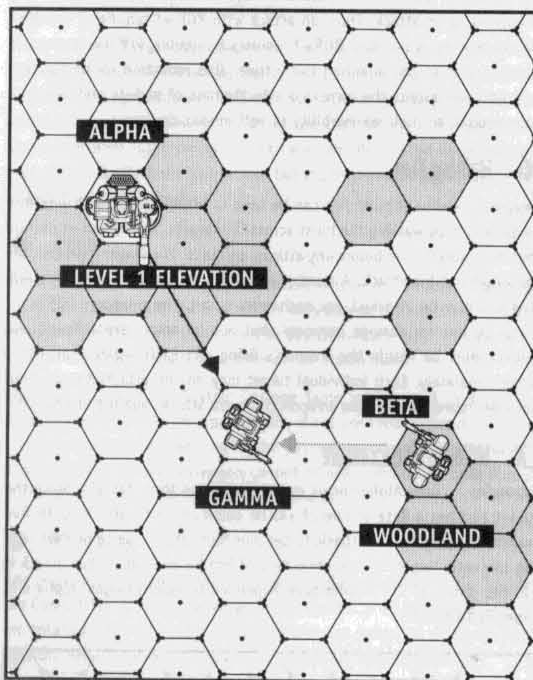

1.12.7 - BURST FIRE

Burst fire is a typical example of the effect-based rule design philosophy that permeates the Silhouette system. Rather than worry about each and every bullet or rocket sent toward the enemy by a rapid fire weapon, they are generalized and abstracted into a form that is easier (and faster) to use during the game.

Any weapon with a Rate of Fire (ROF) rating of 1 or greater is capable of burst fire. The Rate of Fire is added to the weapon's Damage Multiplier when the weapon is used against vehicles and other hard targets such as buildings and other structures. This represents the increased damage effect caused by the pounding of many projectiles upon the target's armor (remember, Silhouette's Damage Multipliers increase exponentially, not linearly). A successful burst fire attack versus infantry and other soft targets, on the other hand, adds the ROF bonus to the Margin of Success instead of the Damage Multiplier to represent the devastating effect of the multiple rounds on the unprotected target(s).

Ten rounds of ammunition are expended (not entirely realistic, but much simpler game-wise) for every point of Rate of Fire bonus used in the attack. Burst fire has the effect of lowering the weapon's total effective damage for the ammo fired because many rounds will simply not connect with the target. To conserve ammunition, the attacker may elect to use only part of the weapon's entire ROF rating. If the ROF rating is equal to zero (by choice or by design), only one round of ammunition is expended per firing of the weapon.





■ Burst Fire Example

Example: Smitty fires his 20mm autocannon at the enemy. His gun has a ROF bonus of 2. He elects to fire with the full ROF bonus, expending 20 rounds of ammunition. He hits with a Margin of Success of 2. His gun's normal Damage Multiplier is x8; since his ROF is 2, this now becomes $(8 + 2 =) 10$. The total is now 20 points of damage. Had he elected to use an ROF bonus of 1 his total damage would have been $((8 + 1) \times 2 =) 18$. He would, however, have saved himself 10 shots. Had he used his full ROF bonus of 2 against infantry, the bonus would have been applied directly to his Margin of Success. This raises his Margin of Success to 4, thereby causing $(8 \times 4 =) 32$ points of damage to the hapless infantry unit.

◆ Missile ROF

Unlike other weapons, rocket and missile launch systems do not expend 10 rounds of ammunition per point of ROF bonus used in the attack. Instead, the number of rockets or missiles used doubles for every point of ROF that is applied to an attack. Thus, an attack with ROF +1 requires 2 missiles, ROF +2 requires 4 missiles, ROF +3 requires 8 missiles, ROF +4 requires 16 missiles, and so on, doubling every time. This reduction in ammunition cost both represents the increased effectiveness of rockets and acts as a counterpoint to their vulnerability to anti-missile devices.

◆ Walking Fire

Weapons capable of burst fire can be used to attack multiple targets in a single action by walking the burst across the targets. A Player must declare that he is walking fire before any attacks are made. The Player then chooses the targets of his attack. A number of targets equal to the weapon's ROF plus one may be attacked. For each extra target, the weapon's ROF is reduced by one for damage purposes (but not for ammo expenditure). All targets must be within the weapon's firing arc. Each separate attack is rolled separately. Each individual target may not be attacked more than once per round by the same weapon (no extra attacks against one target).

■ Walking Fire Example

Example: Gear Alpha sprays rocket fire across three targets. Since the rocket pod has a Rate of Fire of +4, he could chose to attack up to five targets in a single attack (basic target plus four others). Since he is attacking two extra target, his effective Rate of Fire for each individual attack is +2, two points of ROF having been expended to switch target. Alpha still expends 16 rockets.

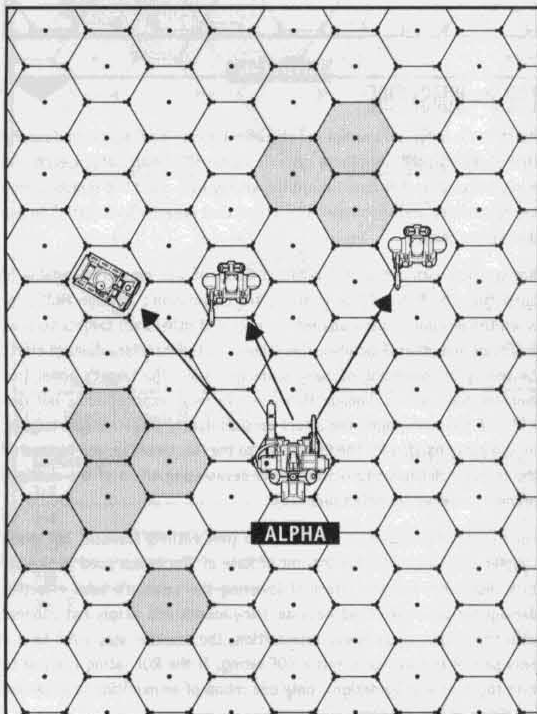

◆ Saturation Fire

A burst fire weapon (ROF equal to or greater than +1) can be used to saturate a mapboard hex and automatically attack anyone entering it. The weapon is put on full automatic fire and ammunition is emptied liberally in the target zone, filling the air with a virtual wall of projectiles. Every unit that is in the target hex or enters the hex later in the combat round suffers an attack automatically, regardless of speed, maneuver or allegiance.

To perform saturation fire, the attacker chooses a hex. He then rolls his attack normally except that half the weapon's ROF (rounded down) is added to his total. The ROF is not used to increase the Damage Multiplier or Margin of Success of the attack. After rolling, the attacker records the total attack roll. Any unit in the hex, or that enters the hex later in the combat round, must surpass this number or be damaged by the saturation fire. The Margin of Failure of the defender is treated as the Margin of Success in a normal attack (i.e. total damage = Margin of Failure x Damage Multiplier of weapon). There are two limitations to this type of fire: the saturation zone cannot be further than the Medium range of the weapon, and the weapon uses 30 shots of ammunition (or 8 rockets) per ROF point used in the attack. If the weapon does not have this much ammo left, the result still stands (although the ammo magazine is emptied). A least 10 rounds of ammunition (or 4 rockets) are required to saturate a hex.

■ Saturation Fire Example

Example: Smitty, our ever vigilant autocannon fiend, decides to saturate a certain hex using all of his autocannon's ROF of +2. Smitty empties his massive clip into the tiny 50-meter hex. His attack roll turns up a 7. Smitty adds 1 (half his ROF bonus) to the total, bringing it to 8. Any unit presently in that hex, or that enters that hex later in the round, must immediately roll a normal defensive roll versus a Threshold of 8 (Smitty's attack roll). If one of these defenders failed the roll, he would be treated as if he had received a successful attack from Smitty's autocannon. The poor schmoe's Margin of Failure would be multiplied by the autocannon's Damage Multiplier of 8. It is a pity that Smitty is now out of ammo, but then again, his opponents are likely to get shredded to itty, bitty pieces.

1.12.8 - AREA EFFECT WEAPONS

Area effect weapons damage everything in their radius, irrespective of friend or foe. These weapons are rated in Area Effect (AE), followed by the radius (in hexes) of their blast area. An AE of radius 0 means that only the target hex is affected (anything present in the target hex must defend against the attack). A single attack roll is made, while each and every vehicle and squad (allies included) in the affected area roll their defense against this value separately. Even if the blast is completely defended against (e. g. Margin of Success equal to 0), any unit in the blast zone still takes half the explosion's Damage Multiplier in concussion damage.

■ Area Effect Example

Example: An area effect weapon (AE1, DM x30) is fired at Gear Alpha (Armor 15/30/45). Both Alpha and Beta nearby are affected since the blast is AE1. The attack roll is low — a mere 3. The Gear rolls a 6 and Beta a 3 (after modifiers). Still, both take 15 points of damage (half the weapon's Damage Multiplier). Beta shrugs off the damage, but Gear Alpha suffers a Light Damage.

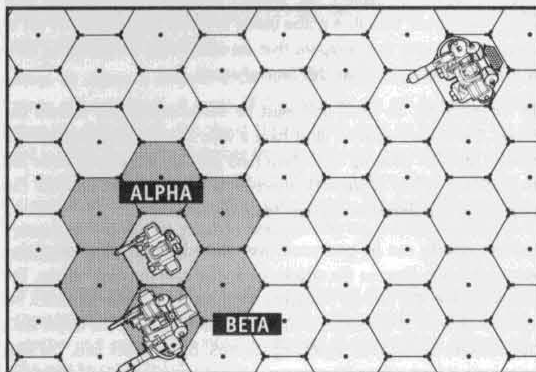

1.13 - DAMAGE

The Armor rating of a vehicle represents the toughness of its best armored location. Aiming for the weaker points of the structure thus increase the chances of damaging the unit. A weapon's damage increases with the Margin of Success of its attack, since weapon damage is rated as a multiplier to the Margin of Success. Thus the better the marksman, the greater the damage.

• **Total Damage = Margin of Success x Damage Multiplier**

This final damage is compared to the Base Armor of the target vehicle. The following table, *Damage versus Armor*, lists the possible outcomes. Only the most severe effect applies. For example, if a vehicle suffers Heavy Damage because it took damage exceeding twice its Base Armor value, it does not suffer Light Damage even though it obviously took damage in excess of its Base Armor rating.

□ Damage versus Armor

Damage versus Armor	Damage smaller than Armor
Outcome	No Effect
What to Do	Nothing; Damage bounces off
Damage versus Armor	Damage greater or equal to Armor
Outcome	Light Damage
What to Do	1 to Armor Rating; -roll on Systems Damage Table, Light
Damage versus Armor	Damage greater or equal to 2 x Armor
Outcome	Heavy Damage
What to Do	-2 to Armor Rating; roll on Systems Damage Table, Heavy
Damage versus Armor	Damage greater or equal to 3 x Armor
Outcome	Overkill
What to Do	Vehicle Destroyed; remove counter
Armor = Vehicle Base Armor	

■ Vehicle Damage Example

Example: Gear Alpha fires his bazooka at tank Beta. Alpha's modified attack roll is 7. Beta's modified defense roll is 4. Alpha hits with a Margin of Success of (7-4) = 3. If Gear Alpha's bazooka has a Damage Multiplier of x20, his total damage is (3 x 20) = 60. Tank Beta has a Base Armor value of 25. Since 60 is over double that value but not triple it, the tank takes Heavy Damage.

1.13.1 - SYSTEMS DAMAGE

The attacker rolls 1d6 to find the location of the hit. When multiple possibilities exist for exactly which vehicle component is damaged, such as when a weapon is damaged, a single die is rolled. If the result is an odd number, the defender chooses which system is damaged. If the result is an even number, the attacker chooses which system is damaged.

For example, a defender might receive a "-1 to Single Weapon" damage effect. If this defender has more than one weapon, a die is rolled. If the number is odd, the defender will probably choose to penalize his most feeble weapon ("we lose more vibroknives that way"). If the number is even, the attacker will most likely opt to damage the defender's main weapon. The penalty is then applied to the Accuracy of the weapon chosen.

If the damage table indicates damage to a system that is not present on the vehicle (or that has already been totaled), the vehicle takes no further damage beyond the loss of Armor points. A vehicle is not destroyed until it is either down to zero Armor point, it receives damage in excess of three times its Armor in a single attack, or the System Damage table result indicates that it is destroyed.

■ Vehicle Damage Example

Example: Following on the previous attack, a roll on the Systems Damage table produces a 2: Structural Damage. This requires a roll on the Structural Damage Subtable B, and this die roll is a 4. One is added to the result, as directed in the previous table. This brings the total to 5: Power Transfer Failure/No Movement. The tank can no longer move, probably because of extensive damage to its treads or gearboxes. It also loses two points of Armor.

◆ Fire Control

Fire Control is a catch-all category that represent the vehicle's targeting devices, acquisition gear and its weaponry. If more than one weapon system is present, all damage received is randomized following the procedure outlined in the previous section.

The damage penalties are applied to the affected weapon's Accuracy. If a weapon's cumulative penalties ever reach a total of -5, the weapon is put out of commission and cannot be used anymore. If the penalties drop to -6 or lower, the weapon is completely destroyed and blown off the hull.

◆ Structure

Structure hits damage the vehicle's frame and structural integrity. The hull and other components are twisted out of shape or ripped apart, causing further damage to the mechanisms within. Most Structure hits are fairly straightforward: loss of Movement Points are applied to one Movement Type, while Maneuver losses affect the vehicle as a whole.

Power Transfer Failure hits destroy the vehicle's transmission, effectively putting all movement systems out of service. It is still possible to fire weaponry, though. Catastrophic Crew Compartment Failure is just that: the vehicle's structure collapses, trapping the crew between the very armor plates that were supposed to protect them. The Reinforced Crew Compartment Perk is ineffective against this, but the Reinforced Structure Perk will absorb the hit as normal.

◆ Crew

"Crew Stunned" results means one action is lost. If the actions were already taken that round, the lost actions carry over to the following round(s). Command points may also be used to pay the action debt. A chit can be placed on the game sheet as a reminder of action owed.

The Crew result on the System Damage Table is also used to determine damage among the vehicle's passengers, if any are aboard. One die is rolled to determine whether the crew or the passengers take the hit. Damage is then applied as normal. Passengers cannot normally replace lost crew, though allowances can be made for this in a scenario.

◆ Movement

Any penalty to the speed of the vehicle is applied to one of its Top Speeds; the Combat Speed is then recalculated as needed. If all Movement Systems are totaled, either through successive minuses (max. -5) or Heavy Damage, the vehicle's defense rolls are equal to zero from now on.

◆ Auxiliary Systems

Auxiliary systems include Sensors, Communications and any Perks which are labeled as auxiliary systems (e. g. life support, ejection seats). If any turret is present, it is counted as an Auxiliary system and may be disabled like the rest (turrets are not affected by "-1" results). A disabled turret is frozen in place and any weapon mounted in it becomes fixed in the arc where it was last fired.

If a vehicle's sensors or fire control are utterly destroyed, the vehicle may still perform actions that require these systems, but it suffers a -5 modifier. If a vehicle's communications system is destroyed, the vehicle may not be used as a forward observer and may not receive Command Points.

Damaged AUX Perks have a -1 to any roll involving those particular systems (for example, -1 on any Sensor roll with Aquatic Sensors), or a 20% loss in efficiency (on systems like mining equipment). If a system's cumulative penalties reach -5 (100% efficiency loss), it is considered destroyed.

■ System Damage Example

Example: In the middle of a furious firefight, Gear Theta is hit by a light autocannon. The MoS is equal to 4. The 32 points of the attack cause a Heavy Damage result. Rolling one die, we get a 1 (Fire Control). Rolling on Subtable A, we get a 3, plus 1 for Heavy Damage. The result is "Single Weapon Destroyed." Gear Theta's Player must now roll 1d6 to determine which one he loses, probably the smaller one. Had the number been even, his opponent would have made that choice for him.





1

☐ Systems Damage Table: Light Damage

Roll	Damaged System	Result
1	Fire Control	Roll on Subtable A
2	Structure	Roll on Subtable B
3	Crew	Crew stunned (-1 action for 1 round)
4	Movement	-1 MP
5	Auxiliary Systems	-1 to 1d6 Auxiliary Systems
6	Roll Twice on this table*	-

* If the attack was a called shot, the attacker hits his target location (as effects 1 to 5 on table, depending on target).

☐ Systems Damage Table: Heavy Damage

Roll	Damaged System	Result
1	Fire Control	Roll on Subtable A and add +1
2	Structure	Roll on Subtable B and add +1
3	Crew	10% casualties, min. 1
4	Movement	1/2 remaining MP (round down) & -2 Maneuver
5	Auxiliary Systems	1d6 Auxiliary System destroyed
6	Roll Twice on this table*	-

* If the attack was a called shot, the attacker hits his target location (as effects 1 to 5 on table, depending on target).

☐ Subtable A: Fire Control Damage

Die Roll	Effect
1	-1 to a single Weapon
2	-2 to a single Weapon
3	-1 to all Weapons
4	Single Weapon destroyed
5	Fire Control system destroyed (-5 to attacks)
6	Roll Twice on this table
7	Ammunition/Fuel Hit (roll 1d6)
1-3	Ammo Storage and Fuel Tank Ruptured (vehicle cannot move or fire weapons)
4-6	Chain Reaction! Ammo and Fuel Explodes! (Vehicle Destroyed and Crew Killed)

☐ Subtable B: Structural Damage

Die Roll	Effect
1	-1 MP
2	1/2 remaining MPs (round down)
3	-1 to Maneuver
4	-2 to Maneuver
5	Power Transfer Failure; no movement
6	Catastrophic crew compartment failure, 75% casualties, min. 1
7	Complete structural failure; vehicle is destroyed; crew survives.

1.13.2 - DAMAGE TO ARMOR

Armor loses its effectiveness when damaged due to cracking and structural fatigue. Bits and parts may fall off, or chinks may develop through which the next attack will reach a vital system or component inside, hastening the vehicle's demise.

When a vehicle receives Light Damage, it loses 1 point of Base Armor permanently in addition to the effect outlined in the System Damage Table. Heavy Damage causes a vehicle to lose 2 points of Base Armor permanently, in addition to the system damage. Each point of Base Armor that is lost reduces the amount needed to inflict Heavy Damage by 2 and the amount need to produce Overkill by 3 (for example, a Hunter with 15/30/45 Base Armor would drop to 14/28/42 after a Light Damage result).

Even if the vehicle has specialized armor-related Perks (such as Reinforced Armor), damage is always taken off the Base Armor rating. This is mostly done to simplify bookkeeping and keep the game moving along.

◆ Armor Loss

Example: Gear Alpha has 15 points of Base Armor (15/30/45). It receives 24 points of damage in one attack, enough to cause Light Damage. The Armor thus drops by one point and becomes (14/28/42). It then receives 28 points of damage. Normally, this would cause Light Damage, but because of the previous hit lowering the Armor, it now causes Heavy Damage. The Armor drops by two points, becoming (12/24/36). Any future hit of 36 points or more will kill the Gear.

1.13.3 - DAMAGE TO ARMS

Arms (whether of the Battle, Tool or Manipulator type) are normally part of the vehicle's basic chassis but are considered weapons for damage purposes. If no other weapon system is carried by the machine, the arm is automatically affected on "Weapon" hits. If other weapon systems are present, the damage is randomized following the usual procedure. Any damage to the arm is also applied to the weapon being carried in that arm. Handheld weapons are usually specified in the design; if not, the weapons are not affected.

Penalties caused by damage are applied equally to all functions of the arm: handheld weapon fire, punching, manipulation, etc. If an arm's cumulative penalties ever reach a total of -5, the arm is put out of commission and cannot be used anymore. If the penalties drop to -6 or lower, the arm is completely destroyed and blown off the hull.

1.14 - INFANTRY RULES

Machines are expensive and require maintenance, but humans need only food and motivation to participate in a battle. Consequently, foot soldiers still form a large percentage of the fighting forces in the 62nd century.

1.14.1 - INFANTRY RECORD SHEET

Each infantry squad has an appropriate record sheet that details the necessary statistics for game play. These sheets are used to tally the damage and record other important information.

The name of the infantry squad should be entered here. Naming a squad can be as elaborate as listing the unit's regiment, battalion, company, platoon and squad designation or as simple as a number (i. e. squad #1).

◆ Quality

There are five levels of infantry quality (see table below). The level of quality determines the stamina and Skill of the squad's members. Stamina is a measure of how much physical punishment each trooper can endure. Unlike vehicle crews, infantry are assigned one generic Skill to keep the game simple. This Skill serves for attack, defense and other action tests.

☐ Infantry Quality

Quality Level	Stamina	Skill
Rookie	3	1
Qualified	3	2
Veteran	4	3
Elite	4	4
Legendary	5	5

◆ Armor

Many infantry squads wear some type of body armor for protection against light weapon fire and shrapnel. There are three primary forms of body armor available to infantry: light flak, heavy flak and "turtleshell," each offering an increasing amount of protection. Tougher armor, however, is restrictive and heavier, slowing down the trooper wearing it; this is simulated by Encumbrance points. Each point of Encumbrance results in a -1 modifier on all rolls made by the squad. Only one type of armor may be worn by a trooper at any one time. Infantry Armor values are not comparable to vehicle Armor values.

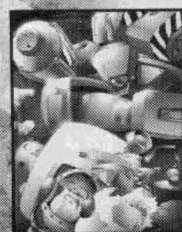



☐ Infantry Armor

Armor Type	Protection	Encumbrance
Light Flak	2	0
Heavy Flak	4	1*
Turtleshell	6	2†

* No encumbrance for Veteran, Elite or Legendary troops
 † Only 1 for Veterans; none for Elite or Legendary

◆ Weapons

Infantry units carry two types of weapons: standard weapons and heavy weapons. Standard weapons are usually some form of rifle. A few troopers (usually 2) in a squad carry a heavy weapon to deal with tougher opponents. Refer to the Infantry Weapons Table to obtain the statistics of particular weapons.

Note that the infantry squad record sheet has no place to record ammunition. This is intentional. Infantry squads are assumed to carry enough ammunition to last them through a battle. While this is not always true in real life, it does dramatically reduce the paperwork for Players with infantry units.

☐ Infantry Standard Weapon

Weapons	Accuracy	Damage	Range	ROF
7mm Rifle	0	x2	1/2/4/8	0
7mm Assault Rifle	0	x2	1/2/4/8	1
9mm Heavy Rifle	0	x3	1/2/4/8	0
15mm Sniper Rifle	+1	x4	2/4/8/16	0

☐ Infantry Heavy Weapon

Weapons	Accuracy	Damage	Range	ROF
9mm Lt. Machine gun	0	x3	2/4/8/16	2
9mm Chaingun	0	x3	1/2/4/8	4
24mm Anti-HG Rifle	+1	x7	3/6/12/24	0
37mm Grenade Rifle	0	x8	1/2/4/8	0
50mm Rocket Launcher	0	x14	1/2/4/8	0
62mm Light Mortar	-1	x12	3*/6/12/24	0
Sniper Laser Rifle	+1	x4	4/8/16/32	0

* Cannot fire at range 2 or less.

◆ Squad Damage Track

The infantry sheet (see *Squad Damage Track*, p. 32) is composed of three columns which represent the ten squad members. The first column (#) lists the members numerically. Circle one of these ten numbers to indicate your squad leader. If he is killed, the squad's leadership Skill rating drops to 1 (all other Skill rolls are unchanged). It is these trooper numbers that the *Infantry Hit Location* table (see page 20) refers to.

The Weapon column reads "Std/Hvy." This refers to standard weapons (Std) and heavy weapons (Hvy). Circle the type of weapon each particular trooper carries.

The third column is composed of eleven boxes. Each box represents one damage point. Each trooper can take a number of damage points equal to his Stamina plus his Armor rating. Cross out the extra boxes for each trooper. When the infantry squad takes damage, cross out one of these boxes for each point of damage the unit takes.

◆ Infantry Squad Examples

Example 1: Infantry squad Alpha is a Veteran squad (Stamina 4) wearing heavy flak armor (Armor 4). Two of the squad members are heavy weapons troopers. The Player chooses trooper number 4 as his leader and circles his number in the first column. He chooses troopers 2 and 8 as his heavy weapons specialists and circles the "Hvy" in their second column. The other eight squadmembers, including the leader, have "Std" circled. Lastly, the Player crosses out the last three boxes of each trooper, leaving 8 damage points for each member of the squad.

◆ Infantry Squad Examples (cont.)

Example 2: Infantry Squad Beta is composed of green recruits, who, because of an administrative mishap, have been outfitted with the finest equipment. The troopers have a Stamina of 3 and are wearing turtleshells (Armor 6). There are only eight men in the unit, but three of them are heavy weapon soldiers (#1, 3, 7 have "Hvy" circled on the sheet). The leader will be #4 (his number is circled). Two damage boxes are crossed out for each trooper, leaving 9 points for each of them. Unfortunately, the bulky and heavy armor will cause a penalty of -2 on all attack rolls made by the inexperienced squad.

1.14.2 - MOVEMENT

Infantry squads on foot receive 2 Movement Points per round. Infantry units do not have Top Speeds, and always move at Combat Speed. They use the Walker terrain movement costs, but it never costs infantry more than 2 MPs to travel through one hex (in short, they can always move at least one hex per round).

There is one exception to this, however: elevation changes. While the squads are assumed to be equipped with all the latest climbing gear, they can only go down the cliffs, not up — climbing is too time-consuming for a combat environment. Furthermore, it would make infantry prone and helpless, something nobody wants during combat. No more than two elevation changes are possible per hex traveled.

◆ Optional Movement Options

Some specialized infantry squads have modes of transportation other than walking. Some rapid deployment teams are equipped with jetpacks or tiny unarmed all-terrain vehicles (dirt bikes and the like). Because they require extra supplies and training, these units are more costly to field and thus comparatively rare.

Jetpack units have 6 MPs and use the same movement costs as Hover vehicles. Squads with light ATVs have 8 MPs and use the same movement costs as Ground vehicles. The condition of the vehicles or jetpacks is not tracked to reduce the paperwork — it is assumed that the vehicle is damaged beyond immediate repair when the trooper becomes a casualty.

1.14.3 - SENSORS

Most infantry squads are not equipped with special sensors, though they have a camera and communication suite mounted within their helmet to relay information to other members of the combat group. When used with the goggles' Head-Up Display, these can be used to receive limited sensor and targeting information.

Infantry have Detection values of 4 during the day and 2 at night, with a range of 1 km (20 hexes). Infantry can be equipped with night vision equipment, giving them a Detection value of 4 at night. They are assumed to have small personal communicators that are sufficient to allow them to coordinate their actions with the rest of their teammates. If tested, these communicators are assumed to have a range of ten kilometers and a Communication rating of -2.

1.14.4 - INFANTRY ACTIONS

Infantry units have one action per squad, which is normally used to attack. When an infantry unit goes on the offensive, it gets one attack per gun type at the cost of a single action. All attack rolls are made with the unit's Infantry Skill (with any applicable modifiers). Weapons of the same type must attack the same target.

Massed attacks of infantry squads also have a special Rate of Fire bonus. If two or more troopers are using the same weapon type, the value listed in the *Infantry ROF Bonus* table on the next page is added to the weapon's Rate of Fire. Infantry weapon ROF otherwise works as for vehicles (see *Burst Fire*, page 15), with the same options.

Even if the entire squad is equipped with disparate weaponry (more than two types of weapons), the squad can attack two different targets at the most. Infantry units can use their weapons' ROF for burst fire, walking fire or even saturation fire.

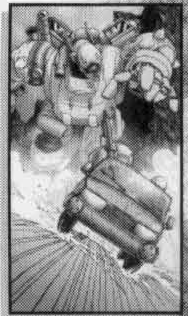



☐ Infantry ROF Bonus

Min. Number of Troopers w/Weapon	ROF bonus
1	0
2	+1
4	+2
8	+3

■ Infantry Attack Examples

Example 1: Infantry squad Alpha has 9 members, 5 of which are armed with 9 mm machineguns (MGs) while the remaining 4 carry 37 mm grenade rifles. One attack will be made with the machineguns (ROF 2), and another with the grenade rifles (ROF 0). If the MGs succeed, they cause a x7 attack (x3, +2 ROF, +2 number of troopers bonus), while the grenade rifles are at x10 (x8 +2).

Example 2: The same squad has taken some casualties later in the game. Only two troopers with MGs remain. They attack, gaining a measly +1 bonus because there are only two of them firing. The elect to put two points of ROF (from the MGs) into boosting the damage and one point to allow them to walk their fire across a second target. The result is two x5 attacks aimed at two different targets.

1.14.5 - ATTACKS VERSUS INFANTRY

Due to their small sizes, dispersed formation and uncanny ability to take advantage of any available cover, infantry do not suffer any defense modifiers for their slow movement: their movement modifier is always 0. In addition, a -2 penalty modifier is applied to any unit other than other infantry squads attempting to target them.

Some vehicles are equipped with specialized anti-infantry weapons which ignore the -2 modifier due to their special targeting systems or method of attack. These weapons are marked with the letters "AI" (for "Anti-Infantry") in their description.

◆ Applying Damage to Infantry

If an infantry squad is hit, the total damage points caused by the attack are calculated normally. The exceptions to this rule are burst fire weapons, which add their ROF bonus to their Margin of Success instead of to the Damage Multiplier when using burst fire (see page 15).

The damage points, however, are applied somewhat differently. They are not compared to the Armor rating; infantry units do not suffer damage like vehicles. Instead, each point of damage is removed from the squad on a one-to-one basis. When the squad takes damage, the attacker rolls one die using the *Infantry Hit Location* Table (at the top of the column at right) to see where in the unit the attack hit.

The table indicates which trooper is the first one to take damage. If the trooper runs out of damage points, he is considered a casualty and the remaining damage points are applied to the next trooper either up or down the list (depending on the die result), and so on. If damage remains to be allotted up past trooper #1 or down past trooper #10, the damage loops around to the other end of the squad's damage track (i. e. to #10 or #1, respectively).

◆ Infantry Casualties

A trooper is not considered to be a casualty until his entire damage track is crossed out. The debilitating effects of injuries are ignored for convenience — the troopers are equipped with emergency first aid packs with stimulants, and some of the damage points may well represent shell shock instead of actual physical wounds. As for casualties in vehicle crew, a trooper with zero points remaining is not necessarily dead — but he is unconscious, wounded or otherwise unable to keep on fighting, and thus takes no further part in the scenario.

The ROF bonuses from mass attacks with infantry weapons is reduced if casualties occur. If the number of squad members with a particular weapon drop below the 2, 4, or 8-member levels (see table at the top of this column), the squad loses the associated ROF bonus.

■ Infantry Damage Examples

Example 1: Infantry squad Bravo has two heavy weapons troopers, #3 and #8. The leader is #9. Each trooper has 6 damage points. An autocannon burst chews into squad Bravo for 32 points of damage. A roll on the *Infantry Hit Location* table turns up a 3. #5 is the first in line for damage and the damage will work its way down the damage track. The first 6 points drop #5. The next 6 points drop #6. The 6 points after that make #7 a casualty. The fourth 6-point group eliminates #8, the heavy gunner. The fifth 6-point group drops #9, the squad leader. #10 takes 2 points of damage but is still up and functional. The unit is now down to one heavy gunner (massed attack ROF bonus drops from +1 to 0) and 4 standard weapon troopers (massed attack ROF bonus drops from +3 to +2). In addition, the unit is now leaderless (Leadership Skill of unit drops to 1).

☐ Infantry Hit Location

Die Roll	Start at Trooper #	Direction
1	1	down
2	3	down
3	5	down
4	6	up
5	8	up
6	10	up

◆ Area Effect Weapons versus Infantry

Infantry units are very vulnerable to area effect weapons designed to be used against them. These weapons typically bounce right up before exploding and showering the landscape under them with thousands of sharp fragments moving extremely fast. This negates most of the cover that is available to infantry units and cause devastating injuries. The anti-personnel grenade launchers that are mounted on Gears and tanks work on the above principle, releasing dozens of micro-bomblets above their targets.

When a weapon with both the Anti-Infantry and an Area Effect hits an hex that contains an infantry unit, the damage is inflicted upon each trooper instead of working its way through the squad.

■ Area Effect Versus Infantry Example

Example: Each trooper in infantry squad Bravo has 7 damage points. An anti-personnel area effect attack hits their hex, doing 6 points of damage. All the troopers lose 6 points from their damage track, leaving each one with a single damage point left. If the area attack had done 7 or more points, the entire squad would have been wiped out.

1.14.6 - INFANTRY THREAT VALUE

Infantry squads are easy to generate. Choose the Skill rating, armor, equipment and weapons, then calculate the Threat rating according to the following formula.

$$\text{Individual Infantryman Threat Value} = \text{square root } ((\text{infantryman's Damage Points})^2 \times \text{Weapon Damage Multiplier})$$

The individual Threat Rating of all infantrymen is added up, then modified according to their Skill level (see the table below). Infantry has a single generic Skill, which is equal to the rating listed in the parentheses. Infantry squads equipped with either jetpacks or All-Terrain Vehicles double their final Threat Value.

☐ Infantry Multiplier To Threat Value

Infantry Type (Skill Level)	Threat Value Multiplier
Rookie (1)	x0.25
Qualified (2)	x1
Veteran (3)	x2.25
Elite (4)	x4
Legendary (5)	x6.25
Legendary (6)	x9
Legendary (7)	x12.25
Legendary (8)	x16





1.15 - PERKS

Many vehicles have special features that are not covered by its primary tactical attributes. These extra features are represented by Perks, most of which have a lesser impact on the tactical performance of the vehicles in this boxed set. They are nonetheless detailed below to ensure complete compatibility with the standard **Heavy Gear** roleplaying and tactical game line. Perks with the designation (AUX) count as Auxiliary Systems for damage purposes.

◆ Airdroppable

The vehicle can be equipped with a parachute or an equivalent device that allows it to be dropped from high or low altitude onto a battlefield. This has limited application unless required for a specific tactical scenario, but it allows for some interesting game opportunities.

◆ Autopilot (AUX)

Autopilots are device that can take over piloting tasks. They can be used to keep a vehicle moving in a straight line or performing 60° turns (one hex facing). In tactical terms, they dodge attacks as a level 1 pilot and can be programmed to ram large targets without endangering the crew, who exits the vehicle beforehand.

◆ Backup Sensors

The vehicle may ignore any Sensor damage effect on the first Auxiliary System Hit on the Systems Damage Table, but then loses this Perk. It can be restored by a normal repair. All non-sensor Auxiliary Systems take normal damage effects, if applicable.

◆ Easy to Modify

The vehicle is designed to be easily modified or repaired (standardized parts, modular aspects). Add +2 to all technical Skill rolls to modify or repair the vehicle. This Perk is primarily meant for campaign games and has no effect during a tactical scenario.

◆ ECM

Electronic CounterMeasures (ECM) are devices used to jam sensors and communication systems. Using ECM to jam requires one action per roll. An Electronic Warfare Skill test is rolled, adding the ECM's rating as a modifier. Unless the roll fumbles, the result of this roll is the Threshold of all enemy Communication or Sensor tests (both use the EW Skill) within the vehicle's ECM range. The jammed Sensors and Communications must pass this test each round just to be functional. ECM range is identical to the vehicle's base Sensor Range.

◆ ECCM

Electronic Counter-CounterMeasures are devices used to block jamming systems or punch through their effects. Using ECCM to prevent jamming requires one action. Roll an Electronic Warfare Skill test, adding the ECCM rating as a modifier. Unless the roll fumbles, the result of this roll is the Threshold of ECM action tests (uses the EW Skill) within the vehicle's ECCM range. The blocked jammers must pass this test each round just to be functional. ECCM range is identical to the vehicle's Sensor Range.

◆ High Towing Capacity (Double)

The vehicle is equipped with a high torque, heavy duty powerplant and a rugged transmission. Its towing capacity is doubled, meaning it can tow up to twice its weight. This has no effect on the tactical game unless required by a scenario.

◆ Hostile Environment Protection: Desert

The vehicle can withstand extended exposure to desert conditions without needing special maintenance to avoid sand built-up. This Perk includes air filters, modified heat exchangers and cloth coverings on delicate mechanisms. It also includes a tiny air conditioning in the cockpit. This has no effect on the tactical game other than to allow the vehicle to operate in desertic terrains.

◆ Manipulator Arm

The vehicle has an arm (or more) that can pick up and manipulate objects. It can lift an object whose Size score is equal to its rating, but never an item whose size is greater than twice the Size of the lifting vehicle. Manipulator arms can be used to punch opponents, for a Damage Multiplier equal to the rating of the arm.

◆ Passenger Seating

The vehicle has extra seats for passengers. The passengers do not confer any extra actions to the vehicle, nor can they control it. Damage is applied to passengers on Crew hits, randomized with the actual crew.

◆ Reinforced Armor

The vehicle has one or more facings (arcs of attack) with better armor than the rest of the vehicle. Four possible arcs can be reinforced: front, rear, right rear flank and left rear flank. When the vehicle is hit on a reinforced facing, the Perk's rating is added to the Base Armor of the vehicle.

◆ Reinforced Crew Compartment

The crew compartment is layered with additional armor and fitted with crash-absorbing material. The vehicle may ignore the first "Crew Hit" on the Systems Damage Table, but then loses this Perk. It can be restored by a normal repair.

◆ Shielded Weapons

The vehicle's weaponry is sheathed in plates of armor. The weapon damage (destruction or penalty) on the Fire Control Damage Table may be ignored. The Perks is then destroyed, but can be restored by a normal repair.

◆ Target Designator

Target Designators are used to lock-on Guided weapons. To do so, the vehicle "attacks" using the designator as the weapon. Its Base Range is equal to its rating (doubled for each successive range band, as usual). It has +0 Accuracy — not modified by Fire Control — and does no damage. A successful attack "paints" the target for incoming Guided munitions. The target remains designated until the end of the round. Designators are not affected by ECM.

1.16 - FLAWS

These vehicle traits are the opposite of Perks. They represent defects and problems with the vehicle. Sometimes, these defects are planned into the vehicle as a cost-cutting measure, at other times the defects are the result of design or production errors.

◆ Annoyance

Annoyance includes weird noises, bad smells, false alarm signals, a cramped cockpit, etc. This Flaw has no tactical effect, but is interesting for roleplaying purposes. It also serves to individualize the various vehicle designs.

◆ Exposed Fire Control

The vehicle's fire control mechanisms or its weaponry are inadequately protected. A +1 modifier is applied when rolling for damage on the Fire Control Damage Table.

◆ Large Sensor Profile

A design feature makes the vehicle highly visible to sensors. The Flaw's rating is subtracted from the vehicle's Concealment when the vehicle is submitted to an enemy sensor search.

◆ Weak Facing

The vehicle has a weak facing (arc of defense). This may be due to incomplete armor coverage, shoddy design or plain bad materials. When the vehicle is attacked on that side, its effective Base Armor is halved.

CHEETAH HACS-01LG-SCT

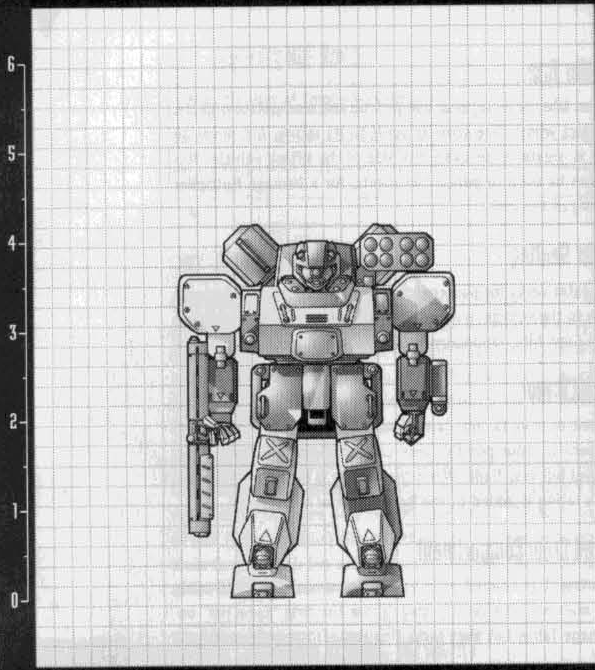

ARMOR DAMAGE

0

--	--	--	--	--	--	--	--	--	--

10

--	--	--	--	--	--	--	--	--	--

20

--	--	--	--	--	--	--	--	--	--

30

--	--	--	--	--	--	--	--	--	--

40

--	--	--	--	--	--	--	--	--	--

CREW INFORMATION

• PILOT NAME: _____

• RANK: _____

• SQUADRON: _____

• AFFILIATION: _____

PILOT (LV/AT): GUNNERY (LV/AT): ELEC. WAR. (LV/AT):

CREW DATA

VEHICLE CREW

• CREW: 1

• BONUS ACTIONS: 0

CREW DAMAGE

VEHICLE CREW

CREW •

BONUS ACTIONS •

SYSTEMS DATA

MOVEMENT

• PRIMARY COMBAT SPD: W 6

• PRIMARY TOP SPD: W 11

• SECONDARY COMBAT SPD: G 8

• SECONDARY TOP SPD: G 15

• MANEUVER: +2

• DEPLOYMENT RANGE: 600

ELECTRONICS

• SENSORS: +2 5

• COMMUNICATION: +1 25

• FIRE CONTROL: 0

ARMOR

• LIGHT DAMAGE: 10

• HEAVY DAMAGE: 20

• OVERKILL: 30

SYSTEMS DAMAGE

MOVEMENT

COMBAT SPD •

TOP SPD •

COMBAT SPD •

TOP SPD •

MANEUVER •

FUEL SPENT •

ELECTRONICS

SENSORS •

COMM •

FIRE CONTROL •

ARMOR

LIGHT DAMAGE •

HEAVY DAMAGE •

OVERKILL •

GENERAL SPECIFICATIONS

• THREAT VALUE: 625 • SIZE: 6 • COST: 468,750 marks

WEAPONS

NAME	CODE	FIRE ARC	S	M	L	EX	Acc	Dam	Qty	ROF	Special
M25 Pack Gun	DPG	Forward	2	4	8	16	-1	x8	1	+2	-
RP-109 Pepperbox	LRP/24	Forward	1	2	4	8	-1	x12	1	+3	Indirect Fire
M-2A Grenade	HG	Forward	0	0	0	0	-1	x15	-	0	Anti-Infantry
HW-VB1 Vibroknife	VB	Forward	0	0	0	0	0	x8	1	0	-

AMMO

	FULL	LEFT
	30	
	24	
	4	
	-	

PERKS

NAME	RATING	GAME EFFECT	AUX
ECM	3	Offensive electronic warfare equipment	Yes
Hostile Environment Protection	-	Desert	
Manipulator Arm x 2	6	Can punch	
Target Designator	2	Target guided weapons	Yes

FLAWS

NAME	RATING	GAME EFFECT
Annoyance	-	Cramped cockpit, max. pilot Build is 0

DEFECTS

NAME	RATING	GAME EFFECT
None	-	-

WEAPONS

WEAPON 01 •

WEAPON 02 •

WEAPON 03 •

WEAPON 04 •

WEAPON 05 •

WEAPON 06 •

WEAPON 07 •

WEAPON 08 •

WEAPON 09 •

WEAPON 10 •

PERKS

PERK 01 •

PERK 02 •

PERK 03 •

PERK 04 •

PERK 05 •

PERK 06 •

PERK 07 •

PERK 08 •

PERK 09 •

PERK 10 •

PERK 11 •



SPITTING COBRA OACS-01H/SU

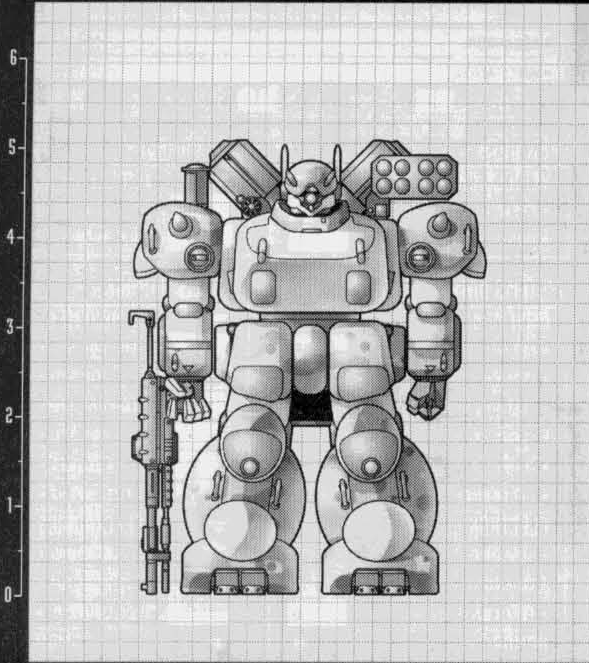

ARMOR DAMAGE

0

10

20

30

40

CREW INFORMATION

- PILOT NAME: _____
- RANK: _____
- SQUADRON: _____
- AFFILIATION: _____

PILOT (LV/AT): GUNNERY (LV/AT): ELEC. WAR. (LV/AT):

CREW DATA

VEHICLE CREW

- CREW: 1
- BONUS ACTIONS: 0

CREW DAMAGE

VEHICLE CREW

- CREW:
- BONUS ACTIONS:

SYSTEMS DATA

MOVEMENT

- PRIMARY COMBAT SPD: W 3
- PRIMARY TOP SPD: W 6
- SECONDARY COMBAT SPD: G 5
- SECONDARY TOP SPD: G 10
- MANEUVER: -1
- DEPLOYMENT RANGE: 400

SYSTEMS DAMAGE

MOVEMENT

- COMBAT SPD:
- TOP SPD:
- COMBAT SPD:
- TOP SPD:
- MANEUVER:
- FUEL SPENT:

ELECTRONICS

- SENSORS: 0 2
- COMMUNICATION: 0 10
- FIRE CONTROL: 0

ELECTRONICS

- SENSORS:
- COMM:
- FIRE CONTROL:

ARMOR

- LIGHT DAMAGE: 21
- HEAVY DAMAGE: 42
- OVERKILL: 63

ARMOR

- LIGHT DAMAGE:
- HEAVY DAMAGE:
- OVERKILL:

GENERAL SPECIFICATIONS

• THREAT VALUE: 818 • SIZE: 7 • COST: 525,857 dinars

WEAPONS

NAME	CODE	FIRE ARC	S	M	L	EX	Acc	Dam	Qty	ROF	Special
MR60 Autocannon	HAC	Forward	3	6	12	24	0	x12	1	=1	-
FSRP-36 Rocket Pod	MRP/18	Forward	2	4	8	16	-1	X18	1	+3	Indirect Fire
SCRP-98 Rocket Pod	HRP/48	Forward	3	6	12	24	-1	x20	1	+4	Indirect Fire
MGU-77 Minigun	LMG	Fixed F.	1	2	4	8	0	x3	1	+4	Anti-Infantry
Vogel-H Mortar	LGM	Forward	3	6	12	24	-1	x15	1	0	Guided, Min.Ran.3
HG-2 Hand Grenade	HG	Forward	0	0	0	0	-1	x15	1	0	Anti-Infantry
VU-11 Vibromachete	VB	Forward	0	0	0	0	0	x8	1	0	-

AMMO

FULL	LEFT
30	
18	
48	
400	
10	
6	
-	

WEAPONS

WEAPON 01

PERKS

NAME	RATING	GAME EFFECT	AUX
Hostile Environment Protection	-	Desert	
Manipulator Arm x2	7	Can punch	
Reinforced Crew Compartment	-	Absorbs first "Crew" hit	

PERKS

PERK 01

FLAWS

NAME	RATING	GAME EFFECT
Large Sensor Profile	1	Subtract from Concealment

DEFECTS

NAME	RATING	GAME EFFECT
None	-	-

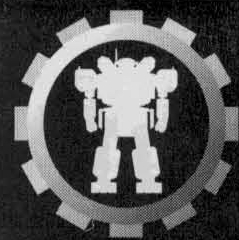

HEAVY GEAR



1

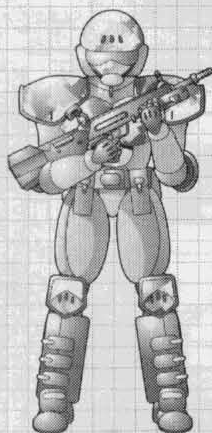

HEAVY GEAR INFANTRY RECORD SHEET

UNIT INFORMATION

UNIT NAME: Standard			
QUALITY: Qualified			
ARMOR: Lt. Flak	ENCUMBRANCE: 0	STAMINA: 3	
ARMOR POINT: 2	DAMAGE POINT: 5		

WEAPONS

STANDARD WEAPON:	ACC	DMG	RANGE				ROF
			S	M	L	EX	
7mm Assault Rifle	0	X2	1	2	4	8	1
HEAVY WEAPON:	ACC	DMG	RANGE				ROF
			S	M	L	EX	
9mm LMG	0	X3	2	4	8	16	2

DAMAGE TRACK

#	WEAPON	DAMAGE POINTS
1	STD	████████████████████
2	STD	████████████████████
3	STD	████████████████████
4	STD	████████████████████
5	HVY	████████████████████
6	STD	████████████████████
7	STD	████████████████████
8	STD	████████████████████
9	STD	████████████████████
10	HVY	████████████████████

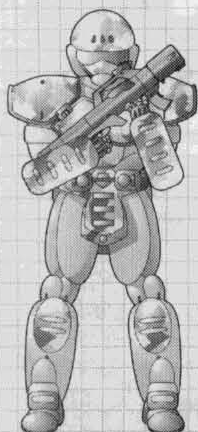

HEAVY GEAR INFANTRY RECORD SHEET

UNIT INFORMATION

UNIT NAME: Heavy Weapons			
QUALITY: Qualified			
ARMOR: Hvy. Flak	ENCUMBRANCE: -1	STAMINA: 3	
ARMOR POINT: 4	DAMAGE POINT: 7		

WEAPONS

STANDARD WEAPON:	ACC	DMG	RANGE				ROF
			S	M	L	EX	
9mm LMG	0	X3	2	4	8	16	2
HEAVY WEAPON:	ACC	DMG	RANGE				ROF
			S	M	L	EX	
50mm Rocket Launcher	0	X14	1	2	4	8	0

DAMAGE TRACK

#	WEAPON	DAMAGE POINTS
1	STD	████████████████████
2	HVY	████████████████████
3	STD	████████████████████
4	HVY	████████████████████
5	STD	████████████████████
6	HVY	████████████████████
7	STD	████████████████████
8	HVY	████████████████████
9	STD	████████████████████
10	STD	████████████████████

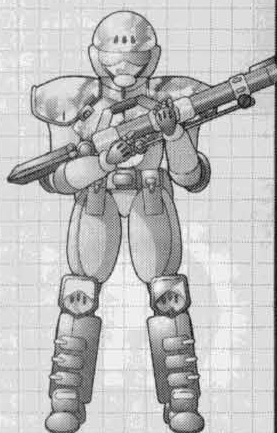

HEAVY GEAR INFANTRY RECORD SHEET

UNIT INFORMATION

UNIT NAME: Recon			
QUALITY: Qualified			
ARMOR: Lt. Flak	ENCUMBRANCE: 0	STAMINA: 3	
ARMOR POINT: 2	DAMAGE POINT: 5		

WEAPONS

STANDARD WEAPON:	ACC	DMG	RANGE				ROF
			S	M	L	EX	
9mm Heavy Rifle	0	X3	1	2	4	8	0
HEAVY WEAPON:	ACC	DMG	RANGE				ROF
			S	M	L	EX	
62mm Lt. Mortar	-1	X12	3	6	12	24	0

DAMAGE TRACK

#	WEAPON	DAMAGE POINTS
1	STD	████████████████████
2	STD	████████████████████
3	STD	████████████████████
4	STD	████████████████████
5	HVY	████████████████████
6	STD	████████████████████
7	STD	████████████████████
8	STD	████████████████████
9	STD	████████████████████
10	HVY	████████████████████

TACTICAL COMBAT RULES



TACTICAL GAME TABLES



DREAM POD 9

MAPBOARDS TERRAIN ICONS

Terrain Type	Walker	Ground	Hover	Obscurement
Clear	1	1	1	-
Rough	1	2	1	-
Sand, Dust	2	2	1	-
Woodland	1	2	2	1
Jungle	2	3	n/a	2
Swamp	2	2	1	-
Water	2*	3*	1	†
Elevation Increase +1	add 2	add 2	add 4	-
Elevation Decrease -1	add 1	-	-	-

* Only Amphibious vehicles may enter these hexes. Other vehicles will flood and automatically be put out of action. In addition, Amphibious vehicles cannot enter or exit this type of hex while moving at Top Speed.

† These only produces Obscurement if the defender is in the hex and is not a Hover vehicle. In this case, Water produces 2 points of Obscurement, Deep Water 4 points.

WEAPONS SUMMARY TABLE

Name	Code	Range	Dam.	Acc.	RoF	Min. Size	Special
AP Grenade Launcher	APGL	1/2/4/8	x3	-1	0	2	Anti-Inf., Indirect Fire, AE=0
Heavy Autocannon	HAC	3/6/12/24	x12	0	+1	5	-
Heavy Guided Mortar	HGM	5/10/20/40	x20	-1	0	5	Guided, Ind. Fire, Min Range 5
Heavy Machine Gun	HMG	1/2/4/8	x4	0	+3	3	Anti-Inf.
Light Autocannon	LAC	2/4/8/16	x8	0	+2	4	-
Light Guided Mortar	LGM	3/6/12/24	x15	-1	0	4	Guided, Ind. Fire, Min Range 3
Light Machine Gun	LMG	1/2/4/8	x3	0	+4	3	Anti-Inf.
Medium Autocannon	MAC	3/6/12/24	x10	0	+1	4	-
Snub Cannon	SC	1/2/4/8	x28	-1	0	6	-
Anti-Tank Missile	ATM	3/6/12/24	x25	+1	0	6	Guided, Indirect Fire
Light Rocket Pack/24	LRP/24	1/2/4/8	x12	-1	+3	3	Indirect Fire
Light Rocket Pack/32	LRP/32	1/2/4/8	x12	-1	+4	3	Indirect Fire
Hand Grenade (1)	HG	0/0/0/0	x15	-1	0	2	Anti-Infantry
Vibroblade	VB	0/0/0/0	x8	0	0	3	Physical Attack Only
Deployable Pack Gun	DPG	2/4/8/16	x8	-1	+2	3	Disposable

INFANTRY WEAPONS

Weapons	Accuracy	Damage	Range	ROF	Weapons	Accuracy	Damage	Range	ROF
7mm Rifle	0	x2	1/2/4/8	0	9mm Chaingun	0	x3	1/2/4/8	4
7mm Assault Rifle	0	x2	1/2/4/8	1	24mm Anti-HG Rifle	+1	x7	3/6/12/24	0
9mm Heavy Rifle	0	x3	1/2/4/8	0	37mm Grenade Rifle	0	x8	1/2/4/8	0
15mm Sniper Rifle	+1	x4	2/4/8/16	0	50mm Rocket Launcher	0	x14	1/2/4/8	0
9mm Lt. Machine gun	0	x3	2/4/8/16	2	62mm Light Mortar	-1	x12	3*/ 6/12/24	0
Sniper Laser Rifle	+1	x4	4/8/16/32	0	* Cannot fire at range 2 or less.				