



# HEROES

ROLE  
PLAYING  
MODULE



# BLOODFEUD!



By Jeff O'Hare



# NEW YORK CITY

## MANHATTAN ISLAND

1. TITANS' TOWER
2. S.T.A.R. LABS
3. CAPT. HALL'S POLICE STATION
4. JOEY PIGEON
5. CANDYMAN
6. EYES WATSON
7. BURKE BROTHERS' WAREHOUSE
8. BABYSITTER BROWN
9. PARADISE THEATER (FORMER HIDEOUT OF BROTHERHOOD OF EVIL)
10. CHURCH OF BLOOD OFFICES (ROARKE BUILDING)
11. J.F.K. AIRPORT
12. EMPIRE STATE BUILDING
13. WORLD TRADE CENTER
14. UNITED NATIONS
15. STATUE OF LIBERTY
16. CENTRAL PARK
17. WASHINGTON SQUARE
18. CITY HALL
19. QUEENSBOROUGH BRIDGE
20. QUEENS — MIDTOWN TUNNEL
21. WILLIAMSBURG BRIDGE
22. MANHATTAN BRIDGE
23. CHARLIE'S FUEL SERVICE (PRESENT HIDEOUT OF BROTHERHOOD OF EVIL)

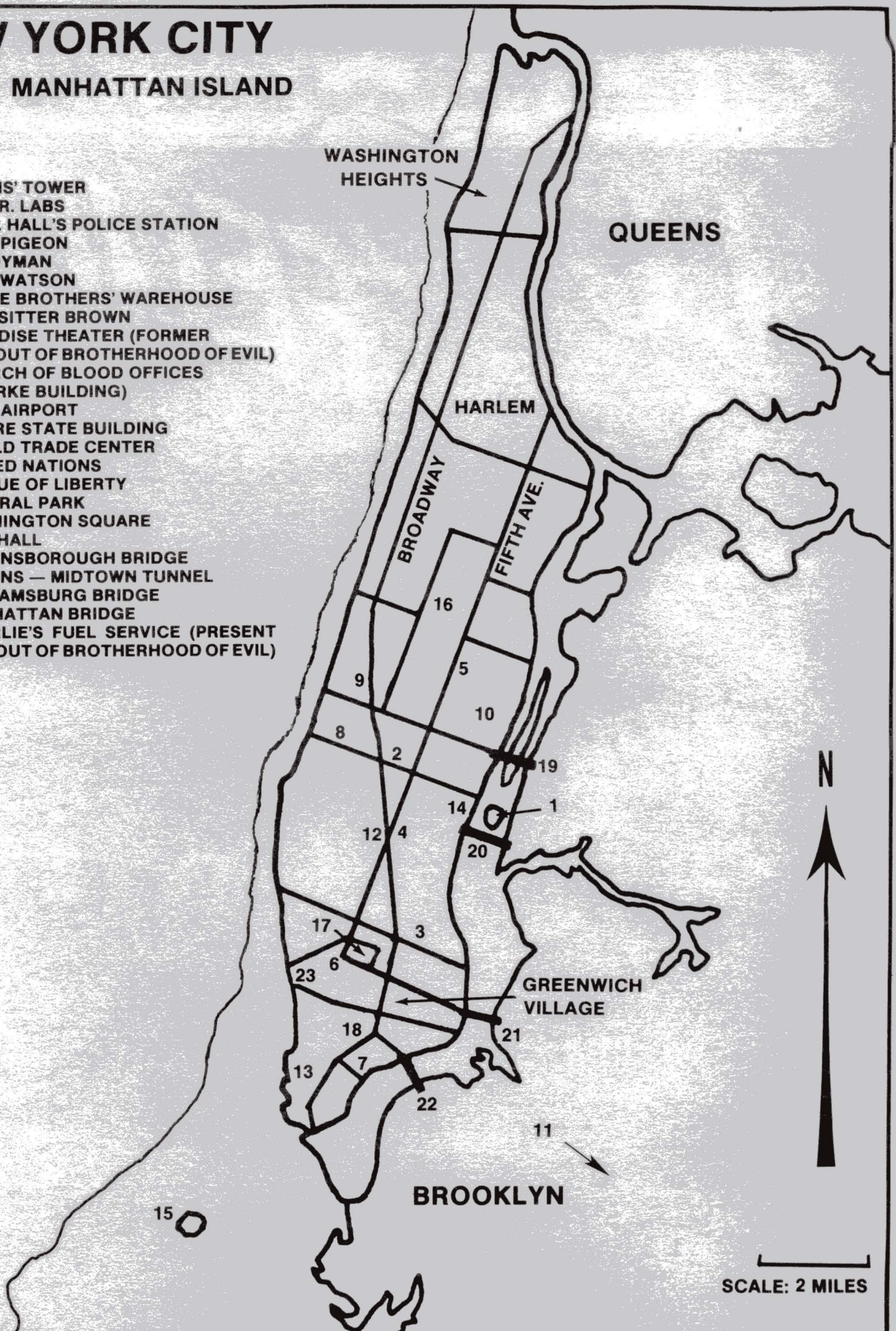

SCALE: 2 MILES



# BLOOD FEUD!

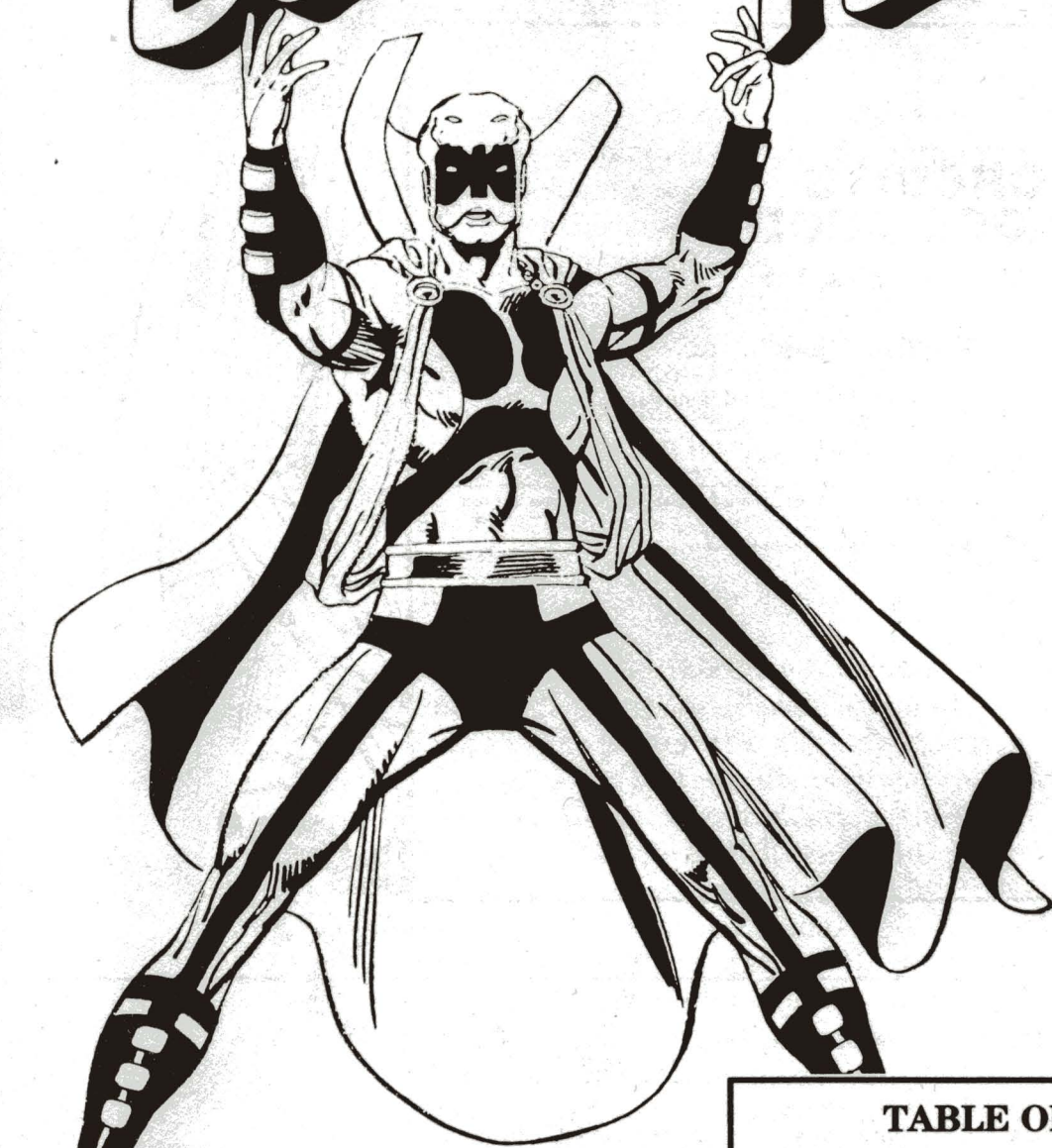

## TABLE OF CONTENTS

How to Use This Book.....	Inside Back Cover
Map: New York City .....	Inside Front Cover
Zandia .....	Page 3
Gamemaster Only .....	Page 4
Player Characters .....	Page 5
The New Brotherhood of Evil .....	Page 6
Non-Player Characters .....	Page 8
Flow Chart.....	Page 9
Encounters .....	Page 10
Endgame.....	Page 29
Maps .....	Page 29



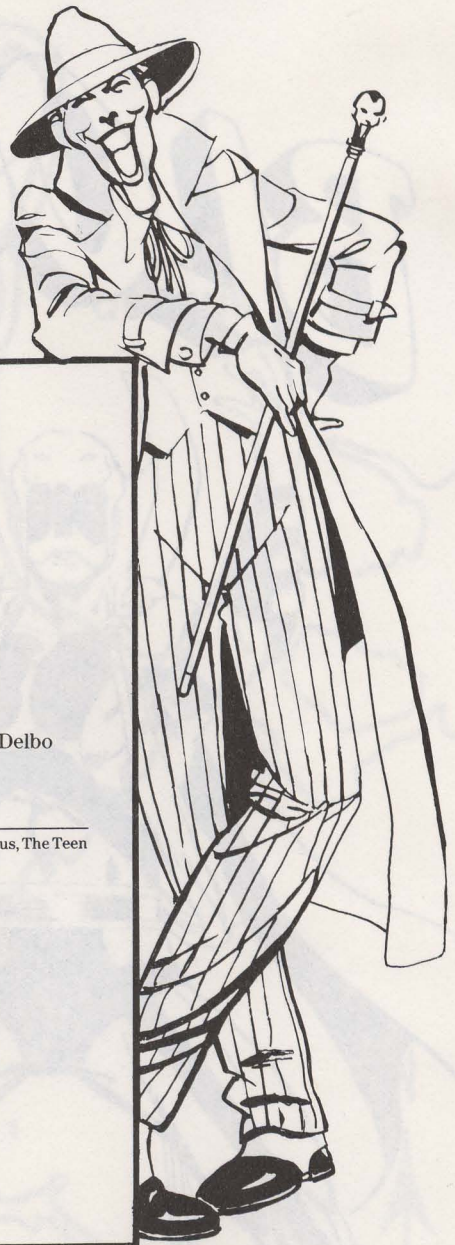

## CREDITS BLOOD FEUD

© 1985 DC Comics, Inc.

All Rights Reserved

Produced by Mayfair Games, Inc.

*Authors:* Jeff O' Hare

*Editors:* Scott Jenkins and Brian Reid

*Front Cover Art:* Ed Hannigan, & Jose Delbo

*Interior Art:* DC Staff

*Maps:* James Clouse & Jerry O' Malley

Brother Blood, The Brotherhood of Evil, Brain, General Zahl, Houngan, Madame Rouge, Monsieur Mallah, Phobia, Plasmus, The Teen Titans, Captain Hall, Jenet Klyburn, Zandia, S.T.A.R. Labs,  
(and any component thereof) are trademarks of DC Comics, Inc. used under license by Mayfair Games, Inc.



is a registered trademark of Mayfair Games Inc.



is a registered trademark of Mayfair Games, under license from DC Comics, Inc.



is a trademark of DC Comics, Inc., used under license by Mayfair Games, Inc.

All characters in this book are fictitious. Any resemblance to actual persons, living or dead, is purely coincidental.

ISBN: 0-912771-56-9

Manufactured in the United States, Chicago, IL

**Mayfair Games, Inc. P.O. Box 48539 Niles, IL 60648**





# ZANDIA

A small island located in the center of the Baltic Sea, Zandia has a population of approximately 3,769, but none of those citizens are natives.

Zandia has no major industry.

Zandia has no imports, nor does it have exports.

It is out of the way of all shipping lanes. The only way to get here is with dire determination or by unfortunate accident.

There are no nations in the civilized world that will come to its aid, but neither are there nations that would dare attack this island.

Zandia is entirely populated by men and women who have nowhere else to go. They are all dangerous criminals whose own lives mean nothing to them the lives of others mean even less.

Whoever controls this island has an excellent base for power, a power of criminal influence that would have its tendrils in every nation on Earth.

Unfortunately, the elected leaders of this country, unless they are careful, soon die.

There is one leader who has stayed in power for centuries. His power is not political. He is the head of the official church of Zandia: the Church of Brother Blood. He is Brother Blood.

Any power that is not sanctioned by Brother Blood is not a power on Zandia.

One power that had the sanction of Brother Blood was that of Madame Rouge and General Zahl. Together, Rouge and Zahl were responsible for the deaths of the legendary Doom Patrol, the attempted murder of the Brain and Monsieur Mallah (Rouge's former comrades in the original Brotherhood of Evil), and the series of experiments that changed Otto Von Furth into the shambling mass known as Plasmus.

The Brain and Monsieur Mallah recruited Plasmus, as well as Houngan, Phobia and Warp to become the New Brotherhood of Evil. Together they attacked and killed General Zahl and Madame Rouge during Zahl and Rouge's bloody takeover of the government of Zandia.

Now, to complete their revenge, they want Brother Blood.



# Gamemaster Only

## STORYLINE

A-30, an experimental gas from S.T.A.R. Labs which is capable of rendering normal people who inhale it temporarily immobile, was found to have a dangerous side effect: it temporarily strips super-powered heroes of their powers. In a daring attack on the New York S.T.A.R. Lab Complex, the gas is stolen by the Brotherhood of Evil.

Meanwhile, word has reached the New York Police Department that a major religious figure is about to be assassinated. If this happens, a massive upheaval would be sparked by the children of a number of powerful politicians. Captain Hall of the New York Police Department is in a touchy situation when he asks for the players to act as bodyguards for the religious figure — Brother Blood.

The players must take this assignment. However there is still time to continue their investigation of the theft of the A-30 gas.

As the pieces come together the players discover that the theft of the A-30 gas is directly related to the threat on Blood's life.

The Brotherhood of Evil wants Brother Blood, and this time they're playing for keeps.

## BLOOD'S MOTIVATION

Brother Blood is coming to New York in order to oversee the building of his new church. The threats against him were discovered by his minions a few days ago and relayed to Sister Dread who then informed Blood.

Blood didn't want any protection at first, being confident about his own ability to protect himself. However, the idea of forcing the Titans to be his "guards" appealed to Blood's sense of irony. If the Titans protect him, Blood can show the world that the Titans are on his side and are thinking of joining the church. If the Titans are unable to protect him, Blood's forces will blame the Titans for the "death" of their leader. Unless the Titans are killed outright while protecting Blood from the Brotherhood of Evil, the minions of Blood will take out their revenge on the Titans immediately.

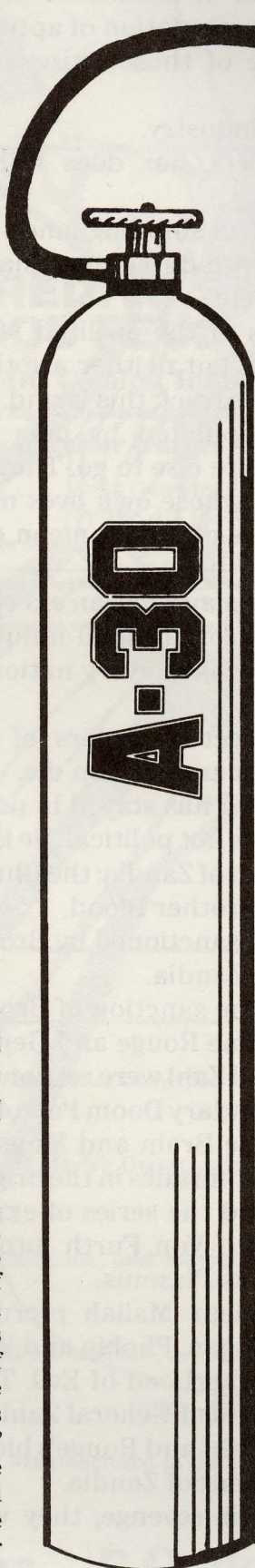

## A-30 Gas

A-30 gas has been under development at S.T.A.R. Labs for several years now. Originally funded by the Pentagon, the project was shifted to Treasury Department control when the special effects of the gas were discovered.

When tests were conducted on felons who volunteered in exchange for lighter sentences, S.T.A.R. Labs found that the gas not only rendered "normals" unconscious, it also robbed super-powered victims of their powers for a short period of time. The Treasury Department took control in order to exploit these powers in the interest of national security.

### A-30 gas has the following properties:

- 1) Against "normals", the gas attacks physically (EV: 25), leaving victims unconscious.
- 2) Against heroes and villains the gas attacks the inherent powers as follows:
  - a) The power with the highest AP rating is the first affected.
  - b) The EV of the gas is 25.
  - c) The power of the victim is the OV/RV.
  - d) The RAPs are subtracted from the victim's power for 8 APs of time.
  - e) Further exposure to the gas will cause an attack on the next strongest power.
- 3) Skills and Attributes of heroes and villains are affected. If a Skill or Attribute has a higher AP value than a Power, then that Skill or Attribute is affected first. Further exposure attacks the next highest Power, Skill, or Attribute.
- 4) Non-inherent powers are unaffected (e.g. all of Cyborg's powers are machine driven and thus unharmed by the gas).
- 5) A suit with the power of sealed systems or the power of sealed systems are added to the OV/RV of the intended victim.

### Desperation Recovery Rolls are made as follows:

- 1) Spend HPs as normal.
- 2) If the power still has positive APs, roll with the permanent APs of the power as AV/EV and 0 as the OV/RV.
- 3) If the power has been reduced below 0 the negative result is the OV/RV.
- 4) The RAPs are the number of APs returned to the character.

A-30 gas is sprayed from a special canister. The range of the spray is 7 APs of distance and the area of effect is 0 APs. Note sweep attacks are 10 uses for each canister and the duration of the gas in the air is 1 phase. The DEX of the Gas is Location-dependent.



# Player Characters

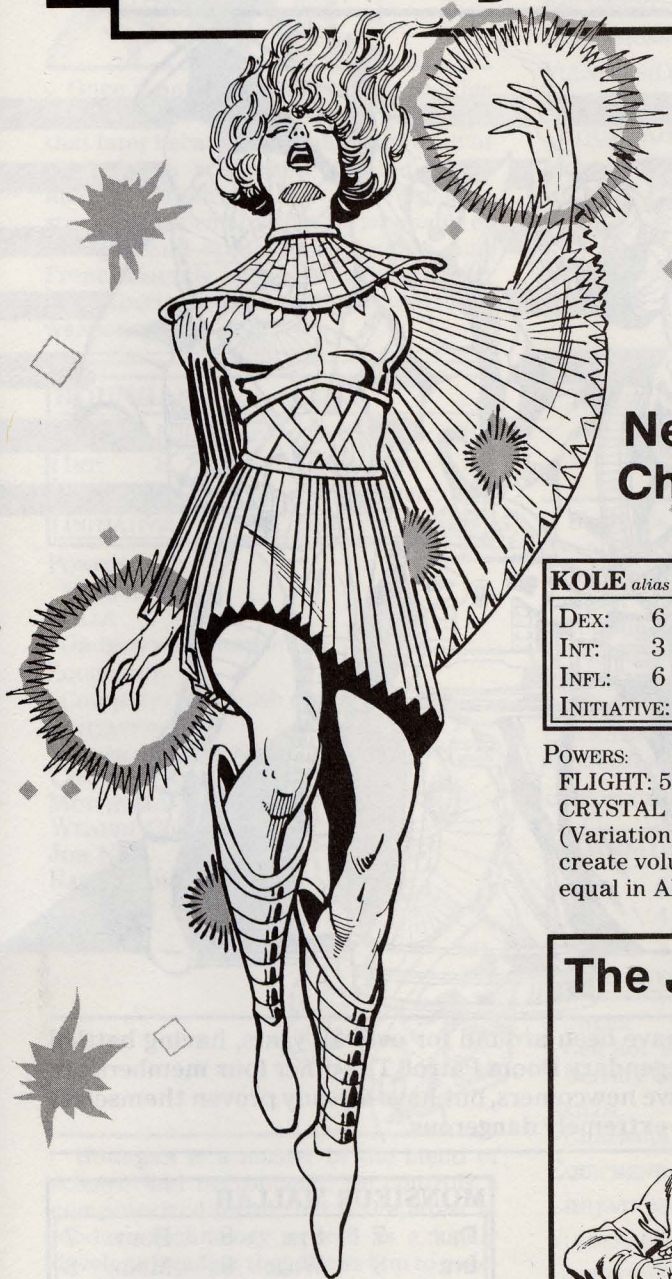

## New Player Character

<b>KOLE</b> <i>alias Kole Weathers</i>					
DEX:	6	STR:	3	BODY:	4
INT:	3	WILL:	4	MIND:	4
INFL:	6	AURA:	3	SPIRIT:	3
INITIATIVE:	15	HERO POINTS:	45		

**POWERS:**  
**FLIGHT:** 5  
**CRYSTAL PRODUCTION:** 10  
 (Variation of Ice Production. Kole can create volumes of crystal that are equal in APs to the RAPs of power. The

crystal may be formed into any shape Kole desires, such as a wall, a shield, a bridge, etc.)

**CRYSTAL CONTROL:** 7

**SKILLS:**

No known skills have been demonstrated as of this writing.

**EQUIPMENT:** NA

**LIMITATIONS:** NA

**VULNERABILITIES:** NA

**CONNECTIONS:**

The gods of Olympus (High-Level)

**MOTIVATION:** Unwanted Power

**WEALTH:** Struggling

**JOB:** NA

**RACE:** Human

Kole is the newest of the new Teen Titans. Hers is the power to create and manipulate crystalline structures out of the air around her. Separated from her real parents as well as from the life she'd come to know on Olympus, she now lives in New York City, trying to deal with her identity as a person. She is staying with Joe Wilson (Jericho).

## The Jericho Effect

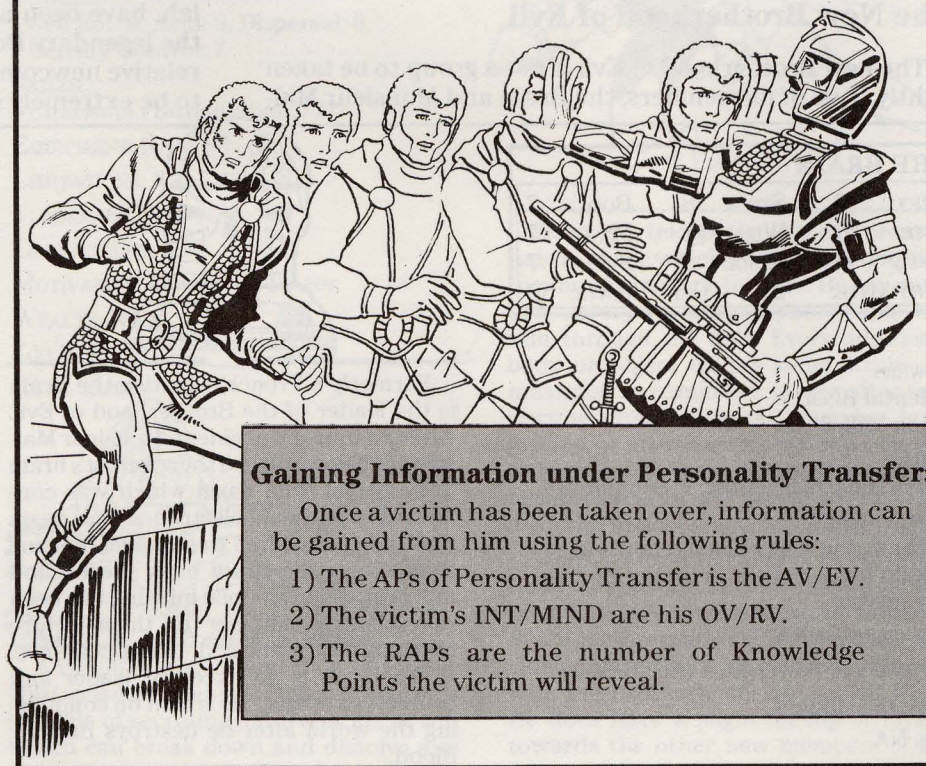

### Gaining Information under Personality Transfer:

Once a victim has been taken over, information can be gained from him using the following rules:

- 1) The APs of Personality Transfer is the AV/EV.
- 2) The victim's INT/MIND are his OV/RV.
- 3) The RAPs are the number of Knowledge Points the victim will reveal.

This adventure was designed with the Teen Titans in mind as the principal characters. However, it is flexible enough to allow other DC Heroes, or even original heroes, to be incorporated into it. The GM should feel free to make whatever adjustments he feels are needed in order to keep this adventure lively and interesting for his particular players.

If there are less players than Titans in this adventure, the GM should stress the importance of having Cyborg and Nightwing present for this adventure.



# The New Brotherhood of Evil



## The New Brotherhood of Evil

The new Brotherhood of Evil is not a group to be taken lightly. Two of its members, the Brain and Monsieur Mal-

lah, have been around for over 20 years, having battled the legendary Doom Patrol. The other four members are relative newcomers, but have already proven themselves to be extremely dangerous.

### THE BRAIN

DEX:	2	STR:	8	BODY:	7
INT:	13	WILL:	11	MIND:	17
INFL:	6	AURA:	5	SPIRIT:	7
INITIATIVE:	21	HERO POINTS:	55		

#### POWERS:

Mental Blast: 7  
Iron Will: 8

#### SKILLS:

Charisma: 6, Scientist: 7, Scholar: 6

#### LIMITATIONS:

Trapped in a mechanical housing,  
Brain must be kept in a solution bowl  
to survive.

#### CONNECTIONS: NA

MOTIVATION: Power Lust (See Below)

WEALTH: Affluent

JOB: NA

RACE: Mechanical Humanoid

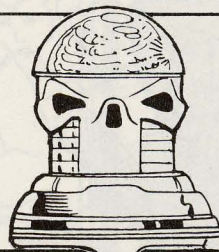

Formerly a French scientist, the Brain is the leader of the Brotherhood of Evil. After an unusual accident, Monsieur Mallah (see below) placed the scientist's brain in a special fluid basin which was connected to powerful electrodes. This basin was then connected to a mobile housing that allows the Brain both speech and movement. This mobile housing has been redesigned a number of times before reaching its present skull-like appearance.

The Brain is an excellent leader and brilliant strategist. He is bent on conquering the world after he destroys Brother Blood.

### MONSIEUR MALLAH

DEX:	7	STR:	8	BODY:	7
INT:	8	WILL:	9	MIND:	8
INFL:	4	AURA:	3	SPIRIT:	4
INITIATIVE:	19	HERO POINTS:	50		

#### POWERS: None

#### SKILLS:

Climbing: 10, Weaponry/Firearms: 4,  
Scholar: 5

#### EQUIPMENT:

.45 Automatic  
(AV: 0, EV: 4, RANGE: 0-3 / 4 / 5, AMMO: 7)

Machine gun  
(AV: 5, EV: 8, RANGE: 0-6 / 7-8 / 9, AMMO: 6)

#### LIMITATIONS: NA

#### VULNERABILITIES: NA

#### CONNECTIONS: NA

MOTIVATION: Devoted to Brain

WEALTH: NA

JOB: NA

RACE: Humanoid Gorilla





Once a normal gorilla, Mallah had his IQ boosted to 178 by the French scientist that later became the Brain. As a result of this, Mallah is slavishly devoted to his mentor. Mallah is at least three times as strong as a normal gorilla. He is capable of thought and speaks both English and French fluently. He is technically oriented and experienced with sophisticated hand weaponry.

**HOUNGAN** *alias Jean-Louis Drou*

DEX:	5	STR:	5	BODY:	6
INT:	8	WILL:	6	MIND:	8
INFL:	5	AURA:	6	SPIRIT:	7
INITIATIVE:	18	HERO POINTS:	50		

**POWERS:**

Voodoo: 8

**SKILLS:**

Gadgets: 9, Charisma: 6

**EQUIPMENT:**

Computerized fetish doll.

**LIMITATIONS:** NA

**VULNERABILITIES:** NA

**CONNECTIONS:** NA

**MOTIVATION:** Power Lust

**WEALTH:** Comfortable

**JOB:** NA

**RACE:** Human



Houngan is a master of the blend of science and necromancy. He controls a computerized fetish that is the latest in modern technology as well as a highly developed gadget that allows him to practice the art of voodoo. By programming the fetish with a piece of tissue from a subject, the fetish will take on the characteristics of that subject. Electronic impulses inflicted upon the fetish will be electronically transmitted to the subject, causing the subject to suffer pain. His vast knowledge of voodoo lore was handed down to him in Haiti. Though proud, Houngan credits the Brain as a good leader and is fiercely devoted to the Brain and the Brotherhood.

**PHOBIA** *alias Angela Hawkins III*

DEX:	6	STR:	4	BODY:	5
INT:	6	WILL:	7	MIND:	8
INFL:	5	AURA:	8	SPIRIT:	6
INITIATIVE:	17	HERO POINTS:	60		

**POWERS:**

Phobia: 14

**SKILLS:**

Charisma (Intimidation): 6

**EQUIPMENT:** NA

**LIMITATIONS:** NA

**VULNERABILITIES:** NA

**CONNECTIONS:**

British Aristocracy (High-level)

**MOTIVATION:** Thrill Seeker

**WEALTH:** Affluent

**JOB:** NA

**RACE:** Human

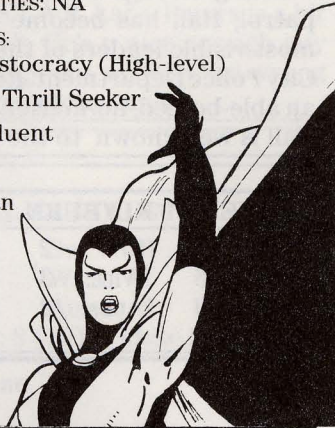

Phobia is the Mistress of Fear. She has the ability to call up the most secret fear from deep within an opponent's subconscious or create a new fear in the mind of an opponent.

Possessing her own innate powers, Phobia isn't totally devoted to the Brotherhood. She is actually a member of the British aristocracy and will seem a bit snobbish at times.

**PLASMUS** *alias Otto Von Furth*

DEX:	6	STR:	8	BODY:	7
INT:	4	WILL:	5	MIND:	5
INFL:	3	AURA:	4	SPIRIT:	4
INITIATIVE:	13	HERO POINTS:	55		

**POWERS:**

Cell Rot: 9, Acid: 9, Dispersal: 8, Density Control: 7

**SKILLS:**

Charisma (Intimidation): 7

**EQUIPMENT:** NA

**LIMITATIONS:** NA

**VULNERABILITIES:** NA

**CONNECTIONS:** NA

**MOTIVATION:** Unwanted Power

**WEALTH:** NA

**JOB:** NA

**RACE:** Humanoid



A victim of experimentation by former Nazi scientist General Zahl, Plasmus is capable of secreting natural acids at will which can break down and dissolve any organic or inorganic material he touches.

Defensively, Plasmus can allow his body cells to lose their cohesion so that a bullet or a punch will pass through him. He can also use this power to absorb tremendous impacts.

Plasmus is a cruel and ruthless individual. He enjoys a battle and is not against engaging in Killing Combat. He has been known to use his natural acids to attack people, causing the skin to melt right off their bodies.

**WARP** *alias Emil LaSalle*

DEX:	8	STR:	6	BODY:	7
INT:	6	WILL:	5	MIND:	6
INFL:	3	AURA:	4	SPIRIT:	4
INITIATIVE:	17	HERO POINTS:	50		

**POWERS:**

Warp: 14

**SKILLS:**

Thief/Stealth: 7, Escape Artist: 12

**EQUIPMENT:** NA

**LIMITATIONS:**

See Below

**VULNERABILITIES:** NA

**CONNECTIONS:**

European Underworld (high-level)

**MOTIVATION:** Unwanted Power

**WEALTH:** Affluent

**JOB:** NA

**RACE:** Human



Warp is a teleporter who can create a hole in space which he uses as a doorway to move from place to place. He can carry or move objects and groups of people with him through the hole. Every additional body or object causes some strain. He must rest to regain lost power after teleporting great distances, carrying large groups, or after a series of jumps. He can only have one warp in use at a time. In order to create a new portal, he must wait until the previous hole has faded.

Warp, a newer member of the Brotherhood, is also one of their most unstable members. He enjoys leading the romantic life of an international criminal. He considers himself to be his own man, working with the Brotherhood and not for them. He does have a slight feeling of loyalty towards the other new members of the group, and will not leave them in peril.



# Friendly Non Player Characters

## CAPTAIN HALL

DEX:	2	STR:	2	BODY:	2
INT:	2	WILL:	2	MIND:	2
INFL:	2	AURA:	2	SPIRIT:	2
INITIATIVE:	6	HERO POINTS:	0		

POWERS:  
None

SKILLS:  
Detective: 3, Weaponry/Firearms: 3

CONNECTIONS:  
New York Police Department  
(High-level)

MOTIVATION: Seeks Justice

WEALTH: Comfortable

JOB: Police Captain

RACE: Human

Rising through the ranks from foot patrol, Hall has become one of the most visible leaders of the New York City Police Department. Respected as an able-bodied, no-nonsense lawman, Hall is well known to the players.

## DR. JENET KLYBURN

DEX:	3	STR:	2	BODY:	2
INT:	5	WILL:	3	MIND:	3
INFL:	3	AURA:	2	SPIRIT:	2
INITIATIVE:	11				

POWERS:  
None

SKILLS:  
Gadgetry: 3, Scientist: 5, Vehicles/Air,  
Land: 2, Medicine: 5

CONNECTIONS:

S.T.A.R. Labs (High-level)

American Medical Association  
(High-level)

MOTIVATION: Unwanted Power

WEALTH: Affluent

JOB: Scientist

RACE: Human

One of the world's leading authorities on polymer skin grafting, Dr. Klyburn recently befriended Cyborg.

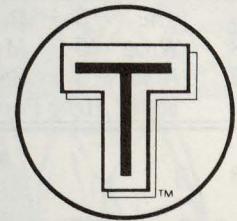

# Hostile/ Neutral NPCs

## HOSTILE NPCs

Street People: Joey Pigeon, The Candyman, Eyes Watson, Babysitter Brown. The players may question these characters to get information about the theft of the A-30 gas. Stats for these individuals are given in the Investigations section.

## WAREHOUSE THUGS

DEX:	3	STR:	2	BODY:	3
INT:	2	WILL:	2	MIND:	2
INFL:	2	AURA:	2	SPIRIT:	2
INITIATIVE:	7	HERO POINTS:	0		

POWERS:  
None

SKILLS:  
Martial Arts: 3, Weaponry/Firearms: 3

## CONFESSORS

DEX:	3	STR:	3	BODY:	3
INT:	5	WILL:	2	MIND:	2
INFL:	3	AURA:	2	SPIRIT:	2
INITIATIVE:	9	HERO POINTS:	0		

POWERS:  
None

SKILLS:  
Martial Artist: 3, Vehicles/Land/Air: 2,  
Weaponry/Firearms/Melee Weapons: 3

EQUIPMENT:

Electronic Prods [DEX: 0, STR: 15, BODY: 18]  
Uses: 6, Duration: 18

BODY ARMOR:

[DEX: 0, STR: 0, BODY: 4]  
Uses: 8, Duration: 12

The Confessors are the security forces of Brother Blood.

## SISTER DREAD

DEX:	2	STR:	2	BODY:	2
INT:	3	WILL:	7	MIND:	9
INFL:	2	AURA:	2	SPIRIT:	3
INITIATIVE:	7	HERO POINTS:	0		

POWERS:  
Control 4

SKILLS:  
Vehicles/Land/Air: 2, Spy-Coding: 3

WEALTH: NA

JOB: Personal Assistant to Brother Blood

RACE: Human

Sister Dread is Brother Blood's administrative assistant. She handles all his correspondence, coordinates all workings of the church, and maintains the smooth running of Blood's offices.

Sister Dread has the following information (in Knowledge Points):  
3) She knows that the appearance of

the church offices is due to holograms.  
4) She knows the time when Blood will arrive in New York (7:30 pm).

6) She knows where the explosives are planted in the church offices. She knows that those explosives will be automatically detonated if security is breached.

## BETHANY SNOW

DEX:	2	STR:	2	BODY:	2
INT:	2	WILL:	2	MIND:	2
INFL:	2	AURA:	2	SPIRIT:	2
INITIATIVE:	6	HERO POINTS:	0		

POWERS:  
None

SKILLS:  
Charisma: 2, Artist/Acting/Photographer: 3, Weaponry/Firearms: 2

WEALTH: Affluent

JOB: News Reporter

RACE: Human

Bethany works for WUBS and is the host of her own interview show, "Snow Storm." She is a member of the Church of Blood, but this fact is only known by the Titans and certain members of the NYPD. She uses her position as a newscaster to do favorable reports on and/or slant news items in favor of the Church.



## NEUTRAL NPCs

Whether or not the neutral characters are friendly towards the players is based upon the actions of the players.

### DR. ROBERT ALPHIAS

DEX:	2	STR:	2	BODY:	2
INT:	5	WILL:	3	MIND:	2
INFL:	2	AURA:	2	SPIRIT:	2
INITIATIVE:	9	HERO POINTS:	0		

POWERS: None

None

SKILLS:

Gadgetry: 3, Scientist: 5, Vehicles/Land: 1

CONNECTIONS:

Defense Department (High-level)

WEALTH: Comfortable

JOB: Scientist

RACE: Human

The selectively absent-minded leader of the S.T.A.R. A-30 gas project, and one of the developers of the A-30 gas.

### PETERS, the lab assistant

DEX:	2	STR:	2	BODY:	2
INT:	3	WILL:	2	MIND:	2
INFL:	2	AURA:	2	SPIRIT:	2
INITIATIVE:	7	HERO POINTS:	0		

POWERS: None

SKILLS:

Scientist: 3, Vehicles/Land: 2

WEALTH: Struggling

JOB: Lab Assistant

RACE: Human

New to S.T.A.R. Labs, Peters is a bit of a nebbish. He's a nice enough guy who just happens to be in the wrong place at the wrong time.

### GENERAL FRANKLIN

DEX:	3	STR:	3	BODY:	3
INT:	3	WILL:	2	MIND:	2
INFL:	2	AURA:	2	SPIRIT:	2
INITIATIVE:	8 (10)	HERO POINTS:	0		

POWERS: None

SKILLS:

Martial Artist: 2, Military Science: 3, Vehicles/Land: 2, Weaponry/Firearms, Heavy Weapons: 4, Weaponry Melee/Weapons: 3

WEALTH: Affluent

JOB: Professional Soldier

RACE: Human

Brusque and to the point, General Franklin is the military liaison to S.T.A.R. Labs for the A-30 project. He is a man of medium temperament who is only interested in the gas for the boon it might prove to be to the military. He doesn't care about the effect it might have on those with super powers.

## Standard NPCs

These include policemen, construction workers, pedestrians, or anyone else the Titans may encounter. They all have Attributes of 2, and the appropriate Skills of 1, 2, or 3. For more information on these standard NPC's, consult the GM Manual.

Other NPCs that may fall into this category are the normal staff workers at the offices of the Church of Blood. These workers (secretaries, receptionists, etc.) would not normally be enemies of the players. However, while they are under the thrall of Brother Blood, they will do all they can to thwart the players.

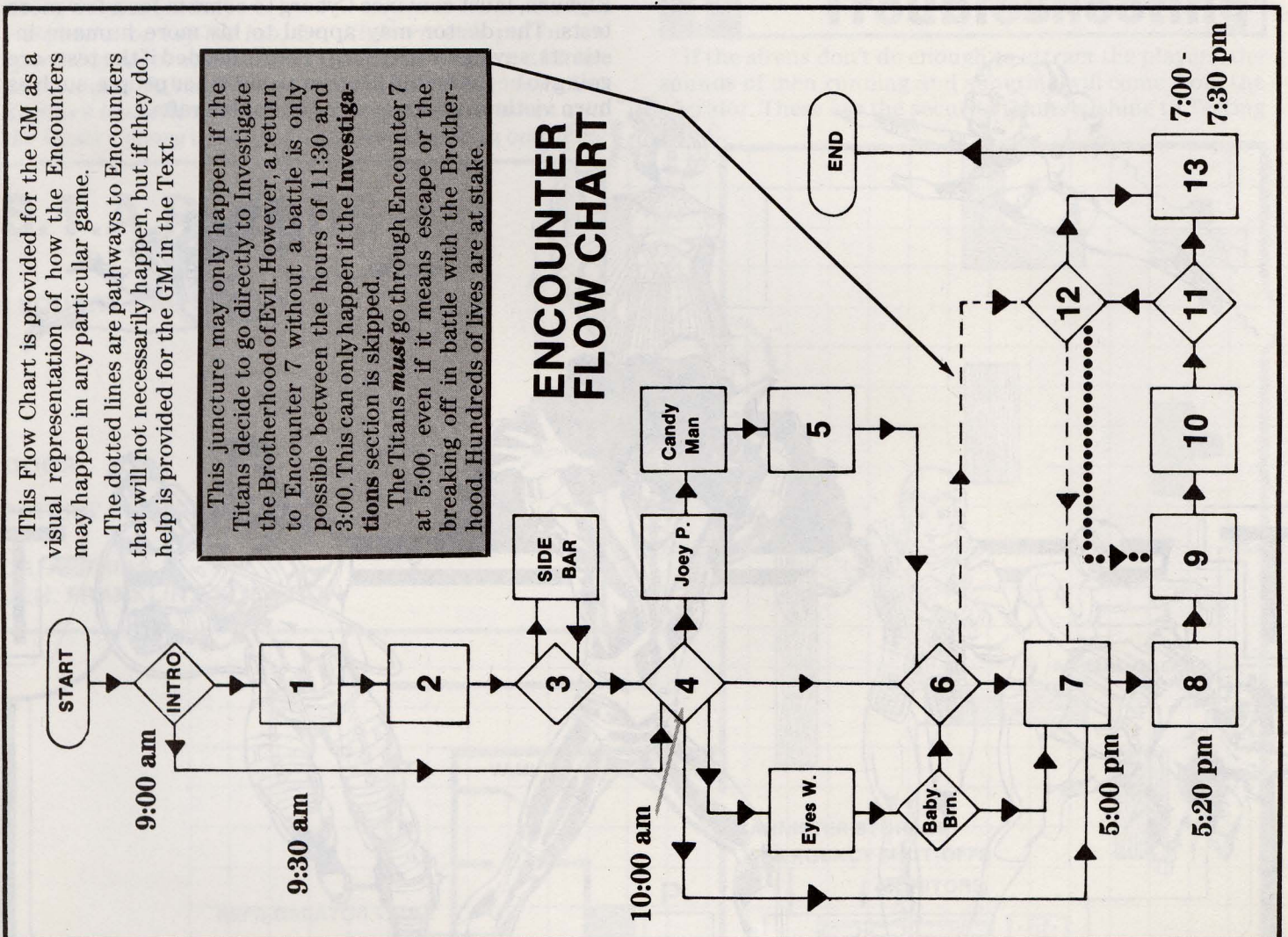



# Introductory Encounter

**S**

## Setup

This encounter starts the adventure. Dr. Jenet Klyburn of S.T.A.R. Labs calls Cyborg to get him to come in for a series of checkups. In playing her, the GM should try to convince Cyborg to bring along the rest of the Titans.

## PI Players' Information

*The phone rings. All of the Titans are at the Tower and Changeling, nearest to the phone, answers.*

Read to Changeling:

*An attractive female voice, which you recognize as that of Dr. Jenet Klyburn of S.T.A.R. Labs, asks for Cyborg.*

Read to Cyborg:

*"Victor," she says, when Cyborg answers. "I'd like you to come down to the Lab for a few hours this morning. The results on your skin grafting experiments have come in, and I'd like to run a few tests on you. It's nothing that will affect you, just a simple check up."*

**GM**

## GM Information

The entire group may accompany Cyborg to S.T.A.R. Labs if they wish to. The GM should remember to try to keep the entire group together, as the group members not involved in the immediate encounter will soon become bored.

Those Titans who do not go to the Lab with Cyborg will meet up with the rest of the group at police Headquarters in Encounter 4.

Go to Encounter 1.



If Cyborg decides he no longer wants to be bothered with S.T.A.R. Labs or the polymer skin tests, the GM as Dr. Klyburn, must convince Cyborg to come in for a few more tests. The doctor may appeal to his more humane instincts, saying that Cyborg's help is needed if the tests are going to be perfected in order to aid other people, such as burn victims, who may need the skin grafts.

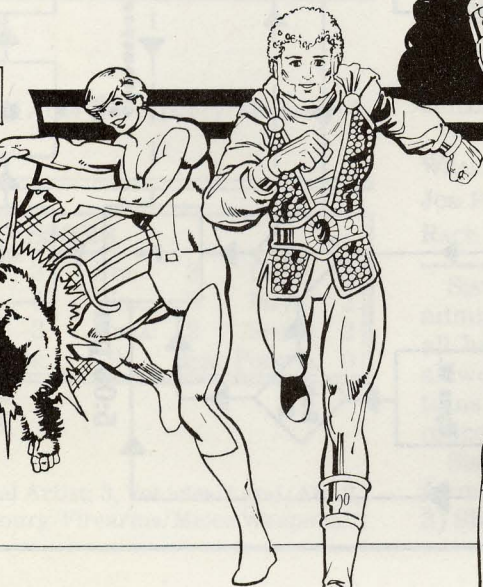



# Encounter One: Only a Test

## S Setup

The players arrive at S.T.A.R. Labs and are led through the halls to Testing Lab A. It is a simple-looking operating room, complete with an observation room. If all players are present, Dr. Klyburn will ask the others to wait in the observation room.

## PI Players' Information

Testing Lab A is outfitted with a single operating table, much like a regular hospital operating room. There are a number of monitoring machines around the room.

Dr. Klyburn takes Cyborg's arm in hers and leads him through one of the doors.

"Victor, it's good to see you again," she says, smiling warmly. "You look like you're holding up well. We've been doing a lot of work with the skin grafting process and the polymer formula. Of course, no human body was made to take the kind of punishment you give yours. But with a few more tests, we may be able to discover what went wrong in your case."

Before entering the lab, Dr. Klyburn will put on an operating gown and a sterile mask. She will have Victor do the same. Taking Cyborg into the operating room, Dr. Klyburn leads him to the table. She has him lie down and she hooks Cyborg up with a few electrodes from one of the

nearby machines. The machine starts to hum as Dr. Klyburn flips one of the switches.

"Now, Victor, some of this my tickle, but I need to measure your skin responses to various stimuli."

Suddenly, the room is rocked and shaken by a loud explosion from somewhere in the complex!

"That's probably just an experiment that got out of hand," says Dr. Klyburn. "I'm sure that if it's something important, we'll hear the alarm."

An electronically filtered voice blares through the P.A. system. "Security Breach, Lab C. Security teams B and C investigate."

## GM GM Information

The explosion is a breach in the wall of Testing Lab C. If Cyborg wants to join in the investigation of the noise, Dr. Klyburn will beg him to wait a minute as she quickly disconnects him from the machines.

Go directly to Encounter 2.

## T Troubleshooting

If the sirens don't do enough to attract the players, the sounds of men running and shouting will come from the corridor. These are the security teams rushing to Testing Lab C.

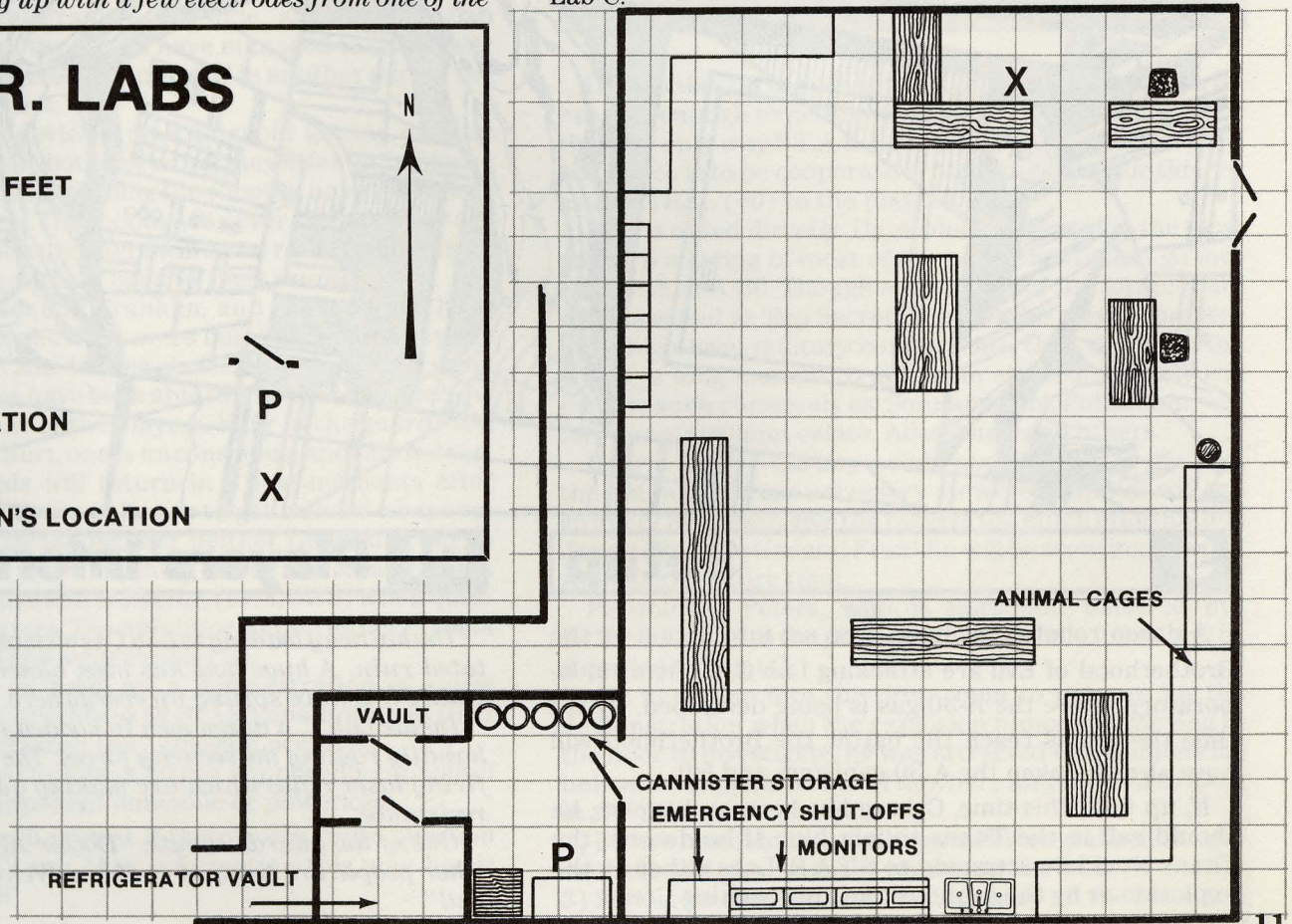
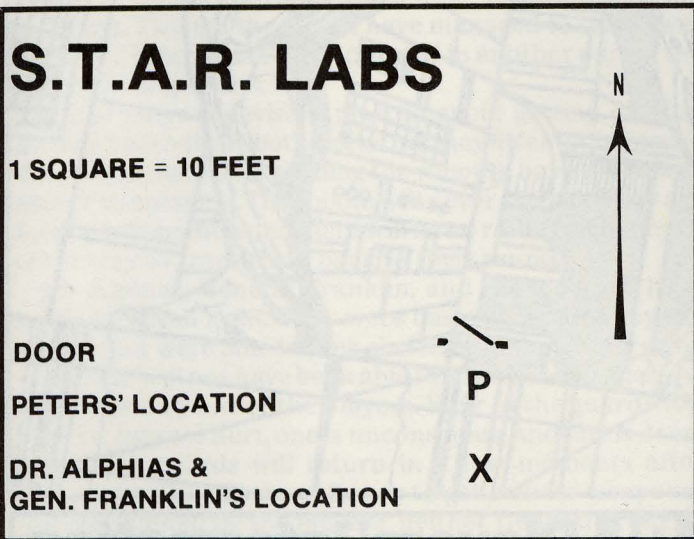



## Encounter Two: **Robot Attack**

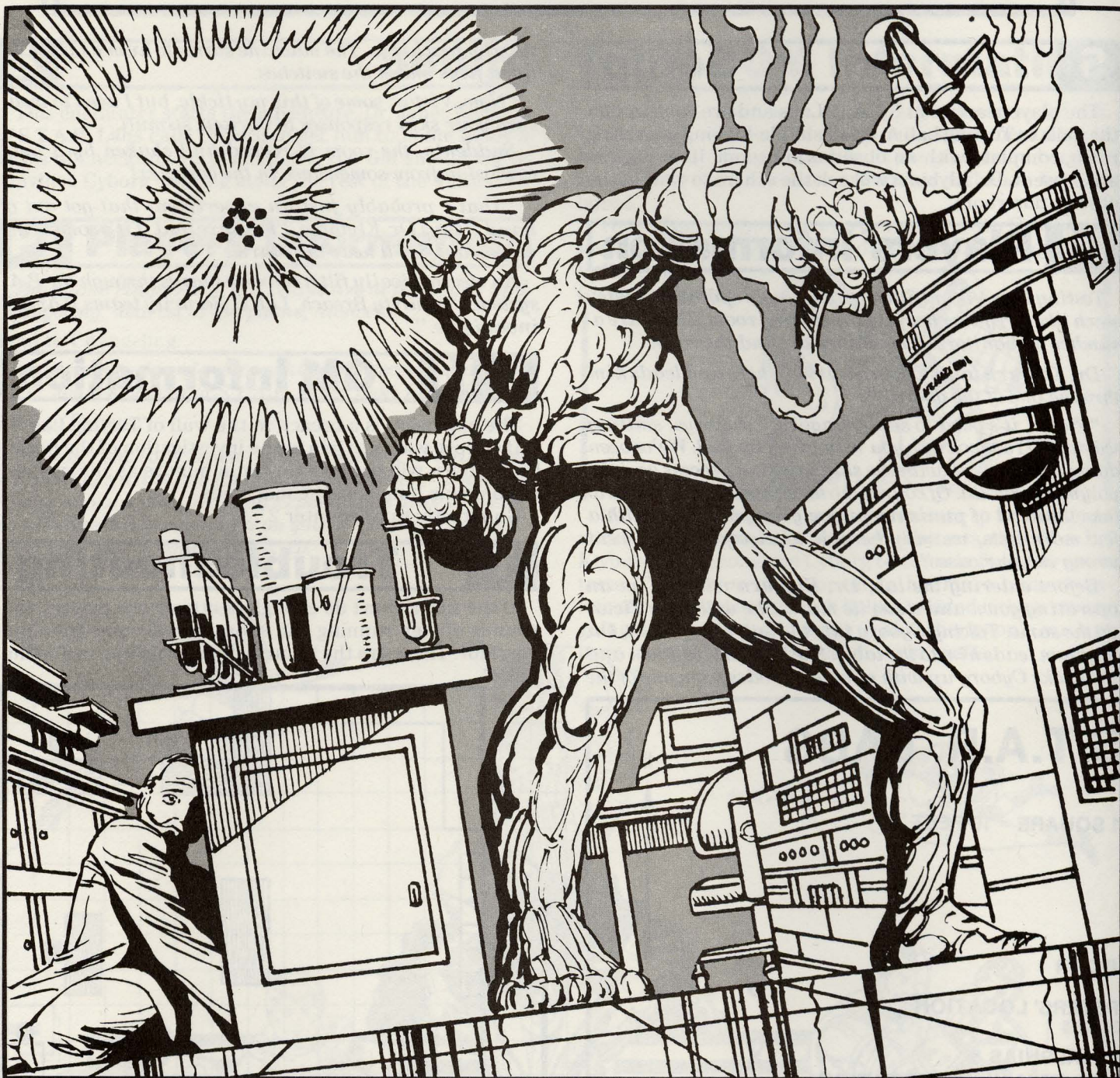

**S**

### **Setup**

A dozen robots that have been set into action by the Brotherhood of Evil are attacking Lab C, a chemical laboratory where the A-30 gas is being developed. By the time the Titans reach the battle, the Brotherhood will have already taken the A-30 canisters and left.

If, up until this time, Cyborg has been on his own, he should call in the Titans to join him. If he doesn't, the Titans would be attracted to S.T.A.R. Labs either by the explosion or by the sound of the approaching sirens.

### **PI Players' Information**

*The hallway leading to Lab C is a smoky scene of devastated ruin. A huge hole has been blown in the exterior wall. Fires have sprung up everywhere.*

*Inside Lab C, a dozen men in hooded red uniforms are handily routing the security forces. The hooded men are firing laser rifles which are making quick work of any resistance.*

*One of the guards shouts: "Doctor Alphas and some other people are trapped in there. We've got to get them out!"*



*A metallic voice rings out as you approach the robots. "Ah, ze Titans! I had not expected to see you so soon, but what a pleasure eet ees to see you one last time before you die!"*

## GM Information

This voice can come from any robot. All the robots will immediately turn to concentrate their assault on the players. If the above piece is read, there is a chance the players will recognize the voice. A Perception Check should be made (OV: 0, RV: 0) for all the Titans (except Kole) to recognize the voice as belonging to the Brain, the leader of the Brotherhood of Evil. As Kole has not met the Brotherhood of Evil, there is no chance that she will recognize the voice.

Any direct blow will reveal to the Titans the fact that they are fighting robots.

ROBOTS					
DEX:	2	STR:	6	BODY:	12
INT:	1	WILL:	3	MIND:	6
INFL:	NA	AURA:	NA	SPIRIT:	NA
INITIATIVE:	4	HERO POINTS:	0		

### POWERS:

None

### SKILLS:

None

### EQUIPMENT:

Laser Rifles

AV: 4 EV: 4 RANGE: 0-3 / 4-5 / 6

Once a robot is defeated, it will self destruct with a 5 AP explosion, leaving only a smoking pile of rubble.

The people trapped along with Dr. Alphias include Brigadier General Franklin, his aide, and Peters, a lab assistant. Though the others have managed to take cover together, Peters has been separated in another part of the Lab by falling debris.

If the players devise a plan to avoid getting directly involved with the robots (meaning they attempt to rescue the people instead of battling the robots), have the robots attack the players. The robots will never retreat. They are totally autonomous, so there will be no radio frequency or other way to trace them back to their source.

Dr. Alphias, General Franklin, and the aide will have made it out all right. They were basically ignored by the robots and were able to seek shelter together. Peters, the assistant, will not have been able to make it out, unless he was helped by one of the players. Four of the guards will be here, two are hurt, one is unconscious, and one is dead. The other guards will return in a few moments after having gone to call the police or to get heavier weapons.

If questioned by the players, neither General Franklin nor his aide will know anything about the assault. Each will appear evasive and HOSTILE (RV: 3, OV: 5) when questioned by the players. The only information either of them will reveal (by Knowledge Points) is:

- 1) The army is on hand for a demonstration of a new military weapon developed by STAR Labs. Both had their backs to the wall when the explosion occurred.
- 4) The weapon is the new A-30 gas, supposedly capable of rendering any opponent immobile or powerless.

The General will protest if the players try to question Dr. Alphias. He'll say: "Any information this man has is highly classified!"

## Perception Check

Sometimes when something is happening in the world around a character, a Perception Check is made by the GM to see if that character is aware of it.

The involved character's Intelligence Attribute (INT) is the Acting Value and his Will Attribute (WILL) is the Effect Value.

This is a roll that should be made by the GM in secret and the information should only be given to the Player if the roll is successful.

A player may initiate a Perception Check by saying that he is on the alert, but this only happens during a situation where the character would normally be alert, such as in a stakeout sequence.

Hero Points may be added to increase the character's INT and WILL up to twice the regular value. If nothing happens in that phase, the Hero Points are lost.

The RAPs are handled in a similar way to the Interrogation rules.

RAPs	Information Perceived
1-2	A quick glance- a shadow moving.
3-4	A recognizable shape or movement with direction. Distance from the perceiving character.
5	A definite object or event.
6	Details about the object or event.

These are guidelines to help the GM. If the perceived event isn't a motion or shape, but a sound or something felt, tasted, or something sensed with mental powers, then the information given out is left up to the GM's discretion.

Dr. Alphias, on the other hand, will be willing to talk. He has had enough experience with these break-ins to know that the only way S.T.A.R. Labs is going to collect on their insurance is to be cooperative. Alphias can be considered as NEUTRAL (+0) to the players.

If he is asked directly, Dr. Alphias will provide the players with a listing of most of the components that go into the finished A-30. Though some parts of the formula are still classified as Top Secret, if any of the players present have high-level military connections, they will get a list which is long enough to get them started. The list will include such chemicals as: Sonnambutol, Potassium, water, Quantotrillium calate, Absorbase, and others.

He will also reveal any points about the A-30 gas that the GM may feel are necessary. However, Alphias will not go out of his way to give the players too much information. Especially since General Franklin will be scowling down at Alphias the entire time.

Persuading Peters, who is hurt and battered but FRIENDLY (-3) to the players, will reveal the following (by Knowledge Points):

- 1) He had gone into the prep room to prepare for the demonstration when the explosion happened. Moving to the door to investigate, he was attracted to a shimmering hole which appeared out of nowhere and seemed to hang in the air.
- 2) Before he could react, a huge monster grabbed the gas canister and gun from the holder on the wall.
- 3) Somehow the creature burned away all the belts and



straps so that the gas canister just fell away from the wall. The monster then disappeared into the shining hole. That's when he fainted, Peters sheepishly admits.

4) The monster was about seven feet tall, shaped like a man, but he had no face because all the skin looked like it had been melted off. Though he can't be sure, Peters thinks that the monster spoke with some kind of German accent.

He won't be able to give any further information.

Going into the preparation room in question will reveal no new pieces of information. There will be no evidence of any "hole" or any monsters. Using the Detective Skill (OV: 0, RV: 0), if a character gets 7 RAPs, that investigator will find a piece of the strap which had been burned through. If the

strap is found it will appear to have been eaten by acid, as opposed to being burned by fire.

The gas gun and the canister will not be anywhere around. Further investigation will reveal no other clues.

Go on to Encounter 3.

## T Troubleshooting

If the players don't question anyone and don't go searching for any information, you, the GM, must spur them to action. One way to do this during this Encounter is to have Dr. Alphais scream "The A-30 gas has been stolen! If it falls in the wrong hands, there is no telling what could happen. As of now, there is no known antidote for the gas. It could bring the combined forces of the free world to a standstill!"

# Encounter Three: A Request

## S Setup

This is the request to meet Captain Hall at his office. The Titans should honor the request, as this is where they will find the most information for their mission.

## PI Players' Information

*Sirens wailing, a number of police cars come screeching onto STAR Labs property. The police will all be surprised, but glad, that you have the situation under control.*

*One of the cops walks up to Nightwing and says: "Captain Hall's been on the radio all morning. He wants to see you in his office right away."*

## GM GM Information

The cop won't be too pushy. If the Titans are busy, he'll go look for information from the doctors inside.

The players must now decide what course of action to take. If they try to find out more about the A-30 gas, go to Investigation Sidebar 1. If they investigate the theft of the A-30 gas, go to the Investigation Section.

If they respond immediately to the Commissioner's request, go to Encounter 4.

If the players choose to track down whoever was behind the theft of the A-30 gas, they'll likely begin right at the S.T.A.R. facility. Unfortunately, no one here will be able to give them any helpful information about the assault or the theft of the gas. The answers to these questions are found in Encounter 4.

### Investigation at S.T.A.R. Labs

#### Time Taken: 1 hr.

If the players choose to find out more about the A-30 gas while at S.T.A.R. Labs, they will be allowed to search through the records available on the S.T.A.R. Labs computer. They will also be able to gain an interview with Dr. Gorden who led the experiments with the gas on powered villains.

Looking through the computer records will reveal the following:

- 1) The gas is highly unstable and will become inert when exposed to air for more than 3 phases.
- 2) The gas has no effect on the attributes or skills of heroes. It also has no effect on non-natural (i.e. mechanical) powers.
- 3) The gas is vulnerable to shifting wind conditions, moving in the direction and at the speed of the prevailing wind conditions.
- 4) The resources of S.T.A.R. Labs have been unable to discover an antidote to A-30 gas after 2 years of effort. No clues as to how to neutralize the gas are known.

#### DR. GORDEN 30 minutes/1 hr

DEX:	2	STR:	2	BODY:	2
INT:	3	WILL:	3	MIND:	3
INFL:	2	AURA:	2	SPIRIT:	3
INITIATIVE:	7	HERO POINTS:	0		

SKILLS: Scientist: 5  
 ATTITUDE: Friendly  
 LOCATION: S.T.A.R. Labs

Dr. Gorden is a bemused-looking man with the tendency to scratch his head when thinking. He is friendly towards the Titans but obviously preoccupied. He will ask the Titans if they are willing to volunteer for an experiment on linking powers to computers. If the characters agree, Dr. Gorden will be helpful towards the Titans (30 minutes to extract information). Otherwise, he will be harder to pin down (1 hour).

If the Titans can get Gorden to talk, he will tell them that the effects of the gas tend to wear off in about 8 APs of time. He will also inform them that the gas seems to attack the strongest power a character has first. It also seems that characters with sealed systems were less susceptible to the gas, and Dr. Gorden speculates that something with sealed systems would also help against the gas.

**GM NOTE:** Powers can be simulated by using the Gadgetry Skill.



# Encounter Four: Captain Hall

## S Setup

Captain Hall, a friendly contact with the New York Police Department, is anxiously waiting for them.

## PI Players' Information

"Through some of our sources," Captain Hall says, "We've learned that an attack may soon be launched against a visiting dignitary while he is in our City. The attack is supposed to be fairly big and will involve some pretty sophisticated weaponry. It is of the utmost importance that we stop this attack and allow no harm to befall this person.

"The man will be in our city for two weeks on a religious matter. He refuses to allow any police to guard him, but he has agreed to have you people around him. That's why we need your help."

"The man," says Captain Hall, "is Brother Blood."

## GM GM Information

Hall will understand their reluctance. He knows that Blood has tortured them all, especially Nightwing in his old guise as Robin. Blood was also directly responsible for the death of one of Cyborg's first loves. However, Hall will be adamant in seeking the help of the heroes. He firmly believes in the information he has received and fears what could erupt if anything does happen to Blood. The city needs the Titans' help; Blood must be protected. If anything happens to him, it would cause an international incident, since Blood is not only a religious leader but highly influential in the government of Zandia.

If the Titans want to investigate the missing A-30 gas, Captain Hall will tell them all he knows. See **Captain Hall's Information** in the Sidebar.

If the players are willing to help immediately and not investigate the missing A-30 gas, go to Encounter 7.

Hall has already made arrangements for the Titans. They are to show up at the New York headquarters of the Church of Brother Blood at the Roarke Building at 5:00 p.m. Blood has agreed to the Titans guarding him if they don't get in his way or try to influence church members.

## T Troubleshooting

Read to the Players:

*Hall hands Nightwing a typewritten note which reads:*

*"There have been rumors of dire threats made against our beloved leader as he prepares to leave the safety of his church. If anything happens to Brother Blood while he is in your city, we, the undersigned, will join 294 of our fellow believers in a show of ultimate faith. The teachings of Brother Blood forbid us from taking a life unjustly. However, our faith will be expressed when we gladly forfeit our own lives for the sake of Brother Blood, who shall rise anew from our ashes. We hold all city authorities personally responsible for the safety of both our leader and ourselves. Brother Blood knows nothing of this note, and we are writing of our own volition."*

*Sincerely,*

*Shawn Brewster  
Noreen Blackwell  
Larry Donohue*

*Janet DiCola  
Nate Coker  
Kevin Allen*

Hall continues: "If some of those names sound familiar it's because they're the children of a few senators, two congressmen, and a major network newscaster. There's more at stake here than just this maniac Blood. There's even more at stake than the lives of these kids.

"There's no way we can prove Blood himself had anything to do with this note. But if anything does happen to him or those kids, and the newspapers manage to get a hold of a copy of this letter, think about the uproar. They'll say we were irresponsible, that we let those kids kill themselves. It'll cause a big shake-up in the government all the way from top to bottom. The whole country could soon be in chaos because our top politicians would be blaming one another for the deaths of their kids.

"Now, are you going to let that happen, or are you going to do something about it?"

## GM GM Information

The note has actually been written by some of Blood's followers, at his insistence. Of course, there is no way to prove this.

### Captain Hall's Information

Read to the Players:

*"The Burke Brothers were amongst those who were rumored to have put up a lot of money for the A-30 gas," says Captain Hall. "You'll probably have better luck checking what the word on the street is about this heist. Try talking to guys like Joey Pigeon down at the Armory or Eyes Watson at his newsstand at 3rd and 6th in the Village.*

*"I can't give you any more help, because I've got problems of my own. I've been told to handle a case where I'm working with the Military Police. It seems as though a bunch of impermeable suits of some kind have been stolen from the armed forces last week. They haven't told me anything about these suits, except for the fact that I'd better find them."*

#### GM INFORMATION:

At this point, the Titans will not be able to find any information about the suits, beyond a photo that the Captain has. The photo shows a number of dull-black rubbery-looking bodysuits with U.S.A.F. printed on the front pockets.

The suits were stolen from testing labs at the Pentagon. All F.B.I. and Secret Service Agents are on the lookout for these suits.

If the Players specifically ask about the Brotherhood of Evil, Captain Hall will tell them the following:

*"The Brotherhood of Evil's last known hideout was on West 60th in Manhattan. It hasn't been touched since the last time you broke up the Brotherhood. Budgetary cutbacks from the city never left the department enough to see about taking the place apart."*

This information will lead the Titans to encounter 6, but not necessarily as their next encounter.



# Investigations

## IN Investigation #1 Joey Pigeon

### JOEY "The Stoolie" PIGEON

DEX:	2	STR:	1	BODY:	2
INT:	2	WILL:	2	MIND:	2
INFL:	1	AURA:	2	SPIRIT:	2
INITIATIVE:	5	HERO POINTS:	0		

POWERS: None

SKILLS: Thief: 2, Vehicles/Land: 2, Weaponry/Firearms: 2

ATTITUDE: Awestruck

LOCATION: Usually found outside the Armory on Madison Ave.

## S Setup

Joey Pigeon is one of the underworld contacts for the police. He knows that being a salesman of information means that he has a short life expectancy, so he lives in a constant state of nervousness. He is a nervous, jumpy little man with quickly darting eyes.

The Titans are led to him by Captain Hall.

## PI Players' Information

*Joey is a small, runty, snivelling man, whose only connection with the underworld is that he is expendable. He is usually used for drops, as a bagman or courier. The information he gets is from listening outside doors while waiting to be given another meaningless job. The threat of violence will be enough to make him talk.*

## GM GM Information

Unfortunately, in this case, it isn't much. He doesn't know anything about the gas being stolen, and he hasn't heard of anybody trying to sell that stuff. The only robbery he's heard about is the disappearance of a six or seven experimental flamethrower cannisters and spray nozzles from the Armory. He doesn't know much about the suits, though he tells the players the Candyman over in Central Park would probably know. He also doesn't know anything about the Brotherhood of Evil, though he has heard they're back on the streets.

This should lead the players to the Candyman.

## IN Investigation #2 The Candyman

### THE CANDYMAN *alias Ernest Smythe*

DEX:	2	STR:	3	BODY:	2
INT:	3	WILL:	2	MIND:	2
INFL:	2	AURA:	2	SPIRIT:	2
INITIATIVE:	7	HERO POINTS:	0		

POWERS: None

SKILLS: Vehicles/Land: 1, Weaponry/Melee Weapons: 2

ATTITUDE: Opposed to characters.

LOCATION: Candyman can be found on a bench outside Central Park, across the street from one of the East Side's fanciest boarding schools.

## S Setup

Joey Pigeon's information should lead the players here.

The Candyman, a well dressed, clean-cut man in a three-piece, gray-tweed business suit is tall, blonde, and has a healthy build. He has an air of self confidence about him, but with a sinister edge to it that gives the feeling that he would sell his grandmother for the right price.

When the heroes arrive, the Candyman will be involved in a cocaine transaction. The first concern of the players should be to look into this transaction.

## PI Players' Information

*When you reach the Candyman, you see him trading envelopes with a young boy of about 13. When the kid sees you, he panics, obviously thinks about running then decides against it. Candyman simply raises an eyebrow.*

*The boy doesn't struggle, but Candyman denies having anything to do with the envelopes. He was just "picking them up, as the young lad had just dropped them."*

## GM GM Information

One envelope contains cocaine, which the kid planned to sell inside the school, while the one that was handed to Candyman has \$5,000 in it.

The Candyman can be influenced on a psychological level (RV: 5, OV: 6), while physical threats don't scare him.

If he get the deal he wants from the players (to let him and the kid go), he'll talk. However, if the Titans ignore his 'deal,' and remind him that giving them the information may make his case look a little better when his case comes to court, then he'll talk.

He won't push too hard if the players decide to keep the envelopes to turn over to the police.

He has the following information, in Knowledge Points:

- 1) *"Last week a strange-looking French guy asked me about where to get the best military hardware in town. I told him to take a hike."*
- 4) *"Then he touched me, and popped me into strange places, everywhere from live volcanoes to the desert. It was weird the way I kept bouncing around. Finally the guy let go and I was back home and shaking in my shoes."*
- 5) *"I talked. I told him that he should go to the Burke Brothers' warehouse down at Pier 11 for whatever he needed."*

Candyman doesn't know anything about the gas theft or the Brotherhood of Evil. He hasn't heard of anyone offering to buy or sell the equipment.

This information should lead the Titans to Encounter 5.



## IN Investigation #3 Eyes Watson

### "EYES" WATSON

DEX:	2	STR:	2	BODY:	2
INT:	3	WILL:	3	MIND:	3
INFL:	2	AURA:	3	SPIRIT:	2
INITIATIVE:	7 (9)	HERO POINTS:	0		

POWERS: None

SKILLS: Martial Artist/Attack Advantage: 2

ATTITUDE: Friendly

LOCATION: Eyes runs a newsstand near the subway entrance at 3rd Street and 6th Avenue in the village.

## S Setup

This encounter is one of the leads that Captain Hall gives to the players in Encounter 4.

Eyes appears to be a blind old man, but moves and reacts as if his dark glasses were only a gimmick and the swinging of his cane is done for fun. If he hits anyone with the cane, he'll snicker and say 'oops.'

He will act as if he has a PERSONAL VENDETTA against the players. This isn't true, it's just that he's a cantankerous old coot. He always complains about "today's kids," having no respect for "a blind old man."

Cash can influence him to become FRIENDLY (RV: 3, OV: 2) and reveal what he knows.

No one is really sure whether Eyes is truly blind or not.

## PI Players' Information

*Eyes Watson, a grizzled old man wearing dark glasses, aimlessly swings his white cane in the air in front of the newsstand that he has run for the past four years. He is the one person in the entire neighborhood who has never been successfully robbed.*

## GM GM Information

Eyes has the following information in Knowledge Points:

- 1) "Yeah, I heard about somebody stealin' gas from somebody, but I don't know who did it."
- 2) "I do know that it weren't no loner job. Them boys was organized: they didn't do it just for fun. They got something big planned."
- 3) "The word's out on the street about it: some of them three-piece suit boys from uptown want to buy the stuff, and some out of town muscle's been looking for some special gas masks."
- 5) "Babysitter was the one talking about the masks. That boy was mouthin' off about being hooked up with the Brotherhood of Evil. That boy's gonna get himself kilt one day real soon. He usually hangs out near the Port Authority."

Information here should lead the players to Babysitter Brown.

## IN Investigation #4 Babysitter Brown

### BABYSITTER BROWN

DEX:	2	STR:	2	BODY:	2
INT:	2	WILL:	2	MIND:	2
INFL:	2	AURA:	2	SPIRIT:	2
INITIATIVE:	6	HERO POINTS:	0		

POWERS: None

SKILLS: Charisma/Persuasion: 3

ATTITUDE: Hostile (RV: 2, OV: 0)

LOCATION: The burger counter in the Port Authority.

## S Setup

"Eyes" Watson's information will lead to here.

Babysitter has a forced air of arrogance about him. This comes across as coolness and toughness to desperate, runaway children, but seems phony and obnoxious to everyone else. He waves his hands in the air as he speaks, as if to illustrate whatever point he is trying to make.

However when questioned, he usually crumbles and is ready to talk when pressure is put to him (RV: 3, OV: 0).

## PI Players' Information

*Sitting at a burger counter is a tall man dressed in a loud paisley jacket. He is trying to talk the young counter girl into running away with him.*

## GM GM Information

Brown is called the Babysitter because of his knack of grabbing runaways and other young hopefuls as they step off the bus for the "Big City." He always starts off by buying them a meal and offering to help them get settled "with friends," usually the Church of Blood.

Though he'll certainly try to hold back as much as possible, he will reveal the following Knowledge Points, if he is asked specifically about the Brotherhood of Evil:

- 1) "I was home watching a rerun when a gorilla kicked in the front door. A real live, walkin' talkin' gorilla! He smelled like a zoo, but he had a gun, so I figured I'd better listen."
- 3) "He asked me about getting high-tech gas masks. I told him that I could get him entire gas suits if he wanted them, but he'd have to pay. He told me not to worry about that."
- 4) "Then he wanted to know if I'd sent any kids to the Church of Blood. I told him sure, they're one of my biggest accounts. Then he went ape on me and back-handed me into the wall. He told me never to send kids there again. Period."
- 5) "Then the gorilla left, saying he'd be back to find out more about raising an army. He orders me to keep an eye out for supplies."

He says he hasn't seen the gorilla since.

He knows absolutely nothing about the A-30 gas, who might have stolen it, or who might want to buy it.

Information gained here may lead the players to either Encounter 6 or to Encounter 7.



# Encounter Five: Warehouse Trap

## S Setup

**LOCATION:** The end of Pier 11 down on the Waterfront.

Before the players go in, read section A. When the players enter the warehouse, read section B. Should they move in further, read section C.

## PI Players' Information

A) *The Burke Brothers' Warehouse is a big, old, rambling building left over from the days when the waterfront was a major import center. During the day this place looks dark and run down. At night, even the wharf rats won't go near it.*

*Word on the street gives the Burkes the reputation of being the biggest and best wholesale suppliers of military hardware and illegal chemicals (nitroglycerine, acid, etc.) on the east coast. They get shipments in and then farm them out to all the different "salesmen" around the city. Except for a few short prison stays, they've been in business for the past six years and have never been the victims of a successful takeover bid. The warehouse is rumored to be a fortress, and the players are advised to approach with caution.*

B) *Inside, the warehouse is dark: there are no bright windows in the Burke's warehouse. Crates and boxes are everywhere—a few of the piles have toppled, blocking some hallways. The thick smell of gunfire hangs in the air, mixed with the salty tang of the ocean, the stench of stale water and the odor of dead fish.*

*If the players turn on a light or use Ultra or Thermal Vision, read the following:*

*The warehouse looks like a whirlwind hit it. Crates have been broken up, the contents are strewn everywhere, bags of unknown substances have been busted up and their white dusty contents have drifted over everything.*

C) *As you reach the rear of the warehouse, the devastation grows worse. The windows and walls of the three offices that line the west wall have been blasted open. The walls, the floors, and the furniture are riddled with bullet holes.*

*The offices have been ransacked, with file cabinets and furniture scattered throughout the room. A layer of papers, mostly business files and office notes, covers the room.*

*There are nine dead bodies in the room: those of the three Burke brothers and six of their hired gunmen. Closer examination will reveal that not a single bullet hole appears in any of the bodies: some have had their limbs torn off, others have had parts of their bodies "melted" away, while some have died with no bodily damage at all—but their faces are drawn back in grimaces of terror.*

*Suddenly, someone shouts "Now!" and a cloud of gas fills the room. A gang of thugs, wearing gas masks, attack!*

## GM GM Information

Eight thugs attack.

The gas masks will protect the thugs from the effects of the A-30 gas, which they are spraying at the Titans. Because of the sneak attack and the closeness of the quarters, treat the DEX of the A-30 gas as being 11.

The Stats for the thugs are listed in the NPC section.

Cyborg and Nightwing should will become paralyzed unless they use a rebreathing device. The gas will affect them as would the Poison Touch power. The other Titans will lose their major powers and will have to rely on their secondary powers or their skills.

When the battle is over, the Titans will probably want to look around the warehouse.

Scouting the perimeter of the warehouse will reveal a huge hole in the waterside wall. Close examination shows that the hole was burned through the wall and not the result of an explosion. Hunks of dripping slime will be hanging on one ragged edge of this hole (a sign of Plasmus' passage).

The big, steel, double-doors at the front of the warehouse have a BODY of 7 APs. They are locked and barred from the inside.

The Scientist skill must be used to identify the chemicals spilled on the floor (OV/RV: 6). The identifiable chemicals include Sonnambutol, Potassium, Quantotrillium calate, and Absorbase.

If the players investigate the offices, they will encounter Debby Gillian.

DEBBY GILLIAN					
DEX:	2	STR:	2	BODY:	2
INT:	2	WILL:	2	MIND:	2
INFL:	2	AURA:	2	SPIRIT:	2
INITIATIVE:	6	HERO POINTS:	5		

SKILLS:

Vehicle/ Land: 2

ATTITUDE: Friendly

Debby will say: "I'm just a secretary and not a member of the Burke Syndicate. I dove for cover the minute the fighting started."

## GM GM Information

She'll be a bit shaken, but she'll be coherent enough to convey the following Clue Points if a Charisma roll is tried.

1) The assault happened at about twelve-thirty. (GM: This was approximately 3 hours after the theft of the A-30 gas.)

2) It was a bunch of weird-looking guys, along with a gorilla and a woman. They came in by burning a hole in the wall.

3) They demanded a bunch of gas suits from Tony Burke, the oldest brother. A black guy in a weird mask did all the talking. He said they needed the stuff right away because they had something big planned for this afternoon. Tony told them to take a hike unless they had some



big cash. That's when the fighting started, and she tried to hide.

4) After the noise from the fighting had died down, she'd heard someone moving crates and throwing things. Though she couldn't see, she's pretty sure the guys who busted in did not get what they were after. The last thing she heard was a voice with a French accent saying, "Now return to me immediately."

6) The Burkes were very secretive about the suits. They told her that "outside sources" were attempting to steal the suits. "I think maybe the brothers stole the suits from the government. They told me to let them know if any government officials called. If those guys who attacked the warehouse didn't find the suits then they would still be in the safe under a bathroom stall in back."

Debby has keys to the safe and will show the safe to the Titans. Inside they will find 10 suits of a special rubber compound that will fit the form of the wearer with a weight of up to 4 APs.

### U.S.A.F. GAS SUIT

[DEX: 0, STR: 0, BODY: 8]

Uses: 2, Duration: 12 (4 hours)

POWERS: Sealed Systems: 11

If a player describes Houngan or any of the other members of the Brotherhood of Evil (except the Brain) to Debby, she'll be able to identify them as the ones in question. She will simply say: "Yes, that's the one." She won't know anything about the Brotherhood as a group.

This information will lead the players to Encounter 6

## T Troubleshooting

If Starfire should fire a starbolt while in the suit, the suit's rubber gloves will melt off, reducing the Sealed Systems power of the suit by 5 APs.

If Jericho attempts to Body Control out of the suit, he will immediately become vulnerable to the gas.

The Sealed Systems power cannot be pushed or increased by Hero Point burning in combat.

# Encounter Six: The Old Hideout

## S Setup

If at anytime the players suspect that the Brotherhood of Evil is involved in this caper, they may want to investigate the last known hideout of the group. The building used by the Brotherhood the last time they were in town is the Paradise Theater, an abandoned building on West 60th Street, near 10th Avenue.

When the players arrive, read section A below. If they go into the theater, read section B. If they go down to the basement, read section C.

## PI Players' Information

A) *The Paradise Theater has been barricaded with boards nailed over every window and door. The place is locked and police signs warn trespassers to stay away. The theater has obviously not been used for some time.*

B) *Inside, a thick layer of dust covers everything. Thin shafts of light filter in through holes in the ceiling and walls, spotlighting the forty rows of worn chairs that face the stage. Cobwebs that have grown into huge clusters seem to be the only things holding this place together. Rats scurry underfoot, irate at having been disturbed in their domain.*

C) *The basement has been gutted to create one wide-open room. The last thing any of the players have heard about this place was that it was still intact, with all of the Brotherhood's tools and equipment left here, since no city funds were available to dismantle the place. Yet now, except for a few oily rags and a few other pieces of trash, the entire area is totally empty. The dust isn't as thickly settled here as it is on the level above.*

## GM GM Information

The boards used to block up the doors and windows are of 3 APs strength.

If the players look around backstage and the Detective Skill is used (RV: 0, OV: 0), they will notice footprints in the dust. Close examination will reveal three sets of booted prints mixed in with a number of other oily, greasy prints. The trail of disturbed dust leads to the basement, which is where the Brotherhood once had their headquarters.

If the players bother to smell the rags in the basement, they may be surprised to find that the stains smell more like high quality fuel, as opposed to regular car oil. Also, the logo "COMPLIMENTS OF CHARLIE'S FUEL SERVICE" will be imprinted on one of the rags.

Seeking more information should lead the players to Encounter 12. (See Troubleshooting)

## T Troubleshooting

The players may check with their computer back in Titans Tower or they may look in the phone book. Either way, they will discover that Charlie's Fuel Service is located on the Lower West Side.





# Encounter Seven: The Lair of Blood

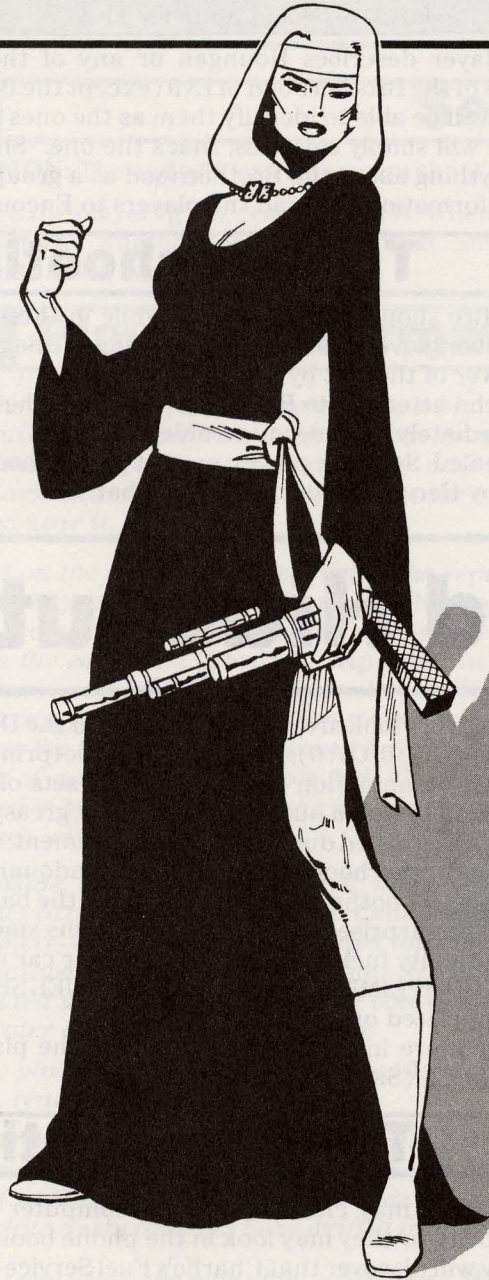

## PI Players' Information

A) The lobby of the Roarke Building looks the same as hundreds of other building lobbies. A long time ago, the floor was clean marble. The place is decently, though not extraordinarily, kept up.

A battery of three elevators are to the left. The highest floor that can be reached by any elevator is the 22nd.

## GM GM Information

As soon as the players reach the 22nd Floor, they will find themselves facing four Confessors. This will happen no matter which way they take to get upstairs. The Confessors will attack immediately, using their electric prods as offensive weapons. This attack will continue for 4 phases. The Confessors' stats are listed in the NPC section.

## PI Players' Information

Read to players:

"Hold!"

*The Confessors stop immediately and come to attention. A tall and imposing woman, dressed in church robes, steps from one side of the Reception Area.*

*"Allow me to introduce myself. I am Sister Dread. Forgive us for this poor welcome. The security teams reacted to your presence before I had a chance to let them know you are here as guests of the Church of Blood."*

*With a wave of her hand, she dismisses the Confessors.*

*"They shall be disciplined for this affront. Now I will escort you about our temporary offices."*

*Sister Dread will beckon the players to follow her through one of the doors.*



## S Setup

To contact Brother Blood, the players must go to the temporary site of the Church of Blood, which is in the Roarke Building, located on 75th Street in the Business District. The construction site of the new Church of Blood is next door. The building crews are working double-shifts in order to complete the project by the target date.

Asking questions around the building or the construction site won't get the players any new information. No one in the Roarke Building really knows much about the Church, except that they're very quiet and don't bother anyone.

Refer to the map of the Construction site on Page 29.

Read paragraph A to the players as they enter the lobby of the building.



Beyond the doors, the entire appearance of the building changes. The place appears to be inside an imposing citadel. The walls are all done in gothic architecture. It looks to be 25 feet from the rocky floor to the arched ceilings above. Flickering torches on the wall illuminate the room, throwing monstrously shifting shadows beneath the pews. The Players are led down a hall that stretches for at least 100 yards. The air is stale and gloomy. Somewhere in the distance, a low chanting can be heard.

## GM GM Information

No information will be given to the players about the assault that occurred at the elevators. Sister Dread will offer no explanation besides "a slip in communications."

The weird appearance of the offices is actually due to great advances in holography. The walls, floor and ceiling only appear to look as they do. The holographic projectors are placed throughout the entire complex, so that everywhere the players look they will see this gothic nightmare. These holographs can be treated as an ILLUSION of 30 APs.

When they reach the dressing room, the players are given robes to wear so that they'll look like the other members of the Church. She then escorts the players on a tour of the facility, taking them into all areas.

Sister Dread will tell the Players the following:  
"Brother Blood is not in the City, but he will be flying in

at 7:30 tonight. You should be at JFK airport so that you may escort him back to the church.

Once the players have completed their tour, it is up to them to determine how to proceed. They will be allowed access to all areas.

If the GM decides to cut the tour short, go immediately to Encounter 8.

The players are free to ask anyone they meet questions about the Church or Brother Blood. However, most of the responses they'll receive will deal with Church dogma or the greatness of Brother Blood. If the players become too insistent in their questionings, Church members will back away and a Security team will show up.

Go to Encounter 8.

## T Troubleshooting

The players don't need to really worry about whether they arrive in costume or not. Brother Blood has a full dossier on all the Titans except Kole and Jericho, and he knows who their secret identities are. Blood's Confessors have also been given pictures of each of the Titans, so that the players will be instantly recognizable.

If the players come up with the idea of disguising themselves, the plan won't work, as Captain Hall has only gotten clearance for the Titans themselves to act as guards for Brother Blood. Blood, through Sister Dread, only agreed to this because of the possibilities the situation holds for using the Titans for Blood's own purposes. (See Blood's Motivation)

## Encounter Eight: Explosion

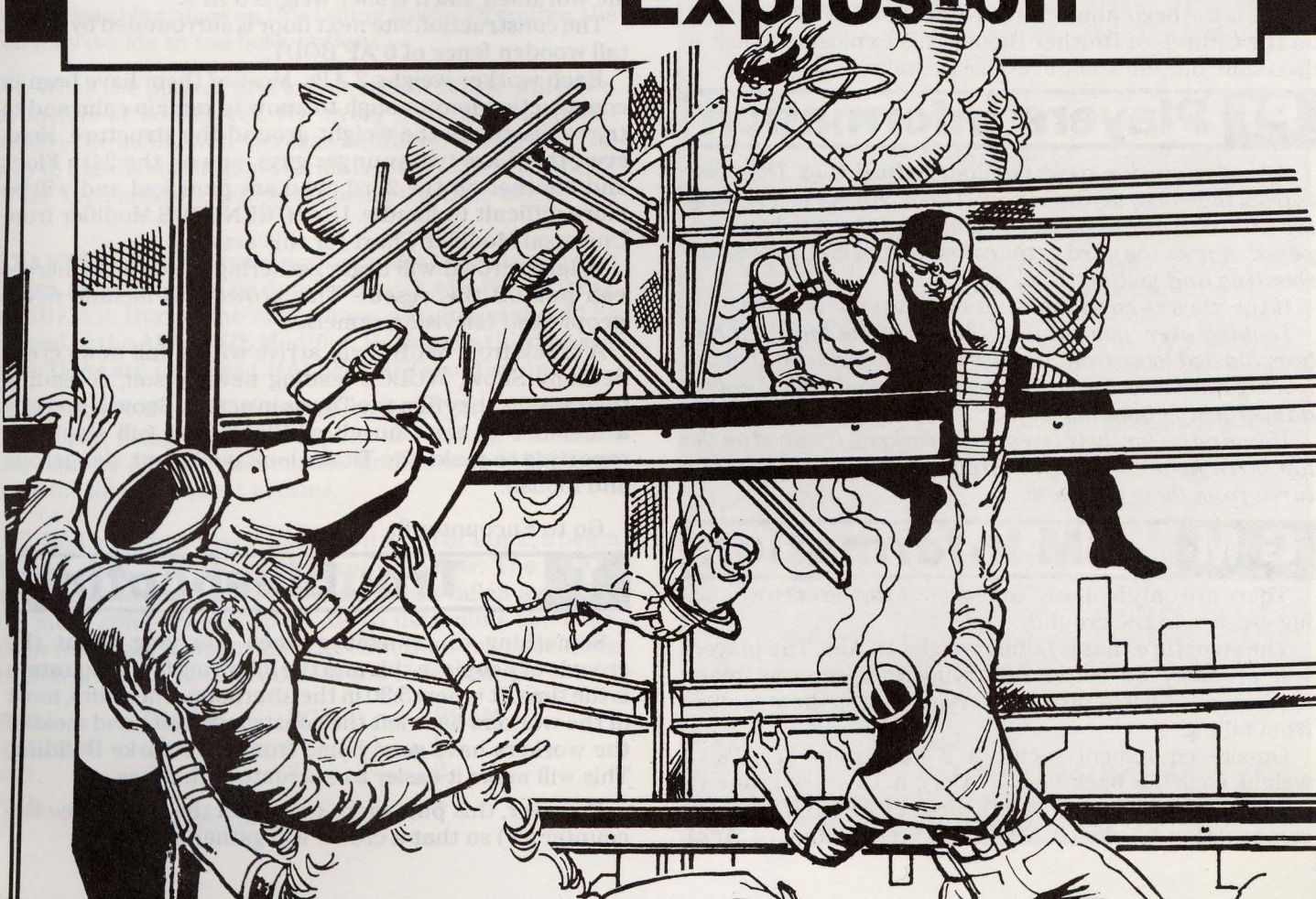



# CONSTRUCTION SITE

ROW

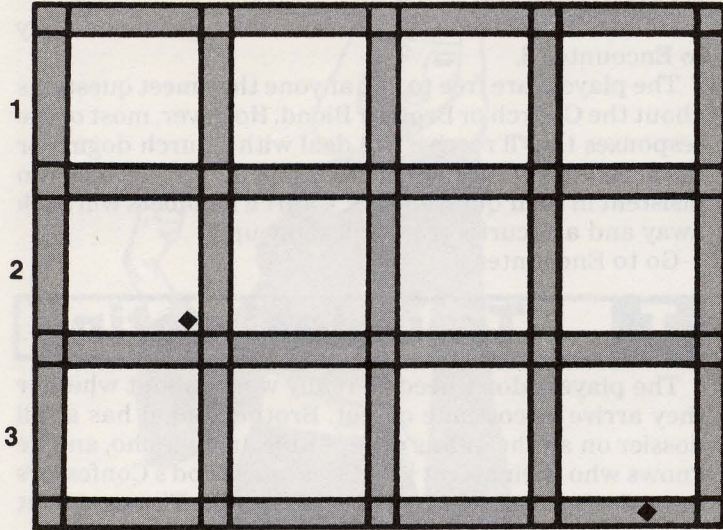

**22nd FLOOR  
(TOP VIEW)**

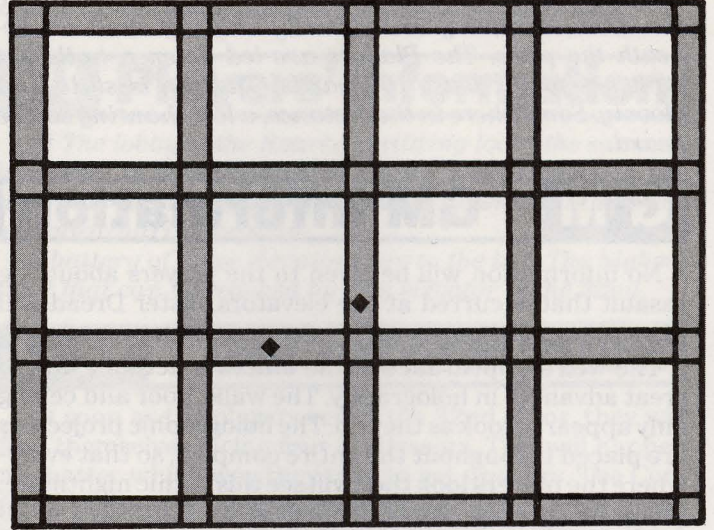

**23rd FLOOR  
(TOP VIEW)**

**S**

## Setup

This is the beginning of the Brotherhood of Evil's attack on the Church of Brother Blood. This explosion is just a diversion, but innocent lives are at stake.

## PI Players' Information

*A loud explosion rocks the Roarke Building. The noise is from the construction site next door. All the members of the Church rush to their windows to see what has happened. Across the yard at the construction site, people are shouting and yelling.*

If the players go to the window, continue reading:

*Looking over, you see that the top of the building has been blasted loose from its base by explosives. The framework of solid steel beams has been shattered, and it teeters dangerously above the yard.*

*Hanging on for their lives are 9 workers, trapped on the top three floors. The metal groans loudly as the beams lurch from their supports.*

## GM GM Information

There are only 5 phases to react before the entire building crashes to the ground.

The structure that is falling weighs 10 APs. The players will probably be better off trying to rescue as many workers as possible, instead of trying to stop the structure from falling.

On-site equipment includes 2 bulldozers (7 APs of weight each), a back-hoe (7 APs), a 16-story crane (9 APs), a cement-mixer (8 APs), pipes (1 AP each), cement construction blocks (0 APs), and steel beams (4 APs).

Trailers are on site being used for an office, a supply shed, and a crew room. Latrines have also been brought in for the workmen. Each trailer weighs 5 APs.

The construction site next door is surrounded by a 1 AP tall wooden fence of 6 AP BODY.

Each worker weighs 2 APs. Most of them have been in construction long enough to know to remain calm and to try to distribute the weight around the structure. However, there are two younger guys, one on the 24th Floor and another on the 23rd, who are panicked and will be more difficult to handle. Use STRENUOUS Modifier from Universal Modifier Chart for this action.

A large crowd will begin gathering to see if the heroes can pull off this rescue. This crowd will include newspeople and television cameras.

A truck from WUBC will arrive with a full news crew. Bethany Snow, WUBC's leading newsperson, is leading this crew as they film the Titans in action. Snow is secretly a member of the Church of Blood. She will slant her reporting to make the Titans look inefficient, dangerous and foolish.

Go to Encounter 9.

## T Troubleshooting

Something to remember when worrying about the crowds of people in this and the following few encounters is the time. It is now 5:30 in the afternoon. Therefore, most of the workers have left the construction site and most of the workers have gone home from the Roarke Building. This will make it easier to evacuate both areas.

However, this puts more people on the street (See Encounter 11) so that a crowd will gather quickly.



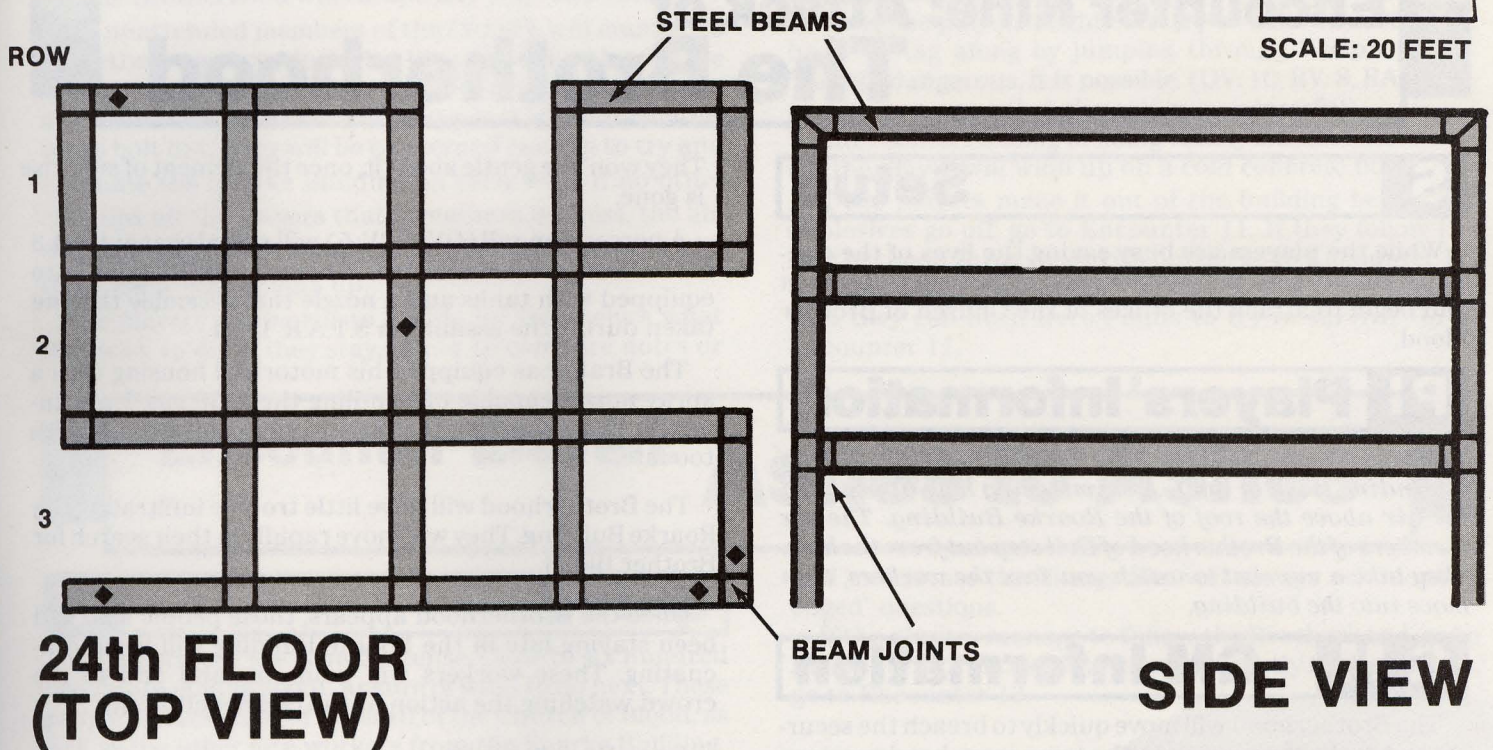

**TRAPPED WORKERS** ◆

The top three floors of the construction site are currently laid out as pictured below. Each beam has a weight of 4 APs and a length of 1 APs.

There are two options as to how to treat the action while it is taking place on this falling frame. Of course, the GM may decide to use both options.

1. When the players first arrive, the structure will be on an incline of 20 degrees. For every 6 AP of time (4 seconds), the incline will increase another five degrees. The way to handle this in game terms is to increase the modifier for each action attempted during the time block.

**EXAMPLE:** If the players arrive on the scene in the first phase, all actions can be done with an **EASY UNIVERSAL MODIFIER**. During the next phase, all actions should be judged at the **AVERAGE** Modifier. During the third phase, all actions are rated as **CHALLENGING**, and so on.

Any direct hit on this structure by anyone (player or Confessor, using powers, weapons or bodies), will cause the structure to tilt, pushing the Modifiers up to the next level for all subsequent actions.

2. Roll one die for each phase. On a roll of 1 or 2, a beam breaks away and falls to the ground below. The way to determine which beam in particular has fallen away is a bit more complicated. Roll 1 die to determine the floor, then roll again to determine the row, then roll once more to determine the beam. Consult the chart below.

ROLL	FLOOR	ROW	BEAM
1-3	24	1	3
4-6	23	2	2
7-9	22	3	1
0	NO BEAM FALLS		

If a zero is rolled at any time during your computations, the building holds for this phase and no beam falls.

During the third phase of the rescue six Confessors, using jet packs, fly out from one of the 24th floor windows of the Roarke Building and swoop to rescue the workers from the collapsing building.

The Confessors are wearing standard jet packs.  
**Jet Packs:** SPEED 6 / STR 3 / BODY 2 / USES 1 / DURATION 8

The Confessors are actually trying to turn this opportunity to their own gain. They will save some of the workers for a propaganda victory, but their first motive is to embarrass or harm the Titans.

The first rescue is for the cameras below, as well as to throw off the suspicions of the Titans. However, if a Titan gets too near one of the Confessors, that Titan will be attacked by that Confessor's electric prod. This would be done to "keep the Titans from endangering the workers."

If the Titans attack the Confessors, Bethany Snow will get the whole thing on videotape, giving a running commentary about how the rescue efforts of the members of the Church of Blood are being hampered by the Titans.

Snow was on her way back to the studio after covering a fire.

The Confessors will back off once all the workers are saved or once the structure falls. They will fly down to the street to stand with the other members of the Church Staff. If asked for comments by any of the reporters gathered, the Confessors answer: "We were only trying to help our fellow man."

If the workers were successfully rescued, the Confessors will take full credit. If the rescue fails, the Confessors will blame it on the Titans.



# Encounter Nine: Attack of The Brotherhood

## S Setup

While the players are busy saving the lives of the construction workers, the Brotherhood of Evil will Teleport in and begin to attack the offices of the Church of Brother Blood.

## PI Players' Information

*Across the way, back atop the Roarke Building, there is a blinding flash of light. A shimmering hole appears in the air above the roof of the Roarke Building. The six members of the Brotherhood of Evil step out from the hole. They take a moment to watch you save the workers, then move into the building.*

## GM GM Information

The Brotherhood will move quickly to breach the security and make their way into the temporary headquarters.

They won't be gentle about it, once the element of surprise is gone.

A perception roll (OV: 5 RV: 5) will reveal that at least 3 of the Brotherhood (Mallah, Plasmus, and Houngan) are equipped with tanks and a nozzle that resemble the one taken during the assault on S.T.A.R. Labs.

The Brain has equipped his motorized housing with a spray nozzle capable of handling the A-30 gas. Unfortunately, there's no way the players will know this until it's too late.

The Brotherhood will have little trouble infiltrating the Roarke Building. They will move rapidly in their search for Brother Blood.

Once the Brotherhood appears, those people who had been staying late in the Roarke Building will begin evacuating. These workers will pour out and add to the crowd watching the action at the construction site.

Go to Encounter 10.

# Encounter Ten: Blood's Fury

## S Setup

The Brotherhood of Evil are searching the offices of the Church of Brother Blood. They will not find Blood, as he has not yet arrived in New York. The Brotherhood is not aware of this fact.

## PI Players' Information

*The members of the Church who are unable to evacuate are quickly affected by the A-30 gas. They fall to the ground, unable to move or act. The offices are in turmoil as the Brotherhood makes its way through.*

## GM GM Information

The aim of the Brotherhood is to kill Brother Blood if they can. They will not hesitate to use the A-30 gas or their natural powers to halt any opposition from Blood's followers.

The Brotherhood will split up on each level, starting on the 22nd Floor. They will spend a total of 5 APs of time going over each floor before regrouping and going up to the next floor. After they've searched all three floors, the Brotherhood will meet on the roof. If confronted by the heroes, the Brotherhood will first spray the players with A-30, then move into combat. Having gone through the complex, whether having battled the heroes or not, the Brotherhood will be irate as they have not found Brother Blood.

Though the raid has been successful and the A-30 gas far exceeds the Brain's expectations, Brother Blood was nowhere to be found. Outraged, the Brain screams for Blood to show himself.

Read to the players:

*Blood's answer is a chilling laugh.*

*As if from out of nowhere, Brother Blood appears. He gloats about what fools the players and the Brotherhood have been. Blood speaks in an eerily booming voice.*

*"How dare you simpletons attack me in my own sanctum? You think to catch me unaware, yet all things are known to Blood!"*

*"It was a simple matter to elude your clumsy efforts. I knew that if I waited you fools would show yourselves. Once you are out of the way, I can fly in without having to soil my hands with your tainted presence. Give my regards to all the other fools who have trespassed against me."*

*Suddenly, the employees of Blood who can move, run out of the building.*

## GM INFORMATION:

If any object is launched against Blood while he's speaking, the object will pass harmlessly through his body. This will reveal that the Brother Blood standing before them is only a holographic image (of 20 APs). Maniacal laughter is all that is left as Blood vanishes.

There are now only 6 APs of time for the players and the members of the Brotherhood to get out of the building. At the end of that time span the building will explode due to explosives secreted below on the 21st Floor. There will be no ticking or other clue to the impending explosion. The explosives, with a force of 20 APs, have been set up in such a way that only the top five floors will be disintegrated.

Once Blood disappears, the Brotherhood, seeing that there is nothing else for them here, will immediately try to escape. If possible they will converge on Warp expecting him to get them out onto the street. If Warp is not availa-



ble, the Brotherhood will escape any way they can.

All unattended members of the Church will manage to make their way outside during the players' battle with the Brotherhood. They all know about the bomb, so any who are present when Blood's image appears will immediately try to bolt out. They will be concerned enough to try and evacuate the Roarke Building on their way. If no other clue tips off the players that something is amiss, the absence of the Church members may be another way to let them know something's up.

The players will be left to decide for themselves what they wish to do. If they stay, either to compare notes or

battle the Brotherhood, that bomb is still going off in 6 APs of time. The players might even try to follow the Brotherhood or tag along by jumping through Warp's portal. Though dangerous, it is possible. (OV: 10, RV: 8, RAPs of 1 or greater means that the action is successful).

After a short feeling of being totally lost and disoriented, the player will wind up on a cold concrete floor.

If the players make it out of the building before the explosives go off, go to Encounter 11. If they follow the Brotherhood through Warp's portal, go to Encounter 12.

If the players get caught in the explosion, remember that they can burn Hero Points to try to survive. Go to Encounter 11.

## Encounter Eleven: Ashes to Ashes

### S Setup

On the streets, the crowd is tense. Close to six hundred people are milling about, unsure of what to do next. These people include most of the staff of the Church of Blood, as well as the other late workers from the Roarke Building.

### PI Players' Information

*Six hundred people are milling about, frightened. Most are looking to you Titans for some help. Some though have been listening to Bethany Snow's litany of lies and are backing away.*

*Pushing through the crowd, Ms. Snow moves in to ask you some questions:*

*"Excuse me, but can you tell us how you Titans are linked to the Brotherhood of Evil? Why are you all here at the offices of the Church of Blood?"*

*As she is talking, the Brotherhood of Evil appears in the middle of the street. The Brain is laughing as he looks over at you.*

*"I congratulate you all on finally putting your talents to better use. I'm a bit surprised you decided to throw in with a despot like Blood, though. I had hoped you might eventually join our Brotherhood, but *c'est la guerre*. Be assured though that we will track down your new leader. Next time he will not escape us."*

*Bethany Snow will pick up on this, saying: "So actually you Titans have become members of the Church of Blood. When did you convert?"*

*"Is it true, as the Church press release reports, that you will act as Brother Blood's bodyguards when his plane comes into JFK Airport tonight at 7:30?"*

### GM GM Information

After speaking, the Brain will order Warp to teleport the Brotherhood back to their hideout, so that they can track down Blood. For more information as to what the Brotherhood is after, consult the Brain's MOTIVATION.

Members of the Church of Blood will begin mourning their brothers and sisters who have been lost in the explosion of their offices. They will blame both the Brotherhood and the Titans for the explosion. (Actually, it was Blood's work. He and Sister Dread foresaw such an occurrence and plan to use this to get more publicity.)

Remember that Bethany Snow wants to manipulate

and embarrass the Titans. She will always ask "double-edged" questions.

If the players manage to follow the Brotherhood, go to Encounter 12. If the players head directly to the airport, go to Encounter 13.





## Encounter Twelve:

# The Lair of Evil

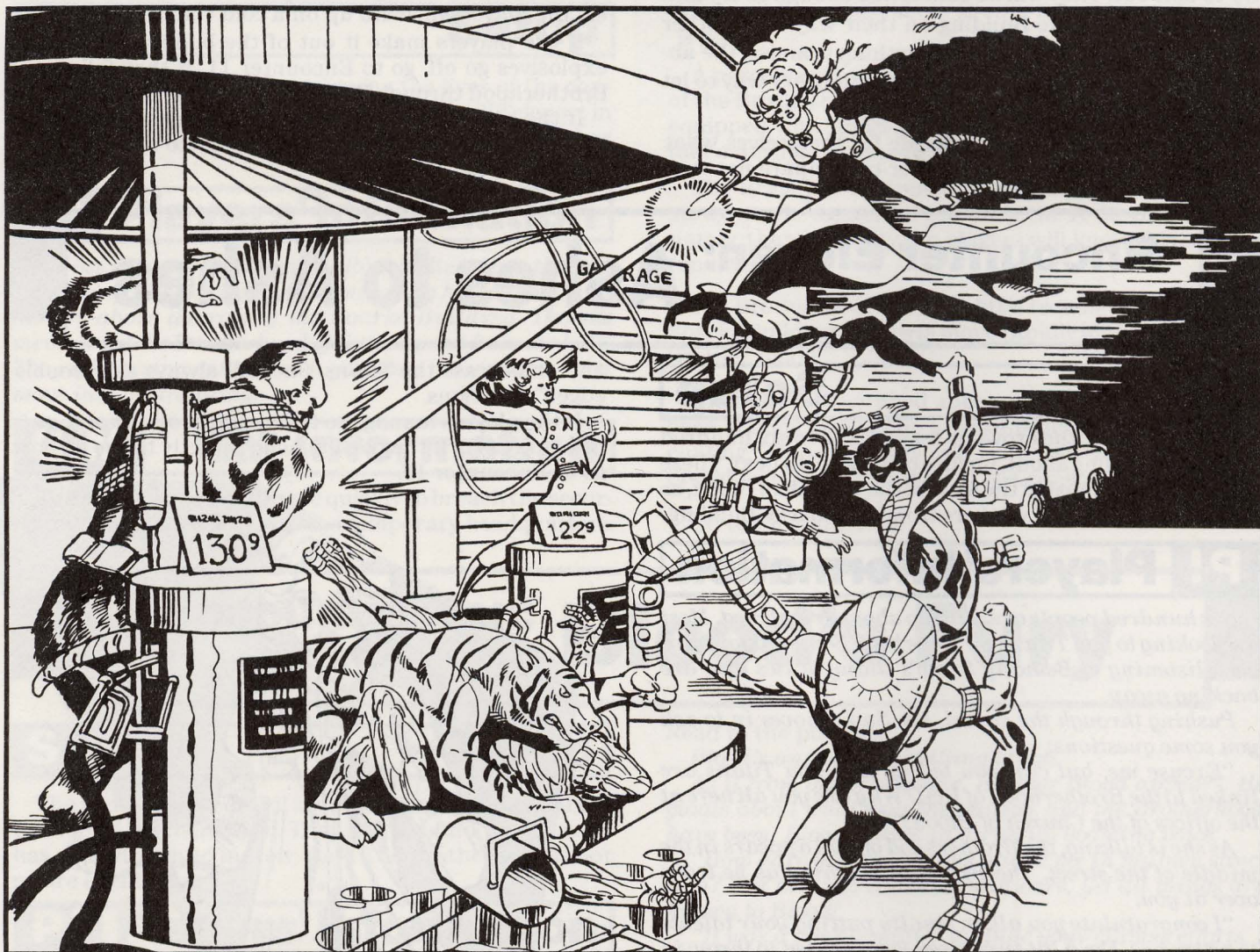

## S

### Setup

Should the Brotherhood of Evil succeed in escaping from Blood's offices, they will head directly back to their current hideout, Charlie's Fuel Service, an abandoned garage on the Lower West Side. As soon as they get there, the Brotherhood will busily begin preparations to track down Brother Blood.

If the players have arrived at this Encounter by jumping into Warp's portal from Encounter 11, the Brain will order the Brotherhood to attack immediately. Warp will be convulsed to the side. This is due to the unexpected strain placed on him by the player's jumping into his portal. He will be out of action for 7 APs of time. Read section A to the Players.

If the players arrived at this Encounter by tracking down the clues in Encounter 6, the Brotherhood may be alert and waiting for them. Realizing that this garage base is not as fortified as he would like it to be, the Brain has equipped it with a number of alarms and other early warning systems (RV: 8, OV: 6). These defense systems

include six robots exactly like those used in the assault on S.T.A.R. Labs.

If the Titans successfully disarm the alarms, refer to the GM INFORMATION section below for the locations of the various members of the Brotherhood of Evil.

If the Titans fail to successfully disarm the alarm system, 3 APs of Time after they enter the garage, Warp will teleport the Brotherhood of Evil in to attack the Titans wherever they may be. Refer to the maps for player location. Read Section B to the players.

If the players arrive here between 11:30 a.m. and 2:00 p.m. through the tracking of clues from Encounter 6, the Brotherhood of Evil will not be here, but all their equipment will be. If the Titans decide to wreck this location now or set a trap, things may go easier on them when they battle the Brotherhood. This is only possible if the Investigations section is skipped.

## PI Players' Information

A) *As the feeling of dizziness fades away, you find yourself on the oil-stained cold concrete floor of a garage.*



Surrounding you are the irate members of the Brotherhood. Warp is off to one side, obviously in great pain. In his metallic accent, the Brain says: "You foolish children. I had hoped not to have to deal with you — yet. But you leave me little choice!" They attack!

B) Suddenly, you are surrounded by the Brotherhood Of Evil! In his metallic accent, the Brain says: "You foolish children. I had hoped not to have to deal with you — yet. But you leave me little choice!" They attack!

## GM GM Information

The Brain has planned ahead for the eventuality that Brother Blood might come out on top of the battle at the Roarke Building. Now he is prepared to take the contest directly to Blood.

Inside, the Brain, Mallah and Warp are going over the garage, preparing it for their departure. Plasmus and Hourgan are on the second floor, dismantling and destroying as much equipment as they can. They're not worried about leaving clues behind, they just don't want anyone to be able to use the Brain's advanced weaponry against them. Phobia will be at the monitoring console on the third floor, watching over the premises while the others go about their tasks.

After they have departed from the offices of Brother Blood, the Brotherhood will spend no more than 9 APs of time preparing for their departure. If the players have not shown up within this time, the Brotherhood will be gone. Check Timeline for more information as to when the Brotherhood is in their hideout.

If the Brotherhood escapes, but they haven't been to Encounter 9 yet, they will go to Encounter 9. If they are escaping after having attacked Brother Blood, they will go to Encounter 13.

## T Troubleshooting

The following information is about how to run the members of the Brotherhood during this encounter.

During any battle that the Brotherhood is winning, the Brain will offer the player-characters a chance to join the Brotherhood in their coming battle against "the malignant evil of Brother Blood."

The players should be allowed to make a choice here, relying on their leader to call the shots. While the players are debating, the Brain or one of the others will certainly attempt to influence (INFL) the characters into seeing the purpose behind the Brotherhood's plan. If the players accept, the Brotherhood will allow the characters to leave the garage, saying that they are to wait until they are contacted for the next move in the Brotherhood's plan. The players are, of course, free to bargain, asking for any wanted concessions (such as no innocent people being used as soldiers, that Blood is brought to justice and not killed, etc.) before making any decision.

If the player-characters refuse to join the Brotherhood, the Brain will try to have his minions subdue or incapacitate the characters, without killing them, in the hope that the characters will make use of one last chance to come to their senses and "see the justice of what the Brotherhood is after."

Once the characters have been captured and securely tied to one of the workout bars (5 APs strength), the Brotherhood will make their escape, abandoning their garage base.

Should the Brotherhood be losing any battle, they will attempt to escape and regroup at JFK Airport. If Warp is present at the base and has fully recovered, the group will use his talent to make good their escape. If he has been detained or is still hurt, the Brotherhood will simply exit and disappear.





# Encounter Thirteen: The Return of **Blood**

## **S** Setup

JFK Airport is located on the western tip of Long Island, in the borough of Queens, 13 APs (14 miles) southeast of Manhattan. It is one of the largest airports in the world.

If the players check with the Flight Tower, read section A of **Airport Investigation**, below. If they go to the airport without checking in with the tower, read section B only. If the players are at the airport by 7:00 pm, read section C.

The information about the incoming flight will only be available to players with High-Level Connections in the police department or with federal agencies. The players must either contact JFK Tower or the FAA directly. Contacting any other airport will bring no information, except for a suggestion to contact one of the other authorities.

### **Airport Investigation:**

- A) If the Titans check in on a high security clearance the tower will answer: "A small passenger plane is due in from Buzzard's Bay, Massachusetts, at approximately 19:30 hours. It is a private flight scheduled to be picked up on the field at section 6 by private car."
- B) Airline terminals at JFK are set up in a wide ring. Domestic flights are processed in their own buildings. Private flights however can land anywhere that has been approved by the tower. It is not unusual for someone using a private jet to be met and taken away by a waiting car.
- C) At 7:00 pm sharp, a limousine will pull up to begin waiting here. A driver in normal livery will step out to stand next to the car. All the windows have been blackened and it is impossible for anyone without X-Ray or Ultra vision to see inside.

### **GM INFORMATION:**

Section 6 is a landing strip off to the southern edge of the airfield, reserved for private and business planes.

The driver of the car is actually one of Brother Blood's Confessors in normal clothing. He will be HOSTILE if approached by the players. In the back of the car, hidden behind the dark glass is Sister Dread. She is dressed in her raiment as a member of the Church of Blood and will intervene if the players threaten the driver.

It will be a simple matter for the Brain to tap into the FAA computer and come up with the same information as given in section A above to players.

## **PI** Players' Information

*At precisely 7:32 pm, a small Cessna jet touches down in Sector 6.*

*A small plane, with the seal of Zandia on its doors, taxis over before stopping. The door slowly opens. Two Confessors file out, to stand on either side of the small*

*stairway. They are tense, alert for any attack.*

*Suddenly, the impressive figure of Brother Blood stands in the open doorway.*

*"How good of you all to come greet me. I must admit I had expected to find you dead though. I do have so many deadly enemies, you know."*

## **GM** GM Information

Blood will continue to gloat about having the Titans as his personal bodyguards. He is HOSTILE to the players and won't even think of thanking them. For more information on his actions during this adventure, consult Blood's MOTIVATION.

As Brother Blood steps down from the plane, a shimmering hole appears near the nose of the plane. The Brotherhood of Evil, complete with the A-30 gas, will step out ready for the attack. They are out to kill Brother Blood, and all promises that were made to the Titans are off.

During any battle, the Confessors stand ready to defend Brother Blood. However, they consider both the Brotherhood and the Titans to be the enemy. If the chance arises, the Confessors will just as readily attack the Titans as the Brotherhood. Should this fact come out later, their excuse is that the Titans got in their way.

If the Brotherhood is defeated during this encounter, they will make use of Warp's power, if he is available, to disappear. Before leaving, the Brain again congratulates the Titans, saying that it's over for now. But he vows that neither the Titans or Brother Blood has seen the last of the Brotherhood of Evil.

At 7:50 pm, the police arrive on the scene. Sirens wailing, Captain Hall will roar up, followed by six other cops in black and white patrol cars.

Unfortunately, Blood has done nothing illegal. He was the one who had been threatened and any actions he took at the airport were only to defend himself. The police will be unable to arrest him and will actually give him an escort into town.

If the Brotherhood of Evil gets through the heroes and is able to attack Brother Blood, the Brotherhood and the players will find out that this is not the real Blood, but one of Blood's disciples in a disguise.

The sides of the plane will open to reveal a large set of speakers. From these speakers will come the sound of the mocking laughter of Brother Blood, and that will continue long into the night. (The speakers have a BODY of 3, in case someone wants to stop the laughter.)

The police will escort the phony Blood to the offices of the Church in what's left of the Roarke Building. From there, the imposter will go to a hotel.

The police are under orders to escort "Brother Blood" into town, and wouldn't know this one from the real one. The officers will wonder about the laughter, but will put it down to "Hero-stuff."



# Endgame

## VICTORY CONDITIONS

The players should consider themselves successful if they are able to thwart the plans of the Brotherhood of Evil. This means recapturing the A-30 gas and keeping the fake Brother Blood safe from harm, even if the Brotherhood successfully eludes capture.

If the players are able to capture the Brotherhood in order to bring them before the authorities, so much the better.

For recovering the gas alone, the players should be awarded 20 Hero Points. The A-30 is the real threat, even though the Brotherhood can be considered "armed and dangerous." If they manage to capture the Brotherhood too, the reward goes up to 40 Hero Points.

If neither of these things occurs, even if Blood is "saved," the players receive no points.

Though the players may certainly want to exact some punishment on Brother Blood, he has not been the villain in this case. Should the Titans go back to the Church for a reckoning, they will not be welcome. They will be considered to be trespassing and the police will be called to remove them.

Other Victory conditions, as well as appropriate rewards, should be determined by the GM. Did the players role-play well, meaning did they stay consistent with the characters they were portraying? How did the players react if they were hit with the A-30 gas and suddenly found that some of their powers were gone? Did they follow through on their investigations? How did they deal with having to guard one of their worst foes? How did they react to the bombing of the construction site? Did they

save anyone? Did they lose anyone from the bomb in Blood's headquarters? Were they able to figure out what was happening before too much was revealed or did you have to tell them?

For further information on how to judge the points earned by the players in this adventure, consult pp. 37-38 of the Players Manual and p. 5 of the GM Manual.

Most importantly, did they play intelligently and did they have fun? Let's hope so. They'll have to be ready and rested for the next time duty calls.

## The Standard Award is as follows:

### Opposition

Superior ..... 25

### Critical Tasks

Work for Hall	<i>Even Odds</i> .....	3
Joey Pigeon	<i>Seldom Fails</i> .....	2
The Candyman	<i>Seldom Fails</i> .....	2
Eyes Watson	<i>Even Odds</i> .....	3
Burke Bros. Warehouse	<i>Seldom Works</i> .....	8
Babysitter Brown	<i>Even Odds</i> .....	3
The Old Hideout	<i>Seldom Fails</i> .....	2
Lair of Blood	<i>Seldom Works</i> .....	8
Escaping Lair of Blood	<i>Seldom Works</i> .....	8

### Area of Consequence

International..... 7

### Severity

Fatal ..... 15

---

**TOTAL** ..... 86

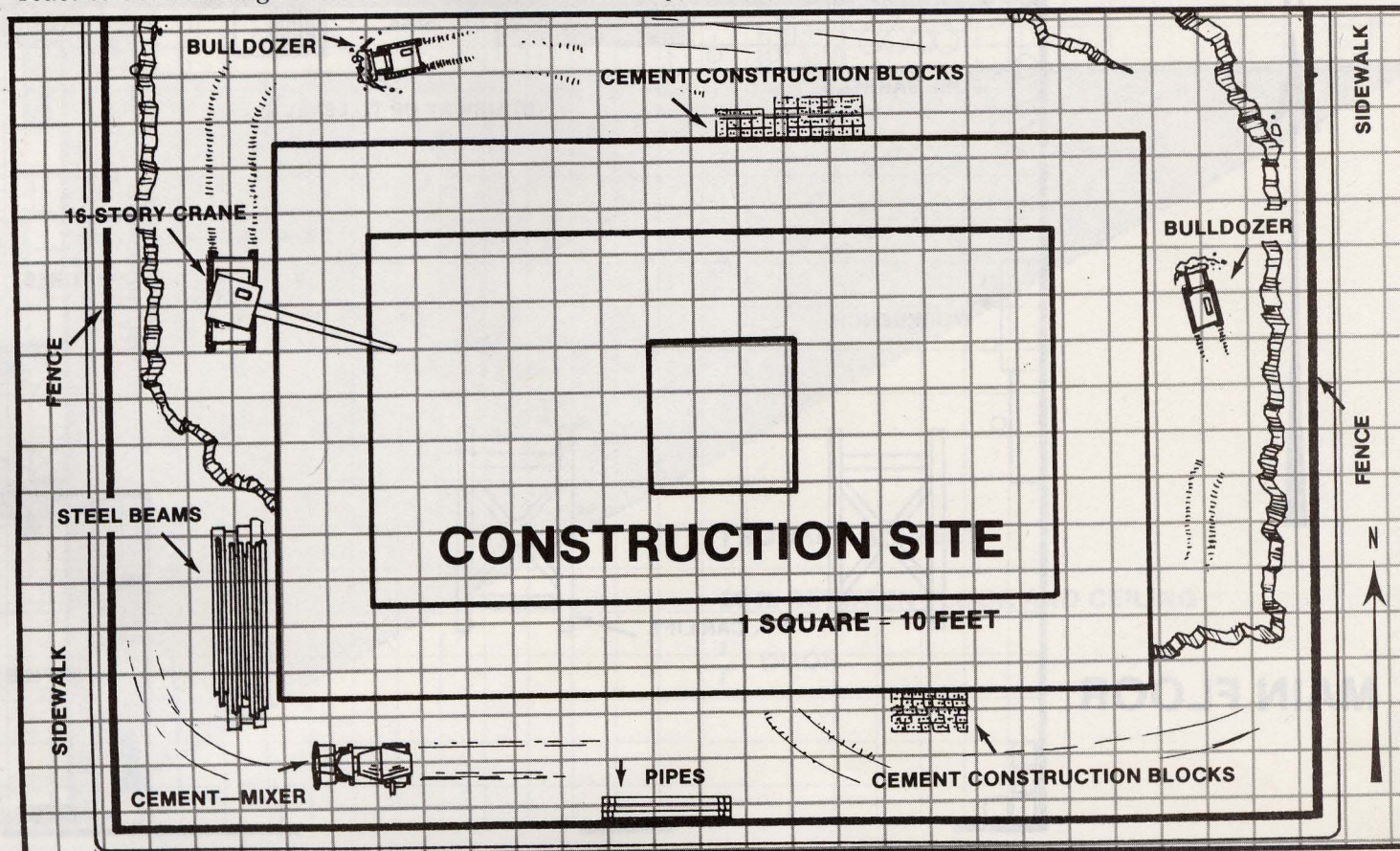



# CHARLIE'S FUEL SERVICE

3rd FLOOR

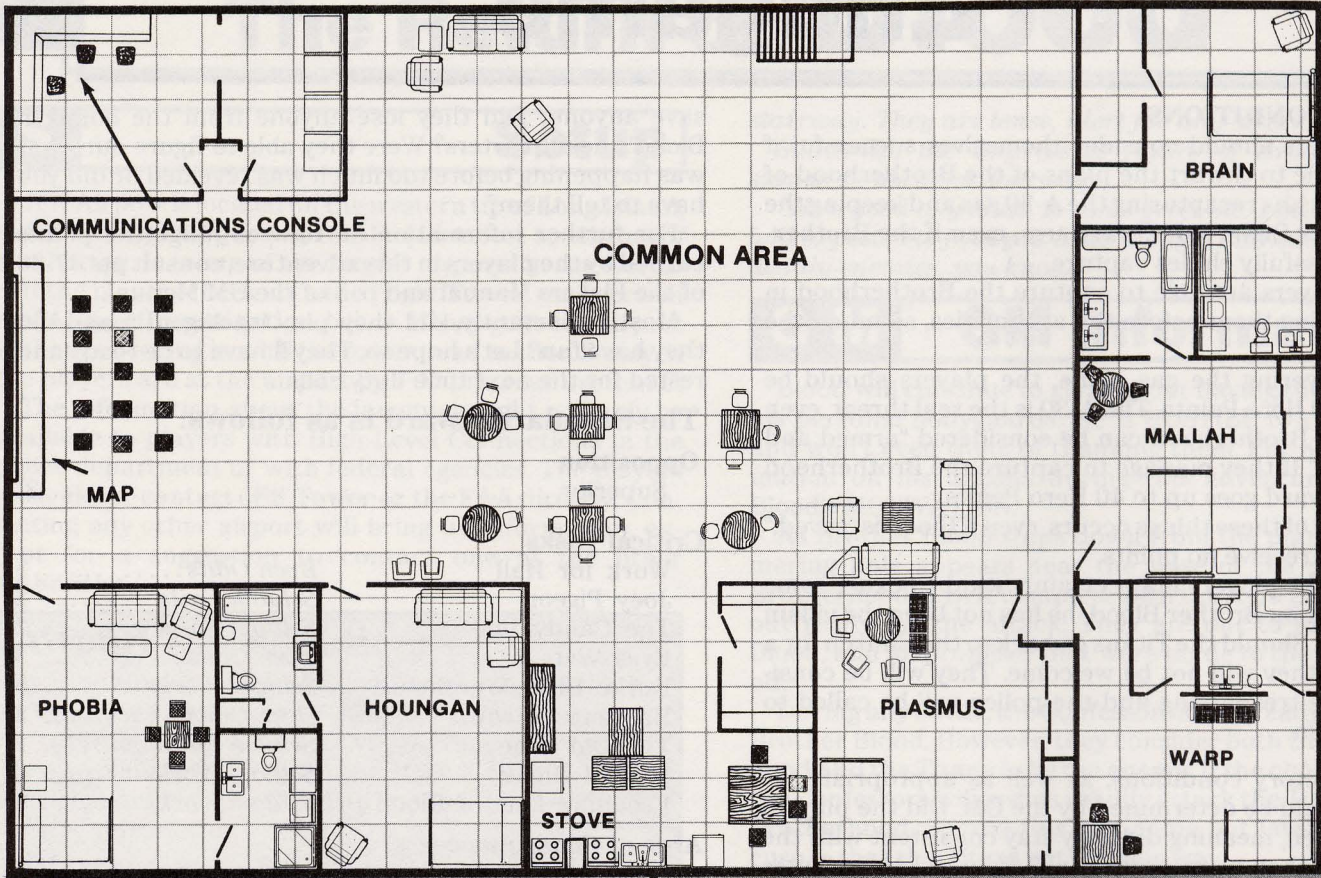

MAIN FLOOR

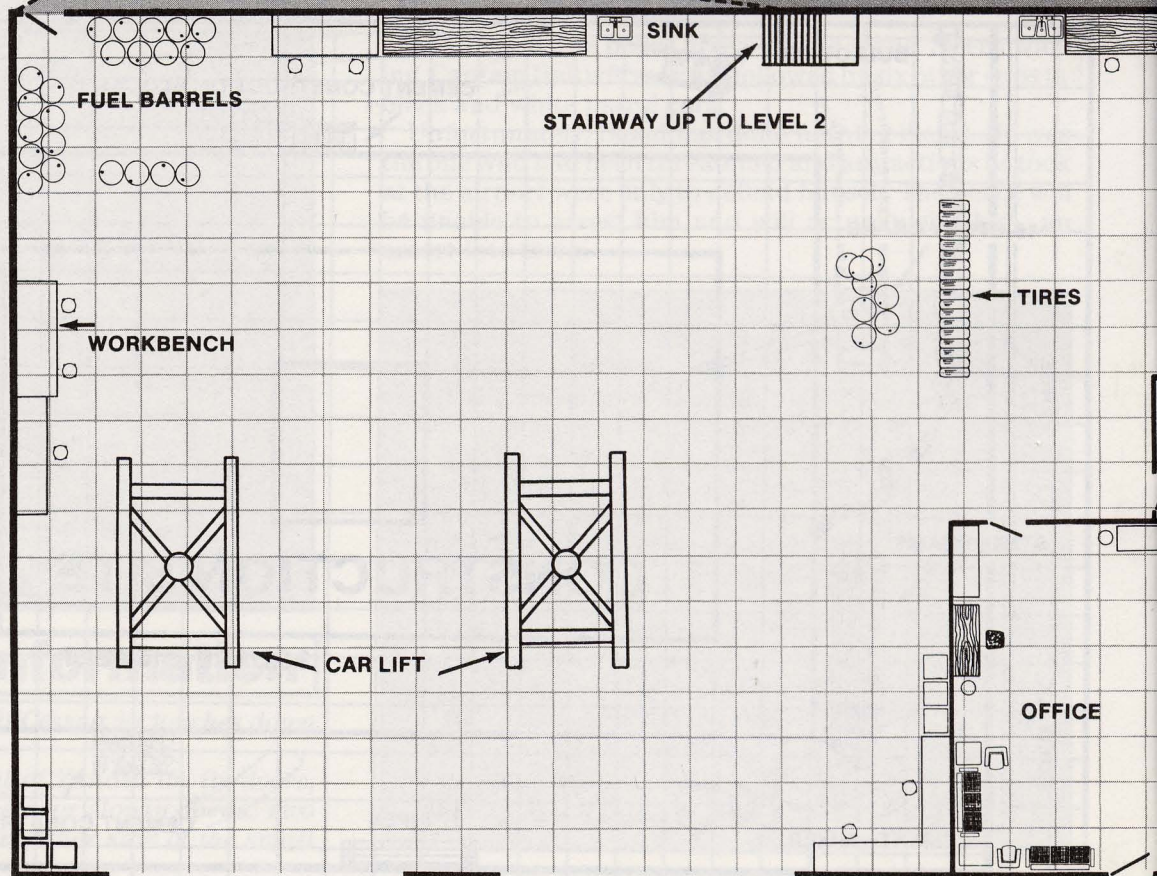



# CURRENT HIDEOUT OF THE BROTHERHOOD OF EVIL

10 ft. BETWEEN FLOOR AND CEILING

2nd FLOOR

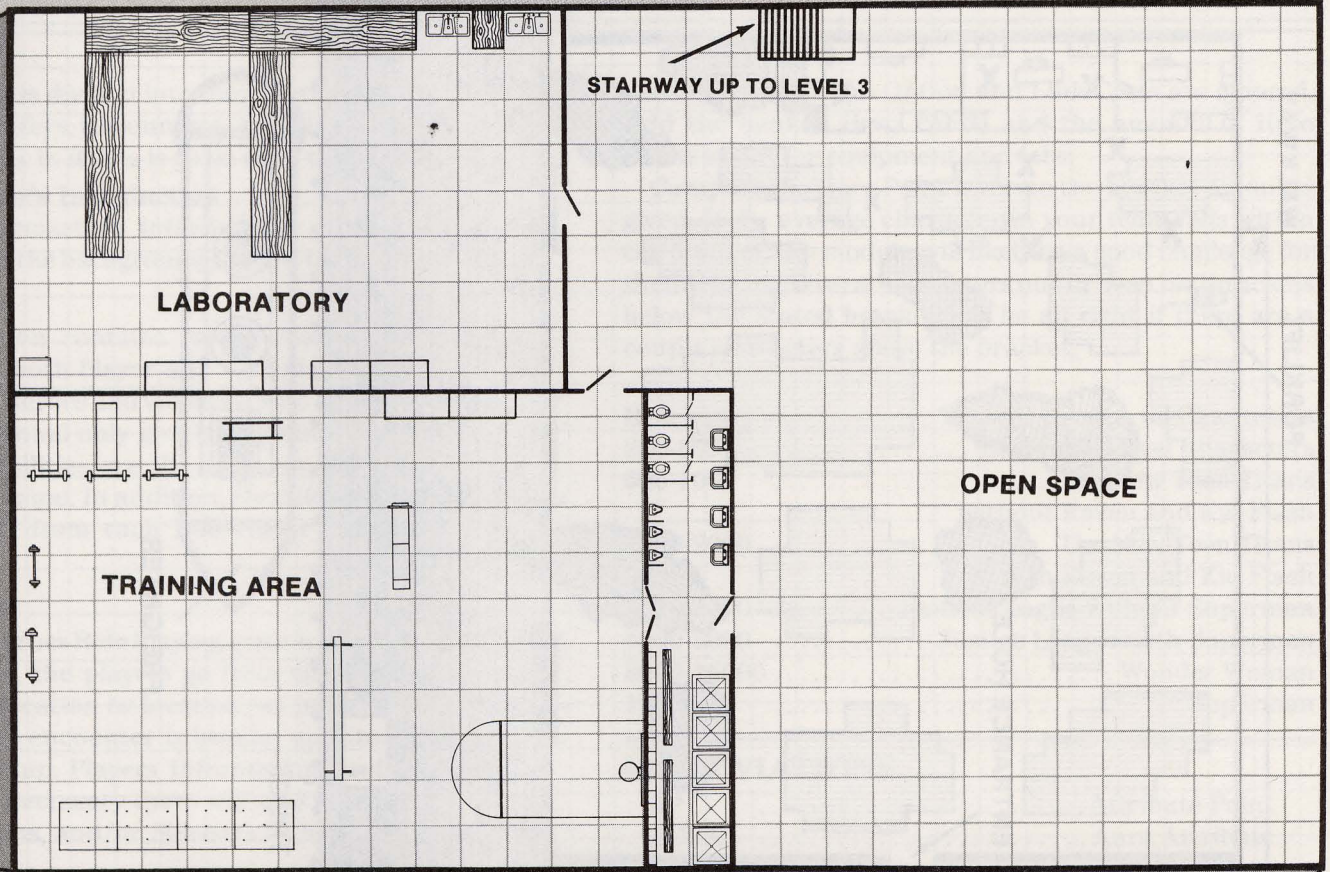

OPEN SPACE

STAIRWAY UP TO LEVEL 3

LABORATORY

TRAINING AREA

← VENDING MACHINES

1 SQUARE = 10 FEET

20 ft. BETWEEN FLOOR AND CEILING

DOOR



# BURKE BROS. WAREHOUSE

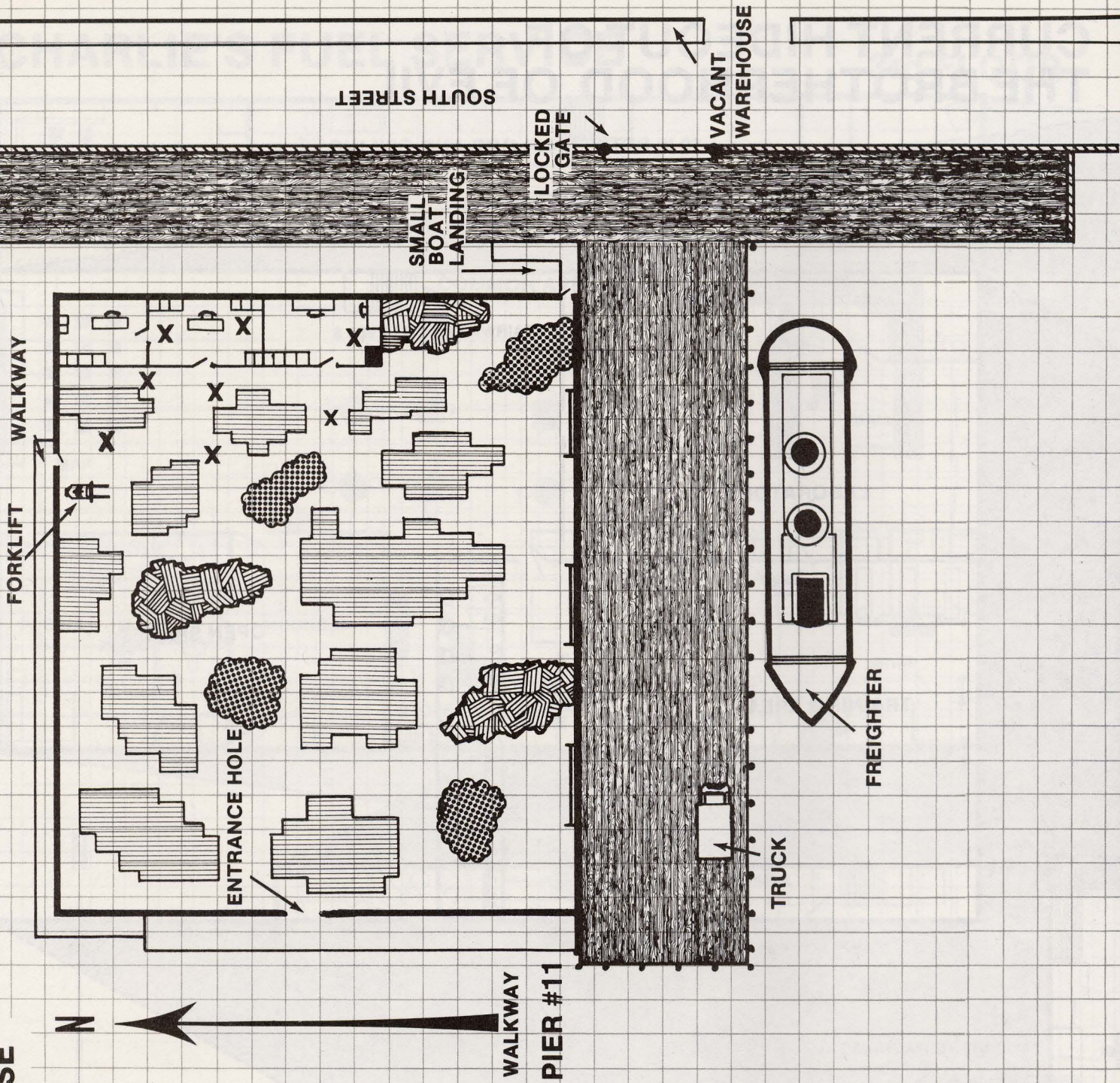

- SAFE
- BODY
- DOOR
- GARAGE DOOR
- CHAIN LINK FENCE
- PYLONS
- BARRELS
- SACKS
- CRATES

1 SQUARE = 10 FEET



---

---

# How to Use This Book

---

---

This book is divided into four sections: GM's Introduction, Characters, Encounters, and Places. In any of these sections, text in italics is to be read to the players.

## Gamemaster's Introduction

The Gamemaster's Introduction provides the Gamemaster with the background needed to run the adventure.

## Characters

This section contains information about the major characters, both Player and Non-Player, involved in the adventure. Heroes and villains which appear in the Gamemaster's Manual only give Hero Points and information; the basic abilities are the same as given in the Gamemaster's Manual. In addition, the information which can be obtained from each Non-Player character appears here.

## Encounters

The DC Heroes Role Playing system is based on encounters. That is, the players go from situation to situation instead of location to location, as in other Role Playing games. Each encounter is broken up into at least three sections: Setup, Players Information, and GM Information. When necessary there will also be Troubleshooting, Rules sections, and/or Sidebars to help the GM run the game.

## Places

Descriptions and maps pertaining to the encounters are in this section. Brief descriptions including game statistics are provided.

## A Note on the Module Difficulty Rating System

Each module which Mayfair will publish will have an estimate on the power of characters. This estimate will be in form stating **For 5-7 Characters Generated using 1000-2000 Hero Points.**

To determine whether your characters will be powerful enough to use the module, add up the number of Hero Points needed to generate the Attributes, Powers, and Skills of the character, including those Powers and Attributes in special equipment that are unable to be pur-

chased. The Batman Option and Link Costs are ignored. Add the banked Hero Points and the amount of Hero Points spent for equipment and labs.

Compare the Hero Point levels to the bracket amounts given. If the average character in your team falls within the bracket, the module will likely be a good challenge for them. Having several characters one or even two brackets below the stated bracket will be all right if there are a couple characters above the bracket.

<b>Brackets</b>	<b>Typical Groups or Characters</b>
250-500 .....	Beginning Level Characters
500-1000 .....	The New Teen Titans without Raven and Kid Flash
1000-2000 .....	The New Teen Titans with Raven and Kid Flash
2000-4000 .....	Justice League without Superman
4000-8000 .....	Justice League with Superman
8000-16000 .....	Wonder Woman
16000+ .....	Superman

---

## ABBREVIATIONS

AP .....	Attribute Point
AURA .....	Aura Attribute
AV .....	Acting Value
BODY .....	Body Attribute
DEX .....	Dexterity Attribute
EV .....	Effect Value
GM .....	Gamemaster
INFL .....	Influence Attribute
INT .....	Intelligence Attribute
MIND .....	Mind Attribute
NA .....	Not Applicable
NPC .....	Non-Player Character
OV .....	Opposing Value
RAP .....	Result Attribute Point
RV .....	Resistance Value
SPIRIT .....	Spirit Attribute
STR .....	Strength Attribute
WILL .....	Willpower Attribute

---



# A S.T.A.R. LAB™ DESTROYED!

## Deadly A-30 Gas Stolen!

In a bold and daring attack, a S.T.A.R. Lab's™ entire supply of a new secret gas is stolen. The villains responsible now have the means to destroy all the world's heroes.

### THE BROTHERHOOD OF EVIL™ HAS STRUCK!

Meanwhile, the Titans™ are called upon to save a controversial world leader from assassination — his death could unleash violence across the globe.

With no way to split up, and time running out, the New Teen Titans™ must choose. They must recover the powerful gas or

### STOP THE ASSASSIN

There's more here than meets the eye and the Titans™ are trapped in the midst of a



0885-203-MFG6.00

ISBN 0-912771-56-9

00052



29877 00600

MAYFAIR GAMES, INC.



™Indicates Trademark of DC Comics Inc. All character names, renditions, associated slogans, and indicia are trademarks of DC Comics Inc. Copyright © 1985 DC Comics Inc. All rights reserved.