



WHO'S WHO TM DC SM 1

IN THE DC UNIVERSE

ROLE-PLAYING SUPPLEMENT



WHO'S **WH** ™

IN THE DC UNIVERSE

The Role-Playing Supplement

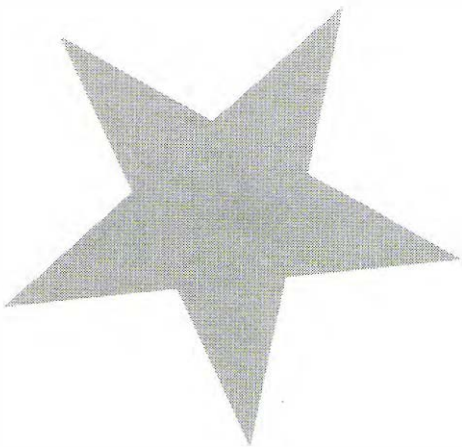

Who's Who #1

©1992 DC Comics Inc.

All Rights Reserved.

Published By Mayfair Games Inc.

Text: Andrew Webster, Ann Goetz, and Ray Winninger

Attribute Table: Bryon K. Mosley

Editors: Ray Winninger and Jennifer Santana

Graphic Design Lay-out: Chris Ferguson, Mike Russo,
Linda Achenbrenner, and Maria Cabardo

Cover Art:

Pencils: Kevin Maguire

Inks: Mike DeCarlo

Color: Bob LeRose

Interior Art: DC Staff

Graphic Design and Maps: Robert McLees

All characters, their distinctive likenesses, names, logos, props and all other related indicia are trademarks of DC Comics Inc. Copyright ©1992 DC Comics Inc. Used under license by Mayfair Games Inc. All rights reserved.



is a trademark of DC Comics Inc., used under license by Mayfair Games Inc.



is a registered trademark of Mayfair Games Inc.

No part of this book may be reproduced in any form or by any means, except for the inclusion of brief quotations in a review, without permission in writing from the publisher. Permission is granted to the purchaser of this book to copy the maps and histories contained herein for personal use, provided that none of the copies are sold or traded.

All characters in this book are fictitious. Any resemblance to actual persons, living or dead, is purely coincidental.

Manufactured in the United States of America.

ISBN: 0-923763-49-X

Mayfair Games Inc. • P.O. Box 48539 • Niles, IL 60648

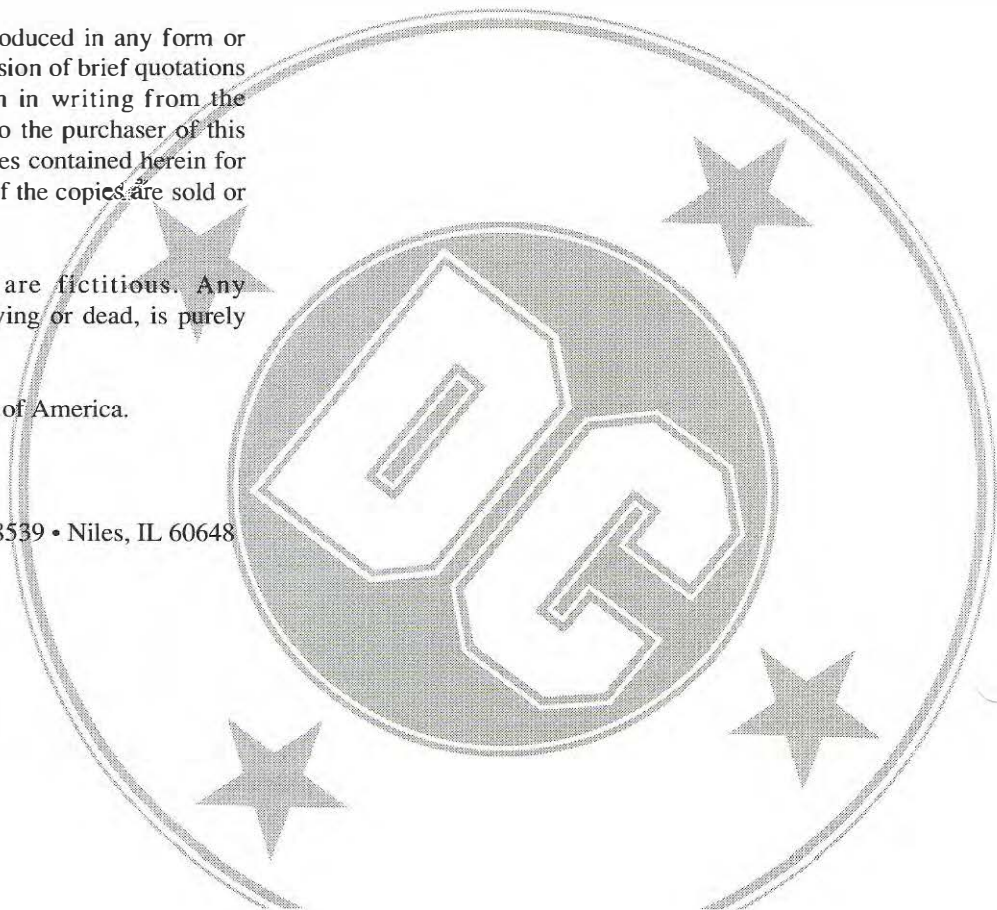
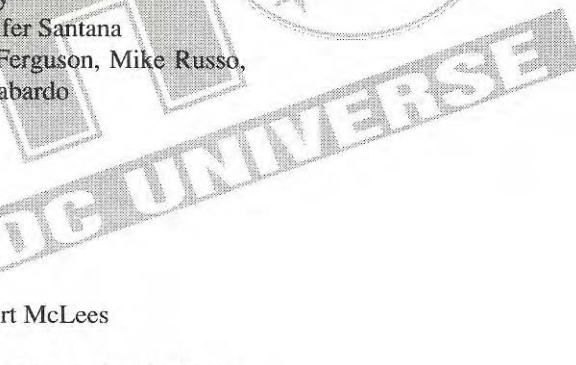

INTRODUCTION

Welcome to the *Who's Who* gaming supplement. This sourcepack allows gamers to keep up with the latest developments in the DC Universe and update all their favorite characters.

This book was designed to function as a supplement to DC's own *Who's Who* series. Each volume of the *Who's Who Gaming Supplement* covers all the characters included in four volumes of DC's *Who's Who*. This particular volume covers the characters featured in issues #1-4 of the DC series. Gamers are advised to insert these pages into their *Who's Who* binders directly after the DC entries they supplement.

In addition to our standard game statistics, each entry in this volume includes a personality descriptions, advice for using the character in your own Adventures, descriptions of the Subplots in which the character has been involved, and a complete listing of the character's appearances in the DC Comics. The cut-off date for these appearance lists is July of 1992, so any appearances after this date are not included.

You should note that comic book characters change and evolve over time. Any discrepancies between the statistics published here and those published elsewhere are intentional and reflect changes in DC's current conception of their characters.

DC Attribute Benchmark Tables:

DEXTERITY (DEX): "Dexterity represents a Character's agility and nimbleness." (*DC HEROES Second Edition, Character Handbook*)

APs	Benchmarks
1-2:	The person has normal agility and can perform activities associated with daily living.
3-4:	The individual has agility equivalent to one who practices athletic abilities beyond what is required for daily living such as: <i>police officers, firemen, clowns, stage performers, dancers</i>
5-6:	The person possesses agility equivalent to individuals who are well honed in athletic prowess as Gymnasts, Stunt men, and Circus Aerialists. <i>Robin, Animal Man, Cyborg</i>
7-8:	The individual is agile enough to be a medal-winning Olympic gymnast. <i>Aquaman, Blue Beetle, Starfire, Vandal Savage, Deadman</i>
9-10:	This person possesses the best agility humanly possible and could easily become a record-setting Gold Medal Olympic gymnast [at the level 10]. <i>Batman, Bronze Tiger, Ra's Al Ghul, Kobra</i>

11-12:	This is a superhuman level of athletic prowess, where the individual can actually dodge high velocity projectiles such as arrows and bullets aimed directly at him or her with moderate effort. <i>Elongated Man, Spectre, Mister Miracle, Amazo</i>
13-15:	This level of agility allows the dodging of laser fire and the ability to sight and catch slower moving projectiles, such as arrows and bullets. <i>Wonder Woman, Superman, Cheetah, Captain Marvel</i>
16-18:	The person is capable of athletic maneuvers that seem to defy the ability of the humanoid structure. His or her reactions are so swift laser fire appears in slow motion. <i>Monitor, Anti-Monitor</i>
19-21:	Reaction time and coordination are so attuned that the individual's thoughts and actions are simultaneous.
22-24:	The character's actions begin before the human brain can complete a thought. <i>Flash (Jay Garrick) [while substituting Superspeed for DEX]</i>
25-27:	A person with agility of this magnitude sees his surroundings, even energy, as motionless and can easily dodge multiple laser fire.
28-30:	A level of agility where the individual's reactions occur as if he was clairvoyant.

STRENGTH (STR): "Strength represents a Character's ability to lift weight and withstand duress." (*DC HEROES Second Edition, Character Handbook*)

APs	Benchmarks
1-2:	A normal human who can lift 200 pounds above his head.
3-4:	A person with exceptional human strength, equivalent to that of professional weight lifters. Lifting Range: 400 - 800 pounds <i>Anthro the Cave Boy, Jonah Hex, Amanda Waller, Wildcat</i>
5-6:	This is the level of maximum human strength. Lifting Range: 900 - 1,600 pounds. <i>Batman, Starfire, Hawkman, Creeper</i>
7-8:	This is super-human strength capable of bending a steel crowbar. Lifting Range: 3 - 6 tons. <i>Aquaman, Cyborg, Nuklon, Firehawk</i>
9-10:	A person with strength of sufficient force to demolish a concrete barrier. Lifting Range: 12 - 25 tons. <i>Hourman, Metamorpho, Red Star, Deathstroke the Terminator</i>
11-12:	The power of the individual's strength can rupture a steel wall. Lifting Range: 50 - 100 tons. <i>Big Barda, Troia, Chemo, Lead of The Metal Men</i>

13-15:	The individual can summon strength to crush titanium without real effort or throw a car a half mile (this can be done at a 15). Lifting Range: 200 - 800 tons. <i>Iron of The Metal Men, Mammoth</i>
16-18:	At this level of strength, most barriers, natural or man-made, cannot stop this individual, as he can easily demolish a fortified bunker. Lifting Range: 1,600 - 6,400 tons. <i>Spectre, Martian Manhunter, Wonder Woman, Solomon Grundy, Grodd</i>
19-21:	This individual possesses strength equivalent to that of the giants of ancient legends. Lifting Range: 12,800 - 51,200 tons. <i>Lobo, Katibak, X'Hal</i>
22-24:	At this level the individual possesses god-like strength. Lifting Range: 102,400 - 409,600 tons. <i>Darkseid, Orion, Ares, Laurel Gand</i>
25-27:	Beings with strength in this range have Titan-level prowess. Lifting Range: 819,200 - 3,276,800 tons. <i>Superman, Heracles, Atlas</i>
28-30+:	This is entity-level strength. Small celestial bodies are obliterated with the exercise of this level of strength. Lifting Range: 6,553,600 - 13,107,200 tons. <i>Monitor, Anti-Monitor, Trigon</i>

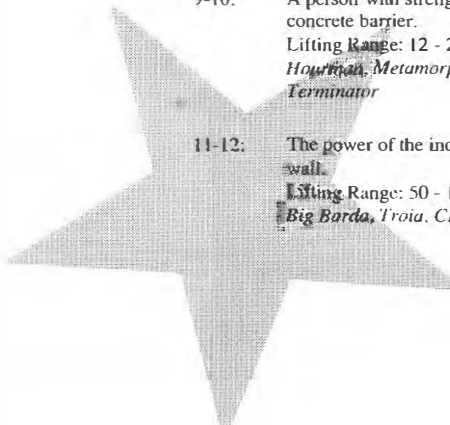

BODY: “This Attribute represents a Character’s standard resistance to physical damage.” (*DC HEROES Second Edition, Character Handbook*)

APs	Benchmarks
1-2:	A normal human who is susceptible to normal pain stimulus.
3-4:	Body conditioned to withstand moderate damage without great pain. The individual can weather many blunt attacks, as a prizefighter or a martial artist. <i>Amanda Waller, John Constantine, Huntress, Captain Boomerang</i>
5-6:	The body is conditioned to withstand the greatest amount of physical damage humanly possible. The individual possesses exceptional resistance to fatigue. <i>Batman, Bronze Tiger, The Warlord, Jonah Hex</i>
7-8:	The body can endure attacks from street-level weaponry, such as knives, chains, bats, and small caliber guns. The body has a density equal to a brick wall. <i>Swamp Thing, Aquaman, Hawkman, Deathstroke the Terminator</i>
9-10:	The body is resilient enough to resist most military weapons, such as high caliber automatic rifles. <i>Big Barda, Red Star, Gold of The Metal Men, Sandman</i>
11-12:	The body can withstand high impact explosives that could demolish a reinforced concrete bunker. Characters with a

INTELLIGENCE (INT): “Intelligence represents a Character’s ability to think rapidly and his/her knowledge of facts.” (*DC HEROES 2nd Edition, Character Handbook*)

APs	Benchmarks
1-2:	This person has the problem-solving abilities of the average high school graduate. <i>Major Force, Gnorm</i>
3-4:	This individual is the equivalent of a particularly bright high school graduate. <i>Plastic Man, Ragman, Peacemaker, Guy Gardner</i>
5-6:	The individual has the ability to process information on the level of the industrious college student. <i>Anthro the Cave Boy, The Flash (Wally West), Robin, Major Disaster</i>
7-8:	The person’s intellectual capacity rivals a professional who is one of ten authorities in a field of study or a born genius. <i>Aquaman, Nightwing, Scarecrow</i>
9-10:	The intellect equals a professional who is one of three world authorities on a subject. <i>Swamp Thing, Hawkman, Grodd, Wonder Woman, Joker</i>

Body in this range literally possess steel-hard skin.
Metamorpho, Green Lantern II, Firestorm, Demon

13-15:	The body has density ranging from titanium (at a 13) to diamond hardness (at a 15). At this level the individual is nearly invulnerable and can easily withstand anti-tank fire. <i>Wonder Woman, Martian Manhunter, Power Girl, Solomon Grundy</i>
16-18:	The body is virtually indestructible and can withstand highly charged plasma beams and direct hits from powerful demolition bombs. <i>Superman, Darkseid, Valor, Arès</i>
19-21:	At this level, the body is impervious to conventional weaponry save for nuclear munitions, and has the density of a wall of Promethium (at a 20). <i>Brimstone</i>
22-24:	At this level, the body can survive the crushing forces of space for extended durations and survive the direct detonation of a multi-kiloton nuclear device.
25-27:	Bodies in this range can withstand forces unleashed by gods.
28-30+:	The body can resist a direct hit from a 100 megaton nuclear weapon. <i>Monitor, Anti-Monitor</i>

11-12:	The person is a genius or has intellect on par with an individual who is the best authority in the world on a subject. <i>Batman, Superman, John Constantine</i>
13-15:	The individual’s intelligence is beyond what is normally experienced on Earth, with the ability to conceive concepts centuries beyond current conventions. <i>Lex Luthor, Pariah, The Brain, Jor-El</i>
16-18:	The person has an intellect giving the individual the ability to adopt concepts completely foreign to his society or environment. <i>Vril Dox II of the LEGION, Brainiac, Highfather, Darkseid</i>
19-21:	This individual has the intellectual ability to master every worldly subject. <i>Phantom Stranger</i>
22-24:	This individual possesses intellect with the ability to comprehend and utilize knowledge spanning the galaxy.
25-27:	At this level, the individual can understand and process knowledge on a universal scale. <i>Anti-Monitor</i>
28-30:	The individual can understand and conceive knowledge that is multi-versal in magnitude. <i>Monitor</i>

WILL: "This Attribute represents a Character's ability to draw conclusions and his/her willpower in general." (*DC HEROES Second Edition, Character Handbook*)

APs	Benchmarks
1-2:	The individual possesses the will to face a new morning and confront the obstacles of a normal life. <i>Solomon Grundy, Ma and Pa Kent, Abigail, Arcane Cable</i>
3-4:	The person has a focused, dedicated will and can summon the courage to save victims from hazardous situations such as burning buildings. He might naively risk his life for stories or glory. <i>Mr. Mxyzptlk, Commissioner Gordon, Lois Lane</i>
5-6:	This individual has exceptional self-discipline and can remain rational and calm during a crisis. <i>Captain Atom, Pariah, Doctor Mid-nite (original), Rocket Red</i>
7-8:	The individual possesses the resolve to conquer any human, rational threat or fear, save death. <i>Bronze Tiger, Catwoman, Mister Miracle, Hawkman, Maxwell Lord</i>
9-10:	The individual possesses enough willpower to override self-preservation and enter an obviously unsurvivable battle. <i>Lady Quark, Sergeant Rock, The Warlord, Enemy Ace</i>

11-12: The will is of an unyielding determination and fanatical strength and the individual is fully capable of confronting sanity-threatening situations and mystical phenomenon with no loss of resolve.
Batman, Joker, Power Girl, Wonder Woman

13-15: The person possesses superhuman resolve to overcome paranormal situations beyond the scope of human comprehension.
Swamp Thing, Sandman, Amethyst

16-18: The individual has sufficient willpower to wield great power with unfaltering confidence or arrogance.
Brainiac, Raven, Spectre, Guy Gardner, Highfather

19-21: Individuals at this level of willpower can dominate situations that could have planetary repercussions.
Superman, Orion

22-24: The individual's will is formidable enough to challenge intergalactic menaces without fear.
Metron, Green Lantern (Alan Scott), Green Lantern (John Stewart)

25-27: The individual possesses god-like mental resolve and is accustomed to overcoming universal obstacles and threats.
Phantom Stranger, Green Lantern (Hal Jordan), Darkseid, Ares

28-30: The individual is resolute even in the face of universal destruction.
Monitor, Anti-Monitor, Guardians of the Universe

MIND: "This Attribute is a measure of a Character's resistance to mental stress." (*DC HEROES Second Edition, Character Handbook*)

APs	Benchmarks
1-2:	A person can endure the normal stress of daily existence.
3-4:	The person's mind is conditioned to withstand stressful conditions similar to those faced by police officers, firemen, and doctors. <i>Hourman, Rocket Red, Cyborg, Speedy</i>
5-6:	The person's mind is equipped to deal with great stress as a part of daily life. Undercover agents, leaders of nations, and most heroes fit this category. <i>Deadman, Green Arrow, Fire, Vixen</i>
7-8:	The individual has the mental fortitude to continue normal activities even in persistently painful or stressful situations, such as those experienced by hardened soldiers. <i>Martian Manhunter, Sergeant Rock, Ra's Al Ghul</i>
9-10:	The individual will maintain self-discipline and sanity even under strenuous torture or pain. <i>Wonder Woman, Eclipso, Solomon Grundy, Circe</i>
11-12:	This person's mental endurance is at the peak of human fortitude. <i>Batman, Swamp Thing, Raven, Brother Blood</i>

13-15: A person with this level of Mind is accustomed to dealing with alien or inexplicable phenomena, or problems outside any human experience. Individuals can handle the stress equated to "the weight of the world" in stride.
Demon, Spectre, Superman, Brainiac

16-18: This person can mentally endure the consistent strain of a hostile and taxing condition such as war for centuries.
Highfather

19-21: At this level, the person has a god-like mental stamina.
Darkseid, Guardians of the Universe, Chemo

22-24: The mind remains whole even in situations where the laws of reality shift.

25-27: The mind can withstand an assault that strikes to the core of the individual's existence.
Phantom Stranger

28-30+: An individual with mental stamina at the level of a primordial entity.
Monitor, Anti-Monitor

INFLUENCE: "Influence represents the power of a Character's personality and presence." (*DC HEROES Second Edition, Character Handbook*)

APs	Benchmarks
1-2:	The individual receives the normal attention accorded any living creature.
3-4:	This person has the persuasive ability to hold and draw the attention of a small audience. <i>most minor entertainers</i>
5-6:	The individual at this level of Influence can hold and draw the attention of a large audience. <i>Flash (Jay Garrick), Black Canary, Booster Gold, Wildcat</i>
7-8:	The personality is so unique as to be highly regarded by several people across a nation or a state. <i>Viking Prince, Queen Hippolyte, Green Arrow, Blackfire</i>
9-10:	This individual's personality is strong enough to attract the attention of the leaders and citizens of many separate nations. <i>Amanda Waller, Batman, Circe, John Constantine, Wonder Woman</i>
11-12:	The person's presence is powerful enough to have gained the attention of even legendary personages. In some cases

their notoriety is so comprehensive as to be a household word across the world.
Swamp Thing, Doctor Fate II

13-15:	This individual can easily garner the attention of an individual from another species. <i>Spectre, Demon</i>
16-18:	This person can attract the attention of powerful personages such as Demons and the Lords of Order and Chaos without effort. <i>Phantom Stranger, Helmet of Nabu</i>
19-21:	This individual receives reactions from people as if the person were a god or goddess without needing any display of power or a reputation. <i>Monitor using the Charisma skill.</i>
22-24:	This person has an overwhelming presence, and can establish a reputation across the galaxy.
25-27:	This person can force a reaction from universal audiences and personages such as Death, Destiny, Sandman, etc.
28-30:	Multi-versal notice can be accomplished.

AURA: "This Attribute represents a Character's ability to intercede with his/her personality to affect the actions of others and also indicates his or her level of magical power." (*DC HEROES 2nd Edition, Character Handbook*)

APs	Benchmarks
1-2:	At this level an individual can leave a basic impression on someone.
3-4:	This individual possesses an Aura equivalent to a that of a very amiable person, such as an actor or a priest. <i>Jonah Hex, Speedy, Hourman (Rex Tyler), The Atom (Ray Palmer)</i>
5-6:	This person has a presence strong enough to change the emotional status of an auditorium-sized crowd of people from dead calm to an electrified frenzy. <i>Queen Hippolyte, Aquaman, Big Barda, Mister Miracle</i>
7-8:	This individual has a mystique capable of affecting the opinions of people across the nation. The person can gain loyalty and respect upon appearance. <i>Batman, Enemy Ace, The Warlord, Green Lantern (Hal Jordan)</i>
9-10:	The individual can alter the opinions of various citizens across the world and is capable of generating a cult following within a region the size of a country. <i>Wonder Woman</i>

11-12:	This individual is capable of generating myths and legends that last for several centuries. <i>Confucius, John Constantine, Eclipse</i>
13-15:	This personality can gain the respect of even legendary figures, such as King Arthur, and sway the opinions of beings of great mystical power. <i>Arion, Circe, Zatanna, Brother Blood</i>
16-18:	The individual can reason with and possibly alter strong personalities, such as those of angels and demons. <i>Demon, Doctor Fate II, Sandman, Darkseid</i>
19-21:	When it comes to strength of personality, this individual can walk amongst the gods as a near-equal. <i>Spectre, X'Hal, Superman</i>
22-24:	This individual's Aura is powerful enough to make his or her word law across the galaxy. <i>Doctor Fate (as Nabu)</i>
25-27:	This personality is powerful enough to etch a legendary standing across the universe. The most powerful beings in the universe will heed this individual. <i>Phantom Stranger, Monitor, Anti-Monitor</i>
28-30:	The individual's presence stretches beyond the confines of this universe.

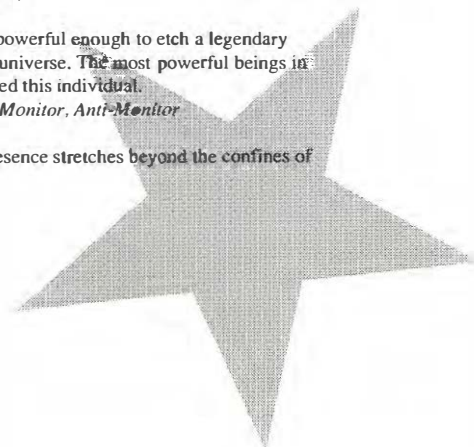

SPiRiT: "This Attribute represents a Character's ability to withstand mystical stress and is also a reflection of the Character's general spiritual resolve." (*DC HEROES Second Edition, Character Handbook*)

APs	Benchmarks
1-2:	The individual can withstand average life experiences with two or three major crises.
3-4:	The person's Spirit is equivalent to that of an individual who can weather an assault on his or her core beliefs. <i>Ice, Changeling, Desaad, Checkmate Knight</i>
5-6:	This person is so secure in his or her beliefs that he or she is willing to die for them. <i>Most Heroes: Huntress, Fire, Cyborg, Booster Gold</i>
7-8:	The individual is capable of enduring several major crises without loss of resolve. <i>John Constantine, Deadman</i>
9-10:	The individual possesses a fortitude that cannot be altered even by the blackest life experiences. He can withstand the mystical assault of an experienced sorcerer. <i>Batman, Wonder Woman, Doctor Occult, Mister Miracle</i>
11-12:	This person has can easily cope with extraordinary phenomena and knows no true fear. This is usually a

qualification for entry into the Green Lantern Corps.
Zatanna, Brother Blood, Hal Jordan, Arion, Sinestro

13-15:	This individual can endure several attacks from a master level sorcerer and traumatic supernatural catastrophes routinely. <i>Amethyst, X'Hal</i>
16-18:	This person's spiritual resilience is equivalent to that of a god-like mystical being. <i>Darkseid, Ares</i>
19-21:	At this level the Spirit remains strong even in the ravages of a hostile environment such as Hell or Qward. <i>Phantom Stranger, Sandman</i>
22-24:	The Spirit can withstand an extended battle with a major demon. <i>Doctor Fate (Nahu)</i>
25-27:	The individual can resist the attack of an entity-level mystical force. <i>Trigon</i>
28-30+:	The person is spiritually pure, or invulnerable, a condition attainable perhaps only in the state of nirvana.



BLACK RACER

DEX:	15	STR:	8	BODY:	16
INT:	9	WILL:	16	MIND:	12
INFL:	11	AURA:	10	SPIRIT:	10
INITIATIVE:	37	HERO POINTS:	175		

- Powers:** Dimension Travel (Travel): 20, Dispersal: 20, Life Sense: 30, Spirit Drain: 35
- Bonus:** Miscellaneous: If Black Racer so wills, anyone touching him is automatically attacked by his Spirit Drain Power.
- Skills:** Military Science (Tracking): 18
- Advantages:** Insta-Change; Lightning Reflexes
- Alter Ego:** Willie Walker
- Motivation:** Responsibility of Power
- Wealth:** N/A
- Occupation:** Messenger of Death
- Equipment:**
SKIS [Flight: 35, BODY: 20]

Powers and Abilities

The Black Racer brings death to any creature he touches. So far, he has yet to discover a being capable of resisting his power. To reach his quarry, the Racer can pass through solid substances and travel to any dimension in the multiverse. While on the move, his skis allow him to exceed lightspeed.

Willie Walker

The Black Racer's alter-ego is crippled Army Sergeant Willie Walker.

WILLIE WALKER

DEX:	0	STR:	0	BODY:	2
INT:	0	WILL:	0	MIND:	6
INFL:	9	AURA:	7	SPIRIT:	9
INITIATIVE:	9	HERO POINTS:	15		

- Skills:** Military Science: 4, Weaponry: 4
- Drawbacks:** Catastrophic Physical Restriction: Walker is in a deep coma. Should he ever emerge from this condition, his DEX/STR becomes 4/4, and his INT/WILL becomes 6/8.

Personality/Role-playing

Sgt. Willie Walker, paralyzed and mute from injuries sustained in Vietnam, is a proud man who

preferred to die rather than live a hopeless life. As Black Racer, he can function as a normal person, but once his mission is complete, Walker returns to his former state, bed-ridden and helpless, until called upon once again. Although his Racer persona allows him to leave his sickbed, Walker is tortured by his dual identity—taking human life is against all his principles.

Once he assumes his Black Racer form, Walker becomes aloof and cold, even callous. Nothing can stop him from accomplishing his goal. He answers only to the Source, and his reasoning is often beyond human comprehension as he is serving the cosmos as a whole. Due to a combination of the Source's influence and Walker's personality, however, the Racer tends to side with the forces of good. Drawn to places where evil and destructive forces are present, he has aided heroes such as the New Gods of New Genesis and Superman.

Using Black Racer in Adventures

An encounter with the Black Racer is an excellent vehicle for propelling the player heroes into a moral dilemma. Suppose the Racer is fated to kill one of their heroes' adversaries. Although it is likely that they would like to be free of their enemy forever, the heroes' moral code will probably force them into protecting their foe from the Black Racer, leading to some interesting role play.

Subplots

Willie Walker has a Death Guilt Subplot, since he knows that he, by giving the Black Racer a human form, is directly responsible for the deaths of many.

Appearances in DC Comics

Action Comics #656; *Adventures of Superman* #470; *Captain Atom* (3) #17, 38, 41-42, 50; *New Gods* (3) #18-19, 24-25; *Superman* (2) #35, 47; *War of the Gods* #4; *Who's Who '90* #3

Black Racer's Skis

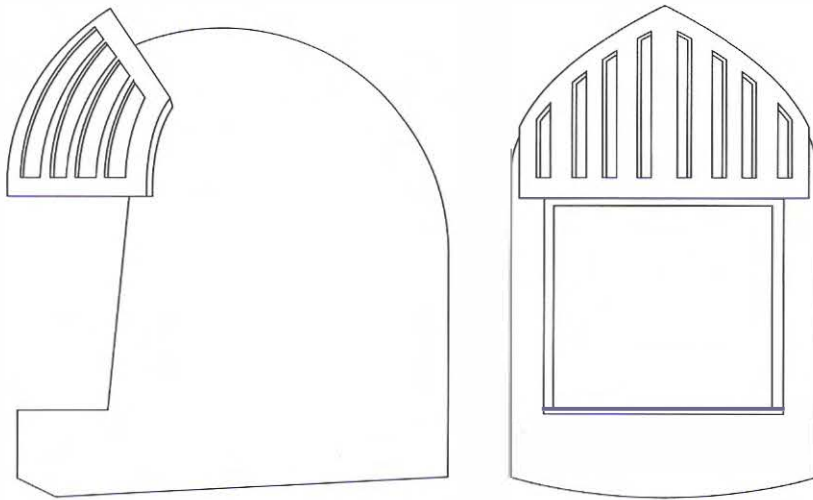
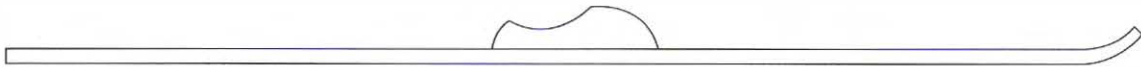
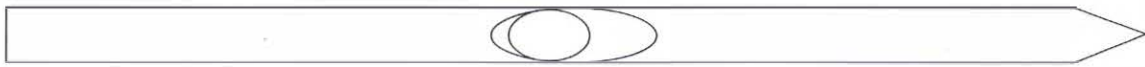

Black Racer's Helmet

BLUE BEETLE

DEX:	8	STR:	4	BODY:	5
INT:	7	WILL:	5	MIND:	5
INFL:	6	AURA:	5	SPIRIT:	5
INITIATIVE:	23	HERO POINTS:	65		

•**Skills:** *Linked

Acrobatics: 8*, Charisma: 6*, Detective: 7*,
Gadgetry: 9, Martial Artist: 6, Scientist: 7*, Thief:
8*, Vehicles: 8*, Weaponry: 8*

•**Advantages:** Connections: Justice League (High),
S.T.A.R. Labs (High); Genius; Intensive Training

•**Drawbacks:** Minor Irrational Attraction to attractive
women; Secret Identity

•**Alter Ego:** Ted Kord

•**Motivation:** Upholding the Good

•**Wealth:** 3

•**Equipment:**

BB Gun [EV: 6, Flash: 6, Super Breath: 6, BODY: 5,
R#: 2]

REMOTE CONTROL [BODY: 3]

Concealed in Blue Beetle's glove, the remote
control allows him to operate the "Bug" from up to
8 miles away (14 APs).

Powers and Abilities

Blue Beetle is a quick-witted, industrious, and formidable opponent . . . when he puts his mind to it. Whereas his mentor Daniel Garrett had the ancient Egyptian Blue Beetle Scarab to protect him from harm, Kord must rely on his mind and resources. For this reason, he has put himself through a rigorous training program that has left him an expert in acrobatics and hand-to-hand fighting. Supplementing these learned abilities are Kord's natural talents in the technological and business arenas.

Personality/Role-playing

Ted's perceptive faculties are sharp enough to enable him to see the funny side of almost any situation. He long ago mastered the art of the wisecrack, which he practices frequently to the occasional dismay of his teammates. At their best, Beetle's humorous asides are infectious, prompting even serious heroes like Batman to respond in kind. But at their worst, the jokes tend to infuriate friend and foe alike, a *faux pas* that Beetle has learned to

sometimes turn to his advantage.

For a time, Beetle was extremely frustrated about a weight problem he had, and he was extremely sensitive about the remarks it drew from his teammates. He has since lost the weight and has now become a health nut, prompting him to remonstrate those who eat unhealthy foods, like his friend Booster.

Using Blue Beetle in Adventures

If the player heroes try to contact the Justice League America, Blue Beetle is one of the first Leaguers they are likely to meet. Beetle's sense of humor should spice up your role playing and add a touch of comic relief to your Adventure.

Subplots

The money making schemes Beetle hatches with his friend, Booster Gold, often draw him into Job Subplots; his weight problems were part of a lengthy Miscellaneous Subplot; he has been involved in numerous short-lived Romances; and like most members of the Justice League, the Beetle is often involved in Friend Subplots centered around his relationships with his teammates.

Kord Omniversal

Up until the Millennium saga, Ted Kord owned and operated a large technological research and development firm based in Chicago. Kord Omniversal specialized in electronics, robotics, and advanced computer circuitry.

At its height, Kord Omniversal had a Wealth rating of 15 (during this same era, the Beetle had a personal Wealth rating of 10). Kord's labs were rated at 13 APs.

Appearances in the DC HEROES Role-Playing Game, Second Edition

Justice League Sourcebook, Background/Roster Book (includes card), Exposed

Appearances in DC Comics

* **Note:** Pre-Crisis appearances are not part of present continuity.

Pre-Crisis: *Americomics* #3, 5; *Blue Beetle* (5) #1-5; *Captain Atom* (2) #83-86; *Charlton Bullseye* #1; *Charlton Portfolio* #1; *Crisis on Infinite Earths* #1-3, 6-7, 9-12; *Ghost Manor* #21; *Who's Who* '85 #3

Current: *Adventures of Superman* #463; *Angel and the Ape* (2) #2; *Aquaman* (4) #1; *Armageddon 2001* #2; *Blue Beetle* (6) #1-24; *Booster Gold* #22, 25; *Captain Atom* (3) #2, 16-17, 20, 24-28, 50; *Doctor Fate* (2) #14-15; *Doom Patrol* (2) #28-29; *Firestorm Annual* #5; *Firestorm, the Nuclear Man* #67; *Flash*

(2) #8; *The Fury of Firestorm* #63-64; *Green Lantern* (3) #1, 4, 9, 13; *Invasion* #2-3; *Justice League* #1-6; *Justice League America* #26-27, 29, 31-37, 39-40, 42-45, 47-on; *Justice League America Annual* #5; *Justice League Annual* #1-4; *Justice League Europe* #7-8, 13-27, 34; *Justice League Europe Annual* #1-2; *Justice League International* #7-25; *Justice League Quarterly* #1, 3, 5; *Justice League Special* #1-2; *Justice League Spectacular* #1; *Legends* #2, 4-6; *Martian Manhunter* #1-2, 4; *Millennium* #1-8; *Mister Miracle* (2) #7-8, 10, 13-17, 19, 25-27; *The New Teen Titans* (2) #19 (behind the scenes); *Secret Origins* (3) #2,35; *Starman* #6; *Suicide Squad* #13; *Time Masters* #1; *War of the Gods* #2, 4; *The Weird* #1-4; *Who's Who* '87 (2) #1; *Who's Who* '90 #4; *Wonder Woman* (2) #25, 49-50, 61

Blue Beetle's BB Gun

side

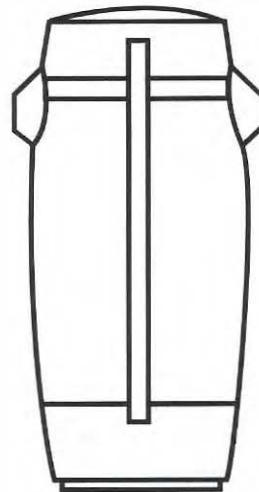
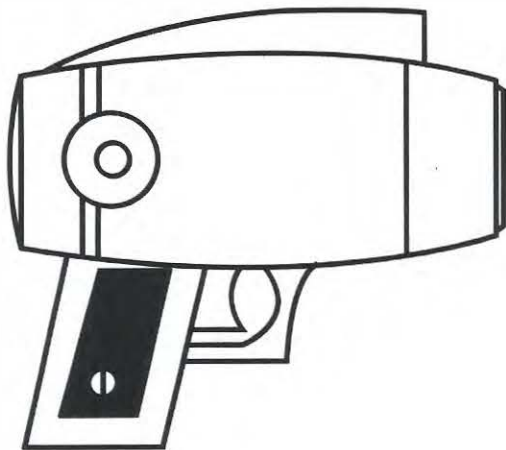

top



front

BOOSTER GOLD

DEX:	6	STR:	4	BODY:	5
INT:	5	WILL:	5	MIND:	5
INFL:	6	AURA:	5	SPIRIT:	5
INITIATIVE:	19	HERO POINTS: 70			

•**Skills:** Charisma: 7, Martial Artist: 5, Scientist: 4, Vehicles: 4

•**Advantages:** Attractive; Connections: Conglomerate (High), Justice League International (High), U.S. Government (Low), Network Television (Low); Popularity

•**Drawbacks:** Minor Irrational Attractions to attractive women and money; Secret Identity

•**Alter Ego:** Michael Jon Carter

•**Motivation:** Thrill of Adventure

•**Wealth:** 3

•**Equipment:**

BOOSTER GOLD BATTLESUIT [STR: 7, BODY: 7, Energy Absorption: 2, Energy Blast: 6, Force Field: 15, Force Shield: 2, Power Reserve: 6, Telescopic Vision: 5, Thermal Vision: 7, R#: 2]

Booster wears a battlesuit that endows him with incredible strength and endurance. Additionally, it allows him to project bolts of force, bubble-like force fields, and limited force shields. The suit's Power Reserve can augment all of its abilities save Telescopic and Thermal Vision. Booster can project his Force Fields at a distance, but any time he does so, the Force Field loses 1 AP for each AP of distance between Booster and the field.

LEGION FLIGHT RING [BODY: 5, Flight: 8, Telepathy: 8]

The Legion Flight Ring allows Booster to fly at speeds approaching the speed of sound. The ring's Telepathy Power enables the wearer to control its functions from a distance, and the ring can emit a distress call ranging across half a galaxy. Since Booster was never trained in the use of the ring, it's doubtful that he is aware of these last two abilities.

SKEETS

DEX:	7	STR:	1	BODY:	9
INT:	6	WILL:	5	MIND:	5
INFL:	4	AURA:	3	SPIRIT:	6
INITIATIVE:	*				

* Note: Skeets acts at Booster's Initiative

•**Powers:** Energy Blast: 6, Gadgetry: 7, Recall: 20, Science: 7

•**Advantages:** Scholar (20th Century history and customs)

During his early adventures, Booster was assisted by a futuristic security robot named Skeets. Booster stole Skeets from the Science Museum just before he left for the 20th Century. Skeets not only provided Booster with valuable information, he also aided him in battle. Skeets was artificially intelligent and a good companion. Booster would have never launched his career without the robot's aid. At present, Skeets is inoperable and in storage in case Booster should need him again.

Booster's New Advantage

Booster was given the Attractive Advantage to correct an oversight in earlier publications.

Powers and Abilities

In the 23rd century, Booster was a professional athlete; his strength, endurance, and reflexes are all well beyond the norm.

With his battlesuit, Booster can lift upwards of three tons and create force fields capable of stopping artillery shells of the largest caliber.

Personality/Role-playing

Michael Jon Carter originally created his Booster Gold persona specifically for the media. His first adventures were aimed at increasing his public recognition and making himself a star. For this reason, a number of heroes still dislike and mistrust Booster.

But now, Booster is no longer interested only in commercialism. He has discovered that he is actually a brave and a good-hearted person willing to risk himself for others. His transformation is not complete—he can still be selfish, and he still thinks about making a fast buck off the hero racket—but he now feels pangs of conscience whenever he even considers selling out.

After he joined the Justice League, Booster made a number of friends who continue to help shape his character. His closest friend is Ted Kord, the Blue Beetle, who helps him provide comic relief for their teammates in the JLI.

Using Booster Gold in Adventures

Although he is constantly changing, Booster is still fascinated by materialism. You might have him

approach one or more of the player heroes looking for help with his latest get-rich-quick scheme. Such a scheme might hinge upon one of the heroes' special powers for success.

Subplots

Booster is most often involved in Money Subplots. He is also constantly searching for Romance and flirting with beautiful women. He has a Public Reputation and works hard to preserve it.

Booster Gold International

Until the Millennium saga, Booster owned a huge firm that specialized in marketing and licensing Booster's image. This firm had a Wealth rating of 14 (during this era, Booster's own Wealth rating was 11).

Appearances in the DC HEROES Role-Playing Game, Second Edition

Justice League Sourcebook, Background/Roster Book (includes card), Exposed, World in the Balance

Appearances in DC Comics

Action Comics #594, 663, 670; *Adventures of Superman* #463, 476, 478; *Animal Man* #20, 22; *Armageddon 2001* #2; *Blasters Special* #1; *Blue Beetle* (6) #20, 22; *Booster Gold* #1-25; *Captain Atom* (3) #16-17, 20, 24-28; *Doom Patrol* (2) #28-29; *Flash* #21; *Invasion!* #2-3; *Justice League* #2 (behind the scenes), 3-6; *Justice League America* #27, 29, 31-38, 40, 51, 53, 56, 57 (behind the scenes), 58, 61; *Justice League America Annual* #5; *Justice League Annual* #1-3; *Justice League Europe* #7-8, 17, 33-34; *Justice League International* #7-9, 11-25; *Justice League Quarterly* #1, 3; *Justice League Special* #1; *Justice League Spectacular* #1; *Martian Manhunter* #1-2, 4; *Millennium* #1, 3-4, 6-8; *Mister Miracle* (2) #7-10, 13-14, 17, 19; *The New Teen Titans* (2) #29-30; *The New Titans Annual* #5 (behind the scenes); *The Outsiders* #18; *Secret Origins* (3) #35, 41; *Suicide Squad* #13; *Time Masters* #1, 2 (behind the scenes), 4; *War of the Gods* #4; *Who's Who '87* (2) #1; *Who's Who '90* #2

Booster's Battle Suit



Legion Flight Ring

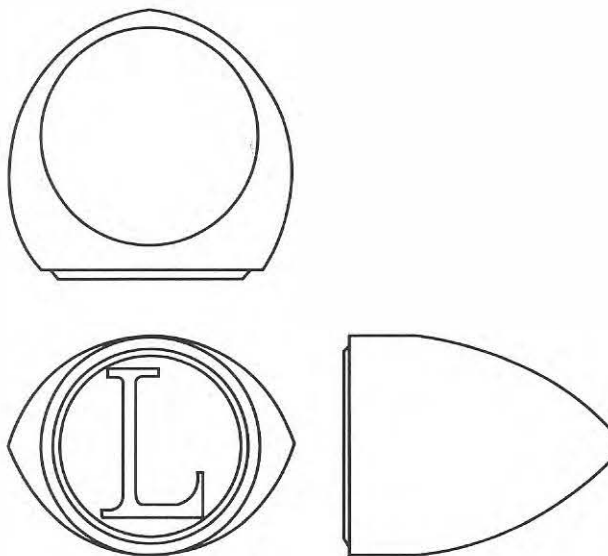

BRAINIAC 5

DEX:	4	STR:	3	BODY:	4
INT:	18	WILL:	15	MIND:	12
INFL:	5	AURA:	4	SPIRIT:	6
INITIATIVE:	27	HERO POINTS:	100		

- Powers:** Recall: 15
- Skills:** Detective: 11, Gadgetry: 20, Medicine: 14, Military Science: 16, Scientist: 20, Vehicles: 4
- Advantages:** Connection: Legion of Super-Heroes (High); Genius; Scholar (temporal physics, robotics, computers); Sharp Eye
- Drawbacks:** Minor Psychological Instability; Mistrust; Public Identity
- Alter Ego:** Querl Dox
- Motivation:** Responsibility of Power
- Wealth:** 14
- Equipment:**
 FORCE FIELD BELT [BODY: 5, Force Field: 20, Force Shield: 16, Sealed Systems: 16, R#: 2] Brainiac 5 no longer uses the Force Field belt.
 TIME BUBBLE [STR: 6, BODY: 10, Time Travel: 45, R#: 2] The Time Bubble allows Brainiac 5 and his fellow Legionnaires to travel in time.
 LEGION FLIGHT RING [BODY: 5, Flight: 8, Telepathy: 8] The Legion Flight Ring allows Brainiac 5 to fly at speeds approaching (but not exceeding) the speed of sound. The ring's Telepathy Power enables the wearer to control its functions from a distance, and the ring can emit a distress call ranging across half a galaxy.

Brainiac 5's Psychological Instability

Brainiac 5's Psychological Instability functions somewhat differently than the standard Drawback found on page 21 of the *Character Handbook*. Whenever he spends more than a day in the laboratory working on a single problem, Brainiac begins to become obsessed. After one day of lab work (15 APs of time), he undergoes a Mental Attack with an AV/EV of 15/15. If this attack earns 1 or more RAPs, Brainiac has become obsessed with the problem at hand and gains a Serious Irrational Attraction to solving the problem. Thereafter, whenever the APs of time he has spent working on the problem increase—i.e., after two days (16 APs), four days (17 APs), etc.—he undergoes another Mental Attack with an AV/EV equal to the total time

he has spent working in the lab. If these attacks ever inflict a total amount of damage exceeding Brainiac 5's MIND score, he becomes temporarily insane (and instantly becomes a Non-Player Character). Brainiac 5 may not spend Hero Points to reduce this Mental damage with Last Ditch Defense, although he may augment his OV and RV with Hero Points against such attacks as usual.

Powers and Abilities

Brainiac 5's intellect is almost without equal, even on his home planet of Colu. He has a completely photographic memory, and he is capable of processing extraordinary amounts of information at extraordinary speeds.

Brainiac 5 is an accomplished scientist, physician, inventor, strategist, and detective.

Personality/Role-playing

He might be incredibly intelligent, but Brainiac 5 has a great deal of difficulty when it comes to expressing his emotions. When he first joined the Legion, he tried to concentrate on his feelings to fit in with his teammates, none of whom was Coluan. He even fell in love with Laurel Gand and spent a number of peaceful years with her. But inevitably, he became so overwhelmed with leading the team and protecting the universe that he was forced to forgo the luxury of emotion so that he could use his intelligence to its capacity.

As a Brainiac, Dox has an affinity for pure logic. As time goes on, he seems less and less interested in establishing normal relationships with his teammates in the reformed Legion.

Using Brainiac 5 in Adventures

Player heroes in the 30th Century are likely to encounter Brainiac 5 when they need a specialized piece of equipment or the solution to a very complex scientific puzzle. Although at first they may have a hard time capturing his attention, Brainiac will certainly provide any assistance he can once the heroes have convinced him that they are on a valid mission.

Subplots

Brainiac was involved in a Romantic Subplot with Laurel Gand. He is often involved in a sort of

Job Subplot with regard to his work as a scientist due to the fact that he has a tendency to suffer nervous breakdowns while working on complex problems.

Appearances in DC Comics

* **Note:** Pre-Crisis appearances are not part of present continuity.

Pre-Crisis: *Action Comics* #276, 285, 287, 289, 381, 385-387, 390-392, 591; *Adventure Comics* #247 (behind the scenes), 282, 290, 303-311, 313-317, 319-323, 325-327, 329-330, 332-351, 353-357, 359-368, 371-379; *All New Collectors' Edition* #C-55; *All-Star Squadron* #53; *Booster Gold* #8-9; *Crisis on Infinite Earths* #2-3, 5, 7-8, 10; *DC Comics Presents* #2, 43; *DC Special* #28; *Infinity, Inc.* #22; *Justice League of America* #147-148; *Karate Kid* #1; *Legion of Super-Heroes* (2) #259-262, 267, 273-275, 277, 280, 282-285, 288-

294, 296-297, 300-306, 308-313 (3) 2-5, 11-12, 14-26, 28, 30, 32-51, 55, 62-63 (4) 3-4; *Legion of Super-Heroes Annual* (2) #1-3 (3) 1; *The New Adventures of Superboy* #50; *Secret Origins* (3) #8, 25, 42; *Secrets of the Legion of Super-Heroes* #1-3; *Superboy* (1) #125, 188, 193, 197-211, 213-220, 222, 224, 226-227, 230; *Superboy and the Legion of Super-Heroes* #231-233, 235-237, 239, 241-245, 247-251, 254, 256-257; *Superman* (1) #156, 167, 213(2) 8; *Superman Family* #207; *Superman's Pal, Jimmy Olsen* #106; *Tales of the Legion* #314-316, 318-319, 321-323; *Who's Who '85* #3; *World's Finest Comics* #142, 168, 284

Current: *Adventures of Superman* #478 (flashback); *Legion of Super-Heroes* (4) #3, 9-13, 15-17, 20-24, 26, 29; *Legion of Super-Heroes Annual* (4) #1-2; *Secret Origins* (3) #47; *Who's Who '90* #3; *Who's Who in the Legion of Super-Heroes* #1

Brainiac 5's Force Field Belt

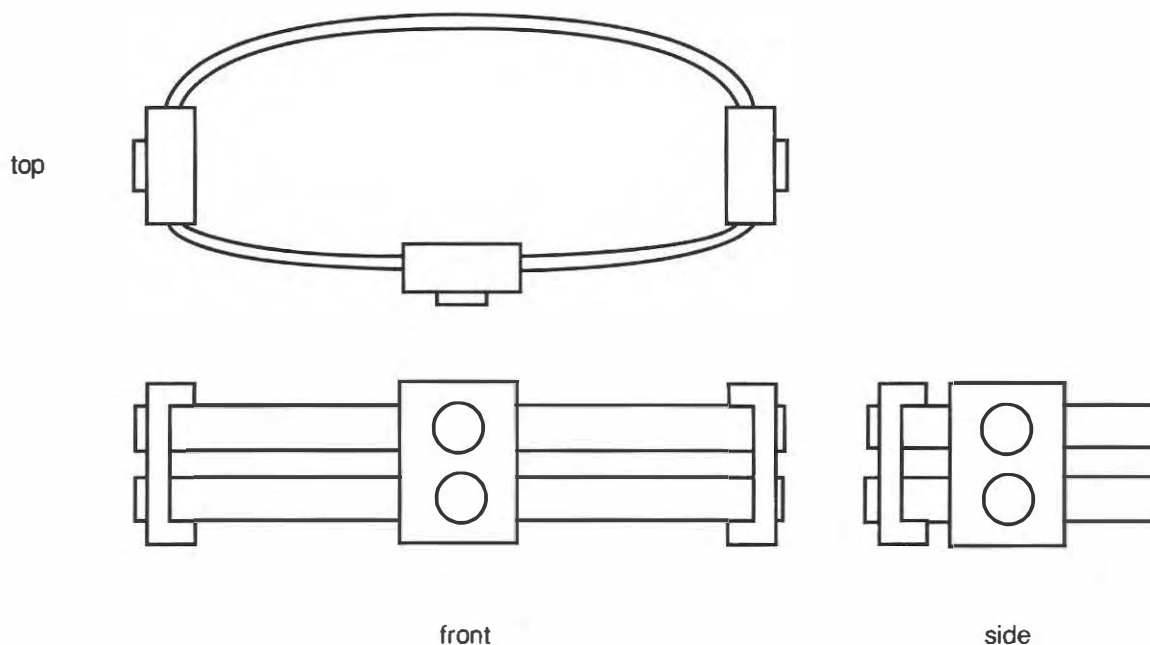

CHALLENGERS OF THE UNKNOWN

ACE

DEX:	6	STR:	4	BODY:	5
INT:	8	WILL:	7	MIND:	7
INFL:	7	AURA:	6	SPIRIT:	6
INITIATIVE:	21	HERO POINTS:	60		

- Skills:** Gadgetry: 8, Occultist: 6, Vehicles (Flying): 8
- Advantages:** Genius; Scholar (occult sciences)
- Drawbacks:** Age (old), Mistrust, Public Identity
- Alter Ego:** Ace Morgan
- Motivation:** Thrill of Adventure
- Wealth:** 9

ROCKY

DEX:	8	STR:	5	BODY:	5
INT:	4	WILL:	6	MIND:	4
INFL:	6	AURA:	5	SPIRIT:	5
INITIATIVE:	20	HERO POINTS:	60		

- Skills:** Martial Artist: 7
- Drawbacks:** Age (old); Mistrust; Public Identity
- Alter Ego:** Rocky Davis
- Motivation:** Thrill of Adventure
- Wealth:** 2

RED

DEX:	9	STR:	5	BODY:	4
INT:	4	WILL:	3	MIND:	4
INFL:	8	AURA:	6	SPIRIT:	6
INITIATIVE:	21	HERO POINTS:	65		

- Skills:** Acrobatics: 5, Military Science: 4, Weaponry: 7
- Drawbacks:** Age (old); Mistrust; Public Identity; Serious Rage
- Alter Ego:** Matthew Ryan
- Motivation:** Thrill of Adventure
- Wealth:** 6

PROF - *deceased*

DEX:	3	STR:	3	BODY:	3
INT:	10	WILL:	7	MIND:	8
INFL:	4	AURA:	3	SPIRIT:	4
INITIATIVE:	17	HERO POINTS:	55		

- Skills:** Gadgetry: 10, Scientist: 12
- Advantages:** Connoisseur; Genius; Scholar (ecology)

- Drawbacks:** Age (old); Exile; Married
- Alter Ego:** Walter Reed Haley
- Motivation:** Thrill of Adventure
- Wealth:** 12

Challenger Mountain

The Challengers built a spectacular base into the side of a mountain. While the team was inactive, the base was a museum.

CHALLENGER MOUNTAIN [BODY: 18 (exterior), Lab Rating: 15, Security System: 10]

Powers and Abilities

Each of the Challengers has skills that are unique, making each member a special part of the team.

Ace is a pilot, gadgeteer, and occultist. He is also a business wizard who knows how to finance monumental projects, such as Challenger Mountain.

Rocky is the team's combat specialist. He is expert in boxing, wrestling, and several of the Oriental martial arts.

Red is expert in both espionage and battle tactics. He usually forms the Challengers' battle plans.

Prof is Challengers' scientist. By selling his inventions, he has provided the team with much-needed funding.

Personality/Role-playing

Kyle Morgan, known as Ace, was once the team leader. He is wise and cool-headed. Ever since Ace began studying the occult, he has been more reflective and just a bit more distant.

Rocky Davis is the current team leader. He was once addicted to both alcohol and material goods, but beat both afflictions to become level-headed and considerate.

Ex-sportsman Matthew "Red" Ryan is the temperamental and adventurous member who often charges thoughtlessly into fights. Red simultaneously respects and reviles Rocky.

Prof was originally a playboy, who took little seriously except his wanton pursuit of pleasure, though he later shifted his pursuits to trying to solve the world's ecology problems.

Appearances in DC Comics

* **Note:** Pre-Crisis appearances are not part of present continuity.

Pre-Crisis: *Adventure Comics* #493-497; *Challengers of the Unknown* (1) #1-75, 81-87; *Crisis on Infinite Earths* #5, 8, 11-12; *DC Comics Presents*

#84; *Doom Patrol* (1) #102; *Infinity, Inc.* #22; *Justice League of America* #144; *The New Adventures of Superboy* #1 (Ace); *Showcase* #6-7, 11-12, 100; *Super-Team Family* #8-10; *Who's Who '85* #4; *World's Finest Comics* #267

Current: *Challengers of the Unknown* (2) #1-8; *Millennium* #8; *Secret Origins* (3) #12, 14 (Ace); *Who's Who '90* #1

Challenger Mountain

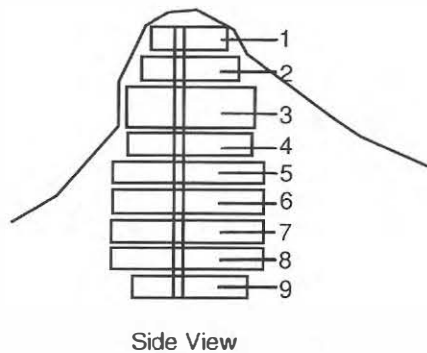

level 1

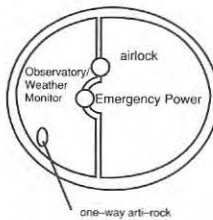

level 2

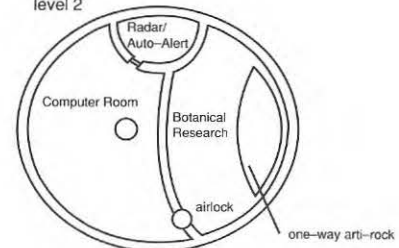

0 8 16 32
feet

level 3

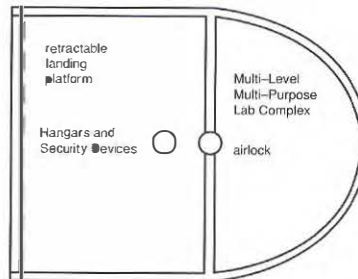

level 4

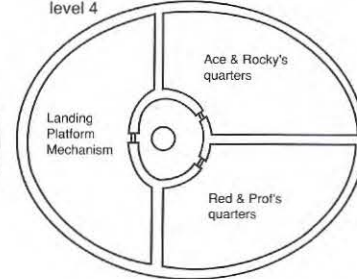

level 6

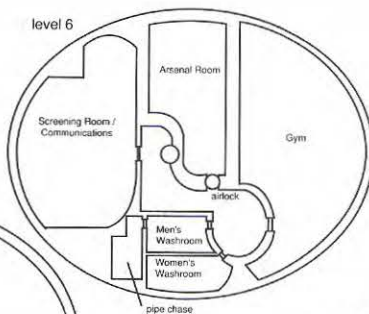

level 8

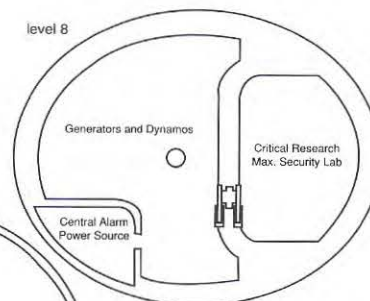

0 8 16 32
feet

level 5

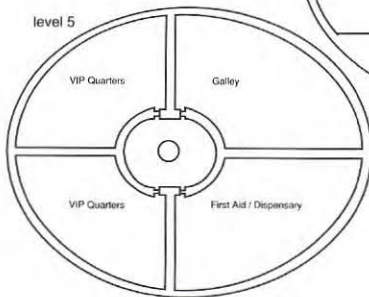

0 8 16 32
feet

level 7

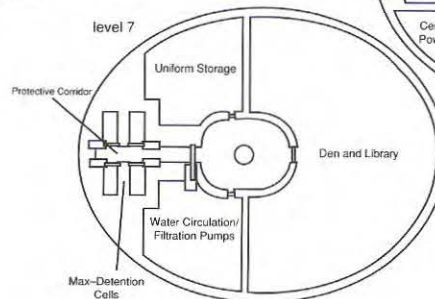

level 9

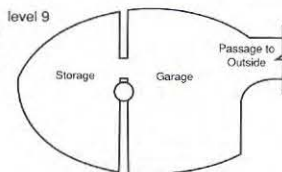

CHANGELING

DEX:	6	STR:	3	BODY:	8
INT:	5	WILL:	5	MIND:	4
INFL:	6	AURA:	5	SPIRIT:	4
INITIATIVE:	17	HERO POINTS:	60		

- Powers:** Shape Change: 8
- Skills:** Charisma: 6
- Advantages:** Connections: Dayton Industries (High), New Titans (High), Robotman (High), Television Industry (Low); Rich Family (Steve Dayton)
- Drawbacks:** Public Identity
- Limitations:** Miscellaneous: Changeling can only hold the form of larger animals for a limited time. If he has taken on the form of a creature with a **BODY** of 5 or higher for three or more consecutive phases, he begins to take 1 point of Mental Bashing damage per phase until he assumes the form of a smaller animal (or resumes his natural form). This damage cannot be removed through the use of Last Ditch Defense; Miscellaneous: All of Changeling's animal forms are green.
- Alter Ego:** Garfield Logan
- Motivation:** Thrill of Adventure
- Wealth:** 18

Animal Forms

When Changeling Shape Changes into an animal form, he assumes the physical characteristics of the animal and can augment those characteristics using his APs of Shape Change. In all cases, his Mental and Mystical Attributes remain the same. Here are Changeling's statistics in some of the forms he commonly assumes.

CHIMPANZEE

DEX: 6 STR: 5 BODY: 4

- Skills:** Acrobatics: 7

ELEPHANT

DEX: 4 STR: 11 BODY: 10

GORILLA

DEX: 4 STR: 8 BODY: 8

HAWK

DEX: 9 STR: 2 BODY: 2

- Powers:** Claws: 2, Flight: 7, Telescopic Vision: 8

Powers and Abilities

Changeling is an accomplished hand-to-hand fighter, but prefers to use his shape changing power in combat. He rarely chooses animal forms that are larger than his own size or weight, because larger forms drain his energy faster and can even exhaust him into unconsciousness—as can numerous, quick transformations. Smaller-than-human forms allow him to concentrate longer. The largest animals he has mimicked to date have been a dinosaur and an elephant, but he can only maintain these forms for approximately one minute. While in animal form, Changeling maintains his full human intellect and ability to speak.

One strange side-effect of Gar's power is that all the forms he assumes are completely green.

Personality/Role-playing

Changeling is a smart-aleck, and his wisecracks are his trademark. He keeps his teammates laughing, and often during a heavy battle or tense situation, it is his comic relief that keeps the Titans' spirits high. Gar is also something of a ladies' man and uses his outrageous sense of humor in his flirtations. In battle, he likes to catch his enemies off guard and anger them with his quips.

Because he has been through rough times and has lost loved ones, Changeling becomes very attached to his friends. He has close relationships with Cliff Steele (Robotman) of the Doom Patrol and Vic Stone (Cyborg) of the New Titans. He will loyally stand behind such friends no matter the circumstances.

Using Changeling in Adventures

If the player heroes attempt to contact the Titans, Changeling is one of the first members they are likely to meet. His easy-going manner should provide plenty of opportunities for entertaining role play.

Changeling is also a good source of information about old Doom Patrol and Titans villains. If the heroes contact him for information, he'll most likely try to involve himself in the case, particularly if one of the heroes is an attractive female.

Subplots

Changeling was involved in a Romantic relationship with the ex-Titan Terra. He was deeply

hurt when he discovered she was using him to infiltrate the team at the behest of Deathstroke. He was also involved in a School Subplot, wherein he was consistently trying to maintain a decent grade point average; a Family subplot with Steve Dayton, his adoptive father; and a series of Friend Subplots centered around his relationships with Cyborg and Robotman.

Appearances in the DC HEROES Role-Playing Game, Second Edition

Background/Roster Book (includes card), New Titans Sourcebook

Appearances in DC Comics

* **Note:** Pre-Crisis appearances are not part of present continuity.

Pre-Crisis: *Action Comics* #532, 536, 546; *Batman and the Outsiders* #5; *The Best of DC* #18; *Captain*

Carrot and His Amazing Zoo Crew #20; *Crisis on Infinite Earths* #3-7, 9-12; *DC Comics Presents* #26 (as dream image); *Doom Patrol* (1) #99-116, 188-120; *The New Teen Titans* (1) #1-15, 17-26, 28-37, 39-40 (2)1-14; *The New Teen Titans Annual* (1) #1-2 (2) 1; *The New Teen Titans Drug Awareness Giveaways* #1-3; *Red Tornado* #3; *Supergirl* (2) #20 *Tales of the New Teen Titans* #1-4; *Tales of the Teen Titans* #41-43, 44 (behind the scenes), 45, 47-58; *Teen Titans* #6, 50-52; *Teen Titans Annual* #3; *Who's Who '85* #4; *Wonder Woman* (1) #287; *World's Finest Comics* #300

Current: *Action Comics* #584, 615; *Batman* #440; *Blue Beetle* (6) #11-14; *Deathstroke the Terminator* #1 (flashback), 4 (flashback); *Flash* (2) #1, 6, 12; *Infinity, Inc.* #45; *Legends* #1-6; *The New Teen Titans* (2) #18-20, 22, 24-31, 33-49; *The New Teen Titans Annual* (2) #2-4; *The New Titans* #50-56, 59, 62-65, 71, 75, 78-79, 82-86; *The New Titans Annual* #5-6; *Secret Origins* (3) #50; *Teen Titans Spotlight* #5, 9, 20; *Who's Who '90* #2

Changeling's Apartment

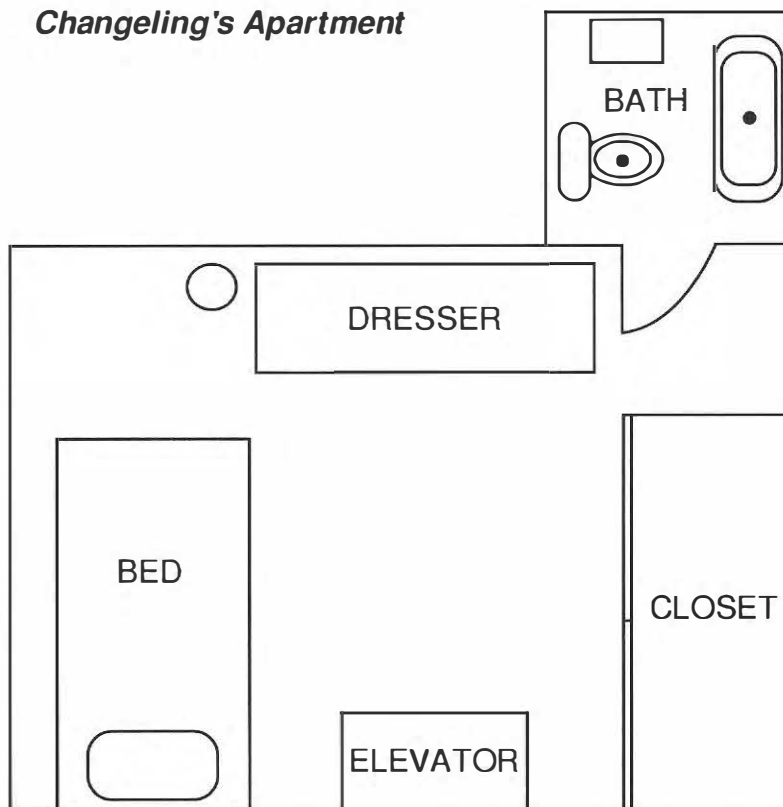

EL DIABLO

DEX:	7	STR:	4	BODY:	5
INT:	7	WILL:	6	MIND:	6
INFL:	6	AURA:	5	SPIRIT:	6
INITIATIVE:	22	HERO POINTS:	60		

•**Skills:** *linked

Acrobatics: 7*, Charisma: 6*, Detective: 7*,
 Martial Artist: 7*, Military Science (Tracking): 7*,
 Thief: 7*, Vehicles (Land): 7*

•**Advantages:** Area Knowledge (Dos Rios, Texas);
 Connections: Dos Rios City Hall (High), Street
 (High); Intensive Training; Iron Nerves;
 Popularity; Scholar (law, Spanish language);
 Miscellaneous: El Diablo mystique (see below)

•**Drawbacks:** Secret Identity

•**Alter Ego:** Rafael Sandoval

•**Motivation:** Seeking Justice

•**Wealth:** 7

•**Equipment:**

KEVLAR VEST [BODY: 6] Beneath his clothing, El
 Diablo wears a thick kevlar vest. The vest gives
 him an RV of 6 against all types of gunfire.

CUSTOMIZED MOTORCYCLE [STR: 4, BODY: 6,
 Running: 7, R#: 2] El Diablo's customized
 motorcycle can attain speeds of well over 100
 miles per hour.

Abilities

El Diablo is a master cyclist and martial artist.
 He's fast, he's agile, and he's dangerous. During his
 adventures, he normally wears a kevlar vest to protect
 himself.

The El Diablo Mystique

Many of the residents of Dos Rios, Texas believe
 that El Diablo is more than a mere costumed crime-
 fighter. Some even believe that he is an agent of the
 Devil, his namesake. For this reason, El Diablo
 receives a special -1 Column-Shift bonus to the OV
 of all his attempts to Intimidate citizens of Dos Rios.
 El Diablo does not receive this bonus against citizens
 who have reason to suspect his true nature (such as
 criminals who have repeatedly encountered him).

Los Diablos

Recently, a group of young adults from the Dos
 Rios barrio, calling themselves Los Diablos, have
 started assisting El Diablo in his crimefighting

activities. Since they are almost as interested in
 uncovering his secrets as in helping him clean up
 their streets, El Diablo sometimes finds Los Diablos
 as much of a liability as an advantage.

TYPICAL MEMBER OF LOS DIABLOS

DEX:	3	STR:	3	BODY:	3
INT:	3	WILL:	3	MIND:	3
INFL:	3	AURA:	3	SPIRIT:	3
INITIATIVE:	9	HERO POINTS:	5		

•**Skills:** Thief: 2, Vehicles (Land): 2, Weaponry: 2

Motorcycle Stunts

El Diablo is an expert motorcycle rider capable
 of performing spectacular stunts. A couple of his
 common maneuvers are:

•**Attacking from a moving motorcycle:** El Diablo
 likes to drive past his targets and punch or kick
 them from the back of his moving motorcycle. The
 AV of such an attack is equal to either El Diablo's
 DEX or his APs of Martial Artist Skill (depending
 upon how he decides to employ his Martial Artist
 during the phase). The EV is equal to the cycle's
 APs of Running (8 APs). After successfully
 launching such an attack, El Diablo must make a
 successful Action Check using his APs of Vehicles
 Skill as the AV/EV against an OV/RV of 4/4
 (Difficult Task) to avoid falling off the bike (if he
 falls, both he and the bike undergo Physical
 Attacks with an AV/EV of 7/7 against an OV/RV
 equal to his and its BODY/BODY respectively).

•**Jumping over obstacles:** Jumping an obstacle
 requires a Action Check using El Diablo's APs of
 Vehicles Skill as the AV/EV against an OV/RV
 determined by consulting the Universal Modifiers
 Table. Jumping a five-foot gap is a Difficult Action
 (OV/RV of 4/4), jumping a ten-foot gap is a
 Strenuous Action (OV/RV of 6/6), jumping a
 fifteen-foot gap is an Extreme Action (OV/RV of
 8/8), and jumping a twenty-foot gap is Pushing the
 Limit (OV/RV of 10/10). El Diablo cannot jump
 farther without a ramp. Using a ramp while making
 a shorter jump modifies the OV/RV by as much as
 -3 Column Shifts, depending on the ramp's size
 and quality.

Personality/Role-playing

Rafael Sandoval, or El Diablo, is a giving man,
 proud of his heritage and willing to sacrifice himself

to safeguard it. He believes strongly in his own abilities and the fact that one man can better the world. Sandoval is stubborn, well-adjusted, optimistic, and determined. Although not as obsessed as Batman, he does not hesitate to break the law to preserve justice. Sandoval holds a special place in his heart for his mentor, Father Guzman, though he and the father disagree over most of El Diablo's methods.

As a crimefighter, El Diablo remains a mystery to the inhabitants of Dos Rios, Texas. While operating in his costumed identity, Sandoval tries to take down his target and disappear without a trace.

Using El Diablo in Adventures

Player heroes visiting Dos Rios, Texas will certainly hear exaggerated tales of El Diablo from the awestruck members of the community. Eventually, the heroes will inevitably encounter Los Diablos, who in turn inform El Diablo of their presence.

When the heroes finally meet El Diablo himself, he can teach them some of the finer points of urban adventuring and introduce them to some of the unique challenges facing his community.

Subplots

Rafael Sandoval puts a lot of effort into concealing his Secret Identity from the community, which, of course, adds to his "mystique." He has a Romance Subplot developing with Virginia Dix as she pursues him, and he is also constantly aware of his Job as a City Councilman.

Appearances in the DC HEROES Role-Playing Game, Second Edition

Atlas of the DC Universe

Appearances in DC Comics

Checkmate! #25; *El Diablo* #1-16; *Justice League America* #42; *Secret Origins* (3) #45; *Who's Who '90* #1

El Diablo's Motorcycle

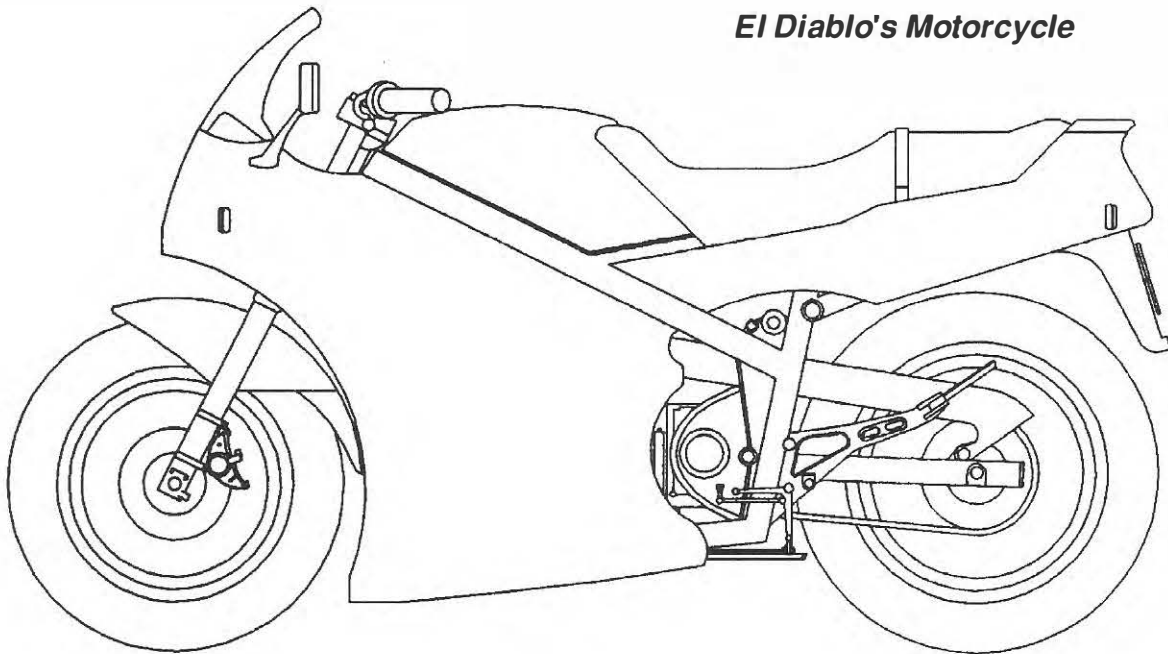

FASTBAK

DEX: 8	STR: 5	BODY: 7
INT: 7	WILL: 6	MIND: 7
INFL: 8	AURA: 8	SPIRIT: 7
INITIATIVE: 25	HERO POINTS: 85	

- Skills:** Acrobatics: 7, Artist (Singer): 10, Gadgetry: 8, Thief: 8, Weaponry: 8
- Advantages:** Area Knowledge (Supertown, New Genesis); Connection: Supertown (High); Insta-Change; Lightning Reflexes; Luck
- Alter Ego:** None
- Motivation:** Upholding the Good
- Wealth:** N/A
- Equipment:**

AEROPADS [BODY: 7, Flight: 40] Within his boots, Fastbak has implanted special devices that allow him to fly at more than 800 times the speed of light.

Mother Box [BODY: 7, INT: 10, WILL: 6, MIND: 6, INFL: 6, AURA: 6, SPIRIT: 6, Danger Sense: 12, Life Sense: 6, Omni-Power: 11, Hero Points: 75]

See the **Mother Box** entry for more details.

Fastbak's Statistics

Because Fastbak's abilities are more clearly defined in *Who's Who '90*, his Attributes and Powers have been fine-tuned to reflect the change.

Stellar Booms

Fastbak is constantly being scolded by Highfather and the other elders of New Genesis for traveling over Supertown at high speeds. Breaking the "light barrier" so close to the ground causes powerful explosions that can damage property. Traveling at a speed of greater than 30 APs within an atmosphere Physically attacks all structures and particularly fragile objects within 12 APs of the traveler with an AV and EV both equal to the traveler's speed minus thirty. If Fastbak were to roar across Supertown at his full speed, for instance, all of the ground structures he passes would be attacked with an AV/EV of 10/10 (40 - 30 = 10)—not enough to destroy a structure constructed with New Genesis technology, but more than enough to shatter windows and generally annoy everyone. Note that the "stellar boom" never affects living beings.

Theoretically, Fastbak can attack a target on the ground by intentionally causing a stellar boom, hoping to destroy the target's weapons and equipment. But since such an attack would be almost impossibly difficult to control, he would usually not do so.

Powers and Abilities

With the exception of Lightray, Fastbak is the fastest New God in Supertown. (On one occasion, he even outraced the Black Racer.) Fastbak derives his speed from a special set of aeropads and boots that he constantly improves. As a New God, Fastbak has super-human perception, agility, and endurance, allowing him to observe his surroundings, change direction, and withstand the tremendous forces placed upon his body, all while flying faster than lightspeed.

Over the years, Fastbak has learned to use his tremendous speed to great advantage in battle. He has developed his own "hit and run" style of combat that is designed to confuse unwary adversaries and prevent opponents from launching counter-blows.

Fastbak's remaining claim to fame is his enchanting singing voice. On New Genesis, he is an artist of some renown.

Personality/Role-playing

Although Fastbak takes pride in his tremendous speed and agility, these are his very attributes that tend to annoy others due to his penchant for zipping around Supertown at unsafe speeds. At present, young Fastbak enjoys nothing more than pushing his speed, and the patience of others, to their very limits. But although he is sometimes reckless, Fastbak remains loyal to his people and always follows the dictums of Highfather, ruler of New Genesis.

Fastbak's mind is as quick as his feet; jokes and snappy retorts are his specialty. Recently, Fastbak spent time on Earth with Orion and Lightray; and ever since, he has taken an interest in American culture. He has even picked up American slang and fashion trends.

Using Fastbak in Adventures

If you are planning an Adventure which culminates in an encounter with the New Gods of New Genesis, Fastbak might make an ideal liaison between the New Gods and the player heroes. He's not too powerful, fun to role play, and he has already demonstrated an interest in the heroes and their culture (assuming your player heroes are Americans).

Subplots

Fastbak is most involved with Subplots that explored his youthfulness and inexperience. Ever since he visited Earth with Orion and Lightray, many

of his Subplots have been centered around his fascination with American culture.

Current: *New Gods* (3) 1, 16, 22, 27; *War of the Gods* #4; *Warlord Annual* #6; *Who's Who '87* (2) #1; *Who's Who '90* #4

Appearances in the DC HEROES Role-Playing Game, Second Edition

Law of Darkness

Appearances in DC Comics

* **Note:** Pre-Crisis appearances are not part of present continuity.

Pre-Crisis: *New Gods* (1) #5, 8

Fastbak's Aeropads

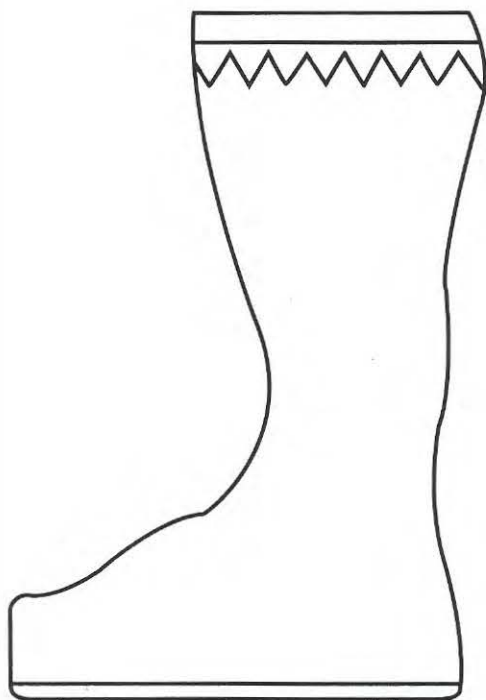

- Motion control sensors
- Data transmission circuitry
- Semi-rigid structural plating
- Data processing circuitry
- Power cells
- Anti-gravity generator
- Anti-gravity focusing matrix

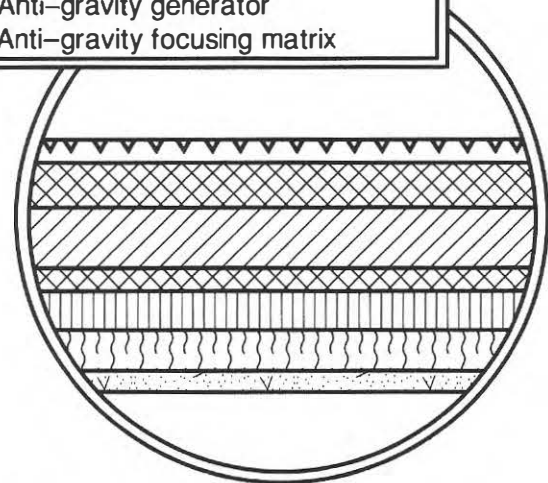

magnified cross-section through sole

FIRE

DEX:	6	STR:	4	BODY:	4
INT:	6	WILL:	5	MIND:	5
INFL:	6	AURA:	6	SPIRIT:	5
INITIATIVE:	20	HERO POINTS:	40		

- Powers:** Dispersal: 9, Flame Being: 6, Flame Project: 8, Flight: 8
- Skills:** Charisma: 8, Martial Artist: 6, Thief: 4, Weaponry: 4
- Limitations:** Miscellaneous: Fire's Powers are really all parts of a single ability. In order to use Flight or Flame Project, she must assume her energy form (i.e., activate Flame Being and Dispersal). All of her Powers have the Minor Power Burnout Limitation. Make a single Burnout roll during any phase in which she uses any of her Powers; if a single Power Burns Out, they all Burn Out together.
- Advantages:** Attractive; Connections: Global Guardians (High), Justice League America (High)
- Alter Ego:** Beatriz Bonilla DaCosta
- Motivation:** Thrill of Adventure
- Wealth:** 5
- Equipment:**
Justice League International Signal Device [BODY: 4, Range: 25] The JLI signal device is capable of transmitting a signal across the world. Note that two-way communication is not possible with this device; it is only capable of emitting a distress signal. Any device with the Super Hearing Power that is within range of such a signal can automatically track it.

Original Form

Fire's abilities were augmented by the Dominators' Gene Bomb. Before she was affected by the bomb, her statistics looked like this:

FIRE (PRE-BOMB FORM)

DEX:	5	STR:	3	BODY:	4
INT:	6	WILL:	5	MIND:	5
INFL:	6	AURA:	6	SPIRIT:	5
INITIATIVE:	19	HERO POINTS:	35		

- Powers:** Flame Project: 8
- Skills:** Charisma: 8, Martial Artist: 6, Thief: 4, Weaponry: 4
- Limitations:** Miscellaneous: Fire's Flame Project

has a range of only 8 inches and can thus be used only against unaware opponents or those she has Grappled.

- Advantages:** Attractive; Connections: Global Guardians (High), Justice League International (High)
- Alter Ego:** Beatriz Bonilla DaCosta
- Motivation:** Thrill of Adventure
- Wealth:** 5

Powers and Abilities

Originally, Fire could emit only a short green flame from her mouth, but the Meta-Gene Bomb detonated during the Dominator Invasion greatly augmented her abilities. Now, she can completely engulf herself in green flame, enabling her to fly, pass through solid objects, and throw bolts of flaming energy.

Since Fire only recently acquired most of her abilities, she still uses them rather awkwardly. Until she gains more experiences with her powers, their true extent remains unknown.

Personality/Role-playing

Beatriz DaCosta is an extrovert. She is more than confident and willing to go after what she wants—she is daring, and her impulsive nature often gets her into trouble. Her attractions to adventure and glamour have cast her in some interesting roles: nightclub showgirl, model, secret agent for the Brazilian government, and member of the Global Guardians and Justice League America.

Fire is cocky, confident, and well aware of her attractiveness, which she flaunts to its fullest advantage. She joined the Justice League for glamour and excitement, but it is the friendships she has built and the loyalty of her teammates that keep her there. Especially important to her is her close friendships with Ice and Oberon.

Using Fire in Adventures

Since she is much more approachable than most members of the team, Fire is an ideal source of information on the Justice League and the villains it has battled. She can also provide the player heroes with information about the now-defunct Global Guardians and the menaces they once battled.

A notorious flirt, Fire might easily work herself into the Romantic Subplot of an attractive male hero.

Subplots

Fire is most often involved in either Job Subplots (regarding her modeling career) or Romantic Subplots (lately with Mister Miracle's aide de camp, Oberon).

Appearances in the DC Heroes Role-Playing Game, Second Edition

Background/Roster Book (includes card), Justice League Sourcebook

Appearances in DC Comics

***Note:** Pre-Crisis appearances are not part of present continuity.

Pre-Crisis: *Crisis on Infinite Earths* #12; *DC Comics Presents* #46; *Super Friends* #25, 42-44, 47

Current: *Action Comics* #650; *Armageddon 2001* #2; *Doctor Fate* (2) #14-15; *Doom Patrol* (2) #29; *Green Lantern* (3) #1, 4, 9, 13; *Infinity, Inc.* #32, 34-37; *Invasion!* #2-3; *Justice League America* #26-32, 33 (behind the scenes), 36-37, 39-40, 42-45, 47-on; *Justice League America Annual* #5; *Justice League Annual* #2-4; *Justice League Europe* #7-8, 11, 13-14, 29-36; *Justice League Europe Annual* #2; *Justice League International* #12, 14-25; *Justice League Quarterly* #1-6; *Justice League Special* #1-2; *Justice League Spectacular* #1; *Mister Miracle* (2) #15-16, 17 (behind the scenes), 25, 27; *Secret Origins* (3) #33; *Time Masters* #1; *War of the Gods* #2, 4; *Who's Who '88* #1; *Who's Who '90*; *Wonder Woman* (2) #25-26, 49-50, 61

JLI Signal Device

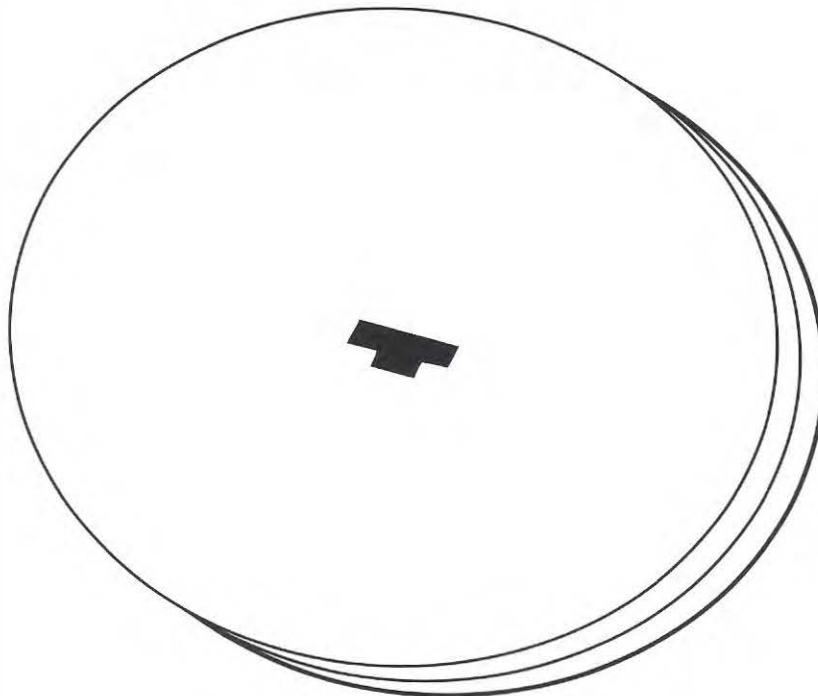

FLAMEBIRD

DEX: 6	STR: 3	BODY: 4
INT: 4	WILL: 4	MIND: 4
INFL: 5	AURA: 5	SPIRIT: 4
INITIATIVE: 17	HERO POINTS: 30	

- **Skills:** Acrobatics: 5, Charisma: 6, Martial Artist: 6, Weaponry: 6
- **Advantages:** Attractive; Connections: Teen Titans (High), Titans West (High); Scholar (tennis, swimming)
- **Drawbacks:** Minor Irrational Attraction to Nightwing; Secret Identity
- **Alter Ego:** Mary Elizabeth "Bette" Kane
- **Motivation:** Thrill of Adventure
- **Wealth:** 8
- **Equipment:**

UTILITY BELT [BODY: 2] The belt contains:

Flares (x2) [BODY: 1, EV: 6, Flash: 6] In an emergency, the flares can be used as a weapon with an EV of 6. (Flamebird automatically enters Killing Combat if she uses them in this fashion.) Once activated, the flares emit a bright red signal that is clearly visible up to 1 mile (10 APs) away.

Flashlight [BODY: 2, R#: 2] The flashlight illuminates a circle ten feet (0 APs) in diameter up to fifty yards (4 APs) away.

Gas Grenades (x4) [BODY: 1, EV: 6, Fog: 5, R#: 2] The grenades attack everyone within the area covered by their Fog Power with an EV of 6.

Gas Mask [BODY: 2, Systemic Antidote: 7] The Mask's Systemic Antidote Power is only usable against harmful gases.

Grappling Hook and Line [STR: 6, BODY: 4] The line is 4 APs (80 feet) long.

Handcuffs [BODY: 9] Anyone attempting to force his way out of the cuffs rolls STR/STR vs. the cuffs' BODY/BODY. Trying to slip out of the cuffs requires a successful Thief roll vs. the cuffs' BODY/BODY.

Throwing Discs (x5) [BODY: 5, EV: 3, Gliding: 3] Flamebird can throw the discs a distance equal to her STR plus the discs' APs of Gliding (6 APs, or 200 yards).

Medical Kit [BODY: 1, Medicine (First Aid): 4; R#: 2]

Radio Transceiver [Range: 13, BODY: 1, R#: 2] This is a standard walkie-talkie, capable of sending and receiving signals over a distance of eight miles.

Flamebird's Attraction to Robin

Flamebird's Minor Irrational Attraction to Robin reflects her schoolgirl crush on Dick Grayson. Whenever she has an opportunity to spend time with Grayson, she must successfully resist her Attraction in order to refuse (i.e., roll a 5 or higher on 2D10). Originally, when Titans West was still an active organization, Flamebird's Irrational Attraction to Robin was Serious (roll 11 or higher to resist).

Powers and Abilities

Flamebird has no superhuman abilities, though she is an Olympic-level athlete and a master of martial arts. Like her hero Robin, Flamebird makes use of a utility belt that houses: four gas bombs and a gas mask, a grappling hook, handcuffs, throwing discs, and a radio.

Personality/Role-playing

Usually, Flamebird comes across as an attractive, flirtatious valley girl looking for a good time. But Bette has proven herself more than an airhead on several occasions. She is actually quite clever, perceptive, and (sometimes) even scheming. She has always been the object of admiration, and as a result, she does not take rejection or failure gracefully.

As a champion tennis player, Bette loves the glory and glamour of victory, but it never lasts long enough to totally satisfy her. Athletic triumphs are easy for Bette, and it is her drive and fiercely competitive nature that make her excel at sports. But this same single-minded pursuit of victory ultimately pulls her away from her friends.

To this day, Bette holds a torch for the original Robin (Dick Grayson, now known as Nightwing). She still spends time with him whenever possible.

Using Flamebird in Adventures

Flamebird wants to start a team of Titans on the West Coast, even though the last such effort was a failure. She might, therefore, recruit player heroes by tempting them with "sun and sand" and all the other obvious benefits of joining a California team. Also, if she feels any team members might be able to link her with Dick Grayson, she'll do her best to start friendships with them.

Furthermore, despite her affinity for Dick Grayson, Bette might be interested in involving herself in an attractive male hero's Romantic Subplot.

Subplots

Flamebird has a Romantic interest in Nightwing, but it really hasn't gone anywhere. She was also involved in a lengthy Romantic Subplot with her former West Coast Titan, the late Golden Eagle.

Appearances in the DC Heroes Role-Playing Game, Second Edition

New Titans Sourcebook

Appearances in DC Comics

Hawk and Dove Annual #1; The New Titans #56; Secret Origins Annual #3; Who's Who '90 #2

Flamebird's Utility Belt

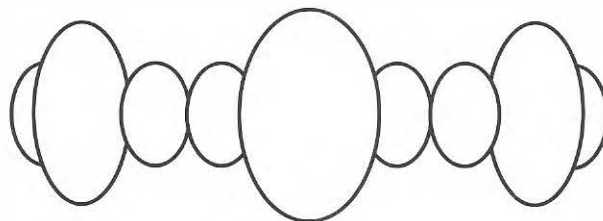
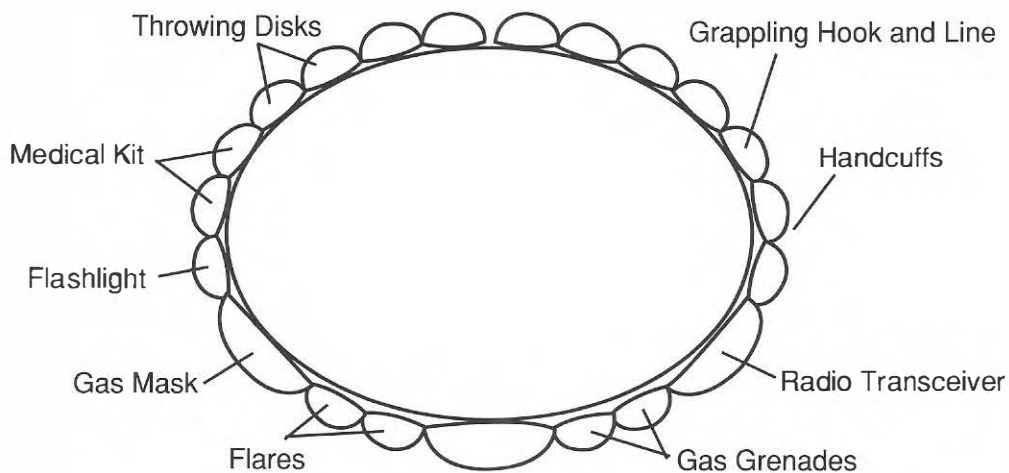

Side View

FLASH III

DEX:	7	STR:	4	BODY:	7
INT:	5	WILL:	5	MIND:	6
INFL:	5	AURA:	4	SPIRIT:	5
INITIATIVE:	31	HERO POINTS:	55		

- Powers:** Air Control: 8, Superspeed: 14
- Skills:** Charisma: 5, Scientist: 3
- Advantages:** Attractive; Connections: Justice League International (High), New Titans (High); Lightning Reflexes
- Drawbacks:** Serious Irrational Attraction to food after prolonged use of Superspeed (see below)
- Alter Ego:** Wally West
- Motivation:** Responsibility of Power
- Wealth:** 5
- Equipment:**

COSTUME [BODY: 6, Flame Immunity: 6] Wally now wears a special heat-resistant costume that helps him resist the effects of friction while running at supersonic speeds.

COSTUME STORAGE RING [BODY: 1, Shrinking: 10] Before he received his new uniform, Wally kept his costume shrunk down inside a hollowed ring. By twisting the ring, he could immediately expand the costume to its normal size. Obviously, the ring's Shrinking Power only worked on the Flash's costume. Wally no longer owns this ring.

The Flash's Metabolism

When he uses his Powers, Flash consumes calories at an unbelievable rate. After using his Powers for a prolonged period, Flash must devour huge quantities of food to replenish these lost calories (say, two dozen hamburgers or half a dozen pizzas).

Although this limitation was once more severe, Flash has spent the last two years learning to control it. Currently, if Flash uses his Powers for four consecutive minutes (only likely during long-distance runs), make an Action Check using the APs of time he has been using his Powers as the AV/EV (6/6 for four minutes) against an OV/RV equal to Flash's BODY/BODY. If this Action Check earns 1 or more RAPs, Flash must immediately stop and eat or all his Powers Burn Out. Thereafter, at each moment the total APs of time he has been using his Powers changes, make another Action Check using the new AV/EV (i.e., after eight minutes make an Action Check with an AV/EV of 7/7; after sixteen minutes make an Action Check with an AV/EV of 8/8, etc.). Note that Flash may spend Hero Points to raise his OV and RV against these "attacks" as usual.

The Flash's Ability Growth

Although Wally is not nearly as fast as he once was, his abilities are constantly improving (until recently, his Superspeed Power was rated at only 10 APs and he was incapable of using Air Control). It is likely that he will eventually recover most, if not all, of his Powers.

When he began operating as Kid Flash, Wally had the following Powers—Air Control: 8, Dispersal: 12, and Superspeed: 20.

Wally's Wealth

Wally West began with a Wealth rating of 3 when he was operating with the original Teen Titans, raised it to 4 when he joined the New Teen Titans, and then raised it to 11 when he won the New York State Lotto shortly after Darkseid's campaign to rob the Earth of its legends. But soon after that, Wally lost all his money during the Millennium affair, reducing his Wealth back to 3. Currently, he has raised his Wealth rating back to 5.

Powers and Abilities

The Flash's powers have fluctuated wildly over the years. At present, he can accelerate to more than six times the speed of sound. While he travels at high speeds, an aura of force protects him from friction and impact damage, and his agility and perception are attuned to high velocities, allowing him to navigate at such speeds.

Due to the training he received from Barry Allen, his friends on the Titans, and his fellow Justice Leaguers, the Flash is an excellent hand-to-hand combatant. His favorite tactics include Multi-Attacks and using his speed to move faster than his opponents can track him.

Personality/Role Playing

When Barry Allen died while saving the Earth from the Anti-Monitor's machinations, Wally found the remains of the his uncle's costume and vowed to honor Barry's memory by taking on the mantle of the Flash. But Wally has always had difficulty living in the shadow of Barry's legend, both emotionally and physically. Despite the fact that he works hard to be the same selfless, responsible Flash as Barry, Wally is often frustrated and disappointed because he believes he is falling short of the mark. Just after he began wearing the Flash uniform, Wally was forced to use his powers for monetary gain, bringing on still

more guilt that only added to his insecurities. By now, all of his Justice League teammates and half his foes have discovered that the best way to anger Wally is to remind him how few mistakes his predecessor made.

West loves women, and to their chagrin, he is very open about his feelings. He sometimes shows off his powers to impress, making him seem crass and unthinking, though he never feels any real malice.

As a member of the Justice League, Flash is a wisecracker, and his teammates look upon him as something of a show-off. But when the chips are down, he is always ready to do his part. He may appear to treat some League business as a joke, but this is only a defense mechanism he uses to deal with the dangers he faces every day. In reality, the Flash takes his role very seriously.

Because the world moves so fast for him, the Flash easily grows bored with his surroundings. When playing him, remember that he has a difficult time sitting still.

Using Flash in Adventures

Wally is a good Character to use as a contact in Justice League Europe. Like Blue Beetle, simply because of his personality, Wally is a good person to have answer the phone. One can always count on some good one-liners from the fastest man alive. Also, as a classic hero, he is good for a quick save if the player heroes need it.

Subplots

Wally was involved in a number of Money Subplots that saw him rise from rags to riches and back to rags. He also had a Romantic Subplot with his girlfriend, Connie, who has since left him for his friend Chunk. He seems to be growing closer to reporter Linda Park, and it is unclear how their relationship will develop.

Appearances in the DC HEROES Role-Playing Game, Second Edition

Justice League Sourcebook, Background/Roster Book, Come On Down!, New Titans Sourcebook, World in the Balance

Appearances in DC Comics

***Note:** Pre-Crisis appearances are not part of present continuity.

Pre-Crisis: *Action Comics* #532, 536, 546; *Batman* #241; *Batman and the Outsiders* #5; *Batman Family* #14; *The Best of DC* #18; *The Brave and The Bold* (1) #54, 60, 83, 94, 102, 149; *Crisis On Infinite Earths* #8-12; *DC Comics Presents* #26 (as dream image); *DC Special Series* #11; *DC Super-Stars* #10; *Doom Patrol* (1) #104; *The Flash* (1) #110-112, 114, 116, 118, 120, 122, 125, 127, 130, 133, 135, 138, 144, 149, 156, 159, 164-165, 167, 173, 189, 202, 204, 207, 209, 211, 216, 220-221, 232, 239-240, 265-266, 269, 277, 324-325, 343-345, 349; *The Hawk and The Dove* (1) #5; *Justice League of America* #114; *The New Teen Titans* (1) #1-11, 13-26, 28-34, 36-37, 39 (2) 2-6; *The New Teen Titans Annual* (1) #1-2; *The New Teen Titans drug awareness giveaways* #2-3; *Secret Society of Super-Villains* #8-9; *Showcase* #59, 100; *Super-Team Family* #13; *Tales of the New Teen Titans* #1-4; *Tales of the Teen Titans* #45, 49-50; *Teen Titans* #1-33, 35-37, 39-40, 42-53; *Who's Who '86* #12; *Wonder Woman* (1) #287; *World's Finest Comics* #205

Current: *Action Comics* #605; *Adventures of Superman* #449, 463; *Armageddon 2001* #2; *Armageddon: Inferno* #2; *Batgirl Special* #1; *Captain Atom* (3) #24-25, 34, 38, 50; *Deathstroke the Terminator* #1 (flashback), 4 (flashback); *Firestorm, the Nuclear Man* #67, 69, 80; *Flash* (2) #1; *Flash Annual* (2) #1-4; *Flash Special* #1; *Green Lantern Corps* #220; *Hawk and Dove* (3) #9; *Hawkworld Annual* #1; *Hero Hotline* #6; *Invasion!* #2-3; *Justice League America* #32, 53, 55-59; *Justice League Annual* #3-4; *Justice League Europe* #1-9, 13, 21, 23-on; *Justice League Europe Annual* #1-2; *Justice League International* #9, 24; *Justice League Quarterly* #1, 3-5; *Justice League Spectacular* #1; *Legends* #1-6; *Manhunter* (2) #8-9; *Millennium* #1, 3-5, 7-8; *The New Teen Titans* (2) #19-21, 24-26, 28-31, 50 (flashback); *The New Titans* #56, 85; *Secret Origins* (3) #13 (flashback), 30, 38 (flashback); *Secret Origins Annual* #2-3; *Starman* #17; *Teen Titans Spotlight* #21; *War of the Gods* #1-2, 4; *Who's Who '87* (2) #2; *Who's Who '90* #2; *Wonder Woman* (2) #61

GEO-FORCE

DEX: 7	STR: 9	BODY: 9
INT: 6	WILL: 8	MIND: 7
INFL: 6	AURA: 5	SPIRIT: 7
INITIATIVE: 19	HERO POINTS: 75	

- Powers:** Energy Blast: 10, Gravity Decrease: 11, Gravity Increase: 11
- Skills:** Charisma: 7
- Advantages:** Area Knowledge (Markovia); Connections: Batman (Low), Markovian Government (High), Outsiders (High); Connoisseur; Iron Nerves; Rich Family; Scholar (Markovian history)
- Drawbacks:** Authority Figure; Catastrophic Irrational Attraction to protecting Markovia
- Alter Ego:** Prince Brion Markov
- Motivation:** Responsibility of Power
- Wealth:** 12

Gravity Powers

With his Gravity Increase and Gravity Decrease Powers, Geo-Force can accomplish any of the following feats:

- Fly:** By combining his Gravity Decrease and Energy Blast Powers, Geo-Force may fly at a speed of 9 APs per phase.
- Grapple an opponent with gravity:** He can "Grapple" Characters by increasing their own weights. Make an Action Check using Geo-Force's APs of Gravity Increase as the AV/EV against an OV/RV equal to the target's STR/BODY. One or more RAPs indicate that the target is "Grappled" with a STR equal to Geo-Force's APs of Gravity Increase. In addition, any RAPs earned that exceed the target's BODY are taken as Physical Bashing Damage.
- Increase the weight of objects:** He can increase the weight of an inanimate object by an amount equal to his own APs of Power. This is an Automatic Action. For instance, he might make the car a villain is lifting over his head (6 APs of weight) suddenly weigh as much as a small building (17 APs of weight).
- Propel objects through the air:** He can propel objects through the air at a speed equal to his APs

of Gravity Decrease minus the object's weight. To move a living creature in this fashion, he must make an Action Check against an OV/RV equal to the target's DEX/BODY. If this Action Check succeeds, treat the target as though it has been Knocked Back a distance equal to the RAPs earned. Geo-Force can also attack targets by flinging heavy objects at them. The AV of such an attack is equal to his APs of Gravity Decrease, and the EV is equal to the weight of the objects flung.

- Reduce the weight of an object:** He can reduce the weight of any inanimate object by an amount equal to his APs of Power. For instance, he might make a car (6 APs of weight) weigh as little as 24 ounces (-5 APs of weight; see the *Rules Manual*, page 63).

Powers and Abilities

Geo-Force can increase or decrease the force of gravity by more than one thousand times in either direction. He also possesses super-human strength (enabling him to lift more than twelve tons over his head), super-human endurance, and the ability to emit bursts of heat ("lava blasts"). By reducing the pull of gravity on his own person and using lava blasts for propulsion, Geo-Force can fly at near-supersonic speeds.

Personality/Role-playing

Geo-Force is first and foremost a noble. His character somewhat resembles that of the mythical knight-in-shining-armor. He is fond of making valiant speeches ("I am afraid I can no longer allow you to plague these good citizens, you black-hearted fiend!", etc.), and he believes in truth, liberty, and justice above all else. Geo-Force is almost completely without fear and would not hesitate to give his life to save one of his friends or an innocent. When confronted by a particularly strong injustice he can become enraged, and he has even been known to enter Killing Combat upon such occasions, though he would never initiate Killing Combat.

Using Geo-Force in Adventures

If the player heroes visit Eastern Europe, there is a strong possibility that they will encounter Geo-Force, particularly if the heroes are tracking a menace that poses a threat to Markovia.

Subplots

Geo-Force was most often involved in Family Subplots with his half-sister Tara, who joined the Titans, and with his sister-in-law Ilona, who took over his throne.

Appearances in DC Comics

* **Note:** Pre-Crisis appearances are not part of present continuity.

Pre-Crisis: *All-Star Squadron* #53; *Batman and the Outsiders* #1-27; *Batman and the Outsiders Annual* #1; *The Brave and The Bold* #200; *Crisis On Infinite*

Earths #1-5, 9, 11-12; *DC Comics Presents* #83; *Justice League of America Annual* #3; *The New Teen Titans* (1) #37 (2) 13; *Teen Titans Annual* #3; *Who's Who '85* #9; *World's Finest Comics* #300, 302

Current: *Adventures of the Outsiders* #33-38; *Armageddon 2001* #2; *Batman and the Outsiders* #28-32; *Batman and the Outsiders Annual* #2; *Blasters Special* #1; *Captain Atom* (3) #57; *Firestorm, the Nuclear Man* #67; *Flash* (2) #8; *Infinity, Inc. Special* #1; *Justice League International* #9; *Justice League Quarterly* #5; *Millennium* #1, 3-5; *The Outsiders* #1-7, 9-28; *The Outsiders Annual* #1; *The Outsiders Special* #1; *Secret Origins* (3) #6 (flashback); *Who's Who '90* #1; *War of the Gods* #1-2; *Wonder Woman* (2) #13

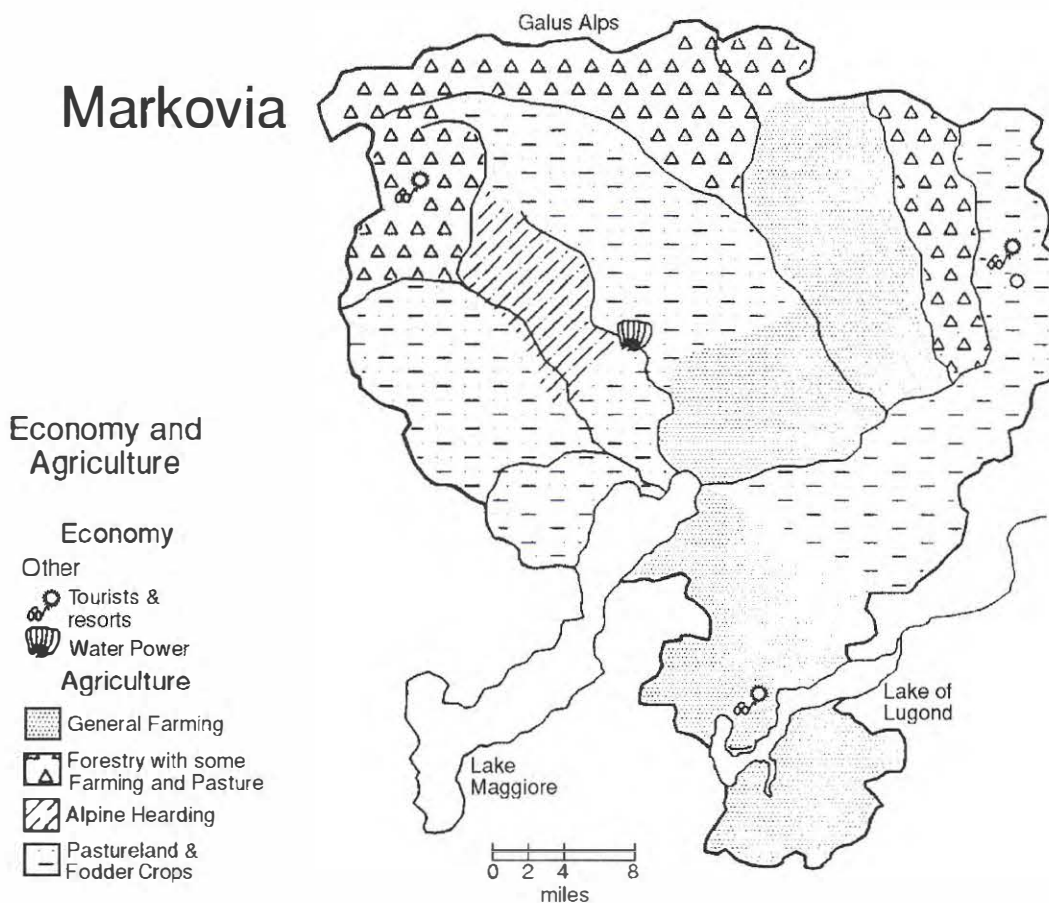

GREEN LANTERN

DEX:	8	STR:	4	BODY:	12(4)
INT:	8	WILL:	25	MIND:	8
INFL:	6	AURA:	7	SPIRIT:	12
INITIATIVE:	24	HERO POINTS: 150			

- Skills:** Martial Artist: 5, Scientist: 4, Vehicles: 10
- Advantages:** Connections: John Stewart (High), Justice League International (High); Iron Nerves; Leadership
- Drawbacks:** Secret Identity
- Alter Ego:** Hal Jordan
- Motivation:** Responsibility of Power
- Wealth:** 3
- Equipment:**

POWER RING [BODY: 25, INT: 10, Comprehend Languages: 20, Flight: 40, Force Manipulation: 25, Invulnerability: 18, Life Sense: 40, Omni-Power: 12, Recall: 20, Regeneration: 4, Sealed Systems: 16, Skin Armor: 4, Spirit Travel: 50]

Green Lantern's Power Ring is an amazingly potent weapon with a virtually unlimited number of capabilities, including the ability to:

- Fly:** The ability to propel the ring-wielder at speeds approaching 1,500 times the speed of light (Flight).
- Form objects of emerald energy:** The ability to form complex objects out of "emerald energy" (Force Manipulation). This ability is directed by (and Linked to) the user's Willpower. He can only form objects that he completely understands. For example, Hal can create a mousetrap because it is simple; he cannot, however, create a color T.V.
- Locate other Green Lanterns:** The ability to detect other Power Rings from several thousand light-years away (Life Sense; this Power can't be used in any other fashion).
- Manifest user's willpower:** This allows the user to manifest many abilities through the sheer force of will (Omni-Power; this Power is linked to 1/2 the user's WILL).
- Project an "energy self":** The power to separate an "energy self" from the ring-wielder (Spirit Travel). This energy self can travel billions of times faster than light and perceive its surroundings normally.
- Protect user physically and heal:** The power to protect the user from physical harm (Invulnerability) and hostile environments, such as the vacuum of outer space (Sealed Systems). The ring also speeds up the user's natural healing abilities to 16 times normal (Regeneration). While wearing the ring,

Green Lantern has a BODY of 10. While the ring is on his finger, it has a BODY equal to his WILL.

- Provide information:** The ability to store huge amounts of information (Recall) and aid the user in problem-solving tasks (Green Lantern can substitute the ring's INT for his own INT when making Action Checks that involve problem-solving).
- Shield the wearer:** The ability to envelop the ring-wielder with a protective sheath of green energy (Skin Armor; Green Lantern loses 1 AP of both Force Manipulation and Omni-Power for each AP of Skin Armor he activates).
- Understand languages:** The ability to translate virtually every language in the universe (Comprehend Languages).

Despite all its virtues, the Power Ring does have a couple of flaws—it must be recharged every 24 hours using the Power Battery (see below), and all of its Powers are useless against anything colored yellow (i.e., a green hammer formed with Force Manipulation won't strike a yellow target; the ring's Sealed Systems Power is useless against yellow gases, etc.).

Power Battery [BODY: 25, Energy Absorption: 18, Invisibility: 15, R#: 2] The Power Battery is usable only to recharge the Power Ring every 24 hours (Energy Absorption). The ring-wielder can will the battery to turn invisible (Invisibility of 15).

What It Takes to be a Green Lantern

The members of the Green Lantern Corps are among the bravest and most noble beings in the universe. Any potential Green Lantern must meet all of the following requirements:

- Fearlessness:** GLs must have a SPIRIT of 12 or higher and the Iron Nerves Advantage. Additionally, all Green Lanterns must follow a strict code of behavior. Any deviation from this code can result in disciplinary action, including removal from the Corps.
- High Willpower:** The higher the Willpower, the more potent the GL. Creatures with WILLS below 15 will be selected for the Corps only under the most unusual circumstances.
- Honesty:** GLs must be completely honest and trustworthy
- Worthiness:** The GL must have a heroic Motivation.

Powers and Abilities

For all practical purposes, the feats Green Lantern can accomplish with his Power Ring are limited only by the strength of his will. Usually, the ring is not capable of reviving the dead or healing the chronically ill, though it will alter physical properties and laws, allowing Jordan to fly through space at a speed that is almost twice the speed of light and protect his body from physical harm. One of the ring's few limitations is that it must be recharged every 24 hours with a special Power Battery.

Hal Jordan is a seasoned hand-to-hand combatant and test pilot, even without his ring.

Personality/Role-playing

Originally brash and reckless, now Jordan's mission as a Green Lantern has been tempered with experience and loss. Although he will always be adventurous and strong-willed by nature, Jordan is now more careful and not so willing to jump into a situation head-first. Most of the time, he prefers to use his mind as much as, or more than, he uses his Power Ring.

Jordan was once in awe of the Green Lantern Corps and the Oan Guardians that led the Green Lanterns. Now he realizes that although they are powerful and wise, even the Guardians have their flaws. Now, more than ever, he questions their authority on decisions that seem opposed to his conscience, a behavior that has often led to reprimands from his superiors.

One of Hal's only insecurities is his relationships with women. He still mourns for Carol Ferris, whom he loved and for whom he once even gave up his ring. She became the villain known as Star Sapphire and is now one of the Green Lanterns' most deadly adversaries, a fact that causes Hal a great deal of emotional pain.

Using Green Lantern in Adventures

Like Superman, all of Hal's heroic peers admire and obey him. If the player heroes seem to be getting out of hand, Green Lantern is a good tool for roping them in and returning them to the right path. Also, the Green Lantern Corps itself is a futuristic version of the Knights of the Round Table. Green Lanterns act in a noble manner and help the downtrodden. If the heroes are in space and need a little assistance, you might add an encounter with a Green Lantern to your Adventure.

Subplots

Hal has been involved in several Job Subplots since he received his ring—in fact, the poor man can't keep a job because of his responsibilities as Green Lantern. Also, he is still involved in a Romantic Subplot with Carol Ferris, even though she now hates him.

Appearances in the DC HEROES Role-Playing Game, Second Edition

Background/Roster Book, The Otherwhere Quest, World in the Balance

Appearances in DC Comics

*Note: Pre-Crisis appearances are not part of present continuity.

Pre-Crisis: *Action Comics* #350, 365-366, 429, 437, 443-444, 470, 473, 480-481, 482 (behind the scenes), 483, 489, 514, 527; *Adventure Comics* #423, 451, 459-460; *All-Star Comics* #68; *Aquaman* (1) #18, 61; *The Atom* #8; *Blackhawk* (1) #228-230; *The Brave and The Bold* #28-30, 59, 69, 100, 134, 155, 173-174, 181; *Challengers of the Unknown* #87; *DC Comics Presents* #6, 26, 43, 71; *DC Special* #27; *DC Special Series* #1, 6, 26; *DC Super-Stars* #14; *Detective Comics* #350; *The Flash* (1) #131, 143, 158, 168, 175, 191, 199, 217-228, 230-231, 233-235, 237-238, 240-243, 245-246, 258, 275-277, 282-283, 332; *Green Lantern* (2) #1-87, 89-164, 166-198; *The Joker* #7; *Justice League of America* #1-33, 35-38, 40-42, 44-47, 49-52, 53 (behind the scenes), 54-56, 59-63, 65-66, 68, 70-74, 77-83, 86-92, 94 (behind the scenes), 95-100, 101 (behind the scenes), 102-115, 117, 119-122, 125-130, 132-133, 135, 136 (behind the scenes), 137, 139-144, 147-151, 153, 155-176, 179, 182-187, 189-190, 192-195, 197-200, 206, 209-212, 219-220, 224, 231, 240; *Limited Collectors' Edition* #C-41; *Metal Men* #54-55; *Mystery In Space* #75; *The New Adventures of Superman* #13; *The New Teen Titans* (1) #4-5; *The Phantom Zone* #2, 4; *The Saga of Swamp Thing* #24; *The Secret Society of Super-Villains* #2-5; *Showcase* #22-24, 100; *Super Friends* #3, 7-9, 25; *Supergirl* (1-2) #8, 20; *Superman* (1) #199, 220 (behind the scenes), 261 (behind the scenes), 311-312, 314, 327, 352, 367; *Superman Family* #171-172; *Superman's Girl Friend, Lois Lane* #74, 128; *Superman's Pal, Jimmy Olsen* #151; *Super-Team Family* #12; *Tales of the Green Lantern Corps* #1-3; *Teen Titans* #25; *Who's Who '85* #9; *Wonder Woman* (1) #212, 214, 222-223, 291, 300; *World's Finest Comics* #189, 201, 246, 250, 255, 274, 300, 302

Current: *Action Comics* #589, 601-635, 642, 650; *Adventures of Superman* #430, 449, 473; *Armageddon 2001* #2; *Batgirl Special* #1; *Blasters Special* #1; *Captain Atom* (3) #24; *Christmas With the Super-Heroes* #2; *Firestorm, the Nuclear Man* #66-69, 81; *Flash* (2) #8; *Green Arrow* (2) #19-20; *Green Lantern* (2) #199-205 (3) 1-10, 12-13, 16-17, 19; *Green Lantern Corps* #206-224; *Green Lantern: Emerald Dawn* #1-6; *Green Lantern: Emerald Dawn II* #1-6; *Green Lantern Special* #1-2; *Infinity, Inc.* #39 (flashback), 50 (flashback); *Invasion!* #2-3; *Justice League* #6; *Justice League America* #40; *Justice League Europe* #16 (flashback), 17, 26 (flashback); *Justice League International* #7, 10, 24; *Justice League of America* #249-250; *Justice League Quarterly* #3, 5 (flashback); *Justice League Spectacular* #1; *Millennium* #1-8; *Mister Miracle* (2) #17; *New Gods* (3) #19; *The New Titans Annual* #5 (behind the scenes); *Power of The Atom* #8-9; *Secret Origins* (3) #7, 22 (flashback), 23 (flashback), 27 (flashback), 30 (flashback), 32, 36, 37-38 (flashback), 46, 50; *Secret Origins Annual* #3 (flashback); *Starman* #6, 13, 41-42; *Suicide Squad* #44; *Superman* (2) #14; *Time Masters* #7; *Who's Who '88* #1; *Who's Who '90* #3; *Wonder Woman* (2) #13

HAWK

DEX: 9	STR: 10	BODY: 10
INT: 3	WILL: 6	MIND: 5
INFL: 8	AURA: 7	SPIRIT: 8
INITIATIVE: 22		HERO POINTS: 50

- Powers:** Jumping: 2, Regeneration: 4, Running: 5
- Skills:** Acrobatics: 4, Military Science: 7, Thief: 7, Weaponry: 6
- Advantages:** Connections: New Titans (Low), U.S. Intelligence Community (Low); Insta-Change: Iron Nerves; Lightning Reflexes
- Drawbacks:** Mistrust; Serious Rage; Secret Identity; Miscellaneous: Hawk automatically reverts to his Hank Hall form when no injustice is present.
- Alter Ego:** Henry (Hank) Hall
- Motivation:** Seeking Justice
- Wealth:** 4

Hank Hall Form

When Hank Hall changes into the Hawk he actually takes on a whole new persona. While in his Hank Hall form, his statistics look like this:

HANK HALL

DEX: 4	STR: 4	BODY: 4
INT: 4	WILL: 6	MIND: 5
INFL: 6	AURA: 3	SPIRIT: 6
INITIATIVE: 16		

- Skills:** Martial Artist: 5, Military Science: 5, Thief: 5, Weaponry: 5

The Death of T'Charr

Hawk's abilities greatly increased with the added energy he received when Lord T'Charr of Chaos died. Before T'Charr's death, Hawk's DEX, STR, and BODY were rated at 7, 6, and 6 APs respectively, and he had no Powers. In this incarnation, all his other Attributes were identical to those of his Hank Hall form.

Hawk's Rage

Hawk walks the edge between Chaos and Order. If he ever rolls a natural 3 on 2D10 in a combat situation, he becomes enraged with Chaos and automatically enters Killing Combat, incurring all the

usual penalties for such a declaration (see *The Rules Manual*, page 18). Should this happen to Hawk too often, it is possible that he might succumb to Chaos forever.

Background Update

Hank Hall, after confronting a future version of himself, has now gone completely insane and has become the villain Monarch. For information on Monarch, see the Monarch entry in a later volume of our *Who's Who* series.

Powers and Abilities

As Hawk, Hank Hall has enough strength to demolish a concrete barrier and can easily withstand gunfire from large-caliber automatic rifles. Hawk can heal most injuries in about one minute, depending on their severity, but he cannot revert to his human form until all of the injuries that would be fatal to the human form have been healed. He can also jump about 150 feet and run at 65 miles per hour.

Personality/Role-playing

Hank Hall has always been a swaggering tough guy who cannot show his gentler emotions. It is difficult for him to be close to anyone, especially since his brother Don's death. This tendency becomes even more pronounced when he's in his Hawk form. The spell that causes his transformation to Hawk affects him not only physically, but mentally as well, causing him to be more chaotic, destructive, and always on the edge of going over to the side of Chaos completely. His partner, Dove, has a restraining influence on Hawk, but without her influence, he is virtually uncontrollable. As a result, other super-heroes mistrust him, as is evidenced by his dismissal from the New Titans.

One of Hank's biggest emotional problems is the guilt he feels over his brother's death. This sometimes cripples him or sends him into a rage, depending on the situation. Hank is also confused about the gentle feelings he has for his girlfriend Renata.

Using Hawk in Adventures

Hawk is known for his mad rampages. Perhaps the player heroes must try to control him and keep him from going berserk. This is a good way to test

the patience of the heroes and put them into a tight spot. Despite his problems, Hank is still a hero. Just how far are the player heroes willing to allow him to go in the name of justice.

Subplots

Many of Hawk's Subplots deal with his Family, particularly his brother and Hank's guilt over Don's death. He is involved Romantically with his girlfriend Renata, but he also has warm feelings for his partner Dove.

Appearances in the DC HEROES Role-Playing Game, Second Edition

Background/Roster Book, New Titans Sourcebook

Appearances in DC Comics

***Note:** Pre-Crisis appearances are not part of present continuity.

Pre-Crisis: *The Brave and The Bold* #181; *Crisis On Infinite Earths* #9, 12; *The Hawk and The Dove* (1) #1-6; *Showcase* #75, 100; *Tales of the Teen Titans* #50; *Teen Titans* #21, 25-29, 31, 50-52; *Who's Who '85* #10

Current: *Armageddon: Alien Agenda* #1-4; *Armageddon 2001* #1-2; *Booster Gold* #16-17; *The Doom Patrol and Suicide Squad Special* #1; *The Fury of Firestorm* #55-56; *Hawk and Dove* (2) #1-5 (3) 1-28; *Hawk and Dove Annual* #1-2; *Invasion!* #2; *Justice League America* #42; *New Gods* (3) #15; *The New Teen Titans* (2) #19-21, 24; *The New Titans* #56; *Secret Origins* (3) #43; *Secret Origins Annual* #3; *Teen Titans Spotlight* #7-8; *Who's Who '90* #1

Hawk's Apartment

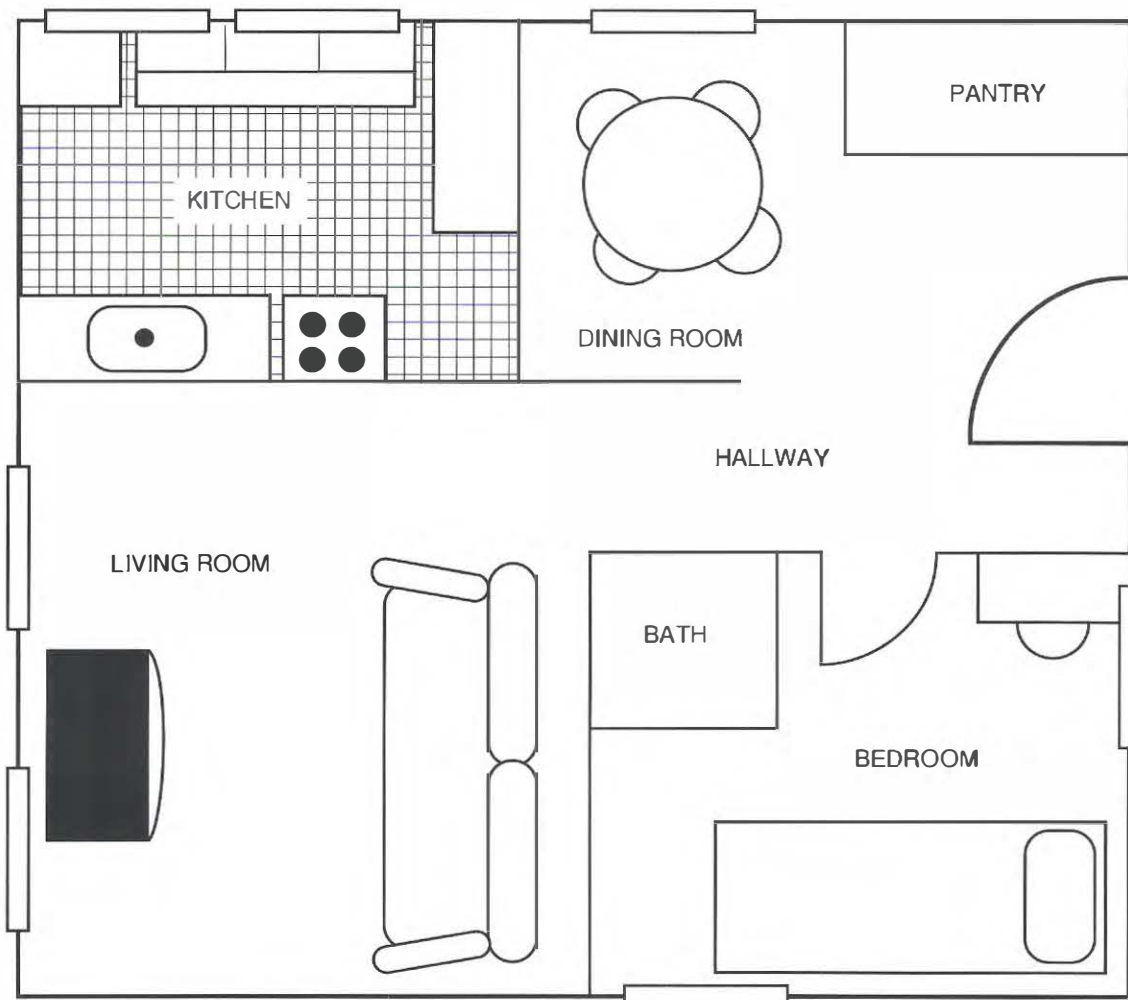

HUMAN TARGET

DEX: 6	STR: 4	BODY: 4
INT: 8	WILL: 9	MIND: 6
INFL: 8	AURA: 6	SPIRIT: 6
INITIATIVE: 24	HERO POINTS: 60	

- Skills:** Acrobatics: 3, Artist (Actor): 10, Detective: 7, Martial Artist: 6, Military Science: 7, Thief: 7, Vehicles: 6, Weaponry: 7
- Advantages:** Connections: Street (High), Underworld (Low)
- Drawbacks:** Serious Irrational Attraction to setting himself up as a target in order to protect others
- Alter Ego:** Christopher Chance
- Motivation:** Seeking Justice
- Wealth:** 11
- Equipment:**

Pistol [EV: 5, BODY: 4, Ammo: 6, R#: 2]

Disguise Kit [BODY: 1, Chameleon: 10] With the disguise kit, Human Target can make himself resemble almost any male of his approximate size and weight. The kit's Chameleon Power is limited to the user's APs of Artist (Actor) Skill; Human Target's Artist (Actor) rating of 10 allows him to use the kit's full rating.

Impersonating a Subject

The Human Target's preferred tactic is to assume the identity of a client and goad the assassins into coming after him. To do so, he uses both his disguise kit and his Artist (Actor) Skill. Anyone encountered by the Human Target while he is in disguise gets two Perception Checks to penetrate his deception. The first Check represents the observer's ability to spot a flaw in the Human Target's physical appearance. The OV and RV of this Check are both equal to the disguise kit's APs of Chameleon Power. The second Check represents the observer's ability to spot a flaw in the Human Target's personality and mannerisms. The OV and RV of this Check are both equal to the Target's APs of Artist (Actor). If the observer is well acquainted with the subject the Human Target is impersonating, he is entitled to a -2 Column Shift bonus to the OV and RV of both Perception Checks.

Powers and Abilities

The Human Target has trained his mind and body for years. He is in peak physical condition, an Olympic-level athlete, and a master marksman and martial artist. His most useful abilities, however, are his mastery of disguise and impersonation. He will assume any role, the more challenging the better, except those he cannot duplicate physically.

Personality/Role-playing

Christopher Chance is a man with a mission; he wants to avenge his father's death at the hands of an underworld enforcer. To that end, the Human Target protects innocent victims from danger by putting himself in their place. He is clever, perceptive, and always has a well-developed plan. Chance combines nerves of steel with a warm, caring personality.

Although he does charge a fee (ten percent of a year's salary whether you are a poor college student or a billionaire), Chance never takes a case for the money. Any funds he acquires are needed to keep his business operational.

Chance's modus operandi is to disguise himself as his clients, assume the clients' roles, and place himself in danger while the clients are safely out of harm's way. When the forces endangering the victim are close (most of Chance's clients have been targeted for death), Chance breaks from his disguise and apprehends the assassins.

Using the Human Target in Adventures

The Human Target can appear anywhere at any time. Since he is a master of disguise, he can be just about anyone the heroes meet. It might be interesting if, near the end of an Adventure, one of your Non-Player Characters suddenly reveals himself as the Human Target. Unknown to the player heroes, the Target was protecting a client and secretly assisting them all through the Adventure.

Subplots

Most of Christopher Chance's Subplots are centered around his Job as a gangbuster and body guard.

Appearances in DC Comics

Current: *Action Comics Weekly* #641; *Human Target Special* #1; *Who's Who '90* #4

***Note:** Pre-Crisis appearances are not part of present continuity.

Pre-Crisis: *Action Comics* #419-420, 422-423, 425-426, 429, 432; *Batman* #349, 351-352; *The Brave and The Bold* #143-144; *Crisis On Infinite Earths* #11; *Detective Comics* #483-484, 486, 493, 500, 515, 517-518; *Human Target Special* #1; *Who's Who '85* #10

Human Target's Gun

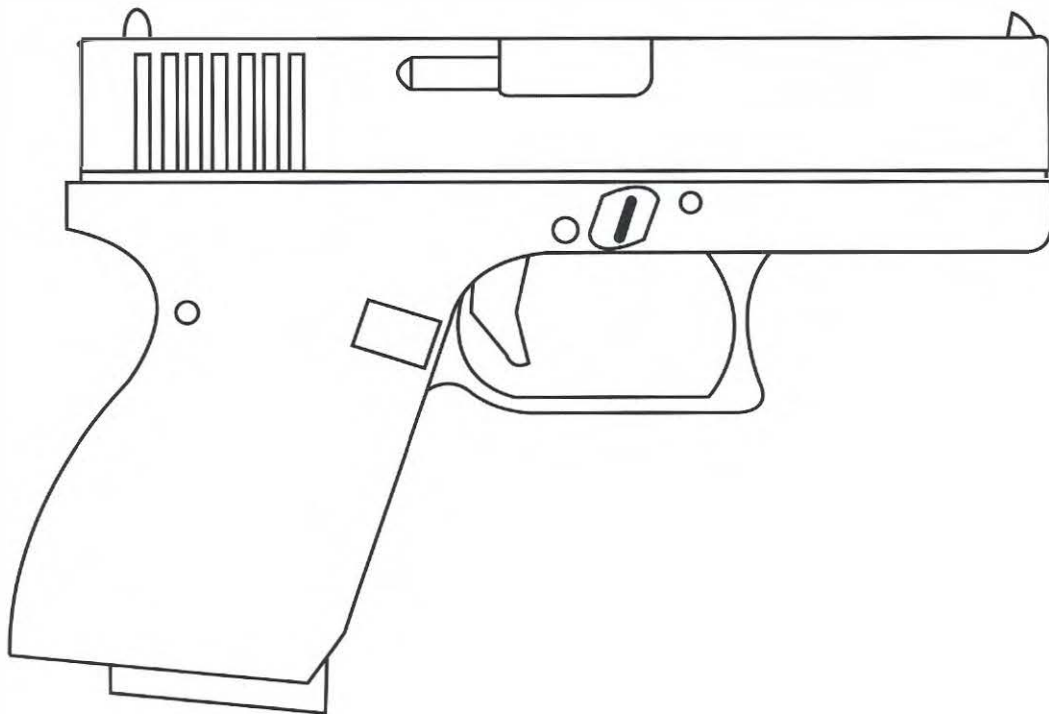

ICE

DEX: 6	STR: 3	BODY: 6
INT: 4	WILL: 5	MIND: 5
INFL: 4	AURA: 4	SPIRIT: 4
INITIATIVE: 14	HERO POINTS: 40	

•**Powers** **Mystic Linked*

Ice Production: 8*

•**Advantages:** Attractive; Connections: Justice League International (High), Global Guardians (High)

•**Drawbacks:** Innocent

•**Alter Ego:** Tora Olafsdotter

•**Motivation:** Upholding the Good

•**Wealth:** 6

Ice Production

With her Ice Production Power, Ice can perform many feats, including the abilities to:

•**Create solid objects:** She may automatically make solid constructs of ice (walls, bridges, etc.) with a volume and BODY both equal to her APs of Power.

•**Create ice shields:** She may create an "ice shield," enabling her to add her APs of Power to her RV in defense against Physical Attacks but preventing her from making any Physical Attack (even an Ice Production attack).

•**Trap objects:** She can trap a target in a block of ice. To do so, she makes an Action Check against an OV/RV equal to the target's DEX/STR. RAPs equal the BODY and volume of the ice block that entraps the target. While entrapped, the target's DEX is reduced by the RAPs earned on the original Ice Production attack, and the target cannot walk, run, or fly.

•**Attack:** Or she may simply attack targets Physically with an AV and EV both equal to her APs of Power.

Powers and Abilities

Tora can magically produce and shape large volumes of ice. Usually, she is capable of creating up to 12.5 tons or 500 cubic feet of solid ice or snow, depending on her whims. She can shape the ice she creates into anything from a snowdrift to a small iceberg that encases an adversary. When encased, her

victims are in a state of suspended animation until she releases them or until the ice melts. Since she has possessed these abilities all her life, she is well-versed in their application and capable of using them to their best advantage.

Personality/Role-playing

Tora is shy but good-natured, a complete outsider from the civilized world and its customs. Since her friend Fire has always served as her tutor, Tora has formed a somewhat unusual view of the modern world.

Despite the fact that she has now adventured alongside the JLI for a couple of years now, Tora has yet to lose her naivete. America continually surprises her with its odd trends and strange contradictions. Even super-heroics make little sense to her (especially the bit about wearing funny costumes), but she enjoys the camaraderie and the excitement. Like her friend Fire, Tora is now enjoying a secondary career as a fashion model. Lately, she has discovered that she rather enjoys the glamour and excitement associated with big-time modeling.

Unlike other Justice Leaguers, Tora takes her role as an international ambassador very seriously. In fact, she is often amazed by some of the nonchalant attitudes of her teammates. In any case, Tora remains a team player, and she takes orders without a loss of pride. Often, she must take care not to let her teammates and friends take advantage of her giving nature.

Ice is the only member of the JLI who has ever shown any compassion for Guy Gardner. In fact, she once agreed to date him.

Using Ice in Adventures

Since she is certainly more approachable than most Justice Leaguers, Ice is an ideal source of information concerning the League and the villains it has battled. She might also provide the player heroes with information about the now-defunct Global Guardians and their adversaries.

Since she is so "straight-laced," Ice might make a good vehicle for chastising more free-spirited heroes.

Subplots

Ice is most often involved with Fire in either Job Subplots (regarding their modeling careers) or in Romantic Subplots (with Guy Gardner). She has many other male admirers, but most of the time she's too innocent to notice.

Appearances in the DC HEROES Role-Playing Game, Second Edition

Justice League Sourcebook, Background/Roster Book, World in the Balance

Appearances in DC Comics

* **Note:** Pre-Crisis appearances are not part of present continuity.

Pre-Crisis: *Super Friends* #9

Current: *Action Comics* #650; *Doctor Fate* (2) #14-15; *Doom Patrol* (2) #29; *Green Lantern* (3) #1, 9, 13, 18; *Infinity, Inc.* #32, 34-37; *Invasion!* #2-3; *Justice League America* #27-29, 31-32, 33 (behind the scenes), 35, 37, 39-40, 42, 44-45, 47, 49-50, 52-53, 55-58, 60; *Justice League America Annual* #5; *Justice League Annual* #2-3; *Justice League Europe* #3, 5, 7-8, 11-14, 28-32, 34; *Justice League Europe Annual* #2; *Justice League International* #12, 14-15, 18-25; *Justice League Quarterly* #1-5; *Justice League Special* #1-2; *Justice League Spectacular* #1; *Mister Miracle* (2) #15-17, 25-27; *Secret Origins* (3) #33; *Time Masters* #1; *War of the Gods* #2, 4; *Who's Who '88* #2; *Who's Who '90* #3; *Wonder Woman* (2) #25-26, 49-50, 61

JLI Signal Device

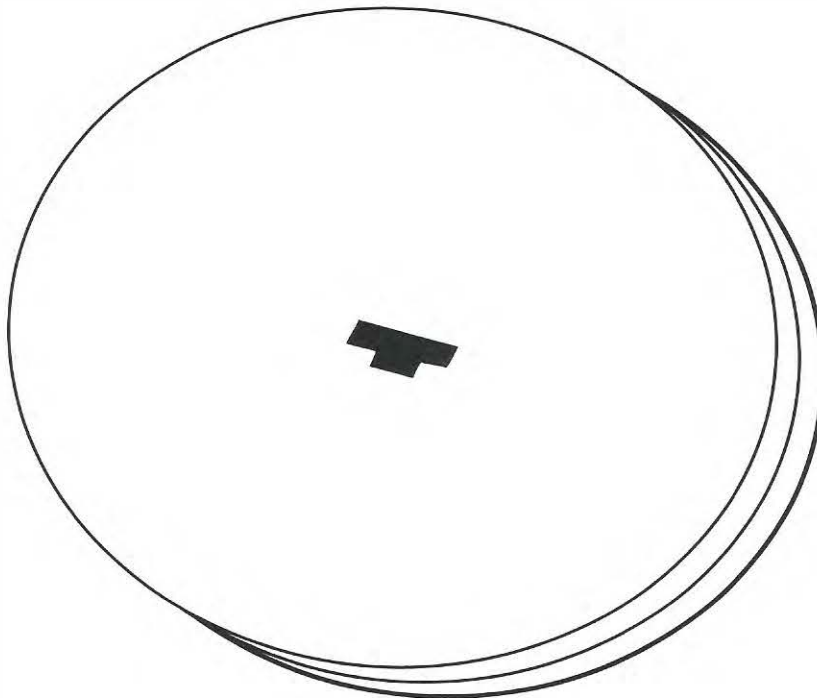

JADE

DEX: 6	STR: 3	BODY: 10
INT: 4	WILL: 16	MIND: 10
INFL: 6	AURA: 5	SPIRIT: 6
INITIATIVE: 16	HERO POINTS: 55	

•**Powers:** *Linked

Dispersal: 9, Flight: 14, Force Manipulation: 16*, Sealed Systems: 14, Skin Armor: 3, Telepathy: 20

•**Limitations:** Miscellaneous: Telepathy only allows Jade to communicate with her brother, Obsidian; Miscellaneous: Jade's Powers are useless against wooden objects.

•**Skills:** Artist (Actor): 3

•**Advantages:** Connections: Infinity Inc. (High), Justice Society of America (High); Insta-Change

•**Alter-Ego:** Jennie-Lynn Hayden

•**Motivation:** Thrill of Adventure

•**Wealth:** 5

Jade's Green Energy

Jade's Powers are all internalized versions of the capabilities of the mystical Power Ring worn by the Golden Age Green Lantern. With her most prominent Power, Force Manipulation, she can shape green energy into just about any physical construct. When Jade creates an object, she divides her APs of Force Manipulation among all of the object's Attributes and abilities. Such objects can have Physical Attributes, Physical Powers, and Skills with Physical Link Attributes. Here are some examples:

Boat [STR: 5, BODY: 5, Swimming: 4]

Energy Bubble [BODY: 16]

Energy Fist [DEX: 5, STR: 9, BODY: 1]

Energy Trampoline [BODY: 10, Jumping: 6]

Energy Crane [STR: 10, BODY: 6]

Any object that Jade creates with a BODY of 0 automatically dissipates into nothingness the instant it strikes any physical object.

Jade and Wood

Like the Golden Age Green Lantern, Jade is vulnerable to wooden objects. For example, her Skin Armor won't protect her against wooden weapons, her Force Manipulation cannot be used to pick up or

attack wooden objects, she cannot use Dispersal to pass through wood, etc.

Jade and Obsidian

Jade has a strange sort of psychic connection with her brother, Todd Rice (Obsidian). The two can somehow read each other's surface thoughts from more than 1,000 miles away. In DC HEROES terms, this ability is represented by Jade's Telepathy Power.

Powers and Abilities

Like Green Lantern, Jade controls a powerful green energy by force of will and can use it for almost anything—flight, force shields, even the creation of weapons or giant objects (weighing up to 900 tons with a maximum volume of 65,000 cubic feet). Jade also has the ability to contact her brother, Todd, telepathically. Her Powers originate from a green, star-shaped birthmark on her left palm, which Jade calls her Power Pulse. If she is tired or distracted, her power wanes.

Unlike a Green Lantern, Jade does not need to recharge her energy.

Personality/Role-playing

Jennie-Lynn Hayden is the spunky, energetic, and vivacious daughter of the Golden Age Green Lantern, Alan Scott. Because she is open and friendly while Obsidian is more introverted, Jade often plays intermediary between him and others. With her perky attitude, she always tries to cheer her melancholy sibling, and in return, he looks out for his overzealous, adventurous sister. Jade and Obsidian have grown very close and work well as a team.

Jennie-Lynn became an actress because she loves attention. Often, she will grab center stage, where she can enjoy the acclaim she receives from her exploits as a hero. This does not mean, however, that she is not serious about her responsibilities. Jennie-Lynn is a true team player who rarely allows her ego to affect her judgement.

Jade loves the challenge of being a super-hero but does not always have the necessary discipline. Although she is in excellent physical condition, she has never received combat training. In battle, she relies heavily on her Powers and imagination to protect herself.

Using Jade in Adventures

Jade is a good source of information about old Infinity, Inc. villains as well as a link to the Golden Age Justice Society of America. She is also a West Coast hero whom the Player Characters might meet while traveling through California.

Subplots

Jade is involved in a Family Subplot with her brother, Obsidian, and her father, Alan Scott, as well as a Romantic Subplot with her former teammate, Brainwave.

Appearances in the DC HEROES Role-Playing Game, Second Edition

Background/Roster Book

Appearances in DC Comics

* **Note:** Pre-Crisis appearances are not part of present continuity.

Pre-Crisis: *All-Star Squadron* #25-26, 53; *All-Star Squadron Annual* #2; *America vs. Justice Society* #1-2, 4; *Crisis on Infinite Earths* #4-5, 7, 9-12; *Infinity, Inc.* #1-23; *Infinity, Inc. Annual* #1; *Who's Who '86* #11

Current: *Armageddon 2001* #2; *Blasters Special* #1; *Flash Annual* #3; *Green Lantern* (3) #19; *Infinity, Inc.* #25-47, 49-53; *Infinity, Inc. Annual* #2; *Infinity, Inc. Special* #1; *Last Days of the Justice Society Special* #1; *Millennium* #1, 3-8; *The New Teen Titans* (2) #38; *The Outsiders Special* #1; *Secret Origins* (3) #9; *Superman* (2) #46; *War of the Gods* #4; *Who's Who '90* #3; *Wonder Woman* (2) #13

Jade's Birthmark

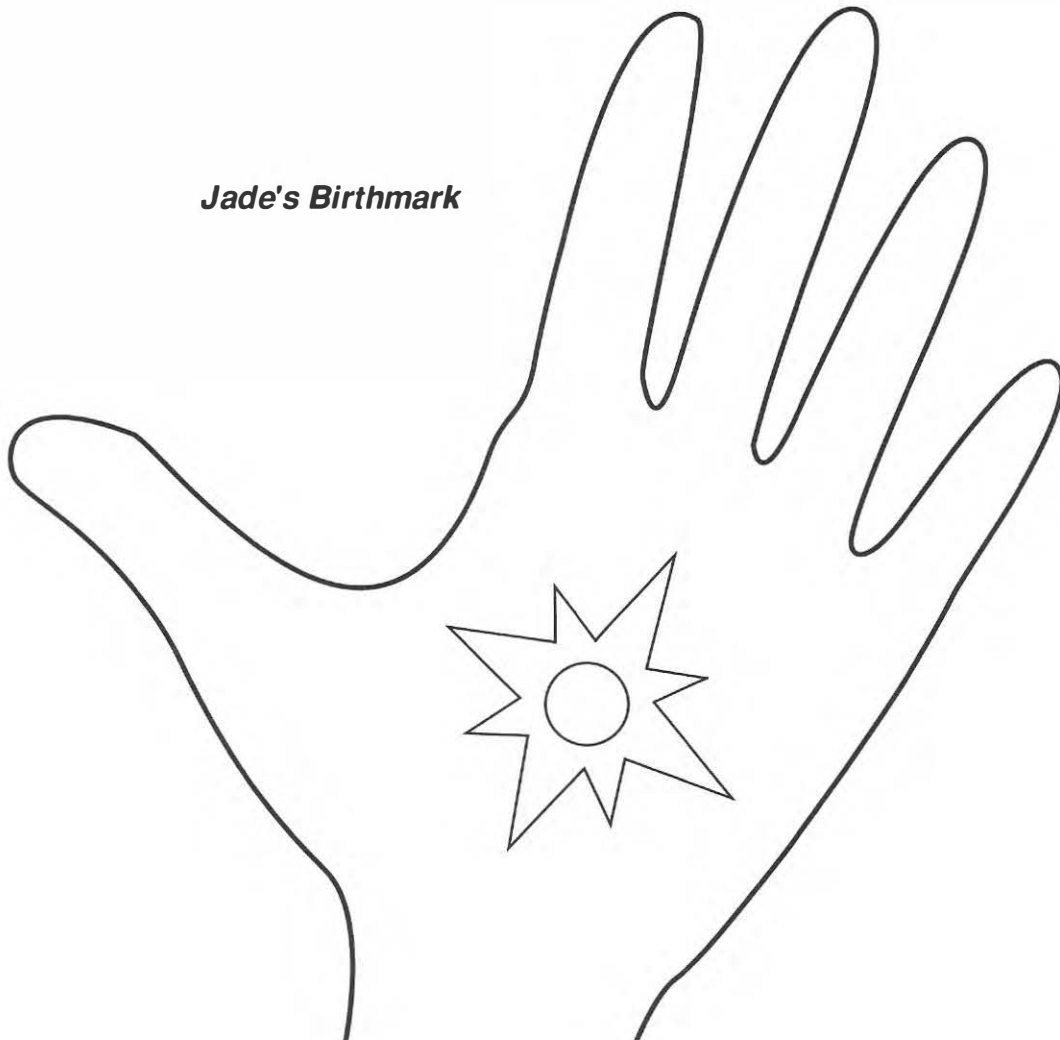

JERICO- *deceased*

DEX: 6	STR: 3	BODY: 5
INT: 7	WILL: 6	MIND: 6
INFL: 7	AURA: 6	SPIRIT: 5
INITIATIVE: 21	HERO POINTS: 60	

- Powers:** Mind Probe: 6, Personality Transfer: 12
- Skills:** Artist: 5, Charisma: 7, Martial Artist: 6
- Limitations:** Miscellaneous: Jericho must make eye contact with his target in order to use his Personality Transfer Power; Miscellaneous: since Jericho is mute, his Personality Transfer Power does not allow him to control the vocal cords of his victims unless he transfers into an unconscious victim; Miscellaneous: Mind Probe only works on victims Jericho has possessed.
- Advantages:** Connections: Mercenary Community (High), New Titans (High); Rich Family (Adeline Wilson).
- Drawbacks:** Serious Irrational Attraction to art and art works; Serious Physical Restriction: Jericho is mute.
- Alter Ego:** Joseph William Wilson
- Motivation:** Upholding the Good
- Wealth:** 5

Jericho's Personality Transfer

Jericho had to make eye contact with his target when using his Personality Transfer Power. If the target was aware of this Limitation, use Jericho's DEX as the AV of his Personality Transfer Action Check rather than his APs of Power (this represents the target's attempts to shield his eyes and look away).

Because Jericho was a mute, he was not capable of controlling the vocal cords of his Personality Transfer victims unless the victim was unconscious at the time of possession. While Jericho was in possession of his body, the victim could still shout out warnings or use his vocal cords in any other fashion.

Jericho sometimes read the minds of the victims he possessed. Once he had successfully used Personality Transfer on a target, he could attempt to Mind Probe that target.

Background Update

After the realm of Azarath was destroyed, the essence of its people quickly sought a new resting

place in order to survive. The Azarathians chose Jericho, because he was more prone to psychic possession than his teammates. Contaminated by the Azarathian evil, Jericho captured his friends and subdued them in order to spread the consciousnesses of the Azarathians among them. During this era, he was evil and cured of his speech disability. Before Jericho could completely fulfill the plans of his evil possessors, his father, Deathstroke, killed him, sending the Azarathians to their final rest as well.

While Jericho was possessed by the citizens of Azarath, he had the following statistics:

JERICO (AZARATHIAN POSSESSION)

DEX: 9	STR: 12	BODY: 6
INT: 8	WILL: 8	MIND: 6
INFL: 11	AURA: 11	SPIRIT: 9
INITIATIVE: 27	HERO POINTS: 60	

- Powers:** **Soul Self*
Flame Project: 14, Force Field: 17*, Mind Probe: 6, Personality Transfer: 12, Phobia: 15*, Spirit Travel: 8*, Teleport: 20
- Bonus:** Flame Projection is invisible and can disintegrate opponents.
- Motivation:** Nihilist

Powers and Abilities

Jericho's power allowed him to take over an adversary's body by making direct eye contact. When this happened, Jericho's body disappeared and his spirit transferred into his opponent's body. His victim's psyche was pushed into unconsciousness while Jericho controlled the body and abilities of the victim. While in this state, Jericho could probe the victim's mind.

Due to the training he received from his mother and father, Jericho was an excellent hand-to-hand combatant, and he knew numerous martial-arts techniques.

Personality/Role-playing

Jericho was a warm, loving man without a malicious bone in his body. His mannerisms were gentle and friendly, and he had many female friends, platonic and otherwise. Joey had a tremendous sensitivity and cared deeply for his friends. He was not violent and did not enter combat lightly.

Art always held a strong attachment for Joey. During his career with the Titans, he went to great

lengths to save artwork that was jeopardized by battle. He also played guitar and painted the portraits of the Titans that hang in the meeting room on level two of the Titans Tower.

Using Jericho in Adventures

Jericho was someone the heroes could consult whenever there was a question about art or art history. When using him as a Non-Player Character, it might be good to learn some sign language or have a book on sign language handy. It might make for some interesting and educational interaction.

Although Jericho seemed preoccupied with his fellow Titans during the Azarathian possession, he could realistically search for other worthy vessels for Azarathian control. As a villain, therefore, he might seek out the heroes for this purpose should he somehow return from the grave.

Appearances in the DC HEROES Role-Playing Game, Second Edition

Background/Roster Book (includes card), New Titans Sourcebook

Appearances in DC Comics

***Note:** Pre-Crisis appearances are not part of present continuity.

Pre-Crisis: *All-Star Squadron* #53; *Crisis On Infinite Earths* #3-5, 9; *The New Teen Titans* (2) #1-14; *The New Teen Titans Annual* (2) #1; *Tales of the Teen Titans* #42-48, 50-52, 56-58; *Teen Titans Annual* #3; *Who's Who '86* #11

Current: *Action Comics* #584; *Batman* #440; *Blue Beetle* (6) #11-13; *Hawk and Dove* (3) #11-12; *The New Teen Titans* (2) #15-18, 20, 22, 24-31, 33-37, 39-49; *The New Teen Titans Annual* (2) #2-4; *The New Titans* #50-55, 57-69, 71-79, 82-84; *The New Titans Annual* #5-7; *The Omega Men* #34-35; *Secret Origins* (3) #13, 46; *Secret Origins Annual* #3; *Teen Titans Spotlight* #3-6; *Who's Who '90* #1

Jericho's Rooms in Titans Tower

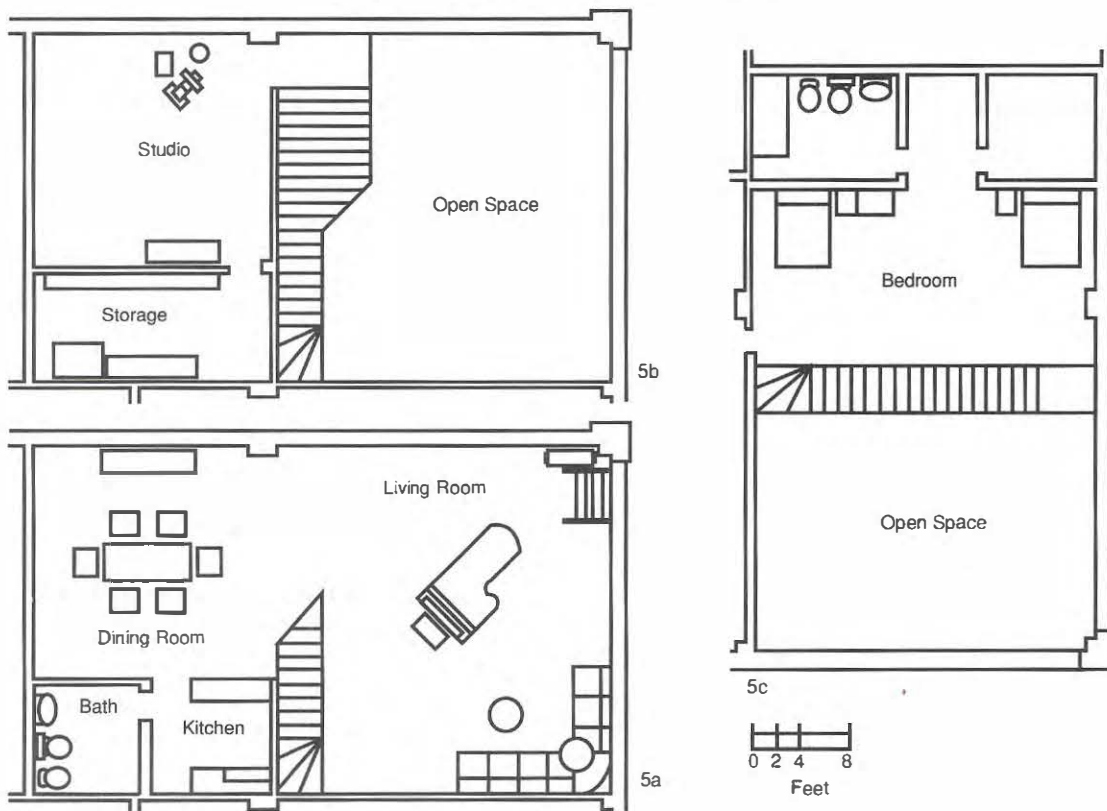

KATANA

DEX: 9	STR: 4	BODY: 5
INT: 7	WILL: 8	MIND: 8
INFL: 8	AURA: 7	SPIRIT: 8
INITIATIVE: 28		HERO POINTS: 65

•**Skills:** *Linked

Acrobatics: 5, Martial Artist: 9*, Medicine: 5, Thief: 9*, Weaponry: 9*

•**Advantages:** Connections: Batman (Low), Outsiders (High); Intensive Training; Iron Nerves; Lightning Reflexes; Scholar (Japanese language and customs, rare books)

•**Drawbacks:** Minor Irrational Attraction to mothering Halo

•**Alter Ego:** Tatsu Yamashiro

•**Motivation:** Seeking Justice

•**Wealth:** 6

•**Equipment:**

Soultaker Sword [EV: 5, BODY: 16, Spirit Drain: 13, Control: 13] When a victim is killed with the Soultaker sword, his immortal soul becomes permanently trapped within the blade. If Soultaker is used to inflict a death blow (i.e. a Killing Combat attack that finally reduces the target's Current Body Condition to less than zero), Katana immediately rolls a Spirit Drain attack against the victim and temporarily adds the drained RAPs to her own SPIRIT as described on page 52 of the *Character Handbook*. But whether or not the Spirit Drain succeeds, the victim's soul is still trapped within Katana's blade.

By holding the sword and concentrating, Katana can telepathically communicate with any soul trapped within. She can even force the trapped souls to give her information. Make an Action Check using the sword's APs of Control as the AV/EV against an OV/RV equal to the target's INFL/SPIRIT. Treat the RAPs earned as Knowledge Points gained.

By performing a complex ritual that takes one full hour (10 APs), Katana can even temporarily release a soul from the blade and compel it to serve her. To draw a victim out of the sword, Katana must make a successful Action Check using her INFL/AURA as the AV/EV against an OV/RV equal to the target's INFL/SPIRIT. Thereafter, she is allowed to make a normal Control attack against the soul (*Character Handbook*, p. 34). If the Control attack fails, the soul instantly returns to the blade. Otherwise, the soul returns to the blade after

it performs the tasks Katana assigns it. Souls released in this fashion have all the Attributes, Powers, and Skills they had while alive.

Short Sword [EV: 4, BODY: 13]

Shuriken (x8) [EV: 2, BODY: 7, Gliding: 1] Katana can throw up to four shuriken in a single phase. She adds one to her final dice roll (after rerolling doubles) for each shuriken she throws after the first. The shuriken have a range equal to the thrower's STR plus the weapon's single AP of Gliding—5 APs, or 100 yards, in Katana's case.

Katana and Halo

After her own children were murdered, Katana transferred her maternal feelings to Halo, her teammate. Whenever Halo is threatened, Katana must Check against her Irrational Attraction to avoid intervening.

Katana's Healing Abilities

Katana's Medicine Skill represents her expert knowledge of Japanese and Chinese herbal healing techniques. Katana can use only the Medical Treatment and First Aid Subskills of Medicine and only if she has access to the herbs, teas, and roots she needs.

Powers and Abilities

Tatsu is master in all forms of the Japanese martial arts, and continually trains to stay in top form. Both her body and mind are in peak condition.

Katana wields a special sword called Soultaker, which can drain the spirit of those who are killed by it, providing its bearer with spiritual power. Among the souls residing in the sword is that of Tatsu's husband, and she can use it to communicate with him (or any other soul trapped in the blade) telepathically. With the sword, Katana can also create corporeal forms for the souls trapped within the blade and force them to do her bidding for short periods of time.

Tatsu is also a skilled healer, using ancient Oriental knowledge and natural remedies to treat injured teammates or others in need.

Personality/Role-playing

Katana is one of the most accomplished martial artists in the world. Driven by a strong force of will and a sense of justice and honor, she took up the art of the katana sword to exact vengeance for the death

of her children and husband at the hands of a ruthless killer.

Although she can be merciless when fighting, even to the point of entering into **Killing Combat**, Tatsu has proven that she can be a very compassionate person. She can be very motherly in her affections, particularly toward her roommate, Halo. She has lost everyone she has ever loved, so it is difficult, though not impossible, for her to open up to others.

Using Katana in Adventures

Katana is one of the tougher heroes in the DC Universe. Most of the time she can be unmoving, and this can present a challenge for the player heroes.

The heroes might meet Katana during an investigation in which they are called upon to ask questions of one of the souls trapped in her sword.

Appearances in DC Comics

* **Note:** Pre-Crisis appearances are not part of present continuity.

Pre-Crisis: *All-Star Squadron* #53; *Batman and the Outsiders* #1-27; *Batman and the Outsiders Annual* #1; *The Brave and The Bold* #200; *Crisis On Infinite Earths* #3-7, 9-10, 12; *DC Comics Presents* #83; *The New Teen Titans* (1) #37; (2) 13; *Red Tornado* #3; *Teen Titans Annual* #3; *Who's Who '86* #12; *World's Finest Comics* #300, 302

Current: *Adventures of the Outsiders* #33-38; *Batman and the Outsiders* #28-32; *Batman and the Outsiders Annual* #2; *Firestorm, the Nuclear Man* #67; *Flash* (2) #8; *Infinity, Inc. Special* #1; *Invasion!* #2; *Millennium* #1, 3, 5; *The Outsiders* #1-28; *The Outsiders Annual* #1; *The Outsiders Special* #1; *Secret Origins* (3) #6 (flashback); *Suicide Squad* #53-57; *War of the Gods* #4; *Who's Who '90* #2

The Soutaker Sword



cross-section

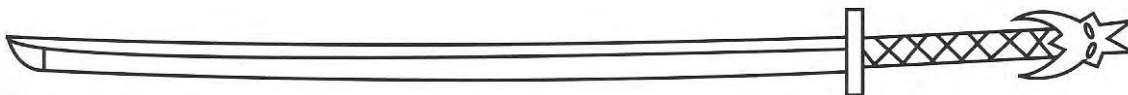
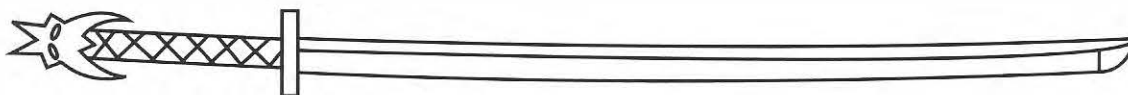

KING FARADAY

DEX:	6	STR:	4	BODY:	4
INT:	8	WILL:	8	MIND:	7
INFL:	7	AURA:	7	SPIRIT:	7
INITIATIVE:	23	HERO POINTS:	65		

- Skills:** Detective: 8, Gadgetry: 6, Martial Artist: 6, Military Science: 8, Thief: 7, Vehicles: 6, Weaponry: 6
- Advantages:** Connections: Central Bureau of Intelligence (High), Intelligence Community (High), New Titans (High), Suicide Squad (Low); Omni-Connection; Scholar (espionage, computer science)
- Drawbacks:** Age (old)
- Alter Ego:** I-Spy (code-name)
- Motivation:** Upholding the Good
- Wealth:** 8
- Equipment:**

Pistol [EV: 5, Body: 4, Ammo: 6, R#: 2]

Miniature Spy Camera [Body: 1, Recall: 8, R#: 2]

Faraday's spy camera is no bigger than the palm of his hand. The camera's Recall Power is restricted to visual information. Use the camera's APs of Power as both the AV and EV of any "Perception Checks" that are made to determine whether or not a subtle detail shows up in a picture taken with the camera. Faraday can take up to 16 snapshots with a single roll of film.

The Central Bureau of Intelligence

When King Faraday joined the CBI, it was a small network of operatives under the direct control of the President of the United States. In those days, the group had a Wealth rating of 13 and consisted of about a dozen agents. After a series of stunning successes, the CBI grew in size and influence. At its height, the organization had a Wealth rating of 17 and employed 45 operatives. It was during this era that the U.S. government began to experiment with the employment of meta-human operatives. As part of one of these early experiments, Faraday was assigned to act as a liaison between the CBI and the New Teen Titans.

The current CBI is much smaller. Now under the complete control of Faraday, the organization employs fewer than a dozen operatives (Wealth

rating of 13). Faraday reports directly to Sarge Steel, the Cabinet-level Director of Meta-Human Activities.

Powers and Abilities

Throughout the course of his career, Faraday has received extensive physical training. Even now, as he grows older, Faraday has a lot of fight left in him. In addition to his physical capabilities, Faraday is a formidable detective and spy. He is expert at subterfuge, demolitions, foreign languages, computer technology, and military tactics.

Personality/Role-playing

A patriotic young man, Faraday believed he could best serve his country by offering his talents to the government as an intelligence operative. Adventurous and bright, he joined the fledgling Central Bureau of Intelligence at a young age and tackled each mission with determination and style. Before long, he was a top-notch spy—smooth, witty, dangerous, and earnest.

Although retired from field duty, I-Spy is well-respected in the intelligence and hero communities. As Director of the CBI, he takes great pride in the organization and its work. Largely due to Faraday's dedication, the CBI is now the most technologically advanced of America's intelligence operations.

Using I-Spy in Adventures

In Adventures, I-Spy is likely to show up in his role as government agent. Anytime and anywhere there is a threat to national security, King Faraday is bound to be nearby.

Faraday might also provide the player heroes with a Connection to the Suicide Squad since he has a great deal of influence over Amanda Waller, the Squad's leader.

Subplots

Faraday is involved in numerous Subplots dealing with political support for the CBI and political conspiracies within the CBI.

Appearances in DC Comics

* **Note:** Pre-Crisis appearances are not part of present continuity.

Pre-Crisis: *Adventure Comics Presents Dial "H" For Hero* #483; *Batman* #313-314, 333-335; *Danger Trail* #1-4; *The Flash* (1) #290-291; *The New Teen Titans* (1) #10 (behind the scenes), 18; *Showcase* #50, 100; *Who's Who '86* #12; *World's Finest Comics* #64

Current: *Ms. Tree Quarterly* #8; *The New Teen Titans* (2) #19-21, 44, 49 (behind the scenes); *The New Teen Titans Annual* (2) #3; *The New Titans* #58; *Secret Origins* (3) #28; *Suicide Squad* #28-29, 38; *Who's Who '90* #2

Spy Camera

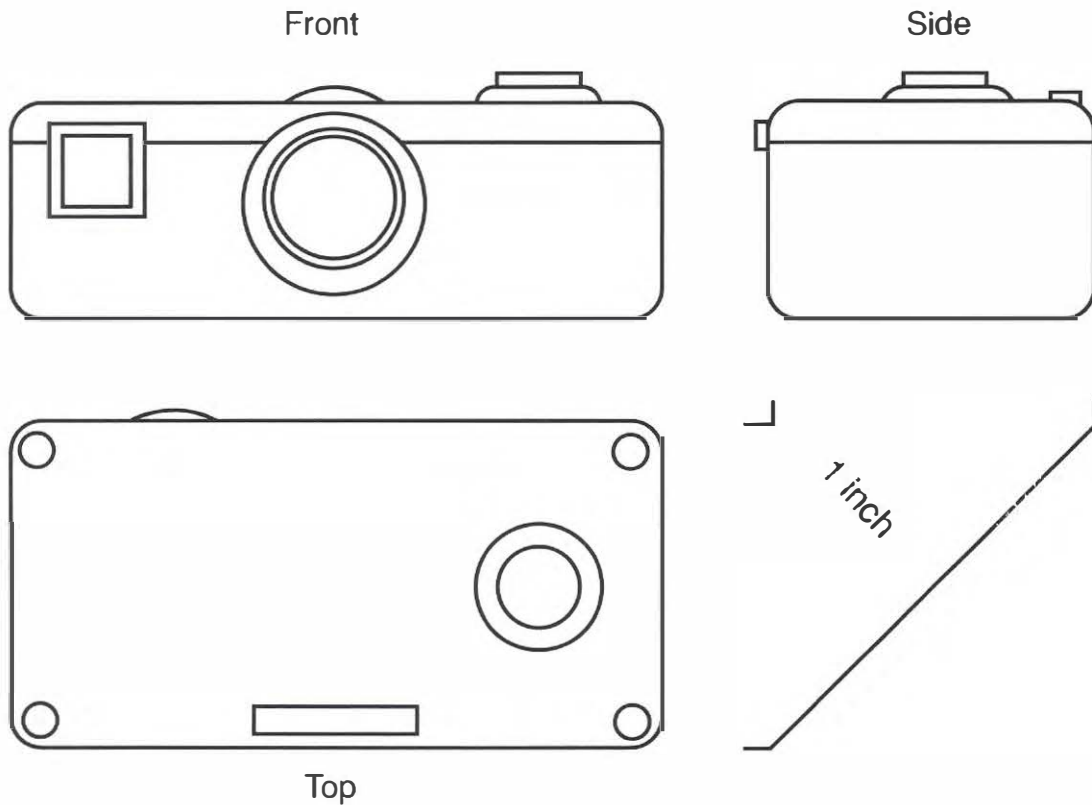

KONO

DEX:	6	STR:	3	BODY:	4
INT:	6	WILL:	5	MIND:	5
INFL:	6	AURA:	5	SPIRIT:	7
INITIATIVE:	18	HERO POINTS:	40		

- Powers:** Density Increase: 9, Dispersal: 9, Gravity Decrease: 9, Gravity Increase: 9, Teleportation: 7
- Skills:** Thief: 6
- Bonuses:** Miscellaneous: Density Increase and Dispersal are both Usable on Others. To use either of these Powers on an unwilling target, Kono must make a successful Action Check against an OV/RV equal to the target's BODY/BODY. To use Density Increase on either herself or another, Kono must use equal APs of Gravity Decrease on a nearby object, and vice versa. To use Dispersal on herself or another, Kono must use equal APs of Density Increase on a nearby object, and vice versa.
- Limitations:** Miscellaneous: Teleportation is only usable to remove small objects from another's person and transfer them to Kono; Miscellaneous: When using her Powers, Kono's clothes disappear unless she exercises extreme concentration (no Actions other than using her Powers are possible while she is concentrating in this fashion).
- Advantages:** Connections: Legion of Super-Heroes (High), Jo Nah's smuggling ring (High)
- Drawbacks:** Minor Irrational Attraction to rebelling against authority and male domination
- Alter Ego:** Brita An'nan
- Motivation:** Thrill of Adventure
- Wealth:** 3

Kono's 'Light Fingers'

By using her Powers in a creative fashion, Kono can transfer small objects away from a target and into her own hands, making her an excellent pickpocket. This ability has a range of approximately 50 yards (4 APs).

Removing an object from a target's pocket or belt is an Automatic Action. If the victim receives 1 or more RAPs on a Perception Check against an OV and RV both equal to Kono's APs of Teleportation, he notices the theft.

Removing an object from a target's hand is a standard Take Away using Kono's APs of Teleportation as the AV/EV.

Powers and Abilities

Kono's Powers allow her to transfer mass from one body or object to another or to herself. She uses this ability to change her own density to pass through solids, allowing her to move like a shadow or defend herself from physical attacks. Kono has also mastered the art of transferring small objects out of the hands of unwitting victims and into her own pockets.

Personality/Role-playing

Brita An'nan (her nickname, Kono, is derived from kono juice, her favorite drink) is a sassy, cocky newcomer to the Legion of Super-Heroes. She was introduced to the group by Jo Nah (formerly Ultra Boy) when he was invited to join the latest incarnation of the Legion.

True to her Sklarian heritage, Kono believes that males are inferior in every species. She rebels against authority figures and rules, but many of her teammates believe this tendency will dissipate as she grows older. In any case, Kono respects Jo Nah and usually follows his orders. Few other males have made such an impression on her, though she has recently grown attached to Furball. When she later learned that Furball is actually Brin Londo (formerly Timberwolf) and a humanoid male, she was both shocked and embarrassed.

Kono is a bit of a loner, feeling superior to most everyone else, and she is therefore set apart from the crowd. When she's bored, she wanders off on her own to find excitement, and usually ends up in trouble.

What Kono is lacking due to youth and inexperience, she makes up for in confidence and daring. She is, as Jo Nah probably realized, a promising recruit for the Legion.

Using Kono in Adventures

Since Kono is such a troublemaker, she might get herself in trouble, forcing the player heroes to rescue her. Although she can fight well, she can always get her companions into a precarious position. If the heroes need to get roped into entering combat, Kono is an excellent vehicle.

Subplots

Kono is often involved in Subplots regarding her friendships with Furball and Jo Nah. At present, she is growing and learning how to interact with her

teammates. Many of her Subplots revolve around these lessons.

Appearances in DC Comics

Legion of Super-Heroes (4) #2-3, 6-7, 10, 13, 15, 17, 20, 22, 26-27-on; *Who's Who* '90 #1

The Planet Sklar

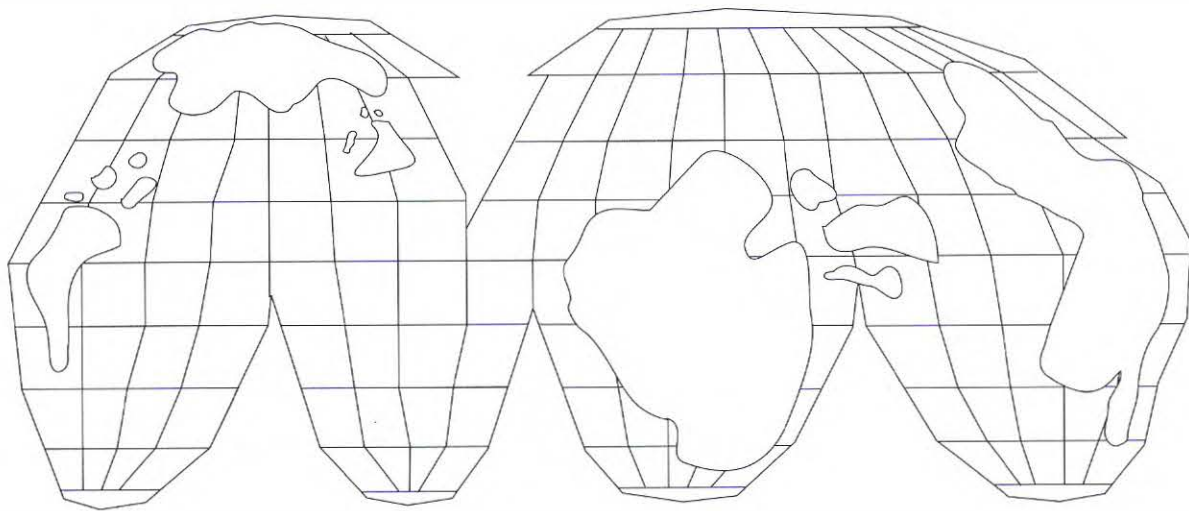

LAUREL GAND

DEX:	14	STR:	23	BODY:	16
INT:	9	WILL:	10	MIND:	8
INFL:	8	AURA:	7	SPIRIT:	8
INITIATIVE:	42	HERO POINTS:	80		

- Powers:** Directional Hearing: 7, Extended Hearing: 7, Flight: 14, Heat Vision: 11, Invulnerability: 18, Microscopic Vision: 14, Recall: 18, Sealed Systems: 10, Super Hearing: 7, Superspeed: 11, Systemic Antidote: 15, Telescopic Vision: 11, Thermal Vision: 11, X-Ray Vision: 11
- Advantages:** Connection: Legion of Super-Heroes (High)
- Drawbacks:** Married; Miscellaneous: lead is poisonous to members of Laurel's race (see below).
- Alter Ego:** Leala Linder
- Motivation:** Upholding the Good
- Wealth:** 5

Laurel's Statistics

Because Laurel's abilities were more clearly defined in *Who's Who '90*, her Attributes, Powers, and Skills were changed to reflect that definition.

Powers and Abilities

Born on Daxam, Laurel has the native abilities and vulnerabilities of her people—she gains staggering superhuman powers under the light of a yellow star. When she is at her peak, Laurel can lift approximately 100,000 tons, fly at sixteen times the speed of sound, and emit bursts of heat from her eyes capable of melting solid steel.

Like most Daxamites, Laurel is highly vulnerable to lead, but her fellow Legionnaire, Brainiac 5, developed a special serum that makes her immune to lead poisoning.

Laurel has received Legionnaire combat and espionage training, although she rarely needs either.

Lead-Poisoning Serum

Laurel takes a special serum that blocks out her Daxamite vulnerability to lead. If she was somehow cut off from the effects of this serum, the presence of lead would nullify all her Powers, reduce all her Physical Attributes to 1, and inflict a single point of Physical Killing Damage per minute until the lead is

removed from her presence or Laurel is killed.

Furthermore, if Laurel is ever isolated from her special serum, she loses all her Powers and all her Physical Attributes drop to 3 under a red sun.

Laurel and the Khunds

Shortly after her parents were killed, Laurel decimated a Khundian fleet from an Electro-Tower base on Ricklef II. Because of this action, she is particularly hated by the Khunds, any of whom would destroy her if given the opportunity (treat as a Serious Irrational Attraction on the part of the Khunds).

Personality/Role-playing

Revered since her childhood when she destroyed a Khundian invasion of her planet, Laurel Gand takes her heroic heritage very seriously. Her name is almost as well-known throughout the galaxy as that of her ancestor, the legendary Valor. To this day, the Khunds have not forgotten their humiliating defeat at her hands. At the same time, Laurel still holds the Khunds responsible for the deaths of her parents and gladly takes vengeance when the opportunities present themselves.

Despite her hatred for the Khunds, Gand has a strong sense of morals and respect for life, law, and authority. She believes in goodness and truth, though she is a powerful opponent who is not afraid to take on any challenge. Determined and obstinate, she does not surrender.

At one time Laurel and Brainiac 5 were romantically involved. After Brainiac had shown how unfeeling he was, however, Laurel began cultivating a relationship with the Green Lantern, Rond Vidar, son of Universo. Recently, she gave birth to a daughter, Lauren. At present she is quite excited about her new role as a mother, though her relationship with Brainiac in the newly reformed Legion is touchy at best. Laurel is still trying to decide where her true affections lie.

Using Laurel Gand in Adventures

Laurel is a legend in her own time and someone who can easily inspire awe in a group of heroes. Bring her in when you need a strong voice of moral obligation or righteous indignation. Like Superman or Valor, she can put heroes who stray from the path back in line.

Subplots

Laurel is involved in a Romantic Subplot with both Rond Vidar and Brainiac 5. Although she is more in love with Vidar, her common-law husband, she is troubled by her feelings for Brainiac. In fact, she often avoids Brainiac 5 rather than deal with these feelings.

Laurel is also involved in a Family Subplot dealing with her newborn daughter.

Appearances in the DC HEROES Role-Playing Game, Second Edition

Atlas of the DC Universe

Appearances in DC Comics

Adventures of Superman #478; *Legion of Super-Heroes* (4) #6-9, 13, 15-18, 20, 23-24, 26; *Legion of Super-Heroes Annual* (4) #1; *Who's Who '90* #2

Ricklef II

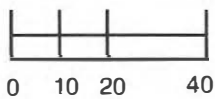
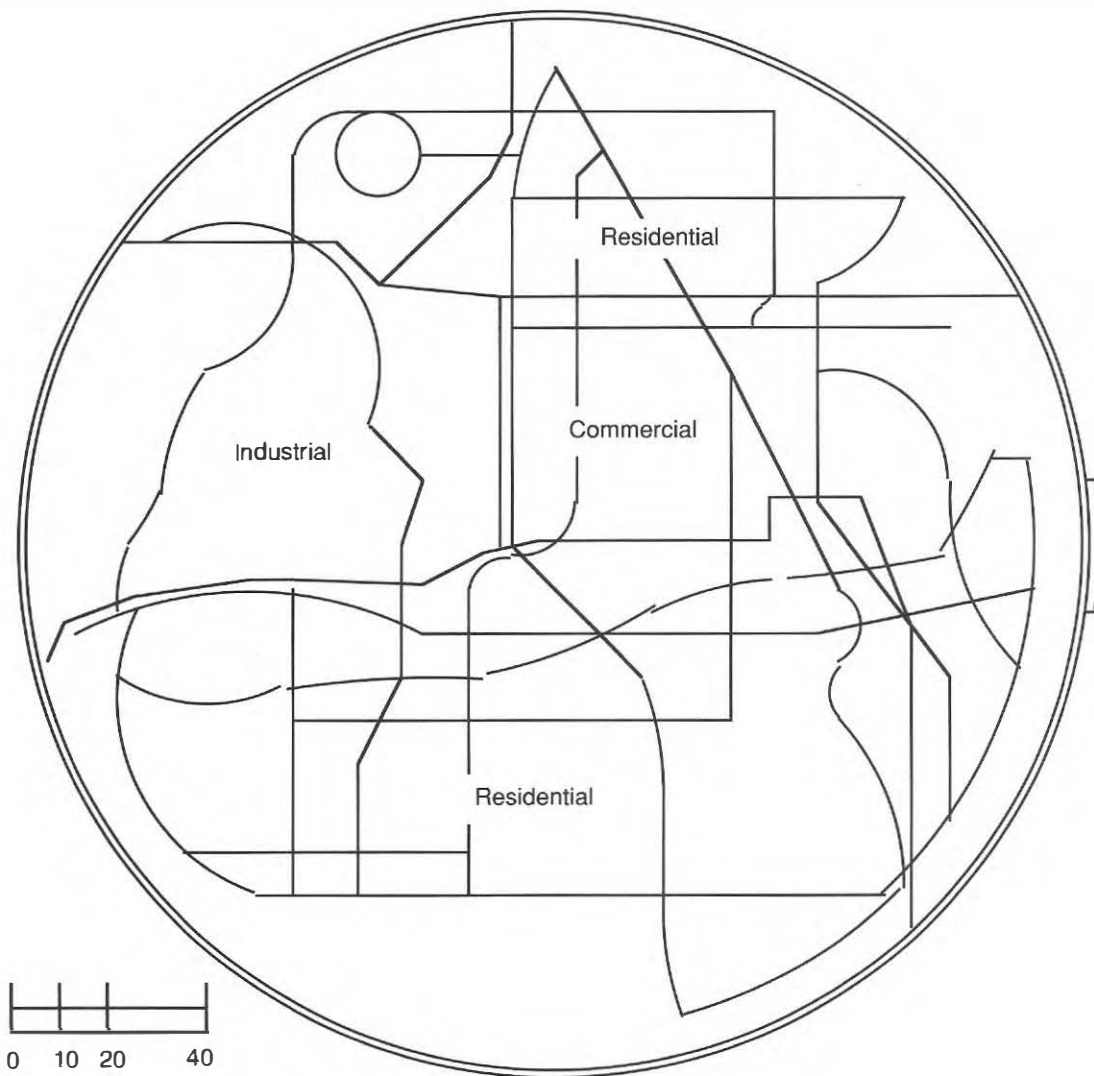

Yards

LIGHTRAY

DEX: 10	STR: 6	BODY: 7
INT: 12	WILL: 9	MIND: 8
INFL: 9	AURA: 9	SPIRIT: 9
INITIATIVE: 31		HERO POINTS: 125

- Powers:** Energy Blast: 18, Flash: 12, Flight: 45, Illusion: 12, Sealed Systems: 15
- Skills:** Acrobatics: 10, Gadgetry: 12, Scientist: 8, Vehicles: 8, Weaponry: 6
- Advantages:** Area Knowledge (Apokolips and Supertown); Connections: Justice League International (High), Supertown (High)
- Alter Ego:** Sollis
- Motivation:** Upholding the Good
- Wealth:** N/A
- Equipment:**

Mother Box [BODY: 7, INT: 10, WILL: 6, MIND: 6, INFL: 6, AURA: 6, SPIRIT: 6, Danger Sense: 12, Life Sense: 6, Omni-Power: 11, Hero Points: 75]

Lightray's Mother Box is built into his headband. See the **Mother Box** entry for more details.

Lightray's Illusions

Lightray's ability to manipulate the electromagnetic spectrum is so refined that he can even bend light to create lifelike illusions. Naturally, these illusions are entirely visual in nature. He can't conjure illusions that speak or make noise.

With 12 APs of Power, Lightray can conjure illusions that are as large as a small house. Lightray's APs of Power also serve as the OV/RV of the Perception Check necessary to recognize that one of his illusions is not real. Observers are entitled to a -3 Column Shift bonus to the OV and RV of such a Perception Check if Lightray has conjured an illusion of a creature or object that would normally make some sort of sound. Contrary to the description of the Illusion Power that appears in the *Character Handbook*, Lightray's illusions cannot inflict harm on a target.

Powers and Abilities

Lightray has several light-based powers, including the abilities to: fly at speeds of almost 50,000 times the speed of light; fire blasts of heat

easily capable of destroying a fortified bunker; emit brilliant bursts of light; and create realistic illusions.

Beyond his superhuman abilities, Lightray is an excellent hand-to-hand combatant.

Personality/Role-playing

Sollis is a peaceful soul, kind even to his enemies. He makes friends quickly and takes time to offer explanations that help keep sticky situations under control. At the scene of a conflict, you will most often see Lightray protecting innocent bystanders or finding a way to defeat his enemies using guile and the least amount force necessary.

Often Sollis' personality counter-balances that of his temperamental best friend, Orion, the greatest and most savage warrior of New Genesis. In fact, Lightray is often instrumental in persuading Orion to use less violent methods, and frequently calms his friend when Orion is enraged. Despite the support and attention he requires, Lightray treats Orion like the brother he once lost.

Lightray loves the freedom of space and relishes his Powers, but never in an abusive way. Most likely, he will try to outwit an opponent while Orion is busy bashing heads.

Background Update

Lightray and Orion are no longer members of Justice League America, as they had more pressing matters to attend to on New Genesis. At times, they still assist the JLI as reserve members.

Using Lightray in Adventures

Lightray is probably the nicest and most approachable of the New Gods. If the heroes have some questions regarding Apokolips or troubles with any of its residents, Lightray would be more than willing to assist them. In fact, if you are running an Adventure set on Apokolips, Lightray and Orion could be made available as a crutch that might help the player heroes survive Darkseid's clutches.

Subplots

Lightray has a Romantic Subplot brewing with Eve Donner, whom he met during one of his trips to Earth. His relationship with his Friend Orion also occupies many of his storylines.

Appearances in the DC HEROES Role-Playing Game, Second Edition

Apokolips Sourcebook, Law of Darkness

Appearances in DC Comics

* **Note:** Pre-Crisis appearances are not part of present continuity.

Pre-Crisis: *Adventure Comics* #459-460; *Challengers of the Unknown* #87; *DC Graphic Novel* #4; *DC Special Series* #10; *Justice League of America* #185; *Mister Miracle* (1) #18; *New Gods* (1) #1-3, 6, 8-12, 14-16, 18-19; (2) 6; *Superman's Pal, Jimmy Olsen* #141; *Super-Team Family* #15; *Who's Who '86* #13

Current: *Action Comics* #586; *Adventures of Superman* #426; *Armageddon 2001* #2; *Cosmic Odyssey* #1-4; *Justice League America* #42-45, 47-50; *Mister Miracle* (2) #25, 27; *New Gods* (3) #1-10, 12-14, 16-18, 20-24, 26-28; *Warlord* (1) #120-121; *Warlord Annual* #6; *Who's Who '90* #4

Lightray's Helmet

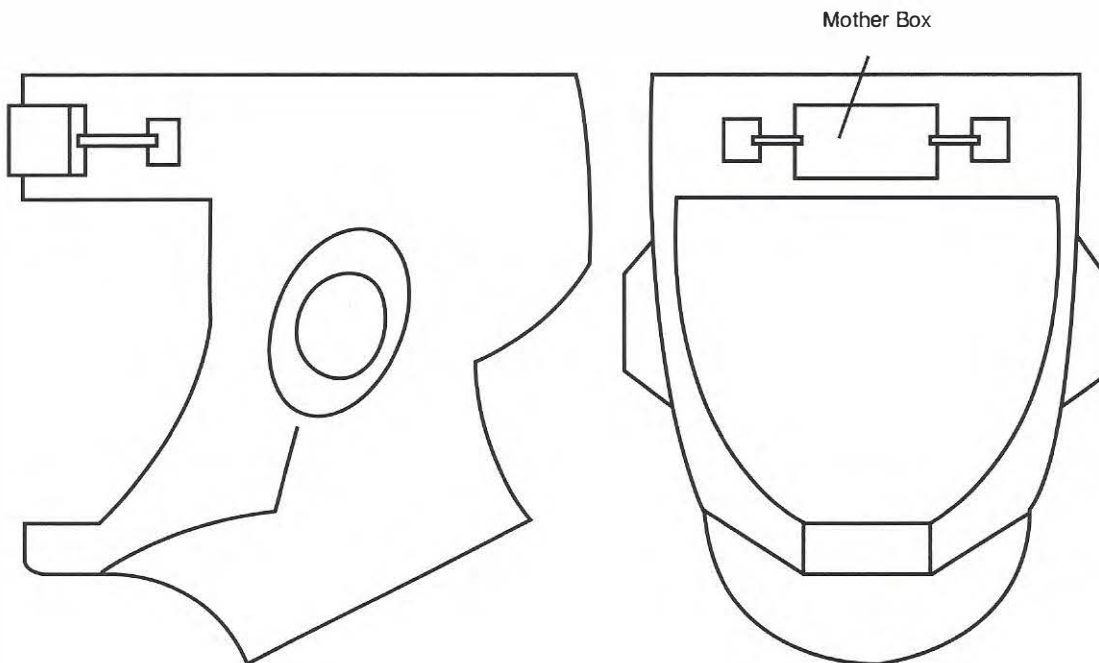

METAMORPHO

DEX: 6	STR: 10	BODY: 11
INT: 5	WILL: 6	MIND: 6
INFL: 6	AURA: 5	SPIRIT: 5
INITIATIVE: 17	HERO POINTS: 90	

- Powers:** Molecular Chameleon: 12, Omni-Arm: 8, Self Manipulation: 15
- Skills:** Charisma: 6
- Bonuses:** Miscellaneous: Metamorpho need not touch a substance to mimic it with Molecular Chameleon. He can easily assume any form he wishes.
- Advantages:** Connections: Justice League International (High), Outsiders (High), Stagg Industries (Low); Rich Family (Simon Stagg)
- Drawbacks:** Married (sort of—Rex's wife, Sapphire Stagg, married another man during Metamorpho's lengthy absence, but she could still be used as a pawn against Metamorpho); Strange Appearance; Fatal Vulnerability to the strange meteor that gave Rex his Powers (range 2 APs)
- Alter Ego:** Rex Mason
- Motivation:** Unwanted Power
- Wealth:** 4

Powers and Abilities

Rex has the power to transform his body into any element or combination of elements in existence. He can also shape his pliable body into a wide variety of different forms and exert physical strength capable of crushing concrete blocks.

Molecular Transformation

Known as the Element Man, Metamorpho can easily transform his body into just about any element or compound he can imagine. When Rex assumes a solid form, his STR and BODY are immediately raised to an AP level equal to the BODY of the substance mimicked. If he assumes a gaseous or liquid form, his STR drops to 0, and he is assumed to be using the Dispersal Power at an AP level equal to his APs of Molecular Chameleon (raising his RV to 23 against Physical Attacks that would not normally affect a gas).

Some of the forms Rex commonly assumes include:

Anesthetic Gas [attacks everyone within a volume of 12 APs within an AV/EV of 8/8, rolled against the

target's BODY/BODY.]

Case Hardened Steel [raises his STR and BODY to 12]
Fog [acts as a Fog cloud rated at 12 APs]

Lodestone [raises Rex's STR to 11 and allows him to function as a magnet (Magnetic Control: 8)]

Water [allows him to pour through cracks and travel at a speed of 12 APs through sewer systems]

Personality/Role-playing

Metamorpho looks upon himself as a freak and is sometimes his own worst critic. He seems gruff and argumentative, but this is really a cover for a sensitive, caring man who is afraid of the monster he believes he has become.

Rex is a good team player. He always helps out when possible and fiercely protects those he loves. At the same time, however, he is the joker of almost any group, making wisecracks during even the most trying times. Usually, his jokes are aimed at himself, since he would never intentionally hurt a friend with his sharp tongue.

Metamorpho normally relies on his abilities to defeat his adversaries. He is rather ingenious in his methods and is always finding new ways to apply his unique powers. He almost hates to use the same technique twice.

At present, Metamorpho feels betrayed and deserted by both his old friends from the Outsiders, who are worried about his mental instability, and by his girlfriend, Sapphire Stagg, who bore him a son and married another man.

Using Metamorpho in Adventures

Metamorpho is the creative combat hero. He can always think of the cleverest and most effective way to use his Powers to defeat an opponent and might, therefore, make a good mentor for a hero who is just getting used to Powers.

Metamorpho is also capable of involving the player heroes in an Adventure. He might, for instance, ask the heroes for assistance in finding a cure for his son, who has all Metamorpho's abilities in an uncontrollable form.

Subplots

Metamorpho has been involved in several Subplots regarding: his Family life, his relationship with his ex-fiancee and his son, and his attempts to find a cure for his son's freakish condition.

Appearances in the DC HEROES Role-Playing Game, Second Edition

Justice League Sourcebook, Background/Roster Book (includes card), Come On Down!

Appearances in DC Comics

*** Note:** Pre-Crisis appearances are not part of present continuity.

Pre-Crisis: *Action Comics* #413-418; *Batman and the Outsiders* #1-27; *Batman and the Outsiders Annual* #1; *The Brave and The Bold* (2) #57-58, 66, 68, 101, 123, 154, 200; *Crisis On Infinite Earths* #3-5, 7, 9-10, 12; *DC Comics Presents* #40, 83; *First Issue Special* #3; *Infinity, Inc.* #22; *Justice League of America* #42, 44, 100-102; *Metamorpho* #1-17; *The New Teen Titans* (1) #37; (2) 13; *Teen Titans Annual*

#3; *Who's Who '86* #15; *World's Finest Comics* #217-220, 226, 229, 300, 302

Current: *Adventures of Superman* #463; *Adventures of the Outsiders* #33-38; *Animal Man* #16, 20; *Armageddon 2001* #2; *Batman and the Outsiders* #28-32; *Batman and the Outsiders Annual* #2; *Captain Atom* (3) #34, 38, 41, 50; *Doctor Fate* (2) #15; *Flash* (2) #29; *Infinity, Inc. Special* #1; *Invasion!* #3; *Justice League America* #32, 53, 55-60; *Justice League Annual* #3-4; *Justice League Europe* #1-9, 11-13, 15-36; *Justice League Europe Annual* #1-2; *Justice League International* #24; *Justice League Quarterly* #3-5; *Justice League Special* #1; *Millennium* #1; *The Outsiders* #1-7, 9-27; *The Outsiders Annual* #1; *The Outsiders Special* #1; *Secret Origins* (3) #6 (flashback); *War of the Gods* #1-2, 4; *Who's Who '90* #2; *Wonder Woman* (2) #50, 61

Orb of Ra

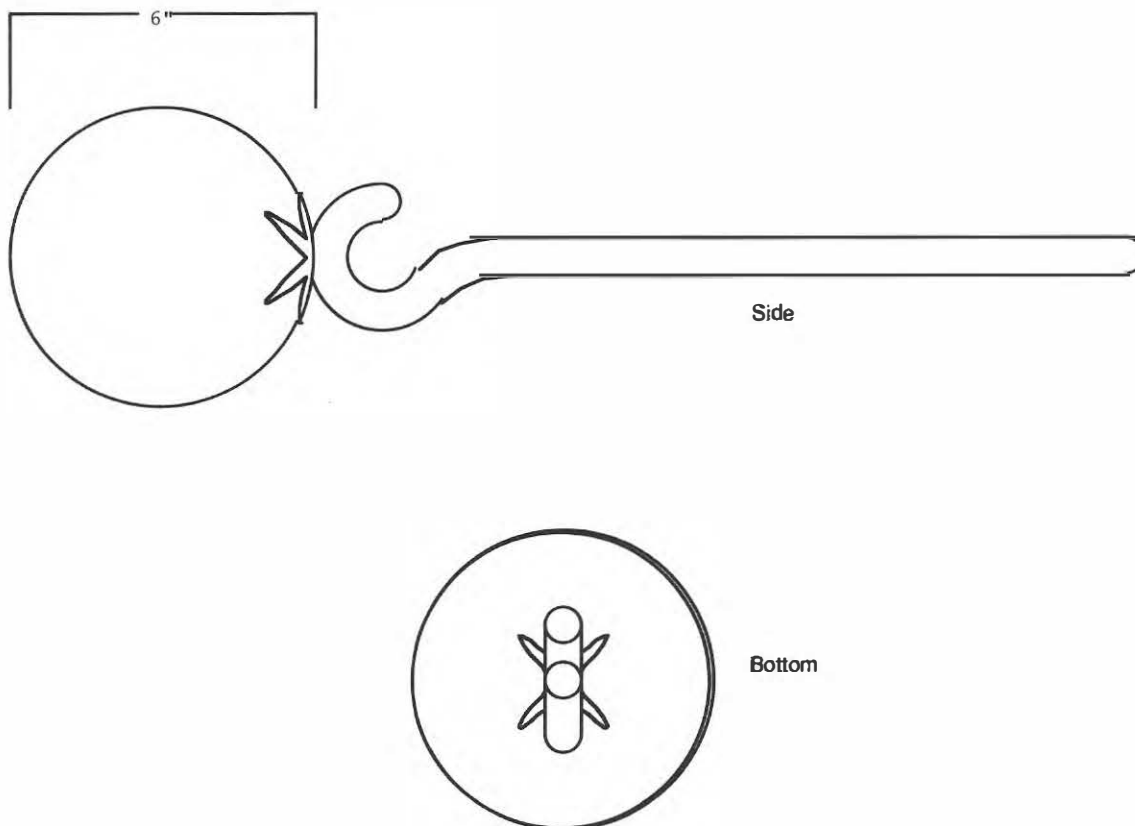

METRON

DEX:	7	STR:	6	BODY:	7
INT:	25	WILL:	23	MIND:	16
INFL:	9	AURA:	2	SPIRIT:	8
INITIATIVE:	41	HERO POINTS: 25			

- Skills:** Gadgetry: 25, Science: 25
- Advantages:** Area Knowledge (Promethean Galaxy); Connections: Darkseid (High), Highfather (High); Genius; Scholar (astronomy, the Source); Sharp Eye
- Drawbacks:** Catastrophic Irrational Attraction to knowledge; Catastrophic Irrational Attraction to penetrating the Forever Barrier
- Alter Ego:** None
- Motivation:** Mercenary
- Wealth:** N/A
- Equipment:**

MOBIUS CHAIR [INT: 20, BODY: 25, Dimension Travel: 13, Flight: 50, Force Field: 25, Omni-Power: 15, Recall: 60, Sealed Systems: 25, Telekinesis: 50, R#: 2]

Metron's Mobius Chair is one of the most sophisticated devices in the whole DC Universe. It is a vehicle, a weapon, and a vast storehouse of knowledge.

Ultimately, the Mobius Chair is powered by a supply of X-Element (when the chair fails a Reliability Check, it has run out of X-Element), forcing Metron to barter with Darkseid in order to keep the chair powered. Given a sufficient supply of X-Element, Metron can completely recharge the chair instantaneously.

The Forever Barrier

Metron's ultimate aim is to penetrate the Forever Barrier, which lies at the edge of the Promethean Galaxy, forever uniting himself directly with the Source. Accomplishing this aim requires a successful Dimension Travel Action Check against an OV/RV of 75/75 (!). Should Metron ever succeed, he immediately adds 15 to all his Mental and Mystical Attributes, gains 200 Hero Points, and becomes a Non-Player Character forever.

Lying in and around the Forever Barrier are a series of cosmic phenomena known as "alephs." Entering an aleph requires a successful Dimension Travel Action Check vs. 35/35 and instantly endows

the traveler with 25 Hero Points and a vision of the future (as per Precognition: 25). Many travelers who enter an aleph mistakenly believe they have penetrated the Source itself. This once happened to Metron.

Powers and Abilities

Metron has an amazing intellect, highly developed scientific faculties, and the technological knowhow to create just about anything he can imagine. He has, in fact, developed a number of weapons for Darkseid in exchange for the X-Element that powers his Mobius Chair. Using the Mobius Chair, he travels great distances and seeks answers to the universe's fundamental questions.

Personality/Role-playing

Metron is probably the most empirical and objective being in the known universe. His one true drive is the pursuit of knowledge—it is all that interests him.

Metron is not allied with either the New Gods of New Genesis or the New Gods of Apokolips, though he has aided both in the past. He is interested only in what he can gain intellectually, and a small piece of arcane knowledge is usually his side of any bargain he makes with either faction.

At one point, Metron's search for knowledge was almost his downfall. When he sought out the Anti-Life Equation and tried to comprehend it, he barely survived with his mind intact; the encounter deeply disturbed his psyche. Metron has since recovered to some extent, though he continues his quest. It appears that nothing will ever move Metron to end his search.

Metron is passionless, calculating, and generally frigid. He is not evil, however, and occasionally sides with the forces of good. It is unknown whether this is because there is a glimmer of humanity within his mechanical shell or it is simply beneficial to Metron's aims that evil tyrants like Darkseid never win their struggles. The closest he has come to friendship is the camaraderie he shares with Orion and Lightray. In fact, Metron saved Lightray's life when he was a boy.

Although Metron is a master of technology and can create things that few men can envision, he is not terribly imaginative and often looks to others as a source of inspiration.

Using Metron in Adventures

Metron is the technological genius of the 20th Century. Players can contact him for help in the technology department, but they may have difficulty persuading him to do anything for them unless they can offer him something in return that will stimulate him intellectually.

Subplots

Most of Metron's Subplots deal with his constant search for knowledge.

Appearances in the DC HEROES Role-Playing Game, Second Edition

Apokolips Sourcebook

Appearances in DC Comics

***Note:** Pre-Crisis appearances are not part of present continuity.

Pre-Crisis: *Adventure Comics* #459-460; *DC Graphic Novel* #4; *DC Special Series* #10; *First Issue Special* #13; *Justice League of America* #183-185; *Mister Miracle* (1) #18-19; *New Gods* (1) #1, 3-5, 7, 12-16, 18-19; *Super-Team Family* #15; *Who's Who '86* #15

Current: *Action Comics* #650 (flashback), 675; *Action Comics Annual* #3; *Cosmic Odyssey* #1; *Justice League International* #11-12; *New Gods* (3) #1-3, 5-6, 9, 11-12, 16, 19-22, 26-28; *Secret Origins* (3) #33; *Superman* (2) #35, 65-66; *Superman: The Man of Steel* #10; *Swamp Thing* (2) #62; *Warlord Annual* #6; *Who's Who '90* #2

Metron's Mobius Chair

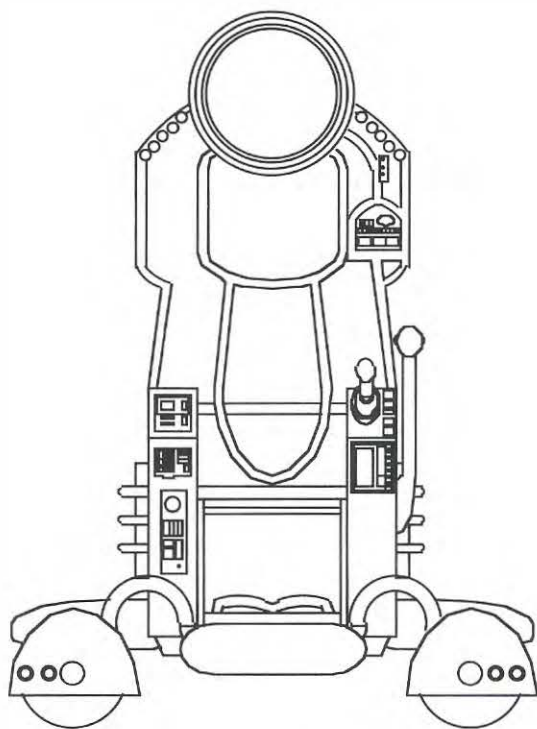

Front

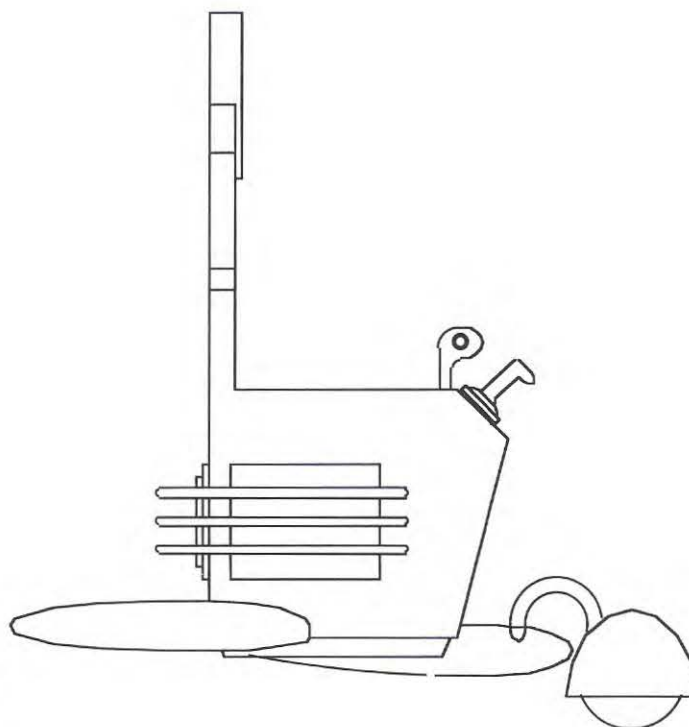

Side

NEW GUARDIANS

HARBINGER

DEX: 8	STR: 8	BODY: 9
INT: 9	WILL: 7	MIND: 8
INFL: 8	AURA: 7	SPIRIT: 7
INITIATIVE: 25	HERO POINTS: 70	

- Powers:** Energy Blast: 15, Flight: 16
- Skills:** Artist (Writer): 8, Charisma: 8, Gadgetry: 9
- Advantages:** Connections: New Guardians (High), Guardians of the Universe (Low)
- Alter Ego:** Lyla
- Motivation:** Upholding the Good
- Wealth:** 4

Note: Harbinger's statistics have changed significantly since her Crisis on Infinite Earths incarnation appearing in the *Background/Roster Book*.

GLOSS

DEX: 4	STR: 4	BODY: 5
INT: 6	WILL: 5	MIND: 5
INFL: 6	AURA: 6	SPIRIT: 6
INITIATIVE: 16	HERO POINTS: 40	

- Powers:** Power Reserve: 10
- Limitations:** Miscellaneous: Power Reserve can be used to augment Gloss' Physical Attributes only.
- Advantages:** Connection: New Guardians (High); Scholar (Chinese language)
- Drawbacks:** Loss Vulnerability: If Gloss is ever isolated from the ley lines crisscrossing the Earth, her Power Reserve won't function.
- Alter Ego:** Xiang Po
- Motivation:** Responsibility of Power
- Wealth:** 4

RAM

DEX: 5	STR: 8	BODY: 8
INT: 11	WILL: 8	MIND: 8
INFL: 6	AURA: 5	SPIRIT: 5
INITIATIVE: 22	HERO POINTS: 40	

- Powers:** Mind Probe: 11, Telepathy: 20
- Limitation:** Miscellaneous: Powers are usable only on computers.
- Skills:** Gadgetry: 7
- Advantages:** Connection: New Guardians (High); Scholar (computers, business, Japanese language)
- Alter Ego:** Takeo Yakata

- Motivation:** Responsibility of Power
- Wealth:** 8

EXTRAÑO

DEX: 5	STR: 3	BODY: 4
INT: 7	WILL: 7	MIND: 6
INFL: 6	AURA: 6	SPIRIT: 6
INITIATIVE: 18	HERO POINTS: 40	

- Powers:** Empathy: 5, Sorcery: 10
- Limitation:** Miscellaneous: Sorcery is limited to 6 APs unless Extraño has possession of his crystal skull; Miscellaneous: Empathy works only on Betty Clawman.
- Advantages:** Connection: New Guardians (High); Scholar (Spanish language)
- Alter Ego:** Gregorio de la Vega
- Motivation:** Responsibility of Power
- Wealth:** 4

BETTY CLAWMAN

DEX: —	STR: —	BODY: —
INT: 8	WILL: 8	MIND: 8
INFL: 10	AURA: 9	SPIRIT: 10
INITIATIVE: 18	HERO POINTS: 40	

- Powers:** Empathy: 5, Illusion: 20, Telepathy: 12
- Limitations:** Miscellaneous: Betty can only use her Powers to affect the dreams of others; Miscellaneous: Empathy usable only on Extraño
- Drawbacks:** Catastrophic Physical Restriction: Betty Clawman has merged with the Dreaming and no longer has a physical form.
- Alter Ego:** None
- Motivation:** Responsibility of Power
- Wealth:** N/A

JET - Deceased

DEX: 8	STR: 4	BODY: 6
INT: 5	WILL: 5	MIND: 5
INFL: 6	AURA: 4	SPIRIT: 6
INITIATIVE: 19	HERO POINTS: 40	

- Powers:** Energy Absorption: 10, Energy Blast: 10, Flight: 10, Force Field: 2, Magnetic Control: 10, Sonic Beam: 10
- Limitations:** Miscellaneous: Energy Absorption only works on electromagnetic energies.
- Advantages:** Connection: New Guardians (High)
- Alter Ego:** Celia Windward
- Motivation:** Responsibility of Power
- Wealth:** 4

TOM KALMAKU

DEX:	3	STR:	3	BODY:	3
INT:	5	WILL:	6	MIND:	5
INFL:	7	AURA:	7	SPIRIT:	7
INITIATIVE:	15	HERO POINTS:	40		

- Powers:** Broadcast Empathy: 14, Empathy: 5, Flash: 5, Flight: 5
- Skills:** Gadgetry: 3
- Advantages:** Connections: Green Lantern (High), New Guardians (High) ; Scholar (mechanical engineering)
- Drawbacks:** Married
- Alter Ego:** None
- Motivation:** Responsibility of Power
- Wealth:** 4

Using the New Guardians in Adventures

Since the New Guardians are the “chosen,” the seeds of the universe’s next immortal race, they are greatly protected by both the Green Lantern Corps and the Guardians of the Universe. The heroes might meet the New Guardians after uncovering a plot to destroy them or capture their prized immortal genes. The New Guardians also handle cases involving racism or prejudice, and the heroes can help them in this regard.

Appearances in DC Comics

New Guardians (Betty, Extrano, Gloss, Jet, Ram): *Adventures of Superman* #437 (Jet only); *Blue Beetle* (6) #21 (behind the scenes); *Booster Gold* #25 (Gloss only); *Green Lantern Corps* #220, 221 (Ram only); *Invasion!* #2-3 (no Betty or Jet); *Justice League International* #10 (behind the scenes); *Millennium* #2-8; *The New Guardians* #1-6, 7-12 (no Jet); *Secret Origins* (3) #23; *Suicide Squad* #23 (no Betty); *Teen Titans Spotlight* #19; *War of the Gods* #4 (Ram only); *Who’s Who* ‘88 #2; *Who’s Who* ‘90 #3

Harbinger, Pre-Crisis: *Action Comics* #564; *All-Star Squadron* #40, 50-51, 53-54, 60; *Amethyst* (1) #2; *Batman* #384; *Batman and the Outsiders* #14-15; *Blue Devil* #5; *Crisis On Infinite Earths* #1-7, 9-12; *DC Comics Presents* #76, 78, 94; *The Flash* (1) #339; *The Fury of Firestorm* #28, 41; *Green Lantern* (2) #173, 176, 178, 194; *Infinity, Inc.* #8, 19, 21-22; *Justice League of America* #232, 234; *The New Teen Titans* (2) #13; *The New Teen Titans Annual* (1) #2; *The Saga of Swamp Thing* #30-31; *Tales of the Legion* #317, 319-320; *Tales of the Teen Titans* #47, 58; *The Vigilante* #14; *Warlord* (1) #91; *Who’s Who* ‘85 #10; *Wonder Woman* (1) #321, 323; *World’s Finest Comics* #311

Harbinger, Current: *Blasters Special* #1; *Booster Gold* #25; *Firestorm, the Nuclear Man* #68; *History of the DC Universe* #1-2; *Invasion!* #2-3; *Justice League International* #10; *Millennium* #1-5, 7-8; *The New Guardians* #1-12; *Teen Titans Spotlight* #19; *War of the Gods* #4

Thomas Kalmaku, Pre-Crisis: *The Brave and The Bold* #173; *Detective Comics* #350; *The Flash* (1) #131; *Green Lantern* (2) #2-7, 9-19, 21, 24-34, 37, 39, 41-49, 52-53, 73-74, 94-95, 122, 124-125, 128-129, 131, 133-136, 138-141, 144-150, 167, 173-174, 176, 178-179, 182-183, 185-188, 193-194; *Justice League of America* #13, 194; *Tales of the Green Lantern Corps* #3

Thomas Kalmaku, Current: *Blue Beetle* (6) #21 (behind the scenes); *Green Lantern* (2) #202, 205; *Green Lantern Corps* #216, 219-221; *Justice League International* #10 (behind the scenes); *The New Guardians* #1, 3-5, 712; *Secret Origins* (3) #23, 26; *Who’s Who* ‘88 #4

Kroef’s Island

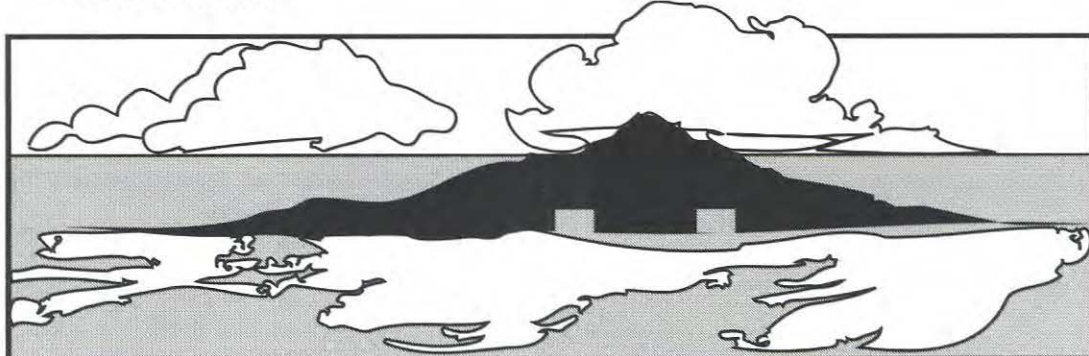

NEWSBOY LEGION

TOMMY

DEX: 4	STR: 2	BODY: 3
INT: 4	WILL: 4	MIND: 3
INFL: 4	AURA: 3	SPIRIT: 3
INITIATIVE: 12	HERO POINTS: 20	

- Skills:** Charisma: 4, Thief (Stealth): 4, Vehicles: 3
- Advantages:** Connection: Cadmus Project (High)
- Drawbacks:** Age (young)
- Alter Ego:** Thomas Tompkins II
- Motivation:** Thrill of Adventure
- Wealth:** 1

GABBY

DEX: 3	STR: 2	BODY: 3
INT: 3	WILL: 3	MIND: 3
INFL: 4	AURA: 3	SPIRIT: 3
INITIATIVE: 10	HERO POINTS: 15	

- Skills:** Thief (Stealth): 4, Vehicles: 3
- Advantages:** Connection: Cadmus Project (High)
- Drawbacks:** Age (young)
- Alter Ego:** John Gabrielli II
- Motivation:** Thrill of Adventure
- Wealth:** 1

SCRAPPER

DEX: 4	STR: 3	BODY: 3
INT: 2	WILL: 3	MIND: 3
INFL: 3	AURA: 3	SPIRIT: 4
INITIATIVE: 9	HERO POINTS: 15	

- Skills:** Thief (Stealth): 4, Vehicles: 4
- Advantages:** Connection: Cadmus Project (High)
- Drawbacks:** Age (young)
- Alter Ego:** Patrick MacGuire
- Motivation:** Thrill of Adventure
- Wealth:** 1

BIG WORDS

DEX: 2	STR: 2	BODY: 3
INT: 6	WILL: 4	MIND: 3
INFL: 3	AURA: 2	SPIRIT: 3
INITIATIVE: 11	HERO POINTS: 15	

- Skills:** Thief (Stealth): 4, Vehicles: 3
- Advantages:** Connection: Cadmus Project (High); Scholar (polysyllabic words)
- Drawbacks:** Age (young)

- Alter Ego:** Anthony Rodrigues II
- Motivation:** Thrill of Adventure
- Wealth:** 1

FLIP

DEX: 3	STR: 2	BODY: 3
INT: 3	WILL: 4	MIND: 3
INFL: 4	AURA: 3	SPIRIT: 3
INITIATIVE: 10	HERO POINTS: 20	

- Skills:** Thief (Stealth): 4, Vehicles: 3
- Advantages:** Connection: Cadmus Project (High)
- Drawbacks:** Age (young)
- Alter Ego:** Walter Johnson II
- Motivation:** Thrill of Adventure
- Wealth:** 1

ANGRY CHARLIE

DEX: 5	STR: 7	BODY: 7
INT: 2	WILL: 2	MIND: 4
INFL: 3	AURA: 2	SPIRIT: 5
INITIATIVE: 10		

A bioengineered "DNAlien," Angry Charlie is looked upon as a sort of pet by the Legion.

Newsboy Equipment

WHIZ WAGON [STR: 8, BODY: 11, R#: 2] Flight: 11, Running: 9, Sealed Systems: 12, Swimming: 6

The Newsboy Legion hijacked the Whiz Wagon from the Hairies, a group of genetically engineered geniuses. The wagon can operate at high speeds on land, in the air, or underwater. By using a special remote-control transmitter [BODY: 1], the Legion can control the Whiz Wagon from as far as four miles away (12 APs).

Powers and Abilities

Like most young children, the members of the Newsboy Legion are more agile and nimble than most adults. They are all quick-minded and able to handle themselves in tough situations because they are used to street life. Most of them have some thieving ability and can sneak in and out of places without making noise or being seen.

Personality/Role-playing

Tommy is the charismatic leader and oldest of this gang of adolescents, who are actually clones of

the original team of rascals who ran the streets of Suicide Slum during the Depression.

Scraper makes up for his small size with his attitude. He is always out to prove that "size don't mean nuthin'," and his teammates are always pulling him out of the fray.

Big Words is a walking dictionary. He comes up with many of the grand schemes the boys pull.

Gabby is a fast talker, but not much of a fighter.

Flip is enthusiastic and adventure-seeking.

All the Newsboy Legionnaires are fun-loving, cantankerous kids. They love an adventure and bore easily, so they tend to cause a lot of mischief. This is why the original Legionnaires were placed under the supervision of Officer Jim Harper (Guardian) and occasionally broke the law.

Since they are clones, the new Legionnaires all believe they are the original Newsboy Legion under the protection of the Guardian; they have all the childhood memories of their namesakes. Because they are confused by post-depression Metropolis, the boys are usually kept within the confines of the Cadmus Project under the strict supervision of the new Guardian.

Using the Newsboy Legion in Adventures

If the Cadmus Project took an interest in one or more of the player heroes, Cadmus officials might dispatch the Newsboy Legion to distract the heroes so they can be subdued and studied.

Appearances in the DC HEROES Role-Playing Game, Second Edition

Superman—The Man of Steel Sourcebook

Appearances in DC Comics

*Note: Pre-Crisis appearances are not part of present continuity.

Newsboy Legion I, Pre-Crisis: *All-Star Squadron* #25, 44; *Star-Spangled Comics* #7-64; *Superman's Pal, Jimmy Olsen* #135-138; *Who's Who* '86 #16

Newsboy Legion I, Current: *Secret Origins* (3) #16, 19, 49; *Superman* (2) #37, 39 (behind the scenes), 54-56; *Superman Annual* (2) #2; *Who's Who* '90 #2; *Young All-Stars* #27 (flashback)

Newsboy Legion II, Pre-Crisis: *Superman Family* #189-194; *Superman's Pal, Jimmy Olsen* #133-139, 141-148, 150; *Who's Who* '86 #16

Newsboy Legion II, Current: *Adventures of Superman* #449; *Secret Origins* (3) #49; *Superman* (2) #37, 54-56; *Superman Annual* (2) #2; *Who's Who* '88 #2; *Who's Who* '90 #2

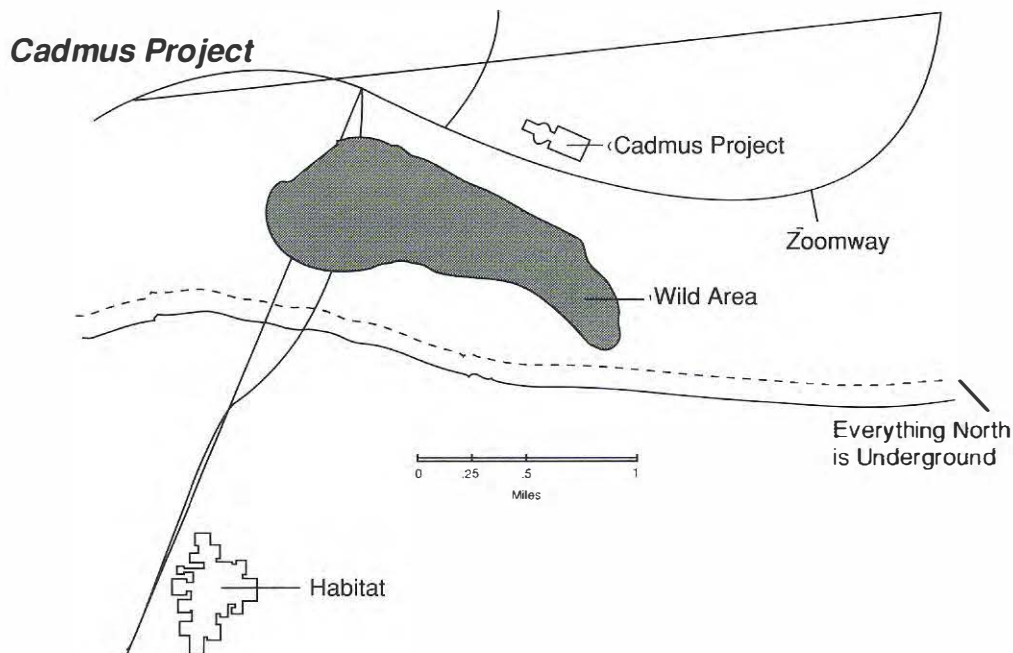

ORION

DEX:	13	STR:	22	BODY:	15
INT:	10	WILL:	19	MIND:	11
INFL:	10	AURA:	8	SPIRIT:	12
INITIATIVE:	35	HERO POINTS:	175		

- Powers:** Invulnerability: 15, Regeneration: 9
- Skills:** Vehicles: 13, Weaponry: 13
- Advantages:** Area Knowledge (Apokolips and Supertown); Connections: Apokolips (Low), Justice League International (Low), Supertown (High); Iron Nerves; Lightning Reflexes
- Drawbacks:** Serious Rage
- Alter Ego:** None
- Motivation:** Responsibility of Power
- Wealth:** N/A
- Equipment:**

ASTRO-GLIDER [STR: 8 BODY: 16 INT: 1, Energy Blast: 25, Flash: 15, Flight: 30, Magnetic Control: 20, Sealed Systems: 14]

The Astro-Glider is Orion's rocket-powered sled. In addition to allowing Orion to travel at speeds faster than light, the sled also can fire magnetic and concussive force beams.

Mother Box [DEX:— STR:— BODY: 7 INT: 10 WILL: 6 MIND: 6 INFL: 6 AURA: 6 SPIRIT: 6] Danger Sense: 12, Life Sense: 6, Omni-Power: 11 Hero Points: 75

Orion wears his Mother Box on his shoulder. See the **Mother Box** page for more details.

Orion's Rage

In combat, Orion's Apokolipsian heritage and the darker side of his personality tend to reveal themselves. In DC HEROES terms, treat this shortcoming as the Serious Rage Drawback. By using his Mother Box and expending his Dice Action for a phase, Orion can automatically regain his composure and cancel the effects of his rage. But to do so, he must be successfully Persuaded. Orion can even attempt to Persuade himself to recover. Once his rage has been triggered, Orion must make a Killing Combat attack each phase until the battle is over or until he recovers. Although Persuasion is a Dice Action, "Persuading" himself only costs Orion the use of an Automatic Action (meaning he must still make a Killing Combat attack during the phase in which he is attempting the Persuasion).

Powers and Abilities

Orion is amazingly strong (able to lift more than 60,000 tons over his head), invulnerable (his skin easily repels bazooka shells), and able to regenerate most superficial wounds in almost a millisecond. He cannot fly like his friend Lightray, so he uses an Astro-Glider, which allows him to travel great distances at tremendous speed. Orion is an accomplished pilot and can use most forms of weaponry with the proficiency of a master.

Personality/Role-playing

Orion is a being of contradictions. He was born of the royal line of Apokolips, but his loyalty lies with the people of New Genesis. He is, in fact, their greatest champion. He loves beauty and peace, and he is loyal to his adopted family and friends. But when angered, the true nature of Orion's lineage rises to the surface, leaving him ruthless and uncontrollable.

Orion is destructive and murderous in battle. During a fight, he might fall into a berserk frenzy at any time. To help him control his rage, he carries a Mother Box that soothes his tormented spirit.

Orion has a great hatred for his true heritage and his natural father, Darkseid; in fact, his life's ambition is to one day topple the tyrant. Darkseid, on the other hand, is wise enough to avoid such confrontations. It was prophesied that one day the two will engage in an epic battle in the fire pits of Apokolips.

Until then, Orion cooperates with his friend Lightray to protect innocents from the evil unleashed by Apokolips. When not fighting evil, he dwells on his existence and searches for the inner peace he may never find.

Background Update

Lightray and Orion are no longer members of Justice League America, as they had more pressing matters to attend to on New Genesis. At times, they still assist this group of heroes as reserve members.

Using Orion in Adventures

If running an Adventure set on Apokolips, you might make Lightray and Orion available as support, or use them to save the player heroes' bacon. If you're in a nasty mood, you might make the player

heroes deal with Orion's temper at the same time they deal with the villains.

Subplots

Orion is mostly involved in Subplots regarding his friendship with Lightray or his deep hatred for his father, Darkseid.

Appearances in the DC HEROES Role-Playing Game, Second Edition

Apokolips Sourcebook, Law of Darkness

Appearances in DC Comics

***Note:** Pre-Crisis appearances are not part of present continuity.

Pre-Crisis: *Adventure Comics* #459-460; *DC Graphic Novel* #4; *DC Special Series* #10; *First Issue Special* #13; *Forever People* (1) #7; *Justice League of America* #183-185; *Legion of Super-Heroes* (2) #290-294 (clone); *Mister Miracle* (1) #18; *New Gods* (1) #1-19 (2) 6; *Super-Team Family* #15; *Who's Who '86* #17

Current: *Action Comics* #586, 650 (flashback); *Adventures of Superman* #426; *Armageddon 2001* #2; *Cosmic Odyssey* #1-4; *Justice League America* #40, 42-45, 47-50; *Mister Miracle* (2) #25, 27; *New Gods* (3) #1-28; *War of the Gods* #3-4; *Warlord Annual* #6; *Who's Who '90* #1

Orion's Astro-Glider

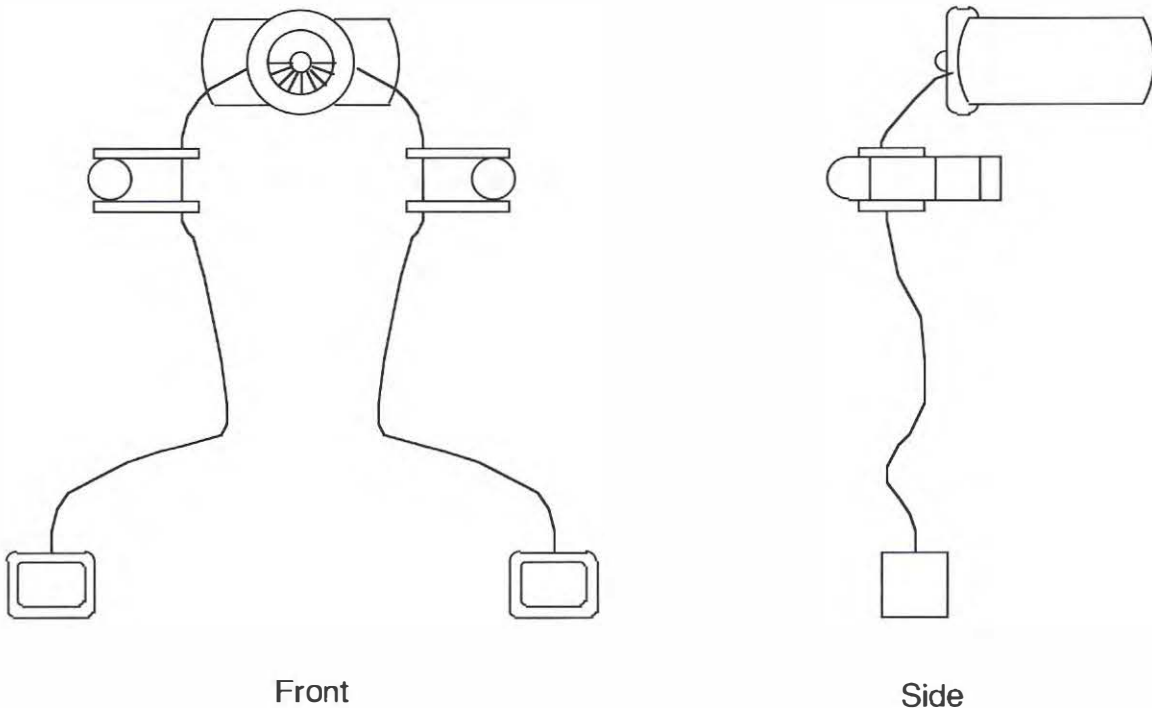

PHANTOM LADY

DEX:	6	STR:	4	BODY:	4
INT:	7	WILL:	6	MIND:	5
INFL:	6	AURA:	5	SPIRIT:	6
INITIATIVE:	21	HERO POINTS:	45		

- Skills:** Acrobatics: 3, Martial Artist: 6, Thief: 7
- Advantages:** Area Knowledge (Washington, D.C.); Attractive; Connections: Justice Department (Low), Media (Low)
- Drawbacks:** Secret Identity
- Alter Ego:** Delilah (Dee) Tyler
- Motivation:** Upholding the Good
- Wealth:** 5
- Equipment:**

Cape and Clasp [BODY: 2, Illusion: 8, Thief (Stealth): 10, R#: 2] Concealed within the Phantom Lady's cape are a series of microprocessors that store and manipulate holographic images. By using a sophisticated lens concealed in her clasp, Phantom Lady can project these holographic illusions at a range of just over 100 yards. So far, she is limited to producing holographic images of herself.

Phantom Lady's cape also contains various electronic countermeasures that mask her presence from electronic security systems (use the cape's APs of Thief/Stealth as the OV/RV of any attempt these systems make to detect her).

BRACELET TASER [AV: 7, EV: 10, Flash: 6, R#: 2] Phantom Lady can use her laser-guided taser as a blasting or cutting weapon. At its highest intensity, it can easily cut through thin sheets of steel (Phantom Lady needn't use the weapon's full EV when she attacks).

GOGGLES [BODY: 2, Ultra Vision: 5] Phantom Lady can add the goggles' APs of Ultra Vision to her RV vs. the Flash Power.

Les Mille Yeux

Dee Tyler first crossed this international criminal cartel when she learned its members were trying to blackmail her father. To this day, Les Mille Yeux (the thousand eyes) is trying to uncover and assassinate the Phantom Lady in retribution.

Assume that Les Mille Yeux has a local chieftain in every urban center with a population of 10,000,000 or more in the world. Each of these chieftains probably has between five and twenty-five operatives at his disposal (Les Yeux operatives are generally armed with some of the most advanced weaponry

available). As a whole, the organization has a Wealth rating of 20, while each local chieftain has a Wealth rating of 11).

Powers and Abilities

The Phantom Lady uses the limits of her opponents' perception to her advantage. Trained by the original Phantom Lady, a "mystery woman" from the Second World War, Tyler is a master of espionage and infiltration.

Tyler's costume is a copy of her mentor's original, scanty enough to distract male opponents and give her an edge in battle. Her special goggles allow her to see in the dark at ranges approaching one hundred yards, and Tyler often employs electronic scramblers and holographic imagers that disrupt security systems.

An undisputed master of *savate* (French kickboxing), Dee Tyler can easily hold her own in hand-to-hand combat.

Personality/Role-playing

Phantom Lady is fearless and confident, almost to the point of being cocky. She is unconcerned about making enemies, relishes danger, and relies on her ingenuity to pull her out of the tightest spots.

Dee is very close to her father and very protective of him. She is willing to risk her life to protect his honor and the honor of his office. For his part, Albert Tyler is oblivious to the capabilities of his daughter, as well as her activities in the guise of Phantom Lady. Now that Dee has finished school, she has returned home to Louisiana to live near her father and support him in his efforts to gain a seat in the U.S. Senate.

In public, Dee pretends to be shallow and flighty. She is naturally energetic, even effervescent. This deception makes it difficult for outsiders to connect her with the confident and level-headed heroine of the shadows.

Using Phantom Lady in Adventures

Phantom Lady is best used in Adventures as a diversion. If she's around, she is the one who can fool security guards and cameras, allowing the heroes to get where they need to go, or to find whom or what they need without interference from authorities or bystanders.

Remember that the Phantom Lady works at a Network Affiliate. The heroes might meet her while she covers a story in their area. In fact, Phantom Lady might make an interesting Romantic Subplot for interested male heroes.

Appearances in DC Comics

Action Comics Weekly #636-641; *Doom Patrol* (2) #29; *Flash* (2) #29; *Starman* #36-39; *Who's Who '90* # 4; *Wonder Woman* (2) #61

Subplots

Delilah is most often involved in Subplots that concern her Family relationship with her father, and his welfare. She also has many male admirers.

Phantom Lady's Equipment

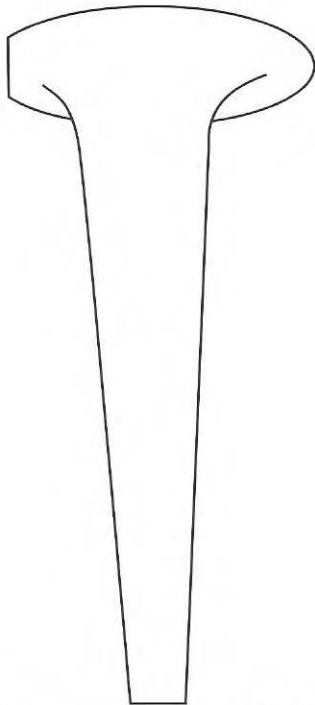

Taser Bracelet (side)

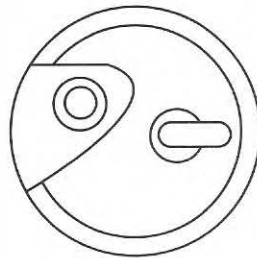

Clasp (back)

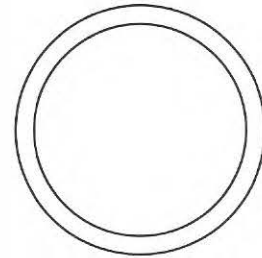

Clasp (front)

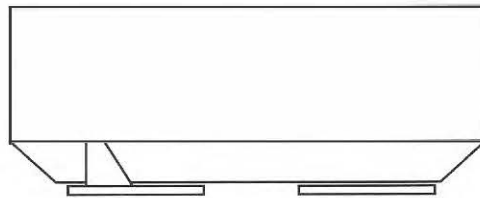

Holographic Projector

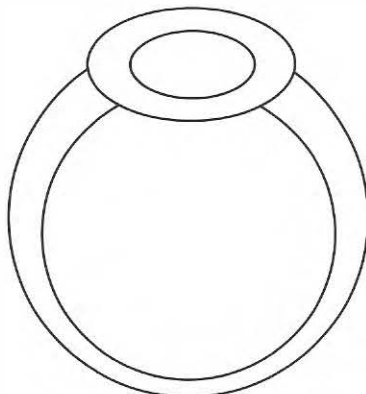

Taser Bracelet (front)

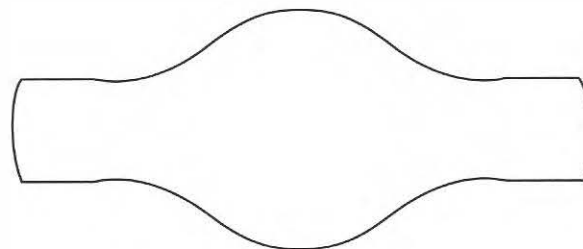

Taser Bracelet (top)

PLASTIC MAN

DEX:	10	STR:	4	BODY:	8
INT:	4	WILL:	6	MIND:	9
INFL:	5	AURA:	4	SPIRIT:	6
INITIATIVE:	21	HERO POINTS:	50		

- Powers:** Dumb Luck: 6, Self Manipulation: 15, Stretching: 15
- Limitations:** Miscellaneous: Plastic Man retains his red and gold costume motif in whatever form he assumes.
- Skills:** Detective: 5, Martial Artist: 5, Thief: 10, Weaponry: 3
- Advantages:** Luck
- Drawbacks:** Serious Irrational Attraction to zaniness; Strange Appearance
- Alter Ego:** Eel O'Brian
- Motivation:** Thrill of Adventure
- Wealth:** 4

Powers and Abilities

Plastic Man has incredible control over his body and has learned to shape it into any form, even objects and shapes a fair amount larger or smaller than his normal size. He can even take forms with moving parts, such as a helicopter or a speedboat. His powers enable him to stretch up to 30 miles and encompass almost 32,000 cubic feet of space. The only drawback to his shape-changing abilities is that any object he becomes keeps the distinctive red and yellow color of his costume.

Plastic Man's body is nearly indestructible and can even endure attacks from small caliber weapons or small explosions. He can also survive tremendous falls by forming himself into a ball and bouncing away.

Self Manipulation

His amazing stretching Powers give Plastic Man the ability to form his body into complex shapes and objects. To do so, Plas divides his APs of Self Manipulation between the Physical Attributes and Powers (as desired) of the object he is mimicking (Plastic Man can only mimic objects with Physical Powers; he cannot mimic objects with only Mental or Mystical Powers). Any object he forms retains Plastic Man's BODY of 8, and Plastic Man takes any damage inflicted upon such objects. Example objects include:

Airplane [STR: 7, Flight: 8]
 Boat [STR: 9, Swimming: 6]
 Car [STR: 8, Running: 7]
 Protective Bubble [volume of 15 APs]
 Slingshot [STR: 15]
 Spring [STR: 9, Jumping: 6]

Woozy Winks

Plastic Man's sidekick is a former asylum inmate known as Woozy Winks. Woozy has the following statistics:

WOOZY WINKS

DEX:	2	STR:	2	BODY:	3
INT:	2	WILL:	3	MIND:	3
INFL:	2	AURA:	2	SPIRIT:	4
INITIATIVE:	6	HERO POINTS:	15		

- Powers:** Dumb Luck: 4
- Drawbacks:** Unluck
- Alter Ego:** None
- Motivation:** Thrill of Adventure
- Wealth:** 4

Personality/Role-playing

Although he was once a criminal, Plastic Man seems to have found his true calling as a crime fighter. In fact, he loves his new hobby so much that he has made it his profession as well.

Presently, Plastic Man is always looking for an adventure. Not terribly bright, he and his pal, Woozy, are making a desperate attempt to make a place for themselves in the hero world. Their zany tactics and unusual personalities, however, make them mistrusted or at least misunderstood by most of their peers. Nonetheless, Plastic Man takes his fate in stride. He is always in costume and ready to accept the next challenge.

Using Plastic Man in Adventures

You want wacky and weird? Bring in Plastic Man. This Character is one the silliest heroes in the DC Universe. You can usually get a lot of comic relief out of forming Plastic Man into the strangest objects he can imagine that still allow him to capture his quarry. For example, he might form himself into a vacuum cleaner to suck up bad guys or even form a giant magnet to prevent the villains' car from making a timely getaway.

The player heroes might meet Plas when they investigate a case that Plastic Man's organization, the Greater Metropolitan Super-Hero World Saving and Chowder Society, is also handling. Perhaps he'll even invite them to join.

Appearances in the DC HEROES Role-Playing Game, Second Edition

Background/Roster Book (includes card)

Appearances in DC Comics

***Note:** Pre-Crisis appearances are not part of present continuity.

Pre-Crisis: *Adventure Comics* #467-478; *All-Star Squadron* #1-4, 7, 31-32, 35-37, 50, 60; *The Brave and The Bold* #76, 95, 123, 148; *Crisis On Infinite Earths* #35; *DC Comics Presents* #39, 93; *DC Super-Stars* #10; *Hit Comics* #32; *Infinity, Inc.* #22; *Justice League of America* #144, 193; *Plastic Man* (1) #1-64 (2) 1-20; *Police Comics* #1-102; *Secret Origins* (3) #30; *Super Friends* #36, 43, 45; *Who's Who '86* #18; *World's Finest Comics* #273

Current: *Action Comics* #661; *Plastic Man* (3) #1-4; *Who's Who '90* #4

Eel O'Brian's Warehouse Hideout

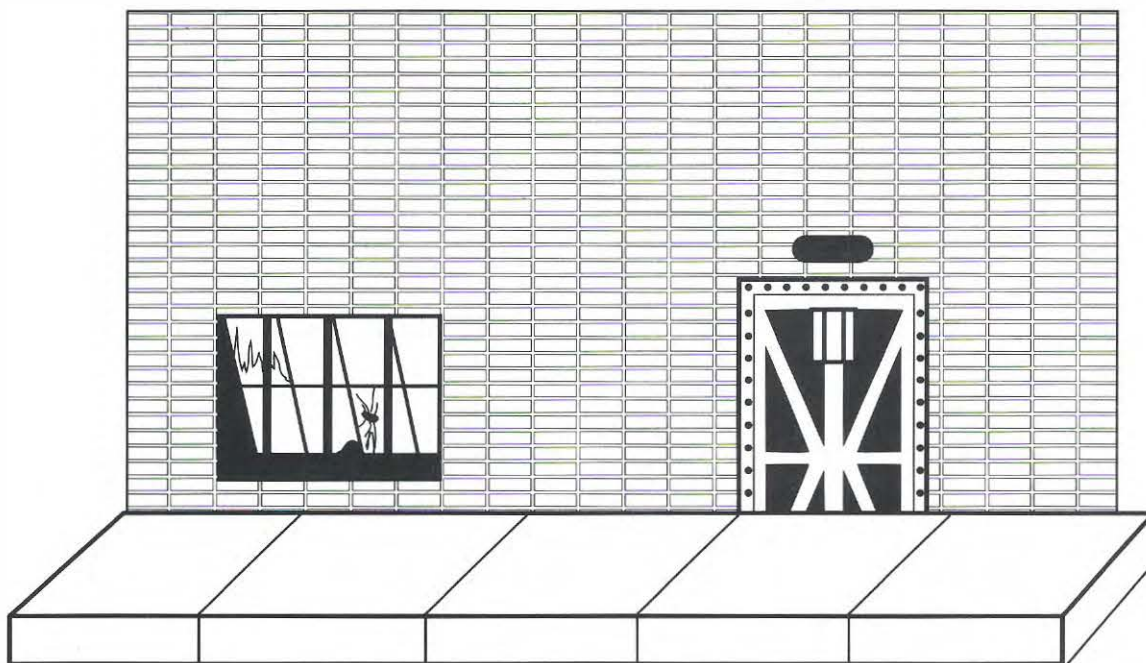

REBIS

DEX: 6	STR: 6	BODY: 6
INT: 10	WILL: 9	MIND: 8
INFL: 8	AURA: 4	SPIRIT: 7
INITIATIVE: 24	HERO POINTS: 65	

- Powers:** Flight: 12, Precognition: 14, Split: 1, Telekinesis: 3
- Limitations:** Miscellaneous: Split is only usable to separate the Negative Energy Being (see below) from Rebis
- Skills:** Medicine: 6, Vehicles: 6
- Advantages:** Connection: Doom Patrol (High)
- Drawbacks:** Strange Appearance; Uncertainty
- Alter Ego:** Larry Trainor/Eleanor Poole
- Motivation:** Responsibility of Power
- Wealth:** 0

Negative Energy Being

By using its Split Power, Rebis can release a negative energy being from "hir" body. The being has the following statistics.

NEGATIVE ENERGY BEING

DEX: 14	STR: 8	BODY: 6
INT: 3	WILL: 5	MIND: 8
INFL: 4	AURA: 2	SPIRIT: 8
INITIATIVE: 21		

- Powers:** Dispersal: 10, Flight: 30, Lightning: 15
- Limitations:** Miscellaneous: Dispersal is Always On and does not allow the energy being to pass through lead; Miscellaneous: the being's Lightning Power has a Range of Touch.

While separated from Rebis, the being passes all of its perceptions back to "hir" and vice versa (i.e., Rebis can see and hear everything the energy being can see and hear, etc.).

If the energy being is ever separated from Rebis for more than sixty seconds (4 APs or fifteen phases), both begin to suffer extreme pain and are affected by a Loss Vulnerability affecting all their Powers and Attributes.

The negative energy being is immune to Mental and Mystical Attacks.

Powers and Abilities

Rebis' body houses a being of pure energy that leaves in the form of a pure-black, humanoid

silhouette that can wrap itself around adversaries and emit massive electrical energy charges. Once free, the energy being travels at the speed of light and can pass through any substance, save lead. While away from Rebis, the energy being has its own rudimentary intellect, though Rebis and the energy creature always share each other's senses, regardless of the distance between them.

Rebis' energy form has only one limitation—the energy being may not remain outside Rebis' body for more than 60 seconds or both the energy being and Rebis begin to feel extreme pain and weakness.

Personality/Role-playing

The being known as Rebis is actually a composite of three separate sentient entities: test pilot Larry Trainor, physician Eleanor Poole, and the energy being that once inhabited both the Negative Man and Negative Woman of the Doom Patrol's previous incarnations. Due to its composite nature, Rebis manifests multiple personalities, all of which attempt to bind with the others and interact as one. As a result, Rebis is often confused about the particulars surrounding "hir" existence, memories, and feelings and spends considerable time away from "hir" teammates in contemplation.

Its fellow Doom Patrol members try to understand Rebis, but often it is simply too bizarre for them to handle. The part of Rebis that is Larry Trainor tries to comfort its friends and occasionally tries to explain itself to the team, but the answers it gives are as confusing as the questions they ask.

Rebis is reluctant to enter into conflict but thinks it is its duty to restrain wrongdoers and keep innocents from being injured by the strange forces the Doom Patrol often faces. Sometimes it is slow to react because it tends to study a situation in detail before reacting.

Using Rebis in Adventures

Rebis is a mind-boggler—just plain strange and full of surprises. Like most Doom Patrol team members and villains, Rebis can be introduced to add a touch of the bizarre to your games.

Since Rebis wields great power, innumerable villainous scientists might want to get their hands on "hir" in order to tap into "hir" energies. The player heroes may find themselves faced with the task of warning Rebis about such a plan, leading to an encounter with the Doom Patrol.

Subplots

Rebis is mostly involved in Subplots that revolve around its finding out the truth behind its own existence and the extent of its abilities.

Appearances in DC Comics

***Note:** Pre-Crisis appearances are not part of present continuity.

As Negative Man, Pre-Crisis: *The Brave and The Bold* #65; *Challengers of the Unknown* #48; *Doom Patrol* (1) #86-121; *My Greatest Adventure* #80-85; *Teen Titans* #6; *Who's Who '86* #16

As Negative Man, Current: *Doom Patrol* (2) #2-13, 16, 18-19; *Doom Patrol Annual* #1; *Invasion!* #3 (behind the scenes); *Teen Titans Spotlight* #9; *Who's Who '88* #2

As Rebis: *Blasters Special* #1; *Doom Patrol* (2) #19-24, 27-33, 35-41, 43-44, 46-52, 54; *Justice League Europe* #17; *Justice League Quarterly* #5 (behind the scenes)

Doom Patrol Headquarters (formerly the JLA Secret Sanctuary)

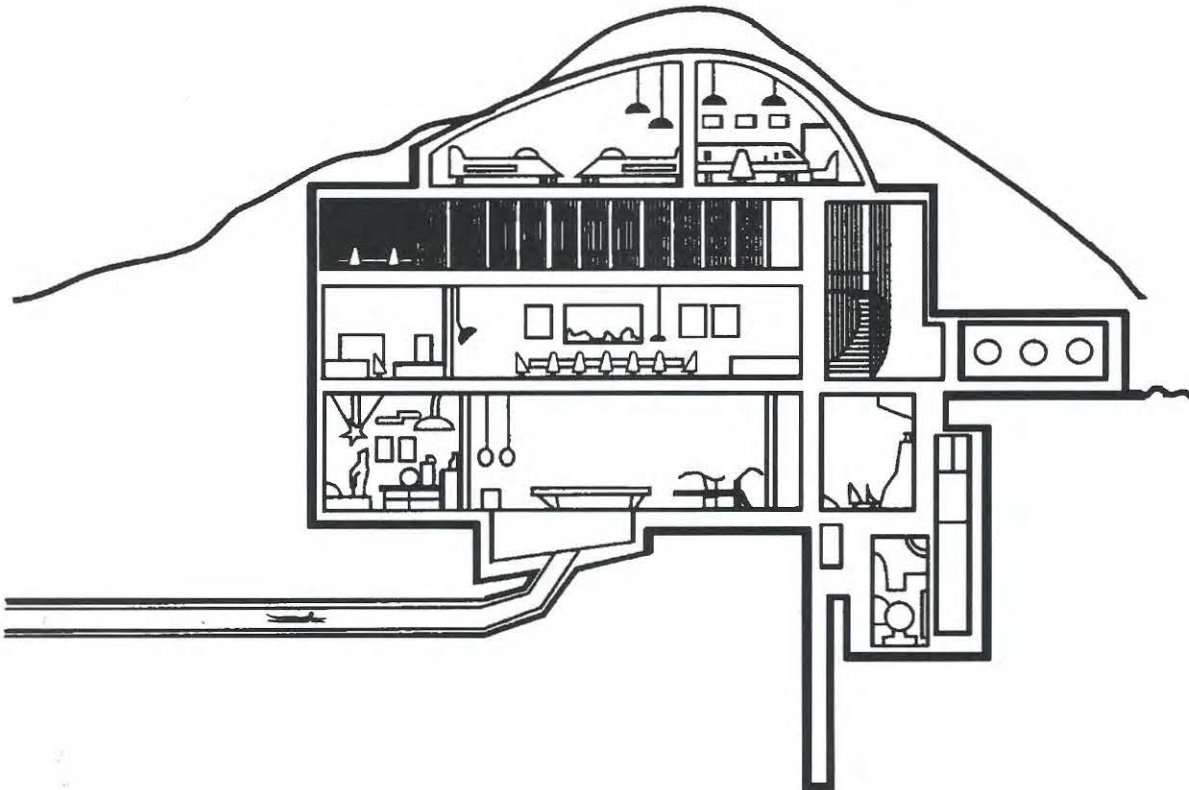

REEP DAGGLE

DEX:	7	STR:	4	BODY:	7
INT:	9	WILL:	6	MIND:	5
INFL:	7	AURA:	6	SPIRIT:	6
INITIATIVE:	27	HERO POINTS:	70		

- **Powers:** Chameleon: 9, Omni-Arm: 9, Self Manipulation: 16, Shape Change: 16
- **Bonuses:** Miscellaneous: Using his Shape Change Power, Reep can assume the form of nonexistent creatures.
- **Limitations:** Miscellaneous: Objects Reep mimics with Self Manipulation won't function. He can mimic an object's appearance only; Miscellaneous: Animal forms Reep mimics with Shape Change can never have a STR greater than 5, regardless of the actual STR of the beast he is mimicking.
- **Skills:** Artist (Actor): 6, Detective: 8, Martial Artist: 5, Thief: 9
- **Advantages:** Connection: Legion of Super-Heroes (High); Lightning Reflexes; Rich Family
- **Drawbacks:** Loss Vulnerability: Reep loses all Powers when exposed to Cancelite; Loss Vulnerability: Hard radiation (15+ APs) might permanently strip Reep of his Powers.
- **Alter Ego:** Chameleon Boy, Cham
- **Motivation:** Upholding the Good
- **Wealth:** 20

Powers and Abilities

As a native of Durla, Reep can ascertain the molecular structure of most living and non-living materials by use of his antennae and then physically transform into an exact replica of the material's structural pattern. With enough concentration, he can even transform into creatures that exist only in his imagination (often legendary creatures) and organisms much larger than his normal Durlan form. Most recently, Daggle learned to rearrange his vital organs to place them in safer parts of his body upon Brainiac 5's advice. This tactic has already proven useful; it saved Daggle's life during a recent attack by Roxxas.

Reep's abilities make him an excellent spy. Toward this end, he often duplicates other humanoids and uses his acting ability to impersonate them.

Specifics on Reep's Shape-Change Powers

With his Powers, Reep Daggle can transform himself into a near-perfect duplicate of any animal (Shape Change), physical object (Self Manipulation), or Character (Chameleon).

The animal forms Reep commonly assumes include:

- **Jovian Montessor:** a huge predatory native of Jupiter. [DEX: 6 STR: 5 BODY: 13, Claws: 7, Running: 6, Skin Armor: 3]
- **Lightning Beast:** a large Korbalian herd animal. [DEX: 4 STR: 5 BODY: 13, Lightning: 11]
- **Octosaurus:** a 12' long protozoan. [DEX: 8 STR: 4 BODY: 9, Energy Blast: 8, Glue: 8, Sonar: 6]
- **Slith:** a six-armed ape. [DEX: 8 STR: 5 BODY: 11, Extra Limb (x4): 5, Running: 2]
- **Winged Durlan:** [Flight: 9]

Personality/ Role-playing

Although he always seems to keep a sense of humor about him, even during the most difficult of times, Daggle takes his responsibilities as a Legionnaire very seriously. His ultimate goals are to alleviate some of Durla's xenophobia toward the rest of the galaxy, to prove that some Durlans are not prejudiced and barbaric, and to show that Durlans play an important part in interplanetary relations.

Daggle is generous and confident, and these traits have made him an effective leader. After he came into money and took over Brande Industries, Daggle took it upon himself to reform the Legion of Super-Heroes after the Great Collapse of 2989. Now he enthusiastically shares command of the team with Rokk Krin and Querl Dox. He is genuinely excited to be a part of the new team and to face new challenges outside the business world.

As Chameleon Boy (or Cham to his friends), Reep Daggle was the Legion of Super-Heroes' detective specialist as well as one of its more powerful and versatile members. Though he has Legionnaire combat training, he finds it useless for the most part and relies heavily on his shape-shifting abilities to carry out his missions.

Using Reep Daggles in Adventures

Daggles is extremely wealthy. Because he is generous and believes in good causes, he might be willing to lend a group of player heroes financial assistance.

Appearances in DC Comics

***Note:** Pre-Crisis appearances are not part of current continuity.

Pre-Crisis: *Action Comics* #267, 287, 289, 309, 383, 390-392; *Adventure Comics* #247 (behind the scenes), 282, 290, 301-304, 306, 308-317, 319-327, 329-330, 333-334, 336-347, 348 (behind the scenes), 349-350, 353, 355, 358-360, 362-364, 372, 374-376, 378-379; *All-New Collectors' Edition* #C-55; *Booster Gold* #8-9; *The Brave and The Bold* #179; *Crisis On Infinite Earths* #2, 5, 8, 10; *DC Comics Presents* #80; *DC Special Series* #21; *Jonah Hex* #15; *Justice*

League of America #147-148; *Karate Kid* #12-13; *Legion of Super-Heroes* (2) #259, 262, 268, 273-274, 276, 280, 284, 286-294, 296-298, 300-301, 304-305, 307-308, 311 (3) 1-11, 14, 16-17, 19-22, 24-26, 28, 32-36, 38-43, 46-49, 54, 62-63 (4) 1, 3; *Legion of Super-Heroes Annual* (2) #1-3 (3) 1, 4; *The New Adventures of Superboy* #50; *Secret Origins* (3) #25, 37, 42; *Secrets of the Legion of Super-Heroes* #1-3; *Superboy* (1) #93, 100, 125, 188, 193, 195, 197-201, 204-205, 207-208, 210, 212-213, 215, 218, 220, 221-226, 228-229; *Superboy and the Legion of Super-Heroes* #232-237, 239, 241, 243-247, 249-250, 256-258; *Superman* (1) #156; *Superman Family* #207; *Superman's Pal, Jimmy Olsen* #72, 85; *Who's Who '85* #4

Current: *Adventures of Superman* #478; *Legion of Super-Heroes* (4) #1, 3, 6-10, 11 (behind the scenes), 12, 14-18, 20, 22, 26, 29-30; *Legion of Super-Heroes Annual* (4) #1-2; *Who's Who '90* #3; *Who's Who in the Legion of Super-Heroes* #1

Reep Daggles' Corporate Office

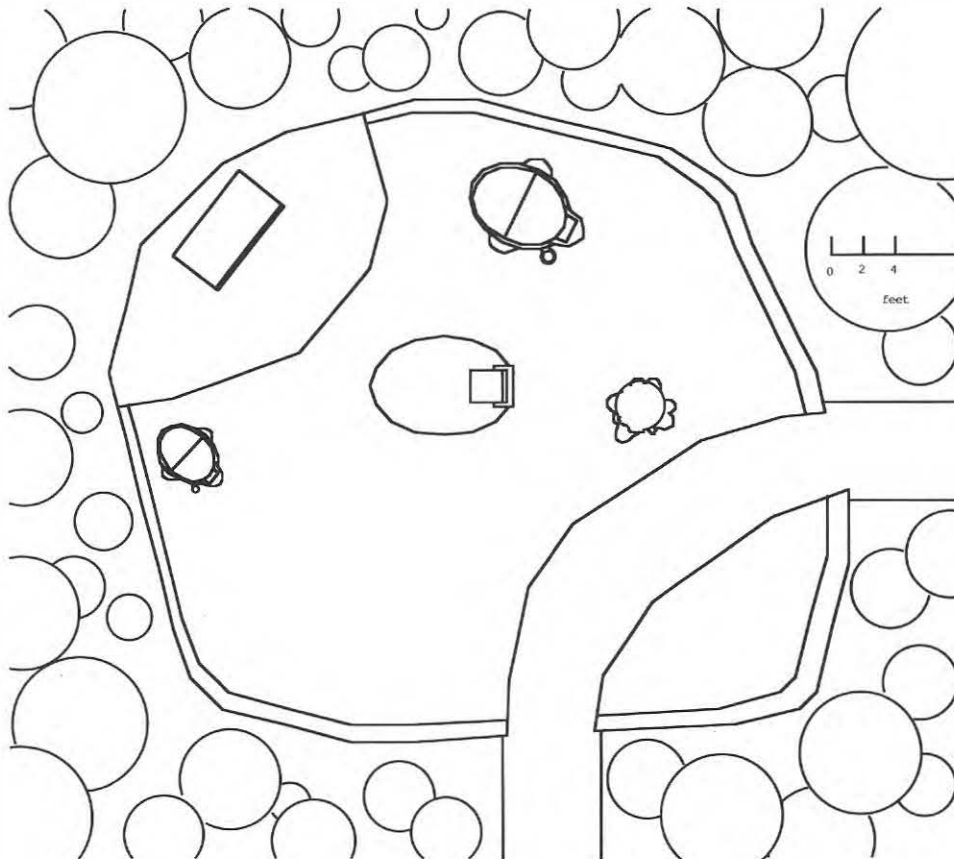

ROCKET RED

DEX: 7	STR: 6	BODY: 6
INT: 4	WILL: 5	MIND: 4
INFL: 4	AURA: 3	SPIRIT: 4
INITIATIVE: 15	HERO POINTS: 60	

- Skills:** Gadgetry: 4, Military Science: 4, Weaponry: 5
- Advantages:** Connections: Justice League International (High), Russia (High)
- Drawbacks:** Married
- Alter Ego:** Dmitri Pushkin
- Motivation:** Responsibility of Power
- Wealth:** 4
- Equipment:**

APOKOLIPS BATTLESUIT [DEX: 9, STR: 9, BODY: 10, Energy Absorption: 4, Energy Blast: 16, Flight: 15, Force Field: 4, Radar Sense: 12, Skin Armor: 2, Super Hearing: 12, Telepathy: 9, Radio Communications at a distance of 16 APs, R#: 3].

Dmitri secured his improved version of the Rocket Red armor during a trip to Apokolips. This battlesuit allows him to withstand even large caliber artillery shells, lift objects weighing more than 13 tons, and attain airspeeds faster than the top speed of any fighter jet. The suit also allows Dmitri to cast out an electrified net [STR: 9, BODY: 10] to entangle nearby opponents and erect a defensive force screen (Force Field; usable only to protect the suit's wearer).

Like the earlier Rocket Red battlesuit, the Apokolipsian model allows Dmitri to tap into nearby computers and electronic devices. To do so, Dmitri uses the suit's Telepathy Power to make an Action Check against an OV/RV equal to the computer's INT/INT. If the Check succeeds, he may then begin to remove information from that computer (Telepathy vs. the computer's INT/INT; RAPs equal Knowledge Points gained) or begin to operate that computer's systems (Telepathy vs. the computer's INT/INT; 1 or more RAPs indicate success). Note that the suit's Telepathy Power is only usable for this purpose.

Original Rocket Red Armor

Before he found his new battlesuit on Apokolips, Dmitri was originally equipped with one of the Rocket Red battlesuits designed by Green Lantern Kilowog. This earlier suit had the following statistics:

ROCKET RED BATTLESUIT [STR: 8, BODY: 9, Energy Blast: 10, Flight: 12, Radar Sense: 10, Super Hearing: 12, Telepathy: 6, Radio Communications at a distance of 15 APs, R#: 2].

The old suit's Telepathy Power was also usable only to connect with computers and electronic devices.

Powers and Abilities

Dmitri Pushkin is one of the last active members of the now-defunct Rocket Red Brigade. During his Rocket Red training, Dmitri underwent genetic alterations that enhanced his strength and physical capacity beyond normal human potential. Like all Rocket Reds, he was then instructed in the operation of armored battlesuits.

Before he even entered the Rocket Red program, Dmitri was a highly trained soldier and hand-to-hand combatant.

Personality/Role-playing

Pushkin, Rocket Red #4, is a Russian patriot, though he has adapted well to Western culture, especially American culture. In fact, he often speaks in out-of-place Americanisms and especially enjoys quoting television commercials.

Dmitri loves life and enjoys new experiences. He sees himself as a "wild and crazy guy," though his former teammates think he's just crazy. Actually, his upbeat nature may be aggravating at times, but it usually keeps his comrades (whoever they may be) in good spirits. Rocket Red believes violence is never the best answer to a problem, and he will always try to find a peaceful solution rather than apply brute force. Under no circumstances, however, will he allow his friends or family to be threatened, and he becomes a determined, unstoppable adversary when they are.

To his surprise, Dmitri finds super-heroics a real kick. Rocket Red is one of the most reliable Justice Leaguers; he has proven his usefulness on and off the battlefield, though he tries to avoid dangerous situations as much as possible. Even while adventuring alongside the JLI, Dmitri is always thinking about his wife and children at home.

Background Update

Now, with the changes in Eastern Europe, Dmitri felt the call of his country and left Justice League Europe to go home to help keep order.

Using Rocket Red in Adventures

Rocket Red is a good contact for player heroes who adventure in Russia. Always helpful, Dmitri might help the heroes interact with the Russian government, culture, and peoples. Since he is also sociable, he might even ask the heroes to dinner, an occasion at which he might try to show the heroes how much he knows about American culture.

Subplots

Rocket Red is most often involved in Subplots that revolve around his Family or his desire to learn about other cultures.

Appearances in the DC HEROES Role-Playing Game, Second Edition

Justice League Sourcebook, Background/Roster Book (includes card), Come on Down!, Atlas of the DC Universe.

Appearances in DC Comics

Animal Man #16, 20; *Armageddon 2001* #2; *Captain Atom* (3) #38, 50; *Captain Atom Annual* #2; *Doctor Fate* (2) #15; *Doom Patrol and Suicide Squad Special* #1; *Flash* (2) #29; *Green Lantern Corps* #209-210; *Invasion!* #2-3; *Justice League* #3; *Justice League America* #32, 53, 55-59; *Justice League Annual* #2; *Justice League Europe* #1-13, 15-36; *Justice League Europe Annual* #2; *Justice League International* #11-24; *Justice League Quarterly* #3-5; *Martian Manhunter* #1-2, 4; *The New Titans Annual* #35; *Secret Origins* (3) #34; *Starman* #13; *Suicide Squad* #13; *War of the Gods* #1-2, 4; *Who's Who '90* #4; *Wonder Woman* (2) #25-26, 49-50

Rocket Red Armor:

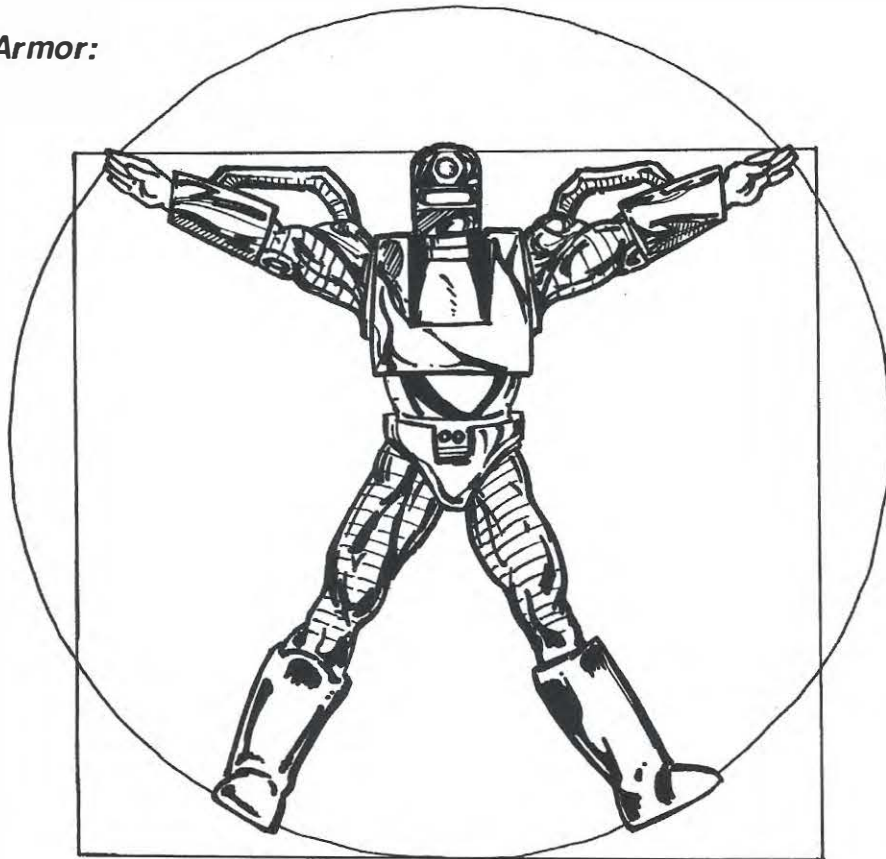

ROKK KRINN

DEX: 7	STR: 4	BODY: 5
INT: 8	WILL: 6	MIND: 6
INFL: 6	AURA: 5	SPIRIT: 7
INITIATIVE: 23	HERO POINTS: 80	

- Skills:** Charisma: 4, Martial Artist: 7, Military Science: 6, Vehicles: 5
- Advantages:** Connection: Legion of Super-Heroes (High); Leadership; Scholar (ancient Earth history)
- Drawbacks:** Minor Physical Restriction (to Braalians): Rokk has lost his Magnetic Powers; Married
- Alter Ego:** Cosmic Boy
- Motivation:** Upholding the Good
- Wealth:** 5

Powers and Abilities

Rokk Krinn was once one of the most powerful Braalians of his time, capable of wielding amazing magnetic powers. But unfortunately, a few years ago, he was permanently stripped of his powers.

Krinn is a natural leader, however, and an expert tactician, as well as a fine hand-to-hand combatant.

Specifics on Rokk's Powers

When he was still known as Cosmic Boy, Rokk had the native Braalian power to control magnetic energy. During this era, he had the Magnetic Control Power rated at 16 APs and the Flight Power rated at 8 APs. Both of these Powers were temporarily reduced to 2 APs whenever Rokk was in the presence of temperatures greater than 180° Fahrenheit.

Rokk permanently lost his Powers during the Battle of Venado Bay while serving with the Braalian armed forces.

Personality/Role-playing

With or without his magnetic abilities, Rokk Krinn (formerly Cosmic Boy) has always been a leader and a model for the other members of the Legion of Super-Heroes.

For Krinn, losing his abilities was like losing a limb or worse. For a time after the accident, he was distraught and wandered space, looking for some sort of inspiration in his life. But thanks to Reep Daggles, his work with the re-formed Legion is helping him regain a positive attitude.

Ever since their homeworlds went to war, there has been tension between Rokk and his teammate, Vi (Shrinking Violet). Both bear the scars of battle and are ashamed of their conduct. Rokk has learned not to blame Vi for the loss of his abilities, however, and the pair of them are presently trying to work out their hostilities.

Rokk Krinn is now married to former substitute Legionnaire Lydda Jath (Night Girl). He left her behind on Braal when he rejoined the Legion, but Reep Daggles is taking care of her financially and she is safe while Krinn is gone.

Should he find himself in combat, Krinn will now remain in the background and allow his powerful teammates to handle much of the physical action while he shouts out ideas, warnings, or commands. If necessary, however, he will do whatever is necessary to protect himself and his teammates from physical harm.

Using Rokk Krinn in Adventures

Rokk is the leader of the Legion of Super-Heroes and a formidable strategist. If the player heroes need advice on how to handle a situation, they might contact Krinn.

Subplots

Rokk Krinn was once involved in a Romantic Subplot with Saturn Girl, who is now married to Garth Ranzz (Lightning Lad). Rokk is now happily married to his wife, Lydda, who is expecting their first child. At this time he is also often involved in a Subplot revolving around his relationship with Vi and another regarding his acceptance of the loss of his Powers.

Appearances in DC Comics

* **Note:** Pre-Crisis appearances are not part of present continuity.

Pre-Crisis: *Action Comics* #267, 276, 285, 287, 289, 298, 386, 389, 392; *Adventure Comics* #247, 267, 282, 290, 293, 300-308, 310-311, 313, 315-319, 323-328, 330-331, 334-337, 342-348, 350-357, 359-360, 362-363, 365-367, 369, 372, 374-376, 380; *All-New Collectors' Edition* #1-55; *The Brave and The Bold* #179; *Cosmic Boy* #1-4; *Crisis On Infinite Earths* #3, 5, 10; *DC Comics Presents* #2, 43; *DC Super-Stars* #17; *Karate Kid* #6, 10, 12-13; *Legends* #1-2; *Legion of Super-Heroes* (2) #262, 267-268, 272, 274, 277-280, 282, 284, 287, 290-297, 299-300, 307-310, 312-313 (3) 2-4, 6-12, 14-15, 17, 23, 31, 36-39, 45, 51, 59 (behind the scenes), 63 (4) 1, 2 (behind the scenes), 3, 30; *Legion of Super-Heroes Annual* (2) #1-3 (3) 3;

Legionnaires Three #1-4; *Secret Origins* (3) #8, 25, 42, 46; *Secrets of the Legion of Super-Heroes* #1-3; *Superboy* (1) #86, 98 (behind the scenes), 100, 125, 247, 173, 176, 191, 195, 197-198, 200-201, 204, 207, 209, 211-213, 215-216, 218, 221-222, 226, 229; *Superboy and the Legion of Super-Heroes* #232, 235-237, 239-240, 243-251, 253-257; *Superman* (1) #147, 152, 155-156, 172 (2) 8; *Superman's Pal, Jimmy Olsen* #72, 85, 100; *Tales of the Legion* #316-318; *Who's Who '85* #5; *World's Finest Comics* #168, 284

Current: *Action Comics* #663; *Adventures of Superman* #476, 478; *Legion of Super-Heroes* (4) #1, 2 (behind the scenes), 3, 6-10, 12-17, 20, 22, 26-27; *Legion of Super-Heroes Annual* (4) #1-2; *New Gods* (3) #22; *Secret Origins* (3) #47 (flashback), 49; *Who's Who '90* #1; *Who's Who in the Legion of Super-Heroes* #1

The Planet Braal

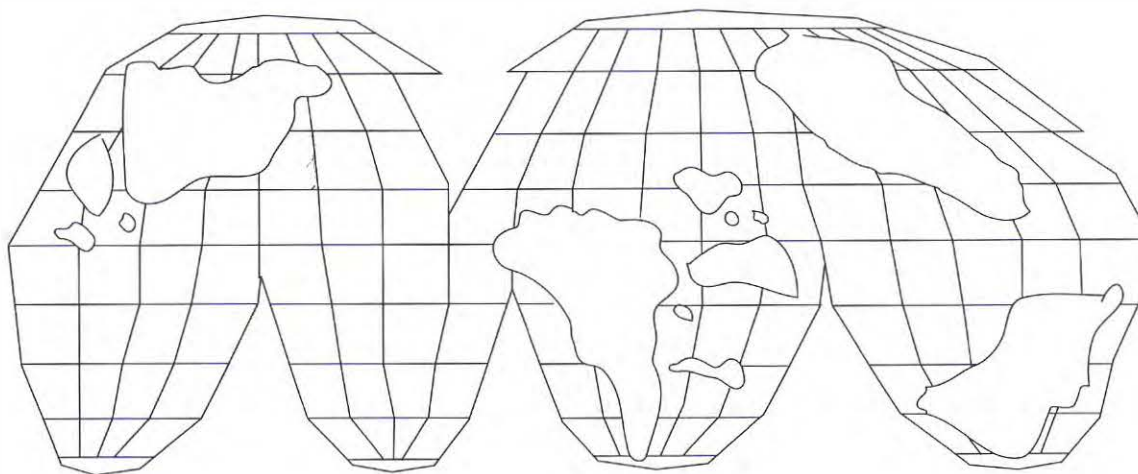

SECRET SIX

VIC SOMMERS

DEX: 5	STR: 4	BODY: 4
INT: 5	WILL: 6	MIND: 5
INFL: 4	AURA: 4	SPIRIT: 5
INITIATIVE: 16		HERO POINTS: 30

- Skills:** Martial Artist: 5, Military Science: 5, Vehicles: 4, Weaponry: 5
- Advantages:** Connections: Secret Six (High), U.S. Military (Low)
- Drawbacks:** Serious Physical Restriction: Sommers is blind.
- Alter Ego:** None
- Motivation:** Seeking Justice
- Wealth:** 5
- Equipment:**

CYBERNETIC GOGGLES [BODY: 3, Microscopic Vision: 3, Telescopic Vision: 3, Ultra Vision: 5] With the goggles, Sommers can see despite his handicap.

Submachine gun [AV: 5, EV: 5, Ammo: 5, Range: 5, R#: 3]

TONY MANTEGNA

DEX: 4	STR: 3	BODY: 4
INT: 6	WILL: 5	MIND: 5
INFL: 5	AURA: 5	SPIRIT: 5
INITIATIVE: 15		HERO POINTS: 30

- Skills:** Artist (Writer): 3, Vehicles: 3, Weaponry: 4
- Advantages:** Connections: Secret Six (High), Press (Low)
- Drawbacks:** Serious Physical Restriction: Mantegna is deaf.
- Alter Ego:** None
- Motivation:** Seeking Justice
- Wealth:** 7
- Equipment:**

HEADSET [BODY: 4, Extended Hearing: 4, Super Hearing: 6] With the headset, Mantegna can hear normally.

Submachine gun [AV: 5, EV: 5, Ammo: 5, Range: 5, R#: 3]

MITCH HOBBERMAN

DEX: 4	STR: 3	BODY: 4
INT: 6	WILL: 5	MIND: 5
INFL: 4	AURA: 4	SPIRIT: 5
INITIATIVE: 14		HERO POINTS: 30

- Skills:** Artist (Sculptor): 3, Gadgetry: 4, Vehicles: 3, Weaponry: 4
- Advantages:** Connections: Motion Picture Industry (Low), Secret Six (High); Scholar (special effects)
- Drawbacks:** Minor Physical Restriction: Hoberman suffers from rheumatoid arthritis.
- Alter Ego:** None
- Motivation:** Seeking Justice
- Wealth:** 5
- Equipment:**

CYBERNETIC GLOVES [BODY: 4, Superspeed: 1] With the gloves, Hoberman can perform complex tasks at great speed. The gloves also block out the effects of his rheumatism. The gloves' Superspeed Power is usable only to speed up tasks in which Hoberman must use his hands.

Submachine gun [AV: 5, EV: 5, Ammo: 5, Range: 5, R#: 3]

MARIA VERDUGO

DEX: 3	STR: 3	BODY: 3
INT: 7	WILL: 7	MIND: 5
INFL: 4	AURA: 4	SPIRIT: 5
INITIATIVE: 14		HERO POINTS: 30

- Skills:** Gadgetry: 5, Science: 5, Vehicles: 2, Weaponry: 3
 - Advantages:** Connection: Secret Six (High); Scholar (computer science)
 - Drawbacks:** Minor Physical Restriction: Verdugo is an epileptic.
 - Alter Ego:** None
 - Motivation:** Seeking Justice
 - Wealth:** 6
 - Equipment:**
- TIARA [BODY: 4] The tiara controls Verdugo's brain impulses and prevents her from suffering epileptic seizures.
- Submachine gun [AV: 5, EV: 5, Ammo: 5, Range: 5, R#: 3]

LADONNA JAMEAL

DEX: 3	STR: 3	BODY: 3
INT: 5	WILL: 5	MIND: 5
INFL: 6	AURA: 4	SPIRIT: 5
INITIATIVE: 14		HERO POINTS: 30

- Skills:** Artist (Actor): 3, Vehicles: 3, Weaponry: 3
- Advantages:** Connections: Motion Picture Industry (Low), Secret Six (High)
- Drawbacks:** Minor Physical Restriction: Jameal is mute.

- Alter Ego:** None
- Motivation:** Seeking Justice
- Wealth:** 6
- Equipment:**

HEADSET [BODY: 4] With the headset, Jameal can simulate normal speech.

Submachine gun [AV: 5, EV: 5, Ammo: 5, Range: 5, R#: 3]

LUKE MCKENDRICK

DEX: 6	STR: 4	BODY: 4
INT: 5	WILL: 4	MIND: 5
INFL: 4	AURA: 4	SPIRIT: 5
INITIATIVE: 15	HERO POINTS: 30	

- Skills:** Vehicles: 3, Weaponry: 4
- Advantages:** Connection: Secret Six (High)
- Drawbacks:** Serious Physical Restriction: McKendrick lost both his legs in a terrorist bombing.
- Alter Ego:** None
- Motivation:** Seeking Justice
- Wealth:** 5
- Equipment:**

LEGS [BODY: 7, Running: 6] With the prosthetic legs, McKendrick can run faster than 60 miles per hour.

Submachine gun [AV: 5, EV: 5, Ammo: 5, Range: 5, R#: 3]

Group Equipment:

SECRET SIX CHOPPER [STR: 9, BODY: 10, Extended Hearing: 4, Radar Sense: 13, Super Hearing: 12, Thief (Stealth): 5, Radio Communications at a distance of 17 APs, R#: 2]. The Chopper carries state-of-the-art surveillance equipment and silencers for the rotor (Thief/Stealth).

Powers and Abilities

The physically challenged members of the Secret Six all received technological replacements for their lost abilities that gave them an advantage over normal humans.

Vic Sommers, blinded in Vietnam during a land mine explosion, was offered a headset that connects to his optic nerves, giving him night vision, telescopic vision, and microscopic vision. His military experience gives him an excellent knowledge of weapons.

Mitch Hoberman's rheumatoid arthritis crippled his hands, but cybernetic gloves designed by Mockingbird control the nerve impulses and block the pain. Hoberman can now move his hands as well or better than before. As a special effects artist, Hoberman often designs illusions that

serve as diversions for his teammates.

LaDonna Jameal was muted and disfigured when a madman threw acid in her face. Mockingbird gave LaDonna a new voice.

Luke McKendrick was given bionic legs, faster than human, to replace his own, which were lost in a bombing.

Maria Verdugo's epilepsy became too much of a barrier for her to work on her mathematics and computer research until she was given a headset that controls her brain's impulses. Now she operates the Secret Six computer network, one of the most high-tech systems in existence.

Anthony Mantegna wears a headset that allows him to hear. He serves as the team's communication specialist.

Personality/Role-playing

Vic Sommers is a perceptive man who was originally reluctant to join the team.

Mitch Hoberman is the team's creative force.

LaDonna Jameal is still psychologically scarred by the ordeal she suffered as a child. Although she can no longer act professionally, her skills still benefit the team.

Luke McKendrick is young and enthusiastic, and he understands commitment to a cause or goal. Luke was the least reluctant to accept his gift.

Maria Verdugo has a naturally strong character and good leadership abilities.

And Tony Mantegna is a reporter with an inquisitive nature.

These Secret Six are no longer under the indirect command of the "Agency" as were their predecessors, though they continue to undertake missions that help those in need.

Using the Secret Six in Adventures

The Secret Six are frequently involved in missions that revolve around government intrigue and corruption. If the player heroes are guided into a plot of this sort, the Secret Six might make excellent guides and assistants. They know the ins and outs of "the system," and they can help the heroes work their way out of jams.

Appearances in DC Comics

Secret Six I: *Action Comics Weekly* #601-602, 629; *Crisis On Infinite Earths* #12; *Secret Six* #1-7; *Who's Who* '86 #20

Secret Six II: *Action Comics Weekly* #601-612, 619-630; *Who's Who* '88 #3; *Who's Who* '90 #2

SINBAD

DEX: 3	STR: 2	BODY: 2
INT: 3	WILL: 3	MIND: 3
INFL: 3	AURA: 2	SPIRIT: 4
INITIATIVE: 9	HERO POINTS: 20	

- **Powers:** Force Field: 1, Mental Blast: 1, Mind Probe: 1, Pyrotechnics: 1, Telekinesis: 1, Telepathy: 1
- **Limitations:** Miscellaneous: Sinbad's Powers have yet to develop. At present, they rarely work; Miscellaneous: Sinbad's Force Field can only be extended to cover himself and one other person.
- **Advantages:** Connections: LexCorp (Low), Superman (Low)
- **Alter Ego:** Davood Nassur
- **Motivation:** Upholding the Good
- **Wealth:** 1
- **Equipment:**

ENHANCER BELT [BODY: 7, Enchantment: 20, R#: 3] The Enhancer Belt is one of LexCorp's most impressive inventions. It is capable of isolating and boosting its wearer's meta-human abilities to Superman's level. Normally, the belt adds 20 APs (up to a maximum of 21 APs) to each of the wearer's Powers and super-human abilities, but the exact effects of the belt are best determined by the Gamemaster.

While Sinbad was wearing the belt, he had the following Powers and abilities: **BODY:** 7, Force Field: 21, Mental Blast: 20, Mind Probe: 15, Pyrotechnics: 16, Telekinesis: 21, Telepathy: 21.

Pyrotechnics

Sinbad has a Power that is new to DC HEROES. Here is its description:

PYROTECHNICS

Link: WILL
Range: Normal
Type: Dice
Base Cost: 15
Factor Cost: 3

Pyrotechnics is the Power to use one's mind to accelerate a target's molecular motion. If the Power user so desires, this motion can be increased to the point where the target becomes uncomfortably hot and possibly to the point where the target bursts

into flames.

In DC HEROES terms, this is a Physical Attack using the attacker's APs of Pyrotechnics as the AV/EV.

Powers and Abilities

Davood's psionic abilities (namely telepathy, telekinesis and mind-reading) were boosted by LexCorp's Enhancer Belt, making him powerful enough to challenge even Superman.

Since the belt was destroyed, Davood's abilities have resumed development at a much slower rate.

Personality/Role-playing

Davood Nassur has the makings of a great superhero. Not only does he possess powerful latent psionic abilities, but he also has a selfless dedication to serving the common good and keeping the peace in his community.

Sinbad, as Davood named himself after the legendary adventurer, has proven his bravery. He faced Superman when it was believed that the Man of Steel was an enemy to the Quracis during the War in the Middle East and sent messages straight to Lex Luthor, threatening the industrialist's power and authority.

For now, Davood is trying to be an ordinary student and American teen. He has learned how to be patient and compromise. With the knowledge of the abilities he may one day develop, he is sometimes cocky and reckless, but he knows that with great power comes great responsibility.

Davood once beat Superman in battle. Now that they are allies, he is proud of that achievement and sometimes likes to rub it in light-heartedly.

Using Sinbad in Adventures

Sinbad lives in the Little Qurac section of Metropolis and is active in public service in that area. He is a troublemaker (albeit an innocent one) and can be introduced as a hindrance who soon becomes a help once he has grown to trust the player heroes. Davood might also serve as a translator should the heroes need such services.

Subplots

Davood is most often involved in Family Subplots, though he does have a Friendly relationship with Superman, who encourages him to carefully nurture his psionic abilities.

Appearances in the DC Heroes Role-Playing Game, Second Edition

Superman—The Man of Steel Sourcebook

Appearances in DC Comics

Action Comics #658; *Adventures of Superman* #471; *Superman (2)* #48; *Who's Who '90* #3

The LexCorp Enhancer Belt

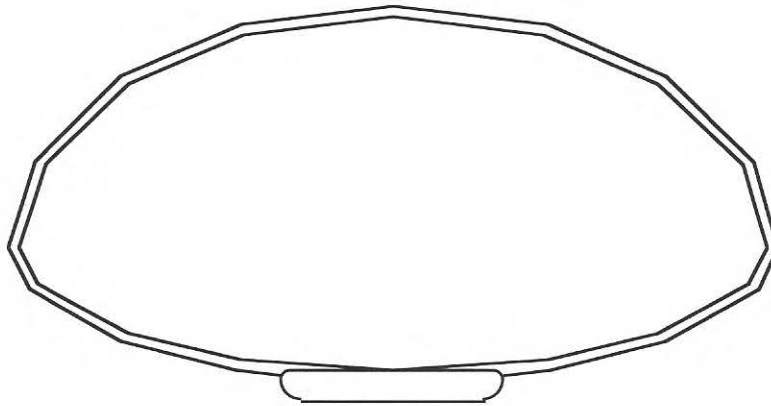

top

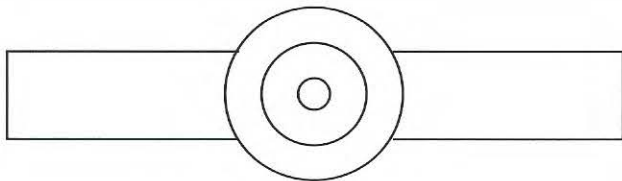

front

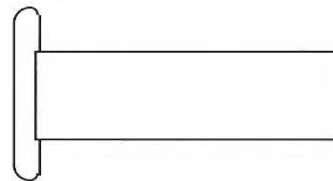

side

SPEEDY

DEX: 6	STR: 4	BODY: 5
INT: 5	WILL: 5	MIND: 4
INFL: 5	AURA: 4	SPIRIT: 5
INITIATIVE: 20	HERO POINTS: 60	

•**Skills:** Acrobatics: 5, Artist (Musician): 3, Detective: 5, Gadgetry: 5, Martial Artist: 6, Weaponry: 9

•**Advantages:** Connections: Green Arrow (High), New Titans (High), U.S. Intelligence Community (High); Lightning Reflexes; Scholar (arrow construction)

•**Drawbacks:** Public Identity

•**Alter Ego:** Roy Harper

•**Motivation:** Seeking Justice

•**Wealth:** 5

•**Equipment:**

Bow [STR: 7, BODY: 4] The bow has a range equal to its STR APs (roughly 400 yards).

Ordinary Arrows (x5) [EV: 3, BODY: 1] These are standard arrows. Unless he performs some sort of Trick Shot, Speedy automatically enters Killing Combat if he uses them on a living creature.

Acid Arrow [Acid: 9, BODY: 1, R#: 2] Use the arrow's APs of Acid as its EV. Again, Speedy automatically enters Killing Combat if he uses this arrow on a living target.

Bola Arrow [STR: 8, BODY: 10, R#: 2] The Bola arrow Grapples its target with an AV equal to Speedy's Weaponry and an EV equal to its STR.

Boxing Glove Arrow [EV: 6, BODY: 1] Speedy rarely uses this arrow these days.

Cryonic Arrow [BODY: 1, Ice Production: 8, R#: 2] Use the arrow's APs of Ice Production as its EV.

Explosive Arrow [BODY: 1, Bomb: 8, R#: 2] If the arrow strikes its target (i.e. Speedy rolls his Success Number or higher), its Bomb Power detonates.

Grappling Hook Arrows (x3) [STR: 8, BODY: 1] The grappling hook arrows trail a swing line (4 APs long) behind them. Speedy makes a Weaponry Action Check against an OV/RV determined by consulting the Universal Modifiers Table to catch the grapple in place (OV/RV of 4/4 for most normal walls—Difficult Action).

Handcuff Arrow [STR: 8, BODY: 1, R#: 2] The handcuff arrow Grapples its target's hands with an EV equal to its STR.

Net Arrows (x2) [STR: 8, BODY: 8, R#: 2] The net arrow Grapples its targets with an EV equal to its STR. Using a net arrow, Speedy can Multi-Attack

more than one opponent as long as all the targets are tightly clustered.

Smokescreen Arrow [BODY: 1, Fog: 8, R#: 2] The arrow's Fog cloud lasts for five phases and is released at the point the arrow strikes a target.

Sonic Arrow [BODY: 1, Sonic Beam: 9, R#: 2] Use the arrow's APs of Sonic Beam as its EV.

6 AP AC Omni-Arrows (x2)

Arrow Construction

Although most of the arrows he uses were built by his former mentor, the Green Arrow, Speedy also can construct his own Trick Arrows. When he does so, he is entitled to a -2 Column-Shift bonus to the OV and RV of all Gadgetry rolls due to his Scholar Advantage.

Powers and Abilities

Speedy is a master archer, second only to his mentor and former partner, Green Arrow. He is also an accomplished hand-to-hand fighter and master detective.

Drug Habit

Much earlier in his career, Speedy was addicted to heroin (a Serious Irrational Attraction). But with the help of Green Arrow, Black Canary, and Green Lantern, he has long since kicked his habit.

Personality/Role-playing

Roy Harper learned much from the Green Arrow, and their relationship at one time was very close. They were not only crime-fighting partners, but Oliver Queen (Arrow's alter ego) adopted Roy as his legal ward. As a result, Roy was deeply hurt when Green Arrow abandoned Speedy to strike out on his own again.

Roy has since gone through rough times. His loneliness drove him to a lengthy drug addiction, which he finally kicked. Now he is on an anti-drug crusade, and he tends to take his aggressions out on drug dealers as he breaks up their cartels. Roy even lends his services to government agencies whenever a suitably profitable drug gang is at large.

Roy Harper is a proud man, almost to the point of stubbornness. This can lead him into trouble as he tends to argue with his peers and teammates. Roy also finds it difficult to admit his true feelings and

tries to hide his loneliness behind a cocky attitude.

Speedy is a notorious ladies' man, and his machismo is usually a cover for his insecurities. Lately, Roy had an affair with the assassin Cheshire. After he discovered he fathered her child, his attitudes toward women changed slightly, and he is now enjoying his new role as a father.

Using Speedy in Adventures

Speedy is now very active in drug enforcement, so if the player heroes need an expert in that field, he would make a good contact.

Subplots

Speedy was once involved in a Subplot that involved his addiction to heroin. He has since kicked the habit and is now spending most of his time breaking up drug rings and trying to be a good father to his baby daughter.

Appearances in the DC HEROES Role-Playing Game, Second Edition

Background/Roster Book, New Titans Sourcebook

Appearances in DC Comics

*Note: Pre-Crisis appearances are not part of present continuity.

Pre-Crisis— Earth One: *Action Comics* #436; *Adventure Comics* #197-269; *The Brave and The Bold* #50, 83, 102, 149; *The Best of DC* #18; *Crisis On Infinite Earths* #9-10; *DC Special Series* #11; *Detective Comics* #402; *Green Arrow Annual* #2 (Who's Who); *Green Lantern* (2) #84 (behind the scenes), 85-86, 100; *The Hawk and The Dove* (1) #5; *Justice League of America* #13; *The New Teen Titans* (1) #27, 29-32; *The New Teen Titans drug awareness giveaway* #1; *Superman Family* #192-194; *Tales of the Teen Titans* #50; *Teen Titans* #4, 11, 19-37, 39-53; *Who's Who '86* #21; *World's Finest Comics* #71-134, 136, 138, 140, 205, 251

Current: *Action Comics Weekly* #613-618, 627-634, 636-640; *Armageddon 2001* #2; *Hawk and Dove* (3) #11-12, 26; *The New Teen Titans* (2) #19-21, 24; *The New Titans* #52, 56, 60-66, 68-69, 71; *The New Titans Annual* #6; *Secret Origins* (3) #13, 38, 50; *Secret Origins Annual* #3; *Suicide Squad* #11-12; *Who's Who '90* #3

Speedy's Arrows

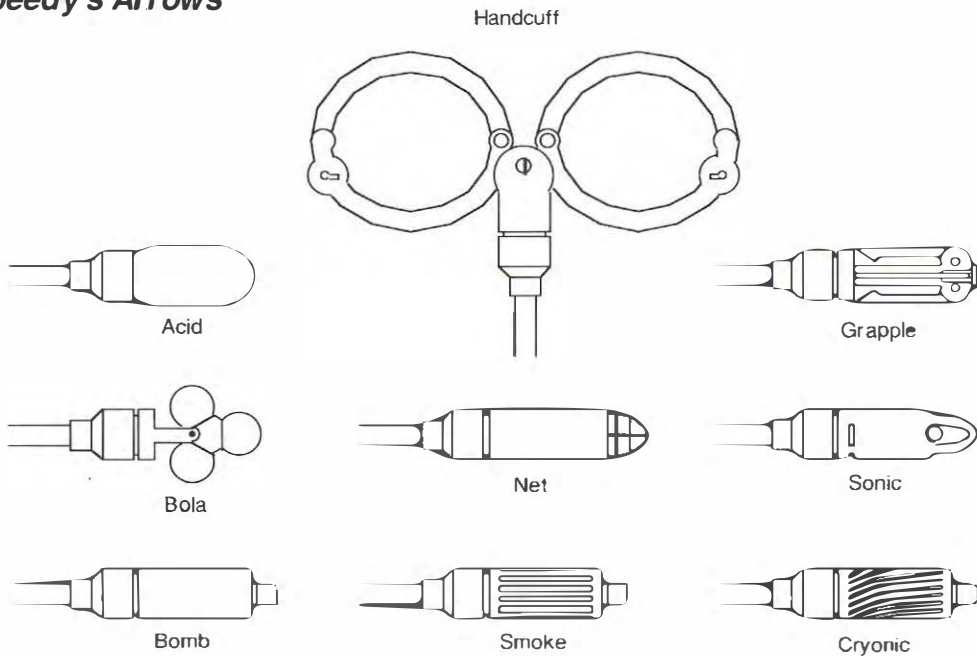

STARMAN

DEX: 7	STR: 9	BODY: 6
INT: 5	WILL: 5	MIND: 5
INFL: 5	AURA: 4	SPIRIT: 5
INITIATIVE: 17	HERO POINTS: 60	

- Powers:** Chameleon: 9, Density Increase: 3, Energy Blast: 10, Flame Project: 10, Flash: 9, Flight: 11, Regeneration: 5, Sealed Systems: 18, Solar Sustenance: 25
- Skills:** Artist (Writer): 3
- Advantages:** Connections: Power Girl (Low), Superman (Low), S.T.A.R. Labs (High); Insta-Change; Miscellaneous: Starman's autonomic functions (heartbeat, breathing, etc.) are no longer necessary to sustain his life, although he makes a conscious effort to maintain them anyway.
- Drawbacks:** Secret Identity
- Alter Ego:** William Payton
- Motivation:** Upholding the Good
- Wealth:** 5

Radiation Leakage

When Starman's skin is punctured (i.e., an appropriate Killing Combat attack inflicts damage against him), he leaks hard radiation with an AV/EV of 7/7 that affects all Characters within 2 APs. The radiation continues to leak until Starman's Regeneration Power heals the wound.

Radiation attacks like this roll directly against an OV/RV equal to the target's BODY/BODY and ignore all other defensive Powers, save Force Fields. Most Characters with Systemic Antidote are allowed to add their APs of Power to their RV vs. radiation.

Powers and Abilities

In essence, Starman is a living star. His abilities permit him to: generate light brighter than that produced by a nuclear explosion, project heat capable of melting steel, fly at approximately 8,000 miles per hour (ten times the speed of sound), create energy blasts capable of demolishing a building, and regenerate physical damage. Payton's

skin is extremely resistant to physical attacks, but when it is breached, it causes a harmful radioactive energy leak.

Payton's less significant powers include: the ability to suspend all his voluntary functions (eating, sleeping, etc.), and the ability to alter his hair color and facial features at will.

Personality/Role-playing

Will Payton is one of the most powerful super-beings on Earth. Most of his powers stem from the fact that he is no longer a true human. Although he has now grown to enjoy his role as a hero, his abilities have left him something of an outsider. Despite this fact, Will takes his responsibilities seriously and understands his heroic obligations.

Starman tries to use his power for good, though the true nature of good sometimes eludes him. At times he is almost afraid of his powers, which sometimes causes him to hesitate during battle.

Will's sister Jayne acts as his moral support, and often has more confidence in her brother than Will has in himself.

Using Starman in Adventures

Starman is one of the few active super-heroes in America's southwest. If your player heroes visit that part of the country, particularly in Arizona, they are bound to hear stories about his many great accomplishments.

Subplots

Will is close to his Family, and family relationships consume much of his time. He is also trying to rediscover the humanity he believes he may have lost.

Appearances in the DC HEROES Role-Playing Game, Second Edition

Background/Roster Book, Superman—The Man of Steel Sourcebook

Appearances in DC Comics

Action Comics #622, 644-645, 659; *Blasters Special* #1; *Armageddon 2001* #2; *Doom Patrol* (2) #29;

Firestorm, the Nuclear Man #80; *Invasion!* #2-3; *Justice League America* #42; *Justice League International* #24; *Justice League Quarterly* #5; *Starman* #1-45; *War of the Gods* #1-4; *Who's Who*

Karen Faulkner's Lab

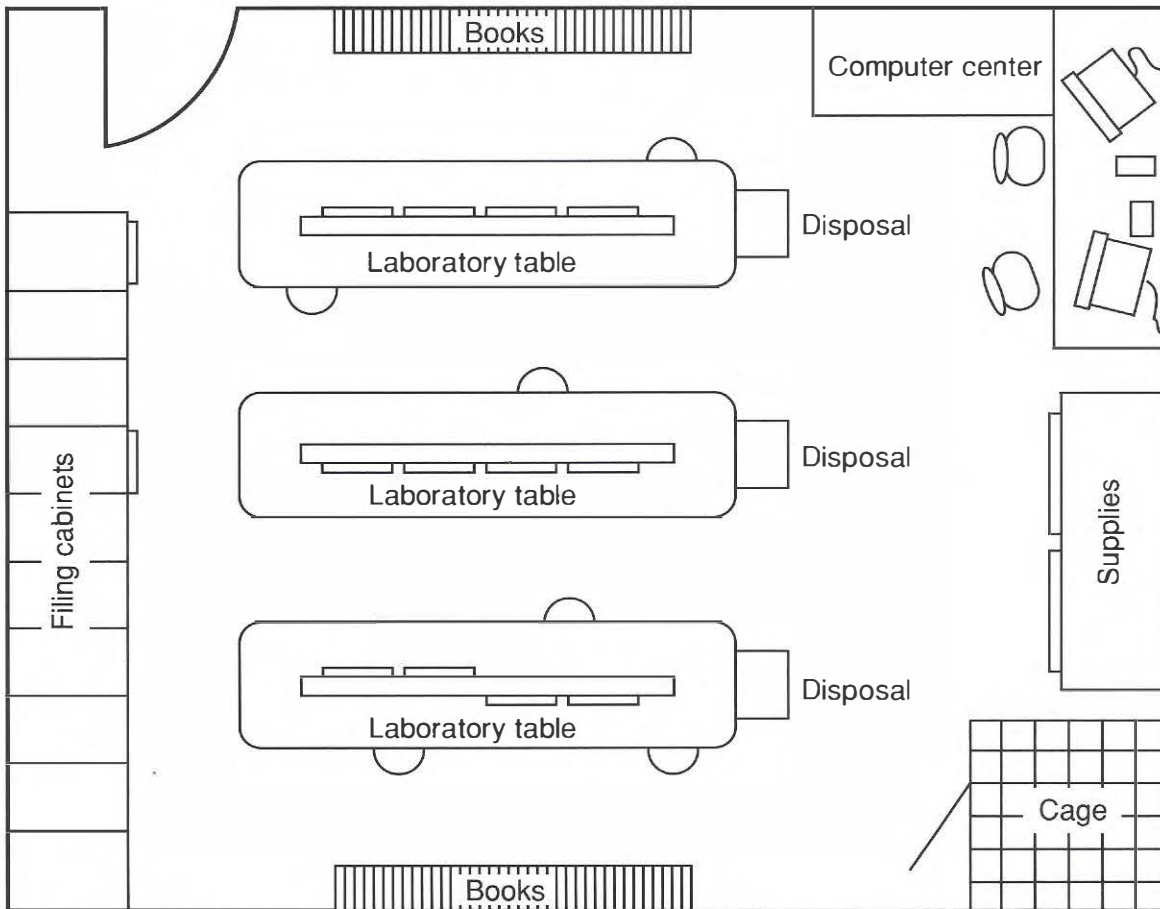

SUPERMAN

DEX:	15	STR:	25	BODY:	18
INT:	11	WILL:	20	MIND:	15
INFL:	10	AURA:	20	SPIRIT:	10
INITIATIVE:	49	HERO POINTS:	200		

- Powers:** Directional Hearing: 8, Extended Hearing: 8, Flight: 15, Heat Vision: 15, Invulnerability: 22, Microscopic Vision: 15, Recall: 20, Sealed Systems: 11, Super Breath: 12, Super Hearing: 8, Superspeed: 11, Systemic Antidote: 18, Telescopic Vision: 13, Thermal Vision: 13, X-Ray Vision: 13
- Skills:** Artist (Journalist): 4, Charisma (Persuasion): 15, Scientist: 10
- Advantages:** Area Knowledge (Metropolis); Connections: Batman (High), Daily Planet (High), Metropolis Police Headquarters (High), White House (High), Justice League International (Low); Expansive Headquarters (Fortress of Solitude); Free Access; Lightning Reflexes; Popularity; Sharp Eye
- Drawbacks:** Secret Identity; Fatal Vulnerability: kryptonite, Range of 2 APs; Loss Vulnerability: magic, Range of 0 APs; Loss Vulnerability: lack of yellow sun radiation, Range of 0 APs (Note: All of Superman's Loss Vulnerabilities affect all of his Attributes and Powers.)
- Alter Ego:** Clark Kent, Kal-El
- Motivation:** Upholding the Good
- Wealth:** 5

Powers and Abilities

Superman's greatest assets are his great strength (reflected by his high STR score) and invulnerability to harm (reflected by his high BODY score and Invulnerability Power). He can easily uproot large office buildings and lift them over his head, and his body can withstand small atomic explosions. With his Flight Power, Superman can attain airspeeds many times greater than the speed of sound, and he can outrace any man-made object. With his Heat Vision, he can melt steel.

Superman also has a wide range of extrasensory abilities that are reflected in his various hearing and vision Powers (Directional Hearing, Extended Hearing, Super Hearing, Microscopic Vision, Telescopic Vision, Thermal Vision, X-Ray Vision). He is virtually immune to disease (Systemic Antidote), able to run and perform complex tasks at superhuman speeds (Superspeed), able to hold his

breath for almost two hours (Sealed Systems), and able to memorize thousands of pages of information (Recall).

Superman's Vulnerabilities

When Superman comes within 40 feet (2 APs) of kryptonite, his DEX immediately drops to 0, his STR drops to 1, and he loses the use of all of his Powers. He then begins to die as per the Fatal Vulnerability rules. While he is under the influence of kryptonite, Superman cannot walk or even stand. With a successful Action Check using his modified STR/STR (1/1) as the AV/EV against an OV/RV both equal to his body weight (3/3), he can pull himself along the ground for a few feet.

Against Powers and attacks of a truly magical nature (including many Mystical Powers and most Mystic-linked Powers), Superman's OV and RV are automatically 2/2. Furthermore, Superman cannot use his Powers or abilities to affect constructs of a magical nature (he cannot smash down a magical wall, for instance, or use his great strength to break enchanted chains).

If Superman is isolated from the effects of Earth's yellow sun for more than three days, he loses all of his Powers according to the Loss Vulnerabilities rules. He instantly regains his abilities once he has been exposed to the yellow sun again.

Personality/Role-playing

Superman is warm, compassionate, fair, energetic, and intelligent. No matter how hard he is pressed, he will never take any action that threatens life, limb, law, or order. His goodwill is legendary. To many, he seems simply too good to be true.

Superman's only real flaws are his occasional naivete and overly optimistic world-view. At times, examples of extreme misfortune and acts of heinous cruelty seem to catch him off guard. He also has a slight problem interacting with normal human beings. His extraordinary abilities sometimes make it difficult for him to identify with humanity, a situation that distresses him.

When in his Clark Kent guise, Superman alters his personality. As Kent he is somewhat dashing and sophisticated, a sharp contrast to Superman's Boy Scout image.

As an extra note, Superman abhors killing, and after having to put some extradimensional villains to death, has sworn never to kill again. In fact, Superman believes in using the minimal amount of force necessary to solve a problem. Therefore, he usually never uses a STR greater than 12 when making hand-to-hand attacks.

Using Superman in Adventures

Superman is a valuable Non-Player Character in any campaign. He can plausibly show up at the last minute to save the heroes should they bite off more than they can chew, though the Gamemaster should try to keep such appearances to a minimum. He can also keep player heroes in line by reminding them of their duty to society. When Superman talks, people listen. Remember not to steal the heroes' thunder, but try to establish Superman as a real presence early in your campaign.

Subplots

Since he's such a popular hero, Superman has numerous Subplots to deal with. He has his Romantic relationship with Lois, his friendships with Lana, Pete, Jimmy, etc., and his Family relationship with his adoptive parents. He has a Death Guilt Subplot over his eradication of the Phantom Zone criminals and Job Subplots centered on Clark's duties at the *Daily Planet*. He also has many enemies, especially Lex Luthor Jr.

Appearances in the DC HEROES Role-Playing Game, Second Edition

Background/Roster Book (includes card), *Superman The Man of Steel Sourcebook*, *Justice League Sourcebook*, *Batman Sourcebook*, *Deadly Fusion*, *In Hot Pursuit*, *World in the Balance*

Appearances in DC Comics

*Note: Pre-Crisis appearances are not part of current continuity.

Pre-Crisis—Earth-One: *Action Comics* #197, 199-206, 209-326, 328-333, 335-337, 339-346, 348-359, 361-372, 374-390, 393-483, 485-582; *Adventure Comics* #130-343, 345-387, 393, 396, 406, 423, 449, 453-459, 464, 477, 485; *The Adventures of Jerry Lewis* #92, 105; *All-New Collectors' Edition* #C55-C56, C58; *All-Star Squadron* #14-15, 53; *The Amazing World of DC Comics Special Edition* #1; *The Amazing World of Superman* #1; *Aquaman* (1) #18, 30, 55; *The Atom* #8; *Batman* #140, 230, 260, 293; *Batman and the Outsiders* #1, 19; *Batman Family* #5, 11, 15 (behind the scenes); *Blackhawk* (1) #228-230; *Black Lightning* #3-5; *Blue Devil* #3-4, 24; *The Brave and the Bold* #28-30, 63, 150, 172, 192; *Captain Action* #1; *Captain Carrot and His Amazing Zoo Crew* #1; *Crisis On Infinite Earths* #2-5, 7, 9-12; *The Daring New Adventures of Supergirl* #1, 8, 12 (behind the scenes), 13; *DC Comics Presents* #1-97; *DC Comics Presents Annual* #1-4; *DC Special* #27; *DC Special Series* #5-6, 11, 21, 26; *DC Super-Stars* #10, 12, 17; *Detective Comics* #292, 447; *Doom Patrol* (1) #104; *Firestorm* (1) #1-2; *The Flash* (1) #175, 199, 203-204, 249, 276-277, 327-329; *Forever People* (1) #1; *Freedom Fighters* #5, 8; *The Fury of Firestorm* #4; *Green Lantern* (2) #29, 87, 122-123, 139, 180, 188; *Heroes Against Hunger* #1; *Inferior Five* #10; *Jemm, Son of Saturn* #3-6; *Justice League of America* #1-5, 7, 8 (behind the scenes), 9-25, 27-34, 36, 38, 40-45, 49-50, 52-53, 55-57, 59-61, 63, 65-66, 68-75, 77-84, 86-92, 94-

106, 109-115, 117-122, 125-135, 137-185, 187-190, 192-19, 198-209, 204-212, 217-224, 231-232, 237-240, 249-250; *Justice League of America Annual* #1, 3; *Kamandi, the Last Boy On Earth* #29 (behind the scenes); *Karate Kid* #10, 12-13; *Legion of Super-Heroes* (2) #259, 277-282, 286, 290-294, 300, 312-313 (3) 11-12; *Legion of Super-Heroes Annual* (2) #1-2; *Limited Collectors' Edition* #C41, C47; *Lois Lane* #1-2; *More Fun Comics* #101-107; *The New Adventures of Superboy* #1-54; *The New Teen Titans* (1) #16, 23-25 (2) 6, 13; *The New Teen Titans Annual* (2) #1; *Phantom Zone* #1-4; *Red Tornado* #1-3; *The Saga of Swamp Thing* #24; *Secret Society of Super-Villains* #5; *Secrets of the Legion of Super-Heroes* #1-3; *Shazam!* #15; *Showcase* #9-10; *Superboy* (1) #1-94, 96-138, 130-133, 135-137, 139-146, 148-155, 157, 159-164, 166-173, 175-182, 184, 186-230; *Superboy and the Legion of Super-Heroes* #231-237, 239-258; *Superboy Spectacular* #1; *Super Friends* #1-47; *Supergirl* (1) #5, 8 (2) 20-21; *Superman* (1) #91-148, 150-158, 160-161, 163-165, 167-174, 176-182, 184-186, 188-191, 195-196, 198-199, 201, 203-206, 208-211, 213-214, 216, 218-221, 223, 225-226, 228-229, 233-238, 240-244, 246-251, 253-271, 273-299, 301-403, 405-422; *Superman Annual* (1) #9-12; *Superman Family* #164-167, 169-173, 175-176, 178-179, 181-199, 201-221; *Superman Special* #1, 3; *Superman Spectacular* #1; *Superman's Girl Friend, Lois Lane* #1-45, 47-50, 52-67, 69-76, 78-85, 87-88, 90-94, 96-103, 105-112, 114-137; *Superman's Pal, Jimmy Olsen* #1-94, 96-103, 105-108, 110-112, 114-121, 123-130, 132-139, 141-163; *Swamp Thing* (2) #46; *Swing With Scooter* #5; *Tales of the Teen Titans* #50; *Teen Titans* #25; *Wonder Woman* (1) #130, 212, 216 (behind the scenes), 218-223, 291, 300; *World of Krypton* (1) #1-3; *World's Finest Comics* #71-135, 137-152, 155-156, 158-160, 162-165, 168-169, 171, 173-177, 181-183, 185-187, 189-196, 198-205, 207-214, 215-216 (behind the scenes), 217-220, 221-222 (behind the scenes), 224 (behind the scenes), 225-226, 228 (behind the scenes), 230-231 (behind the scenes), 232, 233-241, 242 (behind the scenes), 243-323

Pre-Crisis—Earth-Two: *Action Comics* #1-196, 198, 207-208, 484; *Adventure Comics* #462, 466; *All-New Collectors' Edition* #C-54; *All-Star Comics* #7-8, 36, 62-66, 69-71, 74; *All-Star Squadron* #1-4, 17, 20-27, 31-32, 36-37, 53-54, 57-60; *All-Star Squadron Annual* #2-3; *America Vs. the Justice Society* #1-4; *Crisis On Infinite Earths* #1-5, 7, 9-12; *DC Comics Presents Annual* #1, 3; *DC Special* #29; *DC Super-Stars* #17, *Funny Stuff* #22; *Infinity, Inc.* #3, 6-11, 21; *Infinity, Inc. Annual* #1; *Justice League of America* #73-74, 82-83, 91-92, 107-108, 159-160, 183, 193, 195-197, 219; *The New Adventures of Superboy* #15-16; *New York World's Fair* #1-2; *Secret Origins* (3) #1; *Superman* (1) #1-91, 96, 103-105, 327, 329; *Superman Family* #186-187, 195-196, 198-199, 201-222; *World's Best Comics* #1; *Who's Who '86* #22; *World's Finest Comics* #2-70, 271

Current: *Action Comics* #548; *Action Comics Annual* #1-3; *Adventures of Superman* #424; *Adventures of Superman Annual* #1-3; *Animal Man* #2; *Aquaman* (2) #4 (flashback); *Armageddon 2001* #2; *Armageddon: Inferno* #2; *Batgirl Special* #3; *Batman* #428-429; *Booster Gold* #2, 6-7, 16, 23; *Captain Atom* (3) #2, 46, 50; *Challengers of the Unknown* (2) #2; *Christmas With the Super-Heroes* #2; *Cosmic Boy* #1; *Cosmic Odyssey* #1-4; *Doom Patrol* (2) #10, 29; *The Earth Stealers*; *Firestorm, the Nuclear Man* #67-68; *Flash* (2) #8, 53; *The Fury of Firestorm* #63; *Green Lantern Special* #1; *Hawk and Dove* (3) #9, 23; *Invasion!* #2-3; *Justice League America* #40, 53, 61; *Justice League Europe* #9, 17, 26 (flashback); *Justice League Europe Annual* #2; *Justice League International* #7, 9-10, 19; *Justice League of America* #249-250; *Justice League Spectacular* #1; *Legends* #2-6; *L.E.G.I.O.N. '90 Annual* #1; *Lex Luthor: The Unauthorized Biography*; *Man of Steel* #1-6; *Millennium* #1-2, 5-8; *Mister Miracle* (2) #17; *New Gods* (3) #13, 15-16; *The New Teen Titans* (2) #30-31; *The New Titans Annual* #35; *Plastic Man* (3) #4; *Secret Origins* (3) #22-24 (flashback), 32; *Secret Origins Annual* #1; *Starman* #13-14, 38; *Suicide Squad* #44, 59-62; *Superman* (2) #1-30, 32-34, 36; *Superman Annual* (2) #1-2; *Superman For Earth: Superman: The Man of Steel* #1-on; *Swamp Thing* (2) #68, 79; *Time Masters* #2; *War of the Gods* #1-2, 4; *The Weird* #1-4; *Who's Who '86* #22; *Who's Who '90* #1; *Wonder Woman* (2) #13, 16 (behind the scenes), 37, 49-50, 57, 61; *Wonder Woman Annual* #2; *World of Krypton* (2) #4; *World of Metropolis* #1-4; *World of Smallville* #1-4; *World's Finest Comics* #1-3

TIME MASTERS

RIP HUNTER

DEX:	4	STR:	3	BODY:	4
INT:	9	WILL:	5	MIND:	5
INFL:	5	AURA:	4	SPIRIT:	5
INITIATIVE:	18	HERO POINTS:	40		

- Skills:** Gadgetry: 11, Scientist: 11, Vehicles (exotic): 9, Weaponry: 4
- Advantages:** Connections: Booster Gold (Low), S.T.A.R. Labs (Low); Genius; Scholar (temporal physics, time travel)
- Drawbacks:** Minor Irrational Attraction to improving his time vessels
- Alter Ego:** None
- Motivation:** Thrill of Adventure
- Wealth:** 6

Appearances in the DC HEROES Role-Playing Game, Second Edition

Background/Roster Book

JEFF SMITH

DEX:	3	STR:	2	BODY:	4
INT:	8	WILL:	4	MIND:	4
INFL:	3	AURA:	3	SPIRIT:	3
INITIATIVE:	14	HERO POINTS:	20		

- Skills:** Gadgetry: 9, Scientist: 10
- Advantages:** Connections: Metal Men (Low), S.T.A.R. Labs (Low); Genius; Scholar (temporal physics, time travel)
- Drawbacks:** Minor Irrational Attraction to Bonnie Baxter
- Alter Ego:** None
- Motivation:** Thrill of Adventure
- Wealth:** 7

BONNIE BAXTER

DEX:	4	STR:	3	BODY:	4
INT:	7	WILL:	6	MIND:	6
INFL:	5	AURA:	4	SPIRIT:	5
INITIATIVE:	16	HERO POINTS:	20		

- Skills:** Charisma: 6
- Advantages:** Connection: Cave Carson (High)
- Alter Ego:** None
- Motivation:** Upholding the Good
- Wealth:** 3

CORKY BAXTER—deceased

DEX:	3	STR:	2	BODY:	2
INT:	3	WILL:	4	MIND:	2
INFL:	3	AURA:	3	SPIRIT:	3
INITIATIVE:	9	HERO POINTS:	15		

- Alter Ego:** None
- Motivation:** Thrill of Adventure
- Wealth:** 8

TONY

DEX:	4	STR:	3	BODY:	3
INT:	6	WILL:	6	MIND:	5
INFL:	4	AURA:	3	SPIRIT:	6
INITIATIVE:	14	HERO POINTS:	20		

- Skills:** Scientist: 4, Thief: 4
- Advantages:** Scholar (computer science)
- Alter Ego:** Antonia
- Motivation:** Thrill of Adventure
- Wealth:** 2

DAN HUNTER

DEX:	4	STR:	4	BODY:	4
INT:	5	WILL:	4	MIND:	4
INFL:	4	AURA:	3	SPIRIT:	4
INITIATIVE:	13	HERO POINTS:	20		

- Alter Ego:** None
- Motivation:** Thrill of Adventure
- Wealth:** 12

The Time Masters' Equipment

TIME CAPSULE [STR: 6, BODY: 8, Time Travel: 25, R#: 5] The Capsule is a spherical craft, approximately 10 feet in diameter.

BACKPACK TIME TRAVELERS [BODY: 5, Time Travel: 25, R#: 3] The Backpack travelers are slightly more reliable than Hunter's time capsule. Each can transport a single individual and his equipment through time.

Time Travel Restrictions

Unfortunately, Hunter's research shows that each method of time travel will work for an individual on one occasion only. In other words, once someone has used the time capsule, it (and all devices operating on the same principles) will no longer convey that individual.

So far, the Time Masters have discovered six methods of traveling through time: the method used

by Rip's original time sphere, the method used by the Borsten Time Platform Hunter encountered in the 25th Century, the two methods incorporated into the Time Traveler Backpack (one method for departure, one for return), the energy beam of a Green Lantern's Power Ring, and a leap over a black hole's event horizon.

Powers and Abilities

Rip and his team also developed a way to communicate vocally with those who travel through time. Presently, all of the time traveling methods have been used, and the team is searching for more.

Personality/Role-playing

The determined Rip Hunter is a gifted physicist with an obsession for destroying the Illuminati, a millennia-old society founded by Vandal Savage. Unfortunately, Rip is now in the stone age with no means of return.

Jeff Smith, his partner, is more logical than Rip, and he is equally driven. Smith is still in the present day, but he, like Rip, has no means of traveling the time stream. Jeff was in love with Bonnie Baxter, who was connected with the Hunter through Professor "Cave" Carson.

Bonnie Baxter's strong personality and intelligence helped break up the conflicts amongst the scientists and generally kept things working smoothly. She is currently stranded in a post-holocaust future.

Bonnie's brother Corky was the team's tag-along. He was a nuisance to the serious-minded scientists until he committed suicide after joy-riding with a time machine.

Dan Hunter (Rip's cousin), along with "Cave" Carson, financed and supported the Time Masters after Rip's lab was destroyed. In return, Dan wanted adventure and eventually found what he was looking for in the wilderness of 18th Century America.

"Cave" is an aging explorer and college professor who aided Rip's efforts while trying to win back Bonnie's affections. He too remains in the present age.

Antonia, or Tony as she prefers to be called, was the team's eccentric computer expert. She decided to strike out on her own after completing only one mission.

Rip Hunter's time capsule

Using the Time Masters in Adventures

Time travel is difficult to play, but it's always good for a mind-boggling Adventure. The heroes might meet the Time Masters (particularly Jeff Smith) as they search for a means to save their teammates. Perhaps one of the heroes has a Power or Attribute that can fuel a particular time invention.

The heroes can also get information from these Characters regarding their own time-travel efforts.

Appearances in DC Comics

***Note:** Pre-Crisis appearances are not part of present continuity.

Pre-Crisis: *Action Comics* #540-541, 545, 552-554; *Challengers of the Unknown* (1) #85-87; *Crisis On Infinite Earths* #5, 9-12; *DC Comics Presents* #37, 77-78; *The Flash* (1) #342; *Justice League of America* #144; *Rip Hunter... Time Master* #1-29; *Showcase* #20-21, 25-26, 100; *Who's Who '86* #19

Current: *Animal Man* #22; *Booster Gold* #13-16, 25; *Swamp Thing* (2) #86; *Time Masters* #1-8; *Who's Who '87* (2) #5; *Who's Who '90* #1

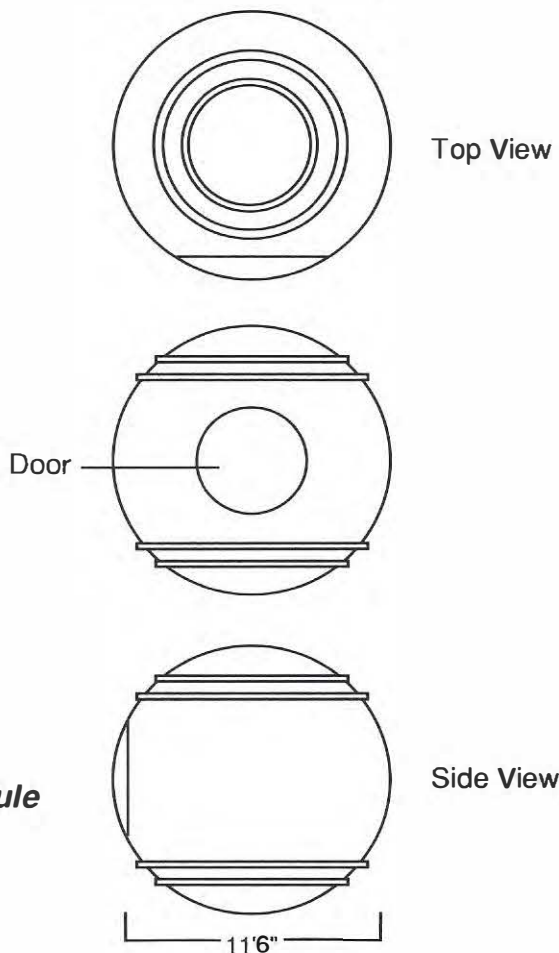

TROIA

DEX:	9	STR:	12	BODY:	7
INT:	6	WILL:	5	MIND:	5
INFL:	5	AURA:	6	SPIRIT:	6
INITIATIVE:	24	HERO POINTS:	65		

- Powers:** Flash: 10, Flight: 9, Force Field: 12, Illusion: 6, Mind Probe: 10, Water Freedom: 7
- Bonuses:** Miscellaneous: Force Field is Usable on Others at a Range of up to 5 APs.
- Limitations:** Miscellaneous: Mind Probe is only usable to reach into the mind of a willing subject to pull forth suppressed memories; Miscellaneous: Illusion is usable only to represent memories pulled forth with Mind Probe.
- Skills:** Artist (Photographer): 3, Charisma: 6, Martial Artist: 8, Vehicles: 6, Weaponry: 8
- Advantages:** Connection: New Titans (High); Lightning Reflexes; Scholar (history, mythology)
- Drawbacks:** Married
- Alter Ego:** Donna Troy
- Motivation:** Upholding the Good
- Wealth:** 5
- Equipment:**
ARMORED TUNIC [BODY: 11, Flash: 6]

Wonder Girl Form

As Wonder Girl, Donna Troy had different abilities. In this form, she had the following statistics:

WONDER GIRL

DEX:	8	STR:	11	BODY:	7
INT:	6	WILL:	5	MIND:	5
INFL:	5	AURA:	5	SPIRIT:	5
INITIATIVE:	23	HERO POINTS:	55		

- Powers:** Gliding: 9, Jumping: 6
- Skills:** Artist (photographer): 3, Charisma: 6, Martial Artist: 8, Vehicles: 5, Weaponry: 7
- Advantages:** Connection: Teen Titans (High); Lightning Reflexes; Scholar (history, mythology)
- Drawbacks:** Married
- Alter Ego:** Donna Troy
- Motivation:** Upholding the Good
- Wealth:** 5
- Equipment**
BRACELETS [BODY: 15] Wonder Girl used her bracelets to stop bullets (see **Wonder Woman** for details).
Lasso [STR: 8, BODY: 11] Wonder Girl's lasso was

approximately 150 feet (4 APs) long. She often used it to Grapple opponents.

Powers and Abilities

Troia can fly, survive underwater, and create powerful force fields. She need not center the fields on herself, and so she often uses them to protect innocent bystanders from harm. Troia also possesses formidable telepathic abilities with which she can pull long forgotten memories from a willing participant's mind. When she does so, she can project the mind's images for all to see. It is possible that Troia has other abilities that have yet to surface.

Troia was trained in combat by the Greek Titans during her youth, so she knows how to defend herself in hand-to-hand combat. In addition, she owns a magical tunic that protects her from tremendous amounts of physical punishment. Due to its mystical nature, the tunic sparkles like the stars and can be used to create a flash of light capable of blinding her opponents.

Mind Probe

Troia uses her Mind Probe to help a subject remember suppressed or concealed memories. To do so, she makes an Action Check against an OV/RV determined by consulting the Universal Modifiers Table (revealing most suppressed memories is a Strenuous Task with an OV/RV of 6/6). If she is trying to help a victim of Hypnosis recall a memory that was deliberately blocked out, the OV and RV of the attempt both equal the RAPs earned on the initial Hypnosis Action Check.

Personality/Role-playing

Donna's career at the beginning of the third version of the Titans was marked by her attempts at perfection. She always tried to give the impression that she had her act together. It seems that Donna did not want others to see her flaws.

Things have straightened themselves out since those days, and her restored memories seem to have made her a more complete person, with more confidence in what she is rather than what she thinks she should be.

Using Troia in Adventures

Like Wonder Woman, Troia is capable of connecting the player heroes with the Greek gods of myth. If the heroes need a guide in Olympus or if the heroes have cosmological questions that need to be answered, Troia is easily accessible via the New Titans. When incorporating Troia into your Adventures, note that she is a powerful Character and remember to prevent her from stealing the player heroes' thunder.

Subplots

Troia is involved in a Romantic/Family Subplot with her temperamental husband, Terry. She is also deeply involved with her Friends, the New Titans, and their problems. Her Job as a fashion photographer also keeps her busy.

Appearances in the DC HEROES Role-Playing Game, Second Edition

Background/Roster Book (includes card), New Titans Sourcebook

Appearances in DC Comics

***Note:** Pre-Crisis appearances are not part of present continuity.

Pre-Crisis: *Action Comics* #532, 536, 546; *Adventure Comics* #461; *Armageddon: Inferno* #2; *Batman and the Outsiders* #5; *The Best of DC* #18; *The Brave and The Bold* (1) #60, 63, 83, 94, 102, 149; *Crisis On Infinite Earths* #3-5, 9-12; *DC Comics Presents* #26 (as dream image); *DC Special Series* #11; *Detective Comics* #474; *Doom Patrol* (1) #104; *The Fury of Firestorm* #42; *The Hawk and The Dove* (1) #5; *Infinity, Inc.* #22; *The New Teen Titans* (1) #1-34, 36-40 (2) 1-14; *The New Teen Titans Annual* (1) #1-2 (2) 1; *The New Teen Titans drug awareness giveaways* #1-3; *Red Tornado* #3; *Showcase* #59-100; *Supergirl* (2) #20; *Tales of the New Teen Titans* #1-4; *Tales of the Teen Titans* #41-43, 44 (behind the scenes), 45-50, 53-54, 56-58; *Teen Titans* #1-53; *Teen Titans Annual* #3; *The Vigilante* #3; *Who's Who*

'87 #26; *Wonder Woman* (1) #265-266, 287, 291 (behind the scenes), 293, 300; *World's Finest Comics* #205, 300

Current: *Action Comics* #584; *Batman* #440; *Blue Beetle* (6) #11-14; *Booster Gold* #21; *Deathstroke the Terminator* #1 (flashback); *Flash* (2) #1, 6; *Hawk and Dove* (3) #11-12; *Infinity, Inc.* #45; *The New Teen Titans* (2) #18-21, 24-49; *The New Teen Titans Annual* (2) #2-4; *The New Titans* #50-69, 71, 78-79, 82; *Secret Origins* #13, 23, (flashback), 38, 46; *Secret Origins Annual* #3; *Teen Titans Spotlight* #12, 15, 21; *War of the Gods* #1-4; *Who's Who '90* #4; *Wonder Woman* #47-49

Troia's Armored Tunic

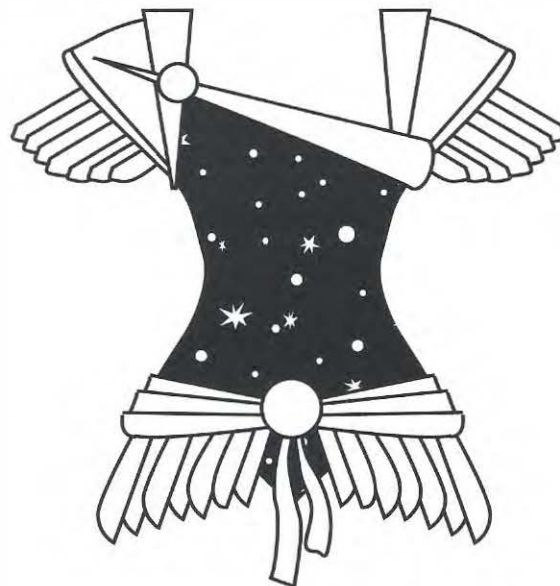

ULTRA THE MULTI-ALIEN

DEX:	10	STR:	10	BODY:	10
INT:	9	WILL:	9	MIND:	7
INFL:	5	AURA:	5	SPIRIT:	5
INITIATIVE:	24	HERO POINTS:	65		

- Powers:** Claws: 3, Energy Blast: 11, Flame Project: 11, Flight: 9, Magnetic Control: 12, Recall: 10
- Limitations:** Miscellaneous: Recall is limited to accessing the memories of the alien races that fused to create Ultra (see below).
- Drawbacks:** Strange Appearance; Miscellaneous: all of Ultra's Powers are limited to specific parts of his body—his super strength is only in his right arm (his other arm has a STR of 6), his Energy Blast and Flame Project Powers are centered in his left leg, his Magnetic Control is centered in his left arm, and his Flight is centered in his right leg.
- Alter Ego:** Ace Arn
- Motivation:** Unwanted Power
- Wealth:** 5
- Equipment:**
HYPER-CONVERTER BELT [BODY: 5] With the belt, Arn can change between his human form and his Ultra form at will (as though he had the Insta-Change Advantage).

Ace Arn Form

When Ultra is in his Ace Arn form, he has the following statistics:

ACE ARN

DEX:	4	STR:	4	BODY:	4
INT:	5	WILL:	5	MIND:	4
INFL:	4	AURA:	4	SPIRIT:	4
INITIATIVE:	13	HERO POINTS:	25		

- Skills:** Vehicles (Space): 4, Weaponry: 4

Alien Memories

In his Ultra form, Arn can access the memories of the four aliens that came together to create him. Allow him to make an Action Check using his APs of Recall as the AV/EV against an OV/RV determined by consulting the Universal Modifiers Table to

answer any question one or more of the four aliens may have been able to answer. Treat the RAPs earned as Knowledge Points.

Powers and Abilities

Ultra the Multi-Alien is actually a mixture of four alien beings. In fact, his body is actually quartered evenly—each section has the characteristics of a specific alien. His upper left torso gives him magnetic control, his upper right torso is endowed with immense strength, his lower left side has electrical and thermal powers, and his right leg ends in a talon and allows him to fly. Ultra also possesses a conglomeration of memories and intelligence that he can access like a database. It is unknown whether Ultra loses the knowledge of the four alien races when he transforms back to human form, but it is probable that he remembers a good deal of it.

Personality/Role-playing

Ace reluctantly learned how to use his abilities and decided to use them for the good of all, but he really wishes he could be human again.

Although Arn has made a great effort to keep his other identity secret, his fiancée Bonnie is beginning to suspect that her lover is actually the alien superhero.

Using Ultra in Adventures

Ultra is a Character from the near future, a time that is not entirely explored in DC continuity. Thus, anyone encountering him is in for an interesting Adventure almost by definition.

Remember, too, that Ultra is a storehouse of alien knowledge. Perhaps he has some bit of information the player heroes need to defeat an adversary.

Subplots

Arn is presently involved in a Romantic Subplot with his fiancée, Bonnie.

Appearances in DC Comics

Mystery in Space #103-110, *Who's Who '90* #4

Ultra's Hyper-Converter Belt

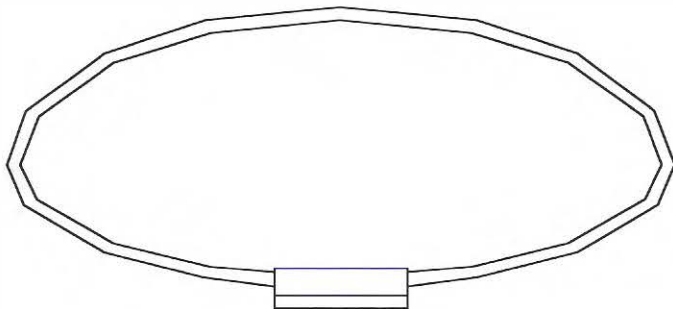

Top

Causes
conversion
to Ultra

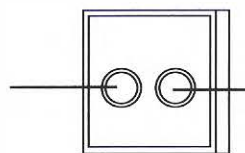

Buckle Interior

Causes
conversion
to Ace

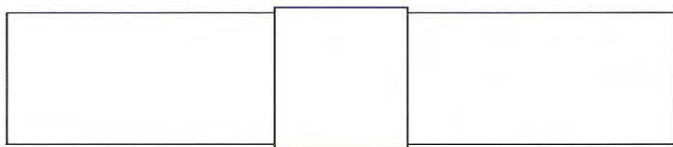

Front

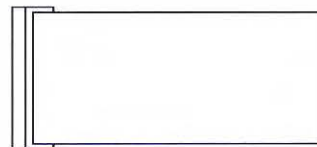

Side

Vril Dox II

DEX: 9	STR: 15	BODY: 11
INT: 16	WILL: 14	MIND: 12
INFL: 9	AURA: 7	SPIRIT: 9
INITIATIVE: 36	HERO POINTS: 100	

- Skills:** Charisma: 11, Detective: 13, Gadgetry: 13, Martial Artist: 8, Medicine: 10, Military Science: 10, Scientist: 13, Vehicles: 9, Weaponry: 11
- Advantages:** Connection: L.E.G.I.O.N. (High); Genius; Iron Nerves; Leadership; Omni-Connection; Popularity; Scholar (galactic politics); Sharp Eye
- Drawbacks:** Authority Figure; Public Identity; Serious Irrational Attraction to destroying Brainiac (Vril Dox I)
- Alter Ego:** None
- Motivation:** Seeking Justice
- Wealth:** 17

Original Form

After he was killed by Stealth, Vril Dox was cloned and revived in a super-human body by his L.E.G.I.O.N. allies. In his original form, Dox's Physical Attributes were DEX: 7 STR: 4 BODY: 5 Initiative: 30.

The Master Tactician

Among Vril Dox's greatest assets is his ability to formulate a brilliant plan. In DC HEROES, this ability is represented by his Leadership Advantage. By using Leadership, Dox can spend his own Hero Points to affect his teammates' Action Checks as long as they are acting under Dox's instructions.

Powers and Abilities

Vril Dox is an accomplished hand-to-hand combatant, and he can hold his own in a fight against someone twice his own strength by using his martial arts abilities and his ability to anticipate his opponent's actions. He also possesses one of the most brilliant and inventive minds in the galaxy, and his perceptive abilities are unmatched. Dox has an inhuman understanding of computers and can understand and control any form of technology.

In his cloned form, Vril Dox is stronger and more durable than ever. He is now able to lift

approximately 450 tons and withstand a hit from a high-impact explosive.

Personality/Role-playing

Vril Dox is manipulative and self-serving. He has convinced the leaders of several worlds of the importance of having L.E.G.I.O.N. operatives working for their world and has tricked his team members to do the dirty work for many of his self-serving schemes, a fact which often places them at odds with him.

Like his father, Vril has a heightened Coluan intelligence that gives him keen logical faculties. He likes order, therefore, and is adamant about not letting power fall into the wrong hands (any hands but his own, that is). It seems that he founded L.E.G.I.O.N. as a sort of police force for his own desires.

Although Dox is usually emotionless and distant, he was once mind-controlled by his teammate Ig'nea and forced to fall in love with her. As a result, he decided to disband the L.E.G.I.O.N. and redouble his efforts to avoid emotional contact.

Vril Dox has vowed to destroy his father, the villain Brainiac, for betraying the people of Colu. Dox will not hesitate to kill Brainiac, if he meets him.

Using Vril Dox II in Adventures

Vril Dox is the leader of L.E.G.I.O.N. Thus, his is the first door that will receive a knock from heroes looking for aid from the team. L.E.G.I.O.N. is likely to become involved in just about any Adventure you set in outer space.

Dealing with Vril Dox calls for some interesting role playing. Always self-serving, he wants to see how he can profit from an experience. The heroes will have a difficult time persuading him to give them assistance if they can't prove it profitable to him in some way.

Subplots

Vril was involved in a Romantic Subplot with his teammate Ig'nea, but he has since discovered that he was being manipulated. He is also father to Stealth's child and has been trying to persuade her to allow him to see the child. He has a deep hatred for his own father and seeks to destroy him at the earliest opportunity.

Appearances in DC Comics

* **Note:** Pre-Crisis appearances are not part of present continuity.

Pre-Crisis: *Superman* (1) # 167

Current: *Adventures of Superman Annual* #2; *Armageddon: Inferno* #2; *Invasion!* #1-2; *L.E.G.I.O.N.* '89 (et al.) #1-on; *L.E.G.I.O.N.* '90 *Annual* (et al.) #1-2; *Lobo* #1-4; *Who's Who* '90 #4

Vril Dox's Lab at L.E.G.I.O.N. Headquarters

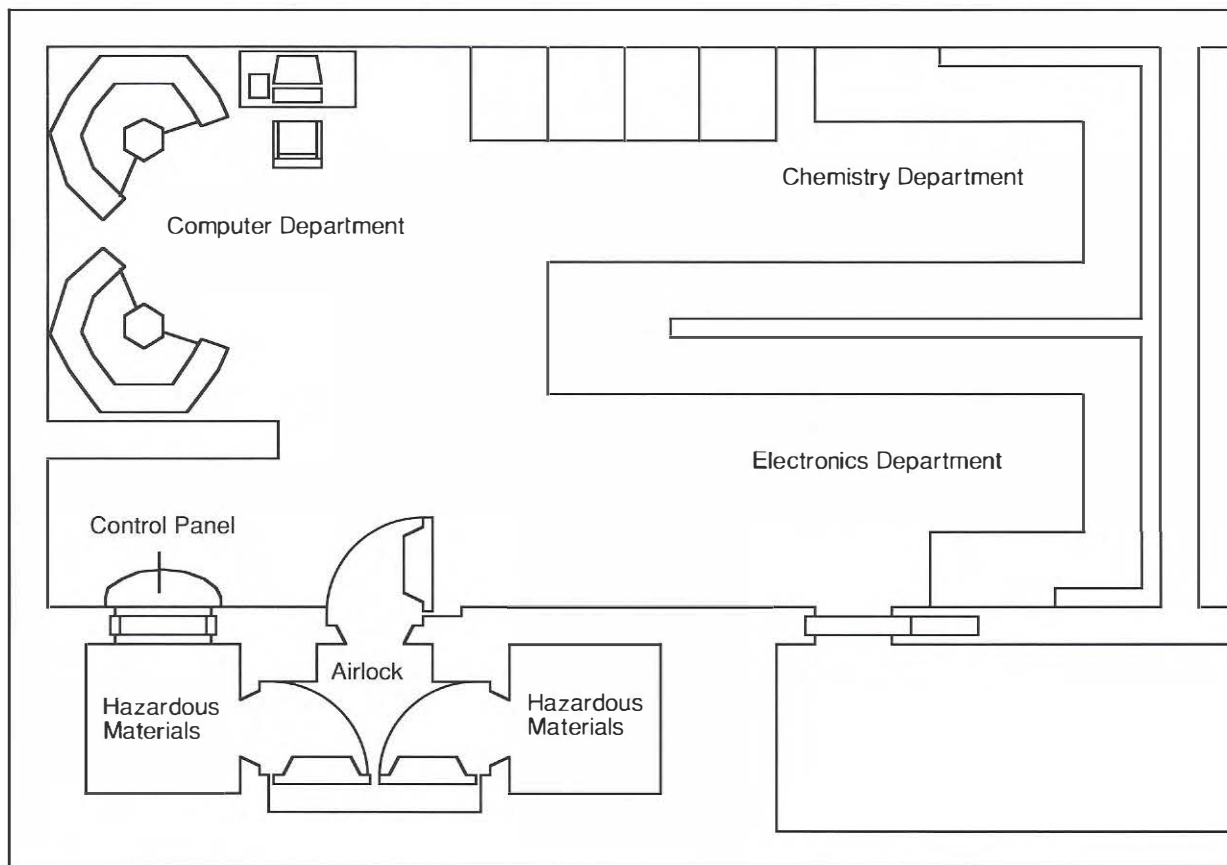

Wonder Woman

DEX:	13	STR:	16	BODY:	13
INT:	9	WILL:	12	MIND:	10
INFL:	10	AURA:	9	SPIRIT:	10
INITIATIVE:	36	HERO POINTS:	150		

- Powers:** Directional Hearing: 4, Flight: 14, Running: 7, Swimming: 6, Telescopic Vision: 3
- Skills:** Acrobatics: 11, Animal Handling: 8, Charisma (Persuasion): 12, Martial Artist: 12, Military Science (Tracking): 10, Weaponry: 13
- Advantages:** Area Knowledge (Themyscira); Attractive; Buddy (Julia Kapatelis); Connections: Gods of Olympus (Low), Justice League International (High), Superman (High), Themyscira (High), United Nations (Low), U.S. Army (Low); Iron Nerves; Lightning Reflexes; Scholar (ancient Greek and Themysciran languages, Greek mythology)
- Drawbacks:** Public Identity; Miscellaneous: Diana still does not fully comprehend the world outside Paradise Island; Diana's RV drops to 4 against Physical Killing Combat, but she may use her Martial Artist Skill to augment it as normal.
- Alter Ego:** Princess Diana of Themyscira
- Motivation:** Upholding the Good
- Wealth:** 5
- Equipment:**

Lasso of Truth [STR: 15, BODY: 35, Animal Control: 15, Control: 5] Fashioned from the Girdle of Gaea, the lasso has the ability to force anyone it has ensnared to tell the truth. Once Wonder Woman has successfully Grappled a target with the lasso, she can use its Control Power to force the target to tell the truth. Roll APs of Control vs. the target's INFL/SPIRIT. Treat RAPs as Knowledge Points gained.

Furthermore, when Wonder Woman lays the lasso on the ground and steps within its loop, beasts are unable to cross the lasso to attack her. Any beast that tries is attacked with 15 APs of Animal Control. If the RAPs from this attack equal or exceed the beast's SPIRIT, it cannot cross over the lasso for an amount of time equal to the RAPs earned (at which time the beast must undergo another attack if it attempts to cross the lasso again).

BRACELETS [BODY: 30] Wonder Woman uses the bracelets to perform Block maneuvers to deflect bullets.

To deflect bullets with her bracelets, Wonder Woman performs a Block maneuver. Roll her

DEX/DEX (13/13) against an OV/RV both equal to the AV of the incoming bullet. If she succeeds, resolve the shot normally, but use the BODY of her bracelets (30) as her RV against the incoming attack. Apply any damage from the attack to the bracelets.

SANDALS OF HERMES [STR: 8, BODY: 8, Teleportation: 23] The Sandals can only Teleport the wearer from Paradise Island to man's world and back.

When wearing the sandals, Wonder Woman can instantly transport herself back to Paradise Island.

Tiara [BODY: 12, EV: 7, Gliding: 1]

Wonder Woman automatically enters into Killing Combat if she throws her razor-sharp tiara at a living target].

Powers and Abilities

Wonder Woman is remarkably strong and swift (as reflected by her high STR and DEX scores and her Running and Flight Powers). At her peak, she can easily lift a large aircraft and run at speeds approaching 100 miles per hour. With her Flight Power, she can attain an airspeed comparable to that of a top-of-the-line jet fighter. Her reflexes are more than 2,000 times faster than those of an average human.

Among Wonder Woman's other abilities are her extended senses (Telescopic Vision and Extended Hearing), and her mastery of acrobatics and hand-to-hand fighting (Acrobatics, Martial Artist, and Weaponry Skills). Her ability in these areas is almost unparalleled.

Personality/Role-playing

Diana is sweet and kind-hearted, a true innocent, but beneath this loving exterior lies the heart and soul of a trained warrior. Although physical confrontation is always her last recourse, she is fully capable of savagely defending herself or others whenever the need arises.

Remember that Wonder Woman is still a relative newcomer to "man's world" and often finds herself confused by her surroundings.

Using Wonder Woman in Adventures

Since Wonder Woman is not very familiar with the day-to-day world, she can be a great character-development tool. As a Non-Player Character, she

can constantly ask the player heroes to explain their actions, forcing the Players to rationalize their behaviors and to think about their Characters.

As a Non-Player Character ally, Wonder Woman can also be used to bring the heroes into a number of unique and interesting adventuring environments: Paradise Island, Olympus, Arwopagus, etc.

Appearances in the DC HEROES Role-Playing Game, Second Edition

Justice League Sourcebook, Background/Roster Book (includes card), Superman—The Man of Steel Sourcebook

Appearances in DC Comics

* **Note:** Pre-Crisis appearances are not part of present continuity.

Pre-Crisis—Earth-One: *Action Comics* #452, 480-481, 482 (behind the scenes), 483, 489, 514, 535, 546, 565; *Adventure Comics* #397, 459-464, 485; *The Adventures of Jerry Lewis* #117; *Aquaman* (1) #18, 30; *The Atom* #8; *Batman and the Outsiders* #1; *Blue Devil* #10; *The Brave and The Bold* (1) #28-30, 60, 63, 78, 87, 105, 131, 140, 158, 172; *Crisis On Infinite Earths* #4-7, 9-12; *DC Comics Presents* #9, 22, 32, 41, 76; *DC Comics Presents Annual* #2; *DC Special* #27; *DC Special Series* #6, 19; *DC Super-Stars* #10; *Doom Patrol* (1) #104; *The Flash* (1) #175, 276-277, 323, 327-329; *Freedom Fighters* #4-5; *The Fury of Firestorm* #4; *Green Lantern* (2) #29, 108; *Infinity, Inc.* #22; *Justice League of America* #1-31, 33-36, 38, 40-41, 43-45, 50, 52-54, 57, 59-61, 63, 65-66, 69, 71, 100-102, 121, 128-129, 132-134, 138-146, 149-151, 153, 155, 157-162, 164-170, 174-176, 179, 182-183, 187-190, 192-193, 195-197, 200, 202-205, 209-212, 217-219, 221-224, 231-232, 237-240, 249; *Justice League of America Annual* #1; *The Legend of Wonder Woman* #1-4; *Limited Collectors' Edition* #C-41; *Metal Man* #21, 56; *Mystery In Space* #75; *The New Teen Titans* (1) #4-5, 32 (behind the scenes) (2) 6; *Phantom Zone* #2, 4; *Red Tornado* #1, 3; *The*

Saga of Swamp Thing #24; *Showcase* #59; *Super Friends* #1-47; *Supergirl* (1) #9 (2) 20; *Superman* (1) #199, 241-242, 326, 349; *Superman Annual* (1) #11; *Superman's Girl Friend Lois Lane* #74, 93, 136; *Super-Team Family* #14; *Tales of the Teen Titans* #45, 49-50; *Teen Titans* #1, 22, 53; *Wonder Woman* (1) #94 (blond Wonder Woman), #105-196, 199-210, 212-228, 243-329; *World's Finest Comics* #199, 204, 246, 250-252, 255, 281, 286-288, 300, 302

Pre-Crisis—Earth-Two: *Action Comics* #516; *Adventure Comics* #462, 466; *All-New Collectors' Edition* #C-54; *All-Star Comics* #8, 11-22, 24-57, 69-70, 74; *All-Star Squadron* #1-4, 16-17, 19-21, 25, 27-28, 30-32, 36-37, 45-46, 50, 57, 60; *All-Star Squadron Annual* #1-3; *America vs. the Justice Society* #1-4; *Big All-American Comic Book* #1; *Comics Cavalcade* #1-29; *Crisis On Infinite Earths* #5, 9-12; *DC Special* #3; *DC Special Series* #9-10; *The Flash* (1) #13; *Infinity, Inc.* #1-5, 7-12, 16 (behind the scenes), 19, 21-22, 25, 27; *Infinity, Inc. Annual* #1; *Justice League of America* #55-56, 73-74, 82-83, 100-102, 113, 123-124, 135, 136 (behind the scenes), 137, 159-160, 183-185, 193, 244; *Sensation Comics* #1-106; *Wonder Woman* (1) #1-93, 196, 228-243, 300; *Who's Who '87* (1) #26; *World's Finest Comics* #244-250

Current: *Action Comics* #600; *Adventures of Superman* #440; *Armageddon 2001* #2; *Armageddon: Inferno* #2; *Blasters Special* #1; *Christmas With the Super-Heroes* #2; *The Demon* (3) #17; *Doctor Fate* (2) #32, 40; *Doom Patrol* (2) #29; *Firestorm, the Nuclear Man* #69; *Flash* (2) #29; *Green Lantern Corps* #220; *Hawkworld* (2) #16; *Invasion!* #2; *Justice League America* #40; *Justice League Europe* #1; *Justice League International* #9, 22, 24; *Legends* #6; *Millennium* #1, 3-8; *Mister Miracle* (2) #17 (behind the scenes); *The New Titans Annual* #5; *War of the Gods* #1-4; *Who's Who '87* (1) #26; *Who's Who '90* #4; *Wonder Woman* (2) #1-31, 33-44, 46-60, 62; *Wonder Woman Annual* #1-2; *Wonder Woman Special* #1

Wonder Woman's Equipment



Tiara

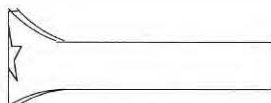

Side View

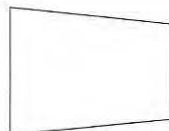

Bracelet

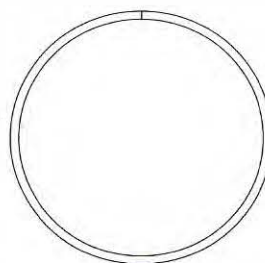

Top View

BARTER

DEX: 3	STR: 3	BODY: 3
INT: 11	WILL: 13	MIND: 12
INFL: 11	AURA: 13	SPIRIT: 10
INITIATIVE: 25	HERO POINTS: 65	

- Skills:** Charisma (Persuasion): 12; Occultist: 9
- Advantages:** Omni-Connection; Pet (Jadoo, see below); Scholar (antiquities, exotic items, trading)
- Drawbacks:** Catastrophic Irrational Attraction to making deals
- Alter Ego:** None
- Motivation:** Mercenary
- Wealth:** 10
- Occupation:** Businessman

Jadoo

Barter has a pet Durlan named Jadoo. Jadoo often assumes the form of an ocelot.

JADOO

DEX: 6	STR: 3	BODY: 5
INT: 3	WILL: 3	MIND: 3
INFL: 2	AURA: 2	SPIRIT: 3
INITIATIVE: 11		

- Powers:** Chameleon: 8, Omni-Arm: 8, Self Manipulation: 8, Shape Change: 8
- Drawback:** Miscellaneous: Jadoo cannot leave Barter's shop

The Hard Sell

If Barter can locate an individual with a palpable longing, he can often seduce that individual into making a costly deal to acquire the object of his obsession. Treat this as a Persuasion attempt. If Barter earns RAPs exceeding the victim's MIND, the victim must make a deal. Characters can resist this effort by spending Hero Points, just like any other form of Character Interaction.

Barter's Trading Shop

Barter conducts all of his business out of an extradimensional shop that periodically appears in most of the world's big cities. The shop has the Dimension Travel (Travel) Power rated at 3 APs and is itself a pocket dimension at a Travel Distance of 1 from the Earth Dimension (see pp. 20-21 of the

Magic Sourcebook). The shop is protected by security systems ranging from powerful Omega beams (Heat Vision of 9) to subjugated demonlings [DEX: 6, STR: 7, BODY: 7, all Mental and Mystical Attributes rated at 2, Initiative: 10].

Powers and Abilities

Barter is a master businessman and possesses formidable knowledge of the occult. He has certainly mastered an occult process for siphoning off "life force" from a willing target in order to escape the effects of aging. Whether or not he has developed other specialized occult rituals is unknown.

Personality/Role-playing

Barter is, as his name implies, the greatest trader of goods and services in the cosmos, and possibly beyond. Known in all dimensions and worlds, he will make a deal with anyone for anything, as long as it is a rare commodity. Barter never takes currency, only something of equal or greater value, and he takes pride in his ability to find an even trade. Barter will trade not only goods, but also knowledge, stories, weapons, etc.

A smooth businessman, Barter deals for himself no matter how selfless he may sound, and when he is angry, he can be vicious and back-stabbing. Hagglng with him is difficult because he thinks he has better things to do with his time than argue with amateurs. He often intimidates his inexperienced customers with an air of superiority, which is magnified by his archaic speech mannerisms.

If a customer is on his toes, Barter can be a great benefit, able to trade things no one else in the cosmos can find. Despite his otherwise unsavory character, Barter's customers can always count on him to deliver as promised once he has concluded a deal.

Using Barter in Adventures

Barter is a good lead-in character for an Adventure. He might contact the Characters to get an item that is in their possession, which could lead to a good bartering session. He also may have an item that the Characters require, which could send them on any number of exciting Adventures. In order to contact Barter, one must pick up a telephone and dial 555-8888. Magically, the next door such a Character enters will lead him into Barter's shop.

Subplots

Barter is always in the market for new goods, and most of his Subplots revolve around acquiring valuable items. He does have a Secret Past, however, that is as yet unrevealed.

Appearances in the DC HEROES Role-Playing Game, Second Edition

Magic Sourcebook

Appearances in DC Comics

Hawk and Dove (3) #1-2, 5-7, 14-17, 25, 27-28;
Secret Origins (3) #43; *Who's Who '90* #4

Barter's Shop

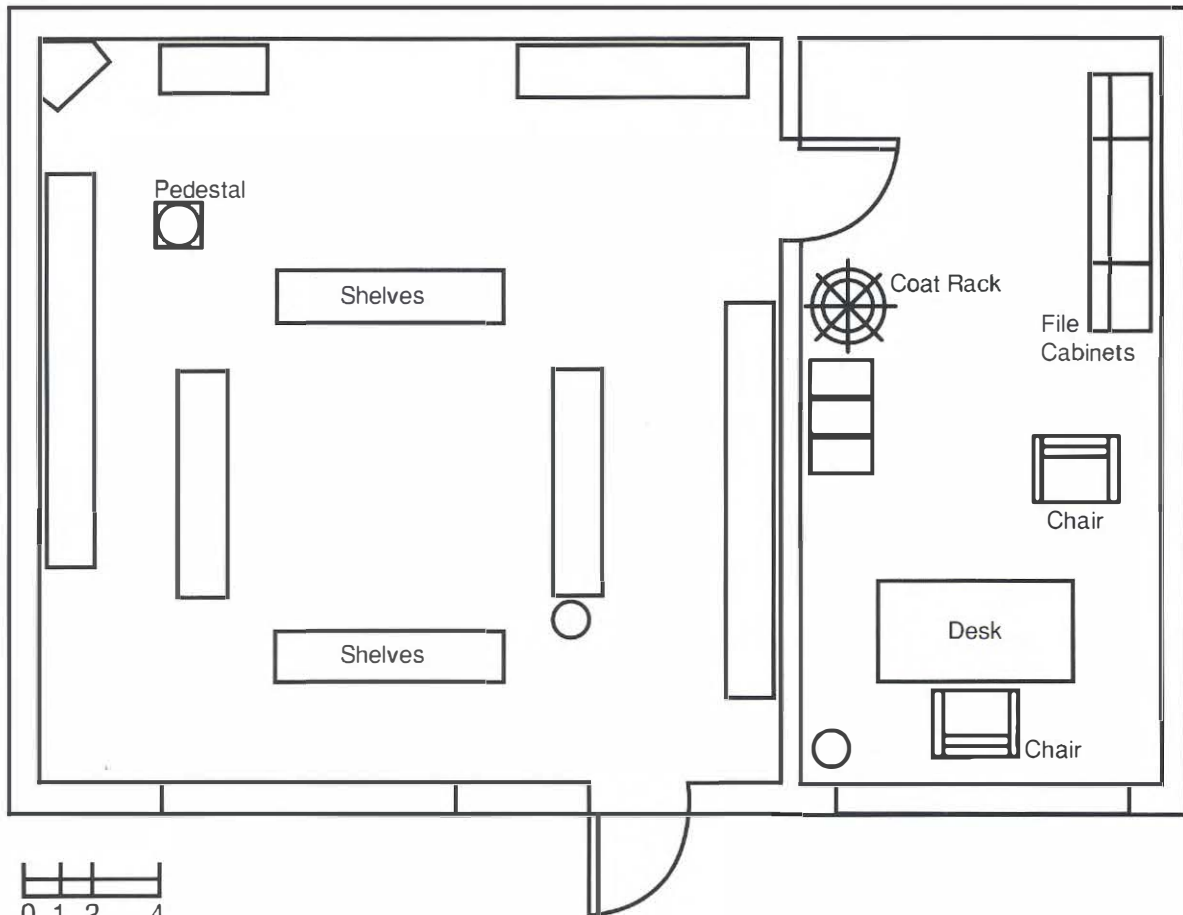

BRAINIAC

DEX:	5	STR:	8	BODY:	10
INT:	18	WILL:	16	MIND:	13
INFL:	8	AURA:	7	SPIRIT:	9
INITIATIVE:	31	HERO POINTS:	100		

- Powers:** Control: 14, Force Field: 12, Illusion: 20, Mental Blast: 16, Mind Blast: 14, Telekinesis: 15, Telepathy: 25
- Skills:** Gadgetry: 16, Scientist: 18
- Advantages:** Connections: Colu (Low); Genius; Leadership; Scholar (computers, robotics, physics); Sharp Eye
- Bonus:** Miscellaneous: Telepathy is also usable on computers.
- Alter Ego:** Vril Dox
- Motivation:** Power Lust
- Wealth:** 10
- Equipment:**

BRAINIAC SPACECRAFT [STR: 20, BODY: 18, INT: 15, WILL: 7, Directional Hearing: 15, Energy Blast: 15, Extended Hearing: 12, Extra Limb (x8): 18, Flight: 40, Force Field: 10, Full Vision: 12, Radar Sense: 40, Recall: 40, Split: 4, Super Hearing: 40, Telescopic Vision: 10, Thermal Vision: 14, Ultra Vision: 14]

Brainiac's spacecraft can easily attain light speed and beyond. Its most potent weapons are its powerful tentacles, which can Grapple or smash both grounded and airborne targets. Each tentacle is approximately 80 feet long (3 APs). The spaceship's on-board computer is one of the most sophisticated in the galaxy [INT: 15, WILL: 7, Recall: 40, Split: 4].

Computer Link

Brainiac has sophisticated cybernetic implants that allow him to connect his brain directly into virtually any computer system. To do this, Brainiac uses his Telepathy Power to make an Action Check against an OV/RV equal to the computer's INT/INT. If the Check succeeds, he may then begin to remove information from that computer (Telepathy vs. the computer's INT/INT; RAPs equal Knowledge Points gained), or begin to operate that computer's systems (Telepathy vs. the computer's INT/INT; 1 or more RAPs indicate success).

Powers and Abilities

Brainiac wields a wide range of mental abilities. He can: control minds, create illusions, create a field of mental energy to protect his body, blast an opponent with a beam of mental energy, cause pain in an opponent's mind, lift and move objects through force of will, and communicate telepathically. He is also a brilliant scientist and has mastered the ability to control, create, and communicate with technology and computers. Implants in his brain allow him to directly connect himself to pieces of technology and augment his abilities.

Milton Fine

Brainiac's body is actually that of Earth-man Milton Fine. When the Fine body was threatened by a brain tumor, Brainiac underwent an experimental operation that enhanced his form, producing the afore-mentioned statistics. Before Brainiac's body was enhanced, he had the following statistics:

BRAINIAC/MILTON FINE HYBRID

DEX:	3	STR:	2	BODY:	7
INT:	15	WILL:	16	MIND:	13
INFL:	8	AURA:	7	SPIRIT:	6
INITIATIVE:	26	HERO POINTS:	50		

- Powers:** Control: 10, Illusion: 20, Mental Blast: 16, Mind Blast: 14, Telekinesis: 15
- Skills:** Gadgetry: 16, Scientist: 18
- Drawbacks:** Minor Psychological Instability (Fine's mind occasionally attempted to wrest control of his body away from Brainiac.)

Personality/Role-playing

Brainiac is an extremely ambitious and imaginative villain. As a result of his supreme intellect, he believes himself to be above other mortals, and his arrogance seems matched only by his ability to hate. He has no compunction about stealing or hurting other beings.

Although he once used his mental capacity primarily for scientific pursuits, he is now more interested in power. He has never been caring or emotional, considering logic and intellect of primary importance. He seems to enjoy causing pain or humiliation, particularly when dealing with powerful beings like Superman.

Using Brainiac in Adventures

Most of Brainiac's schemes revolve around attempts to capture super-advanced technology. He might try to capture an alien super-weapon or computer or discover the ancient secrets of a long-lost alien civilization.

Subplots

Brainiac is involved in an active Enemy/Family Subplot with his son, Vril Dox II, though he is most often a minor player in the Subplots of others. For instance, Brainiac once influenced Superman to unwittingly masquerade as a crime fighter known as Gangbuster. Many Miscellaneous Subplots like this come as a result of Brainiac's manipulations.

Appearances in the DC HEROES Role-Playing Game, Second Edition

Background/Roster Book, Superman--The Man of Steel Sourcebook

Appearances in DC Comics

***Note:** Pre-Crisis appearances are not part of present continuity.

Pre-Crisis: *Action Comics* #242, 275, 280, 286, 292, 318, 332, 335, 339, 342, 400, 413, 417-418, 443, 489-491, 514, 528-530, 544-546, 572; *Adventure Comics* #388-389; *Crisis on Infinite Earths* #3, 6-7, 9-12; *DC Comics Presents* #80; *DC Special Series* #5; *Justice League of America* #137; *Legionnaires Three* #1; *The New Teen Titans Annual* (2) #1; *Secrets of the Legion of Super-Heroes* #2; *Superboy* (1) #106; *Superman* (1) #167, 257, 271, 299, 338, 370; *Superman Family* #183; *Superman's Girl Friend Lois Lane* #17, 44; *Superman's Pal, Jimmy Olsen* #116, 130; *Who's Who '85* #3; *World of Krypton* (1) #2; *World's Finest Comics* #144, 158

Current: *Action Comics* #646-649; *Adventures of Superman* #438, 441, 445, 447-448, 451, 456, 462; *Adventures of Superman Annual* #2; *L.E.G.I.O.N. '91* #23; *L.E.G.I.O.N. '90 Annual* #1; *Superman* (2) #20 (behind the scenes), 25-28, 30-31, 33, 35; *Who's Who '88* #1; *Who's Who '90* #3

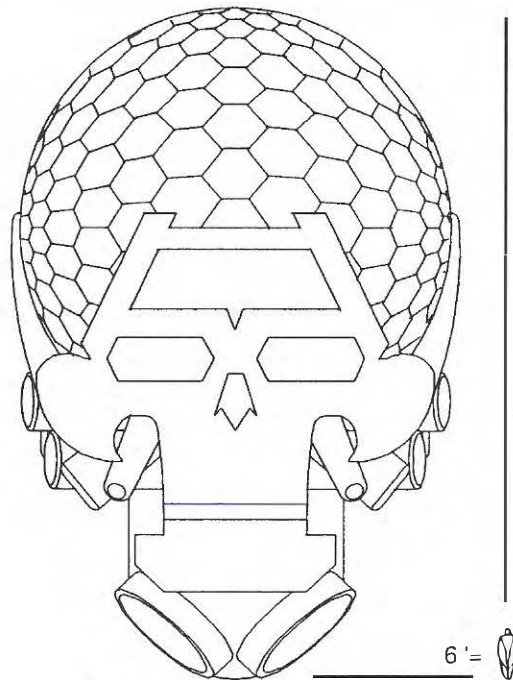

BRAINIAC'S SHIP

front view

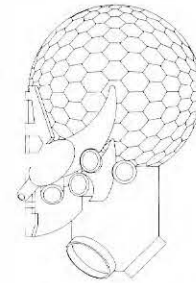

side view

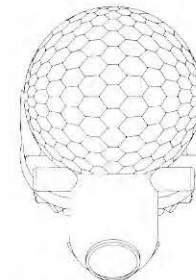

back view

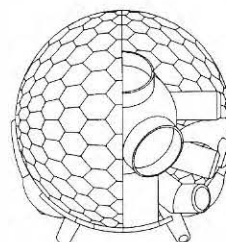

top/bottom view

BROTHERHOOD OF DADA

MR. NOBODY-deceased

DEX: 8	STR: 3	BODY: 11
INT: 8	WILL: 7	MIND: 7
INFL: 8	AURA: 7	SPIRIT: 7
INITIATIVE: 24	HERO POINTS: 70	

- Powers:** Two-Dimensional: 2
- Skills:** Gadgetry: 5, Scientist: 5
- Advantages:** Connections: Brotherhood of Dada (High); Leadership
- Drawbacks:** Serious Irrational Attraction to Dada; Serious Psychological Instability; Strange Appearance
- Limitations:** Two-Dimensional Power is Always On.
- Alter Ego:** Mr. Morden
- Motivation:** Psychopath
- Wealth:** 8

SLEEPWALK

DEX: 5	STR: 3/14	BODY: 3/9
INT: 3	WILL: 3	MIND: 6
INFL: 3	AURA: 2	SPIRIT: 6
INITIATIVE: 11	HERO POINTS: 35	

- Advantages:** Connections: Brotherhood of Dada (High)
- Drawbacks:** Miscellaneous: Sleepwalk is a somnambulist and walks through most of her adventures in a sleep-like state. Although she is not fully conscious of her actions in this state, she does seem to have a sense of purpose.
- Limitations:** Miscellaneous: Sleepwalk's STR and BODY increase to 14 and 9 while she is sleeping. While awake, her STR and BODY are both 3.
- Equipment:**
Stereo Headphones [Hypnosis: 7, BODY: 1] The Stereo Headphones (and the Barry Manilow cassettes they play) are usable only to Hypnotize Holly to sleep. Add the stereo's APs of Hypnosis to Sleepwalk's MIND to determine the RV of any efforts to wake her.
- Alter Ego:** Holly McKenzie
- Motivation:** Psychopath
- Wealth:** 5

FRENZY

DEX: 5	STR: 4	BODY: 5
INT: 2	WILL: 3	MIND: 4
INFL: 3	AURA: 5	SPIRIT: 10
INITIATIVE: 10	HERO POINTS: 45	

- Powers:** Air Control: 7, Lightning: 3
- Advantages:** Connection: Brotherhood of Dada (High)
- Limitations:** Miscellaneous: Frenzy's Lightning Power is somewhat uncontrollable. Anyone within 1 AP of Frenzy when he assumes his "tornado form" (i.e., uses Air Control) is automatically attacked by his Lightning Power.
- Alter Ego:** Lloyd Jefferson
- Motivation:** Psychopath
- Wealth:** 5

THE FOG

DEX: 4	STR: 3	BODY: 3
INT: 5	WILL: 6	MIND: 6
INFL: 4	AURA: 4	SPIRIT: 5
INITIATIVE: 13	HERO POINTS: 35	

- Powers:** Dispersal: 12; Self Link (Fog): 5; Spirit Drain: 9
- Advantages:** Connection: Brotherhood of Dada (High)
- Drawbacks:** Serious Psychological Instability (many of the Fog's victims are still alive inside him, and sometimes they attempt to manifest their own consciousness.)
- Bonuses:** Miscellaneous: If the Fog inflicts Spirit Drain damage greater than or equal to twice the target's base SPIRIT, the target's personality is absorbed into the Fog forever.
- Limitations:** Miscellaneous: Spirit Drain and Dispersal only work when the Fog is using Self Link (Fog); Miscellaneous: The Fog cannot add the RAPs he earns on Spirit Drain attacks to his own SPIRIT.
- Alter Ego:** Byron Shelley
- Motivation:** Psychopath
- Wealth:** 5

THE QUIZ

DEX: 5	STR: 3	BODY: 3
INT: 5	WILL: 6	MIND: 4
INFL: 4	AURA: 3	SPIRIT: 5
INITIATIVE: 14	HERO POINTS: 35	

- Powers:** Omni-Power: 16
- Advantages:** Connection: Brotherhood of Dada (High); Scholar (Japanese language)
- Drawbacks:** Catastrophic Irrational Attraction to

cleanliness; Serious Psychological Instability; Miscellaneous: The Quiz does not speak English.

•**Bonus:** Miscellaneous: The Quiz's Omni-Power works somewhat differently than the ability described in the *Character Handbook*. With it, the Quiz can mimic any Power or Skill or raise any of her Attributes to 16. Although she can only mimic one Power/Skill/Attribute at a time, she can rapidly change between mimicked abilities, allowing her to shift abilities as many times as she likes during a single phase. The Quiz pays no Hero Point fees for using her Omni-Power.

•**Limitations:** Miscellaneous (and weird!): Quiz loses the ability to imitate any power or ability that has been named aloud by an opponent in her presence. Note that the "power" of the previous sentence is not necessarily the same thing as a DC HEROES "Power." "Unstoppable beams of energy" and "blasts of plasma force" are two different powers, though they are both represented by the Energy Blast Power in DC HEROES.

•**Alter Ego:** Unknown

•**Motivation:** Psychopath

•**Wealth:** 5

The Painting that Ate Paris

During one of their more outlandish capers, the Brotherhood of Dada stole an ancient mystical painting that had the power to devour those who looked at it. Anyone looking at this painting is attacked by the Dimension Travel (Banishment) Power rated at 12 APs. A successful attack sends the target to the "Dada Dimension," a strange land dominated by surreal landscapes reminiscent of the works of various schools of abstract art. The Dada Dimension is a pocket dimension located at a Travel Distance of 1 from the Earth Dimension (see pp. 20-21 of *Magic Sourcebook*).

Background Update

Recently, Mr. Nobody escaped from the Painting that Ate Paris and recruited a new Brotherhood of Dada. Government agents then killed him and this new team.

Powers and Abilities

The members of the Brotherhood of Dada have powers and abilities that are as surrealistic as their odd names.

Mr. Nobody was always two-dimensional, although he could be seen from most angles. He seemed impervious to physical harm and explained this by arguing that he was purely abstract.

While asleep, Holly McKenzie, also known as Sleepwalk, can throw a car approximately one-half mile and lift approximately 700 tons. When she awakens, her strength is that of a normal human.

Lloyd Jefferson, also known as the Frenzy, can turn into a whirling tornado strong enough to blow an elephant an eighth of a mile. He also emits lethal bolts of lightning.

The Fog turns into a mind-numbing gas.

The Quiz has every super-power you haven't yet thought of.

Personality/Role-playing

The members of this team are all certified nutcases. Mr. Nobody, for example, was the master of the ridiculous and the meaningless. He strived for fame, and he had a strong presence that swayed others to listen and follow. Nobody preferred to have others do the work while he delivered soliloquies or simply spoke nonsense.

Sleepwalk fights while she's asleep, and when awakened, she usually asks to be told what she did.

The Quiz speaks only Japanese and is an obsessive-compulsive about cleanliness. She is likely to fly into a rage if her containment suit is ruptured.

The personalities of Frenzy and Fog remain enigmatic.

Using the Brotherhood in Adventures

These characters are designed to add a bit of absurdity to your campaigns. If the heroes need a good mind-wrenching, surrealistic Adventure of non sequiturs and nonsense, consider forcing them into an encounter with the Brotherhood of Dada.

The leader of the Brotherhood, Mr. Nobody, was convinced that everything in the world is completely pointless. Consequently, many of the Brotherhood's schemes revolved around Nobody's attempts to prove this theory.

Appearances in DC Comics

Doom Patrol (2) #23-29, 49-52; *Who's Who '90* #1

CAPTAIN BOOMERANG

DEX: 8	STR: 3	BODY: 4
INT: 4	WILL: 4	MIND: 4
INFL: 6	AURA: 3	SPIRIT: 3
INITIATIVE: 18	HERO POINTS: 50	

- Skills:** Gadgetry: 4, Weaponry (Exotic): 11
- Advantages:** Connections: Flash's Rogues' Gallery (Low), Suicide Squad (Low), Underworld (Low); Scholar (boomerang construction)
- Drawbacks:** Unluck
- Alter Ego:** George "Digger" Harkness
- Motivation:** Mercenary
- Wealth:** 4
- Equipment:**

Standard Boomerangs (x5) [EV: 3, BODY: 5, Gliding: 3] Captain Boomerang can throw his boomerangs a distance equal to his own STR plus the boomerang's APs of Gliding (usually 6 APs or 200 yards). Most boomerangs return to his hand one phase after they are thrown (Captain Boomerang can automatically retrieve the boomerang by expending an Automatic Action).

Bafflerangs (x2) [BODY: 5, Flash: 7, Gliding: 3, R#: 2] These boomerangs emit a bright flash upon reaching their mark, blinding all targets in range (treat as a standard Flash attack).

Exploding Boomerang [BODY: 5, Bomb: 8, EV: 3, Gliding: 3, R#: 2] When these boomerangs strike a target, they explode. Treat as a standard boomerang attack. If Captain Boomerang rolls his success number or greater, the boomerang explodes, and everyone within range is attacked with the Bomb Power, as described on page 24 of the *Character Handbook*.

Razorang [EV: 6, BODY: 5, Gliding: 3] The Razorang has a sharpened steel edge. When he uses it, Captain Boomerang automatically enters Killing Combat.

Smokarangs (x3) [BODY: 5, Fog: 12, Gliding: 3, R#: 2] The Smokarangs trail a thick cloud of smoke behind them when thrown, allowing Captain Boomerang to obscure his escape.

Sonic Boomerangs (x2) [BODY: 5, Sonic Beam: 7, Gliding: 3, R#: 2] These boomerangs attack all in range with a powerful sonic beam. Use Captain Boomerang's APs of Weaponry Skill as the AV of this attack and the boomerang's APs of Sonic Beam as the EV.

7 AP AC Omni-Gadget Boomerangs (x2)

When throwing a boomerang, Captain Boomerang's AV is equal to his APs of Weaponry (Exotic) Skill.

Powers and Abilities

George Harkness is an enterprising Australian, who has created a number of specialized variations to help him pull off crimes. With no super powers, only his advanced skill in the ancient hunting weapon, Captain Boomerang is a match even for the Flash. With his practiced talent, he rarely ever misses, and is able to judge the exact trajectory of his weapons with great accuracy.

Personality/Role-playing

Captain Boomerang is abrasive, argumentative, rude, and nearly impossible to respect or trust. He rarely takes on opponents more powerful than himself, preferring to leave them to his teammates. When an opportunity arises to gain recognition or wealth, he will grab it.

As a member of the Suicide Squad, his skills are extremely useful, but Harkness is not a team player. He thinks only of himself and will leave other team members in the lurch. And yet, although he has had numerous chances to escape his incarceration and duties as a member of the Suicide Squad, he has not attempted to do so.

Harkness is not a people person. He is always ready for a fight and starts many of them. He does not respect authority, namely Amanda Waller or Rick Flagg, and he often refuses to follow orders. Generally a loner, the only person he seemed close to is his mother, who is now dead.

Boomerang is a fierce fighter and a killer, but he always announces his presence before making an attack. This is mostly a trick, since his boomerangs usually hit an opponent from behind.

Subplots

Captain Boomerang was involved in a Family Subplot with his mother, who is now dead. Other than that, he has many Miscellaneous Subplots regarding his desire to escape and commit crimes. At one point, he masqueraded as the Mirror Master to get away with pulling off some heists. Now most of his Subplots revolve around his disagreements with his teammates.

Boomerang Construction

Although Captain Boomerang's Gadgetry Skill is rated at only 4 APs, he is still a master craftsman when it comes to the design and construction of boomerangs. His Scholar Advantage gives him -2 Column Shifts to the OV/RV of any Gadgetry Action Checks that involve the construction of boomerangs, no matter how outlandish the connection (even a boomerang-shaped spacecraft would earn the bonus).

Trick Shots

Captain Boomerang is a master of the Trick Shot, the Critical Blow, and the Devastating Attack (see page 23 of the *Rules Manual*). Here are some of his common maneuvers:

- Trip an Opponent (+2 Column Shifts to the OV):** 1 or more RAPs indicate opponent has been tripped and must take no Dice Action during his next phase in order to stand again.
- Disarm an Opponent (+3 Column Shifts to the OV):** 1 or more RAPs allow Boomerang to knock a removable Gadget or simple object away from an opponent.
- Retrieve an Object (+5 Column Shifts to the OV):** This is similar to Disarm an Opponent, only success indicates that the Gadget returns to the thrower with the boomerang.
- Hit a Switch or Button:** Captain Boomerang can turn off a light switch or press a button on a computer keyboard. The OV/RV of such attempts is 8/8 (Extreme Task), so he'll usually Go For Broke when taking such an action.
- Aimed Shots:** Captain Boomerang's accuracy is amazing, meaning he can usually strike particularly

vulnerable parts of his target. Treat such attempts as standard Critical Blows and Devastating Attacks.

- Bounce Attack:** Boomerang can bounce one of his weapons off walls in order to strike an opponent from behind. Treat this as a standard Critical Blow or Devastating Attack.

Appearances in the DC HEROES Role-Playing Game, Second Edition

Background/Roster Book (includes card)

Appearances in DC Comics

***Note:** Pre-Crisis appearances are not part of present continuity.

Pre-Crisis: *Batman* #322, 388; *Crisis on Infinite Earths* #5; *Detective Comics* #555; *The Flash* (1) #117, 124, 148, 155, 174, 209, 227, 242-244, 275, 278, 283, 310-311, 325, 338, 342, 348-350; *Justice League of America* #61; *Secret Society of Super-Villains* #1, 3-6; *Who's Who '85* #4

Current: *Blue Devil* #30; *Checkmate!* #16, 18; *Cosmic Boy* #3; *Firestorm Annual* #5; *Firestorm, the Nuclear Man* #87; *Flash* (2) #19; *The Fury of Firestorm* #64; *Invasion!* #2-3; *Justice League International* #13; *Legends* #3-6; *Millennium* #4; *Secret Origins* (3) #41; *Secret Origins Annual* #2; *Suicide Squad* #1-5, 7-9, 11-18, 19 (behind the scenes), 20-25, 27, 29-37, 41-46, 47 (behind the scenes), 49-51, 54-59, 61-66; *Suicide Squad Annual* #1; *War of the Gods* #3-4; *Who's Who '90* #2; *Wonder Woman* (2) #61

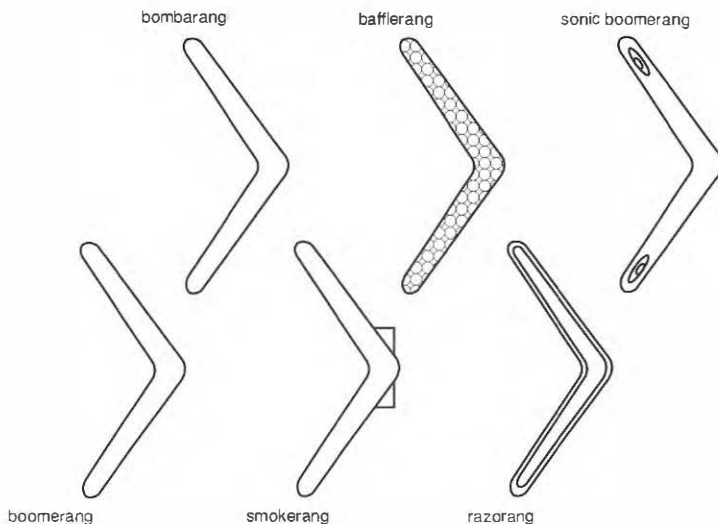

CHEETAH

DEX: 13	STR: 8	BODY: 10
INT: 8	WILL: 7	MIND: 7
INFL: 8	AURA: 6	SPIRIT: 8
INITIATIVE: 33	HERO POINTS: 60	

- **Powers:** Claws: 9, Extra Limb (tail): 8, Jumping: 2, Running: 6, Ultra Vision: 9
- **Skills:** Acrobatics: 13, Martial Artist: 9, Military Science (Tracking): 12, Thief (Stealth): 13
- **Advantages:** Buddy (Chuma), Lightning Reflexes
- **Drawbacks:** Serious Rage
- **Alter Ego:** Barbara Minerva
- **Motivation:** Psychopath
- **Wealth:** N/A

Barbara Minerva

In her Barbara Minerva form, Cheetah has the following statistics:

BARBARA MINERVA

DEX: 3	STR: 2	BODY: 3
INT: 8	WILL: 7	MIND: 7
INFL: 6	AURA: 3	SPIRIT: 6
INITIATIVE: 17	HERO POINTS: 60	

- **Skills:** Occultist: 5, Scientist: 5
- **Advantages:** Scholar (archaeology, Cheetah ritual)
- **Wealth:** 8

Powers and Abilities

When Minerva becomes the Cheetah, she receives the power of the Urzkartagan cat goddess. She is fast, reaching the same speed as the cheetah itself, about 64 miles an hour. Cheetah can scale almost any surface, use her tail as an extra limb, and slice through steel with her claws. Her heightened form gives her feline and instincts and a predatory mentality. Her eyes can see as only a cat can, giving her an advantage in the dark, and she often uses her stealth to get as close to a victim as possible before striking.

Personality/ Role-playing

Minerva is respected in her field for her knowledge and ambition, but she is known to do anything, including turning on colleagues, to get what she wants. She is intimidating and can make people

follow her orders without question. Being self-centered, she has had no friends since her only companion, Chuma, high priest of Urzkartaga, was killed.

Minerva is obsessed with finding a means of reversing the side effect of the Cheetah ritual and pursues any possible solution. While doing so, the Cheetah fights like her namesake and kills with no hesitation. When in the form of Cheetah, she hunts down human prey and eats her victims to gain strength.

Using Cheetah in Adventures

Minerva is desperately searching for a way to reverse the effect of the Cheetah ritual ailment, which weakens her each time she reverts back from the Cheetah. Therefore, she may seek out the Characters if they have something that might remedy her condition.

Subplots

Cheetah is often involved in a Power Complication Subplot. This, of course, has become the motivation for most of her criminal activity.

The Cheetah Ritual

To become the Cheetah, Minerva performs a complex ritual during which she must paint her face and drink an elixir made from the crushed berries of a rare plant mixed with human blood. In all, the ritual takes approximately two hours (11 APs) to perform and requires a successful Occultist Action Check against an OV/RV of 6/6 (OV/RV of 2/2 for Minerva due to her Scholar Advantage).

Appearances in the DC HEROES Role-Playing Game, Second Edition

Background/Roster Book (includes card)

Appearances in DC Comics

***Note:** Pre-Crisis appearances are not part of present continuity.

Pre-Crisis: *Comics Cavalcade* #11; *Crisis on Infinite Earths* #9; *DC Special* #3; *Infinity, Inc.* #22; *Justice League of America* #195-197; *Sensation Comics* #22;

Super Friends #1-2; *Who's Who '85* #4; *Wonder Woman* (1) #6, 28, 160, 166, 196, 230, 274-275, 323

Current: *Who's Who '88* #1; *Who's Who '90* #4; *Wonder Woman* (2) #7-9, 27-31, 33-35, 51, 54 (behind the scenes), 56, (behind the scenes), 59-61, 63; *Wonder Woman Special* #1

Temple of the Urzkargan Cat Goddess

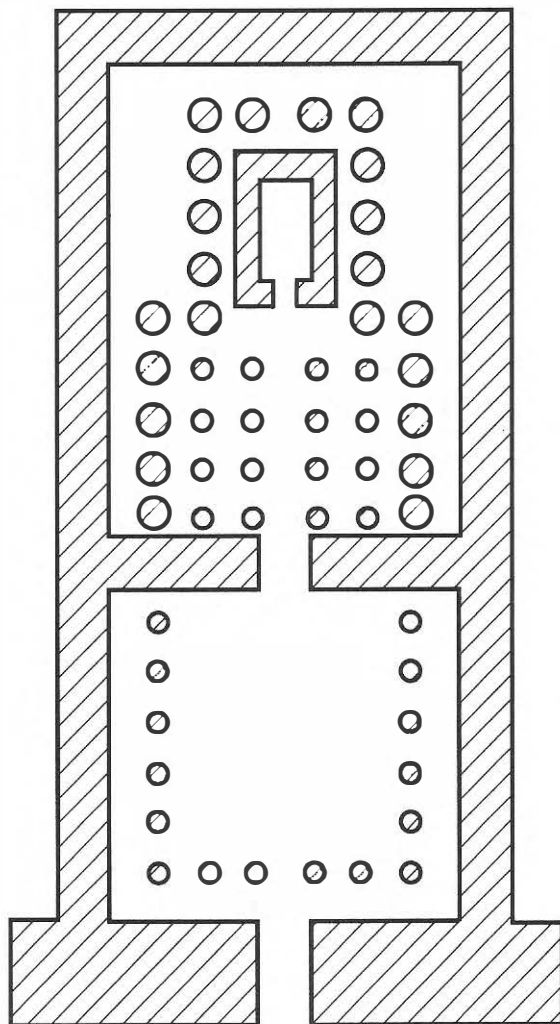
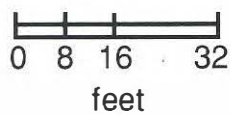

CHRONOS

DEX: 5	STR: 4	BODY: 3
INT: 9	WILL: 7	MIND: 7
INFL: 5	AURA: 4	SPIRIT: 4
INITIATIVE: 19	HERO POINTS: 65	

- Skills:** Gadgetry: 9, Scientist: 9, Thief: 5, Vehicles: 4, Weaponry: 6
- Advantages:** Connection: Suicide Squad (Low); Genius; Scholar (temporal physics)
- Drawbacks:** Catastrophic Irrational Attraction to clocks and clock-motif crimes; Serious Irrational Attraction to destroying the Atom (Ray Palmer)
- Alter Ego:** David Clinton
- Motivation:** Power Lust
- Wealth:** 8
- Equipment:**

BATTLESUIT [BODY: 6, Cell Rot: 9, Postcognition: 12, Teleportation: 8, Time Travel: 15] While wearing the suit, Chronos can travel in time, rapidly age living things, peer into the past, and jump through the time-space continuum.

8 AP ABCD Omni-Gadgets
Chronos' Omni-Gadgets always have a time or clock motif.

Old Equipment

In an earlier incarnation, before he built the battlesuit, Chronos used a completely different set of equipment. Among his more infamous devices were:

- Exploding Hourglasses** [BODY: 1, Bomb: 8, R#: 2]
When thrown, these small hourglasses would explode like hand grenades.
 - Wristwatch** [EV: 5, BODY: 4, R#: 2] The watch fired its hands as small darts.
 - Flying Sundial** [Flight: 9, BODY: 8] The sundial was a large flying platform.
- 8 AP ABCD Omni-Gadgets

Powers and Abilities

In his suit, Chronos can travel a few hours in time, teleport about a 1/4 mile, and see a few hours into the past. He has often employed highly technical, time-oriented equipment, including exploding hourglasses, a wristwatch gun, and a flying sundial, to carry out his plans.

Clinton is skilled with mechanical objects, and at one point, owned a clock shop where he made and repaired his wares. The shop also served as a front for his criminal activities. In the shop, Clinton designed numerous weapons based on various forms of timepieces.

Personality/Role-playing

Chronos is a man obsessed with time. He believes that timing is the most important thing in crime and therefore uses clock-motif equipment to aid him in his unlawful practices. As a result of his obsession, Chronos plans every step of his crimes thoroughly and precisely. He will always have at least one back-up plan—sometimes several. In short, he knows the value of patience.

Chronos is calm under pressure and is not the least bit intimidated by costumed heroes. He has been defeated more than once by the Atom, however, and holds a vendetta against the hero.

Using Chronos in Adventures

Chronos has examined the future and has used his knowledge of what will occur to make himself a rich man. For this reason, he may know that the player heroes are capable of foiling some of his future plans, bringing him into conflict with the heroes. Or, perhaps the heroes have some special piece of equipment he may try to steal.

Subplots

Chronos is involved in an Enemy Subplot with the Atom, but most often he creates Subplots or story threads for other Characters. His obsession with time-related objects weaves him through many storylines.

Appearances in the DC HEROES Role-Playing Game, Second Edition

Background/Roster Book

Appearances in DC Comics

***Note:** Pre-Crisis appearances are not part of present continuity.

Pre-Crisis: *Action Comics* #427, 443, 516; *The Atom* #3, 13, 28; *Cancelled Comics Cavalcade* #2; *Crisis*

on *Infinite Earths* #9; *DC Special* #27; *DC Super-Stars* #10; *Detective Comics* #368; *Justice League of America* #21-22, 111, 143, 158, 219-220; *Super Friends* #22; *Who's Who '85*; *Wonder Woman* (1) #220; *World's Finest Comics* #319-321

Current: *Action Comics* #664; *Blue Beetle* (6) #3, 7, 9-10, 21-22; *Legends* #4; *Power of The Atom* #3-8; *Suicide Squad* #3-4; *Who's Who '90* #4

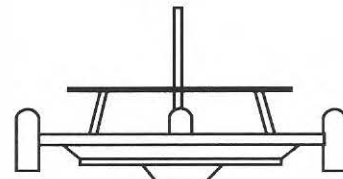

front

Flying Sundial

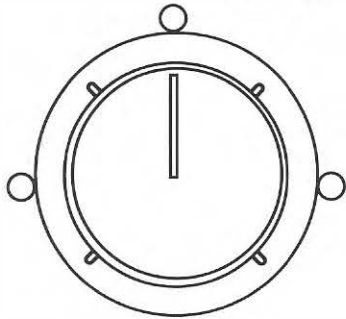

top

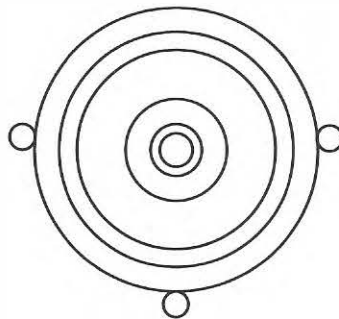

bottom

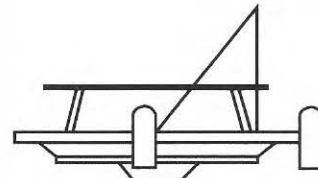

side

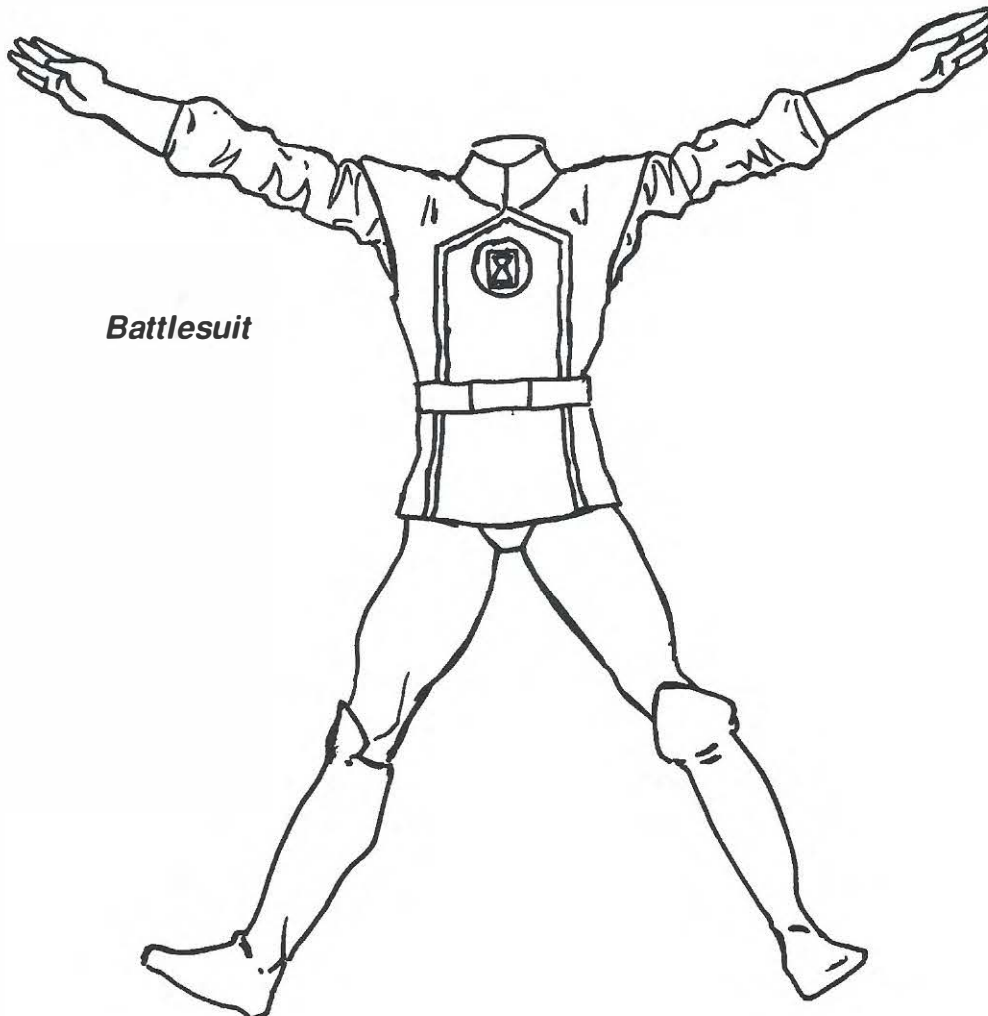

Battlesuit

COUNT VERTIGO

DEX: 6	STR: 4	BODY: 5
INT: 5	WILL: 5	MIND: 4
INFL: 5	AURA: 4	SPIRIT: 4
INITIATIVE: 18	HERO POINTS: 45	

- Powers:** Flight: 7, Illusion: 8
- Skills:** Martial Artist: 5, Thief: 6
- Advantages:** Connections: Suicide Squad (High), Vlatava (High)
- Limitations:** Miscellaneous: Illusion Power can only be used to disorient opponents. (See below.)
- Alter Ego:** Werner Vertigo
- Motivation:** Psychopath
- Wealth:** 10

The Vertigo Effect

Count Vertigo possesses a strange variant of the standard Illusion Power. With this Power, Vertigo can disorient and unbalance his opponents in any of the following fashions:

- Disorientation:** He can lead an opponent to move in the direction of his choice with a successful Action Check against the target's INT/MIND that earns one or more RAPs.
- Invisibility:** He can make himself seem to disappear. Locating him requires a successful Perception Check vs. 8/8 (Vertigo's APs of Power).
- Lasting Effect:** He can make an Action Check against the target's INT/MIND and subtract any RAPs earned from the target's DEX and INT for a number of phases equal to the RAPs earned.
- Mental Attack:** He can make a straight Mental Attack (OV/RV equal to the target's INT/MIND).

Vertigo's Statistics

Because Count Vertigo's abilities were more clearly defined in *Who's Who '90* his Illusion Power has been lowered from 10 APs to 8 APs, and he has been given the Flight Power.

Powers and Abilities

Count Werner Vertigo gained his abilities from a small electronic device implanted in his right temple that was originally designed to counteract an inner-

ear defect he has had since childhood. He soon learned how to use the device to manipulate the perceptions of others, affecting their balance by giving them the sensation that everything is spinning wildly, contorting out of shape, and flying apart. The range of the device is nearly two blocks (1/4 mile or 250 cubic feet), and it can disorient every person within this radius. The Count himself, however, is immune to the effects of the device.

In the past, Vertigo has also used magnetic boots to walk on ceilings or walls to add to the vertiginous effect. He can also fly, though exactly how he accomplishes this feat remains unknown.

Personality/Role-playing

The Count is arrogant, self-serving, insecure, and holds old-fashioned European ideals. At one time he was diagnosed as manic-depressive, and although the condition has been cured, his dramatic mood swings have become a habit. This, combined with the disturbing nature of his abilities, makes him an extremely dangerous individual.

The Count has a strong sense of nationalism with regard to his home country Vlatava and is very proud of his royal heritage. Therefore, although he is in fine physical condition and knows many fighting techniques, he will always use his vertigo abilities first, preferring not to sully his hands in physical combat.

Using Count Vertigo in Adventures

Vertigo is less active since he has become a permanent member of the Suicide Squad. If he does commit any crimes, they would be related to his family's loss of status and power in Eastern Europe. For example, one of his grandest crimes was to recover the royal jewels of Vlatava, which had been sold off years ago.

Count Vertigo could be used as an authority on countries that were once part of the Soviet Union.

Subplots

Count Vertigo has been involved in a Subplot relating to his mental condition. He is worried that it is inherited and is somewhat afraid of any personal relationships with women for this reason. This has even caused him to refuse the throne, which was recently offered him.

Appearances in the DC HEROES Role-Playing Game, Second Edition

Background/Roster Book (includes card)

Appearances in DC Comics

***Note:** Pre-Crisis appearances are not part of present continuity.

Pre-Crisis: *Crisis on Infinite Earths* #9; *Green Arrow* (1) #203; *Who's Who '85* #5; *World's Finest Comics* #251-252, 270, 272-273

Current: *Blasters Special* #1; *Invasion!* #3; *Legends* #4; *Manhunter* (2) #7; *Suicide Squad* #24-25, 27-28, 31, 32 (behind the scenes), 33-37, 41-43, 46-48, 51, 54-59, 61-66; *War of the Gods* #3-4; *Who's Who '90* #3

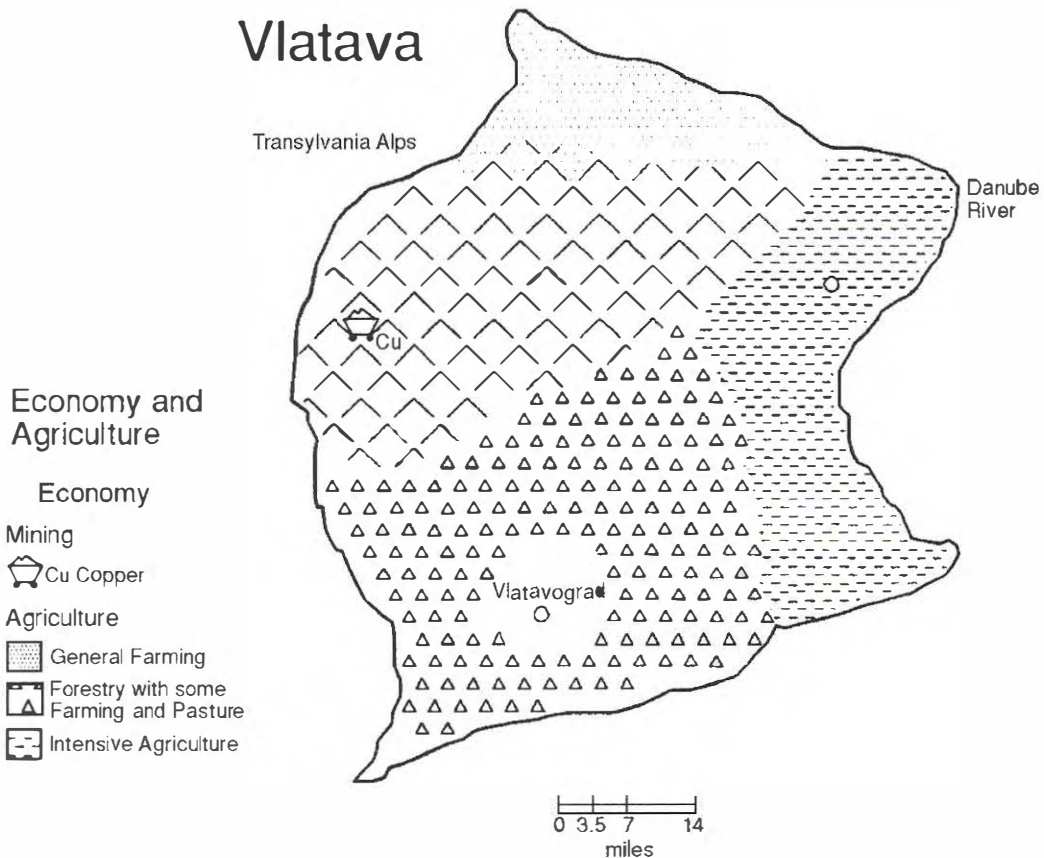

DARKSEID

DEX: 10	STR: 22	BODY: 16
INT: 18	WILL: 26	MIND: 20
INFL: 17	AURA: 17	SPIRIT: 18
INITIATIVE: 45	HERO POINTS: 250	

- **Powers:** Continuum Control: 30, Dimension Travel: 8, Invulnerability: 20, Regeneration: 8, Warp: 65
- **Skills:** Charisma: 18, Scientist: 15
- **Bonuses:** Miscellaneous: Through his Continuum Control Power, Darkseid can exercise the Omega Effect (see below).
- **Limitations:** Miscellaneous: Darkseid's Continuum Control, Warp, and Dimension Travel Powers are all powered by X-Element, which he absorbs into his body (see below).
- **Advantages:** Area Knowledge (Apokolips); Leadership
- **Drawbacks:** Catastrophic Irrational Attraction to discovering the Anti-Life Equation
- **Alter Ego:** None
- **Motivation:** Power Lust
- **Wealth:** N/A

The Omega Effect

If Darkseid uses Continuum Control to attack a target with an Energy Blast and receives a number of RAPs equalling or exceeding twice the target's BODY, he can disintegrate the target, scattering its atoms across the cosmos. Later, Darkseid can reassemble and resurrect targets that have been destroyed in this fashion by making a successful Action Check against an OV and RV both equal to twice the target's BODY.

Furthermore, Darkseid's Powers can affect targets well beyond his line of sight (up to 30 APs away) and can even reach out into other dimensions.

X-Element

Darkseid's Continuum Control, Dimension Travel, and Warp Powers are all fueled by a supply of X-Element, which he absorbs into his body. Treat all of these Powers as though they had a Gadget Reliability Number of 2. Once any of the Powers "breaks down," Darkseid has exhausted his supply of X-Element and must replenish it to use any of these Powers again. To replenish the X-Element, Darkseid must return to his fortress in Armagetton and undergo a process that takes approximately one hour (10 APs).

Powers and Abilities

The true extent of Darkseid's power is unknown. To date, he has demonstrated that he can easily destroy beings with his Omega Beams and then bring them back to life later. These beams are so powerful that they can threaten even Superman. Darkseid is also ageless and can transport himself or his minions to just about anywhere in the known universe. He is also intelligent beyond human comprehension and prefers to work through his horde of agents (known as Darkseid's Elite) while he stays in the shadows.

One-on-one, Darkseid the Destroyer is an extremely dangerous foe. He uses his Omega Beams first to Disintegrate or Teleport his enemies away.

Personality/Role-playing

One of the most destructive forces in the universe, Darkseid the Destroyer will stop at nothing until he gets exactly what he wants. And what he wants is to rule, and finally destroy, everything.

The despot of Apokolips surrounds himself with weapons of war and advanced technology, caring more about them than the people under his rule. He tolerates no free expression from his subjects and quickly crushes any uprisings orchestrated by the "lowlies." He has even destroyed his own family members and loyal followers to further his own ends.

Unlike his son, Orion, Darkseid is controlled and calm, preferring to scheme rather than rampage. He sends henchmen to do his dirty work unless matters of negotiation or honor are at stake. Most importantly, he knows when to admit defeat, and he will Teleport away from a situation to fight another time when he is overpowered.

Using Darkseid in Adventures

Darkseid's final goal is the completion of the Anti-Life Equation, which would decimate all life in the universe. In those rare moments when he is not in search of the Anti-Life Equation, he wars on New Genesis or wreaks havoc upon the heroes of Earth to satisfy his hate for them. Perhaps the Player Characters have something that Darkseid believes will enable him to degrade or destroy Earth's heroes. In any case, Darkseid is powerful enough to implement villainous schemes on the epic scale. Remember, however, he usually hides his involvement by using his minions to carry out his plans.

Subplots

Darkseid's search for the Anti-Life Equation is essentially a lengthy, on-going Subplot.

Appearances in the DC Heroes Role-Playing Game Second Edition

Background/Roster Book, Apokolips Sourcebook, Atlas of the DC Universe, Law of Darkness

Appearances in DC Comics

•**Note:** Pre-Crisis appearances are not part of present continuity.

Pre-Crisis: *Adventure Comics* #459-460; *Crisis on Infinite Earths* #8, 12; *DC Graphic Novel* #4; *First Issue Special* #13; *Forever People* (1) #1-8, 11; *Justice League of America* #183-185; *Legion of Super-Heroes* (2) #287, 289-294 (3) 18, 23; *Legion of*

Super-Heroes Annual (2) #1, 3 (3) 2; *Mister Miracle* (1) #9, 18, 21-23, 25; *New Gods* (1) #1-2, 4, 7, 11-19 (2) 6; *Secret Society of Super-Villains* #1-2 (behind the scenes), 3-5; *Superman's Girl Friend Lois Lane* #111 (behind the scenes), 116, 118; *Superman's Pal, Jimmy Olsen* #136, 152; *Super-Team Family* #15; *Who's Who '85* #6

Current: *Action Comics* #586, 592-593, 600, 635-638, 643; *Adventures of Superman* #426; *Cosmic Odyssey* #1-4; *Doctor Fate* (2) #9-12; *Firestorm, the Nuclear Man* #76; *Forever People* (2) #6; *The Fury of Firestorm* #55, 58; *Invasion* #1 (behind the scenes); *Justice League International* #21; *Legends* #1-6; *Legion of Super-Heroes* (4) #21-24; *Millennium* #8; *Mister Miracle* (2) #17-19; *Mister Miracle Special* #1; *New Gods* (3) #1, 3, 5-17, 19-27; *Secret Origins* (3) #33; *Suicide Squad* #3, 36; *Superman* (2) #3; *Superman Annual* (2) #2; *Swamp Thing* (2) #62; *Warlord* (1) #121; *Warlord Annual* #6; *War of the Gods* #3-4; *Who's Who '90* #1; *Wonder Woman* (2) #19

Tower of Rage

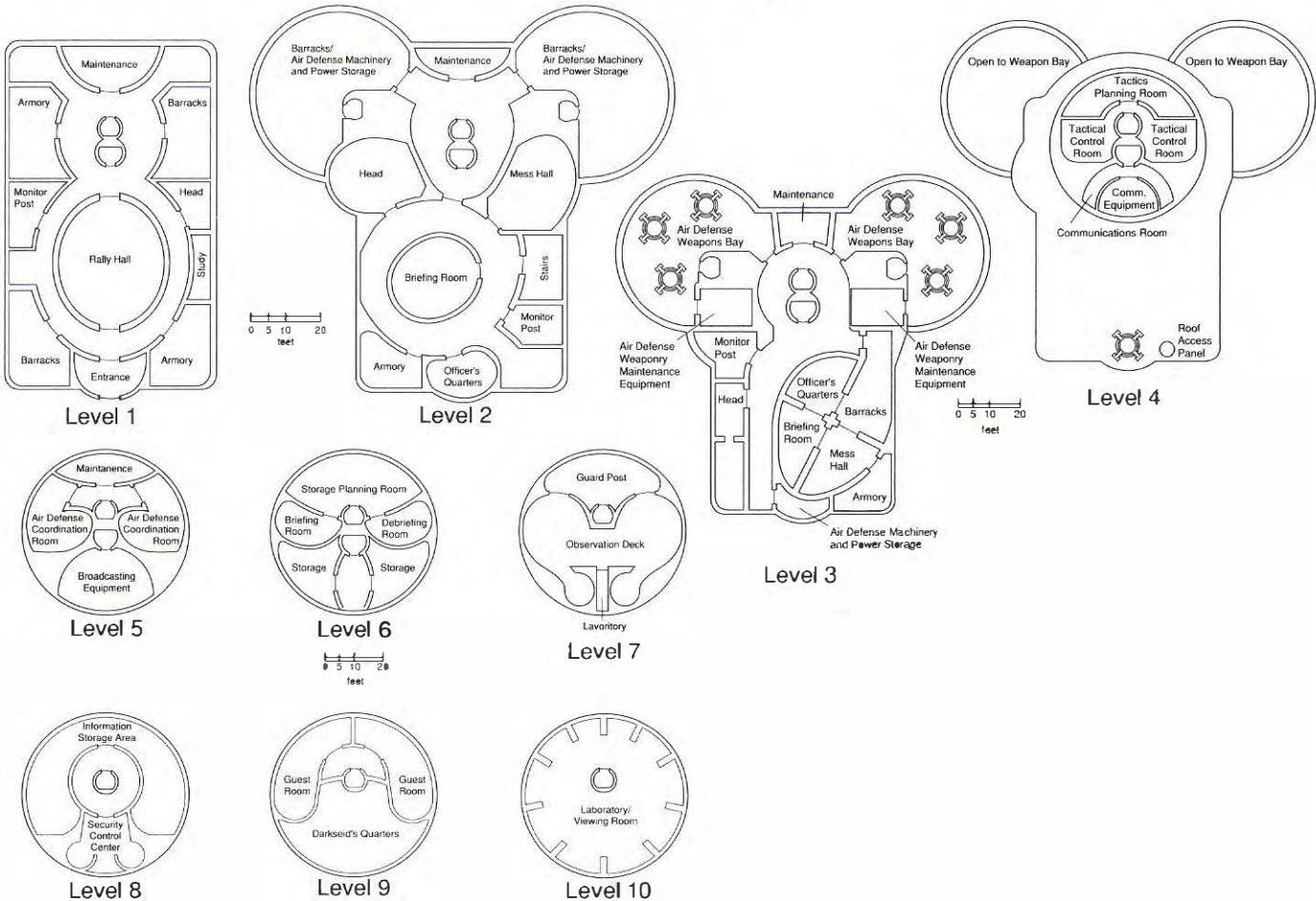

DEADLINE

DEX: 11	STR: 7	BODY: 8
INT: 4	WILL: 5	MIND: 4
INFL: 6	AURA: 6	SPIRIT: 5
INITIATIVE: 23	HERO POINTS: 40	

- **Powers:** Dispersal: 14, Mind Over Matter: 3
- **Skills:** Thief (Stealth): 8, Weaponry: 11
- **Advantages:** Lightning Reflexes; Scholar (assassination planning)
- **Drawbacks:** Minor Irrational Attraction to killing Starman; Serious Irrational Attraction to completing a "hit;" Minor Rage; Secret Identity
- **Alter Ego:** Unknown
- **Motivation:** Mercenary
- **Wealth:** 11
- **Equipment:**

Anti-Grav Disks [BODY: 8, Flight: 12, R#: 2]
 ARMOR [BODY: 10]

Deadline's armor is impervious to everything up to and including small caliber artillery shells. Special pouches and containers for spare ammunition are located all over the armor, so Deadline can "Repair" any of his weapons that fail a Reliability Check by consuming a single Dice Action (although Deadline must give up his Dice Action for the phase, the Repair is an Automatic Action).

Energy Rifle [BODY: 5, EV: 7, R#: 2]

GAUNTLETS [BODY: 4, Bomb: 7, Fog: 8, Poison Touch: 8, R#: 3] Deadline's gauntlets can fire either explosive projectiles (Bomb: 7) or gas pellets. The gas pellets attack everyone within the range of their Fog Power with Poison Touch rated at 8 APs.

Helmet [BODY: 9, Extended Hearing: 4, Super Hearing: 11, Ultra Vision: 7] The helmet picks up radio signals, allows Deadline to see in the dark, and extends the range of his hearing.

Hiring Deadline

Deadline is one of the most skilled and highest paid hitmen in the DC Universe. Locating him for a job requires a High-level Connection with the underworld or organized crime (or a string of Connections/Persuasion attempts leading to someone with such a Connection). Actually hiring Deadline requires a Wealth Check against an OV/RV of 15/15 (roughly \$800,000).

Powers and Abilities

Deadline is impervious to pain and extreme temperatures. Possibly his most formidable ability is his power to disperse his molecules, allowing him to pass through solid objects and giving him a tactical advantage over his victims. As if this was not enough, Deadline has outfitted himself in the latest high-tech equipment and weapons to aid him in his work. Though his specialized toys are unnecessary (he is equally deadly with ordinary weapons), he prefers them.

Personality/Role-playing

Deadline does what he is paid to do and fulfills his contracts to the letter. Usually he doesn't let anyone or anything deter him from his completing an assignment. But ever since Starman interfered in one of his assassinations, Deadline has hated the hero, and will usually drop all for a chance to kill him.

Deadline's methods are direct and well-planned. As a result, he believes he is unstoppable and often inflicts unnecessary damage just to prove that he cannot be defeated. Deadline is also noted for the perverse pleasure he receives from the media attention his crimes bring him.

Since he is considered a master of his trade by his clients, Deadline has amassed a small fortune over the years. He has invested some of his money in a base where he can continue training, developing his abilities, and designing weapons.

Using Deadline in Adventures

Deadline is a hitman. One way to bring him into an Adventure is to have him hired to attack one (or all) of the Player Characters. He's a good vehicle for introducing a more powerful villain who wants to see the heroes out of the way. Deadline is also a vehicle by which the player heroes can meet Starman, who will most likely show up to help them defeat the assassin.

Subplots

Deadline's was involved in a lengthy Enemies Subplot with Starman. He was constantly building his weapons arsenal and training to destroy the superhero. Since Starman died, however, Deadline is mostly involved in Job Subplots centering around his activities as a notorious hit man.

Appearances in DC Comics

Starman #15, 22-25; *Suicide Squad* #63-65; *Who's Who '90* #2

Deadline's Helmet

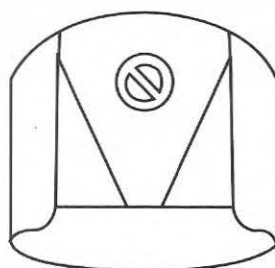

front

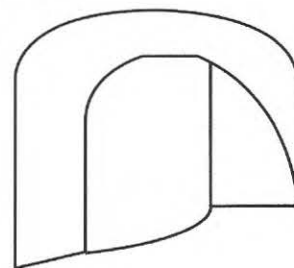

side

Deadline's Gauntlet Weapons

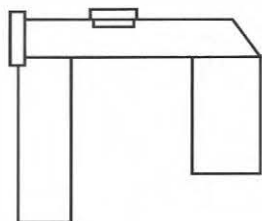

side



front

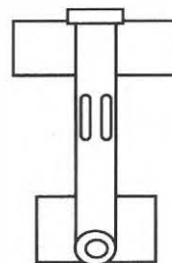

top

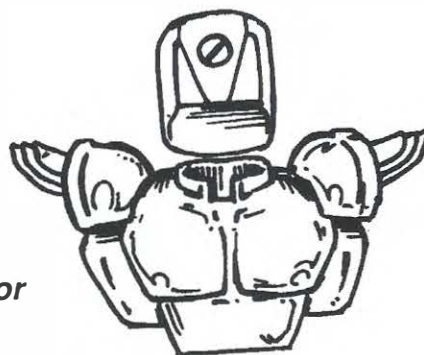

Deadline's Armor

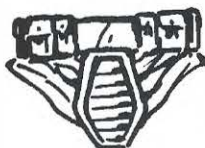

DEADSHOT

DEX: 8	STR: 4	BODY: 5
INT: 6	WILL: 6	MIND: 6
INFL: 6	AURA: 4	SPIRIT: 7
INITIATIVE: 24	HERO POINTS: 45	

- Skills:** Gadgetry: 4, Martial Artist: 6, Thief: 7, Weaponry (Firearms): 12
- Advantages:** Connections: Suicide Squad (High), Underworld (High); Iron Nerves; Lightning Reflexes; Scholar (firearm construction)
- Drawbacks:** Minor Irrational Attraction to entering Killing Combat; Minor Irrational Attraction to dying; Serious Irrational Attraction to using Trick Shots

•**Alter Ego:** Floyd Lawton

•**Motivation:** Psychopath

•**Wealth:** 10

•**Equipment:**

SILENT WRIST MAGNUMS [BODY: 5, EV: 5, Thief (Stealth): 5, Ammo: 8, R#: 2] The magnum's APs of Thief/Stealth function as the OV/RV of the Perception Check necessary to hear the guns when they are fired.

EYE SCOPE [BODY: 3, Telescopic Vision: 9, Thermal Vision: 7] When firing his weapons while using the scope, treat Deadshot as though his Weaponry (Firearms) Skill is rated at 12 APs.

CARTRIDGE BELT [BODY: 4] Deadshot carries 12 complete loads for his wrist guns on a specially designed cartridge belt.

Deadshot's Psychology

Deadshot has a number of Irrational Attractions that require a bit of explanation.

His Irrational Attraction to entering Killing Combat is due to a deeply seated bitterness that sometimes consumes him when he fights. Whenever Deadshot enters battle, he makes a dice roll and automatically enters Killing Combat if he rolls less than 5. Only one such roll is necessary per battle.

Deadshot's Irrational Attraction to dying represents his peculiar "death wish." Note that this doesn't mean that he must make an Attraction Check every round and blow his own head off if he fails. Instead, force Deadshot to check against his Attraction every time he is presented with an opportunity to die in a spectacular fashion—fighting scores of enemies, sacrificing his life to achieve some

goal, grabbing an enemy and falling off a skyscraper, etc. In any case, this Attraction has no effect when Deadshot is not in combat.

And finally, his Irrational Attraction to Trick Shots stems from his need to demonstrate his skill. At the beginning of each battle, Deadshot makes a single Attraction Check. If he fails the Check, he must use nothing but Trick Shots for the duration of that battle. No such Check is necessary if Deadshot is fighting a foe who has beaten him in the past, such as Batman.

Trick Shots

Deadshot is a master of the Trick Shot, the Critical Blow, and the Devastating Attack (see pp. 20-23 of the *Rules Manual*). Among the maneuvers he commonly employs are:

- Aimed Shots:** Deadshot's accuracy is amazing, meaning he can usually strike particularly vulnerable parts of his target. Treat such attempts as standard Critical Blows and Devastating Attacks.
- Disarm an Opponent (+3 Column Shifts to the OV):** 1 or more RAPs allow Deadshot to shoot a removable Gadget away from an opponent.
- Graze Target (+2 Column Shifts to the OV):** By employing this maneuver, Deadshot can graze his target to avoid permanent injury. If he does not employ this maneuver (or a similar maneuver) when attacking a living being, he automatically enters into Killing Combat.
- Hit a Switch or Button:** Deadshot can turn off a light switch or press a button on a computer keyboard. The OV/RV of such attempts is 8/8 (Extreme Task), so he'll usually Go For Broke when taking such an action.
- Show-Off Trick Shots (+2 Column Shifts to the OV):** Sometimes (often in connection with his Irrational Attraction), Deadshot employs Trick Shots for no other purpose than to demonstrate his skills. He might ricochet a bullet into a target, for instance, or shoot an object so that it topples onto his real target. Although the OV of these shots is increased, they cause no extra damage.
- Trip an Opponent (+2 Column Shifts to the OV):** 1 or more RAPs indicate the opponent has been tripped and can take no Dice Action during his next phase in order to stand again. Deadshot performs this maneuver by shooting the ground directly in front of the opponent.

Powers and Abilities

Deadshot is an uncanny marksman and weaponsmith. He carries specialized guns and equipment, specifically his Wrist Magnums and eye scope, which he often employs.

Personality/Role-playing

Floyd Lawton, Deadshot, is abrasive, angry, and possibly the most dangerous member of the Suicide Squad. He likes to play by his own rules and is not a team player, but since he needs to belong to the team, he will follow orders. He is a loner and will not associate with others except in matters of business. His death wish and showing off often endanger the members of the team.

Deadshot's mental profile is filled with neuroses. He only saw violence in his family and received little affection. As a result, it is now impossible for him to have an emotional relationship with anyone, and he withdraws from any person who tries to get near him emotionally. Right now his mental stability seems to be deteriorating further, possibly leading to more violent and suicidal tendencies.

Deadshot's tactics are unique. When up against weaker opponents, he will give himself a handicap, and with more powerful adversaries, he likes to use Trick Shots, so that everyone he encounters has a chance of defeating him. In most situations he prefers to use his weaponry to stay out of arm's reach of his opponents.

Deadshot has a vendetta against Batman, though he has found that he is unable, for some emotional or psychological reason, to shoot the Caped Crusader. Instead, he is driven to find a different way to kill Batman.

Using Deadshot in Adventures

Deadshot is a hitman who can easily be employed by any wealthy villain to attack the heroes. In most situations he does what he is paid to do. Other than that, he is a perfect lead-in for an encounter with the Suicide Squad, as he often goes rogue and needs to be returned to Belle Reve.

Subplots

Deadshot is most often involved in Subplots that involve his teammates on the Suicide Squad and his inability to relate to them on an emotional level.

Appearances in the DC HEROES Role-Playing Game, Second Edition

Background/Roster Book (includes card)

Appearances in DC Comics

***Note:** Pre-Crisis appearances are not part of present continuity.

Pre-Crisis: *Batman* #59, 351, 354, 361, 400; *Crisis on Infinite Earths* #10; *Detective Comics* #474, 518, 520, 536; *Who's Who '85* #6

Current: *Deadshot* #1-4; *Firestorm Annual* #5; *The Fury of Firestorm* #64; *Justice League International* #13; *Legends* #1-4; *Millennium* #4; *Suicide Squad* #1-10, 13-16, 18, 22, 33-34, 36-37, 39-46, 47 (behind the scenes), 49-51, 53-59, 61-66; *War of the Gods* #3-4; *Who's Who '90* #3; *Wonder Woman* (2) #61

Deadshot's Wrist Magnums

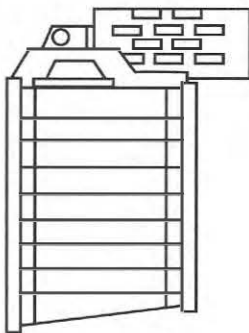

side

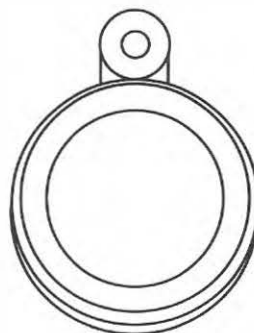

front

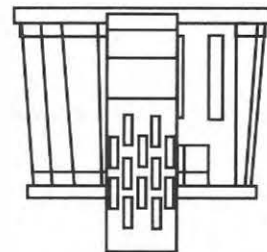

top

DESAAD

DEX: 4	STR: 3	BODY: 4
INT: 15	WILL: 5	MIND: 4
INFL: 4	AURA: 3	SPIRIT: 3
INITIATIVE: 23	HERO POINTS: 125	

- Skills:** Gadgetry: 18, Scientist: 15
- Advantages:** Area Knowledge (Apokolips); Connection: Apokolips (High); Genius; Scholar (pain)
- Drawbacks:** Catastrophic Irrational Attraction to inflicting pain
- Alter Ego:** None
- Motivation:** Psychopath
- Wealth:** N/A
- Equipment:**
Killing Gloves [BODY: 5, Energy Blast: 18, R#: 3]
The Killing Gloves are huge gauntlets that project immensely potent beams of force.
15 AP ABCD Omni-Gadgets (x2)
Desaad is constantly inventing new torture implements and instruments of cruelty.

Desaad's Laboratory and Gadget Design

On Apokolips, Desaad has one of the finest and largest laboratories in the universe (rated at 30 APs).

Since Desaad almost always designs an item or weapon in a way that will cause the most pain to the victim, he adds +1 Column Shift to the OV and RV of all his Gadgetry rolls when building items. If he can successfully resist his Irrational Attraction before making a Gadgetry roll, he can ignore this penalty.

Happyland

Desaad runs a mock amusement park that is actually a prison for his victims. Most prisoners are bound in restraints with a BODY of 25 that are secured with special locks (OV/RV of 18/18 against a Thief/Lockpicking attempt).

Hundreds of happy customers enter Happyland each day and look upon Desaad's victims without recognizing their true nature (the victims were all disguised with the Illusion Power rated at 10 APs). After a while, the visitors begin to take a psychological toll upon the victims. After each week

of imprisonment, the victims undergo a Mental Attack with an AV/EV of 5/5. If these attacks ever inflict cumulative damage equal to twice the victim's MIND, the victim goes mad.

Powers and Abilities

One of Darkseid's most experienced, intelligent, and vile minions, Desaad has devoted his life to mastering the science of torture. His value to Darkseid lies chiefly in his ability to create weapons and machines of pain capable of breaking the wills of those whom Darkseid wishes to conquer

Personality/Role-playing

Desaad cares for no one but himself. He has no friends, nor does he want any. He has even backstabbed his master during the course of his own self-serving endeavors. But Desaad mostly cowers from Darkseid and follows his master's every word. In some ways, the two are much alike, and Darkseid finds Desaad's inventions ingenious as well as amusing.

Desaad delights in torture, and his scientific expertise and advancements have helped Darkseid maintain his empire. Desaad brainwashes recruits for Darkseid's armies, a task he relishes. He is perverse, but clever and focused. He knows what he wants and how to get it. He knows his value to Darkseid is often dubious, and he spends a good deal of his energy humoring the Destroyer and trying to stay alive.

Desaad is also known for his cowardice. He prefers to trick an adversary rather than fight, and always has some gadget or weapon ready (under the folds of his cloak) that suits his needs exactly. Even when he does become embroiled in direct conflicts, Desaad will never fight fairly and will attempt to use one of his many inventions to destroy his opponent the instant the enemy turns his back.

Occasionally, Desaad lets his passions rule his decisions and makes foolish mistakes, disguising himself as Darkseid without the permission or knowledge of his lord, for instance. When Darkseid is displeased with his servant and finds him guilty of treachery, the despot destroys him with his Omega Blast. But when he again becomes useful, Darkseid inevitably restores Desaad to life.

Using Desaad in Adventures

Desaad is the ultimate artificer of evil. If your Adventure calls for a twisted invention, bomb, or instrument of destruction, perhaps it was either stolen from his lab or employed by the master torturer himself.

Desaad usually uses his technological weapons in the service of Darkseid, although he sometimes tries to further his own psychotic ends. Perhaps he believes that one of the heroes or Non-Player Characters would make interesting testing material for some new torture equipment.

You might also consider foreshadowing one of Darkseid's appearances with a preliminary appearance by Desaad.

Subplots

Desaad's Job and hobby is torture, and most of his Subplots revolve around this pursuit.

Appearances in the DC HEROES Role-Playing Game, Second Edition

Apokolips Sourcebook, Background/Roster Book

Appearances in DC Comics

***Note:** Pre-Crisis appearances are not part of present continuity.

Pre-Crisis: *Adventure Comics* #459-460; *Crisis on Infinite Earths* #8, 12; *Forever People* (1) #2-6, 8; *New Gods* (1) #2, 7, 11, 17-19 (2) 6; *Superman's Girl Friend Lois Lane* #116; *Who's Who '85*

Current: *Action Comics* #600, 643; *Adventures of Superman* #456; *Cosmic Odyssey* #1, 4; *Firestorm, the Nuclear Man* #76; *Legends* #1-4; *Mister Miracle Special* #1; *New Gods* (3) #1, 3-12, 15-16, 19-20, 23-28; *Suicide Squad* #3; *Superman* (2) #16, 35; *War of the Gods* #1, 3-4; *Warlord* (1) #114-115, 120-121; *Warlord Annual* #6; *Who's Who '90* #4

Desaad's Killing Gloves

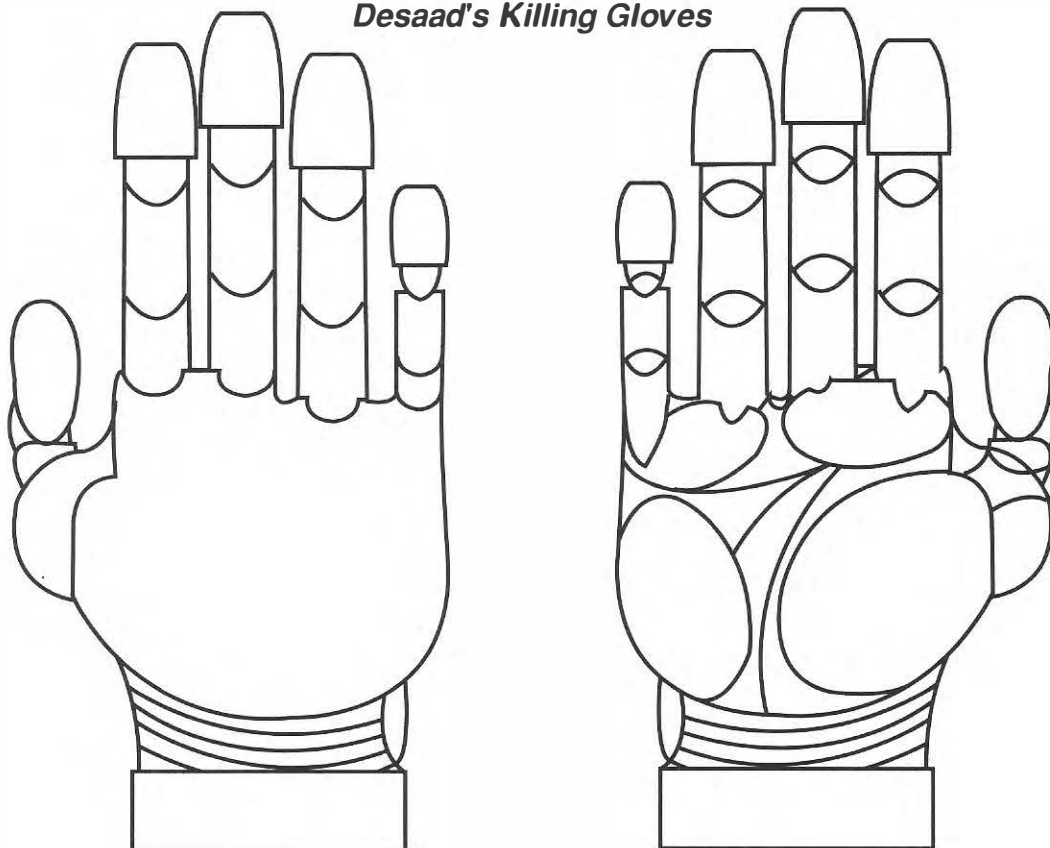

DESPERO

DEX: 8	STR: 20	BODY: 16
INT: 2	WILL: 11	MIND: 7
INFL: 8	AURA: 7	SPIRIT: 9
INITIATIVE: 18	HERO POINTS: 100	

- Powers:** Invulnerability: 20, Mental Blast: 14, Regeneration: 6, Skin Armor: 2
- Drawbacks:** Catastrophic Rage; Catastrophic Irrational Attraction to destroying the Justice League; Miscellaneous: Despero is a creature of instinct, incapable of coherent thought; Strange Appearance
- Alter Ego:** None
- Motivation:** Psychopath
- Wealth:** 10

Powers and Abilities

Despero's strength and mental capacity were increased when he entered the legendary Flame of Py'tar. But exposure to the flame also cost him much of his mental capacity. Although Despero was once great strategist, he is now quick to adopt a "trash-and-bum" attitude. He now relies almost exclusively upon his brute strength and rage, with the occasional help of a mental blast from his third eye.

Despero's Earlier Form

Despero was once a genius who possessed psychic abilities controlled by his mutant third eye—among them: the abilities to control other beings mentally, create illusions, read minds, regenerate, teleport, project psychic blasts, lift objects telekinetically, and communicate telepathically. Despero was highly trained in the use of all these abilities and made extremely effective use of them in combat.

DESPERO (PRE-PY'TAR)

DEX: 6	STR: 6	BODY: 7
INT: 11	WILL: 13	MIND: 7
INFL: 8	AURA: 7	SPIRIT: 8
INITIATIVE: 25	HERO POINTS: 100	

- Powers:** Control: 15, Growth: 6, Illusion: 15, Mental Blast: 16, Mind Probe: 25, Regeneration: 1, Telekinesis: 16, Telepathy: 25, Teleportation: 20
- Skills:** Gadgets: 13, Scientist: 15
- Advantages:** Genius

- Drawbacks:** Strange Appearance; Catastrophic Rage; Catastrophic Irrational Attraction to destroying the Justice League
- Bonuses:** Miscellaneous: Teleportation is Usable on Others. In order to Teleport unwilling targets, Despero must make an Action Check using his APs of Power as the AV/EV against an OV/RV equal to the target's INT/MIND. If the RAPs from this roll equal or exceed the target's MIND, Despero can Teleport the target to the destination of his choice. Each use of this Power costs Despero 25 Hero Points.
- Alter Ego:** None
- Motivation:** Power Lust
- Wealth:** 10

Personality/Role-playing

Despero is a mutated alien telepath from the planet Kalanor. By the time he reached adulthood, Despero had already established himself as one of the most ruthless members of his race. In fact, he even killed his own parents to facilitate his rise to power. During this earlier incarnation, Despero was completely focused on conquering worlds and increasing his own personal power. After the Justice Leaguers repeatedly thwarted several such attempts, Despero resolved to destroy them.

In his new form, Despero frequently enters enraged fits that cloud his judgment. In many ways, he is a mindless, rampaging savage.

Background Update

Consumed with hate, Despero recently escaped from his prison on Manga Khan's starship and launched one final raging attack against the Justice League. Manga Khan's former servant, L-Ron, along with Green Lantern and Kilowog, eventually found a means of defeating him. But as a result, L-Ron's consciousness was placed within Despero's body and Despero's consciousness was placed within L-Ron's body. L-Ron (in Despero's body) later returned to serve Manga Khan, while Despero was returned to Earth for safe-keeping.

Even more recently, Despero (in L-Ron's body) launched yet another attack upon the Justice League. This encounter concluded with the destruction of L-Ron's body, but no one knows whether or not Despero's consciousness was destroyed along with it.

Using Despero in Adventures

Despero wants power. But more than that, he wants to destroy the Justice League. Thus, he is an excellent tool for leading the player heroes into encounters with the JLI. Perhaps the heroes might stumble across Despero as he prepares to launch yet another assault upon his hated rivals.

Appearances in the DC HEROES Role-Playing Game, Second Edition

Justice League Sourcebook

Appearances in DC Comics

***Note:** Pre-Crisis appearances are not part of present continuity.

Pre-Crisis: *Crisis on Infinite Earths* #10; *Justice League of America* #1, 26, 133-134, 177-178; *Who's Who '85* #6;

Current: *Green Lantern (3)* #20; *Justice League America* #37-40, 42, 56-58; *Justice League Europe* #31, 33-34, 36; *Justice League of America* #247-254; *Who's Who '90* #2

Magna Khan's Control Collar

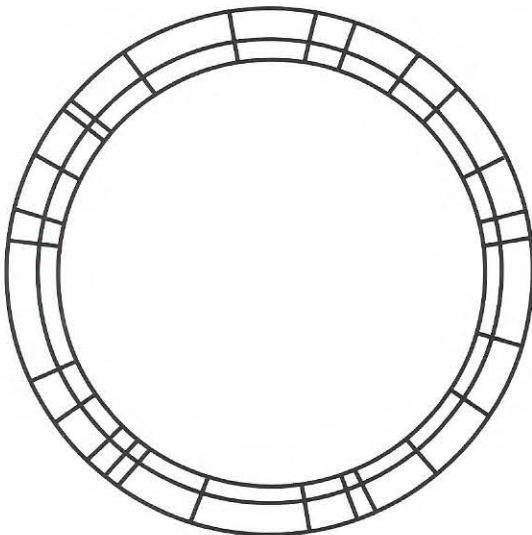

top

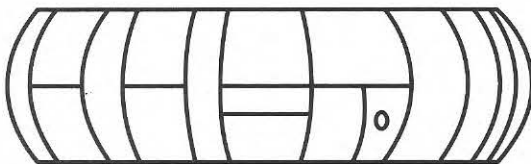

back

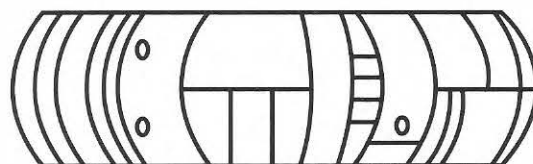

front

DOCTOR POLARIS

DEX: 6	STR: 4	BODY: 7
INT: 8	WILL: 5	MIND: 4
INFL: 6	AURA: 5	SPIRIT: 5
INITIATIVE: 20	HERO POINTS: 80	

- Powers:** Energy Absorption: 12, Energy Blast: 10, Flash: 10, Flight: 8, Force Field: 12, Magnetic Control: 16
- Skills:** Charisma: 6, Gadgetry: 7, Medicine: 7, Scientist: 7
- Bonuses:** Miscellaneous: Doctor Polaris can create a magnetic field around a Green Lantern's Power Ring that prevents the ring from functioning. To do so, he uses his APs of Magnetic Control as the AV/EV against an OV/RV equal to the Green Lantern's DEX/DEX. Positive RAPs indicate the ring won't function. Polaris can maintain this field as long as he wishes, but he can't use any of his other Powers while doing so. He can only affect one ring at a time.
- Limitations:** Miscellaneous: Energy Absorption only works on magnetic energy.
- Advantages:** Connection: Underworld (High); Genius; Scholar (magnetism)
- Drawbacks:** Serious Psychological Instability (dual personality)
- Alter Ego:** Neal Emerson
- Motivation:** Power Lust (as Polaris)/Responsibility of Power (as Emerson)
- Wealth:** 6

Powers and Abilities

Doctor Polaris once used an array of weapons and gadgets designed to manipulate magnetism to allow him to conduct his crime sprees. At some point, however, Emerson gained magnetic powers of his own. Exactly how this happened remains a mystery. But Polaris now has the abilities to: fly, absorb magnetic energy, create bursts of light, create a protective magnetic fields around his body, and fire magnetic energy bolts. Objects that cannot be magnetized are immune to his manipulation.

Magnetic Control

With his Magnetic Control Power, Doctor Polaris can perform any of the following feats:

- Deflect metallic weapons and projectiles aimed at his person:** Add Doctor Polaris' APs of Power to his RV vs. such attacks.
- Hurl metallic objects at a target:** The AV and EV of such an effort are both equal to Doctor Polaris' APs of Power. The OV/RV is equal the target's DEX/BODY.
- Move metals and metallic objects:** The AV and EV of such an effort both equal his APs of Power. The OV and RV are both equal to the weight of the object being moved. The RAPs earned indicate the distance he moves the target object.

Older Incarnation

Originally, Doctor Polaris had no super-human abilities. In this earlier incarnation, his BODY was only 5, he had no Powers, and he carried a special Gadget known as the Magno-Gun.

Magno-Gun [BODY: 6, Energy Absorption: 10, Energy Blast: 10, Magnetic Control: 14, Force Field: 10, R#: 2] The Magno-Gun's Energy Absorption Power is usable only on Magnetic Energy.

Personality/Role-playing

There are two sides to Doctor Polaris. Originally, Neal Emerson was a scientific genius who used his skills to save lives. But too much contact with magnetic energy fields caused a split in his personality, and a malevolent, power-lusting side of Emerson developed and took control. Although this persona cares only for himself and what he can get, Emerson's kind, selfless personality is not forever lost and occasionally breaks through to the surface. Usually, a shock or psychological jolt causes Emerson to undergo a personality shift.

In his normal state of mind, Emerson is completely benevolent and caring. This side of Emerson hates his opposing personality and fears its inevitable return to control.

In his evil persona, Polaris is destructive and self-centered. In this state, he holds a vendetta against Green Lantern Hal Jordan, who foiled many of his past schemes. Since a drive for power dominates his personality, the evil Emerson does not work well with others unless he is in charge.

Using Doctor Polaris in Adventures

Doctor Polaris's strong vendetta against Hal Jordan makes him an ideal Character for leading the player heroes into encounters with Hal. Perhaps the heroes might stumble across Emerson as he prepares his latest plot to destroy Jordan.

Subplots

Most of Polaris's Subplots revolve around the mental struggle between his two personalities.

Appearances in the DC HEROES Role-Playing Game, Second Edition

BackgroundiRoster Book, World in the Balance

Appearances in DC Comics

***Note:** Pre-Crisis appearances are not part of present continuity.

Pre-Crisis: *Crisis on Infinite Earths* #1-5, 9,10; *DC Super-Stars* #10; *Green Lantern* (2) #21, 46-47, 65, 133-135; *Justice League of America* #35; *The New Teen Titans* (1) #17; *Who's Who '85* #6; *Wonder Woman* (1) #303-304; *World's Finest Comics* #260

Current: *Green Lantern* (2) #200-203; *The Ray* #4-5; *Starman* #17-18; *Who's Who '90* #2

Dr. Polaris' Helmet

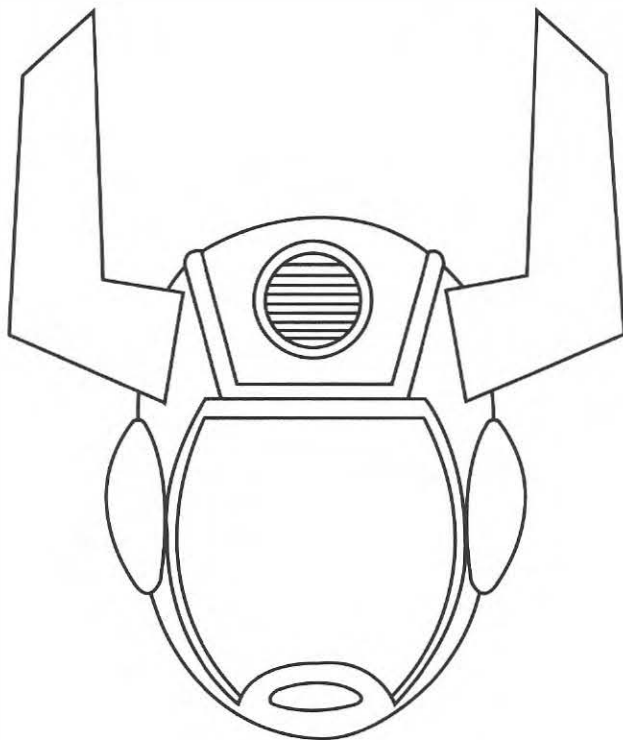

Front

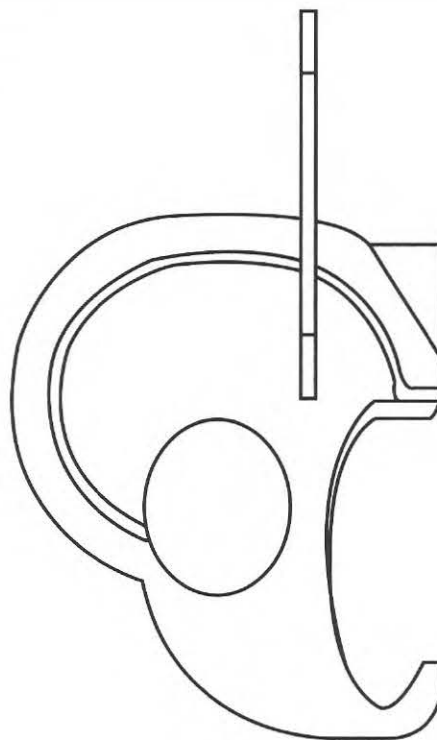

Side

GORILLA GRODD

DEX: 10	STR: 16	BODY: 11
INT: 10	WILL: 11	MIND: 11
INFL: 7	AURA: 6	SPIRIT: 8
INITIATIVE: 29	HERO POINTS: 110	

- Powers:** Control: 12, Matter Manipulation: 8, Mental Blast: 8, Mind Probe: 8, Mind Shield: 8, Personality Transfer: 10, Telekinesis: 12, Telepathy: 16
- Skills:** Acrobatics: 8, Charisma (Intimidation): 10, Gadgetry: 12, Scientist: 12
- Advantages:** Area Knowledge (Gorilla City); Connections: Flash's Rogues' Gallery (Low), Gorilla City (Low), Secret Society of Super-Villains (Low); Genius; Lightning Reflexes
- Drawbacks:** Minor Rage; Strange Appearance
- Alter Ego:** None
- Motivation:** Power Lust
- Wealth:** 8

Gorilla Grodd's Statistics

Because Grodd's abilities were more clearly defined in *Who's Who '90*, his Attributes and Powers have been fine-tuned.

Gorilla City

Grodd is an inhabitant of Gorilla City, a vast metropolis constructed by super-evolved gorillas during the 19th Century. Located in equatorial Africa between the Congo and the Sudan, the city is hidden by a vast invisibility screen (Invisibility: 10) and covered by a force dome (Force Field: 8) that allows the gorillas to enter and leave, but automatically keeps out all intruders. In game terms, only Characters with the Area Knowledge (Gorilla City) Advantage know the city's exact location.

Powers and Abilities

Like all members of his race, Grodd underwent an evolutionary process that boosted his intelligence to super-human levels and gave him amazing psionic powers. Currently, Grodd can communicate telepathically, control minds by exercising his

tremendous willpower, project psionic blasts, and telekinetically lift objects weighing up to 60 tons. Grodd can also change the molecular structure and shape of up to 250 cubic feet of matter and can transfer his own personality into the minds of others.

Beyond his mental powers, Grodd is an extremely skilled scientist. Over the years, he has developed innumerable high-tech gadgets and weapons.

Personality/Role-playing

Grodd's immediate ambition is to conquer his native Gorilla City as a stepping stone on the path to world domination. His intellectual arrogance leads him to believe that all living creatures, even his fellow inhabitants of Gorilla City, are inferior to his grand intellect and therefore should serve him. For their part, Grodd's fellow gorillas view him as a dangerous menace and keep him imprisoned in a catatonic state to prevent him from causing further mischief.

In combat, Grodd prefers to use his psionic abilities to defeat his enemies and to coerce others to do his bidding. He often surrounds himself with an army of intelligent gorillas he has subjugated through the use of his Control Power.

Using Gorilla Grodd in Adventures

Grodd is yet another villain who is capable of threatening the entire planet. His formidable combination of physical and mental abilities make him a very challenging opponent indeed.

The player heroes might meet a recently escaped Grodd in the jungles of Africa. Perhaps the heroes were stranded in the jungle after a convenient plane crash, or perhaps they are simply vacationing. Such an adventure will inevitably allow the heroes to explore the legendary Gorilla City.

Grodd is also capable of using his psionic abilities to influence henchmen from thousands of miles away. You might unexpectedly reveal him as "the real culprit" toward the end of just about any Adventure.

Appearances in the DC HEROES Role-Playing Game, Second Edition

Background/Roster Book

Appearances in DC Comics

***Note:** Pre-Crisis appearances are not part of present continuity.

Pre-Crisis: *Action Comics* #424, 443; *Captain Carrot and His Amazing Zoo Crew* #20; *Crisis On Infinite Earths* #9; *DC Special Series* #6, 11; *DC Super-Stars* #14; *The Flash* (1) #106-108, 115, 127,

155, 172, 209, 294-295, 313, 327, 329-331; *Secret Society of Super-Villains* #1-4, 8-11; *Super Friends* #30; *Super-Team Family* #3, 13-14; *Who's Who '85*

Current: *Angel and the Ape* (2) #1 (behind the scenes), 2-4; *Blue Devil* #30; *Flash* (2) #45-47; *Secret Origins* (3) #40-41; *Swamp Thing Annual* #3; *Who's Who '90* #3

Gorilla City

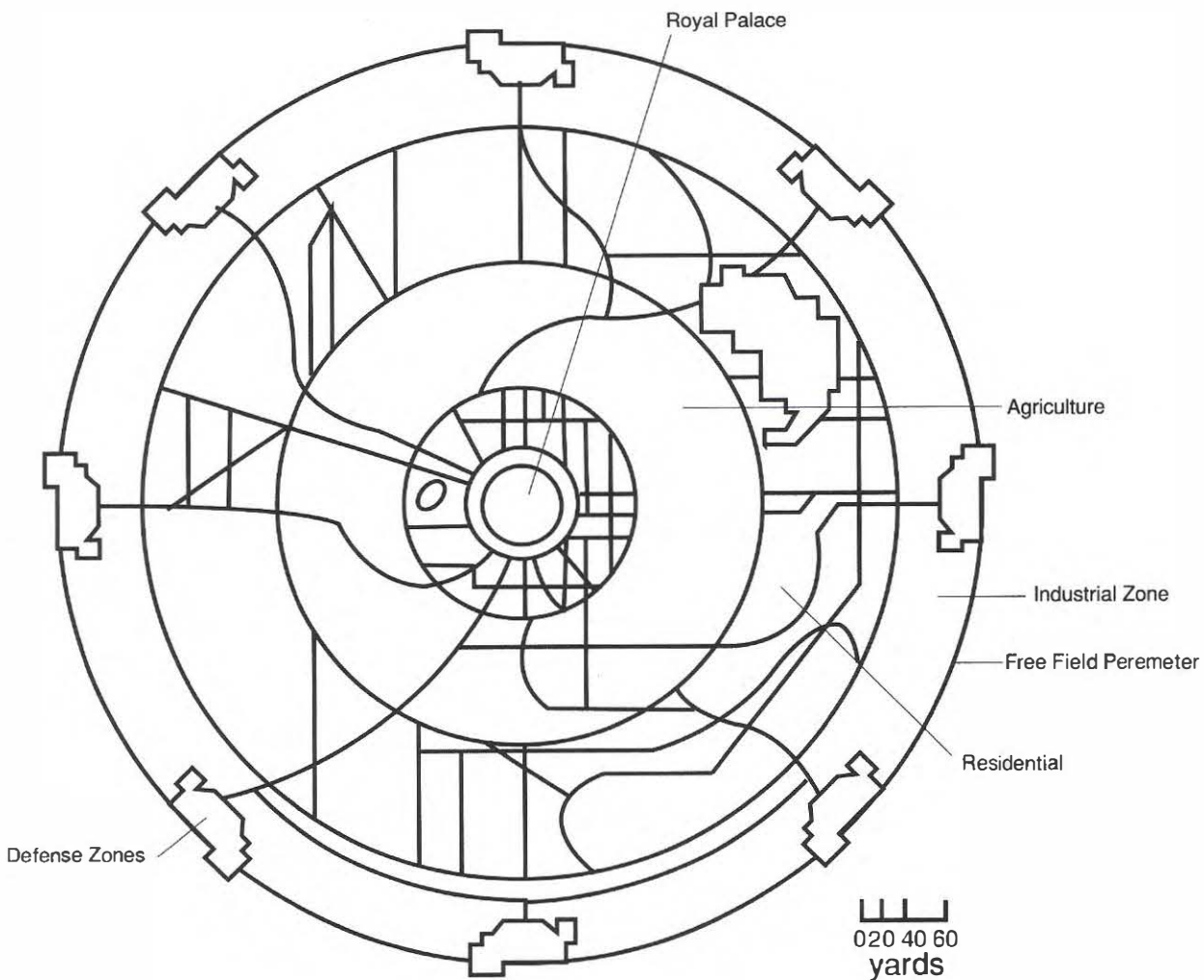

GRANNY GOODNESS

DEX: 7	STR: 7	BODY: 7
INT: 10	WILL: 10	MIND: 10
INFL: 10	AURA: 9	SPIRIT: 10
INITIATIVE: 29		HERO POINTS: 125

- Skills:** Charisma: 13, Gadgetry: 6, Martial Artist: 9, Weaponry: 7
- Advantages:** Area Knowledge (Apokolips); Connection: Apokolips (High); Leadership; Scholar (training)
- Drawbacks:** Serious Irrational Attraction to breaking the will of her pupils
- Alter Ego:** None
- Motivation:** Psychopath
- Wealth:** N/A
- Equipment:**
ARMOR [BODY: 8] Granny's Armor protects her from everything up to and including small caliber artillery shells.
Mega-Rod [BODY: 9, Energy Blast: 11, R#: 2] The Mega-Rod is a powerful blasting weapon that was designed and built in Desaad's labs on Apokolips.

Happiness Home and Granny's Training

Granny Goodness is Darkseid's schoolmarm. Her assignment is to indoctrinate youth (and anyone else she can get her hands on) into the way of life on Apokolips. To accomplish this aim, she operates a huge "orphanage" known as the Happiness Home, a combination school, jail, and torture chamber. Special individuals (such as any heroic Player Character in your campaign) who find themselves in the Happiness Home will be sent to the dreaded "Section Zero" for Granny's personal attention.

You can resolve any trip to the Happiness Home as follows: each week, allow the heroes to plot and resolve a single escape attempt, if they so desire (escape from Section Zero is difficult—all of the locks and security systems are rated at 13/13, and cell walls have a BODY of 20). At the end of each week (after the escape attempt is resolved), Granny can make a single Mental Attack (using her INT/WILL as the AV/EV and incorporating her Scholar/training Advantage) against her victims, incorporating the standard Multi-Attack penalties. The OV/RV of this

attack is equal to the victim's WILL/MIND. If Granny's attacks ever inflict a total amount of Mental Bashing Damage equal to twice the target's MIND, the target has been successfully indoctrinated and becomes a slave-like devotee of Darkseid. Note that it is impossible to recover the Bashing Damage Granny inflicts while still a prisoner in the Happiness Home.

Powers and Abilities

Granny Goodness is highly skilled in the arts of brainwashing and defensive instruction. Over the years, Darkseid himself has come to appreciate her special "talents" and for good reason. Her success record is remarkable; very few of her students have managed to resist her re-education programming. Granny has maintained this impressive string of successes by constantly updating her methodology and inventing new instruments of torture and indoctrination.

Granny is also an effective warrior who specializes in hand-to-hand combat.

Personality/Role-playing

Granny Goodness is the personal instructor of Darkseid's troops, and she loves her work. She professes to care deeply for her students, and tends to use endearing words while torturing them. To her, they are her children, and she is proud when they walk out of her orphanage hardened fighting men and women. Granny demands loyalty and affection from her students, often threatening them with the power of Darkseid just as Earth mothers threaten their children with the mythical "boogie man." She is so dedicated to her work that she spends most of her time working in the Happiness Home, never slowing to rest or reflect. She takes great pleasure in handling those few students with wills strong enough to require her own special attention.

In many respects, Granny is completely mad. She delights in levels of cruelty unthinkable to humans, and always clings to the strange belief that her cruelty is actually benefitting her victims.

In combat, Granny normally surrounds herself with some of the special military forces she has trained. She is a powerful fighter, but she expects her "children" to protect her. She rarely attempts to kill her adversaries, preferring instead to torture them and turn them over to the side of Darkseid.

Using Granny Goodness in Adventures

If they travel to Apokolips, the player heroes might find themselves imprisoned within Granny's orphanage. The ensuing test of wills should make an entertaining Adventure.

The player heroes might also encounter Granny as the leader of a special team of Apokolipsian warriors.

Subplots

Granny is most often involved in Enemy Subplots with Scott Free (Mister Miracle) and his wife, Big Barda (formerly of the Female Furies). Despite the fact that she hates him, Granny cannot bring herself to kill Scott Free because the moment she does so, she admits she is incapable of breaking his will.

Appearances in the DC HEROES Role-Playing Game, Second Edition

Apokolips Sourcebook, Law of Darkness

Appearances in DC Comics

***Note:** Pre-Crisis appearances are not part of present continuity.

Pre-Crisis: *The Brave and The Bold* #128; *First Issue Special* #13; *Justice League of America* #183-185; *Mister Miracle* (1) #2, 7-8, 18-21, 25; *New Gods* (1-2) #17; 6; *Who's Who '85* #9

Current: *Action Comics* #586; *Hawk and Dove* (3) #21 (behind the scenes); *Justice League International* #20-21; *Legends* #2; *Mister Miracle* (2) #17-18, 25; *Mister Miracle Special* #1; *New Gods* (3) #9; *Secret Origins* (3) #33; *Suicide Squad* #34-36; *Warlord Annual* #6; *Who's Who '90* #4

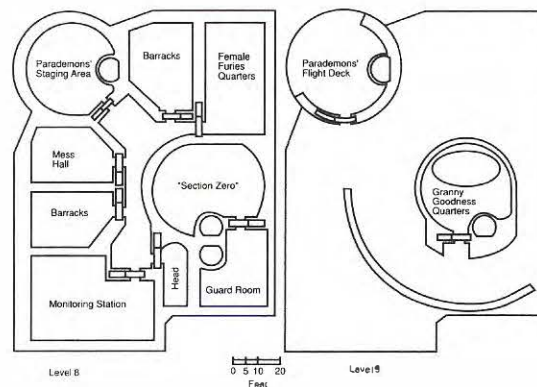
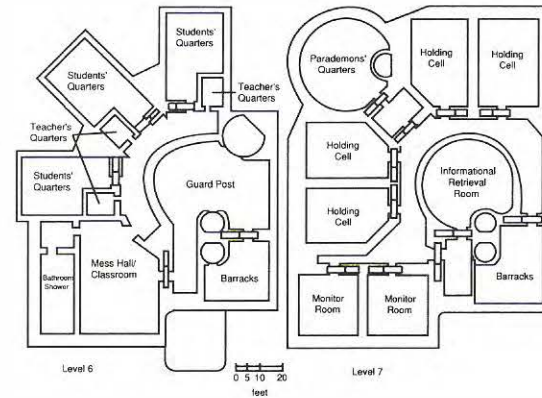
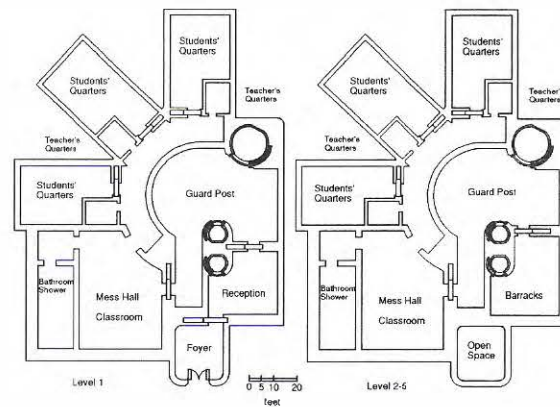

KADAVER

DEX: 3	STR: 4	BODY: 3
INT: 8	WILL: 7	MIND: 6
INFL: 7	AURA: 6	SPIRIT: 6
INITIATIVE: 18	HERO POINTS: 45	

- Powers:** Hypnotism: 10
- Skills:** Charisma: 7; Thief: 6; Weaponry: 6
- Advantages:** Connection: Underworld (Low); Scholar (death, horror films)
- Drawbacks:** Serious Irrational Attraction to morbid crimes that put his own life at risk
- Alter Ego:** Mortimer Kadaver
- Motivation:** Psychopath
- Wealth:** 7

Kadaver's Hideout

Kadaver maintains a hideout beneath an abandoned building in Gotham City. In addition to the usual accouterments (Locks and Security Systems rated at 7 APs), Kadaver's hideout houses several more exotic attractions, including: a quicklime pit (Cell Rot: 9); a guillotine (STR: 9, EV: 9, BODY: 9, automatically severs the head of anyone with a BODY less than or equal to 7 who is strapped into it when the blade falls); an iron maiden (BODY: 12, Claws: 10; Kadaver can push a target into the iron maiden and close the door with a successful Trick Shot); a hangman's noose (BODY: 8, EV: 8; with a successful Trick Shot, Kadaver can snare someone in the noose, requiring the target to take strangulation damage—AV/EV of 8/8 vs. the target's BODY/BODY—in all succeeding phases until the target dies or breaks free); and an executioner's axe (EV: 6, BODY: 12).

Hypnotism

Kadaver is a master hypnotist. To use this ability, he makes an Action Check against the target's INT/MIND and divides the RAPs he earns between one or more "hypnotic suggestions." Each of these suggestions consists of an action (i.e., what Kadaver wants the victim to do) and a condition (when Kadaver wants the victim to do it). Example suggestions might include: "Next time you are in Police Headquarters, steal some of Commissioner Gordon's stationery," "At exactly 11:00 a.m., go to Police Headquarters and place this bomb in the

basement," or "If Batman is about to capture you, pull out your gun and shoot yourself."

Later, as a suggestion's condition occurs, make another Action Check using the RAPs assigned to that suggestion as the AV/EV against an OV/RV equal to the target's INT/MIND. If this Action Check earns one or more RAPs, the target must fulfill the suggestion. Any suggestion that would cause the target to perform an action that strongly violates his personal beliefs (ordering Commissioner Gordon to blow up Police Headquarters, or a typical thug to kill himself), entitles the target to a +2 Column Shift bonus to both the OV and RV of this final Action Check.

Powers and Abilities

Kadaver has hypnotic ability, but not enough to threaten someone with superior willpower and presence of mind. Although he is not a fighter, Kadaver will use any of the medieval weapons in his lair to attack someone who has angered or humiliated him. His most dangerous asset is undoubtedly his warped, unpredictable nature.

Personality/Role-playing

Kadaver is an evil, self-serving loner who is fascinated with the morbid and uses macabre themes in all his criminal activities. Normally dressed in costumes cribbed from B-grade horror movies, Kadaver spends most of his time finding new ways to frighten his victims and devising new criminal schemes. He relaxes by sleeping in an ornate coffin dressed in a Dracula costume.

There is nothing Kadaver enjoys more than the suffering of his victims. While he usually employs others to do his legwork, he prefers to leave the jobs that require the psychological torture of his victims for himself.

But despite his eccentricities, Kadaver is an ingenious criminal. His various methods of extracting money from his victims usually revolve around death threats and torture. Beyond his sadism, he is distinguished only by his greed.

Using Kadaver in Adventures

Kadaver is a homicidal maniac, much like the Joker. The classic "life and death" situations into which he will try to maneuver the player heroes

should provide you with plenty of opportunities to introduce a healthy dose of suspense into your Adventures.

Appearances in DC Comics

Detective Comics #588-589, 610-611; *Who's Who* '90#3

Kadaver's Hideout

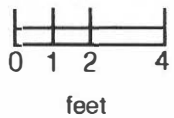
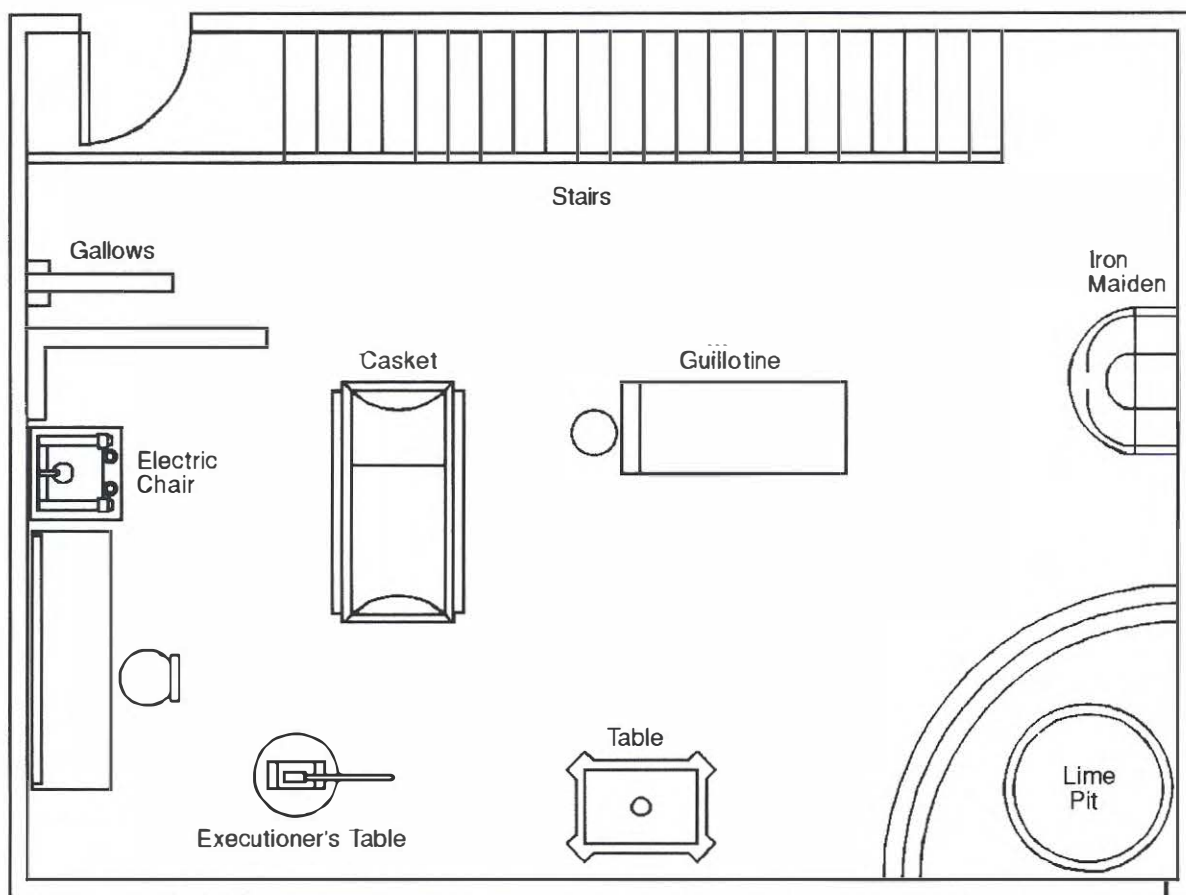

KESTREL

DEX: 9	STR: 7	BODY: 7
INT: 5	WILL: 8	MIND: 9
INFL: 9	AURA: 9	SPIRIT: 11
INITIATIVE: 25	HERO POINTS: 35	

- **Powers:** Claws: 13, Dimension Travel (Travel): 4, Invulnerability: 11, Jumping: 3, Life Sense: 20, Personality Transfer: 13, Regeneration: 4, Running: 5, Teleportation: 10
- **Limitations:** Miscellaneous: Life Sense is only usable to locate Hawk.
- **Skills:** Acrobatics: 4, Thief: 8
- **Advantages:** Insta-Change; Lightning Reflexes
- **Drawbacks:** Catastrophic Irrational Attraction to killing Dove and to attempting to persuade Hawk to side with Chaos; Miscellaneous: Kestrel isn't really a living being, but a magical spell.
- **Alter Ego:** Various
- **Motivation:** Nihilist
- **Wealth:** N/A

The Kestrel Spell

Kestrel is actually a single complex magic spell cast by the Lords of Chaos. In DC HEROES terms, any Character with the Sorcery Power and knowledge of the Kestrel Spell can cast the spell and summon Kestrel. Treat such a Character as though he is using Sorcery to mimic a combined total of 35 APs of Power for as long as the spell remains in effect.

Host Bodies

Kestrel always grafts itself onto a host body using its Personality Transfer Power. In addition to its own abilities, Kestrel can use those of its host.

Kestrel can switch back and forth between its Kestrel form and its host form by simply speaking a command word. In host form, the only Kestrel ability it retains is the Life Sense Power.

Should a Personality Transfer attempt ever fail, Kestrel is immediately dispelled unless there is another host in the vicinity. Hawk once dispelled Kestrel by Persuading it to take over his own body, and then preventing it from doing so by using Hero Points to boost his OV and RV against Kestrel's Personality Transfer Action Check.

Powers and Abilities

The Kestrel entity is endowed with super-human strength and stamina; it can easily lift three tons over its head and operate for weeks without rest.

Kestrel's most formidable weapons are its razor-honed talons, which are capable of slashing through reinforced steel. Magically enhanced, the talons can even tear open space itself, leaving a dimensional rift large enough to step through.

Another important component of the Kestrel spell allows it to sense and track the Hawk from hundred of miles away.

Personality/Role-playing

The Kestrel was created to destroy, and it pursues this mission rather single-mindedly. Kestrel will do whatever necessary to either kill its targets or seduce them over to the side of Chaos.

In Kestrel form, the spell creature is a rampaging, maddened assassin. When it is operating in the guise of its host body, the Kestrel maintains a great deal of the host's personality, but adds its own sinister veneer.

Using Kestrel in Adventures

Although the Kestrel failed to destroy Hawk, it certainly proved an effective weapon. If the player heroes should somehow anger the Lords of Chaos or another group of powerful mystical entities, perhaps the spellcasters will retaliate by dispatching Kestrel to destroy them.

Subplots

Kestrel can work its way into a hero's Family or Friends Subplots by selecting one of the hero's loved ones as its host body.

Appearances in DC Comics

Hawk and Dove (2) #1-5 (3) 6-11, 13-17, 26; *Who's Who '90* #3

Kestrel's Mask



KGBEAST—deceased

NKVDemon—deceased

KGBEAST

DEX:	9	STR:	5	BODY:	6
INT:	8	WILL:	10	MIND:	10
INFL:	8	AURA:	7	SPIRIT:	10
INITIATIVE:	29	HERO POINTS:	85		

•**Skills:** *Linked

Acrobatics: 9*, Detective: 8*, Martial Artist: 9*, Military Science: 8*, Thief: 9*, Vehicles: 9*, Weaponry: 9*

•**Advantages:** Connections: KGB (High), Street (High); Iron Nerves; Lightning Reflexes; Scholar (assassinations)

•**Drawbacks:** Minor Physical Restriction: KGBEAST has only one hand; Catastrophic Irrational Attraction to completing an assignment

•**Alter Ego:** Anatoli Knyazev

•**Motivation:** Mercenary

•**Wealth:** 8

•**Equipment:**

GUN-HAND ATTACHMENT [AV: 5, EV: 6/4, Ammo: 8, R#: 3] A prosthetic attachment KGBEAST wears in place of his severed left hand sports a sub-machinegun (AV: 5, EV: 6, R#: 2) and a bayonet (EV: 4).

NKVDemon

DEX:	7	STR:	7	BODY:	6
INT:	6	WILL:	8	MIND:	8
INFL:	6	AURA:	5	SPIRIT:	8
INITIATIVE:	23	HERO POINTS:	65		

•**Powers:** Mind Over Matter: 2, Skin Armor: 1

•**Skills:** *Linked

Acrobatics: 7*, Detective: 6*, Martial Artist: 7*, Military Science: 6*, Thief: 7*, Vehicles: 7*, Weaponry: 7*

•**Advantages:** Connections: NKVD (High), Street (Low); Iron Nerves; Lightning Reflexes

•**Alter Ego:** Gregor Dosynski

•**Motivation:** Mercenary

•**Wealth:** 6

•**Equipment:**

Pistol [EV: 5, BODY: 4, Ammo: 6, R#: 2]

Knife [EV: 3, BODY: 7]

KGBEAST's Statistics

The statistics for KGBEAST provided here are substantially higher than those published previously due to the new information in *Who's Who '90*.

Powers and Abilities

Both NKVDemon and KGBEAST were top assassins for covert government agencies. They were trained in various forms of combat and weaponry, and each used his own custom-built weapons.

The NKVDemon was a bit more powerful than his mentor, the KGBEAST, in that he underwent chemical treatments that gave him super-human strength and endurance. These treatments also destroyed his nerve endings rendering him incapable of feeling the pain of his injuries during battle.

Dosynski and Knyazev were both experts at subterfuge and used ingenious disguises and decoys to gain proximity to their intended victims.

Personality/Role-playing

KGBEAST was one of Russia's top agents, and an expert assassin. Patriotic in his own twisted way, Knyazev's only drive was his belief in the superiority of the Russian people. Although he no longer had the sanction of the Soviet government, he believed his openly brutal actions were benefitting his homeland. Generally, he pursued his missions so single-mindedly that he would mercilessly murder hundreds in pursuit of a single target.

NKVDemon was a protege of KGBEAST. He strongly believed in his mentor's philosophies to the point where he copied much of the Beast's style, though the Demon was a bit more discriminate. He killed only those on his target list and interlopers who endangered his plans. The NKVDemon took pride in his fighting style and treated his opponents as honored adversaries.

Using KGBEAST and NKVDemon in Adventures

If you somehow brought this pair back from the grave, you might think about setting an Adventure in the ever-changing Soviet Union. They'd make ideal adversaries for the player heroes. Perhaps the KGBEAST and the NKVDemon are members of some

sort of conspiracy aimed at restoring the communist government to power.

Or, now that the Russian communists are out of power, perhaps the few communist nations that remain are bidding for the services of the Beast and the Demon.

**Appearances in the DC HEROES
Role-Playing Game, Second Edition**

Batman Sourcebook

Appearances in DC Comics

KGBeast: *Batman* #417-420; *Who's Who '88* #2; *Who's Who '90* #4

NKV Demon: *Batman* #445-447; *Who's Who '90* #4

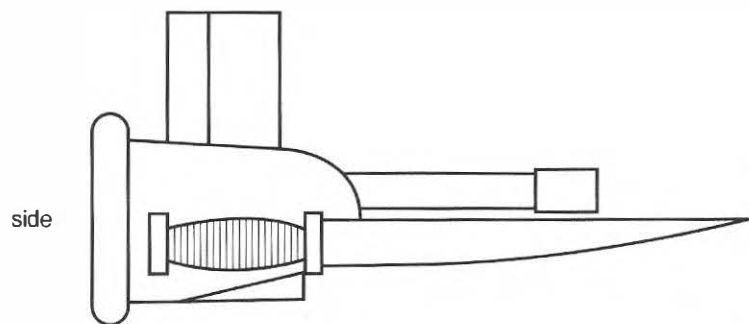
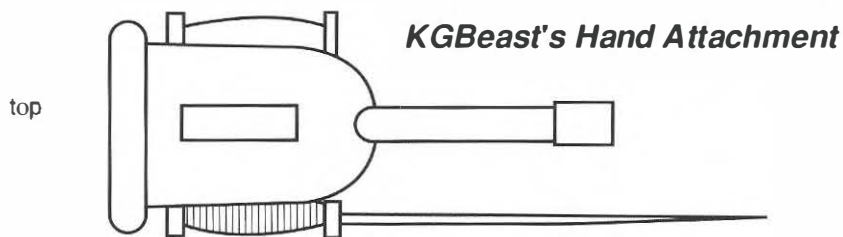

NKV Demon's Gun

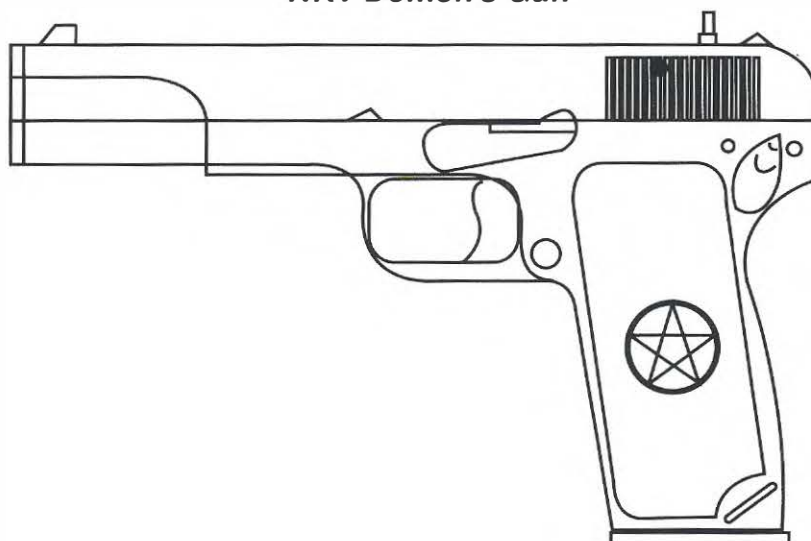

MANGA KHAN

DEX: 0	STR: 0	BODY: 1
INT: 8	WILL: 5	MIND: 5
INFL: 7	AURA: 6	SPIRIT: 5
INITIATIVE: 15	HERO POINTS: 95	

- Powers:** Dispersal: 35, Self Link (Energy Blast): 1, Shouting: 10, Telepathy: 3
- Limitations:** Miscellaneous: Dispersal and Self Link (Energy Blast) are Always On.
- Skills:** Charisma: 8, Gadgetry: 10, Scientist: 10, Thief (Stealth): 4, Vehicles (Space): 5
- Advantages:** Leadership; Scholar (trade, bartering)
- Drawbacks:** Serious Irrational Attraction to talking out loud to himself; Catastrophic Irrational Attraction to profit; Unluck
- Alter Ego:** None
- Motivation:** Mercenary
- Wealth:** 23
- Equipment:**

CONTAINMENT SUIT [DEX: 6, STR: 9, BODY: 9, INT: 2] The containment suit is a robotic body inhabited by the gaseous Khan entity. While in the containment suit, Khan cannot use his Dispersal and Self Link (Energy Blast) Powers. Khan's containment body can be knocked unconscious in the usual fashion (i.e., rendered unable to move or speak until it recovers), but the Khan entity inside will retain awareness. Destroying the body does not harm the Khan entity in any fashion.

L-Ron

Manga Khan has a robotic lackey named L-Ron. In his first incarnation, L-Ron had the following statistics:

L-RON

DEX: 4	STR: 4	BODY: 7
INT: 6	WILL: 5	MIND: 4
INFL: 2	AURA: 2	SPIRIT: 2
INITIATIVE: 12	HERO POINTS: 15	

- Skills:** Charisma: 4, Vehicles (Space): 8

L-Ron's consciousness has been nested within the body of the alien super-criminal Despero (see *Despero*, for more details).

The Cluster

Manga Khan owns and operates a colossal starship known as the Cluster (STR: 30, BODY: 30,

Flight: 20, Warp: 37). Among its features are its advanced sensors (Radar Sense: 35), its broadcast facilities (telecommunications at a range of 41 APs), and its automated defenses (Force Field: 10). Whether or not the Cluster is armed is unknown.

Shouting

Manga Khan has the ability to launch into melodramatic monologues of such quality that everyone who hears them is forced to stop and listen. This ability is reflected by his Shouting Power.

To Shout, Khan makes an Action Check against an OV/RV equal to the target's INFL/SPIRIT (using the standard Multi-Attack penalties if more than one target is present). If this Action Check earns 1 or more RAPs, all targets must pause and allow Khan an opportunity to finish his monologue before they take any other Actions. Once Khan ceases his monologue, play resumes where it left off.

Powers and Abilities

Like all members of the Pawsteem race, Manga Khan is actually a psionic, gaseous cloud. He usually remains within his mechanical body to interact more easily with other races. But at times, Khan finds his gaseous form useful for stealthy escapes. Khan's containment suit has a built-in artificial intelligence and can operate alone for short periods of time, allowing him to be in two places at once. He simply programs the suit to spew out a stream of pre-recorded rhetoric, and no one knows the difference.

Of all his special abilities, Khan gets the most use out of his booming voice. In an open area, he can be heard almost one mile away without audio enhancement. See **Shouting**, above.

Personality/Role-playing

Manga Khan comes from a culture that values bartering above all else. (In fact, Khan's parents traded their young son to the original owners of the starship he now controls.) As a result, Khan's whole life revolves around trade, and he quickly grows bored in those few moments he finds himself working toward something other than a deal. He likes the Earth because he has noticed that humans have a similar mentality. He has even fearlessly (or stupidly) tried to make deals with Darkseid himself.

Having grown weary of standard trades long ago, Khan now spends his time dreaming up eccentric and imaginative new deals, ranging from an interplanetary “home shopping network” to peddling the Justice League’s secrets. These schemes often attract the attention of Earth’s heroes, though Khan doesn’t really intend to cause trouble—he’s just trying to make a good trade.

Khan can become overly emotional at times and is known for being boisterously melodramatic. Somewhat scatterbrained, he relies on a number of robots, such as his faithful servant L-Ron, to keep his administrative affairs in order and to check him when he begins one of his infamous extended monologues.

Although not really “evil,” Manga Khan loves the idea of being considered a super-villain. In his eyes, the title carries respect and authority.

Using Manga Khan in Adventures

As the main villain in an Adventure, Khan generally gets his hands on something of value to the player heroes, who must then make some sort of deal

to retrieve it.

You can also peripherally involve Khan in an Adventure by allowing the heroes to discover that he has something they need to defeat the scenario’s major menace.

Bartering with Khan and becoming entwined in his wacky schemes usually provide plenty of opportunities for entertaining role playing.

Appearances in the DC HEROES Role-Playing Game ,Second Edition

Justice League Sourcebook, Background/Roster Book, Come On Down!

Appearances in DC Comics

Justice League America #42, 53-54; *Justice League Europe* #28, 30, 32-34, 36; *Justice League International* #14-18, 20-21; *Justice League Special* #1; *Mister Miracle* (2) #13-18; *Who’s Who* ‘88 #2; *Who’s Who* ‘90 #3

The Cluster

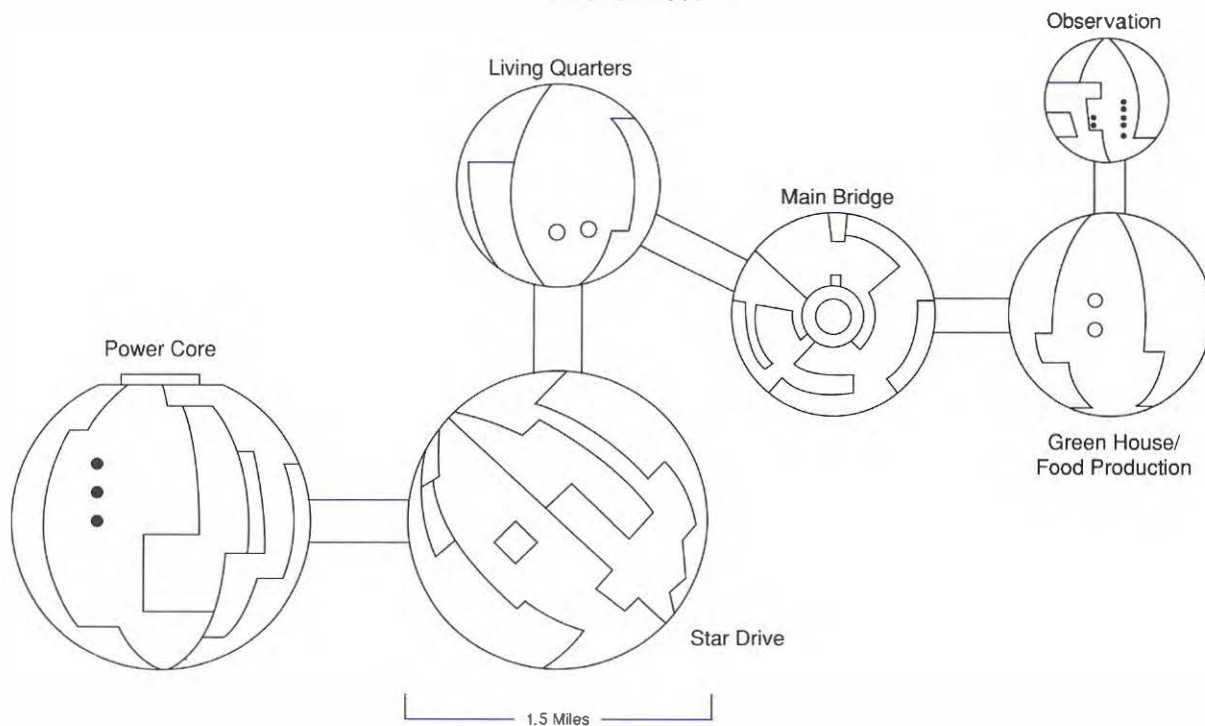

MAXIMA

DEX: 10	STR: 20	BODY: 16
INT: 7	WILL: 12	MIND: 10
INFL: 7	AURA: 7	SPIRIT: 8
INITIATIVE: 24		HERO POINTS: 75

- Powers:** Control: 13, Force Field: 10, Heat Vision: 15, Illusion: 13, Mental Blast: 16, Mental Freeze: 13 (see below), Mind Blast: 10, Sealed Systems: 10, Suspension: 10, Telekinesis: 20, Telepathy: 16
- Skills:** Charisma: 8, Vehicles (Space): 7, Weaponry: 7
- Advantages:** Attractive; Connections: Almerac (High), Justice League International (Low); Insta-Change; Leadership
- Drawbacks:** Serious Irrational Attraction to Superman
- Alter Ego:** None
- Motivation:** Responsibility of Power
- Wealth:** 20

Maxima's Statistics

Information in *Who's Who '90* provided a clearer picture of Maxima's abilities, leading to the changes in statistics from previously published material.

Powers and Abilities

Born of a lineage that was genetically controlled, Maxima's body and mind are superior to those of most members of her race. Among her formidable psionic abilities are: telepathy with a range of one mile, mind control, and the ability to telekinetically move up to 25,000 tons or deliver a punch that can knock down Superman. She can also fire blasts of energy from her eyes and raise Force Fields that can withstand most large caliber artillery shells. Maxima is nearly as invulnerable as Superman, which she believes entitles her to bear Superman's offspring.

Maxima's Specific Powers

Some of Maxima's Powers and abilities require additional explanation:

- Strength:** Maxima has a STR of 20 only because she can augment her physical strength with her Telekinesis Power. If this Power is somehow neutralized, her STR immediately drops to 5.

- Mental Freeze:** "Mental Freeze" works exactly like the Mystic Freeze Power save for the fact that the target's INT/MIND are used as the OV/RV rather than the target's INFL/SPIRIT. Mental Freeze has the same Base and Factor Costs as Mystic Freeze (see page 50 of the *Character Handbook*).

- Insta-Change:** Maxima frequently uses her Illusion Power to change the appearance of her clothing. In this way, she can instantly change into her Maxima costume.

- Sealed Systems:** Maxima's Sealed Systems Power represents her ability to surround herself with a protective force field bubble. She cannot use Sealed Systems without using her Force Field Power to erect such a barrier.

Simulacra

In the past, Maxima has used simulacra of herself to carry out tasks she does not deem important enough for personal attention. Each simulacrum has all of her Powers and abilities rated 3 APs lower than her own totals. The simulacra follow all of Maxima's orders without question.

Personality/Role-playing

Maxima is the ruler of the Almerac, a warrior race that conquers other strong races and assimilates the survivors into their gene pool. Thus, she is driven to find the most perfect and powerful being available to take as her mate. She has already tried to select Superman as her consort and was furious when he rebuffed her.

Maxima is as passionate and arrogant as she is strong. Anything taken as a slight to her royal station will send her into a rage.

In line with her Almeracian upbringing, Maxima is a warrior with great respect for those who prove themselves in battle, one of the characteristics that drew her to Superman. In battle herself, she is fearless, ruthless, and nearly unstoppable.

Background Update

After Superman helped free her from the clutches of Brainiac, Maxima decided to help the Man of Steel form a new Justice League International. She is now a member of the American branch of that team, though it is unknown exactly how long this arrangement will last.

Using Maxima in Adventures

Maxima is a good vehicle for introducing comic relief into your Adventures. Perhaps when the heroes attempt to contact the JLA, she answers the call and gives them the ultimate royal brush-off. Or maybe she could pursue one of the heroes as a suitable mate, leading to some interesting interplay.

Subplots

Maxima is most often involved in a pseudo-Romantic Subplot as she tries to find a mate with suitable genes for her lineage. She is also involved in Miscellaneous Subplots that revolve around her attempts to understand Earth culture.

Sazu

On her first visit to Earth, Maxima had her handmaiden present as an observer and assistant. Although she is not on Earth with Maxima at present, Sazu might reappear in the future.

SAZU

DEX: 2	STR: 2	BODY: 2
INT: 6	WILL: 5	MIND: 4
INFL: 3	AURA: 3	SPIRIT: 3
INITIATIVE: 11	HERO POINTS: 30	

- Powers:** Extra Limb (x2): 4, Telekinesis: 12, Mental Blast: 10
- Skills:** Vehicles (Space): 5
- Advantages:** Connection: Almerac Royal House (High); Sharp Eye
- Drawbacks:** Strange Appearance
- Alter Ego:** None
- Motivation:** Responsibility of Power
- Wealth:** 0

Appearances in the DC HEROES Role-Playing Game, Second Edition

Superman—The Man of Steel Sourcebook

Appearances in DC Comics

Action Comics #645, 650-651, 675; Adventures of Superman #458, 464, 488; Justice League America #61; Justice League Spectacular #1; Superman #65-66; Superman: The Man of Steel #9-10; Who's Who '90#2

Maxima's Ship

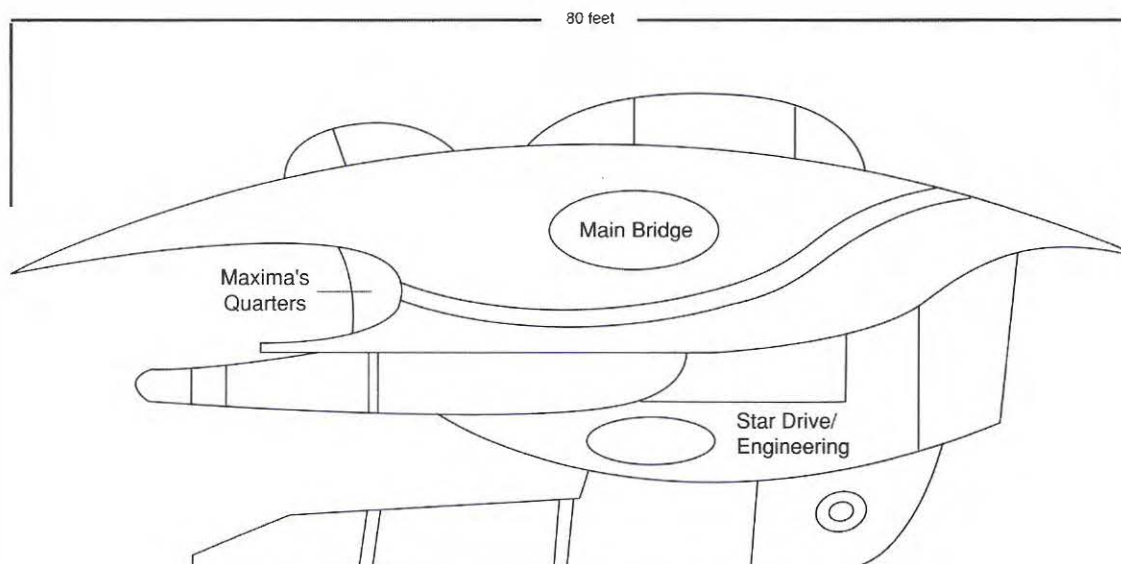

MORDRU

DEX: 8	STR: 6	BODY: 8
INT: 12	WILL: 15	MIND: 13
INFL: 13	AURA: 17	SPIRIT: 20
INITIATIVE: 33	HERO POINTS: 150	

- Powers:** Awareness: 14, Magic Sense: 18, Sorcery: 30
- Skills:** Occultist: 16
- Advantages:** Leadership
- Drawbacks:** Minor Psychological Instability; Catastrophic Fear of being buried alive; Loss Vulnerability: Mordru instantly falls into a catatonic state (all of his Mental and Physical Attributes and Powers are reduced to 0) if he is totally encased in a solid, airless space or buried alive.
- Alter Ego:** Wynne of Gemworld
- Motivation:** Power Lust
- Wealth:** 20

20th Century and 30th Century Versions

The above statistics represent Mordru's current 30th Century incarnation. A much less powerful Mordru battled against Princess Amethyst during the 20th Century. During this era, Mordru had the following statistics.

MORDRU - 20th Century Version

DEX: 6	STR: 4	BODY: 4
INT: 10	WILL: 13	MIND: 9
INFL: 8	AURA: 13	SPIRIT: 13
INITIATIVE: 24	HERO POINTS: 70	

- Powers:** Awareness: 8, Magic Sense: 10, Sorcery: 20
- Skills:** Occultist: 13
- Advantages:** Leadership

Note that Mordru had not yet developed any of his Drawbacks during the 20th Century.

At the height of his power, during his early clashes with the Legion of Super-Heroes, Mordru's Sorcery Power was rated at 35 APs. He lost much of this Power after he was temporarily stripped of his magical abilities by the Council of Teachers.

Sorcery

Mordru frequently uses his Sorcery Power to mimic the following abilities: Energy Blast, Flight,

Force Field, Force Shield, Growth, Invulnerability, Magic Blast, Magic Shield, Skin Armor, and Teleportation.

Powers and Abilities

Mordru is one of the most powerful mortal sorcerers to have ever existed. At the peak of his power, he rivalled even the legendary Merlin.

Due to a deep-seated phobia, Mordru is frozen with fear if he is encased in a closed space and deprived of air.

Personality/Role-playing

Mordru is an example of the corrupting power of magic. His grandiose goal is to conquer worlds and subjugate races, and he suffers from an overconfidence that sometimes blinds him and leads him to fail. He is evil, self-serving, and arrogant. The members of the Legion of Super-Heroes have attempted to "rehabilitate" him upon countless occasions in the past, but he always inevitably returns to a malevolent, power grubbing state of mind.

Mordru's manner is calculating and cautious. He always waits for an ideal moment before making his move, and when he does finally act, he acts with precision. He is a fierce and experienced fighter who can devastate an adversary, but he relies too heavily on his magic and has a tendency to underestimate his foes.

Mordru's greatest adversaries are the members of the Legion of Super-Heroes who have continuously thwarted his schemes. He hates them as much as he loves power. Glorith the Time Sorceress is another annoyance and the cause of much of his power loss, political as well as magical. Glorith and Mordru now share a sort of alliance, though it is likely that Mordru will inevitably decide to dispatch his ally.

Using Mordru in Adventures

Mordru is an excellent antagonist for epic-scale adventures set in the 30th Century. His power is so great that he often proves an easy match for dozens of heroes.

Most of Mordru's schemes are at least partially political in nature. He is deft at seducing others over to his side and interfering in the relations between cultures.

Subplots

Mordru was once involved in a Romantic Subplot with the White Witch, a former Legionnaire. Right now, he is more involved with ruling his world and trying to subjugate others.

Appearances in the DC HEROES Role-Playing Game, Second Edition

Atlas of the DC Universe

Appearances in DC Comics

***Note:** Pre-Crisis appearances are not part of present continuity.

Pre-Crisis: *Adventure Comics* #369-370; *Justice League of America* #147-148; *Legion of Super-Heroes* (2) #276, 291 (3) 27 (4) 5; *Legion of Super-Heroes Annual* (2) #3; *Superboy* (1) #173, 188; *Superman* (1) #213; *Tales of the Legion* #315-316; *Who's Who '86* #16; *Who's Who '88* #2

Current: *Amethyst* (2) #1-4; *Legion of Super-Heroes* (4) #3, 6-7; *Legion of Super-Heroes Annual* (4) #1; *Who's Who '91* #2; *Who's Who in the Legion of Super-Heroes* #5

Mordru's Castle

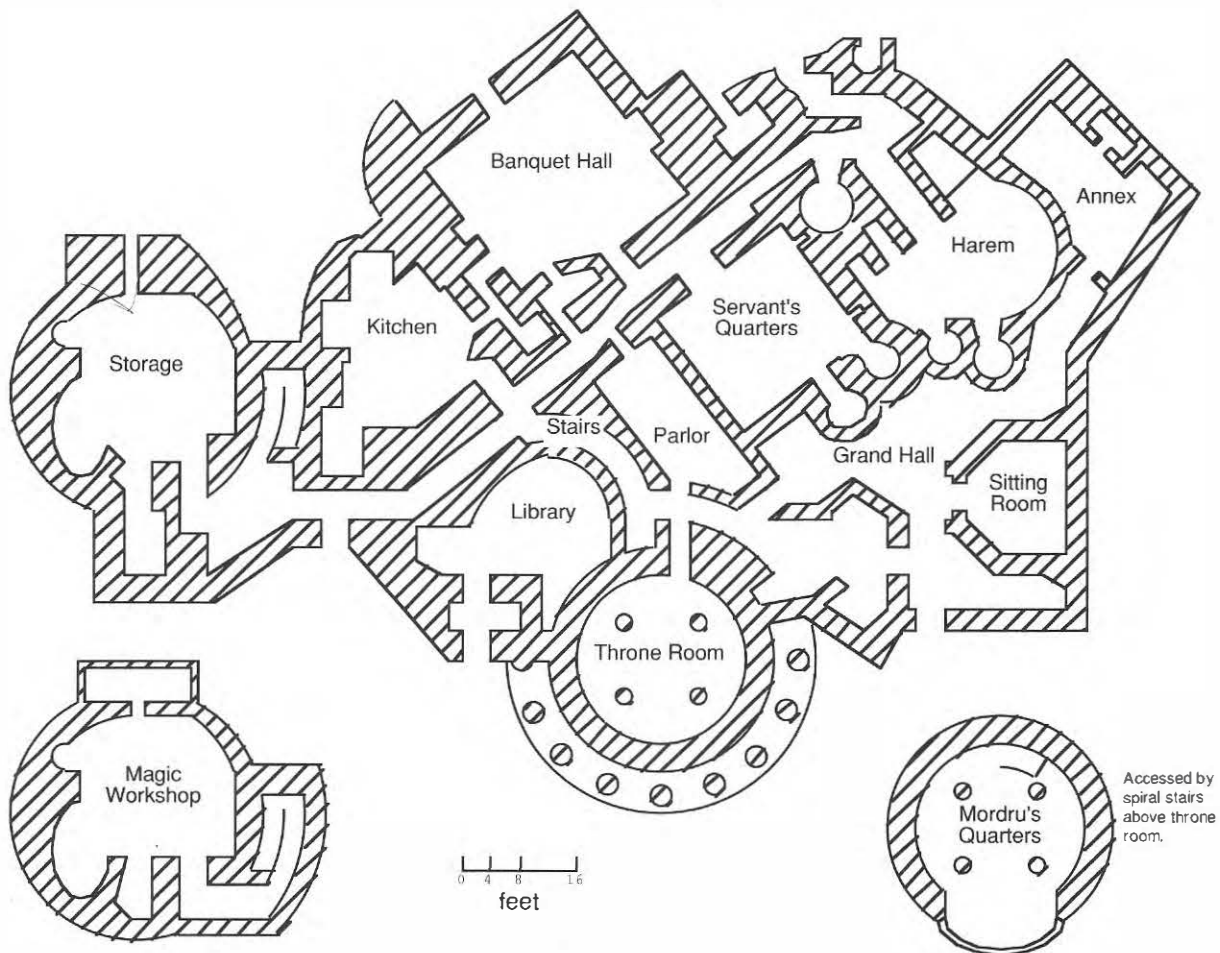

MUDPACK

CLAYFACE I

DEX: 4	STR: 4	BODY: 4
INT: 6	WILL: 6	MIND: 4
INFL: 6	AURA: 5	SPIRIT: 5
INITIATIVE: 18	HERO POINTS: 55	

- Skills:** Artist (Actor): 4, Charisma: 6, Martial Artist: 5, Thief: 5, Weaponry: 5
- Advantages:** Connections: Motion Picture Industry (Low), Mudpack (High)
- Drawbacks:** Serious Psychological Instability (this Clayface feels threatened by any attempts to diminish his accomplishments as an actor); Age (old)
- Alter Ego:** Basil Karlo
- Motivation:** Psychopath
- Wealth:** 4
- Equipment:**
Knife [EV: 3, BODY: 8]

Appearances in DC Comics

***NOTE:** Pre-Crisis appearances are not part of present continuity.

Pre-Crisis: *Batman* #208; *Detective Comics* #40, 49, 496; *Who's Who* '85 #5

Current: *Batman Annual* #13 (Who's Who); *Detective Comics* #604-607; *Secret Origins* (3) #44; *Who's Who* '90 #2

CLAYFACE II - deceased

DEX: 5	STR: 4	BODY: 4
INT: 4	WILL: 3	MIND: 4
INFL: 3	AURA: 4	SPIRIT: 3
INITIATIVE: 14	HERO POINTS: 45	

- Skills:** Artist (Actor): 4, Charisma: 4, Thief: 6
- Advantages:** Connections: Gotham State Prison (Low), Underworld (High); Lightning Reflexes
- Drawbacks:** Minor Psychological Instability
- Alter Ego:** Matthew Hagen
- Motivation:** Mercenary
- Wealth:** 4
- Equipment:**

CLAYFACE CHEMICAL [STR: 6, BODY: 7, Chameleon: 7, Dispersal: 3, Self Manipulation: 5, Shape Change: 7] After bathing in the pool of shimmering liquid, Hagen could assume any form he could imagine—he could even take on the shape of real and imaginary animals or alter his features to look like those of another person. After either 13 or 16 APs of time (depending on which version of the liquid Hagen is using), the effects of the liquid wear off.

Appearances in the DC HEROES Role-Playing Game, Second Edition

Batman Sourcebook, Batman Role-Playing Game

Appearances in DC Comics

***Note:** Pre-Crisis appearances are not part of present continuity.

Pre-Crisis: *Action Comics* #443; *Batman* #159; *Crisis On Infinite Earths* #9-10, 12; *Detective Comics* #298, 304, 312, 478, 526; *Who's Who* '85 #5; *World's Finest Comics* #140, 144, 263-264

Current: *Batman Annual* #13 (Who's Who); *Detective Comics* #604-607 (corpse); *Hawk and Dove Annual* #1; *Secret Origins* (3) #44; *Who's Who* '90 #2

CLAYFACE III

DEX: 2	STR: 2	BODY: 2
INT: 3	WILL: 5	MIND: 3
INFL: 7	AURA: 2	SPIRIT: 6
INITIATIVE: 12	HERO POINTS: 45	

- Powers:** Cell Rot: 9
- Limitations:** Miscellaneous: Clayface's Cell Rot Power always affects those he touches; attempting to touch a target automatically places him in Killing Combat.
- Skills:** Scientist: 5
- Advantages:** Connection: Arkham Asylum (Low)
- Drawbacks:** Serious Irrational Jealousy: Payne is convinced that his "wife" is deserting him for other males she comes in contact with; Serious Psychological Instability; Strange Appearance
- Alter Ego:** Preston Payne
- Motivation:** Psychopath
- Wealth:** 2
- Equipment:**
CONTAINMENT SUIT [DEX: 7, STR: 7, BODY: 8]
The suit prevents Clayface's touch from harming others.
Mannequin [BODY: 1]
Payne once believed that the mannequin was alive and that he was married to it.

Appearances in the DC HEROES Role-Playing Game, Second Edition

Background/Roster Book, Batman Sourcebook, Batman Role-Playing Game

Appearances in DC Comics

Arkham Asylum; Batman #400; Batman Annual #11, #13 (Who's Who); Detective Comics #477-478, 604-607; Doctor Fate (2) #18; Secret Origins (3) #23, 44; Swamp Thing (2) #52, 66; Who's Who '85 #5; Who's Who '90 #2

CLAYFACE IV

DEX: 4	STR: 3	BODY: 7
INT: 5	WILL: 5	MIND: 4
INFL: 5	AURA: 3	SPIRIT: 4
INITIATIVE: 14	HERO POINTS: 40	

- Powers:** Chameleon: 7, Dispersal: 2, Mimic: 14
- Skills:** Thief: 4
- Advantages:** Connection: Kobra (Low)
- Drawbacks:** Strange Appearance
- Alter Ego:** Sondra Fuller
- Motivation:** Psychopath
- Wealth:** 4

Appearances in DC Comics

Batman Annual #13 (Who's Who); Detective Comics #604-607; The Outsiders #21-22; Secret Origins (3) #44; Who's Who '87 (2) #5; Who's Who '90 #2

The Ultimate Clayface

Just after the Mudpack was formed, Clayface I had himself injected with blood samples from each of his comrades, giving him the Powers of all four Clayfaces. In this form, Karlo's BODY is 7, and he has all the following Powers—Cell Rot: 9, Chameleon: 7, Dispersal: 3, Mimic: 14, Self Manipulation: 5, and Shape Change: 7.

Powers and Abilities

Karlo, the first Clayface, had no super powers and little acting talent. He recently received a serum from Matthew Hagen that gives him the combined Powers of all the Clayfaces.

Matthew Hagen was the second Clayface. While he was alive, he was a small-time criminal whose shape-change abilities and malleability gave him unusual talents.

Preston Payne has the ability to dissolve other organisms with an acidic touch. He wears a containment suit to hold his form and to protect others from his ability. It works as an exoskeleton, increasing his strength.

Sondra Fuller is the fourth Clayface. She received her powers from the villain Kobra. She has shape-changing abilities and can duplicate the Powers of others for short periods.

Personality/Role-playing

The Mudpack was a short-lived group of villains who had all taken the name of Clayface at some point in their careers. It was led by the first Clayface, Basil Karlo, to exact revenge on the Batman for the humiliation and defeat of all four Clayfaces.

Basil Karlo is a disillusioned old man, hanging on to past glories. Batman and Robin (Dick Grayson) once stopped Karlo's killing spree on the set of a remake of his old movie "The Terror." He is ruthless and vindictive but not terribly clever.

Matthew Hagen was a petty thief and hood. He was principally motivated by the lure of money, hiring himself out to pull heists and not hesitating to kill to accomplish his goals.

Preston Payne, driven mad by his powers, was placed in Arkham Asylum, where he was at peace until Karlo released him. At one time, Payne was in love with a mannequin, but his relationship with Sondra Fuller has apparently cured of him of that problem.

Sondra Fuller took on the Clayface powers to change her life and gain power. She is self-centered and not dissatisfied with her new form. Sondra and Preston Payne have developed a romantic relationship, and they are currently devoting more of their time to each other than to crime.

Using the Mudpack in Adventures

Since none of the leaders of the Mudpack is very bright, the heroes might easily encounter a reorganized incarnation of the group under the sway of a new master villain.

OCEAN MASTER

DEX: 6	STR: 5	BODY: 5
INT: 10	WILL: 8	MIND: 5
INFL: 7	AURA: 6	SPIRIT: 7
INITIATIVE: 23	HERO POINTS: 60	

- Powers:** **Mystic Linked*
Illusion: 10*, Magic Blast: 7
- Skills:** Charisma (Intimidation): 7, Gadgetry: 5, Military Science: 8, Occultist: 8, Thief: 6, Vehicles: 6, Weaponry: 6
- Advantages:** Connections: Atlantis (Low), Pirates (Low), Savages of Maarzon (High); Scholar (Atlantean history and magic)
- Drawbacks:** Catastrophic Irrational Attraction to destroying Aquaman; Serious Rage
- Alter Ego:** Orm Marius
- Motivation:** Nihilist
- Wealth:** 6
- Equipment:**

BATTLE ARMOR [BODY: 7, Water Freedom: 8, Ultra Vision: 7]

While wearing his battle armor, Ocean Master can breathe and survive underwater. While operating underwater, the armor increases his Initiative score to 25 due to its Water Freedom Power.

Ocean Master's Atlantean Magic

The most formidable weapon in Ocean Master's arsenal is his knowledge of ancient Atlantean magic. Through his study of the arcane arts, Ocean Master has learned to create realistic illusions and to project destructive bolts of eldritch force. In addition to these abilities, Ocean Master commonly employs Occultist Ritual Magic. Some of his commonly performed Rituals include:

CONTROL ANIMALS

Effect—Animal Control: 12

Casting Time—30 minutes (9 APs)

Necessary Components—none

Special Restrictions—this spell will only control water creatures; adding other special components (usually costing upwards of 15 APs) allows Ocean

Master to control mysterious magical creatures imprisoned beneath the sea.

MIND CONTROL

Effect—Control: 12

Casting Time—one hour (10 APs)

Necessary Components—none

Special Restrictions—this spell only works on Atlanteans and other undersea dwellers.

SUMMON ANIMALS

Effect—Animal Summoning: 12

Casting Time—30 minutes (9 APs)

Necessary Components—none

Special Restrictions—this spell will only summon water creatures; adding other special components (usually costing upwards of 15 APs) allows Ocean Master to summon mysterious magical creatures imprisoned beneath the sea.

Powers and Abilities

All of Ocean Master's powers stem from special equipment, since he does not share Aquaman's genetically-endowed abilities. Orm is an expert on ancient Atlantis and has developed potent magical skills. He is proficient in hand-to-hand combat, but mostly relies on his special equipment while operating underwater.

Personality/Role-playing

Since his early childhood, Orm has been locked in a fierce rivalry with his half-brother, Arthur Curry, better known as Aquaman. Eventually, Orm became so jealous of his brother's accomplishments that he resolved to destroy Curry, a mission he has made numerous attempts to fulfill. After each of these attempts, loyalty to his half-brother has prompted Aquaman to protect Orm from the authorities, which only humiliates and angers the Ocean Master further. Orm believes that Aquaman continues to forgive him only to illustrate yet another flaw in his character.

While pursuing the destruction of Aquaman, the Ocean Master will not allow anything to stand in his way. Although he would certainly kill Aquaman quickly if given the opportunity, he would much rather torture and humiliate him first.

Using Ocean Master in Adventures

Player heroes are most likely to encounter the Ocean Master by stumbling across one of his periodic plots aimed at eliminating Aquaman. Such Adventures provide an ideal opportunity to explore a unique setting—the undersea environment.

Subplots

Ocean Master is involved in a lengthy Family/Enemy Subplot with his half-brother and rival, Aquaman. At times, his mastery of ancient Atlantean magic has led to Power Complications.

Appearances in DC Comics

***Note:** Pre-Crisis appearances are not part of present continuity.

Pre-Crisis: *Action Comics* #443, 517-520; *Adventure Comics* #444; *Aquaman* (1) #29, 32, 35, 37, 49-52, 62-63; *The Brave and The Bold* (1) #82; *Crisis On Infinite Earths* #5-6, 9; *DC Comics Presents* #5; *Teen Titans* #28-29; *Who's Who '86* #17

Current: *Aquaman* (2) #1-4; *Who's Who '90* #1

Ocean Master's Helmet

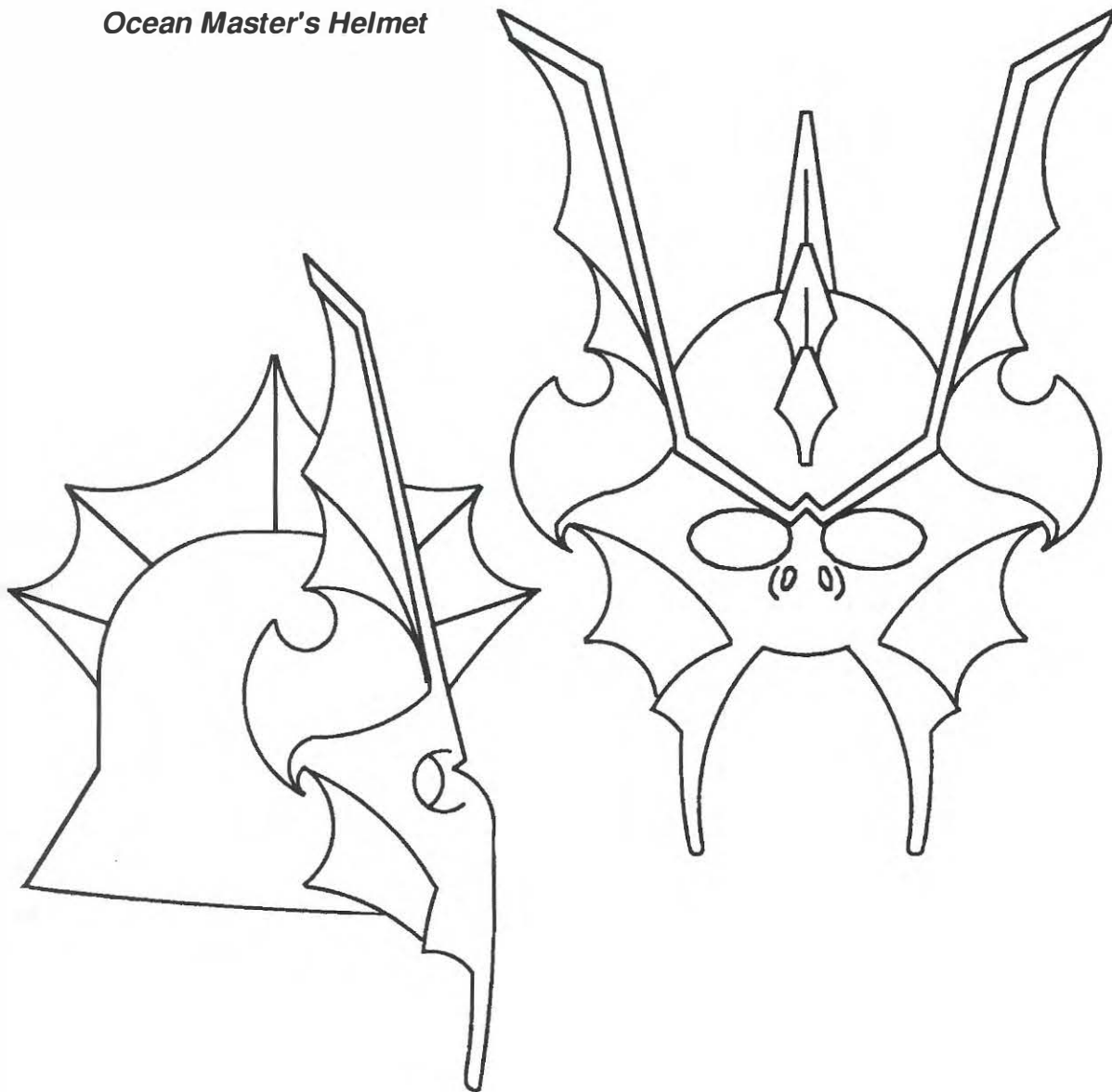

PERSUADER

DEX: 8	STR: 7	BODY: 8
INT: 4	WILL: 6	MIND: 6
INFL: 4	AURA: 3	SPIRIT: 7
INITIATIVE: 20	HERO POINTS: 75	

- Skills:** Martial Artist: 8, Thief: 7, Weaponry: 12
- Advantages:** Connections: Criminal Underworld (High), Fatal Five (High), Legion of Super-Heroes (Low); Lightning Reflexes
- Drawbacks:** Minor Rage
- Alter Ego:** Nyuen Chun Ti
- Motivation:** Mercenary
- Wealth:** 9
- Equipment:**

Atomic Axe [EV: 20, BODY: 18, Energy Absorption: 20] The Atomic Axe is an ancient relic from one of Earth's World Wars. The axe is so potent, it can cut through any known substance. It can even slice through raw energy.

To use the axe's Energy Absorption Power in combat, Persuader must make an Action Check using his Weaponry Skill as the AV and the axe's APs of Energy Absorption as the EV against an OV/RV equal to the AV/EV of the energy attack. One or more RAPs indicate that Persuader has successfully interrupted the energy attack. Resolve the attack normally, and reduce the RAPs earned on the attack by 25 (see the *Character Handbook*, page 25).

BATTLE ARMOR [BODY: 15]

At the present time, Persuader rarely wears his battle armor.

The Atomic Axe

Because he has used it for so long, Persuader has formed a "telekinetic bond" with his Atomic Axe. He is able to summon the axe to his hand from a range of over fifty miles (16 APs; to reach his hand, the axe travels through the air at a speed of 12 APs per phase), and he can sense the location of the axe from more than 100 miles away (17 APs).

Persuader's Underground Connections

Persuader has a very special High-level Connection with the criminal underworld. He has performed so many assassinations for each of the top

families in organized crime that they are all afraid of what he might tell the authorities if he is ever incarcerated. If Persuader is captured and brought to justice, many of the United Planets' most powerful organized criminals will use all their influence to see him released.

Persuader and the Emerald Empress

With the death of the Emerald Empress, the Persuader has become even more sullen and cruel. Before the Empress died, he did not have the Minor Rage Drawback.

Powers and Abilities

Persuader is one of the most skilled combatants in the United Planets. His strength is far beyond human average, and his reflexes are amazingly quick. Over the years, he has supplemented his natural ability with rigorous training in several different martial arts.

With the rare Atomic Axe he won in mortal combat, Persuader is one of the most feared assassins in the entire galaxy. Because he has used it for so long, he can now control the axe telekinetically, allowing him to strike even when he's down or out of position.

Personality/Role-playing

The Persuader's philosophy is simple: kill or be killed. He has survived his many struggles due to his determination and readiness to defend himself in mortal combat. Over the years, he has mentally prepared himself for battle to the extent that he now enjoys it. Wealth does not mean nearly as much to him as his own personal glory.

A loner, the Persuader does not work well with others. The only exception to this policy was his involvement with the Fatal Five, a relationship made possible by his attraction to the Emerald Empress. Since the Empress' death, he has returned to working as a solo operative.

Persuader is very direct. He performs his missions quickly and efficiently. He gives little thought to the law and is rarely challenged by it, though the Legion of Super-Heroes often gives him trouble.

Using Persuader in Adventures

Persuader presents the player heroes with a formidable challenge. Most often he is hired by a bigger villain either to eliminate troublesome heroes or to keep them at bay while the major villain accomplishes his main goal. Generally, Persuader is one of the many obstacles the player heroes must overcome in order to reveal their real mission.

Subplots

While the Emerald Empress was alive, Persuader was involved in a pseudo-Romantic Subplot with her. Currently, he is involved in a series of Job Subplots surrounding the complications resulting from assassinations.

Appearances in DC Comics

***Note:** Pre-Crisis appearances are not part of present continuity.

Pre-Crisis: *Adventure Comics* #352-353, 365-367, 378; *Crisis On Infinite Earths* #5, 10; *Legion of Super-Heroes* (2) #269-271 (3) 18, 21, 24-26; *Superboy* (1) #198, 219; *Superboy and the Legion of Super-Heroes* #231, 246-247; *Tales of the Legion* #318-319, 324; *Who's Who '86* #17

Current: *Legion of Super-Heroes* (4) #12-13; *Who's Who '90* #4; *Who's Who in the Legion of Super-Heroes* #2

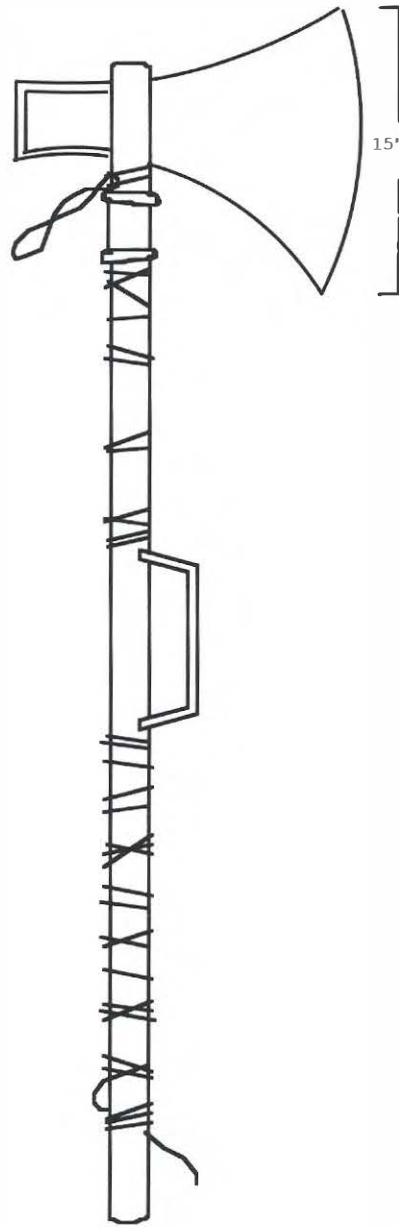

SCARECROW

DEX: 4	STR: 2	BODY: 4
INT: 7	WILL: 6	MIND: 4
INFL: 6	AURA: 3	SPIRIT: 5
INITIATIVE: 17	HERO POINTS: 50	

- Skills:** Gadgetry: 7, Scientist: 7
- Advantages:** Connections: Arkham Asylum (Low), Underworld (Low); Genius; Scholar (fear, psychology)
- Drawbacks:** Minor Irrational Attraction to causing fear
- Alter Ego:** Dr. Jonathan Crane
- Motivation:** Psychopath
- Wealth:** 6
- Equipment:**

Fear Drug [Phobia: 16] The Fear Drug is based on the same principles as the fear transmitters but is even more potent. To work, it must be swallowed by or injected into its victim.

Fear Transmitters (x3) [BODY: 2, Phobia: 15, R#: 2] Usually shaped like small skulls, Crane's Fear Transmitters create realistic illusions that bring a target's worst nightmare to life.

The Fear Factor

Scarecrow is an expert at building devices capable of isolating a target's fears and using them against the target. In DC HEROES, this ability is simulated using the Phobia Power.

When Scarecrow activates one of his Fear Transmitters, he makes an Action Check against an OV/RV equal to the target's INT/MIND. If the RAPs earned equal or exceed the victim's MIND, the victim can do nothing but quiver in fear for an amount of time equal to the RAPs earned minus his MIND (11 RAPs earned makes a Character with a MIND of 4 quiver for 7 APs of time, or 8 minutes).

A Character experiencing the effects of the Fear Transmitter can attempt to free himself from its Phobia Power each phase by making an Action Check using his INT/WILL against an OV and RV both equal to the RAPs earned on the Fear Transmitter's Phobia roll. As soon as these Action Checks earn a cumulative RAP total that equals or exceeds the RAPs earned on the Phobia roll, the target is released from the Phobia and experiences no further side-effects.

Thugs

Like many of Batman's foes, the Scarecrow likes to surround himself with hordes of thugs who carry out his dirty work. These thugs have the following statistics.

TYPICAL THUG

DEX: 3	STR: 3	BODY: 3
INT: 2	WILL: 2	MIND: 2
INFL: 2	AURA: 2	SPIRIT: 3
INITIATIVE: 7		

- Skills:** Vehicles: 3, Weaponry: 3

Abilities

The Scarcrow is a well-educated man who used his scientific training to develop a number of aids, both chemical and electronic, to help him exploit the intense emotions of others.

Personality/Role-playing

Doctor Crane is insane. His obsession with phobias has led him to focus his scientific research on the fears and weaknesses of the human psyche. Most of the time, Scarecrow tests his theories on his enemies, not only to prove his scientific theories, but simply because he enjoys causing terror in others.

Crane's other love is scholarship, an interest that led his peers to ostracize him at an early age. When on the loose, he prefers quietly studying criminal activity and using the money from his sprees to fund further research into the psychology of fear. Presently, Scarecrow spends much of his time in Arkham Asylum, where he seems content with the few books he is allowed.

Physically, the Scarecrow is slight and sickly. In fact, it was his frail form that gave him his nickname. His scrawny frame adds to his frightening image when in costume, but does little for him in a fight. As a result, Crane relies heavily on his special equipment and his wits to survive a conflict, though he always attempts to plan his crimes to avoid such situations. When possible, Scarecrow leaves a special signature—a single blade of straw—at the site of those crimes of which he is particularly proud.

Even though Scarecrow is insane, he still knows when he is beaten. If trapped, he usually makes heavy use of his special fear equipment before fleeing to fight another day.

Using Scarecrow in Adventures

Scarecrow usually steals money or valuable objects to raise funds to continue his research. An encounter with Scarecrow might lead to an interesting role playing encounter with the Batman, who can provide the player heroes with valuable information about Doctor Crane's past criminal activities.

Remember, when battling the Scarecrow, Players and Gamemasters should take the opportunity to develop their Characters by inventing and describing in detail the deeply-seated fears the Characters experience as the Scarecrow attacks them.

Appearances in the DC HEROES Role-Playing Game, Second Edition

Background/Roster Book, Justice League Sourcebook, Batman Sourcebook, Batman Role-Playing Game

Appearances in DC Comics

***Note:** Pre-Crisis appearances are not part of present continuity.

Pre-Crisis: *Batman* #189, 200, 262, 291-294, 296, 373, 400; *The Brave and The Bold* #197; *Crisis On Infinite Earths* #9; *Detective Comics* #73, 389, 486, 503, 526, 540; *First Issue Special* #7; *The Joker* #8; *Justice League of America* #111, 143, 158; *Super Friends* #32; *Who's Who '86* #20; *World's Finest Comics* #3

Current: *Animal Man* #23; *Arkham Asylum*; *Batman* #415, 455 (behind the scenes), 456-457; *Batman-Judge Dredd: Judgment On Gotham*; *Captain Atom* (3) #33; *Detective Comics* #571; *Detective Comics Annual* #2 (Who's Who); *Sandman* (2) #5, 7; *Secret Origins* (3) #23; *Secret Origins Special* #1 (behind the scenes); *Who's Who '90* #1

Scarecrow's Fear Transmitters:

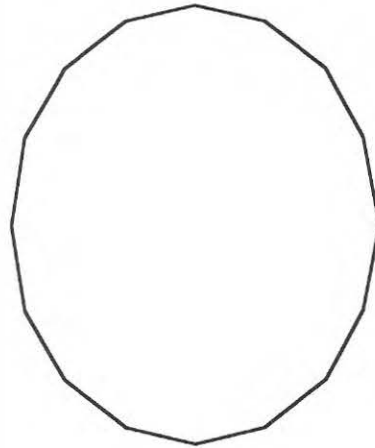

Top View



Front View

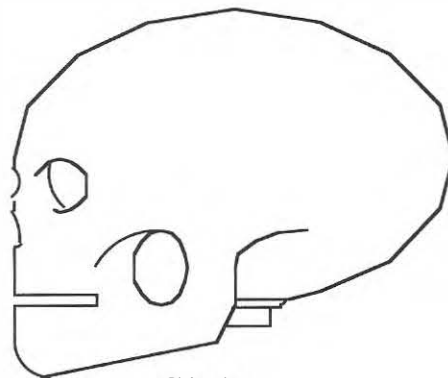

Side view

SILVER SWAN

DEX: 6	STR: 3	BODY: 5
INT: 4	WILL: 3	MIND: 4
INFL: 4	AURA: 3	SPIRIT: 4
INITIATIVE: 14	HERO POINTS: 40	

- Powers:** Flight: 8, Force Field: 10, Mind Blast: 7, Sonic Beam: 13
- Limitations:** Miscellaneous: Silver Swan's Flight Power is uncontrollable; she cannot use it without her cybernetic wings.
- Advantages:** Attractive; Connection: Wonder Woman (Low)
- Drawbacks:** Innocent
- Alter Ego:** Valerie Beaudry
- Motivation:** Unwanted Power
- Wealth:** 6
- Equipment:**

WINGS [BODY: 9] With her cybernetic wings, Silver Swan can use her Flight Power normally. Without them, she spins out of control every time she tries to fly.

Powers and Abilities

Silver Swan has a wide range of sonic abilities that allow her to project powerful beams of force and create dense force fields. When properly applied, her sonic blast is capable of shattering solid steel, and Silver Swan's control over the blast is so refined that she can narrow its beam to strike very small targets. Her one weakness is the fact that she is incapable of using her blast and her force field abilities simultaneously.

Silver Swan is also capable of flight, but must use her artificial wings for control.

Silver Swan's Mind Blast

By carefully attuning the frequency of her sonic beam, Silver Swan can cause a target to experience splitting headaches and mental agony.

The Dominators' Gene Bomb

Before the Dominators' Gene Bomb temporarily robbed her of her abilities, the Silver Swan was much

more powerful. In this earlier incarnation, she had the following Powers: Flight: 9, Force Field: 13, Mind Blast: 9, Sonic Beam: 16.

Personality/Role-playing

Because her parents' were exposed to radiation, Beaudry was born deformed and hideously ugly. Her strange condition left her friendless throughout her formative years, and her loneliness led her to consider the special operations and genetic manipulations sponsored by Armbruster a godsend. As an added bonus, Armbruster's doctors not only made Valerie beautiful, they also unleashed her latent meta-human abilities.

Silver Swan is not a true criminal. She is weak-willed and was easily duped by the corrupt Armbruster. Beaudry is innocent and easily frightened--even her own powers often terrify her.

After her ordeal at the hands of Armbruster, Beaudry found it difficult to trust another living soul. But now that she has been reunited with the only true friend she ever had, a long distance pen pal, she is learning to trust all over again.

Using Silver Swan in Adventures

If you are using the Silver Swan as a villain, she was undoubtedly duped into misusing her powers by yet another power-mad fiend. If you give the player heroes an opportunity to return her to the straight and narrow, Valerie might become a recurring Non-Player Character in your campaign, and her future travails might provide the player heroes with plenty of Subplot springboards.

Subplots

Valerie is presently involved in a Friend Subplot centered around her friendship with Maxine, her pen pal. She was once involved in a Romantic Subplot with Henry Cobb Ambruster, which ended when she found out he was using her.

Appearances in DC Comics

***Note:** Pre-Crisis appearances are not part of present continuity.

Pre-Crisis: *Crisis On Infinite Earths* #9; *Who's Who* '86 #21; *Wonder Woman* (1) #288-290, 323

Current: *Suicide Squad* #58; *War of the Gods* #2-4; *Who's Who* '88 #3; *Who's Who* '90 #3; *Wonder Woman* (2) #15-16, 42-44, 59, 61

Silver Swan's Wings

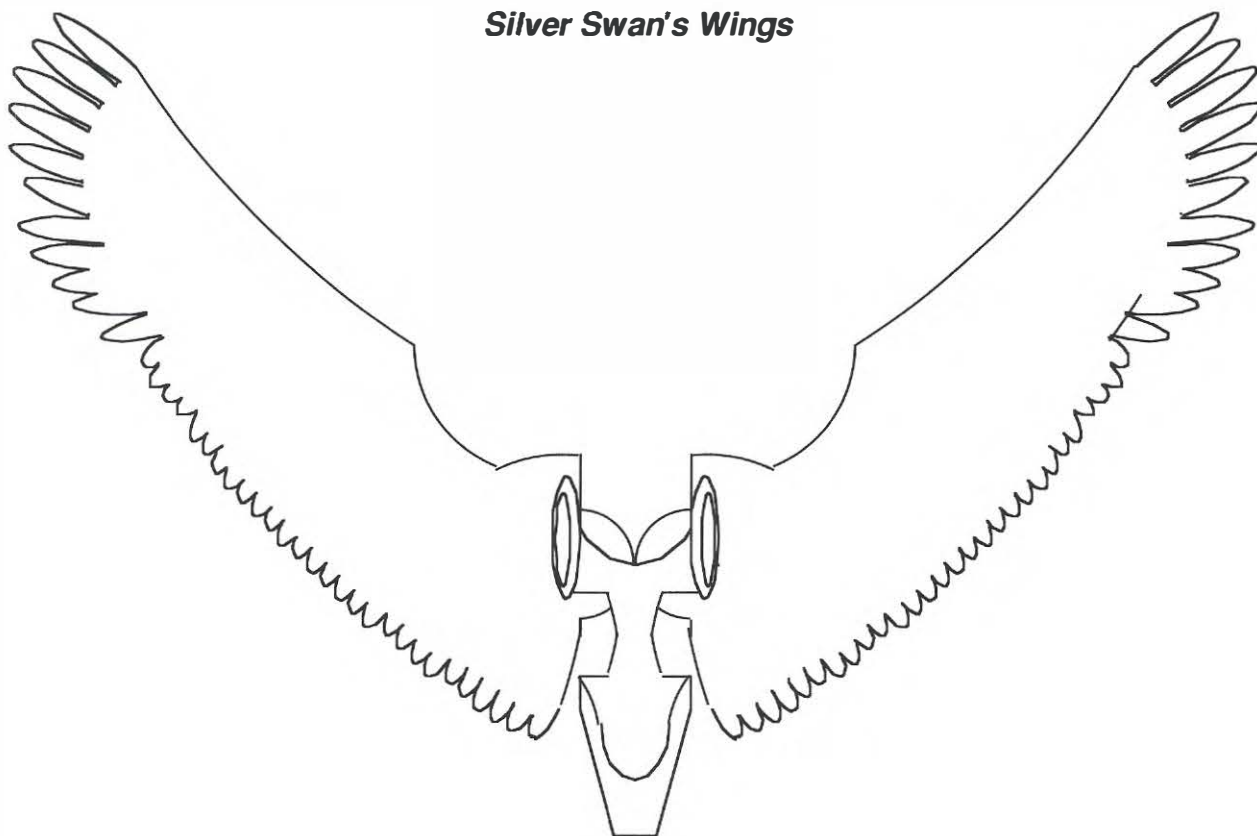

SINESTRO—*deceased*

DEX: 7	STR: 3	BODY: 10 (4)
INT: 11	WILL: 21	MIND: 11
INFL: 7	AURA: 10	SPIRIT: 11
INITIATIVE: 25	HERO POINTS: 110	

- Skills:** Charisma: 10, Gadgets: 10, Scientist: 10
- Advantages:** Connections: Anti-Matter Universe of Qward (Low), Secret Society of Super-Villains (High); Genius; Iron Nerves; Leadership
- Drawbacks:** Catastrophic Irrational Attraction to destroying the Green Lantern Corps (particularly Hal Jordan)
- Alter Ego:** None
- Motivation:** Power Lust
- Wealth:** 12
- Equipment:**
POWER RING [INT: 10, BODY: 21, Comprehend Languages: 20, Flight: 40, Force Manipulation: 21, Invulnerability: 18, Life Sense: 40, Omni-Power: 10, Recall: 20, Regeneration: 4, Sealed Systems: 16, Skin Armor: 4, Spirit Travel: 50]

Sinestro's Power Ring is an amazingly potent weapon with a virtually unlimited number of capabilities, including the ability to:

- Fly:** The ability to propel the ring-wielder at speeds approaching 1,500 times the speed of light (Flight).
- Form objects of yellow energy:** The ability to form complex objects out of "yellow energy" (Force Manipulation). This ability is directed by (and Linked to) the user's Willpower.
- Locate other Power Rings:** The ability to detect other Power Rings from several thousand light-years away (Life Sense; this Power can't be used in any other fashion).
- Manifest user's Willpower:** This allows the user to create objects from the force of will (Omni-Power, linked to 1/2 the user's WILL).
- Project an "energy self":** The power to separate an "energy self" from the ring-wielder (Spirit Travel). This energy self can travel billions of times faster than light and perceive its surroundings normally.
- Protect user physically and heal:** The power to protect the user from physical harm (Invulnerability) and hostile environments, such as the vacuum of outer space (Sealed Systems). The ring also speeds up the user's natural healing abilities to 16 times normal (Regeneration). While wearing the ring, Sinestro has a BODY of 10. While the ring is on his finger, it has a BODY equal to his WILL.

- Provide information:** The ability to store huge amounts of information (Recall).
- Shield the wearer:** The ability to envelop the ring-wielder with a protective sheath of yellow energy (Skin Armor; Sinestro loses 1 AP of both Force Manipulation and Omni-Power for each AP of Skin Armor he activates).
- Understand languages:** The ability to comprehend and translate virtually every language in the universe (Comprehend Languages).

Despite all of its virtues, Sinestro's Power Ring does have a flaw: it must be recharged every 24 hours using a special Power Battery (see below). Note that Sinestro's ring makes use of yellow energy, meaning that the Power Rings of the Green Lantern Corps do not affect its constructs.

Power Battery [BODY: 25, Energy Absorption: 18, Invisibility: 15, R#: 2] The Power Battery is usable only to recharge the Power Ring every 24 hours (Energy Absorption). The ring-wielder can will the battery to turn invisible (Invisibility of 15).

Powers and Abilities

Sinestro's most formidable weapon, of course, was his yellow power ring. Sinestro's ring was identical to those worn by the members of the Green Lantern Corps, save for the fact that it had no special vulnerability to the color yellow.

Sinestro's formidable intellect and willpower made him dangerous even without his ring.

Personality/Role-playing

While he was alive, Sinestro had two ambitions: to gain revenge upon the Green Lantern Corps, and to usurp as much power as possible.

Sinestro was a notorious schemer. He never simply called his opponents out to battle. Instead, he preferred to concoct elaborate plots and mask his own involvement in those plots for as long as possible. He usually enslaved others to carry out his schemes, and often had several contingency plans and escape routes laid out in case his schemes went awry. This sort of preparedness made Sinestro extremely difficult to incarcerate. Over the years, he always managed to escape from even the most formidable prisons ever devised.

Using Sinestro in Adventures

While he was alive, Sinestro was capable of more destruction than almost any other threat the player heroes are likely to face. He was ideally suited to epic-scale Adventures that force the player heroes to cooperate with hordes of other adventurers. Sinestro was also a fine vehicle for drawing the player heroes into Adventures set against the exotic backdrop of outer space.

Sinestro's Death

Although Sinestro is dead, his soul lives on in the remnants of the shattered Central Power Battery on Oa. Given his tremendous intellect and penchant for amazing escapes, it's likely that he will one day escape even this prison.

Appearances in DC Heroes Role-Playing Game, Second Edition

Atlas of the DC Universe

Sinestro's Ring

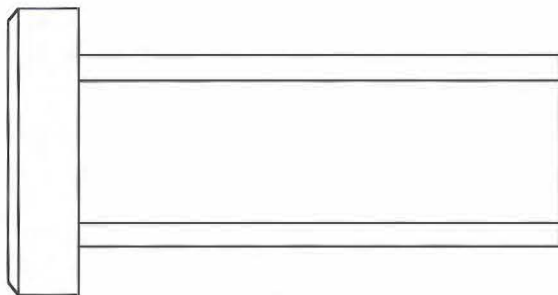

Side

Appearances in DC Comics

***Note:** Pre-Crisis appearances are not part of present continuity.

Pre-Crisis: *Action Comics* #443-444; *The Brave and The Bold* (1) #173-174; *Crisis On Infinite Earths* #5, 9-10; *DC Special Series* #6; *The Flash* (1) #222; *Green Lantern* (2) #7, 9, 11, 15, 18, 52, 73 (behind the scenes), 74, 82, 91-92, 123-125, 127, 195, 198; *Secret Society of Super-Villains* #1-5, 10; *Super Friends* #10, 45-46; *Who's Who '86* #21; *World's Finest Comics* #254

Current: *Green Lantern* (2) #200; *Green Lantern Corps* #217-224; *Green Lantern Corps Annual* #2; *Green Lantern: Emerald Dawn* #5-6; *Green Lantern: Emerald Dawn II* #1-6; *Millennium* #8; *Secret Origins* (3) #7 (flashback), 23 (flashback); *Who's Who '88* #3; *Who's Who '90* #1

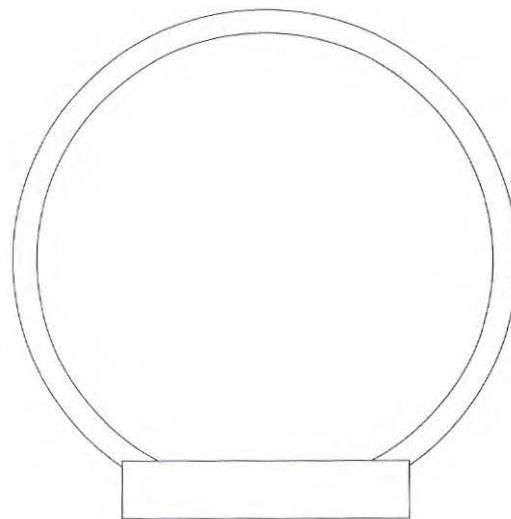

Top

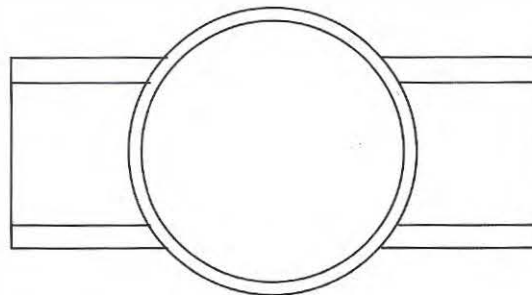

Front

SPIDER-GIRL

DEX: 7	STR: 5	BODY: 6
INT: 4	WILL: 3	MIND: 4
INFL: 4	AURA: 3	SPIRIT: 4
INITIATIVE: 17	HERO POINTS: 45	

- **Powers:** Extra-Limb (hair): 8, Omni-Arm: 7, Stretching: 2
- **Limitations:** Miscellaneous: Omni-Arm is limited to mimicking very simple objects.
- **Skills:** Charisma: 6, Detective: 3, Martial Artist: 6, Thief: 5
- **Advantages:** Attractive; Connections: Law Enforcement Community (Low), Legion of Super-Villains (High), Street (High)
- **Drawbacks:** Minor Irrational Attraction to attractive men
- **Alter Ego:** Sussa Paka
- **Motivation:** Thrill of Adventure
- **Wealth:** 6

Powers and Abilities

Paka underwent mutagenetic experiments as a young child, which gave her the amazing ability to control her hair as a sort of prehensile limb. She may use her hair to create shapes, such as hand-like forms for grasping, or flail it wildly about to entangle one or more opponents. Although Spider-Girl's hair is not particularly strong, she is well-trained in its use and can manipulate it very effectively.

Specifics on Spider-Girl's Hair

Spider-Girl can use her prehensile hair to perform a number of unusual feats. She can Grapple targets or attack Physically with the hair at ranges up to 2 APs (the limit of her Stretching Power. The AV of such an attack is equal to her DEX, the EV is equal to her APs of Extra Limb). And she can use her Omni-Arm Power to form useful simple objects out of her hair—giant hands, pry bars, etc.

Personality/Role-playing

Spider-Girl originates from Taltar, a matriarchal world. Taltarian scientists developed her special abilities as a weapon against the dominant male

presence in the universe which they believed would one day endanger their world. Despite her upbringing, Paka does not necessarily believe that males are evil or even inferior to females. In fact, she loves men and spends much of her free time teasing and chasing them, and sometimes getting them to chase after her. The main reason she tried to join the Legion of Super-Heroes was to surround herself with sexy male Legionnaires. And when she failed, she was happy enough to end up in the Legion of Super-Villains in the company of Cosmic King.

Spider-Girl is independent. She has always used her abilities selfishly, and to this day, she refuses to become involved in schemes that do not benefit her directly. She would much rather annoy others than aid them, especially the members of the Legion of Super-Heroes, against whom she still holds a grudge.

Although she is considered a criminal, Spider-Girl's real interests are adventure and survival. In reality, she holds no malice at all. In fact, she occasionally aids those on the side of the law. Paka never uses her abilities to kill or seriously harm her opponents. Generally, she will use her powers only to protect herself or prevent confrontation altogether.

Spider-Girl's Addictions

When she was in Cosmic King's Legion of Super-Villains, Spider-Girl was Seriously Irrationally Attracted to both Cosmic King and the narcotic drugs with which he occasionally supplied his followers. She has since been cured of both addictions.

Using Spider-Girl in Adventures

Spider-Girl is an independent detective whom the heroes can run across at any time or place. She might become involved in a Romantic Subplot with any male player hero who happens to catch her fancy.

Subplots

Spider-Girl is most often involved in Subplots that revolve around her fascination with men and her troubles with the law.

Appearances in DC Comics

***Note:** Pre-Crisis appearances are not part of present continuity.

Pre-Crisis: *Adventure Comics* #323, 372; *Legion of Super-Heroes* (3) #1-2, 4-5, 8, 18; *Superboy* (1) #208

Current: *Legion of Super-Heroes* (4) #22-23 (text); *Who's Who '90* #3; *Who's Who in the Legion of Super-Heroes* #4

Spider Girl's Thieving Tools

"Pick" for mechanical locks

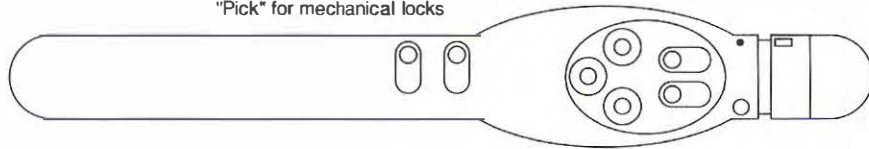

Security system "reroute" board

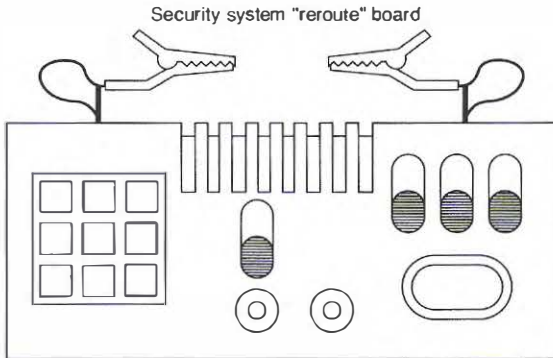

"Pick" for electronic locks

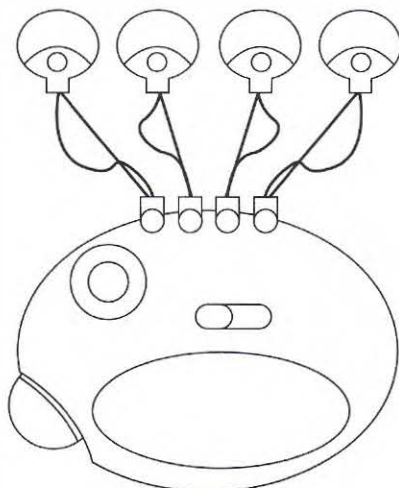
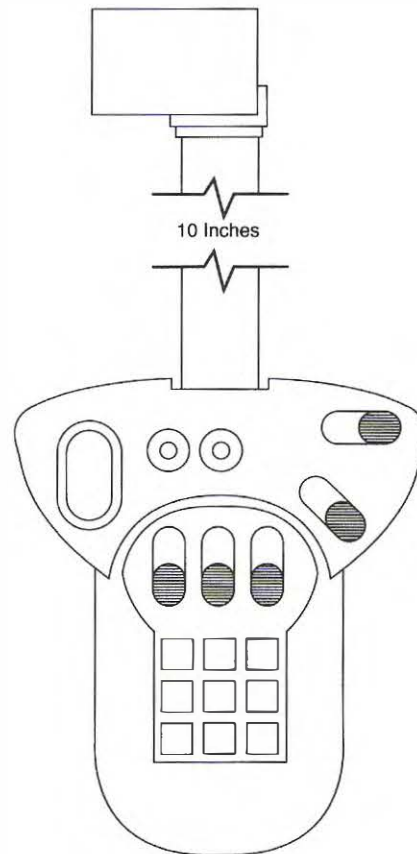

"Pick" for magnetic locks

VANDAL SAVAGE

DEX: 7	STR: 9	BODY: 9
INT: 10	WILL: 10	MIND: 8
INFL: 9	AURA: 7	SPIRIT: 8
INITIATIVE: 28	HERO POINTS: 110	

- Powers:** Dimension Travel: 8, Invulnerability: 16, Systemic Antidote: 15
- Skills:** Charisma: 8, Detective: 9, Gadgetry: 7, Martial Artist: 8, Military Science: 10, Occultist: 7, Scientist: 7, Weaponry: 6
- Advantages:** Connections: Business Community (High), Illuminati (High); Connoisseur; Genius; Omni-Connection; Scholar (business, history, political science); Sharp Eye
- Drawbacks:** Minor Irrational Attraction to destroying the Flash
- Alter Ego:** Vandal Adg
- Motivation:** Power Lust
- Wealth:** 16

Immortality

Vandal Savage is nearly immortal, not aging, and all but immune to disease. If subjected to traumatic injury, however, he can die.

Savage's Powers in DC HEROES

Savage has only recently regained a few Powers that he possessed earlier in his career (his high STR and the ability to open interdimensional warps). Before he regained these Powers, his STR was rated at 4 APs and he could not Dimension Travel.

To maintain his Powers, Savage must drink human blood. If he fails to drink the blood at least once a month, the Powers fade away.

Velocity-9

Velocity-9 is a drug Savage invented to combat his arch-enemy, the Flash. Anyone who takes the drug acquires the Superspeed Power rated at 9 APs but must make an Action Check using WILL/WILL as the AV/EV against an OV/RV of 9/9 to avoid developing a Catastrophic Irrational Attraction to the drug. Should the user develop this Attraction, he must keep taking additional doses of V-9 every 48 hours or die.

Velocity-9 addiction can be treated using the Medicine (Medical Treatment) Subskill. To do so, make a Medicine Action Check against an OV/RV of 6/6. Treatment takes roughly one month and requires proper facilities.

Powers and Abilities

Vandal Savage's foremost ability is his longevity; he is nearly immortal, though he can be killed by extreme injuries. Savage is also inhumanly strong (able to bench-press almost 25 tons); his body is extremely durable, making him impervious to most normal injuries; and he has the ability to warp between dimensions, a power that comes in handy when he needs to beat a hasty retreat.

Personality/Role-playing

Vandal Savage has pursued power relentlessly ever since he gained his immortality. Over the last several centuries, he has adopted innumerable personalities and subtly manipulated history in ways that benefit himself.

Until recently, Savage enjoyed direct conflict with his enemies. But after he encountered the powerful metahuman heroes of the 20th Century, he began distancing himself from his dirty work as much as possible, reducing the chance that he might suffer a permanent defeat. Now, he mainly works through intermediaries and limits his own direct involvement to the predictable gloat that precedes a plan coming to fruition.

Savage's ultimate ambition, of course, is the complete conquest of the world. The one unique virtue he brings to this ambition is patience. Unlike many of his rivals in the super-villain community, Savage is willing to bide his time. After all, only his enemies are getting older.

Using Vandal Savage in Adventures

Two characteristics generally distinguish a Vandal Savage Adventure: a complex scheme and an economic bent. Savage's plots are always complicated affairs with several layers built-in between himself and his enemies. Likewise, most of Savage's crimes are set against a backdrop of high finance or economic exploitation.

Subplots

Vandal Savage has a personal grudge against the Flash, and he will pursue a fight with him whenever he can. Other than that, because of his 50,000 years of life, he has probably been involved in just about any Subplot imaginable.

Appearances in the DC HEROES Role-Playing Game, Second Edition

Background/Roster Book

Appearances in DC Comics

***Note:** Pre-Crisis appearances are part of present continuity.

Pre-Crisis: *Action Comics* #515-516, 542-543, 552-553, 556; *All-Star Comics* #37, 64-65; *Crisis On Infinite Earths* #4-5, 9; *The Flash* (1) #137, 215, 235; *Green Lantern* (1) #10; *Who's Who* '87 (1) #25

Current: *Flash* (2) #1-2, 12-14, 16-18, 48-50; *Infinity, Inc. Annual* #2 (flashback); *Justice Society of America* #1-3, 4 (behind the scenes), 5-8; *Time Masters* #1-8; *Who's Who* '90 #4



WEATHER WIZARD

DEX: 4	STR: 3	BODY: 4
INT: 5	WILL: 4	MIND: 3
INFL: 3	AURA: 3	SPIRIT: 4
INITIATIVE: 12	HERO POINTS: 50	

- Skills:** Gadgetry: 5, Thief: 7
- Advantages:** Connection: Flash's Rogues' Gallery (Low); Scholar (weather sciences)
- Alter Ego:** Mark Mardon
- Motivation:** Mercenary
- Wealth:** 4
- Equipment:**

Weather Wand [BODY: 5, Air Control: 14, Flight: 8, Fog: 25, Ice Production: 14, Lightning: 14, Water Control: 14, Weather Control: 16]

The Weather Wand is a potent weapon that allows Weather Wizard to manipulate climatic conditions over an area as large as a small city.

Controlling the Weather

With his Wand, the Weather Wizard has complete control over local weather. To change the weather, he uses his Weather Control Power as described on page 53 of the *Character Handbook*. Here are the game effects of instituting some of the weather conditions listed:

- Rain:** Visibility is impaired. All ranged attacks suffer -1 Column Shift to their AVs. All Vehicle Skill Checks suffer -2 Column Shifts to their AVs and EVs.
- Monsoon:** Same as above, only ranged attacks suffer -3 Column Shifts to their AVs, and Vehicle Skill Checks suffer a -4 Column-Shift penalty to their AVs and EVs.
- Record Cold:** All unprotected Characters attack with a -1 Column-Shift penalty to their AVs. Unprotected Characters are also attacked Physically (AV/EV of 2/2) after one phase of exposure (0 APs of time), again after two phases (1 AP of time), again after four phases (2 APs of time), and whenever the total time of exposure reaches a new AP level thereafter.
- Record Heat:** All unprotected Characters attack with a -1 Column-Shift penalty to their AVs.

Unprotected Characters are also attacked Physically (AV/EV of 2/2) after one phase of exposure (0 APs of time), again after two phases (1 AP of time), again after four phases (2 APs of time), and whenever the total time of exposure reaches a new AP level thereafter.

- Tornado/Gale:** See the *Rules Manual*, page 64. The size of the tornado or hurricane (gale) that is summoned is equal to the RAPs earned on the Weather Control Action Check (minimum value of 7, maximum value of 15; adjust up or down if the RAPs don't fall into this range).

Powers and Abilities

With the Weather Wand, Mardon can alter weather conditions on a scale ranging from a few square feet to an entire city. The wand can change conditions immediately, create more than one effect at once, and even alter conditions within enclosed spaces. Mardon has a mental link with the Weather Wand, allowing him to control it by thought alone; even if he is separated from the wand, he can wield its powers. The wand also allows the Weather Wizard to create compressed clouds of water vapor, thick enough to stand on, allowing him to fly.

Personality/Role-playing

Mardon does not realize the potential of the power he possesses and lacks the ingenuity to exercise his abilities to their fullest. He still commits only petty crimes and never fails to leave ironclad evidence behind him. Despite these shortcomings, he has a cocky attitude and sees himself as a formidable super-villain.

Weather Wizard is obsessed with avenging himself upon those who defeat him. He first used his abilities to get back at the three guards who first escorted him to prison, and later, he became bent on avenging his defeats at the hands of the second Flash (Barry Allen).

Mardon is no fighter, this much he knows. His Weather Wand is his strength, and he will stay at least arm's length from his opponents, hoping the wand will get him out of tight spots. Most often, he uses weather conditions to slow down adversaries or negate their super-powers in order to give him time to escape.

Using Weather Wizard in Adventures

The Weather Wizard is just plain silly and fun. He's a good villain to begin an Adventure with, since he only uses his Powers for petty theft. He is also a good lead-in to a more sinister villain, who could be manipulating him into committing his crime.

Remember, if the heroes bring him in, they will find themselves on his revenge list and will probably be one of his targets should he ever escape from jail.

Subplots

Weather Wizard seems most preoccupied with gaining revenge on those who have wronged him in the past, particularly the Flash. He seems to spend most of his time thinking up schemes to fulfill his vengeful needs and to fill his pockets with money.

Appearances in DC Comics

***Note:** Pre-Crisis appearances are not part of present continuity.

Pre-Crisis: *Action Comics* #441; *Adventure Comics* #450, 466; *Crisis On Infinite Earths* #5, 9; *DC Super-Stars* #10; *Detective Comics* #353; *The Flash* (1) #110, 130, 145, 175, 222, 231, 242-244, 254, 256, 325-326, 338-342, 347-350; *Justice League of America* #41; *Super Friends* #37; *Who's Who '87* (1) #25; *World's Finest Comics* #276

Current: *Blue Devil* #30; *Flash* (2) #19; *Justice League America* #43; *Secret Origins* (3) #41; *Secret Origins Annual* #2; *Who's Who '90* #4

Weather Wizard's Wand

bottom view



top view



ALFRED PENNYWORTH

DEX: 3	STR: 3	BODY: 3
INT: 4	WILL: 4	MIND: 3
INFL: 2	AURA: 2	SPIRIT: 3
INITIATIVE: 9	HERO POINTS: 10	

- Skills:** Artist (Actor): 8, Detective: 4, Medicine: 4
- Advantages:** Connections: Batman (High), Nightwing (Low); Connoisseur; Rich Friend (Bruce Wayne)
- Alter Ego:** None
- Motivation:** Upholding the Good
- Wealth:** 5

Powers and Abilities

Alfred's unique abilities make him one of Batman's most valuable resources. Besides being a good butler, Alfred is also a trained medic and a near-incomparable actor. Because he has kept up his training, Alfred's medical abilities now rival those of a physician. He's even picked up some detective skills from observing the Batman over the years. Because of those things, all of Alfred's Skills are upgraded from those published previously.

Impersonating the Batman

Alfred often uses his acting abilities to mimic Batman's voice, diverting suspicion from Bruce Wayne or throwing enemies off. To perform such a feat, Alfred must call upon his Artist (Actor) Skill. Alfred can automatically impersonate the Batman's voice, but anyone who hears the impersonation is allowed a Perception Check (AV/EV equal to the listener's INT/WILL) to detect his deception. The OV and RV of the Check are both equal to Alfred's APs of Skill (5/5). If the listener is familiar with Batman's voice, he is allowed -2 Column Shifts to both the OV and the RV of the Perception Check.

Personality/Role-playing

Alfred Pennyworth is a loyal man who has cared for Wayne Manor and its residents for decades. He is the only family left to Bruce Wayne save Robin, and

he would die for Bruce if a situation called for it. He cares for Wayne in a paternal way and sometimes even treats him as an overly adventurous boy. Although he would prefer his master to stop playing vigilante and often says so, Alfred, more than anyone, understands what drives Batman. Still, he likes to throw out an occasional sarcastic remark or argue about Batman's obsessive behavior.

Alfred is a kind and generous man. In his role of butler he may seem aloof, but he is actually far from it. Alfred has made many sacrifices and put himself in danger's way for his master. He is perceptive, witty, opinionated, and decisive—a true match for Batman's steel. Only he can order the Batman to his room to rest.

Using Alfred Pennyworth in Adventures

Alfred often acts as Bruce Wayne's representative. In this manner he can secretly bring information to the Batman, who can later assist the Players. Also, Wayne might send Alfred to manipulate the player heroes in a way that would benefit the Batman's investigations. If you want the heroes to meet Batman, it might be interesting to foreshadow his appearance with an appearance by Alfred.

Subplots

Although Alfred himself does not have a Secret Identity, his boss does. Therefore, he is most often involved in Subplots in which he tries to protect his master's secrets. In addition, he is frequently involved in Job Subplots.

Appearances in the DC HEROES Role-Playing Game, Second Edition

Background/Roster Book, Batman Sourcebook, Batman Role-playing Game

Appearances in DC Comics

***Note:** Pre-Crisis appearances are not part of present continuity.

Pre-Crisis (Alfred Beagle)—Earth Two: *Batman* #16-18, 2-34, 36, 40, 52, 55, 62-64, 67-68, 70, 73, 81, 83, 85, 92; *The Brave and The Bold* #167; *DC Super-Stars* #17;

Detective Comics #75, 82-83, 96, 98-99, 101, 105, 109-110, 179, 209, 223; *Infinity, Inc.* #9; *Star Spangled Comics* #65-66, 91, 93, 100, 109, 118, 121, 125; *Superman Family* #211; *Wonder Woman* (1) #294-295; *World's Finest Comics* #12, 19, 57, 64

Pre-Crisis (Alfred Pennyworth)—Earth One: *Action Comics* #478; *Batman* #99, 105, 110-112, 120, 125, 128, 131, 135, 140-141, 145, 147-148, 150-151, 154-157, 159, 162-163, 188-191, 200-202, 205, 209-211, 214-217, 219, 222, 226-227, 230, 232, 234-236, 240, 247-250, 252-253, 256, 260-261, 263-264, 266-268, 270-280, 284-285, 287-290, 297-307, 310, 312, 315, 316 (behind the scenes), 317, 319-323, 325-331, 335-356, 358-361, 363-364, 366-379, 381, 383-385, 387-388, 390, 394-395, 400; *Batman and the Outsiders* #1, 3, 6, 13, 16, 19-20, 25-26; *Batman and the Outsiders Annual* #1; *Batman Annual* #8-10; *Batman Family* #4, 7-8, 11-13, 17-18, 20; *Batman Special* #1; *Blue Devil* #19; *The Brave and The Bold* #79, 82-83, 88-90, 96, 100-101, 105, 113, 141-142, 147, 150-151, 153, 157, 165, 168-169, 171, 173, 176, 177, 184, 187, 190-191, 193 (behind the scenes), 194, 200; *Crisis on Infinite Earths* #5; *DC Comics Presents* #41, 83; *DC Comics Presents Annual* #2; *DC Special Series* #1, 8, 15; *Detective Comics* #234, 241, 245, 249, 304, 306-307, 320, 328, 334, 336, 340, 349, 356, 359, 361, 364-370, 372-373, 378-381, 383 (behind the scenes), 385-387, 393-395, 400-401, 412, 418, 421-422, 425, 428-429, 434, 436, 438, 440-441, 445-447, 449-450, 455-473, 478, 480-489, 492-494, 497-498, 500-504, 506-511, 513-524, 526-530, 532, 535-544, 546-548, 551-552, 554-555, 559-560, 563-564; *Justice League of America* #61 (behind the scenes), 154; *Man-Bat* (1) #1; *The New*

Teen Titans (1) #33, 37; *Super Friends* #5, 32 (behind the scenes), 35, 44; *Superman* (1) 405 (behind the scenes); *Superman's Pal, Jimmy Olsen* #111; *Swamp Thing* (1) #7; *The Untold Legend of Batman* #1-3; *Who's Who '86* #17; *World's Finest Comics* #77, 80, 134-135, 139, 168, 171, 174, 181, 199, 202, 218, 248, 250, 259-260, 268, 275-276, 279-281, 284-286, 289, 290 (behind the scenes), 291, 294, 296, 303, 308-309, 314-315, 322-323

Current: *Action Comics* #606, 654; *Adventures of Superman* #467; *Batman* #401-408, 410-416, 418, 420, 423, 425-426, 428, 431, 433-443, 444 (behind the scenes), 445, 448, 452, 454-457, 459, 462, 465, 467-469, 471-472, 474; *Batman Annual* #12-14; *Batman: Bride of the Demon*; *Batman: Full Circle*; *Batman: Son of the Demon*; *Batman: The Cult* #3-4, *Batman: The Killing Joke*; *Batman 3-D*; *Batman Versus Predator* #1; *Christmas with the Super-Heroes* #2; *Cosmic Odyssey* #2; *Deathstroke the Terminator* #7; *Detective Comics* #567, 569, 571, 573-578, 580-582, 591, 594, 596, 598-601, 608-609, 613-616, 618-620, 622, 624-631, 635, 638, 641-644; *Detective Comics Annual* #1; *Green Arrow Annual* #1; *Legends of the Dark Knight* #1-9, 10 (behind the scenes), 11-25, 27, 30-31; *Manhunter* (2) #17; *Ms. Tree Quarterly* #1; *The New Teen Titans* (2) #18; *The New Titans* #55, 58, 60-61; *The Question Annual* #2; *Robin* #1; *Robin II* #1-4; *Secret Origins* (3) #39; *Secret Origins Annual* #3; *Starman* #9; *Suicide Squad* #40; *Superman* (2) #44, 64; *Swamp Thing* (2) #66; *Teen Titans Spotlight* #14; *Who's Who '88* #4; *Who's Who '90* #3; *Wonder Woman* (2) #57; *World's Finest Comics* #1-3

Wayne Manor

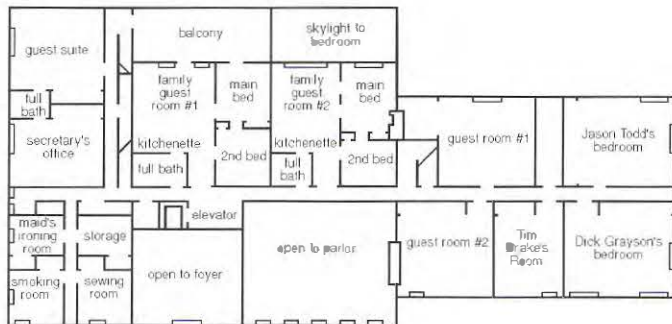

second floor

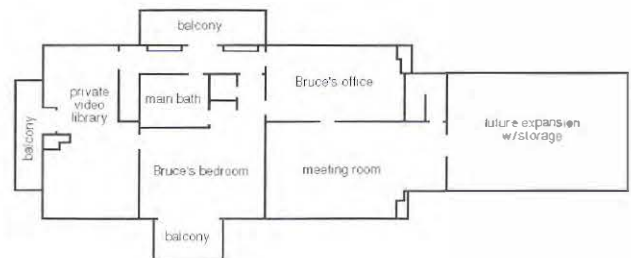

third floor

first floor

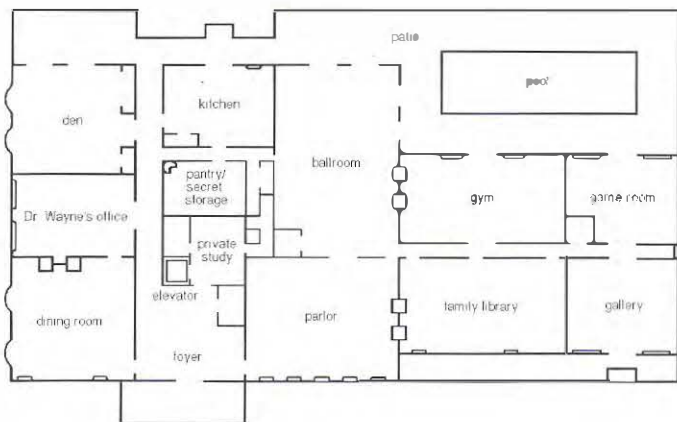

basement

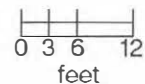
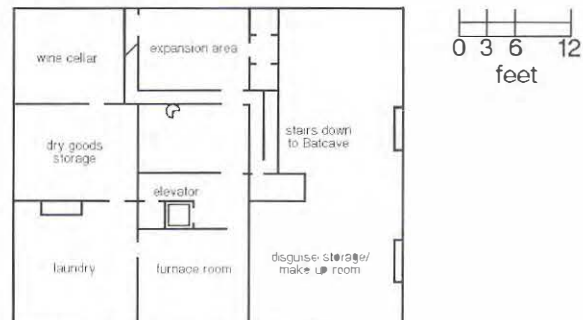

AMANDA BLAKE WALLER

DEX: 3	STR: 3	BODY: 3
INT: 11	WILL: 8	MIND: 8
INFL: 9	AURA: 8	SPIRIT: 8
INITIATIVE: 23	HERO POINTS: 35	

- Skills:** Charisma: **10**, Detective: 8, Weaponry: 3
- Advantages:** Connections: Checkmate (Low), Republican Party (High), Suicide Squad (High), Task Force X (High), U.S. Government (High); Iron Nerves; Leadership; Omni-Connection; Scholar (bureaucracy, politics)
- Alter Ego:** the "Wall" (nickname)
- Motivation:** Seeking Justice
- Wealth:** 9
- Occupation:** Director of Task Force X

Task Force X/Suicide Squad

The Suicide Squad is a team of meta-human operatives that carries out special intelligence missions for the U.S. government. Most of the Squad members are convicted criminals who agreed to join the Squad in return for reduced prison sentences.

Originally, the Squad was a part of Task Force X, the meta-human arm of the U.S. intelligence community. In those days, the Squad had a group Wealth rating of 12.

Currently, the Squad is a government organization with only semi-official status. Amanda Waller has complete control over the Squad and is free to refuse missions. The Squad now receives a \$1 million fee (Wealth value of 16, good for one roll only) for each mission Waller accepts.

Powers and Abilities

Waller's most impressive talents are her nearly unrivaled charisma and determination. A born leader, she is capable of effectively commanding even tough criminals. She is also so strong-willed, she has opposed Batman without flinching. Waller also has a knack for devising intricate, but effective, political schemes.

Personality/ Role-playing

Amanda Waller, or "the Wall" as her operatives call her, is hard-nosed and obstinate; she is not easily intimidated by anyone. This determined, often unrelenting nature makes her an excellent leader for the rag-tag group of meta-humans known as the Suicide Squad.

Amanda Waller is also very intelligent. She is not only a scholar in politics, but street smart. She knows how to deal with people and prefers to talk, or intimidate, her way out of most situations. "The Wall" can out-argue anyone, even Batman, and will not accept insubordination.

One of Waller's greatest weaknesses is her inability to trust anyone. She often has difficulties with authority figures (especially when they are wrong) or rules that do not fit into her plans.

The less-seen side of this remarkable woman is that of the caring mother who has suffered due to the loss of loved ones. This is no doubt why she is so hard on the Suicide Squad and others.

Using Waller in Adventures

As the head of the Suicide Squad, Waller often tries to recruit heroes with abilities that fit the requirements of a given mission. She might, therefore, attempt to convince the player heroes to accompany the Suicide Squad on a particular mission tailored to their abilities. She is also the primary contact person for the Suicide Squad, making her an ideal Contact for the heroes.

Subplots

Amanda's family was murdered, and she often feels guilt or hostility in relation to the incident. She, therefore, is often involved in Death Guilt Subplots about her family as well as about the members of the Suicide Squad whom she has lost. She has many enemies which often entangle her in Enemy Subplots, and, for the most part, her team, the Suicide Squad, is a secret organization that must maintain its Secret Identity.

Appearances in the DC HEROES Role-Playing Game, Second Edition

Background/Roster Book

Appearances in DC Comics

Adventures of Superman #449, 481; *Captain Atom* (3) #21-22, 24-25, 30, 49; *Checkmate!* #1, 8-9, 15-16, 18; *Deadshot* #1, 4; *Doom Patrol and Suicide Squad Special* #1; *The Fury of Firestorm* #55, 62-64; *Hawkworld* #23; *Invasion!* #1-3; *Justice League America* #27; *Justice League International* #13; *Legends* #1, 3-5; *Manhunter* (2) #6-7, 14; *Millennium* #3; *Secret Origins* (3) #14, 28; *Suicide Squad* #1-5, 8-14, 19, 21-55, 56-57 (behind the scenes), 58-66; *Suicide Squad Annual* #1; *Superman Annual* (2) #1; *Who's Who '88* #4; *Who's Who '90* #1; *Wonder Woman* (2) #26, 61

Amanda Waller's Office

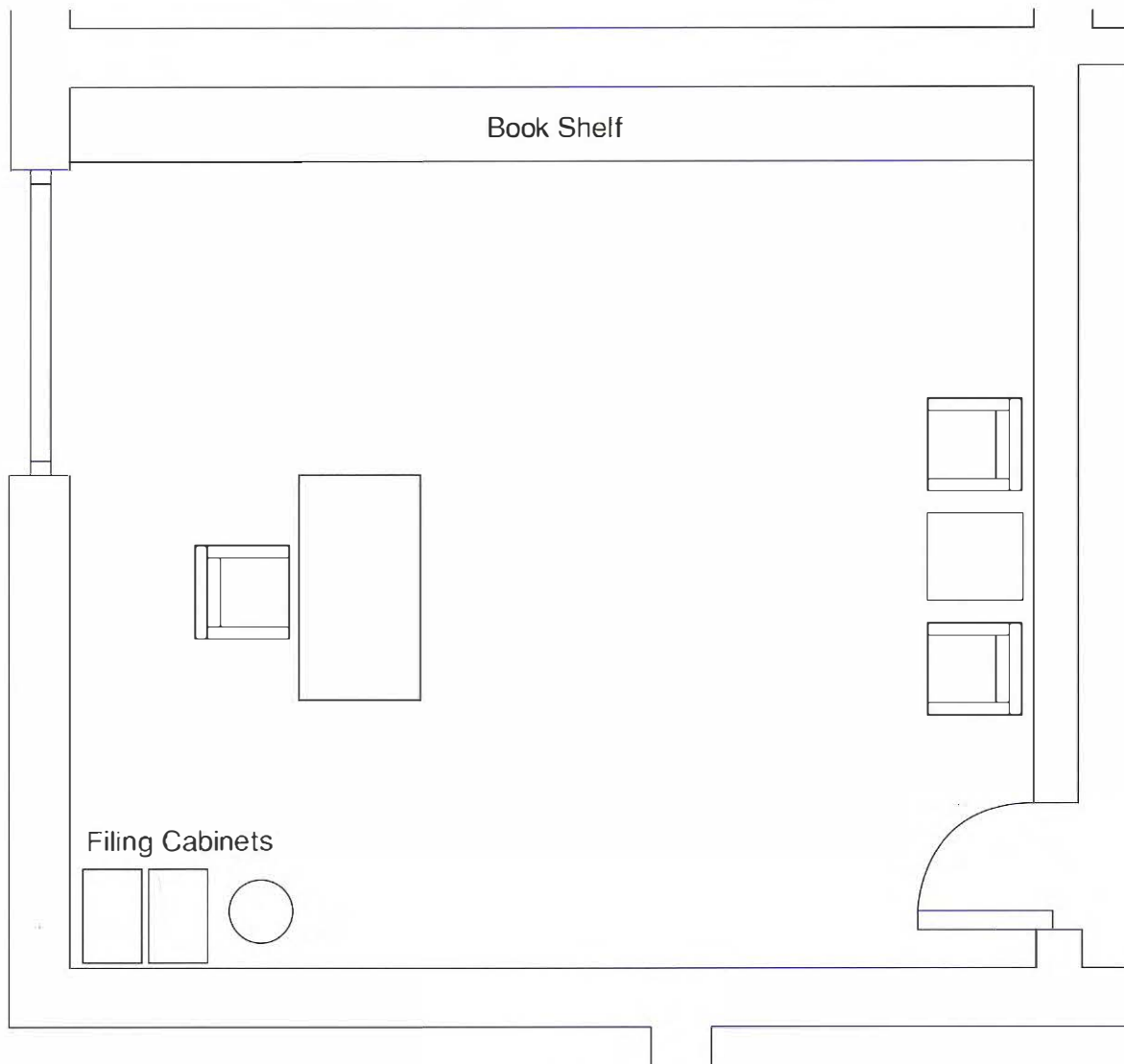

CHUNK

DEX: 3	STR: 4	BODY: 8
INT: 9	WILL: 8	MIND: 5
INFL: 4	AURA: 4	SPIRIT: 5
INITIATIVE: 16	HERO POINTS: 65	

- Powers:** Dimension Travel: 6, Projectile Weapons: 8, Teleportation: 20
- Skills:** Gadgetry: 6, Scientist: 7
- Limitations:** Miscellaneous: Dimension Travel can only be used for transit between the Earth Dimension and the "Chunk Dimension," a pocket dimension at a Travel Distance of 1 from the Earth Dimension (see pp. 20-21 of the *Magic Sourcebook*).
- Advantages:** Area Knowledge (Chunk Dimension); Connection: Flash (High); Genius
- Drawbacks:** Public Identity; Miscellaneous: Chunk must periodically banish items to the Chunk Dimension in order to survive, much like other living creatures need to eat.
- Alter Ego:** Chester P. Runk
- Motivation:** Unwanted Power
- Wealth:** 9

Chunk's Statistics

Because Chunk's abilities were more clearly defined in *Who's Who '90*, his Dimension Travel has been lowered from 8 APs to 6 APs, and his Attributes and Skills have been raised.

Powers and Abilities

Chunk has the ability to send matter to another dimension through his own body, which acts as a portal. This dimension is comprised of vast deserts and barren landscapes. With his abilities, Chunk can also travel to this dimension himself; he often goes there when he needs some time alone. He can even take others with him and has done so upon occasion. In fact, for a time he took criminals there and left them to fend for themselves. Later the Flash convinced him that this was wrong, so he freed them all.

Because of his ability, Chunk must consume (transport to another dimension) 47 times his own

weight (12.5 tons or 9 APs) each week to fill the vortex within him.

Runk is also a genius, and his knowledge of physics and technology is formidable.

Personality/Role-playing

Although Chester committed crimes to satiate his hunger, he is not a criminal in the normal sense. He is not greedy or dangerous; in fact, he's downright sweet. Others are drawn to his mild nature; but, unfortunately, they often take advantage of it. Being kind-hearted, he does not seem to mind.

Chester lives in the mansion formerly owned by Wally West. Wally's mother is his secretary, and he remains one of Wally West's closest friends.

Using Chunk in Adventures

Chester now uses his abilities as a removal specialist, sending unwanted inorganic materials through to the Chunk Dimension and satisfying his need in the process. The Player Characters, therefore, could contact him to get rid of some hazardous waste and dense or dangerous materials they can't handle.

Subplots

As of this writing, Chester is involved in a Romantic Subplot with Wally West's former girlfriend, Connie. His Power Complications also keep him occupied, and he is often involved in the Flash's own Subplots.

The Chunk Dimension

To survive, Chunk must absorb large quantities of matter into his Chunk dimension. If he goes two days without absorbing any matter, his Attributes are lowered according to the rules for Loss Vulnerabilities found on page 23 of the *Character Handbook*.

Appearances in the DC HEROES Role-Playing Game, Second Edition

Background/Roster Book

Appearances in DC Comics

Flash (2) #9-11, 15, 18-19, 21-25, 27-28, 35-36, 47-49, 55, 58-60; *Flash Annual* #2-4; *Invasion!* #2; *Manhunter* (2) #8; *Who's Who '88* #1; *Who's Who '90* #3

***Flash's Old Mansion, now
owned by Chunk***

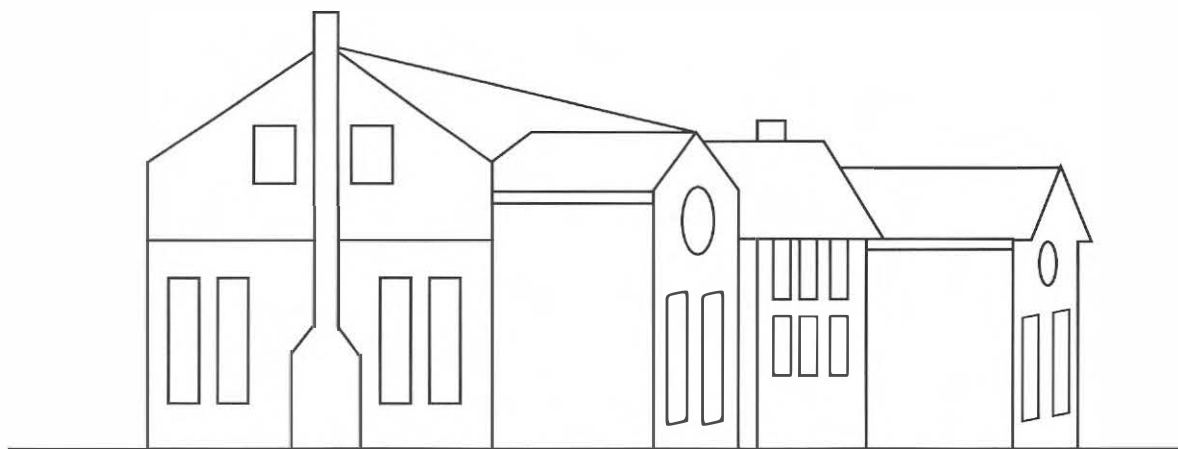

LIGHTNING LORD

DEX: 5	STR: 3	BODY: 5
INT: 7	WILL: 6	MIND: 5
INFL: 6	AURA: 5	SPIRIT: 6
INITIATIVE: 20	HERO POINTS: 70	

- Powers:** Lightning: 8
- Skills:** Martial Artist: 4, Science: 5, Vehicles: 5
- Advantages:** Connections: Legion of Super-Heroes (Low), Ranzz family (High); Leadership
- Drawbacks:** Guilt; Mistrust
- Alter Ego:** Mekt Ranzz
- Motivation:** Upholding the Good
- Wealth:** 7

Mistrust

Although he has regained some of his esteem, Lightning Lord is a paroled criminal who has committed many horrible crimes. For this reason, the public will never trust him completely.

Powers and Abilities

Lightning Lord's abilities are exactly those of his siblings. He has the power to absorb electrical energy and release it in powerful bursts. Ranzz never received Legionnaire training, however, so he has less control than his brother Lightning Lad.

Although in good physical shape, he is a poor hand-to-hand combatant. In the past, he relied on his rage to give him the strength and edge he needed to defeat an enemy.

Since his days as a criminal, Mekt has rarely used his lightning abilities. As a result, he is even less skilled in their use than he used to be. With a little training, he could conceivably regain a great deal of lost ability. Should this happen, raise his DEX and BODY to 6 APs, his STR to 4 APs, and his Lightning Power to 11 APs.

Personality/Role-playing

Mekt was born without a twin, an odd biological condition that made him a social outcast on his home planet of Winath. Disturbed by his treatment, Mekt Ranzz retaliated by using his powers for self-serving schemes, which later led to his reputation as a dangerous criminal.

After some counseling, Mekt has developed a conscience over the crimes and heinous acts he committed. Recently, his brother, Garth (Lightning

Lad), and Garth's wife, Imra (Saturn Girl), took him in and placed him in charge of operations at their Lightning Ring Plantation. He is proud to help his sibling and glad to have the chance to prove his newfound goodness. Recently, Lightning Lord proved his sincerity and loyalty to his family by almost dying while protecting them from the dreaded Roxxas the Butcher.

Guilty about his past life, Mekt has undergone a complete emotional change. He is now kind and unwilling to harm anyone or use his powers to be forceful. At times he even seems naive, but that seems to be a protective psychological response to all that he has faced in his life.

Using Lightning Lord in Adventures

Although he appears naive, Lightning Lord is actually quite savvy in the ways of the universe. He knows how the underworld and super-villain organizations operate. In Adventures, he is best used as the sorrowful voice of experience. More than likely he will not volunteer his experience, but if the heroes need to get information, Mekt might be persuaded to aid them. Remember that Mekt's hesitancy to speak about his past could lead to some entertaining interplay as the player heroes try to cajole information out of him.

Subplots

Presently Mekt is involved in a lengthy Family Subplot with his brother and his brother's wife, as he grows accustomed to a family relationship. Mekt is also kept busy by his Job as a business executive of the Lightning Ring Ranch.

Appearances in DC Comics

***Note:** Pre-Crisis appearances are not part of present continuity.

Pre-Crisis: *Adventure Comics* #331 (variant), 354-355 (variant), 372; *Crisis On Infinite Earths* #9-10; *Legion of Super-Heroes* (2-4) #300 (variant), 302; 1-6, 45; 3; *Secrets of the Legion of Super-Heroes* #1; *Superboy* (1) #147, 172, 207-208; *Superboy and the Legion of Super-Heroes* #241; *Superman* (1) #147 (variant); *Superman's Pal, Jimmy Olsen* #63 (variant), 86 (variant); *Who's Who* '86 #13

Current: *Legion of Super-Heroes* (4) #3, 10, 11 (behind the scenes); *Who's Who* '90 #4; *Who's Who in the Legion of Super-Heroes* #4

Planet Winath

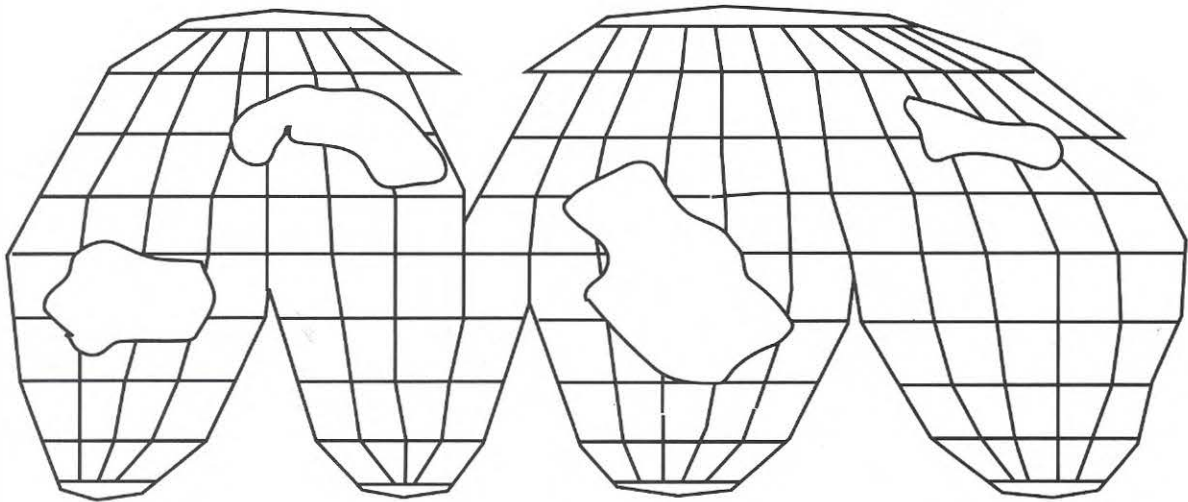

MA & PA KENT

MARTHA FORDMAN KENT

DEX: 2	STR: 1	BODY: 2
INT: 3	WILL: 2	MIND: 2
INFL: 3	AURA: 3	SPIRIT: 3
INITIATIVE: 8	HERO POINTS: 5	

- Skills:** Artist (Cooking): 3, Charisma: 4
- Advantages:** Connection: Superman (High); Scholar (Rhubarb pie—the best recipe in the whole state!)
- Drawbacks:** Age (Old)
- Motivation:** Upholding the Good
- Wealth:** 4

JONATHAN KENT

DEX: 2	STR: 2	BODY: 2
INT: 3	WILL: 2	MIND: 2
INFL: 3	AURA: 3	SPIRIT: 3
INITIATIVE: 8	HERO POINTS: 5	

- Skills:** Animal Handling: 2, Weaponry (Firearms): 2
- Advantages:** Connection: Superman (High); Scholar (Farming, Science-fiction literature)
- Drawbacks:** Age (Old)
- Motivation:** Upholding the Good
- Wealth:** 4

Ma and Pa Kent and Superman

Ma and Pa Kent remain a stabilizing influence in Superman's often chaotic life. Whenever he is troubled, Superman is compelled to visit them (treat as a Minor Irrational Attraction). Should either Ma or Pa Kent die, Superman immediately pays a 50 Hero Point "grief" fee.

Powers and Abilities

Jonathan Kent is not only a successful farmer, he is a crack shot with a rifle and very good with animals. He is also well-educated, being especially knowledgeable about literature, which is one of his greatest loves. Over the years, this passion has allowed him to develop the abilities of an accomplished storyteller.

Martha Kent is a natural born charmer, and a marvelous cook to boot. With her genuine personality and giving nature, she inspires confidence and trust.

Personality/Role-playing

Jonathan and Martha Kent must be among the most understanding parents in America. Not only did they manage to raise a young orphan, but they instilled in him a strong sense of morals and responsibility that led him to become the world's greatest hero.

The Kents are a typical American farming family. Hard working, they have successfully run a farm for decades while simultaneously raising a child.

Pa Kent is quick with a joke and loves the lifestyle he has created. He is something of a workaholic, and proud (but not pompous) about his accomplishments. Jonathan's main concern is protecting his farm and family, even against powers only Superman himself can handle.

Martha is a generous and loving woman, quick to offer words of support or advice. She cares for Pa, making sure he does not work too hard and that he always has a full glass of lemonade. Ma and Pa are Superman's truest friends and closest confidants. Only at home with his family can the Man of Steel be little Clark Kent again.

Using Ma and Pa Kent in Adventures

Let's face it, everyone who reads comics knows that Superman is Clark Kent. However, in this role-playing game, the Player Characters are not privy to this information. Ma and Pa Kent are good for tantalizing the players with this sacred information.

The player heroes might meet the Kents as a result of an accident that leaves the heroes stranded somewhere near Smallville, Kansas. Perhaps Pa will drive by and take the heroes home for dinner and help them solve their transportation problems. Of course, Ma is smart enough to keep all the couple's Superman paraphernalia hidden or to explain away those few items that can't be hidden. The Kents' "cover-up" might lead to lots of entertaining interplay.

Subplots

Ma and Pa Kent are Family Subplot Characters for Superman. If anything goes wrong with them, he jumps right in to save or help them. He's a good son, and although he has never disobeyed them, they still worry about him.

Appearances in the DC HEROES Role-Playing Game, Second Edition

Background/Roster Book, Atlas of the DC Universe, Superman—The Man of Steel Sourcebook

Appearances in DC Comics

***Note:** Pre-Crisis appearances are not part of present continuity.

Pre-Crisis—Earth Two: *Action Comics* #106, 132, 141, 158, 172, 186, 189; *The New Adventures of Superboy* #15-16; *Secret Origins* #1; *Superman* (1) #1, 53, 57, 61, 73, 74, 90, 105; *World's Finest Comics* #57, 69

Pre-Crisis—Earth One: *Action Comics* #242, 288, 337, 399, 469, 494, 500, 507-508, 538, 558; *Adventure Comics* #149, 211, 217-219, 224-225, 236, 238, 240, 242, 247-248, 251, 257, 259-260, 262, 267, 269-274, 276-278, 281-286, 288-294, 296-298,

301, 304-309, 311-315, 369-370, 378; 453-458; *The Amazing World of Superman*; *The Brave and The Bold* #192; *DC Super-Stars* #12; *The New Adventures of Superboy* #1-2, 4-19, 21-54; *Superboy* (1) #1-100 (most issues), 102-122, 124-126, 128, 130-131, 133-134, 137, 139-140, 142, 144-146, 148, 150-151, 153-155, 157, 159, 161-162, 164, 167-170, 173, 175-180, 182, 184, 186-187, 189, 192-194, 196, 208, 255; *Superman* (1) #130, 141, 152, 161, 249, 286, 296, 318, 327, 362, 369, 380; *Superman Annual* (1) #10; *Superman Family* #182, 191-197, 216; *Superman: The Secret Years* #1, 4; *World's Finest Comics* #84, 285, 300

Current: *Action Comics* #596-597, 644, 652, 653 (background only), 655, 667, 668 (Pa), 669; *Action Comics Annual* #3 (Pa); *Adventures of Superman* #430, 436, 440 (Ma), 445-446 (Pa), 448, 450-451, 453-454, 456-457, 462-465, 468-469, 474, 480, 482, 486; *Man of Steel* #1, 6; *Superman* (2) #2, 8, 12, 20-22, 30, 33-34, 41, 45, 50 (Ma), 57, 59; *Superman For Earth*; *Superman: The Man of Steel* #1, 3; *World of Smallville* #1-4; *Who's Who* '88 #4; *Who's Who* '90 #1

Smallville

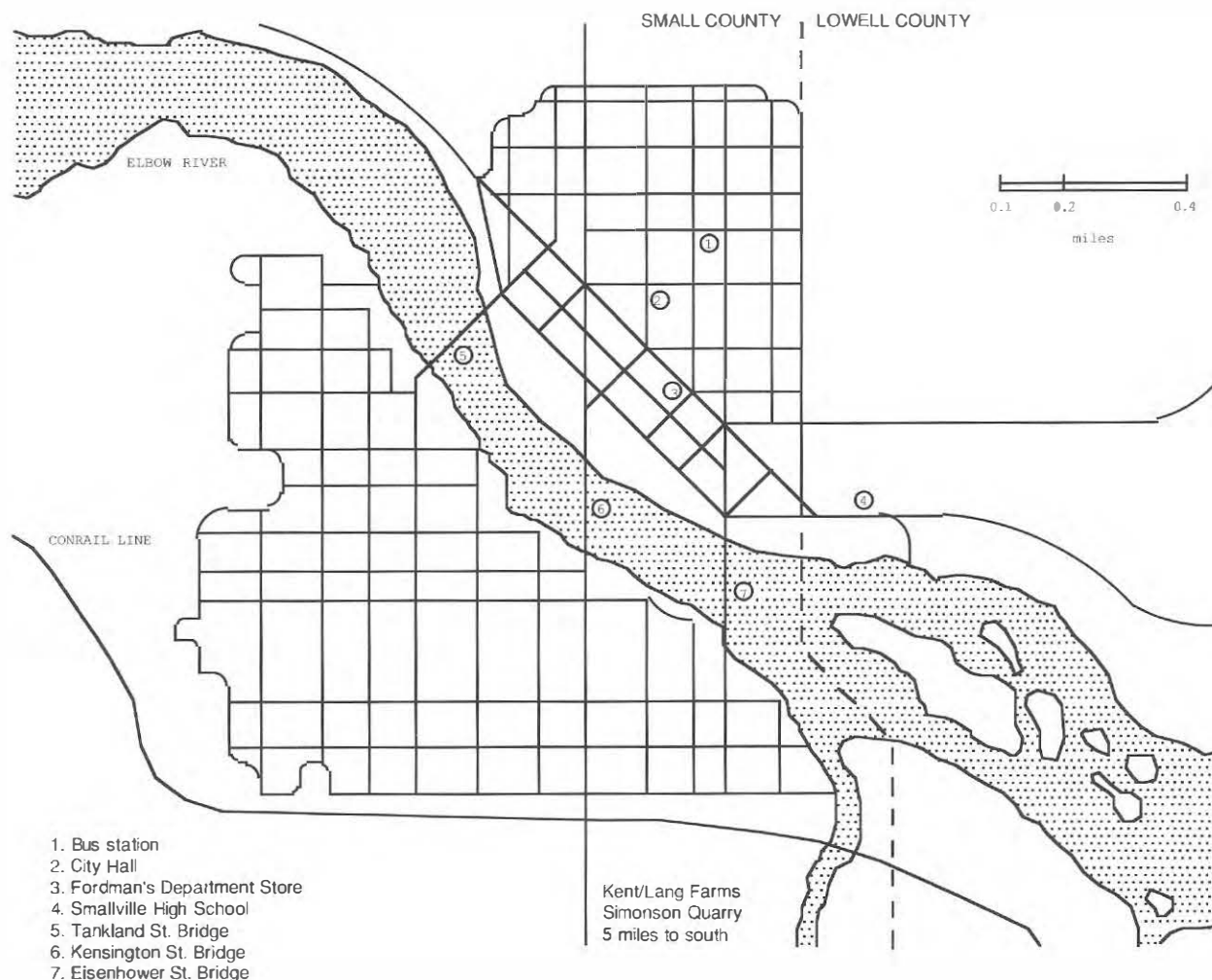

MAXWELL LORD

DEX: 2	STR: 2	BODY: 2
INT: 11	WILL: 7	MIND: 5
INFL: 8	AURA: 8	SPIRIT: 3
INITIATIVE: 21	HERO POINTS: 45	

- Powers:** Hypnosis: 15 (see below)
- Bonuses:** Miscellaneous: Max can implant hypnotic suggestions telepathically (without speaking to the target) over great distances (range of 15 APs).
- Limitations:** Miscellaneous: every time Lord uses his Hypnosis Power, his nose bleeds.
- Skills:** Charisma: 10
- Advantages:** Connections: Justice League International (High), United Nations (High); Gift of Gab; Omni-Connection
- Alter Ego:** None
- Motivation:** Seeking Justice
- Wealth:** 13

Lord's Statistics

As a result of character growth, Maxwell Lord's statistics have changed, primarily in improved Attributes, from those published previously.

Powers and Abilities

Maxwell Lord recently developed the ability to "push" people subconsciously. He can implant a suggestion into someone's subconscious mind, forcing the target to suddenly get an idea, hear something, or have a change of heart. Although Lord doesn't really need to use this ability to persuade people to do what he wants, it sometimes gives him an edge. When he uses the Power, however, it gives him a noticeable nosebleed.

Specifics on Max's Hypnotic Powers

After the Dominators exploded their Gene Bomb, Max developed the Power to influence the subconscious minds of others. But with his Power, Max can never force a mind to accept something completely alien to it. For instance, he could never force Martian Manhunter to believe himself to be a badger, or hypnotize Blue Beetle into believing he is

the President of the United States. But he might possibly persuade Beetle to quit the Justice League, or convince the Manhunter that some of his teammates don't like him. If he wishes, Max can substitute his APs of Power for his AV and EV when making Persuasion attempts (this is considered a "use" of the Power, so it will cause Max's nose to bleed).

Just recently, Max informed the Justice League that he no longer has this ability. Whether this is true or not remains to be seen.

Personality/Role-playing

Maxwell Lord is one of the most conniving, manipulative, hard-nosed, and (often) ruthless businessmen in the DC Universe. He is a shrewd dealer, a fast talker, and one of the best things that ever happened to Justice League International.

Although Lord was once an uncaring entrepreneur, he had a change of character after an encounter with an alien super-computer. Frustrated by his own shortcomings as a person, he has now fully invested himself in the Justice League. Because he dreams secretly of being a hero himself, he is determined to make the Justice League work, and he'll use any means he can to do so.

The Leaguers themselves have finally forgiven Max for his past failings. There is a bond among them, and Lord now considers the League members to be his friends, particularly Martian Manhunter. Still, most of the time he tries to keep his personal life separate from those of the team.

Using Maxwell Lord in Adventures

Maxwell Lord is a schemer and troublemaker. He might try to recruit the player heroes for a mission that the Justice League is ostensibly unable to undertake. Such missions often hold a great number of surprises.

Subplots

Maxwell Lord has many enemies, some known and some unknown. Hitmen threaten his life constantly. He is often involved in Subplots regarding these Enemies and his Friends in the Justice League.

**Appearances in the DC HEROES
Role-Playing Game, Second Edition**

Background/Roster Book, Justice League Sourcebook

Appearances in DC Comics

Adventures of Superman #449; *Booster Gold* #16; *Captain Atom* (3) #22, 24-25; *Detective Comics* #595; *Doom Patrol* #25 (behind the scenes); *Green*

Lantern (3) #9; *Hawkworld* (2) #23; *Invasion!* #1-3; *Justice League* #1-4, 6; *Justice League America* #26-27, 29-31, 33-35, 37, 40-47, 49-50, 52-55, 57, 59-63; *Justice League Annual* #3-5; *Justice League Europe* #1, 4-5, 13 (behind the scenes), 17, 19, 20 (behind the scenes), 21, 31-36; *Justice League International* #7, 9, 11-14, 16, 19-22, 24-25; *Justice League Quarterly* #1, 2 (behind the scenes), 3-4; *Mister Miracle* (2) #11, 17, 25-26; *Power of The Atom* #5; *Secret Origins* (3) #35; *Suicide Squad* #13; *Who's Who '88* #4; *Who's Who '90* #2

Maxwell Lord's Office

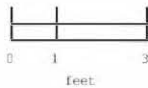
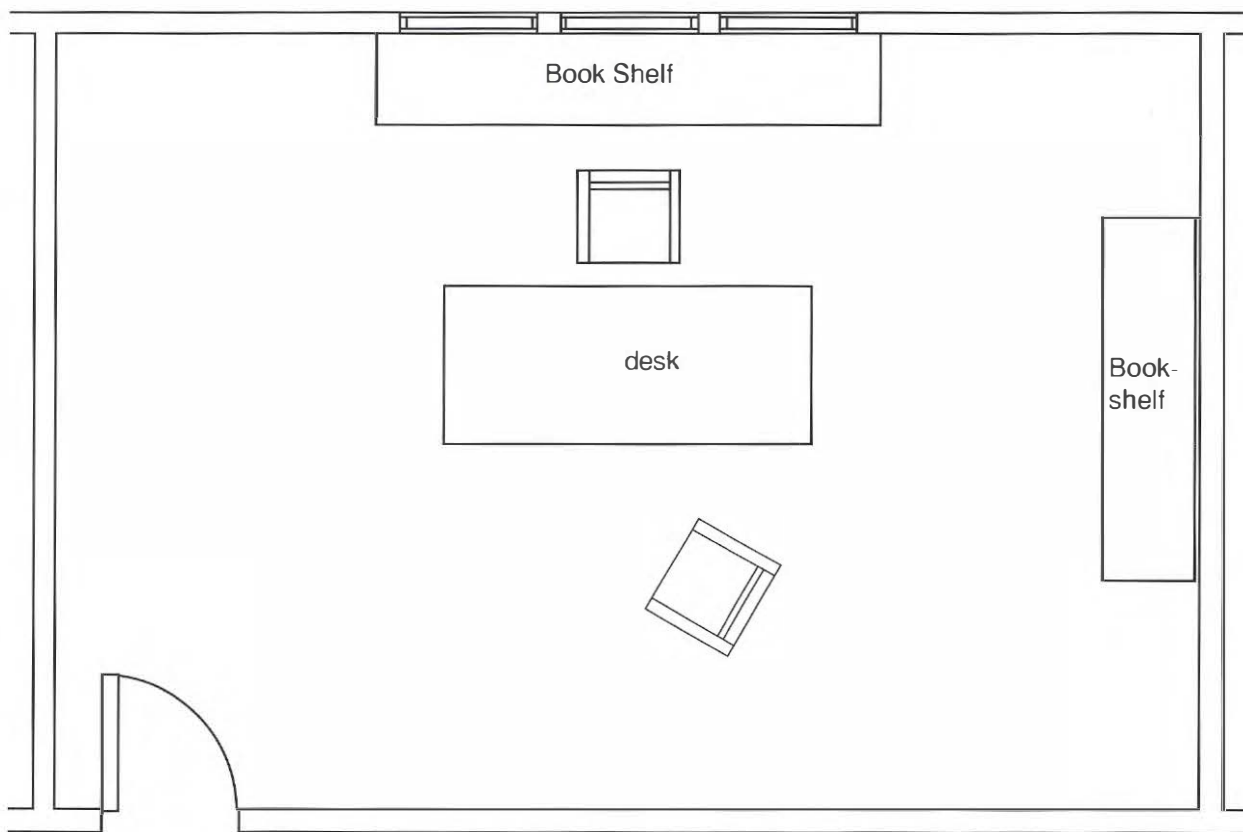

BLUE BEETLE'S BUG

DEX: 5	STR: 10	BODY: 10
INT: 10	WILL: 3	MIND: 0

Features

- Computer:** The Bug has a powerful computer [INT: 10, WILL: 3, Recall: 20].
- Fuel Requirements:** The Bug is completely solar-powered and capable of operating almost a month without maintenance [Solar Sustenance: 20].
- Hull Protection:** The Bug has an armored hull and magnetic deflector shields [BODY: 10, Force Shield: 5]. Blue Beetle can also electrify the Bug's hull [Lightning: 10; attacks anyone who touches the hull].
- Legs:** The Bug's "legs" are sharp and capable of functioning like pincers [Claws: 8; use the Bug's DEX as AV]. The Bug's two forelegs can also grasp, hold, and even throw objects [Extra Limb (x2): 10; the forelegs use the Bug's DEX as their AV].
- Offensive Weaponry:** The Bug can project beams of magnetic or solar energy [Magnetic Control: 9, Heat Vision: 9; Magnetic Control can also be used to magnetize the Bug's hull].
- Sealed Environment:** The Bug is a sealed environment, capable of remaining underwater for a day before coming up for air [Sealed Systems: 15].
- Sensors:** The Bug features a full range of sensors [Directional Hearing: 10, Extended Hearing: 6, Full Vision: 6, Radar Sense: 12, Super Hearing: 12, Telescopic Vision: 5, Ultra Vision: 10].
- Stealth:** The Bug is both streamlined for silent operation [Thief (Stealth): 8] and highly maneuverable [the Bug's DEX of 5 provides the operator with a "Team Attack" bonus of -1 Column Shift to the OV of all piloting rolls].

- Supersonic Flight:** The Bug is capable of supersonic flight [Flight: 11].
- Underwater Speed:** While underwater, the Bug can attain speeds of up to 60 miles per hour [Swimming: 6].

Description/Role-playing

Presently, Blue Beetle uses the Bug to transport the Justice League America and conduct reconnaissance at battle scenes. Since joining the JLI, he has added enough seats to carry the whole team. In fact, when Beetle applied to join the League, the Bug was one of his selling points. With it, he becomes super-human in a way, controlling its mechanisms as easily as he controls his own body.

After joining the JLI, Blue Beetle lined the Bug with personal items to make it more "homey." Now, he can listen to classic rock while the other Leaguers are fighting Despero.

Appearances in the DC HEROES Role-Playing Game, Second Edition

Background/Roster Book, Justice League Sourcebook

Appearances in DC Comics

Blue Beetle (6) #1-7, 9-24; Booster Gold #22, 25; Captain Atom (3) #2; Crisis On Infinite Earths #1, 3, 6-7, 9; Firestorm Annual #5; Invasion! #2; Justice League #1-3, 5; Justice League America #42, 47, 61, 63; Justice League Annual #1; Justice League Europe #34; Justice League International #7, 19, 25; Justice League Special #2; Legends #2, 4-5; Millennium #2, 8; Mister Miracle (2) #7-8, 25; Secret Origins (3) #2; Starman #6; The Weird #1-2; Who's Who '90 #1

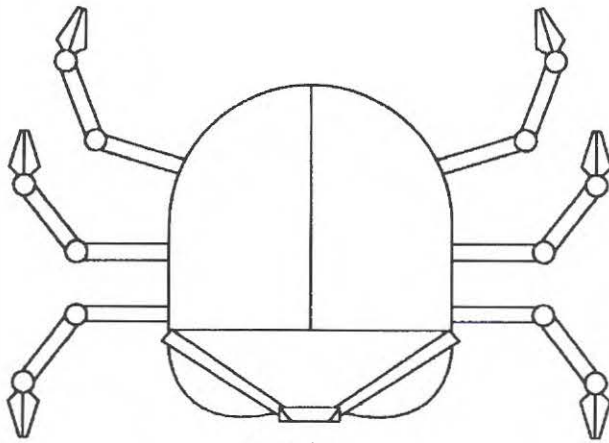

top view

extra seating

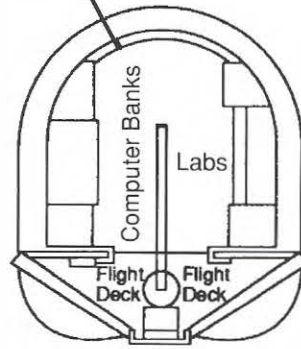

interior view

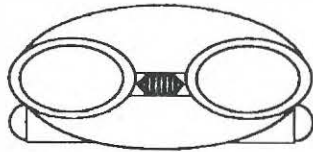

front view

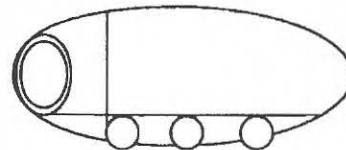

side view

MOTHER BOX

DEX: —	STR: —	BODY: 7
INT: 10	WILL: 6	MIND: 6
INFL: 6	AURA: 6	SPIRIT: 6
HERO POINTS: 75		

- Powers:** Danger Sense: 12, Life Sense: 6, Omni-Power: 11
- Advantages:** Leadership

Special Rules for Mother Box Use

Mother Boxes are the free-thinking, living computers employed by the New Gods of New Genesis. In a sense, Mother Box is a special Omni-Gadget that can be used over and over again.

Because Mother Box has the Leadership Advantage, she can automatically transfer her Hero Points to her user. In addition, through his affection for Mother Box, the user can transfer Hero Points back to her. To do so, the user must make a successful Action Check using his INFL/AURA as the AV/EV against an OV/RV of 6/6 (Mother Box's SPIRIT). Only one such attempt is allowed per day. Note that all Hero Points spent to enable Mother Box to use her Omni-Power must come from Mother Box herself.

The user's affection can also repair a Mother Box. Treat this as a normal Repair attempt, though no tools are necessary, and the user's INFL/AURA are used as the AV/EV of the attempt.

Any Character who possesses both a Mother Box and a sample of X-Element can automatically create a Boom Tube capable of transporting him between dimensions and galaxies. Boom Tubes have the Warp Power rated at 65 APs, the Dimension Travel Power rated at 8 APs, and remain open for approximately 8 seconds (1 AP).

Finally, only Characters who are spiritually worthy can use Mother Boxes. In game terms, this means only Characters with heroic Motivations (Upholding the Good, Seeking Justice, Thrill of Adventure, Responsibility of Power, etc.) can use a box; those with villainous Motivations cannot.

How Characters Use the Mother Box

The New Gods use the Mother Box in many ways, and some have special uses for the wondrous mechanism. Orion, for instance, uses his Mother Box

to help calm him, while the Forever People use their Mother Box to help them form the Infinity Man.

All Mother Boxes are capable of transforming matter, sensing living beings, and warning their users of imminent peril.

Lightray, Mister Miracle (Scott Free), and others integrate their Mother Boxes into their costumes to protect them.

Appearances in the DC HEROES Role-Playing Game, Second Edition

Apokolips Sourcebook, Law of Darkness

Appearances in DC Comics

Action Comics #586, 593, 675; *Adventures of Superman* #489; *Adventure Comics* #459-460; *Blue Beetle* (6) #21; *The Brave and The Bold* (1) #112; *Cosmic Odyssey* #1; *DC Graphic Novel* #4; *Forever People* (1) #1-11 (2) 1-6; *Justice League America* #29-30; *Justice League International* #11, 15; *Justice League of America* #183; *Mister Miracle* (1) #9, 11, 15, 19-20, 23 (2) 2-3, 9, 11-12, 14-18, 21-24, 27; *New Gods* (1) #2-6, 13-18 (3) 1-2, 4-6, 9, 12-16, 23-24, 27; *Superman* (2) #65; *Superman: The Man of Steel* #10; *Super-Team Family* #15; *Swamp Thing* (2) #62; *Warlord Annual* #6; *Who's Who '86* #16; *Who's Who '90* #2

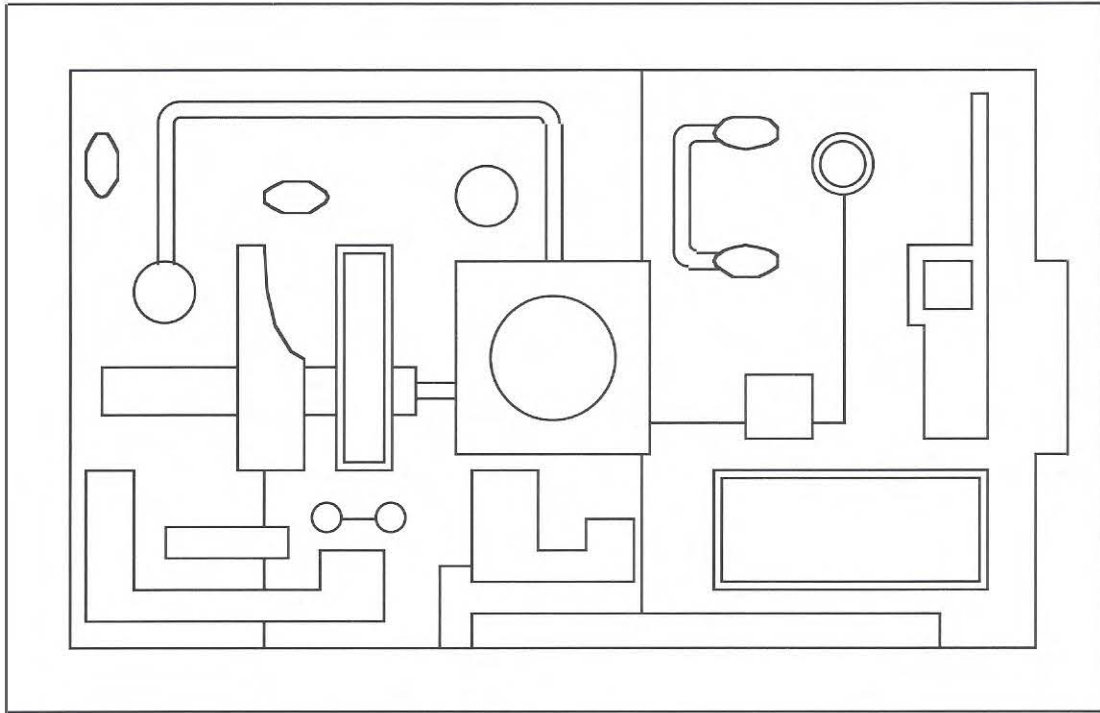

front view

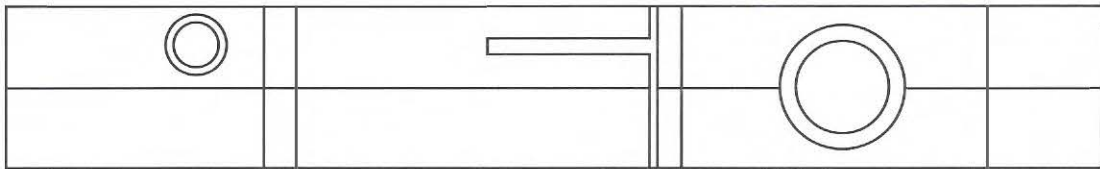

side view

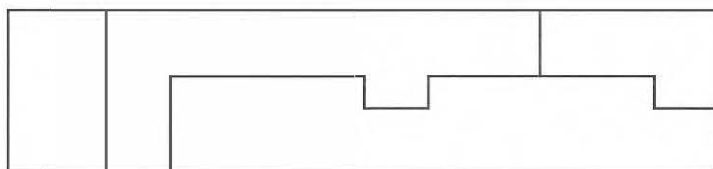

top view

S.T.A.R. LABS

TYPICAL S.T.A.R. LABS SCIENTIST

DEX: 2	STR: 2	BODY: 2
INT: 6	WILL: 5	MIND: 3
INFL: 2	AURA: 2	SPIRIT: 2
INITIATIVE: 10		

- Skills:** Gadgetry: 6, Scientist: 6
- Advantages:** Scholar (specialty of own facility)

S.T.A.R. LABS SECURITY OFFICER

DEX: 3	STR: 3	BODY: 3
INT: 2	WILL: 2	MIND: 2
INFL: 2	AURA: 2	SPIRIT: 2
INITIATIVE: 7		

- Skills:** Weaponry: 3

DR. JENET KLYBURN

DEX: 2	STR: 2	BODY: 2
INT: 7	WILL: 7	MIND: 3
INFL: 4	AURA: 3	SPIRIT: 2
INITIATIVE: 13	HERO POINTS: 10	

- Skills:** Gadgetry: 8, Scientist: 7
 - Advantages:** Genius
- Klyburn is the director of S.T.A.R.'s New York facility.

Typical S.T.A.R. Labs Facility

The typical S.T.A.R. Labs facility has the following features:

- Laboratory:** Each facility has a laboratory rated at 16 APs. S.T.A.R.'s (now destroyed) main facility in Metropolis featured a lab rated at 20 APs.
- Security Systems:** The typical S.T.A.R. Labs building has security systems rated at 9 APs (11 APs for the Metropolis main facility).
- Top Personnel:** Each facility has between ten and 100 research scientists (as described above). Each scientist has the Scholar Advantage in the field in which his facility specializes (see the list of facilities). At least one scientist at each branch has the Genius Advantage, allowing the branch to produce the most advanced equipment imaginable. Every location also has approximately twice as many security officers as scientific personnel.

- Funding:** Each S.T.A.R. facility has an individual Wealth rating of 16 for funding projects.

Connections with S.T.A.R. Labs

With the Gamemaster's permission, Characters who have High-level Connections with S.T.A.R. Labs can Persuade S.T.A.R. scientists to Repair and Construct Gadgets. Due to recent budget restrictions, however, all such Persuasion attempts are now considered Strenuous (+3 Column Shifts to the OV and RV).

Some of the Largest Facilities Are:

- Central City:** Concentration of meta-human studies; Connection: Flash (High)
- Chicago:** High-tech manufacturing; Connection: Blue Beetle (High)
- Gotham:** Bioengineering and bio-weaponry; Connection: Wayne Enterprises (Low)
- New York:** Concentration of meta-human studies; Connection: New Titans (High)
- Metropolis:** Downtown Facility—Administrative offices and various research; Queensland Park Facility—Marine biology. **Note:** The Metropolis Downtown Facility was destroyed during the *Armageddon 2001* saga. It is currently being rebuilt outside the downtown area.
- Phoenix:** Meta-human research, geophysics, meteorology, natural disasters; Connections: Rampage (High), Starman (High)
- San Diego:** Chemical engineering, chemical warfare; Connection: Animal Man (Low); Director: Dr. Myers
- San Francisco:** Meta-human research; Connections: New Titans (Low), Red Star (High), Thunder & Lightning (High)
- Seattle:** Psychology, psionics; Connection: Green Arrow (Low)

Using S.T.A.R. Labs in Adventures

A S.T.A.R. Labs facility is a good setting for an Adventure. Perhaps a scientific experiment goes awry, and the player heroes are called in to help solve the problem. S.T.A.R. Labs is also a good place for the heroes to gain information and seek help on scientific matters. Because the scientists at these facilities are always willing to learn something new, it wouldn't be too difficult for the heroes to interest

S.T.A.R. personnel in some new scientific phenomenon they've encountered.

Appearances in DC Comics

***Note:** Pre-Crisis appearances are not part of present continuity.

Pre-Crisis: *Action Comics* #426, 439-440, 442 (mention), 454, 456, 464, 480 (behind the scenes), 487, 503, 508, 513 (behind the scenes), 522, 525, 532-533, 536-537, 539, 552 (behind the scenes), 574, 581; *Adventure Comics* #454, 459, 464, 472; *Batman* #305, 308, 316, 358; *Batman and the Outsiders* #4; *Blue Devil* #2-3, 17; *The Brave and The Bold* (1) #147, 160, 179; *Crisis On Infinite Earths* #9; *The Daring New Adventures of Supergirl* #4 and 13 (both behind the scenes); *DC Comics Presents* #3-5, 8, 17, 23-24, 26, 35, 48, 50, 55, 57, 90, 93-94; *Detective Comics* #468, 478-479; *The Flash* (1) #212, 285, 288, 296; *The Fury of Firestorm* #20 (behind the scenes); *The Fury of Firestorm Annual* #1; *Green Lantern* (2) #174 (behind the scenes), 175-177; *The Joker* #8; *Justice League of America* #125, 130-131, 154 (behind the scenes), 162, 173-174, 181 (mention), 221, 24; *Justice League of America Annual* #3; *Karate Kid* #11 (behind the scenes), 12-14; *The New Teen Titans* (1) #2, 3 (behind the scenes), 7, 17, 32, 36 (2) 13; *Phantom Zone* #1; *Red Tornado* #2; *Secret Society of Super-Villains* #10, 12-13; *Super Friends* #1-2; *Superman* (1) #246, 251, 253, 258, 274, 290, 293, 303-304, 310, 312, 315-316, 323, 326, 331, 342, 345, 347, 355, 370, 378, 396, 399, 403 (behind the scenes), 407; *Superman Family* #178, 185, 187-189, 192, 194-195, 202 (behind the scenes), 203, 221 (behind the scenes); *Superman Spectacular* #1; *Tales*

of the New Teen Titans #1; *Tales of the Teen Titans* #51-54, 56-58; *Who's Who '86* #20; *Wonder Woman* (1) #322-323; *World's Finest Comics* #258, 266, 276-277, 294, 301, 308

Current: *Action Comics* #622, 644, 650-651 (behind the scenes), 670; *Adventures of Superman* #450, 452-454, 459, 464, 482-484; *Animal Man* #1-4, 33 (behind the scenes), 35-36, 41-43, 47; *Aquaman* (4) #6 (mention); *Armageddon 2001* #2; *Blue Beetle* (6) #1-4, 6, 9, 11-12, 14-19; *Blue Devil* #22 (behind the scenes), 25, 28; *Booster Gold* #1-2, 6-7 (behind the scenes), 11, 13, 16 (behind the scenes); *Detective Comics* #595, 607; *Doctor Fate* (2) #26 (mention); *Firestorm* (2) #94 (behind the scenes), 99 (mention); *Firestorm, the Nuclear Man* #76-77, 82 (behind the scenes), 91 (behind the scenes); *Flash* (2) #1 (behind the scenes), 3-4, 14 (mention), 50; *The Fury of Firestorm* #58; *Hawk and Dove* (3) #2, 19-20 (behind the scenes); *Hawk and Dove Annual* #1; *Justice League* #1; *Justice League Annual* #2; *Justice League International* #7-8, 11, 15 (all behind the scenes); *Justice League Quarterly* #1; *The New Teen Titans* (2) #19, 22 (behind the scenes), 24, 29, 33, 36-37, 41-43, 45-49; *The New Titans* #55-56, 58-59, 62-65, 66 (behind the scenes), 79, 81, 85-86; *The New Titans Annual* #5; *The Outsiders* #25-26, 28; *Peacemaker* (2) #2 (text); *The Phantom Stranger* (3) #1-2; *Secret Origins* (3) #4, 28 (see *Who's Who '88* #3, p. 5), 37, 46; *Secret Origins Annual* #3; *Starman* #7, 13-14, 19-21, 25, 32-33, 35 (behind the scenes), 36-39; *Superman* (2) #24, 30-31, 37, 61; *Superman: The Man of Steel* #4-5; *Swamp Thing Annual* #4; *Teen Titans Spotlight* #9, 16-17; *War of the Gods* #1-2, 4; *The Weird* #1-2, 4; *Who's Who '90* #4

Main U.S. locations of S.T.A.R. Labs

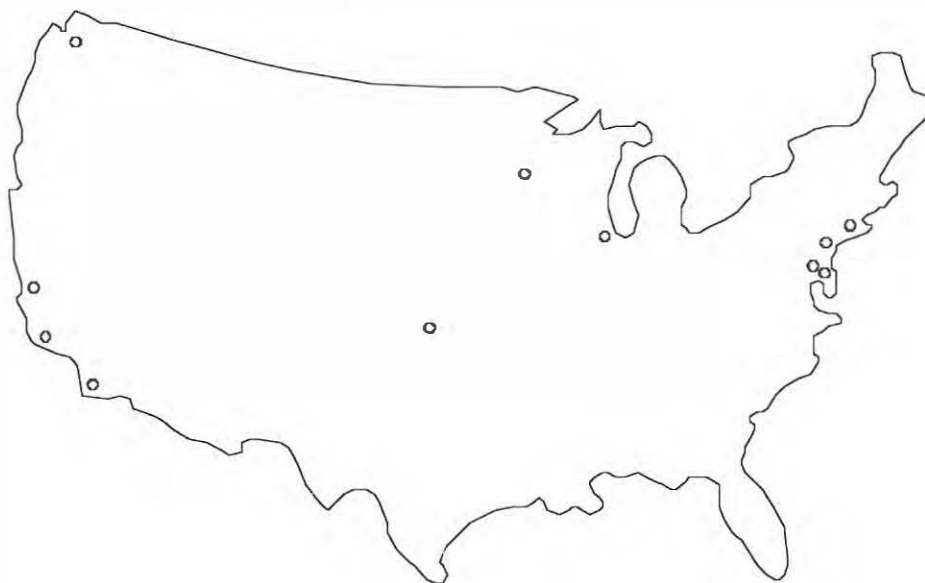

APOKOLIPS

PARADEMON CAPTAINS

DEX: 6	STR: 6	BODY: 7
INT: 3	WILL: 4	MIND: 2
INFL: 3	AURA: 3	SPIRIT: 2
INITIATIVE: 12	HERO POINTS: 5	

- Powers:** Flight: 8
- Skills:** Military Science: 5, Vehicles: 6, Weaponry: 6
- Advantages:** Leadership

PARADEMON FOOTSOLDIERS

DEX: 6	STR: 6	BODY: 6
INT: 2	WILL: 3	MIND: 2
INFL: 2	AURA: 2	SPIRIT: 2
INITIATIVE: 10	HERO POINTS: 0	

- Powers:** Flight: 8
- Skills:** Military Science: 4, Vehicles: 6, Weaponry: 6

DOG CAVALRYMAN

DEX: 6	STR: 6	BODY: 6
INT: 3	WILL: 2	MIND: 2
INFL: 3	AURA: 2	SPIRIT: 2
INITIATIVE: 12	HERO POINTS: 5	

- Skills:** Animal Handling: 7, Military Science: 5, Vehicles: 4, Weaponry: 6
- Drawbacks:** Serious Irrational Attraction to violence
- Equipment:** UNIFORM [BODY: 7, Skin Armor: 3]

DOG MOUNT

DEX: 5	STR: 6	BODY: 8
INT: 1	WILL: 2	MIND: 2
INFL: 2	AURA: 2	SPIRIT: 2
INITIATIVE: 8		

- Powers:** Claws: 9, Running: 5

TYPICAL "HUNGER DOG"

DEX: 2	STR: 2	BODY: 2
INT: 2	WILL: 2	MIND: 2
INFL: 2	AURA: 2	SPIRIT: 1
INITIATIVE: 6	HERO POINTS: 0	

- Skills:** Thief (Stealth): 5

Apokolips Weaponry

Standard Blaster [EV: 5, BODY: 3, R#: 2]
 Heavy Blaster [EV: 8, BODY: 3, R#: 2]
 Extra Heavy Blaster [EV: 12, BODY: 3, R#: 2]
 WAR DOG ROBOT [DEX: 8, STR: 8, BODY: 10, INT: 2, WILL: 1, MIND: 1, Claws: 9, Skin Armor: 4]

Description/Role-playing

Apokolips is a planet of unspeakable pain and deprivation. The entire population lives and dies to serve a malevolent dictator, Darkseid the Destroyer.

Hidden forever in the shadow of New Genesis, its lush, verdant twin, Apokolips wallows in barrenness and desolation. If there ever was a natural ecology, it has long since been overrun with cities so large they combine to create a world of man-made machines, edifices, and sprawling factories that build weapons of war and other destructive devices. Apokolips is powered by nuclear "fire-pits" from which towers of radioactive flame burst forth, visible even from orbit. Waste and unusable machinery are thrown into the pits, and unfortunate "lowlies" or "hunger dogs," dredge out what is left to use in new constructs.

Living conditions on Apokolips are terrible, and simple existence is a chore for most lowlies. The majority of inhabitants do not have the comforts of the extremely high level of technology on their world. Most lowlies are lucky to live in shanties or run-down apartments. The planet's surface is filthy and almost uninhabitable, and beneath it live horrible creatures the residents hope never to face.

Visitors to Apokolips are easily lost in the maze of machinery and buildings that decorate the patchwork planet. The inhabitants are not friendly, since they only care for their survival, and those obviously not from the area are quickly apprehended or destroyed by some paramilitary patrol.

Darkseid lives in relative luxury, and from his Tower of Rage he views the city and its poorest area, Armagetto.

Hazards

Life on Apokolips is perilous. Visitors to this world can look forward to: acid rain storms (all unprotected Characters are attacked with the Acid Power at 1-7 APs); clouds of poisonous gas (Poison

Touch of 3-8 APs); horrible diseases (physical attacks with EVs ranging from 1-8); high winds (subtract 2 APs from all movement rates when moving against the wind); and confusing geography (periodic Perception Checks against an OV/RV of 5/5 to avoid getting lost).

Using Apokolips in Adventures

Apokolips is a role-playing gauntlet. It is probably the most challenging setting in the DC Universe and is well-suited for testing a Character's mettle. Just staying alive here presents several unique challenges.

Appearances in the DC HEROES Role-Playing Game, Second Edition

Apokolips Sourcebook, Background/Roster Book, Law of Darkness

Appearances in DC Comics

***Note:** Pre-Crisis appearances are not part of present continuity.

Pre-Crisis: *Adventure Comics* #459-460; *Crisis on Infinite Earths* #8, 12; *DC Graphic Novel* #4; *DC Special Series* #10; *First Issue Special* #13; *Forever People* (1) #6; *Justice League of America* #183-185; *Legion of Super-Heroes* (2) #287, 289-290, 293-294; *Legion of Super-Heroes Annual* (2) #1; *Mister Miracle* (1) #5-9, 21-22, 24-25; *New Gods* (1) #1, 7, 12-14, 16-19, (2) 6; *Superman's Pal, Jimmy Olsen* #141; *Super-Team Family* #15; *Who's Who '85* #1

Current: *Action Comics* #586, 592; *Adventures of Superman* #426; *Cosmic Odyssey* #1, 4; *Doctor Fate* (2) #11-12; *The Fury of Firestorm* #58; *Justice League International* #19-21; *Legends* #1-6; *Millennium* #8; *Mister Miracle* (2) 17-18; *New Gods* (3) 1-3, 5-13, 15-17, 19-28; *Secret Origins* (3) #33; *Suicide Squad* #3, 34-36; *Superman* (2) #3; *Swamp Thing* (2) #62; *Warlord* (1) #121; *Warlord Annual* #6; *War of the Gods* #3-4; *Who's Who '90* #3

Apokolips

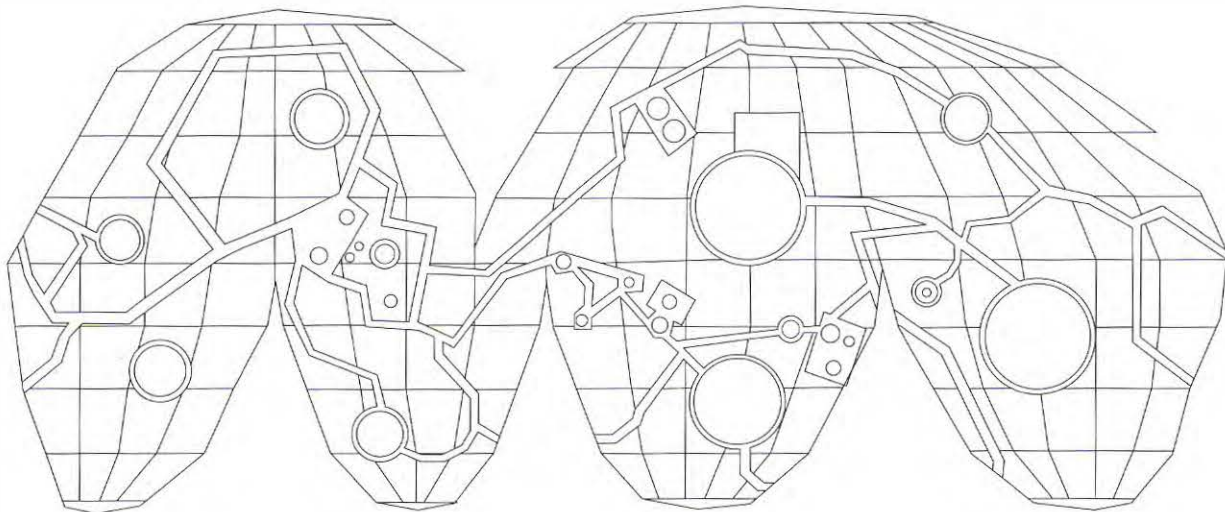

ATLANTIS

First Age Personalities

LORD ARION

DEX: 6	STR: 4	BODY: 6
INT: 8	WILL: 10	MIND: 9
INFL: 10	AURA: 13	SPIRIT: 11
INITIATIVE: 26	HERO POINTS: 75	

•**Powers:** **Mystic Linked*

Danger Sense: 9*, Energy Absorption: 2*, Illusion: 8*, Magic Sense: 9, Power Reserve: 8*, Sorcery: 8

•**Skills:** Animal Handling: 4, Martial Artist: 6, Occultist: 7, Weaponry: 6

•**Limitations:** Miscellaneous: Power Reserve can only be used in conjunction with Sorcery. Arion's Power Reserve begins at 0 APs. The APs of energy he absorbs using Energy Absorption are added to his Power Reserve until it reaches its full capacity of 8 APs. Arion retains absorbed energy for 8 APs of time.

•**Advantages:** Area Knowledge (Atlantis); Connection: Atlantis (High); Leadership; Popularity

•**Drawbacks:** Authority Figure

•**Alter Ego:** None

•**Motivation:** Upholding the Good

•**Wealth:** 10

GARN DANUETH

DEX: 5	STR: 4	BODY: 5
INT: 8	WILL: 9	MIND: 8
INFL: 10	AURA: 12	SPIRIT: 10
INITIATIVE: 25	HERO POINTS: 75	

•**Powers:** **Mystic Linked*

Control: 10*, Energy Absorption: 2*, Flight: 8*, Magic Blast: 10, Power Reserve: 6*, Sorcery: 7, Spirit Travel: 12

•**Skills:** Animal Handling: 3, Martial Artist: 6, Occultist: 6, Weaponry: 6

•**Limitations:** Miscellaneous: Power Reserve can only be used in conjunction with Sorcery. Garn's Power Reserve begins at 0 APs. The APs of energy he absorbs using Energy Absorption are added to his Power Reserve until it reaches its full capacity of 8 APs. Garn retains absorbed energy for 8 APs of time.

•**Advantages:** Area Knowledge (Atlantis); Connections: Mu (High), Darkworld (Low); Leadership

•**Alter Ego:** None

•**Motivation:** Power Lust

•**Wealth:** 7

TYPICAL ATLANTEAN

DEX: 2	STR: 2	BODY: 2
INT: 3	WILL: 3	MIND: 3
INFL: 3	AURA: 3	SPIRIT: 3
INITIATIVE: 8		

•**Skills:** Animal Handling: 2, Weaponry: 2

Modern Personalities

MERA

DEX: 6	STR: 6	BODY: 7
INT: 7	WILL: 7	MIND: 5
INFL: 3	AURA: 4	SPIRIT: 4
INITIATIVE: 16 18	HERO POINTS: 25	

•**Powers:** Swimming: 6, Telepathy: 3, Water Control: 8, Water Freedom: 8

•**Skills:** Charisma: 4

•**Advantages:** Area Knowledge (Atlantis); Connections: Aquaman (High), Poseidonis (High)

•**Drawbacks:** Married; Fatal Vulnerability: Mera begins to die after being out of contact with water for one hour.

•**Alter Ego:** Mera Curry

•**Motivation:** Responsibility of Power

•**Wealth:** 8

TYPICAL MODERN ATLANTEAN

DEX: 3	STR: 3	BODY: 3
INT: 2	WILL: 2	MIND: 2
INFL: 2	AURA: 2	SPIRIT: 2
INITIATIVE: 7 9		

•**Powers:** Swimming: 4, Telepathy: 3, Water Freedom: 4

•**Drawbacks:** Fatal Vulnerability to lack of contact with water; Strange Appearance (Tritonians only)

Description

Today, most Atlanteans live in the domed cities of Poseidonis and Tritonis, located approximately 7,000 feet beneath the surface of the North Atlantic Ocean.

Other Atlantean outposts include the Domain of the Idyllists, who maintain their philosophy of pacificism despite the actions of their onetime ruler, Thar the Insane, and the cave-dwelling Savages of Maarzon, a society of primitives whose origins are unknown.

Poseidonis and Tritonis are now separate kingdoms, peacefully coexisting after a lengthy period of costly warfare. While both kingdoms possess a high degree of technological sophistication, the Tritonians tend to apply their knowledge to civil engineering and other peaceful pursuits, while Poseidonis remains more militant in its outlook. Poseidonians are often embroiled in civil and political disputes that frequently erupt into full-scale revolution.

Poseidonis has a primarily agrarian economy, having developed sophisticated salt-water hydroponic farming techniques in its huge, ocean-floor farming communes. The city trades with several surface nations but places heavy restrictions on the sale of its technological creations, which are far more advanced than those of surface technology. In recent years, the city was opened to visits from surface dwellers, but this did not last long.

Tritonis is located several hundred leagues south of Poseidonis. Its population of mer-people is less inclined to engage in aggressive behavior and directs its energies to a thorough examination of the environment and the betterment of undersea life.

Using Atlantis in Adventures

Atlantis is a great setting for Adventures and a good vehicle for the Players to meet Aquaman. Perhaps the heroes can assist Aquaman in turning back an ecological threat that endangers both the underwater cities and the surface world. The ocean is always an interesting environment in which to set an Adventure because of the limitations it places on the

Characters. Remember to refer to the rules for underwater Adventures on page 25 of the *Rules Manual*.

Appearances in the DC HEROES Role-Playing Game, Second Edition

Atlas of the DC Universe, Background/Roster Book

Appearances in DC Comics

*Note: Pre-Crisis appearances are not part of present continuity.

Pre-Crisis: *Action Comics* #230, 269-270, 276, 278, 284-286, 290, 295, 297-298, 302, 307, 309-313, 325-326, 365, 371, 475, 519; *Adventure Comics* #260, 266, 269, 280, 304, 333, 435-437, 441-444, 446-450, 461-466, 478; *Aquaman* (1) #3, 7, 14, 18-24, 28, 30, 32-36, 38, 40-43, 46-49, 51-52, 60, 62; *Arion, Lord of Atlantis* #1-35; *Arion, Lord of Atlantis Special* #1; *The Atom* #5; *Batman* #19; *The Brave and The Bold* #51, 73, 114; *Comic Cavalcade* #18; *Crisis On Infinite Earths* #1-7, 10, 12; *DC Comics Presents* #5, 46, 75; *DC Special Series* #5; *Justice League of America* #86, 90, 110, 135, 142, 146, 217; *More Fun Comics* #73; *Mystery In Space* #57; *Sensation Comics* #35; *Showcase* #30; *Superboy* (1) #52, 192, 194; *Superman* (1) #67, 117, 122, 129, 135, 138-139, 146, 148, 154, 156-158, 165, 176, 204, 266, 408; *Superman's Girl Friend, Lois Lane* #28, 42, 44; *Superman's Pal, Jimmy Olsen* #52-53, 63, 76; *Superman: The Secret Years* #2-3; *Teen Titans* #49; *Warlord* (1) #5, 15, 27, 39, 55-62, 75, 86; *Warlord Annual* #1-3; *Who's Who '85* #1; *World's Finest Comics* #29, 262, 268; *Wonder Woman* (1) #8, 57, 215

Current: *Action Comics Weekly* #617; *Aquaman* (2) #1-4, (3) 1-5, (4) 1; *Aquaman Special* (1) #1, (2) 1; *The Atlantis Chronicles* #1-7; *The Books of Magic* #1; *Doom Patrol* (2) #17; *Invasion!* #2; *Secret Origins* (3) #11; *Superman* (2) #12, 63; *Time Masters* #6-7; *Warlord* (1) #199, 121; *Who's Who '90* #1

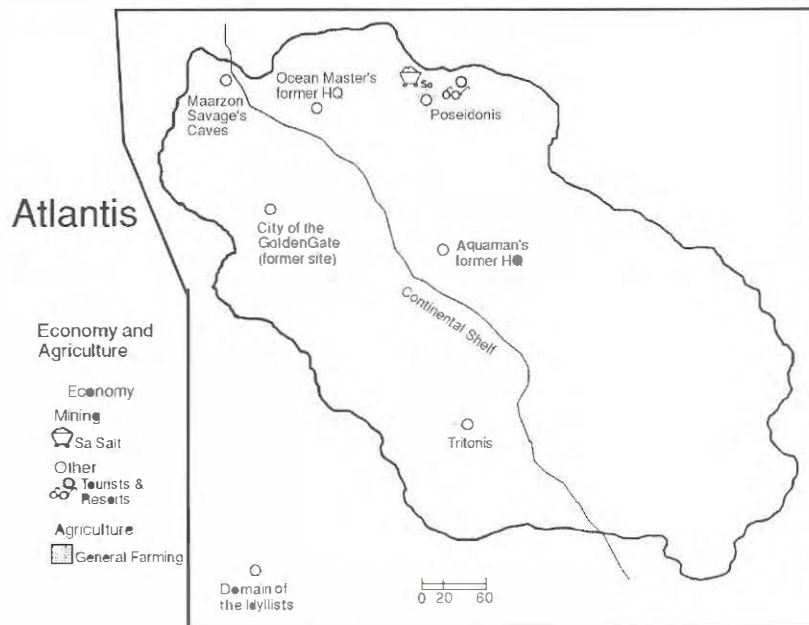

HAWKWORLD

BYTH (FORMER ADMINISTRATOR OF PROTECTION)

DEX: 9	STR: 6	BODY: 7
INT: 7	WILL: 8	MIND: 7
INFL: 4	AURA: 5	SPIRIT: 4
INITIATIVE: 22	HERO POINTS: 50	

- Powers:** Shape Change: 13
- Skills:** Charisma: 7, Detective: 7, Martial Artist: 7, Military Science: 9, Weaponry: 9
- Bonuses:** Miscellaneous: Byth's Shape Change Power allows him to assume the form of any animal he has ever seen. Byth can also use Shape Change to alter only a single part of his body, allowing him to assume parts of several forms simultaneously.
- Advantages:** Area Knowledge (Thanagar); Connections: Thanagarian Underground (High), Wingmen (Low); Leadership
- Drawbacks:** Catastrophic Irrational Attraction to the "Krotan Drug;" Serious Psychological Instability; Serious Rage
- Motivation:** Power Lust
- Wealth:** 12

TYPICAL WINGMAN

DEX: 7	STR: 5	BODY: 6
INT: 3	WILL: 5	MIND: 6
INFL: 4	AURA: 3	SPIRIT: 6
INITIATIVE: 18	HERO POINTS: 10	

- Skills:** Martial Artist: 7, Military Science: 7, Vehicles: 5, Weaponry: 7
- Advantages:** Lightning Reflexes

Wingmen Equipment

Battle Armor [BODY: 9]
 Helmet [BODY: 9, Thermal Vision: 13]
 ANTI-GRAV BELT [BODY: 9, Gravity Decrease: 7]
 Wings [STR: 6, BODY: 10, Flight: 8] The wings will not function unless used with an anti-grav belt.
 Rifle [BODY: 5, AV: 4, EV: 6, Ammo: 15, R#: 2]
 Pistol [BODY: 5, EV: 6, Ammo: 8, R#: 2]
 Mace [BODY: 9, EV: 5]

The Krotan Drug

This strange narcotic endows anyone who uses it with shape-shifting abilities (Shape Change: 13), but

all users automatically develop a Catastrophic Irrational Attraction to the drug.

Description

Thanagar is a divided society, with human masters living in gleaming, towering cities in the sky, and their alien slaves cast down into the squalor of their lower-level slums. These slums breed crime, disease, malnutrition, murder, and black market activity. The aliens are watched closely by the Thanagarian police, the Wingmen, an elite airborne corps of paramilitary personnel whose flight is made possible by artificial wings and the power of Nth Metal, an anti-gravity device.

The native Thanagarians have grown decadent, corrupt, and blind to the cruelty their society forces on enslaved aliens. Even the Wingmen police command is corrupt, with officials recently involved in the drug trade that plagues the alien slums.

Using Thanagar in Adventures

Thanagar is one of the most unsavory settings in the DC Universe and an ideal proving ground for heroes. An interesting method for bringing the heroes to Thanagar is to have a close friend or relative kidnapped by slave traders to work on Thanagar's Downside. Heroes who find themselves in such a predicament might turn to Hawkman to help them navigate Thanagar's many perils.

Appearances in the DC HEROES Role-Playing Game, Second Edition

Atlas of the DC Universe

Appearances in DC Comics

***Note:** Pre-Crisis appearances are not part of present continuity.

Pre-Crisis: *Action Comics* #588; *The Brave and The Bold* (1) #34, 42-43; *DC Comics Presents* #95; *DC Super-Stars* #14; *Hawkman* (1-2) #1, 12, 18-19; 1-12; *Hawkman Special* #1; *Justice League of America* #80-81, 117; *Legion of Super-Heroes* (2) #290, 294, 313; *Legion of Super-Heroes Annual* (3) #1; *The Shadow War of Hawkman* #1-4; *Showcase* #101-103; *Superboy* (1) #217; *Who's Who '87* #23; *World's Finest Comics* #269-270, 278-279

Current: *Adventures of Superman* #448; *Animal Man* #6; *Cosmic Odyssey* #2-3; *Hawkworld* (1-2) #1-3; 1, 6-7, 10-12, 14-15, 17, 19; *Hawkworld Annual* #1; *Invasion!* #1-2; *New Gods* (3) #18; *Power of The Atom* #8; *Suicide Squad* #23; *Superman* (2) #26; *Swamp Thing* (2) #57-58, 97; *Who's Who '90* #2; *Wonder Woman* (2) #25

Thanagar

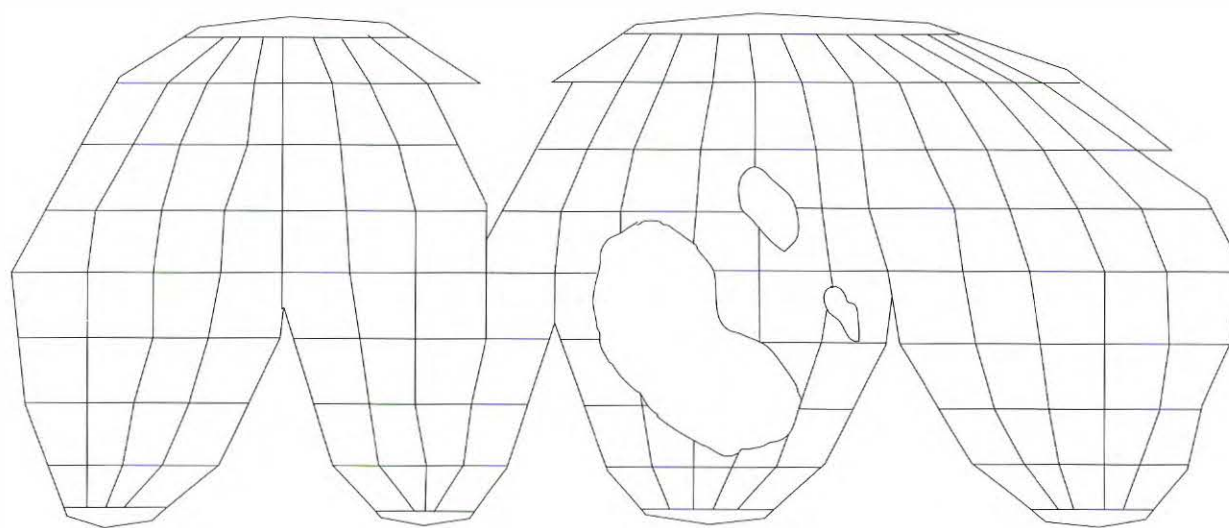

AMETHYST

DEX: 4	STR: 3	BODY: 7
INT: 10	WILL: 14	MIND: 9
INFL: 10	AURA: 15	SPIRIT: 15
INITIATIVE: 24	HERO POINTS: 85	

- **Powers** (†30th Century only): Awareness: 10, Flight: 10, Magic Sense: 10, Self-Link (Spirit Travel): 25†, Sorcery: 22, Truesight: 15
- **Skills**: Occultist: 11, Weaponry (melee weapons): 4
- **Advantages**: Area Knowledge (Gemworld); Connections: Gemworld (High), Lords of Order (Low); Popularity
- **Drawbacks**: Innocent; Serious Physical Restriction: Amethyst is blind.
- **Equipment**: Amethyst Necklace [BODY: 6, Dimension Travel: 12]
- **Alter Ego**: Amy Winston
- **Motivation**: Upholding the Good
- **Wealth**: 8
- **Occupation**: Princess of Gemworld

Amethyst's Statistics

Amethyst's statistics have been altered since the *Background/Roster Book* and *Atlas of the DC Universe* were published due to some recent revelations. She is now blind and has found her "inner sight" with the help of Dr. Fate (Truesight). In her 30th Century incarnation, she has shown that she can manifest herself as a soul-being (Self-Link [Spirit Travel]).

Amethyst's Magic

In DC HEROES terms, Amethyst uses the Sorcery Power (see the *Character Handbook*, page 51). Powers she frequently mimics include: Dimension Travel, Magic Blast, Energy Blast, Magic Field, Force Field, Magic Shield, and Force Shield.

Powers and Abilities

Amethyst is a Lord of Order and a sorceress. By skillfully reshaping ambient magical forces, she can fly, project powerful bolts of eldritch energy, travel

between the dimensions, or perform just about any other feat she can imagine.

While fighting the Anti-Monitor's shadow demons, Amethyst was struck blind. She has since developed an extraordinary magical sense that enables her to "see" beyond the limits of normal vision.

Personality/Role-playing

Over the course of her career, Amethyst metamorphosed from a mere Earth child into the soul of Gemworld. There are three stages in her development:

• **Adolescence—the Heir Apparent**: The first stage of Amethyst's development was one of tremendous growth. She began her adventures as a child, but her personality soon blossomed to match her new, mature appearance.

Although Amethyst was young, cautious, and unsure of herself, she always possessed many of the inherent qualities of a Lord of Order. During her early excursions into Gemworld, she was caught up in events that one would normally find overwhelming, and she quickly learned to rise to the occasion.

This stage ended with the destruction of Dark Opal.

• **Womanhood—the Preserver**: The second stage in Amethyst's development began with a disastrous event that trapped her and her friend Emerald on Earth. This was a volatile phase for Amethyst; during this era she grew up and learned the truth about herself.

Right in the midst of her hardship and sacrifice, she was swept up into the Crisis on Infinite Earths and blinded by agents of the Anti-Monitor. With the aid of Doctor Fate, she discovered her status as a living Lord of Order and learned to compensate for her blindness by developing her innate magical senses.

This difficult period ended when Amethyst merged with the Gemworld and underwent her staggering physical transformation.

• **Deification—the Soul of Gemworld**: Amethyst's cycle of growth ended when she accepted her position as the soul of her people and bestowed the bounty of a Golden Age upon them. Now mature and wise, she is more a goddess than a woman.

Using Amethyst in Adventures

The Gemworld is one of the most peculiar locales in the DC Universe and is an excellent setting for off-beat, “change of pace” adventures. Once the action moves to Gemworld, of course, Princess Amethyst becomes both a convenient tour guide and an obvious ally of the player heroes.

As a Lord of Order, Amethyst might also rush to the aid of heroes beleaguered by the forces of Chaos.

Subplots

Since Amethyst was an adopted child, she is frequently involved in Family Subplots. She is also involved in Friend Subplots centered around her relationship with Emerald, and Enemies Subplots that feature the forces of Chaos and Dark Opal. She was once involved in a Romantic Subplot with Lord Topaz, which ended shortly after the Crisis.

Appearances in the DC HEROES Role-Playing Game, Second Edition

Background/Roster Book, Atlas of the DC Universe, Magic Sourcebook

Appearances in DC Comics

Amethyst (1) #1-16, (2) 1-4; *Amethyst Annual* #1; *Amethyst, Princess of Gemworld* #1-12; *Amethyst Special* #1; *Crisis on Infinite Earths* #5, 10-11; *DC Comics Presents* #63; *Legion of Super-Heroes* (2) #298, (3) 63, (4) 20; *Who's Who '85* #1; *Who's Who '87* (2) #1; *Who's Who '90* #1

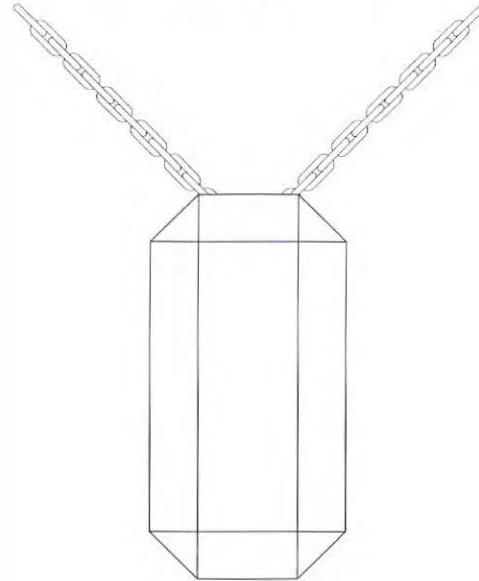

front view

Amethyst's necklace

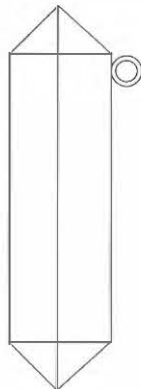

side view

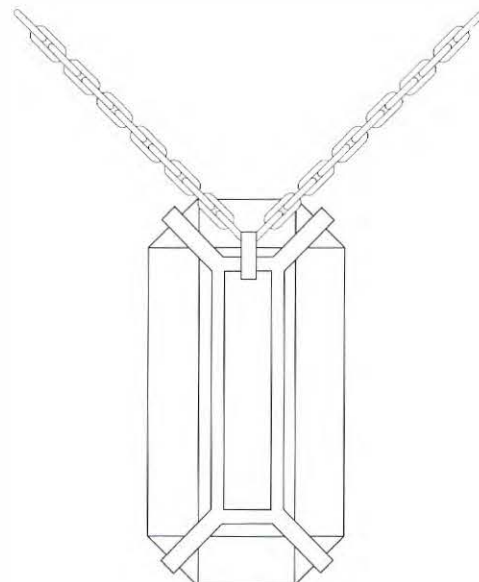

back view



chain

BLAZE

DEX: 7	STR: 5	BODY: 7
INT: 9	WILL: 7	MIND: 7
INFL: 10	AURA: 7	SPIRIT: 7
INITIATIVE: 26	HERO POINTS: 55	

•**Powers:** **Mystic Linked*

Chameleon: 8*, Dimension Travel: 10, Sorcery: 13

•**Skills:** Occultist: 10

•**Advantages:** Attractive (as Angelica); Connections: Hell (Low), Street (High)

•**Drawbacks:** Catastrophic Rage; Strange Appearance (in demon form)

•**Alter Ego:** Angelica Blaze

•**Motivation:** Nihilist

•**Wealth:** 7

•**Occupation:** Ruler of a Netherworld Dimension

Blaze's Netherworld

Blaze inhabits her own pocket dimension that she calls her Netherworld (located at a Travel Distance of 1 from the Realm of the Just Dead; see pp. 20-21 of the *Magic Sourcebook*). For the most part, Blaze's realm consists of rocky outcroppings and pools of molten lava, but Blaze is capable of shaping the dimension to match her whims. Within her Netherworld, Blaze's Sorcery increases to 20 APs, and she takes no Mystical Bashing Damage from using the Power. While battling here, Blaze frequently uses her Sorcery to mimic the Earth Control, Earth Animation, Flame Control, and Flame Animation Powers.

Powers and Abilities

A minor demon, Blaze has a wide range of occult powers. She can alter her appearance at will, belch forth bursts of magical flame, and manipulate ambient magical energies to accomplish just about any imaginable aim.

Personality/Role-playing

Blaze is a creature of pure evil who seems to have nearly limitless power in the brimstone-filled

realm where she corrupts and enslaves human souls for pleasure.

To keep herself entertained, she spends a good deal of time recruiting souls on Earth. For this purpose, she becomes the sultry, alluring Angelica Blaze, the proprietor of a nightclub called Blaze's.

Blaze prefers to entice humans to the side of evil. The kinder the personality the better, for she loves nothing more than to torture those who are pure. After leading her victims into temptation, she either makes deals with them or allows her underlings to destroy them.

Blaze is a fiend who prides herself in her abilities to deceive and entice. Not even other creatures of the night can trust her.

Using Blaze in Adventures

Blaze is likely to try to lead innocent and pure heroes into temptation by kidnapping them and spiriting them off to her underground realm.

Blaze might also tempt a Non-Player Character that is close to one of the heroes, necessitating a dramatic rescue.

Subplots

Blaze is more likely to become involved in the Subplots of others than Subplots of her own. She could easily lead a Character into Power Complications, Job, Family, Romantic, or Enemy Subplots. She would use any of these to torture her victims.

Appearances in the DC HEROES Role-Playing Game, Second Edition

Superman—The Man of Steel Sourcebook

Appearances in DC Comics

Action Comics #656, 662; *Adventures of Superman* #469-470; *Superman* (2) #34, 47; *Who's Who '90* #4

Blaze's nightclub

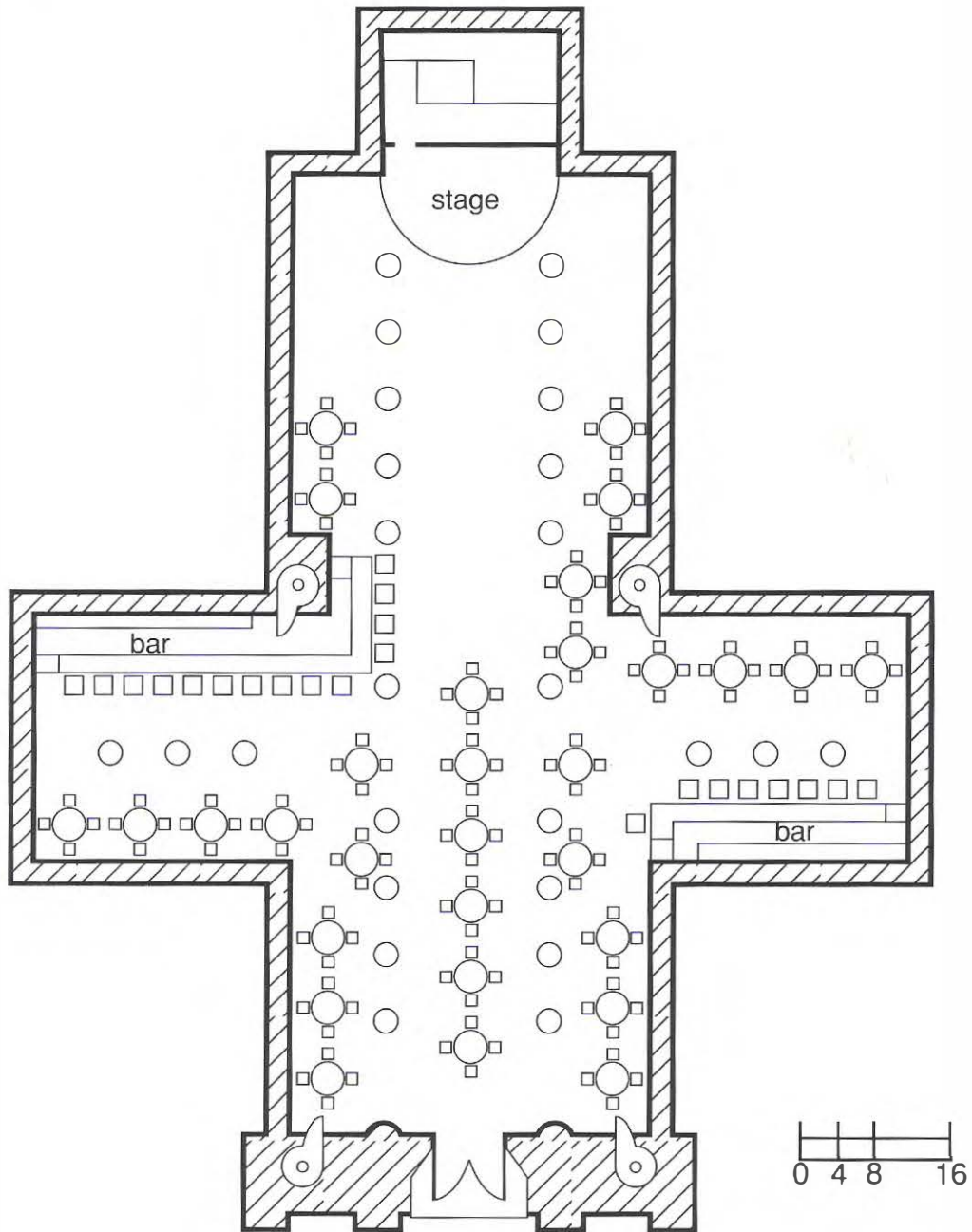

CAIN & ABEL

CAIN

DEX: 3	STR: 3	BODY: 3
INT: 7	WILL: 6	MIND: 3
INFL: 7	AURA: 6	SPIRIT: 4
INITIATIVE: 17	HERO POINTS: 25	

- Powers:** Awareness: 6, Invulnerability: 8, Regeneration: 8
- Skills:** Artist (Storytelling): 12, Charisma (Intimidation): 7
- Bonuses:** Miscellaneous: Cain's Regeneration Power works even after he is dead, making him essentially immortal.
- Advantages:** Area Knowledge (House of Mystery); Connections: Abel (High), Dream Dimension (High), Morpheus (Low); Scholar (stories)
- Drawbacks:** Serious Irrational Attraction to killing his brother Abel
- Alter Ego:** None
- Motivation:** Responsibility of Power/Psychopath
- Wealth:** N/A

ABEL

DEX: 2	STR: 2	BODY: 2
INT: 5	WILL: 2	MIND: 2
INFL: 2	AURA: 7	SPIRIT: 1
INITIATIVE: 9	HERO POINTS: 25	

- Powers:** Awareness: 6, Regeneration: 8
- Skills:** Artist (Storytelling): 12; Charisma: 4
- Bonuses:** Miscellaneous: Abel's Regeneration Power works even after he is dead, making him essentially immortal.
- Advantages:** Area Knowledge (House of Secrets); Connections: Cain (High), Dream Dimension (High), Morpheus (Low); Pet (Goldie/Irving); Scholar (stories)
- Drawbacks:** Minor Irrational Fear of his brother Cain
- Alter Ego:** None
- Motivation:** Responsibility of Power/Unwanted Power
- Wealth:** N/A

Mystical Insights

Morpheus, the Lord of Dreams, often dispatches Cain and Abel to contact mortals through their dreams in order to give the dreamers insights into their lives. When this happens, a mortal chooses one

of the brothers as a host and listens to a story that he relates (Cain's stories are mysteries that are dark and impenetrable; Abel's stories are secrets that the listener cannot share with another soul). Once the story (and the dream) has concluded, the dreamer can find an insight into an earthly dilemma. Give the dreamer a Perception Check against an OV/RV of 15/15 and allow him to add Cain or Abel's APs of Artist (Storyteller) to both his Acting and Effect Values. Treat the RAPs as Knowledge Points.

House of Mystery and House of Secrets

The House of Mystery and the House of Secrets, the respective residences of Cain and Abel, are usually located side-by-side in the Dream Dimension of Morpheus. But when the flow of mystical energy across the Earth is at a peak, one or both houses sometimes shift into the Earth Dimension and appear deep in the hills of Kentucky. In any case, only those beings who are singled out to receive a mystery or a secret by one or more of the powerful mystical entities roaming the DC Universe can reach the houses.

Inside, the houses defy belief. They are clearly larger on the inside than they are on the outside and contain a maze of rooms and hallways. Virtually every room in the houses is a library crammed with dusty tomes and bizarre artifacts. Those who wander into one of the houses without a guide will inevitably end up lost in the winding passageways.

The Mark of Cain

Cain bears a mark that was inscribed upon him long before the beginning of civilization. This mark signifies that anyone who causes Cain injury shall suffer the wrath of ancient and mysterious mystical forces. Outside of the Earth Dimension, this mark is widely recognized and feared—almost no one aware of its true nature would dare ignore it.

Powers and Abilities

Cain and Abel are a pair of occult entities who are older than civilization itself. Long ago, they gained the power of immortality and learned the art of storytelling, which they now put to use by entrancing sleeping mortals at the behest of Morpheus and mystical beings of equal stature.

After he slew Abel for the first time, Cain received a mark on his forehead that prevents anyone from harming him. This mark was mocked by the demons in Hell when Cain was sent there as an emissary of Morpheus, but they too abided by the warnings attributed to it. Nonetheless, the demons did manage to shake Cain's self-confidence.

Personality/Role-playing

Abel is cowardly and paranoid. He particularly fears the wrath of his temperamental and homicidal brother, who attempts to slay him upon occasion (though Abel always regenerates and forgives Cain, begging his brother not to hurt him again). Abel is always the more caring and gregarious of the two.

Cain is more malicious and angers easily, especially at his brother's foolishness. But recently, Cain has made an effort to turn over a new leaf. Lately, he has even given his brother a gift, a gold baby gargoyle (since named Goldie) as an apology.

Both brothers are extremely proud of their storytelling abilities and will argue with one another for the chance to entertain a traveler. They are also equally afraid and awed by the master of the Dream Dimension, Morpheus, and will do as he commands as long as he is around to watch them.

Using Cain and Abel in Adventures

Cain and Abel are spirit guides, brothers, and keepers of the ancient stories that teach lessons through subconscious imagery. This being the case, Cain and Abel are excellent vehicles for relating secrets or clues to heroes in the heroes' dreams. They are excellent for starting Subplots by giving a hero a secret he cannot reveal or a mystery he cannot solve.

Appearances in the DC HEROES Role-Playing Game, Second Edition

Background/Roster Book, Magic Sourcebook, Atlas of the DC Universe

Appearances in DC Comics

Cain: *Ambush Bug* #3, *Blue Devil* #20-21, 26, 29-30, *The Books of Magic* #3; *The Brave and The Bold* #93; *DC Comics Presents* #53; *DC Special* #11; *DC Special Series* #21; *House of Secrets* #92; *House of Mystery* #175-321; *Phantom Stranger* (2) #24; *Plop!* #1-24; *The Saga of the Swamp Thing* #33; *Sandman* (2) #2, 7, 9, 22, 24, 26; *Secret Origins* (3) #24; *Secrets of Haunted House* #1, 44; *Swamp Thing* (2) #49-50; *Who's Who '85* #4; *Who's Who '90* #1; *The Witching Hour* #13

Abel: *Blue Devil* #20, 29; *The Books of Magic* #3; *DC Special Series* #21; *House of Mystery* #250-251; *House of Secrets* #81-139, 141-154; *Plop!* #1-24; *The Saga of the Swamp Thing* #33; *Sandman* (2) #2, 7, 9-10, 22, 26; *Secrets of Haunted House* #1, 40-46; *Swamp Thing* (2) #49-50; *The Unexpected* #189-213; *Who's Who '85* #1; *Who's Who '90* #1; *The Witching Hour* #13



House of Mystery / House of Secrets

DEADMAN

DEX: 8	STR: 4	BODY: 7
INT: 5	WILL: 6	MIND: 6
INFL: 7	AURA: 8	SPIRIT: 8
INITIATIVE: 24	HERO POINTS: 65	

•**Powers:** **Mystic Linked*

Awareness: 8, Invisibility: 20*, Invulnerability: 12*, Personality Transfer: 18*, Self Link (Spirit Travel): 30

•**Skills:** Acrobatics: 8, Martial Artist: 5, Occultist (Occult Knowledge): 5, Thief: 6

•**Advantages:** Area Knowledge (Realm of the Just Dead); Connections: Phantom Stranger (Low), Rama Kushna (Low); Lightning Reflexes

•**Limitations:** Invisibility and Self Link (Spirit Travel) are Always On; Deadman can be seen automatically by Characters with the Magic Sense Power or by any Character he encounters in the Afterworlds.

•**Alter Ego:** Boston Brand

•**Motivation:** Unwanted Power

•**Wealth:** N/A

The Realm of the Just Dead

Deadman spends most of his time roaming about a formless, white void known as the Realm of the Just Dead (Travel Distance of 9 from the Earth Dimension; see pp. 20-21 of the *Magic Sourcebook*). All who die pass through this plane on their way to the Afterworlds. Deadman helps the newly departed cross the void to reach the Gray Path, where they are met by the Phantom Stranger, who ushers the souls of the dead to their final resting places.

All Characters in the Realm of the Just Dead move at a speed equal to their INFL (to a maximum of 4 APs per phase). You can assume that the whole plane is only 15 APs from end to end, but the lack of geography makes it difficult to navigate. Crossing the plane without the aid of a knowledgeable resident (like Deadman) requires a successful Action Check using INFL/AURA as the AV/EV against an OV/RV of 6/6 (Strenuous Task). Anyone failing this Check is doomed to wander aimlessly for a day (15 APs) before making another Check. Fortunately, other than a few disgruntled souls, the only hazard to be encountered in the Realm of the Just Dead is the

herds of Poltergeists that sometimes roam the plane in search of excess ectoplasmic energy.

POLTERGEIST

DEX: 7	STR: 8	BODY: 8
INT: 1	WILL: 2	MIND: 8
INFL: 7	AURA: 10	SPIRIT: 11
INITIATIVE: 15		

•**Powers:** Spirit Drain: 15

Powers and Abilities

Essentially little more than a ghost, Deadman has the ability to enter and possess the bodies of the living. He is also very attuned to the mystical goings-on in the multiverse and often relates important information to those to whom it applies. Deadman is invisible to human eyes, although magical entities can see and talk to him.

Personality/Role-playing

For the most part, Deadman is easy-going and sarcastic. He often launches himself into battle without thought or fear, playfully mocking his enemies as he goes. But at times, the weight of his mission crashes down upon him, temporarily causing him to adopt a more morose posture.

When he first became Deadman, Boston Brand experienced extraordinary isolation and loneliness. It took a long time for him to accept existence without the physical pleasures of life. As a result, he spent much of his time absorbed in self-pity and misery, bemoaning his fate. He was able to overcome his depression only after he began to comprehend Rama Kushna and the special missions he undertook in her name.

Many of the members of Earth's mystical community can see and talk to Deadman, so he spends much of his time consorting with them and discussing cosmic events. When he is not visiting the Phantom Stranger, the Spectre, Swamp Thing, or any of his other friends, Deadman keeps busy exploring the outer reaches of the spirit worlds and greeting the souls of the recently departed in the Realm of the Just Dead. In fact, he finds the latter task particularly pleasing, especially when he is able to comfort a particularly confused soul and safely steer him into the care of the Phantom Stranger.

One of the unique aspects of the Deadman comic series was the strange visuals of Deadman hovering in space, sitting in cars driven by oblivious drivers, leaping off satellites, irreverently sitting on someone's head, etc. When playing Deadman, try to play up his fun-loving nature by describing similar visuals. The fact that Deadman is invisible to most often makes him an ideal vehicle for comic relief.

Using Deadman in Adventures

Boston Brand makes a great informant. When there is expository information of a mystical nature that the GM wants to convey to the heroes (especially news of events on the spirit plane), Deadman is the ideal conduit. While the Characters are strolling along, for instance, an ordinary cab driver, news vendor, or similarly nondescript person might approach them and cheerfully announce that he is Boston Brand. After a bit of light banter, Deadman can then proceed to reveal what he knows, answer any additional questions the player heroes care to ask and disappear as mysteriously as he appeared, leaving his host body just a little bewildered.

Of course, if there are no Non-Player Characters around for Deadman to inhabit, he can always use one of the heroes' own bodies, providing the players with plenty of opportunities for creative and challenging role playing.

Subplots

Shortly after he was created, Deadman was involved in a lengthy Enemies Subplot during which

he sought the identity of his killer. Brand was also involved temporarily in a Romantic Subplot with an assassin named Lotus.

Appearances in the DC HEROES Role-Playing Game, Second Edition

Background/Roster Book, Magic Sourcebook

Appearances in DC Comics

***Note:** Pre-Crisis appearances are not part of present continuity.

Pre-Crisis: *Adventure Comics* #459-466; *Aquaman* (1) #50-52; *The Brave and The Bold* #79, 86, 104, 133; *Challengers of the Unknown* #74, 84-87; *Crisis on Infinite Earths* #5, 7, 11-12; *DC Comics Presents* #24; *DC Super-Stars* #18; *Detective Comics* #500; *Forever People* (1) #9-10; *Justice League of America* #94; *The Phantom Stranger* (2) #33, 39-41; *Strange Adventures* #205-216; *Superman Family* #184; *Swamp Thing Annual* #2; *Who's Who '85* #6; *World's Finest Comics* #223, 227

Current: *Action Comics* #601-612, 618-621, 623-626, 642, 670; *The Books of Magic* #2; *Christmas with the Super-Heroes* #2; *Deadman* (2) #1-4; *Deadman: Love After Death* #1-2; *Doctor Fate* (2) #8-9; *Invasion!* #2; *Millennium* #8; *Secret Origins* (3) #15; *The Spectre* (2) #1, 11, 23; *The Spectre Annual* #1; *Swamp Thing* (2) #49-51, 55; *War of the Gods* #4; *Who's Who '90* #3

Nanda Parbat

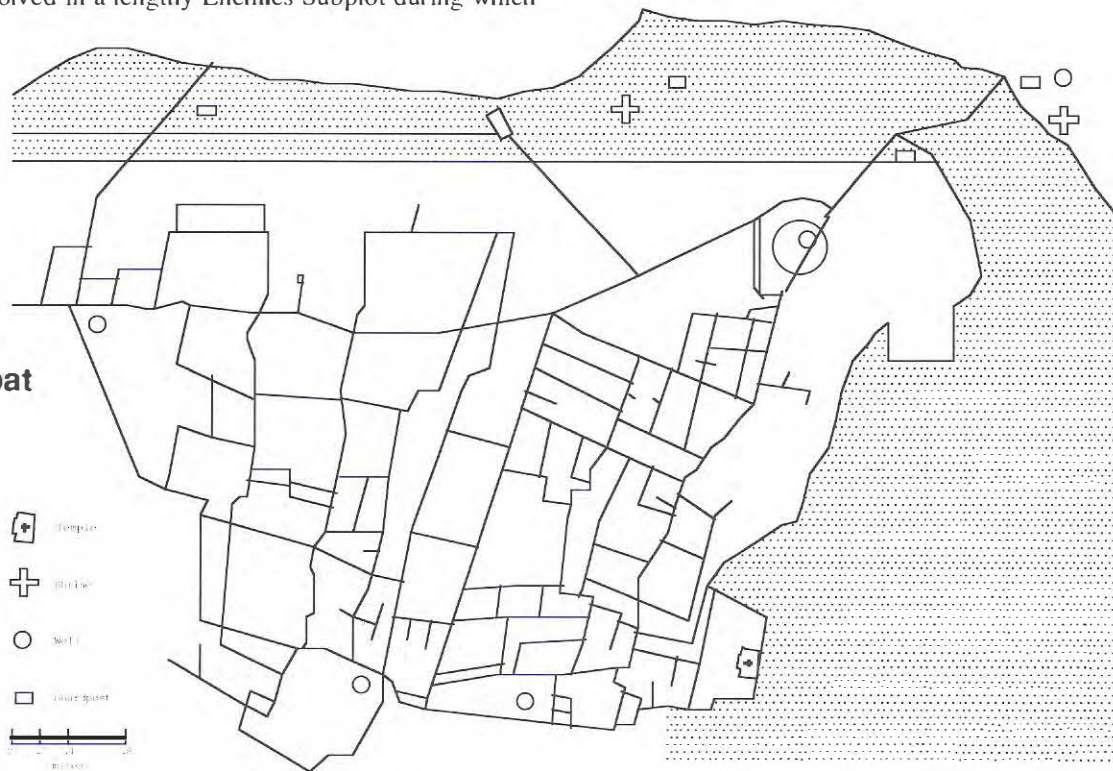

I . . . VAMPIRE

DEX: 10	STR: 8	BODY: 11
INT: 9	WILL: 10	MIND: 10
INFL: 10	AURA: 12	SPIRIT: 10
INITIATIVE: 29	HERO POINTS: 85	

- Powers:** Animal Control: 10, Dispersal: 10, Hypnosis: 8, Invulnerability: 18, Regeneration: 10, Self Link (Fog): 7, Shape Change: 10, Vampirism: 10
- Bonuses:** Miscellaneous: Bennett's Regeneration Power allows him to heal damage even after he has been killed, making him immortal.
- Limitations:** Miscellaneous: Shape Change can only be used to transform into a bat or wolf; Miscellaneous: Animal Control only works on bats, rats, and wolves; Miscellaneous: Dispersal is only in effect (and is always in effect) when Bennett activates his Self Link (Fog); Miscellaneous: use of Vampirism Power leaves telltale marks on the victim's neck.
- Advantages:** Connection: Lords of Order (Low); Connoisseur
- Drawbacks:** Attack Vulnerability: -4 Column Shifts vs. wooden stakes; Fatal Vulnerability: Bennett takes 2 points of Physical Killing Damage each phase he is exposed to sunlight; Miscellaneous: crosses and holy symbols may be used to attack Bennett with an EV of 8 provided the attacker truly believes in the symbol he is brandishing; Miscellaneous: Bennett must use Vampirism once per week to survive; Guilt; Serious Irrational Fear of garlic.
- Alter Ego:** Andrew Bennett
- Motivation:** Unwanted Power
- Wealth:** 8

The Curse of the Vampire

Andrew Bennett has all of the powers and limitations of the traditional vampire. He casts no reflection, he is repulsed by garlic, he can be harmed only by wooden stakes or exposure to sunlight, etc.

Roughly once per week (sometimes less often), Bennett must use his Vampirism Power to feed (his use of this Power is considered Killing Combat). Bennett can transform any target he kills with his Vampirism Power into a vampire. Such a target gains a STR, DEX, and BODY equal to 7 (or maintains his own Physical Attributes if they are higher than 7),

gains all of Bennett's Powers rated at 5 APs, gains all of Bennett's Drawbacks and Limitations (save Guilt), and adds two APs to his INFL, AURA, and SPIRIT. All of the target's other abilities (Mental Attributes, pre-existing Powers and Skills, etc.) remain the same.

Bennett's Other Forms

As a vampire, Bennett can assume the form of a wolf, a bat, or a cloud of mist. To assume either of the first two forms, he calls upon his Shape Change Power. To assume the last form, he uses Self Link (Fog). Here are his statistics in these forms:

BAT FORM

DEX: 6 STR: 1 BODY: 2

- Powers:** Flight: 5, Radar Sense: 6

WOLF FORM

DEX: 4 STR: 2 BODY: 4

- Powers:** Analytical Smell/Tracking Scent: 9, Claws: 4, Extended Hearing: 4

MIST FORM

In this form, Bennett's DEX and STR are both 0, but his Dispersal Power becomes active, giving him an RV of 21 vs. Physical Attacks. As a mist, Bennett can fill a large room, obscuring vision as though the room were covered with the Fog Power rated at 7 APs. Bennett's mist form can move roughly 100 miles per hour.

Immortality

Bennett's curse is even more malevolent than that suffered by most vampires. Although he is still vulnerable to sunlight, holy symbols, wooden stakes, and the like, none of these objects will truly kill him. Whenever he is seemingly killed, he simply reforms within a week, forced to continue on with his cursed existence.

Within the last several decades, Bennett has refused to feed, hoping to starve himself to death. For this reason, he now lives in great physical pain.

Powers and Abilities

Bennett can do most of the things that other vampires can do. He can summon and control

animals, use hypnosis, transform himself into a bat or wolf, regenerate, and transform into a vapor. He has strength enough to lift 6 tons and can withstand the explosion of a couple sticks of dynamite. Having been exposed to a super-vampiric formula, he cannot die, although he can be seriously injured.

Personality/Role-playing

As noble as he was during his normal lifetime, Bennett is even more so in his undead form. He has never considered humans inferior to vampires, and unlike his peers, he will not destroy human life or violate his code of honor. The best example of this behavior is his ability to fight the thirst for human blood that has plagued him for four centuries. Bennett has always managed to find some substitute (such as animal blood or stored blood) for the blood of the living. More than anything, he hates his undead life and has spent the majority of it searching for peace.

For hundreds of years, Bennett attempted to stop Mary Seward's wrongdoing by destroying the vampiric Cult of the Blood Red Moon, which she began for the purpose of destroying humanity. He feels great guilt because it was he who made his former lover a vampire in the first place. Although he was finally able to destroy the cult, he still carries that guilt.

Using I . . . Vampire in Adventures

Bennett can be used to lead the player heroes into the world of vampires and werewolves that prowl about the darker corners of the DC Universe. Such an adventure often provides an effective change of pace.

Subplots

Bennett was first involved in a Romantic Subplot with his lover Mary Seward, whom he infected with the vampiric curse. She eventually succumbed to the curse and founded the Cult of the Blood Red Moon, which Bennett has since destroyed. Presently, most of Bennett's Subplots revolve around his goal of finding eternal peace.

Appearances in the DC HEROES Role-Playing Game, Second Edition

Background/Roster Book, Magic Sourcebook

Appearances in DC Comics

*Note: Pre-Crisis appearances are not part of present continuity.

Pre Crisis: *The Brave and The Bold* #195; *House of Mystery* #290-295, 297, 299, 302-320; *Who's Who* '86 #11

Current: *Doctor Fate* (2) #1-6, *Who's Who* '90 #2

One of the many symbols of the cult of the Blood Red Moon

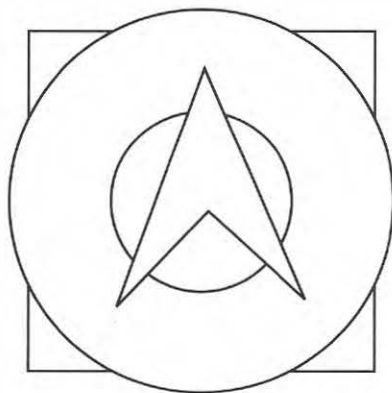

MADAME XANADU

DEX: 3	STR: 2	BODY: 2
INT: 10	WILL: 10	MIND: 8
INFL: 9	AURA: 13	SPIRIT: 8
INITIATIVE: 22	HERO POINTS: 40	

•**Skills:** Occultist: 13

•**Advantages:** Connections: Earth's Mystical Community (High), the Spectre (High); Scholar (occult artifacts); Miscellaneous: due to the effects of a magic ritual, Madame Xanadu ages at one-tenth the normal rate.

•**Alter Ego:** Unknown

•**Motivation:** Responsibility of Power

•**Wealth:** 6

•**Equipment:**

Tarot Cards [BODY: 1] Madame Xanadu uses her Tarot cards as a focus, allowing her to perform a number of specialized occult Rituals (see below).

13 AP ABCD Omni-Artifact

Madame Xanadu's Greenwich Village parlor is a sort of storehouse for occult artifacts and magical objects of all descriptions.

***Note:** Artifacts are described as Objects in the *Rules Manual*.

Madame Xanadu's Occult Rituals

Madame Xanadu is a practitioner of Occult Ritual Magic (see pages 60-61 of the *Character Handbook* or pages 23-28 of the *Magic Sourcebook*). Among the Rituals she commonly employs are:

PREDICT FUTURE

Effect—Precognition: 17

Casting Time—15 minutes (8 APs)

Necessary Components—Tarot cards; Cost of \$50 (1 AP)

Special Restrictions—None

This is standard fortune telling. While employing this ritual, Madame Xanadu lays her Tarot cards out in ritualized patterns.

SENSE EMOTION

Effect—Empathy: 10

Casting Time—15 minutes (8 APs)

Necessary Components—Tarot cards; Cost of \$50 (1 AP)

Special Restrictions—None

Madame Xanadu can also use her Tarot cards to gauge the emotional state of a client.

DETECT COSMIC CALAMITY

Effect—Awareness: 10

Casting Time—15 minutes (8 APs)

Necessary Components—Tarot cards; Cost of \$50 (1 AP)

Special Restrictions—None

Any impending cosmic calamity will show up in one of Madame Xanadu's periodic readings.

ANSWER QUESTION

Effect—INT: 15, WILL: 15

Casting Time—15 minutes (8 APs)

Necessary Components—Tarot cards; Cost of \$50 (1 AP)

Special Restrictions—None

Instead of mimicking Powers, this Ritual mimics the effects of a pair of Attributes; Madame Xanadu can use the Ritual's INT and WILL as the AV/EV of a single Perception Check or as the AV/EV of an attempt to answer a question or solve a problem.

LEVITATION

Effect—Telekinesis: 2

Casting Time—Instantaneous (0 APs)

Necessary Components—None

Special Restrictions—None

Through the use of this Ritual, Madame Xanadu can levitate small objects with a mere wave of her hand.

Role-playing Precognition

Playing out precognition in a game session is tricky. The Gamemaster should reveal only minimal information in Madame Xanadu's card readings, not all the answers to the player heroes' problems. Also, remember that few of Madame Xanadu's predictions come true in the expected manner.

Enterprising Gamemasters can even create their own Tarot readings for games or give important clues through Tarot cards. This is not at all necessary, but it can add flavor to a game.

Powers and Abilities

One of the more enigmatic occultists in the world, Madame Xanadu is a seer who excels as a spiritual adviser and cartomancer (one who performs

divination by cards). She is precognitive and senses when her destiny is tied to the fate of another. Some people are mysteriously compelled to enter her shop, and some just stumble upon it by “accident,” or synchronous connection. She is so skilled at her disciplines that she often uses her cards to gain insights into those who seek her advice even before they find her.

But although Madame Xanadu can dispense essential wisdom and shed light on a problem, it is ultimately the responsibility of her clients to heed her advice and implement their own solutions. Those who come looking for easy answers are inevitably disappointed. The sort of problems Madame Xanadu is interested in examining must always be faced alone.

In her Greenwich Village parlor, Madame X. maintains a large collection of magical artifacts. She monitors the active ones, dampens the power of the dangerous ones, and safeguards the entire collection. When she defeats a demons or creature of sorcery, she often captures its essence and adds it to her collection to keep it from causing further trouble.

Furthermore, Madame Xanadu has mastered a wide variety of occult rituals, including a spell that allows her to slow down the effects of aging.

Personality/Role-playing

Madame Xanadu’s origins are mysterious, and she evidently prefers it that way since she takes obvious pains to keep her past hidden. She is rumored to be of Eastern European gypsy descent, and she speaks with a trace of an accent.

Madame Xanadu is a calm and sensuous woman of great wisdom and patience. She cares deeply about the people who come to her for assistance and invests herself completely in her work. But Madame Xanadu never involves herself in her clients’ problems personally. She holds back and advises, watching and waiting, and letting her clients confront their inner terrors alone.

Using Madame Xanadu in Adventures

Madame Xanadu makes an excellent source of information in any Adventure that touches upon the supernatural—and sometimes in those that do not. If the heroes are in Greenwich Village, New York, they might come across a quaint shop on Christie Street

that stands beneath a sign reading “Enter Freely and Unafraid.” Feel free to compel them to enter. Interplay with the mysterious Xanadu can be fun.

Also, Madame Xanadu can conveniently separate the player heroes from any magical artifacts they have captured by adding them to her collection.

Subplots

For a time, Madame Xanadu was involved in a Romantic Subplot with the Spectre. During this era, she provided the greatly de-powered Spectre with her spiritual insights and acted as his confidante and aide. At the peak of this relationship, the two became spiritual lovers, and their magical bonding enhanced Madame Xanadu’s mystical abilities in mysterious ways.

Appearances in the DC HEROES Role-Playing Game, Second Edition

Background/Roster Book, Magic Sourcebook

Appearances in DC Comics

***Note:** Pre-Crisis appearances are not part of present continuity.

Pre-Crisis: *Blue Devil Annual* #1; *Crisis On Infinite Earths* #10, 12; *DC Comics Presents* #65; *DC Special Series* #21; *Doorway to Nightmare* #1-5; *Madame Xanadu* #1; *Secrets of Haunted House* #44; *Unexpected* #190, 192, 194-195; *Who’s Who ‘86* #14; *Wonder Woman* (1) #291-293

Current: *Blue Devil* #31; *The Books of Magic* #2; *Captain Atom* (3) #57; *Millennium* #4; *The Spectre* (2) #1-20, 23, 26, 28; *The Spectre Annual* #1; *Suicide Squad* #8; *War of the Gods* #2-4; *Who’s Who ‘90* #3

Madame Xanadu's shop

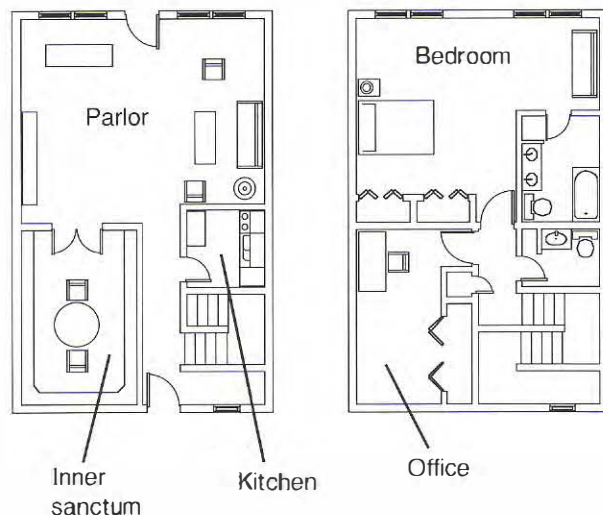

NAIAD

DEX: 12	STR: 10	BODY: 8
INT: 8	WILL: 11	MIND: 10
INFL: 9	AURA: 11	SPIRIT: 9
INITIATIVE: 29	HERO POINTS: 80	

- Powers:** Dispersal: 10, Force Manipulation: 18, Growth: 12, Invulnerability: 13, Spirit Travel: 23, Water Animation: 18, Water Control: 18, Water Freedom: 12
- Bonuses:** Miscellaneous: Naiad doesn't leave a physical body behind when she uses her Spirit Travel Power. Instead, she can use Spirit Travel to move her consciousness into any body of water within range of her Power, no matter how large or small (from an ocean to a single drop). When she forms a new body using Spirit Travel, her Current Body Condition is instantly restored to its full value.
- Limitations:** Miscellaneous: Naiad's Force Manipulation represents her ability to shape water into solid objects. She cannot use Force Manipulation to form complex objects with moving parts; Miscellaneous: Naiad's Powers have no direct effect on other elementals.
- Advantages:** Scholar (ecology, oceanology)
- Drawbacks:** Loss Vulnerability: When Naiad inhabits bodies of water in which the pollution count is particularly high, she is weakened. Subtract 4 APs from her STR and all her Powers; Serious Irrational Attraction to punishing polluters
- Alter Ego:** Mai Miyazaki
- Motivation:** Seeking Justice
- Wealth:** N/A

Naiad in DC HEROES

Naiad's fluid body is represented by her Dispersal Power. Add her active APs of Dispersal to her BODY to determine her RV against Physical Attacks. She can also use Dispersal to pour through tiny openings, allowing her to pass through any object that is not watertight. And unlike most Characters with Dispersal, Naiad does not subtract any APs from her STR when Dispersed—in this form, she can still make Physical Attacks at her full EV.

Naiad's Spirit Travel Power makes her almost impossible to defeat physically. And although she is vulnerable to Mental and Mystical Attacks, she will certainly use Spirit Travel to flee from an opponent capable of defeating her in this fashion.

Powers and Abilities

Naiad is the fourth elemental, the sentient embodiment of all the water on Earth. Although no longer human, she still holds onto many of her human characteristics, often appearing in the form of a giant woman made of water. Naiad's abilities allow her to transfer her consciousness into any pool, lake, or ocean and animate approximately 32 million cubic feet of water, creating tidal waves or whirlpools. Naiad can even shape water into solid forms, (a fist for instance), for short periods of time.

As a water elemental, Naiad is bonded to all the oceans, lakes, streams, etc. of the world and all the life that is contained within them. Toxins and pollutants, therefore, cause her excruciating pain. Firestorm discovered that a great dispersal of water also can damage her. Beyond that, she is nearly indestructible due to her ability to transfer her spirit instantly from place to place in much the same manner as Swamp Thing.

Personality/Role-playing

As a human, Mai Miyazaki was a strong-willed and angry youth. Horrified by the damage done to the Earth by man, she devoted her life to protecting the environment and to fighting those too callous to care about the damage they do.

Naiad holds onto some of the strongest emotions of her lost humanity—hate and anger. When her body died in an oil fire and transformed into a water elemental, the anger lived on in a new form. She now blames humanity for the damage it has caused to the planet and prefers to punish and destroy.

Naiad dislikes the other elementals but cannot harm them directly. She was finally convinced that humanity also has a right to live on Earth, but she still holds humans in the lowest regard. Naiad is arrogant as well as powerful.

Using Naiad in Adventures

The heroes might encounter Naiad while they are trying to stem an environmental disaster, such as a major oil spill. Because of her nature, Naiad is likely to assume that the heroes are not a help but a hindrance, leading to combat unless the heroes can calm her down.

Subplots

Naiad is often involved in Subplots that deal with her pursuit of vengeance against mankind for its treatment of Earth's waters.

Appearances to Date in DC Comics

Firestorm, the Nuclear Man #90-93; *Who's Who '90* #2

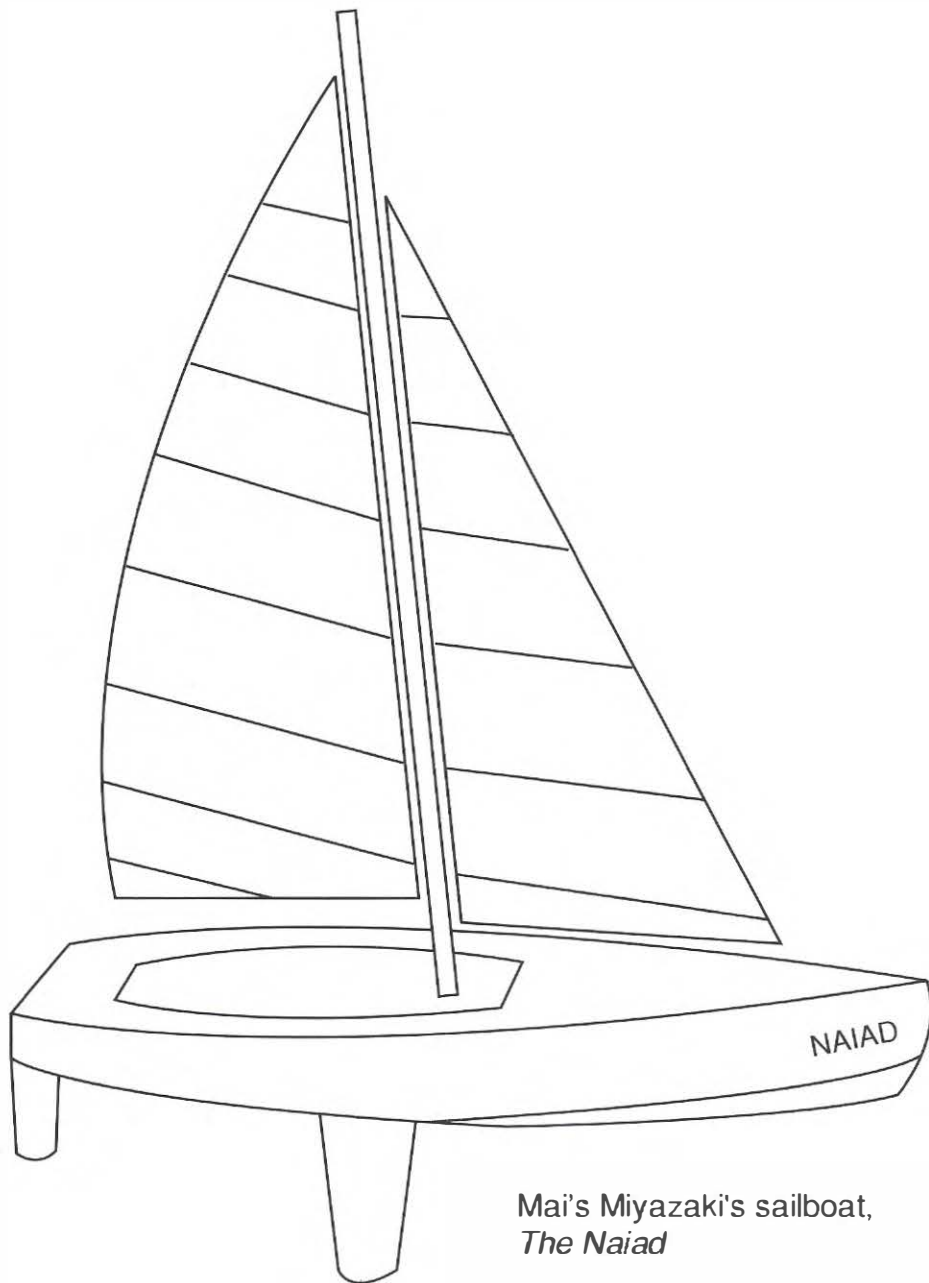

Mai's Miyazaki's sailboat,
The Naiad

WOTAN

DEX: 4	STR: 3	BODY: 4
INT: 10	WILL: 10	MIND: 9
INFL: 12	AURA: 15	SPIRIT: 16
INITIATIVE: 26	HERO POINTS: 120	

- Powers:** Awareness: 9, Magic Sense: 12, Sorcery: 30
- Skills:** Gadgetry: 10, Occultist: 11, Scientist: 11
- Advantages:** Genius; Leadership
- Alter Ego:** Unknown
- Motivation:** Responsibility of Power
- Wealth:** 10

Sorcery

In the past, Wotan most frequently mimicked the following abilities with his Sorcery Power: Chameleon, Dimension Travel, Flight, Invulnerability, Magic Blast, Personality Transfer, Shape Change, and Spirit Drain.

Wotan has also perfected a spell of immortality that he casts upon himself periodically to increase his life span.

The Avatar

Before he confronted the Avatar, Wotan's Motivation was Power Lust, and his INFL and AURA were rated at 10 and 13 APs, respectively.

Powers and Abilities

Wotan's powers of sorcery are rather formidable. For millennia he has used them to transfer his spirit from one body to another, making him essentially immortal. He has also developed scientific skills and knowledge that almost rival his magical abilities. But when Wotan tries to combine these two forces, it often leads to failure due to their essentially opposing natures.

Wotan can also sense the presence of magic and is well aware of happenings in the magical community.

Personality/Role-playing

Wotan once occupied much of his time with an exploration of pain and death. He once believed he could understand these concepts only through the

cultivation of power. Thus, his innumerable attempts to rule or destroy the world.

But recently, Wotan found peace at the tomb of the Avatar in India, where he tried to conquer the power of God. His experiences in the tomb transformed him to the extent that he is no longer a being to be feared. Wotan now remains as near to the tomb as possible to stay in contact with the source of inner peace he has found.

Using Wotan in Adventures

When Wotan was a true villain, he was a "big threat" and an ideal antagonist for Adventures on the epic scale, particularly epics with a mystical bent.

Presently, Wotan is a source of wisdom and a caretaker at the tomb of the Avatar. If the heroes need some guidance on the philosophy of existence—"what is the meaning of life?"—Wotan might be able to assist them.

Subplots

Wotan is presently dealing with a Job as one of the curators at the tomb of the Avatar. There, he greets visitors and offers them words of wisdom and peace.

Appearances in the DC HEROES Role-Playing Game, Second Edition

Magic Sourcebook

Appearances in DC Comics

***Note:** Pre-Crisis appearances are not part of present continuity.

Pre-Crisis: *All-Star Squadron* #1-3, 47; *All-Star Squadron Annual* #3; *Justice League of America* #193; *More Fun Comics* #55-56, 70; *Who's Who '87* (1) #26

Current: *Doctor Fate* (2) #14-15, info on 24; *Secret Origins* (3) #24; *The Spectre* (2) #7-8; *Who's Who '88* #4; *Who's Who '90* #1

Tomb of Avatar

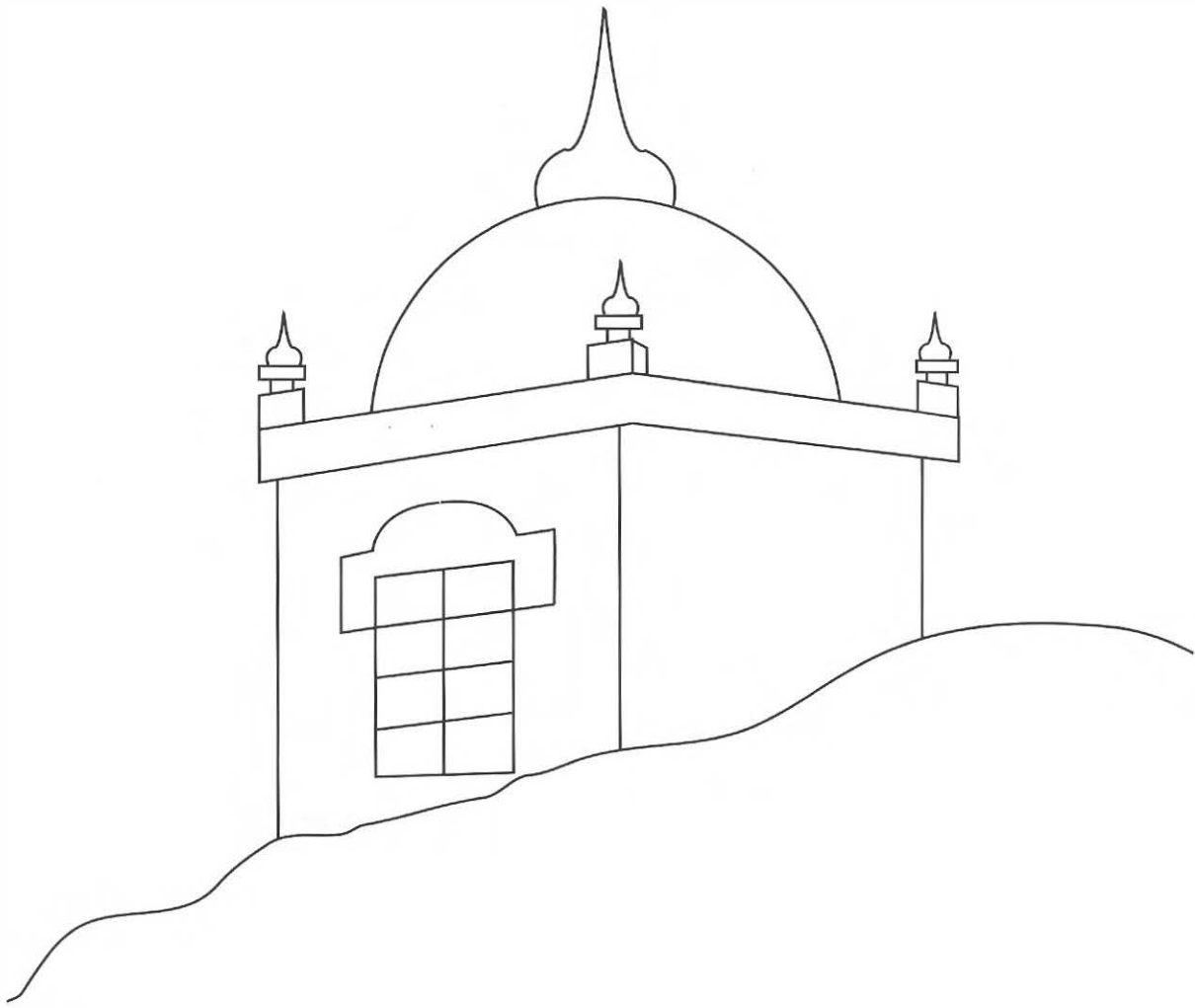

DOMINATORS

DEX: 2	STR: 2	BODY: 4
INT: 8	WILL: 7	MIND: 6
INFL: 4	AURA: 4	SPIRIT: 4
INITIATIVE: 14	HERO POINTS: 15-60	

- Skills:** Charisma: 6, Gadgetry: 13, Military Science: 11, Scientist: 13, Vehicles (Space): 3
- Advantages:** Genius; Scholar (bioengineering)
- Drawbacks:** Miscellaneous: All Dominators must obey the orders of other Dominators who belong to a superior caste.
- Major Representatives:** None; Dominators have no individual identities.
- Motivation:** Power Lust
- Wealth:** 15
- Equipment:**

DOMINATOR SPACECRAFT [DEX: 4, STR: 10, BODY: 15, INT: 14, WILL: 4, Energy Blast: 15, Extended Hearing: 8, Flight: 24, Full Vision: 12, Projectile Weapons: 19, Radar Sense: 35, Radio Communications: 40, Recall: 25, Scaled Systems: 28, Skin Armor: 4, Super Hearing: 18, Telescopic Vision: 6, Warp: 39, R#: 2 (R#: 5 on Projectile Weapons)]

30TH CENTURY SPACECRAFT [DEX: 4, STR: 10, BODY: 16, INT: 16, WILL: 7, Energy Blast: 18, Extended Hearing: 11, Flight: 24, Force Field: 4, Full Vision: 12, Projectile Weapons: 23, Radar Sense: 40, Radio Communications: 43, Recall: 30, Scaled Systems: 30, Skin Armor: 4, Super Hearing: 22, Telescopic Vision: 8, Warp: 40, R#: 2 (R#: 4 on Projectile Weapons)]. Both the 20th and 30th Century models of the standard Dominator spacecraft are incredibly sophisticated vessels. Both are capable of flight at velocities approaching the speed of light and warp travel at speeds of more than 800 times the speed of light. Both carry missile and energy-beam weaponry, a full range of sensors, and a powerful computer.

GENE BOMB [BODY: 8, Mutation: 25, Neutralize: 25] The Dominators' Gene Bomb affects a human target who possesses the so-called "meta-gene" in one of three ways: it strips the target of previously acquired super-human abilities; it alters the target's previously acquired super-human abilities; or it activates a dormant meta-gene, endowing the target with super-human abilities (the bomb's Mutation Power, a variant of the ability described in the *Character Handbook*). Exactly how these abilities

function is best left up to the Gamemaster on a case-by-case basis. In any event, the effects of the bomb can be reversed with a special antidote.

The Gene Bomb is large enough to affect all subjects within 25 APs of its detonation zone.

Powers and Abilities

Dominators are fabulous scientists. They have developed space-faring ships, elaborate machinery and weapons, and even an ability to "grow" mechanical technology from bio-organic forms. By the 30th Century they will have the ability to clone and genetically manipulate organisms.

Personality/Role-playing

From the 20th Century to the 30th, Dominators maintain their focus and disposition. This race is proud of its heritage and achievements and has very little regard for other life forms. A good deal of the Dominators' lust for power and desire to rule over other races comes from their strong belief in their own superiority. As a result, Dominators are repulsed by the appearance of most other races, especially humans, whom they both hate and fear. Furthermore, the Dominators are born schemers and always develop plans that leave themselves in the safest possible position.

Most Dominators look exactly alike with the exception of the size of the red disks on their foreheads. They employ a rigid caste system, in which those with the largest disks are important government administrators, while those with smaller disks hold lesser roles. Members of the race who break from their appropriate role in the caste are usually punished and often have their disks scraped to reduce their status.

Using Dominators in Adventures

The Dominators are extremely formidable villains who are more than capable of threatening an entire world. Their carefully conceived plans will usually attract the attention of several separate heroes and hero teams, making them ideally suited for epic-scale campaigns and Adventures.

In the 30th Century, the Dominators are intent on entrenching themselves on Earth and will ruthlessly fight those who threaten their position.

Appearances in the DC HEROES Role-Playing Game, Second Edition

Background/Roster Book, Atlas of the DC Universe, World in the Balance

Appearances in DC Comics

***Note:** Pre-Crisis appearances are not part of present continuity.

Pre-Crisis: *Adventure Comics* #361; *Legion of Super-Heroes* (3) #33-34; *Superboy* (1) #225 (behind

the scenes); *Superboy and the Legion of Super-Heroes* #243-245; *Legion of Super-Heroes Annual* (2) #3 (3) 1-2

Current: *Adventures of Superman* #448-449; *Blasters Special* #1; *Captain Atom* (3) #52; *Checkmate!* #12; *The Demon* (3) #6; *Emerald Dawn II* #2; *Invasion!* #1-3; *Justice League America* #61-62; *Justice League Europe* #4; *L.E.G.I.O.N. '91* #27; *Legion of Super-Heroes* (4) #3, 6, 11-15, 19-22, 24-30; *Legion of Super-Heroes Annual* (4) #2; *Starman* #5; *Swamp Thing* (2) #80-81, 96; *Who's Who '90* #1; *Who's Who in the Legion of Super-Heroes* #2-3

Dominator Caste System



The Ones
(White on Red)

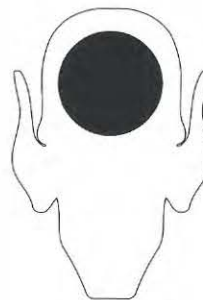

Upper Caste
(Red)



Middle Caste
(Red)

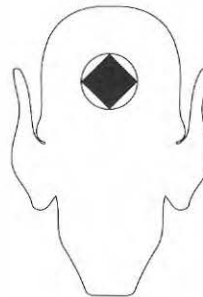

Diamond Caste
Intellectuals and Scientists
(Red on Gray)



Lower Caste
(Red)



Elite Military Forces
(Blue)

KHUNDS

TYPICAL KHUNDIAN SOLDIER

DEX: 4	STR: 4	BODY: 6
INT: 2	WILL: 4	MIND: 4
INFL: 2	AURA: 2	SPIRIT: 4
INITIATIVE: 10		

- **Skills:** Martial Artist: 5, Military Science: 5, Weaponry: 4
- **Drawbacks:** Minor Irrational Attraction to an honorable death

TYPICAL KHUNDIAN WARLORD

DEX: 4	STR: 4	BODY: 6
INT: 7	WILL: 7	MIND: 7
INFL: 6	AURA: 4	SPIRIT: 7
INITIATIVE: 19		

- **Skills:** Charisma: 6, Martial Artist: 5, Military Science: 9, Weaponry: 4
- **Advantages:** Leadership
- **Drawbacks:** Minor Irrational Attraction to an honorable death

KHUNDIAN CYBER-WARRIOR

DEX: 8	STR: 9	BODY: 8
INT: 2	WILL: 6	MIND: 6
INFL: 2	AURA: 2	SPIRIT: 7
INITIATIVE: 12	HERO POINTS: 15	

- **Powers:** Lightning: 9, Skin Armor: 4, Thermal Vision: 4
- **Skills:** Vehicles: 5, Weaponry: 8
- **Drawbacks:** Minor Irrational Attraction to an honorable death

WARLORD GARLAK

DEX: 5	STR: 5	BODY: 6
INT: 9	WILL: 8	MIND: 8
INFL: 8	AURA: 7	SPIRIT: 9
INITIATIVE: 24	HERO POINTS: 65	

- **Skills:** Charisma: 8, Martial Artist: 7, Military Science: 12, Thief: 7, Vehicles: 7, Weaponry: 7
- **Advantages:** Leadership; Scholar (tactics)
- **Drawbacks:** Minor Irrational Attraction to an honorable death

Khundian Equipment

General

Sonic Stunner [BODY: 6, Sonic Beam: 7] This small disk-shaped weapon is non-lethal and is used by Khundian security forces.

Neutralizer [BODY: 6, Neutralize: 10, R#: 2] The Khunds invented the neutralizer in the 30th Century to nullify powers and characteristics derived from the human meta-gene.

20th Century

Blaster [BODY: 6, Energy Blast: 7, R#: 2]

Body Armor [BODY: 7]

BATTLECRUISER [DEX: 2, STR: 16, BODY: 17, INT: 11, WILL: 4, Energy Blast: 16, Extended Hearing: 6, Flight: 20, Full Vision: 10, Projectile Weapons: 19, Radar Sense: 32, Radio Communications: 38, Recall: 22, Sealed Systems: 28, Skin Armor: 6, Super Hearing: 17, Telescopic Vision: 5, Warp: 37, R#: 2 (R#: 3 on Projectile Weapons)]

30th Century

Blaster [BODY: 6, Energy Blast: 8, R#: 2]

Body Armor [BODY: 8]

BATTLECRUISER [DEX: 3, STR: 18, BODY: 18, INT: 13, WILL: 6, Energy Blast: 18, Extended Hearing: 11, Flight: 23, Full Vision: 12, Projectile Weapons: 23, Radar Sense: 37, Radio Communications: 41, Recall: 26, Scaled Systems: 29, Skin Armor: 7, Super Hearing: 20, Telescopic Vision: 6, Warp: 39, R#: 2 (R#: 3 on Projectile Weapons)]

Both the 20th and 30th Century models of the Khundian Battlecruisers are incredibly sophisticated vessels. Both are capable of flight at velocities approaching the speed of light and warp travel at speeds of more than 500 times the speed of light. Both carry extremely potent missile and energy-beam weaponry, a full range of sensors, and a powerful computer.

Powers and Abilities

Khunds are powerfully built, stocky, and able to take great punishment. Despite their size, they are very quick. Certain Khunds have undergone surgery to enhance their bodies with cybernetic implants, since the race has no super-powered members.

The Khunds also possess superior technological know-how, but have applied it only toward military ends.

Personality/Role-playing

The Khunds are one of the most warlike races in the known universe. They live for battle; roughly one half of all Khundian males serve in the military. They take great pride in their warrior heritage and consider most nonviolent races beneath their contempt.

Mostly eclipsed by its own moon, Khundia itself is a dark, foreboding planet. Its atmosphere is thick and acrid because the Khunds have carelessly destroyed their ecosystem. Khundia is also extremely over-populated, its people living under a constant state of martial law.

Khunds believe themselves to be intellectuals, although they promote prejudice and ignorance and rely almost completely on brute force to attain their goals. Dominated by the male of the species, Khunds consider humiliation or defeat at the hands of a female the worst fate possible. In fact, it is believed that no female Khund known has been allowed in their military. Hence, almost every male child learns to battle at a very early age and is imbued with a strong sense of honor which he will defend with his life, even from the smallest insult.

The Khundian warlords are some of the best military strategists in the galaxy, and by the end of the 30th Century, after the Great Collapse of the economy, the Khundian Regime will envelop a number of worlds.

Using Khunds in Adventures

Khunds are a warlike race capable of threatening an entire world. For this reason, they are ideally suited to adventures on the epic scale. If you plan to run a "space opera" campaign or adventure, the Khunds are among your ideal antagonists.

Appearances in the DC HEROES Role-Playing Game, Second Edition

Atlas of the DC Universe

Appearances in DC Comics

***Note:** Pre-Crisis appearances are not part of present continuity.

Pre-Crisis: *Adventure Comics* #346-347; *Legion of Super-Heroes* (2-3) #285, 287, 298-300, 307-310; 10, 51, 53-55; *Superboy* (1) #217, 236-237, 242-245; *Who's Who* '86 #12

Current: *Detective Comics* #595; *Emerald Dawn II* #2, 4; *Firestorm, the Nuclear Man* #80; *Hawk and Dove* (3) #1; *Invasion!* #1-3; *Justice League Europe* #31; *Justice League International* #22, 24; *L.E.G.I.O.N.* '89 #8, 11, 20, 24-27; *Legion of Super-Heroes* (4) #8 (text), 9, 11, 13-17, 30; *Power of The Atom* #7-8; *Starman* #5; *Suicide Squad* #23; *Who's Who* '90 #4; *Who's Who in the Legion of Super-Heroes* #3; *Wonder Woman* (2) #25, 27

Khund Weapons

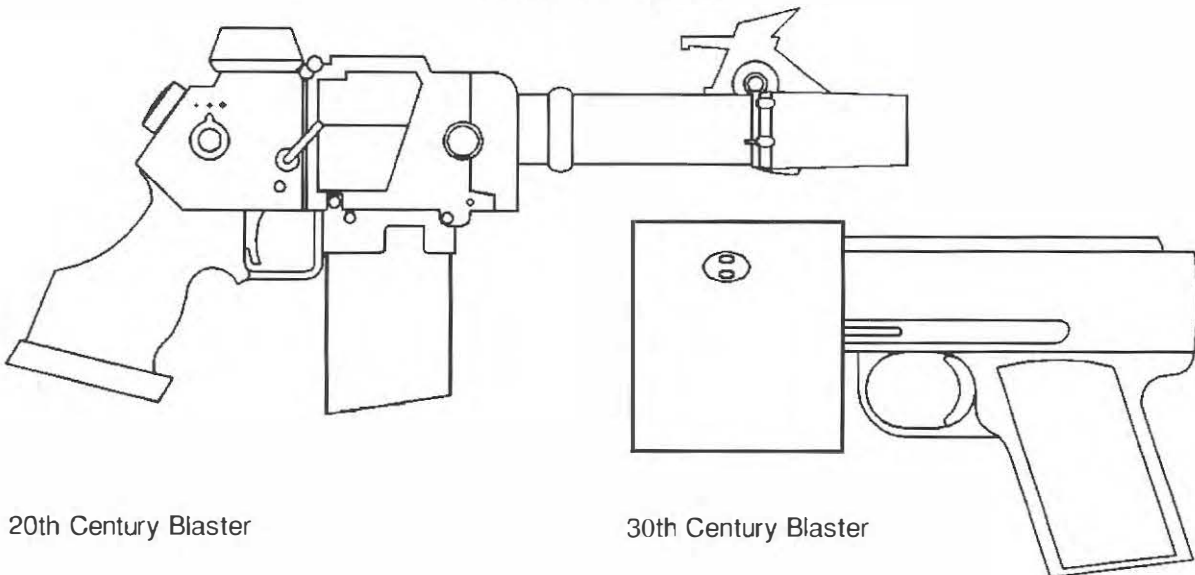

20th Century Blaster

30th Century Blaster