

Paper Models of Polyhedra

Gijs Korthals Altes

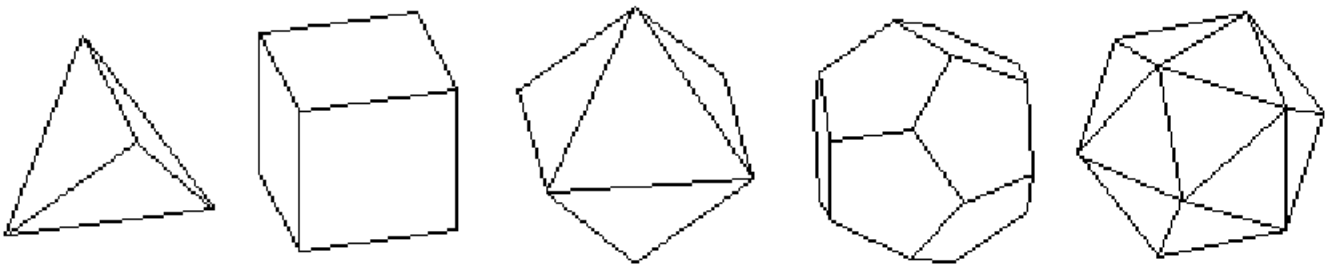

Polyhedra are beautiful 3-D geometrical figures that have fascinated philosophers, mathematicians and artists for millennia

Paper Models of Polyhedra

Platonic Solids

Dodecahedron
Cube and Tetrahedron
Octahedron
Icosahedron

Archimedean Solids

Cuboctahedron
Icosidodecahedron
Truncated Tetrahedron
Truncated Octahedron
Truncated Cube
Truncated Icosahedron (soccer ball)
Truncated dodecahedron
Rhombicuboctahedron
Truncated Cuboctahedron
Rhombicosidodecahedron
Truncated Icosidodecahedron
Snub Cube
Snub Dodecahedron

Kepler-Poinsot Polyhedra

Great Stellated Dodecahedron
Small Stellated Dodecahedron
Great Icosahedron
Great Dodecahedron

Other Uniform Polyhedra

Tetrahemihexahedron
Octahemioctahedron
Cubohemioctahedron
Small Rhombihexahedron
Small Rhombidodecahedron
Small Dodecahemiododecahedron
Small Ditrigonal Icosidodecahedron
Great Dodecahedron

Compounds

Stella Octangula
Compound of Cube and Octahedron
Compound of Dodecahedron and Icosahedron
Compound of Two Cubes
Compound of Three Cubes
Compound of Five Cubes
Compound of Five Octahedra
Compound of Five Tetrahedra
Compound of Truncated Icosahedron and Pentakisidodecahedron

Other Polyhedra

Pentagonal Hexecontahedron

Pentagonalconsitetrahedron

Pyramid

Pentagonal Pyramid

Decahedron

Rhombic Dodecahedron

Great Rhombihexacron

Pentagonal Dipyramid

Pentakisdodecahedron

Small Triakisoctahedron

Small Triambic Icosahedron

Polyhedra Made of Isosceles Triangles

Third Stellation of the Icosahedron

Sixth Stellation of the Icosahedron

Seventh Stellation of the Icosahedron

Eighth Stellation of the Icosahedron

Ninth Stellation of the Icosahedron

Final Stellation of the Icosahedron

Prism and Antiprism

Triangular Prism

Pentagonal Prism

Pentagonal Antiprism

Triangular Prism

Octagonal Prism

Octagonal Antiprism

Pentagrammic Prism

Pentagrammic Antiprism

Hexagrammic Prism

Hexagrammic Antiprism

Twisted Rectangular Prism

Kaleidocycles

Hexagonal Kaleidocycle

Octagonal Kaleidocycle

Decagonal Kaleidocycle

Other Paper Models

Cylinder

Tapered Cylinder

Cone

Special Cones

"Matryoska house"

"Matryoska house" 50%

Globe

Chevaux-de-frise

Dodecahedron

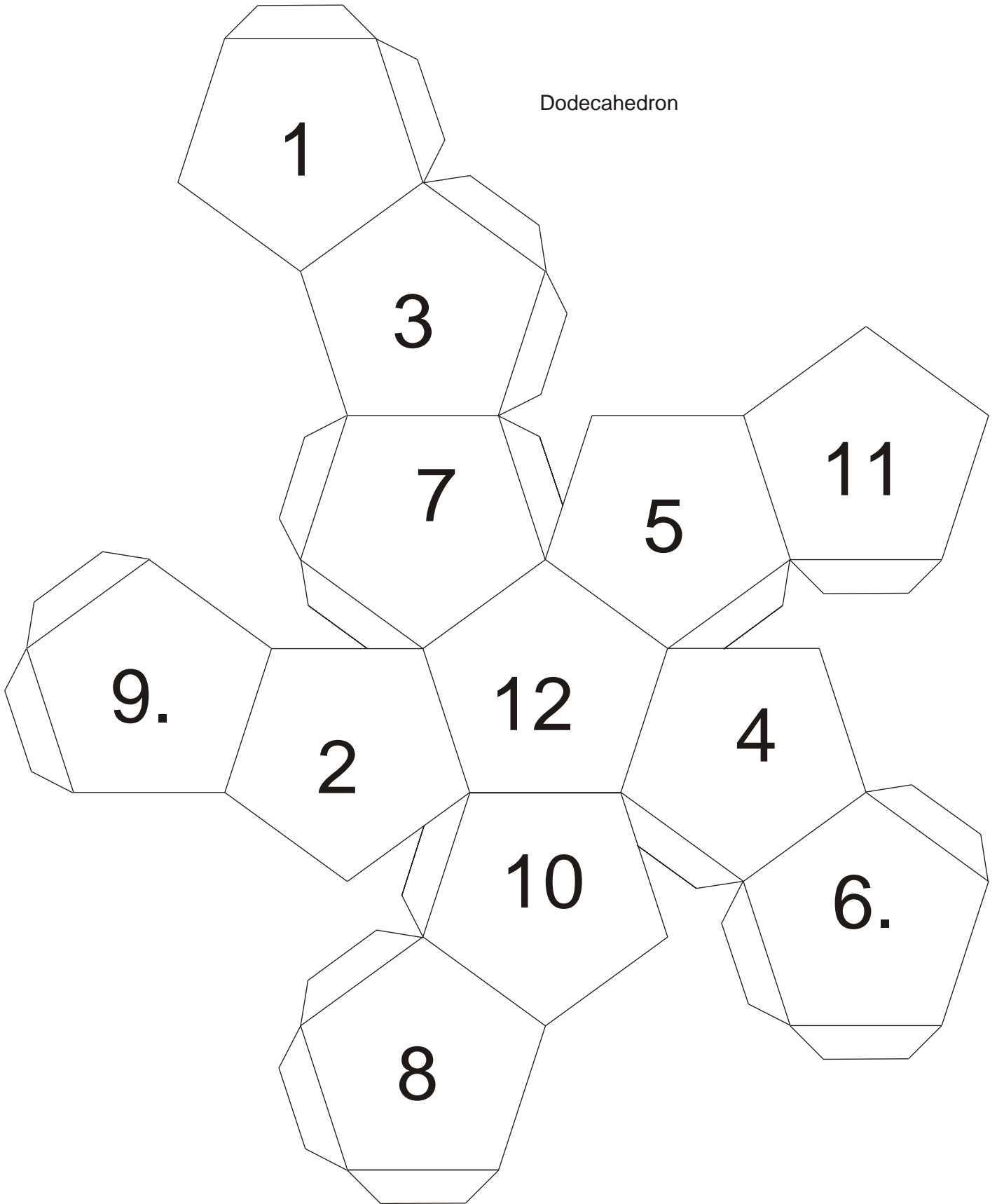

Dodecahedron

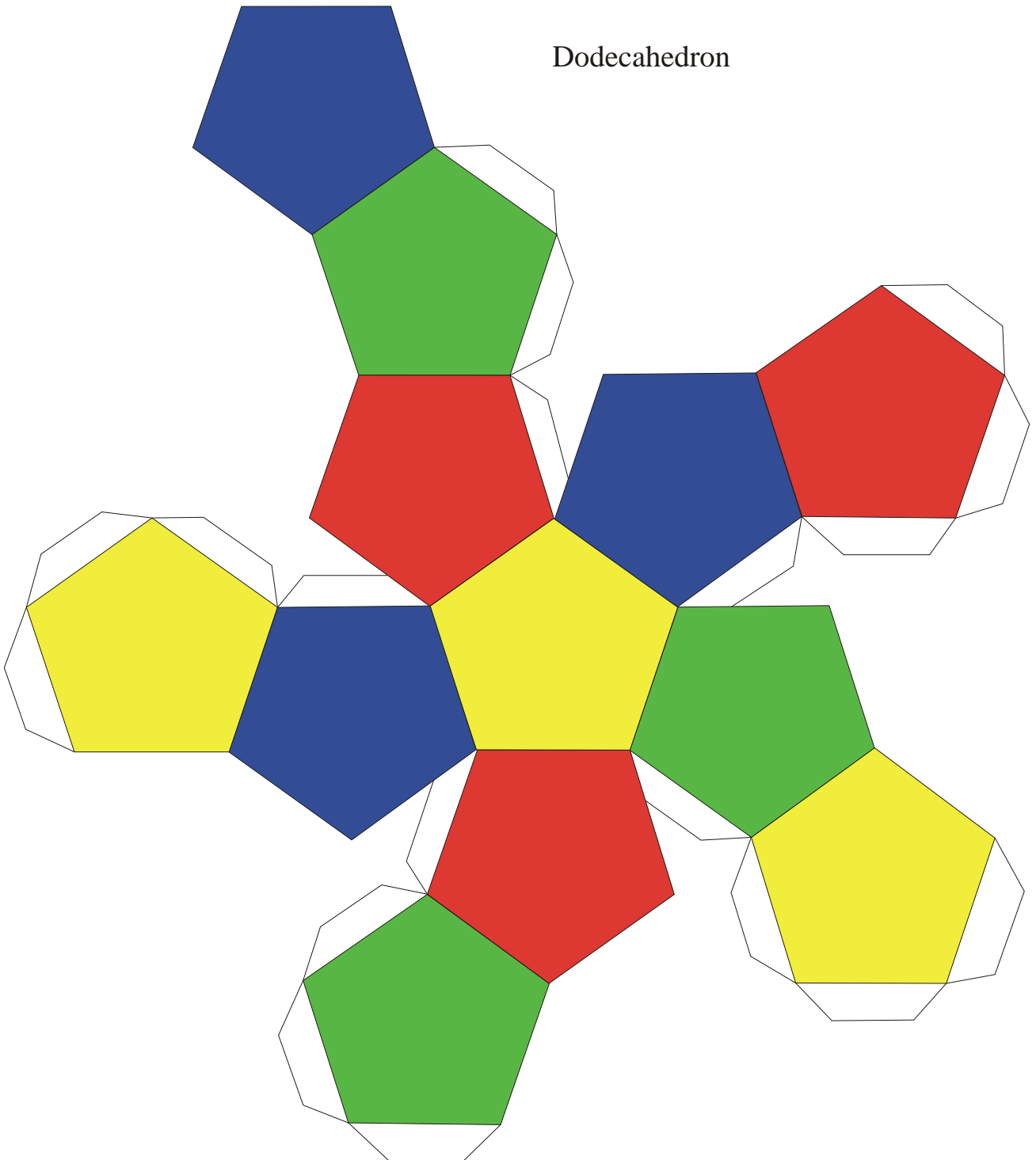

Dodecahedron

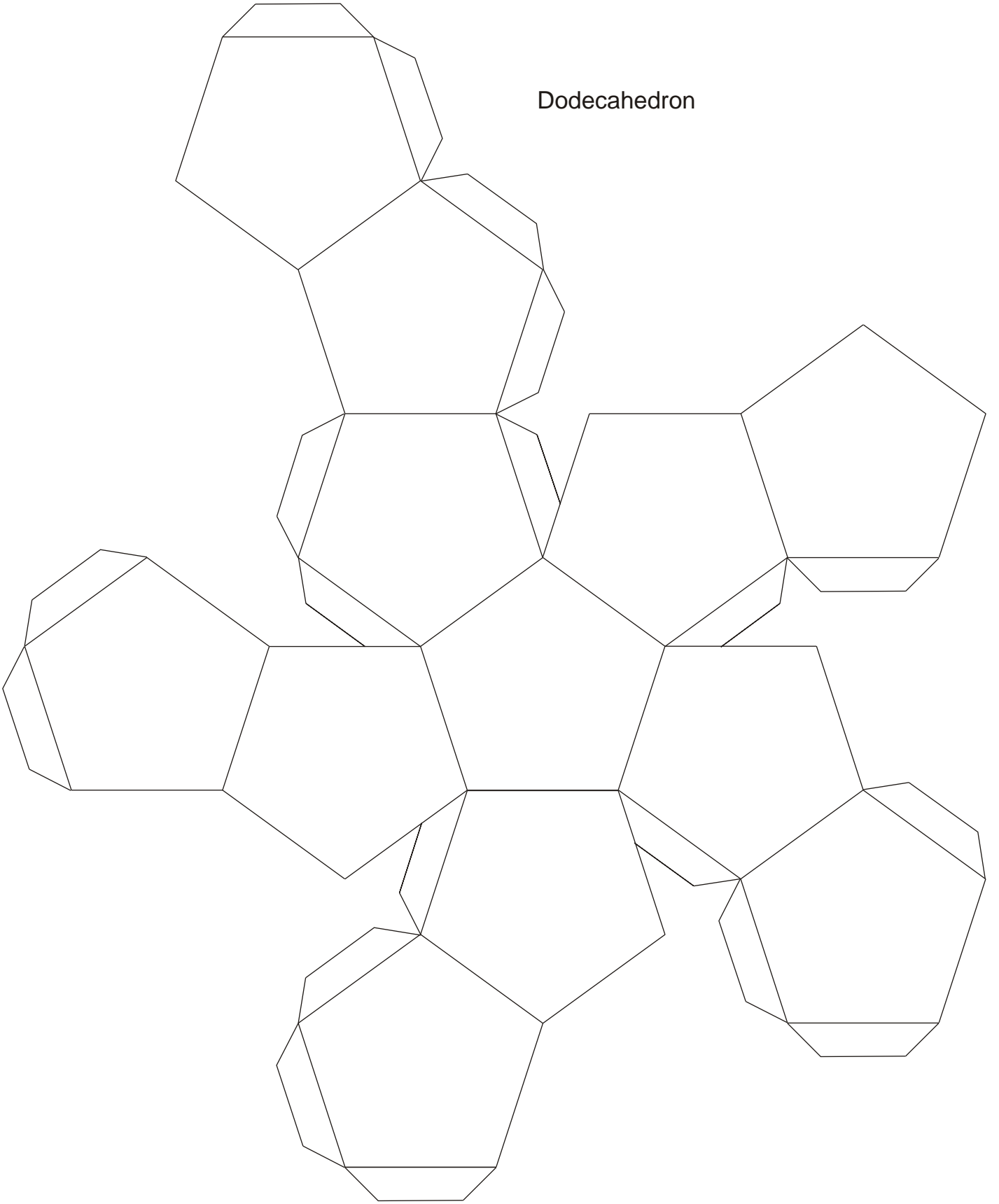

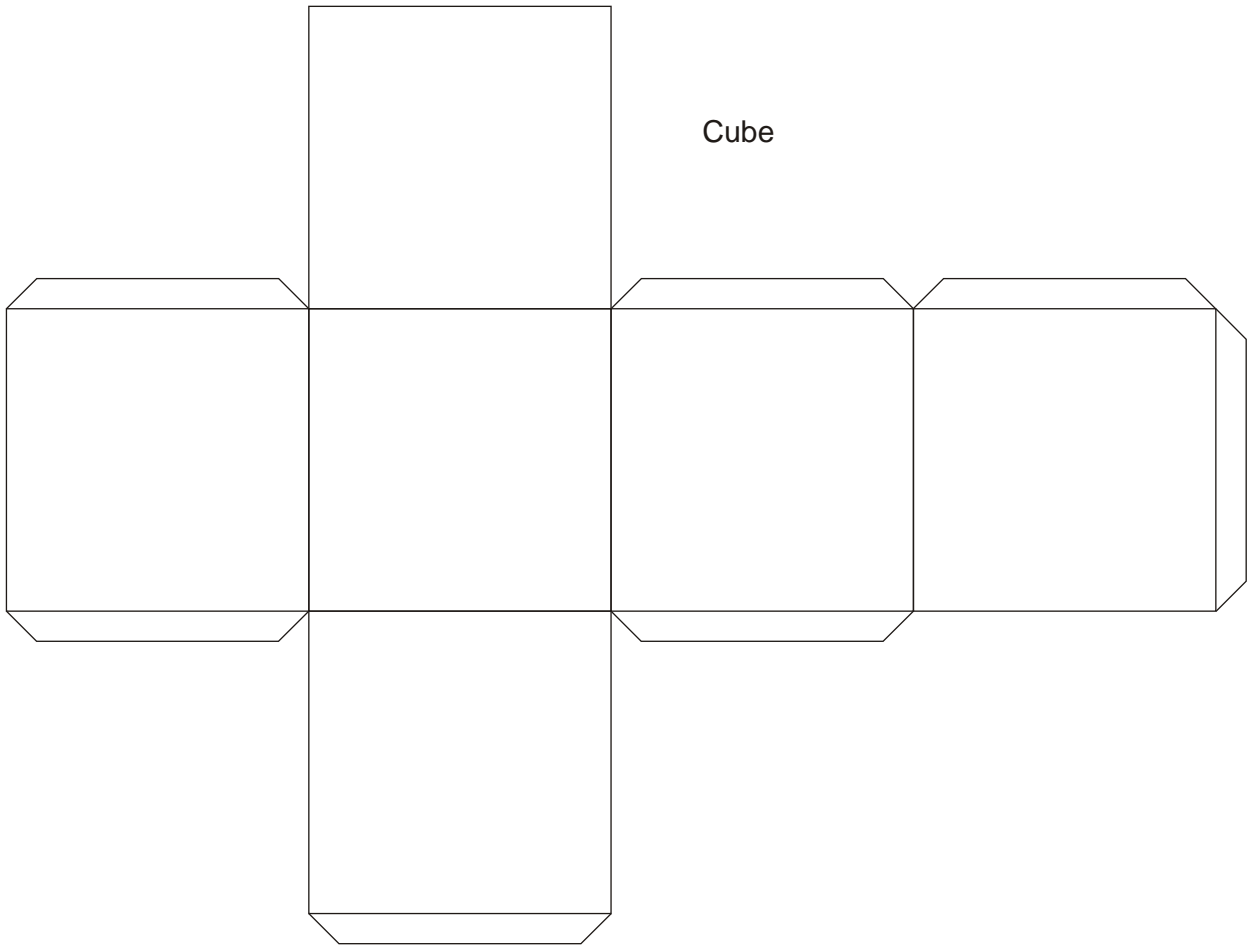

Cube

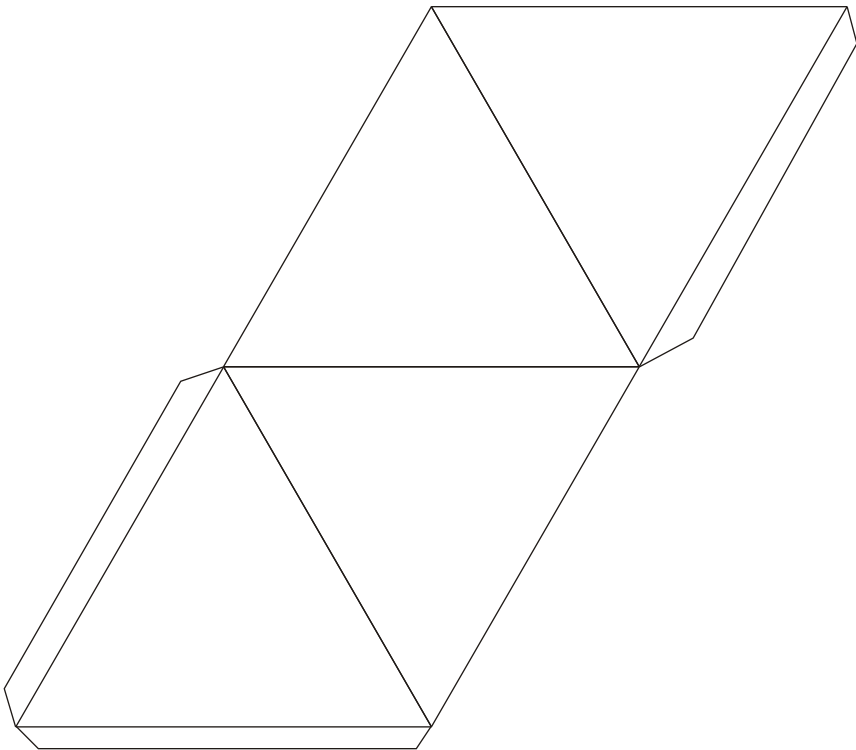

Tetrahedron

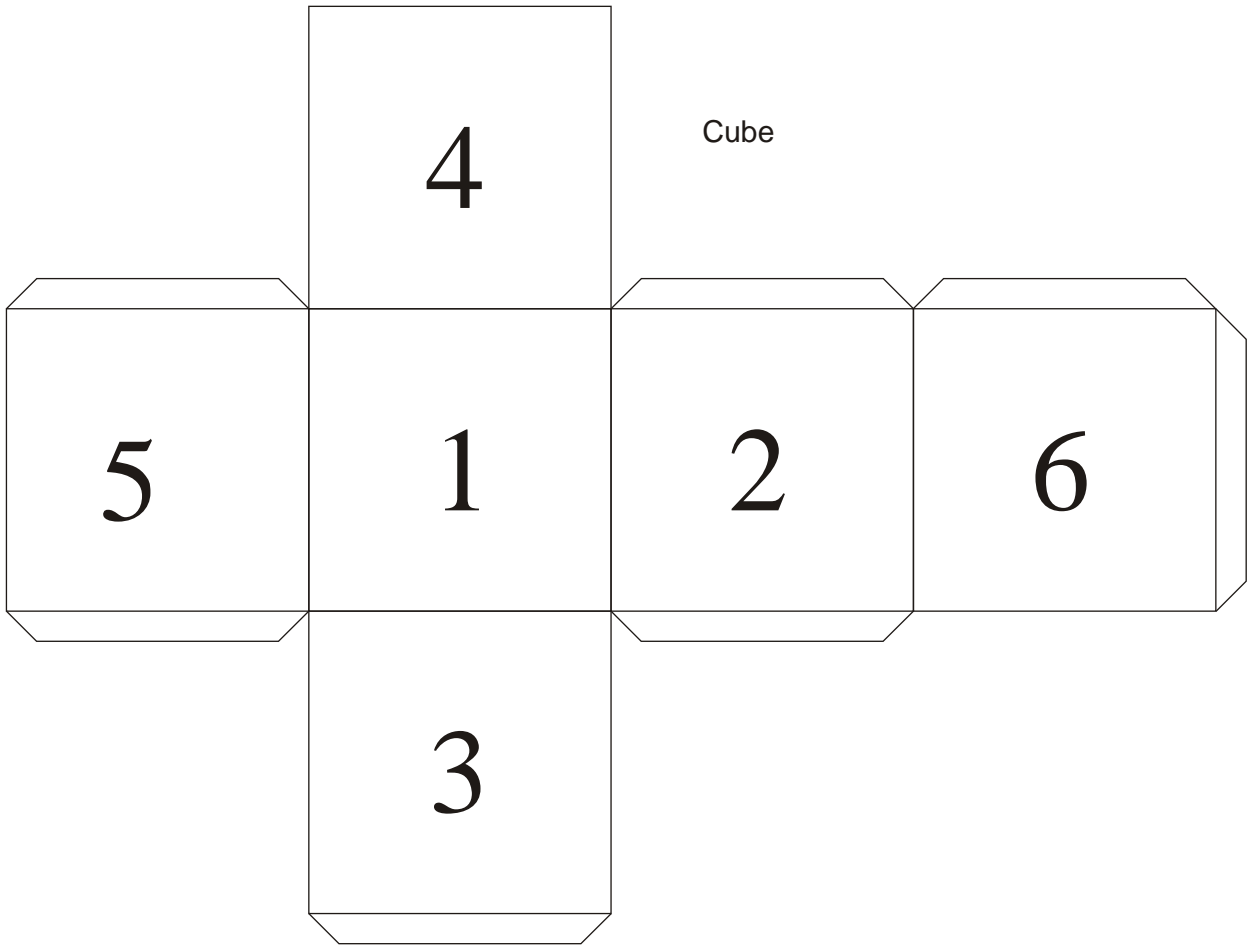

Cube

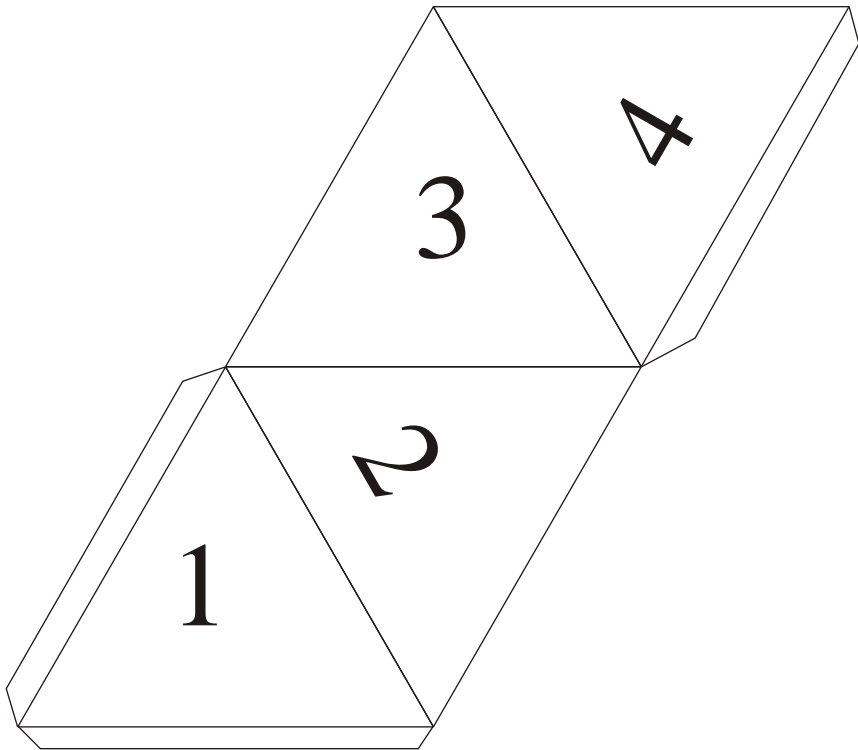

Tetrahedron

Octahedron

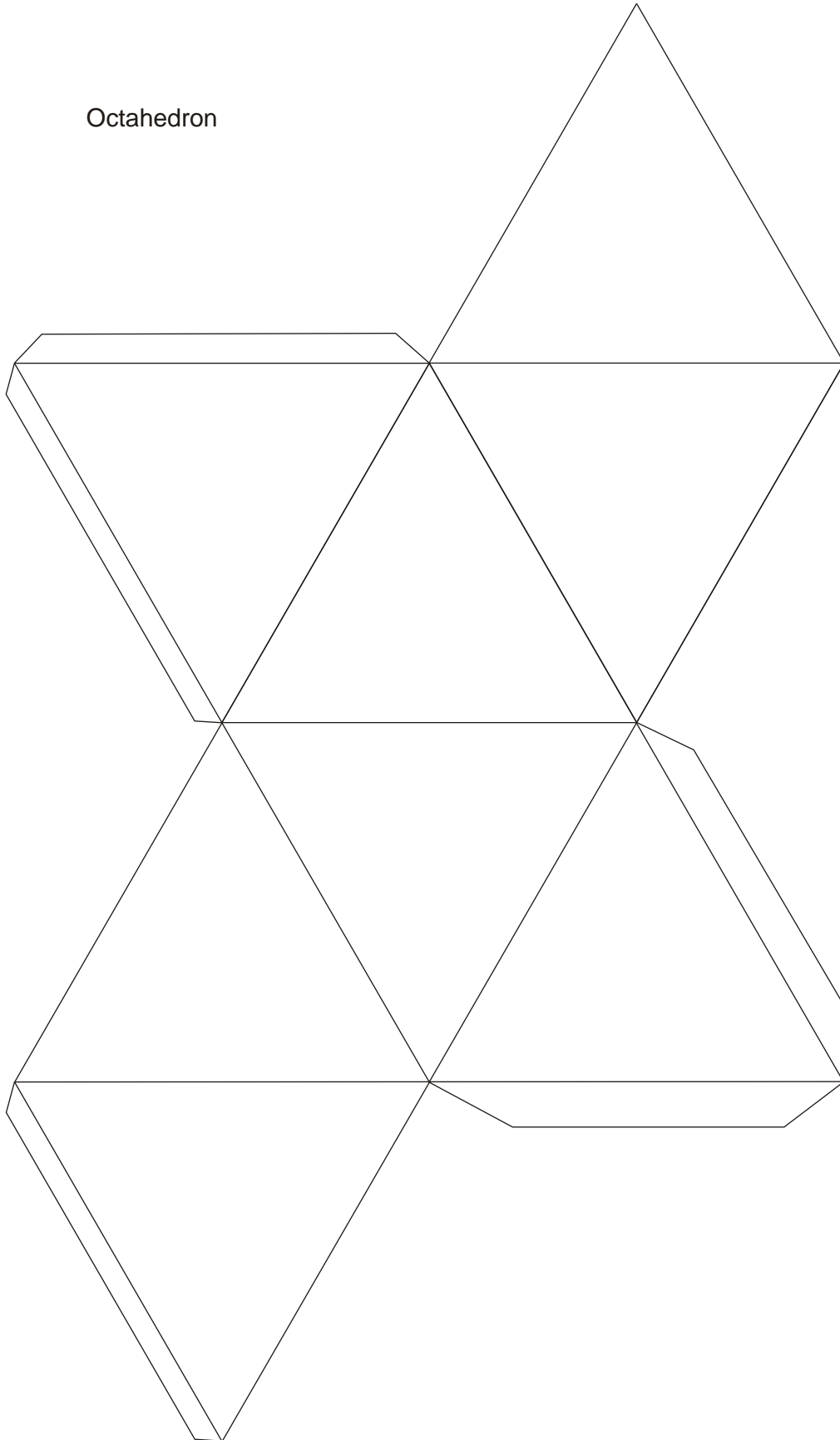

Icosahedron

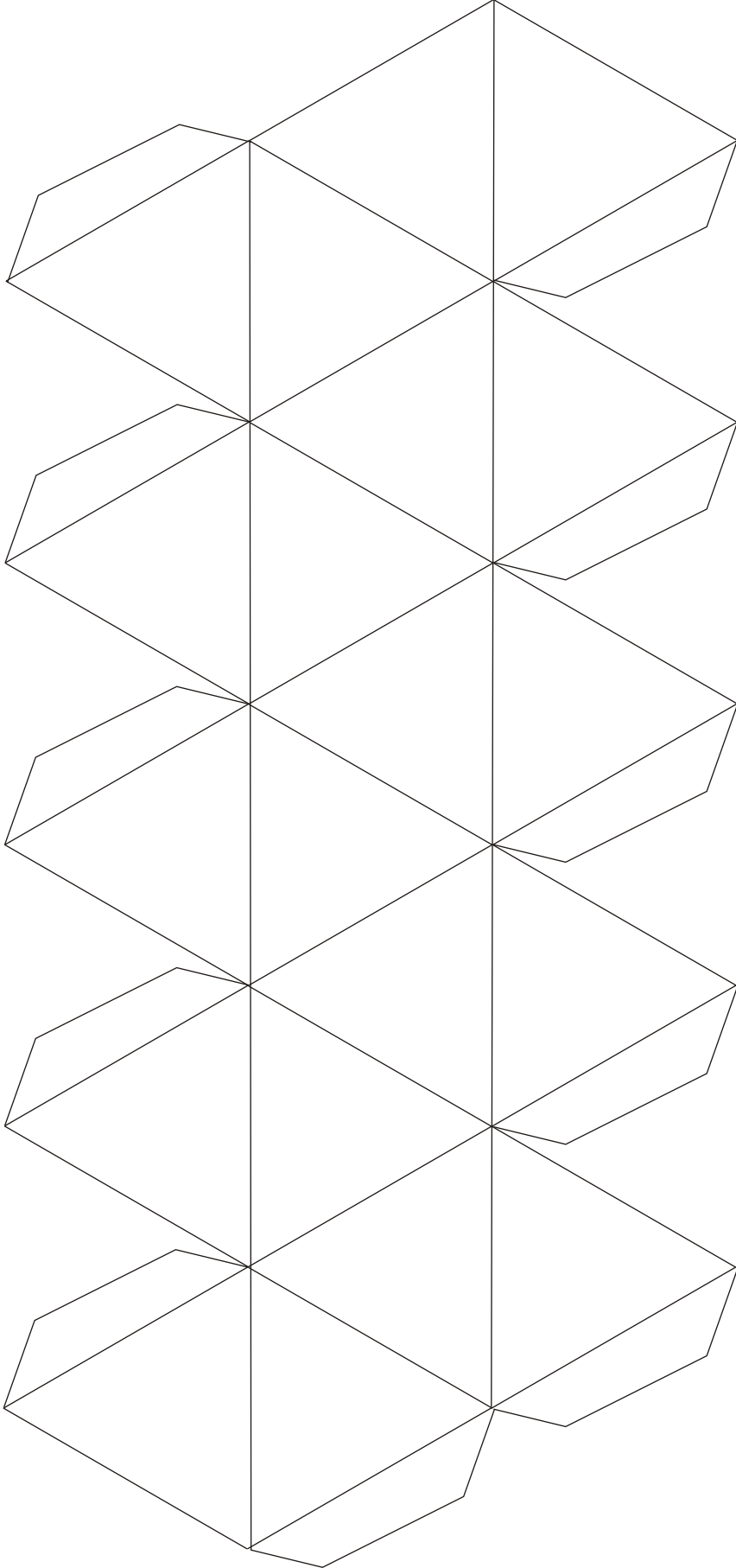

Cuboctahedron

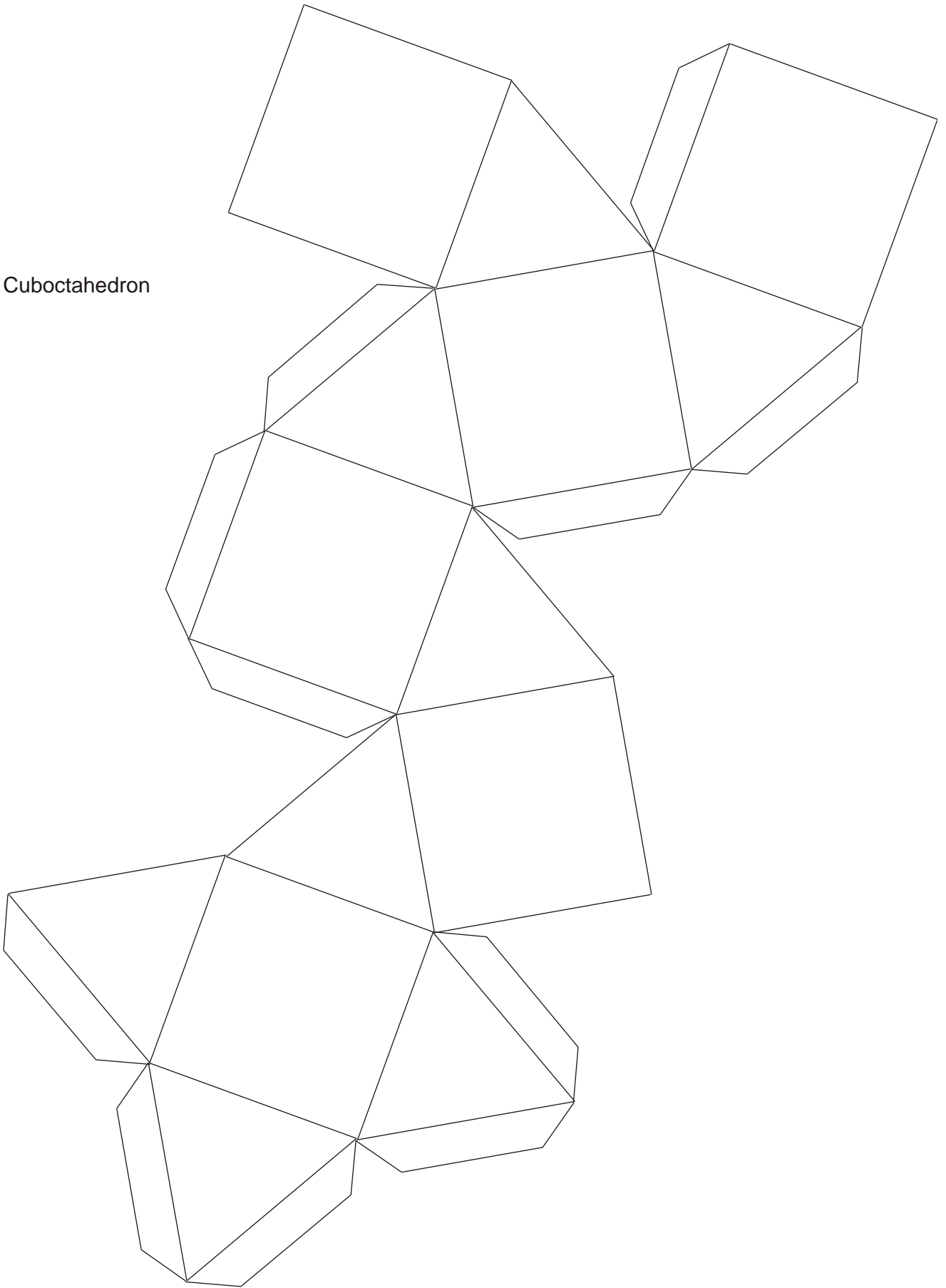

Icosidodecahedron

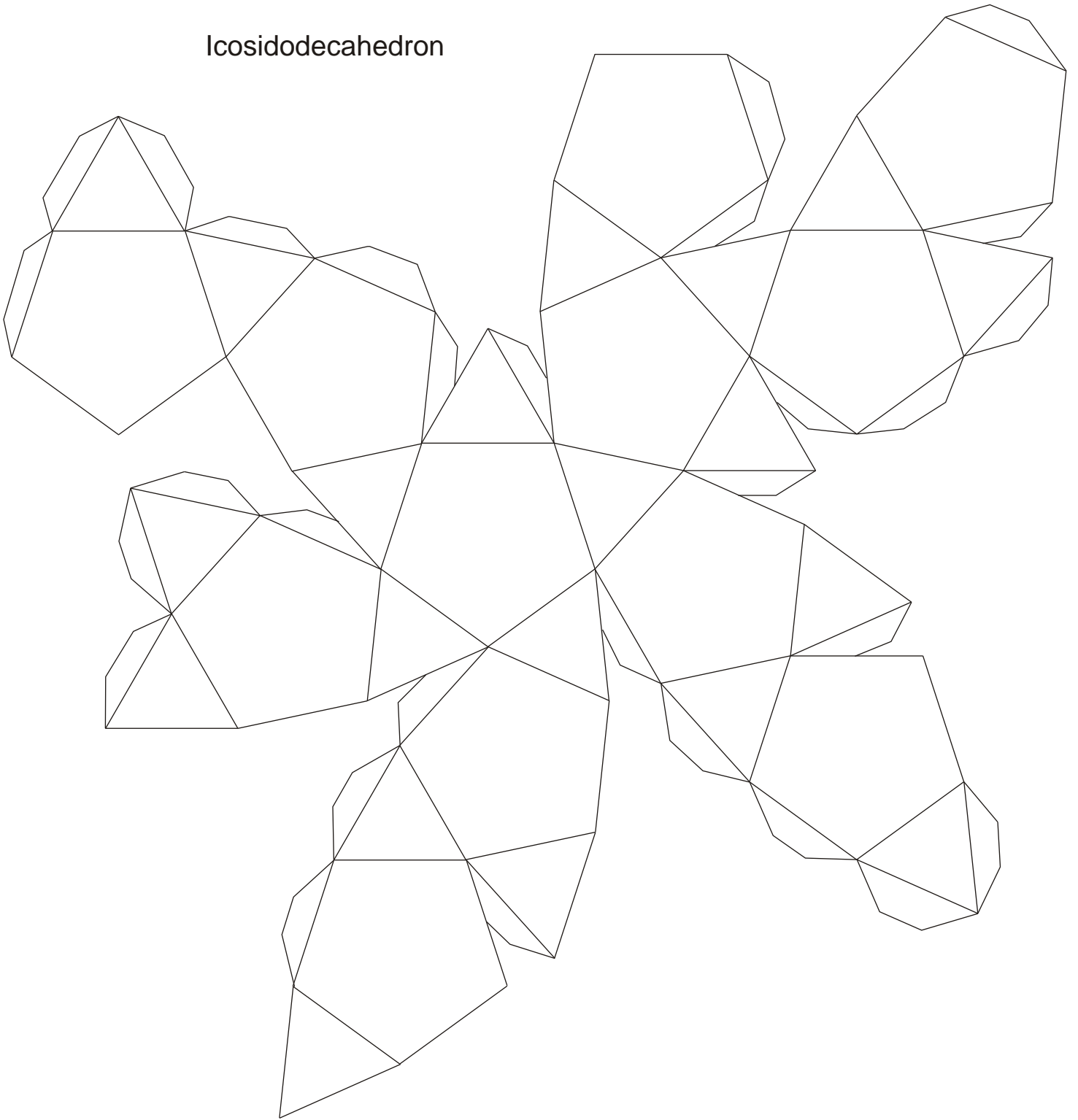

Truncated Tetrahedron

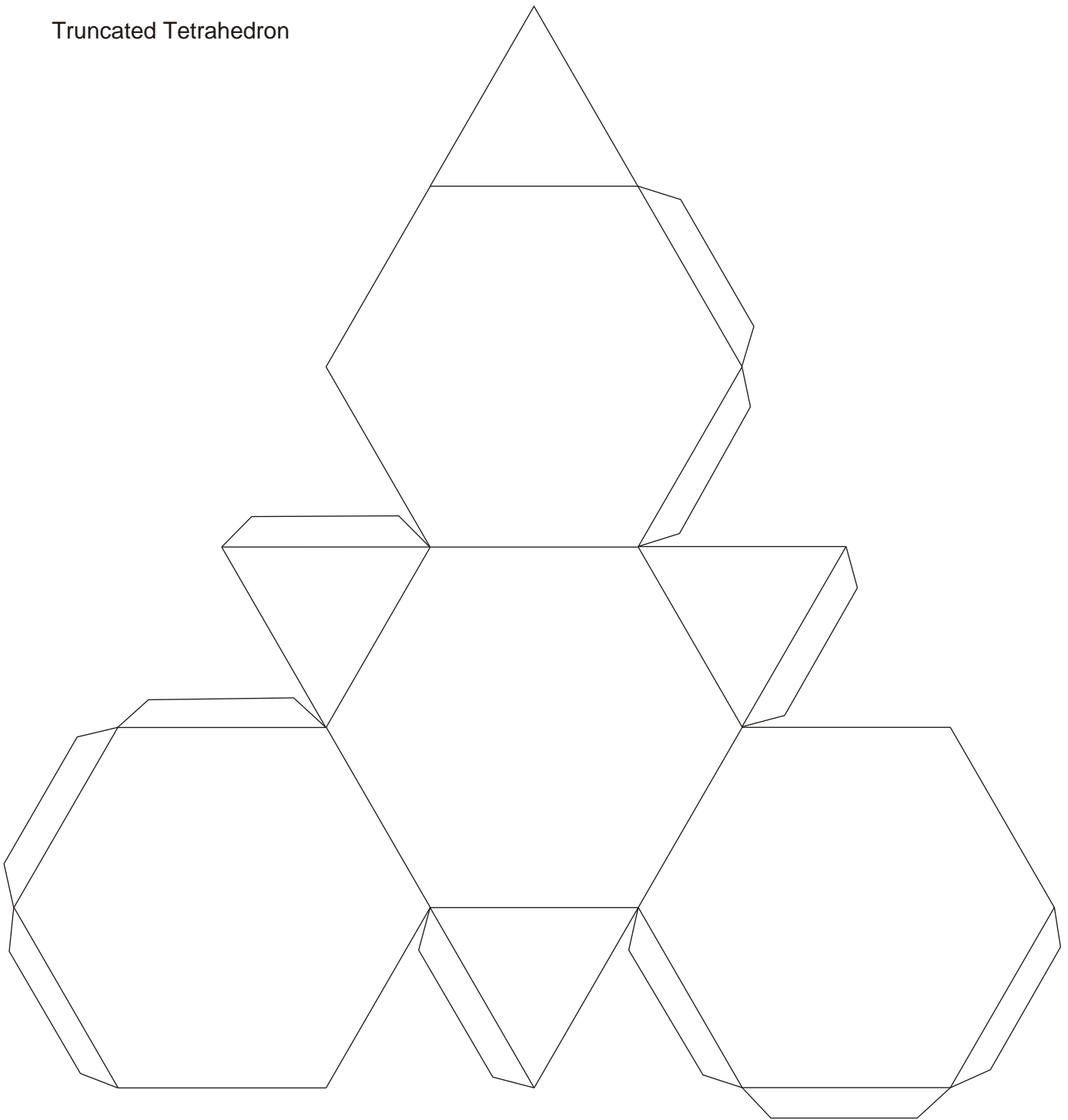

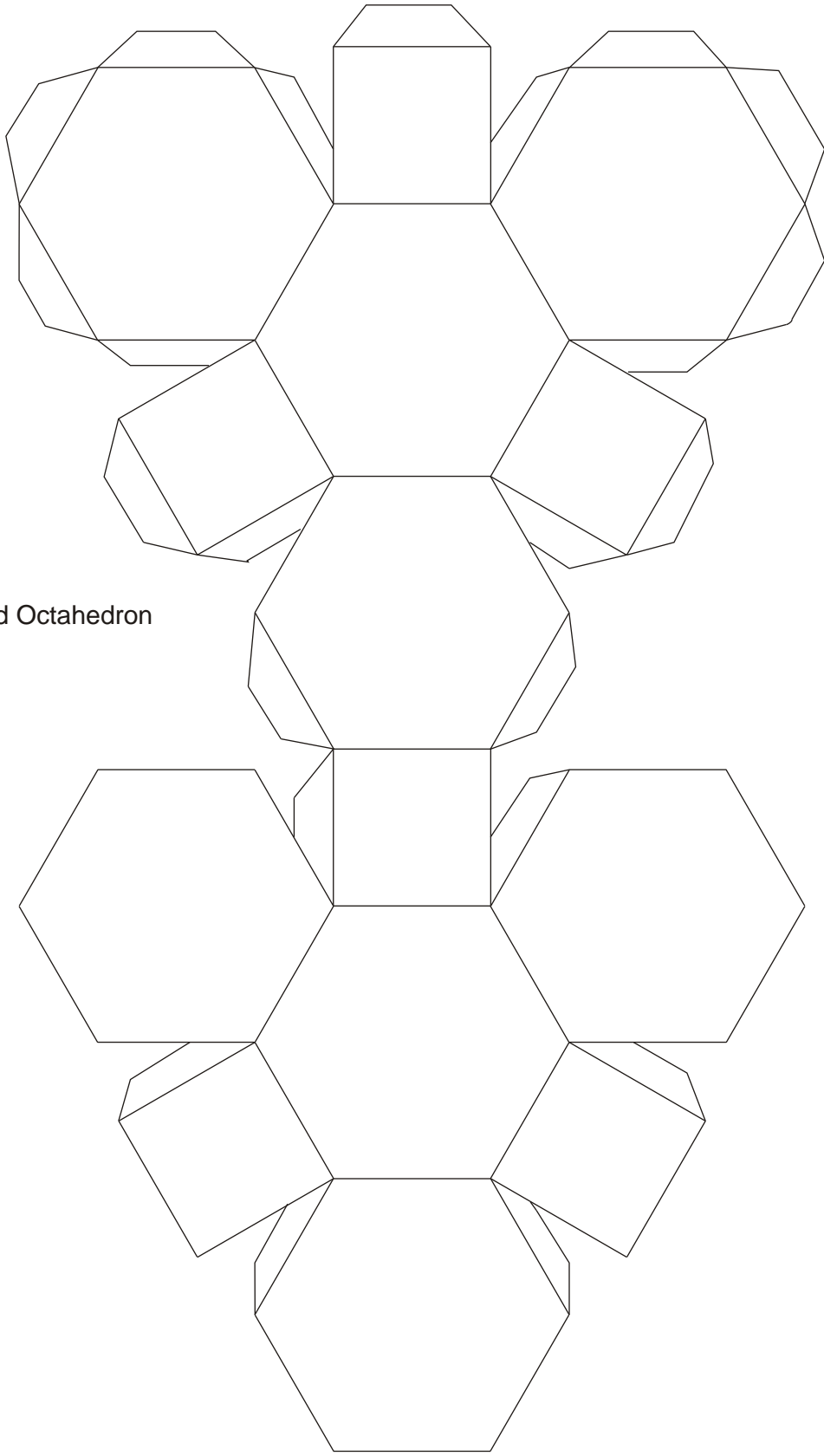

Truncated Octahedron

Truncated Cube

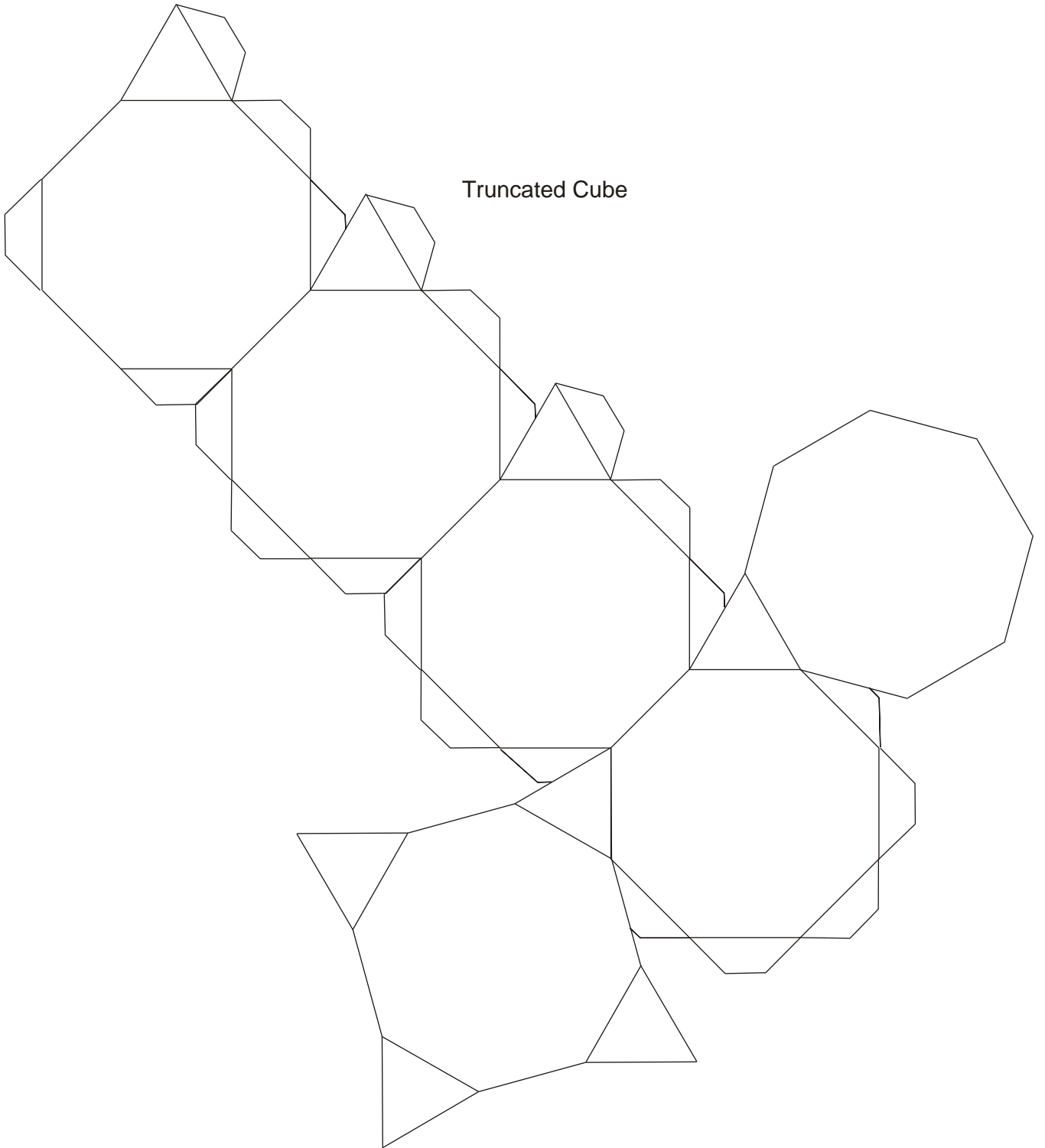

Truncated icosahedron

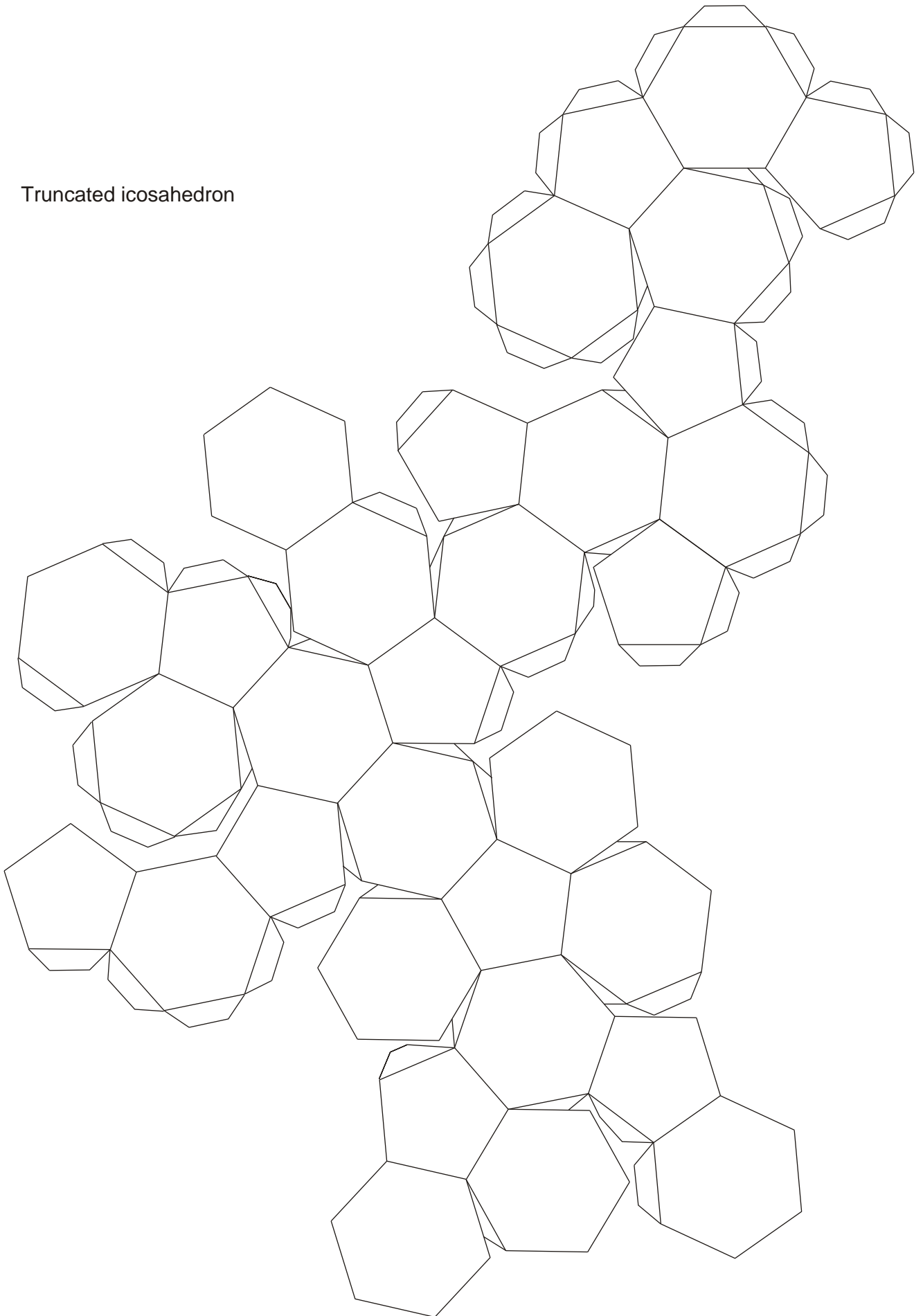

Truncated dodecahedron

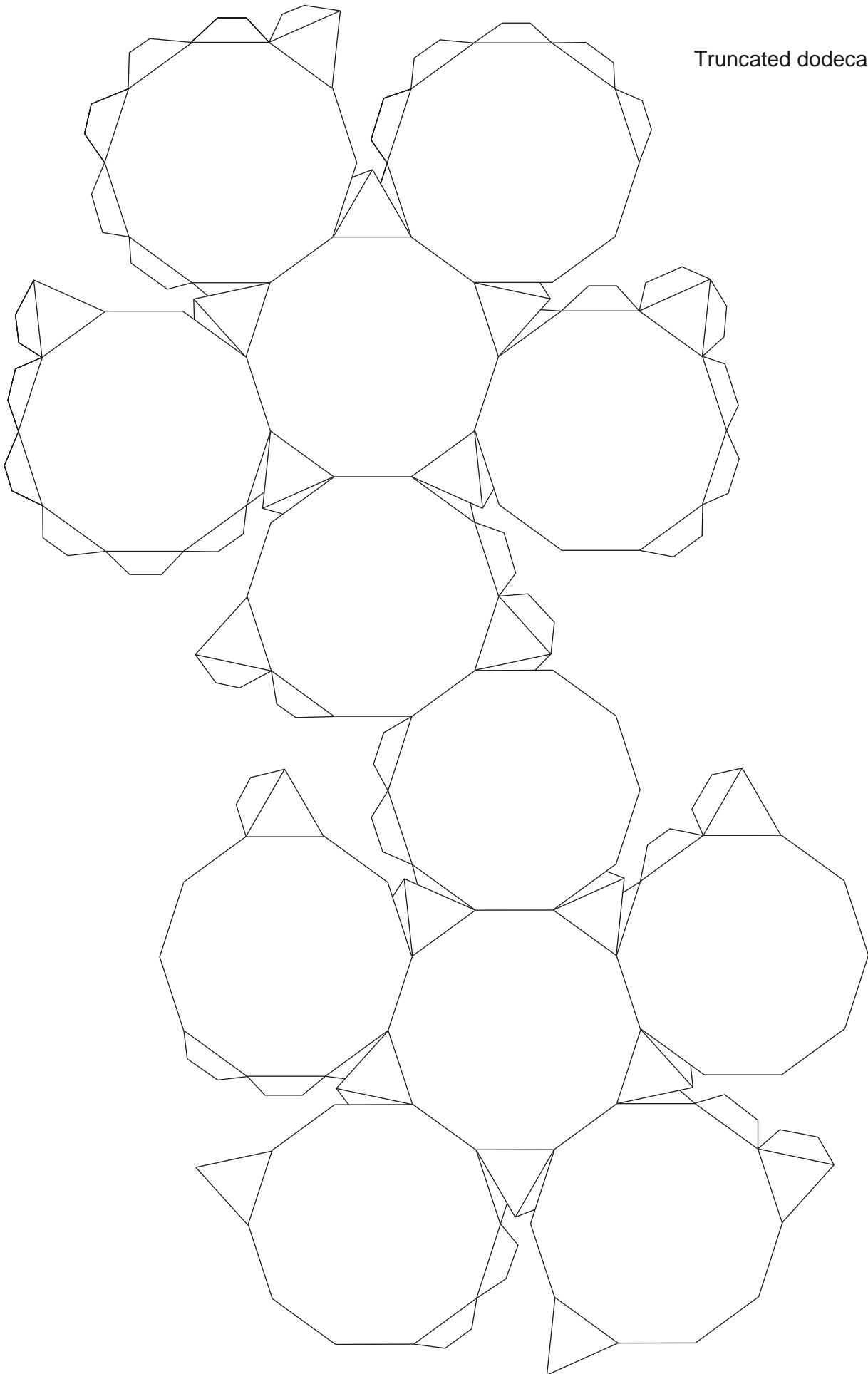

Rhombicuboctahedron

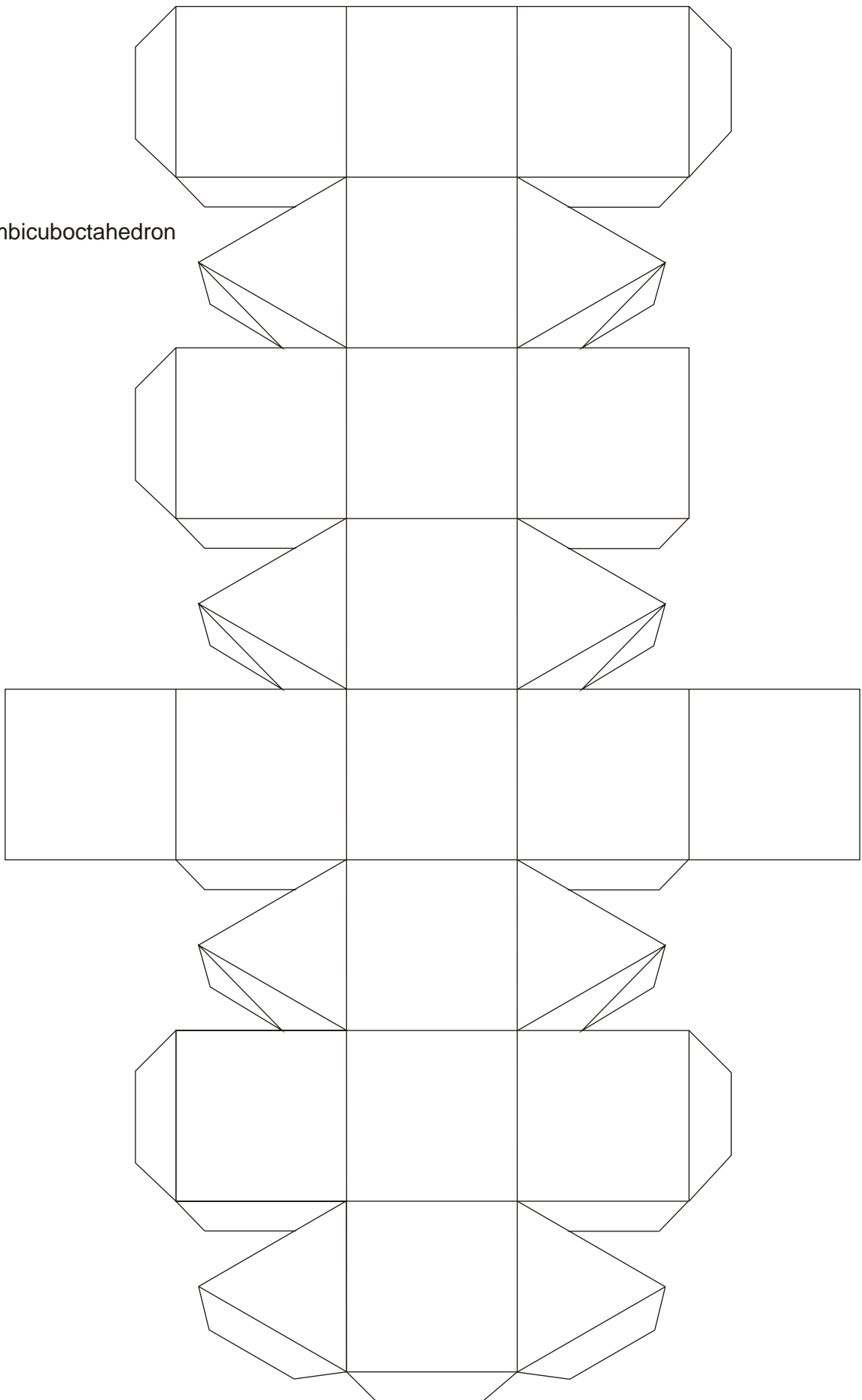

Truncated cuboctahedron

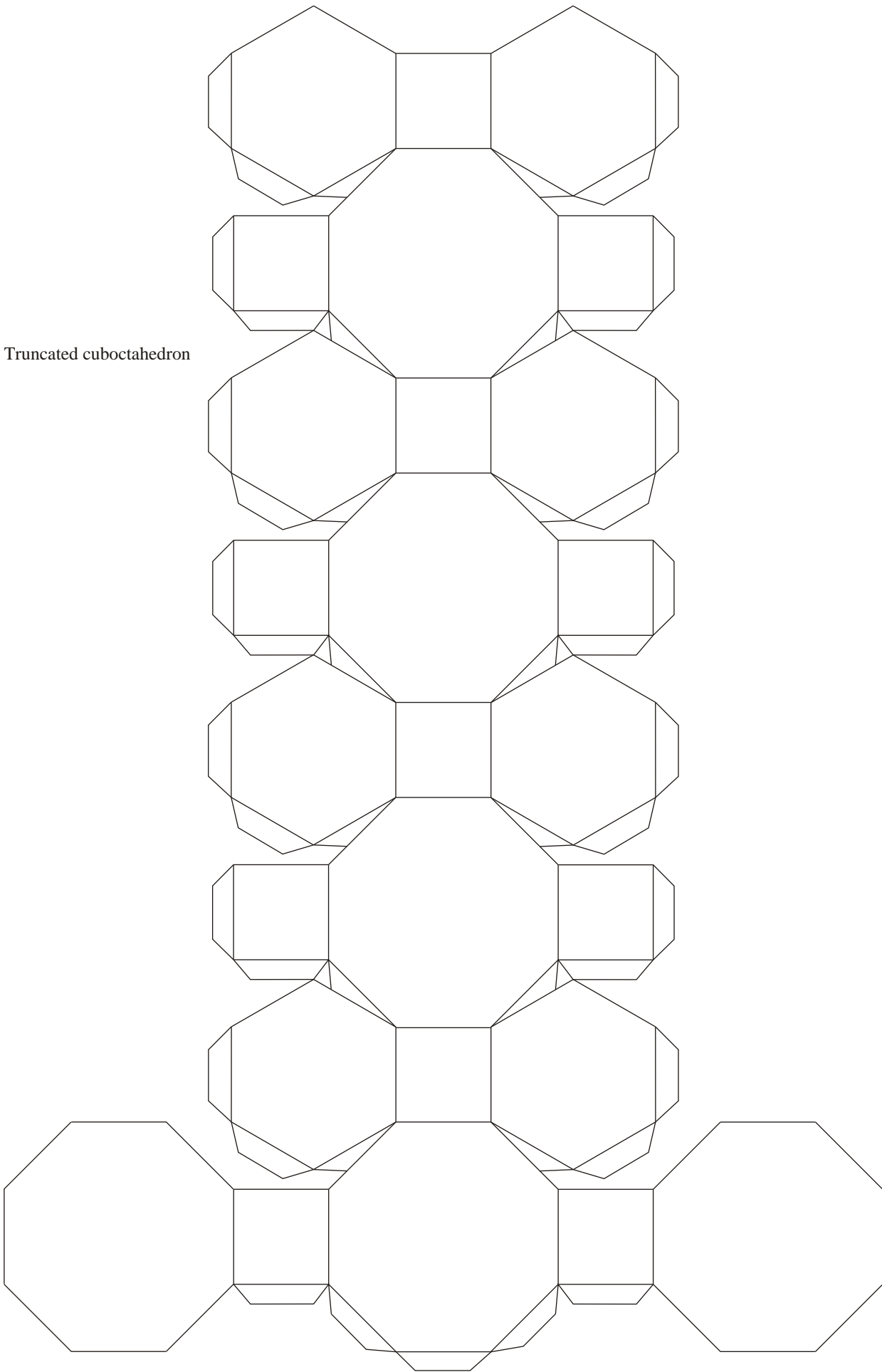

Rombicosidodecahedron

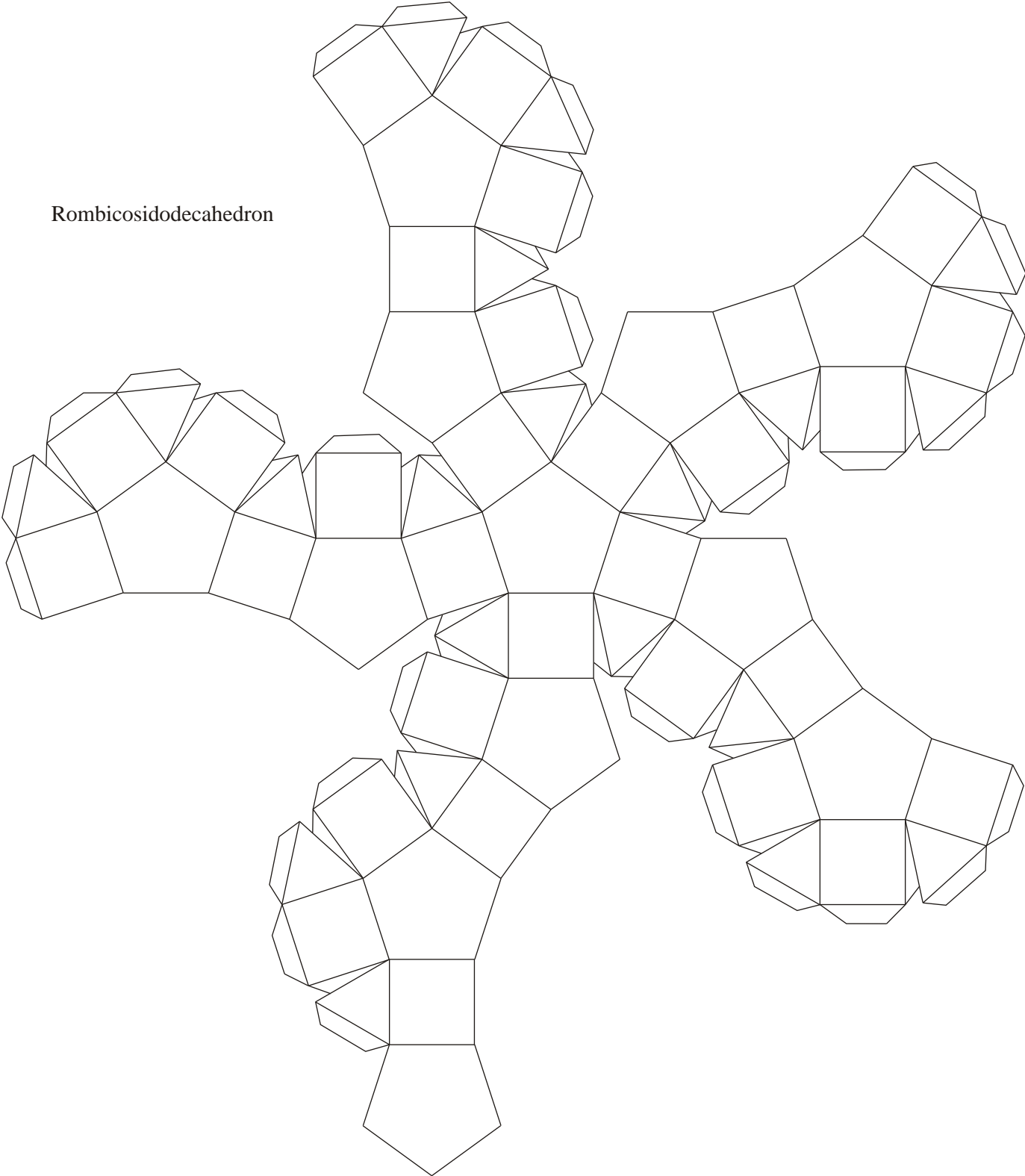

Truncated Icosidodecahedron

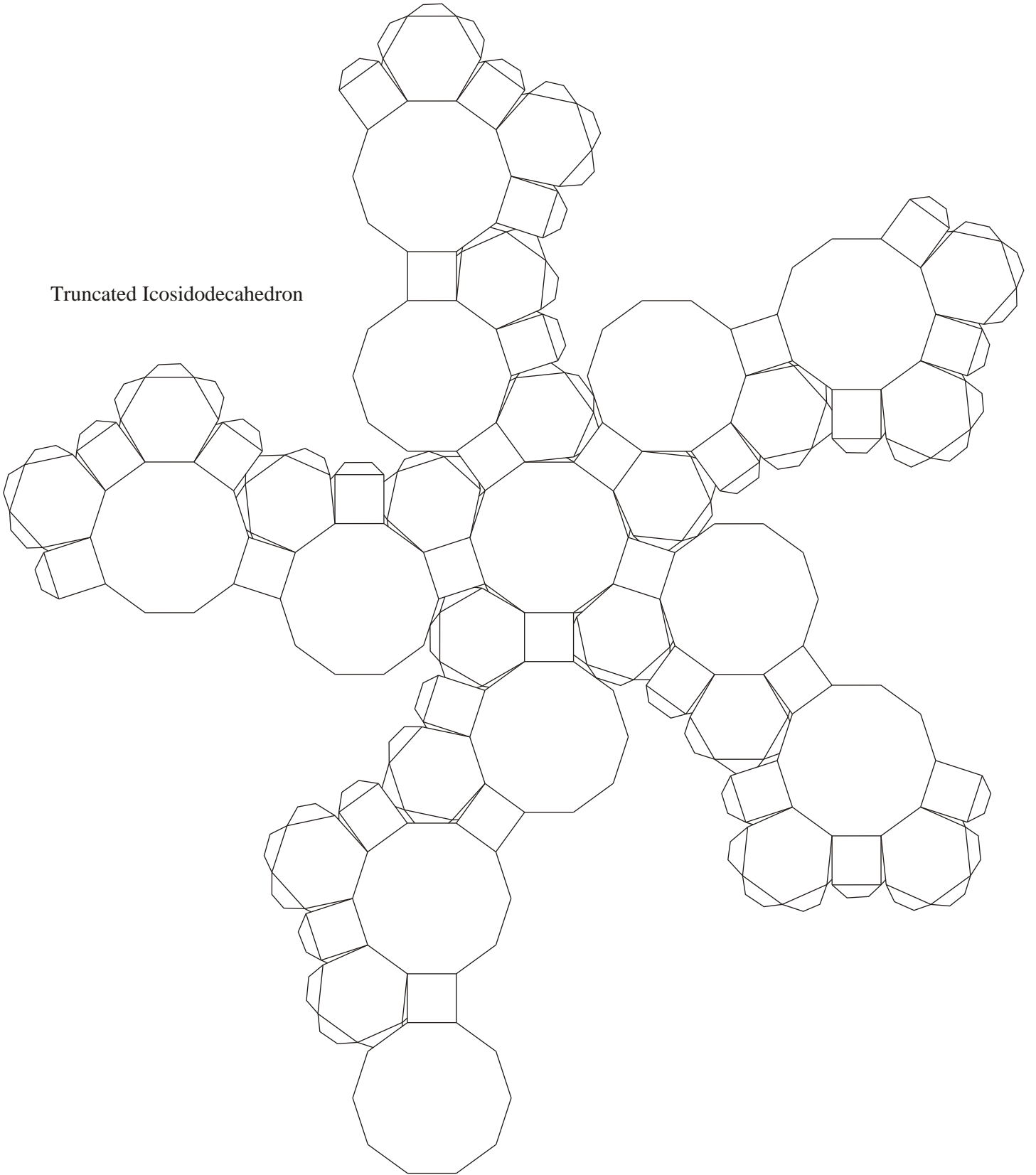

Snub cube

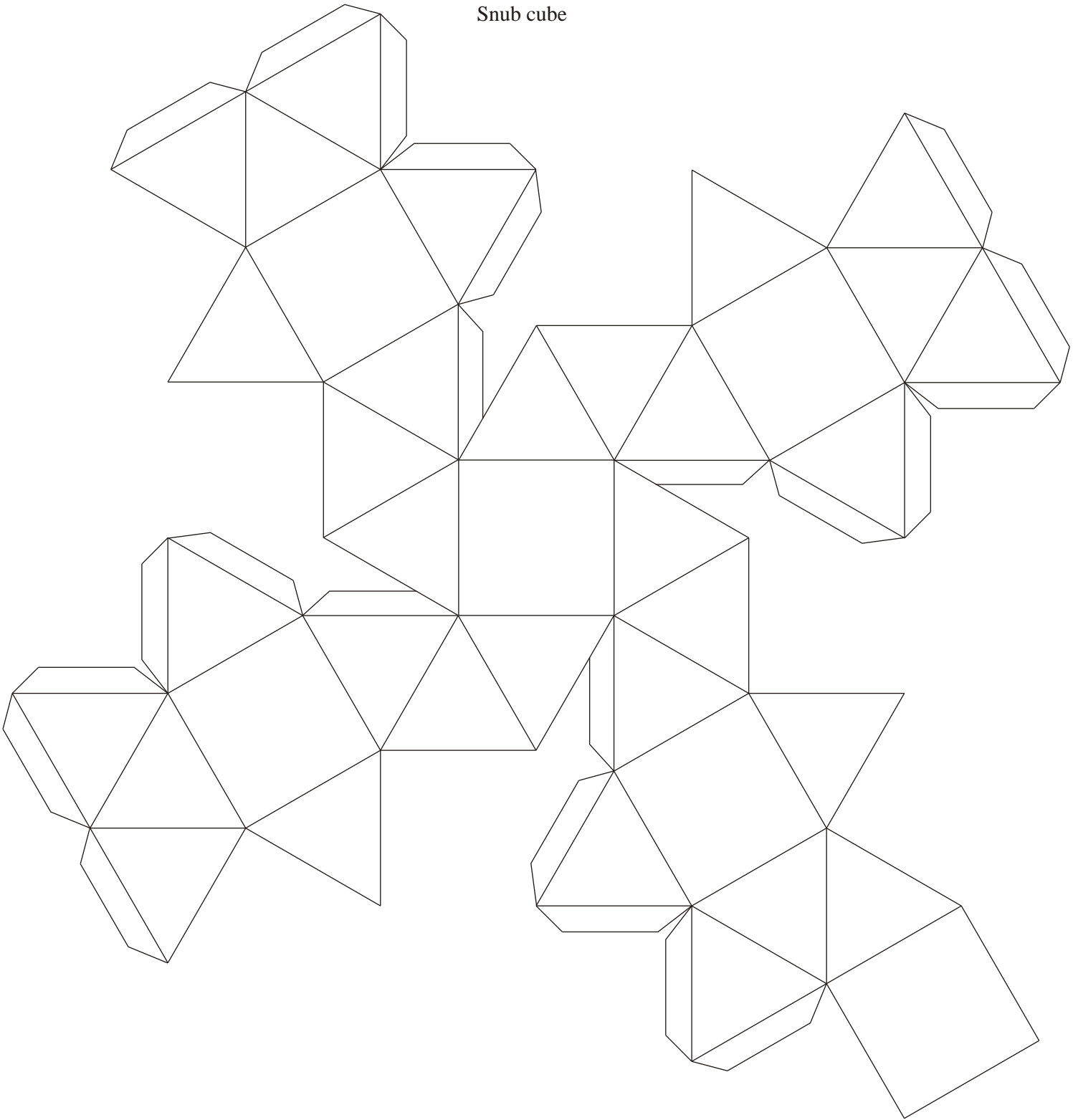

Snub cube
Right-handed

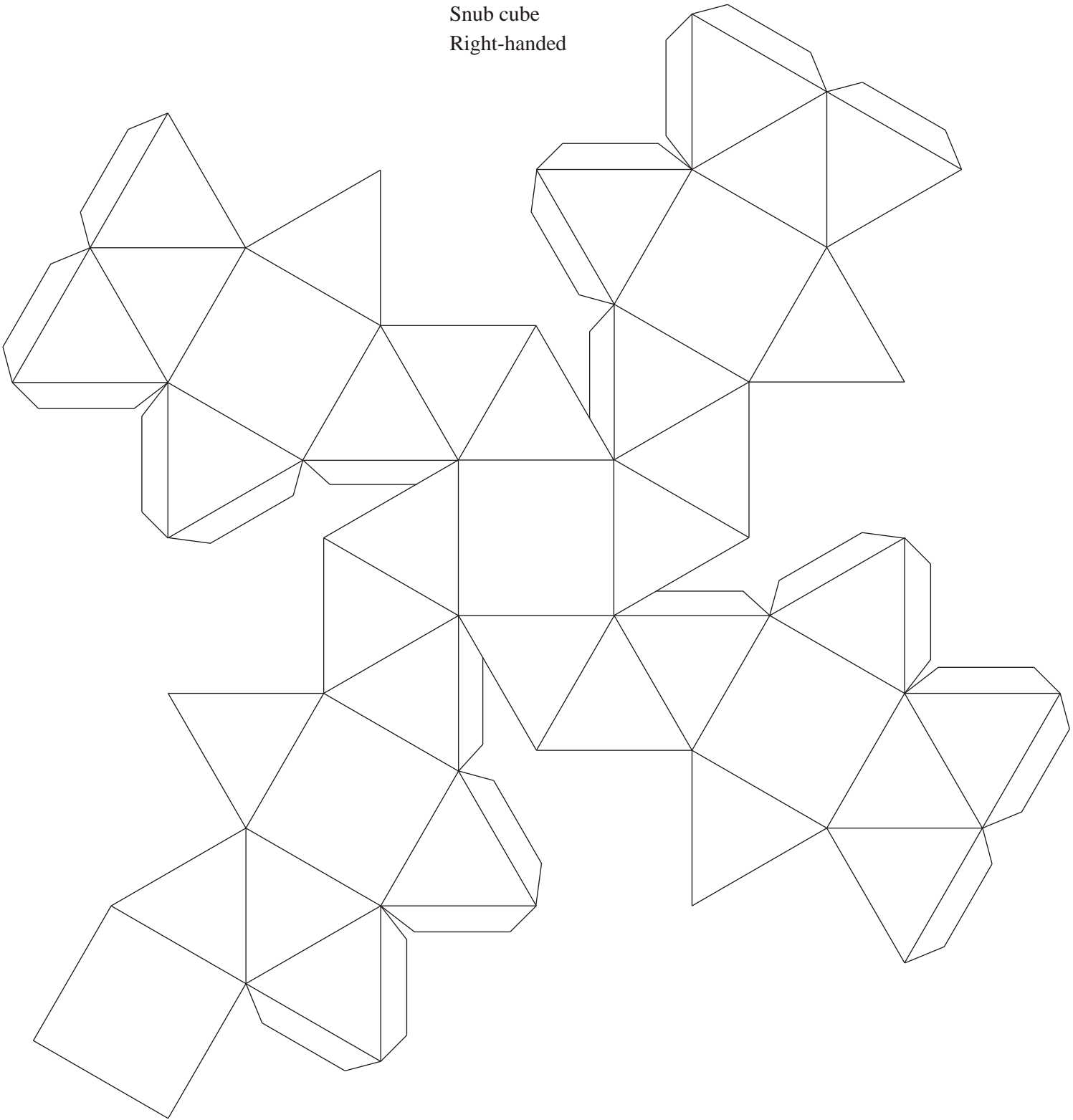

Snub dodecahedron

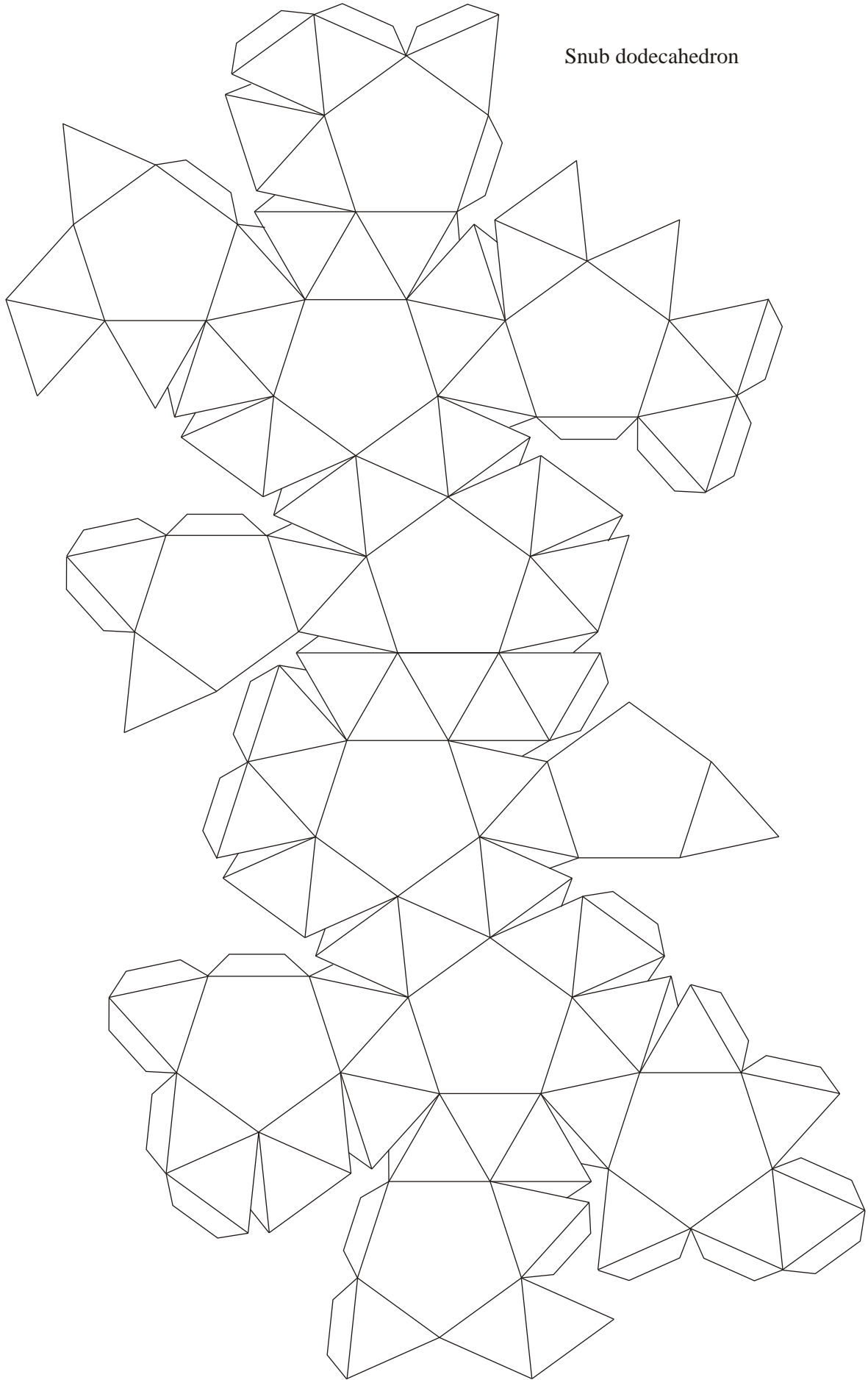

Snub dodecahedron
Right-handed

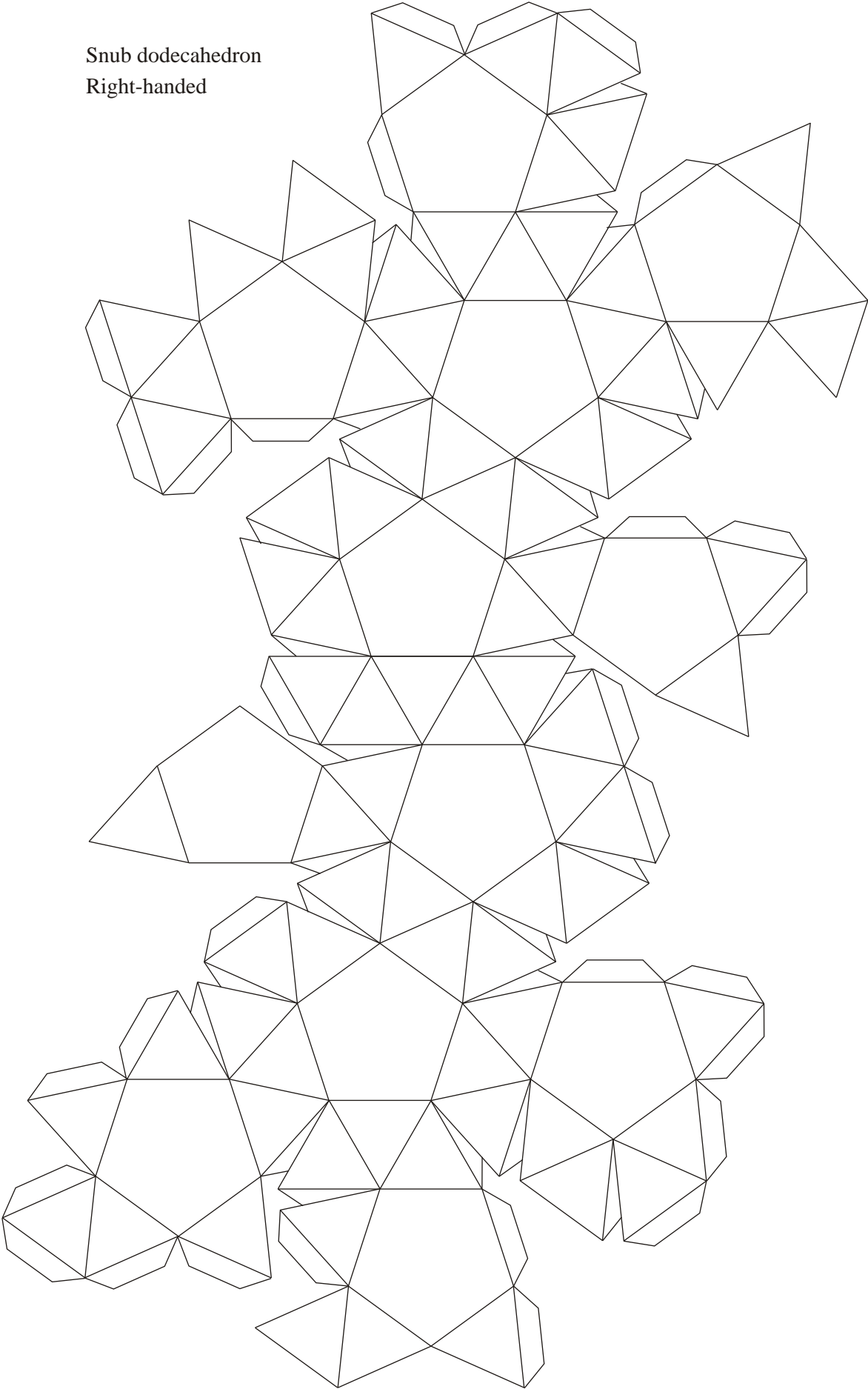

Small Stellated Dodecahedron

On this page a model out
of one piece On the next pages
a model out of six pieces.

Fold the long lines backwards
fold the short lines forwards

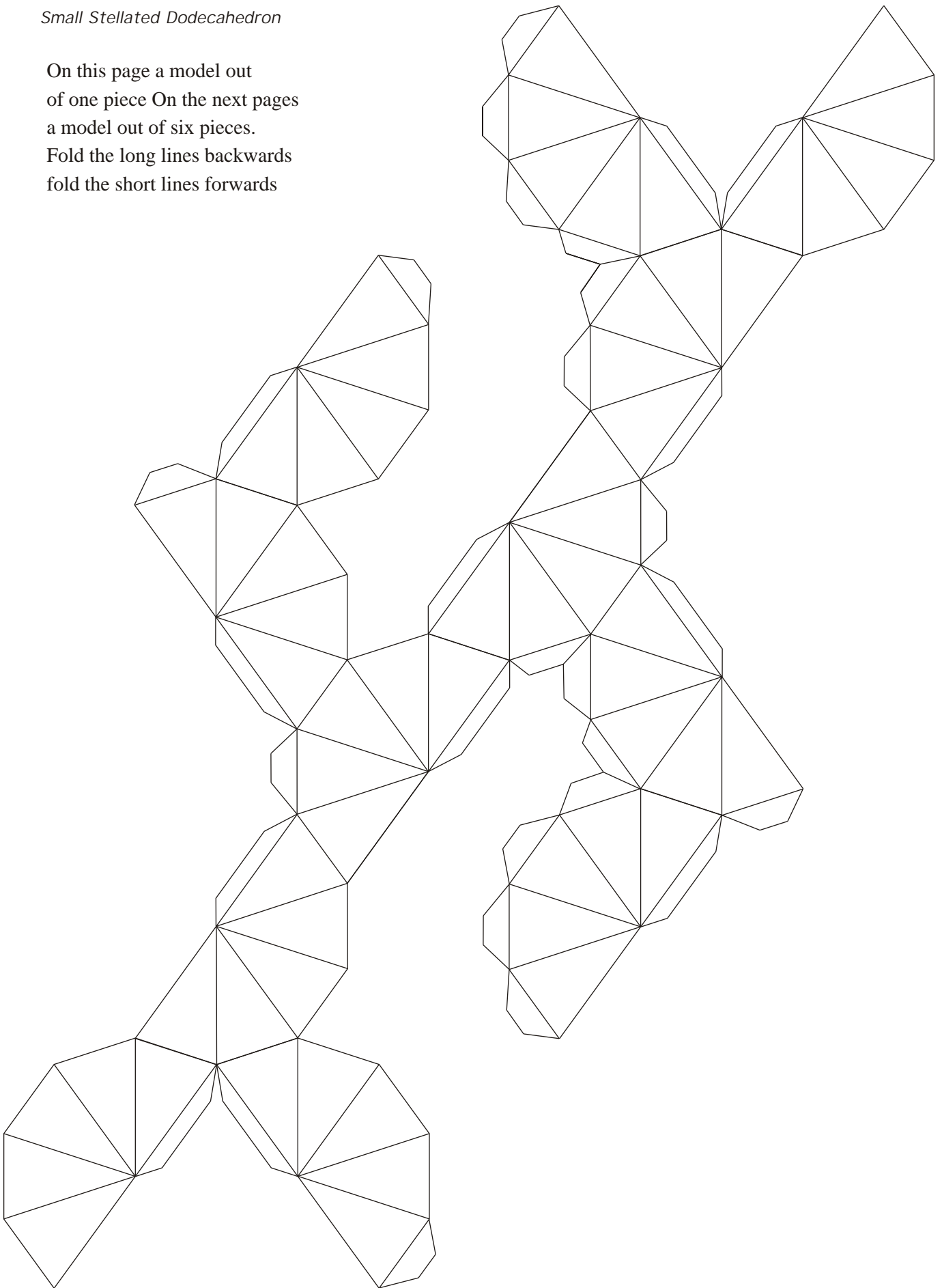

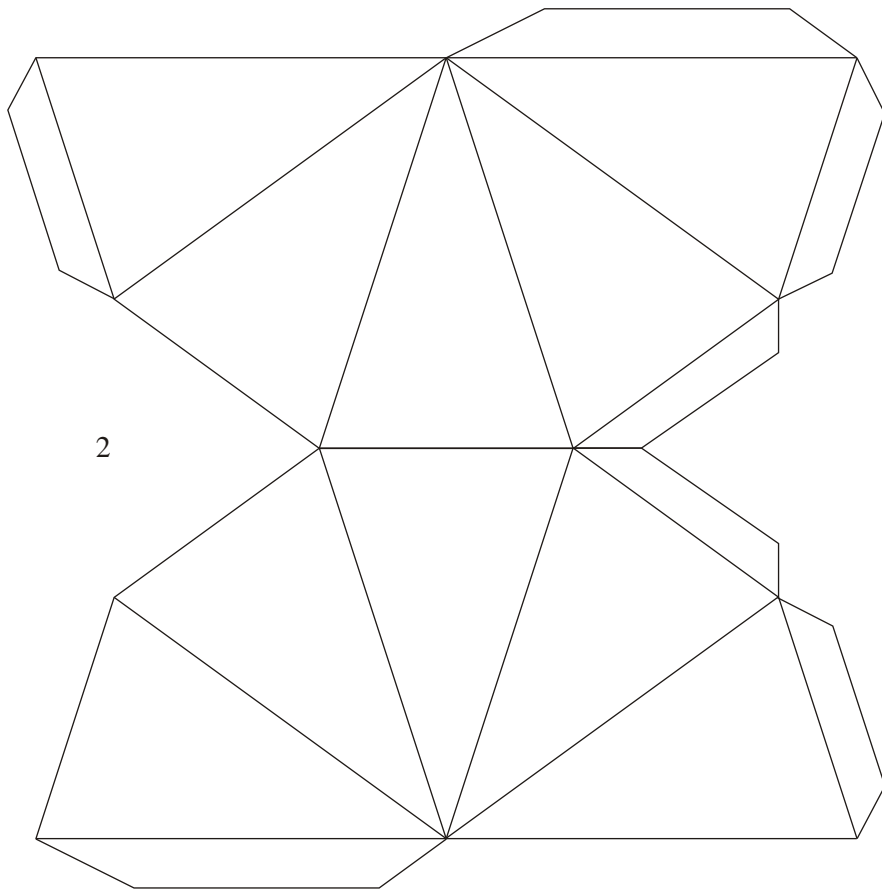
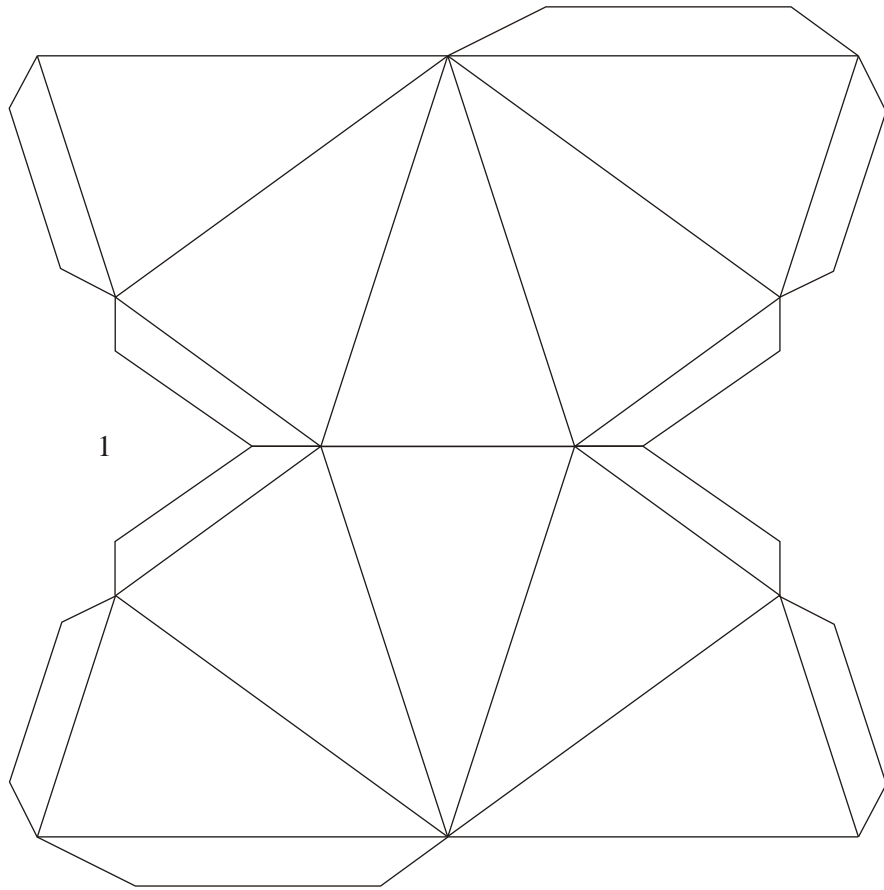

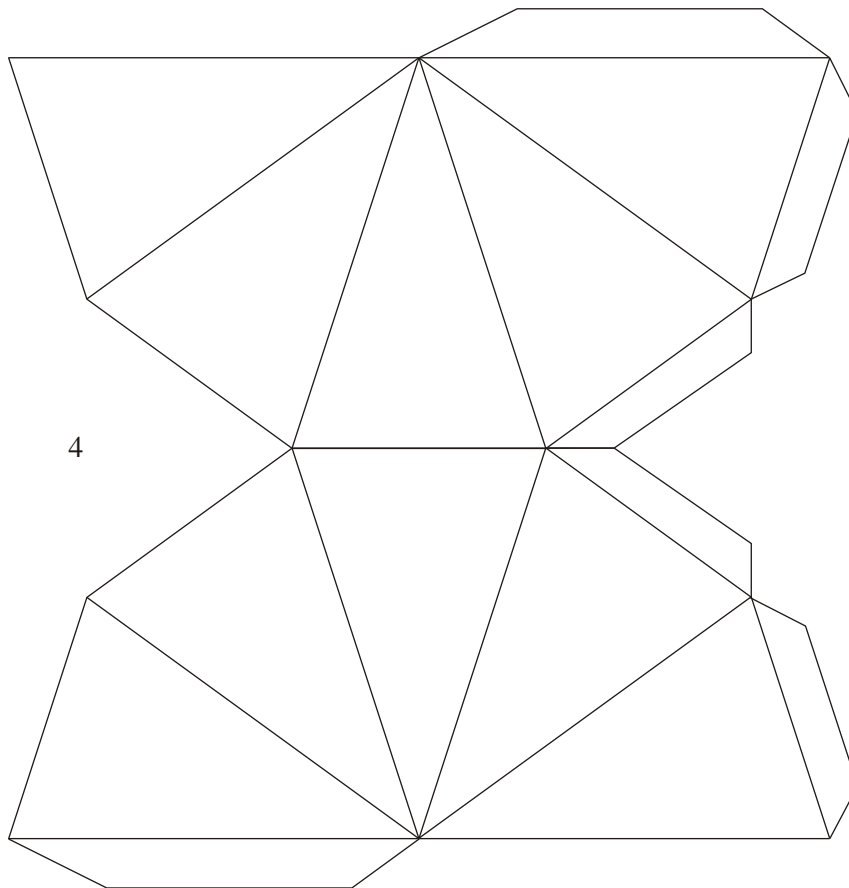
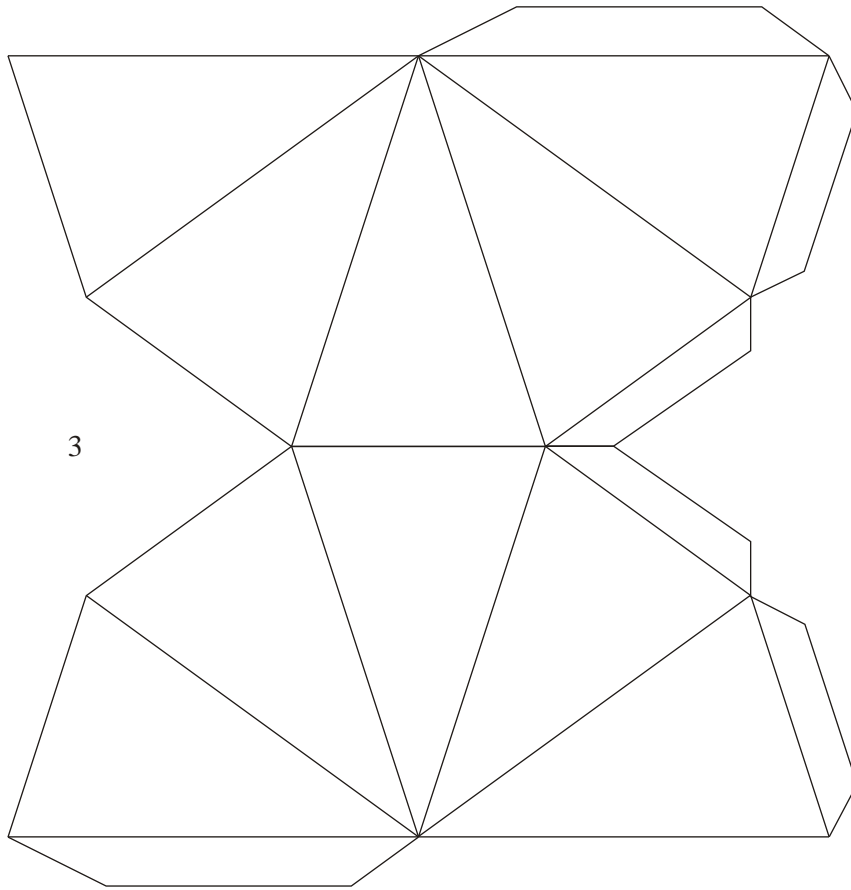

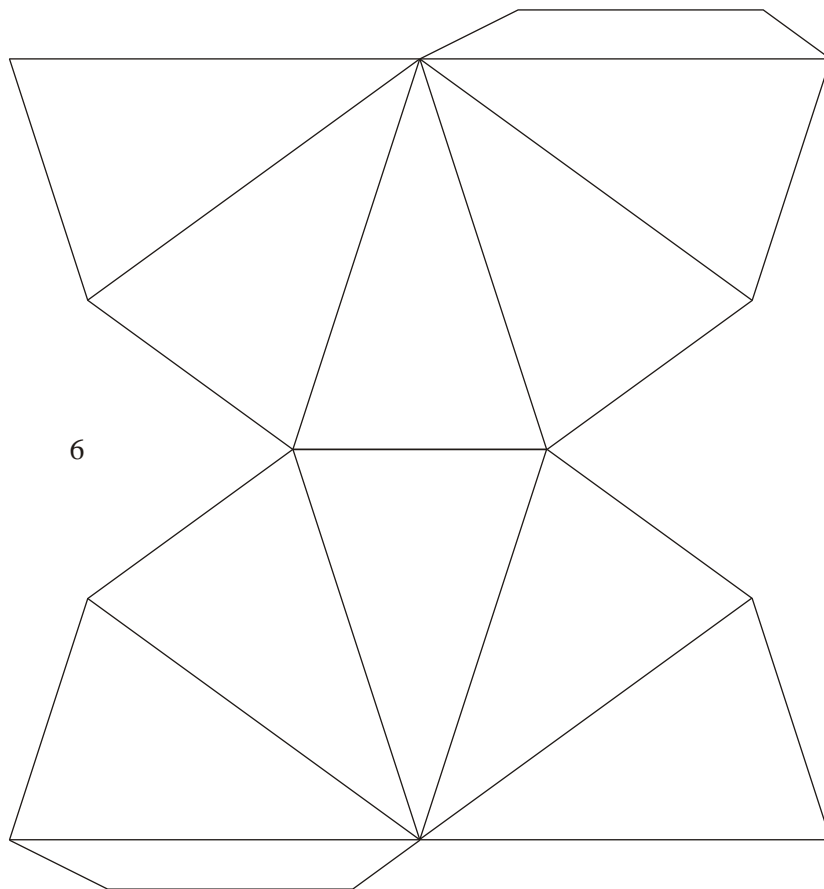
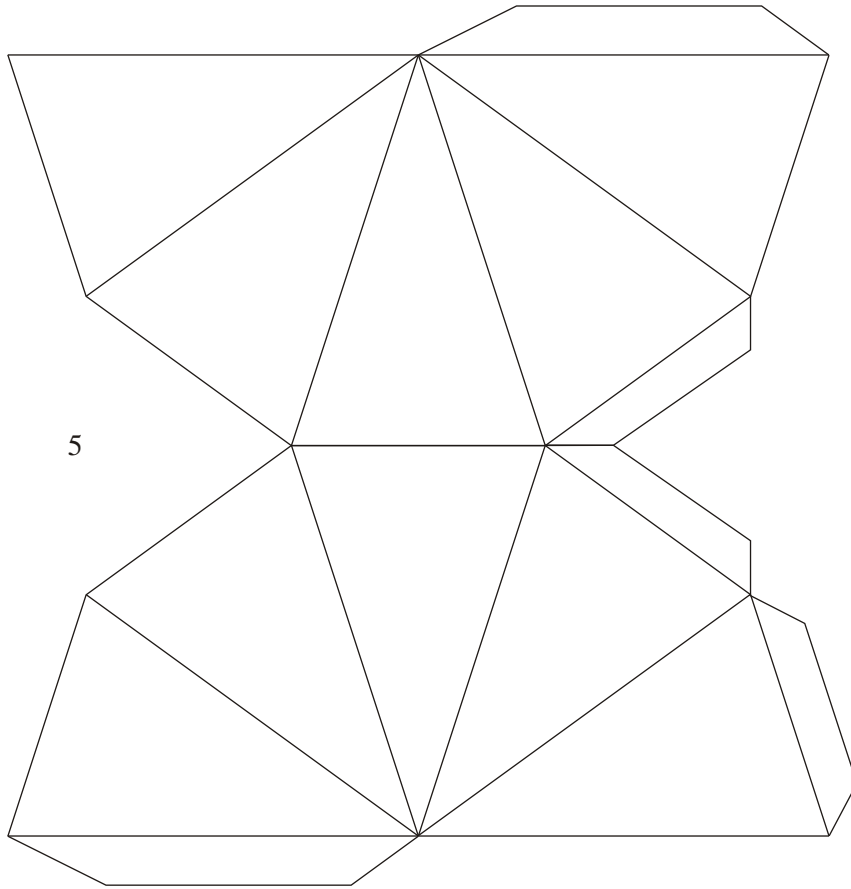

Octahemioctahedron

----- type 1
----- type 2

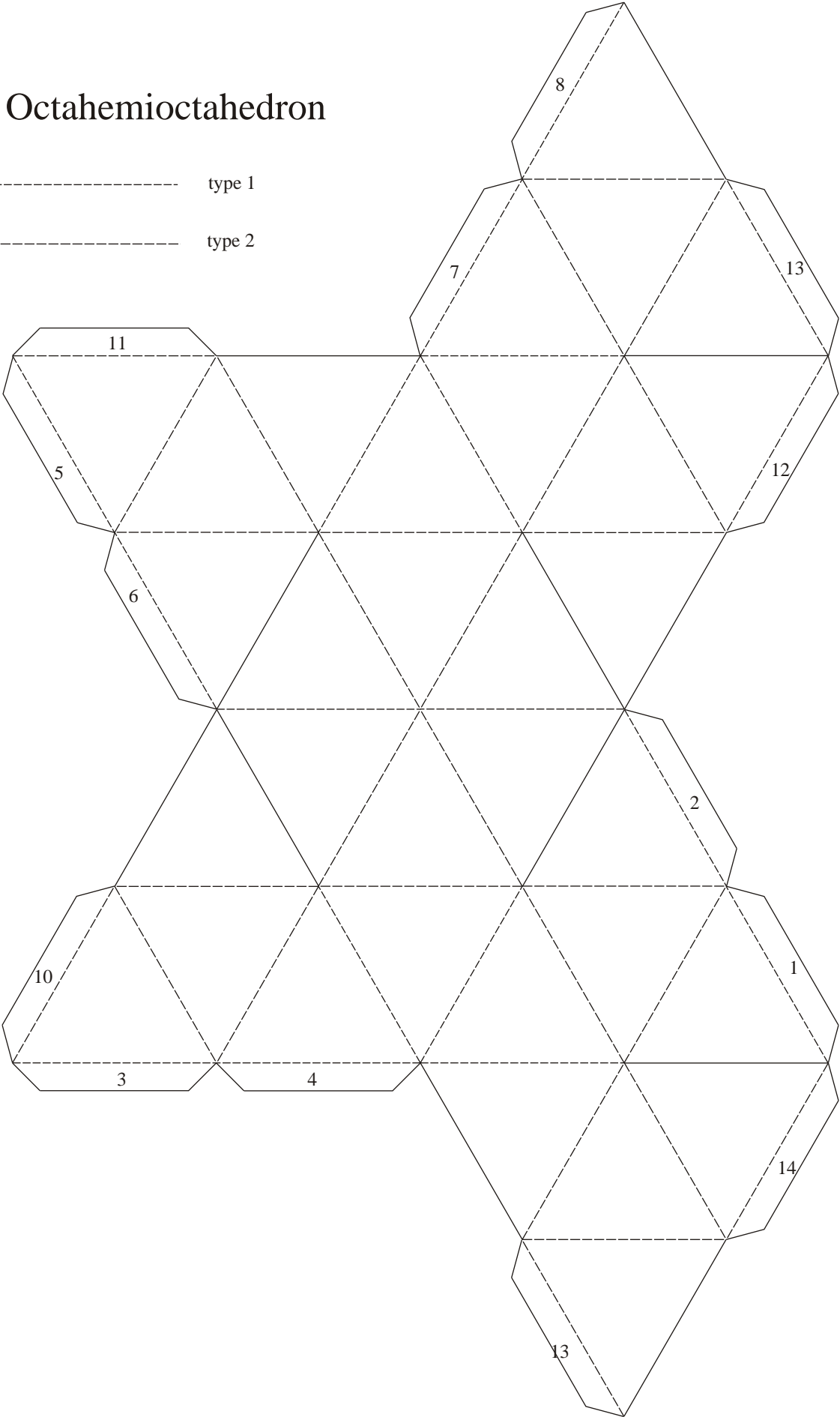

Cubohemioctahedron

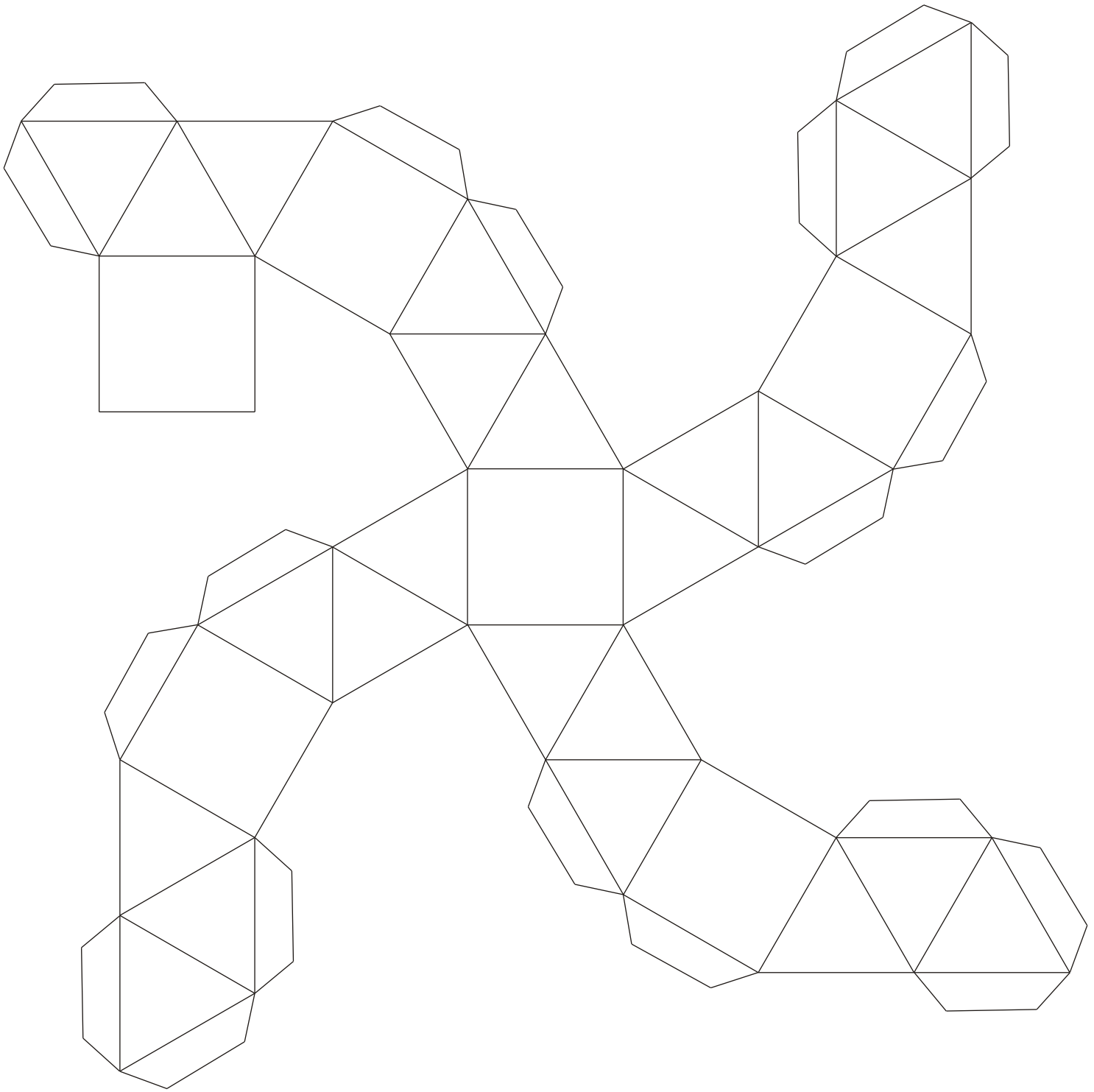

Small Rhombidodecahedron

(small version)

Fold the dotted lines forwards

Fold the other lines

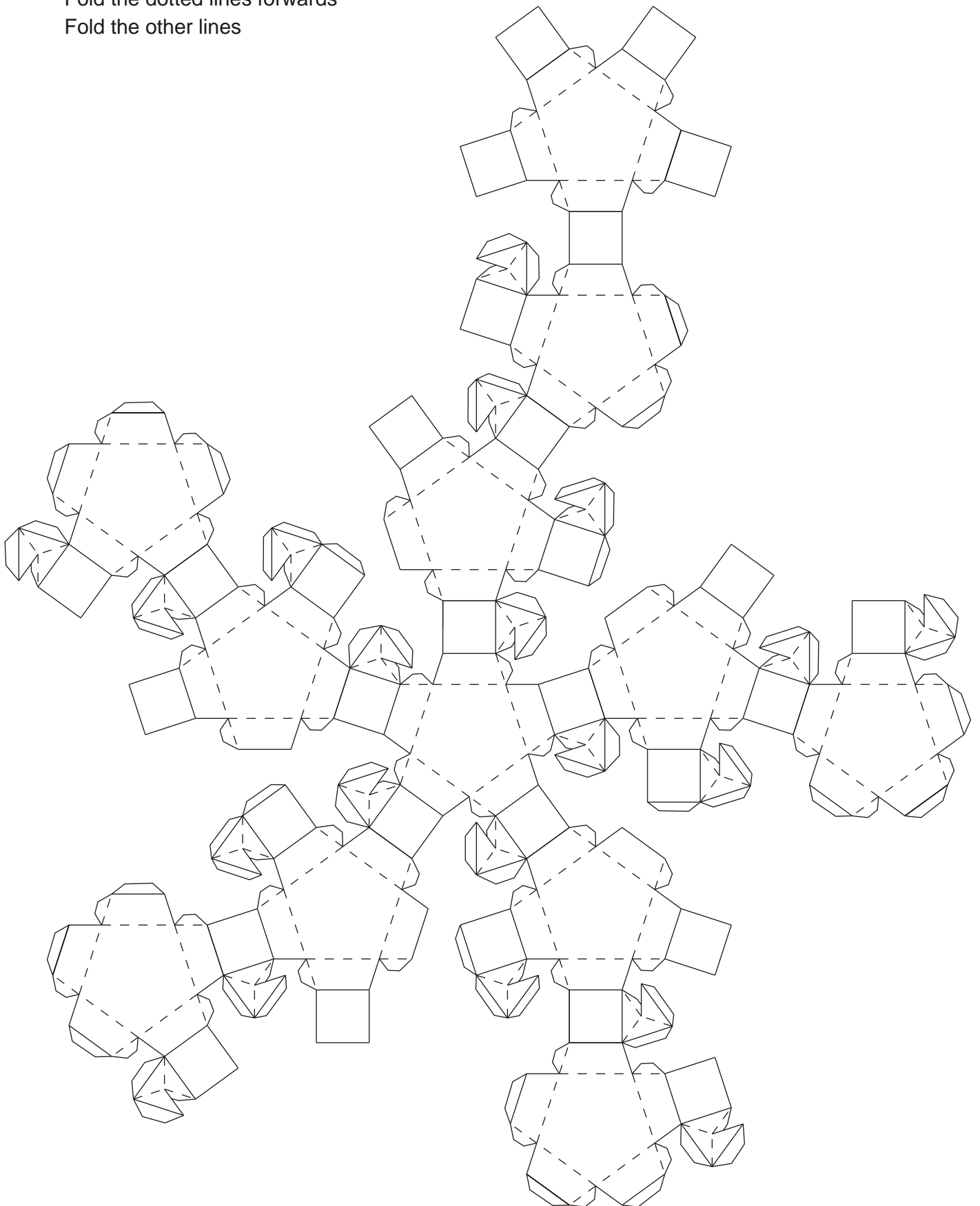

Small Rhombidodecahedron

(large version)

Fold the dotted lines forwards

Fold the other lines

A

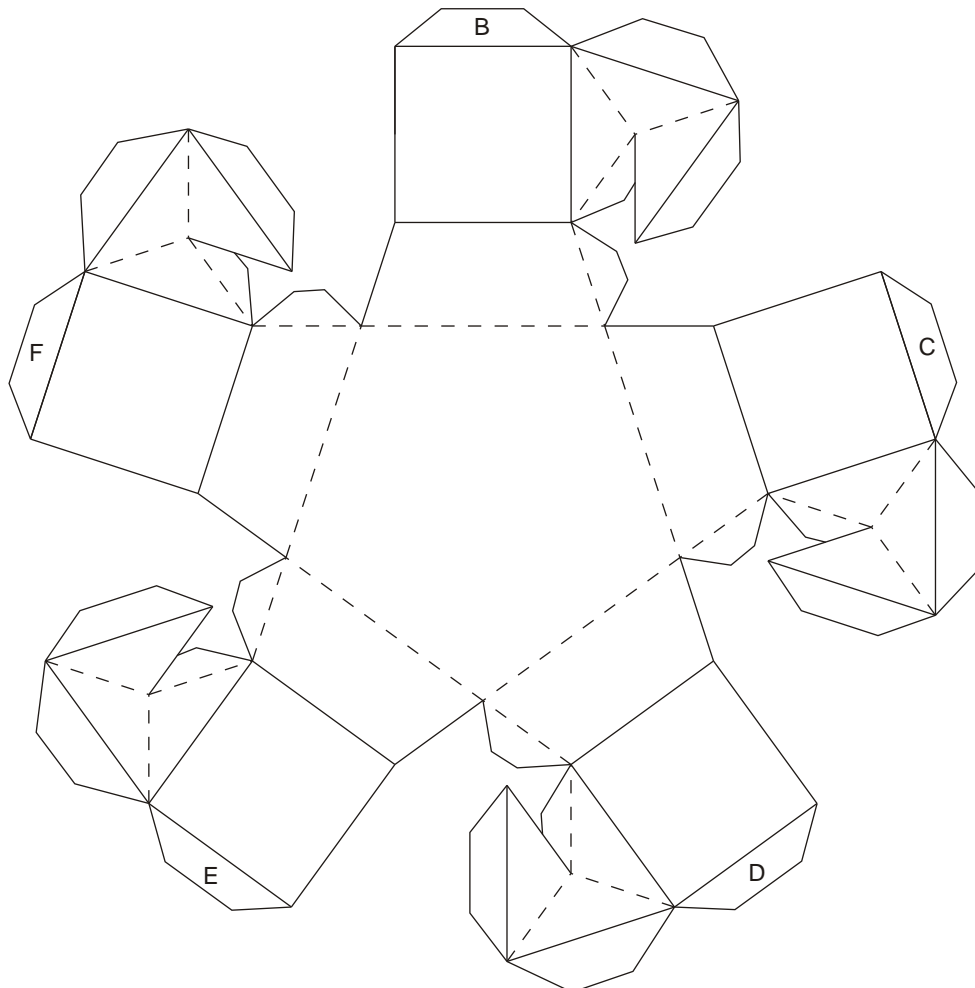

B

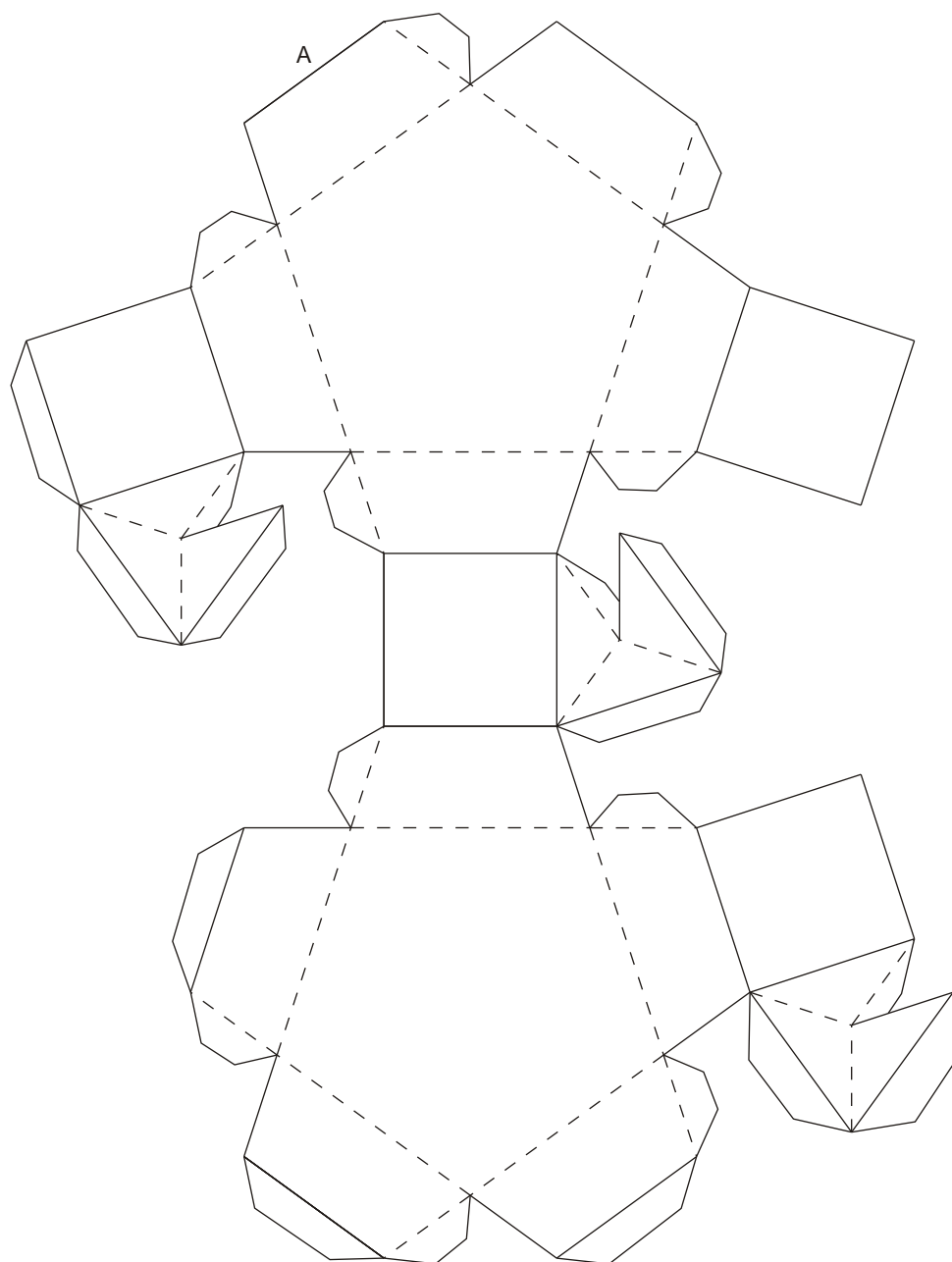

C

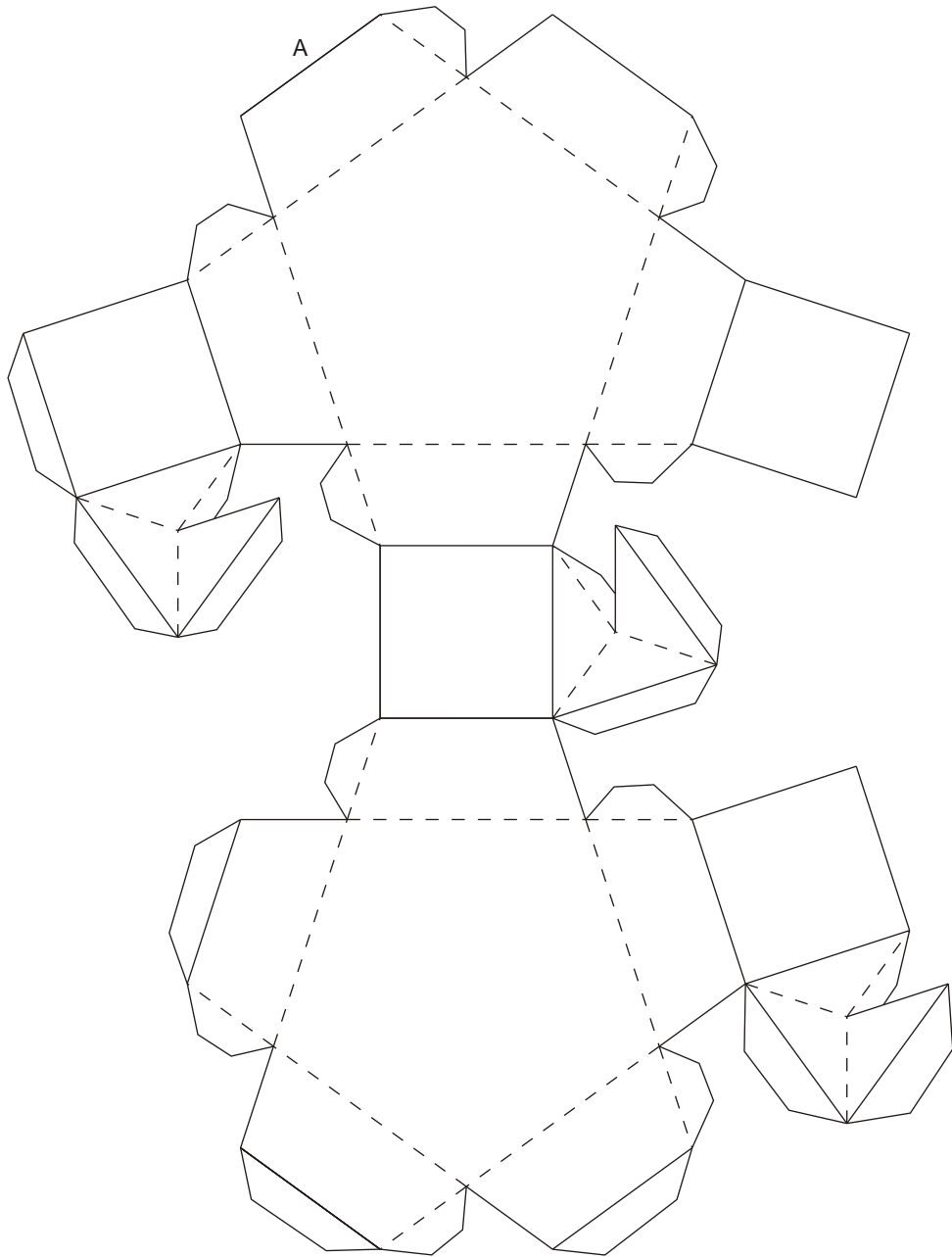

D

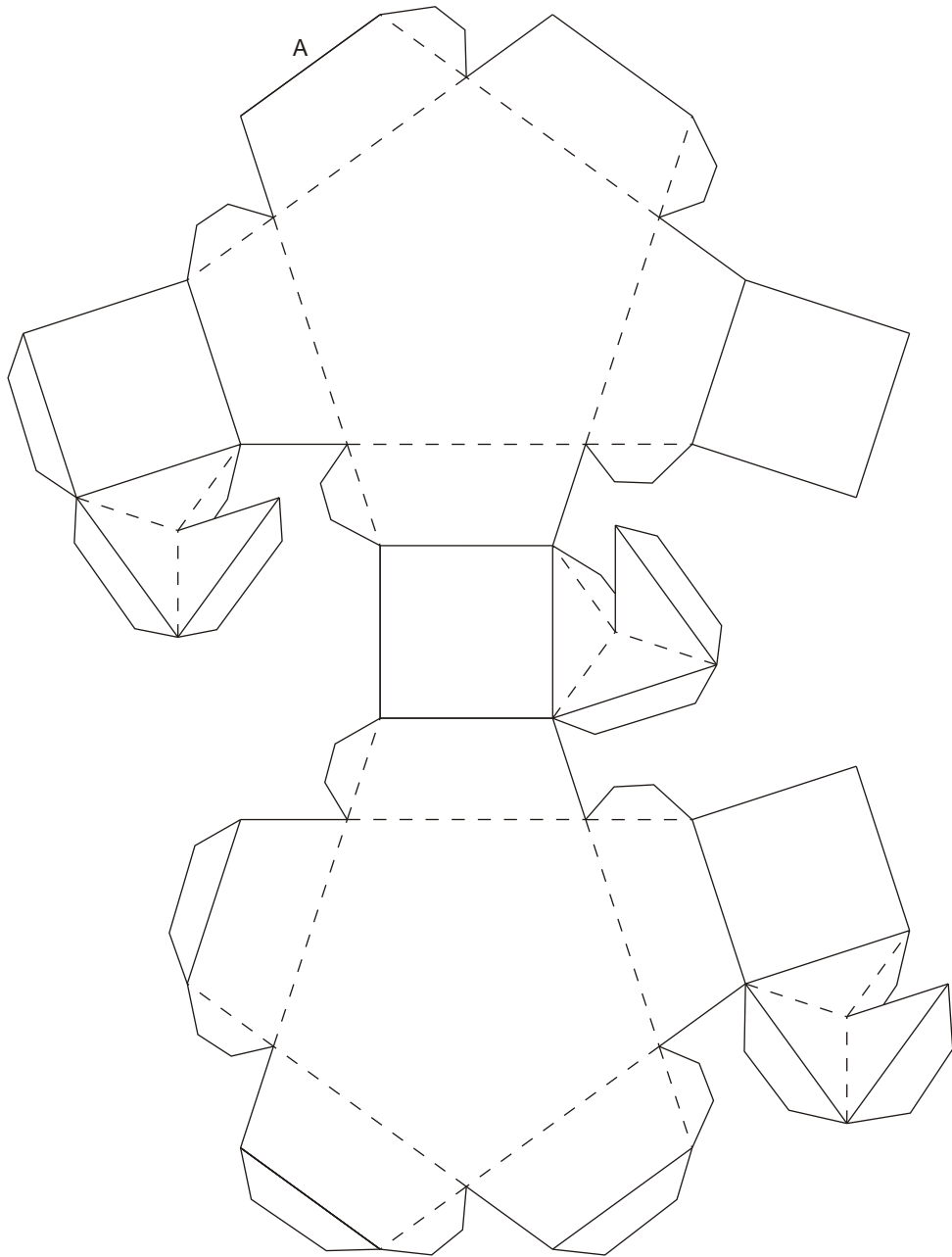

E

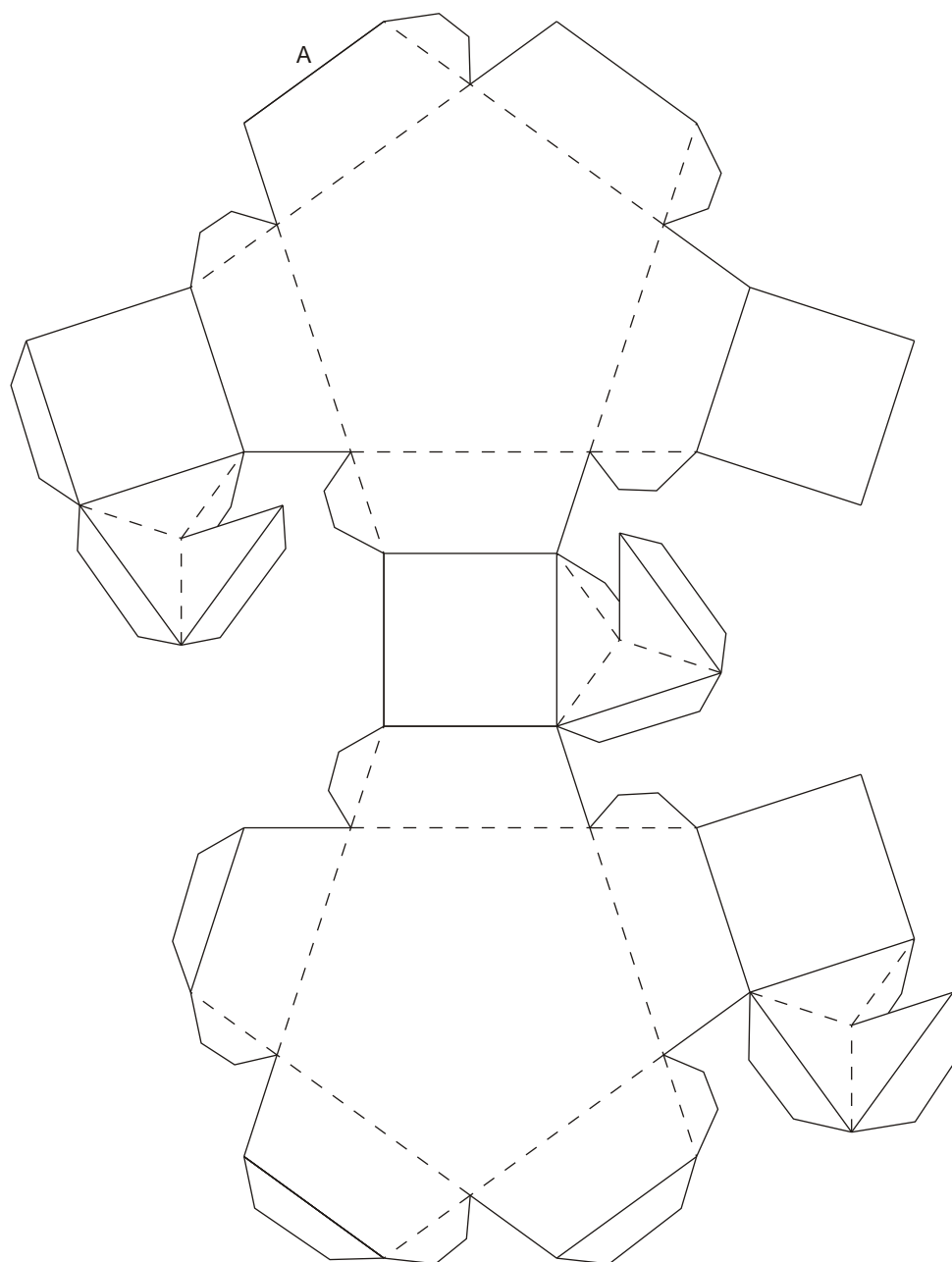

F

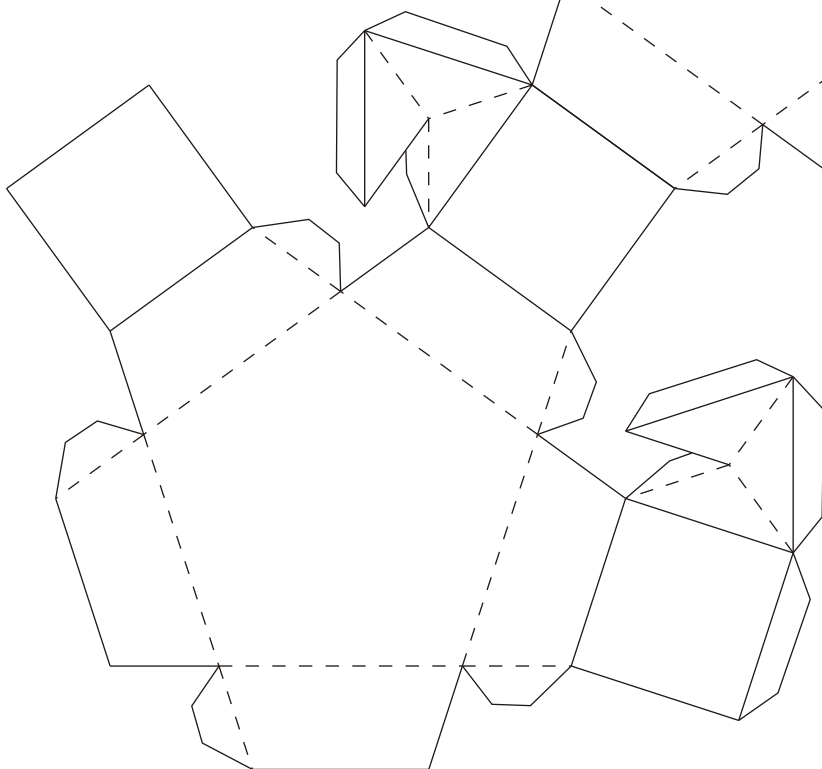
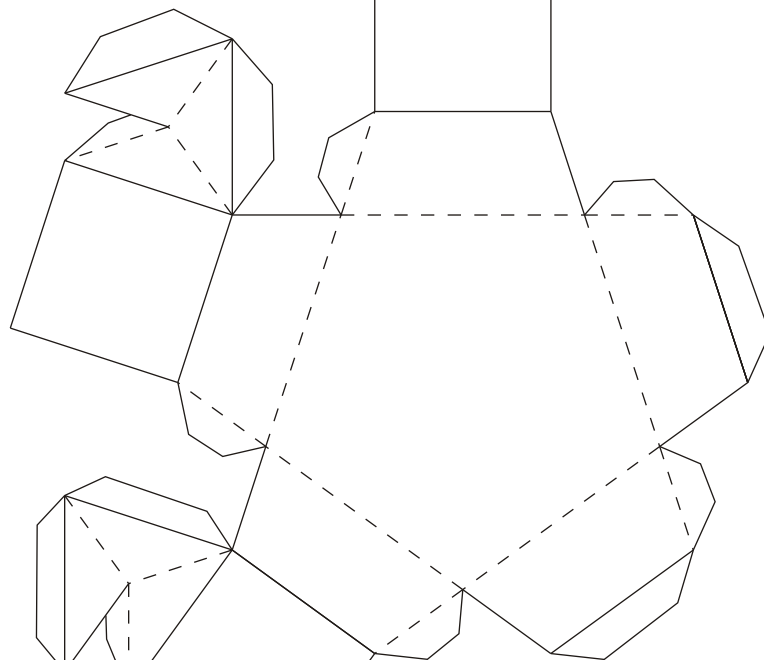
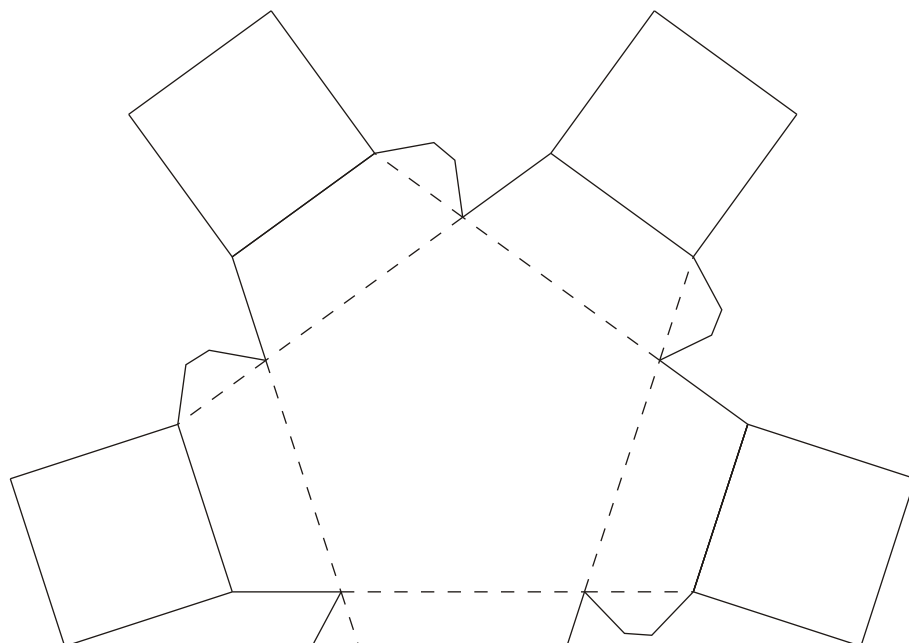

A

Small dodecahemidodecahedron

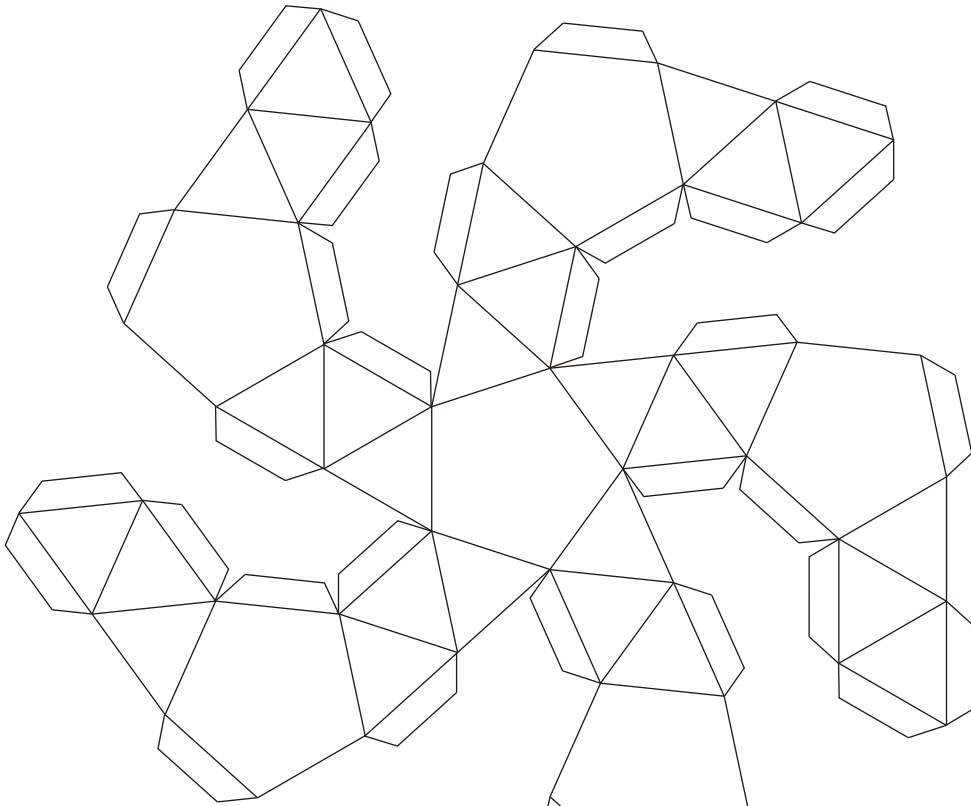

Folds the lines between the triangles forwards. Folds the other lines backwards.

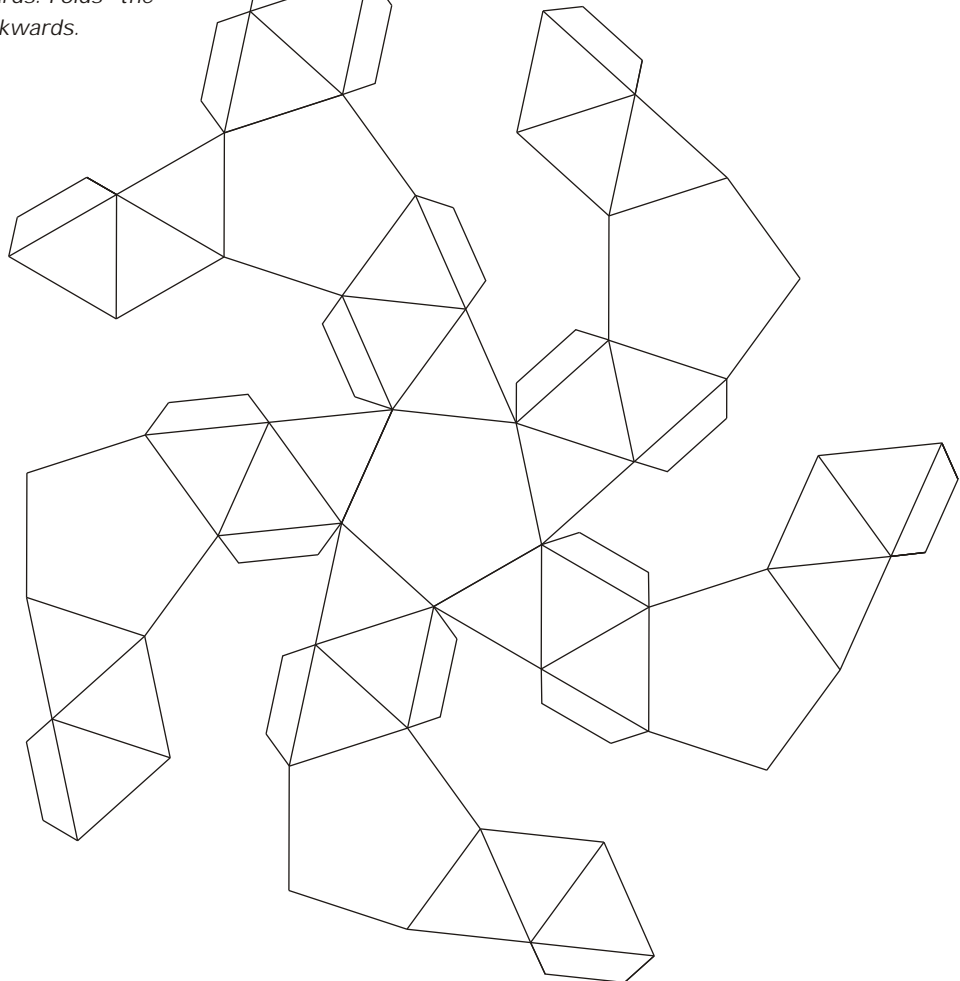

*Great Stellated Dodecahedron
made out of one piece of paper.
Cut the lines between the long
and the short sides of the triangles.
Fold the long lines backwards and
fold the short lines forwards.*

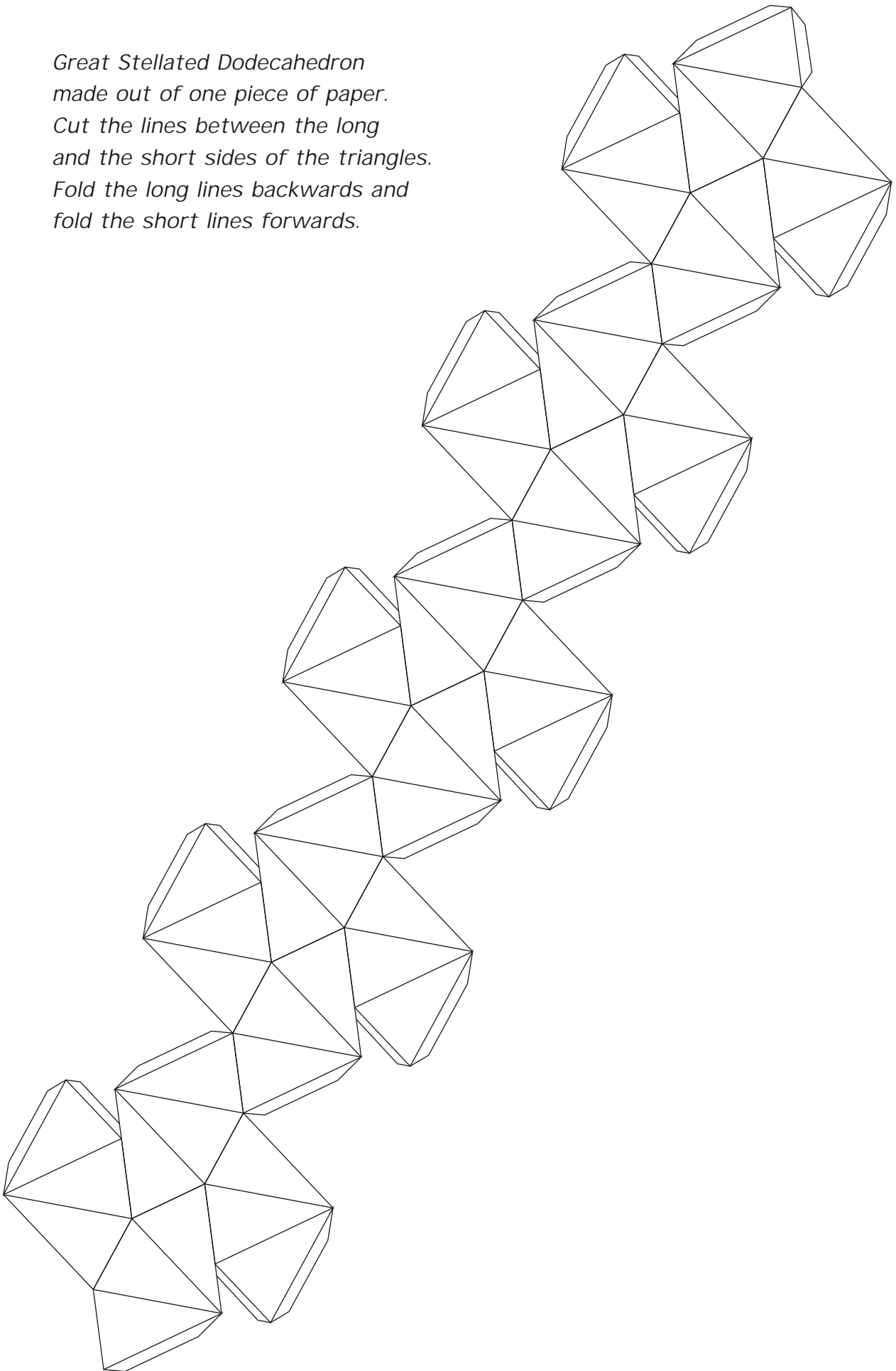

*Great Stellated Dodecahedron
made out of two pieces of paper.
Cut the lines between the long
and the short sides of the triangles.
Fold the long lines backwards and
fold the short lines forwards.
This is piece one. On the next page
is piece two.*

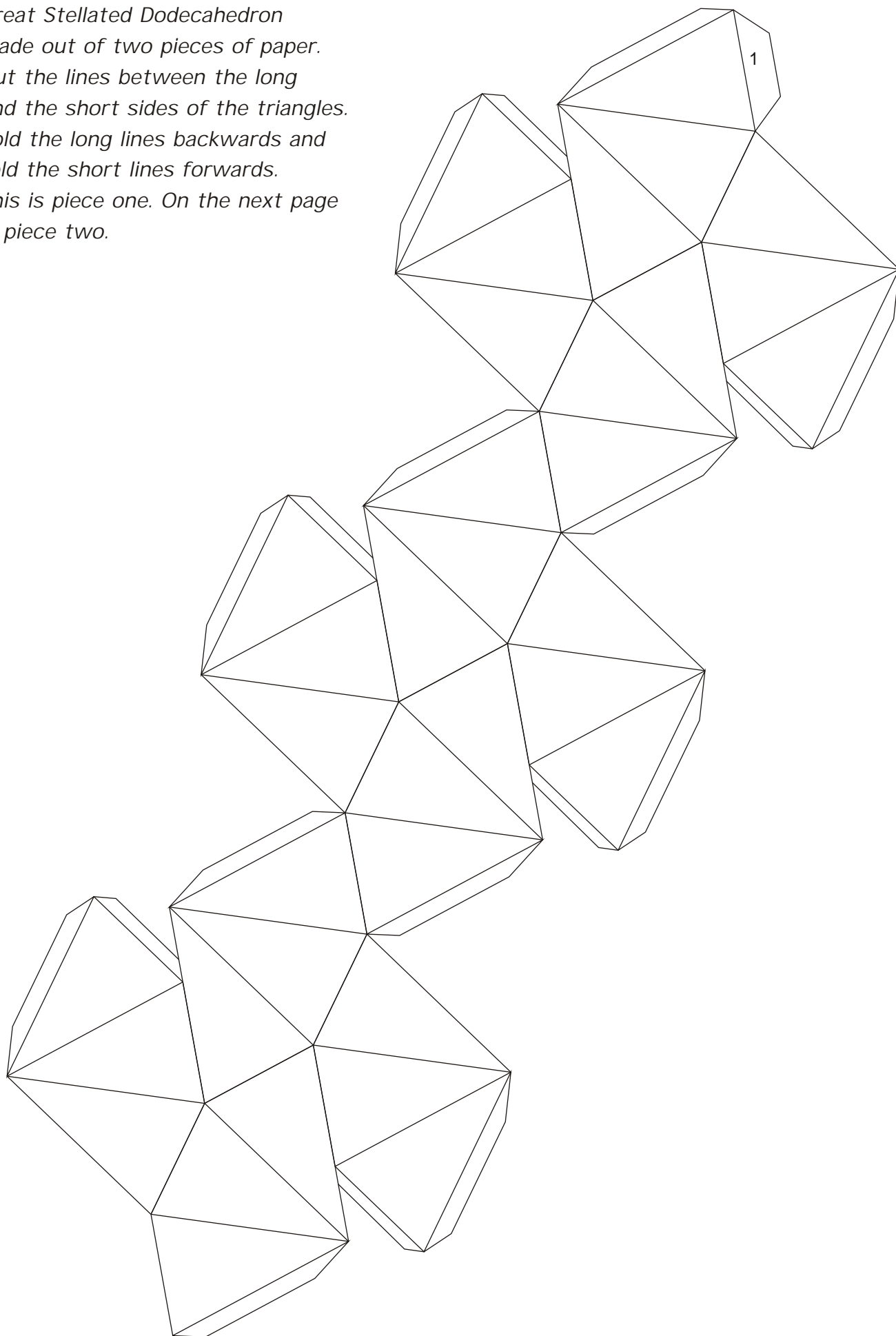

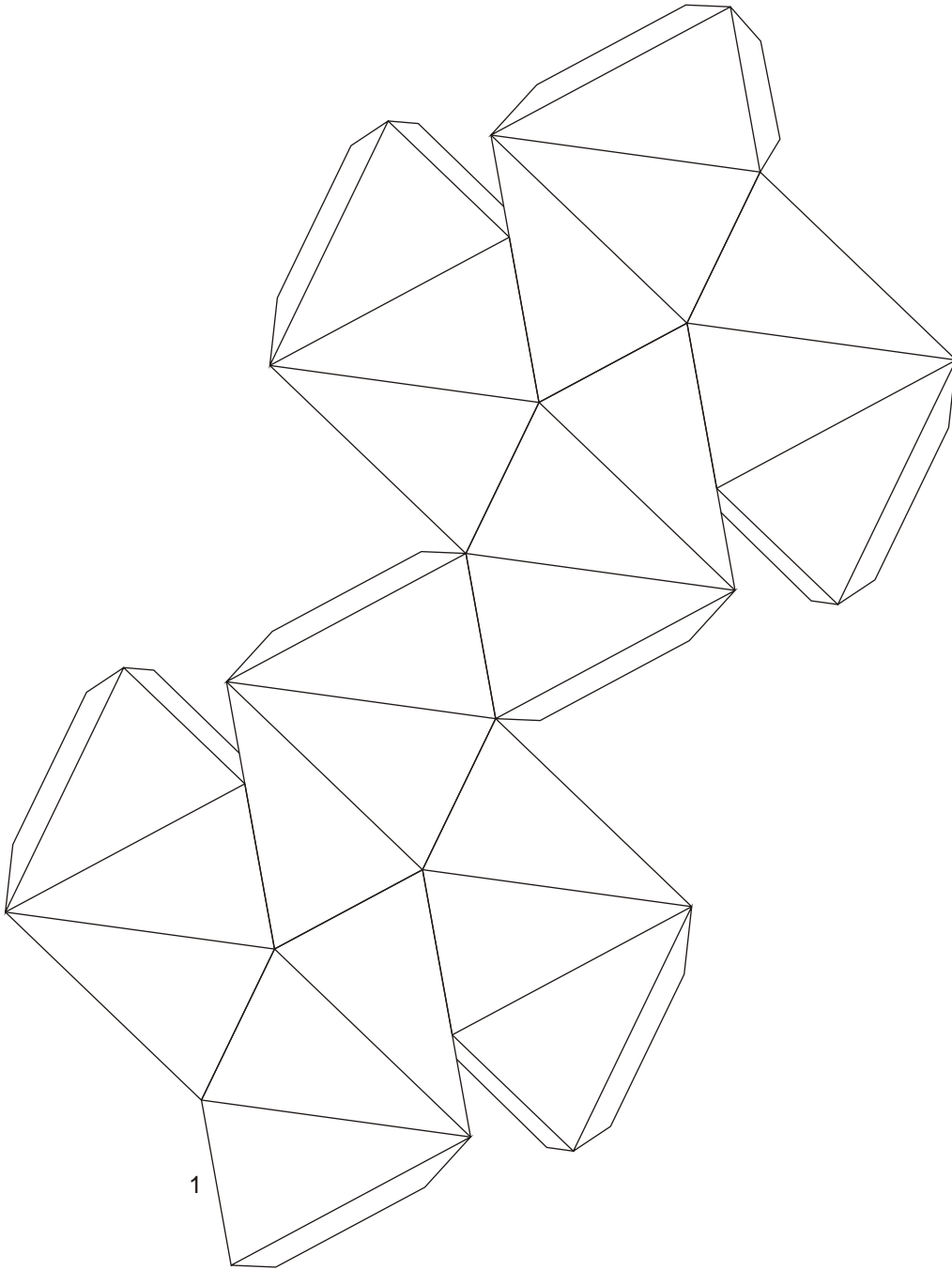

*Great Stellated Dodecahedron
made out of five pieces of paper.
Cut the lines between the long
and the short sides of the triangles.
Fold the long lines backwards and
fold the short lines forwards.
N= Next part P= Previous part*

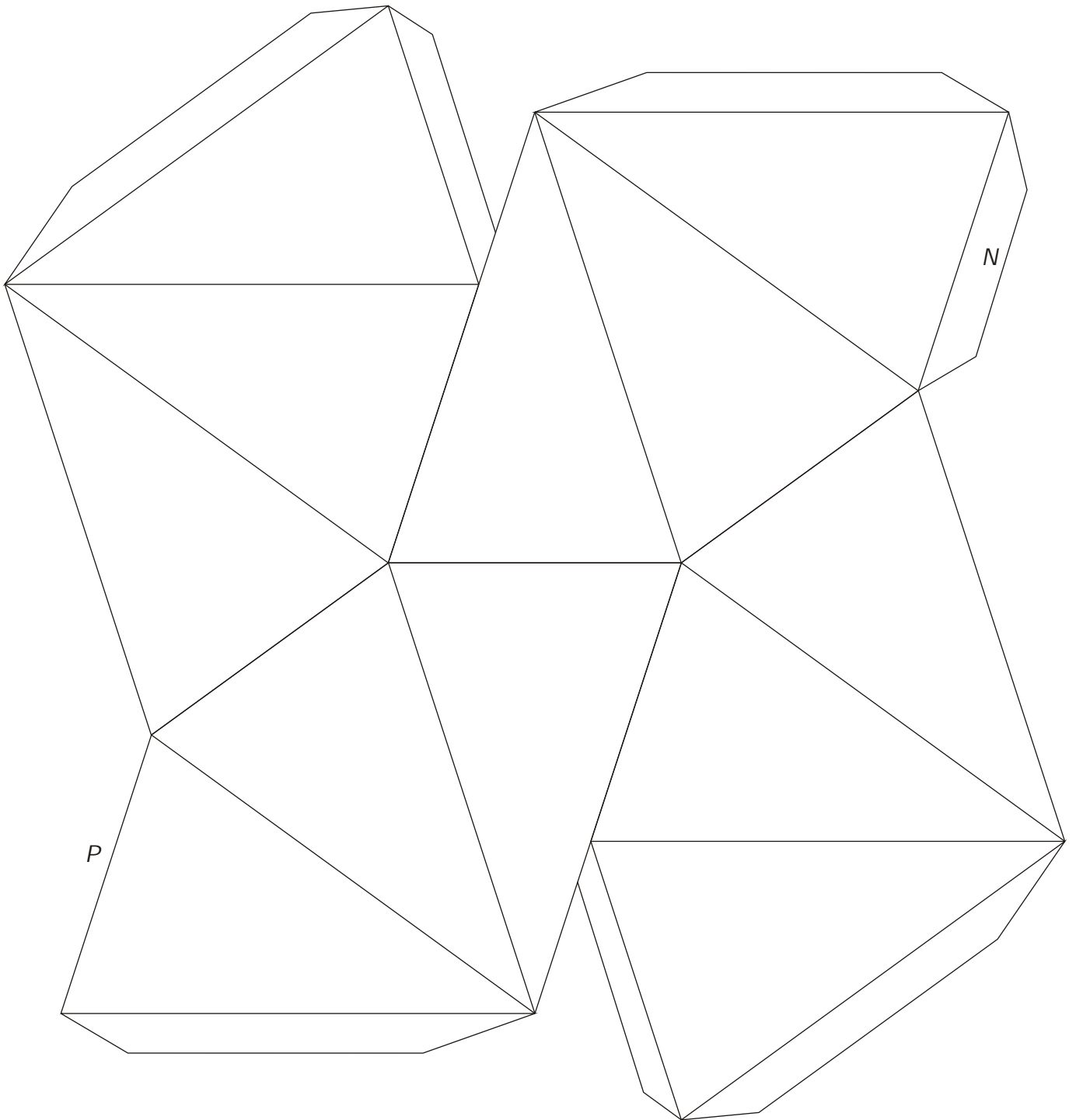

*Great Stellated Dodecahedron
made out of five pieces of paper.
Cut the lines between the long
and the short sides of the triangles.
Fold the long lines backwards and
fold the short lines forwards.
N= Next part P= Previous part*

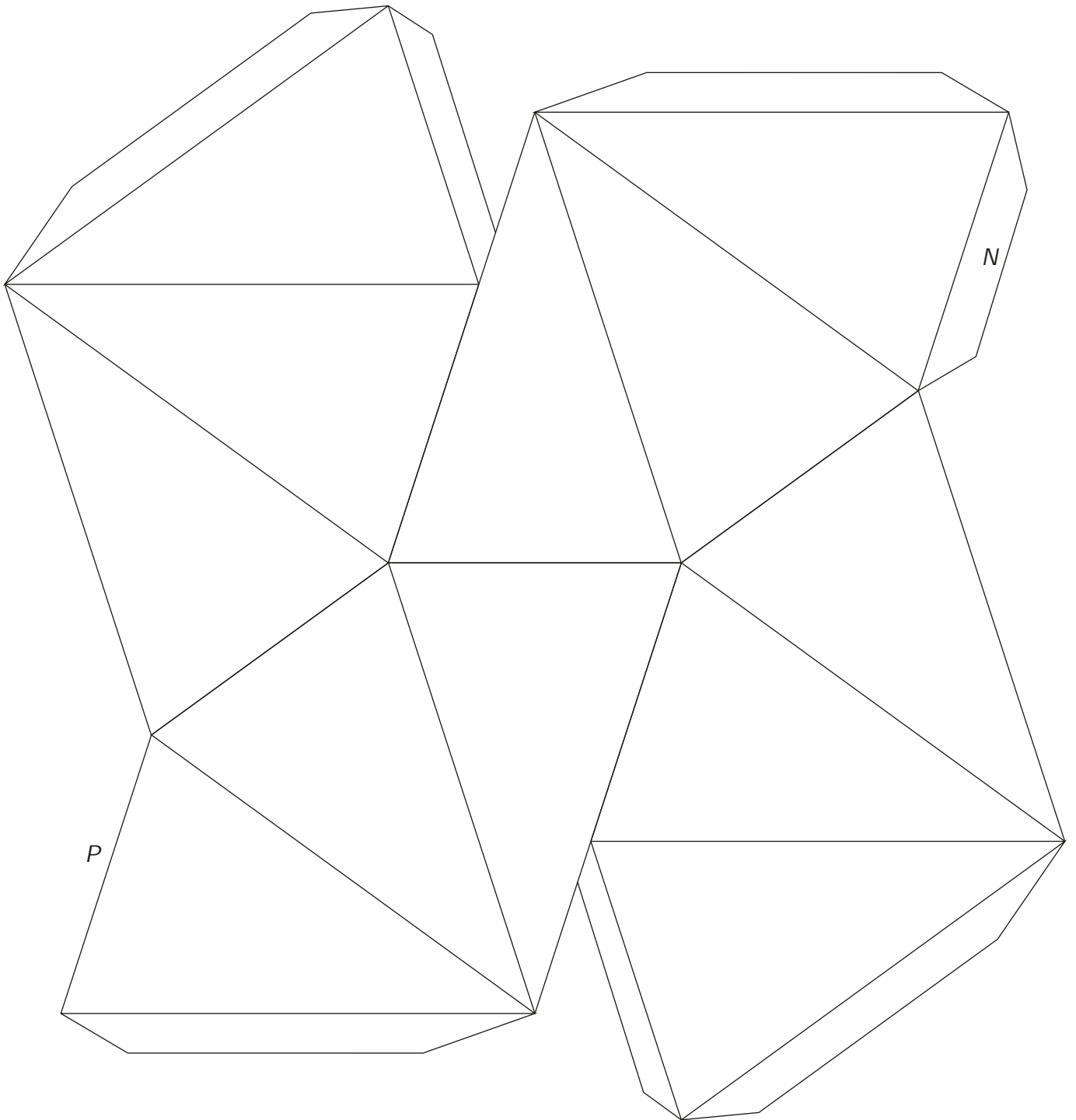

*Great Stellated Dodecahedron
made out of five pieces of paper.
Cut the lines between the long
and the short sides of the triangles.
Fold the long lines backwards and
fold the short lines forwards.
N= Next part P= Previous part*

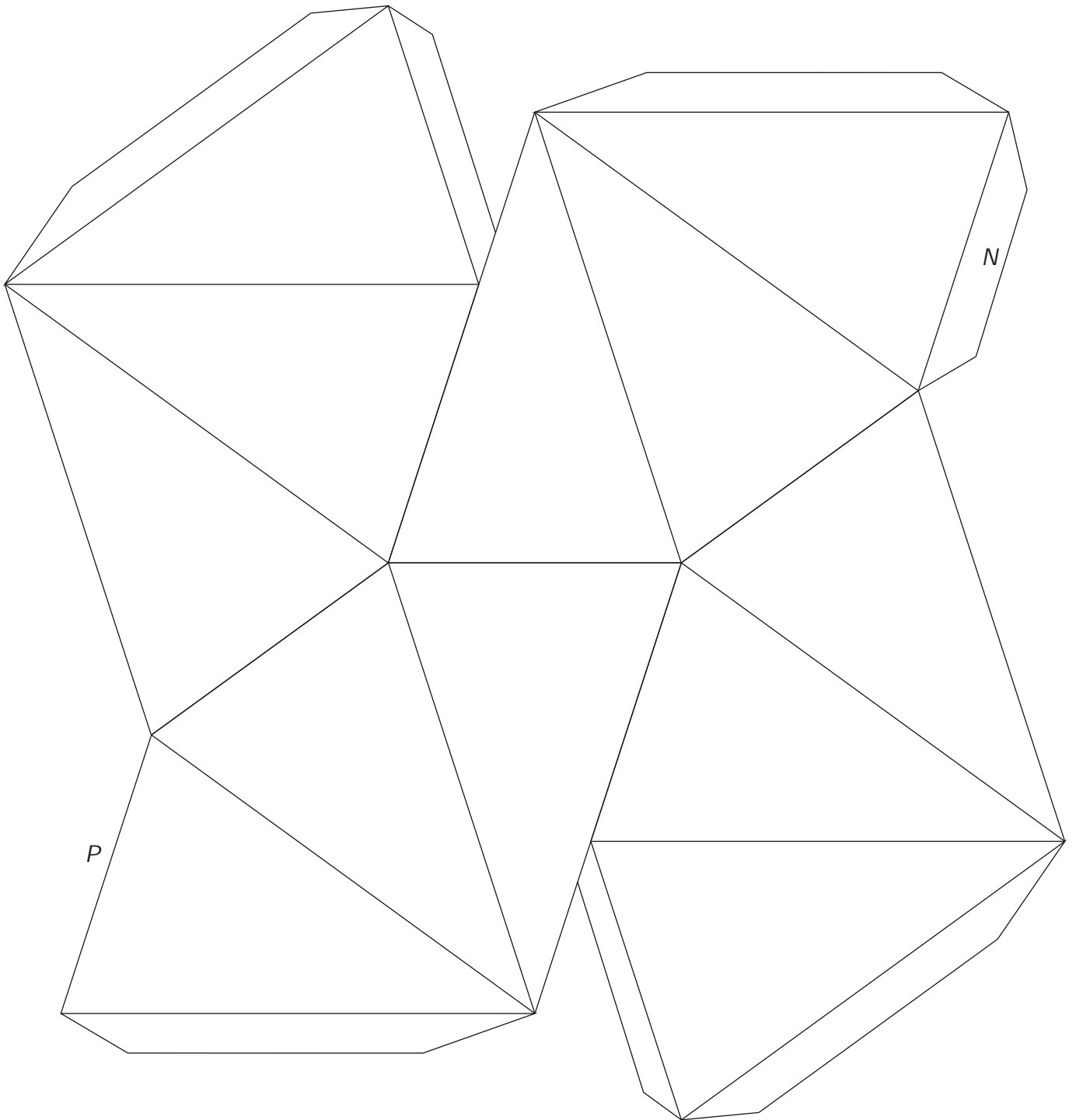

*Great Stellated Dodecahedron
made out of five pieces of paper.
Cut the lines between the long
and the short sides of the triangles.
Fold the long lines backwards and
fold the short lines forwards.
N= Next part P= Previous part*

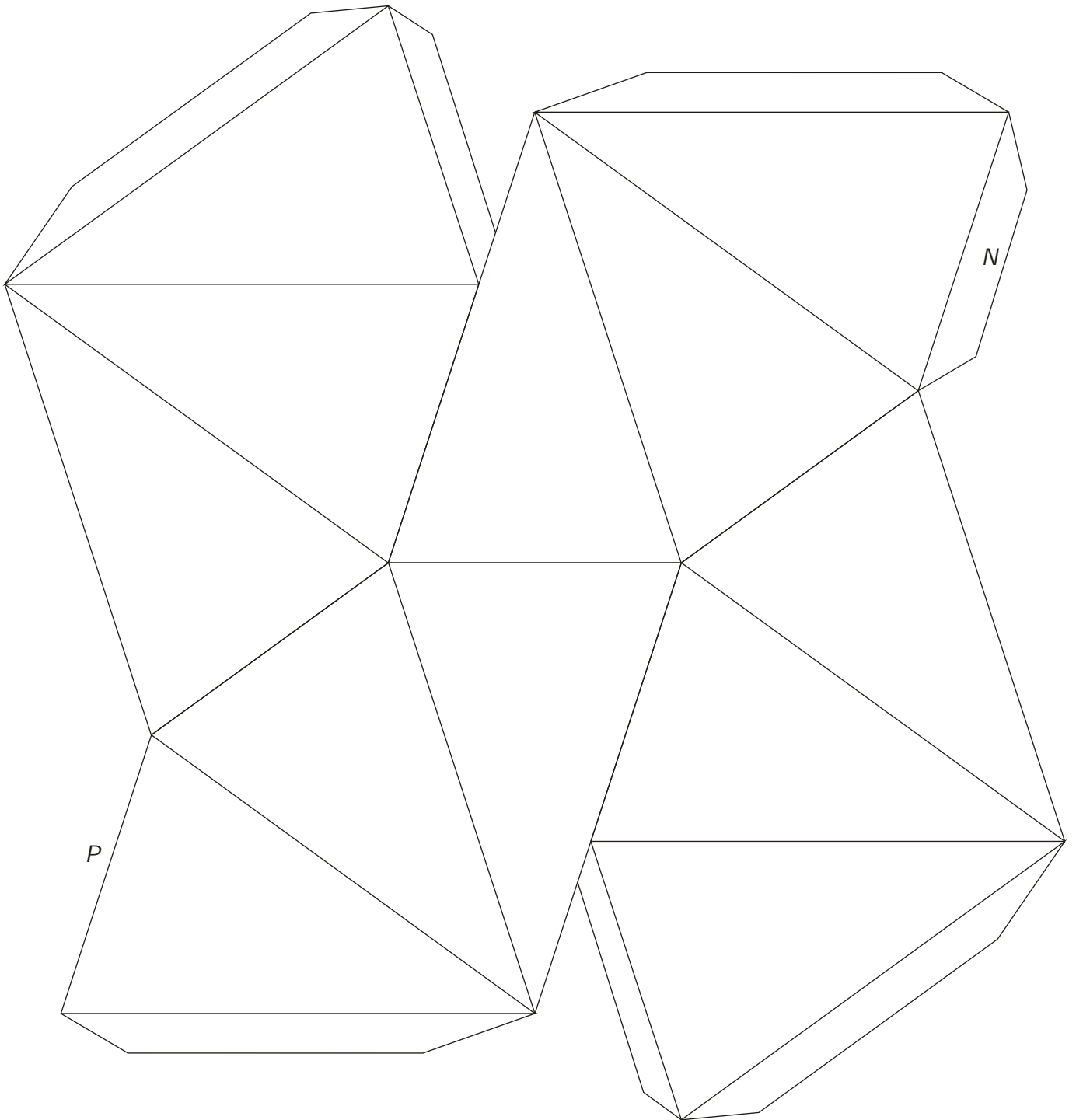

*Great Stellated Dodecahedron
made out of five pieces of paper.
Cut the lines between the long
and the short sides of the triangles.
Fold the long lines backwards and
fold the short lines forwards.
N= Next part P= Previous part*

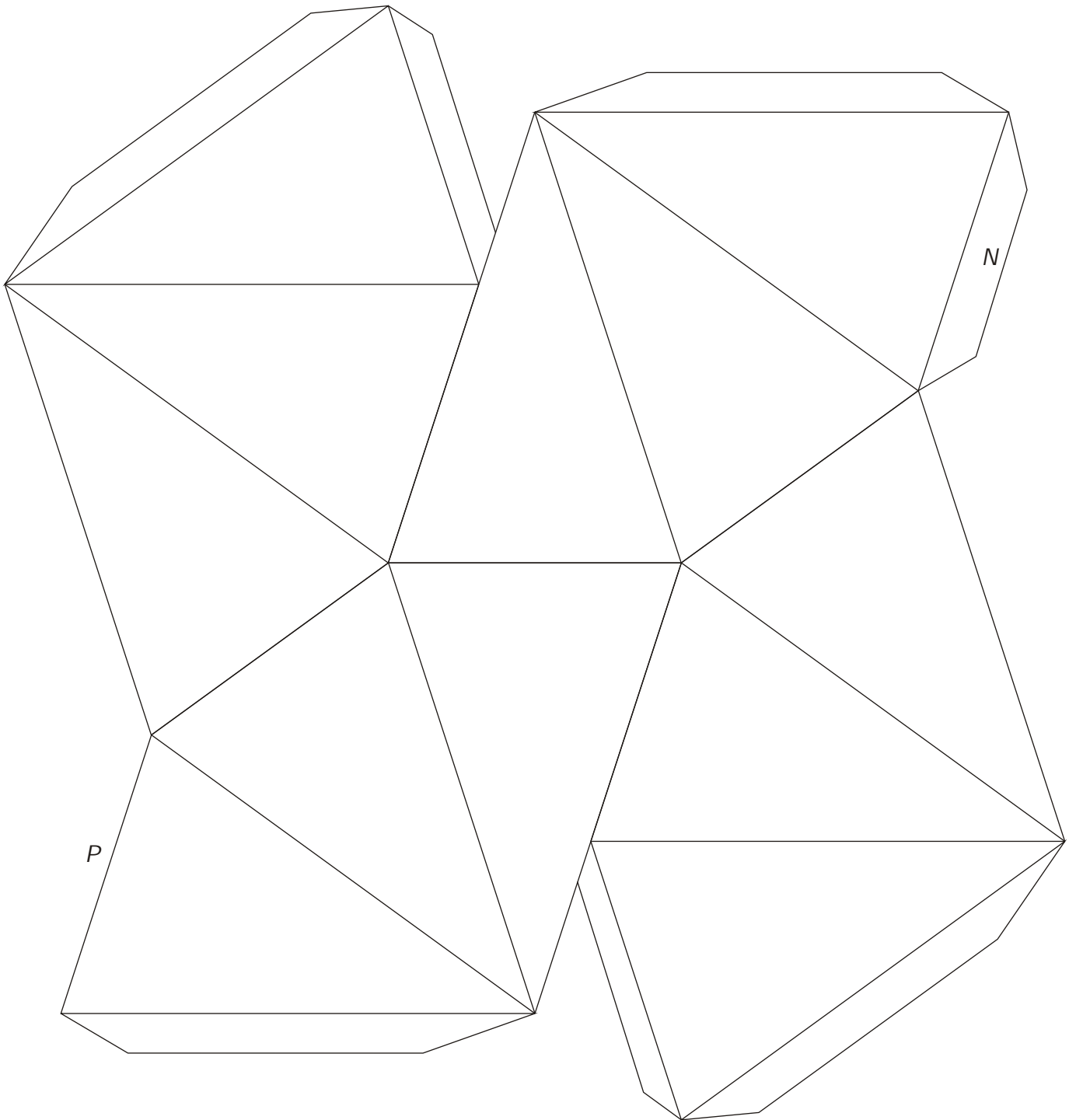

Pentagonale hexacontahedron

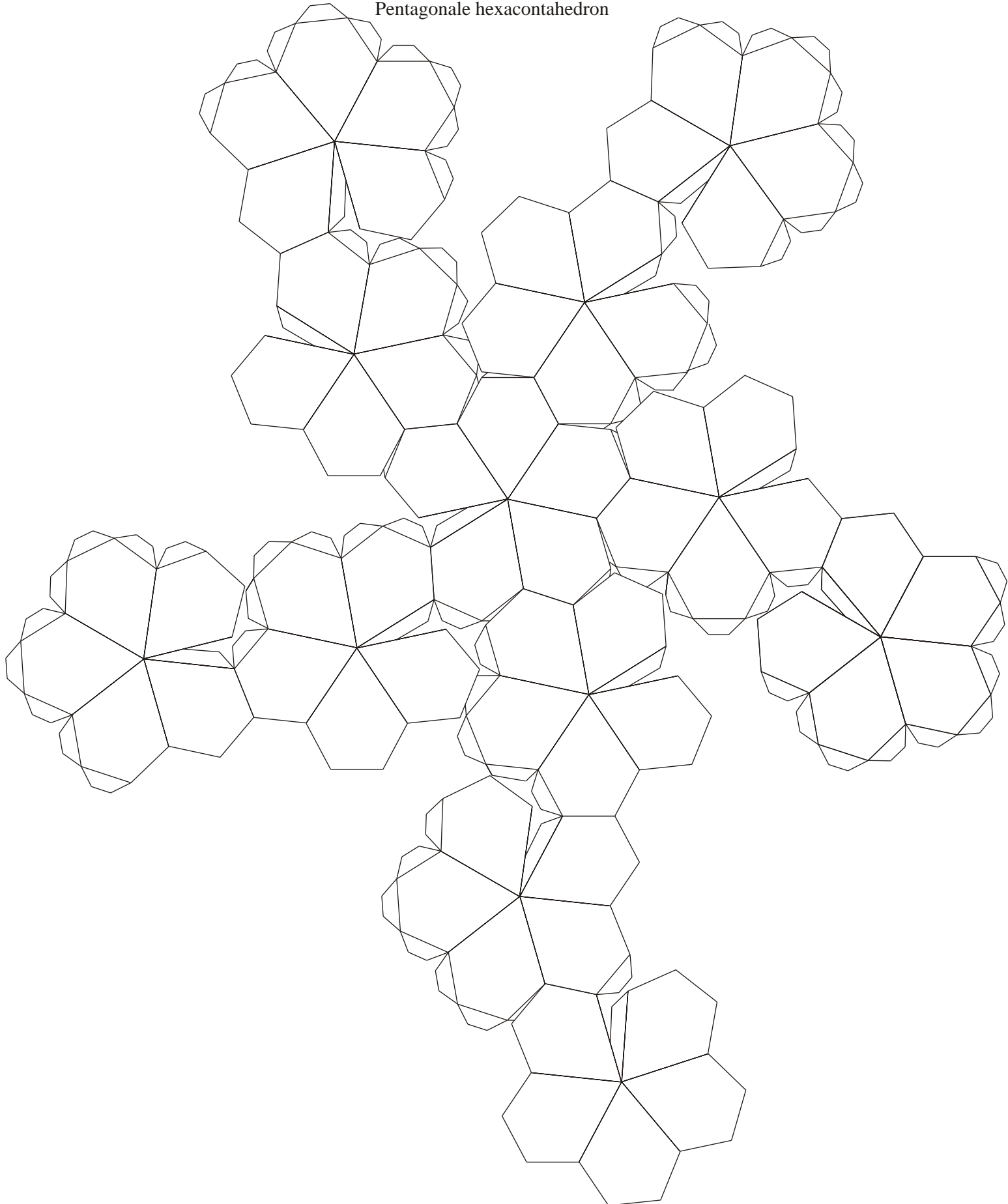

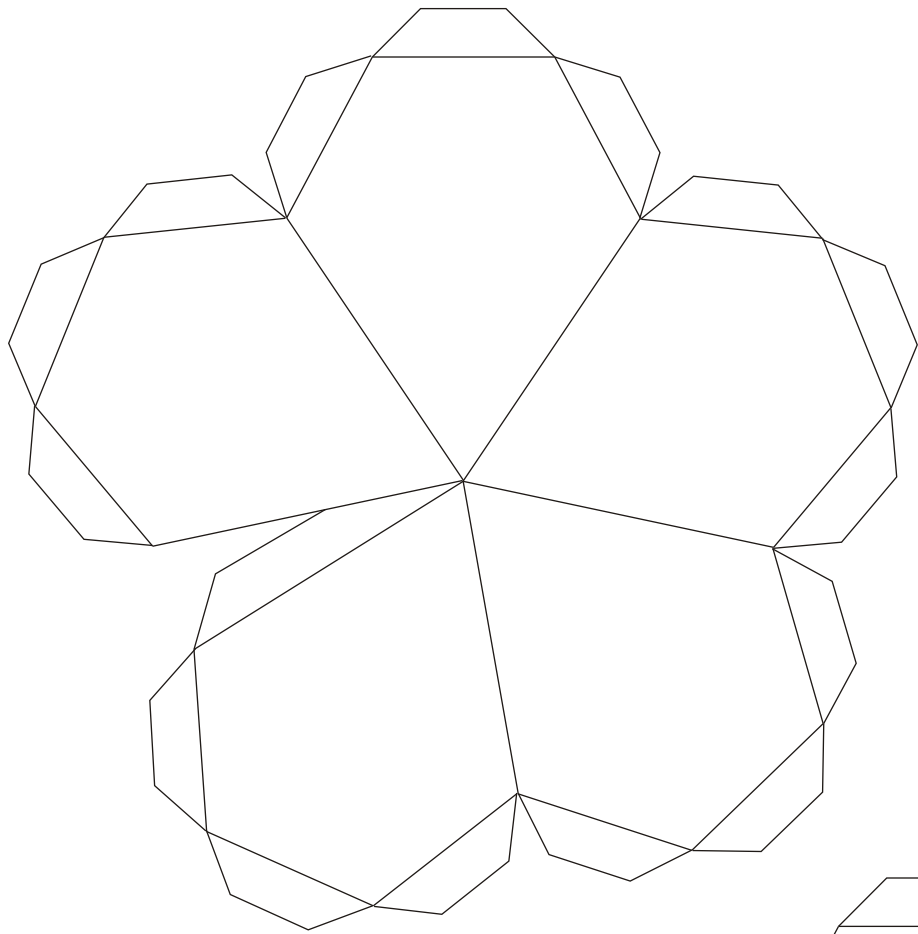

1

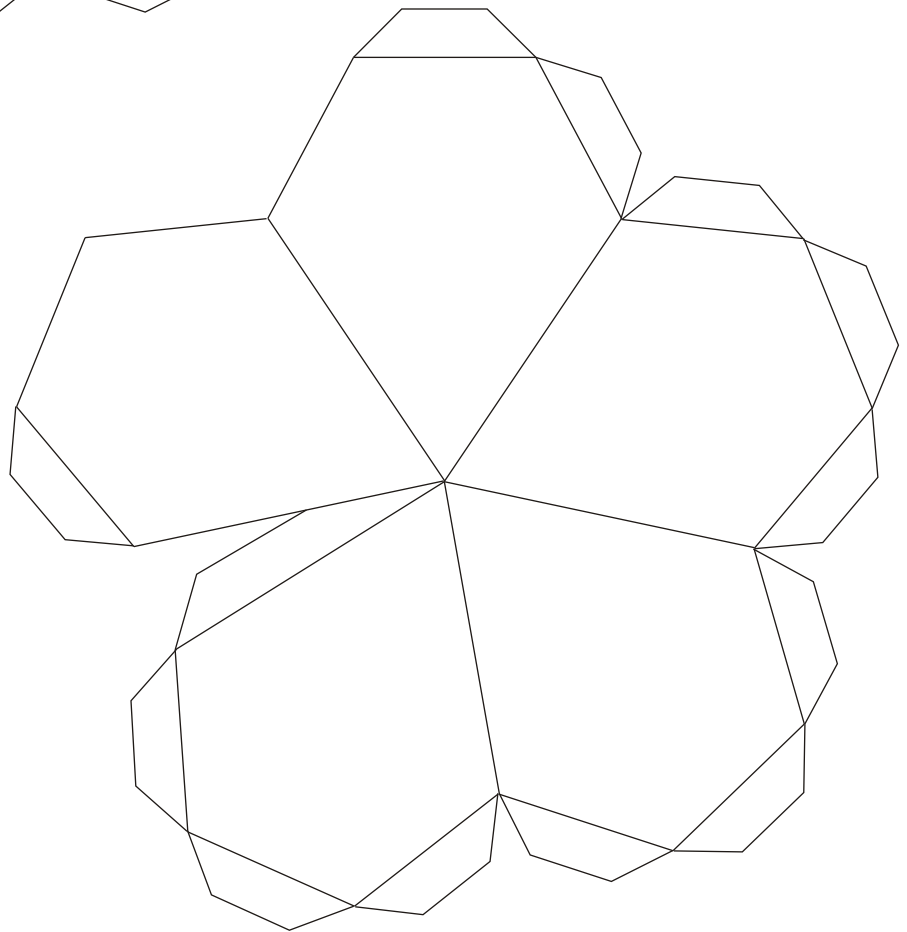

2

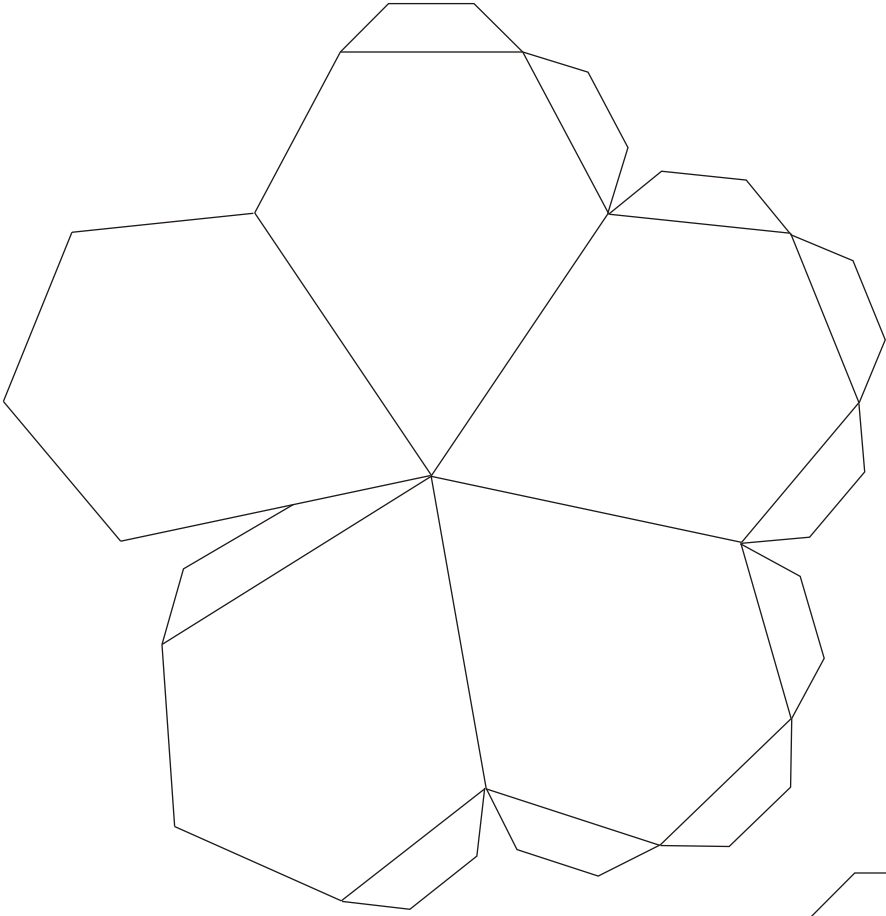

3

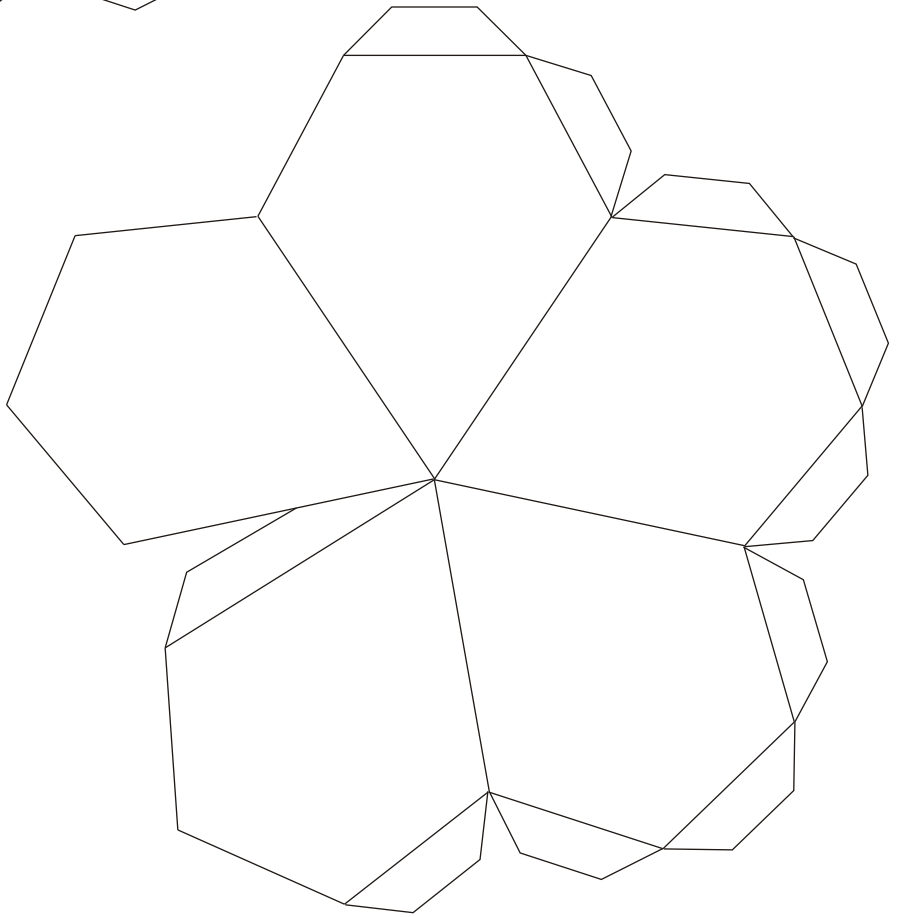

4

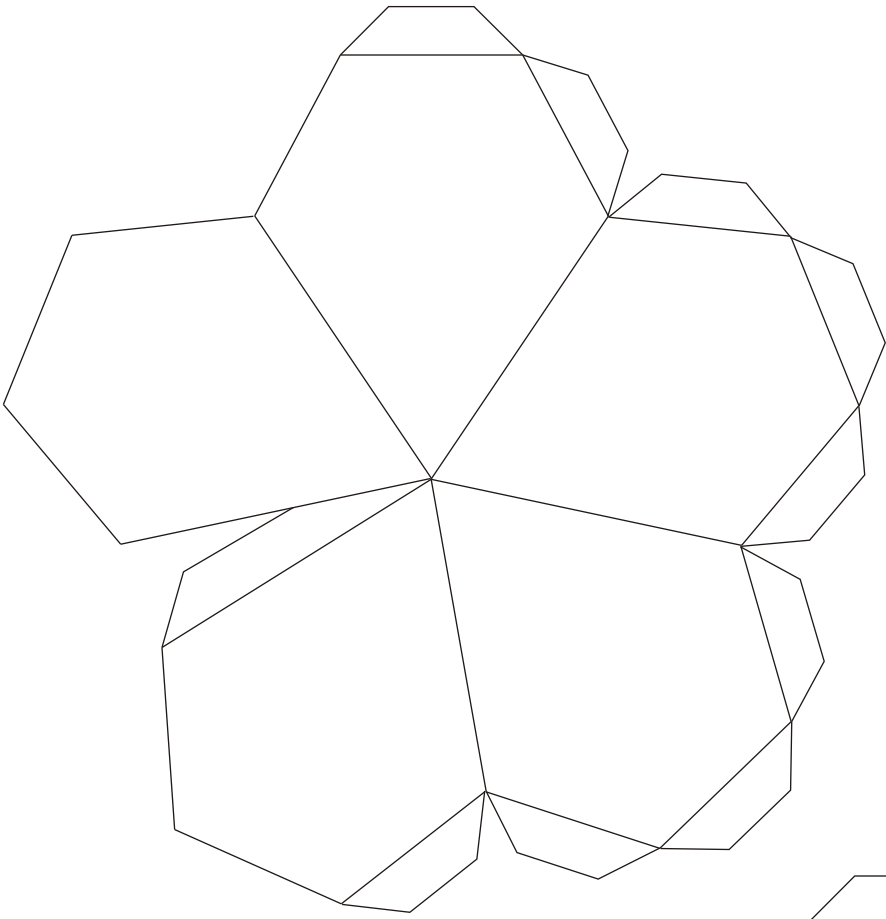

5

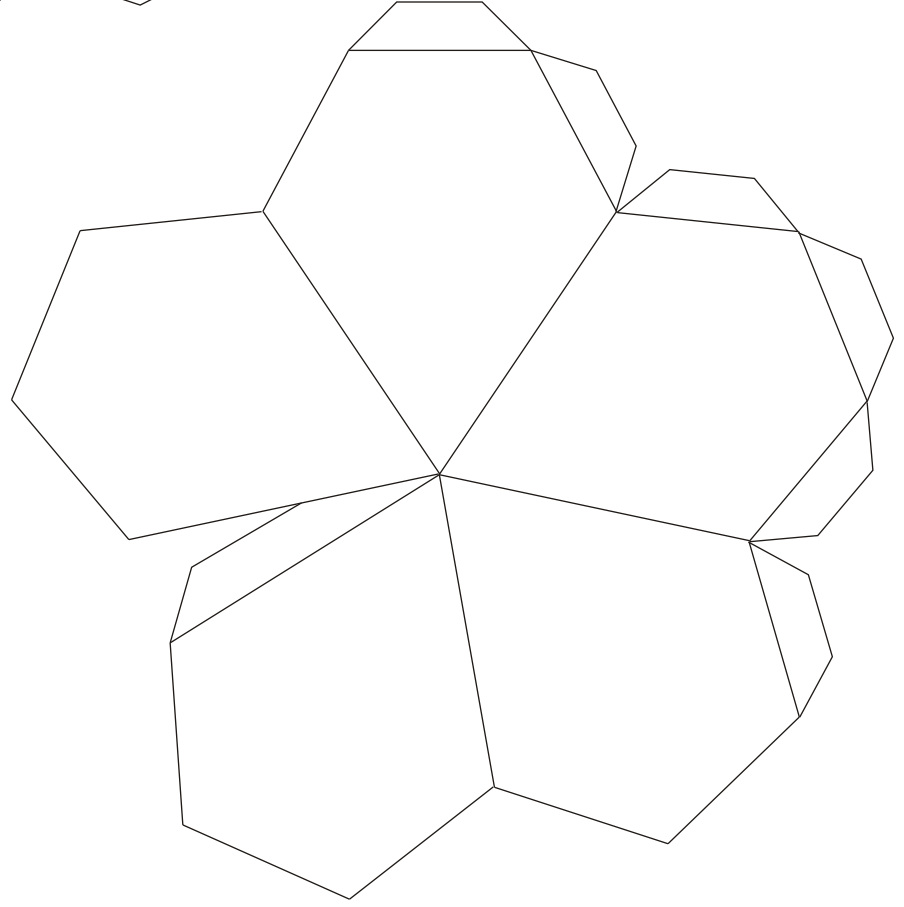

6

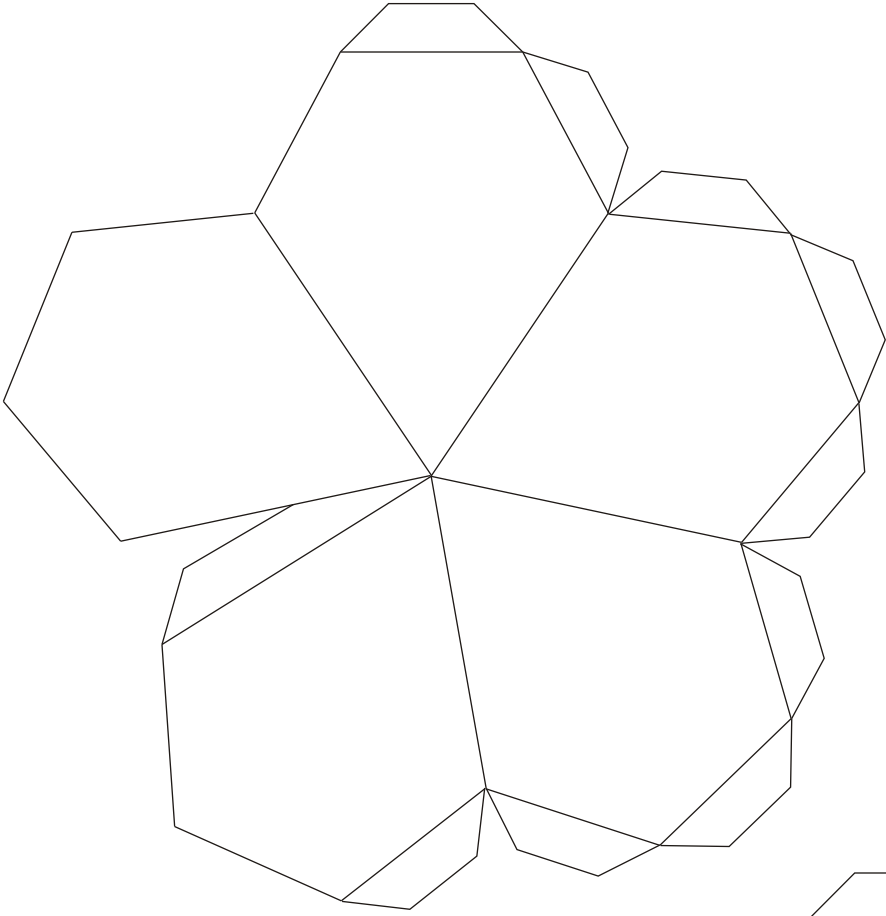

7

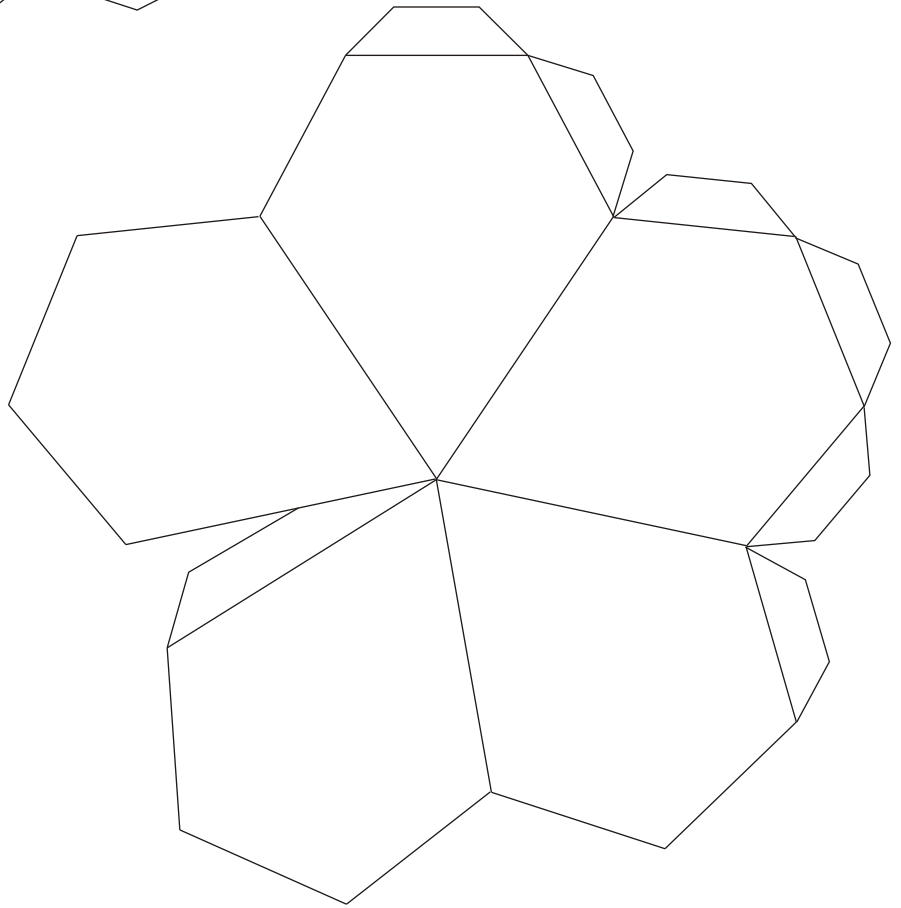

8

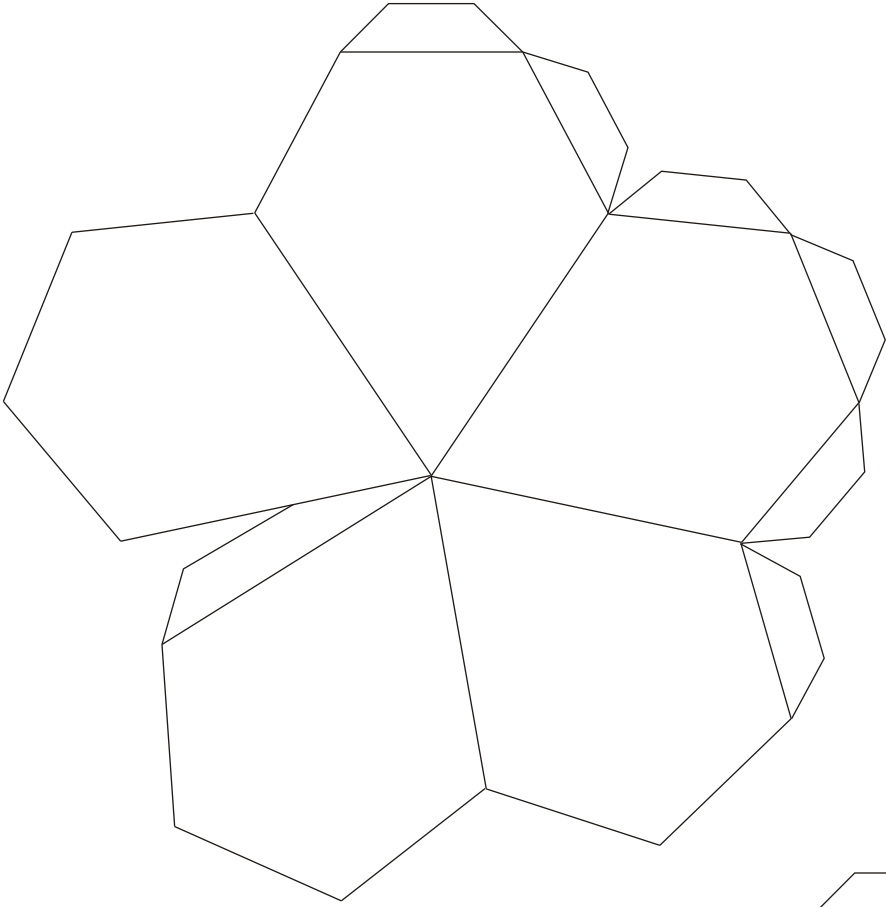

9

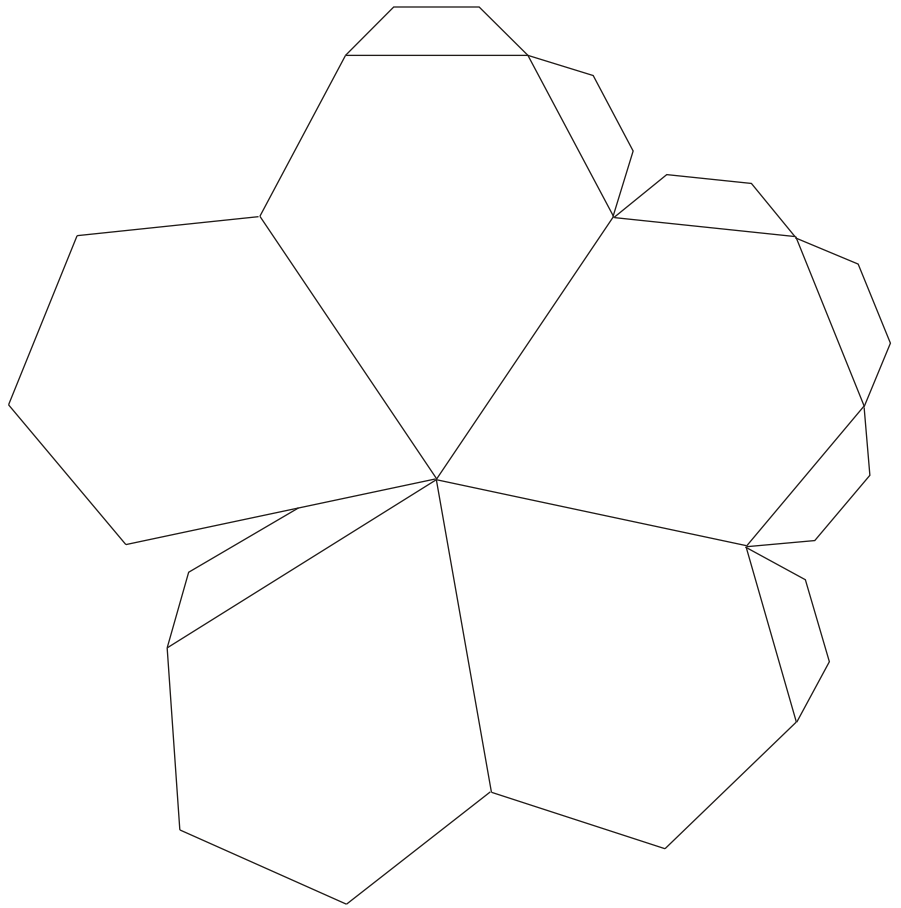

10

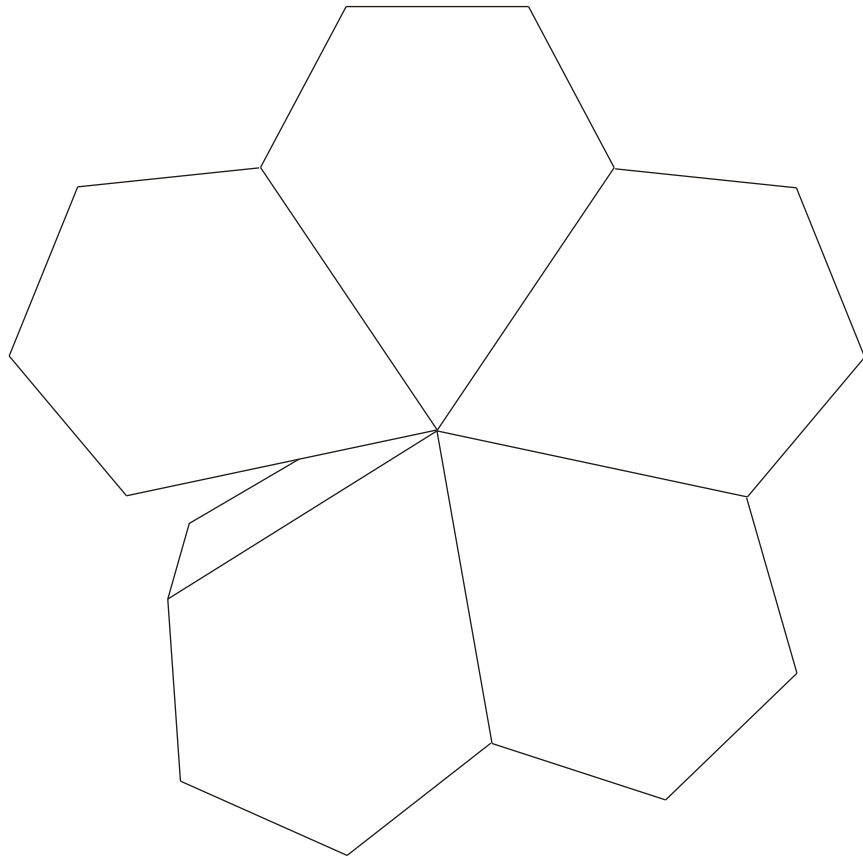
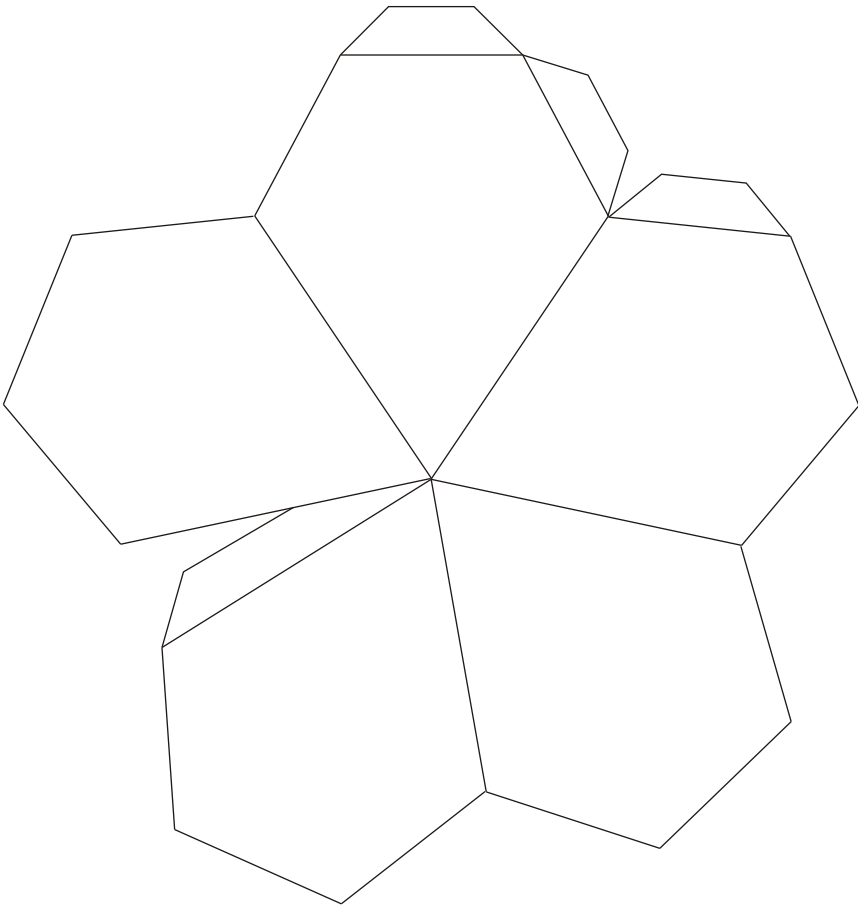

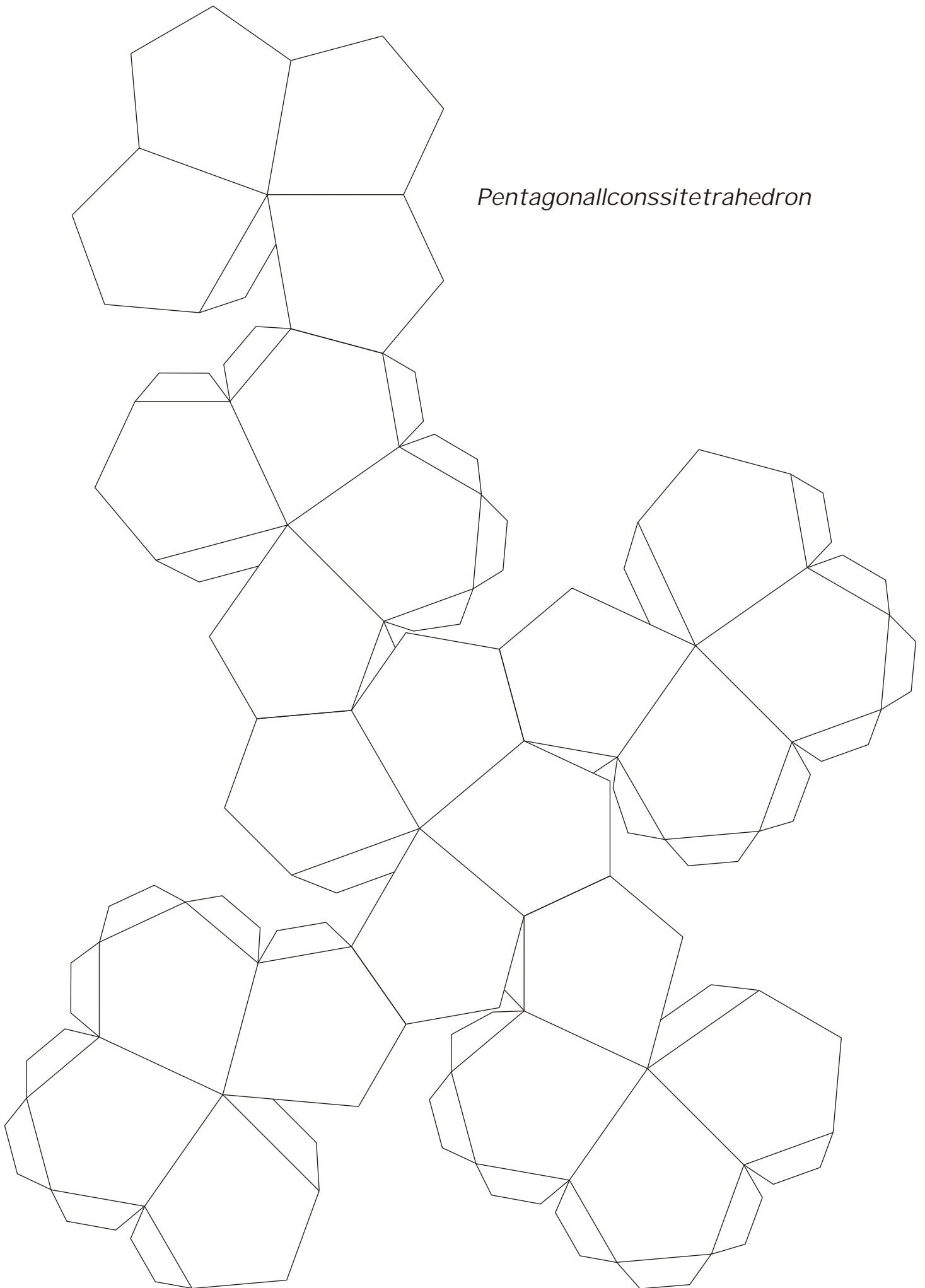

Pentagonallconssitetrahedron

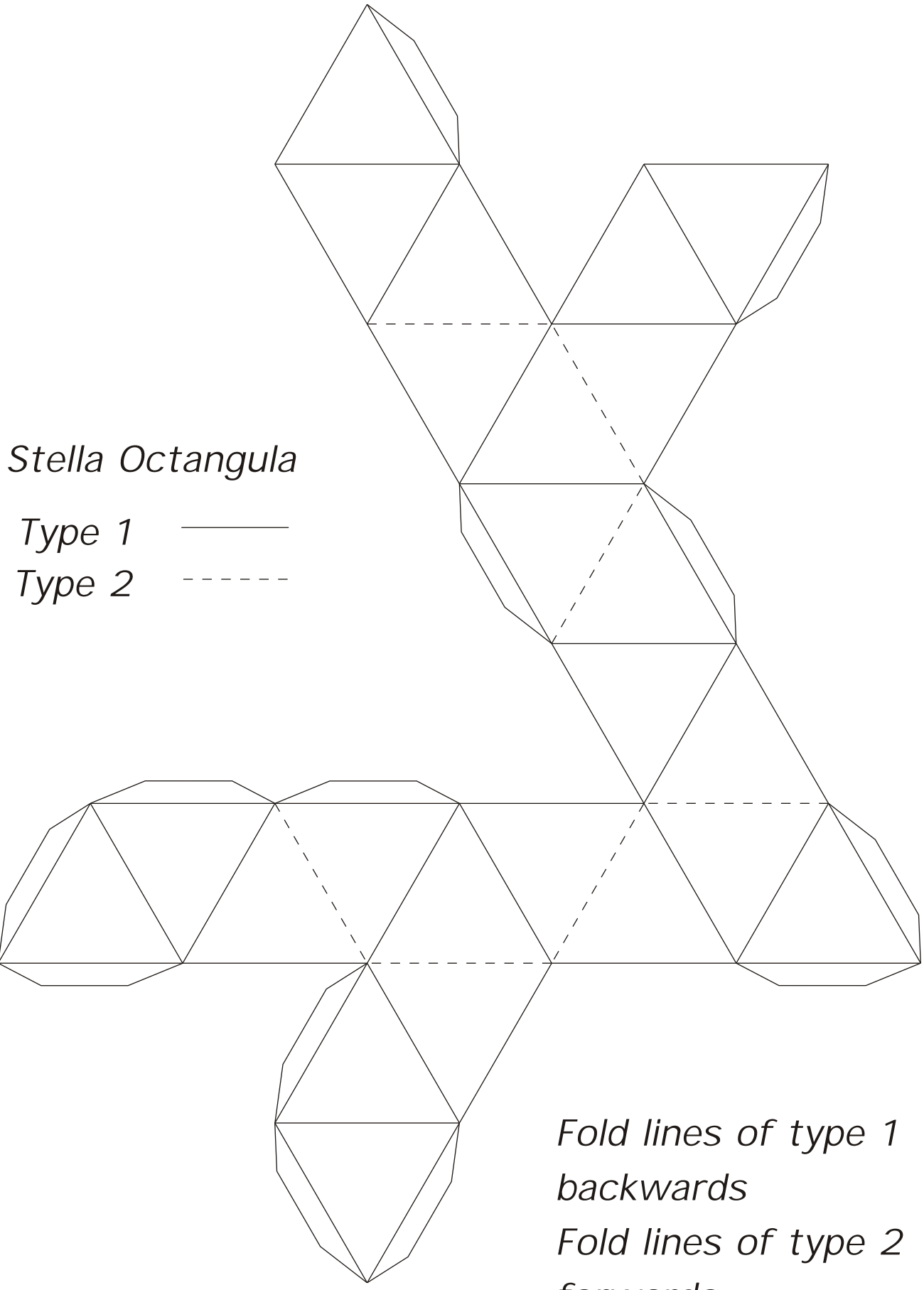

Stella Octangula

Type 1 ———

Type 2 - - - - -

*Fold lines of type 1
backwards*

*Fold lines of type 2
forwards*

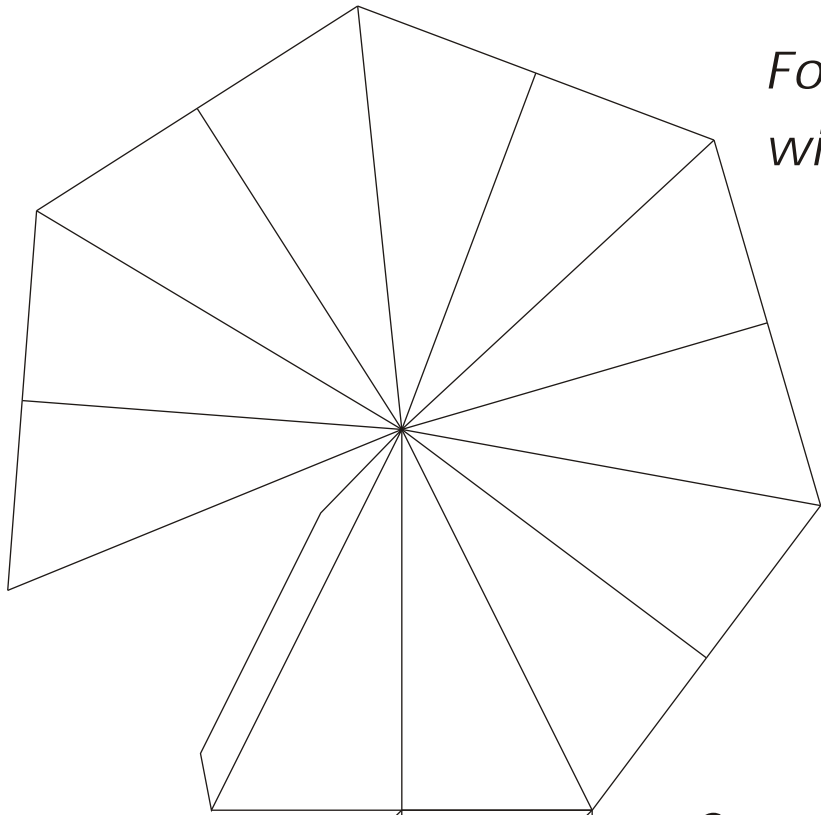

*Fold the lines
with a rightangle
backwards
fold the other
lines forwards*

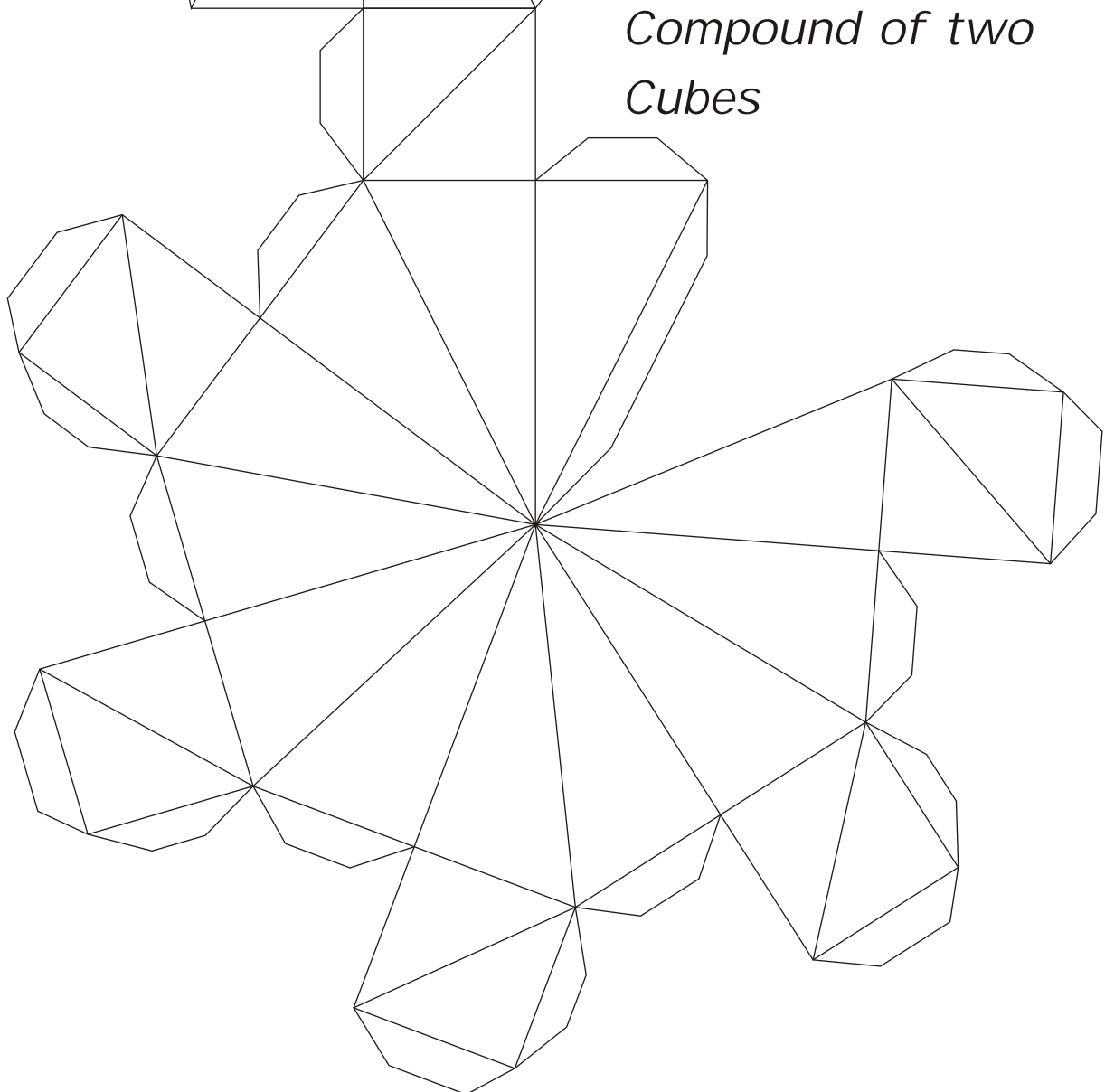

*Compound of two
Cubes*

Compound of Three Cubes

(Small version)

Fold the dotted lines forwards

Fold the other lines backwards

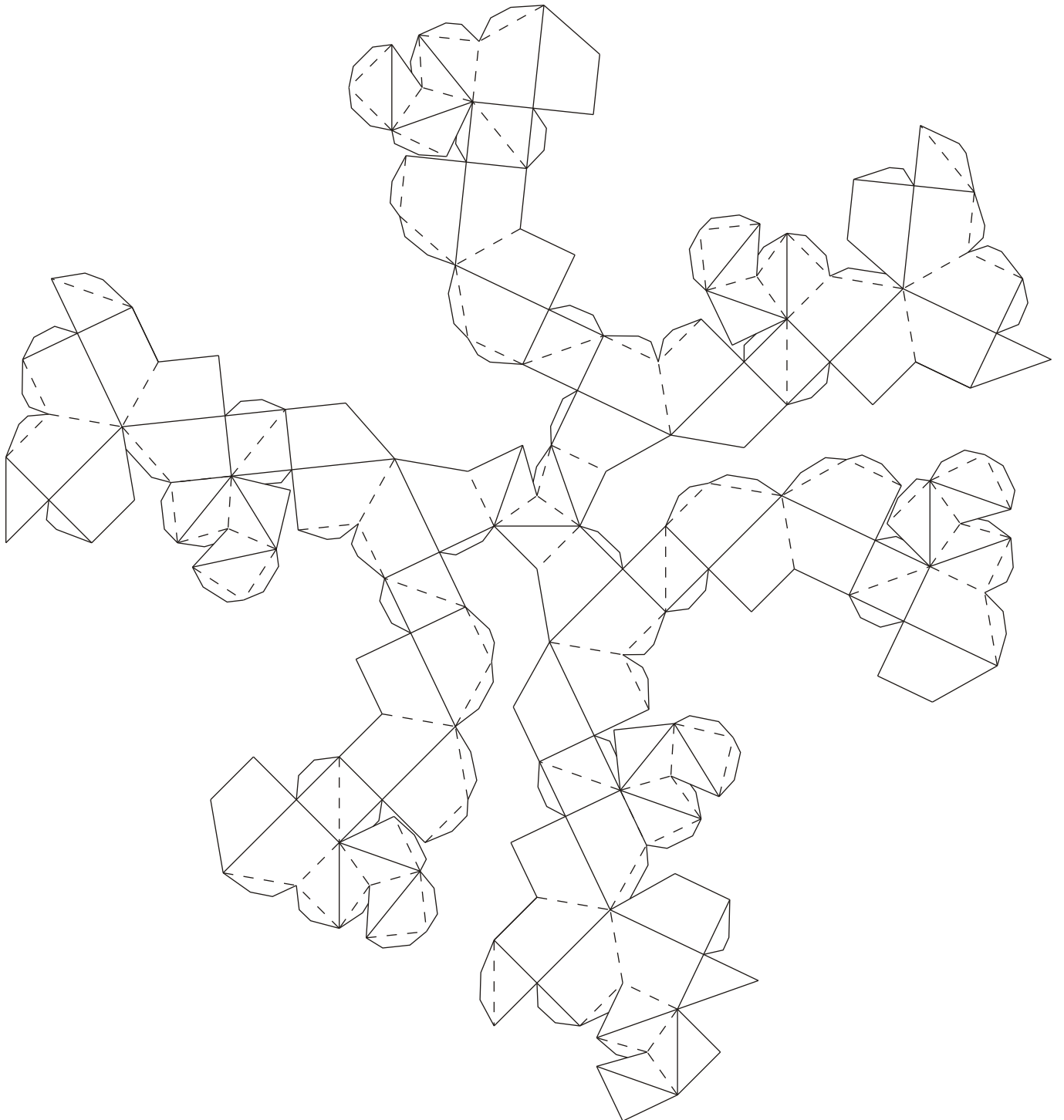

Compound of Three Cubes

(Small version)

Fold the dotted lines forwards

Fold the other lines backwards

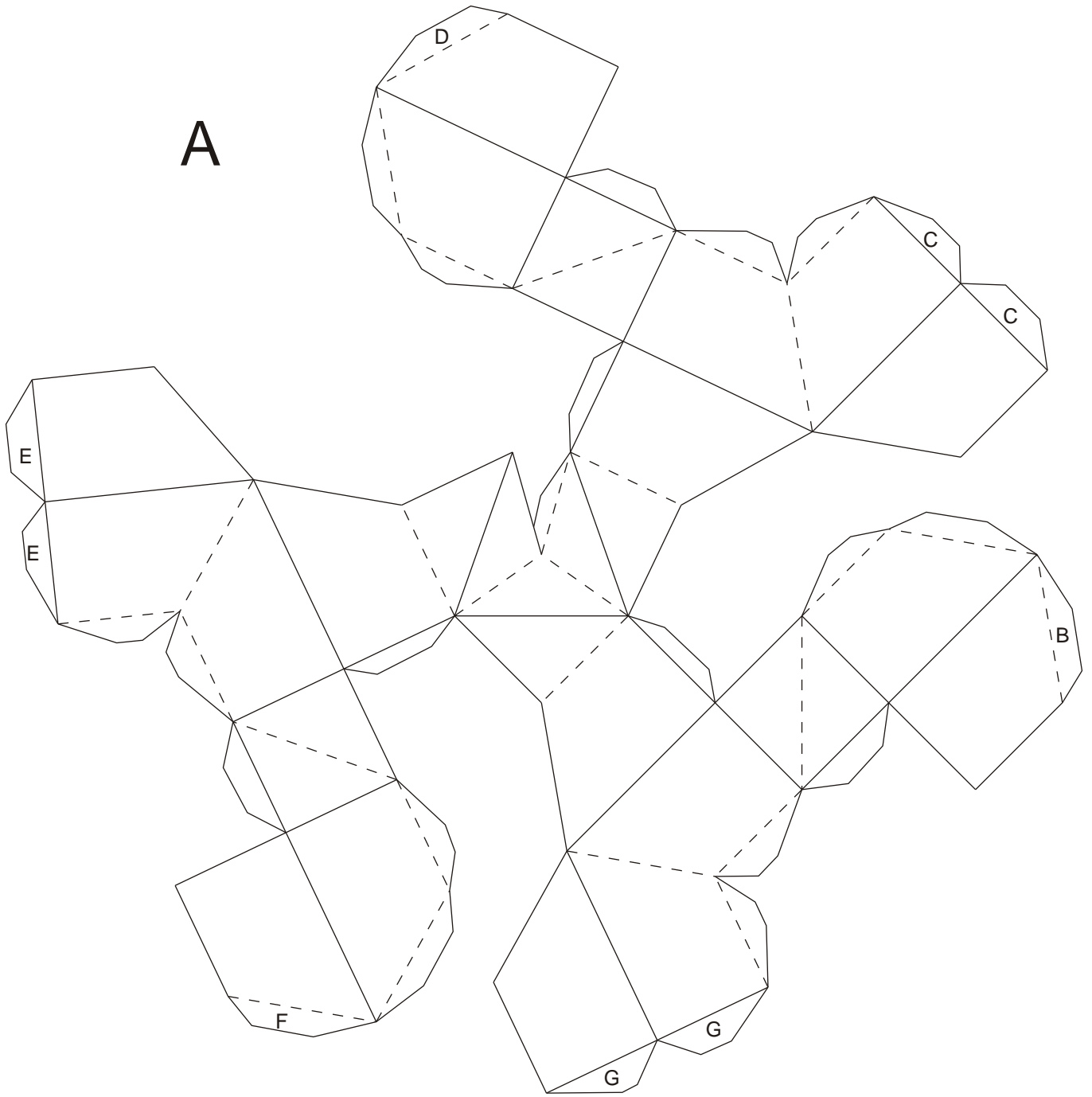

B

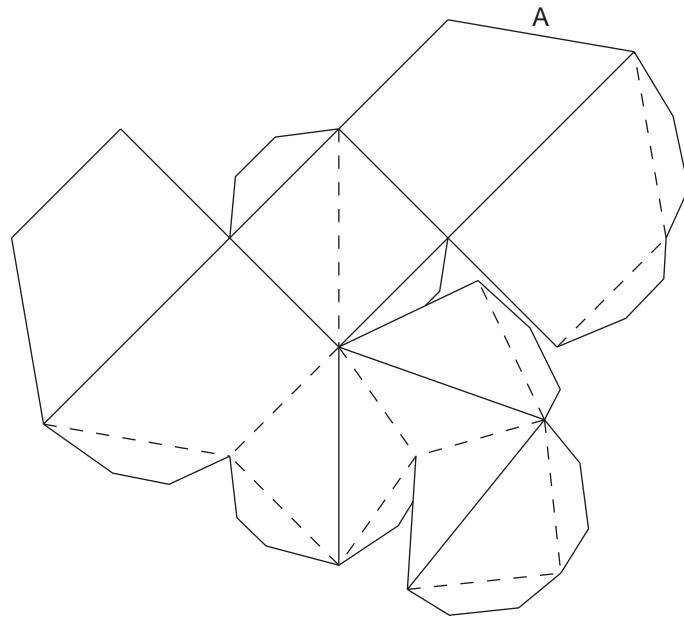

C

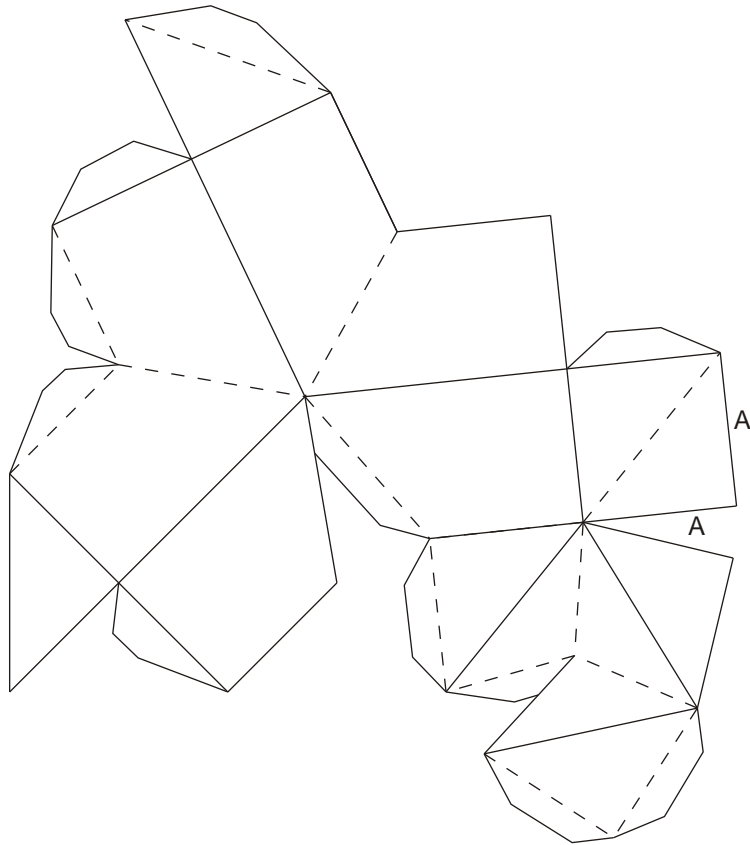

D

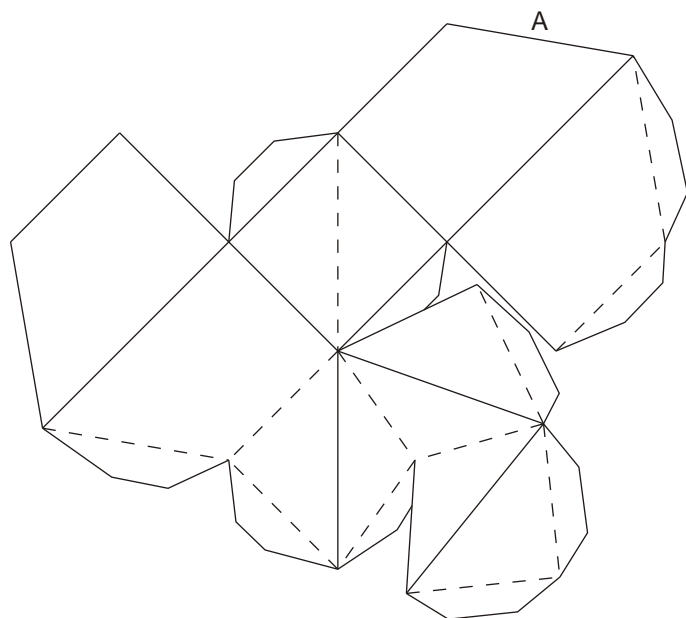

E

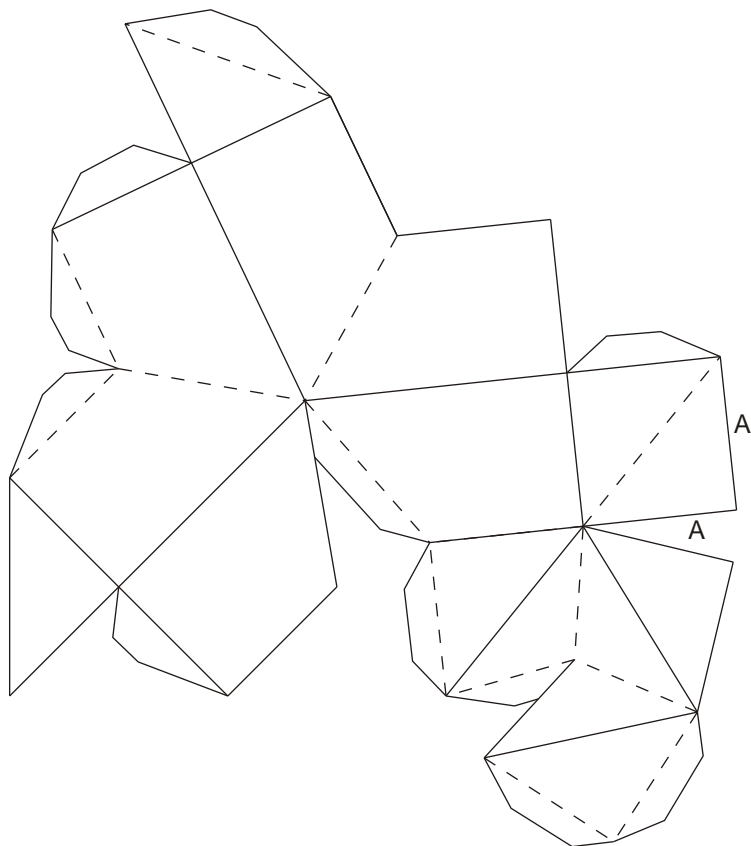

F

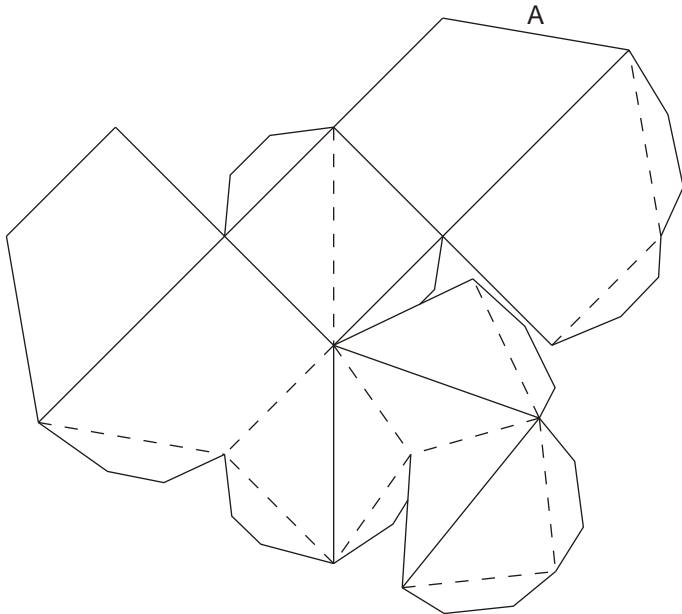

G

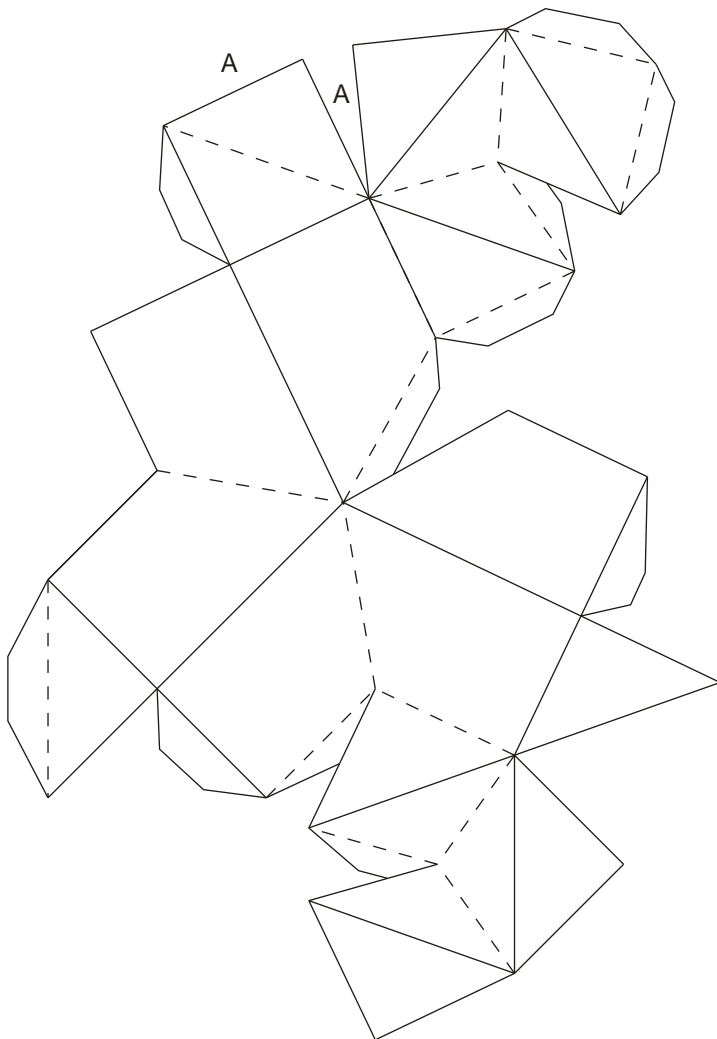

On this page a compound of five cubes
made of one piece of paper.

On the next pages a compound of five
cubes made of 7 pieces of paper

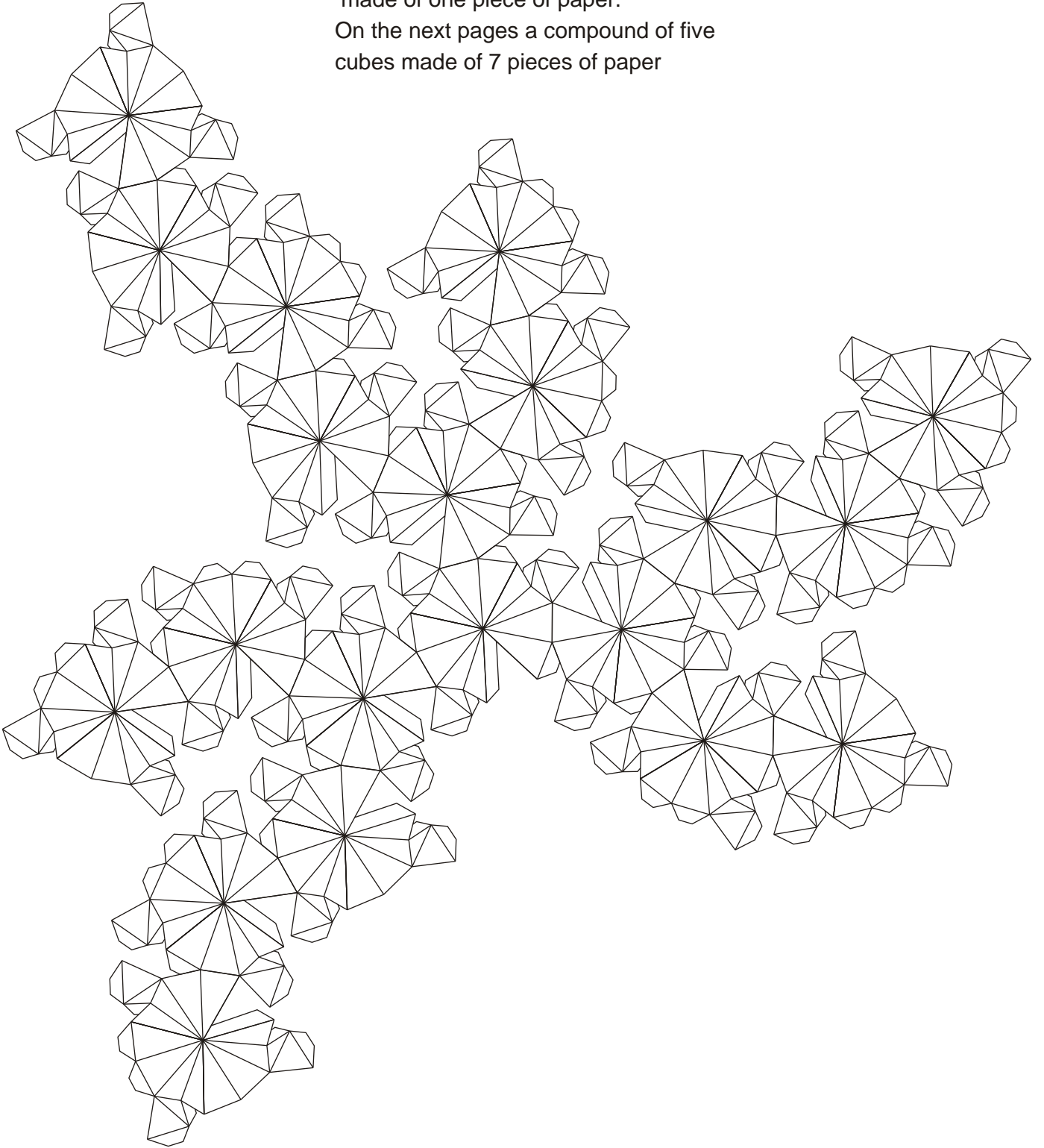

Instructions:

Cut and fold the piece(s) of paper.
Glue the part without tabs around it last.
This is the top part of piece F. This one
opposites the center part of piece A.

Below an example of a part

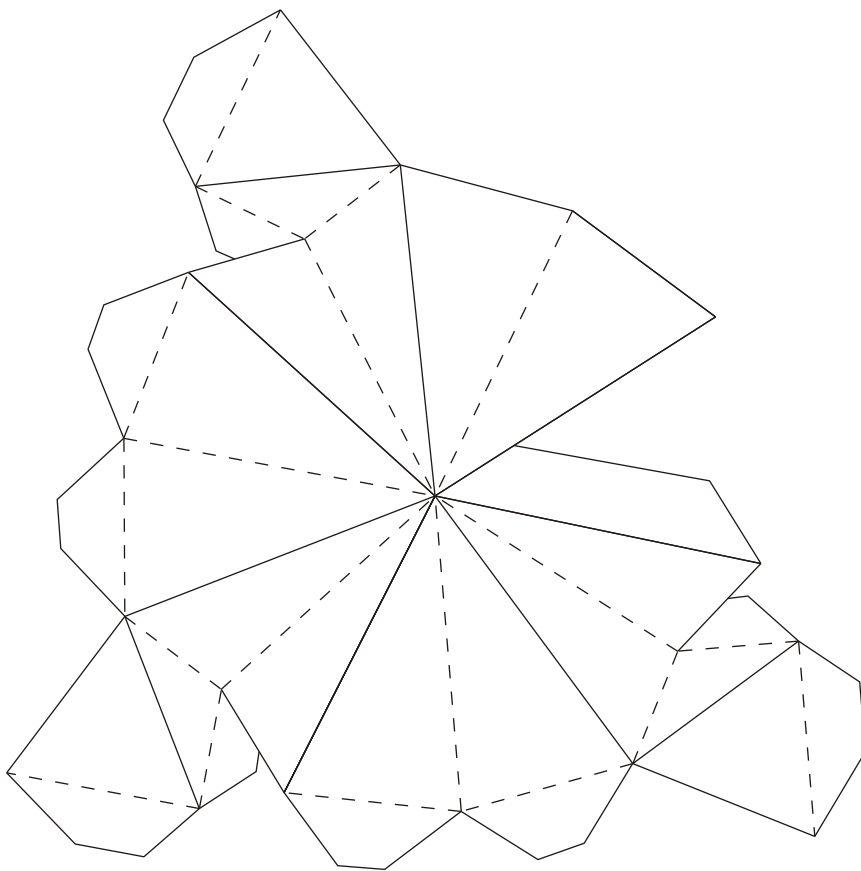

----- Fold forwards

————— Fold backwards

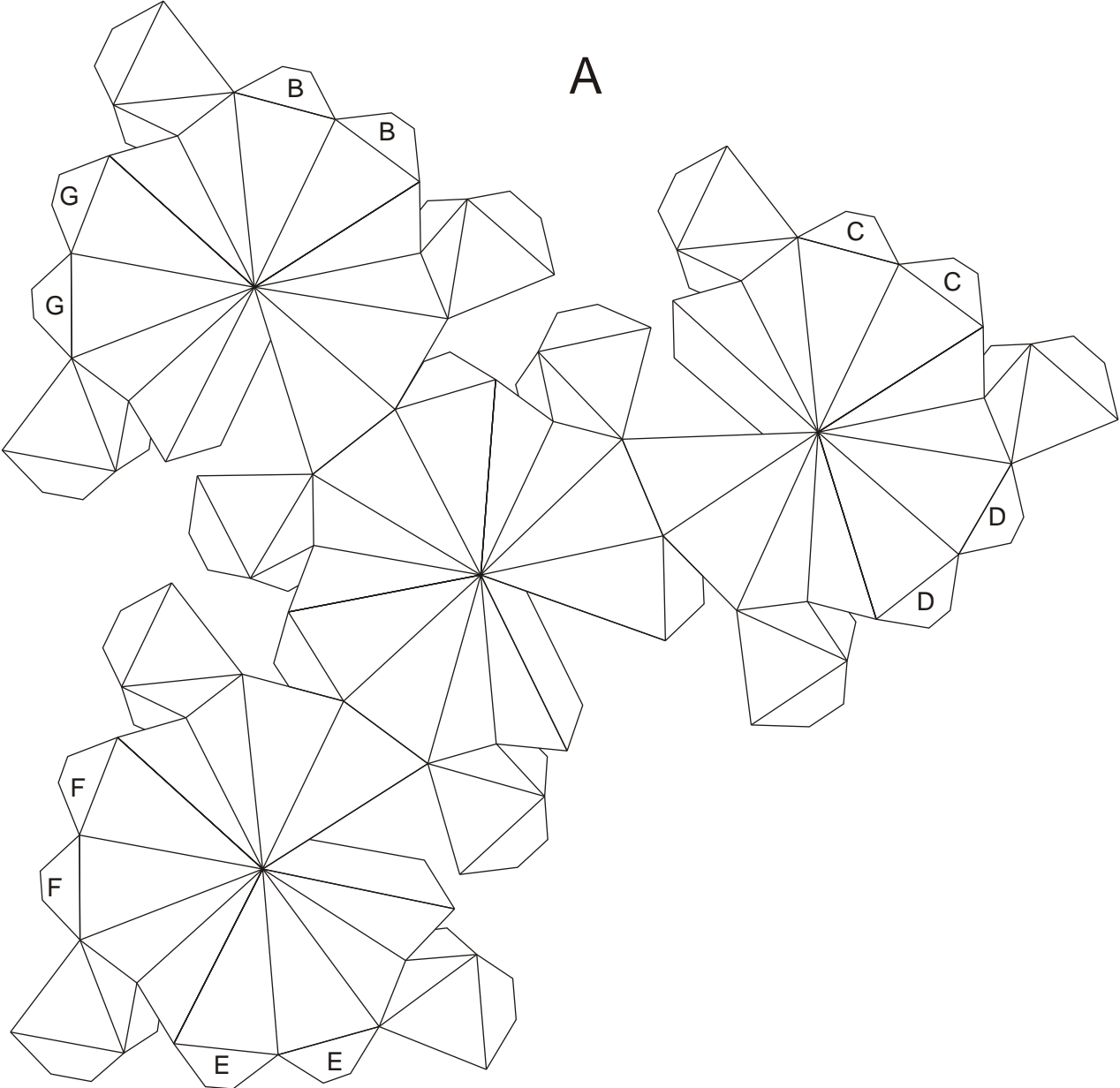

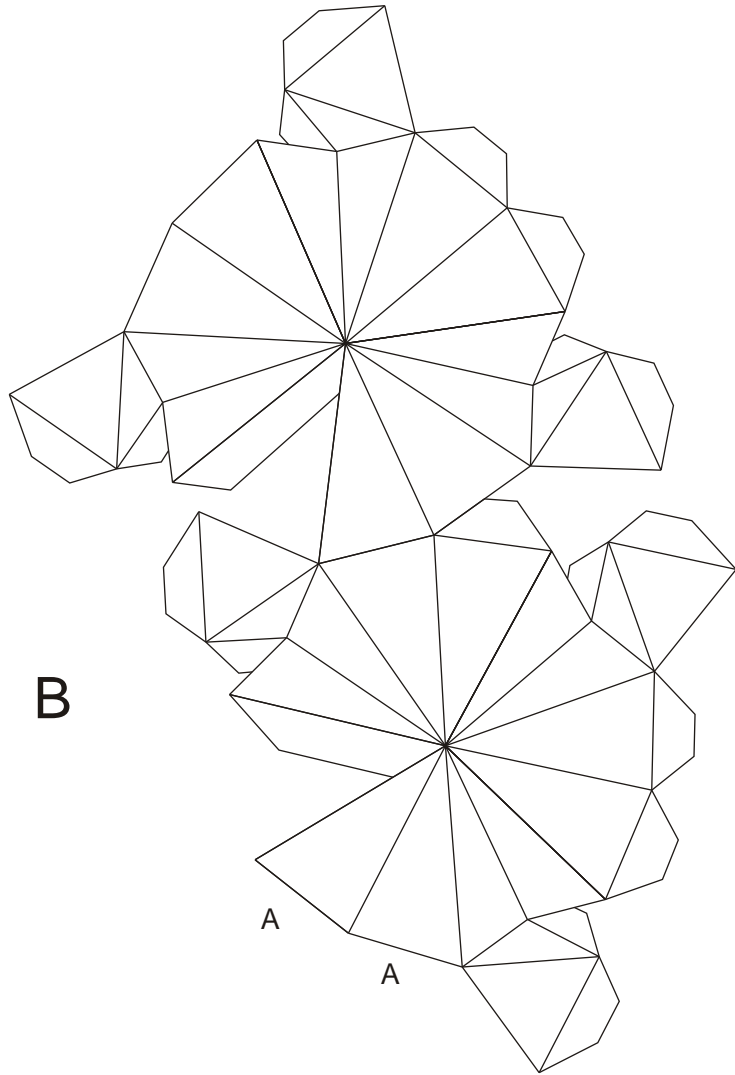

B

A

A

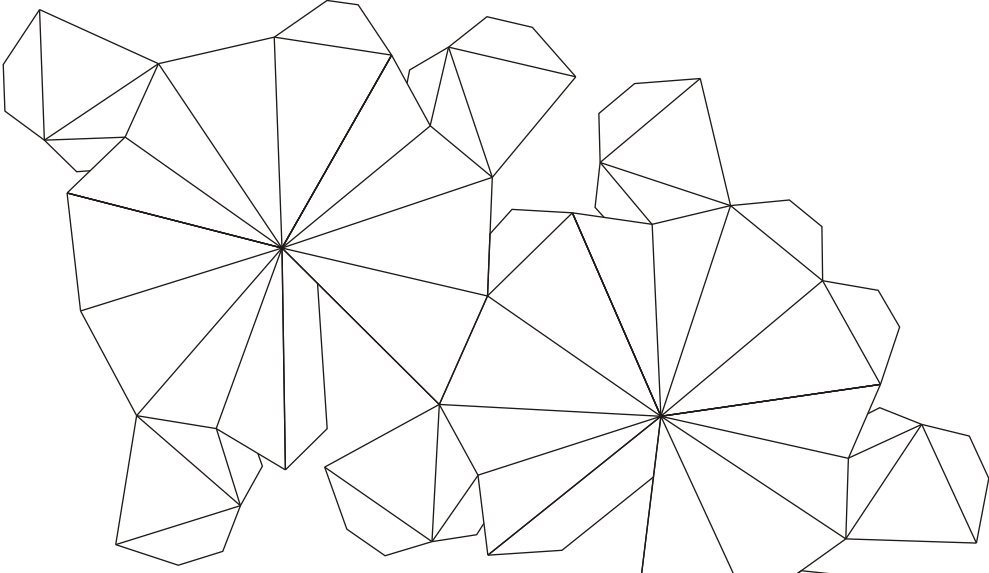

C

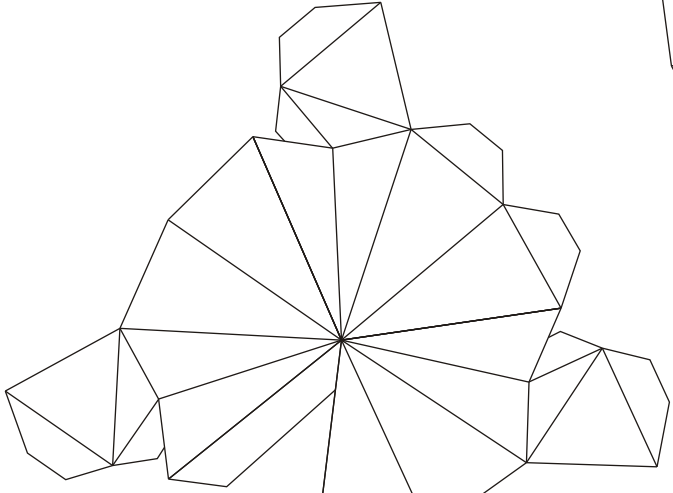
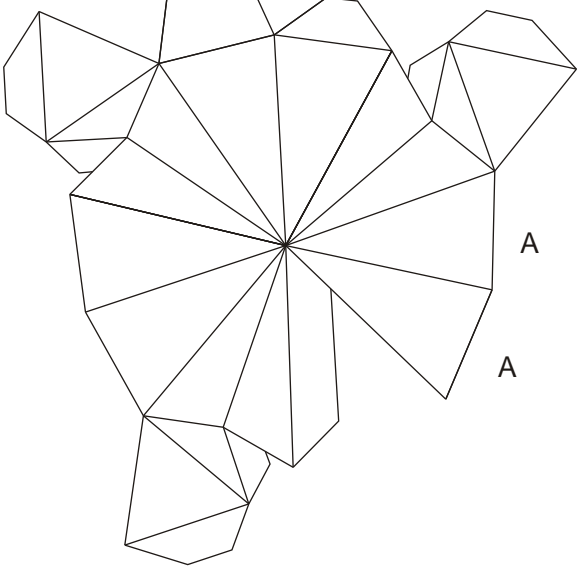

D

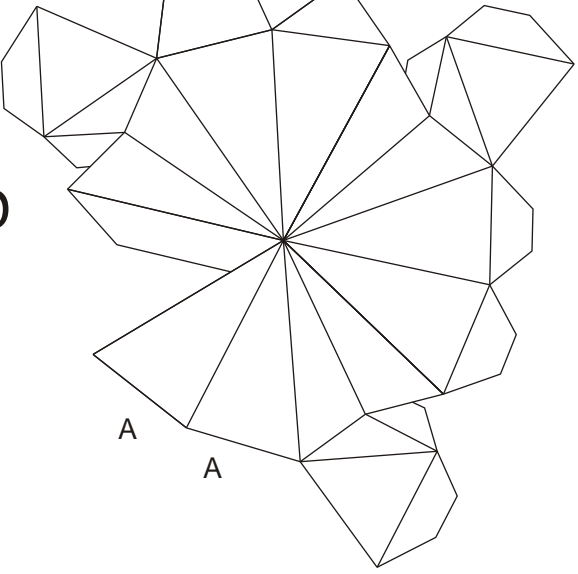

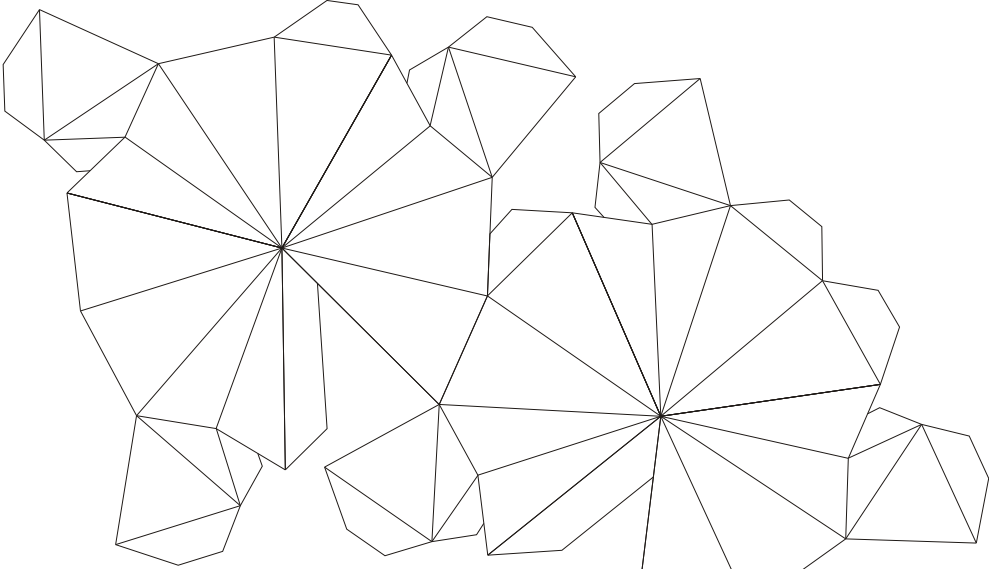

E

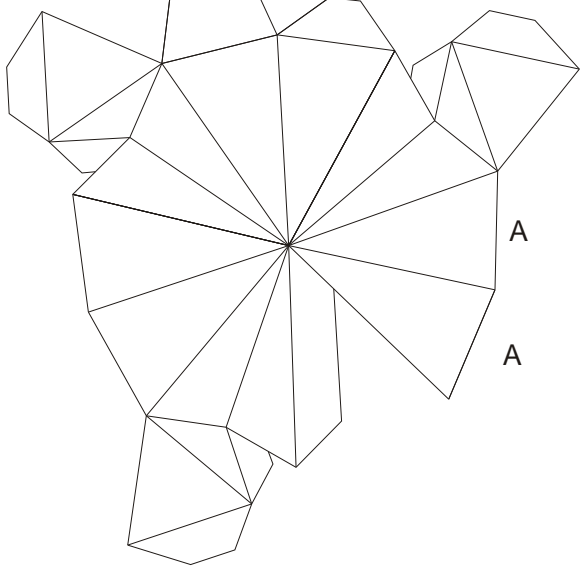

A

A

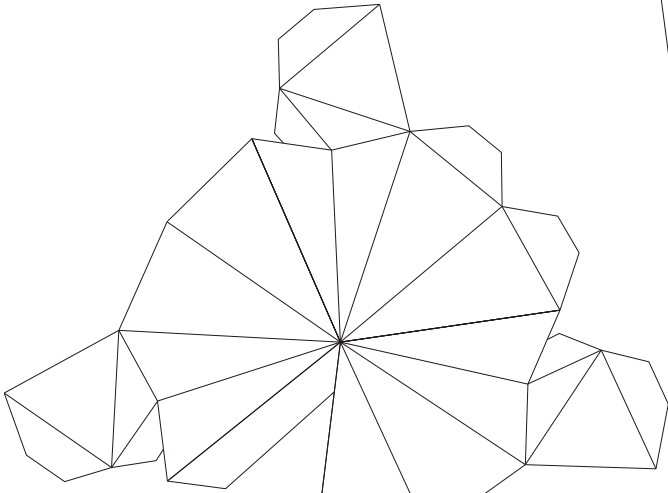

F

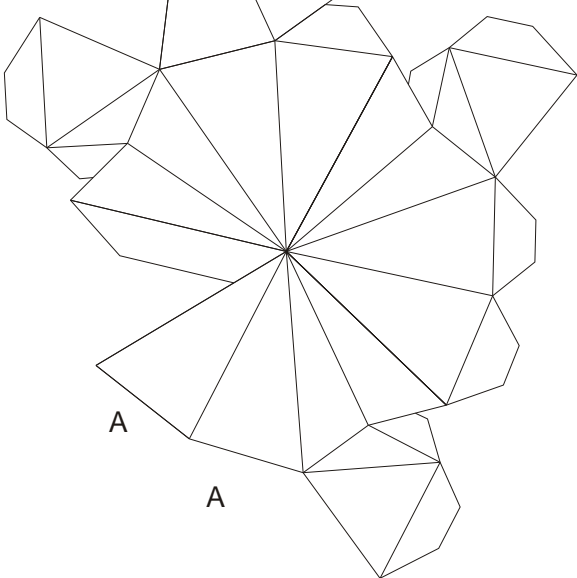

A

A

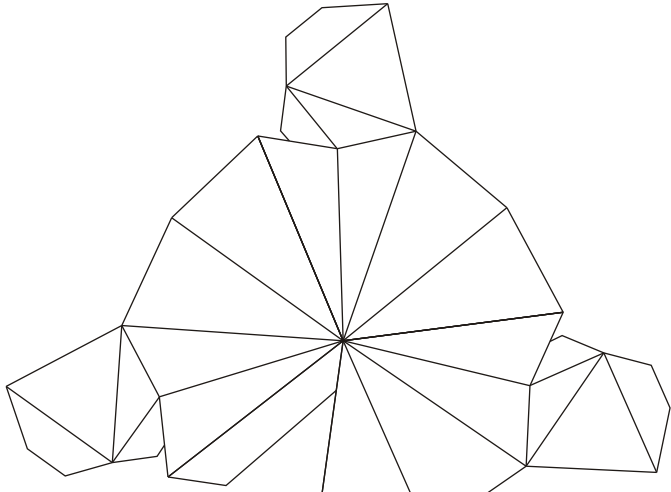

G

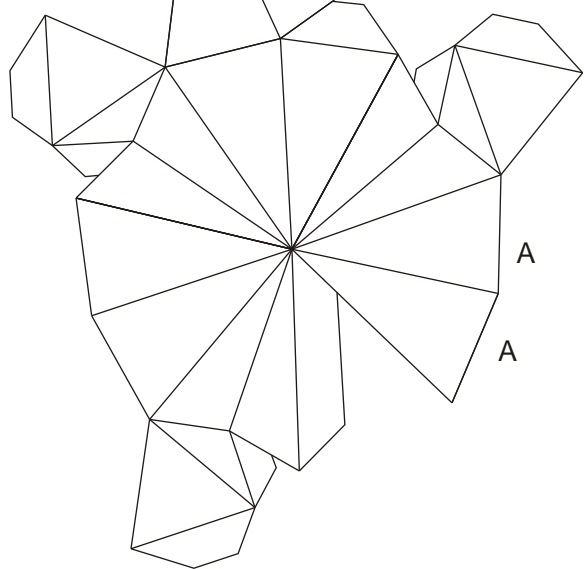
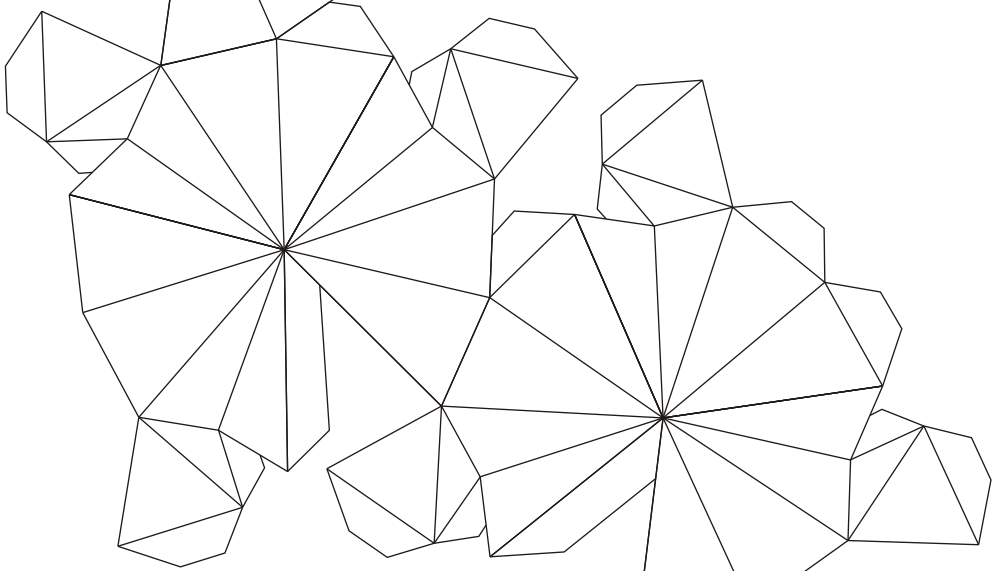

A

A

Compound of five Octahedra

If you use paper in five different colors
each octahedron has a different color

Color 1

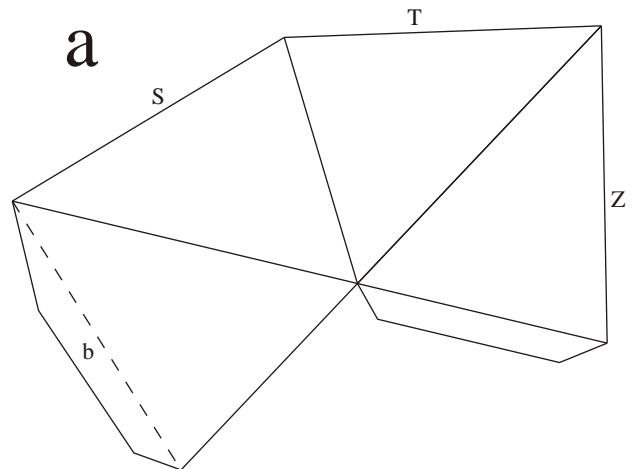
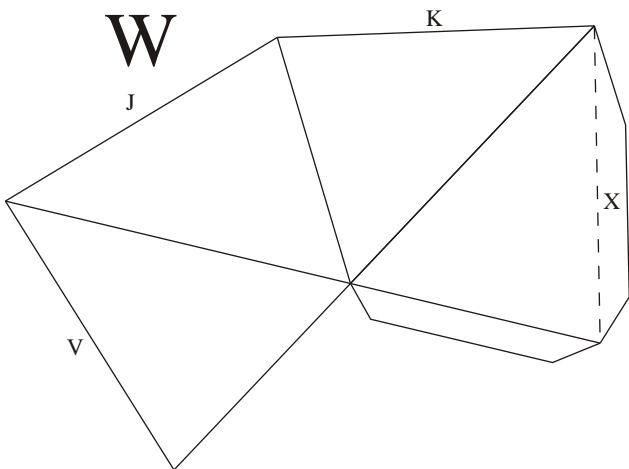
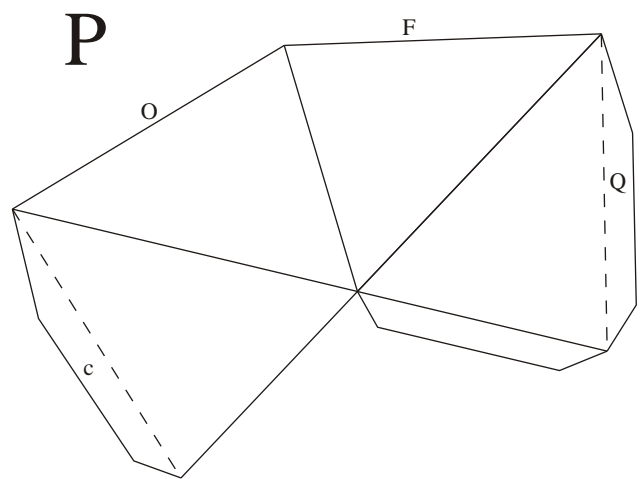
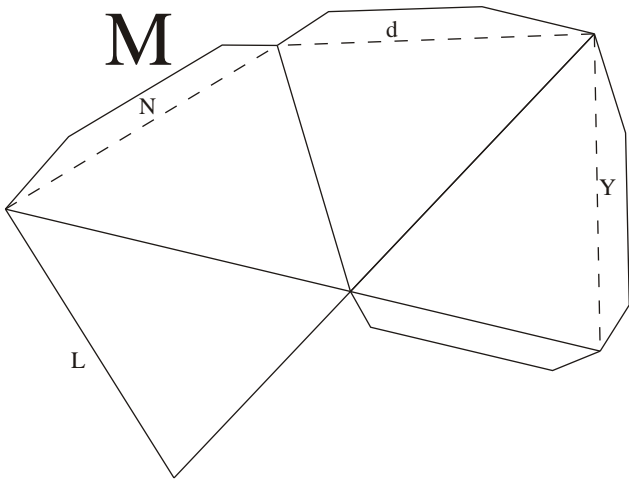
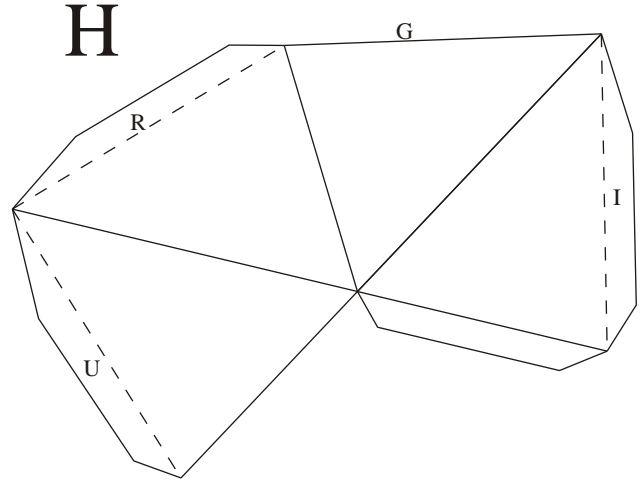
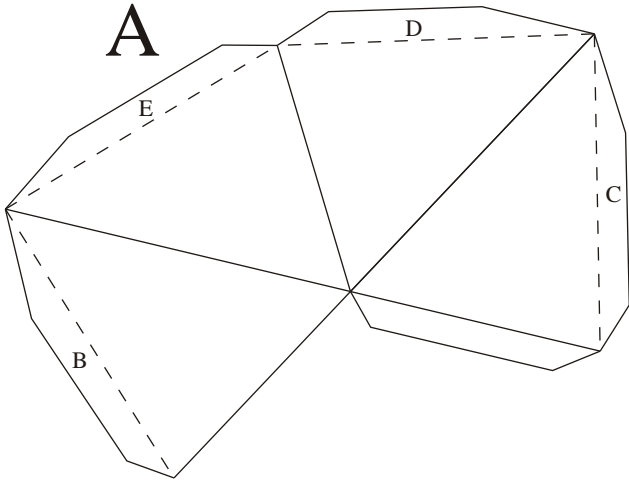

Compound of five Octahedra

Color 2

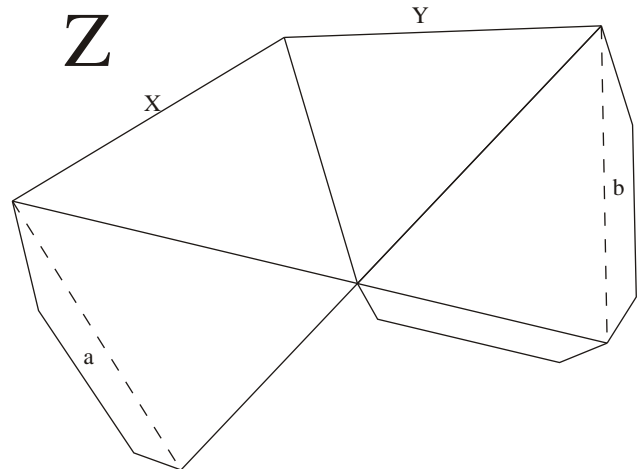
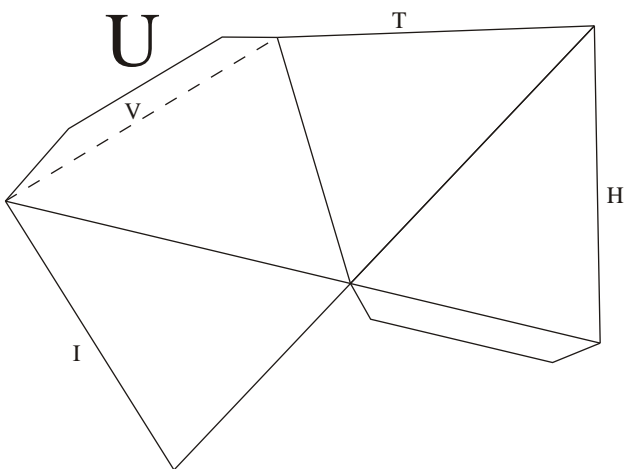
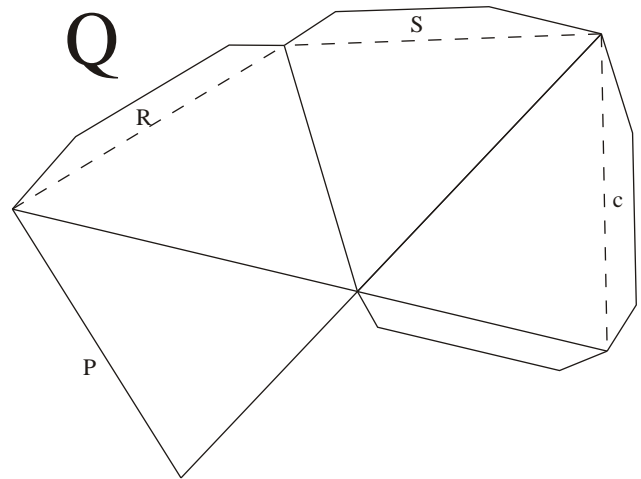
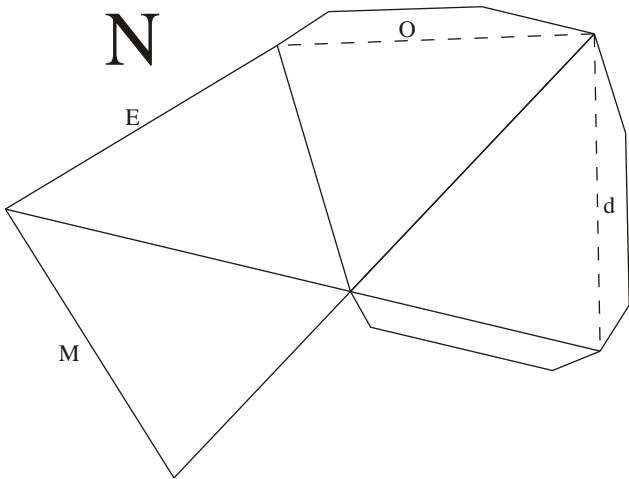
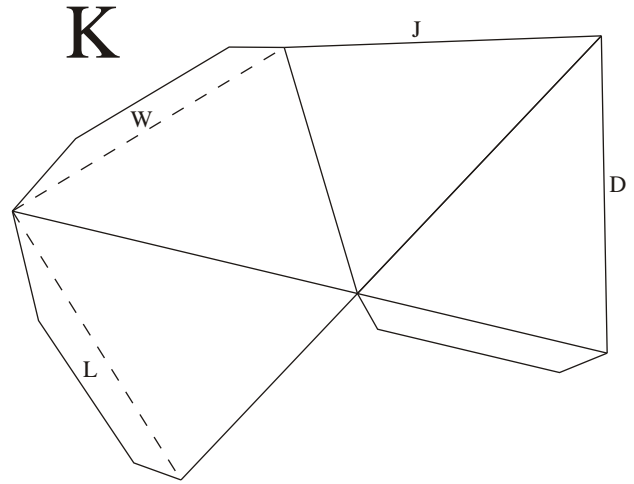
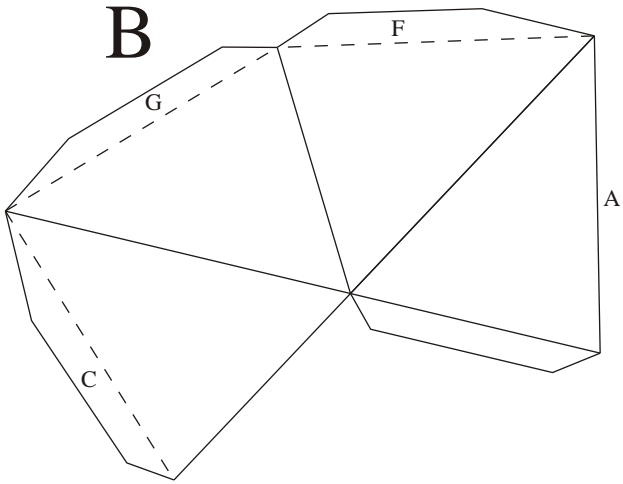

Compound of five Octahedra

Color 3

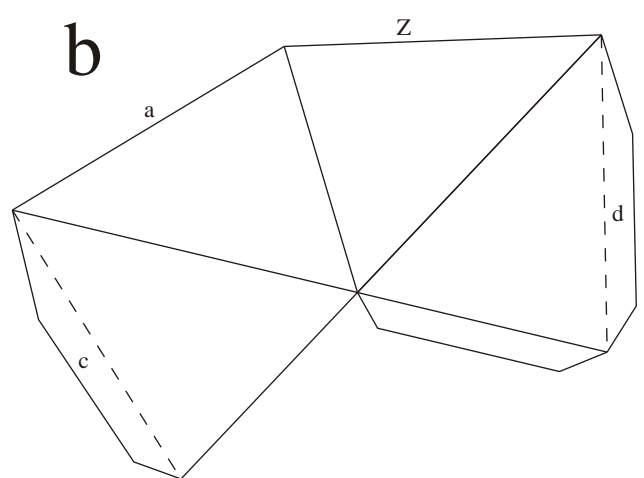
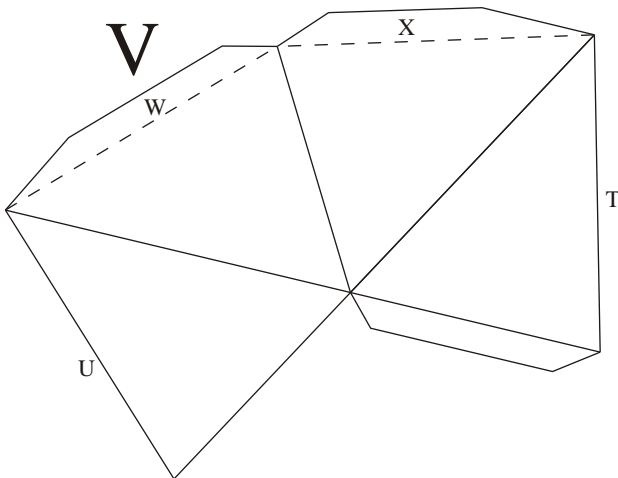
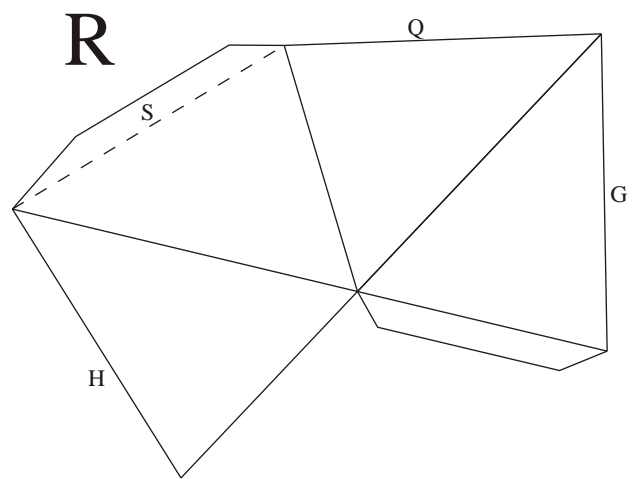
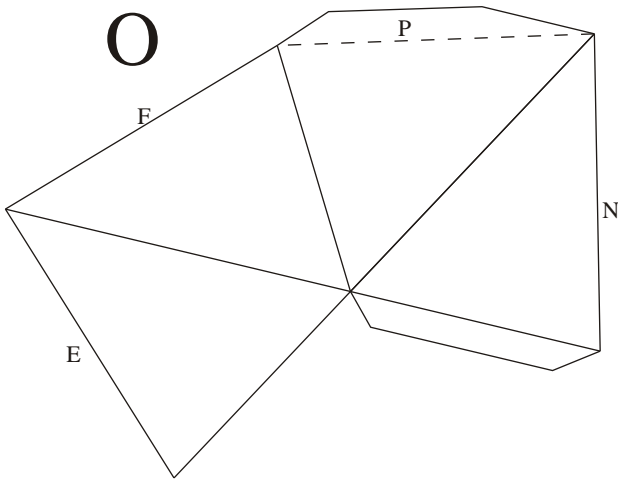
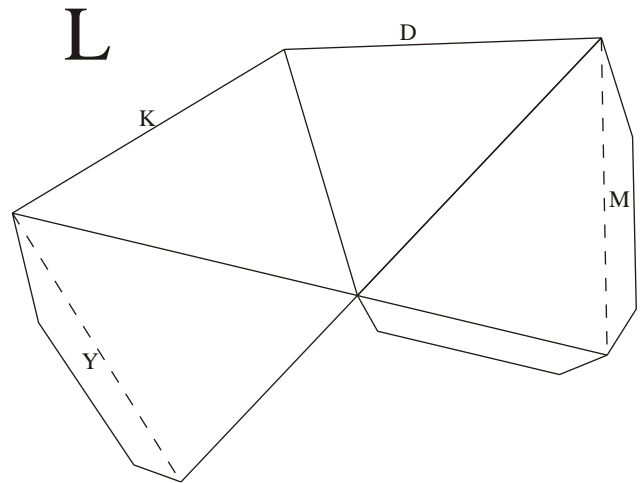
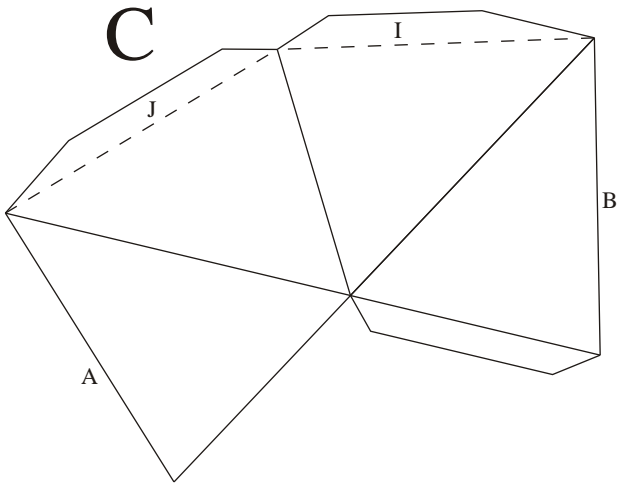

Compound of five Octahedra

Color 4

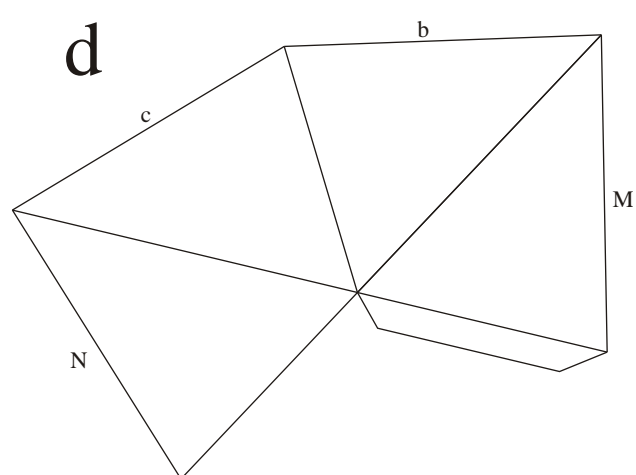
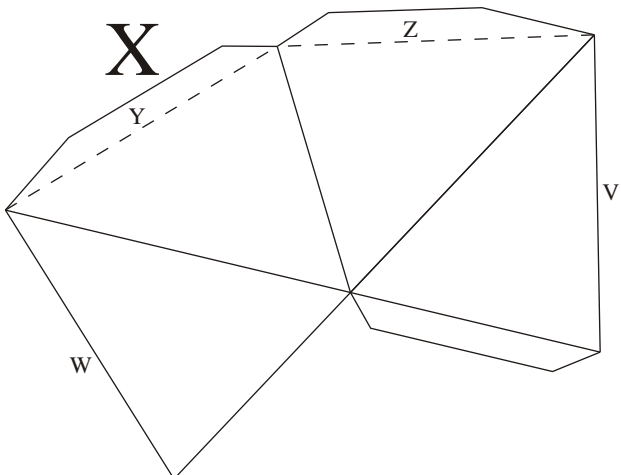
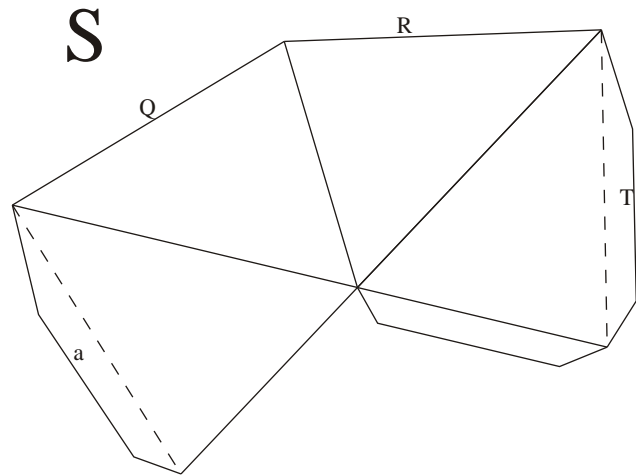
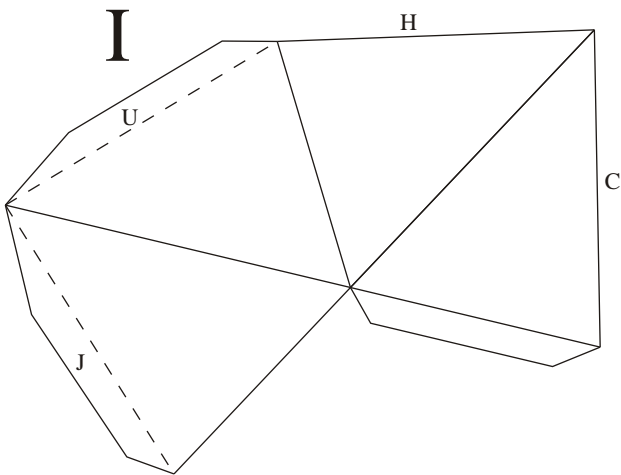
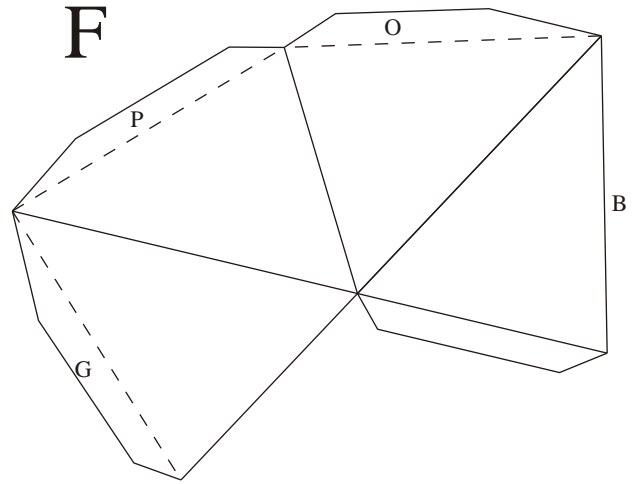
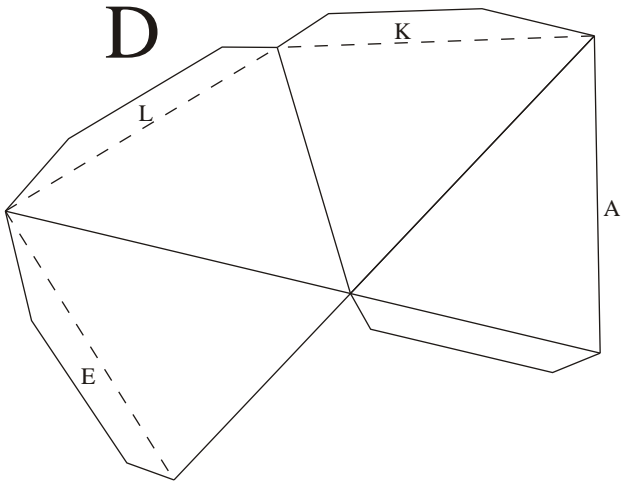

Compound of five Octahedra

Color 5

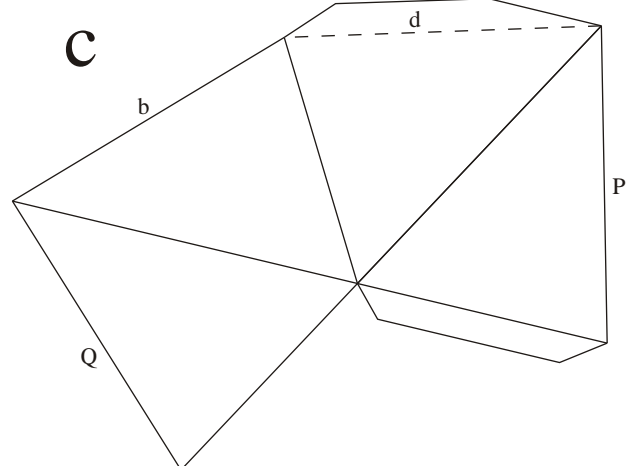
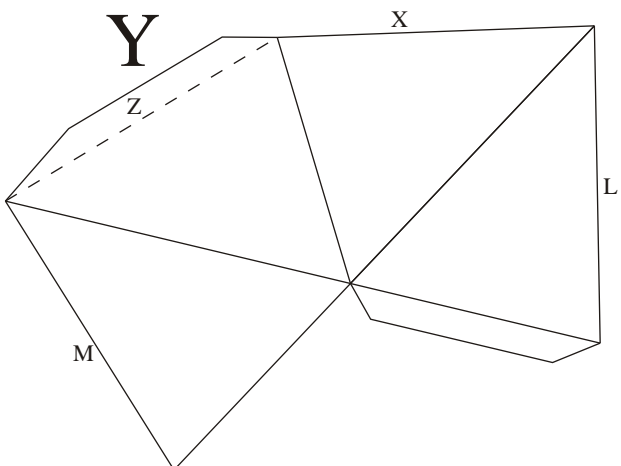
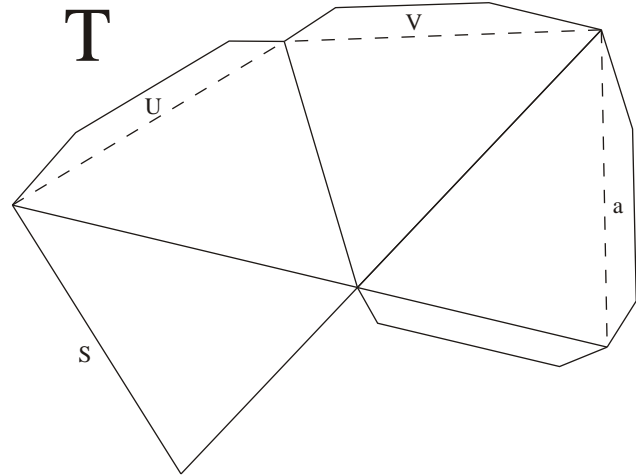
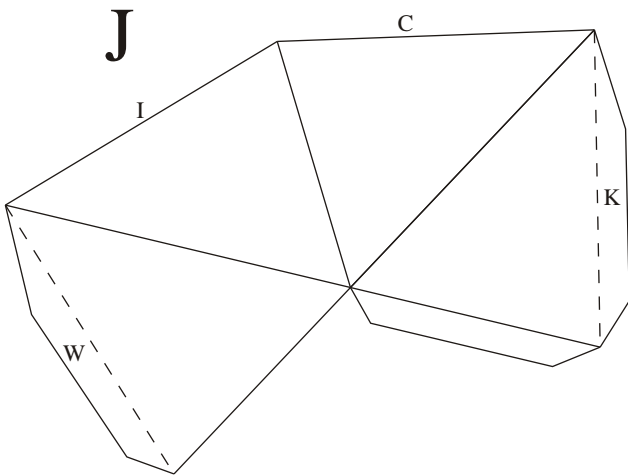
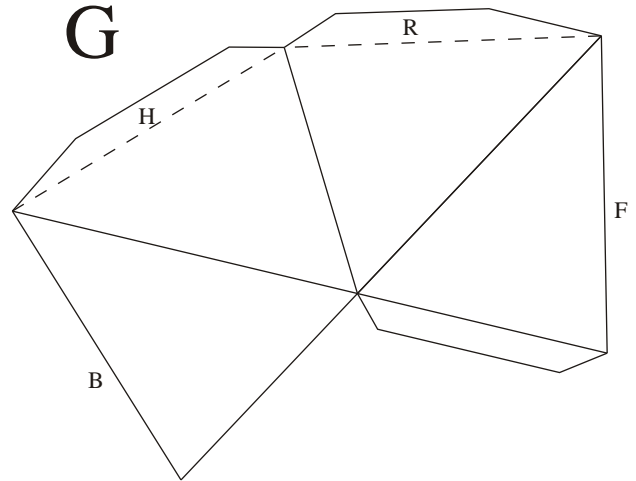
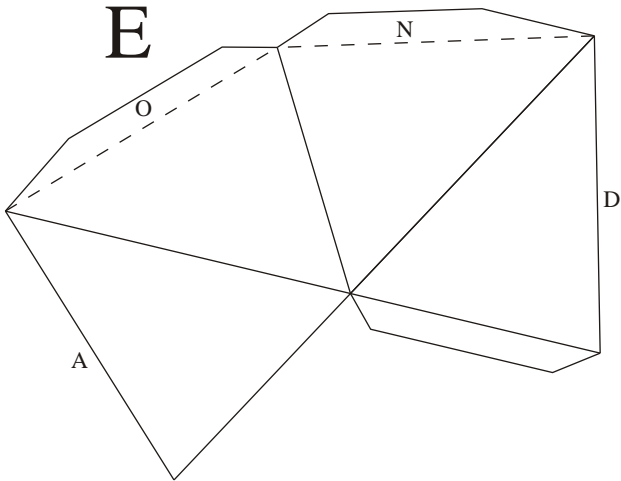

Pyramids

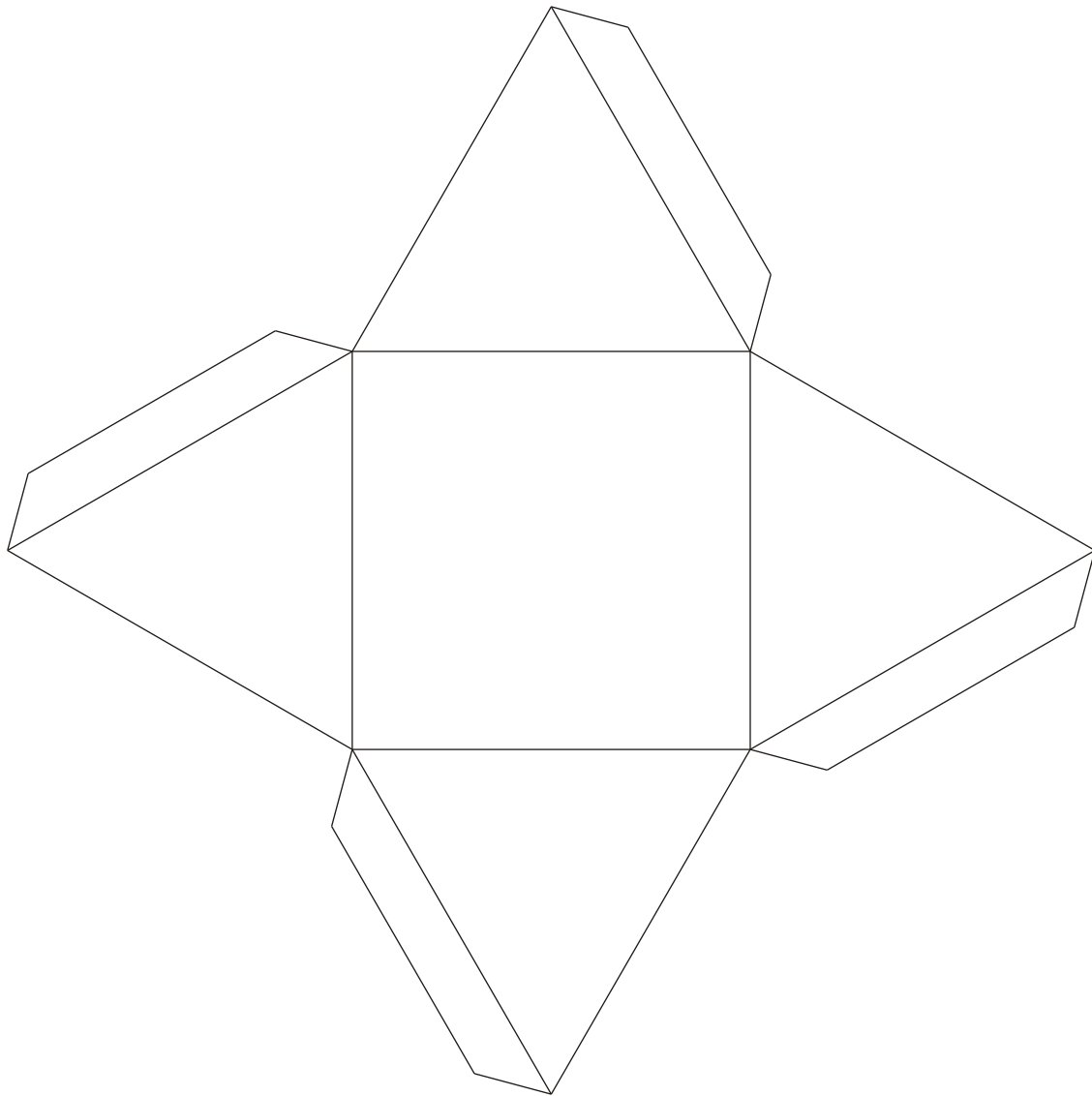
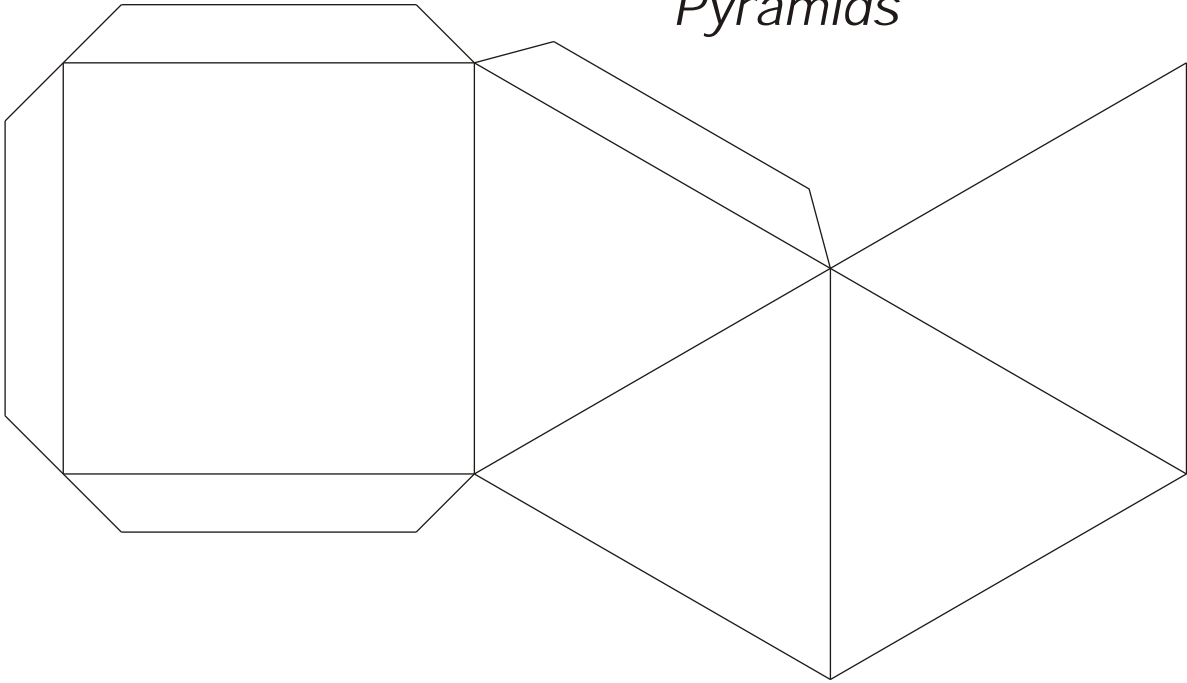

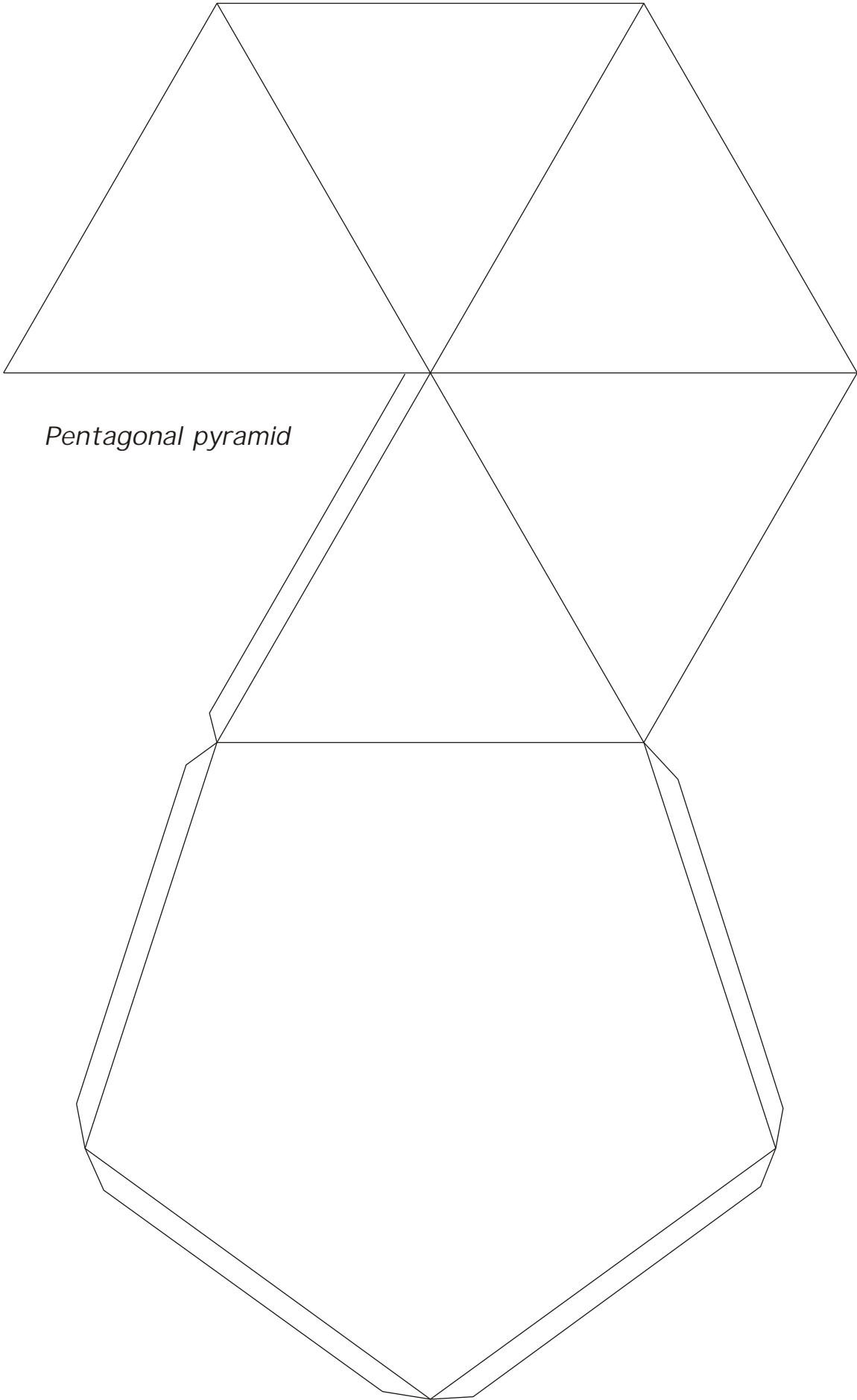

Pentagonal pyramid

Decahedron

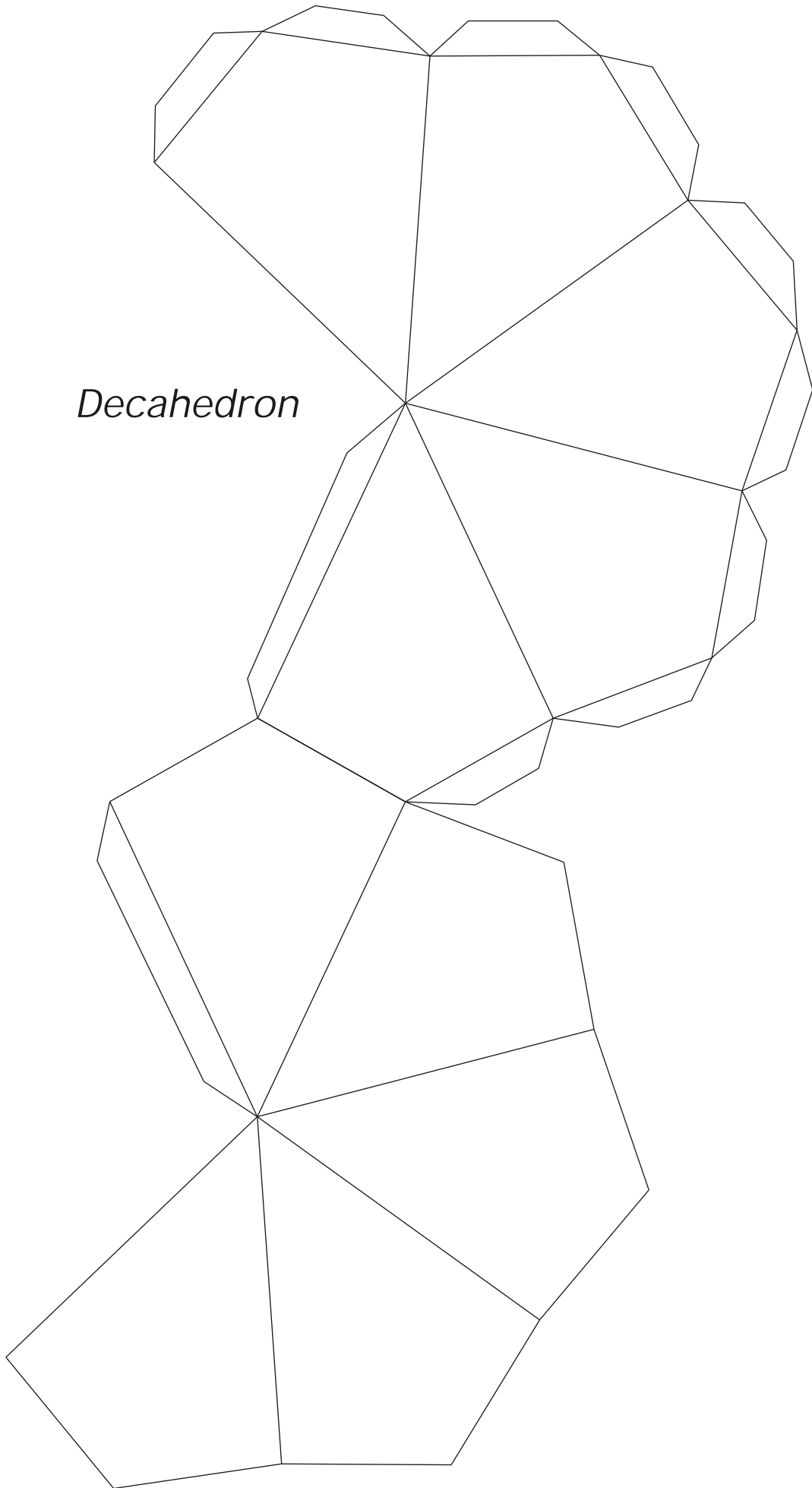

Rhombic Dodecahedron

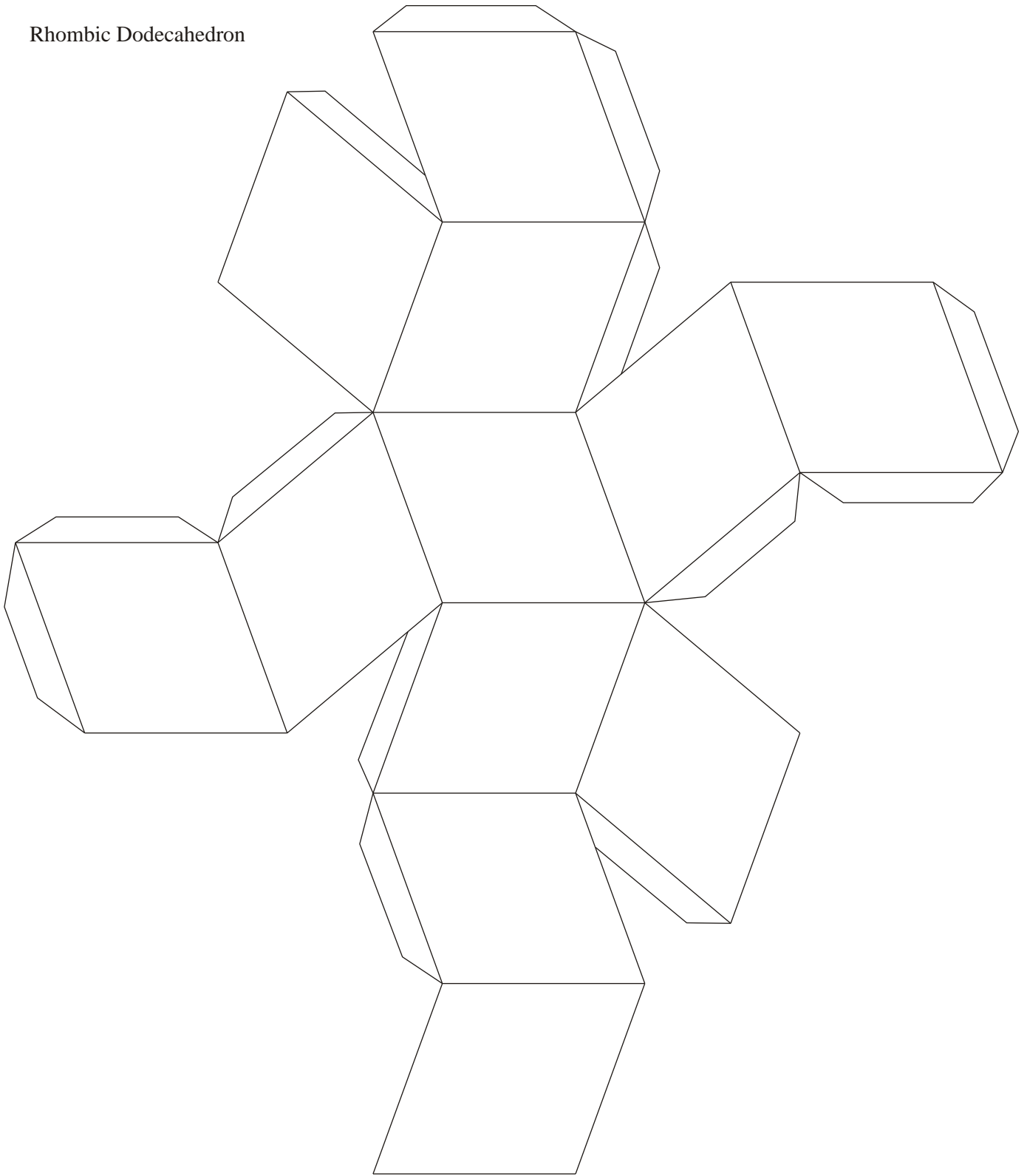

Great Rhombihexacron

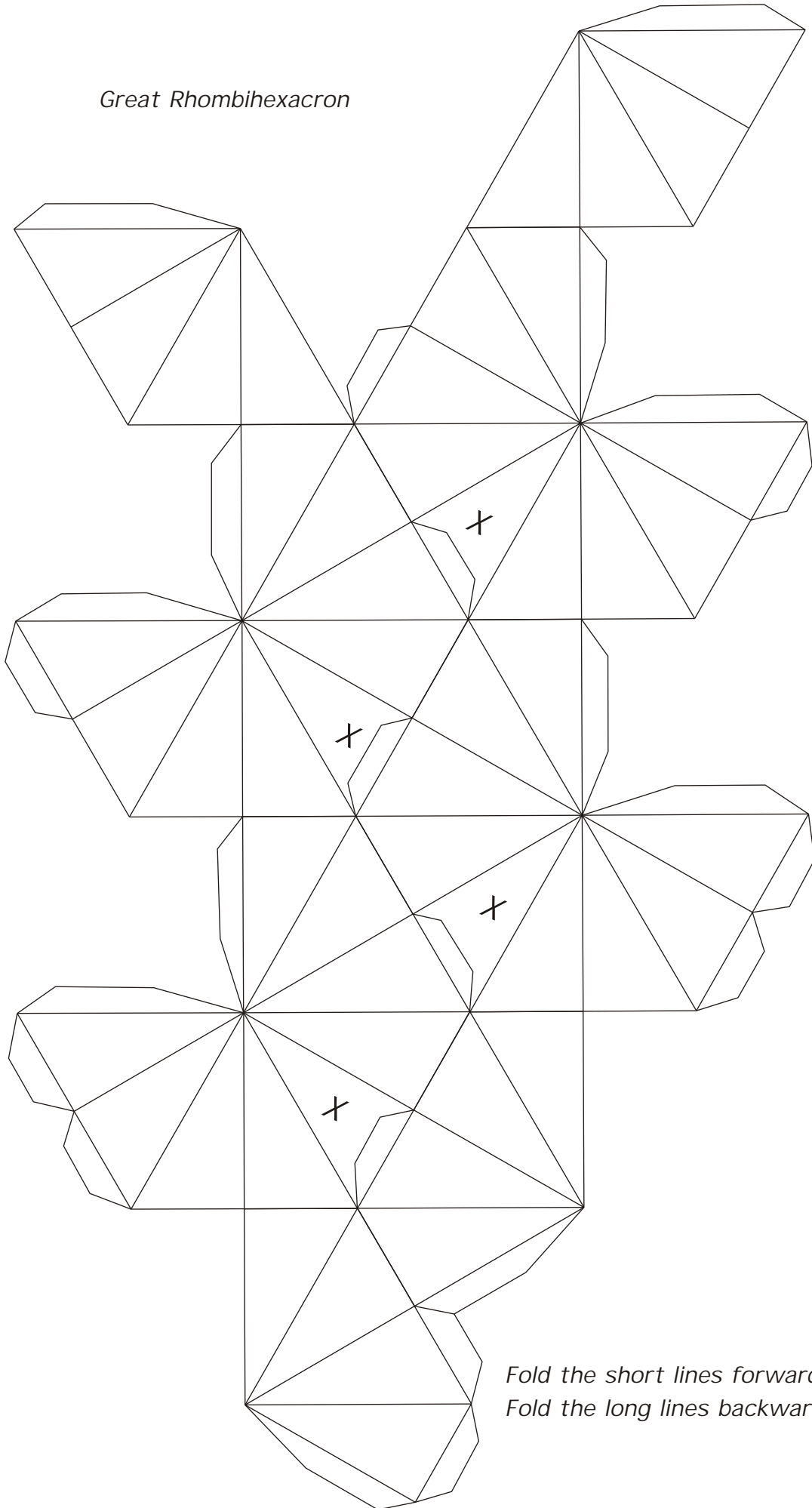

*Fold the short lines forwards
Fold the long lines backwards*

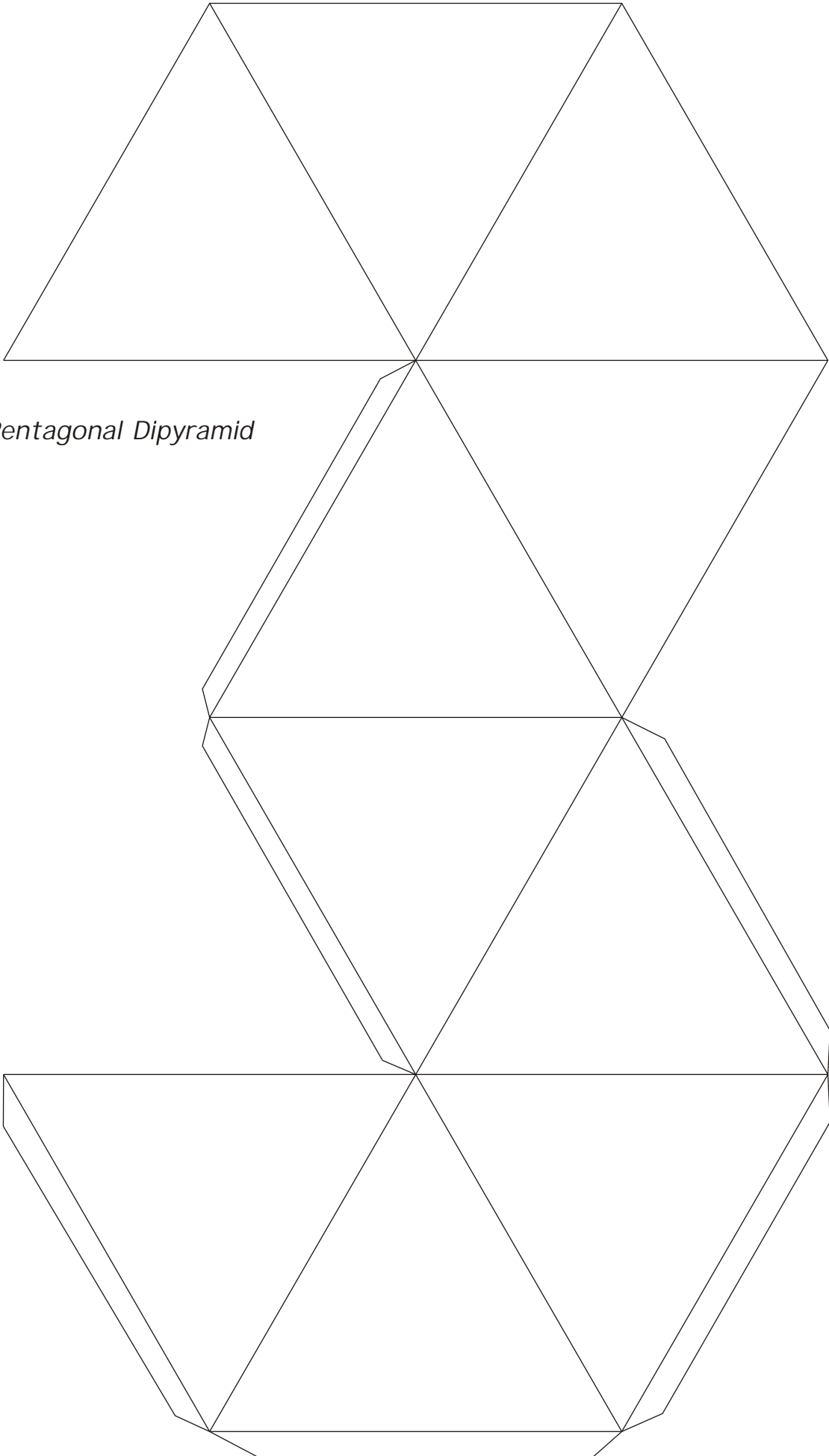

Pentagonal Dipyramid

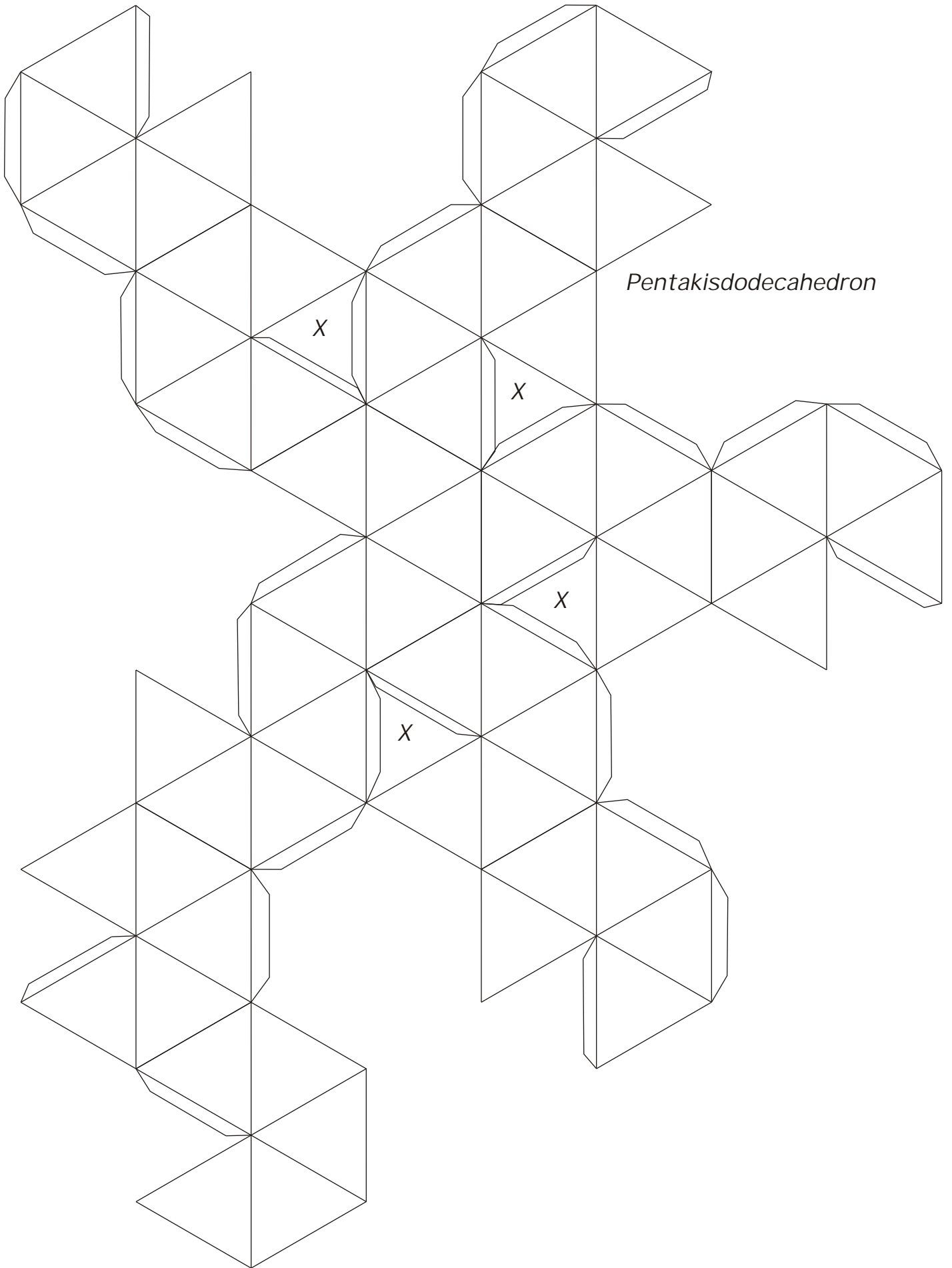

Pentakisdodecahedron

X

X

X

X

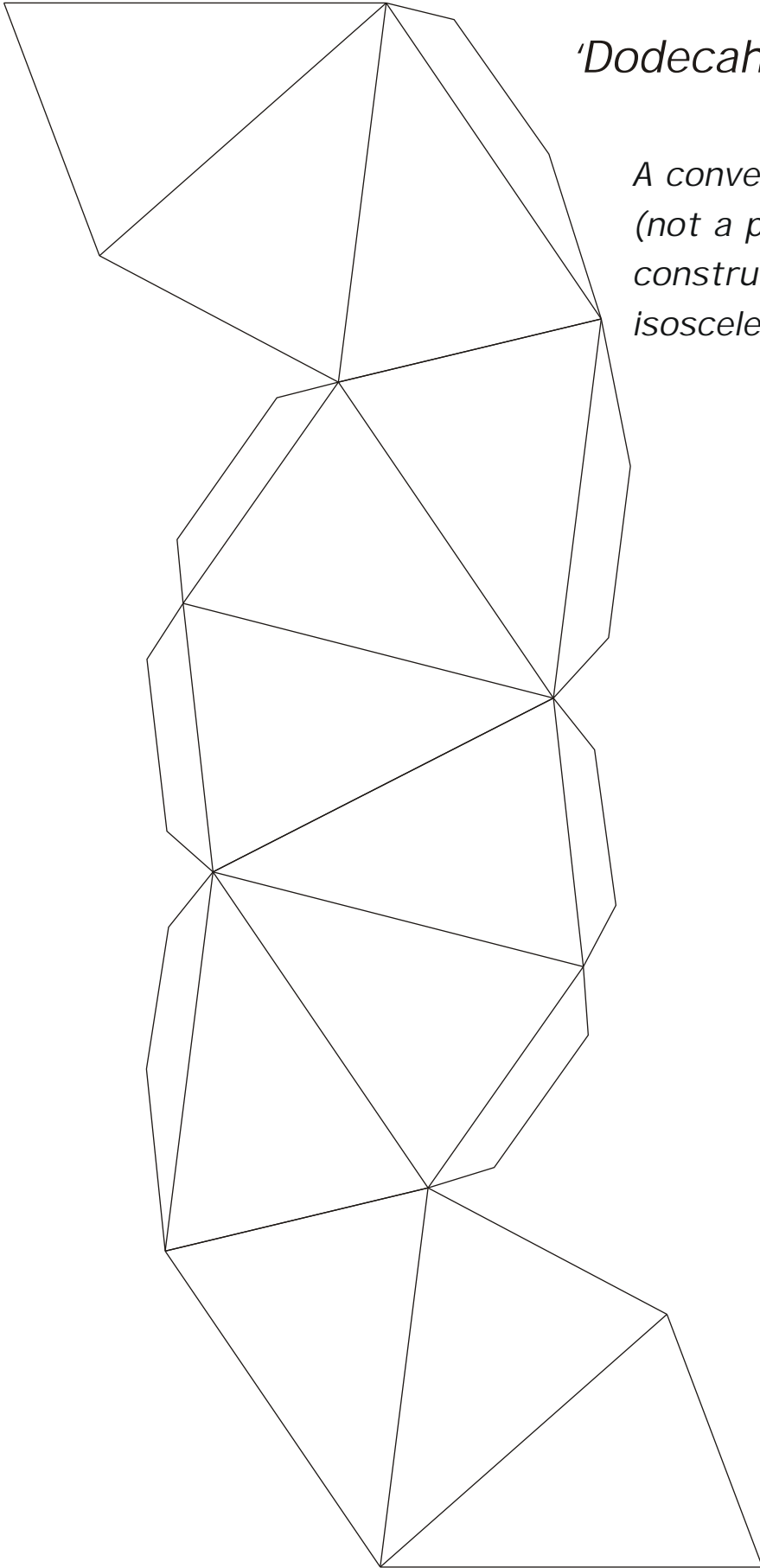

'Dodecahedron'

*A convex dodecahedron
(not a platonic solid)
constructed of 12
isosceles triangles*

Hexakaidecahedron

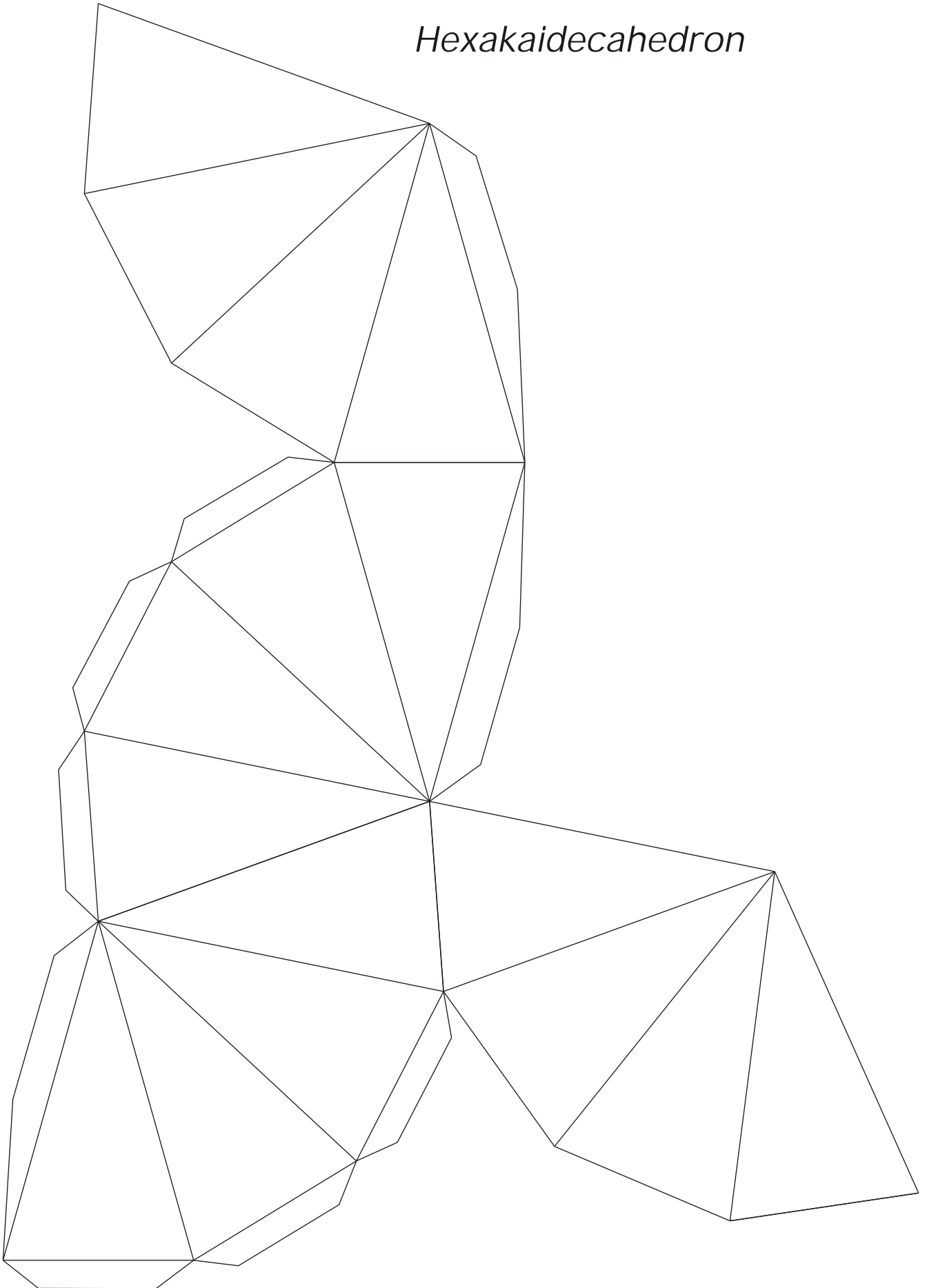

'Icosahedron'

A convex icosahedron
(not a platonic solid)
constructed of 20
isosceles triangles

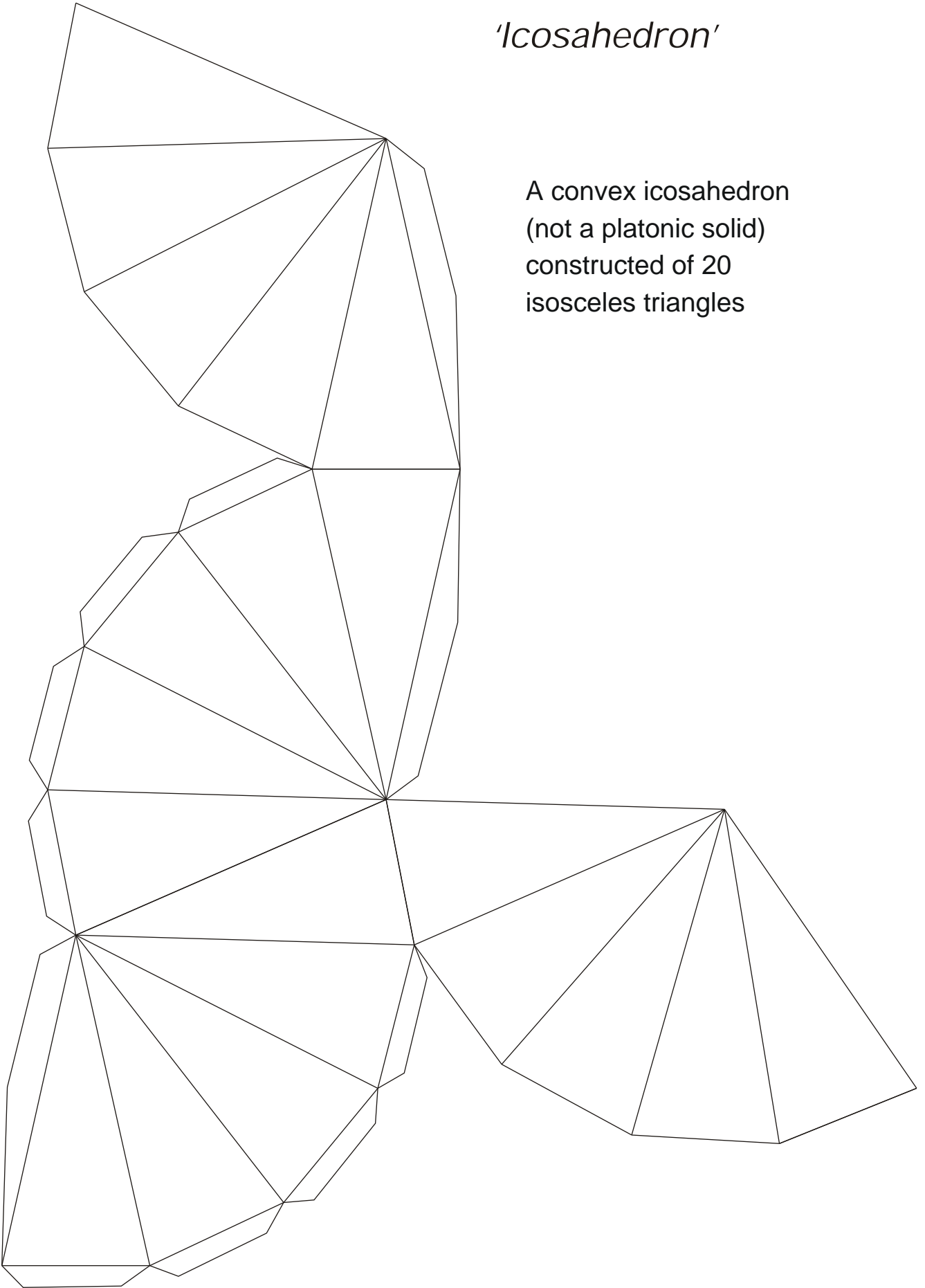

Icositetrahedron

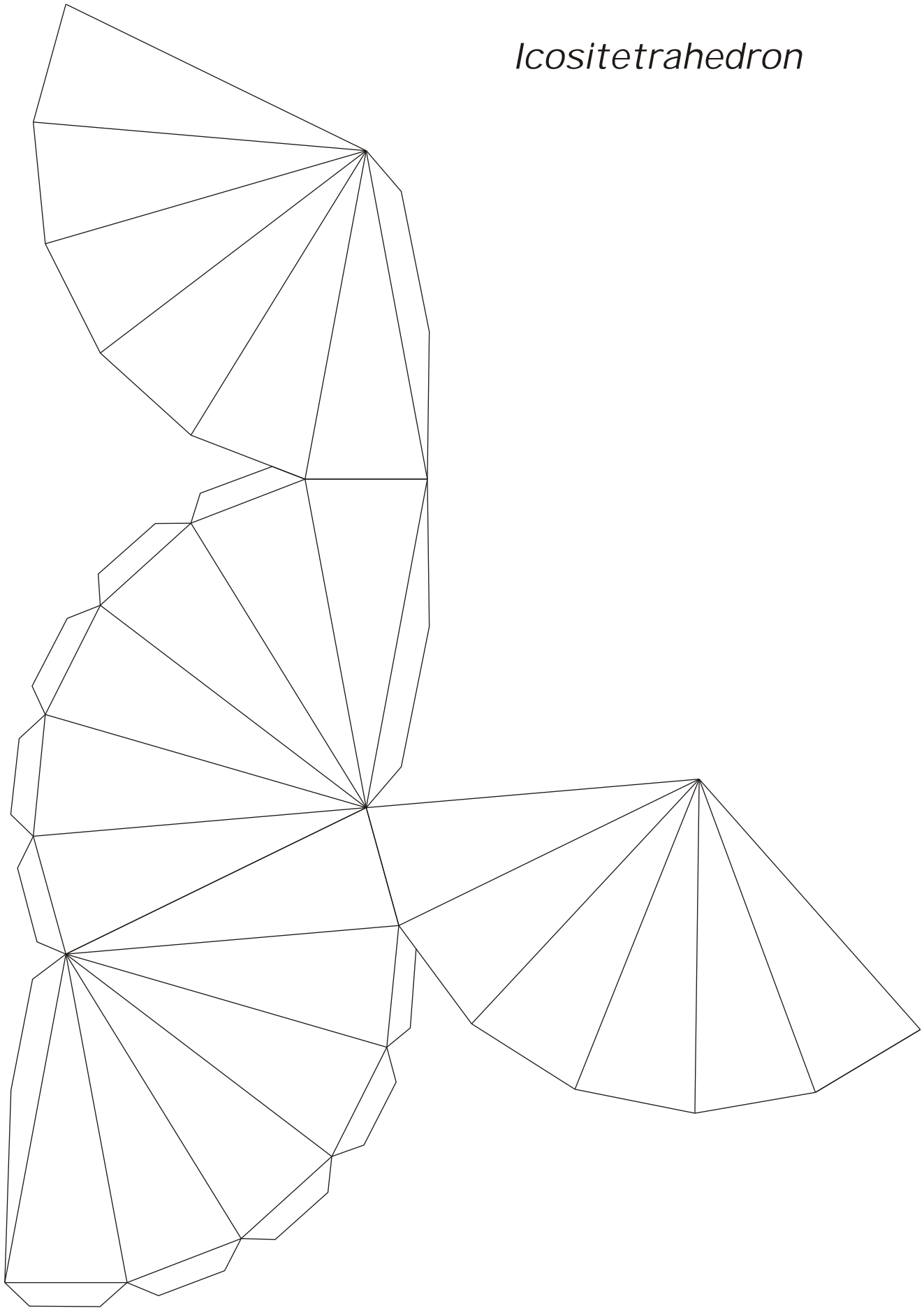

Icosioctahedron

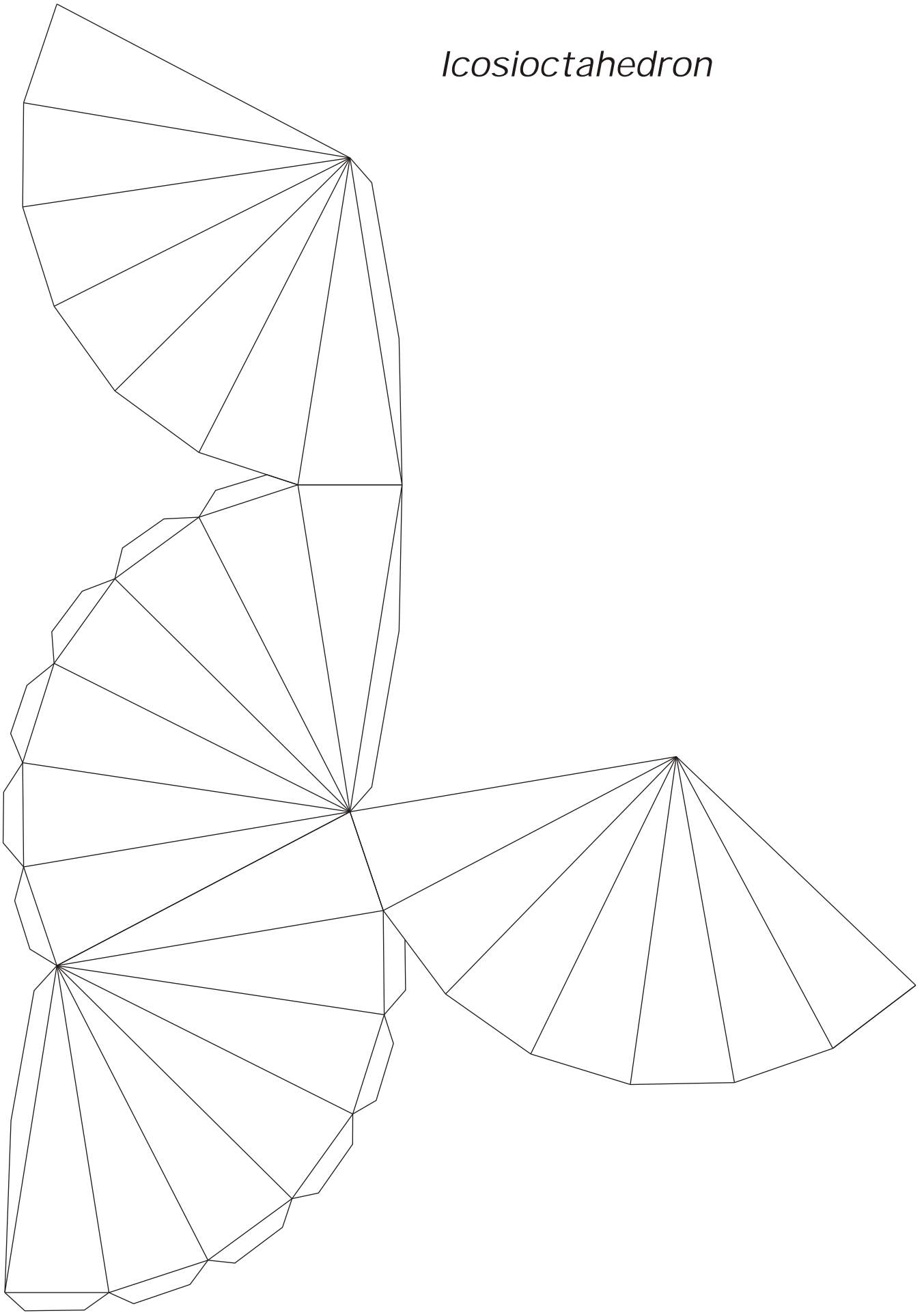

Tricontidihedron

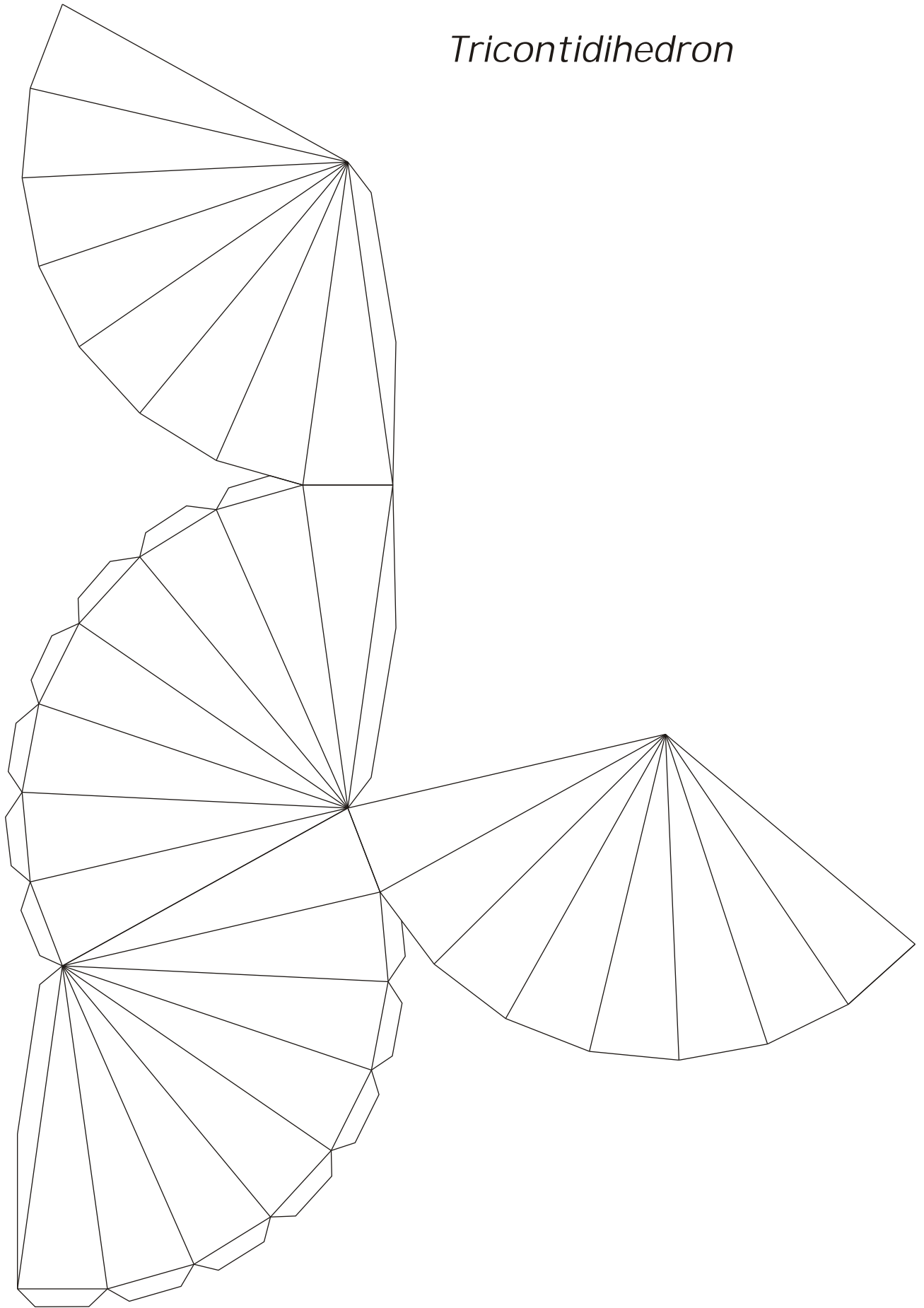

Tricontihexahedron

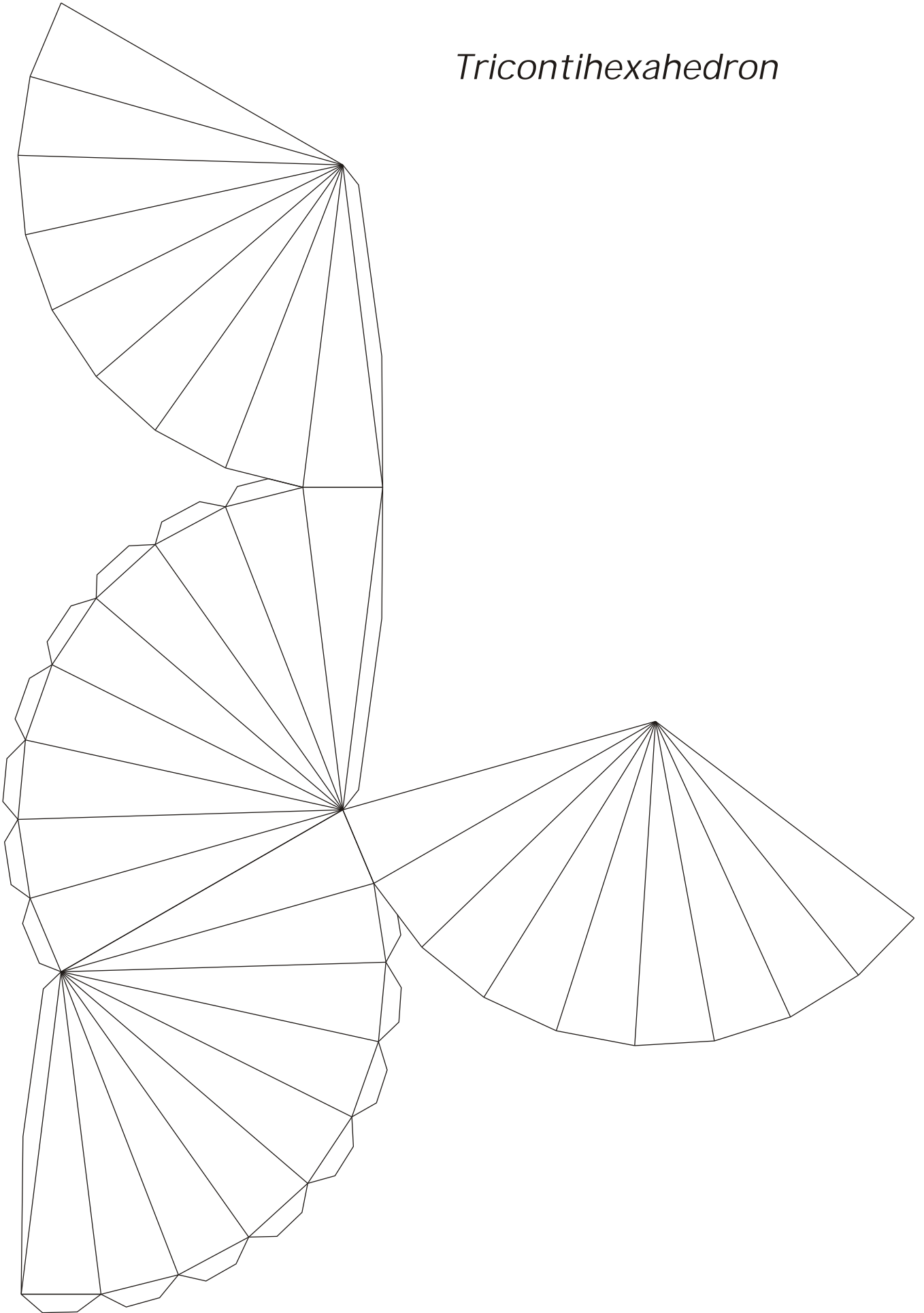

Tetracontahedron

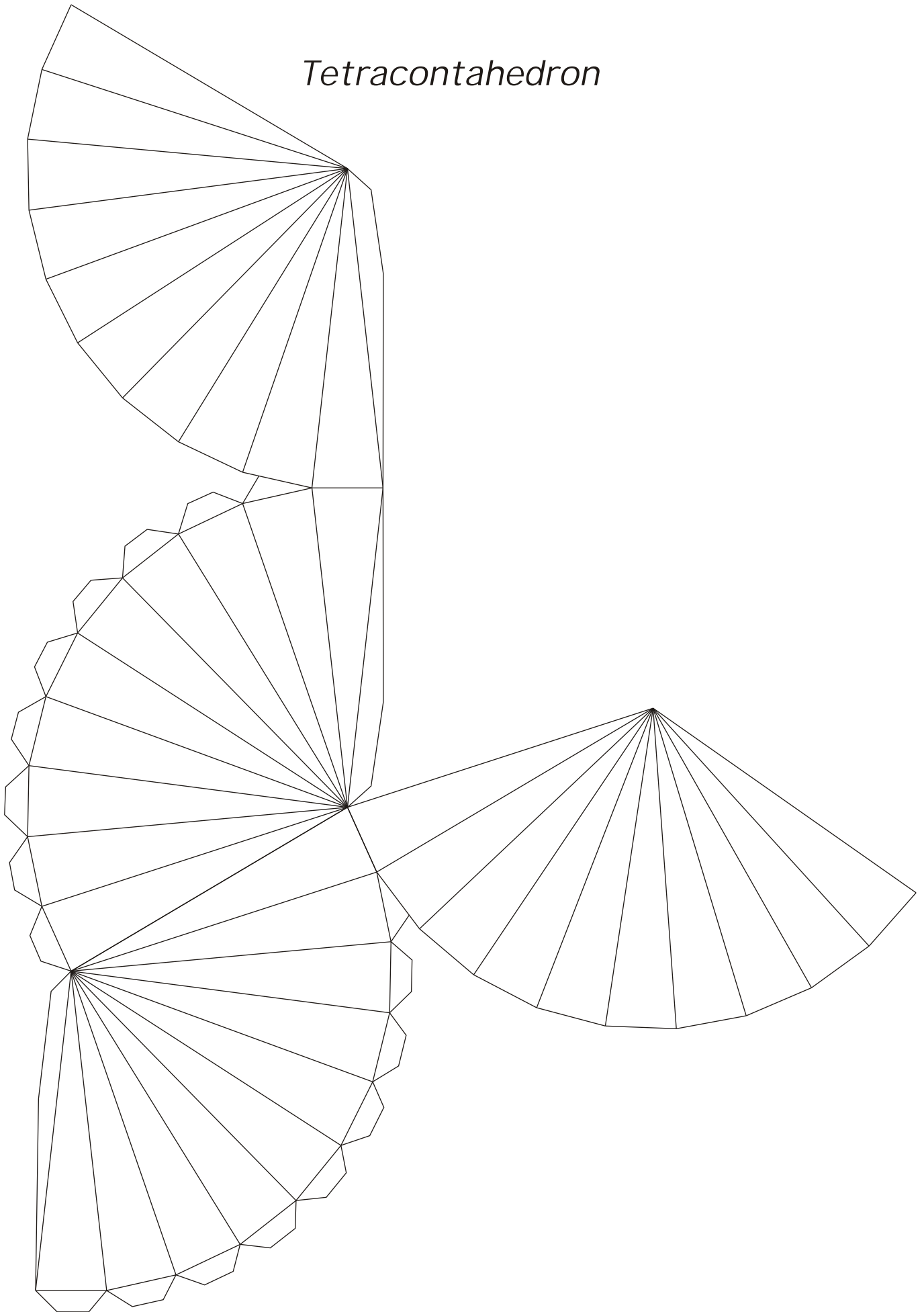

Hecatohedron

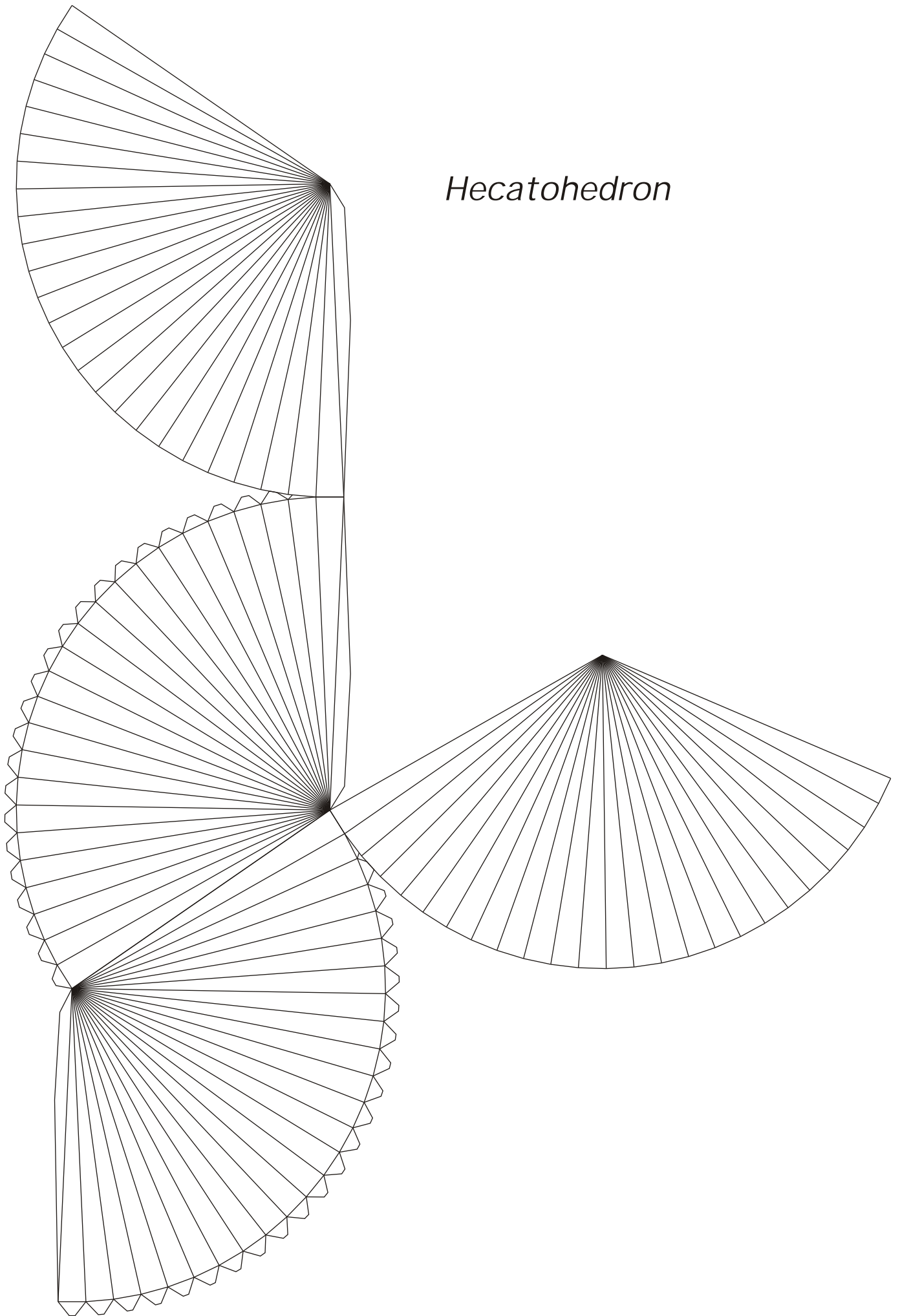

Third Stallation of the Icosahedron

Fold the dotted lines forwards
Fold the other lines backwards

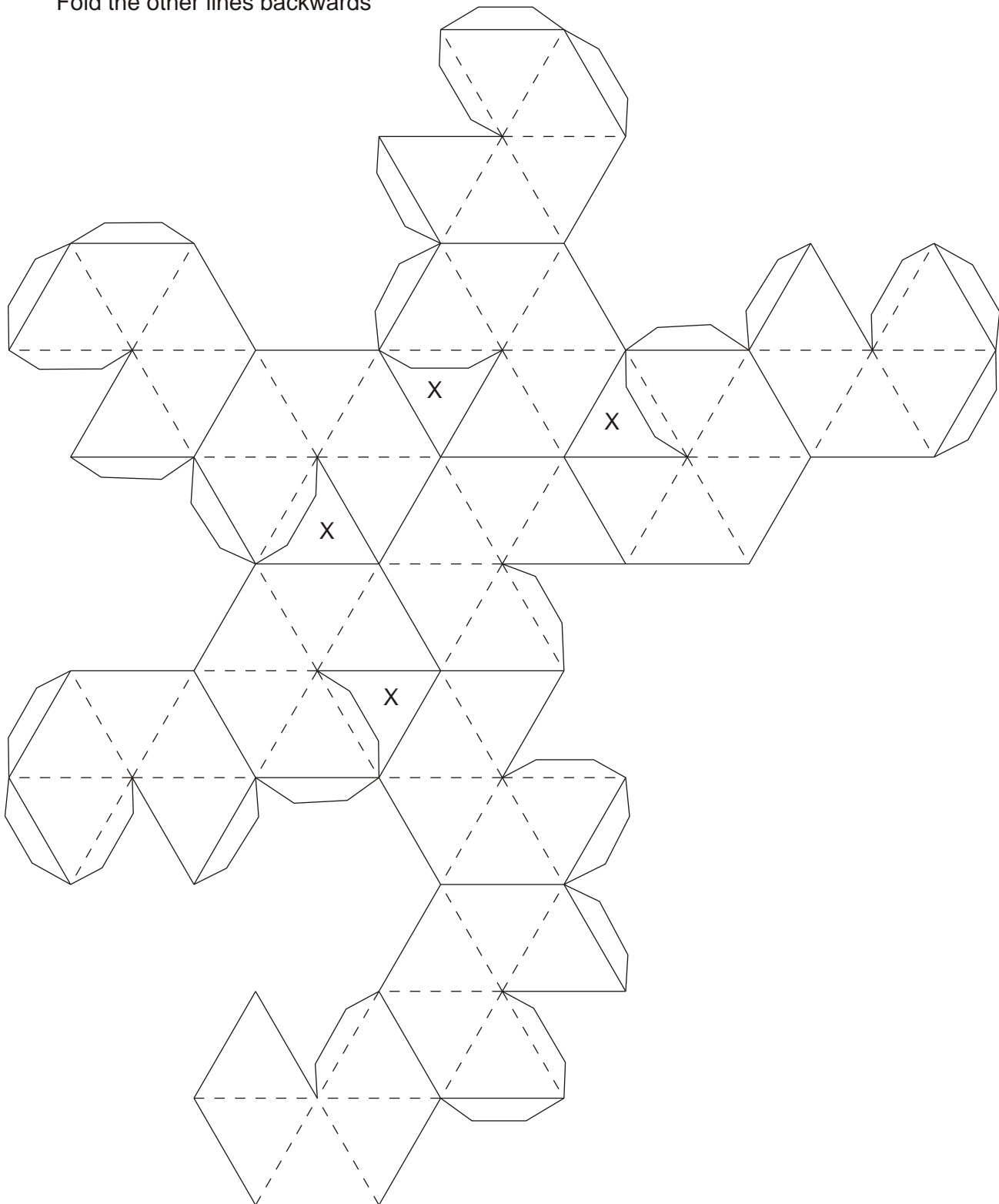

Third Stellation of the Icosahedron

Fold the dotted lines forwards
Fold the other lines backwards

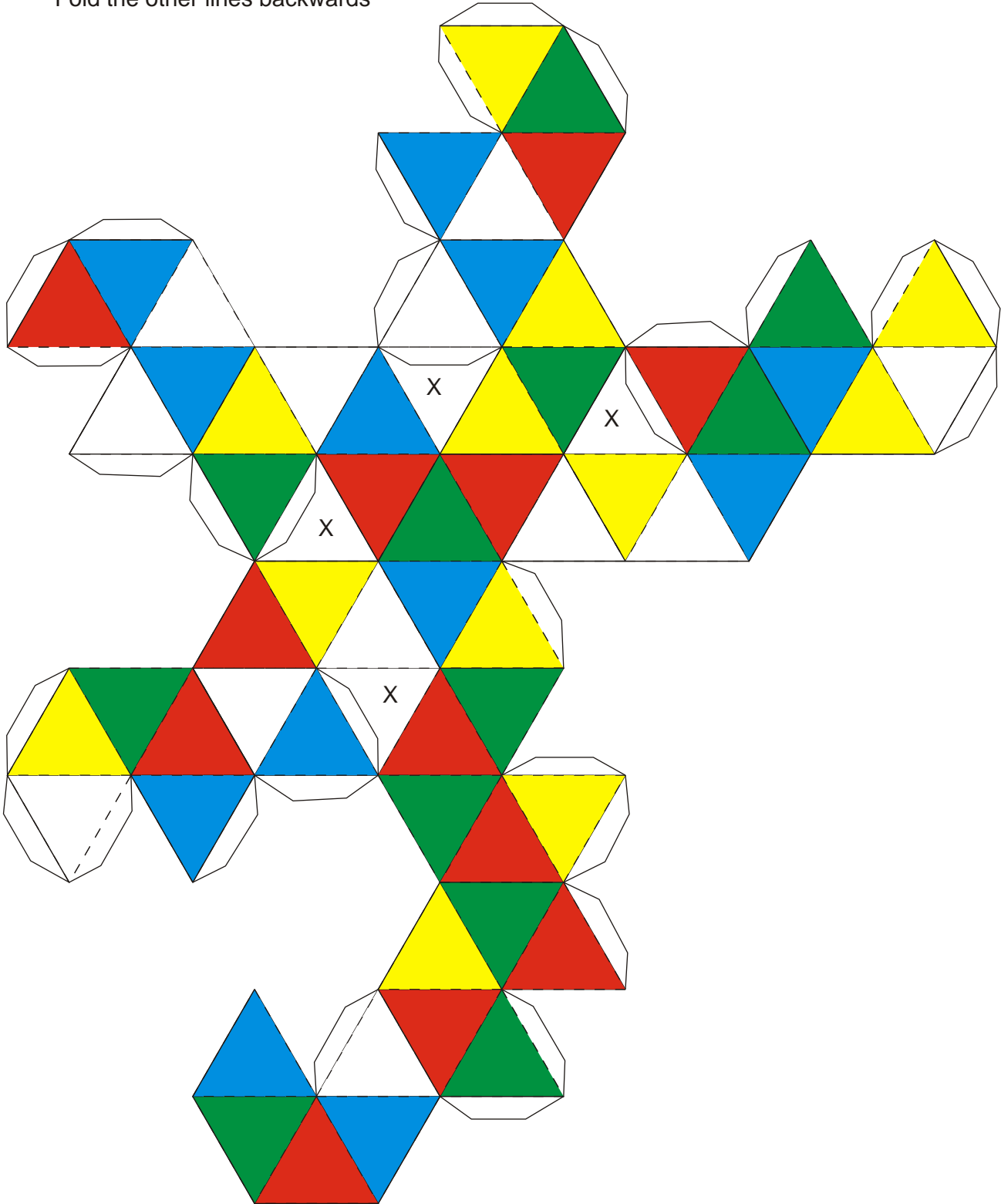

Sixth Stallation of the Icosahedron

(small version)

Fold the dotted lines forwards

Fold the other lines backwards

First glue part A

Glue the parts A-M on A

Part A:

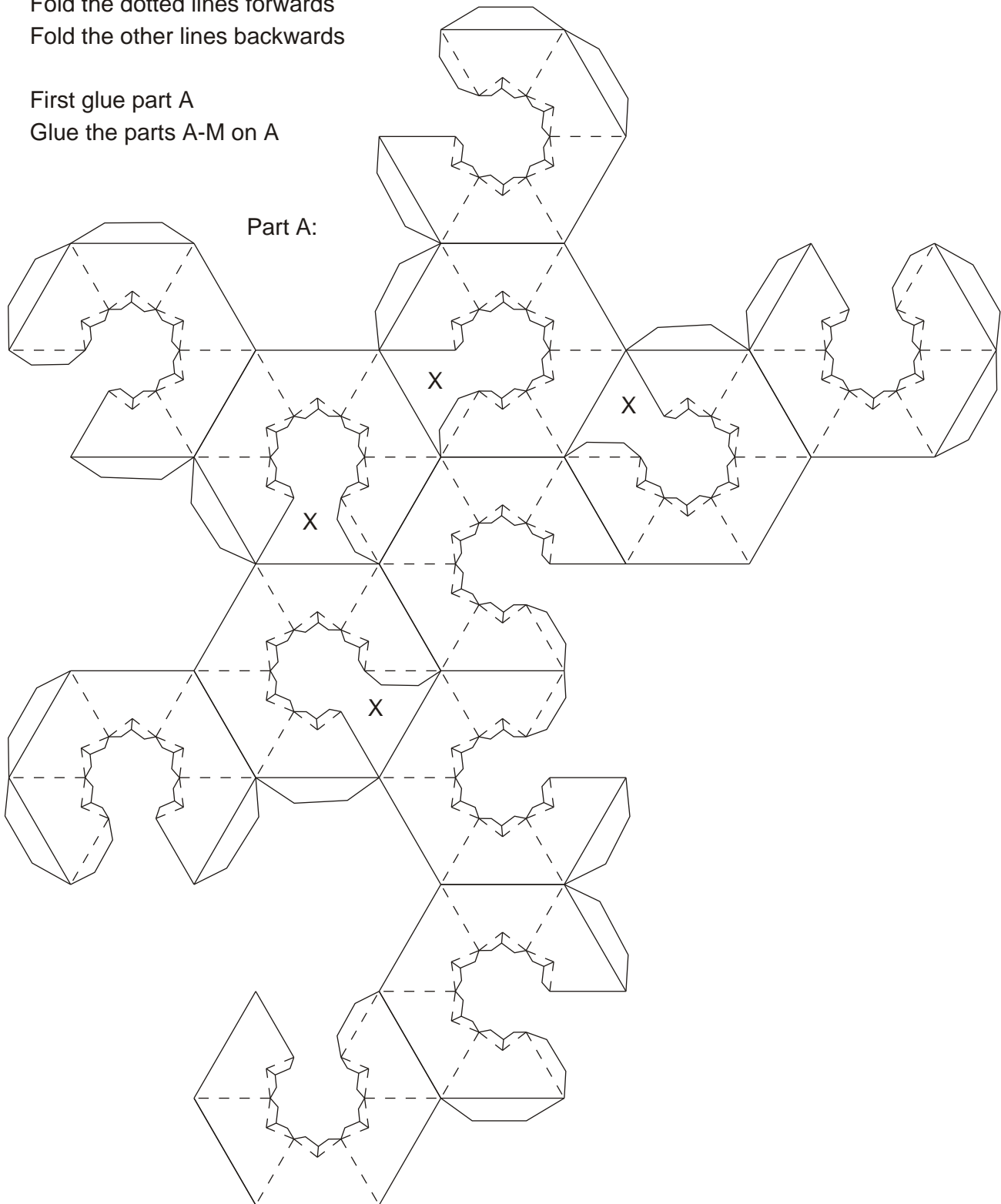

Parts B-M

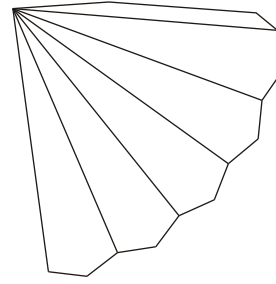
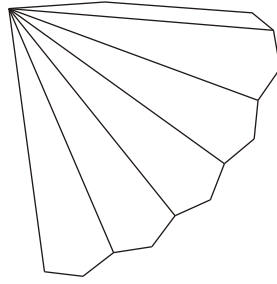
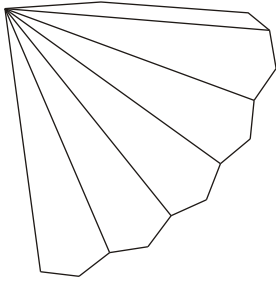
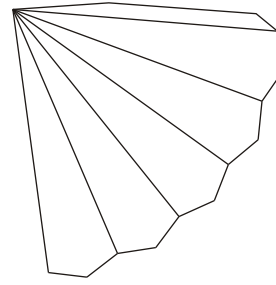
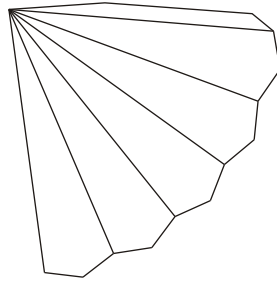
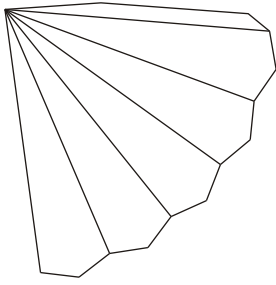
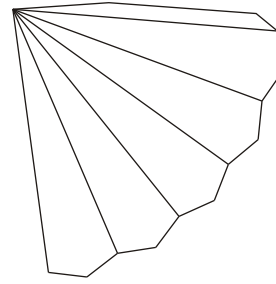
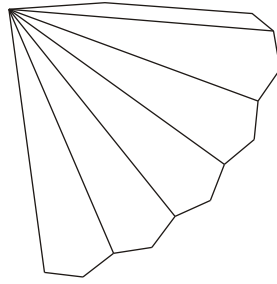
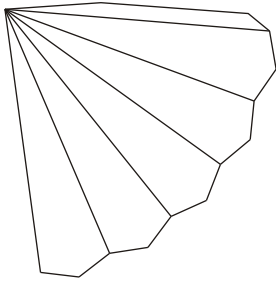
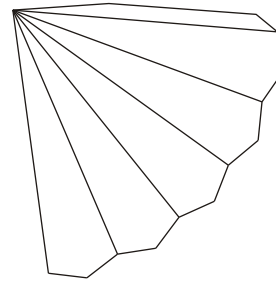
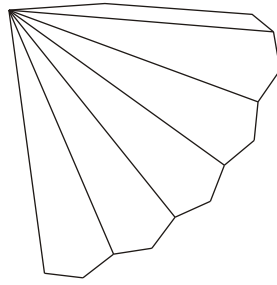
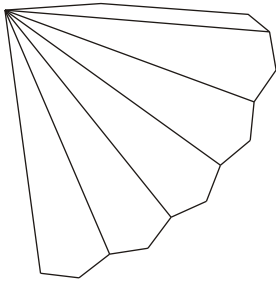

Sixth Stellation of the Icosahedron (large version)

First glue the parts A until F

Glue the 12 other parts on the ABCDEF

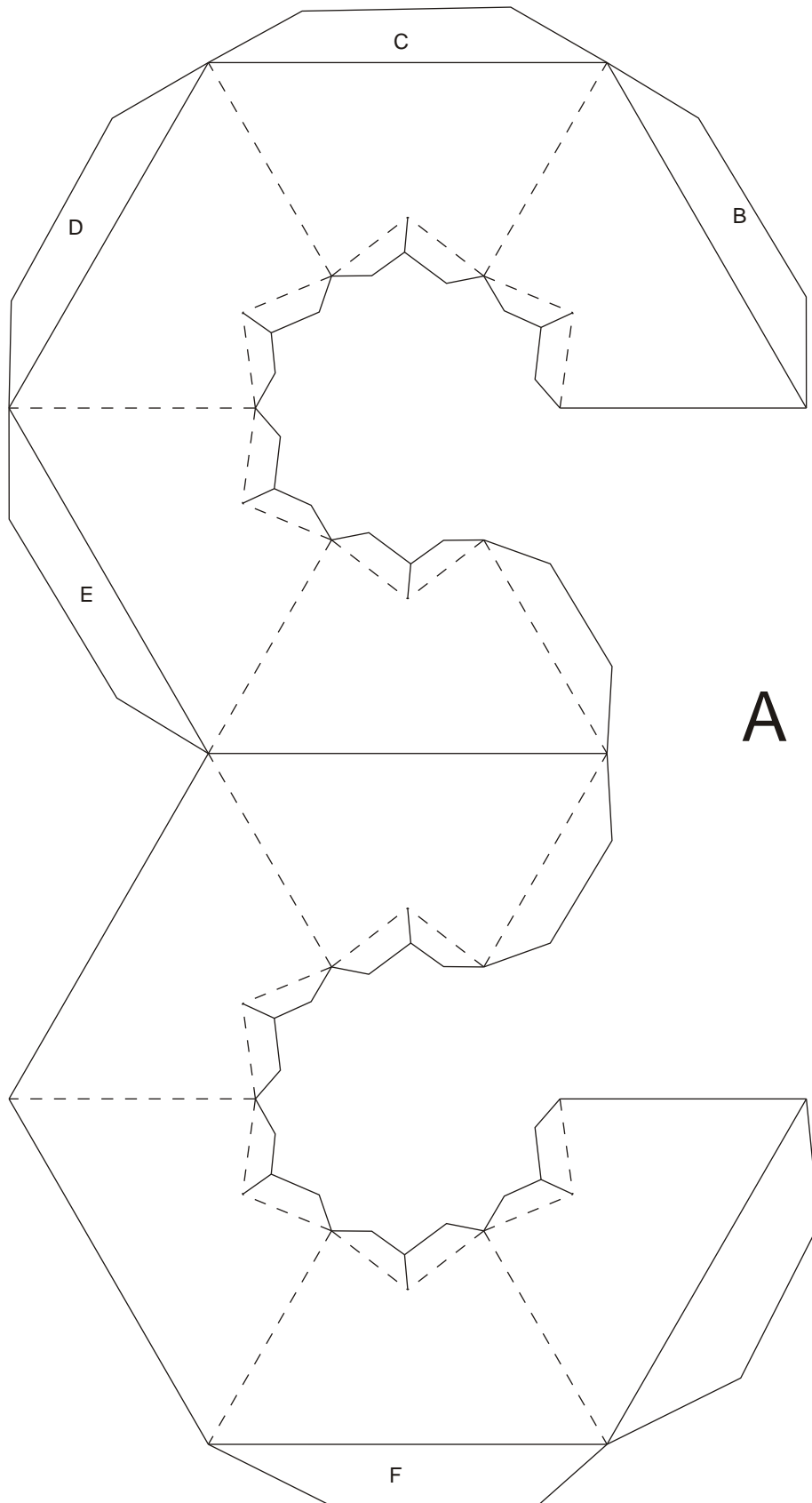

Sixth Stellation of the Icosahedron (large version)

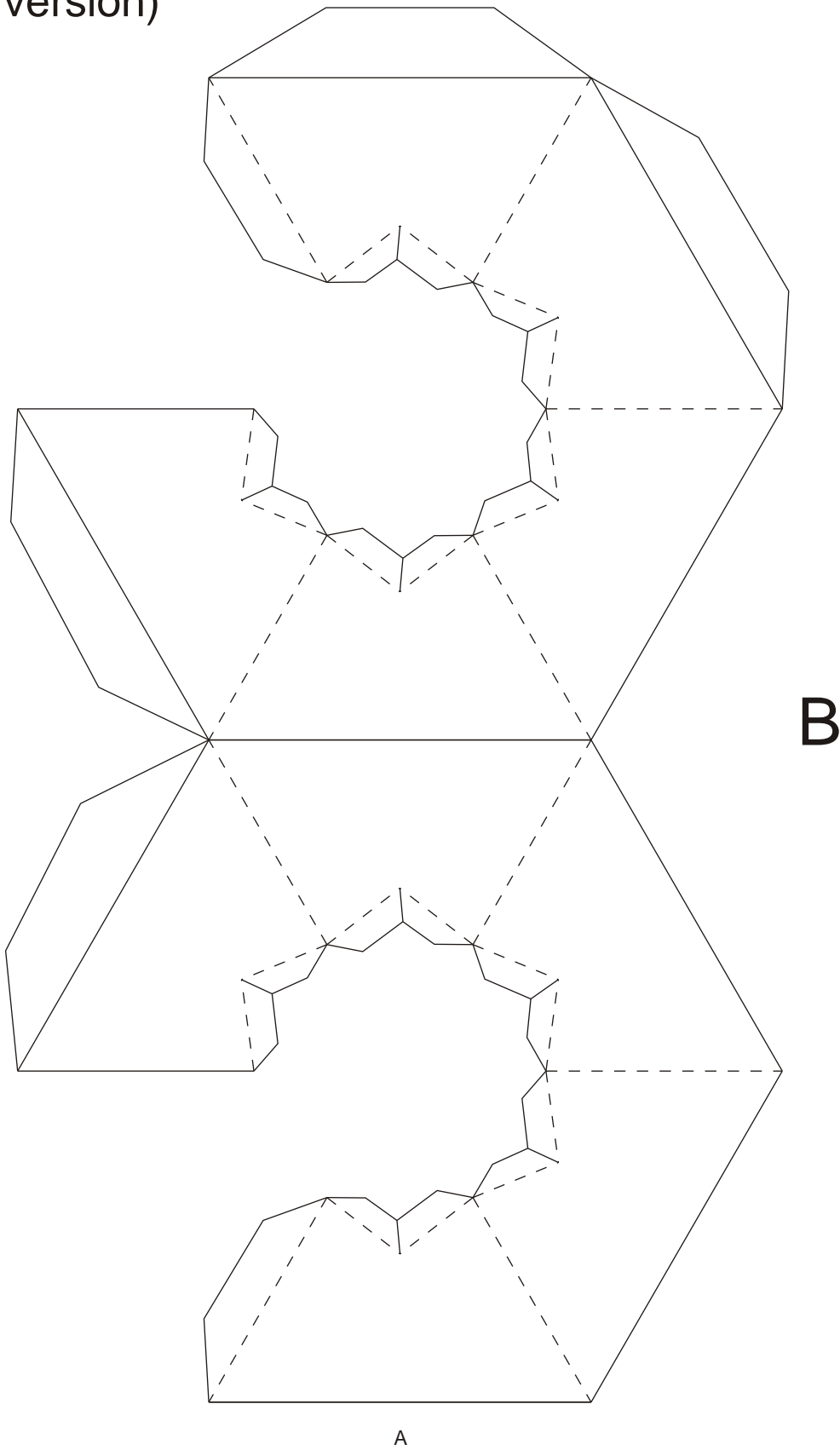

Sixth Stellation of the Icosahedron (large version)

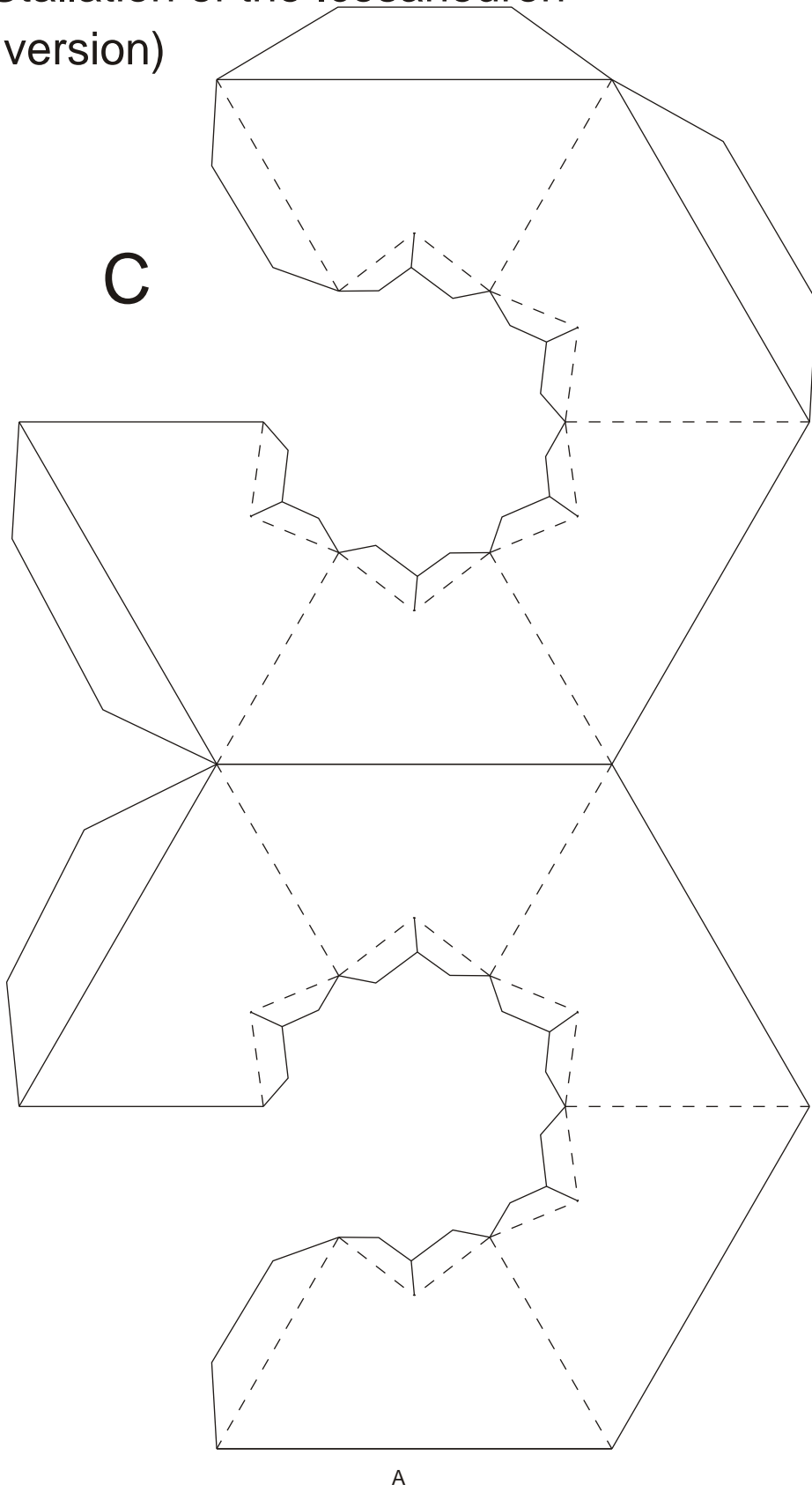

Sixth Stellation of the Icosahedron
(large version)

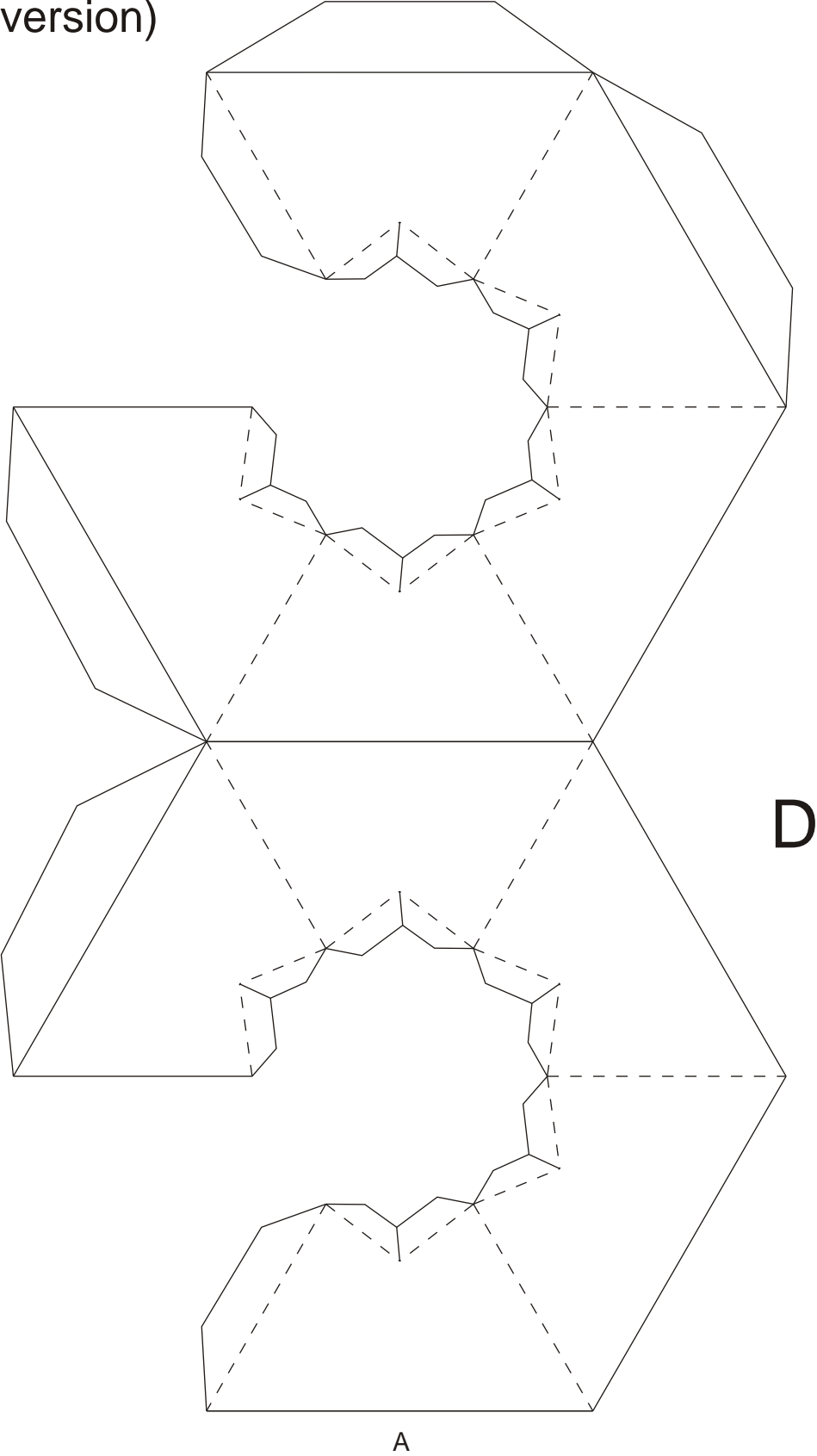

Sixth Stellation of the Icosahedron (large version)

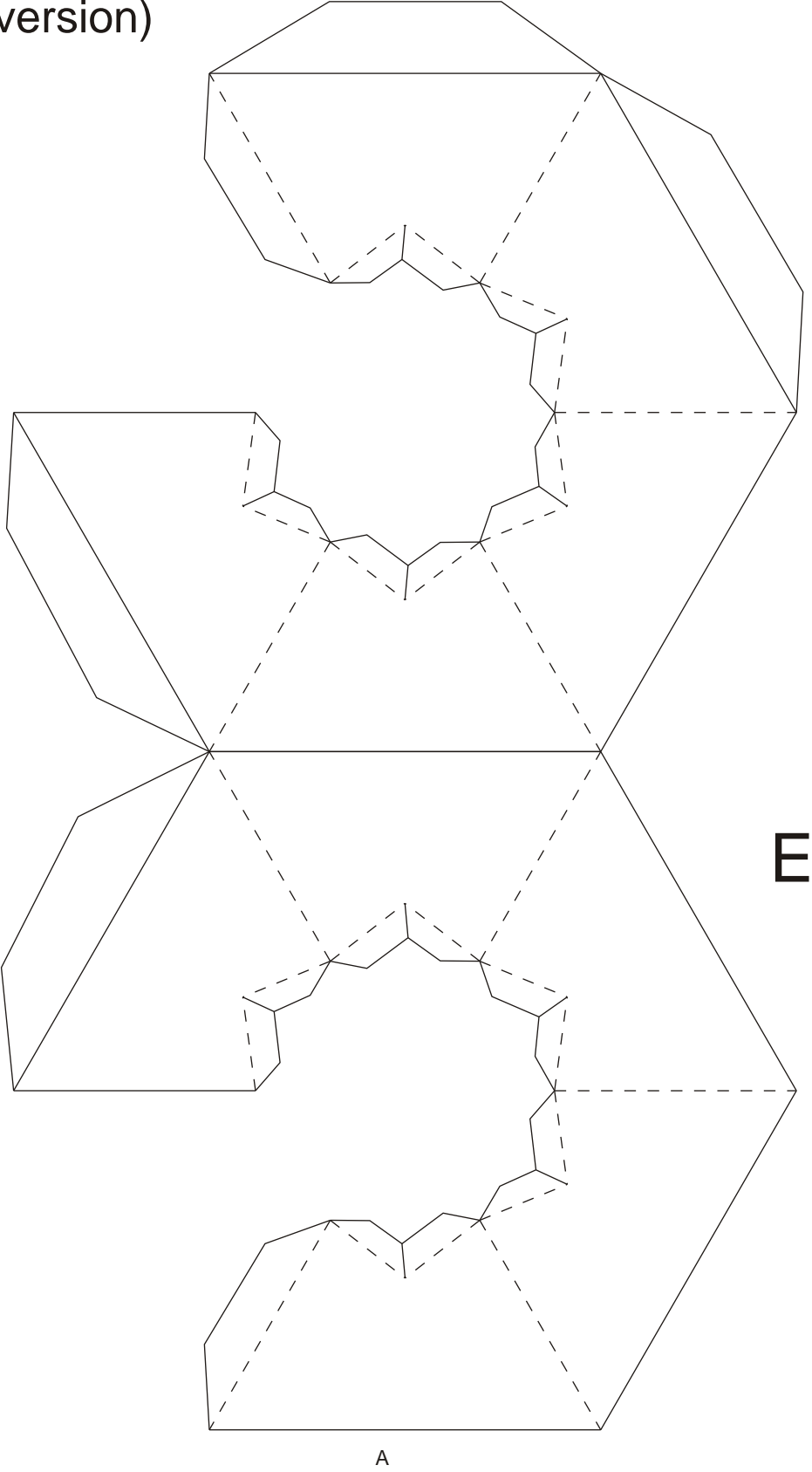

Sixth Stellation of the Icosahedron (large version)

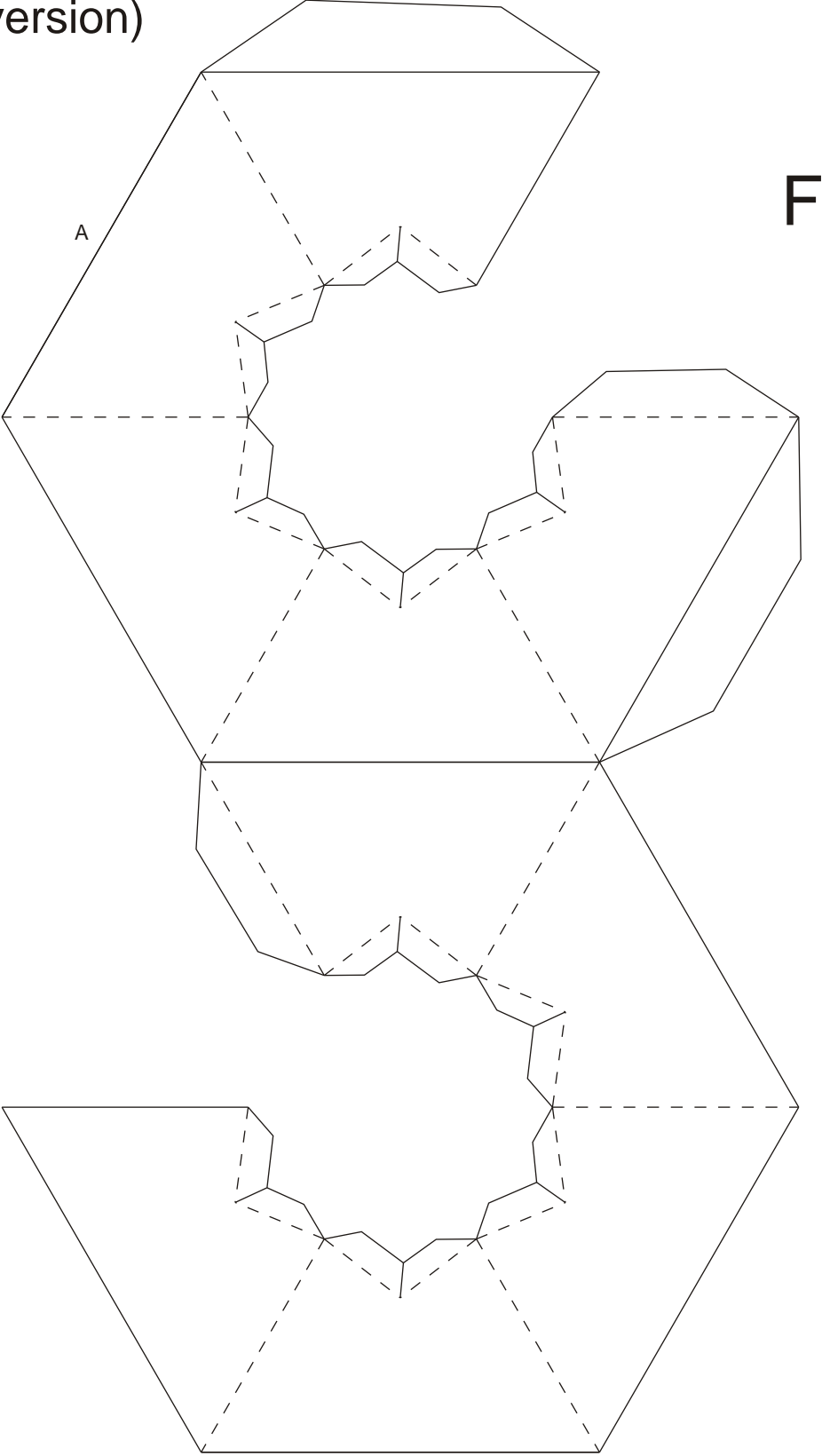

Sixth Stallation of the Icosahedron

(large)

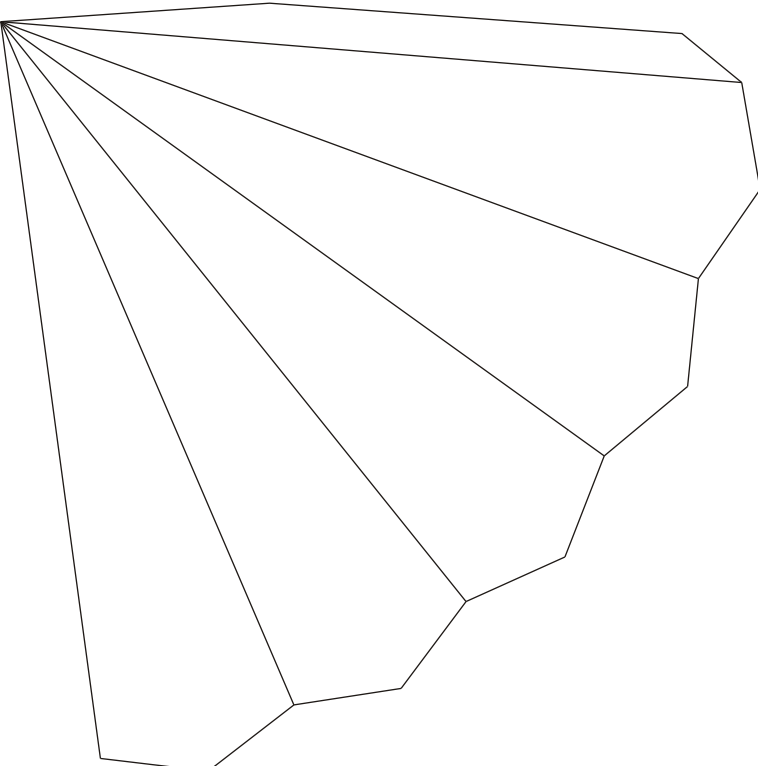
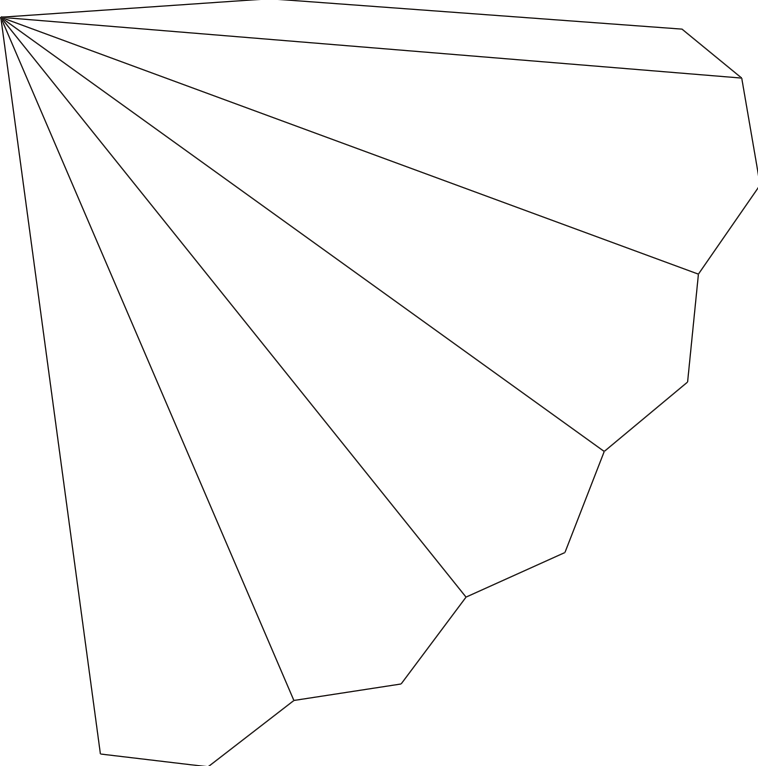

Sixth Stallation of the Icosahedron

(large)

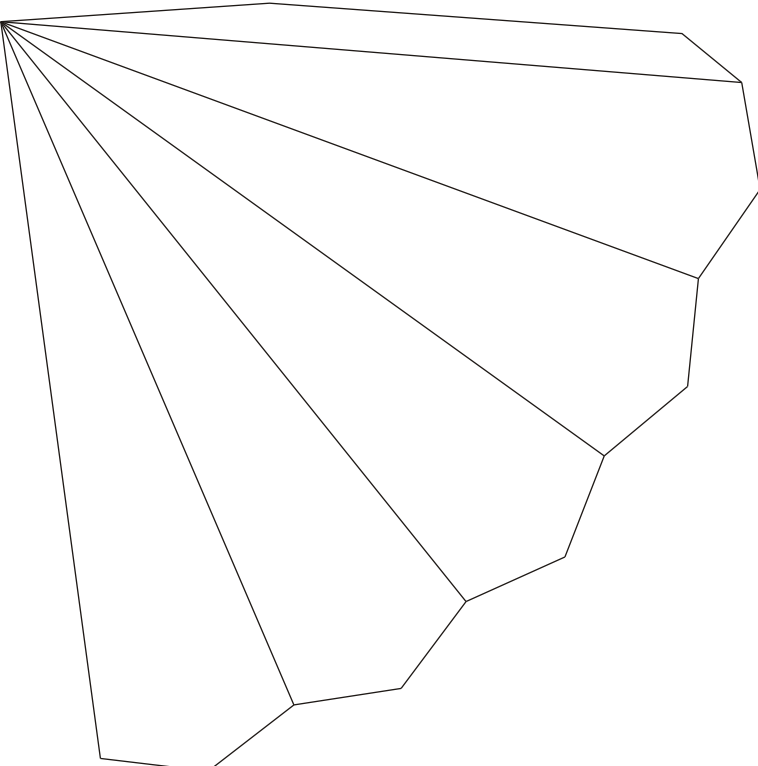
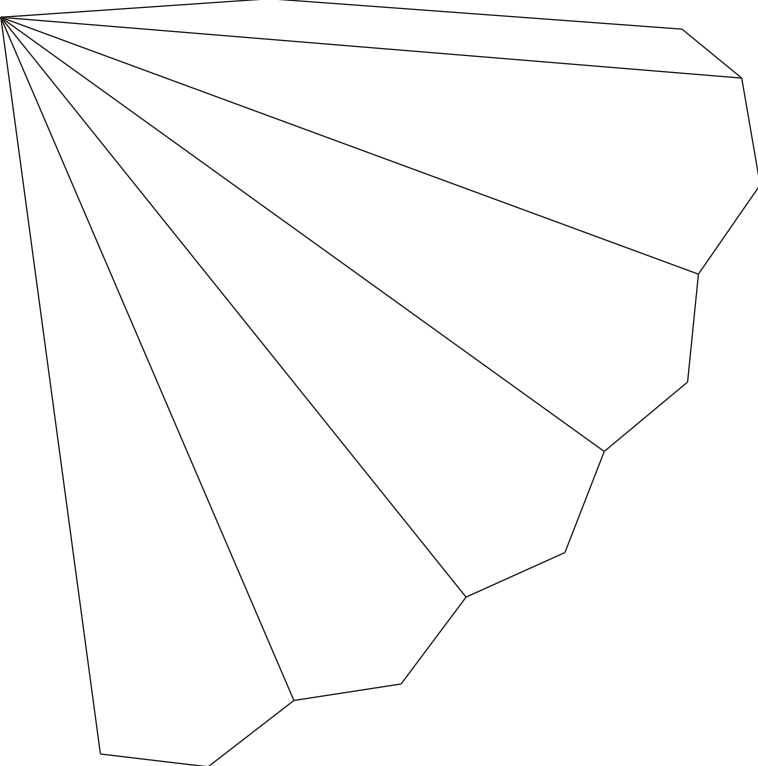

Sixth Stallation of the Icosahedron

(large)

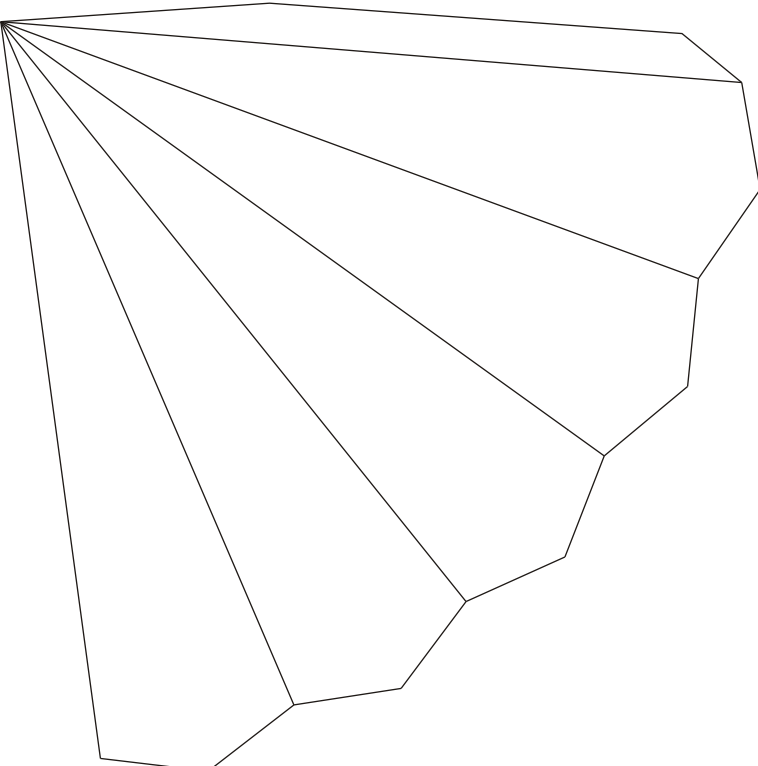
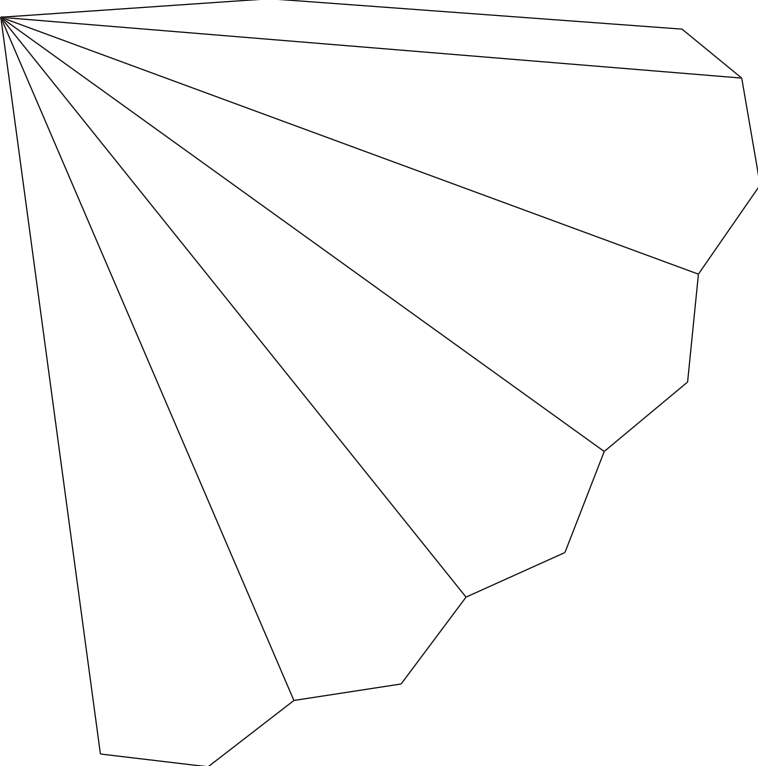

Sixth Stallation of the Icosahedron

(large)

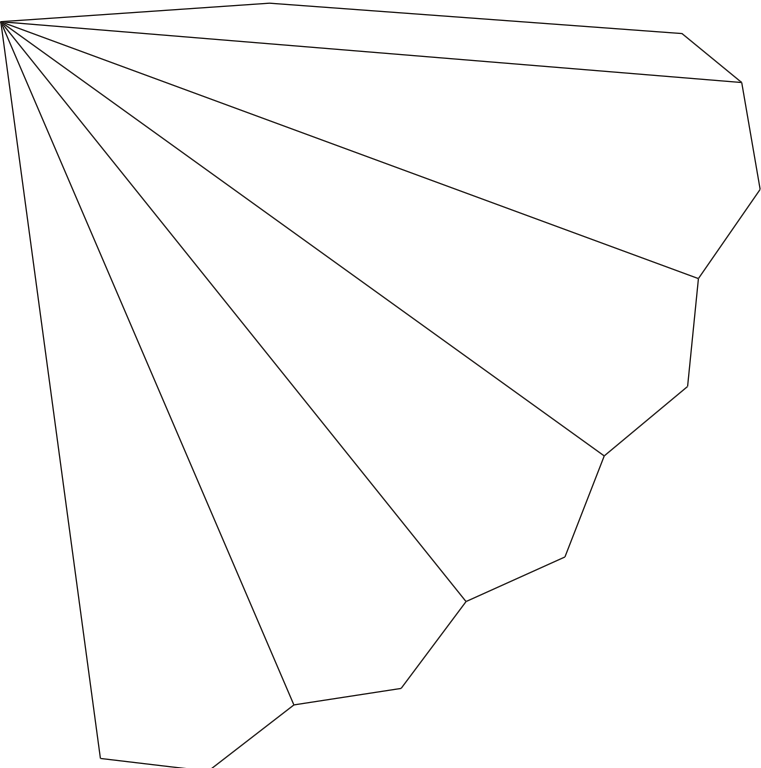
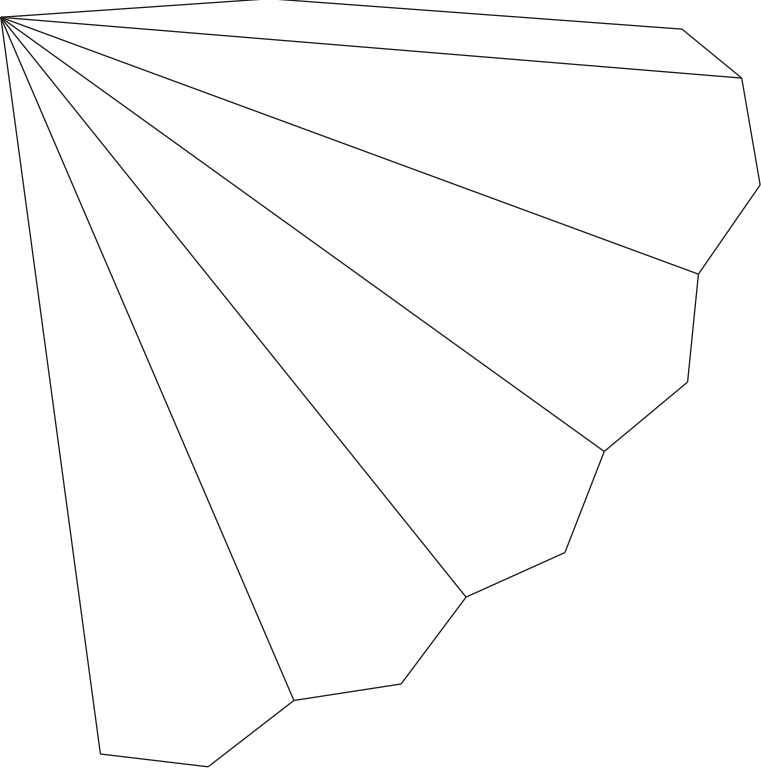

Sixth Stallation of the Icosahedron

(large)

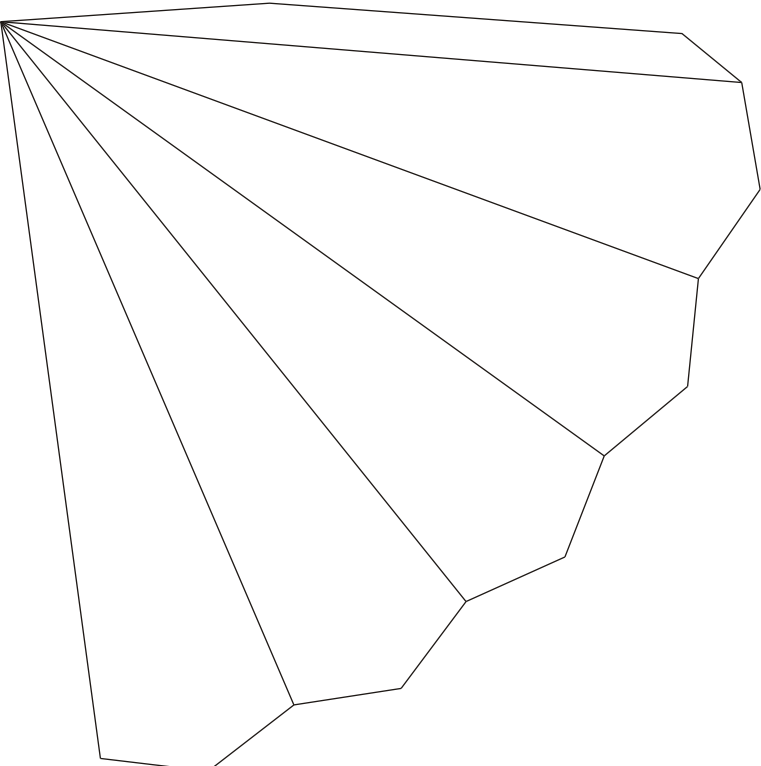
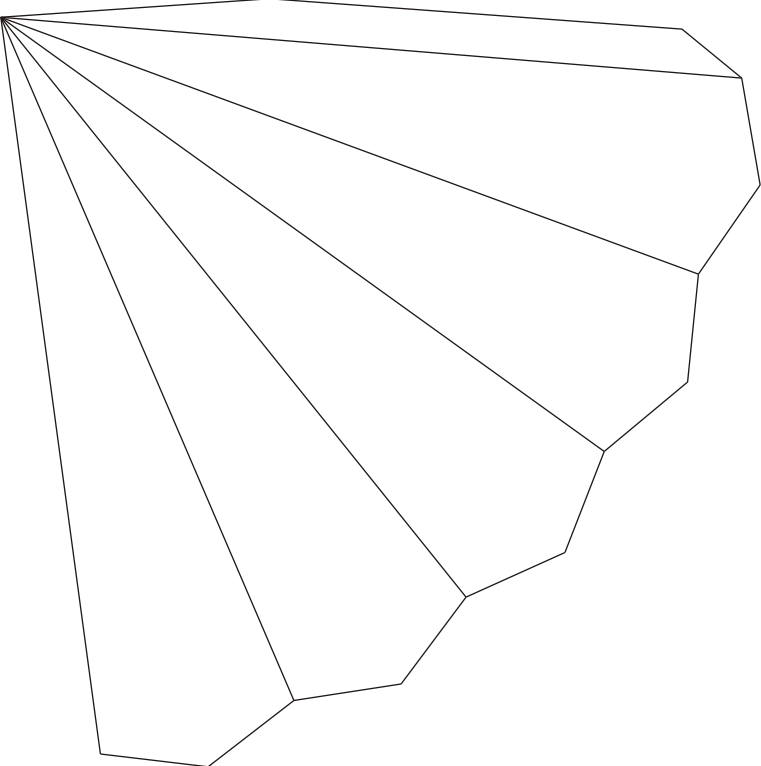

Sixth Stallation of the Icosahedron

(large)

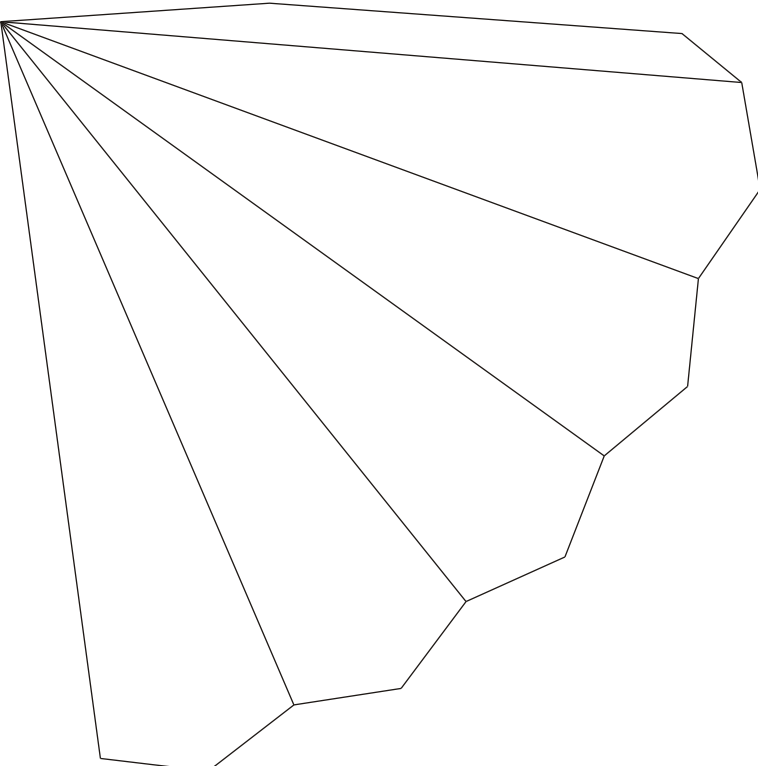
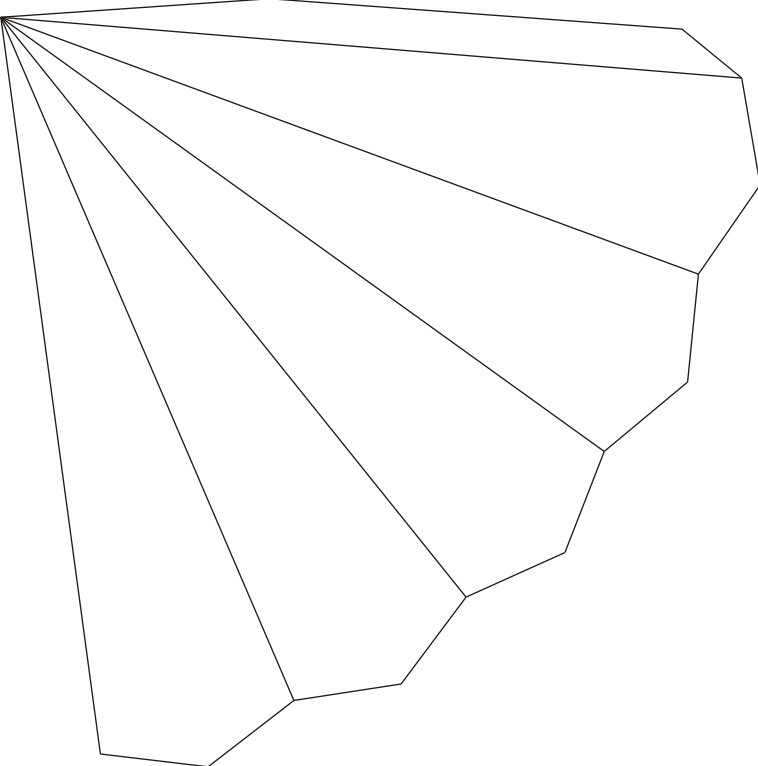

Seventh Stellation of the Icosahedron

A

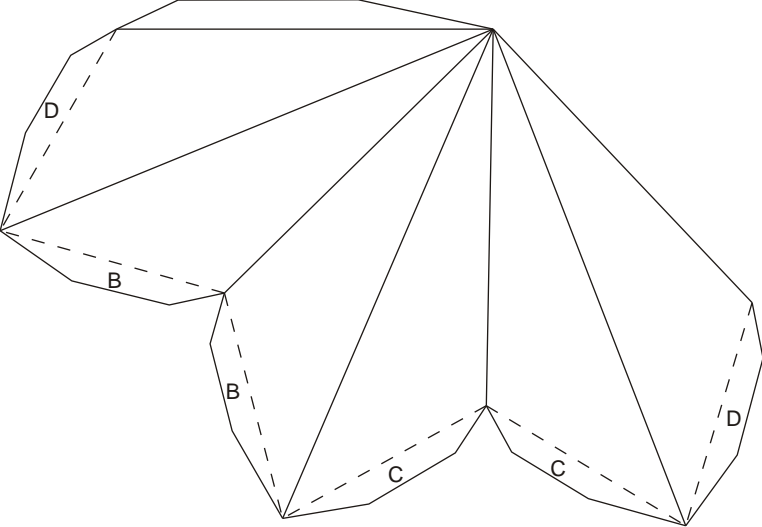

B

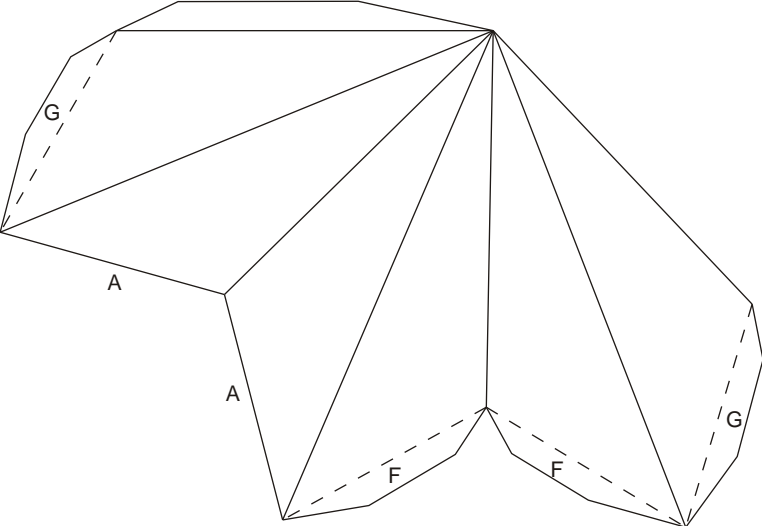

C

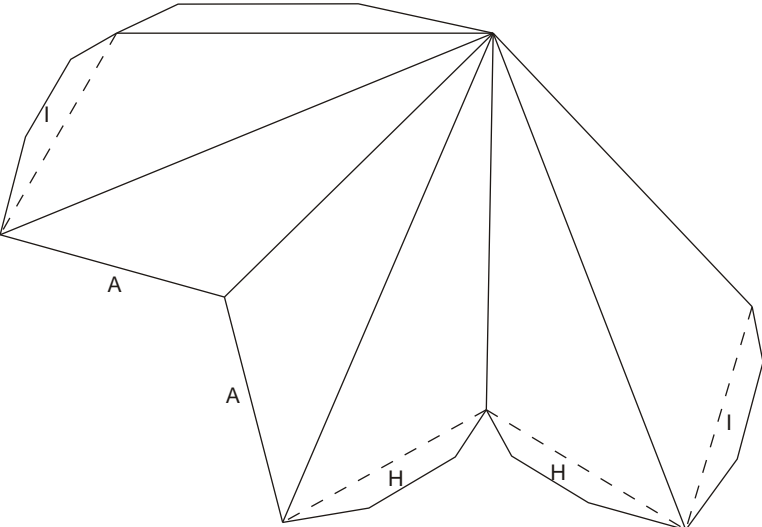

Seventh Stellation of the Icosahedron

D

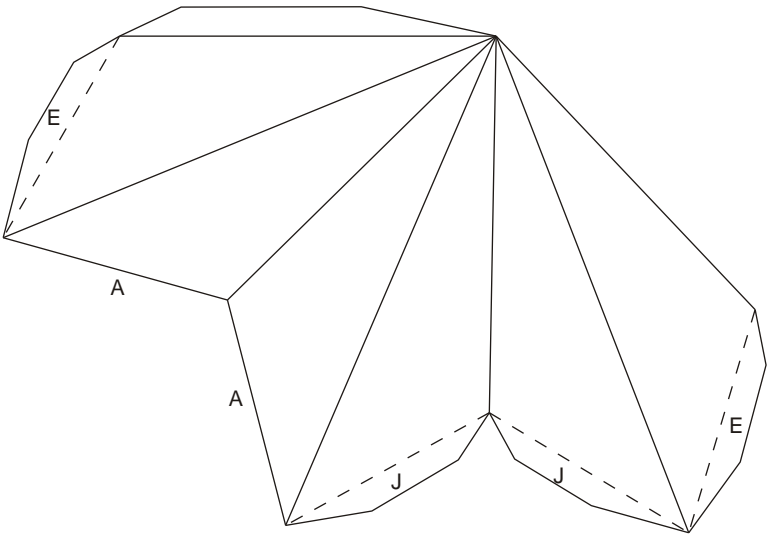

E

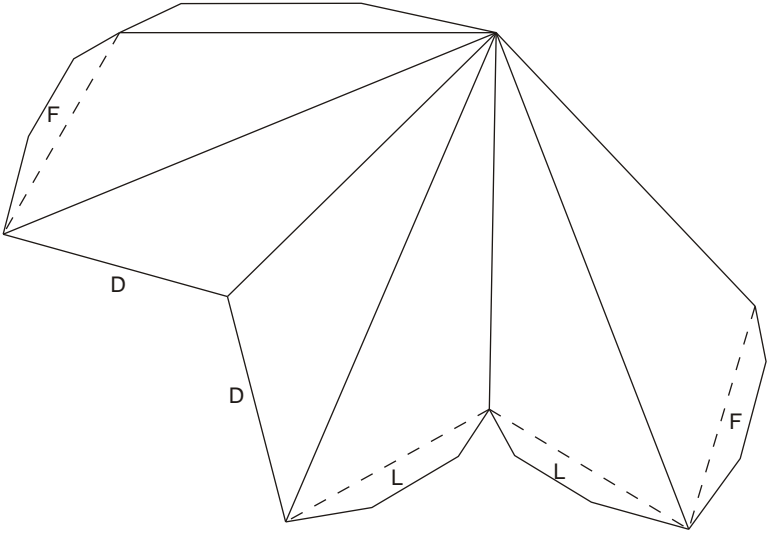

F

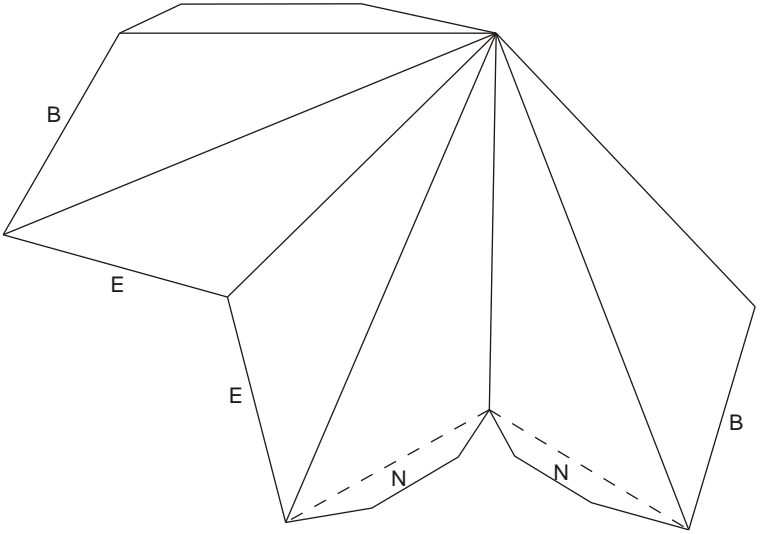

Seventh Stellation of the Icosahedron

G

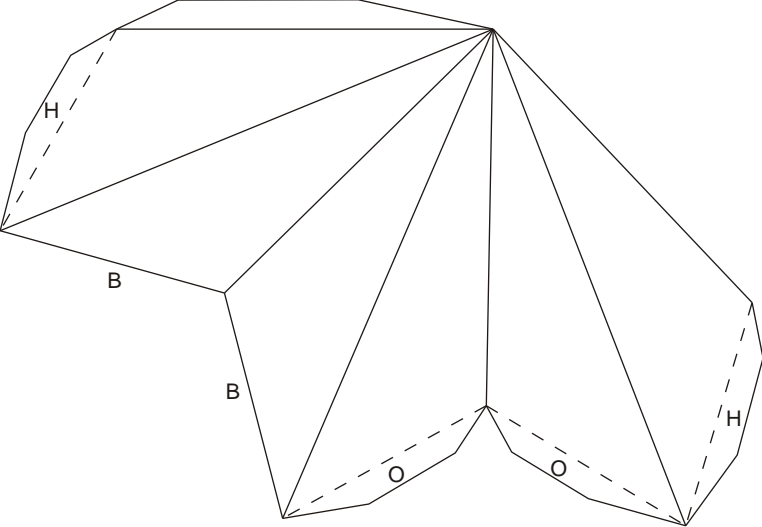

H

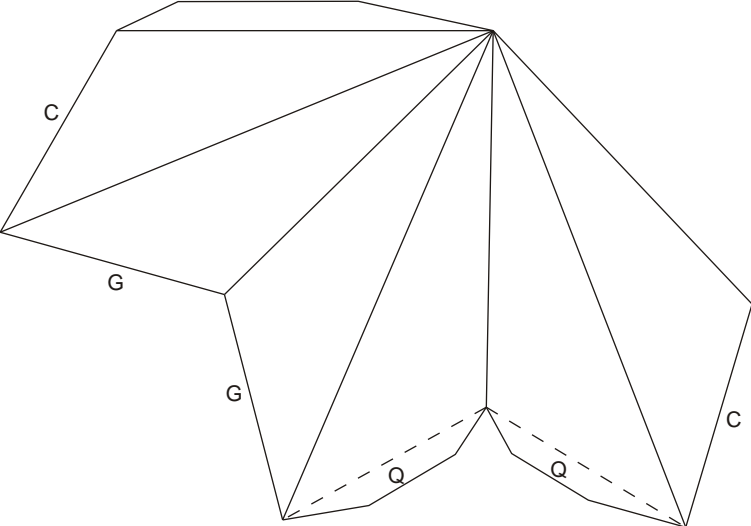

I

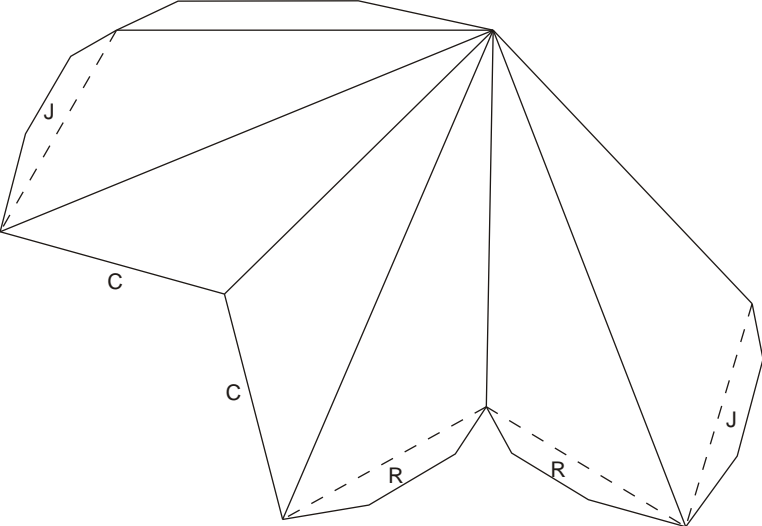

Seventh Stellation of the Icosahedron

J

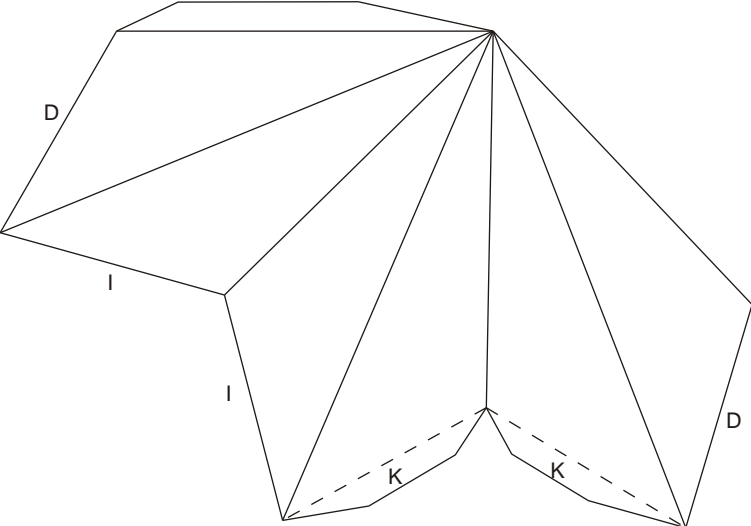

K

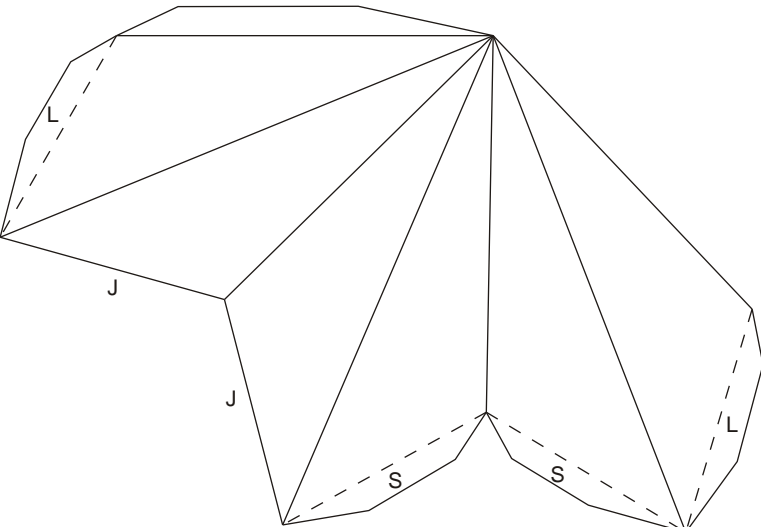

L

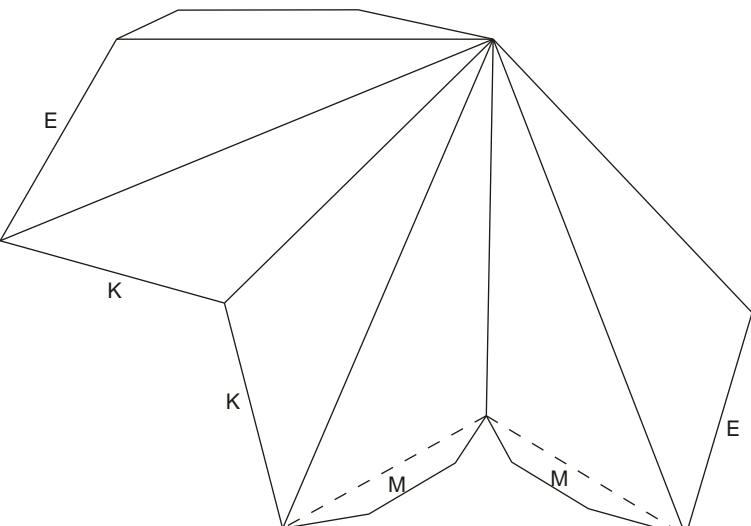

Seventh Stellation of the Icosahedron

M

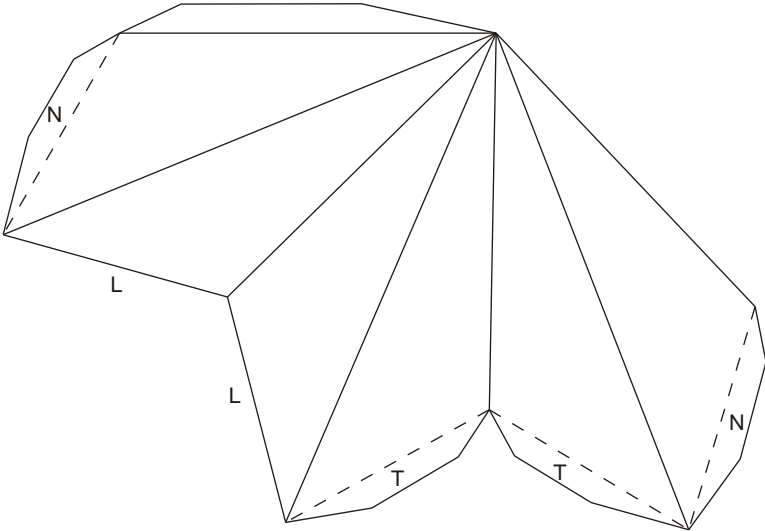

N

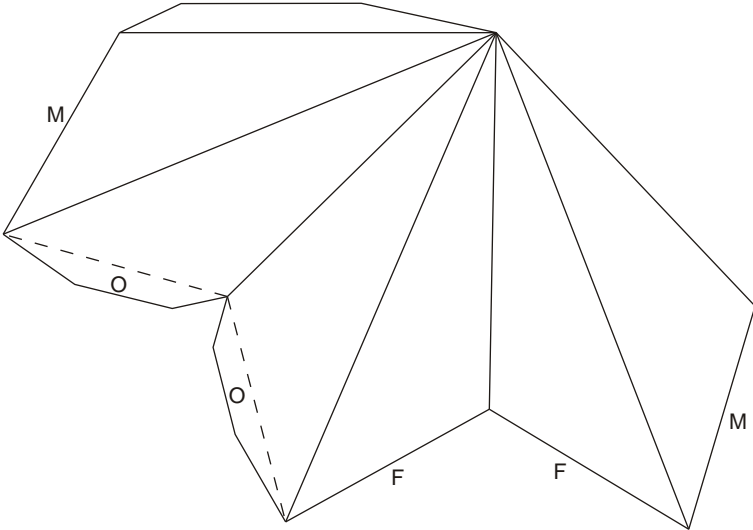

O

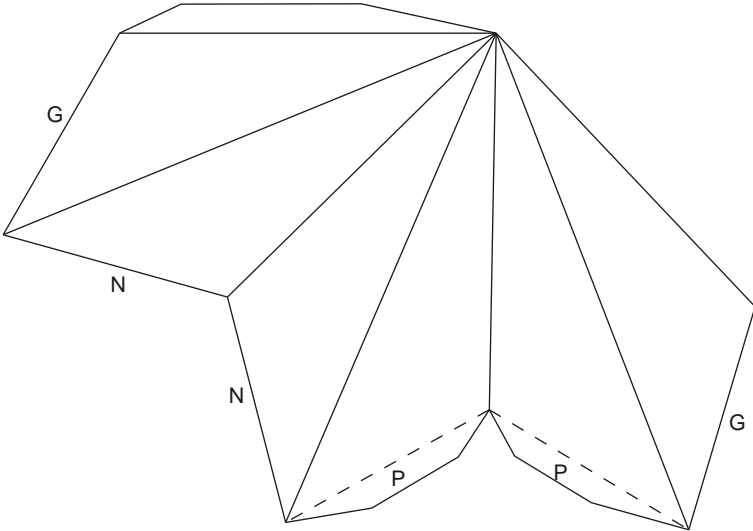

Seventh Stellation of the Icosahedron

P

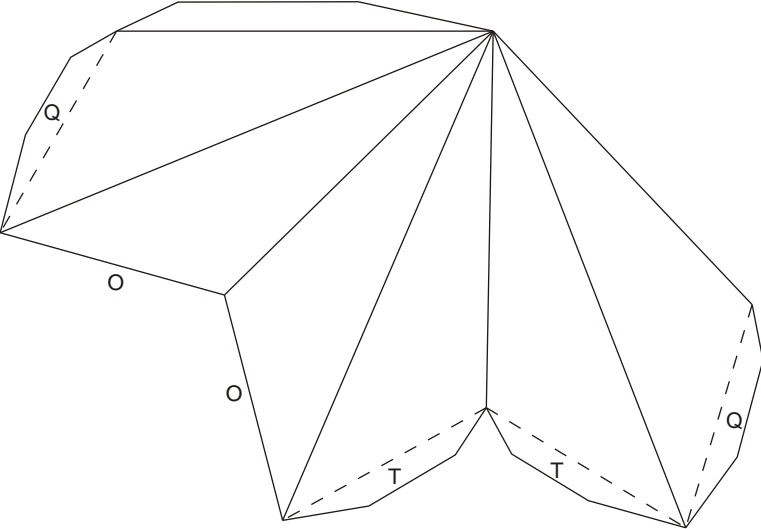

Q

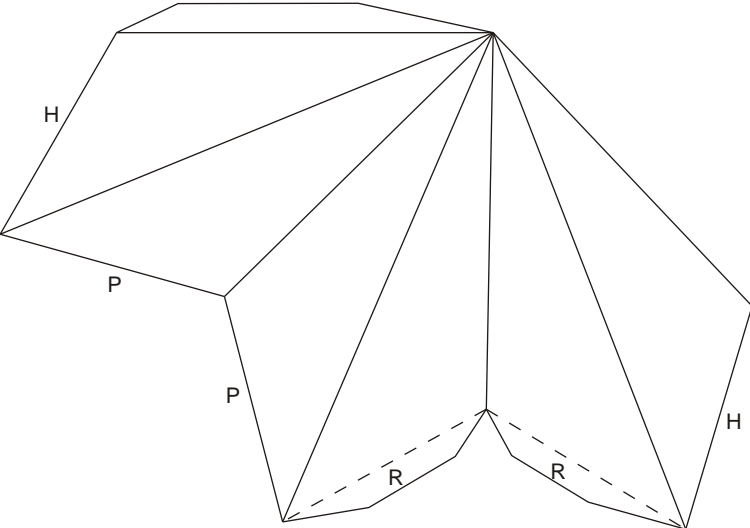

R

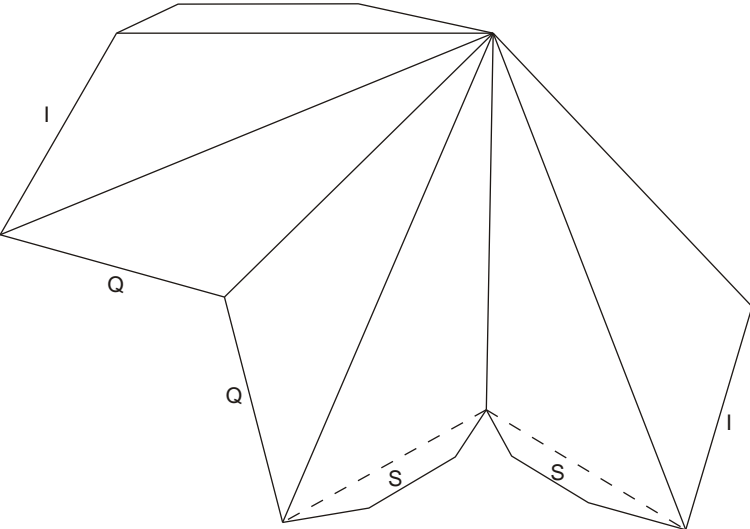

Seventh Stellation of the Icosahedron

S

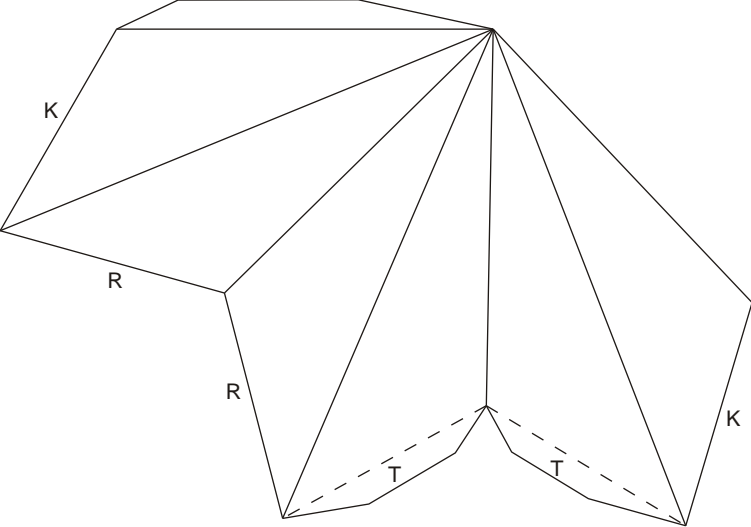

T

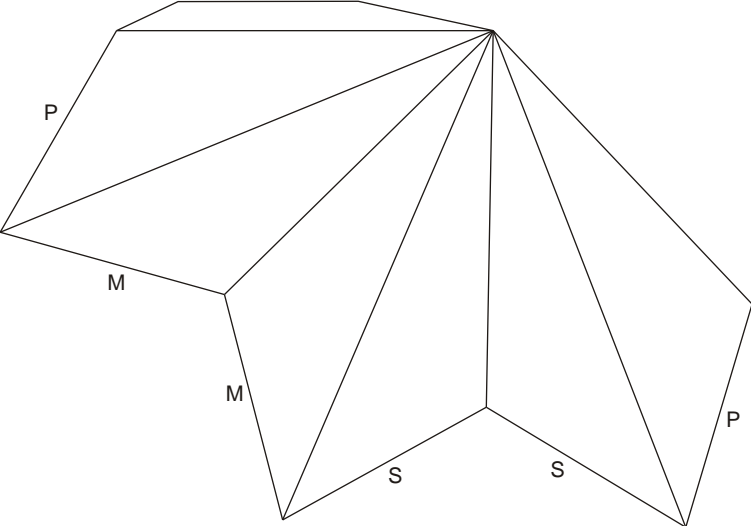

Eighth Stellation of the Icosahedron

(Large version)

Fold dotted lines forwards

Fold other lines backwards

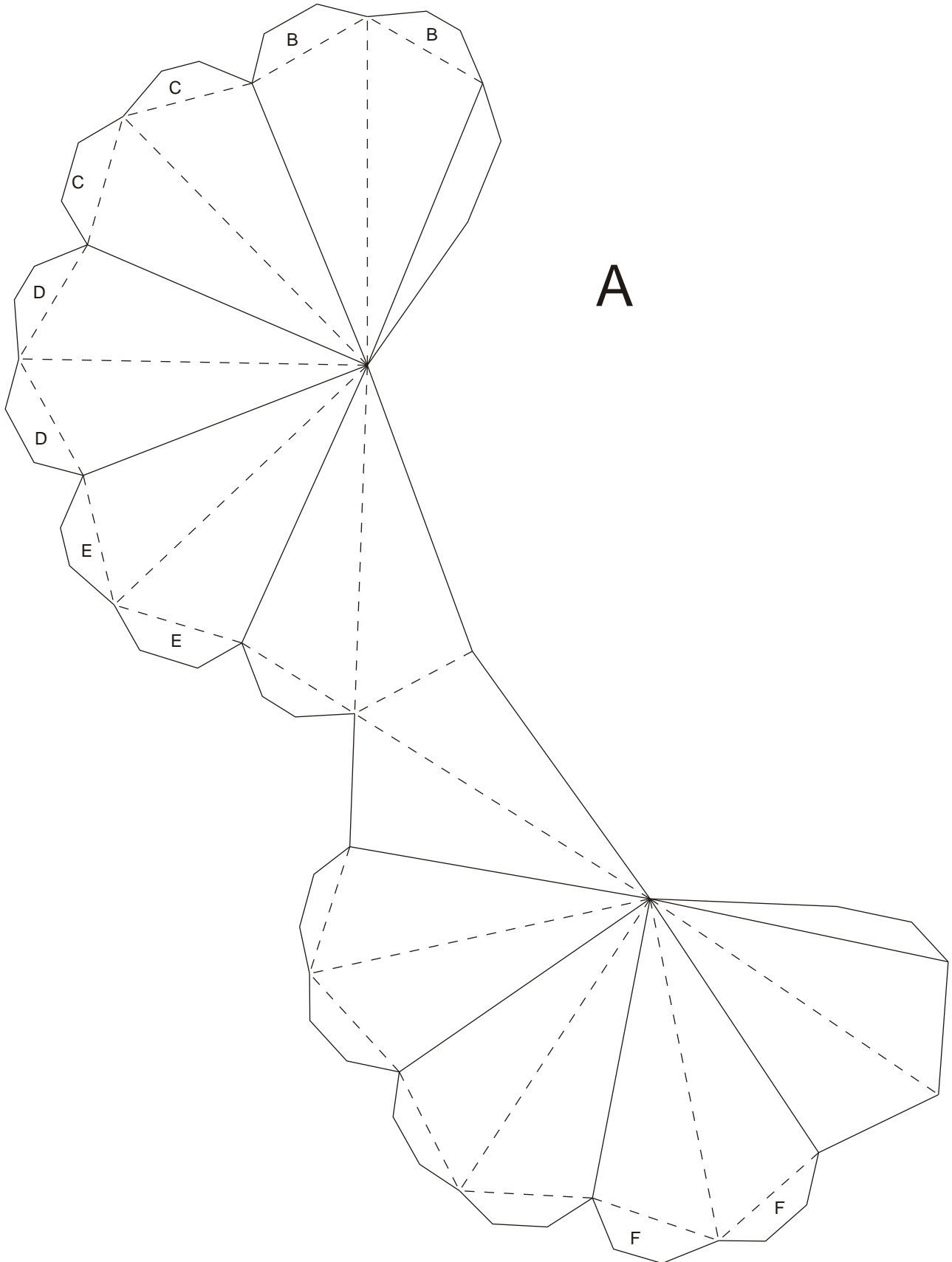

Eighth Stellation of the Icosahedron

(Large version)

Fold dotted lines forwards

Fold other lines backwards

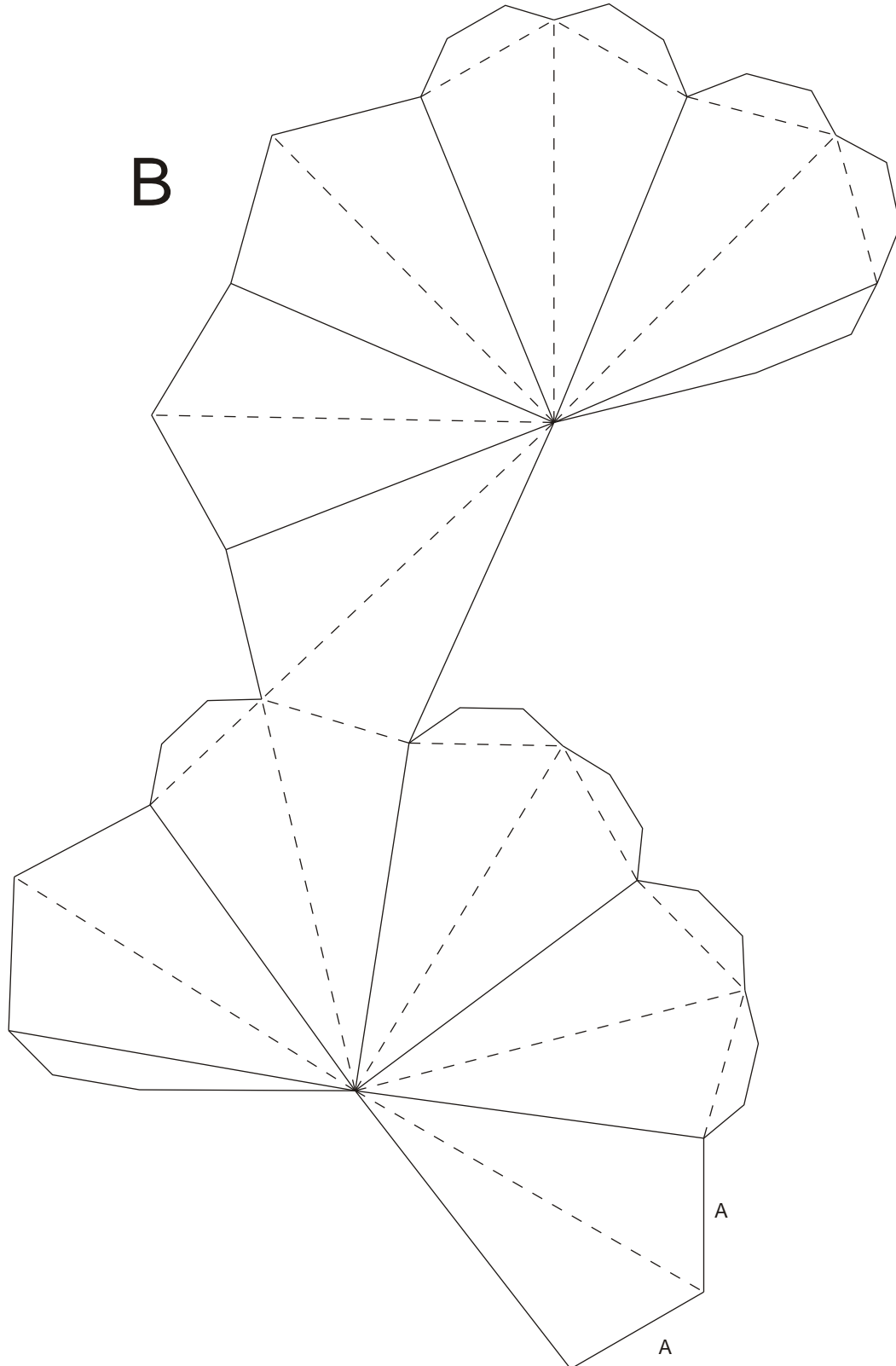

Eighth Stellation of the Icosahedron

(Large version)

Fold dotted lines forwards

Fold other lines backwards

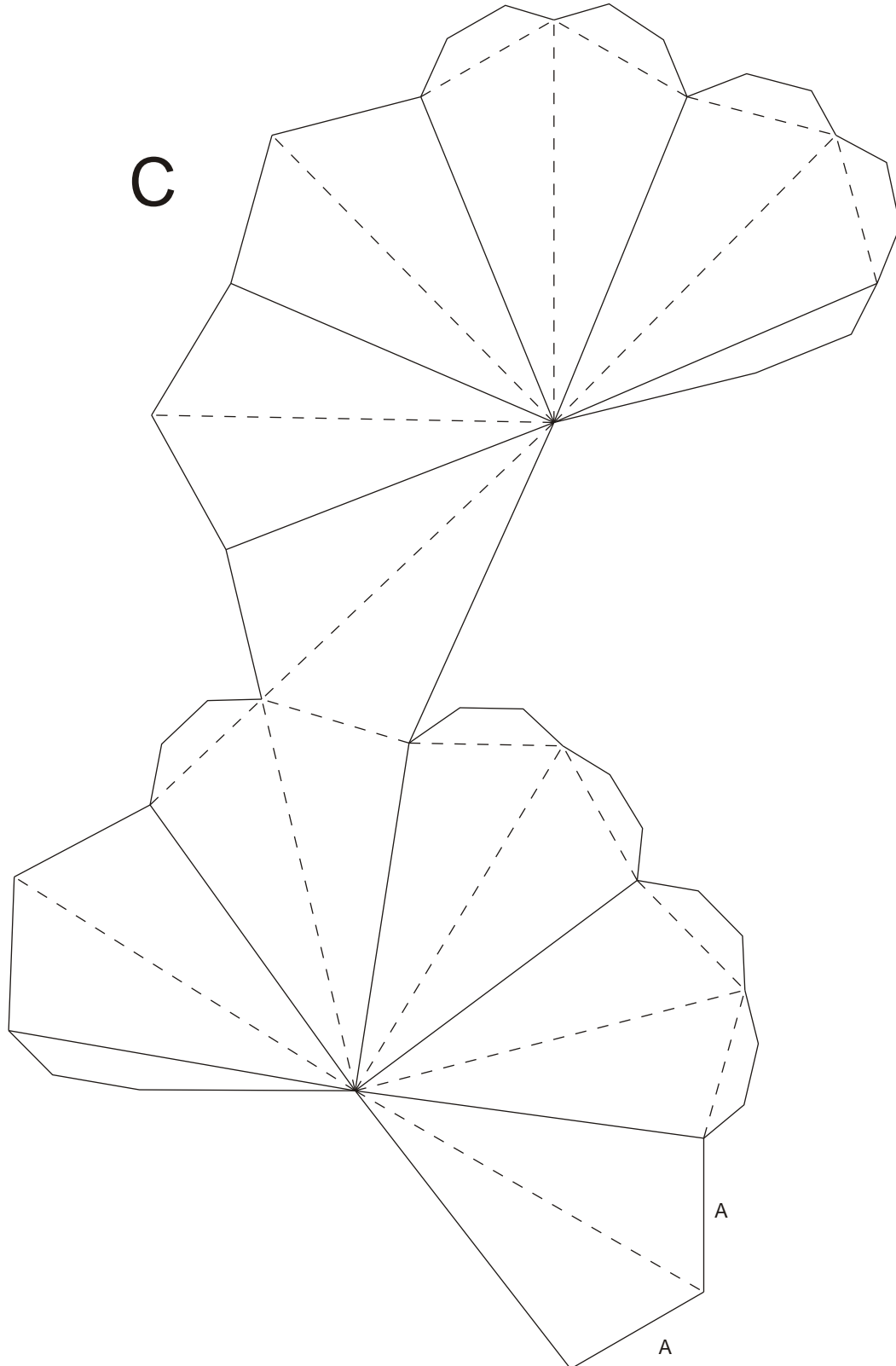

Eighth Stellation of the Icosahedron

(Large version)

Fold dotted lines forwards

Fold other lines backwards

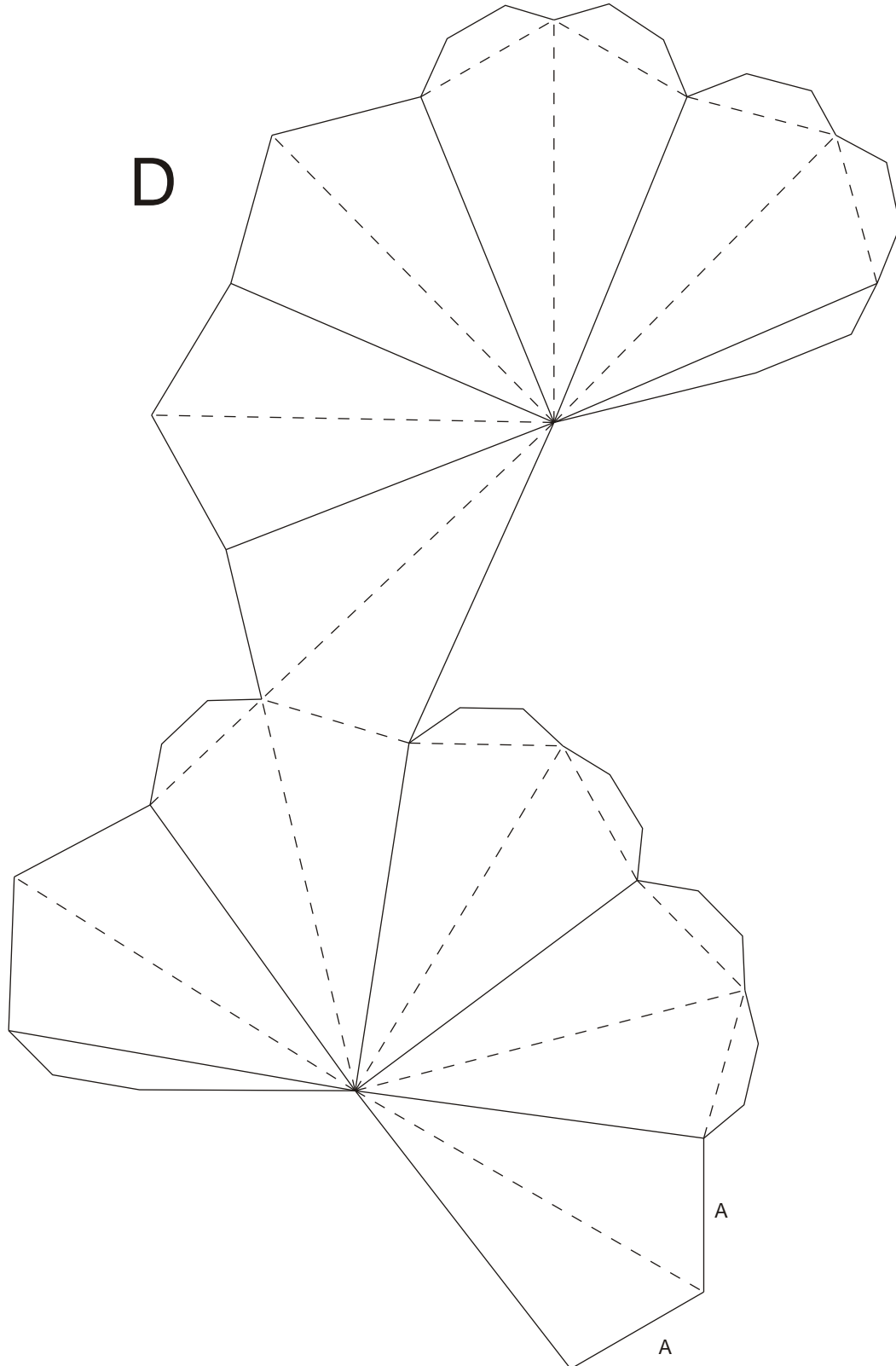

Eighth Stellation of the Icosahedron

(Large version)

Fold dotted lines forwards

Fold other lines backwards

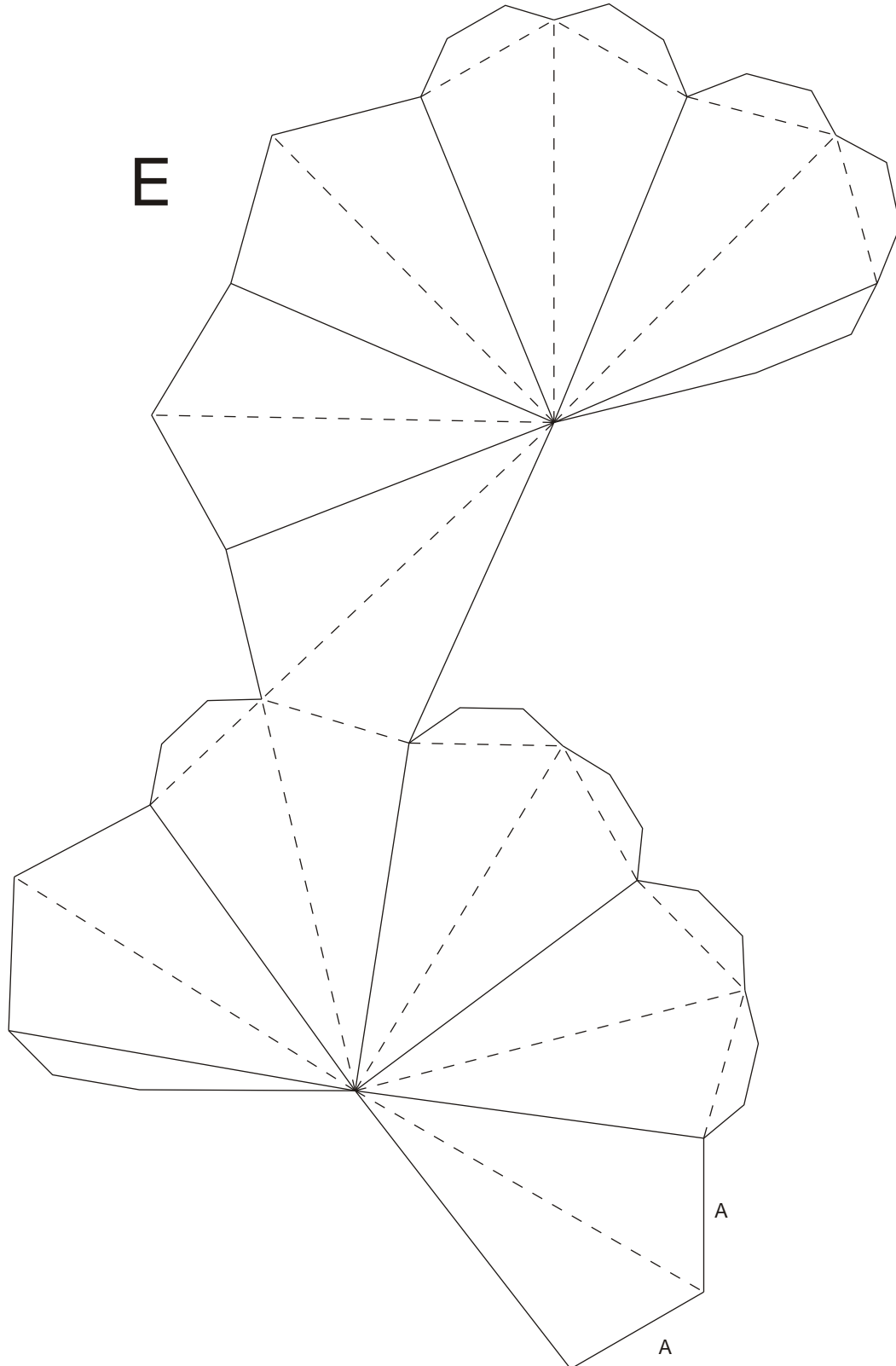

Eighth Stellation of the Icosahedron

(Large version)

Hold dotted lines forwards

Fold other lines backwards

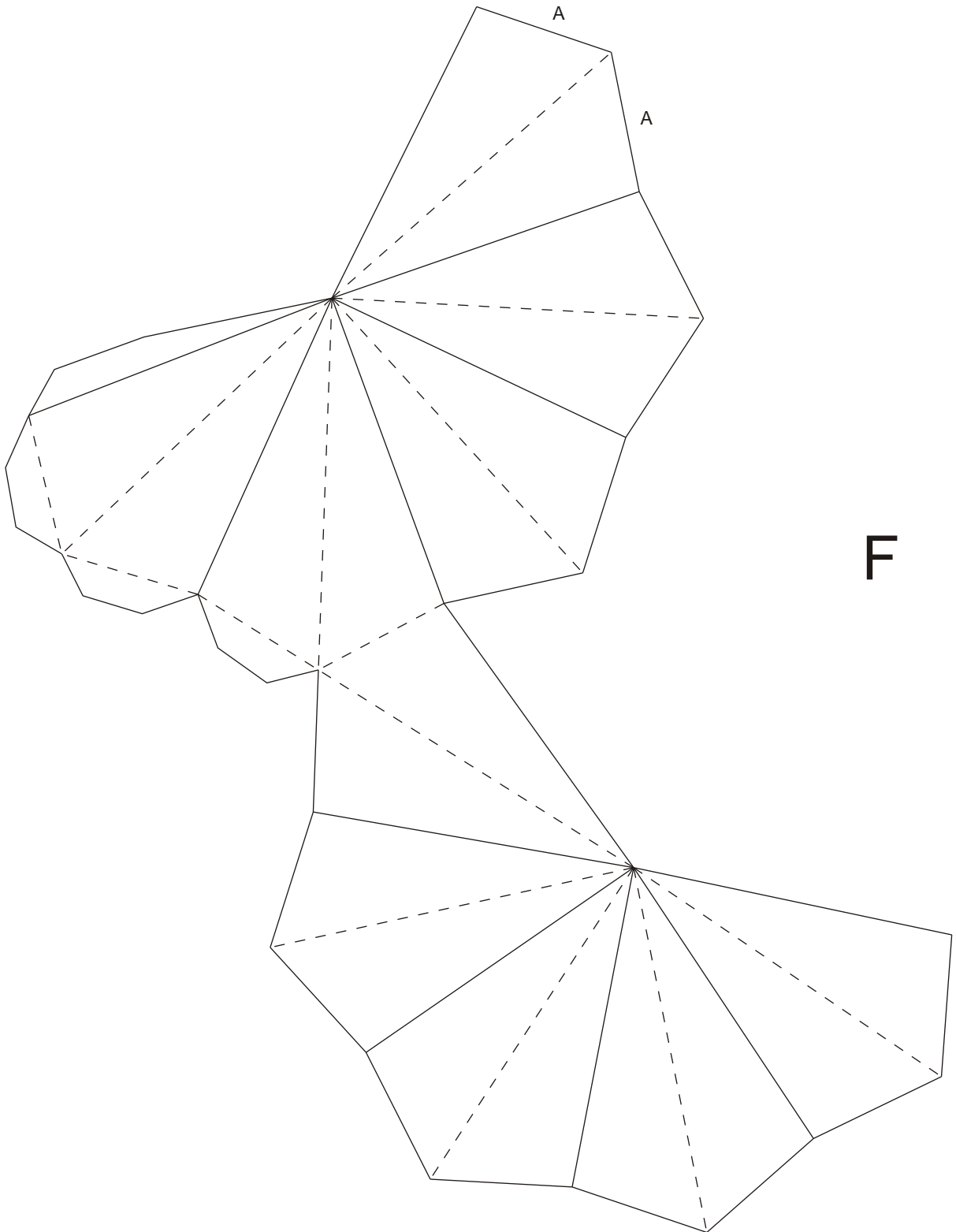

Ninth Stellation of the Icosahedron

Fold the dotted lines forwards

Fold the other lines backwards

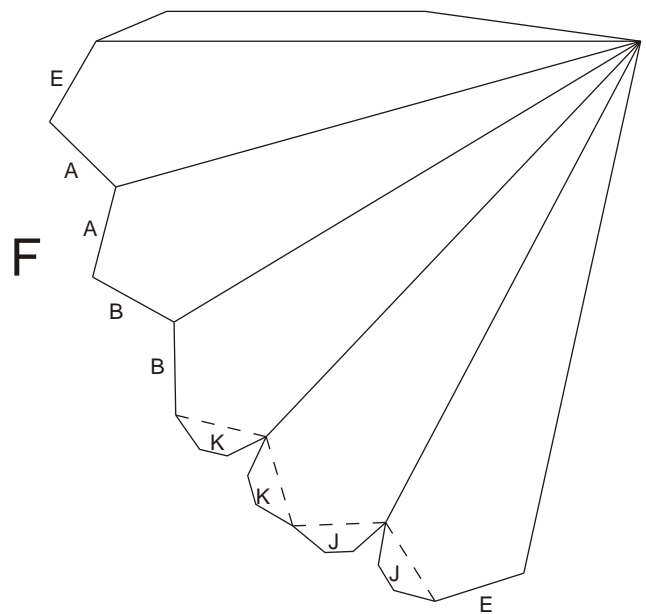
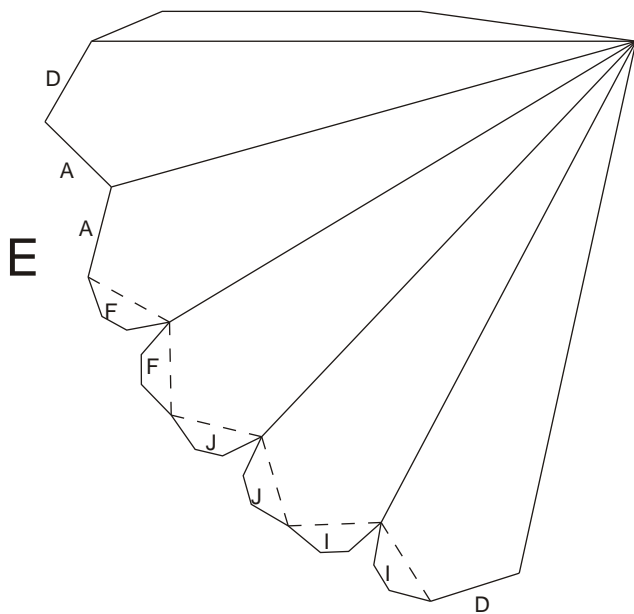
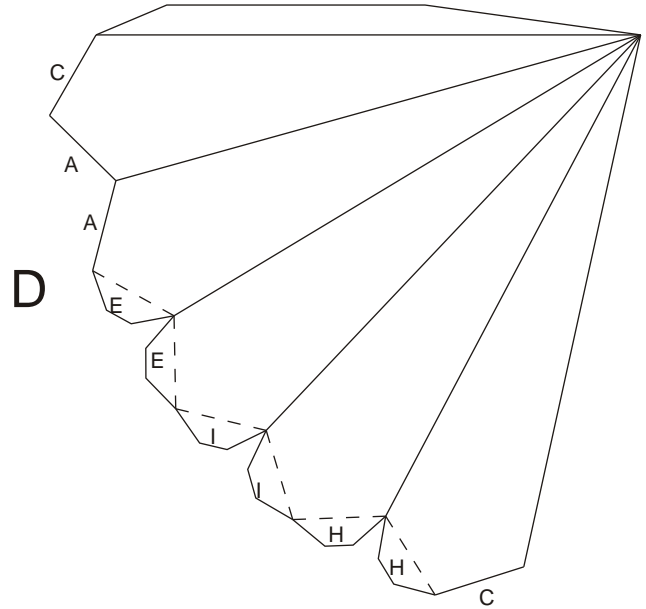
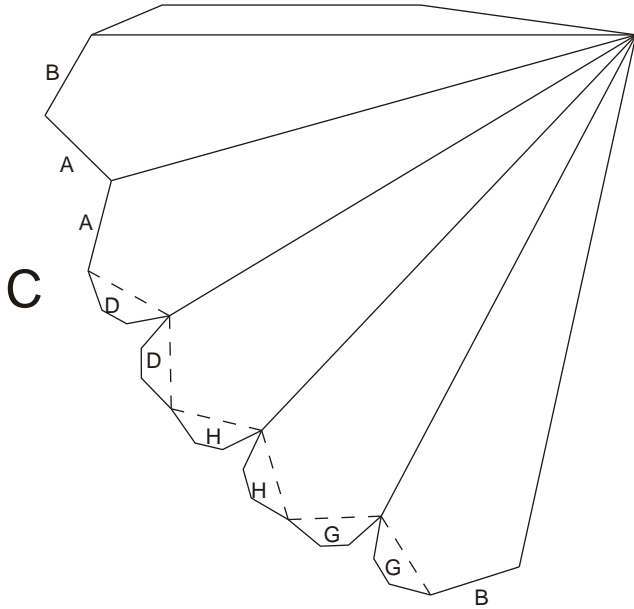
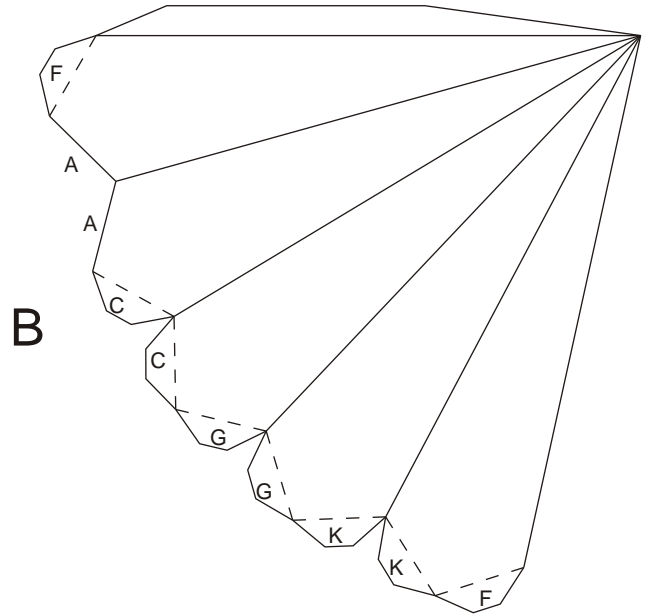
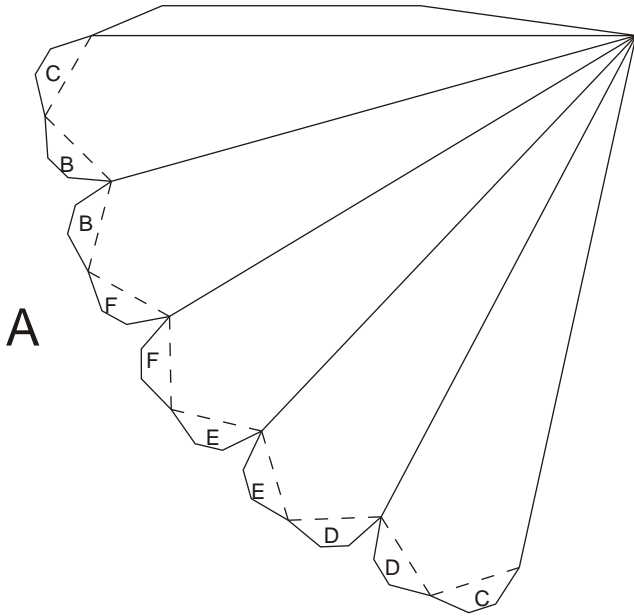

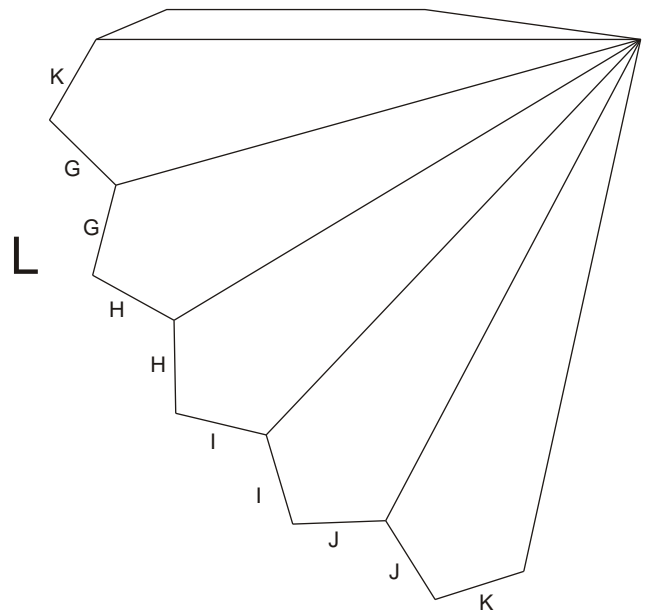
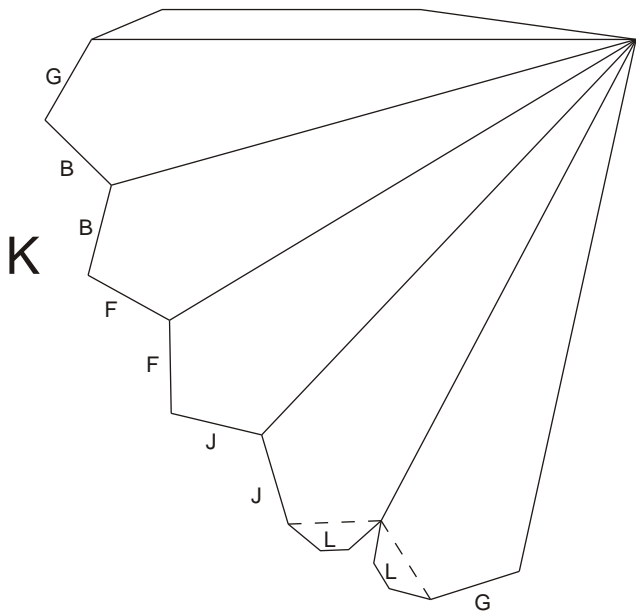
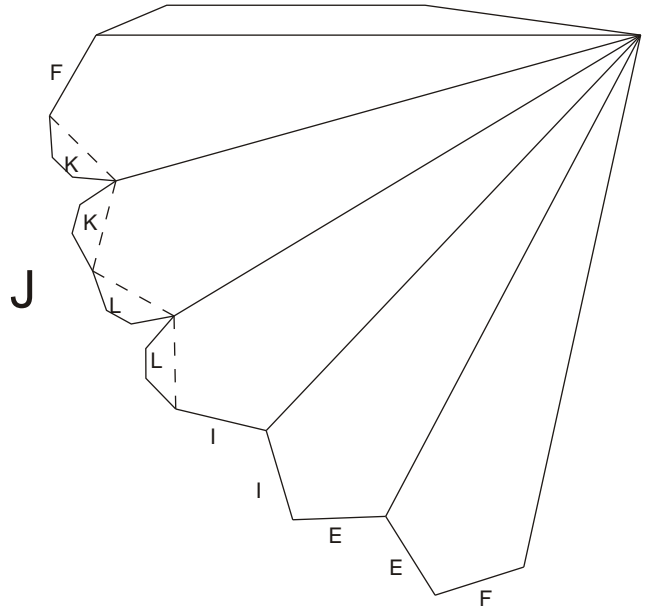
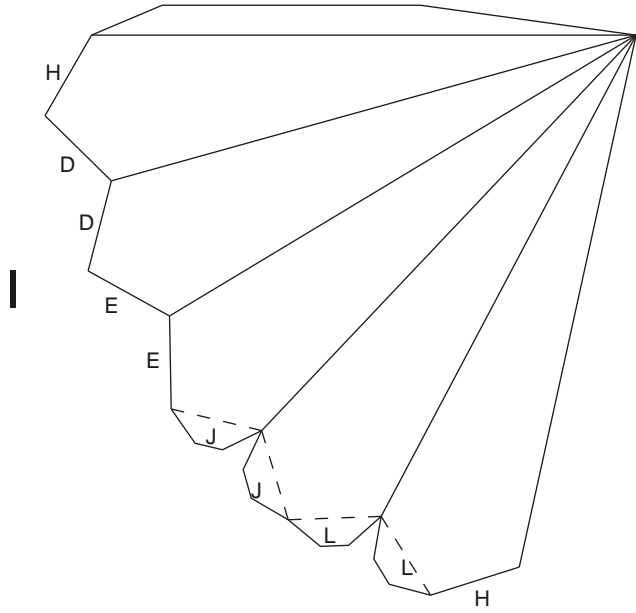
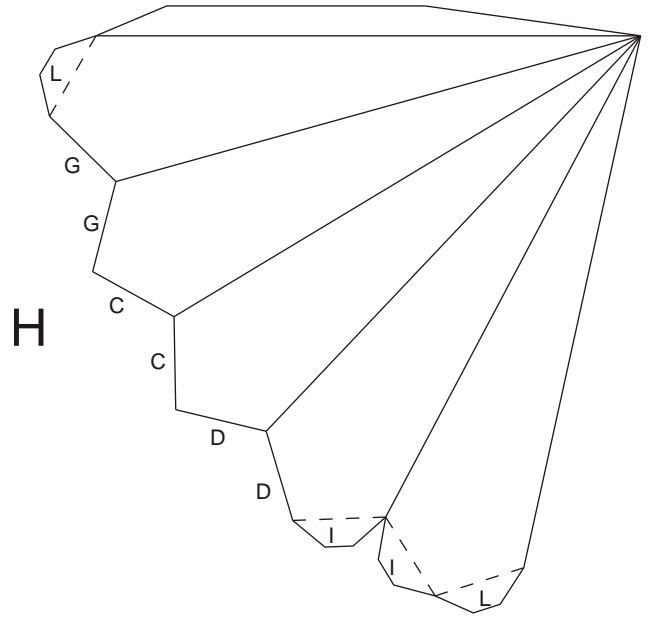
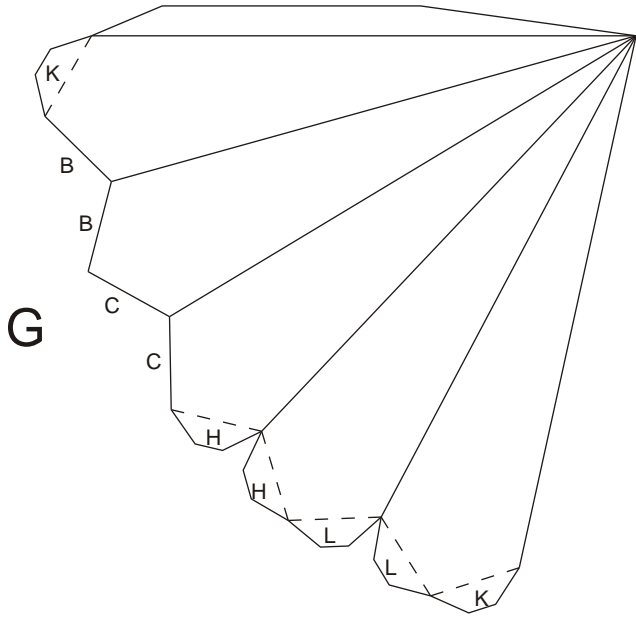

Final Stellation of the icosahedron

Fold the dotted lines forwards
Fold the other lines backwards

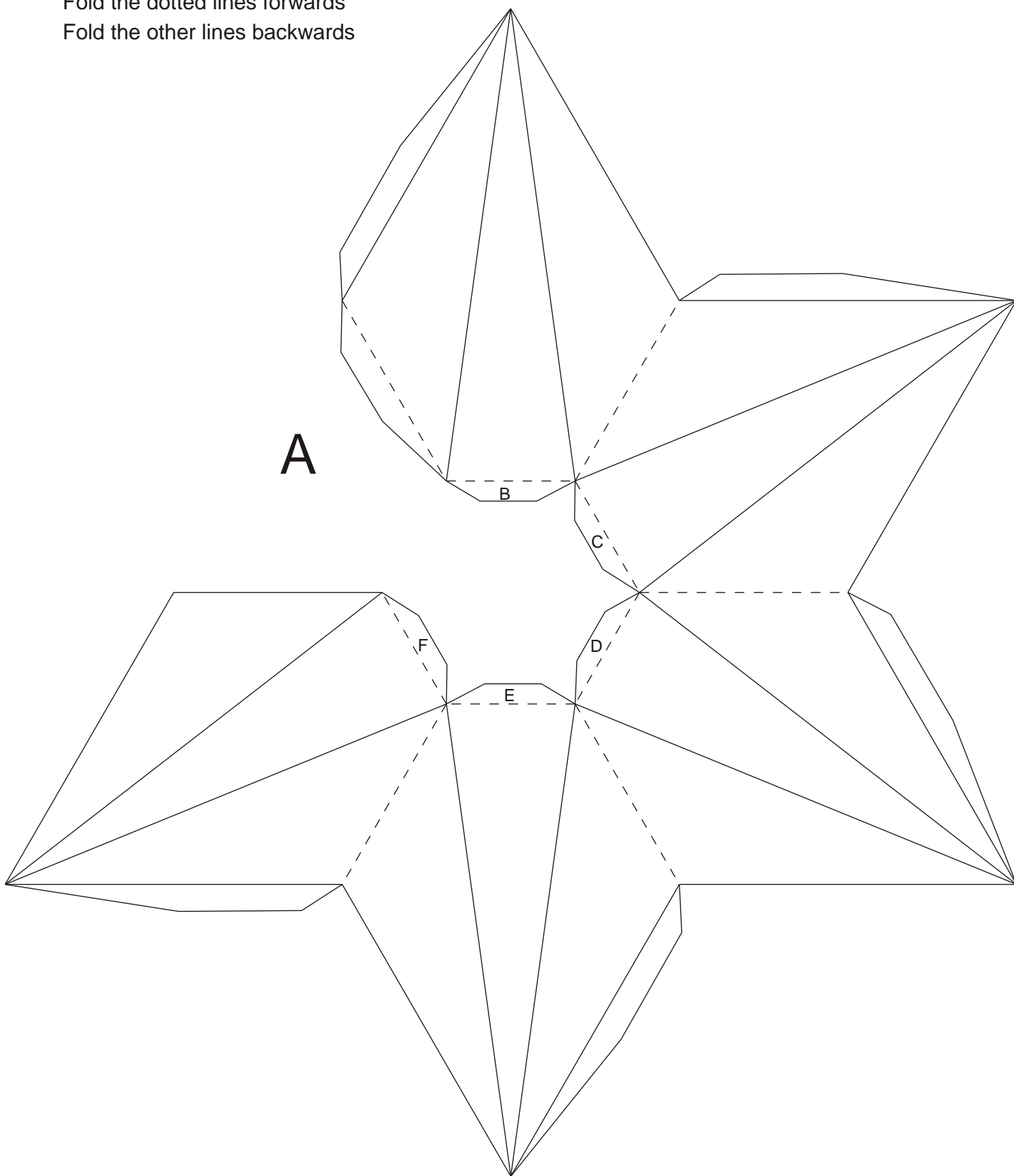

Final Stellation of the icosahedron

Fold the dotted lines forwards
Fold the other lines backwards

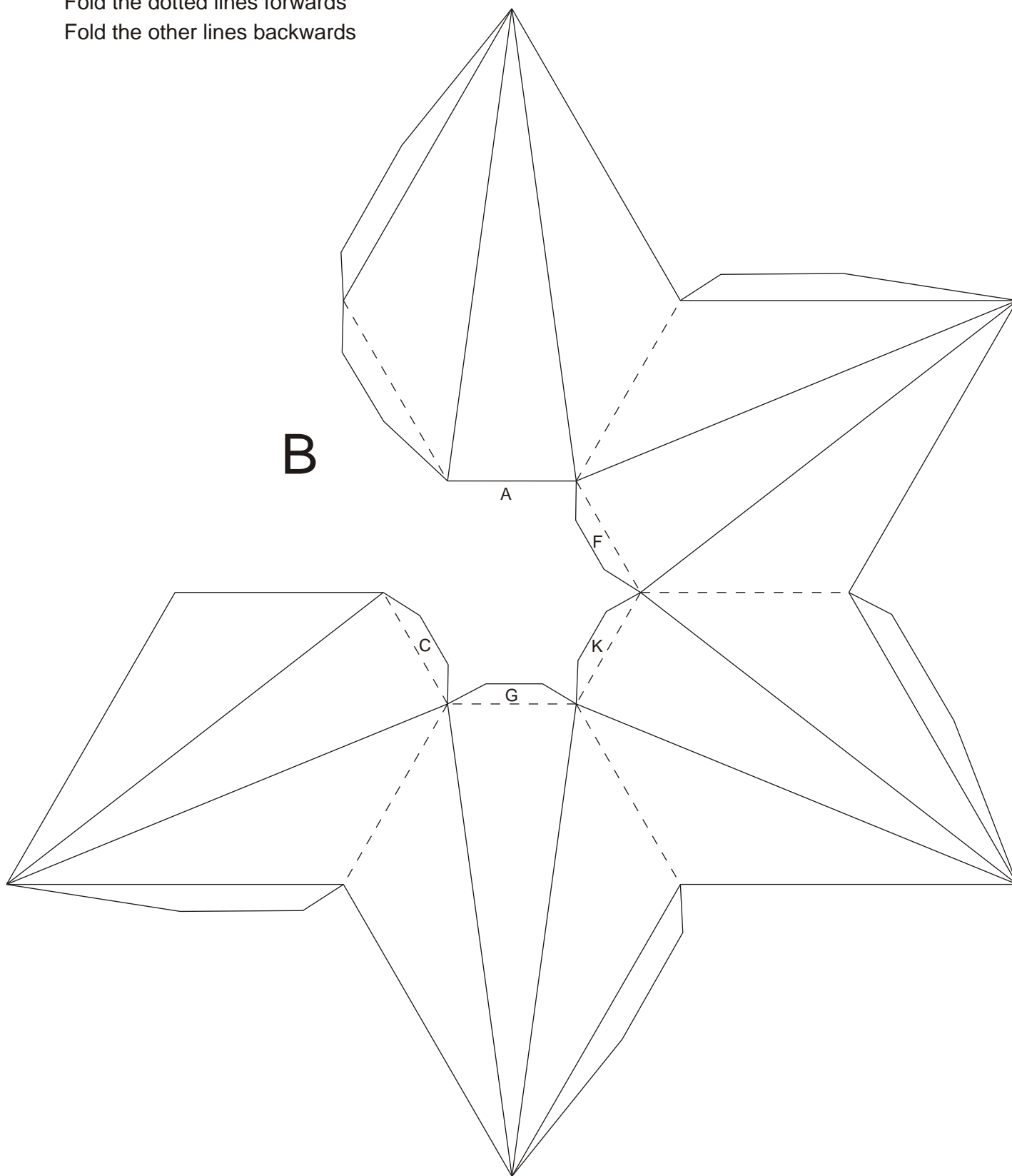

Final Stellation of the icosahedron

Fold the dotted lines forwards
Fold the other lines backwards

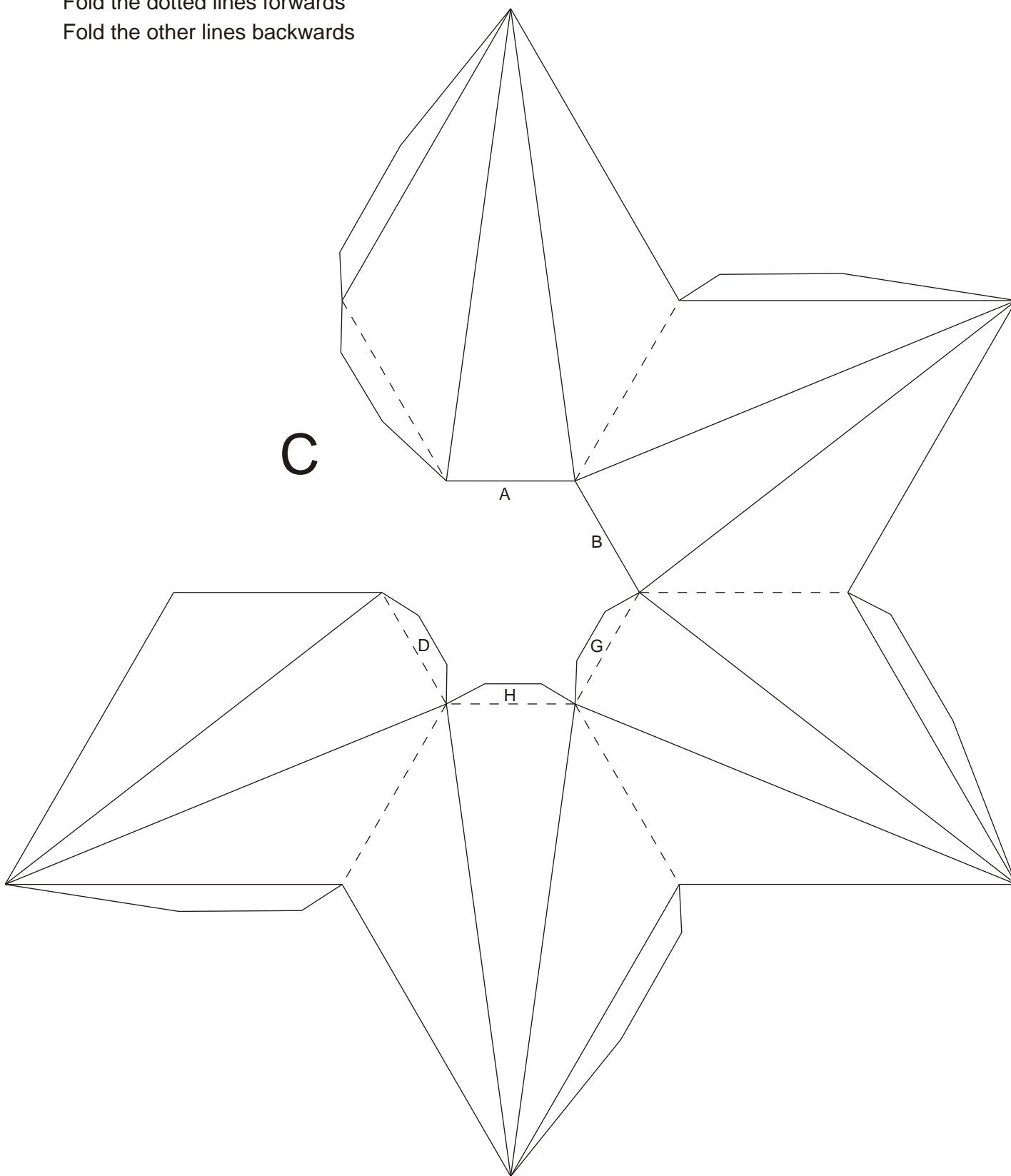

Final Stellation of the icosahedron

Fold the dotted lines forwards
Fold the other lines backwards

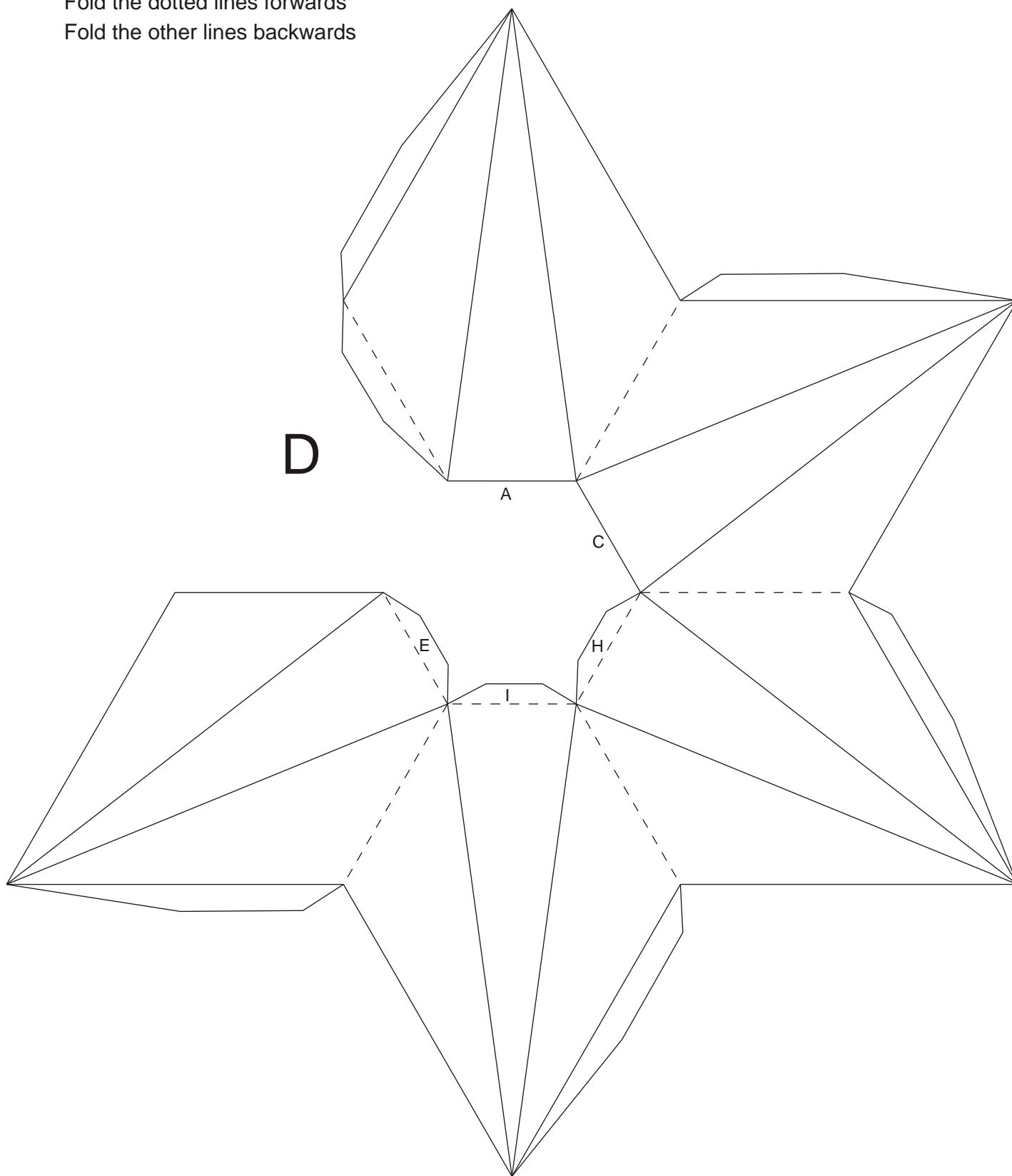

Final Stellation of the icosahedron

Fold the dotted lines forwards
Fold the other lines backwards

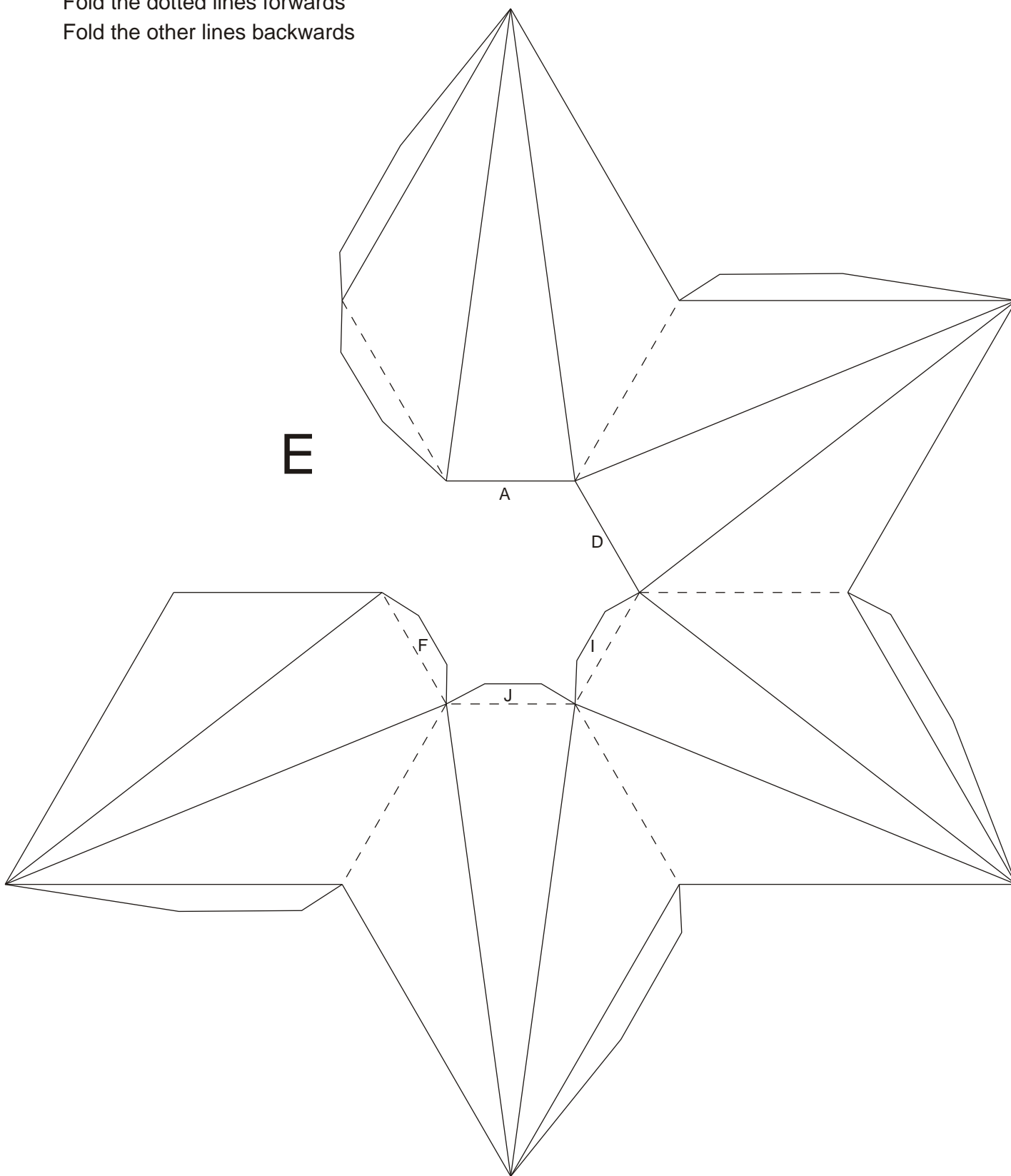

Final Stellation of the icosahedron

Fold the dotted lines forwards
Fold the other lines backwards

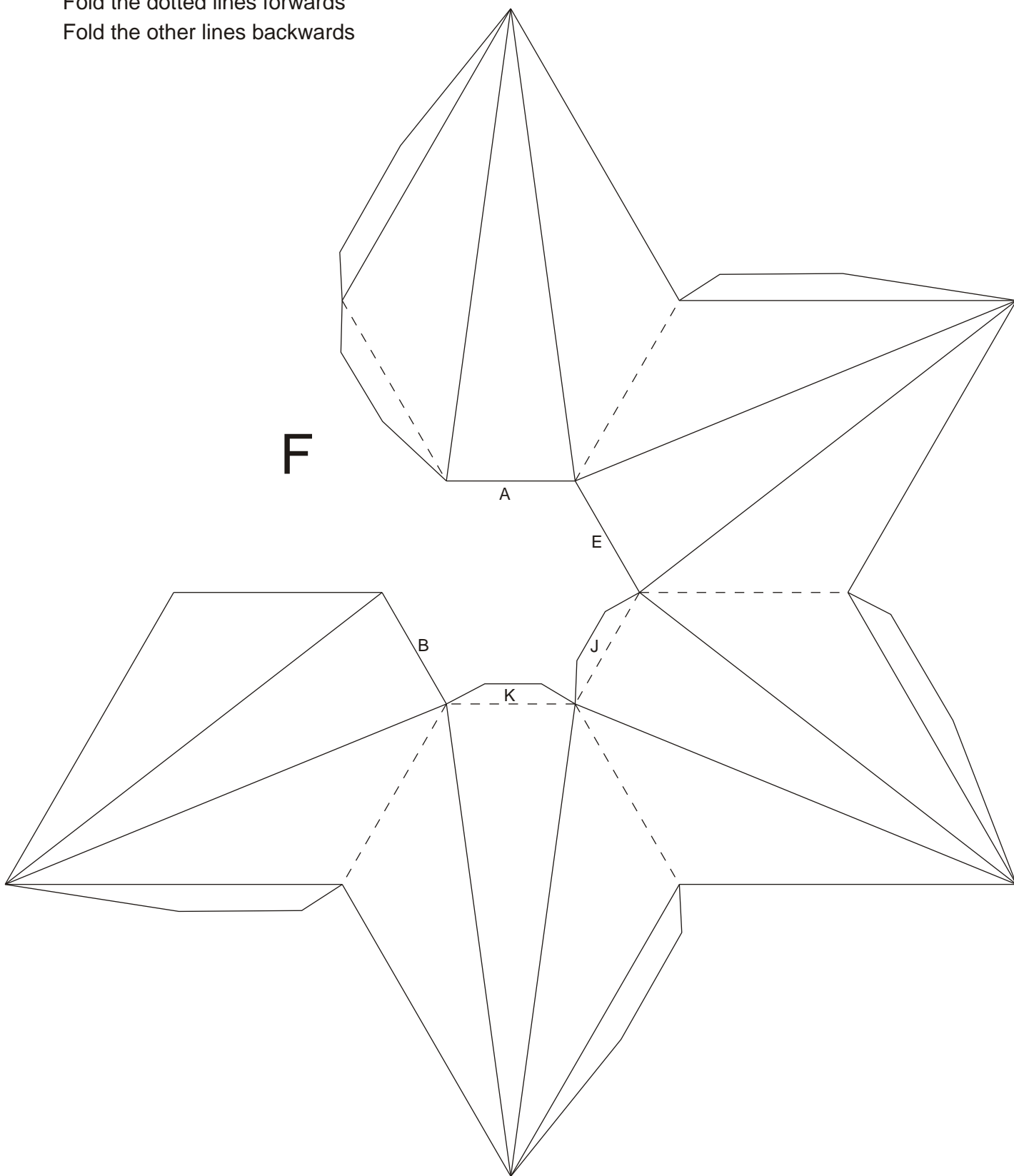

Final Stellation of the icosahedron

Fold the dotted lines forwards
Fold the other lines backwards

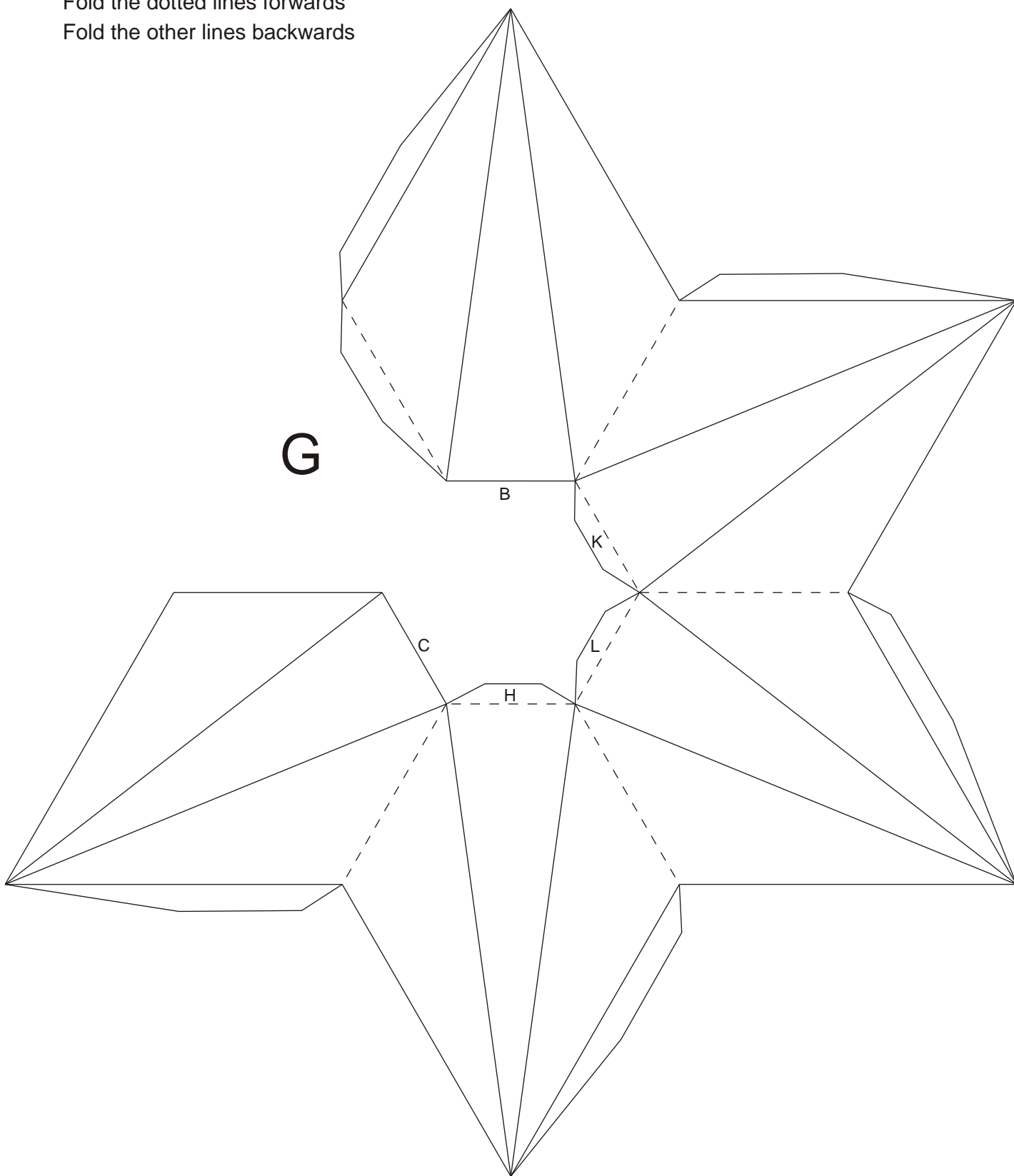

Final Stellation of the icosahedron

Fold the dotted lines forwards
Fold the other lines backwards

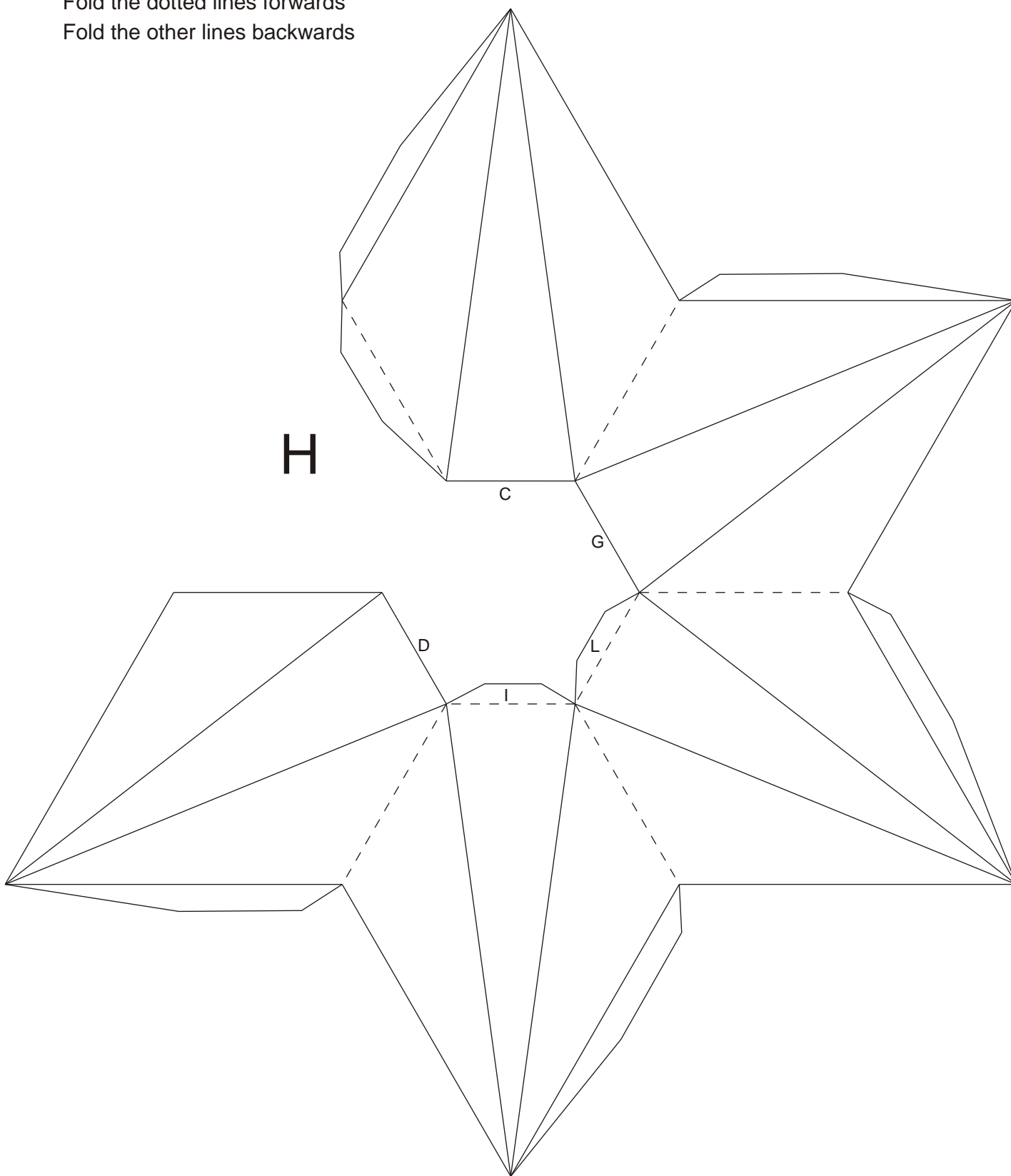

Final Stellation of the icosahedron

Fold the dotted lines forwards
Fold the other lines backwards

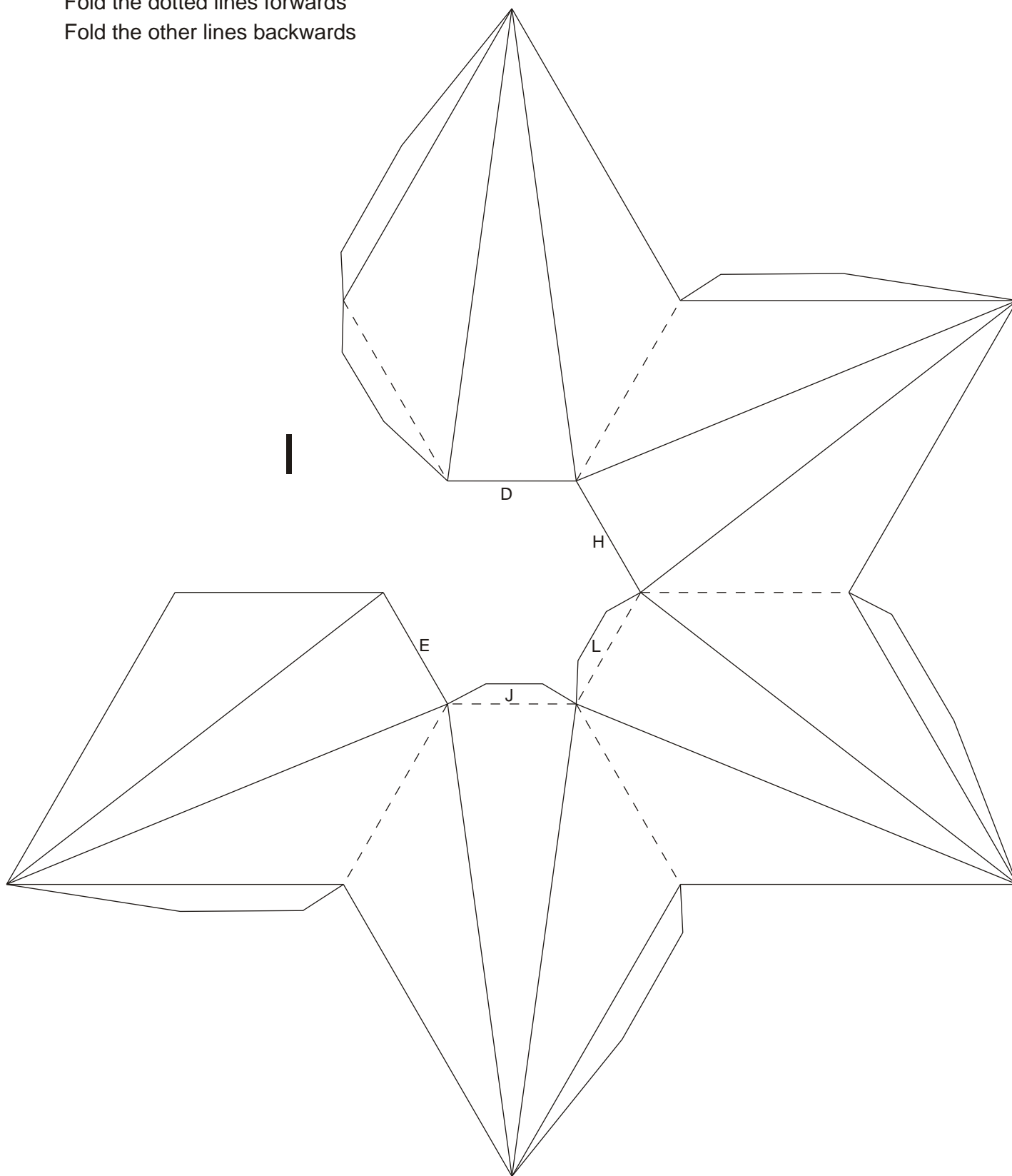

Final Stellation of the icosahedron

Fold the dotted lines forwards
Fold the other lines backwards

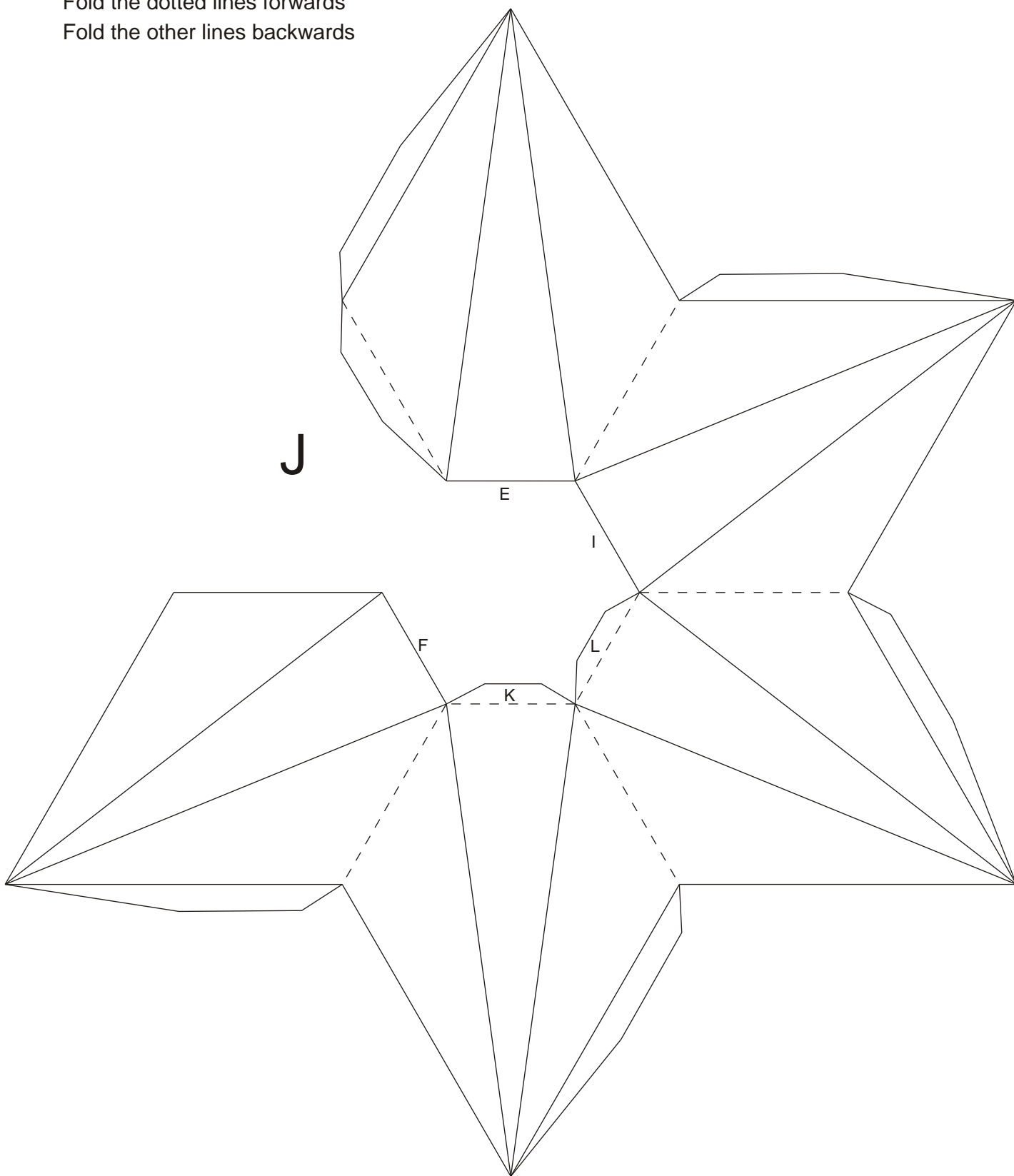

Final Stellation of the icosahedron

Fold the dotted lines forwards
Fold the other lines backwards

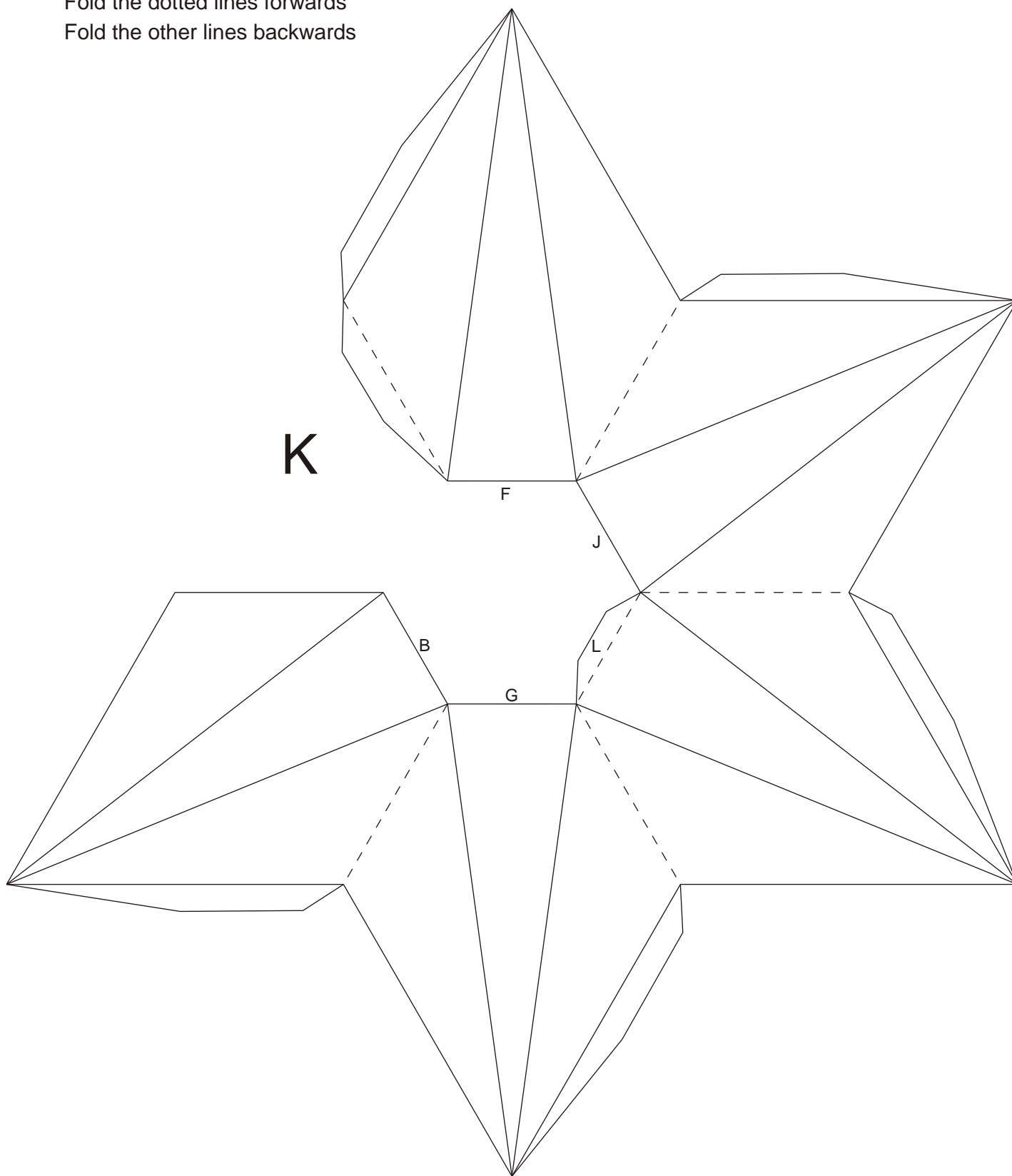

Final Stellation of the icosahedron

Fold the dotted lines forwards
Fold the other lines backwards

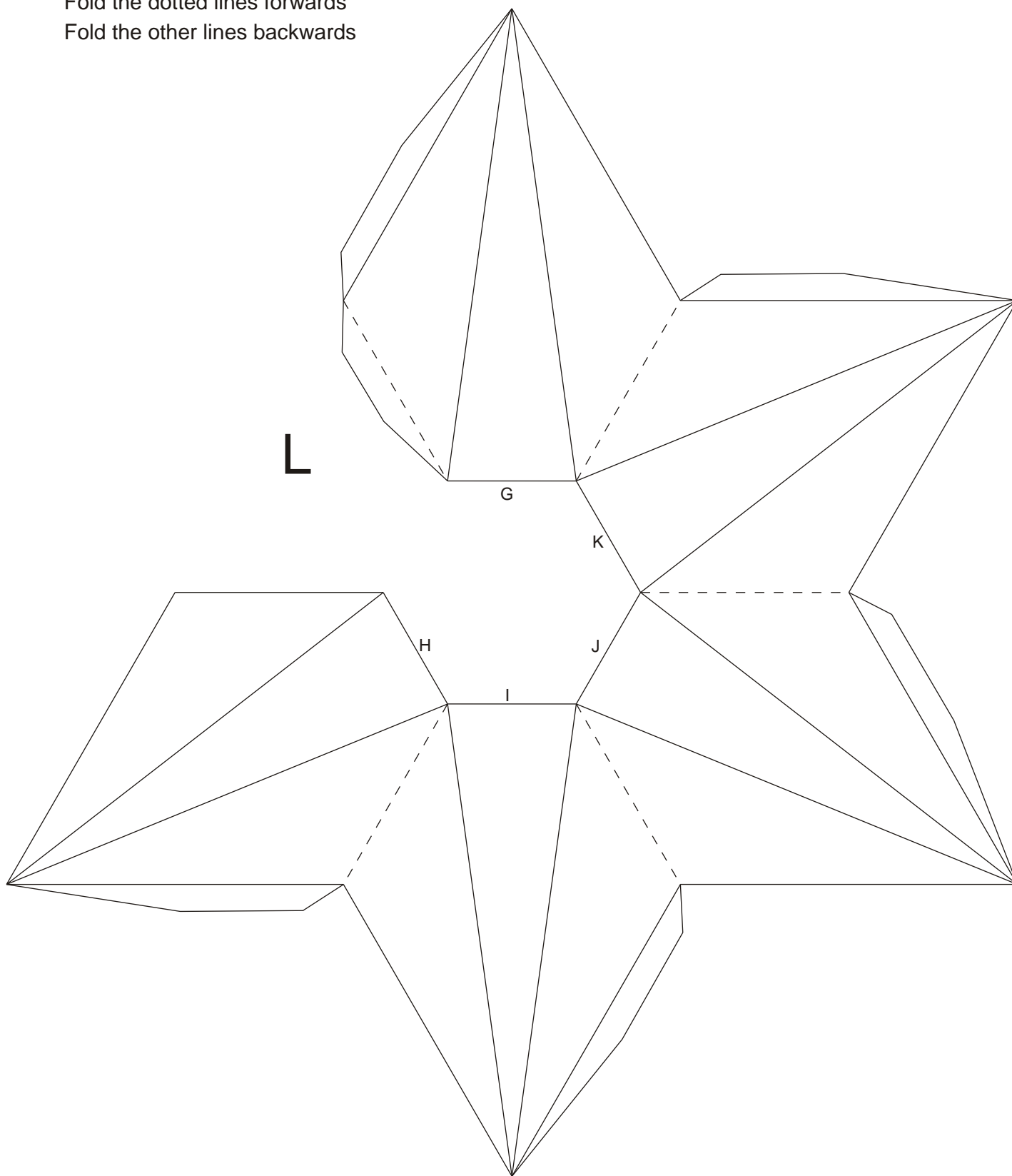

Triangular prisms

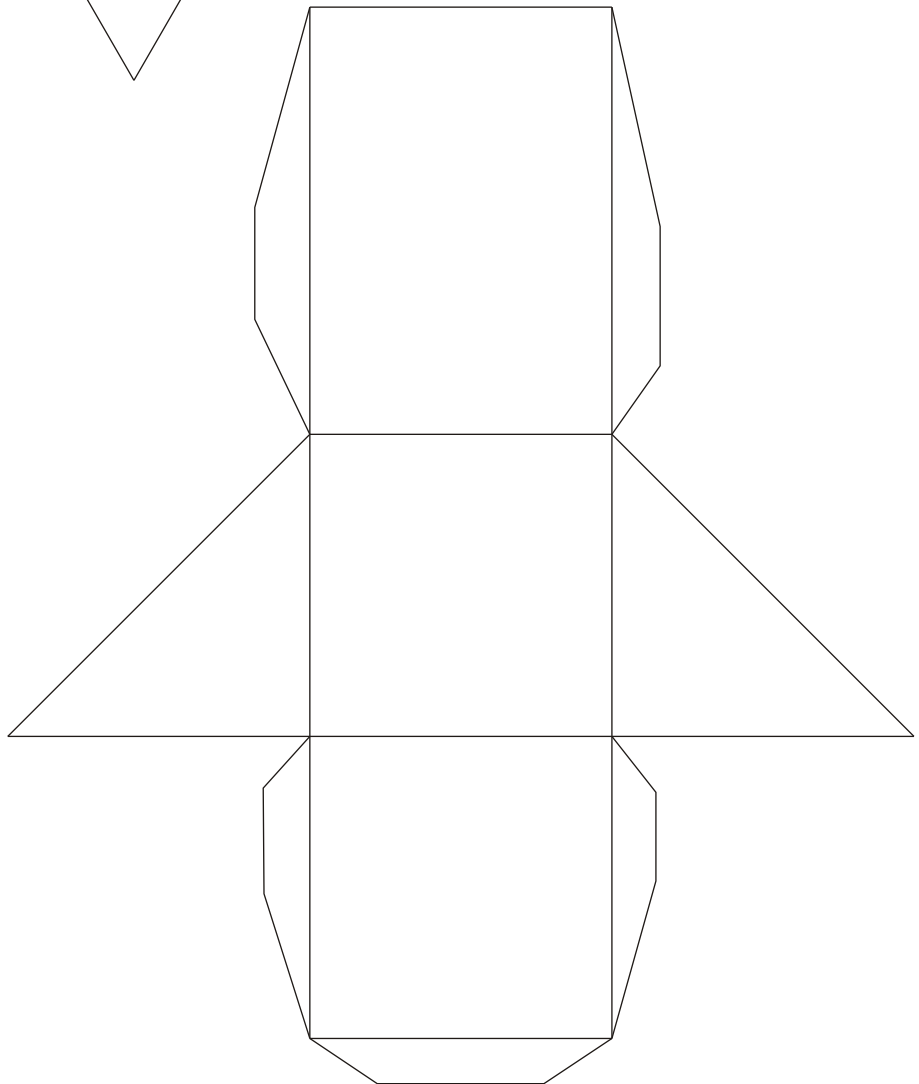
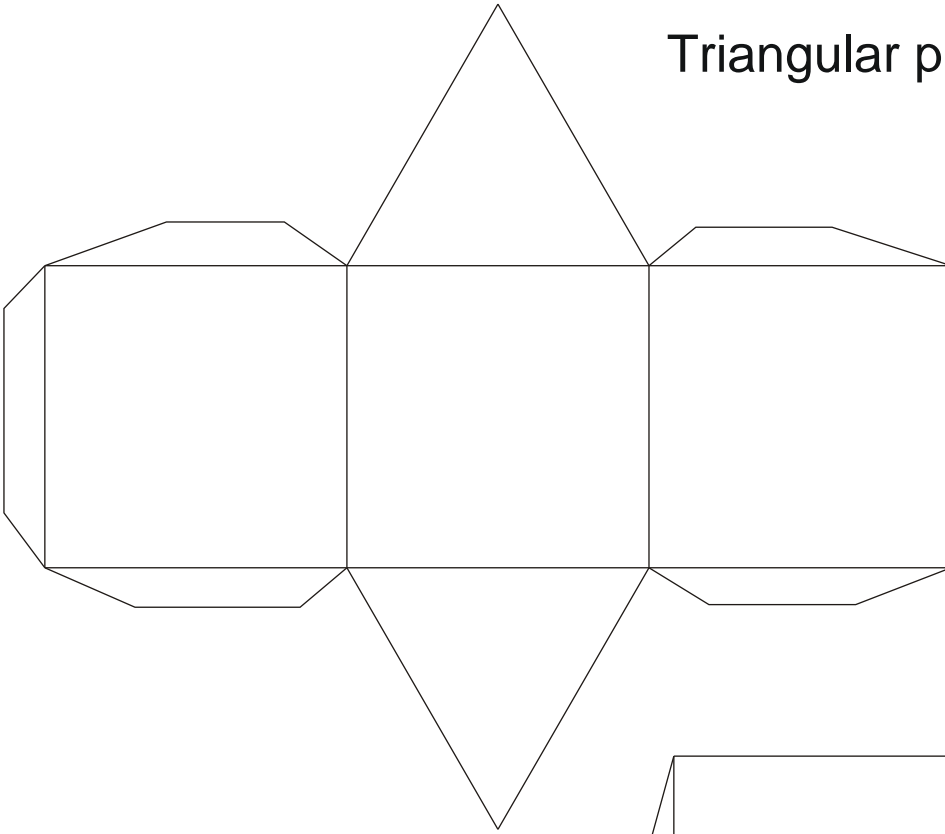

Pentagonal Prism

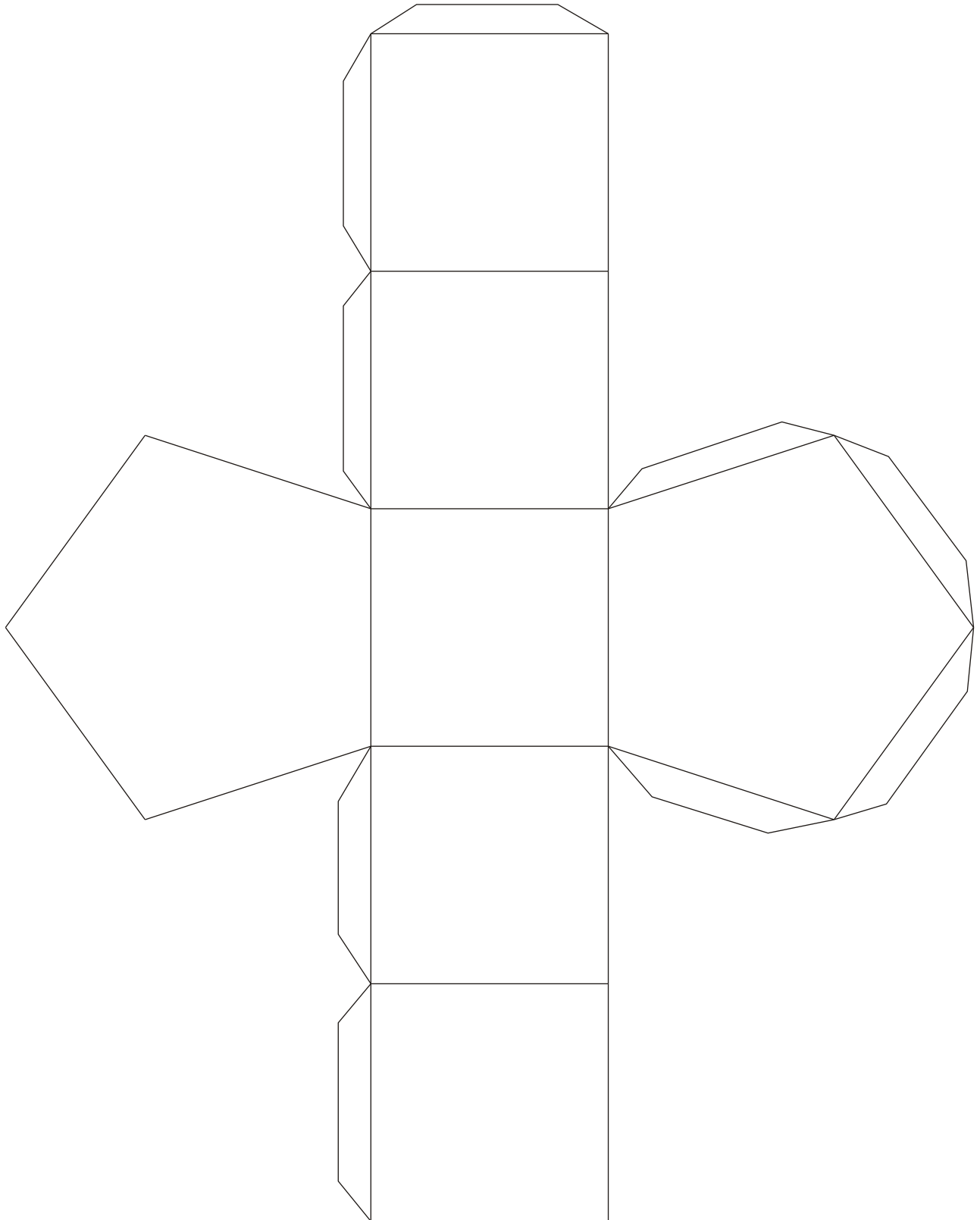

Pentagonal Antiprism

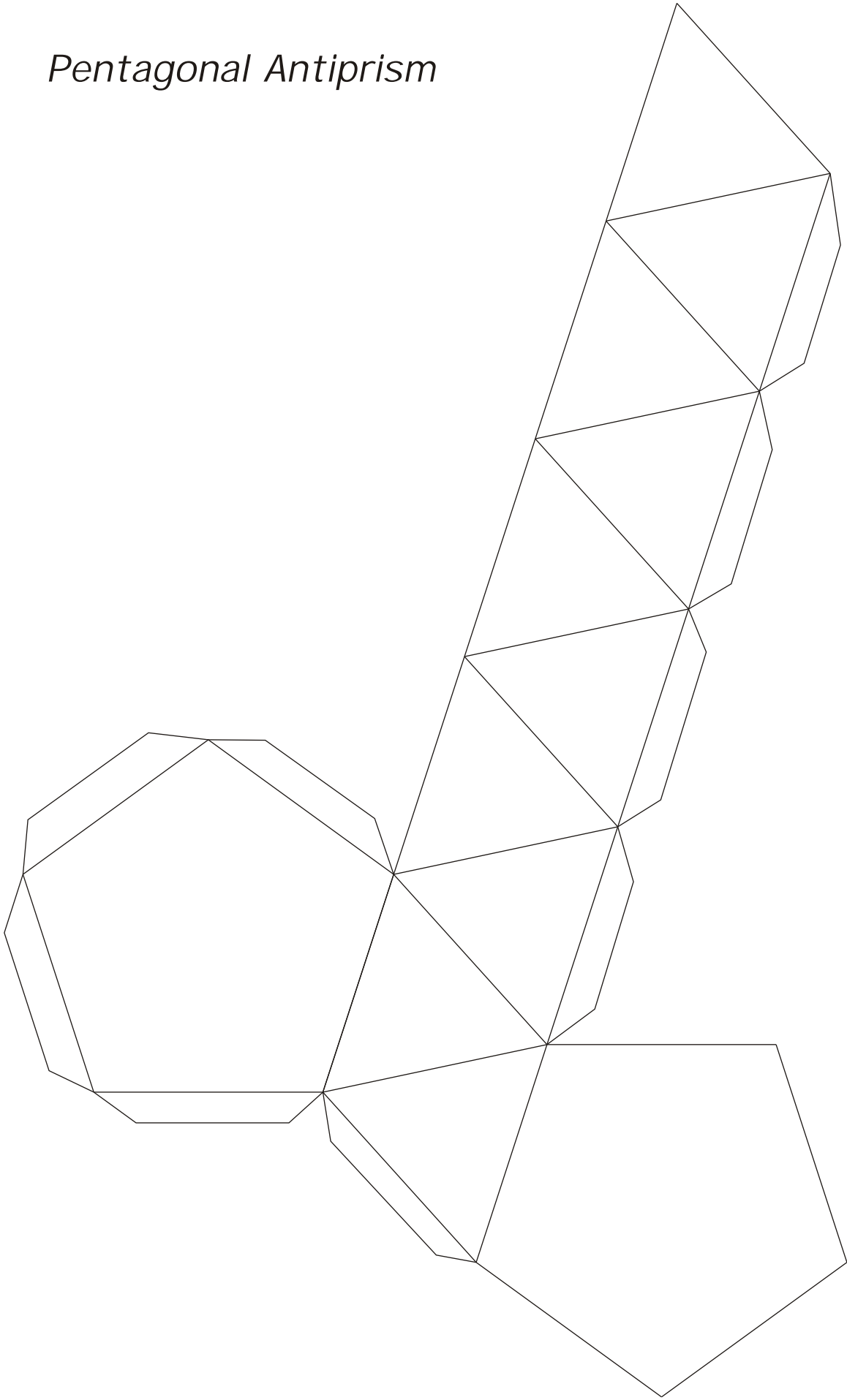

Octagonal Prism

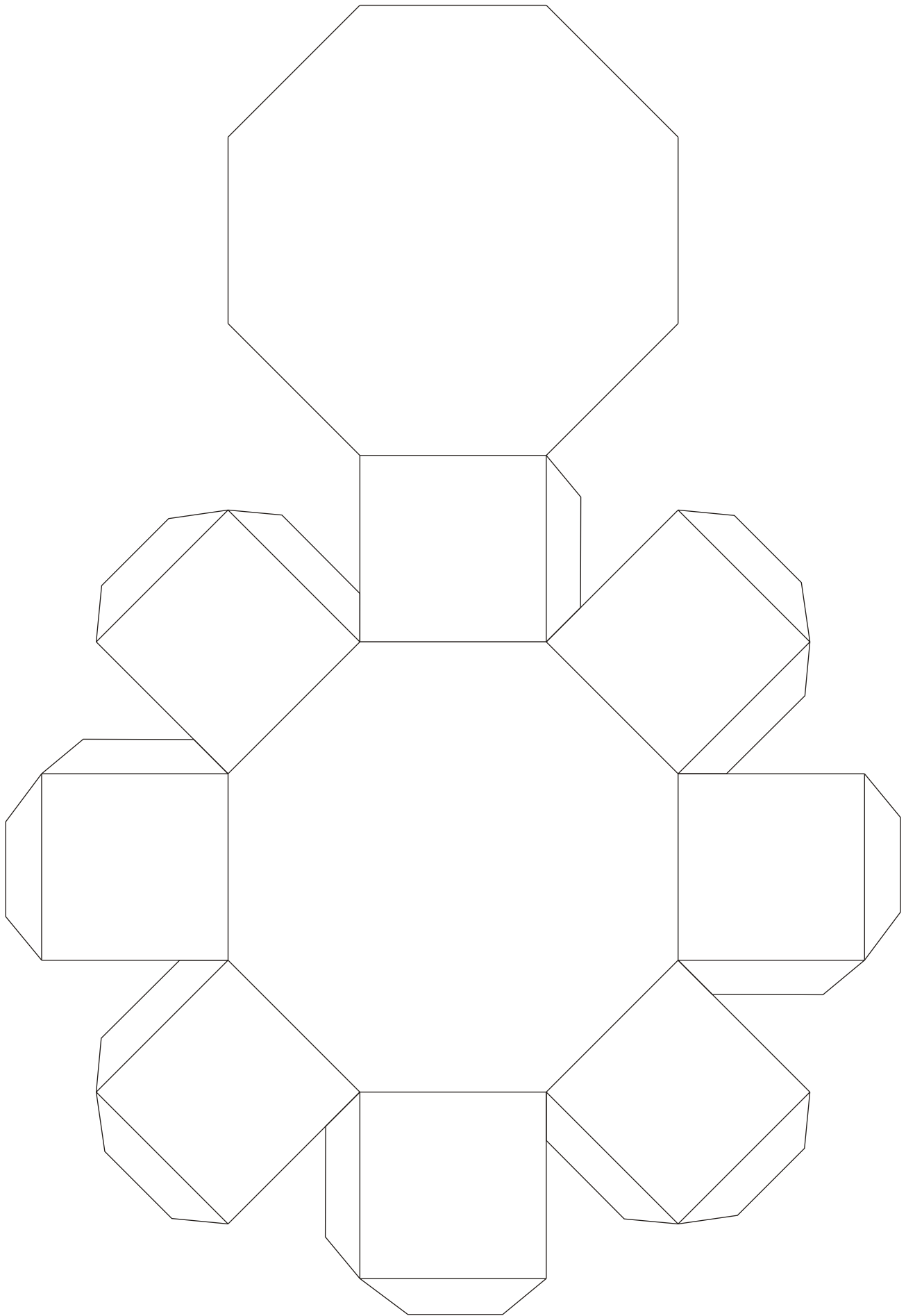

Octagonal Antiprism

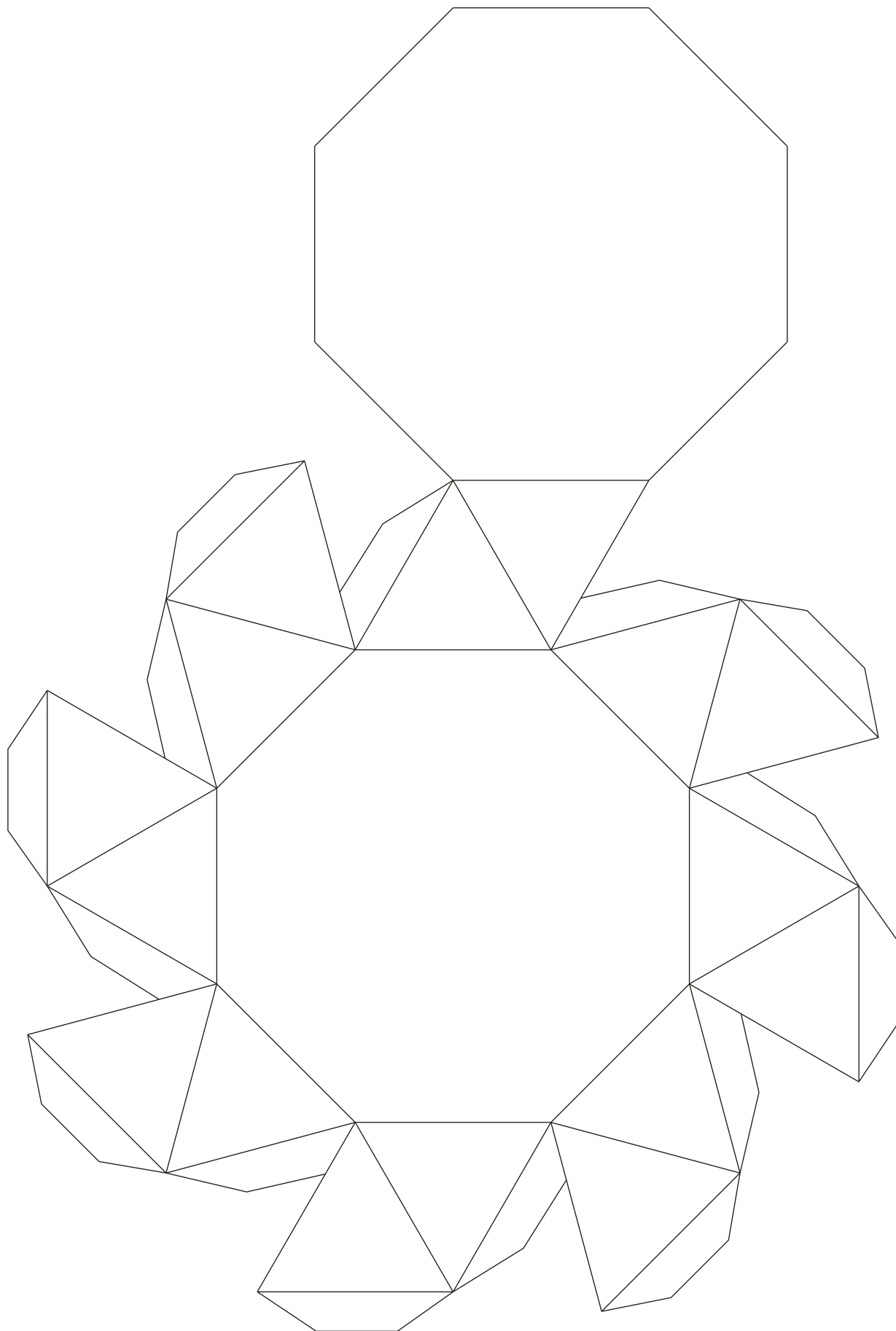

Pentagrammic Prism

Fold the dotted lines forwards

Fold the other lines backwards

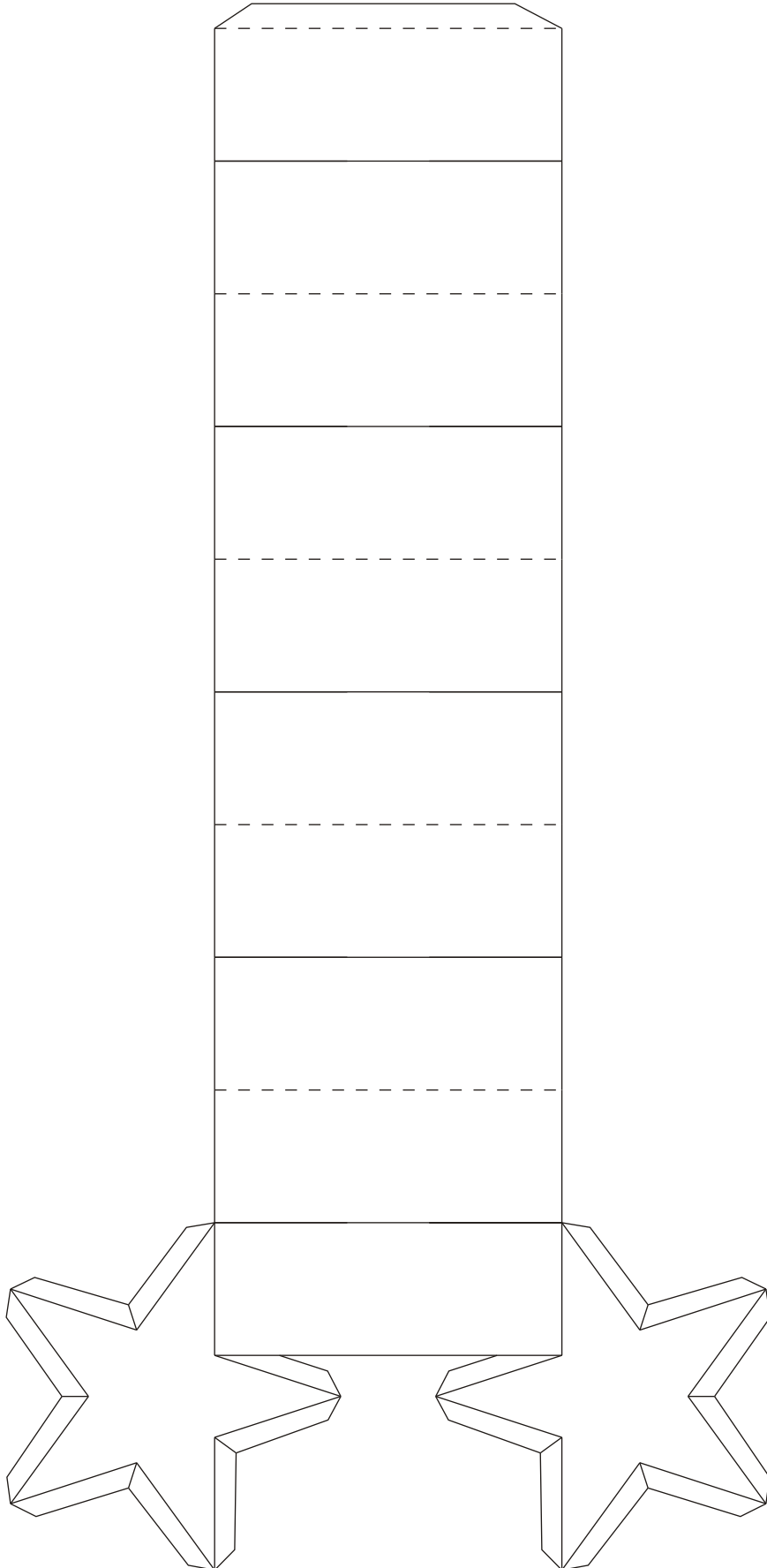

Pentagrammic Antiprism

Fold the dotted lines forwards

Fold the other lines backwards

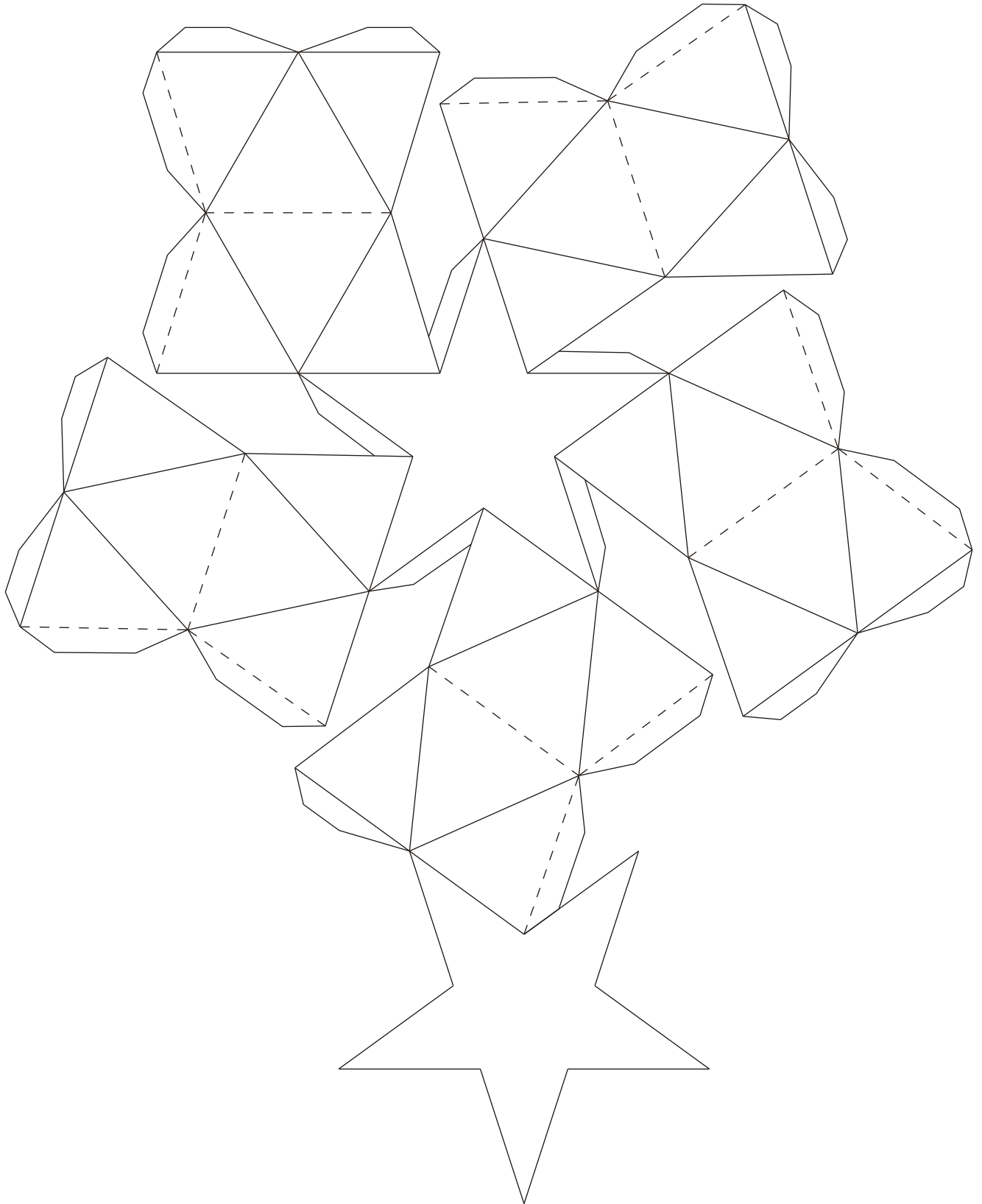

Hexagrammic Prism

Fold the dotted lines forwards

Fold the other lines backwards

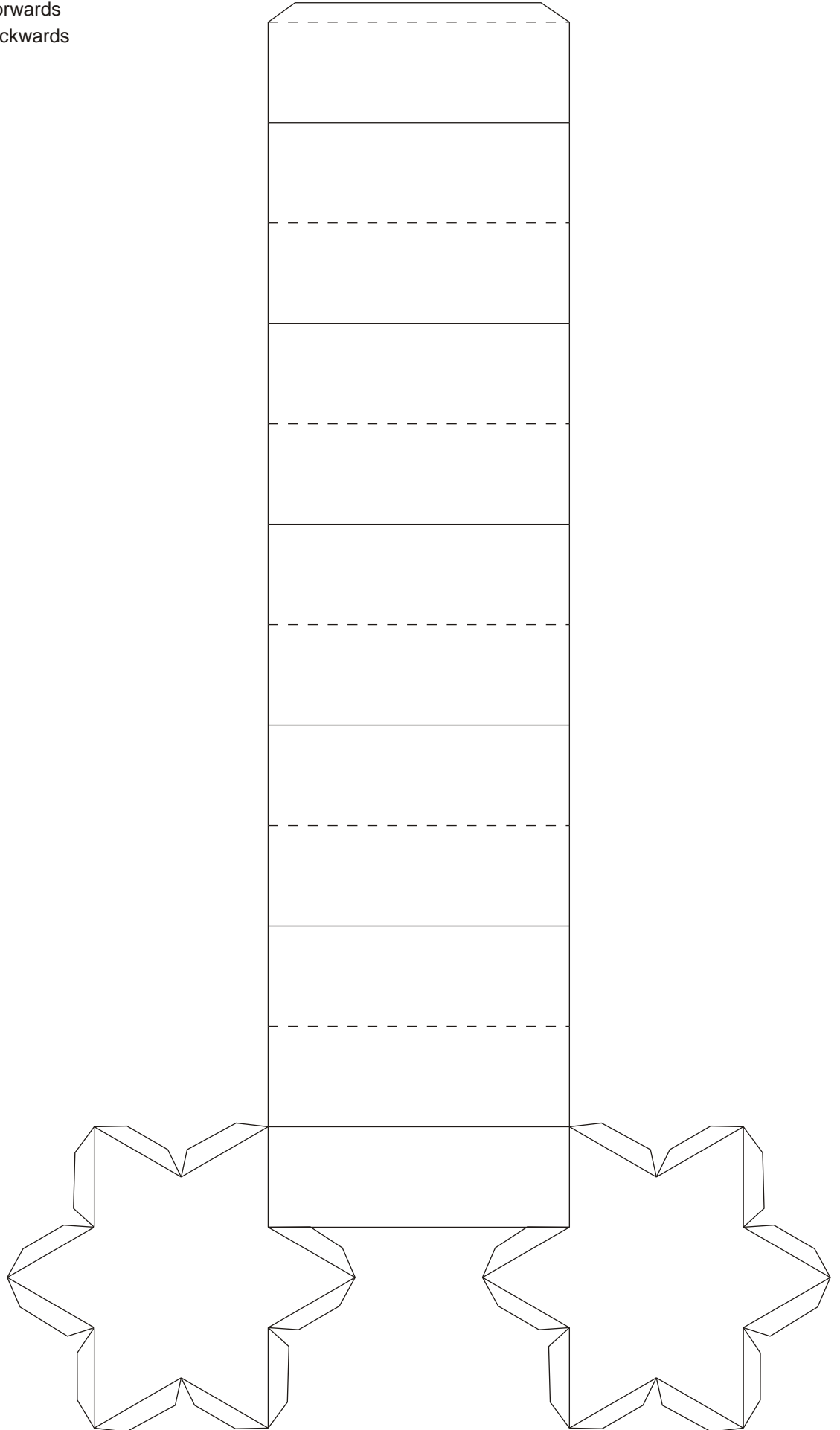

Hexagrammic Antiprism

Fold the dotted lines forwards

Fold the other lines backwards

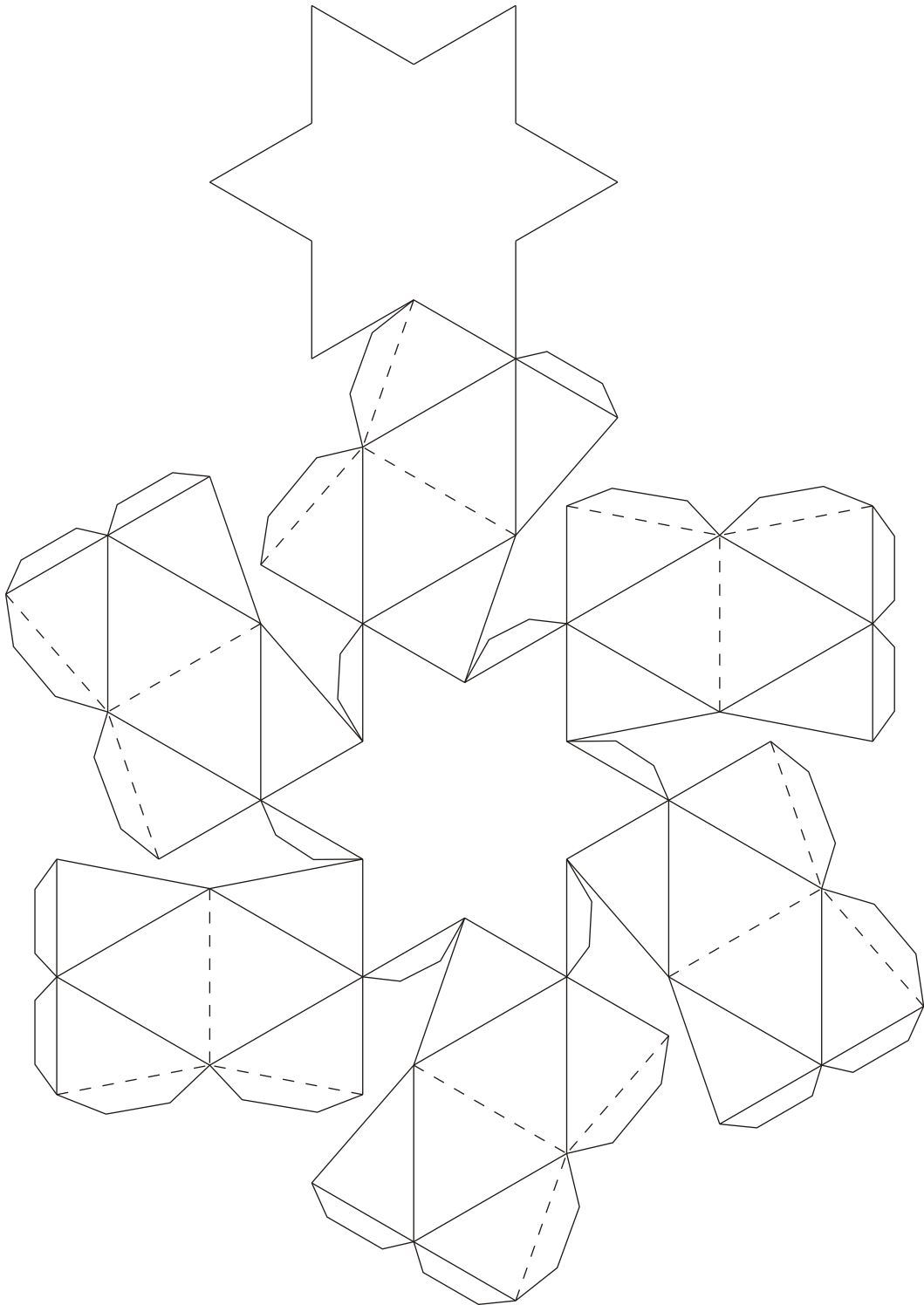

Twisted rectangular prism (45 degrees)

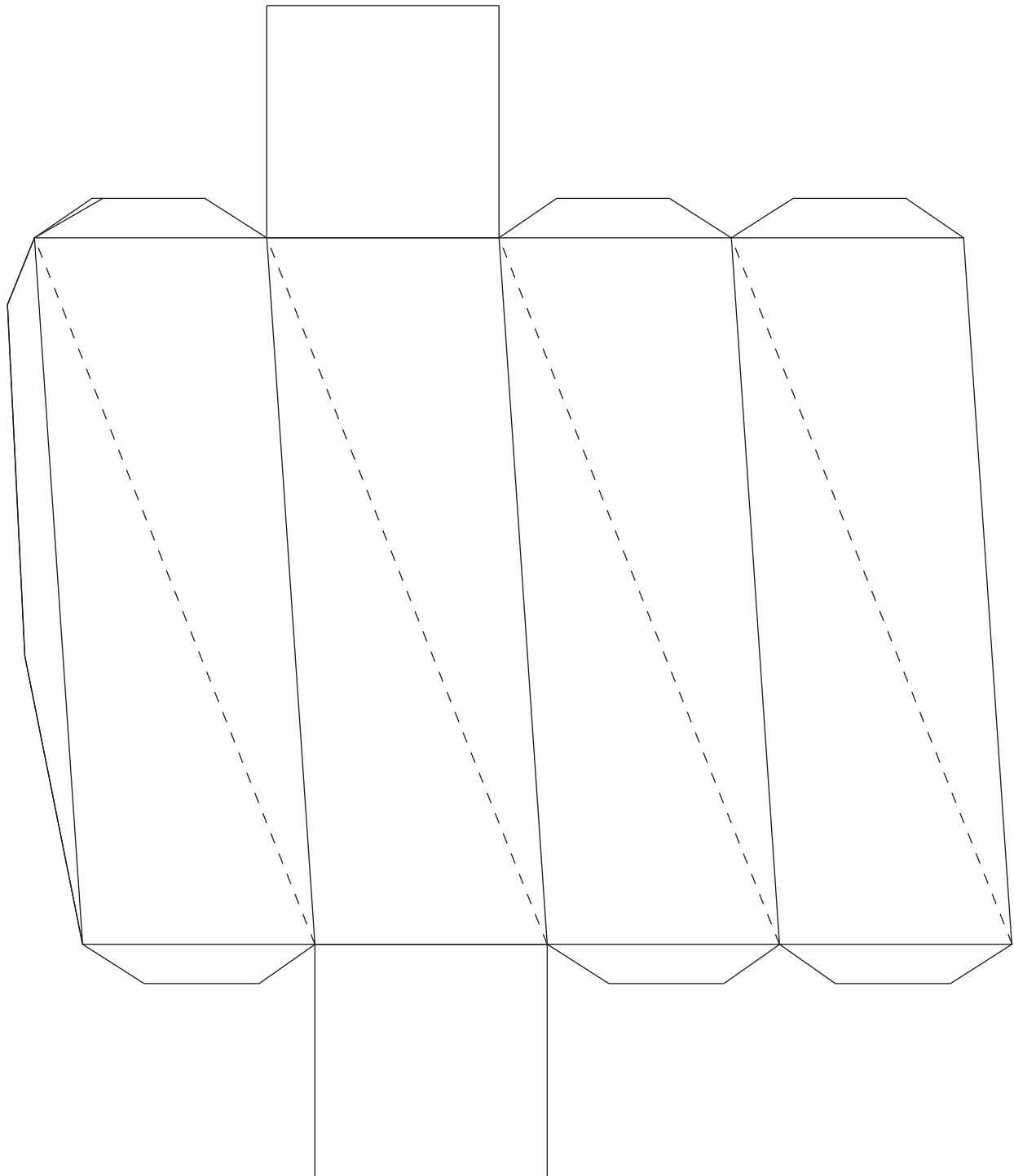

Twisted rectangular prism (90 degrees)

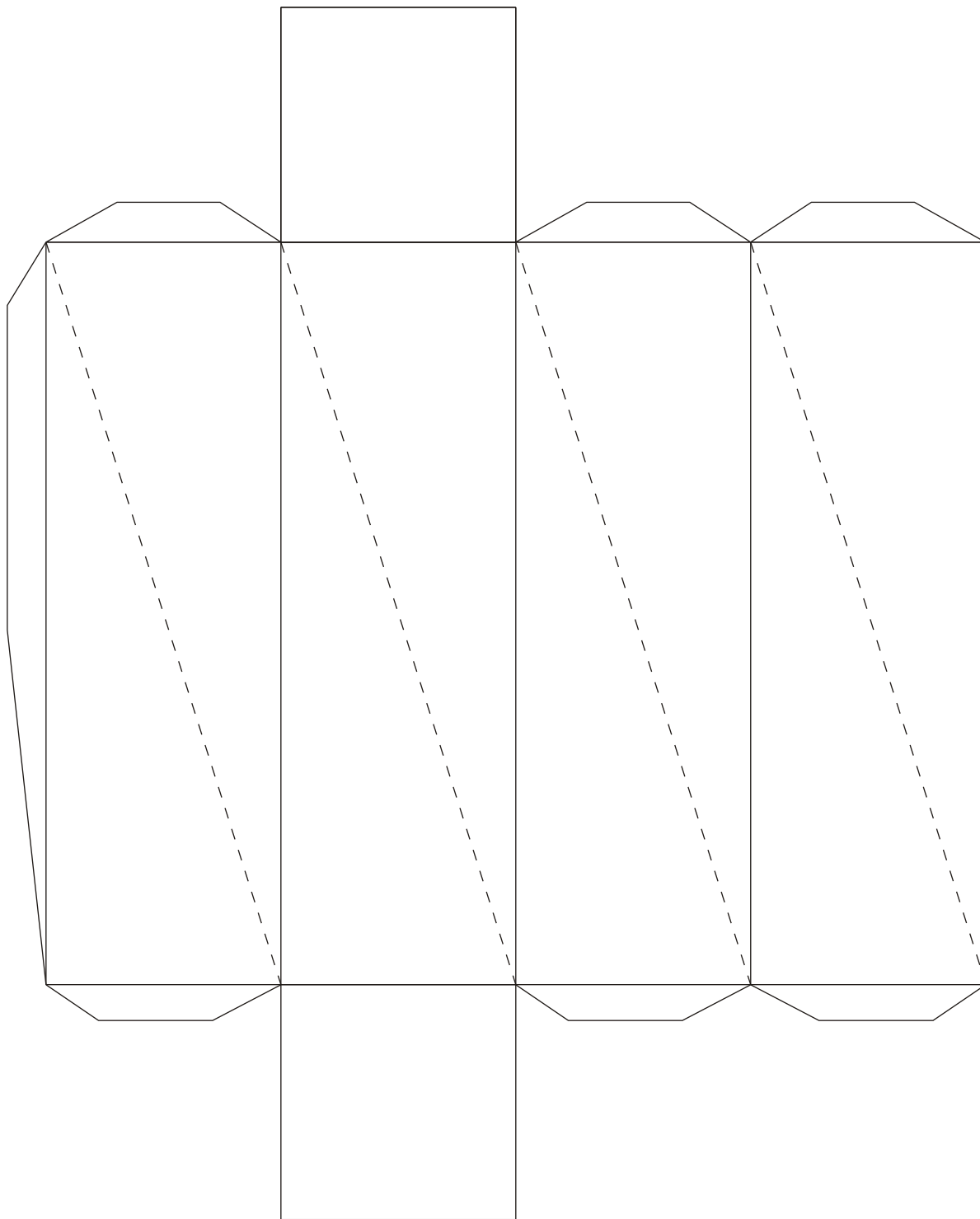

Twisted rectangular prism (+ 45 -45 degrees)

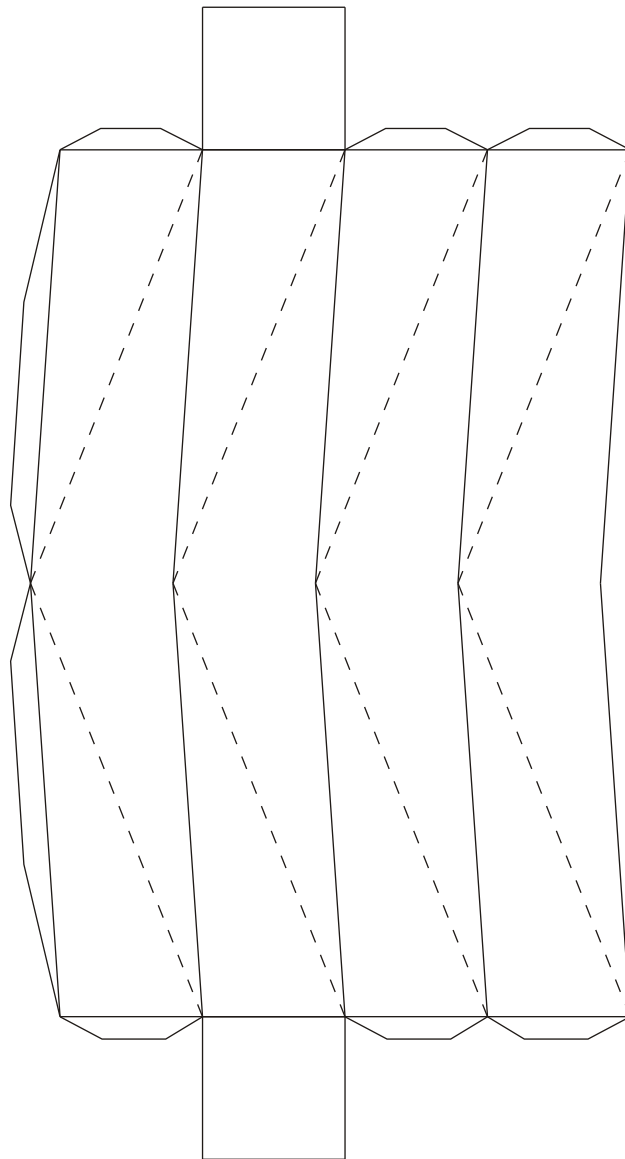

Kaleidocyclus

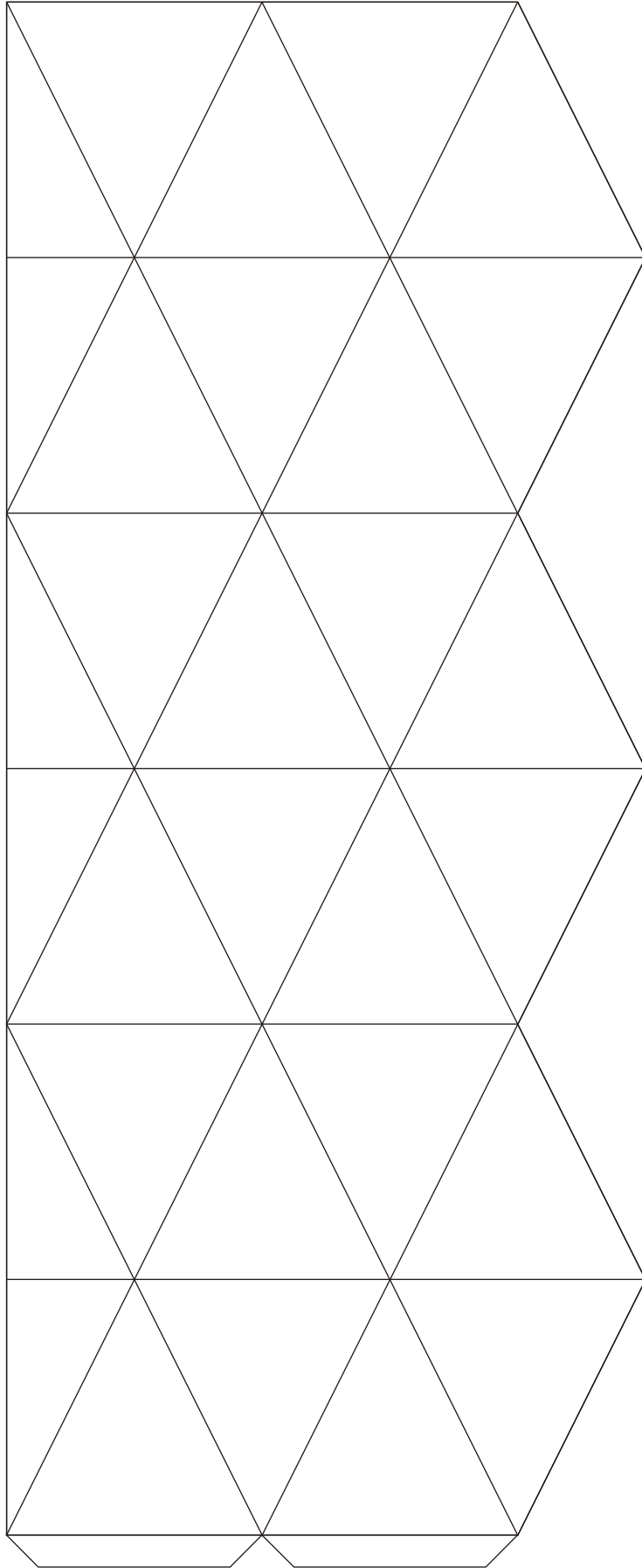

Caleidocycclus 8

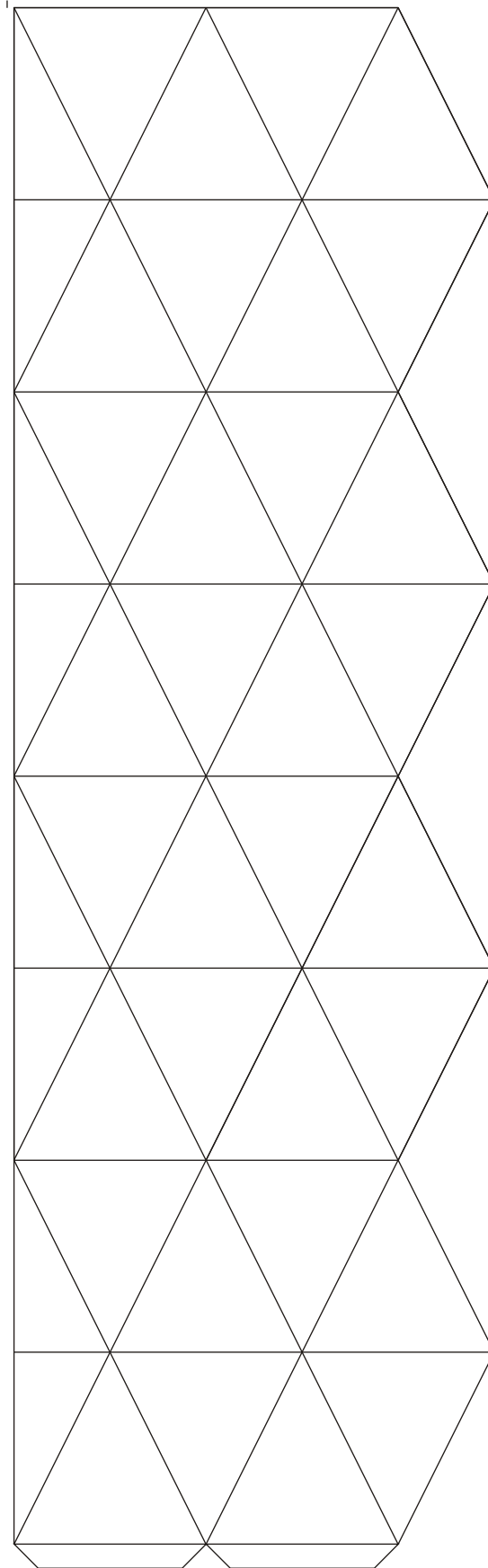

Caleidocyclus 10

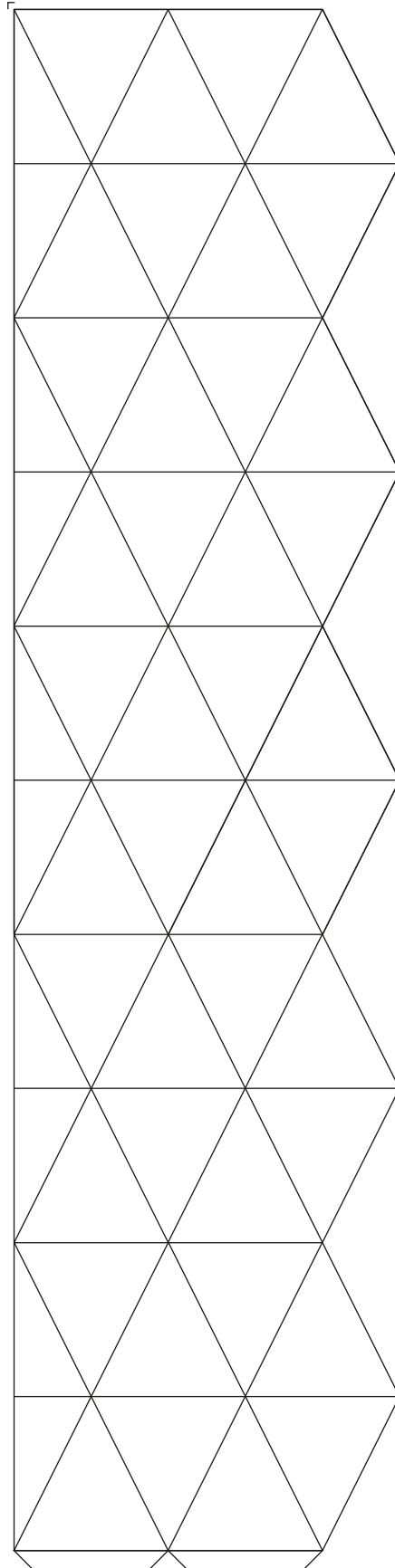

Cylinder

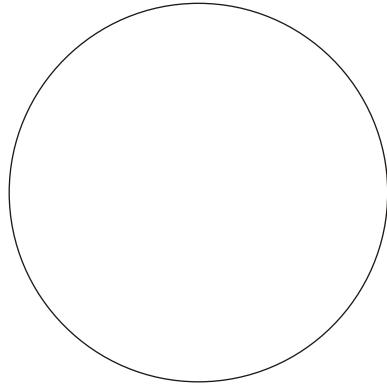
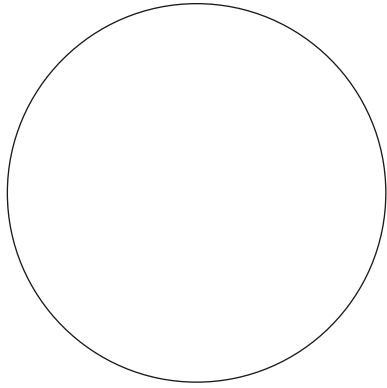

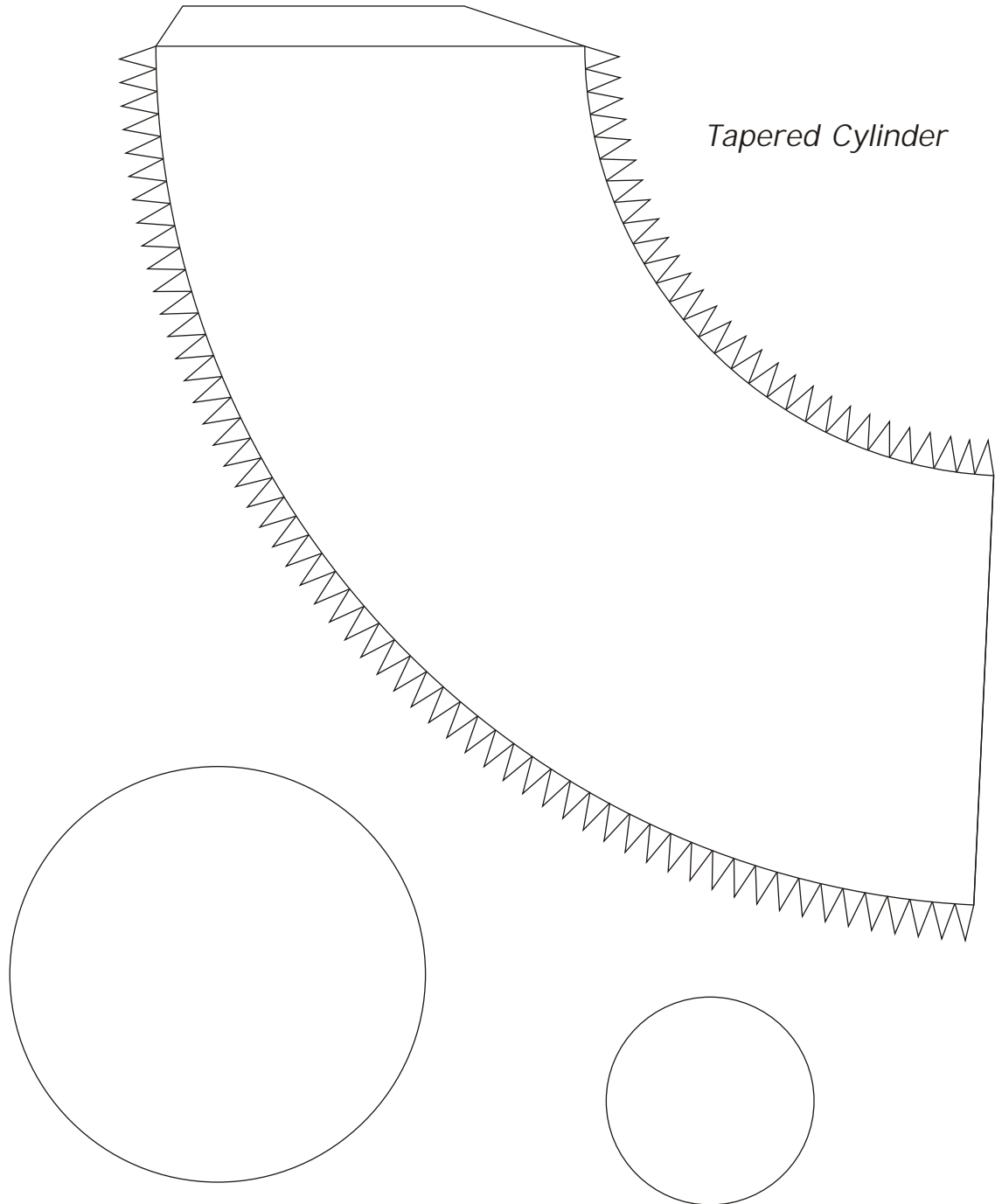

Tapered Cylinder

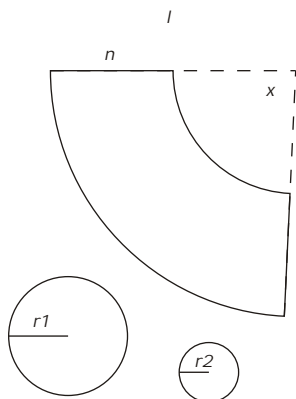

$$l = \sqrt{r^2 + h^2}$$

$$c = 2 \pi r1$$

$$x = 360.2 \cdot \frac{\pi \cdot l}{c}$$

$$d = c \cdot n / l$$

r1 = radius

r2 = radius

c = circumference of circle 1

d = circumference of circle 2

x = angle of the part of the large circle

l = radius of the large circle

h = height of the cone

i = height of the tapered cylinder

π = pi = 3.1415

Cone

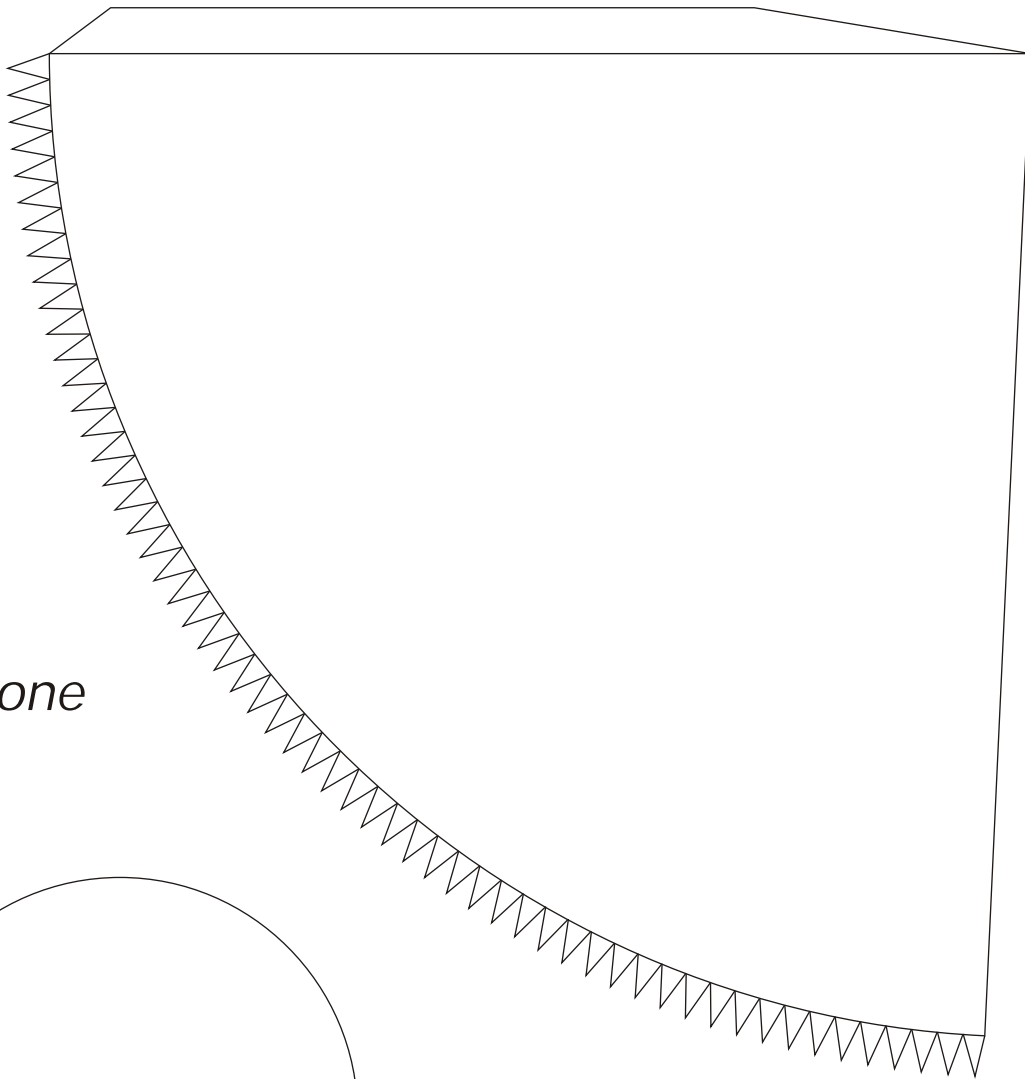
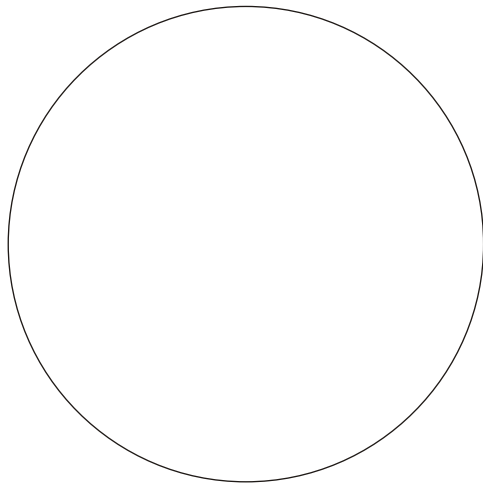

$$l = \sqrt{r^2 + h^2}$$

$$c = 2 \pi r$$

$$x = 360.2 \cdot \pi \cdot l / c$$

r = radius
c = circumference of the circle
x = angle of the part of the large circle
l = radius of the large circle
h = height of the cone
 π = pi = 3.1415

Asymmetric Cone

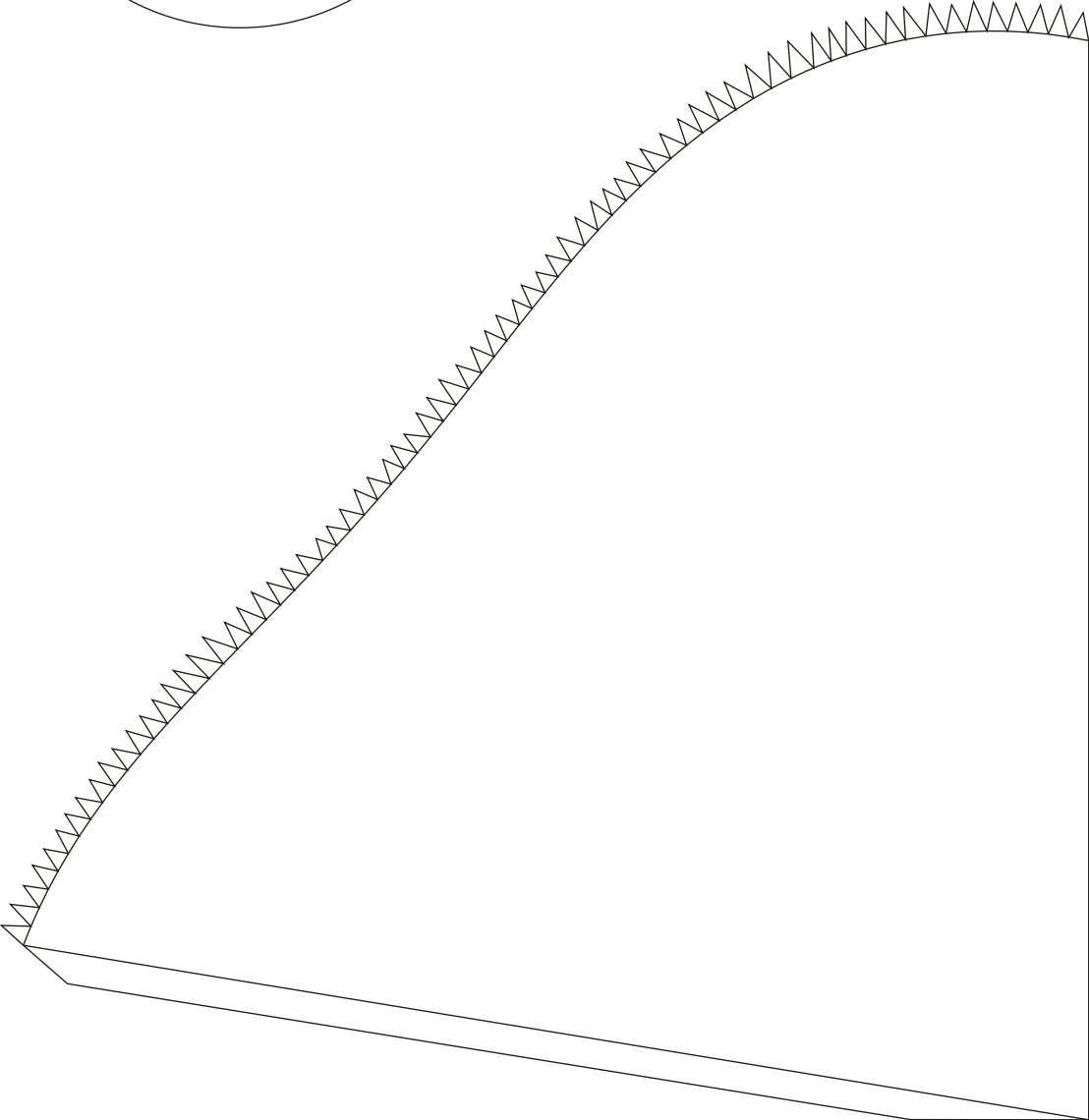
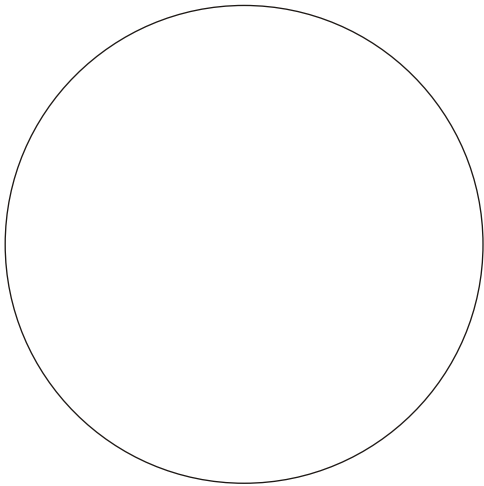

Square Cone

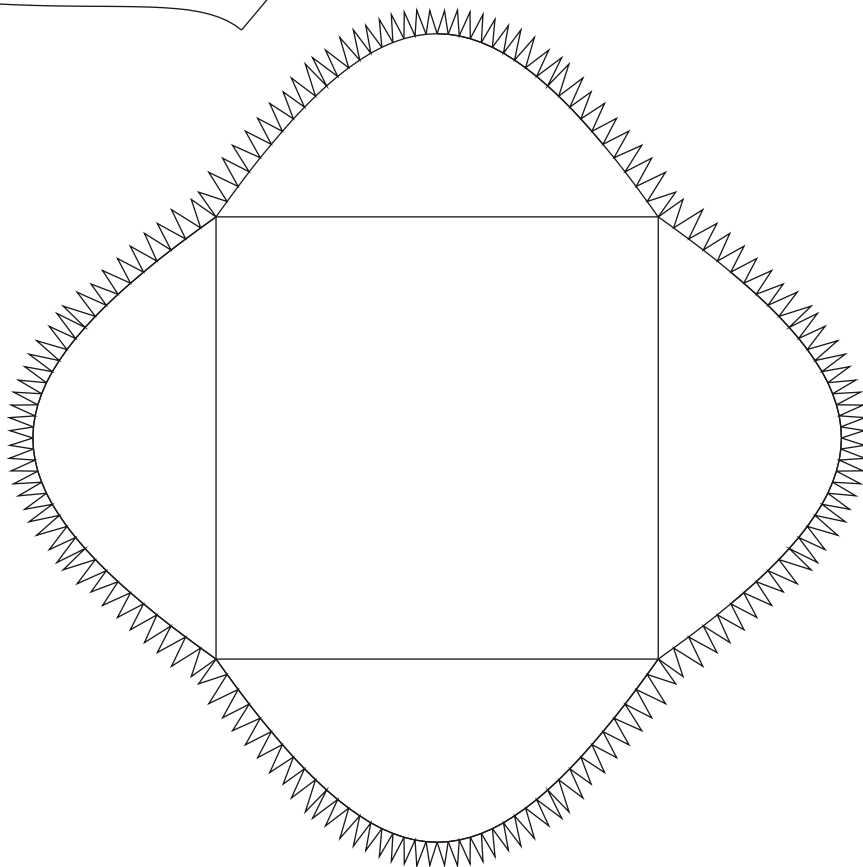
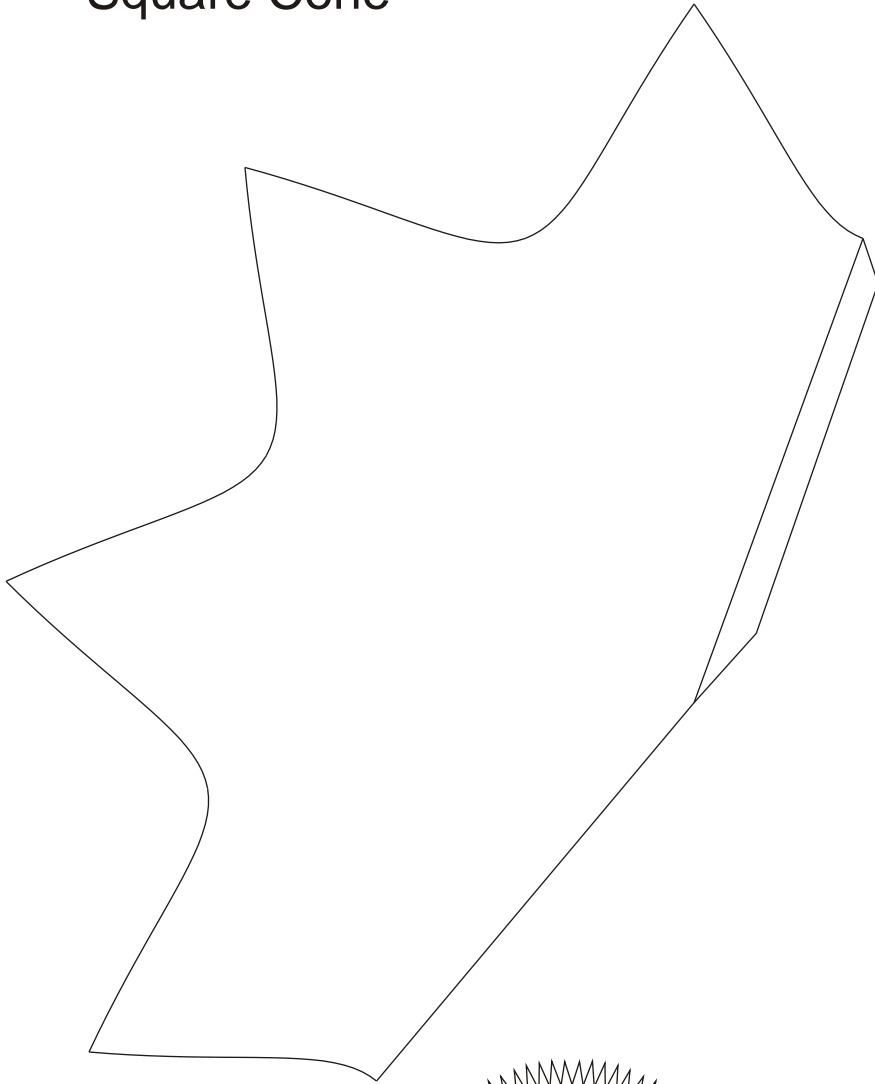

Square Cone

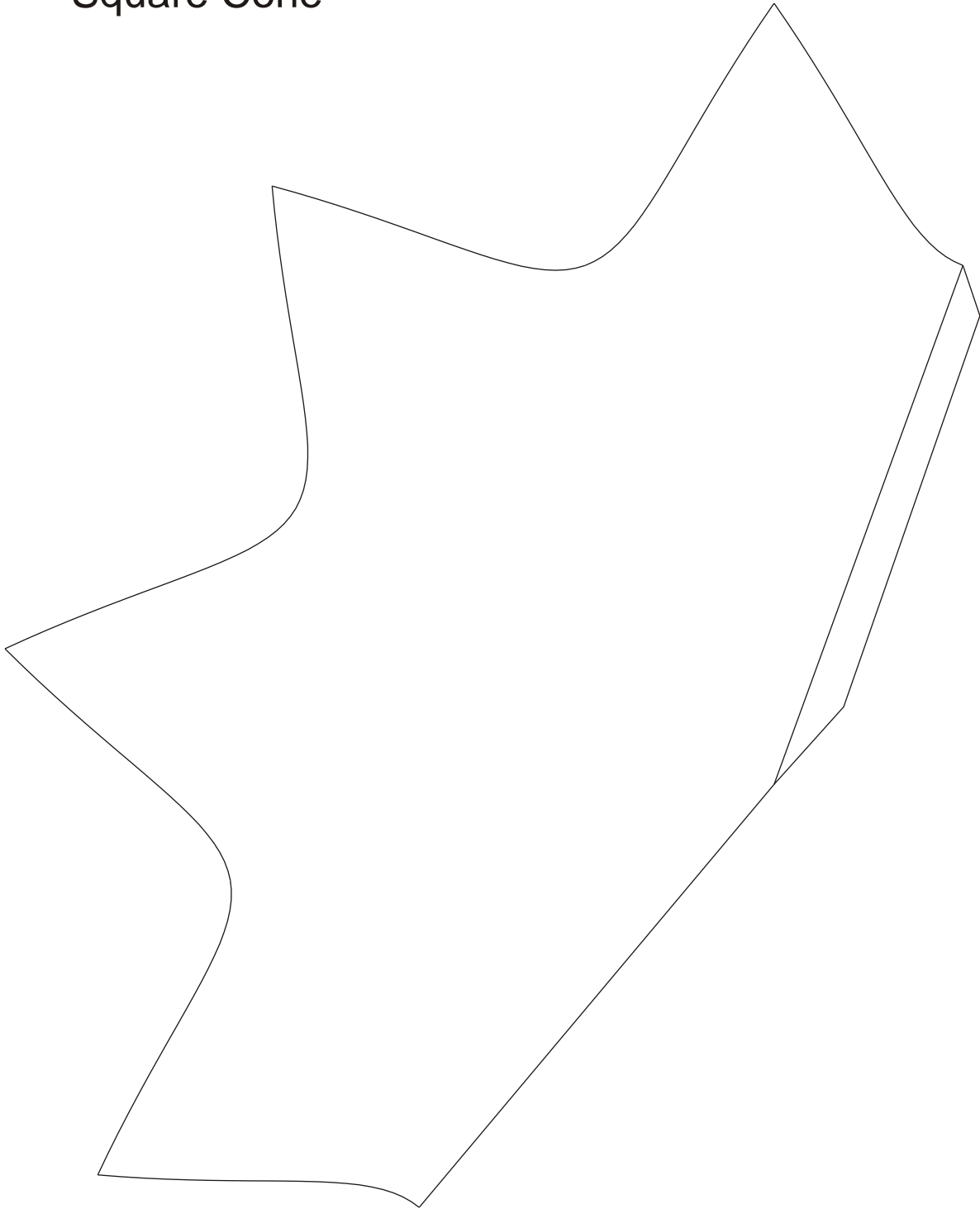

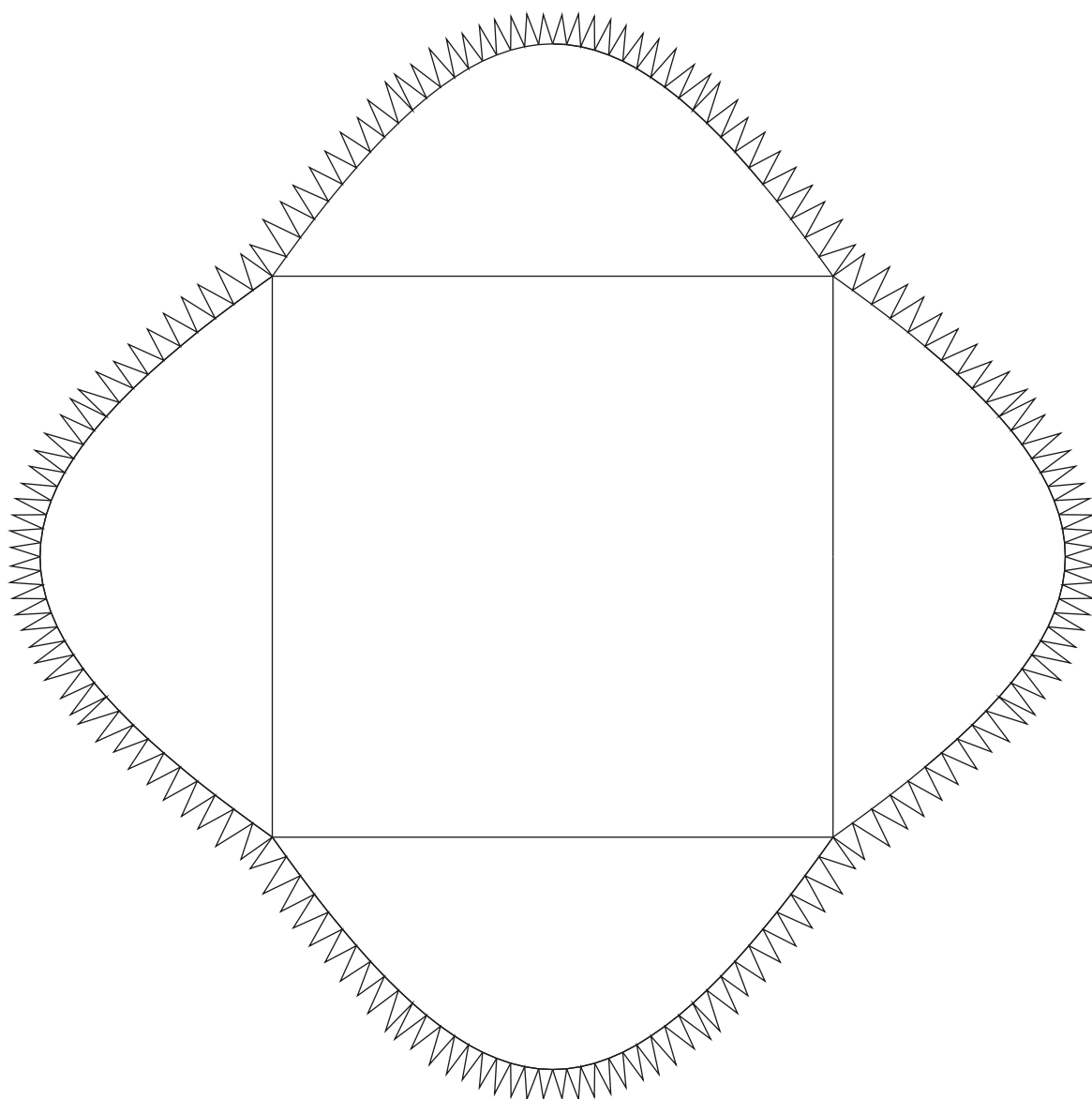

Paper Colour 1/ papier kleur1

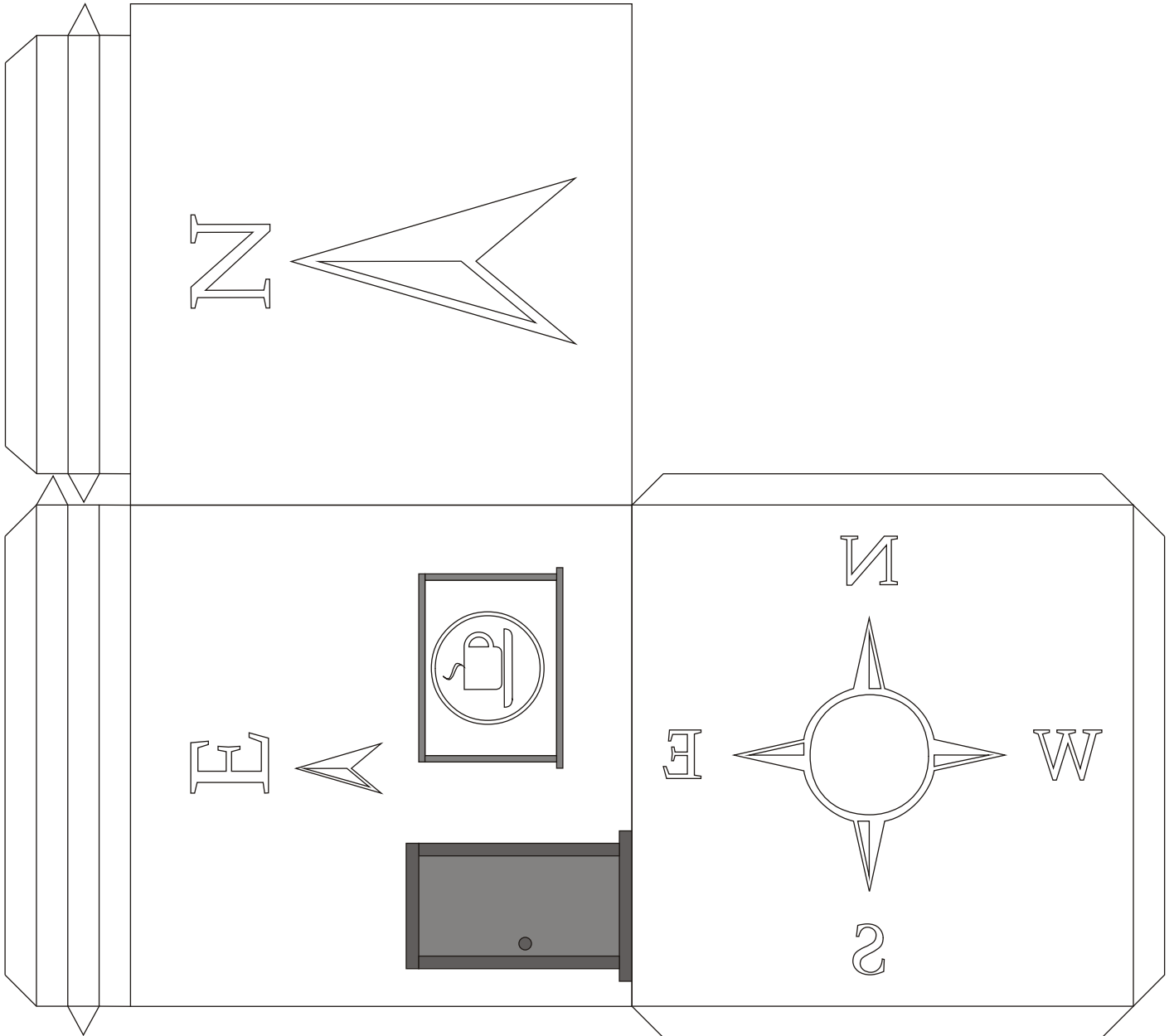

noordelijke, oostelijke muur huis en de bodem

north, east wall of the house and the floor

Paper Colour 1/ papier kleur1

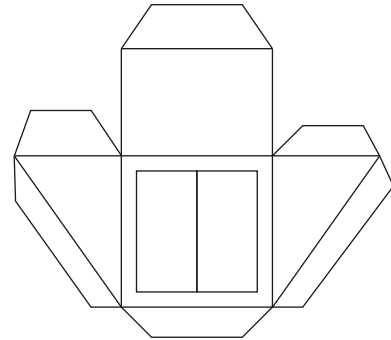
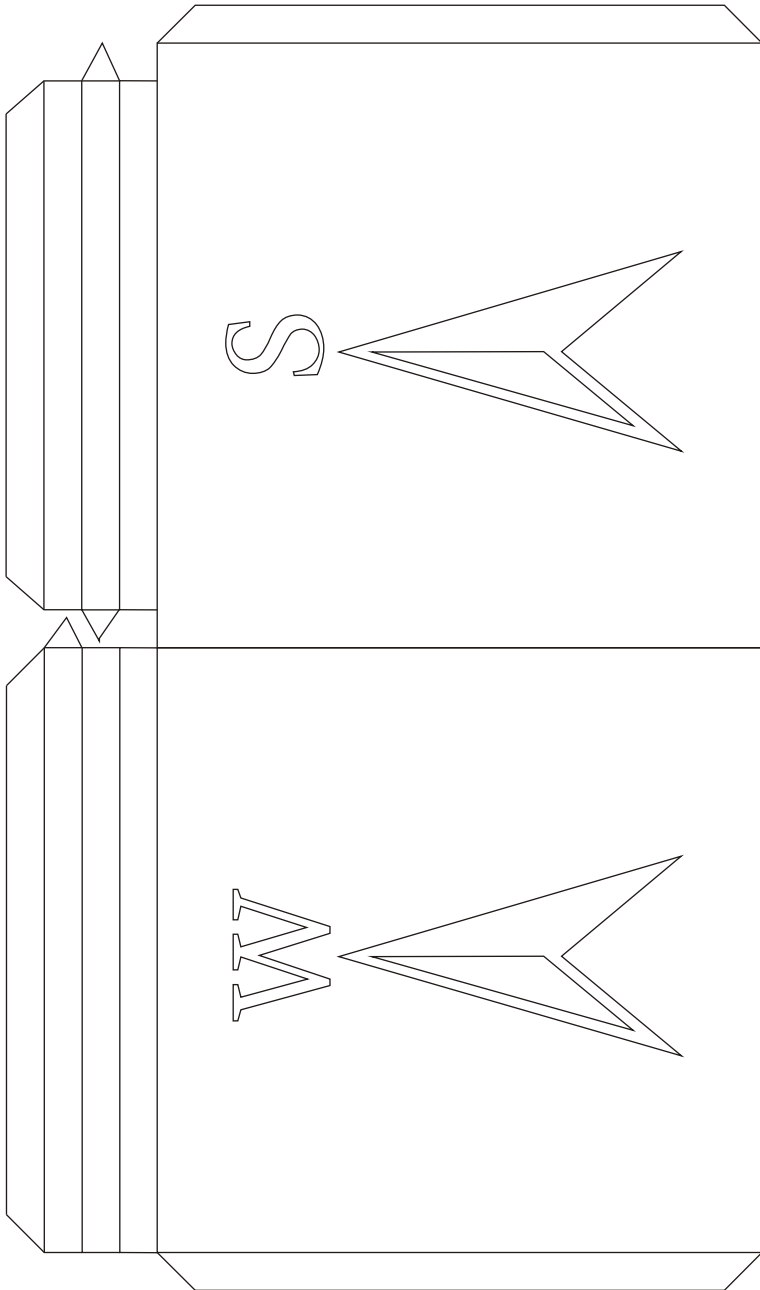

dakkapel
dormer-window

zuidelijke en westelijke muur huis
south and west wall house

paper colour 2 / papier kleur 2

onderkantdak plus twee zijden
two sides of the roof

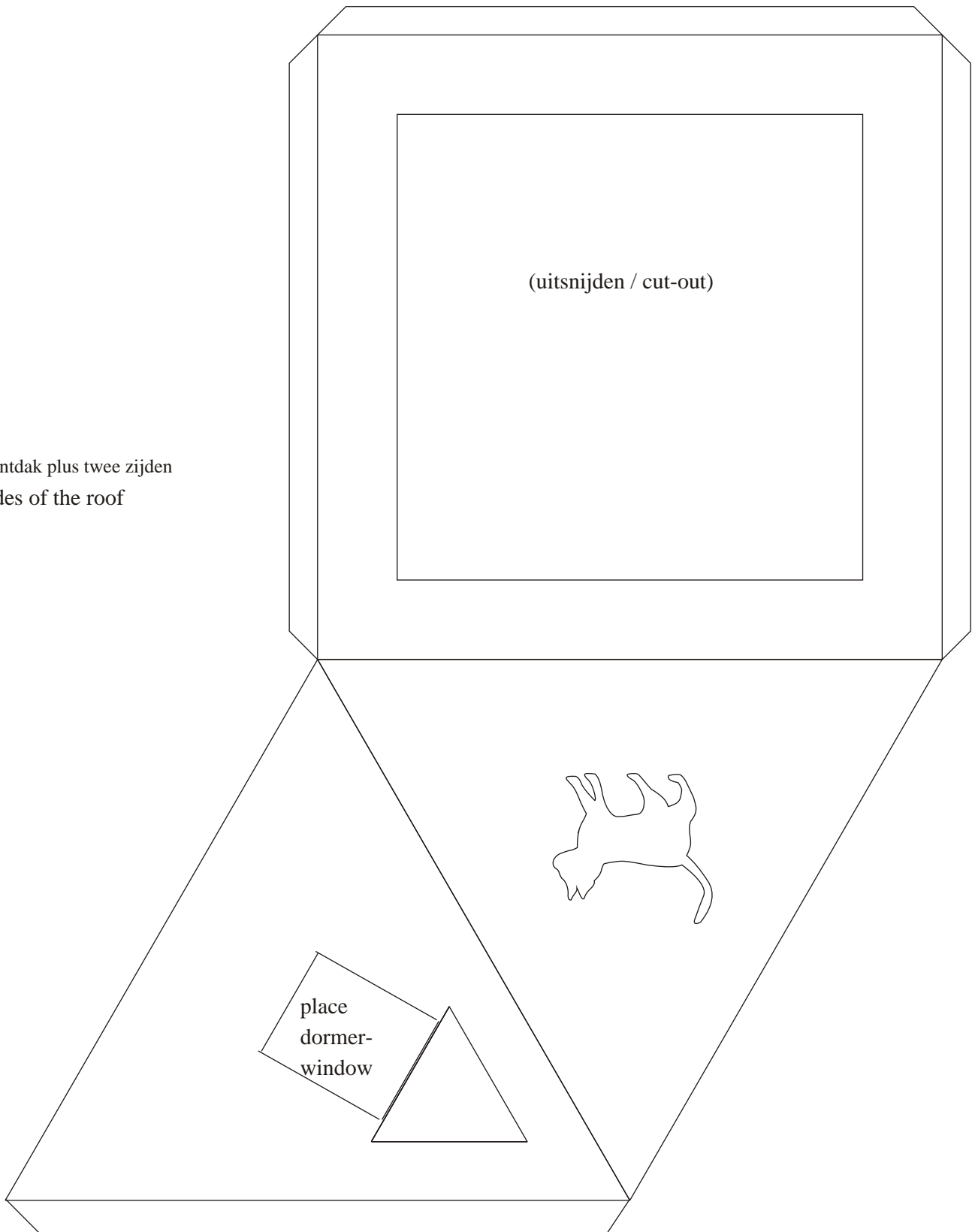

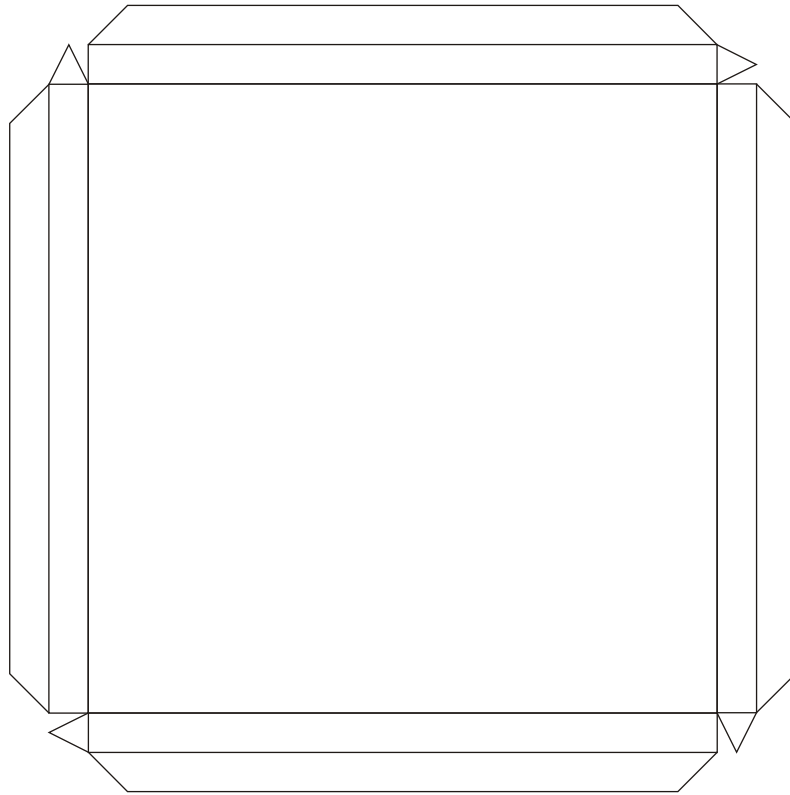

onderkant dak/
bottom roof
fits around walls
don't glue roof on the
walls

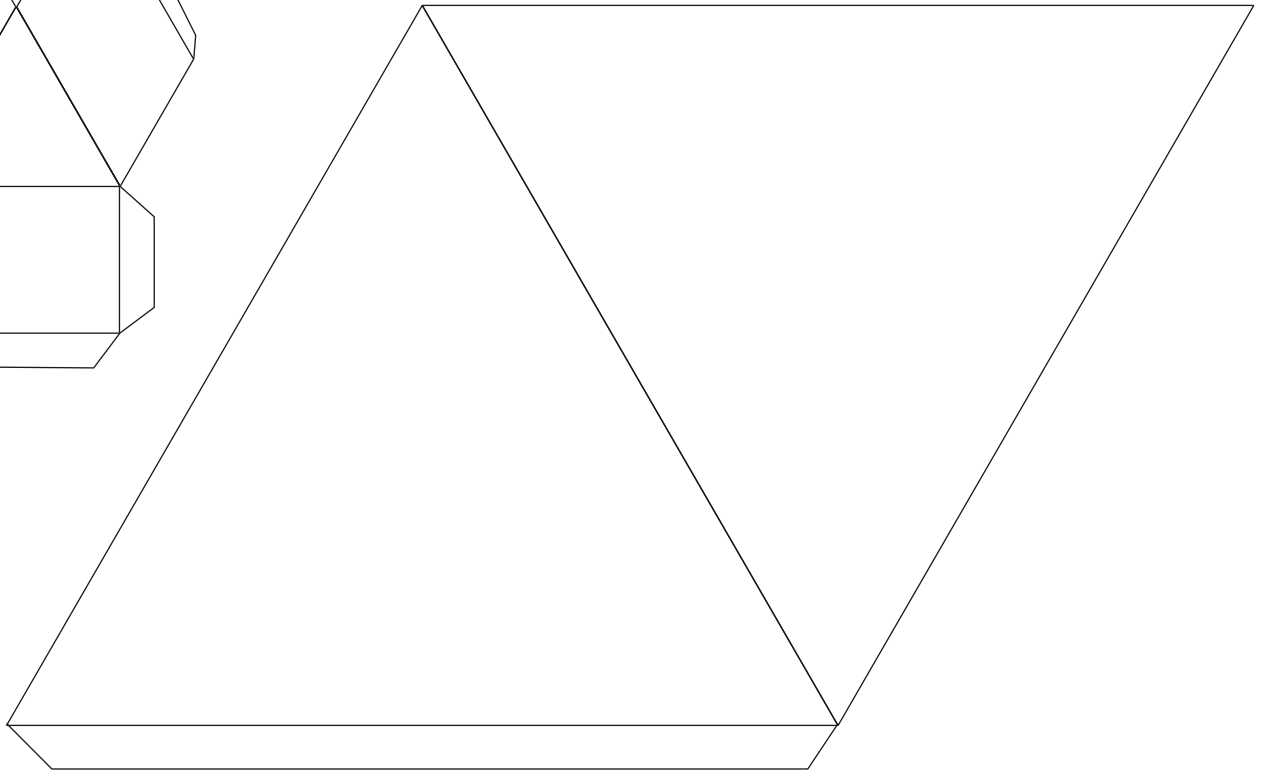
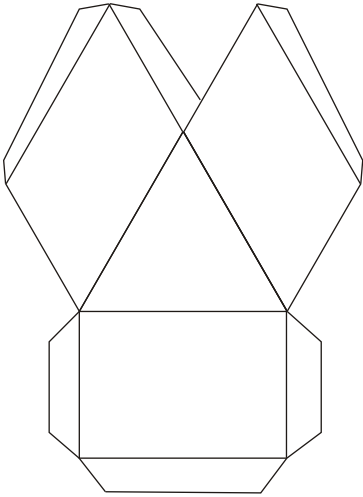

Twee zijden dak
Two sides of the roof

paper colour 2 / papier kleur 2

Paper Colour 1/ papier kleur1

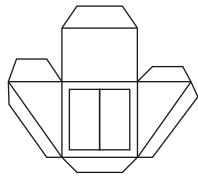
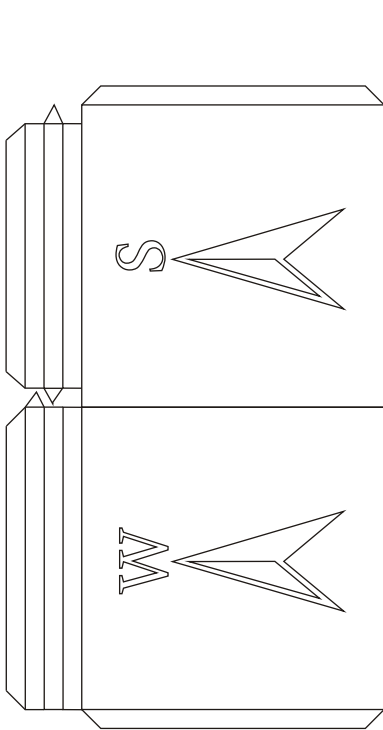

dakkapel
dormer-window

zuidelijke en westelijke muur huis
south and west wall house

Paper Colour 1/ papier kleur1

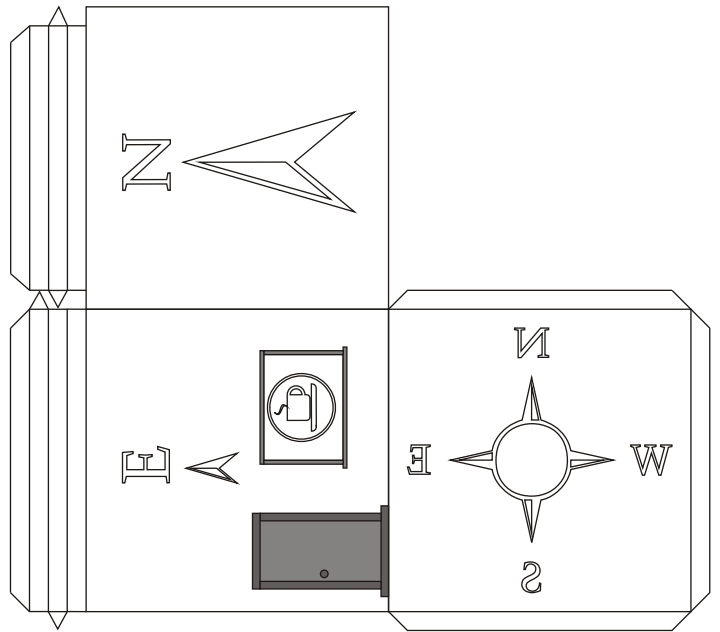

noordelijke, oostelijke muur huis en de bodem
north, east wall of the house and the floor

Paper Colour 1/ papier kleur1

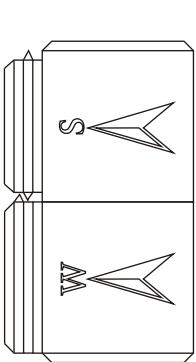

zuidelijke en westelijke muur huis
south and west wall house

Paper Colour 1/ papier kleur1

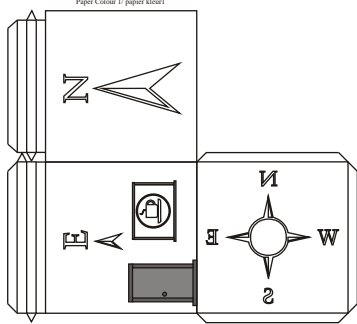

noordelijke, oostelijke muur huis en de bodem
north, east wall of the house and the floor

Paper Colour 1/ papier kleur1

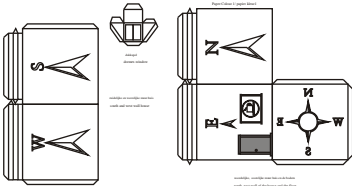

zuidelijke en westelijke muur huis
south and west wall house

noordelijke, oostelijke muur huis en de bodem
north, east wall of the house and the floor

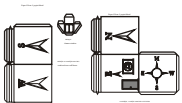

paper colour 2 / papier kleur 2

onderkantdak plus twee zijden
two sides of the roof

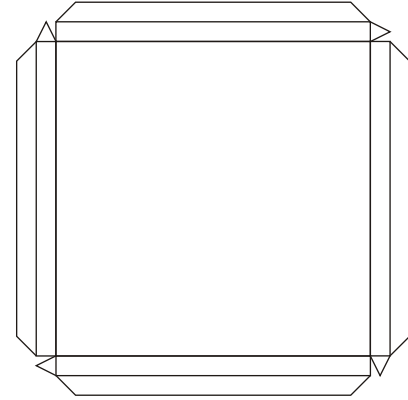
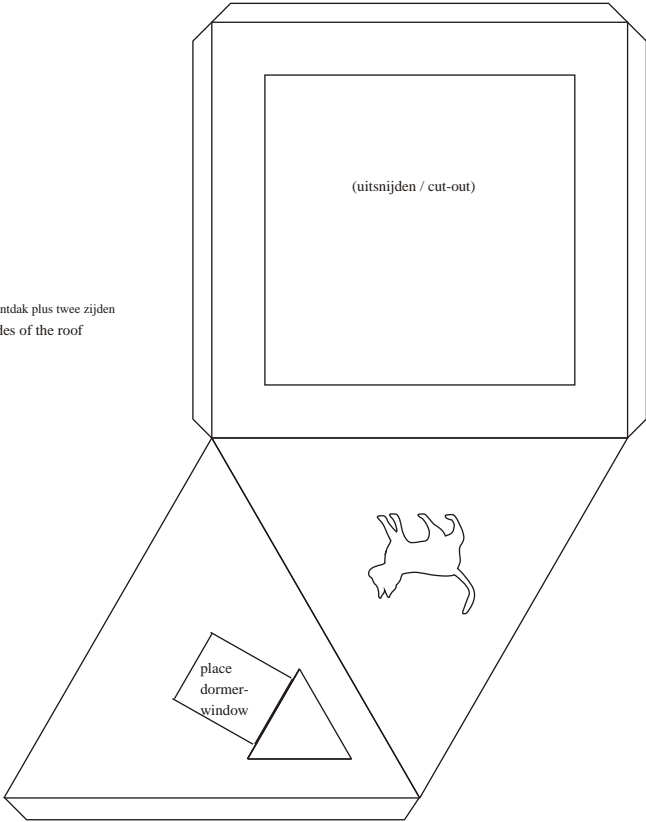

onderkant dak/
bottom roof
fits around walls
don't glue roof on the
walls

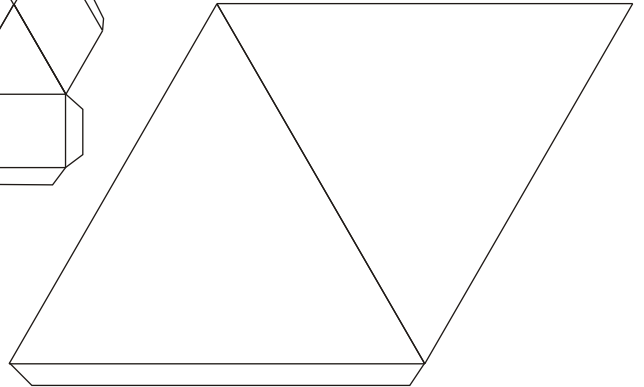
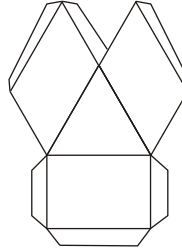

Twee zijden dak
Two sides of the roof

paper colour 2 / papier kleur 2

paper colour 2 / papier kleur 2

onderkantdak plus twee zijden
two sides of the roof

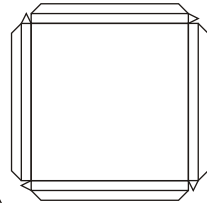
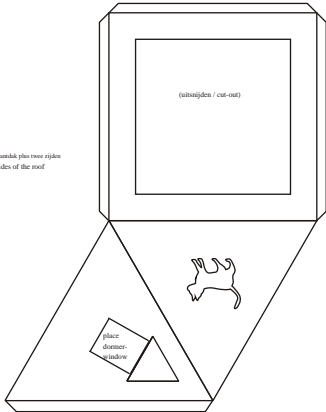

onderkant dak/
bottom roof
fits around walls
don't glue roof on the
walls

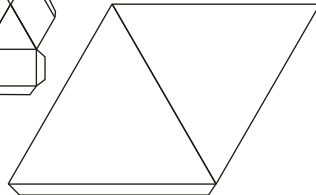

Twee zijden dak
Two sides of the roof

paper colour 2 / papier kleur 2

paper colour 2 / papier kleur 2

paper colour 2 / papier kleur 2

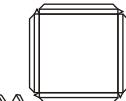
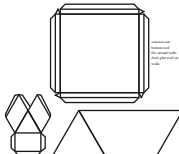
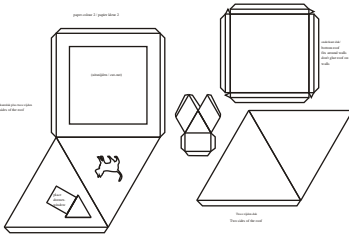

Twee zijden dak
Two sides of the roof

paper colour 2 / papier kleur 2



paper colour 2 / papier kleur 2

Globe

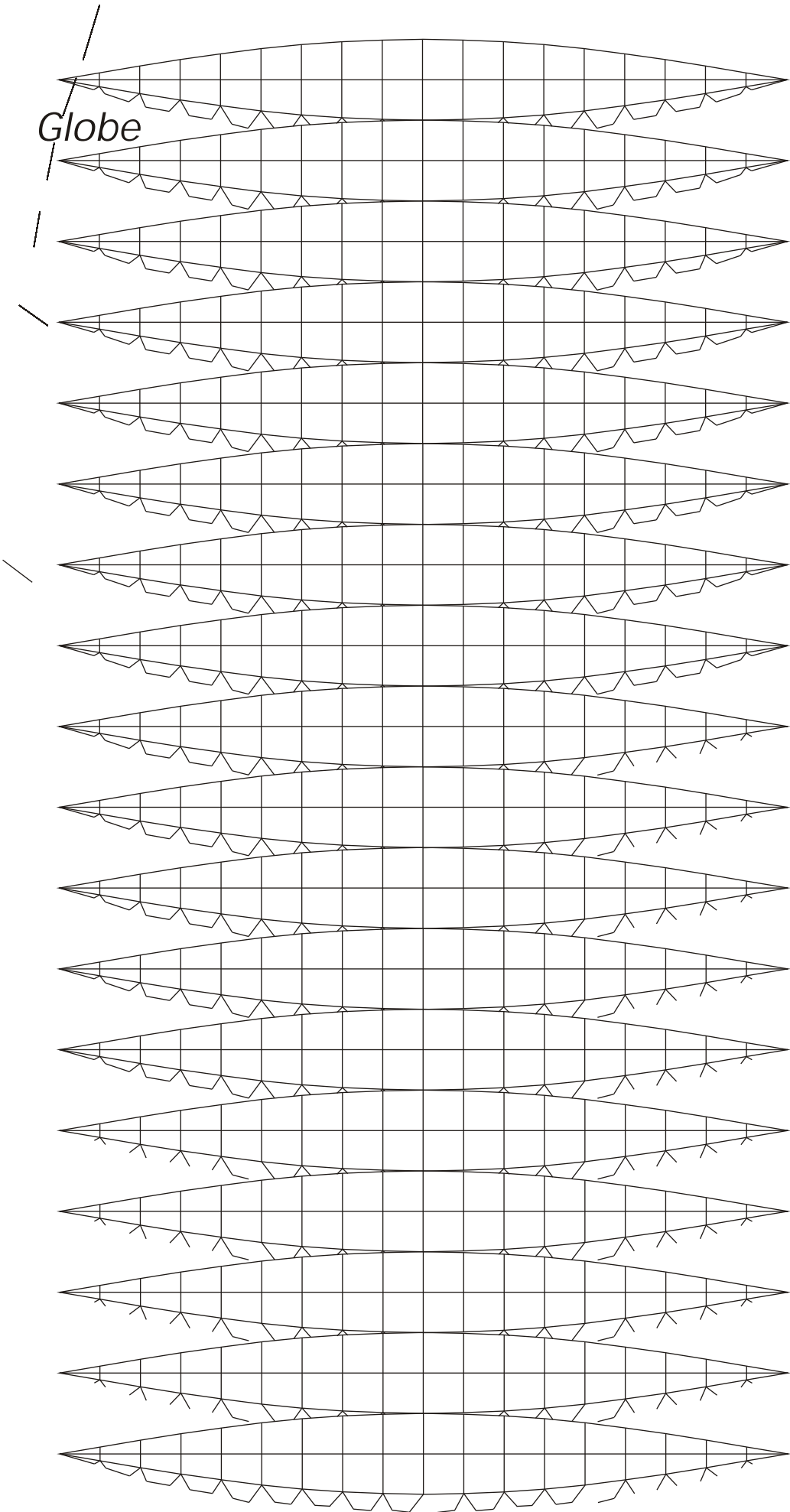

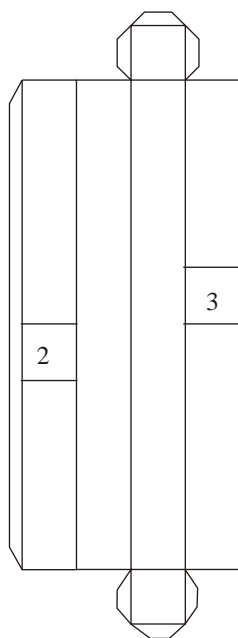
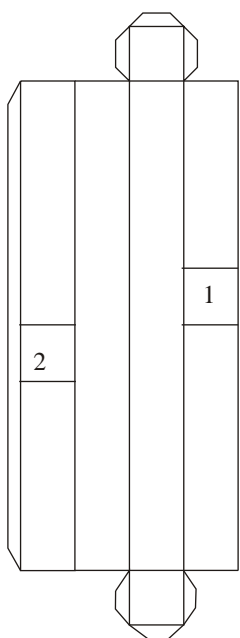
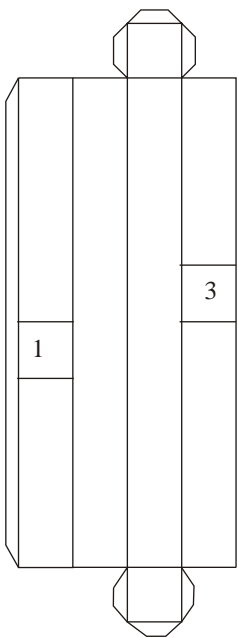
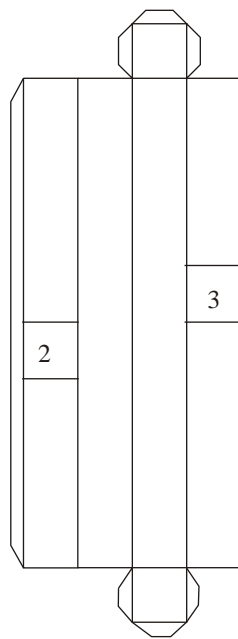
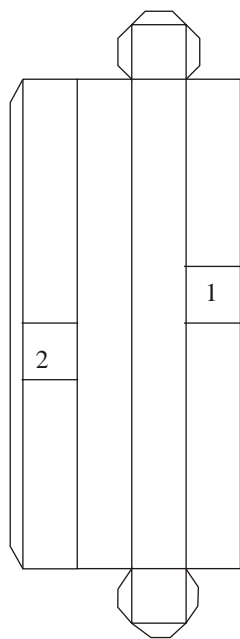
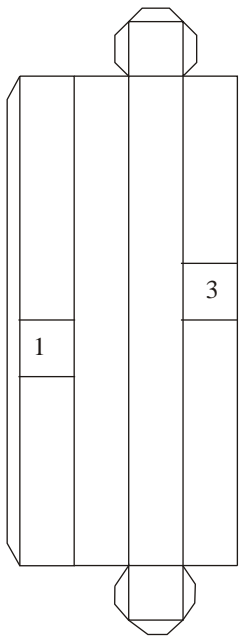
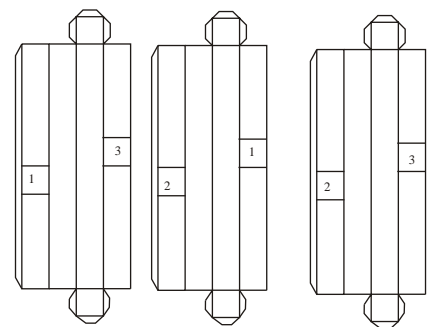
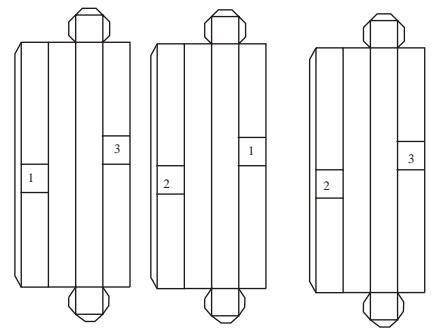
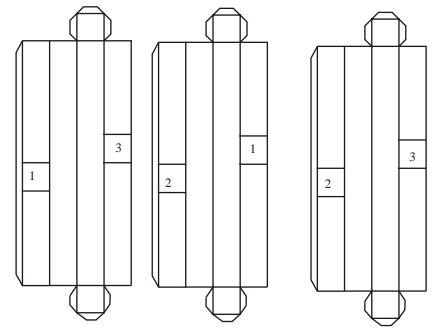
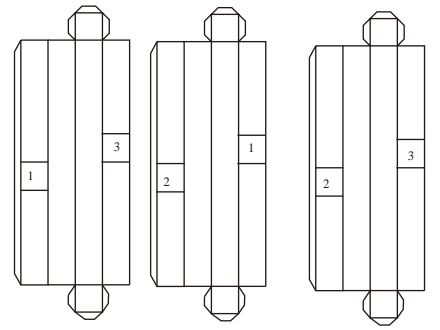
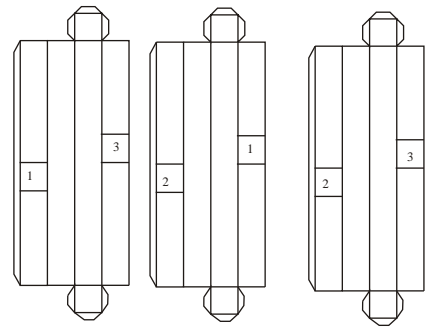
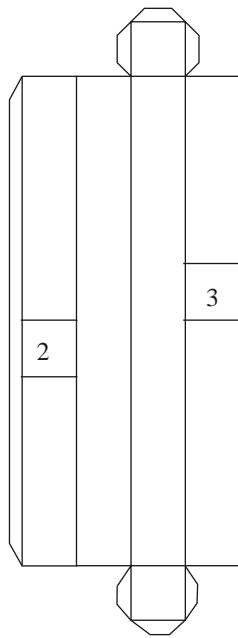
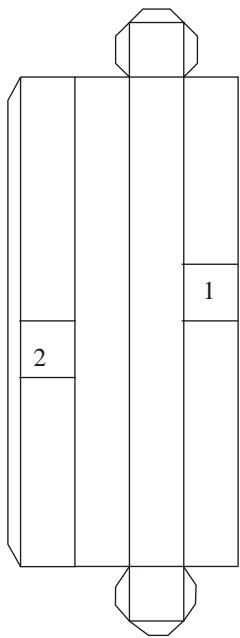
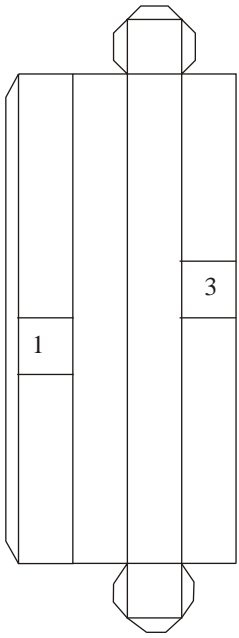

Large Chevaux-de-frise

The other two parts are on the next two pages

