

MOBILE FRAME

ZERO 

INTERCEPT ORBIT

OVERVIEW

THE BATTLE OF HANNOVER GATE, SC0245	1	Mobile Frame Companies	22
Transit Gates	12	Aces	22
		Determine Points Per Asset (PPA)	25
OBJECT & OVERVIEW	13	SETTING UP THE TABLE	25
What You Need to Play	14	Ask all the players:	26
Build Your Fleet	15	Setting Up the Scoreboard & Tactical Order	26
		Placing Assets Into the Battlespace	27
CREATING YOUR FLEET	15	The Game Starts Now	27
Systems and Dice	16	A ship's turn	28
Shipboard weapons	19	Declare Your Target	28
Defensive systems	19	Defend Your Ship	28
Communications and sensor systems	20	Repair Your Ship	28
Catapults	20	Optionally, Shoot	29
Build Your Ships	20	Ranges	29
Capital Ships	20	Attack vs. Defense	29
Frigates	22	Damage	29
		Cover	30

Move and Maneuver Your Ship	30	Playing with Mobile Frame Zero: <i>Rapid Attack</i>	41
Ramming, Collisions, and Passing	32	FAQ	42
Rolling collision dice	33		
The Edge of the Table	34		
Launch, Fuel, and Repair Companies	34	SHIPYARD INSTRUCTIONS	43
Spot a Tactical Asset	35	Free Colony ships	
A mobile frame company's turn	35	Zealous Carrier	44
Defend Your Company	35	Liberator Frigate	52
Dodging Away	36	Ijad ships	
Optionally, Shoot	36	Aushad Carrier	57
Dogfight range	36	Ojebed Frigate	63
Move	36	Solar Union ships	
Abandoning Assets	37	Palau Carrier	67
Spot a Tactical Asset	37	Samar Frigate	74
Capturing HVAs	38		
Ending the Turn	38		
Ending the Round	38		
Capture ships and repel boarders	38		
When a Ship Is Captured	39		
Bingo Fuel	39		



THE BATTLE OF HANNOVER GATE, SC0245

Onboard the
TTM carrier **Pehlivan**

Scramble! Scramble! This is not a drill! Pilots to frames! Pilots to frames!

Commander Abacan Foss' eyes flashed open and he lurched forward in the tightly packed zero-Gee sleeping bag. He instinctively grabbed for his flight suit, suspended from a magnetic hook by the side of the bed.

"Be back in a few minutes," he whispered through a kiss to the groggy head that mumbled beside him.

Foss held out his Gee-suit in front of him as he somersaulted through space, extending his legs into the flight suit's, and zipping it halfway. As he rotated, he grabbed his boots from their mount on the wall, pulled them on, latched them, and kicked himself toward the door. Without a look, he grabbed the rest of his gear from his locker as he flew out the bulkhead of his quarters. Outside, crew hurtled down the hall, flying through the air to their battle stations. He slid into the river of bodies. "Make a hole!" he shouted.



Forty six seconds later Abacan was latching himself into his ST-10L Osprey — he felt the built-in harness latch to the seat back and his Gee-suit hug tighter around his body. His visor, marked with the Eyes of Horus, slid into place across his eyes. For a moment it was dark, then a constellation of data appeared around him: his rapidly filling fuel tank, the status of the booster on his frame's back, the power available for his laser, the muscle cylinder pressure, and a target reticle that wouldn't be empty much longer. Before him, the hangar walls and the bustling crew appeared, but his concentration was on the data. "This is Agha, checking in. 96% fueled. *Red Knights*, check in!"

One by one, they announced themselves through the radio.

"Tajen, checking in. 95% fueled."

"Grasher, checking in. 91% fueled."

"Shooting Star, checking in. 97% fueled." The rest of the company oohed in respect. It wasn't often a pilot was ready before the Commander.

"Eightlimbs, checking in. 95% fueled, dammit."

A new voice in Foss's ear, the deck officer: "Agha, rails are charged. You are clear to launch. Good hunting."

The feet of his Osprey clicked into the catapult, and Foss took one last glance around the hangar: the labor frames backing away, the deck crew turning their faces away from the impending blast of launch, giving hand signals.

He looked forward again, raised his laser carbine to his shoulder, crouched, and said through a smirk, "Captain, this won't take more than a few minutes. Take good care of my ship."

Foss flipped a thumb switch, and the booster on the frame's back exploded to life. In the roar he missed the captain's irritated response. The Osprey shook as it crouched deeper, and then the catapult jolted free. Foss crushed into his seat as the crew disappeared behind him, along with the lit, protective walls of the hangar. He kept his eyes on the end of the deck, which disappeared almost as quickly as the hangar had. At the end of the deck, the Osprey leapt into

space, angling toward the white flower that was his destination: the Ijad frigate *Ready Fist*.

The booster cut out and he flipped the switch again. He felt the thump as the booster ejected from the frame's back to forever tumble across space.

For a moment, there was quiet.

To his left lay the black canvas of open space, marked with the brilliant gem of Hannover Gate hanging in the sky. A shining string of civilian ships emerged from the sphere in the center of the ring. He saluted them — he wanted them to have a story about the dashing bravery of his company that they could tell everyone when they landed.

To his right, the orange sphere of Tetravaal loomed. It was an ugly planet. He'd only been on the surface once while on leave, and he hadn't enjoyed the arid, gritty environment one bit.

Fewer than two seconds had passed. He kept the rifle raised, pointed at the growing white flower in his reticle. "Agha, checking in."

In his ear came the litany. "Tajen, checking in. Five by five." Her girlish voice had a steel edge to it now.

"Grasher, checking in. Five by five."

"Shooting Star, checking in. Five by five."

"Eightlimbs, checking in. Five by five."

"Agha is five by five. OK, kids, let's see if we can bring a flower back to our lady."

The bud ahead now blossomed into a blue, glittering constellation of chaos as the Ijad antiframe batteries lit the sky around them.

Onboard the Grasping Hand Tribe frigate, **Ready Fist**

Chief Aubehih peered around the head of their human Second, Elmon Juel, extending their palps from Aubehih's place at the back of Elmon's neck. But Juel's eyes were far sharper and gave them both a better view of the station as it rose past the limb

of Tetravaal. Elmon's hands gripped the arms of the command chair. To her bondmate, she thought, "I expect we'll encounter support fire first, Aubehih." Then, out loud, "Comms, what's the status of our fleet?"

The communication officer, a meter-tall pukethih operating controls with all four of its dextrous limbs, turned its acceleration chair turned to face Elmon. "Chief, *Rising Storm* reports that they will launch frames at first sight of a hostile ship. *Calm Ocean* and *Ahah's Respite* have withdrawn to a safe distance."

Aubehih's thoughts played in Elmon's mind: "I'm afraid the Imperialists may have learned from the last encounter, my bond. We may see different tactics from the last time." Juel scowled in response.

The pukethih sensor officer's voice rang out: "Contact! Two — no, correction, three ships at 320 mark 15. One unidentified capital ship — it looks like a carrier — one frigate, and the carrier *Pehlivan!*"

The communication officer, their voice cool, said, "*Rising Storm* reports all frames are away, en route to — to the *Pehlivan!* They're not coming to guard us!"

Elmon could feel Aubehih's wince in her mind. To her bondmate, she thought, "Let's hope that's the right choice, then."

"New contact!" came the sensor officer's voice again. "Frames inbound! They came from the *Pehlivan!*"

Aubehih's anger grew, and Elmon could feel it as her heart began to beat faster. "Those fools on the *Rising Storm* have left us defenseless," said the bonded pair in unison through Elmon's sneer. Then, loudly, "Light the sky. Give them the fight they came for!"

On the hull of the ship, stingbeams swiveled and lit luminous blue scratches across the black canvas of space. On the bridge, Elmon's lips pursed. She could see the flares of the incoming frames dodging, the sparkle of their chaff and flares. There was a bright flash: one of the incoming frames was down. A red-and-white-striped arm spun by the bridge window, still holding its rifle.

When Elmon again looked toward the now-visible incoming fleet, she suddenly found her field of view broken. She blinked and realized that before her, just three meters away, were the head and shoulders of

a mobile frame in the red, white, and black stripes of the infamous *Red Knights* company. Painted across its sensor head was the pair of Egyptian eyes that were everpresent in books about her own people's history. The frame pressed a pistol the size of Elmon's torso against the window and leaned in, placing its forehead against the thin barrier between them and the void of space.

A voice echoed through the bridge, coming directly from the window. "Chief!" said the voice, "I've heard so much about you! I'd love to sit and have a little talk! Why don't you turn your weapons to 45 mark 0 and light up your sloppy friend there, then come over to my place for some tea!"

The voice had absurd self-assurance to it.

A puketih shouted, "Chief, cargo bay two is open! Reports of fighting in corridors!"

Aubehih's disgust at their comrade's failure showed on Elmon's face. Together they said, "Open up on the *Rising Storm*. They will suffer the natural consequences of their decision."

Onboard the Free Colony Carrier frigate **Jolly Rager**

All lights were down in the converted cargo bay. Rica Chall could only hear own heavy breathing echoing metallicly through the hot, dark, cramped cockpit of her highly modded Commissar frame, *Hot Pants*. An hour ago, she and the rest of her company, *Hazardous Cargo*, had grasped the launch rails hidden within their ship, checked in one last time, and powered down.

She hadn't much liked this plan. Too risky. They were to transit in with false papers, carrying "industrial supplies for the Pleasant Creek town on Tetravaal." On some level, she supposed that was true.

The ships — two freighters already known to Hannover Gate — had been gutted. In the place of the normal cargo of industrial and agricultural goods, the ships' mechanics had installed a full, if cramped, hangar, now loaded with not only *Hazardous Cargo* but also their sister company: *Foot, Meet Snake*. They'd left the ships' old names on the outside of

the hull, but inside they referred to them as the *Jolly Rager* and *Mister Punchy*. Once they'd won this battle, they promised each other, they'd write these names in bold letters on the hull's exterior.

Behind them trailed *Pile o' Crap* and *Mom's Pantry*, their supply ships for their land campaign — should they manage to get all the way to the surface.

A few minutes ago, Rica had felt the transit in her gut — then, some gentle acceleration that told her that no one was yet pursuing the ship.

The chronometer on her wrist counted down. Only twenty seconds before they were to launch.

She felt more acceleration and saw, through her tiny view slit, the Commissar's arm go taut, as though hanging from a tree branch.

Ten seconds. She looked around in the dim emergency lights of the hangar. The other frames were where they had started, each grasping the launch rail, clanging gently against each other in the tight quarters. She couldn't see inside any of them and couldn't risk a radio check-in.

Three seconds. Two seconds. One second. Zero. Nothing happened. Had something gone wrong?

Then, suddenly, the lights came on. Rica startled for a moment, then remembered the plan. She powered up just in time to hear, “—ault rails are charged! Launch in three. Two. One. Igni—” The sound of the radio was drowned out by the sudden rush of blood in her ears as the launch rail yanked her frame forward. She dangled by one hand, barely holding on. She hit the ignition switch and the booster lit behind her, shaking her frame violently. “Stay together!” she said through her teeth.

The false wall at the head of the hangar disintegrated as its explosive bolts blew and the company flew free into open space.

The *Jolly Rager* disappeared behind her, diminishing quickly into the distance. Out of the corner of her eye, she saw a cluster of missiles departing the starboard hull of *Mister Punchy*, headed for a target she couldn't yet see.

Captain Jaeger spoke in her ear. “Pilots, you're heading into the thick of it! There's a TTM company

already trying to board the Ijad frigate *Ready Fist*. Take 'em out and see what you can bring home for us!”

Rica called to her comrades. “Which of you chabbers is down for a dust-up? Follow my *Hot Pants* and I'll show you a good time!”

They checked in. “Grunt is down to kick down some TTMs!”

“Cheap Shot has a score to settle!”

“Stiletto is fixin' to score some parts!”

“Chucker is ready to punch some holes!”

She could hear *Foot*, *Meet Snake* checking in, as well. They had been green in their last outing on Mummen, where the fighting had been on the ground, but had come out victorious through their admirable restraint. She expected one of them to make ace today.

Rica flicked on her sensor suite, and the frame pulled the long-range targeting laser over its shoulder.

She pulled its scope over the sensor eye of *Hot Pants* and pointed it at the ongoing battle before them. Through the scope she saw the boarding action. Weird Ijad labor frames desperately fought off the incoming TTMs, but the Ijad were wholly outmatched. She spotted a red, white, and black frame, marked with Egyptian eyes, dodging the Ijad antiframe fire as though they were dancing together. She couldn't get a bead on it until the frame grabbed ahold of the superstructure and peered in the window of the bridge. The moment it stopped, she pulled the trigger on the laser and a circle appeared around the garish frame in her viewscreen. “*Foot!*” she said into her mic. “There's the set. Spike it for us!”

:|o

Aboard the *Ready Fist*, Aubehih and Juel were gritting Elmon's teeth. While doing what their captors demanded, they looked for ways to defy them and take back their ship. All at once, the opportunity came: the sensor officer kicked off their chair and floated toward the captain. Grabbing the handhold beside Elmon's acceleration chair, the officer pointed into space and whispered, “Chief, more mobile



frames are incoming. They launched from a carrier disguised as a noncombatant freighter. They are targeting our captors! We're saved!"

Elmon looked out into the blackness. She could see the flares of the launch pods glittering as they approached. "We'll see," she said.

!IO

Commander Foss's frame stood atop the bridge of the *Ready Fist*, clamped to the top by its magnetic boots, surveying the area. In the distance he could see the crescent-shaped *Rising Storm*. To his irritation, he saw that they'd gotten their decoy launcher working again; the *Ready Fist* was having a hard time targeting it. He swung his long rifle to his shoulder and took aim through the sight. The decoys interfered with his targeting system, but he could almost see the bridge. He breathed out and squeezed the trigger — only to be interrupted by a shock that threw his aim. Only after a moment did he realize that alarms were ringing in his cockpit. His head cleared and he saw: his targeting was down, his left arm was gone, and muscle cylinder fluid was gushing out into space, frothing and boiling in the





vacuum. “No!” he shouted. But the voice just added to the chaos in his cockpit.

∴

Rica fought hard and was glad for the support the *Foot* gave them. The *Red Knights* lost two of their state-of-the-art mobile frames, but it had taken her entire company to subdue the bright red frame with “Eight Limbs” written on its chest. They’d wrestled across the top of the *Ijad* frigate, and her own frame had taken considerable damage from the knees and elbows of her opponent. But eventually Rica had found purchase for her crowbar, and the red frame fled into the depths of space, venting atmosphere.

Finally, Rica caught her breath. She called through her radio, “*Ijad* frigate, we would be pleased if you would join us in the resistance of Tetravaal against the Imperialists.”

This was enough for Aubehih and Elmon. “Very well,” they said. “Let us all turn our guns toward our distant possessors.”

∴

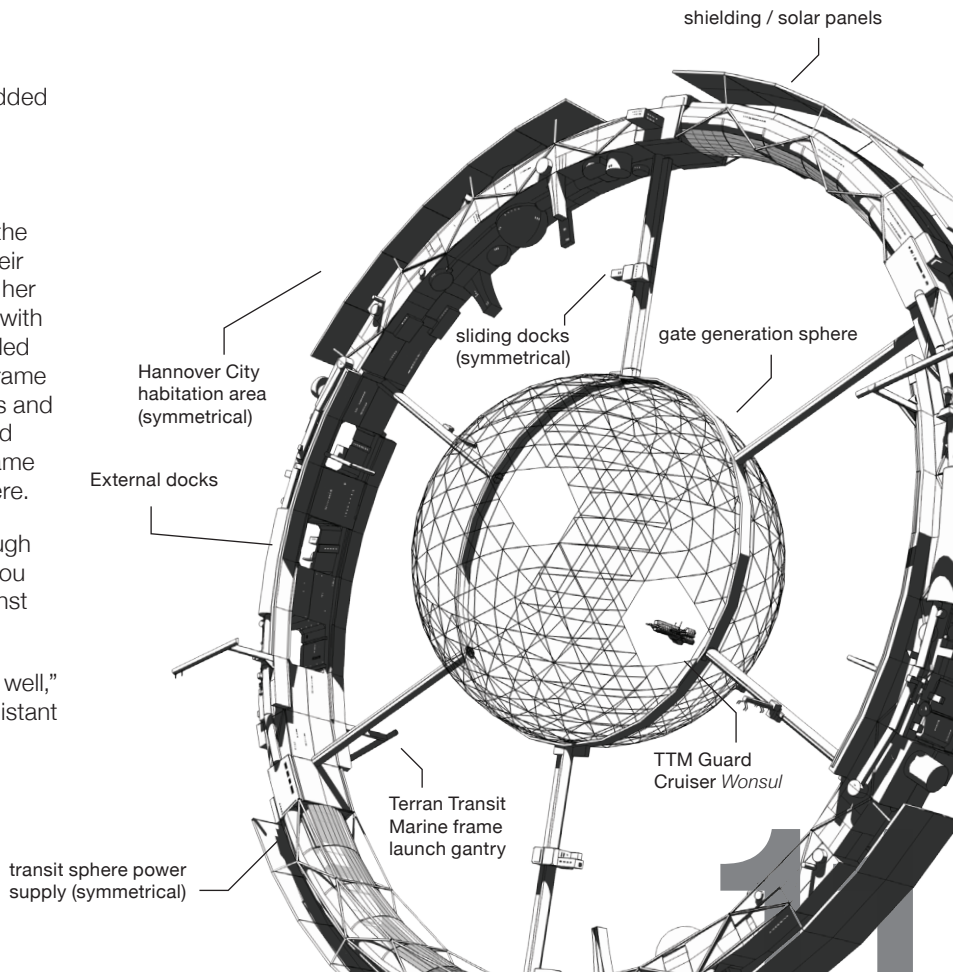

Transit Gates

All interstellar travel (and even some travel within a solar system, such as between Earth and Jupiter) uses transit gates to reduce travel times to a human-workable span.

Travel to and from a gate in orbit might take as little as a few hours to weeks, depending on the specific location of the spaceport and gate. In some cases, a single transit gate will serve multiple planetary orbits, requiring months of travel time.

Because they are often built according to the limitations of local materials and needs, they take many different forms.

Ujebehu Station — originally the Solar Union-allied *Ample Corporation Gate* — provides much of the power to Amejihu City, below. Because of the intense weather that characterizes the planet of Ujowahu (known formerly as Chaumas), shuttle travel to and from the station is often dangerous, and most of the station-tribe live high in orbit, where communication and trade with the rest of the gate network is easier.

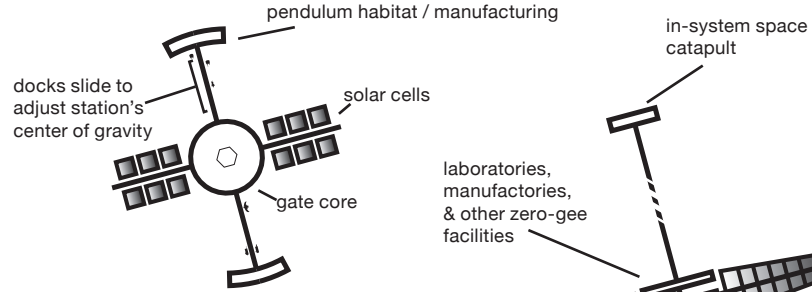

The Arjuna Transit Corporation has begun building their gate toward a ring configuration. Many smaller colonies' gates never proceed past this stage.

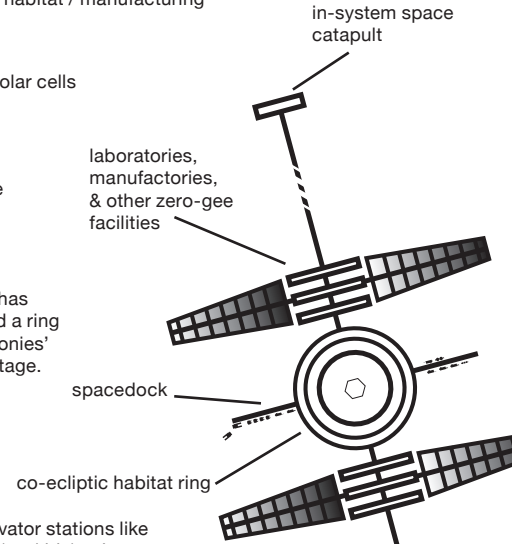

Space elevator stations like Earth's *Sulam Ya'akov* hang in the center of gravity of the space elevator ribbon, which runs for tens of thousands of kilometers above and below. Swinging from the outer end of the ribbon is a spacedock from which ships can arrive and depart, using energy from the orbit to reduce the time and expense of travel between bodies within the Sol system.

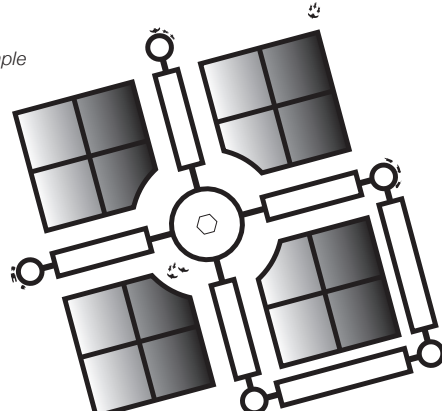

OBJECT & OVERVIEW

Use your fleet of ships and mobile frame companies — your Tactical Assets, or “TAs” — to **gain points by capturing** your opponents’ ships and High Value Assets.

To cost your opponent points, destroy or capture their ships and companies.

Be careful of your **fuel!** When your mobile frame companies run out of fuel, you’ll lose points for them unless you can rescue them!

Whoever has the most points when the Doomsday Clock reaches zero wins!

You’ll find this game easier to play if you’ve already played **Mobile Frame Zero: Rapid Attack**, but these rules should be enough to get you started!

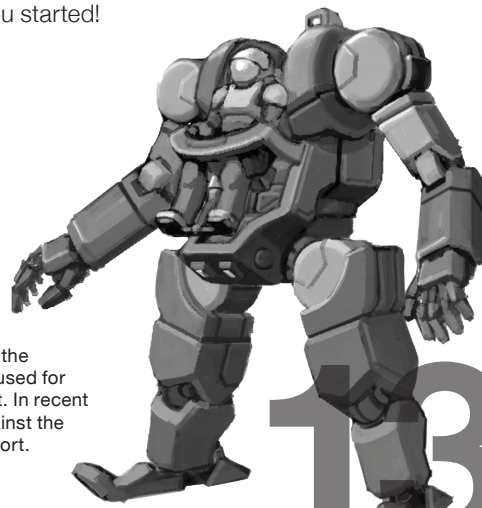

The JK-Aleph labor frame, basis of the Conscript mobile frame, has been used for decades on Solar Union spacecraft. In recent years, it has found itself turned against the very frames they were built to support.

What You Need to Play

- » A distinctive, 12-sided **Doomsday die** that you can use to count down turns.
- » A **ruler** made of **eight 1x4 LEGO® click hinges**, with distinctive colors for the first (“Dogfight” range) and second (point defense range) segments of the ruler.
- » **3–5 pieces of space debris** — spacewrecks, satellites, or asteroids, each no bigger than a ship, on a 4x4 base.
- » **A square or circular table about 4 rulers across.** If your table is larger than that, tape off an area of the appropriate size. Slightly smaller is OK, but you might want to reduce the length of the ruler by 1 hinge.
- » **A piece of paper or whiteboard to keep score,** big enough that all players can see it.

- » **Dice** in an assortment of colors. You might not need all of these, but make sure before you play that, between all players, you have all the ones your fleet calls for. You’ll need some six-sided (“d6” or just “dice”) and some eight-sided (“d8”) dice.
- » **2 white dice**
- » **3 red dice**
- » **About a dozen small blue dice**
- » **About a dozen small yellow dice**
- » **About six small black dice**
- » **1 green die**
- » **1 red d8**
- » **1 green d8**
- » **1 blue d8**
- » **1 yellow d8**

If you don't have click hinges, you can download a maneuver key from: mobileframezero.com/mfz/maneuverkey/

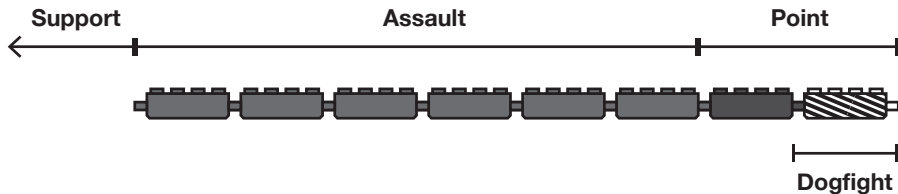

A ruler made of LEGO® click hinges with the ranges marked.

CREATING YOUR FLEET

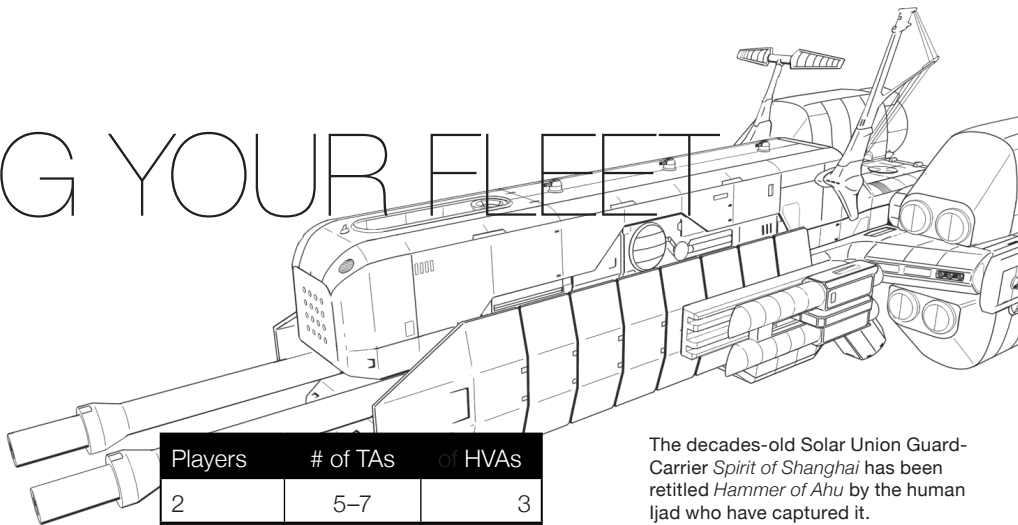

Build Your Fleet

Before you gather together to play, each player will need to **build a fleet** in secret. You'll build your fleet from a combination of **Tactical Assets (TAs)** — ships and mobile frame companies — and **High Value Assets (HVAs)** — shuttles, cargo, unarmed prototypes, and other defenseless vessels.

The number of assets you can build depends on the number of players in the upcoming game.

Players	# of TAs	# of HVAs
2	5-7	3
3	4-6	2
4	3-5	1

High Value Assets (HVAs) have strategic value to your faction, but are tactical liabilities during a battle.

They might be shuttles bearing diplomats or revolutionary leaders, smuggled prototype mobile frames, or cargo

The decades-old Solar Union Guard-Carrier *Spirit of Shanghai* has been retitled *Hammer of Ahu* by the human Jlad who have captured it.

If all players agree, you can **increase both the minimum and maximum number of Tactical Assets by 2** for a major, day-long space battle.

ships loaded with illegal peaches. They're hard to maneuver, hard to protect, and extremely valuable. If you're playing with LEGO® or other building bricks, make each HVA no bigger than 12 studs in its largest dimension, resting on a base 8x4 studs in size.

Tactical Assets (TAs) are the ships and mobile frame companies that fight.

They're warships and companies of mobile frames. Warships are large and destructive, but must overcome their own forward momentum to move the direction and speed you want. Frame companies turn on a dime, but attack only within a very limited range.

Systems and Dice

All TAs have a set of **systems**. When you begin a TA's turn, its systems give you a variety of dice to roll. Over the course of the turn, you will assign these dice to accomplish various functions, such as defending, repairing, targeting, and moving.

There are five principal types of systems: weapons, defensive systems, comms systems, and mobile frame catapults. Mobile frame companies all start with a movement system, as well. Each type of system gives a specific color of dice — weapons

give **red**, defenses give **blue**, comms gives **yellow**, catapults give **black**, and movement gives **green**.

Collectively these dice are called the **system dice**. Note that there are a few dice that don't quite work as systems: ace dice (colored d8s) and the green die used by frigates are lost only when all other dice are lost.

Each color of system dice can only be assigned to certain functions. For example, red dice can only be used to attack opponents on the battlespace.

A Terran Transit Marine Close-In Weapon System (CIWS) directional turret following the pattern of historical anti-aircraft weapons.

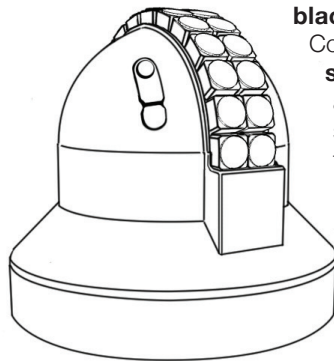
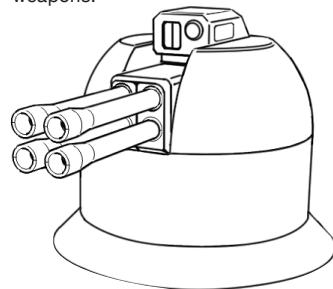

A Free Colony point defense weapon, loaded with directional mines for defending against mobile frames.

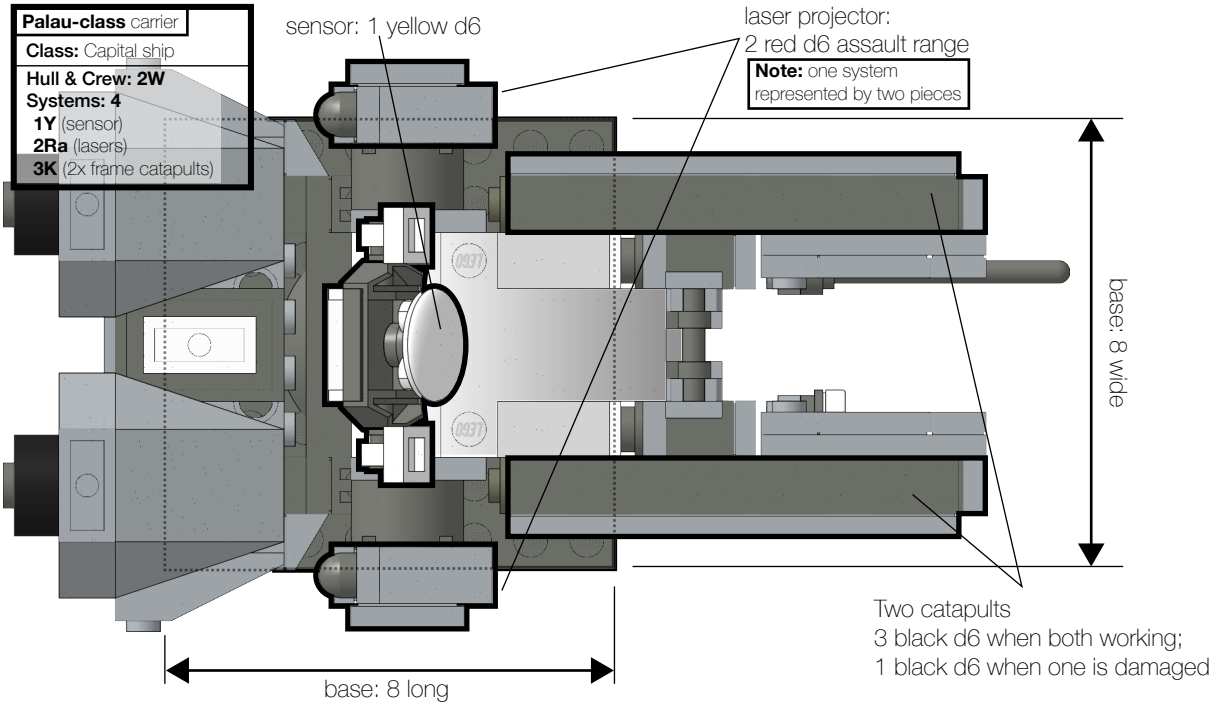

Ojebed-class
Class: Frigate
Hull & Crew: 2W
Systems: 3
1Y (sensor)
2Ra&d8 (paired stingbeams)
Bonus dice: 1G (frigate)

paired stingbeams:
 2 red d6 & red d8 when both working;
 2 red d6 when one is damaged

sensor: 1 yellow d6

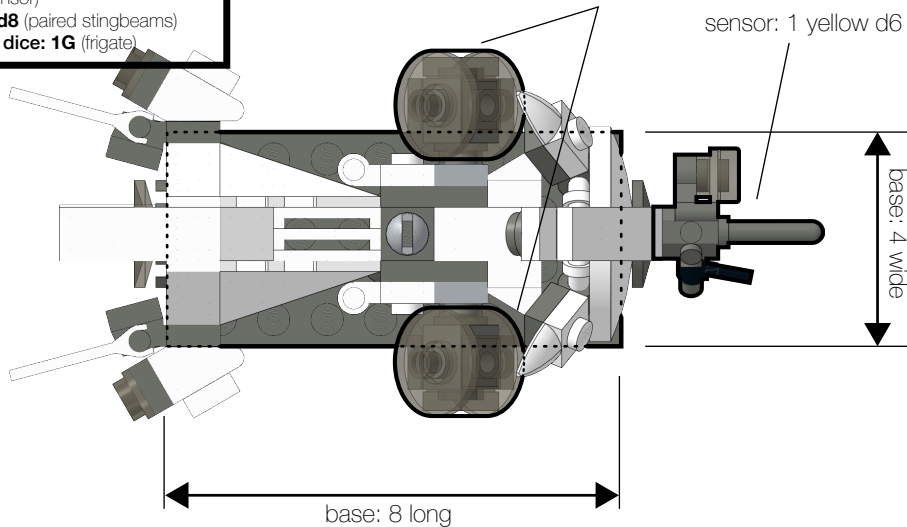

The Ojebed-class *Withering-Gaze-Of-Sun*, outfitted as an assault-range ship destroyer.

In addition to their systems, all TAs have a crew, infrastructure, or basic mobile frame components, which give **two white dice**. These dice can be used in place of any system dice. Additionally, a ship can use white dice to repair the ship itself.

Shipboard weapons

A **shipboard** weapon can be designed to hit, by ascending distance, at three ranges: **point** range, **assault** range, or **support** range.

Each weapon can be devoted to either one range or can be split into two ranges at a reduction in effectiveness.

A weapon devoted to one range gives **two red dice** when you target at that range.

A weapon designed for two ranges gives **one red die** when you target at either range.

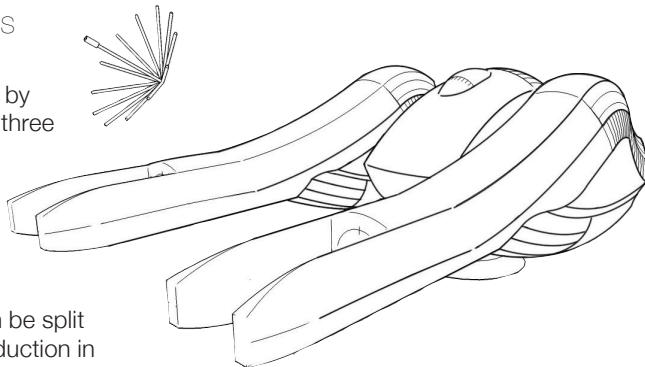

If you devote two of a ship's weapons to the same range, they give a total of **two red dice and one red d8**.

A ship may not have more than two weapons devoted to the same single range.

The Ijad petalcaster railgun turret launches cylindrical projectiles that deploy into broad, fast-moving, frame-destroying obstacles, derisively called "umbrellas" by their resentful targets.

Defensive systems

Armor, chaff dispensers, and electronic countermeasures keep your ship from taking the full brunt of an enemy's blow.

A single defensive system gives **one blue die**.

A second defensive system gives **an additional blue die**. Additionally, it lets the TA make any ships of your choice within point defense range take hits as though they were in cover (more on page 30).

Communications and sensor systems

Antennae and sensors let a ship direct and enhance the attacks of other TAs.

A single comms system gives **one yellow die**. Additionally, it lets the ship **spot** any TA in assault range or closer (more on page 37).

A second comms system lets the ship spot any TA anywhere in the battlespace.

A ship without a comms system may use its white dice to spot any TA in assault range, but only one that is not in cover.

Catapults

Flight decks launch companies of mobile frames across the battlespace while their hangars repair and refuel incoming friendly frame companies.

One catapult gives **one black die**.

A second catapult gives **two additional black dice**, making repair and refueling much more effective.

A ship with no catapults may not repair or refuel frames.

Build Your Ships

Capital Ships are powerful but inelegant warships.

In addition to their infrastructure and crew of two white dice, they have **four systems**.

The model should be no greater than **16 studs across** in its largest dimension.

They rest on a base **8x8 studs** in size.

A Conscript, modified for space use, launches from the port catapult of the *Zealous*-class Free Colony carrier *Thunderthighs*.

LINE FEED 1 SPINK PA1

00:01:22.23

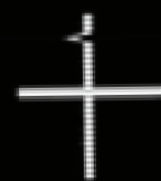
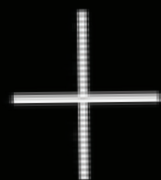
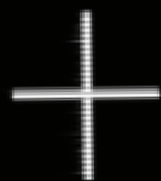

23



Frigates are faster and more maneuverable than capital ships.

In addition to their infrastructure and crew of two white dice, they carry **three systems**.

They roll a **green die** to help them maneuver. This die is not a system, and the ship's player rolls it as long as the ship has at least one system or white die.

Frigates are **no more than 12 studs across** in their greatest dimension.

They rest on a base **4x8 studs** in size.

Mobile Frame Companies

Compared to heavy, massive warships, mobile frame companies are fast and maneuverable, but vulnerable to both point defense fire and other frame companies. While you may command a fleet with no companies, you'll find it very difficult to win!

Companies can **board** ships and HVAs alike, capturing them for both their points and tactical purposes (page 38).

You get a number of companies equal to the number of catapults you have in your fleet.

In addition to their pilots and mobile frames, giving **two white dice**, all companies have four systems:

- » a dogfight-range weapon system (giving 2 red dice)
- » a defense system (giving 1 blue die)
- » a communication system (giving 1 yellow die)
- » a movement system (giving 1 green die)

They rest on a base of **4x4 studs**.

Aces

Every fleet with at least one catapult has one company led by a **mobile frame ace**. There are four aces, and each has their own special power and provides another die to their company. **The ace is not a system** and cannot be lost until their company has been destroyed by losing all four of its system



dice and both of its white dice. Mark the company that the ace leads with a special model. When you build your fleet, decide which kind of ace your fleet has.

Pick one:

The **red ace** not only shoots well, but also far.

Gives an **additional red d8**.

Also, the ace's company may target TAs at assault range as though they were in dogfight range.

The **blue ace** not only protects their company, but also friendly TAs nearby.

Gives an **additional blue d8**.

Also, this ace's company makes any friendly TA within point defense range take hits as though in cover.

The **green ace** not only moves their company quickly, but also can move other models.

Gives an **additional green d8**.

Also, on its turn and during the turn of any TAs it is touching, the ace's company may move a TA it is touching one unit in any direction **or** change the heading of a ship it is touching by one click

The **yellow ace** not only spots particularly well, but also allows other spots to add to their own spot.

Gives an **additional yellow d8**.

Also, this ace's company may spot any ship within point defense range.

Place **both** the yellow d8 and its regular yellow die on the ship that this company is spotting. If there's already a yellow d6 there, replace it if the new d6 is higher. If there's already a yellow d8 there, replace it if the new d8 is higher.

An *Argonaut* protective spacesuit, often used by Free Colony deck crews because of its industrial safety features.



When this ace's company assigns its yellow die, add the ace's d8 to the same spotting target.

Other TAs may replace either of these dice later if they have a higher d6 or d8.

Finally, a company with **any ace** boards enemy ships more effectively, rolling an additional yellow d8 when boarding.

:10

SETTING UP THE TABLE

When you arrive at the table with your friends, you'll show off your fleet to each other. Point out each ship, company, and HVA, making sure everyone can see **what system gives what dice** and **how to recognize your ace**. Also, if it's at all unclear, make sure everyone knows which end is the bow on your ships.

Determine Points Per Asset (PPA)

Before playing, each player must determine their points per asset (PPA) — essentially the strategic value of each of their assets. **In the beginning, each asset of each player (HVAs and TAs alike) is worth 5 points.** Now we'll do some quick measurements to determine how to modify each player's PPA to match the force they've brought to the table.

Ask all the players:

Who has the **greatest number of TAs** — both ships and companies? **Reduce that player's PPA by one.**

	ITM	IJAD	FC
HVA	2	2	2
TAs	5	3	4
SYS	8	4	10
PPA	③	⑦	⑤
	21	35	30

Who has the **fewest TAs**? **Increase that player's PPA by one.**

Who has the **most systems** across all their ships? Do not count individual systems in companies. **Reduce that player's PPA by one.**

Who has the **fewest systems** across all their ships? Again, do not count companies. **Increase that player's PPA by one.**

On any ties, all tied players tweak their PPA.

An example scoreboard. The Terran Transit Marines have the strongest force, and so the lowest score — they have to accomplish the most to win. If they lose a ship, HVA, or company, it costs them fewer points, as well.

Setting Up the Scoreboard and Tactical Order

Write all the players' names across the top of the scoreboard, along with the PPA of each underneath. Then, each player multiplies their PPA by the number of assets they have — HVAs, ships, and companies — and write that down under their name. **These are your starting scores!**

The order of largest to smallest score is **tactical order**. You'll use it to determine whose turn it is when not directly responding to another player's attack.

If there is a tie for first place, then all tied players roll off. Whoever wins the roll-off can choose to remove a TA or continue forward with the tie.

The player with the highest score is the **defender**. The player with lowest score is the **primary attacker**, and all other players are **secondary attackers**.

Placing Assets Into the Battlespace

You'll set up your fleets from **defender to attackers to defender**.

Defender, place one HVA anywhere you like on the table.

Place your remaining HVAs within assault range (the full length of the ruler) of the first HVA.

Place one ship within assault range of the first HVA.

Primary attacker, place one ship just within assault range of the defender's ship, but no closer.

Secondary attackers, place one ship anywhere on the table outside assault range of the defender's HVAs and ships.

All attackers, take turns from highest to lowest score, placing your ships one at a time outside of assault range from any of the primary defender's assets. Then, take turns as before, placing your companies

touching your carriers, one company per catapult for each ship. Finally, take turns as before, placing your HVAs.

Defender, place the rest of your ships within assault range of the HVAs and first ship you placed. Then, place your companies, each touching one of your carriers, one company per catapult for each ship.

Place a few pieces of space debris around the table one at a time, taking turns in tactical order — from highest to lowest score, then starting again at the top. Place them no closer than assault range from any ship but your own, and no closer than assault range to another piece of debris. If there's nowhere legal a player wants to place debris, stop placing debris.

The Game Starts Now

Set the Doomsday Clock to 11.

Defender, begin the round by picking a ship or HVA to take its turn. In future turns, you may pick a mobile

frame company, but only after you have **launched** one with a catapult (page 34).

If you want to attack something in this turn, declare the ship's **target** (enemy TA or space debris) and the **range** at which your ship is attacking.

Now roll all the ship's dice — its system dice and its two white dice — at once.

On a ship's turn, you'll:

- » declare your **target**
- » **defend** your ship
- » **repair** your ship
- » optionally, **shoot**
- » **maneuver** and **move**
- » optionally, **shoot** if you haven't yet
- » **launch, fuel, and repair mobile frame companies**
- » **spot** a TA

Declare Your Target

Declare which weapon you are using, then target a TA your ship can hit, either where it is now or where it will be at the end of its move. If your ship has no weapons, you may only declare a target at dogfight range for the onboard labor frames to attack with small arms.

Defend Your Ship

Allocate a blue die, if any, or switch its value to that of an unallocated white die to use as your **defense number** for the rest of this round. If you don't choose one, your defense number will be 0 for the round.

Repair Your Ship

If any unallocated white dice are 5s or 6s, you may spend them to repair systems that the ship has lost, one for each die spent. When you do, just re-attach the systems you wish to repair. You may not repair white dice or give the ship systems that you didn't build it with.

Optionally, Shoot

If you're within the range you chose to your declared target, you can allocate a red die or switch its value to that of an unallocated white die to attack. Continue in normal combat and tactical order.

If you wish, you may instead opt to shoot after your move, or not at all.

Ranges

You can declare a target that is, or you hope will be, within range of your chosen weapons.

If your ship has no point defense weapon systems, its crew can still fight in their labor frames, attacking at dogfight range with its white dice, which represent their mobile frame-scale small arms.

Combat Order

If your target doesn't have a defense number yet, you'll switch to **combat order**. In combat order:

1. You proceed with your turn until you've allocated your attack die, then put your turn on hold until your target has gotten a chance to get a defense number.
2. The target then goes through the first part of their turn—declaring a target, rolling, and allocating a defense number.
3. Once you've done that, finish your turn.
4. Once your turn as ended, your target completes their turn.

A ship may only target companies at point defense range or companies touching a ship that is within point defense range.

Attack vs. Defense

If your target already has a defense number, subtract the defense number from your attack number and roll that many d6s. They are your **hit dice**. It doesn't matter what color the hit dice are.

Damage

Weapons fired at **support range** damage systems on targeted ships with **5s and 6s** on their hit dice.

Weapons fired at **assault range** damage systems on targeted ships with **4s, 5s, and 6s** on their hit dice.

Weapons fired at **point defense range** damage systems on targeted ships and companies with **5s and 6s** on their hit dice.

When you lose a system to damage, put it at the side of the table. You'll need it again if your crew repairs it!

Cover

A target is in cover from an attacker when there is space debris or another ship between the attacker and target, and the debris or other ship is within point defense range of the target. It is taking cover behind

If the target is in cover, the cover absorbs all **5s** from weapons fired at **support range or point defense range**, and all **4s** from weapons fired at **assault range**. If the cover is debris, remove it from the table when it absorbs the first hit.

If the target in cover has been spotted (page 37), the attacker may ignore the cover, in which case it neither absorbs dice nor gets destroyed if it is debris.

A piece of cover that is, itself, a target has a defense number of 0 and, if it is hit, is destroyed and removed from the table.

Move and Maneuver Your Ship

A ship requires constant maneuvering to stay on course, and will move straight forward 4 units unless you order it to maneuver. To **maneuver** the ship, allocate a green die or unallocated white die. Each pip on your maneuver die allows you to pick one of the following:

Increase the speed of the ship this turn by 1.

Decrease the speed of the ship this turn by 1. Ships may not reverse.

Click a single hinge on the ruler either once (for capital ships, frigates, and HVAs) or twice (for frigates only). Ships and HVAs may not click a single hinge more than once in a turn.

Avoid a collision with space debris that lies in the ship's path.

Once you choose to maneuver, begin the ship's **movement** by placing the end of the ruler at the back of the ship's base.

To move a ship forward, slide the ship along the ruler for as long as it's going straight.

To turn your ship, click the ruler in the direction you want to turn and place it along the base on the inside of the upcoming curve.

To finish the turn, line up the front of the base with the next segment of the ruler, rotating it in place.

When you move a ship, you may leave behind any of the ship's companies right where they were, or reposition them anywhere on the table touching the ship or its base.

All other players' companies may opt to continue on with the ship, choosing where to position themselves in tactical order, or stay where they are on the table.

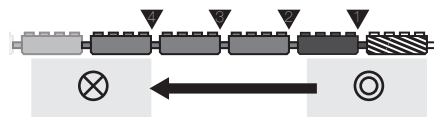

Basic ship movement, moving 4 forward.

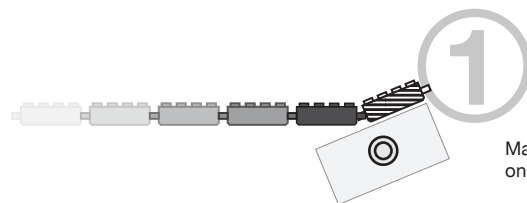

Making a turn by using one maneuver pip.

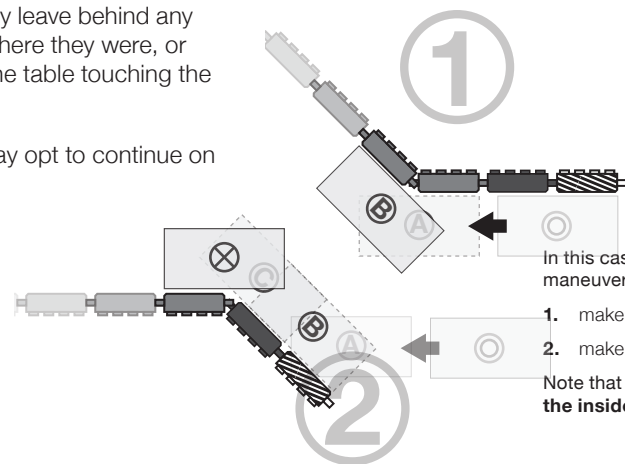
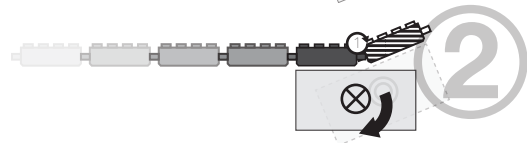

In this case, the player has used a maneuver pip to:

1. make a starboard turn
2. make a port turn

Note that **the ruler always goes on the inside** of a turn.



Ramming, Collisions, and Passing

Sometimes, you'll ram another ship or HVA on purpose, and sometimes you'll collide with something against your wishes.

If a ship ends its turn touching another ship, they collide, whether they wanted to or not. Skip to rolling collision dice.

If a ship's move would take it all the way through another ship or its base, however, the players will choose whether to ram or to avoid the collision.

If one ship is a frigate, the frigate's player can use the ship's maneuverability to decide unilaterally if the ships collide or not.

If neither or both ships are frigates, the moving player says whether the ship wants to ram or not. If that player decides not to ram, then the other player decides if they want to. If either player wants to ram, that ship will ram the other.

The Ijad company *Fire-Of-Clouds* rides the twice-captured Free Colony Samar-class frigate *Meat Tenderizer* into its companion vessel, *Pocket Slingshot*, hoping to refuel on its captured deck.

Stop the ship as soon as it touches the other ship and roll collision dice.

If a ship moves through or touches a mobile frame company, the company's player can decide if they cling to the ship. If the company is out of fuel (no pips on its fuel die), the ship's player decides instead whether the ship will capture or rescue the company (page 40).

If a ship moves through a piece of space debris, its player can avoid the debris by spending one pip from the maneuver die (green or white). Otherwise, stop the ship where it touches the debris and roll collision dice. Then, choose to remove the debris altogether or move it the same distance as the ship's current speed, though not into an immediate collision.

Rolling collision dice

When a ship collides with something, roll a number of dice equal to the speed of the moving ship — the total distance it would have traveled had no collision occurred. Each 1 or 2 damages one system on the ramming ship. Each 4, 5, or 6 damages one

system on the rammed ship, but does not affect debris.

Starting with the rammer, each player turns their opponent's ship by a number of clicks up to the number of its systems damaged by the collision. If turning would cause another collision, stop the turn just before the ships collide, then roll collision dice equal to the number of clicks remaining in the turn for the two new colliding ships.

If a ship collides with an HVA, the HVA takes no damage from 4s, 5s, and 6s on collision dice, but the rammer still turns the HVA as described before.

HVAs may never opt to ram. If an HVA would end its turn on top of another ship, it stops before the collision happens. If its move will take it through a ship, that ship can unilaterally opt to ram it or allow it to pass.

The Edge of the Table

If a TA leaves the edge of the table, it's lost in space and won't be able to return to the battlespace until the battle has ended. The owner of the ship loses its points immediately and removes the model from the game.

If in doubt about whether the ship is still on the table, it is.

If an HVA hits the edge of the table, the player with the highest score, other than the HVA's owner, rotates it in any direction they like to keep it from going off the table.

Launch, Fuel, and Repair Companies

If your ship has a catapult system and a company of frames touching the ship or its base, you can opt to **fuel and repair the company** and to **launch one company per catapult**.

You may allocate a black or unallocated white die to **repair** any company back to as many total systems and white dice as the repair die shows, up to 6.

You may also allocate a black or unallocated white die to **fuel** any company by optionally replacing its current fuel die (if any) and then launch them.

When you launch a company, place it on the table anywhere out of cover to the launching carrier, and place a black fuel die beside it. The company is now attached to its destination and may opt to move along with it. The fuel die will count down every round, as well as when the company dodges incoming fire.

The frame company can now be chosen to take its turn in normal tactical order.

Example

It's the FC Carrier *Wildcat*'s turn. Onboard is the mobile frame company *Wang's Wobblies* with: 2 white dice, 1 weapon, and 1 defensive system left.

The *Wildcat* rolls a 5 and, as the owner of the *Wobblies*, opts to repair its sensor system, regaining its dice. If the die had been a 6, the owner of the *Wobblies* could repair the movement system, as well.

Spot a Tactical Asset

A ship may allocate a **yellow die** or an unallocated white die to spot any TA or to replace an existing allocated yellow die of lower value.

If the spotting ship has **no comms systems**, it may only spot a TA **out of cover at assault range or closer**.

If the spotting ship has **one comms system**, it may spot a TA at **assault range**.

If the spotting ship has **two comms systems**, it may spot **a single TA anywhere in the battlespace**.

On a mobile frame company's turn, you'll:

- » **declare a target** that is, or you hope to be, in dogfight range this turn
- » **defend** your company
- » optionally, **attack**
- » **move**
- » optionally, **attack** if it hasn't yet
- » **spot** a TA

Companies have different capabilities from ships and work slightly differently.

Defend Your Company

Allocate a blue or unallocated white die as your company's defense number.

The blue ace allows its company, when attacked, to take hits as though in cover, and may make any

other unit in point defense range take hits as though in cover.

Dodging Away

When a company takes a hit, if it has a green die and is touching any asset, it may spend one fuel to step to a distance of one unit directly away from the asset, rather than taking one hit.

Optionally, Shoot

Allocate a red die or an unallocated white die as your attack. You may opt to shoot at the end of your move instead of at the beginning, or not at all.

Dogfight range

Companies may only attack at dogfight range.

Dogfight range is 1 ruler unit, or where the target is touching a ship within 1 ruler unit.

The red ace allows its company to also attack at point defense and assault range.

Frame companies **damage other frame companies** on hit dice of **4-6** and **damage ships** on **5-6**.

Move

Allocate a green or unallocated white die to move the company. While a company has a green die, it may move in a straight line in any direction, even through obstacles without prompting collision. If a company does not have a green die, it must move around obstacles rather than through them.

During its move, if a company comes into contact with an unfueled company, whether friendly or not, the moving company can carry the other company with them, **rescuing** or **capturing** it.

The green ace may adjust each ship it touches, either moving it one unit or turning it one click in any direction. Additionally, when a ship moves itself while touching a green ace, the ace may adjust the ship as normal and may unilaterally decide if the ship collides with another model. If both ships are carrying a green ace, the ships will collide if either wants them to.

Abandoning Assets

If the last company of the player who owns a captured ship abandons it by flying at least 1 unit away — by being destroyed, or by running out of fuel — the ship retains any unfinished maneuvers. Immediately **return to the control of the original owner of the ship.**

HVAs remain in the possession of the last player to have a ship within point defense range of it, or a company within dogfight range of it.

Spot a Tactical Asset

Allocate a yellow or unallocated white die to spot. Frame companies can only spot TAs in dogfight range.

The yellow ace, when its company spots, may place its yellow d8 on the same spotting target. Additionally, the yellow ace allows its company to spot at point defense range.

The *Fire-Of-Clouds* mobile frame company captures the communication satellite high value asset that has been broadcasting propaganda to the colony below.



Capturing HVAs

When only one player has ships within point defense range of, or companies within dogfight range of, an opponent's HVA, she may immediately capture it. Once she captures it, she increases her score by her PPA, and the ship's previous owner reduces his own points by his PPA. The new owner now takes the HVA as her own. If the HVA has already moved this round, the new owner may not move it until next round. Until another player captures the HVA, the new owner controls it and retain its points.

Ending the Turn

Once you finish taking the turn for an asset, the turn passes to the current highest scorer with any assets left to move this turn, or they may pass to the next player down the scoreboard, who then makes the same decision. If you have the lowest score and have not moved an asset, you must take your turn.

Ending the Round

When every asset has taken its turn:

1. Remove all blue (defense) and yellow (spotting) dice from the table.
2. Capture ships and repel boarders.
3. Reduce the Doomsday Clock by one.
4. Starting with the current leader, ask each player except the one with the lowest score if they want count down the Doomsday Clock by another tick.
5. Reduce each black (fuel) die by one.

Capture ships and repel boarders.

At the end of the round, if any company is touching an opponent's ship or its base, each player with companies on this ship rolls **one yellow die for each of their participating companies, plus a yellow d8 if one of their participating companies is led by an ace**. The owner of the ship additionally rolls all red dice for point defense weapon systems on the ship.

One player may opt to aid another before they roll, giving that player their dice to roll. That player may not take possession of the ship this round.

The player with the most yellow dice reading 3 or higher captures the ship. If none are highest, the current owner of the ship keeps it.

Each 4 or 5 on a yellow or red die damages one system of an enemy company. The ship's player determines how many of each hit affects which boarding player, but the boarders decide which companies take each hit.

Each 6 damages two enemy mobile frame systems.

Each 7 damages three enemy mobile frame systems.

Each 8 damages four enemy mobile frame systems.

The player taking the damage determines which company takes each hit, if they have a choice.

The ship is never damaged by boarders.

When a Ship Is Captured

The capturing player increases their score by their own PPA.

The captured player reduces their score by their own PPA.

A captured ship acts as though the captured player owns it, except:

The white dice of the captured ship remain in the hands of the original owner. The original owner may allocate them as they wish on that ship's turn after the captor rolls the ship's colored dice, even replacing colored dice of higher values.

Bingo Fuel

A frame company with only 1 fuel left is at bingo fuel. This round is their last opportunity to get to a friendly carrier and refuel before they go adrift.

When you turn down the fuel die from 1 to 0, the frame company has run out of fuel. The player who owns the company loses its points immediately.

The company's engines have gone cold. **No one can target a drifting company, and it does not get a turn.** The company stays in place on the table unless another asset affects it.

Any asset can capture or rescue a drifting company by passing within point defense range of it. The captured company will stay touching the capturing/rescuing asset as long as the asset's owner likes. If the asset's owner doesn't release the company, only by capturing or destroying the ship that's holding it can they be rescued.

Companies may dodge away from a drifting company that they're carrying by spending one fuel, as when on ships.

Once the company is refueled, control and points revert to the original owner of the company.

:!o

Playing with Mobile Frame Zero: *Rapid Attack*

Set up two tables. **One will host the mobile frame battles.** Whenever mobile frames clash in the battlespace, set up a battle at Mobile Frame Zero: *Rapid Attack* scale.

For each system remaining in a company, include one frame (that is, up to four). If your ace is present, one model will represent that ace. Each ace gets their colored d8. The **red ace** can shoot at any range with any weapon. The **yellow ace's** yellow d8 works as per these rules, at any range. The **green ace** may move any frame within Hand-To-Hand range (or HtH range of another frame that is HtH range) along with the green ace, or one in any direction. The **blue ace** makes any frame in Direct range take damage as though in cover. If the ace is taken out in battle, the

company will not lose the ace's power, but will lose one white die.

Set a special objective that represents control of the ship. Whoever owns it at Doomsday Zero wins the ship!

Defender, set two turrets with two red dice at Direct range equal to the number of point defense weapons on the ship. Each has two red dice and a red d8.

For each frame your company has lost, remove one die from the company on the *Intercept Orbit* table.

Expect this campaign-length battle to take many sessions!

FAQ

What can I do if a ship only has white dice?

A ship can:

- » Repair itself
- » Defend itself
- » Maneuver and ram
- » Attack enemy TAs at dogfight range
- » Spot TAs that are both out of cover and no further than assault range

Can I use a fleet with no mobile frames?

Sure. Good luck with that.

(See: The Battle of Taranto, 1940. And *Pirates of the Caribbean*, by Verbinski, Depp, et al.)

How should I set up?

It might seem like the edge of the table is safe, but that's only until someone runs into your ships or a green ace comes and makes a mess of your tight, cornered formation.

What should I do if I want to publish Mobile Frame Zero stuff in public?

See the back section in *Mobile Frame Zero: Rapid Attack*. Mobile Frame Zero games use the Creative Commons, Attribution, Noncommercial Share-Alike license, but to use the brand names ("Mobile Frame", "Solar Union", "Free Colony", "Ijad", and other trademarks), you'll have to follow the instructions detailed in that book.

If you want to publish commercially, please contact joshua@glyphpress.com and we'll talk!

SHIPYARD INSTRUCTIONS

Warfare is evolving quickly in SC0245. For centuries, common sense has dictated that space battles would be won by the mightiest warships in the battlespace, but the introduction of the mobile frames to space warfare has dramatically changed that equation.

As military doctrine struggles to catch up with the new reality, it also struggles to make best use of the many ships that already trade between transit gates, as well as those who defend them from pirates, insurgents, and unwelcome militaries.

Here are six ships typically found around the transit gates of the Free Colonies, Ijad, and Solar Union.

While these six are common, spacecraft are expensive to build and there are many hulls still in flight a century after their maiden voyage. Additionally, designs proliferate around colonies with their own particular needs.

Ijad spacecraft, in particular, are unhindered by design tradition and in many ways have leapt over Solar Union technologies in the same ways they have with mobile frame technology.

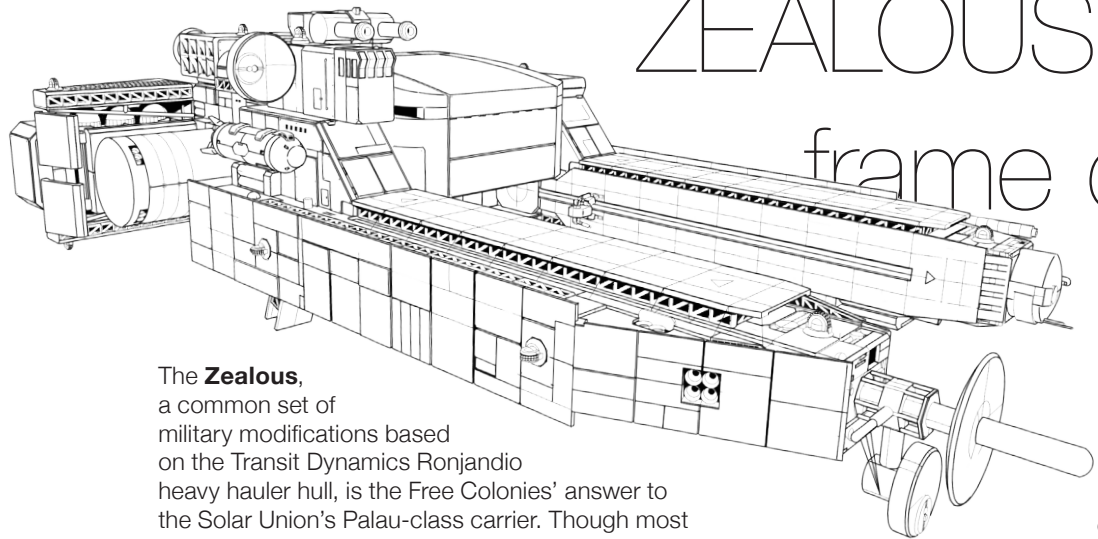

ZEALOUS-class frame carrier

The **Zealous**, a common set of military modifications based on the Transit Dynamics Ronjandio heavy hauler hull, is the Free Colonies' answer to the Solar Union's Palau-class carrier. Though most carry a mobile frame catapult in their central hull and leading down the left cargo arm, Zealous-modified ships can often be seen flexing their cargo arms to lend withering firepower, blinding decoy swarms, and target clarity to the battlespace.

Like for other Free Colony ships, the apparent civilian profile gives even this heavy warship the chance to pass undetected through the gate network on forged credentials.

Capital ship, 2W1K1Y2Rp2Ra

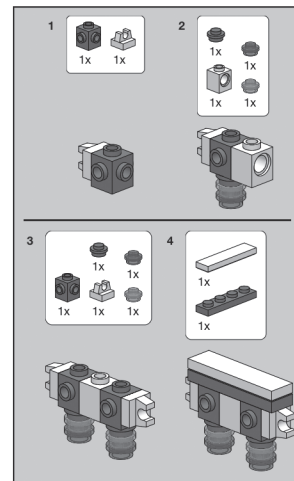
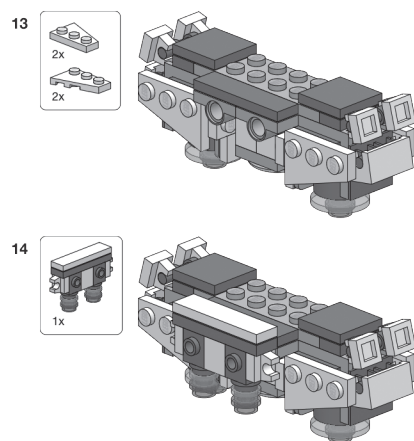
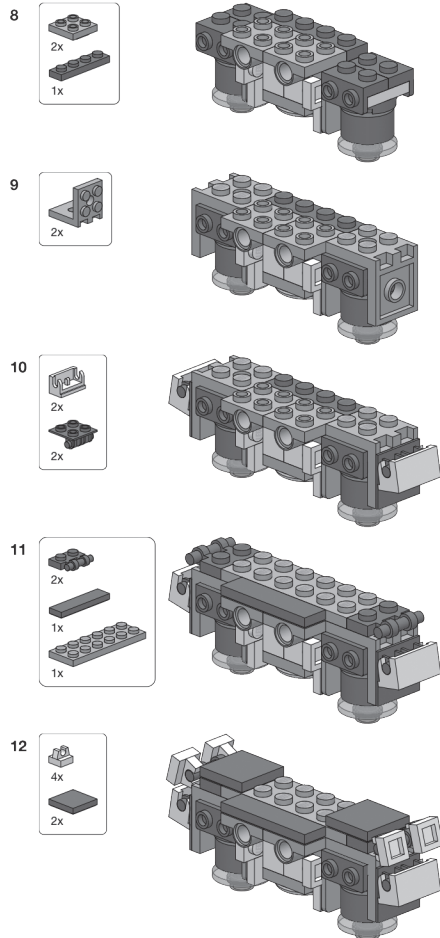
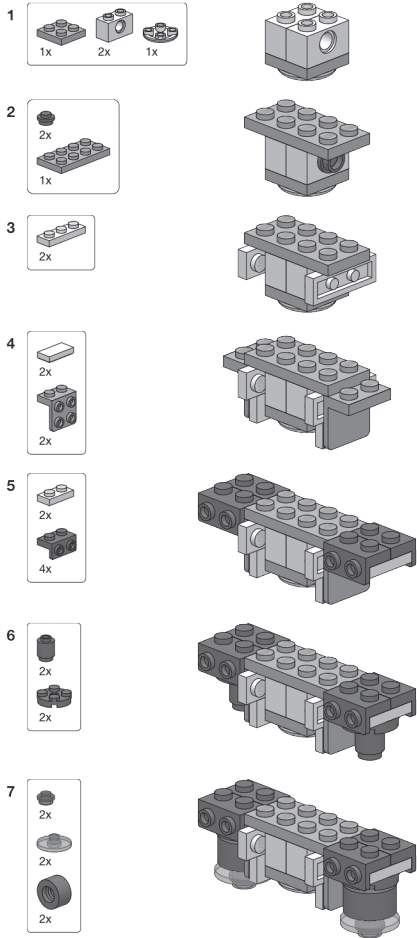

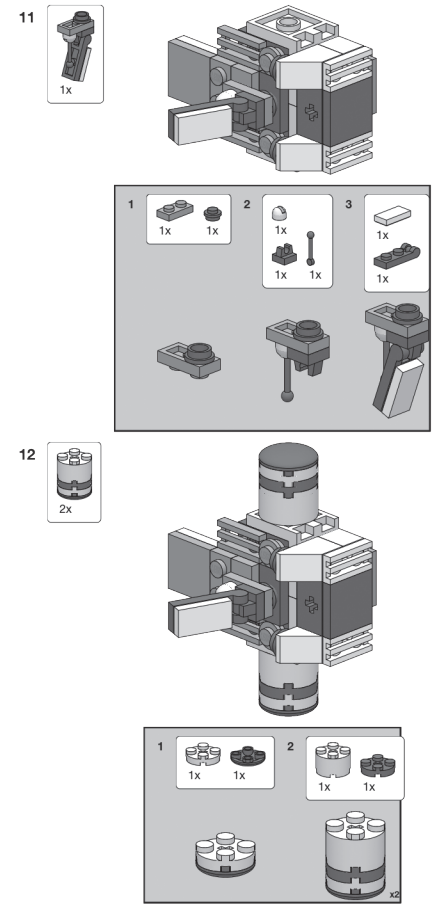
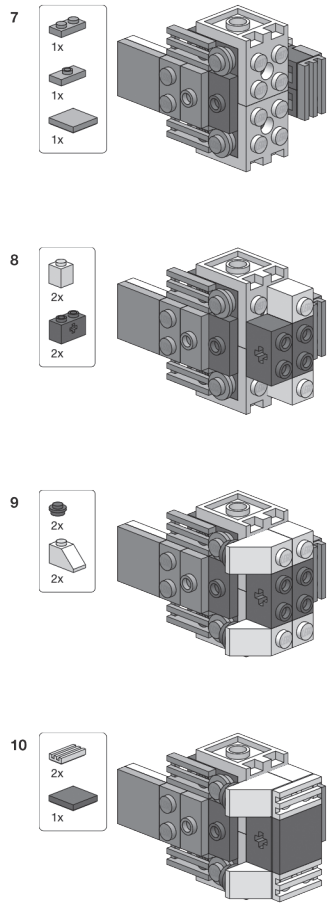
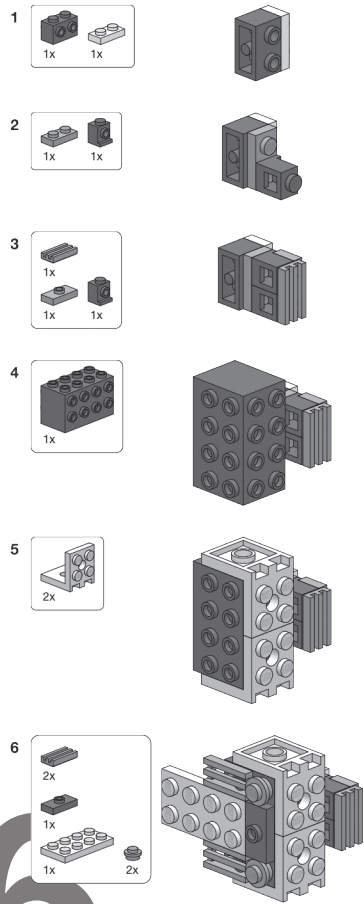

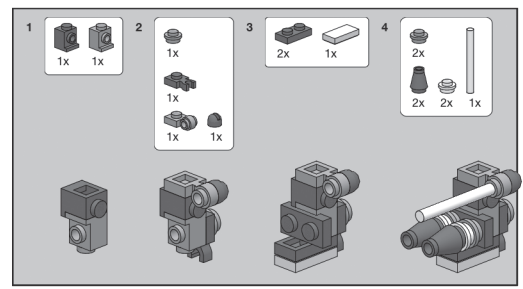
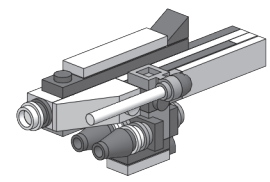
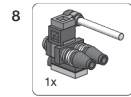
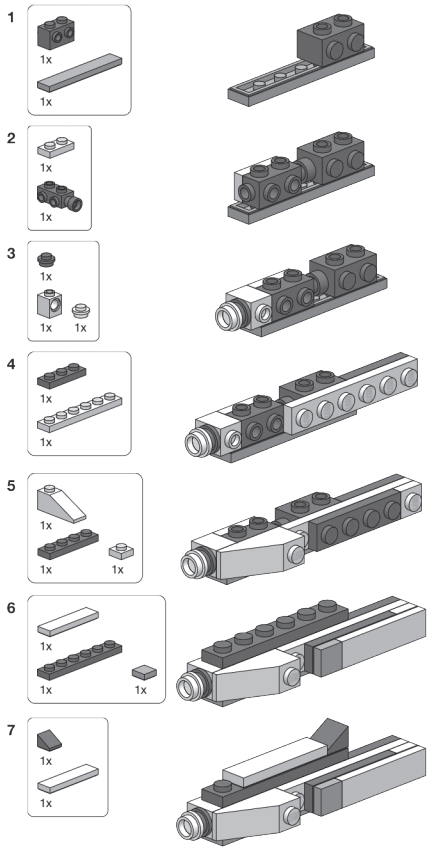

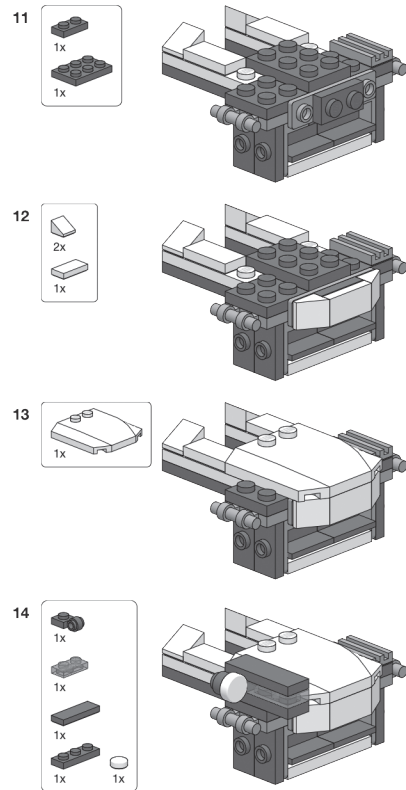
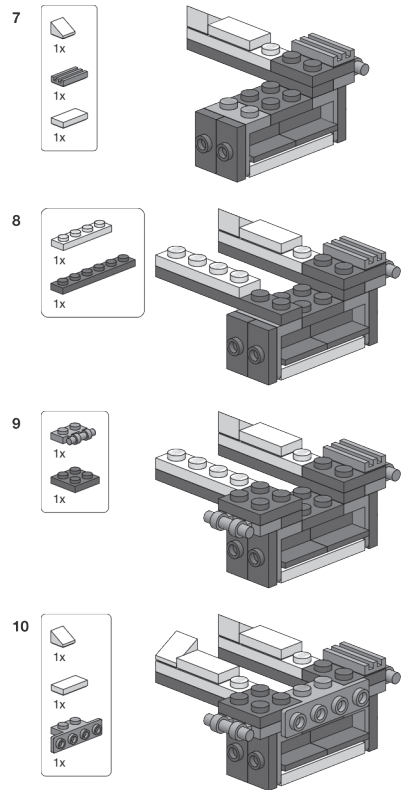
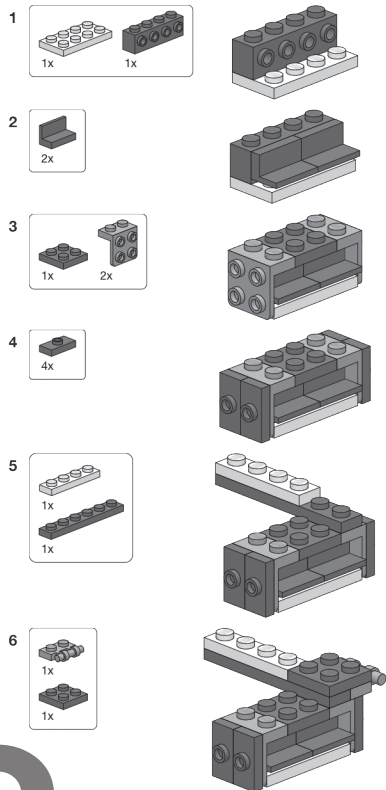

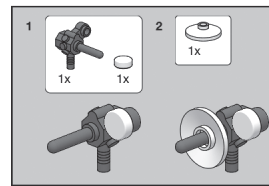
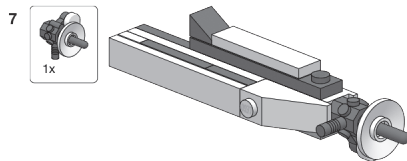
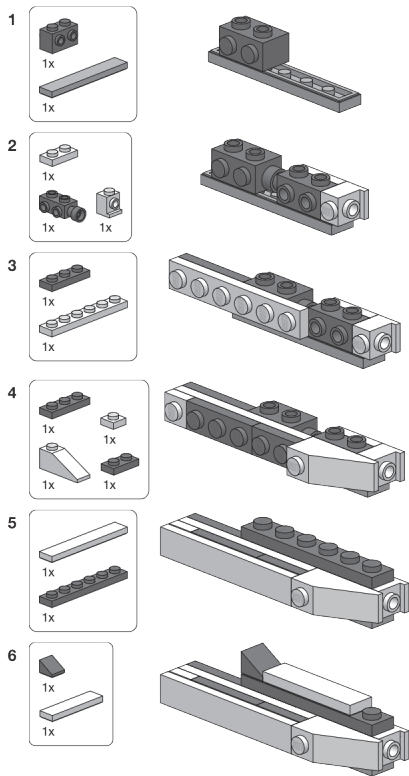

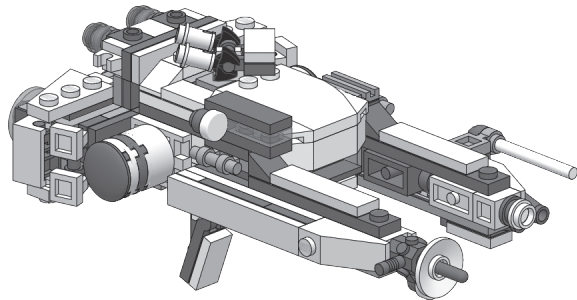
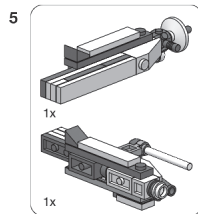
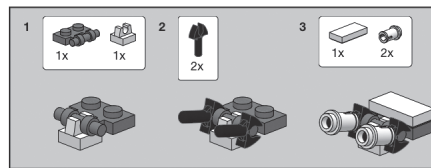
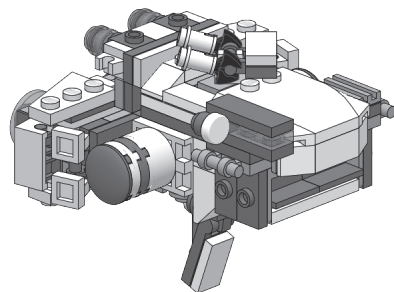
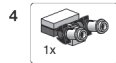
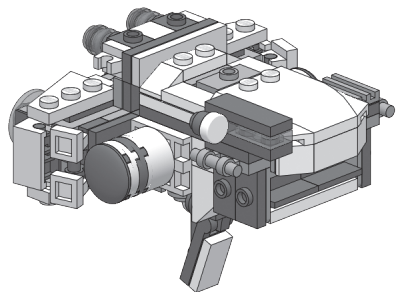
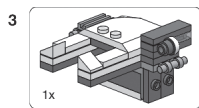
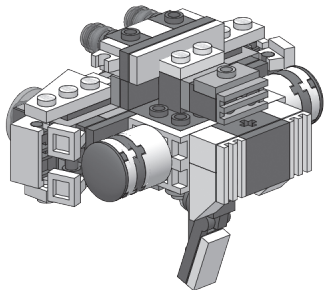
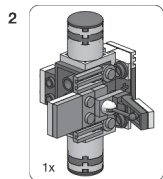
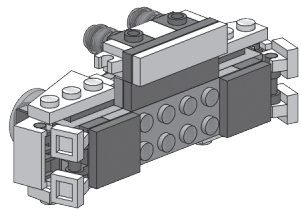
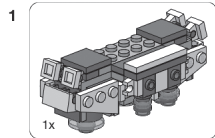

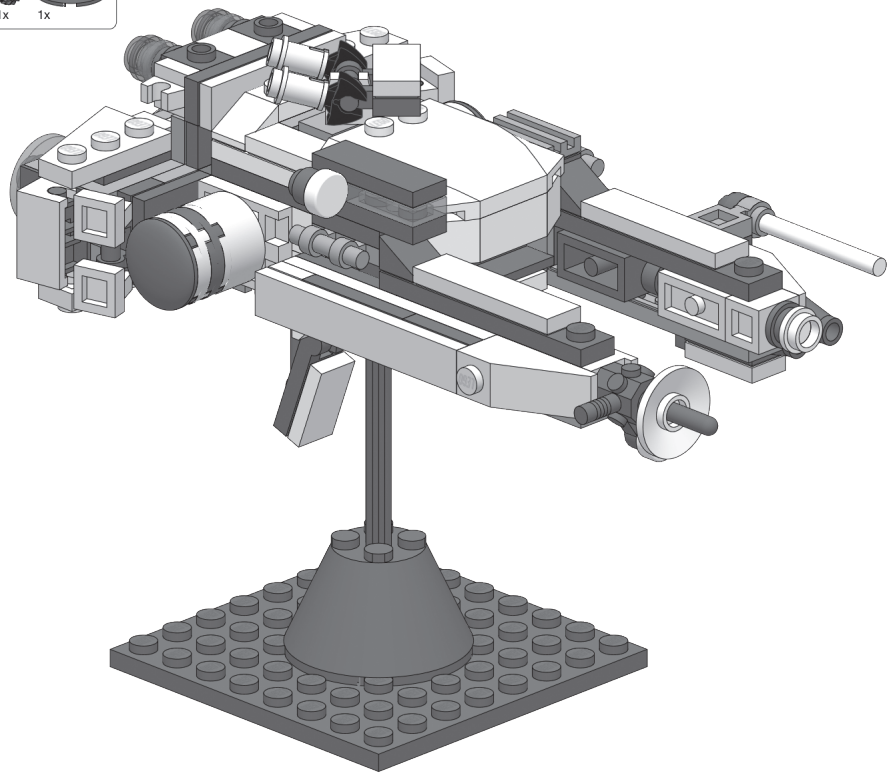
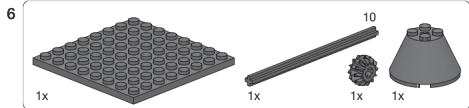

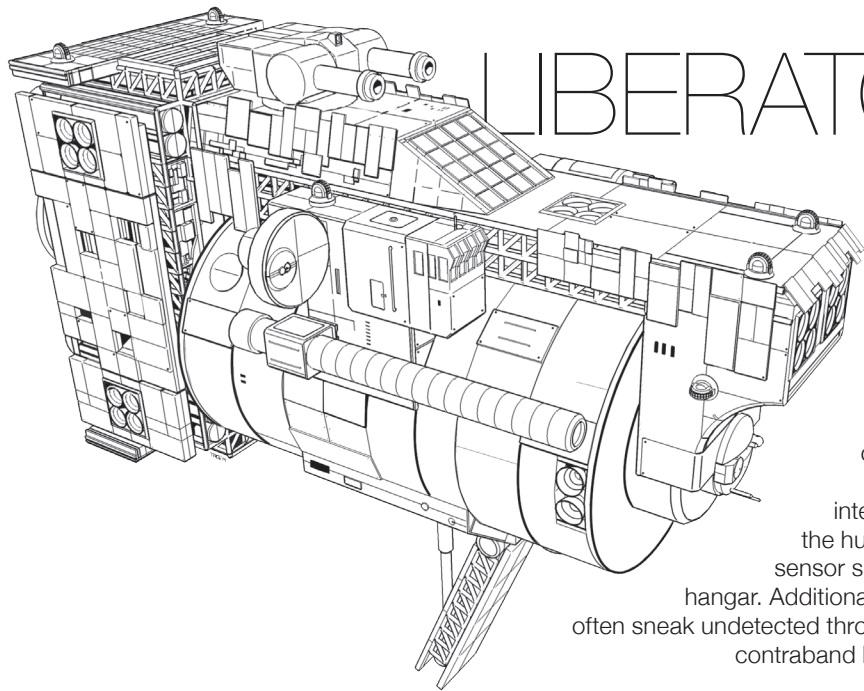

LIBERATOR-class frigate

Like most Free Colony ships, the **Liberator** is less a formal class and more a set of downloadable plans for converting a common category of craft to military purposes. The voluminous, interchangeable tank that forms the bulk of the hull has found use as a weapons battery, sensor suite, decoy launcher, and mobile frame hangar. Additionally, the profile is so common that it can often sneak undetected through hostile-held transit gates, carrying contraband hidden by forged registration numbers.

Frigate, 1G2W2Ra&d81Y

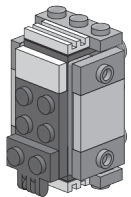
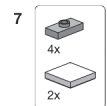
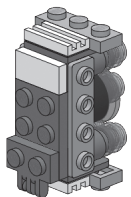
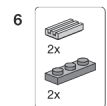
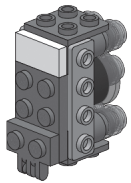
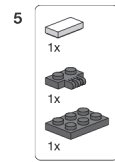
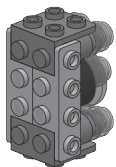
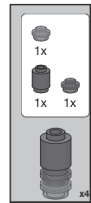
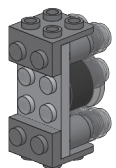
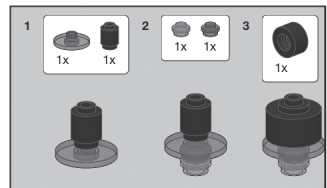
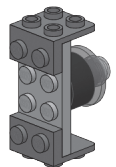
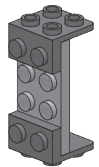
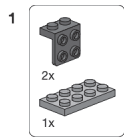

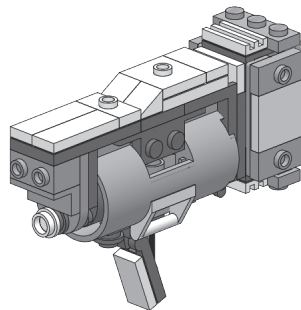
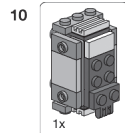
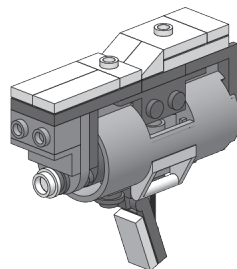
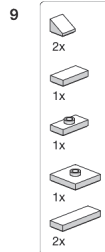
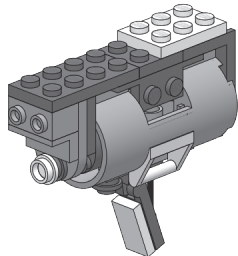
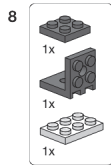
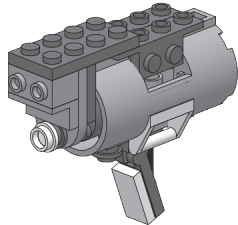
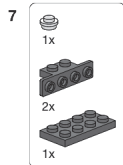
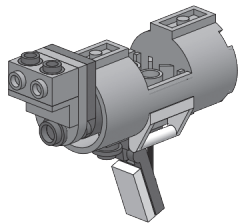
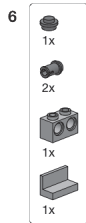
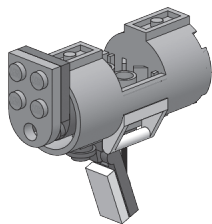
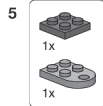
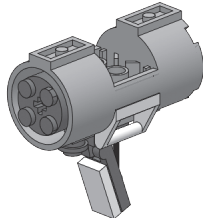
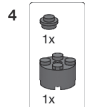
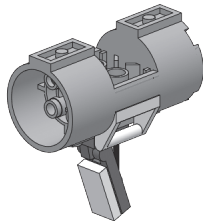
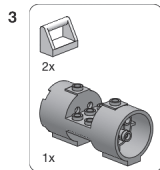
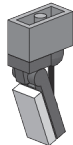
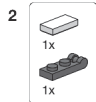
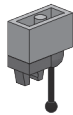
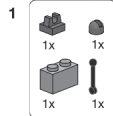

11

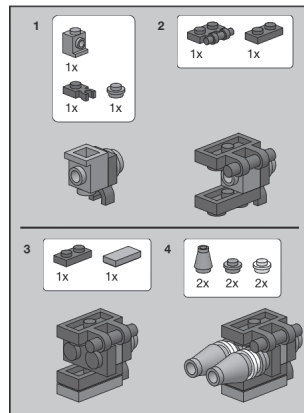
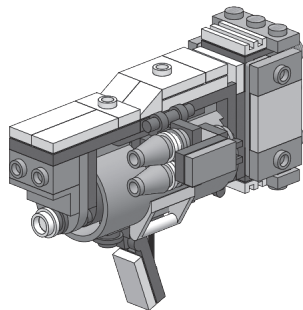

12

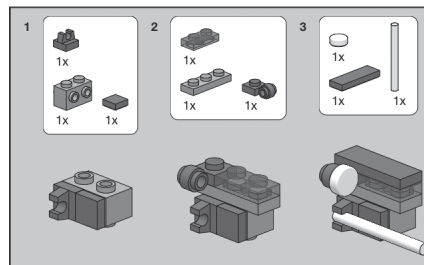
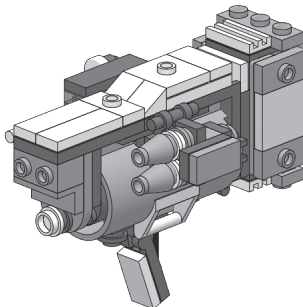
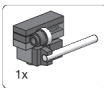

13

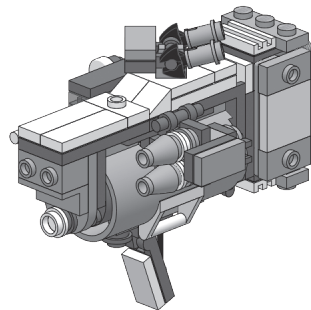
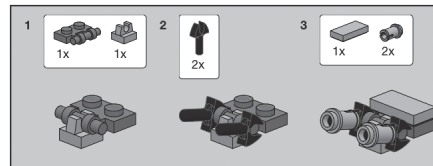

14

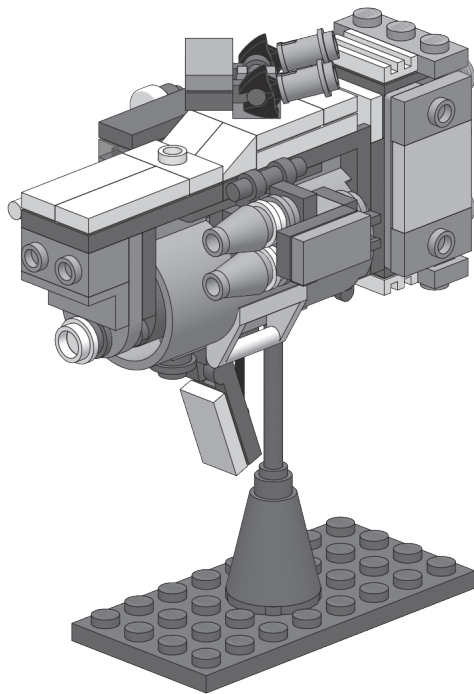
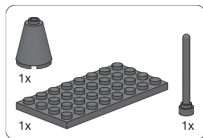

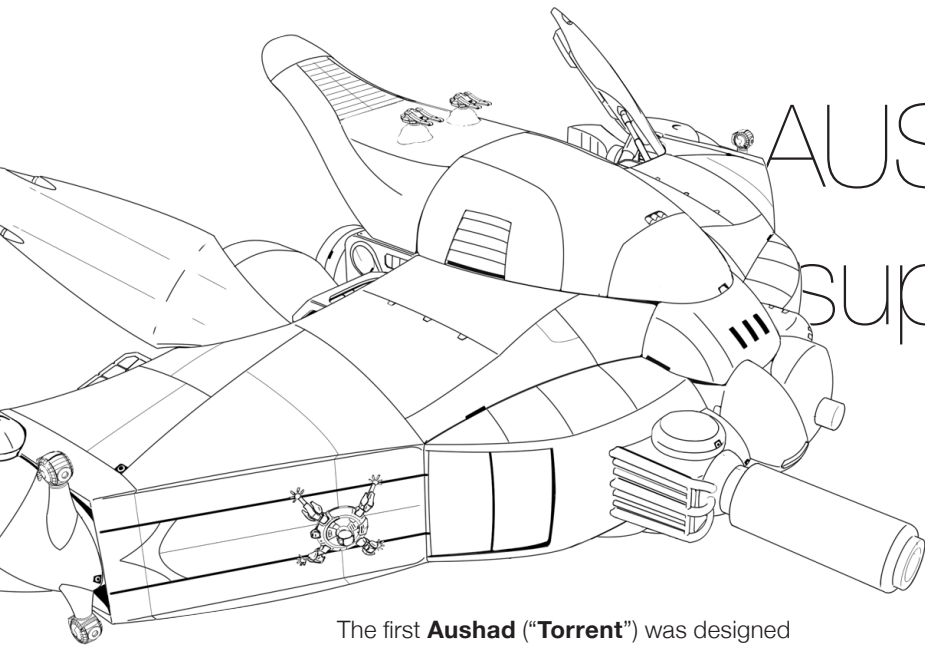

AUSHAD-class support carrier

The first **Aushad** ("**Torrent**") was designed and built orbiting the Ijad birthworld to complement the capabilities of the Ojebed frigate, using its long-range, bow-mounted particle beam to soften targets before raining space-adapted Scrambers and Suzerains in to capture them. They often carry point defense *petalcaster* weapons to

help protect their deck while the frames are away, and rely on their crescent-shaped armor shield to protect from incoming fire.

Inspired by an aquatic creature called an *ujekeh*, the Aushad can subtly and gracefully maneuver its bulk by the use of its twitching, wobbling maneuver fins, giving it the appearance of an undersea animal.

Capital ship, 2W1K2Rp2Rs1B

1



1x 3
1x 1x 1x 1x

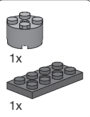

1x
1x

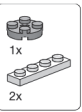

1x
1x
2x

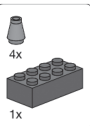

4x
1x

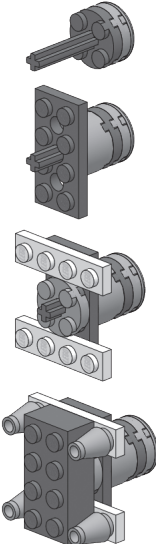

5

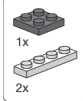

1x
2x

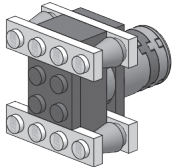

6



2x

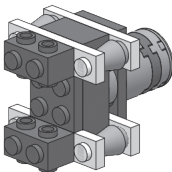

7



2x

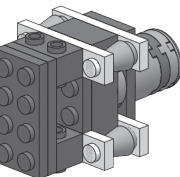

8

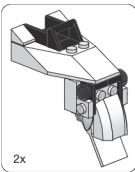

2x

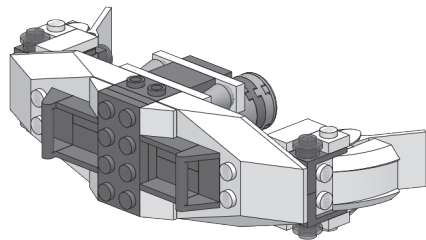

<p>1</p> <p>1x 1x</p>	<p>4</p> <p>1x 2x</p>	<p>7</p> <p>1x 2x</p>	<p>9</p> <p>1x 1x</p>
<p>2</p> <p>1x 1x</p>	<p>5</p> <p>2x</p>	<p>8</p> <p>1x 1x</p>	<p>10</p> <p>2x 2x 2x</p>
<p>3</p> <p>2x</p>	<p>6</p> <p>1x 1x 1x</p>	<p>8</p> <p>1x 1x</p>	<p>10</p> <p>2x 2x 2x</p>

9

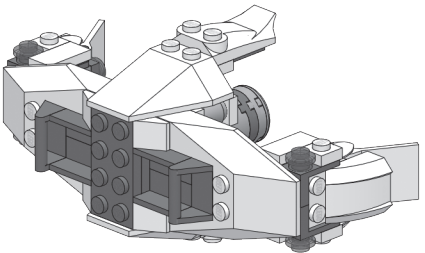
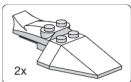

1

2

3

x2

10

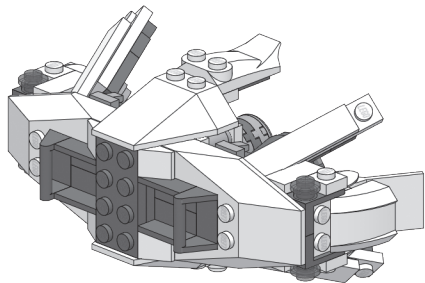

1

2

3

1

2

x2

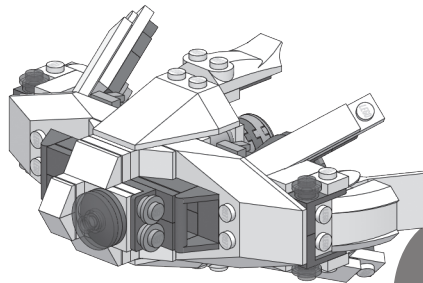
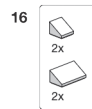
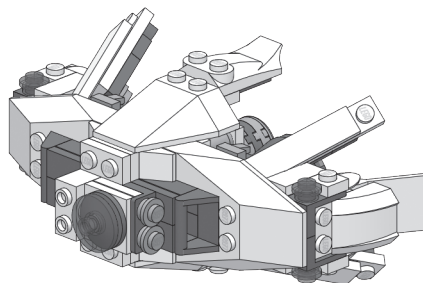
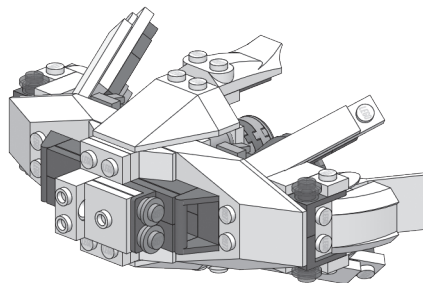
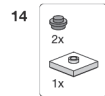
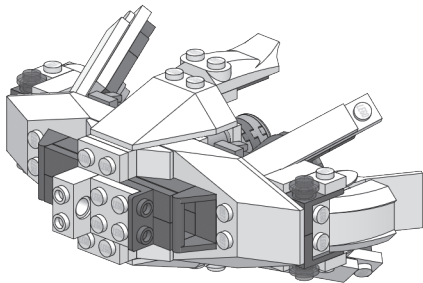
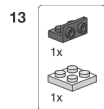
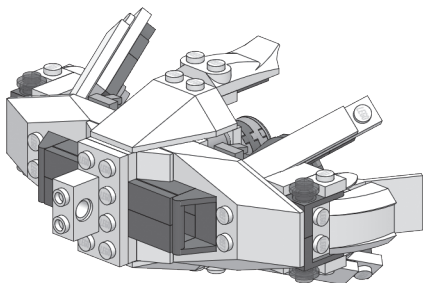
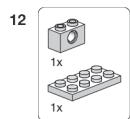
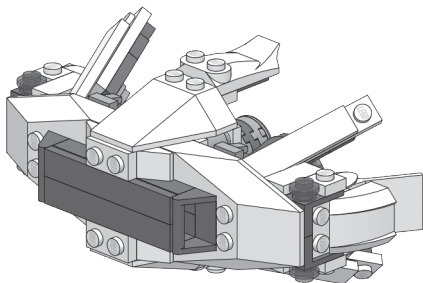
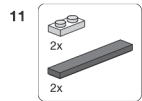

17

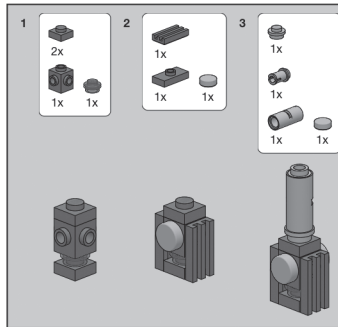
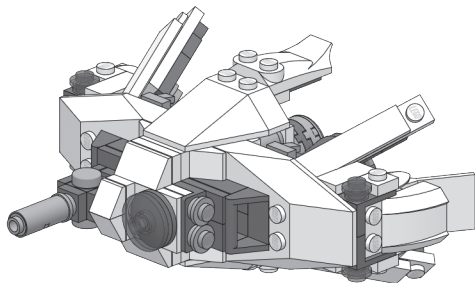

18

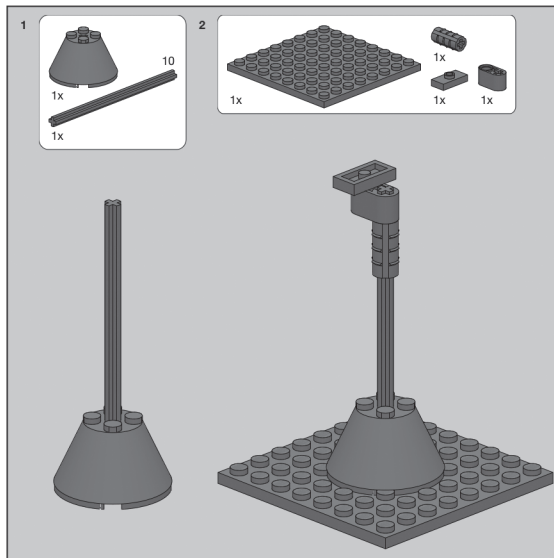
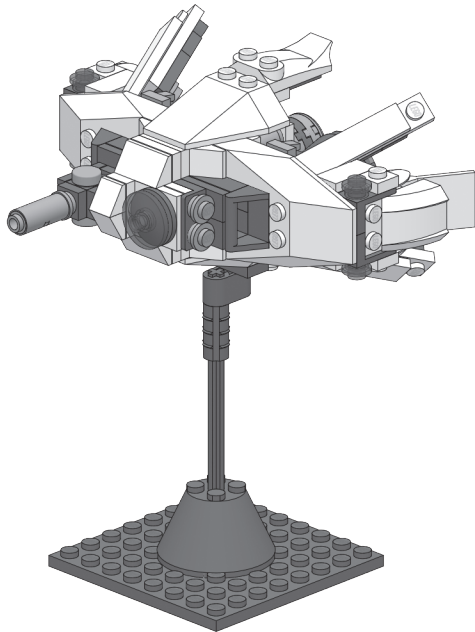
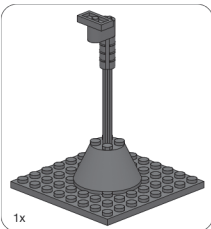

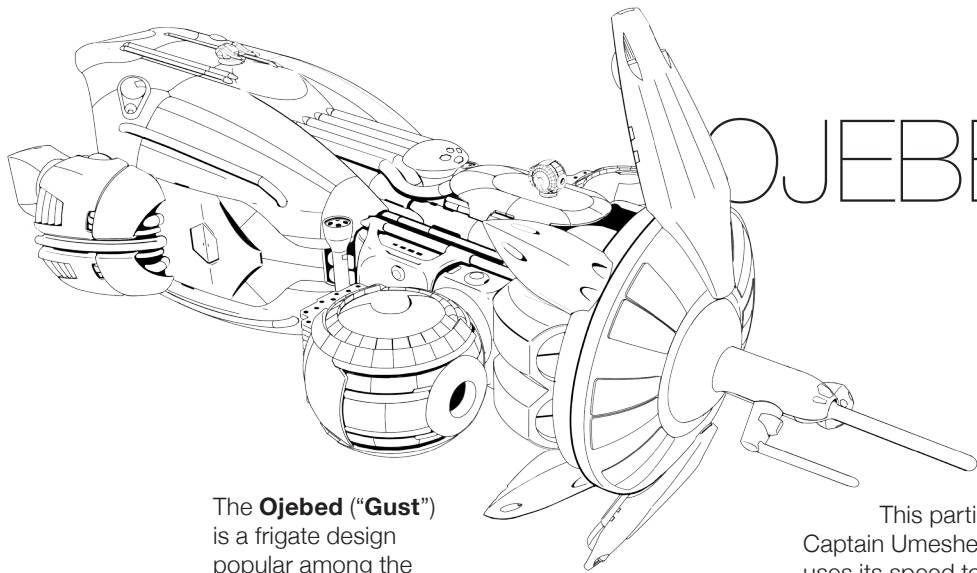

OJEBED-class frigate

The **Ojebed** (“**Gust**”) is a frigate design popular among the crew-tribes of the Ijad, capable of reducing an attacking mobile frame company to tatters. Like most Ijad ships, the “class” designation is seen more as a set of suggestions, observations, and recommendations made by other crews and design teams. When Free Colony or Solar Union fleets have fought Ojebed-heavy fleets, they have often found themselves making the unfortunate

assumption that Ojebed-class ships would act similarly.

This particular configuration, first used by Captain Umeshelih’s crew-tribe Shaker-of-Skies, uses its speed to put the ship in the thick of battle, cutting raiding frames off friendly ships and daring frame companies to try and capture it.

The uniqueness of each Ojebed gives their crews a sense of powerful loyalty to their own ship, and it is not uncommon for rivalries between crews to blossom during battle.

Frigate, 1G2W2Rp&d81y

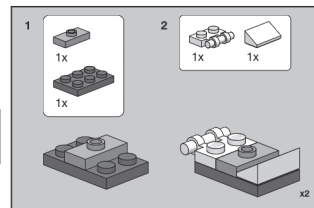
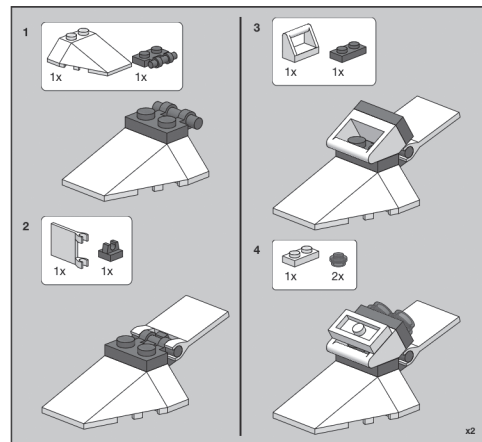
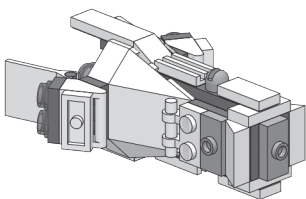
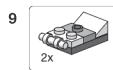
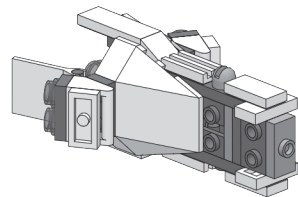
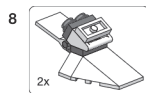
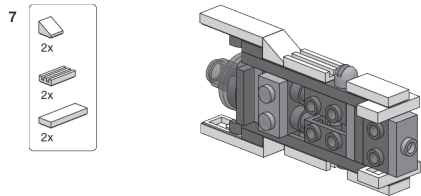
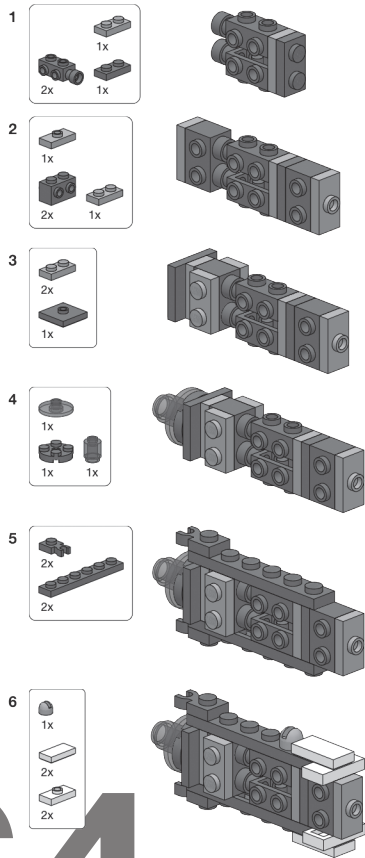

10

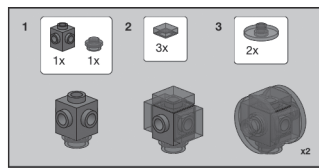
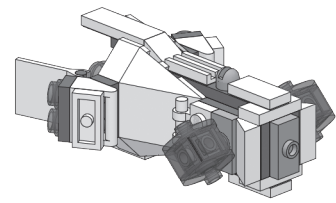

11

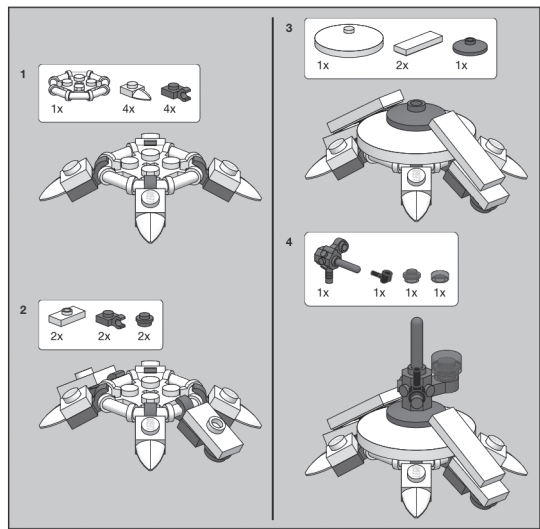
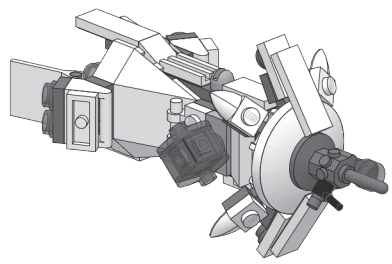
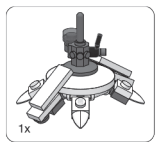

12

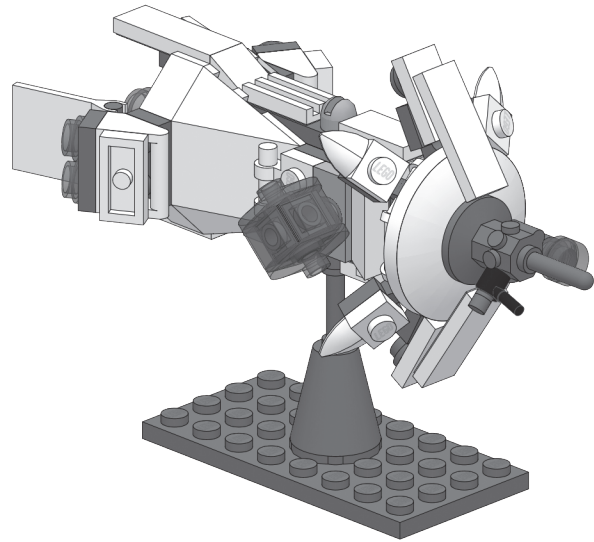
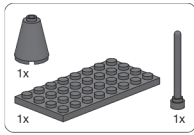

66

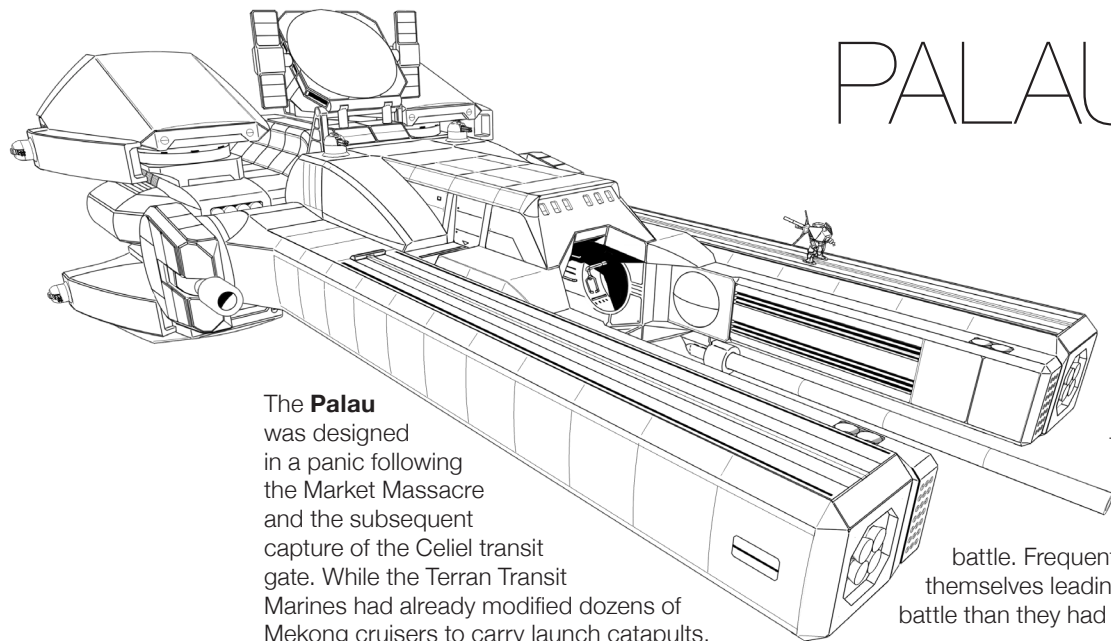

PALAU-class carrier

The **Palau** was designed in a panic following the Market Massacre and the subsequent capture of the Celiel transit gate. While the Terran Transit Marines had already modified dozens of Mekong cruisers to carry launch catapults, the Palau was the first dedicated mobile frame carrier, and it has proven its fitness to purpose time and again over the intervening decades.

Armed with sensors and point defense weapons to support its twin catapults, it often finds use as the flagship of a fleet, operating as a base of command for a battle. Frequently, Palau-class ships find themselves leading more ships out of the battle than they had entered with.

Capital ship, 2W1Y2Rp2K

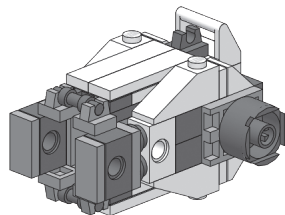
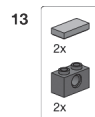
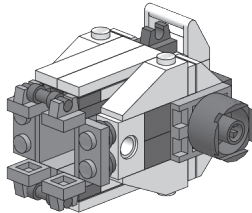
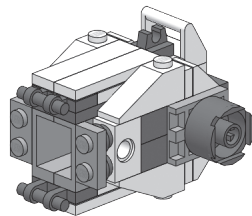
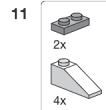
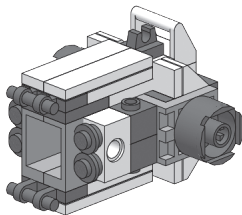
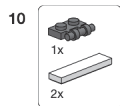
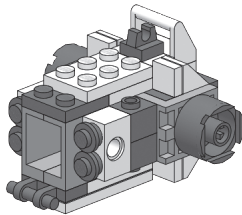
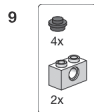
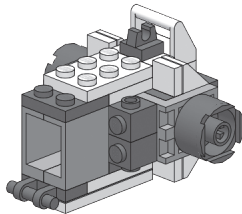
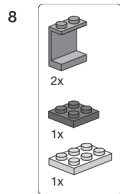
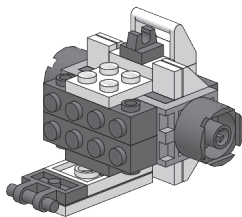
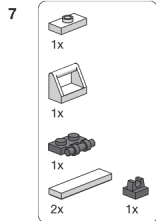
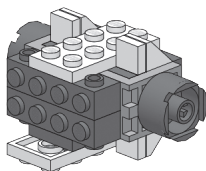
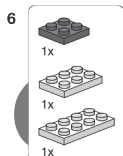
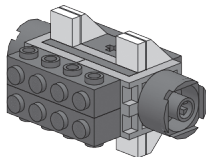
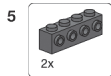
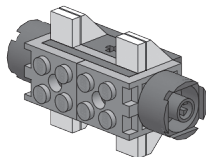
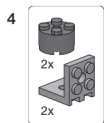
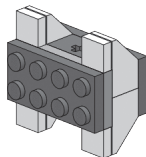
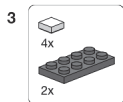
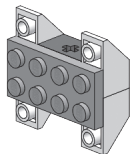
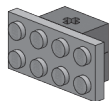
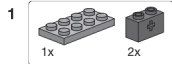

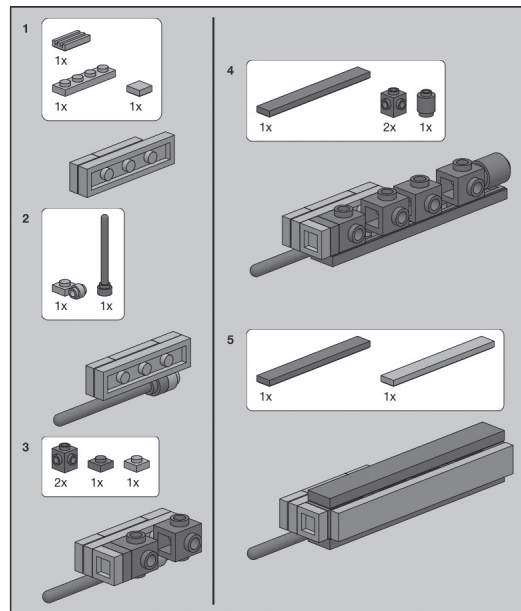
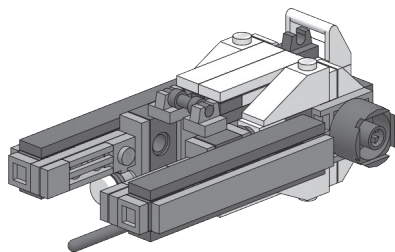
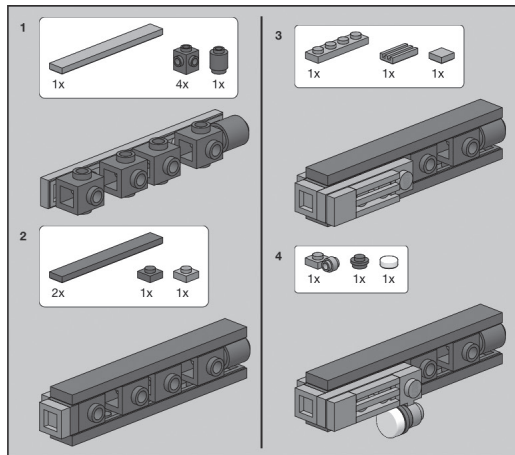
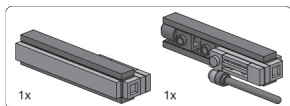

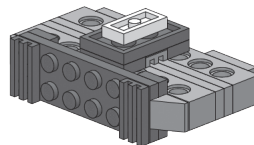
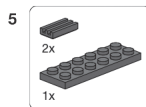
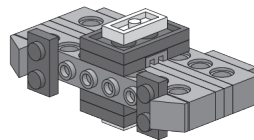
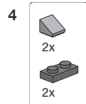
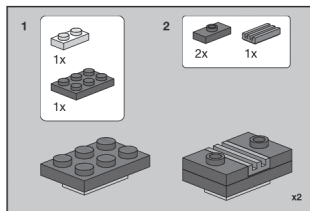
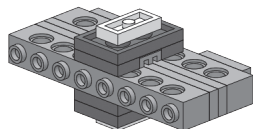
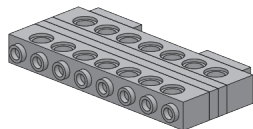
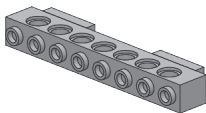
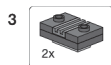
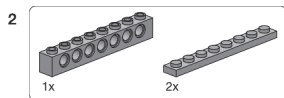
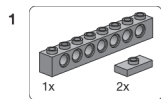

6

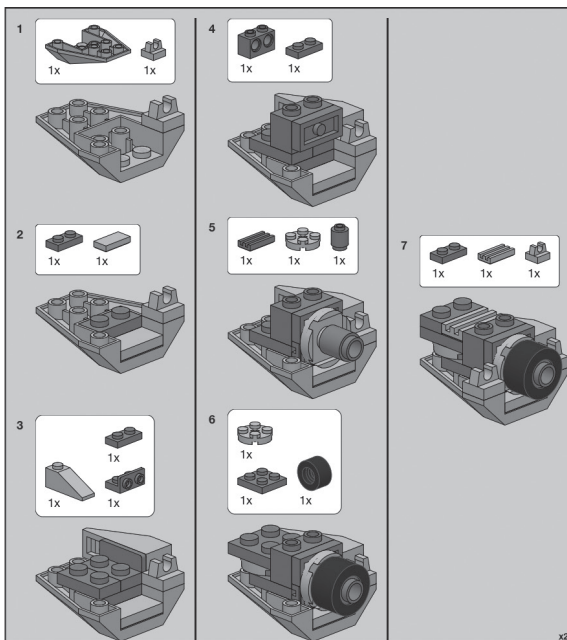
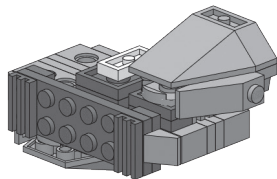
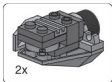

7

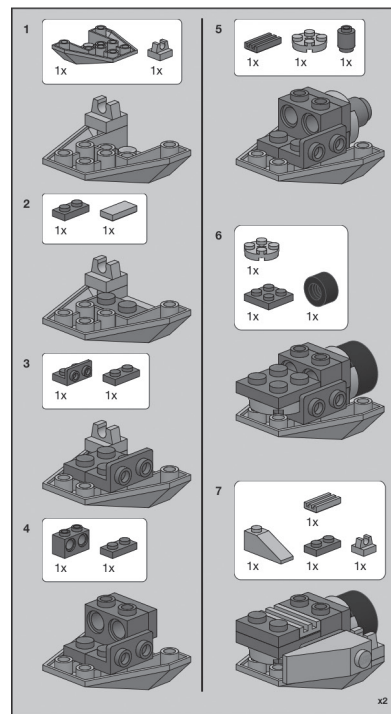
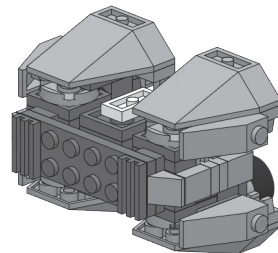
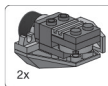

15

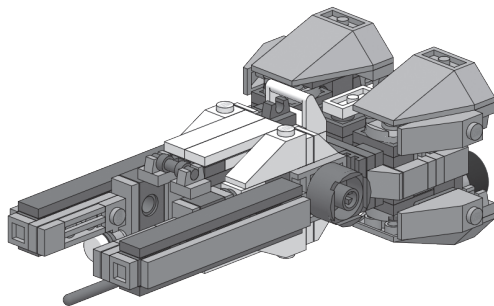
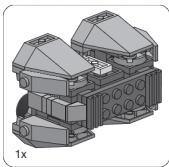

16

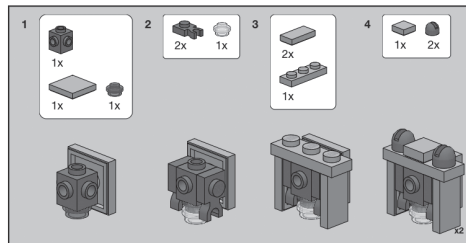
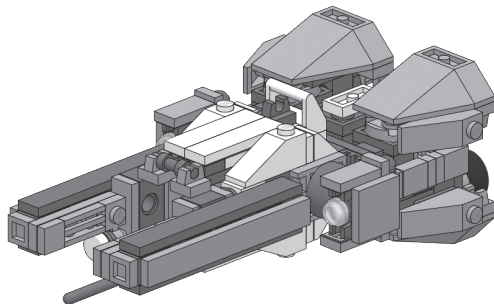

17

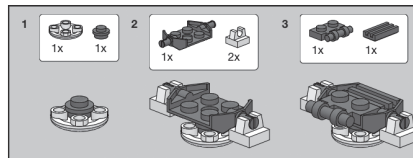
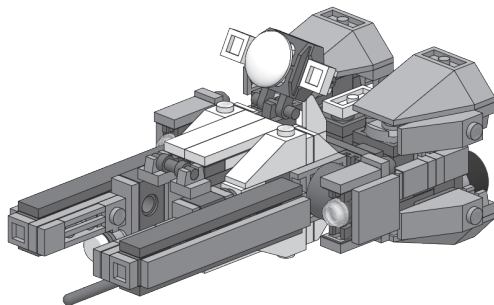

18

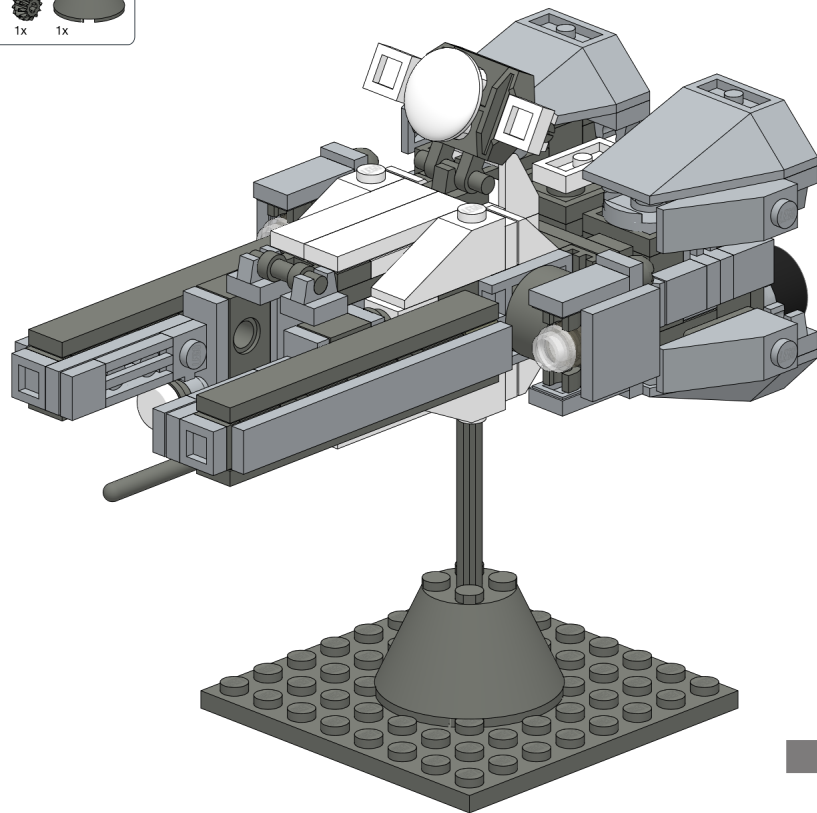
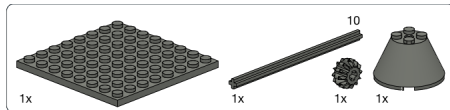

73

SAMAR-class frigate

The **Samar** is a relatively new SU design, with the first ships leaving Jovian shipyards for use by the the Terran Transit Marines in SC0230. The design has since been transferred to all branches of the Solar Union militaries, who use its modular design to satisfy each of their distinct mission requirements. Despite its flexibility, though, it has found itself with a reputation as a deadly torpedo boat, and many a battle has been won by a Samar crippling multiple enemy ships.

Most Samars bear a nickname that implies a rugged loyalty, rather than violence.

Frigate, 1G2W1B2Ra&d8

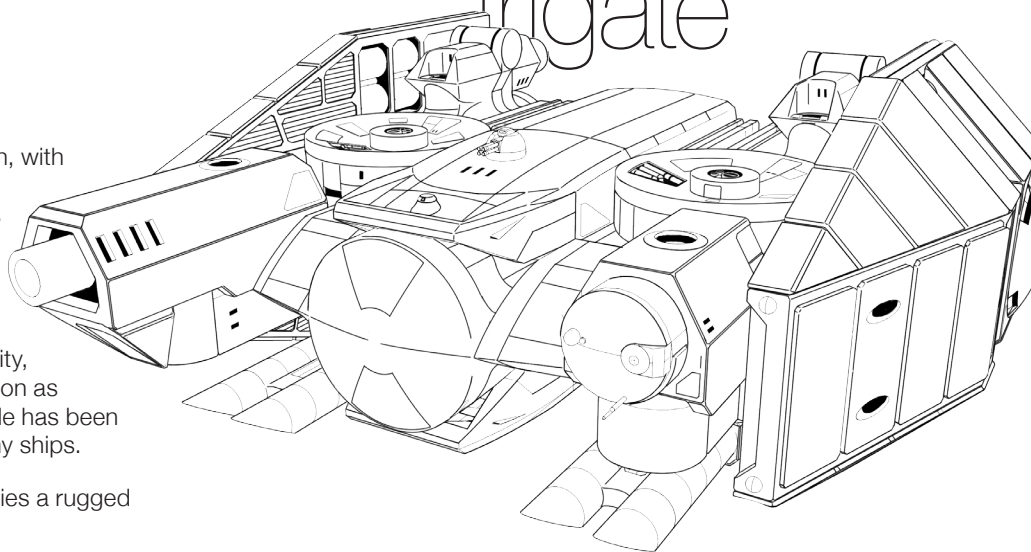

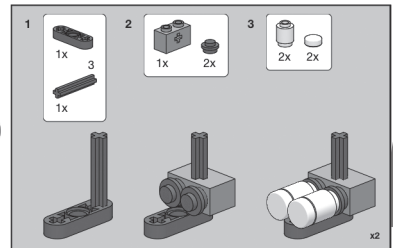
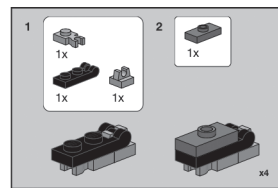
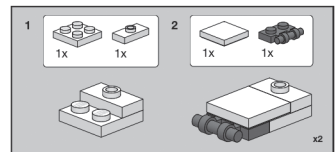
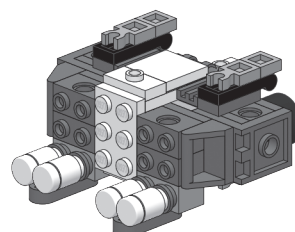
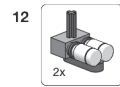
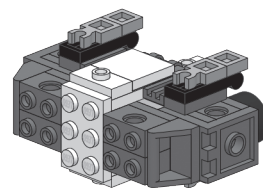
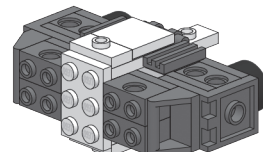
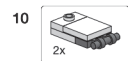
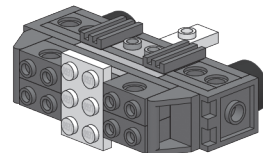
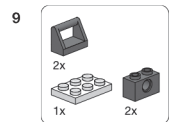
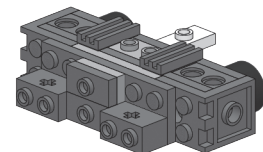
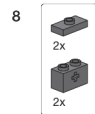
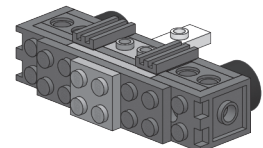
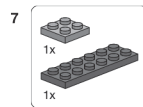
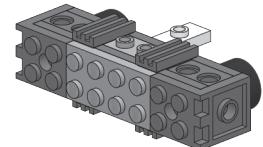
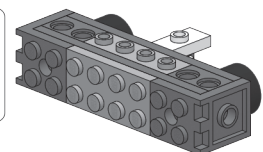
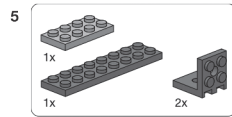
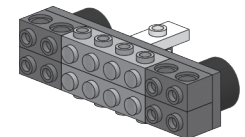
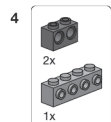
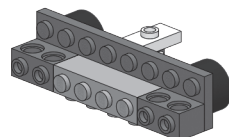
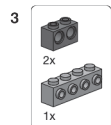
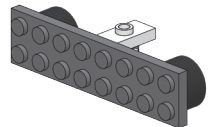
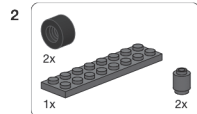

13

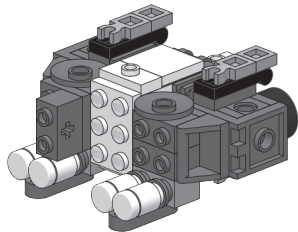
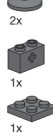

14

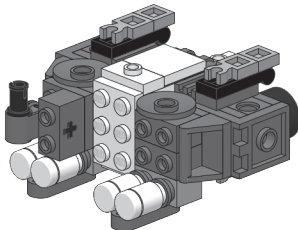

15

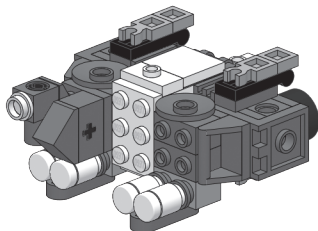

16

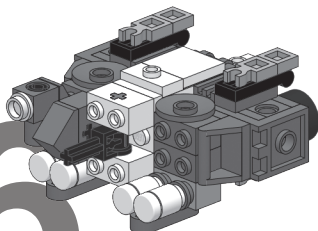

17

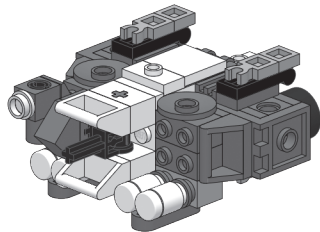

18

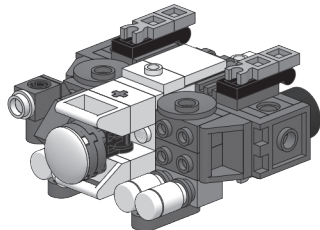

19

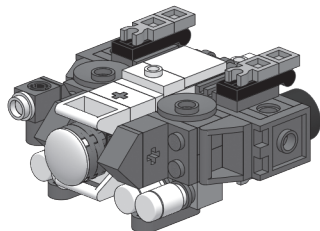

20

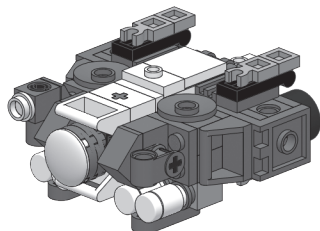
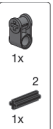

21

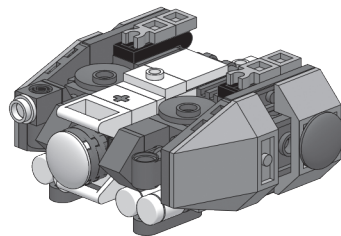
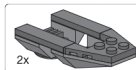

1

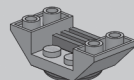
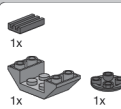

2

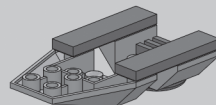
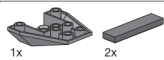

3

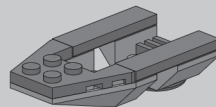

x2

22

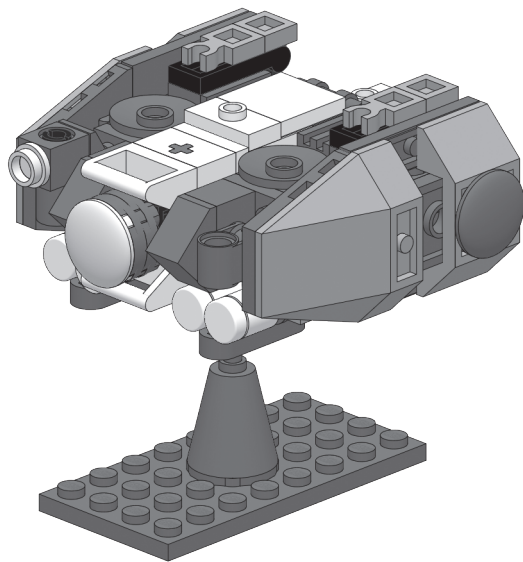
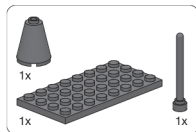

Mobile Frame Company

A mobile frame company model represents any number of frames, but this one consists of three humanoid ones — perhaps ST-10 Ospreys or space-adapted Commissars. As the company takes damage, it loses the colored studs from its base to show which systems it has lost.

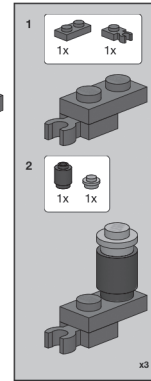
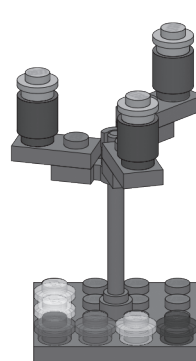
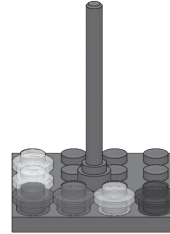
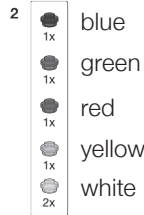
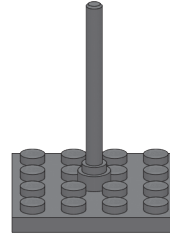
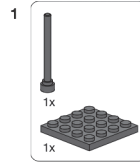

Mobile Frame Ace

Here is a simple, humanoid mobile frame ace model. To use it, replace the post in the company model with the stand or simply add it to the stand.

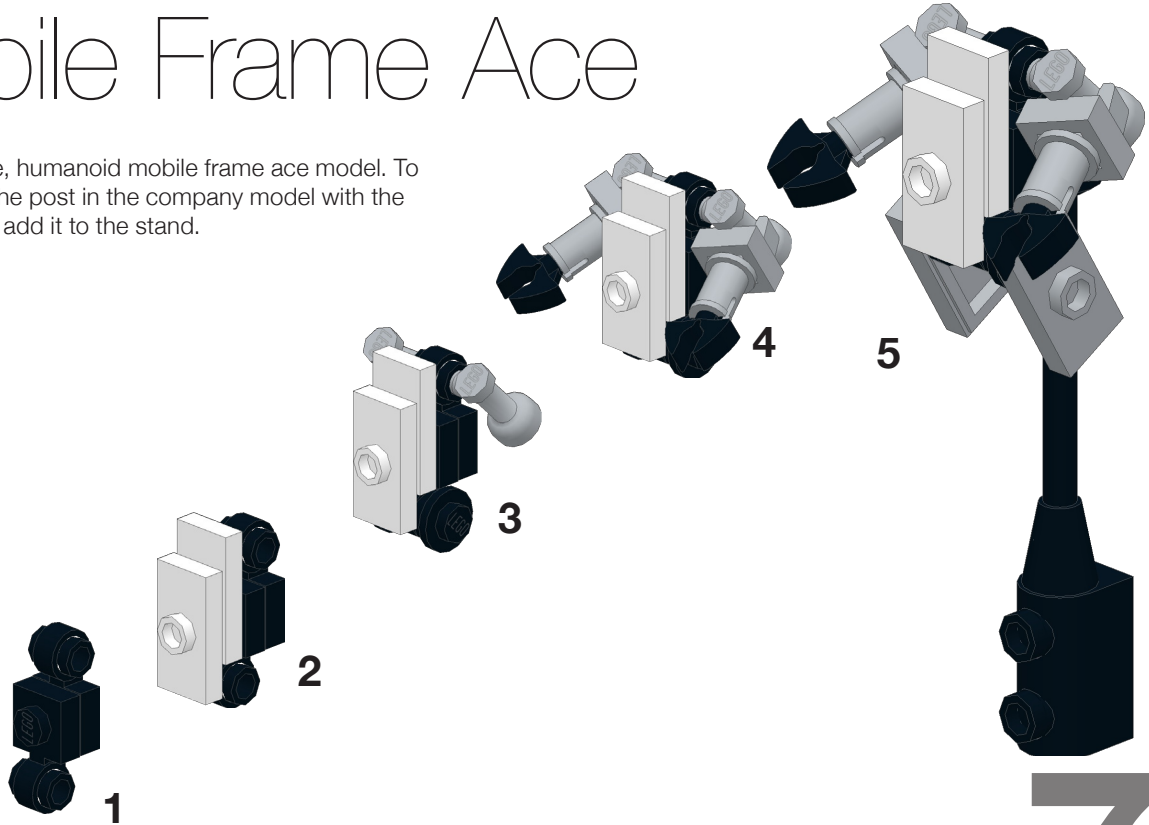

Mediography

Mobile Frame Zero's Solar Calendar setting is inspired by several historical (or even current) events. And, of course, some really cool fiction. You might find inspiration for your fleets by studying these!

- » **The Battle of Taranto** is the moment when the 19th-century "Dreadnought" doctrine, where ships were designed ever larger, and with larger and larger guns, was shown flawed by small, agile airplanes.
- » **The Battle of Coral Sea** was the first naval battle between aircraft carriers. The ships never even saw each other.
- » **The Battle of Midway** is often considered the moment that the "Sleeping Giant" woke, where American industrial resources were brought to bear in a way no one had seen before.
- » **Superdimensional Fortress Macross** features the kind of mecha/fighter battles you'll see in *Intercept Orbit*.
- » **Legend of Galactic Heroes** is a great anime naval yarn, told with beautiful spaceships and thoughtful characters.
- » Of course, many incarnations of **Mobile Suit Gundam** feature mobile suits, launched into space from carriers, dogfighting and occasionally boarding enemy ships.
- » You can never go wrong reading up at **Atomic Rockets**, at projectrho.com