

PALLADIUM BOOKS® PRESENTS . . .

ROBOTECH® II: THE ROLE-PLAYING GAME

# The SENTINELS™

By Kevin Siembieda

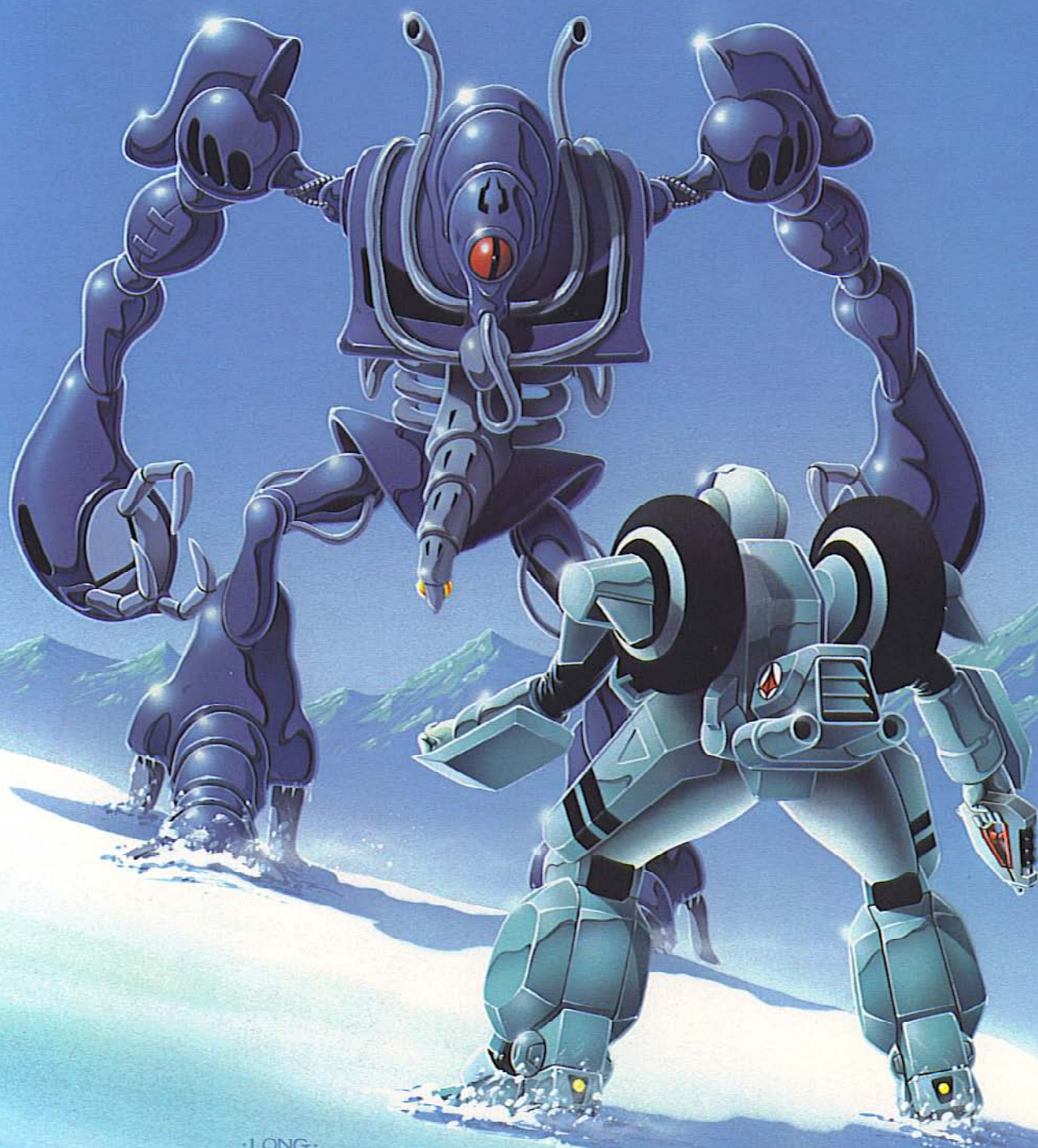

LONG

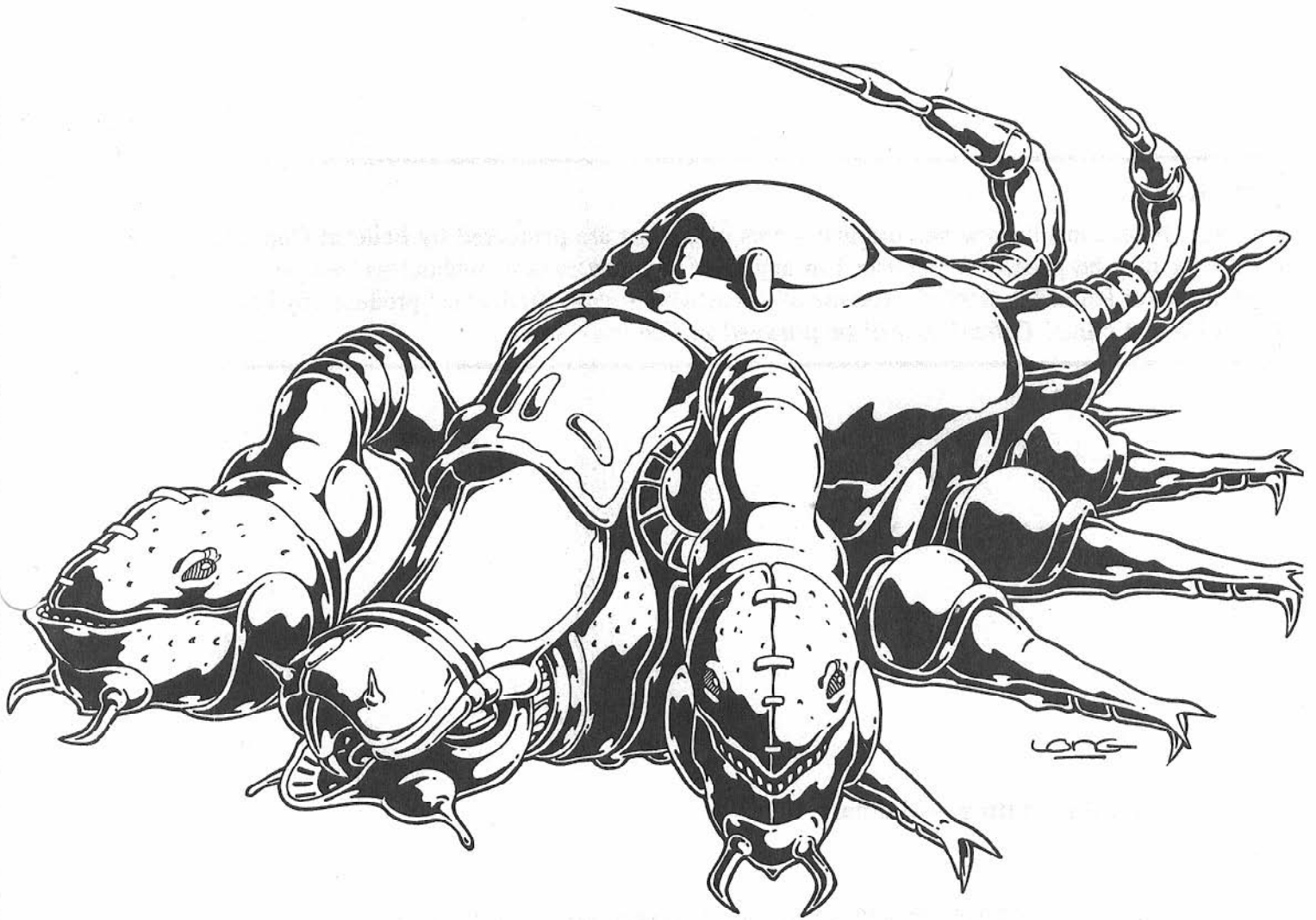

PALLADIUM BOOKS® PRESENTS . . .

ROBOTECH® II:™ THE ROLE-PLAYING GAME

# The SENTINELS™

Compatible with the Robotech® RPG, Invid Invasion,  
and all the other Robotech® RPG source books.



Dedicated to the Tōn.

**WARNING**

This book contains new and original works of art that are **protected by Federal Copyright Law**. **NO** artwork may be printed or published in any form, for any reason, without *written permission* from the Publisher of Palladium Books®. The use of this artwork, in any product not produced by Palladium Books® is a Federal crime! ***Offenders will be pursued in Federal Court.***

**Seventh Printing — January 1995**

Copyright © 1983, 1984, 1985, 1986, 1987, 1988 Kevin Siembieda. All rights reserved.

Characters copyright © 1985, 1987 by Harmony Gold U.S.A., Inc./Tatsunoko Production Co. Ltd. All rights Reserved.

Copyright © 1987 by Harmony Gold U.S.A., Inc. All rights reserved.

Copyright © 1987 by Kevin Siembieda. All rights reserved under the Universal Copyright Convention. No part of this book may be reproduced in part or whole, in any form or by any means, without permission from the publisher, except for brief quotes for use in reviews. All incidents, situations, institutions, governments and people are fictional and any similarity, without satiric intent, of characters or persons living or dead is strictly coincidental.

ROBOTECH is a registered trademark owned and licensed by Harmony Gold U.S.A., Inc.

ROBOTECH II: The Sentinels is a trademark owned and licensed by Harmony Gold U.S.A., Inc.

Palladium Books and Megaverse are registered trademarks owned and licensed by Kevin Siembieda.

ROBOTECH II: The Sentinels is published by Palladium Books Inc., 12455 Universal Drive, Taylor, MI 48180.

Printed in the United States of America.

PALLADIUM BOOKS® PRESENTS . . .

ROBOTECH® II: THE ROLE-PLAYING GAME

# The SENTINELS™

Written By: Kevin Siembieda

**Editors:** Alex Marciniszyn  
Randi Cartier

**Cover Artist:** Kevin Long  
**Interior Artist:** Kevin Long

**Additional Art:** Kevin Siembieda  
Thomas J. Gould

**Titan Technical Renderings:** Larry Nelson

**Japanese Translations:** Koichiro Tanaka

**Typography:** Maryann Siembieda

**Keylining:** Kevin Siembieda

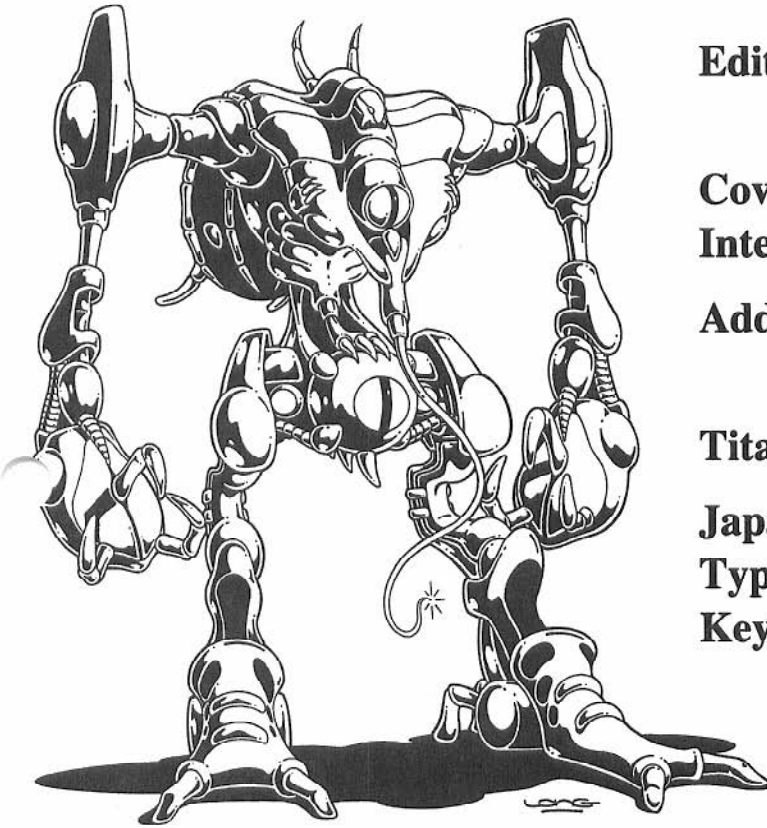

**Special thanks to:** Tony, Alex, Maryann, Tom, Pin, Rick, and Carl Macek. A very special thanks to Jeff Gomez for his excellent advice.



# CONTENTS

## Page

Lines of Reality (REF History) . . . . .	5	Vehicles . . . . .	107
Playing Robotech II: The Sentinels™ . . . . .	6	REF Vehicles . . . . .	107
Creating a Character . . . . .	6	Alien Vehicles . . . . .	111
Step One: The Eight Attributes . . . . .	6	Titan Mecha/Assault Transport . . . . .	113
Attributes Bonus Chart . . . . .	7	Weapons . . . . .	118
Step Two: Hit Points & S.D.C. . . . .	7	The Invid (history) . . . . .	121
Optional Damage Rules . . . . .	8	Invid Mecha . . . . .	126
Mega-Structure and M.D.C. . . . .	9	Sensors and Equipment . . . . .	126
Step Three: Selecting an Occupation & Skills . . . . .	10	Invid Scout . . . . .	126
Step Four: Equipment & Money . . . . .	10	Invid Armored Scout . . . . .	126
Step Five: Rounding Out One's Character . . . . .	10	Space Booster . . . . .	128
Alignments . . . . .	10	Invid Trooper . . . . .	128
Experience System . . . . .	12	Invid Shock Trooper . . . . .	129
Determining Experience . . . . .	13	Invid Enforcer . . . . .	129
Experience Levels Per O.C.C. . . . .	14	Red Enforcer . . . . .	131
REF Occupational Character Classes (O.C.C.s) . . . . .	15	Invid Vehicles . . . . .	131
REF Veritech Pilot . . . . .	16	All-Terrain Invid Assault Carrier . . . . .	132
REF Destroid Pilot . . . . .	16	The Inorganics . . . . .	134
REF Cyclone Rider . . . . .	17	Cougar . . . . .	134
Zentraedi REF Warrior . . . . .	18	Odeon . . . . .	136
REF Military Specialist . . . . .	19	Scrim . . . . .	138
REF Bio-Maintenance Engineer . . . . .	20	Crann . . . . .	139
REF Communications Engineer . . . . .	22	Hive Notes . . . . .	141
REF Field Scientist . . . . .	23	Sentinel Adventures . . . . .	142
The Sentinel Aliens . . . . .	24	Blue Team . . . . .	142
Bearmen of Carbonara . . . . .	24	Hide & Seek . . . . .	145
Amazons of Praxis . . . . .	25	Free-For-All . . . . .	145
Cat People of Garuda . . . . .	28	Sentinel Characters . . . . .	147
Stone Men of Spheris . . . . .	31	SDF-3 . . . . .	150
Mystics of Peryton . . . . .	33		
An Alien Game Note . . . . .	35		
Skills Listed by Category . . . . .	36		
Skill Descriptions . . . . .	37		
Combat . . . . .	44		
Combat Terms . . . . .	44		
S.D.C. for Characters . . . . .	46		
Hand to Hand Combat . . . . .	46		
Modern Weapon Proficiencies . . . . .	47		
Mecha Combat Rules . . . . .	48		
Mini-Missiles . . . . .	52		
Mecha in Space . . . . .	52		
Missile Chart . . . . .	54		
Mecha Hand to Hand Combat . . . . .	55		
New Mecha Descriptions . . . . .	60		
Destroids . . . . .	60		
Excaliber MK VII . . . . .	61		
Gladiator MK III . . . . .	63		
M.A.C. III . . . . .	65		
Raidar X (REF) . . . . .	66		
Spartan MK XIII . . . . .	68		
REF Tactical Battle Pod . . . . .	70		
REF Officer's Pod . . . . .	72		
REF Cyclops . . . . .	73		
Cyclones . . . . .	75		
VR-052 Battler . . . . .	76		
VR-041 Saber . . . . .	77		
VR-038 Light . . . . .	79		
Cyclone Special Equipment . . . . .	80		
Veritech Fighters . . . . .	81		
Alpha Fighter . . . . .	82		
Shadow Fighter . . . . .	85		
Beta Fighter . . . . .	87		
Vindicator VF-1V . . . . .	91		
Hover Tank . . . . .	93		
REF Spacecraft . . . . .	94		
Horizon Troop Shuttle . . . . .	94		
Garfish Troop Carrier . . . . .	97		
Ikazuchi Command Carrier . . . . .	99		
Ikazuchi Floor Plans . . . . .	101		

## QUICK FIND TABLE

REF Time Line (Lines of Reality) . . . . .	5
Experience Levels for REF O.C.C.s . . . . .	14
Occupational Character Classes (O.C.C.) Begins . . . . .	15
Destroid Pilot (NEW) . . . . .	16
Zentraedi Warrior (NEW) . . . . .	18
The Sentinel Aliens Begin . . . . .	24
Praxian RAT-1 Pegasus Mecha . . . . .	27
Cat People (Guardans) Psi Powers . . . . .	29
Stone Men (Spherians) Lasers & Powers . . . . .	33
Perytonian's Mystic Powers . . . . .	34
Skills Listed by Category . . . . .	36
Espionage Skills . . . . .	37
Physical Skills . . . . .	39
Pilot Skills . . . . .	40
Rogue Skills . . . . .	42
Combat Rules Begin . . . . .	44
Physical S.D.C. for REF O.C.C.s . . . . .	46
Hand to Hand Combat . . . . .	46
Modern Weapon Proficiencies . . . . .	47
Mecha Combat Rules Begin . . . . .	48
Destroid Space Propulsion System . . . . .	52
Missile Chart . . . . .	54
Mecha Hand to Hand Combat . . . . .	55
New Mecha Descriptions Begin . . . . .	60
CVR-3 Body Armor . . . . .	80
Shadow Fighter Cloaking Device . . . . .	82
EU-13 Destabilizer . . . . .	85
EU-12 Destabilizer . . . . .	91
REF Spaceships Begin . . . . .	94
Pinpoint Barrier Defense System . . . . .	100
Comparative Scale of Spacecraft . . . . .	106
Titan Transport (GMU) . . . . .	113
Invid Regent . . . . .	122
Invid Brain . . . . .	125
Invid Sensors and Equipment . . . . .	126
Invid Perception Factor (see NOTES) . . . . .	126
Inorganics Begin . . . . .	134

# LINES OF REALITY

From the journal of historian Jeffrey Gomez the third, GPI, circa 2098, Mars Base.

*"History is a strangely malleable substance that can be shaped and molded by the view of the historian. Of course, lack of accurate documentation and the ravages of war are often the two villains that corrupt our perception about the past. Such is the case with humankind's most brilliant and desperate episode in modern history, the legendary Robotech Wars.*

*"Whatever accurate records of events that may have existed perished in the devastating onslaught of the Invid's Invasion, circa 2035. Although names, places, events and even photographs are known to us, they are mere fragments of an intergalactic puzzle. Details are muddled. Even the population of the Earth at the time of the SDF-3's departure is hotly debated. Some believe that less than 50,000 had survived the first Robotech War, and of those, a quarter comprised the members of the Robotech Expeditionary Force.*

*"In reality, the world population must have numbered into the 350 million range. A horrifyingly tiny number when one realizes that the global population was well over 10 billion in 2009.*

*"Data is especially sketchy regarding the Robotech Expeditionary Force (REF). Existing documentation focuses on the SDF-3, little else. We know that the SDF-3 was manned by a 'crew' of 10,000, and while many have taken this to reflect the entire REF operation, this seems incomprehensible. The 'crew' of the SDF-3 does not necessarily include the fighting troops. The smaller SDF-1 had a 'crew' of 800 plus 1200 military personnel. Yet it would ultimately hold an additional 70,000 civilians. Furthermore, an army troop of 10,000 pitting themselves against the might of the Robotech Master's intergalactic empire (or so they believed) sounds more like an act of suicide rather than heroics. Not a likely prospect with the greatest military and scientific minds of the century working together.*

*"It is likely that the SDF-3 was the flagship and ultimate weapon of an armada of REF warships. The new wave historians have been so bold as to suggest that the REF 'fleet' may have contained 30,000 spacecraft with troops of at least one million. Remember, approximately four million Zentraedi warships were sent against the Earth during the First Robotech War.*

*"To support this speculation, historians quickly point to the decade of preparation spent on board the Robotech Factory captured by the RDF. If existing data can be believed, the giant automated space factory could build 60 of the mile long Zentraedi landing ships (Quiltra Queleual) and a full complement of 40,000 mecha for each within a year's time. It could repair/restore twice as many damaged vessels or build five times as many smaller vessels within the same time span (the REF vessels that liberated Reflex Point were half to one third the size of the landing ship).*

*"The most convincing evidence in support of the REF armada theory is the number of REF vessels that returned to Earth to combat the invid invaders. Although exact numbers do not exist, it is acknowledged by all scholars that several hundred spacecraft were part of each of the two smaller REF assaults and several thousand warships (of which ruins are plentiful) and countless mecha were engaged in the famous battle of Reflex Point, circa 2038. All known data indicates that this armada was exclusively the REF and entirely human, spoiling the hypothesis that it may have been a combined force of humans and the 'alien' Sentinels. If aliens were among that particular REF armada, there is no evidence to attest to their presence.*

*"The argument that the REF could build an armada of ships in space also fails to hold water. Certainly, new vessels were created in the long years of the expeditionary force's campaign. But to suggest that the SDF-3 and a crew of 10,000 could do so seems ludicrous. Who*

*built the vessels and more importantly, who crewed them? Certainly not the 10,000 humans of the SDF-3. That would mean one pilot per ship and excavations of crashed REF spacecraft clearly revealed that they accommodated a large crew, troops and mecha. Human troops.*

*"Specific dates are also foggy. We know that the First Robotech War began in July 2009, on the day of the SDF-1's christening, and ended in December 2013. We also know that the Robotech Masters appeared in 2030 or 2031, setting into motion the Second Robotech War. That war lasted approximately 16 months. Conflicting data indicates that the invid invaded three, five or eight years later. The invid's devastating assault nearly succeeded in obliterating humankind. Civilization was laid to waste, plunging mankind into a new dark age. The exact time of the battle at Reflex Point is another date that seems to float within a five year span and has been the target of intense controversy.*

*"I believe that the following dates are closer to the real events than those previously published. However, the truth behind a legend is always a difficult thing to prove."*

A Robotech Timeline; Earth.

## August 2022

- Preparations for the departure of the SDF-3 and the Robotech Expeditionary Force are completed.
- Doctor Emil Lang is placed in charge of REF operations.

## Late August 2022

- Commander Rick Hunter and Admiral Lisa Hayes are wed.
- The SDF-3 (and the REF) departs for the Robotech Master's homeworld. Among them are Commander in Chief Rick Hunter; Captain of the SDF-3, (Admiral) Lisa Hayes; Colonel T.R. Edwards (Head of Military Strategy), Captain Max Sterling (Leader of the famous Skull Squadron), Lieutenant Commander Miriya Sterling (Second in Command of the Skull Squadron), Lt. Commander Vince Grant (Special Operations and Ground based Mobile Unit Pilot), Field Commander Breetai (Second in Command only to Rick and Lisa), Ambassador Exedore (Zentraedi/Robotech Master historian and military advisor), Colonel Johnathan Wolfe, famed Doctor Emile Lang, Doctor R. Burke, and young freedom fighters Lancer and Scott Bernard.
- The SDF-3 and the REF arrive at the Master's homeworld, Tirol.
- Tirol is under siege by the invid. War begins.

## September 2022

- Lynn Minmei, celebrity pop singer and hero of the first Robotech War, is confirmed missing and is believed to have been accidentally taken along on the SDF-3. (Survivors of the assault on Reflex Point would confirm this rumor). Ms. Minmei and her companion, singer "Janice," are never again seen on Earth.

## Late September 2022

- The Robotech Factory space folds to rendezvous with the REF at Tirol. It is never heard from again. Its disappearance remains a mystery to this day.

## January 2031

- The Robotech Masters arrive on Earth. The Second Robotech War begins.

## April 2032

- The last of the Robotech Master's main force is destroyed above the old SDF-1 memorial site.
- Unknown to mankind, spores from the Invid Flower of Life had been unleashed upon the fertile Earth. The flowers would thrive and ultimately draw the invid to our planet.

## July 2032

- The world government collapses completely. Anarchy reigns.



## November 2032

- The E.B.S.I.S. emerges as the new world power.

## February 2033

- The last remnants of the Armies of the Southern Cross formally disband. North America is locked in civil unrest, while South America prospers under the guidance of the E.B.S.I.S.

## December 2035

- The Invid appear without warning. The Earth is decimated. The Third Robotech War has begun.
- Occupying Invid troops establish hive bases and begin the cultivation of the Invid Flower of Life (the source of proticulture). Earth is to become a farm colony.

## May 2036

- The Invid dominate the Earth. Hundreds of Invid hives, proticulture farms and factories dot the occupied Earth. Still humankind struggles out of the ashes to rebuild.
- Organized freedom fighters begin their guerilla warfare against the alien invaders.
- *The first REF fleet* returns to Earth and is swiftly destroyed by the Invid. Colonel J. Wolfe survives and establishes a secret military base to combat the Invid. Renowned freedom fighter "Lancer" also survives.

## March 2037

- *The second REF fleet* (estimated 400 warships) mounts an assault that faces annihilation before they can penetrate Earth's atmosphere.
- Famed freedom fighter, Scott Bernard, is reportedly the sole survivor.

## Fall 2037 or 2038

- Col. Johnathan Wolfe is slain, leading a rescue mission.
- Organized resistance is at its height.

## Summer 2038 or 2039

- The Battle at Reflex Point. The (entire?) REF fleet returns to confront the minions of the Invid Regis.
- The SDF-3 and its famous crew have not made the space jump. Whereabouts unknown.
- The Invid are routed and flee Earth, but the cost is heavy. An estimated 98% of the REF fleet (thousands of vessels) are destroyed.
- The Invid are believed to have left the Earth forever.
- Scott Bernard leaves Earth to lead a search party to find the SDF-3. He is never seen again.

## Summer 2039 or 2040

- The Invid return with a smaller occupying force (estimated 2.5 million) to cultivate the Invid Flower of Life.
- Resistance begins anew. Spirits are high.
- The SDF-3 remains lost.
- The whereabouts of the "Sentinels" is unknown.
- The fight for a free Earth continues.

# PLAYING ROBOTECH II: THE SENTINELS

Readers will find that this book's focus is on details and facts such as the hard data on the new mecha, spacecraft and alien races. There are a lot of great new devices that seem to have been ignored by other sources. These items are developed from animation drawings, model sheets, and film production notes. Some of the spaceships are actually from the REF assault forces seen in the Invid Invasion. As always, I have tried to be as accurate and loyal to the original animation, story, and concepts as possible.

The lack of focus on specific characters and events is intentional. Players should feel free to play Rick, Max, Lisa, Breetai and all the other famous Robotech heroes, *if that's what they want to do*. The Del Rey novels or the Eternity comic books can supply dozens of ideas and battles to re-create. However, I think that the best approach to playing **Robotech II: The Sentinels** is to focus on the details, *the untold stories*, of the war. T.V. characters and newly created player characters alike can be sent on mission after mission which are small but crucial fragments of the larger story. Don't worry about re-creating an epic battle with thousands of combatants. Instead, zoom in and focus on the actions of those *special* few heroes (your characters) and their role in these events.

**Sentinels**, more so than the other episodes of Robotech, is a "classic" war story. Almost World War II in space. Mindless hack and slash adventures will always be a temptation, so it will be a challenge to game masters and players to keep the adventures fresh and exciting. There can be all types of reconnaissance and spy missions; or sabotage and rescue. The characters will not always be close to the REF when they need to secure ammunition and repairs. Often they will be sent on faraway assignments with limited availability of supplies and manpower. Or they may become cut off from the main force and must utilize guerilla tactics to survive or reach a safe haven. Remember, the REF and the Sentinels are *not* just killin' machines, but liberators. Honorable, peace loving individuals who fight for freedom and who fight to free other worlds dominated by the evil Invid and Robotech Masters.

All the REF/Sentinels adventures take place in a distant galaxy. Ironically, while they fight to free other worlds from the tyranny of the Invid Regent, Earth is attacked by both the Robotech Masters and the Invid (the Invid forces are divided: one led by the Regent and the other by the Regis on Earth). The wars on Earth do not become known to the REF until years later, (approximately 3036), when the first reconnaissance/assault wave arrives on Earth.

## CREATING A CHARACTER

The creation of a character is relatively simple, requiring five main steps:

- Step 1: The Eight Attributes (and bonuses)
- Step 2: Hit Points and S.D.C.
- Step 3: Occupational Character Class
- Step 4: Equipment and Money
- Step 5: Alignments

## STEP 1: THE EIGHT ATTRIBUTES and ATTRIBUTE BONUSES

The first step in creating a character is to roll-up the eight attributes: I.Q., M.E., P.S., P.P., P.E., P.B., and Spd.

Three, six-sided dice are rolled to determine each attribute. The higher the number, the greater the ability. If an attribute is "exceptional," 16, 17, or 18, then an additional six-sided die is rolled and the result is added to the total for that attribute.

**Intelligence Quotient (I.Q.):** Indicates the intelligence of the character. The exact I.Q. is equal to the I.Q. attribute multiplied by ten. Characters with an I.Q. of 17 or better, will receive a one time bonus added to all of the character's skill percentages.

**Mental Endurance (M.E.):** Measures the amount of mental and emotional stress the character can withstand.

**Mental Affinity (M.A.):** Shows the character's personal charm and charisma. Natural leaders, with a M.A. of 17 or higher, have a bonus to invoke trust or intimidation in others.

## ATTRIBUTE BONUS CHART

	17	18	19	20	21	22	23	24	25	26	27	28	29	30
I.Q. add to all skills. One time bonus.	+3%	+4%	+5%	+6%	+7%	+8%	+9%	+10%	+11%	+12%	+13%	+14%	+15%	+16%
M.E. save vs. psionic attack/insanity	+1	+2	+2	+3	+3	+4	+4	+5	+5	+6	+6	+7	+7	+8
M.A. trust/intimidate	45%	50%	55%	60%	65%	70%	75%	80%	84%	88%	92%	94%	96%	97%
P.S. Hand to Hand Combat: Damage	+2	+3	+4	+5	+6	+7	+8	+9	+10	+11	+12	+13	+14	+15
P.P. parry, dodge and strike bonus	+1	+2	+2	+3	+3	+4	+4	+5	+5	+6	+6	+7	+7	+8
P.E. save vs. coma/death	+5%	+6%	+8%	+10%	+12%	+14%	+16%	+18%	+20%	+22%	+24%	+26%	+28%	+30%
save vs. poison	+1	+2	+2	+3	+3	+4	+4	+5	+5	+6	+6	+7	+7	+8
P.B. charm/impress	35%	40%	45%	50%	55%	60%	65%	70%	75%	80%	83%	86%	90%	92%
Spd: No special bonuses other than the raw, natural ability to run.														

**Physical Strength (P.S.):** This is the raw physical power of a character. The P.S. times 10 indicates how heavy an object (in pounds) the character can carry. A character can lift 30 times the P.S. Exceptionally strong characters, having a P.S. of 15-19, can carry 20 times their P.S. and lift 40 times their P.S. Someone with a P.S. of 20-23 can carry 30 times their P.S. and lift 60 times their P.S. Anyone with a P.S. of 24 or higher can carry 50 times their P.S. and lift 100 times their P.S. Any character with a P.S. of 17 or better receives a bonus to damage in hand to hand combat.

**Physical Prowess (P.P.):** Shows the degree of dexterity and agility of the character. A P.P. of 17 or higher is rewarded with bonuses to dodge, parry and strike.

**Physical Endurance (P.E.):** Indicates the character's stamina and durability. The amount of physical punishment, and resistance to fatigue and disease, are determined by P.E. A character can carry the maximum weight load (see P.S.) for the P.E. times 4 minutes. Carrying the maximum weight while running or fighting can only be done for the P.E. times 2 minutes. If a character lifts the maximum weight (see P.S.), then it can only be held for as many melee rounds (15 seconds each) as the character has points of P.E. A character can run at maximum speed for one minute for each point of P.E. Characters with a P.E. of 17 or better receive bonuses to save vs. coma, death and toxins.

**Physical Beauty (P.B.):** Is an indication of the physical attractiveness of the character. A P.B. of 17 or better will be rewarded with a bonus to charm or impress.

**Speed (Spd):** Specifically, this is the character's maximum running speed. The Spd. times 20 is the number of yards or meters that the character can run in one minute.



## STEP 2: HIT POINTS & S.D.C.

### HIT POINTS

Hit points might best be thought of as life points because they indicate how much physical damage (cuts, bruises, etc.) a character can withstand before he/she dies. These are the points that are observed during a battle (or melee) to determine how much damage is inflicted on friend or foe. Each time a character is struck by a weapon he takes physical damage. The individual players keep score of how many hit points their character has remaining by subtracting the damage from his/her character's hit points each time that character is hit by a weapon. Likewise, the game master keeps score of how much damage the player inflicts upon his opponent. When a character has zero hit points, he is in a coma and will soon die unless extensive medical aid is applied. When a character's hit points have been knocked far below zero, he is dead and beyond saving.

### DETERMINING HIT POINTS

Now that you have some idea of what hit points are about, let us get into the technical aspects of their determination and use.

**1. Base Hit Points:** Having rolled up your 8 attributes, you will recall that one is **physical endurance** (P.E.). The physical endurance score indicates your character's base/starting amount of hit points. This number means that he/she can lose that many hit points before dying.

Some of you will have a character with many hit points . . . don't get too cocky; a laser in the right hands can whittle you down to size in one melee round. Others will find themselves with a character who has only a handful of hit points (as little as 3), . . . don't despair or feel cheated; you'll just have to use cleverness and cunning in avoiding direct confrontations until you've built up your hit points.

**2. Building Hit Points:** After determining your base hit points, pick up one six-sided die, roll it and add the number rolled to your hit point base. Only roll one six-sided die one time.

As your character grows in knowledge and experience he will gain more skill and expertise in his chosen profession (see: Occupational Character Classes). At the same time he will also mature physically, increasing his hit points. Thus, each time a character attains a new experience level, roll one six-sided die and add it to the existing hit points.

### RECOVERY OF HIT POINTS

After a battle, characters who have sustained physical damage must tend to their wounds. The attending of wounds can be administered by fellow characters, trained medical personnel or by oneself, if the character has first-aid skills and is not physically impaired.

First-aid-type skills include basic and immediate medical treatment, such as bandaging and cleaning of wounds, stopping of bleeding and so on, until the character can receive better medical care.

**Recovery: Non-professional treatment.** This is basic, first-aid-type treatment performed by oneself, or non-medically trained people. This type of treatment may be used if the character is not able to seek professional treatment immediately. It is not necessarily inferior treatment, especially for not too serious an ailment, but just lacks the full facilities and experience of a major medical institution. **Rate of Recovery:** Two hit points per day (24 hours).

**Recovery: Professional treatment.** This is medical treatment from a doctor, clinic or hospital. **Rate of Recovery:** Two hit points per day for the first two days, and four hit points per day for each following day, until the character has regained all of his/her original hit points.

### SURVIVING COMA AND DEATH

When a character's hit points are reduced to zero (or less) he/she collapses, lapsing into a coma. This character is near death, and will die in a matter of hours unless he/she receives immediate medical treatment.

How much damage below zero a character can undergo is indicated by the physical endurance (P.E.) attribute. A character can take one



point of damage below zero (negative 1, -2, -3, etc.) for each P.E. point. **Example:** A character with a P.E. of 9 will lapse into a coma at zero hit points, but still lives up to a negative 9. However, if the character receives more damage (which is very possible) than the P.E., he is dead with no hope of recovery. Thus, if a character with a P.E. of 9 takes 10 points or more below zero, exceeding his P.E., he is beyond medical help and dies.

### Coma Length

The length of time a character in a coma will survive without treatment is again indicated by the P.E. Add one hour for each P.E. point. **Example:** P.E. 9=9 hours, P.E. 10=10 hours, and so on.

### Recovery From a Coma

Whether a character survives the coma and is stabilized (brought back to, at least, one hit point above zero) is determined by the roll of percentile dice. If the player rolls two successful recovery rolls out of three tries, the character breaks out of the coma and is no longer in danger of dying. This also means that he is brought up to one hit point above zero. Recovery of hit points from that time on is standard; see Recovery of Hit Points. **Note:** This can be attempted every hour.

### Recovery Ratio (roll 2 out of 3)

- Treatment from non-professional, medical individual, but with medical skills: 1-18%.
- Treatment from an intern or nurse (R.N.): 1-32%.
- Treatment from a doctor without proper facilities: 1-46%.
- Treatment from a doctor at a clinic (fair facilities): 1-56%.
- Treatment from a hospital: 1-66%.
- Treatment from a major, large hospital: 1-70%.

## OPTIONAL DAMAGE RULES

A character receives serious physical damage when he loses a great amount of hit points. The following is a list of side effects from physical damage. The effects of the damage are generally temporary and cumulative. Thus, if a character suffers the loss of a great deal of hit points within a short time he will suffer the multiple affects of physical damage. **Roll each time severe damage is endured.**

Roll Percentile	Damage	Minuses
1-14	Minor bruises and lacerations.	Spd -2 -1 to dodge
15-29	Severely bruised and battered muscles	P.P. -1 Spd -3
30-44	Damaged (sprain, pulled, cut, etc.) arm or shoulder.	P.P. -3
45-59	Damaged leg or hip.	Spd is 1/2 -2 to dodge
60-74	Damaged hand and/or wrist	P.P. -1 P.S. -2
75-89	Head Injury	-5% on all skills; Spd -2
90-00	Damaged back or pelvis.	P.E. -1 P.P. -2 Spd -3

**NOTE:** None of these effects are permanent nor life threatening. Minuses apply to that one limb. Speed minuses affect the whole body. Remember effects are cumulative; roll each time the character is badly hurt.

**About blood loss.** When a character is severely hurt, down to only 15% of his hit points and is bleeding; he will soon die of blood loss unless he or she receives immediate medical attention. Even a basic first aid and no or little movement can bind wounds and prevent further

blood loss/damage. Without medical aid the person will continue to lose blood and take **one point (hit point) of damage every minute/4 melee rounds.**

### Side-Effects from Physical Damage (Hit Points) (Optional)

Roll on this table when 75% to 99% (almost all) hit points are depleted. Impairment is temporary, lasting 1-4 weeks (roll one four-sided die).

Roll Percentile	Damage	Minuses
1-10	Severely battered and bruised	Spd -2 -3 to dodge
11-20	Torn arm muscle	P.P. -3 P.S. -2
21-29	Torn leg muscle	Spd is 1/2 -2 to dodge
30-39	Fractured bone: arm	P.P. -2 P.S. -3
40-49	Fractured bone: leg	Spd is 1/2 -4 to dodge
50-59	Fractured bone: ribs or pelvis	P.E. -2 Spd is 1/2
60-69	Broken bone: arm	P.P. is 1/2 P.S. is 1/2
70-79	Broken bone: leg	Spd is 1/3 -6 to dodge
80-89	Broken bone: ribs	P.E. -3 P.P. -1 Spd -3
90-00	Severe Concussion	-8 on all skills, Spd -3

**NOTE:** None of these effects are permanent nor life threatening, although painful and debilitating. Minuses apply to that one particular limb. Speed minuses affect the whole body. Remember, effects are cumulative.

### Optional Recovery Side-Effects from Severe Damage/Near Death (Hit Points)

Roll on this table when a character has lost all of his/her hit points and has been near death (coma). **Impairment is permanent** as a result of the grave physical damage. **NOTE:** This is not a mandatory table, but is left up to the game master's discretion.

- 1-10 No permanent damage.
- 11-20 Major stiffness in joints; reduce P.P. by 2.
- 21-39 Minor stiffness in joints; reduce P.P. by 1.
- 40-55 Legs impaired; walk with a limp reduce Spd by 2.
- 56-70 Major scarring; reduce P.B. by 2.
- 71-82 Chronic pain; reduce P.E. by 1.
- 83-92 Minor brain damage; reduce I.Q. by 1.
- 93-00 Major brain damage; reduce I.Q. by 2 and M.E. by 1.



KEVIN SIEMBIEDA 1988

# STRUCTURAL DAMAGE CAPACITY, MEGA-STRUCTURES AND MEGA-DAMAGE

In this game there are three types of physical measures of damage or endurance.

**Hit Point**  
**S.D.C.**  
**M.D.C.**

## HIT POINTS

Hit points might best be thought of as life points, because they indicate how much physical damage (cuts, bruises, wounds, etc.) a character can withstand before he or she dies. ALL living creatures have hit points. *Also see Creating A Character: Step 2 for details.*

## S.D.C. or STRUCTURAL DAMAGE CAPACITY

There are two types of S.D.C. The first applies to living creatures and is a sort of supplement to hit points. The second applies to inanimate, non-living structures such as chairs, locks, doors, buildings, vehicles and so on.

*Structural Damage Capacity* (S.D.C.) points are similar to hit points, but represent physical toughness or endurance rather than life. Most living creatures, including Humans and Zentraedi, have S.D.C. points. S.D.C. in people is a sort of reserve stamina that enables them to suffer physical abuse, strain or pain, but keep on going. A perfect example is a boxer. A boxer has built up his body, toughening muscles and increasing his body's resistance to fatigue and pain, through intense physical training. Now, if YOU (yes, you, the reader) and this boxer engaged in hand to hand combat, you could deliver several punches to the boxer and he would barely feel it. One or two counter punches from the boxer will knock you to the ground. The point of this example is that the boxer has a much greater S.D.C. than a normal person. Consequently, he can take much greater physical punishment before he will begin to suffer from it.

*Inanimate objects, such as buildings, vehicles, furniture and so on, also have S.D.C.* In this case, the S.D.C. indicates the total amount of damage that the object can withstand. These S.D.C. function exactly like hit point except that they apply to non-living things. Any damage sustained is subtracted from the S.D.C. When the S.D.C. is reduced to zero it is broken or smashed beyond repair. **A NOTE TO THE GAMEMASTER:** The S.D.C. system just described is a standard rule in most Palladium Books® games. From time to time I hear the complaint, for example: How can somebody be bashing or shooting into a door and the door is in perfect condition until all of its S.D.C. are depleted? My answer is: It's not in perfect condition. Using the example of the door, the G.M. should explain exactly what's happening: "You bash into the door with your shoulder. It's a very solid door and you inflict minimal damage (give S.D.C. damage). You realize that it will take quite a while to gain entry this way and you may hurt yourself." Or: "You can feel the door give a little under your great strength (give S.D.C. damage). Another bash and the door frame cracks and moans, but it still holds (as the door's S.D.C. dwindles), but it's definitely giving." Or: "Your sub-machinegun riddles the wood door with a dozen holes (something the player can look through), but the door is still locked and holding strong." Obviously, attacks on normal objects will scrape, dent, crack, splinter, crumble and so on, even if the object is not destroyed. To smash or destroy something may require multiple attacks, and in some cases, like being locked behind an iron door or bulkhead without a weapon or proper tools, it will be impossible to damage the item at all.

# M.D.C. or MEGA-STRUCTURES and MEGA-DAMAGE

Mega-Damage Capacity (M.D.C.) is a damage system that will be new to most of you. It is a structural damage capacity that reflects staggering advancements in science and technology. A technology that has created new super-tough alloys, micronized energy sources, galaxy spanning vehicles, and weapons with more power, precision and range than any 20th century weapon.

In effect, M.D.C. is a *super-structural damage capacity* that far outstrips the normal S.D.C. **In the context of this specific book, M.D.C. applies to . . .**

- ALL Earth Mecha, such as the Veritech and Gladiator.
- ALL Alien Mecha, such as the Battle Pods.
- ALL Alien spacecraft.
- ALL Human spacecraft.
- Most vehicles and objects of war.

All of those listed are built to withstand incredible punishment . . . *mega-damage*. As such, they are in a class of their own.

## M.D.C. vs S.D.C.

- 1) Generally, 100 S.D.C. (or hit points) equals about ONE M.D.C. point.
- 2) This also means that One Mega-Damage point does approximately 100 S.D.C. point's worth of damage.
- 3) Most conventional weapons do absolutely no damage to a mega-structure, even when combined.
- 4) **Example:** The old RDF Gladiator defense mecha engages a group of *thirty rebel bandits*. The bandits are armed with conventional arms consisting of sub machineguns, grenades, and flamethrowers. Suppose they stay to fight this *one* mecha and ALL begin to shoot at him. The Gladiator, being 37ft (11.3 meters) tall, is an easy target, so everybody hits at least three times. The combined damage inflicted is 400 S.D.C., but the Gladiator walks out of the hail of bullets and explosives with only a few scratches and smudges on its paint job. **It took NO damage.**

The pilot sees a half dozen bandits running toward a car to make a getaway. There's no need for excessive gun play, so the Gladiator fires one laser blast from its gun cluster (1D4 M.D.); it strikes (the roll to strike is 16) and does a mere 3, mega-damage points (M.D.). The car is blown in half because the 3 M.D. points are equal to about 300 S.D.C., the FULL S.D.C. of the vehicle.

A full size Zentraedi steps out from behind a building firing a standard alien gun pod (it does mega-damage). The alien has initiative and fires four shots. Two miss entirely. Two are solid hits, doing full damage to the Gladiator; 1D6 mega-damage per each hit. In this case the damage rolled is low; 7 M.D. is inflicted (that's about 700 S.D.C.). A mere scratch to the Gladiator. Combat continues.

## Mega-Damage (M.D.) and Mega-Structural Capacity (M.S.C.) Summary

1. One Mega-Damage Point (M.D. point) is about equal to 100 S.D.C. Always round S.D.C. down when assessing damage; for example, an object that has 219 S.D.C. is hit by 2 M.D. points of damage, the item is totaled (all 219 S.D.C.).
2. One Mega-Damage Point is also equal to 100 hit points.
3. Conventional weapons, normal grenades, automatic weapons, flamethrowers, even rams from an automobile, DO NOT harm mega-structures such as Veritech Fighters, Starships, and all Human and Alien mecha.

## STEP 3: SELECTING AN OCCUPATION & SKILLS

For the sake of simplicity, each player chooses ONE Occupational Character Class (O.C.C.), with its small selection of O.C.C. skills, and additional training/skills. Each O.C.C. indicates a major area of study and knowledge that is pertinent to the character's occupation. Unlike **Heroes Unlimited** or the **Palladium Role-Playing Game**, the skill selection is very limited and does not include secondary skills. However, players will find their characters to be capable, as well as different, from every other O.C.C. This quick character generation system will enable players to build characters quickly and completely. The scope of the establishing scenario setting is, in itself, limiting, so playing characters have been designed to fit snugly into that environment with maximum playability.

Each O.C.C. has skills or skill bonuses in areas not available to the other O.C.C.s. Consequently, players may want to consider what O.C.C.s their fellow players are selecting, in order to build a well rounded team or group of characters. Of course, this does not mean that every player should select a different O.C.C.; it simply means to consider the desired scope and versatility of your *team* when selecting an O.C.C. The same is true when selecting individual skills. The team with the most versatility and combined strengths is most likely to persevere (and this *is* a team oriented game). The cast of characters and their respective O.C.C.s will depend on the number of players and personal preferences. I would recommend that players go with what they feel most comfortable playing and their instincts above all else.

### O.C.C. REQUIREMENTS

The selection of an O.C.C. is limited only by the minimum attribute(s) requirement needed to play. The eight attributes should have already been determined by the roll of three, six-sided dice (see Creating a Character: Step 1). Generally, a player will be able to choose from two or three possibilities.

### O.C.C. SKILLS

Each O.C.C. has two skill categories: O.C.C. Skills and Other Skills. O.C.C. skills are skills that everyone in that chosen occupation have trained in. They are basic and crucial skills to that occupation. **The Other Skills** are other areas of training and knowledge possessed by the character. They may augment the occupational skills or simply reflect other interests.

### SKILL BONUSES

The base proficiency or skill level is denoted in each skill *description*. Also, you'll notice that many of the skills, under every O.C.C., will have a skill bonus indicated. The skill bonus will be shown as a plus (+) symbol followed by a number. All skill bonuses are one time bonuses, applicable immediately. As the character grows in experience (via experience levels), the skill proficiency also grows. **NOTE: Maximum skill ability is 98% because there is always some margin of error.**

**If NO skill bonus is indicated** then this means there is no bonus available from that O.C.C. ONLY the unmodified base skill proficiency is used.

**See skill descriptions for specific explanations and proficiencies.**

### MULTIPLE O.C.C.'s

Considering the war torn conditions, it's unlikely that a character would really get an opportunity to study more than one area of expertise. Consequently, a multiple O.C.C. could be more of a hindrance than a help. However, for those of you who still desire a split character class, here are the rules and conditions.

1. The character must meet the physical and/or mental **attribute requirements**.
2. **Must first reach third level** or higher in his or her original O.C.C.

3. **Begins the New O.C.C.** at zero experience and at "field training level," which means the usual O.C.C. skills are selected, but NO BONUSES APPLY.
4. **Players must score 2000** experience points before attaining first level. At first level, all the usual bonus points are added to each skill and regular experience point accumulation begins at zero.
5. The previous/original O.C.C. skill knowledge and proficiency, and experience points, are permanently **frozen** at the point when the new O.C.C. was selected. This means that while the character retains his previous O.C.C.'s skill knowledge and abilities, those skills are NOT increasing because he/she spends the bulk of the time in perfecting the new O.C.C. skills.

However, if the same skill is chosen in both O.C.C.s, that skill will continue to improve, but ONLY beginning after it has reached the previous skill level. **Example:** If the skill is frozen at level three, it remains so until the skill level of the new O.C.C. reaches level three. At that point, the experience points/level can again apply to that skill and the character's skill proficiency in that particular area will continue to increase at the same level as his/her current O.C.C.

## STEP 4: EQUIPMENT AND MONEY

All characters are issued a set of **standard equipment**, as well as equipment available in the field or under special conditions. Also assume each character has a number of "common" personal items such as a modest wardrobe, stereo, video/TV, artwork, knickknacks, booze, and so on. Each character also has his own small, one bedroom, studio-type apartment.

**Money** is referred to as credits. Each specific Occupational Character Class (O.C.C.) indicates the monthly salary in credits and the formula for determining the character's available savings in credits. Players may use their character's savings/credits as they deem appropriate.

## STEP 5: ROUNDING OUT ONE'S CHARACTER

### ALIGNMENTS

**Good:** Principled and Scrupulous  
**Selfish:** Unprincipled and Anarchist  
**Evil:** Miscreant, Aberrant and Diabolic

Alignments are an important factor in developing a character, his/her attitudes and moral principles. ALL players *must* choose an alignment for their character.

### NEUTRAL

First of all, there is *no* such thing as an absolute or true neutral. All people tend toward good, evil or self-gratification. An absolute true neutral could not make a decision, go on an adventure, kill, or take any action of any kind without leaning toward good, evil or self-gratification. It is humanly impossible and is, therefore, eliminated in the context of this game. (I realize that some of the philosophers out there may disagree with this, but that's a topic for philosophical debate and not a factor of this game. Sorry, no neutrals).

### GOOD ALIGNMENTS

#### Principled, Scrupulous

Because a character is of a good alignment, it does not make him/her a saint. Good characters can be just as irritating, obnoxious, arrogant, even prejudiced and full of quirks. However, life and freedom are of the highest priority. Such a person can always be trusted in a life and death situation. Ben Dixon is a good example of a lovable, but irritating, good guy.



### **Principled (Good)**

Principled characters are, generally, the strong, moral characters. Rick Hunter and Lisa Hayes are of a principled alignment, with the highest regard for other's lives and well-being, truth and honor.

#### **Principled characters will . . .**

1. Always keep his word.
2. Avoid lies.
3. Never kill or attack an unarmed foe.
4. Never harm an innocent.
5. Never torture for any reason.
6. Never kill for pleasure.
7. Always help others.
8. Work well in a group.
9. Respect authority, law, self-discipline and honor.
10. Never betray a friend.
11. Never break the law unless conditions are desperate. This means no breaking and entry, theft, torture, unprovoked assaults, etc.

### **Scrupulous (Good)**

Scrupulous characters value life and freedom above all else, and despise those who would deprive others of them. This type of hero is typically portrayed in many Clint Eastwood and Charles Bronson films; the person who is forced to work beyond the law, yet for the law, and the greater good of the people. They are not vicious or vindictive men, but are men driven to right injustice. I must point out that these characters will always *attempt* to work with or within the law whenever possible. Roy Fokker would fall into this alignment.

#### **Scrupulous Characters Will . . .**

1. Keep his word to any other good person.
2. Lie only to people of selfish or evil alignments.
3. Never attack or kill an unarmed foe.
4. Never harm an innocent.
5. Never torture for pleasure, but may use muscle to extract information from criminals or evil characters.
6. Never kill for pleasure; will always *attempt* to bring the villain to justice alive, no matter how vile he may be.
7. Always help others.
8. Attempt to work within the law whenever possible.
9. Bend and, occasionally, break the law when deemed necessary. This means they may use strong-arm techniques, harass, break and enter, theft, and so on.
10. Distrust authority.
11. Work with groups, but dislike confining laws and bureaucracy (red tape).
12. Never betray a friend.

### **SELFISH ALIGNMENTS (But Not Necessarily Evil)**

#### **Unprincipled (Selfish)**

This, *basically*, good person tends to be selfish and greedy, and holds his/her personal freedom and welfare above almost everything else. He/she dislikes confining laws and self-discipline, and distrusts authority. This is the Han Solo, Star Wars, character. The guy who is always looking for the best deal, associates with good and evil characters, is continually tempted to lie and cheat, and hates himself for being loyal and helping others. The beautiful, but self-absorbed, Lynn Minmei would be unprincipled.

#### **Unprincipled Characters Will . . .**

1. Have a high regard for life and freedom.
2. Keep his word of honor.
3. Lie and cheat if necessary (especially to those of anarchist and evil alignments).
4. Will not kill an unarmed foe (but will take advantage of one).
5. Help those in need.
6. Not use torture unless absolutely necessary.

7. Work with a group, especially if profitable.
8. Never harm an innocent.
9. Never kill for pleasure.
10. Dislike authority.
11. Never betray a friend.

#### **Anarchist (Selfish)**

This type of character likes to indulge himself in everything. He is the insurgent, con man, gambler and high roller; the uncommitted freebooter seeking nothing more than self-gratification. This character will at least consider doing anything if the price is right. These people are intrigued by power, glory and wealth. Life has meaning, but his has the greatest meaning. Laws and rules infringe on personal freedom and were meant to be broken. An anarchist aligned person is always looking for the best deal, and will work with good, selfish or evil to get it, as long as he comes out of the situation on top. The anarchist is continually teetering between good and evil, rebelling, and bending the law to fit his needs.

#### **Anarchist Characters Will . . .**

1. May keep his word.
2. Lie and cheat if he feels it necessary.
3. Not likely to kill an unarmed foe, but will certainly knockout, attack, or beat up an unarmed foe.
4. Never kill an innocent (but may harm or kidnap).
5. Not likely to help someone without some ulterior motive (even if it's only to show off).
6. Seldom kill for pleasure.
7. Use torture to extract information (not *likely* to torture for pleasure).
8. Not work well in a group (this is the cocky, loudmouth who is likely to do as he damn well pleases).
9. Have little respect for self-discipline or authority.
10. May betray a friend.

### **EVIL ALIGNMENTS**

#### **Miscreant**

#### **Aberrant**

#### **Diabolic**

All evil characters are not bent on universal genocide or domination over all living creatures. They are not maniacal people actively seeking to harm innocent people. Nor are all evil characters sadistic and untrustworthy. Many evil characters may actually seem kind or likable.

There is nothing wrong with playing an evil character, although he may not survive too long if he betrays or harms too many people. This is fantasy role-playing, not reality. You can play any type of character you desire, just continue to play in character.

Evil alignments are a step beyond the self-gratification of the selfish alignments. Evil characters are ruthless individuals who are willing to say or do anything to achieve their goal. Human life has little meaning to them, and friends tend to be (but not always) people to use and discard when they are no longer of value. Evil aligned people do not automatically slay any good aligned person because of different ethics and philosophy. All the better to use good to achieve their own goals, for the end always justifies the means.

#### **Miscreant (Evil)**

This self-serving, unscrupulous character is out only for himself. Power, glory, wealth, position, and anything that will make his life more comfortable is his goal. It matters not who gets caught in the middle, as long as he comes out smelling like a rose. This person will lie to, cheat and kill anyone to attain his personal goals. Khyron is a perfect example of miscreant.

#### **Miscreant Characters Will . . .**

1. Not necessarily keep his word to anyone.
2. Lie to and cheat anyone, good or evil.

3. Most definitely attack an unarmed foe (those are the best kind).
4. Use or harm an innocent.
5. Use torture for extracting information and for pleasure.
6. May kill for sheer pleasure.
7. Feel no compulsion to help without some sort of tangible reward.
8. Work with others if it will help him attain his personal goal.
9. Kill an unarmed foe as readily as he would a potential threat or competitor.
10. Has no deference for laws or authority, but will work within the law if he must.
11. Will betray a friend if it serves his needs.

#### Aberrant (Evil)

The cliché that there is “No honor among thieves,” is false when dealing with the aberrant character. This is a person who is driven to attain his goals through force, power, and intimidation. Yet the aberrant person stands apart from the norm with his own personal code of ethics (although twisted ethics by the standards of good). He expects loyalty from his minions, punishing disloyalty and treachery with a swift, merciful death. An aberrant person will always keep his word of honor and uphold any bargains. He will define his terms and live by them, whether anyone else likes it or not. Breetai and Exedore fit this category.

#### Aberrant Characters Will . . .

1. Always keep his word of honor (he is honorable).
2. Lie to and cheat those not worthy of his respect.
3. May or may not kill an unarmed foe.
4. Not kill (may harm, kidnap) an innocent, particularly a child.
5. Never kills for pleasure.
6. Not resort to inhumane treatment of prisoners, but torture, although distasteful, is a necessary means of extracting information.
7. Never torture for pleasure.
8. May or may not help someone in need.
9. Work with others to attain his goals.
10. Respect honor and self-discipline.
11. Never betray a friend.

#### Diabolic (Evil)

This is the category where the megalomaniac, violent, and most despicable characters fall. This is the cruel, brutal killer who trusts no one and has no value for anyone or anything that gets in his way. Aberrant aligned characters find these unhonorable people just as revolting as a good aligned character. General Dolza fits this description.

#### Diabolic Characters Will . . .

1. Rarely keep his word (and have no honor).
2. Lie to and cheat anyone.
3. Most certainly attack and kill an unarmed foe.
4. Use, hurt and kill an innocent without a second thought or for pleasure.
5. Use torture for pleasure and information.
6. Kill for sheer pleasure.
7. Likely to help someone only to kill or rob him.
8. Not work well within a group (consistently disregarding orders to do as he pleases).
9. Despise honor, authority, and self-discipline.
10. Associate mostly with other evil alignments.
11. Betray friends (after all, you can always find friends).

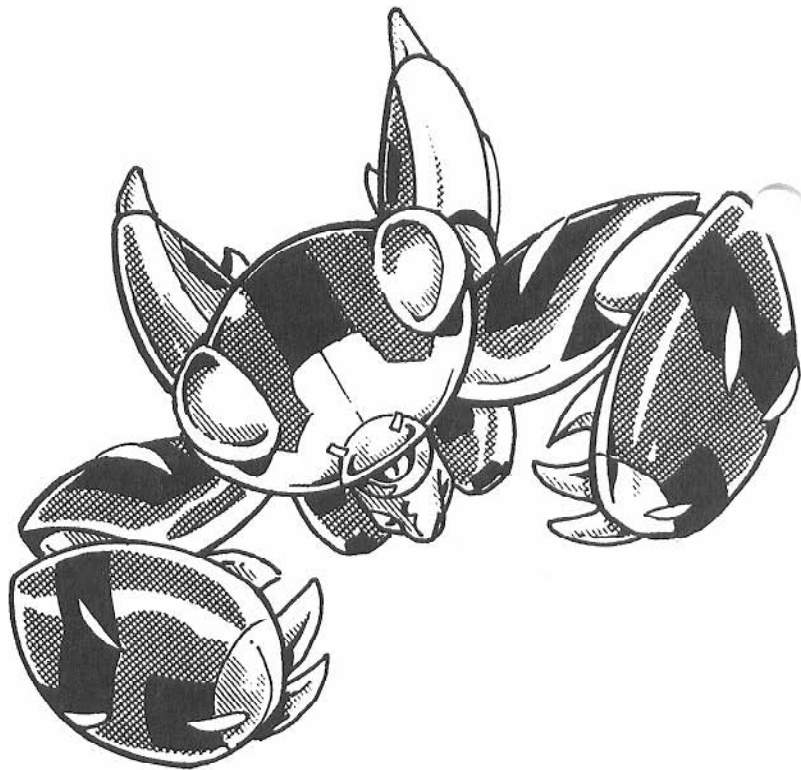

## EXPERIENCE

An Experience Level System is used for two reasons: 1) To fit in with the other Palladium Books games and 2) because I've found it to be a fun and realistic system. After all, nothing can substitute for real experience, especially in a combat situation.

Readers will also notice that each Occupational Character Class (O.C.C.) has its own experience level tables. The varying levels of experience needed for each O.C.C. reflect the difficulty of certain skills or areas of study, as well as game balance.

### EXPERIENCE POINTS

Except in specially devised scenarios and tournaments, there is no winner in a role-playing game. The accumulation of heroic deeds, friends, prestige, weapons, equipment, knowledge and skills, can be construed to be the results of winning. If a character survives and meets with success in his endeavors, that is winning. However, there are rewards besides the acquisition of material goods and reputations, and that's developing your character's skills, knowledge and abilities. This is accomplished through the gathering of experience points.

#### Why An Experience Point System?

The reason I use an experience point system is because I find it extremely realistic and practical. Training is useful, but there is no substitute for experience. I don't know how many times I've read a comic book with the main character thinking to himself something like — “Only my years of experience enabled me to beat him.” or, “He's good, but lacked the years of experience and training to handle the situation”. Practical experience in the field is an important and real factor in the development of a character.

The experience system is specifically designed so that characters will mature fairly rapidly, tapering off as they reach higher levels of experience (around fifth or sixth level).

Why do the experience levels only go to level 15? Because characters are not likely to ever reach that level, even after years of regular play. In my original **Palladium Role-Playing Game** play-test campaign, after two years of weekly, long (average 9 hours) playing sessions; the characters averaged 7th to 9th level and were progressing, ever so slowly, toward tenth level. Realistically, a high level character is not necessarily all that fun to play unless the campaign maintains a high level of challenge and adventure.

## Experience Points and Their Application

It's difficult to devise a point system by which a game master can judge and reward his players fairly. The ultimate purpose of experience points and experience levels is to provide a means in which the player's character can grow and develop. Many fantasy role-playing games have their own unique system, charts, equations and computations, for distributing experience points. You may want to adapt one of these systems to this game if that's what you're comfortable with.

On the other hand, I use a very subjective method of observation and logic. I feel that any twit can chop or blast a creature that has just pounced out from around the corner. Most experience points systems concentrate on the "kill factor," but what about the thought process? What about the decisions, plans, or motives for a particular action? Doesn't cleverness and a cool head count? Aren't these the true ingredients of good role-playing? It seems unfair to me that the person who devises a clever plan should get much less experience points than the players who carry out the plan because they are better skilled to do so. And what about role-playing? Shouldn't the brilliant medical student playing a character with an I.Q. of 3 (and staying firmly in character, saying and doing things as the character, even though he realizes the stupidity as a player) get experience for playing in character? Hell yes! Considering how flexible and subjective most of the other role-playing conditions and rules are, I don't see the logic in having a strict, and limited experience point system. So, here is my chaotic, and subjective experience system.

Each player's character, involved in a given situation/confrontation, should receive the appropriate experience points. The game master (GM) should make a list of his players at the beginning of the game and jot down each player's experience points as they gather them throughout the course of the game. At the end of the game, the GM totals each player's points and gives them each totals, so that they can keep track of their growing experience and skills.

The difficulty with this system of determining experience points is the subjectivity. The GM must utilize the preceding experience outline with some thought. **Example:** Eight third level characters armed to the teeth and in heavy armor kill an average opponent. The eight players should receive experience points for killing a minor menace. After all, the creature didn't have a chance and presented no real threat to the characters. However, if one or two first or second level characters killed or subdued the same opponent, they should receive experience points for killing a major or even a great menace, because the threat and the ingenuity involved is much greater.

I've found this method stimulates imaginative playing instead of promoting slash and kill. GMs, don't play Santa Claus, heaping on wonderful amounts of experience points; be fair and tolerant. Let your players truly earn their experience points, growing in skill and knowledge. If you have a group of players rising rapidly in experience levels, you will know it's because they are clever and imaginative players. And that's what this game is all about.

## Character (O.C.C.) Experience Levels

Each Occupational Character Class (O.C.C.) has a listing for Levels of Experience. A character involved in an adventure gains experience points for his thoughts, actions and deeds. As these experience points accumulate, the character will reach new plateaus, indicating his continual development and mastery of his chosen O.C.C.; and the skills, knowledge and abilities involved. Each time a player's character accumulates enough experience in a particular O.C.C., his skills increase accordingly. This is why the skills are listed by levels.

A clever plan, a quick attack, all earn experience points. The more experience a character receives, the higher the level he attains in that occupation, the greater his skills. **Players:** Be certain to keep a careful record of the experience given to you at the end of each game. When a character attains a new level, be certain to tell the GM so that your skills and hit points can be increased accordingly.

## Experience and Hit Points

Each time a character reaches a new level of experience, the player gets to roll **one**, six-sided die and add the number rolled to the character's hit points. This indicates the physical development and maturity of the character as he develops.

## Per Level of Experience

Per level of experience, or per each level of experience, or per level of the (and O.C.C.), indicates that the person can perform a skill or ability at his highest level of experience. This often indicates the amount of damage that can be inflicted or a duration.

<u>Point</u>	<u>The Action</u>
25	Performing a critical skill.
25	Clever, but futile idea.
100	Clever, useful idea or action.
100	Quick thinking idea or action.
200	A critical plan or action that saves the character's life and/or a few comrades.
400-1000	A critical plan or action that saves the entire group or many people.
100-300	Endangering the character's own life to help others.
500-700	Self-sacrifice (or potential self-sacrifice) in a life and death situation (like leaping in front of a blast meant for someone else to save that person, even though likely to die; or offering own life to save the group or another).
100	Avoiding unnecessary violence.
100-200	Deductive reasoning and/or insight.
50	Good judgment.
50-100	Playing in character bonus.
25-50	Daring (clever or not).
75-100	Killing or subduing a minor menace.
150-300	Killing or subduing a major menace.
	Killing or subduing a great menace.

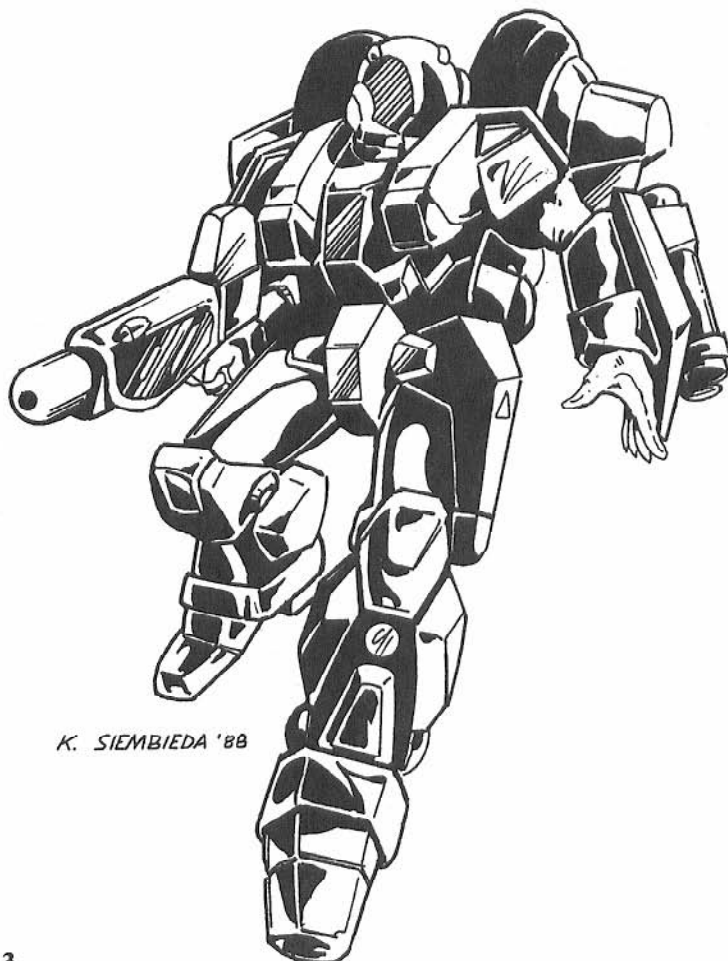

K. SIEMBIEDA '88



## EXPERIENCE LEVELS FOR REF O.C.C.

**Note:** These Experience Tables include the *Invid Invasion O.C.C.s*

<u>Veritech Pilot</u>	<u>Destroid Pilot</u>	<u>Cyclone Rider</u>	<u>Zentraedi</u>
1 0,000-2,100	1 0,000-2,050	1 0,000-2,000	1 0,000-1,950
2 2,101-4,200	2 2,051-4,100	2 2,001-4,000	2 1,951-3,900
3 4,201-8,400	3 4,101-8,250	3 4,001-8,200	3 3,901-8,800
4 8,401-17,200	4 8,251-16,500	4 8,201-16,400	4 8,801-17,600
5 17,201-25,400	5 16,501-24,600	5 16,401-24,500	5 17,601-25,600
6 25,401-35,800	6 24,601-34,700	6 24,501-34,600	6 25,601-35,600
7 35,801-51,000	7 34,701-49,800	7 34,601-49,700	7 35,601-50,600
8 51,001-71,200	8 49,801-69,900	8 49,701-69,800	8 50,601-70,600
9 71,201-96,400	9 69,901-95,000	9 69,801-94,900	9 70,601-95,600
10 96,401-131,600	10 95,001-130,100	10 94,901-129,000	10 95,601-125,600
11 131,601-181,800	11 130,101-180,200	11 129,001-179,100	11 125,601-175,600
12 181,801-232,000	12 180,201-230,300	12 179,101-229,200	12 175,601-225,600
13 232,001-282,200	13 230,301-280,400	13 229,201-279,300	13 225,601-275,600
14 282,201-342,400	14 280,401-340,500	14 279,301-329,400	14 275,601-325,600
15 342,401-402,600	15 340,501-400,600	15 329,401-389,500	15 325,601-375,600

<u>Military Specialist</u>	<u>Bio-Maintenance Engineer Communications</u>	<u>Field Scientist</u>	<u>Nomad Scout</u>
1 0,000-2,120	1 0,000-1,925	1 0,000-2,140	1 0,000-1,900
2 2,121-4,240	2 1,926-3,850	2 2,141-4,280	2 1,901-3,800
3 4,241-8,480	3 3,851-7,450	3 4,281-8,560	3 3,801-7,300
4 8,481-16,960	4 7,451-14,900	4 8,561-17,520	4 7,301-14,300
5 16,961-24,960	5 14,901-21,000	5 17,521-25,520	5 14,301-21,000
6 24,961-34,960	6 21,001-31,000	6 25,521-35,520	6 21,001-30,000
7 34,961-49,960	7 31,001-41,600	7 35,521-50,520	7 30,001-40,000
8 49,961-69,960	8 41,601-53,000	8 50,521-71,000	8 40,001-53,000
9 69,961-94,960	9 53,001-73,000	9 71,001-96,100	9 53,001-73,000
10 94,961-129,960	10 73,001-103,500	10 96,101-131,200	10 73,001-103,000
11 129,961-179,960	11 103,501-139,000	11 131,201-181,300	11 103,001-138,000
12 179,961-229,960	12 139,001-189,000	12 181,301-231,400	12 138,001-188,000
13 229,961-279,960	13 189,001-239,000	13 231,401-281,500	13 188,001-238,000
14 279,961-329,960	14 239,001-289,000	14 281,501-341,600	14 238,001-288,000
15 329,961-389,961	15 289,001-339,000	15 341,601-401,700	15 288,001-328,000

<u>Non-Military</u>	<u>Perytonian Wizard</u>
1 0,000-1,875	1 0,000-2,240
2 1,876-3,750	2 2,241-4,480
3 3,751-7,250	3 4,481-8,960
4 7,251-14,100	4 8,961-17,920
5 14,101-21,200	5 17,921-25,920
6 21,201-31,200	6 25,921-35,920
7 31,201-41,200	7 35,921-50,920
8 41,201-51,200	8 50,921-70,920
9 51,201-71,200	9 70,921-95,920
10 71,201-101,500	10 95,921-135,920
11 101,501-136,500	11 135,921-185,920
12 136,501-186,500	12 185,921-225,920
13 186,501-236,500	13 225,921-275,920
14 236,501-286,500	14 275,921-335,920
15 286,501-326,500	15 335,921-395,920

**Note:** *Freedom Fighter O.C.C.* (see *Invid Invasion*) uses the Cyclone Rider table. *Praxian Warriors* use the Zentraedi table. *Carbonara Warriors* use the Cyclone Rider table. *Garudan Warriors* use the Military Specialist table. *Spherian Adventurers* use the Field Scientist table and *Perytonian Energy Wizards* have their own table.

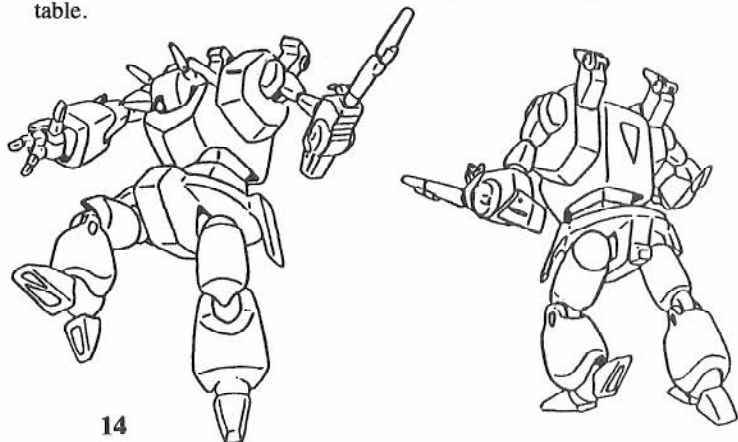

## OCCUPATIONAL CHARACTER CLASSES (O.C.C.)

### REF O.C.C.

Veritech Pilot  
 Destroid Pilot  
 Cyclone Rider  
 Zentraedi Warrior  
 Military Specialist  
 Bio-Maintenance Engineer  
 Communications  
 Field Scientist

### Requirements

I.Q. 9, P.P. 9  
 I.Q. 7  
 I.Q. 8, P.P. 8  
 Zentraedi Race  
 I.Q. 10, M.A. 10  
 I.Q. 8, P.S. 10  
 I.Q. 10  
 I.Q. 12

### Alien O.C.C.

Carbonarian Warrior  
 Praxian Warrior  
 Garudan Warrior  
 Spherian Adventurer  
 Perytonian Wizard Warrior

### Requirements

Must be Carbonarian  
 Must be Praxian  
 Must be Garudan  
 Must be Spherian  
 Must be Perytonian

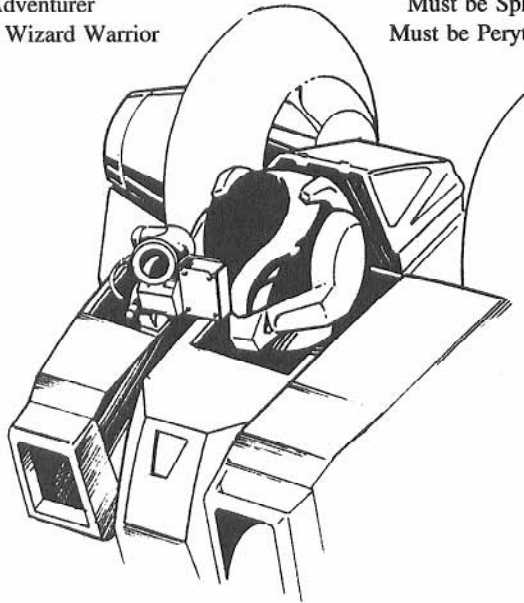

## SELECTING AN O.C.C.

When selecting an O.C.C. it is important to bear in mind the type of scenarios or campaign your game master intends to run. Presumably, adventures will be mostly combat oriented, but may include rescue, reconnaissance, sabotage, spying, et cetera, in space, on land, in alien cities and who knows where else. It is probably wise to create a group of soldiers with a variety of mecha, skills, and special abilities.

*Game masters*, let players have as much control in designing their characters as possible. The allocation of mecha, ammunition and equipment will vary with the type of assignment and the commanding officer. This is where you, the GM, can get creative by providing or limiting the equipment and the assignments. Is the commanding officer stingy? Stupid? Psycho-gung ho? volunteering the group for all the most dangerous assignments (and perhaps limiting their equipment)? That's up to the GM. Remember, these are high-powered mecha, but 60 missiles only go so far if the character(s) is on a mission without access to additional ammunition and/or no REF support. GMs remember, these mecha were made tough so that they could survive rough situations. The REF is fighting an intergalactic war. Resources must be limited.

Think big! Both players and GMs should think big. This is an epic war adventure of intergalactic proportions. The characters are larger than life heroes whose actions, no matter how trivial they may sometimes seem, *will* make a difference! They are the new Rick Hunters, Lisa Hayes's, Max Sterlings, Breetais and all the rest who must vanquish a horribly evil foe with awesome power. Have Fun!! Save a galaxy today!

# THE REF VERITECH FIGHTER PILOT O.C.C.

The Veritech Fighter pilot is still the very elite of the Robotech Defense Force (RDF) and the Robotech Expeditionary Force (REF). The smaller and more agile Alpha and Beta Fighters make these mecha pilots deadlier than ever.

As Robotechnology improves the trend is to make simpler and simpler mecha so that minimal training is necessary. But do not think this makes for a less capable veritech pilot. On the contrary, these men and women are the most skilled mecha pilots in the galaxy. The simpler operation of the mecha enables the veritech pilot to add a whole complement of mecha to his list of skills. Thus, the *REF veritech pilot* can fly the alpha fighter, beta fighter, shadow fighter (alpha), VF-1V vindicator, the old Macross VF series veritech and the Southern Cross logan and AJACS.

The veritech pilot of the REF is also trained in the use of the sensational cyclone, the all-purpose personal combat mecha.

The piloting of Destroids, old and new, is no longer an optional part of the veritech pilot's training. The emphasis of the veritech pilot's training is on the mastery of the many types of transformable "veritech" mecha. Destroid piloting is now a completely distinct and separate occupational character class (O.C.C.).

The cyclone combat training is specifically limited to the VR-052 Cyclone Battler and the standard Battler weapon systems only.

In addition to the O.C.C. skills listed, with bonuses in parentheses, the player can select "other" skill areas. These additional skills are limited as stated.

**Attribute Requirements:** I.Q. 9, P.P. 9 or higher is preferred.

### O.C.C. Skills:

Pilot Jet (+20%)  
 Pilot Veritech Fighters (all) (+20%)  
 Mecha Combat: Veritech Fighter (select two\*)  
 Mecha Combat: Cyclone\*\*  
 Weapon Systems (+20%)  
 Read Sensory Instruments (+15%)  
 Navigation (air, land, water) (+15%)  
 Hand to Hand: Expert\*\*\*

\*Select two specific types of Veritech mecha combat from Alpha, Beta, and Vindicator. ALL types of veritechs can be operated by the veritech fighter pilot, but at the basic training level. To increase one's skill, the character must select the specific mecha combat training. Use the Beta *Basic* training abilities if the veritech pilot has no formal mecha combat training in the Logan and/or AJACS Southern Cross mecha. The Macross and Southern Cross Veritech Fighter O.C.C.s can pilot the VF-1V Vindicator with the usual VF veritech bonuses, but all new mecha are piloted at the basic training level.

\*\*Does not include the special bonuses for the VR-038-LT, nor the Cyclone Rider O.C.C. special strike bonus from the W.P. Cyclone Weapon System.

\*\*\*Hand to Hand: Expert can be changed to Martial Arts, but costs one "other" skill.

**Other Skills:** Select 14 other skills. Plus one additional at level three, two at level six and one at level eleven. All new skills start at level one proficiency.

Communications: Any

Domestic: Any

Electrical: Basic Electronics only

Espionage: None

Mechanical: Basic, auto, aircraft and veritech mechanics only. (+5%)

Medical: First Aid only  
Physical: Any  
Pilot: Any except destroid. (+10% on all aircraft)  
Pilot Related: Any (+10%)  
Science: Math only  
Technical: Any  
Rogue: None  
W.P.: Any, except Cyclone Weapon Systems.  
Wilderness: None

**Standard Equipment:** Alpha fighter or beta fighter of choice. **Note:** The shadow fighters are given only to experienced pilots (4th level and higher) who have proven themselves in combat. The veritech fighter will be in top condition, with full armaments. A VR-052 Battler cyclone is stored in both the alpha and beta for use in ground combat and as a survival suit should the fighter crash land. The pilot wears CVR-3 body armor. Other items include the Gallant

H-90 as the standard sidearm (no choice) with the additional rifle stock extension optional, 4 extra H-90 energy clips, canteen (4 pints), food rations for two weeks, first-aid kit, extra uniform, 3 signal flares, a survival knife, binoculars, and flashlight.

**Authorized Clearance Upon Assignment:** Any veritech fighter, including the VF series veritech (Macross), the vindicator, or shadow fighter. These are authorized only by the commanding officer for special missions (which could be frequent depending on the characters and the campaign). Land vehicles, aircraft, and other vehicles may also be made available. Other items include special weapons, explosives, optical enhancements, special equipment, and access to computers and special facilities.

**Monthly Wages:** 2400 credits per month for enlisted pilots at levels 1-5, 3000 credits per month for 6th level and higher, while high ranking officers (captain and up) make 3800 to 4900 credits per month.

**Personal Savings:** 4D6 × 100

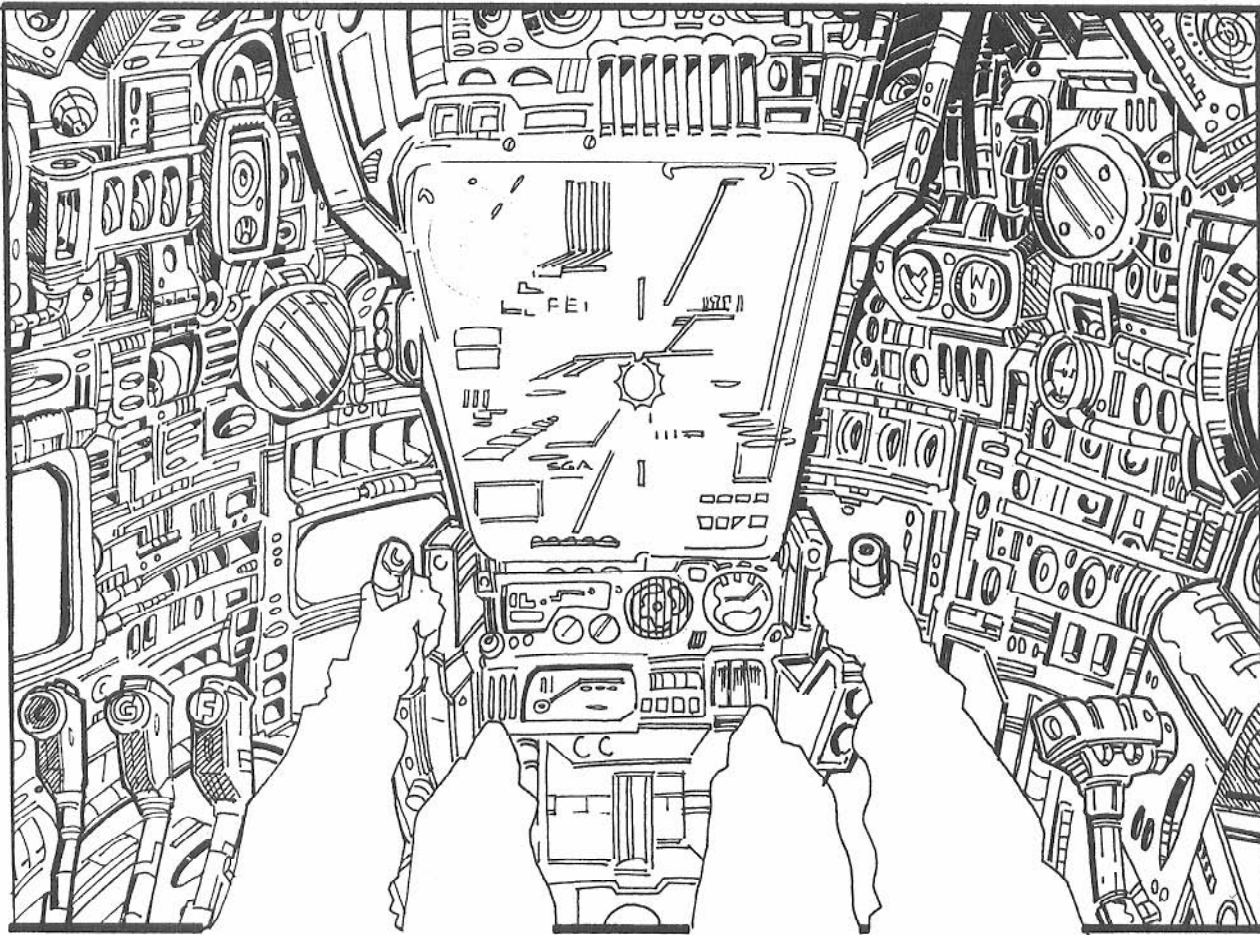

## REF DESTROID PILOT O.C.C.

The Destroid Pilot is, as always, the elite grunt of the Robotech forces. These are the characters who operate the giant non-transformable mecha into the jaws of death, fighting tooth and nail against an inhuman enemy. Whether they be the lumbering giants of the RDF or the smaller, faster REF models, Destroids represent some of the most powerful weapons of war ever created by man. Each individual destroid packs more firepower than a 20th century tank division.

The new REF destroids are even more powerful than the amazing RDF juggernauts. Generally, the REF destroids can endure greater damage, move twice as quick, have more versatility in size and limb, and possess even more powerful weapons. The ground mecha, cyclones, and the awesome power of the various transformable veritech fighters provides the REF troops with a full range of mechanized warriors. It is this great variety of mecha and specialization that has created a sharply defined line between each of the military O.C.C.s and the type of mecha available to that O.C.C.

The REF destroid pilot is much more a specialist than his RDF brother. Only the destroid pilot is trained in the operation *all* destroids.



Although a few other O.C.C.s can learn to pilot one or two particular destroids, none have the range of mecha piloting skills nor experience of the destroid pilot.

After initial training (includes "Basic" destroid combat), the character receives *mecha combat* training in three specific destroids (Note: Cyclones and veritechs are not considered to be destroids. Choose 3 destroids.) This specialized training instills in the pilot the maximum knowledge and combat abilities of those three *specific* destroids. Additional mecha combat training can be selected as "other" skills. Note that each type of destroid is different, including the old RDF models. This means combat training in a new REF Gladiator MK III does not automatically include the RDF Gladiator MK II. The pilot *can* operate the RDF MK II Gladiator (the destroid O.C.C. training enables the pilot to operate ALL destroids), but combat will be at the basic level (See *Hand to Hand Bonuses from Destroid Basic Combat Training*). Although the rudimentaries in piloting any destroid are similar, the specific operating details, movement and response time, and weapon systems do vary with each individual type and model of mecha. See *Robotech the Role-Playing Game (Book One) for RDF Mecha and Combat bonuses*.

In addition to the O.C.C. skills listed, with bonuses in parenthesis, the player can select "other" skill areas. These additional skills are limited as stated.

**Attribute Requirements:** I.Q. 7. A high P.P. is preferred, but not a necessity.

**O.C.C. Skills:**

Pilot Destroids (all) (+20%)\*

Mecha Combat: Destroid (select 3)\*\*

Weapon Systems (+15%)

Read Sensory Instruments (+10%)

Pilot Automobile (+10%)

W.P. Energy Rifle

W.P. Energy Pistol

Hand to Hand: Basic\*\*\*

\*Can operate all Destroids and Southern Cross Battloids, but combat skills may be at the basic level.

\*\*Select three specific types and models of Destroids from any of the RDF or REF Destroids, except Zentraedi types. The latter can be selected, but as an "other" skill selection. The character can pilot those three specific Destroids with maximum efficiency and maximum combat bonuses. All others are automatically at the *basic* combat level.

\*\*\*Hand to Hand: Basic can be changed to Expert, but costs one "other" skill.

**Other Skills:** Select 16 other skills. Plus two additional at level three, two at level six, and one at level eleven. All new skills start at level one proficiency.

Communications: Radio skills only

Domestic: Any

Electrical: Basic Electronics only

Espionage: None

Mechanical: Basic; automobile, aircraft, and mecha mechanics only (+5%)

Medical: First aid (or paramedic, but costs two skills)

Physical: Any

Pilot: Any except veritech, and cyclone is limited to basic combat. (+10% on any destroid, +10% on any ground vehicle, +5% on any air or space craft)

Pilot Related: Any (+10%)

Rogue: None

Science: Math only

Technical: Any

W.P.: Any except Cyclone Weapon Systems

Wilderness: None

**Standard Equipment:** Destroid of choice with weapon systems fully loaded. Choice of energy rifle, choice of sidearm (usually a Sal-9), 6 to 12 extra energy clips for each (stored inside the mecha), and a CVR-3 body armor. Other items include: binoculars, oxygen tank and gas mask, first-aid kit, personal canteen, 2 gallons of water stored inside the mecha, tool kit, work overalls, extra uniform, flashlight, 12 signal flares, 6 to 12 cobalt limpet mines and 200ft (61m) of nylon cord. There is enough room in a destroid to stow additional weapons, ammunition, equipment and/or personal items.

**Authorized Clearance Upon Assignment:** Additional or special energy weapons, grenades, explosives, equipment, land vehicle, aircraft and mecha.

**Monthly Wages:** 2000 credits per month for enlisted men at levels 1-5, 2800 credits per month for 6th level and higher, while high ranking officers (captain and up) make 3400 to 4200 credits per month.

**Personal Savings:** 3D6×100

## THE REF CYCLONE RIDER O.C.C.

The cyclone rider is a new breed of mecha warrior, a combination of destroid pilot and military specialist. The cyclone riders could be considered to be the elite *special forces* of the REF/RDF. It is the cyclone rider who is usually involved in covert operations, reconnaissance, rescue missions, demolition, and intelligence. Armed with the human-size power armor of the cyclone, its wearer becomes a pint size juggernaut, faster, stronger, capable of limited flight and armed with mini-missiles and energy weapons. The small size insures stealth and a mobility that no other mecha enjoys.

The cyclone rider is trained in the use of all three cyclone types and all cyclone weapon systems including the CADS-1 system of the VR-041 Saber cyclone. Each of the three cyclone models have their own unique characteristics.

*The VR-052 Battler Cyclone* is the heavy-duty combat unit and is the most common.

*The VR-041 Saber Cyclone* is a special unit designed for CADS-1 hand to hand combat and espionage.

*The VR-038-LT Light Combat Cyclone* is often thought of as being simply a lightweight model for female warriors. While it is true that the VR-038-LT was designed with women soldiers in mind, it has proven to be a superior unit for stealth and, consequently, is used for clandestine operations. The light combat cyclone has an even quicker reaction time than its heavier predecessors and enjoys several combat bonuses the others do not. As a result, the light combat cyclone can be used by men and women, and is often the mecha of choice for clandestine operations where hand to hand combat and precision timing are required.

The cyclone rider can also learn to operate the new REF destroids (see *Sentinels*) and may request alpha fighter training, but must have the pilot jet skill and uses the mecha combat table Hand to Hand Bonuses from Alpha Basic Training. The basic training table means the character lacks the full skills and abilities of a veritech pilot whose O.C.C. has provided in depth and lengthy formal training.

Destroid piloting skills are limited to the RDF and/or REF Gladiator, Excaliber, or Raidar X. Training will focus on one specific destroid model, rather than the full range of destroids. The character is also restricted to Hand to Hand Bonuses from Destroid Basic Combat Training. The basic training table illustrates the secondary nature of destroid piloting skills to this O.C.C. The skill is so limited that the character

will have great difficulty piloting any other type of destroid (unlike the Destroid Pilot O.C.C.). The best he or she can hope for is to be able to start a different mecha and get it to move at half speed; no bonuses, and only one attack (total) per melee. **Note:** To pilot a destroid, the character must spend two "other" skill selections; one on pilot destroid (specific model) and one on basic destroid combat for that specific model. The character can elect to pilot additional specific destroids at a cost of one "other" skill each (includes additional operating knowledge and basic combat for each type/model).

In addition to the O.C.C. skills listed, with bonuses in parentheses, the player can select "other" skill areas. These additional skills are limited as stated.

**Attribute Requirements:** I.Q. 8, P.P. 8 or higher is preferred.

**O.C.C. Skills:**

- Pilot Motorcycle (+20%)
- Pilot Mecha: Cyclone (all) (+20%)
- Mecha Combat: Cyclone (all types)
- Weapon Systems (+15%)
- W.P. Cyclone Weapon Systems\*
- W.P. Gallant
- W.P. Heavy
- Hand to Hand: Expert\*\*

\*W.P. Cyclone Weapon Systems is *exclusive* to the cyclone rider and adds a bonus of +1 to strike when using the GR-97 forearm missile launcher, Gallant H-90, CADS-1 saber system, EP-40 pulse beam cannon, EP-37 60mm beam cannon, and RL-6 heavy rocket cannon.

\*\*Upgrade to Martial Arts costs one extra "other" skill.

**Other Skills:** Select 14 other skills. Plus two additional at level three, one at level six and one at level eleven. All new skills start at level one proficiency.

Communication: Any (+5% on all radio)

Domestic: Any

Electrical: Basic electronics only

Espionage: Detect Ambush, Detect Concealment, Escape Artist, Intelligence, Land Navigation, and Wilderness Survival only (+5%).

Mechanical: Basic and Automotive (includes motorcycle) only (+10%).

Medical: First Aid only.

Physical: Any

Pilot: Any (+10% on all ground vehicles/mecha. Must have pilot jet skill to select Alpha, Beta, or other flying mecha and, even then, hand to hand mecha combat is limited to "Basic" training).

Science: Math only.

Technical: Any (+10% on both demolition skills).

Rogue: Any (+15%)

W.P.: Any

Wilderness: None (May select any as a future additional skill).

**Standard Equipment:** Choice of cyclone model (may change from assignment to assignment) and choice of cyclone weapon system, and CVR-3 cyclone body armor. Sidearm is the Gallant H-90 with rifle stock attachment and six additional energy clips. An additional energy or conventional rifle may be selected plus four ammo clips, as well as an additional sidearm (not a Gallant H-90). Other items include 2D4 cobalt limpet mines, 1D6 cobalt grenades, binoculars, two canteens, food rations for two weeks, an extra uniform, flashlight, survival knife, 3 signal flares, 100ft (30m) of light nylon cord and detachable storage boxes for the cyclone. **Note:** The CVR-3 armor has a radio built into the helmet.

**Authorized Clearance Upon Assignment:** Additional or special weapons, equipment, land vehicle, aircraft, mecha (if applicable), additional missiles and explosives.

**Monthly Wages:** 2000 credits per month for enlisted men at levels 1-5, 2800 credits per month for 6th level and higher, while high ranking officers (captain and up) make 3400 to 4200 credits per month. **Personal Savings:** 3D6 x 100

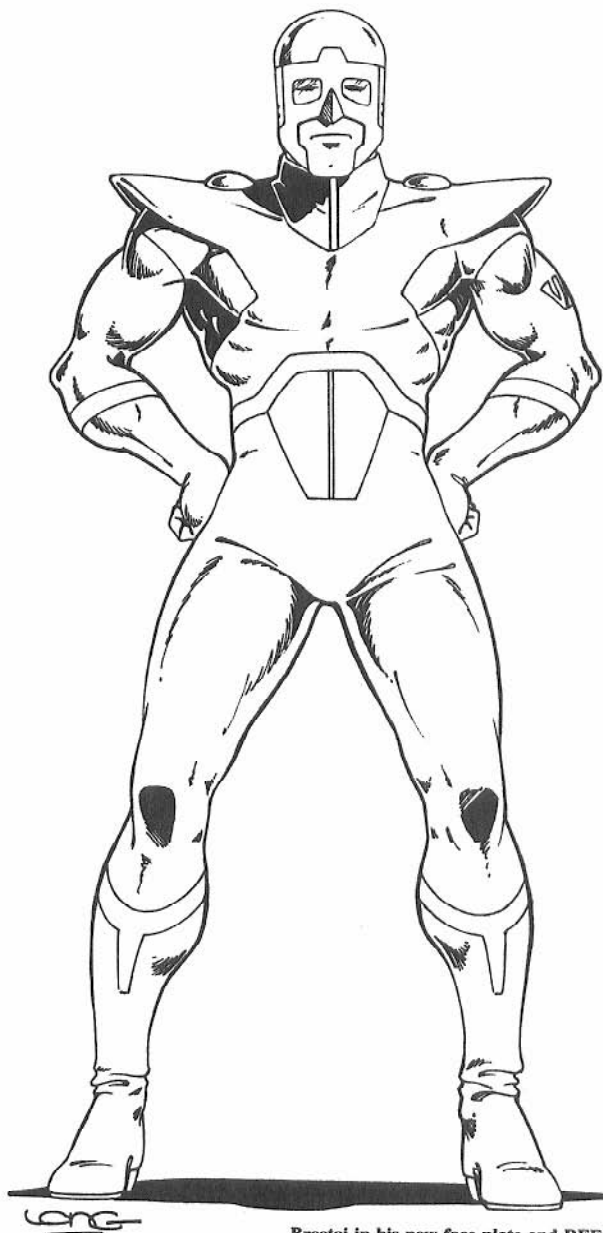

Breetai in his new face plate and REF uniform.

## ZENTRAEDI REF WARRIOR O.C.C.

All Zentraedi have been micronized by the time the SDF-3 makes its flight to the Robotech Masters' homeworld. Among the crew and troops is the majority of the surviving Zentraedi population. At least 30% of the REF troops are comprised of "loyal" Zentraedi. Their loyalty may stem from a variety of sources. Many have grown to love their adopted planet and the micronians who would dare to embrace an enemy. Others do like the humans, but their true loyalty lies with their charismatic leader, Breetai. They will follow Breetai anywhere without question. Even micronization is acceptable now that Breetai has, himself, been micronized. Still others see this as a means to exact revenge against the Robotech Masters, or long for the thrill of battle. Whatever the reason, they represent the REF as fearless warriors willing to die to protect the Earth.

The greatest change for the Zentraedi is being reduced ("micronized") from 50 foot giants to normal size humans. This caused an immediate problem in that the Zentraedi's psychological indoctrination by the Masters and their ignorance of simple science and technology seriously impaired their ability to adapt to the complex human mecha. The solution

was to create new human size mecha based on the designs of the old Zentraedi battle pods. Ironically, the smaller battle pods are even tougher and more powerful than the old 50 foot pods. This has pleased the Zentraedi to no end. *See the new REF Battle Pods in the Destroid section.*

Human destroid pilots *can* learn to operate the Zentraedi style mecha, but the pods are generally considered to be exclusive to the Zentraedi warriors. Battle Pod mecha training counts as a separate skill choice for the destroid pilot and is not part of his/her formal training.

The creation of a Zentraedi character is a little different than that of a human being. Even the number of dice rolled for the eight attributes are different. Roll on the following tables to create your Zentraedi Warrior.

#### Gender

01-75 Male

76-00 Female (always an officer, add 1D6 to the I.Q.)

**Alignment:** Any

**Micronized Height:** 5ft plus 3D6 inches

**Weight:** 130lbs (45kg) plus 2D4 × 10lbs

#### The Eight Attributes:

I.Q. 3D6

M.E. 2D6

M.A. 2D6

P.S. 4D6

P.P. 3D6

P.E. 4D6

P.B. 2D6

Spd. 3D6

As usual, a roll of 16, 17, or 18 provides a bonus roll of 1D6 and bonuses on abilities. Likewise, a roll of 11 or 12 on 2D6 also gets a bonus roll of 1D6.

**Physical S.D.C.:** 20 + 3D6

#### Reason for Joining the REF

##### Roll Percentile Dice

**01-15** Hate humans, but will follow Breetai anywhere and obey him without question.

**16-37** Feel betrayed by the Robotech Masters and fellow Zentraedi. You crave revenge. Humans are generally seen as friends.

**38-59** Fiercely loyal! Earth is your new home and micronians your adopted race; anyone who threatens them must be destroyed.

**60-80** A born warrior! Loyal, but still suspicious of humans. You are a warrior, combat is a part of you, and this should be a glorious war that will rock a galaxy.

**81-90** The humans seem to be honorable and trustworthy, but you have your doubts. You feel superior to humans and tend to be arrogant. Breetai's leadership and the opportunity to prove yourself in a fight means more than any sense of gratitude or loyalty to humans.

**91-00** Hate the Robotech Masters and Invid more than humans, so why not join the REF and extract some revenge. Will seriously consider betraying humans if the opportunity arises.

**Attribute Requirements:** Soldier: None. Officer: I.Q. 12 or higher.

#### O.C.C. Skills:

(All O.C.C. skills start at second level proficiency)

Pilot Zentraedi Style Mecha

Mecha Combat: All Zentraedi style mecha

Weapon Systems (+10%)

Radio: Basic (+5%)

Navigation: Air, Land, Water (+10%)

Navigation: Space (+10%)

W.P. Energy Rifle

W.P. Energy Pistol

Hand to Hand: Basic\*

\*Hand to Hand: Basic can be upgraded to Expert at the cost of one "other" skill. Officers automatically start with Hand to Hand: Expert, which can be changed to Martial Arts at the cost of one "other" skill selection (available only to the officers).

**Other Skills:** Select 8 if a soldier, 10 if an officer, plus two additional skills at level three, one at level six and one at level twelve. All "other" skills start at level one proficiency.

**Communications:** Radio: Scramblers, and T.V./Video only.

**Domestic:** Any

**Electrical:** None

**Espionage:** Soldier: None; Officer — Any (+10%)

**Mechanical:** None

**Medical:** First Aid only

**Physical:** Any (+3% when applicable)

**Pilot:** Zentraedi mecha, spacecraft, shuttles, automobiles and small trucks only (+10%) (officers can also pilot aircraft).

**Pilot Related:** Any (+10%)

**Rogue Skills:** Any (+10%)

**Science:** Math only

**Technical:** Any (Officers are +5%)

**W.P.:** Any, except Cyclone Weapon Systems

**Wilderness:** None

**Special Equipment:** Z1-Battle Pod (only officers get the Z2-Officer's Pod), CVR-3 body armor, Fal-2 laser rifle, panther pulse laser, six extra energy clips for each, six cobalt grenades, survival knife, two canteens, food rations for two weeks, flashlight, binoculars, 3 signal flares, 100ft (30m) of light rope and grappling hook, and an extra uniform. Officers can choose the types of weapons they use.

**Authorized Clearance Upon Assignment:** Additional or special weapons, equipment, land vehicle, Z3-Recon Pod, and aircraft if applicable.

**Monthly Wages:** 2000 credits per month for warriors at levels 1-5, 2500 credits per month for 6th level and higher, while high ranking officers (captain and up) make 3500 to 4500 credits per month.

**Personal Savings:** 2D6 × 100 for soldiers. 4D6 × 100 for officers.

## REF MILITARY SPECIALIST O.C.C.

The Robotech Expeditionary Force (REF) Military Specialist is a jack-of-all-trades: He or she is trained in the use of the VR-041 Saber Cyclone and is a fair Alpha pilot, but the main emphasis of training is on espionage. It is the military specialist who usually leads a group of cyclone riders on covert missions, for the REF military specialist is a master at information gathering and subterfuge.

Cyclone combat training is specifically limited to the VR-041 Saber cyclone and the CADS-1 saber system.

The alpha assigned to a REF military specialist will usually be the VAF-6R reconnaissance alpha.

In addition to the O.C.C. skills listed, with bonuses indicated in parentheses, the player can select "other" skill areas. These additional skills are limited as stated.

**Attribute Requirements:** I.Q. 10, M.A. 10 or higher is preferred, as well as a high P.P., but neither is mandatory.

#### O.C.C. Skills:

Pilot Jet (+10%)

Pilot Cyclone (+10% to pilot the VR-041 Saber specifically, but can pilot any cyclone).

Mecha Combat: Cyclone (VR-041 only)\*

Intelligence (+20%)



Interrogation (+15%)

Disguise (+15%)

W.P. Energy Rifle

W.P. Gallant

Hand to Hand: Martial Arts.

\*Mecha Combat: Cyclone is specifically limited to the VR-041 Saber cyclone, with full bonuses. The pilot cyclone skill enables the character to pilot any of the three cyclones, but the VR-052 and VR-038-LT cannot be used at full proficiency; use Hand to Hand Combat Bonuses Basic Training.

The pilot jet skill allows the character to select a veritech piloting skill (alpha and beta are usually encouraged) and mecha combat skills, but will always be at the "Basic" training level.

**Other Skills:** Select 16 other skills, but at least two must be communications and two espionage. Plus two additional skills at level three, one at level six, one at level nine and one at level twelve. All new skills start at level one proficiency.

Communication: All at +10%; but Cryptography at +15%.

Domestic: Any

Electronics: Any

Espionage: Any (+15%)

Mechanical: Basic, Automotive, Aircraft, Computer Repair and Locksmith only (+5%)

Medical: Paramedic only (+5%)

Physical: Any (+10% when applicable)

Pilot: Any except destroids (+5% on motorcycle, alpha, beta, and all aircraft; all mecha combat is limited to "Basic").

Science: Any

Technical: Any (+5%; both demolition skills are +10%)

Rogue: Any (+10% on streetwise only).

W.P.: Any except cyclone weapon systems.

Wilderness: None (may select any as future additional skills).

**Standard Equipment:** VR-041 Saber cyclone with a pair of CADS-1 and full missile load. CVR-3 cyclone body armor, Gallant H-90 with attachable rifle stock and six extra energy clips, sidearm of choice, 4 cobalt limpet mines, and 6 cobalt grenades. Other items include 2 survival knives, an additional hand-held weapon of choice, 3 signal flares, binoculars, two canteens, food rations for two weeks, flashlight, an extra uniform, a camouflage uniform, 100ft (30m) of nylon cord with grappling hook, and a personal land vehicle other than the cyclone (usually a land rover, jeep, automobile or hover cycle).

**Authorized Clearance Upon Assignment:** VAF-6R reconnaissance alpha with full armaments, explosives, additional or special weapons, surveillance equipment, special radio equipment, optical enhancements, video and photo equipment, personal computer, assault vehicle, aircraft and access to laboratory and computer facilities.

**Monthly Wages:** 2100 credits per month at levels 1-5, 2800 credits per month for 6th level and higher, while high ranking officers make 3600 to 4600 credits per month.

**Personal Savings:** 4D6 × 100

# REF BIO-MAINTENANCE ENGINEER O.C.C.

A new breed of mechanic is the Bio-Maintenance Engineer, an expert in mecha and protoculture powered devices. It is the duty of the Bio-Maintenance Engineer (BME) to service, repair, modify and maintain mecha in perfect working order. The BME has an in depth knowledge of protoculture and can adapt the invid and zentraedi energy cells for human use. He or she can also recharge energy clips for weapons, repair conventional vehicles and may have a number of other mechanical and/or electrical skills.

Although the character can fix and maintain mecha with astounding skill, he/she can not pilot mecha. If he or she has the pilot motorcycle skill, he/she can pilot the cyclone only in motorcycle mode. Likewise, the alpha and beta can be piloted in jet mode if the character has the pilot jet skill. No mecha combat skills are available (not even the "basic" training category). This is not some odd oversight on the part of the military, but is intentional. It was feared that knowledge of mecha mechanics and protoculture combined with the knowledge of piloting mecha would make the Bio-Maintenance Engineer a security threat. A disgruntled BME soldier or spy could, theoretically, have easy access to mecha, steal one, and sell the mecha and his services on the black market. To help curb this, the RDF brass made the decision to prohibit a BME from learning mecha piloting and mecha combat skills.

In addition to the O.C.C. skills and "other" skills available, the Bio-Maintenance Engineer has a number of special skills.

## SPECIAL SKILLS (Exclusive to the BME)

### 1. Repairing Mecha

**Base Skill:** 55% + 5% per level of experience.

This special skill enables the character to build, repair, custom modify and maintain all types of mecha. This means the bio-maintenance engineer can restore M.D.C. armor, replace damaged limbs, replace/repair damaged weapons and parts, replace energy cells and adapt alien protoculture energy cells to human mecha.

### Repair Penalties

The following penalties apply whenever the character tries to build, repair or modify a mecha. The penalties generally reflect the complexity and difficulty of the job. *All penalties are accumulative.* For example: Working on replacing the arm of an alpha fighter, the character is -25% to replace the limb, but also -10% because he does not have the electrical engineer skill and then add a -5% aircraft construction penalty because the alpha is also an aircraft. Total penalty is -40%. Another -20% would apply if it were a rush job or -10% if improper tools were being used.

### Mecha Repair Penalties

- 30% if the character does not have mecha electronics.
- 10% if the character does not have the electrical engineer skill. Electrical skill is important for all repairs.
- 25% replacing a limb (hand, arm, leg, etc.) A failed roll means a frozen, and non-transforming body part. An impaired leg will reduce running speed by half and -2 to dodge. An impaired arm means (minus) -1 melee attack and -1 to parry.
- 10% replacing or repairing sensory equipment like radar, optics, etc. A failed roll means the sensor is not working.
- 5% aircraft construction; any type of aircraft work other than maintenance.
- 20% V.T.O.L. capabilities; tricky work.
- 25% propulsion systems, hover jet(s), etc. A failed roll means a fault in the system; best speed and altitude are half normal. Also, -2 to dodge.

- 20% weapon systems repair, replacement or installation. A failed roll means the weapon does not function. No penalty if the person has the armorer skill.
- 5% electrical wiring. A failed roll means not connected properly.
- 5% adapting invid or zentraedi energy cells for human mecha. A failed roll means try again.
- 15% protoculture energy system repair or replacement. A failed roll means improper connection and mecha is without power. Try again.
- 20% adding M.D.C. by replacing or patching the armor. Difficult and time consuming work. Must have replacement armor available (salvaged from another mecha or factory material). A failed roll means the weight and design are awkward. Reduce maximum speed by 20% and -10% to all piloting rolls. You can tear it down and try again.
- 10% own original design modification.
- 20% rush job; takes half the usual time, but may be flawed (a failed roll).
- 10% for every 20 hours of continuous work without at least six hours of sleep.
- 10% improper tools. Takes twice as long as normal and quality may be inferior (a failed roll).

### Time Restrictions

The amount of time needed to work on a mecha varies with the complexity of the task. The player and game master will have to work together on deciding how much time will be needed to do the work properly. Also the hours of work required may be interrupted with breaks for food, rest, sleep and combat. Precision work requires an alert mind and hand not dulled by fatigue. Some estimates for work time are:

1. Simple maintenance such as oil change, cleaning, lubrication, and changing protoculture cells will take 10 to 20 minutes, even in the middle of a forest.
2. Adapting alien protoculture storage cells for use in human mecha will take an hour or two.
3. Equipment repairs of separate units like radar, radio, targeting computer and so on can get complicated taking anywhere from one hour to six or eight hours. Use of RDF repair facilities will reduce the time by half.
4. Add on another 2D4 hours to completely replace the equipment mentioned in #3.
5. Major engine work; 8 to 48 hours.
6. Replacing or repairing a weapon system; 2 to 16 hours.
7. Replacing M.D.C. armor requires about two (2) hours for every 10 M.D.C. points restored. Replacement armor must be salvaged from other mecha. RDF and Southern Cross bases used to keep replacement armor at the base mecha maintenance and repair facility, but all such bases (and factories) are believed to have been destroyed. Heavy equipment and mecha welding and bonding tools are required. Field repairs are difficult, even with the bonding equipment and at least one battloid to assist with the heavy work for the full duration takes three times longer (six hours per every 10 M.D.C.).
8. Replacing a mecha limb is also difficult and is best done at a mechanics facility. Under the best conditions, an entire appendage can be replaced in 10 or 12 hours. In the field, a battloid will be needed to assist in the heavy work (an alpha arm weighs nearly two tons) and will take twice as long.

## 2. RECOGNIZE MECHA QUALITY

**Base Skill:** 50% + 5% per each additional level of experience from the firsthand examination.

20% + 5% per each additional level when observing from a distance.

Bio-Maintenance Engineer is so adept at his/her trade that the character can size up the quality, condition and/or damage of any mecha,

veritech or battloid, by looking at it (of course, first hand inspection is best). Their expert eye can estimate the vehicle's capabilities, approximate M.D.C., speed, maneuverability, weapons, etc.

**Attribute Requirements:** I.Q. 8, P.S. 10. A high P.P. is preferred too, but is not a prerequisite.

### O.C.C. Skills:

Mechanical Engineer (+20%)  
 Veritech Mechanics (+20%)  
 Mecha Mechanics (+15%)  
 Mecha Electronics (+15%)  
 Weapon Systems (+10%)  
 Computer Operation (+10%)  
 W.P. Energy Pistol  
 W.P. Energy Rifle  
 Hand to Hand: Basic\*

\*Hand to Hand: Basic can be changed to Hand to Hand: Expert at the cost of one "other" skill or to Martial Arts at the cost of two "other" skills.

**Other Skills:** Select 16 other skills, but at least two must be selected from mechanical. Plus two additional skills at level three, one at level six and one at level eleven. All new skills start at level one proficiency.

Communications: Any

Domestic: Any

Electronics: Any (+5%)

Espionage: None

Mechanical: Any (+15%)

Medical: First Aid or Paramedic, but the latter counts as two skill choices.

Physical: Any

Pilot: Any, except Mecha and Mecha Combat (+10% on any ground vehicle skills, +5% aircraft).

Pilot Related: Any (+5% on all ground vehicles).

Science: Math only

Technical: Any

Rogue: None

W.P.: Any, except Cyclone Weapon Systems.

Wilderness: None

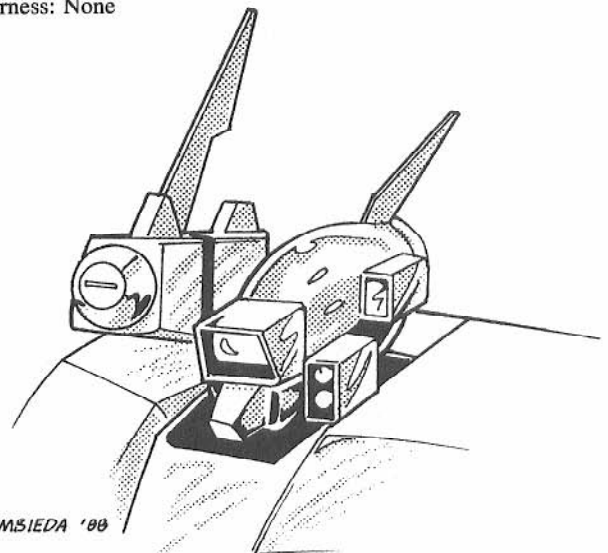

**Authorized Clearance Upon Assignment:** Assault vehicle, other land vehicle, aircraft, jet pack, special weapons, explosives, special equipment, spacesuit, and access to full garage/repair/factory facilities.

**Monthly Wages:** 2300 credits per month for enlisted men at levels 1-5, 3000 credits per month for 6th level and higher, while high ranking officers receive 3600 to 4800 credits per month.

**Personal Savings:** 6D6 × 100

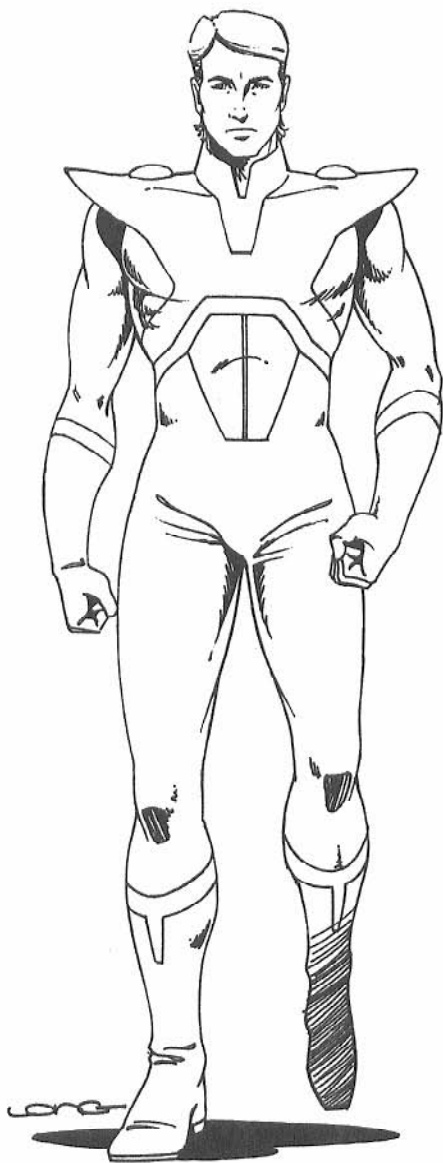

## REF COMMUNICATIONS ENGINEER O.C.C.

The communications engineer is the high-tech wizard who can link an entire world with sight and sound. This character has an in depth knowledge of state of the art communication systems, including satellite relays, laser transmissions, video telecasts and surveillance. It is his or her job to establish and maintain communications on the battlefield and into space. The character can be a vital link to survival whether he/she is a field operator, a member of a reconnaissance team, or a deck officer on the bridge of a spaceship.

The emphasis of this O.C.C. training is on communications and related skills; however, this is war, and the character is a soldier. Consequently, the communications engineer is also taught combat skills, and it is strongly suggested that he learn to pilot some form of mecha.

The engineer can learn to pilot any one or two of the following mecha: VAF-6R Reconnaissance Alpha, VR-038 Light Cyclone or VR-052 Battler Cyclone, and/or the RDF or REF Gladiator, Excaliber, Raidar X or Spartan. Unfortunately, the best possible mecha combat training is *BASIC*. For Example: If Cyclone Mecha Combat is selected, only the Hand to Hand Bonuses from Cyclone Basic Training apply.

Each mecha type selected will cost two "other" skills; one to pilot and one for *basic* mecha combat of that one specific type and model of mecha. Of course, these two mecha skills may be the difference between life and death in combat.

In addition to the O.C.C. skills listed, with bonuses in parenthesis, the player can select "other" skill areas. These additional skills are limited as stated.

**Attribute Requirements:** I.Q. 10

### O.C.C. Skills:

**Laser Communications** (+15%)

Radio: Basic (+30%)

Radio: Scrambler (+15%)

Radio: Satellite Relay (+30%)

Surveillance Systems (+10%)

Read Sensory Instruments (+10%)

Computer Operation (+15%)

W.P. Energy Rifle

Hand to Hand: Basic\*

\*Hand to Hand: Basic can be upgraded to Expert, but costs one "other" skill. Upgrading from basic to martial arts will cost two "other" skill selections.

**Other Skills:** Select 16 other skills. Plus two additional at level three, two at level six, and one at level eleven.

Communications: Any (+10%)

Domestic: Any

Electrical: Basic electronics (or electrical engineer, but cost three other skill selections). (+5%)

Espionage: None

Mechanical: Basic; automobile, aircraft, and computer repair only.

Medical: First Aid only

Physical: Any

Pilot: Any conventional or military vehicle; mecha is restricted as previously explained.

Pilot Related: Any (+10%)

Rogue Skills: None

Science: Math only

Technical: Any (+5%)

W.P.: Any except Cyclone Weapon Systems

Wilderness: None

**Standard Equipment:** Choice of AAT-30 or hover cycle or conventional vehicle like a jeep, land rover or dune buggy. Choice of energy rifle (usually a Wolverine assault rifle), choice of sidearm (usually a Sal-9 laser pistol or "Wolf" auto pistol) and 4 to 6 extra ammo clips for each. Other items include: CVR-3 body armor for combat, extra uniform, protective goggles, wrist radio, binoculars, canteen, flashlight, utility belt, mini-tool pack, and 3 signal flares.

**Authorized Clearance Upon Assignment:** Long-range radio back-pack unit (700 mile/1120km range), special radio equipment/boosters/relays/scramblers, sensory scanning equipment, surveillance devices, optical enhancements, video and photo equipment, additional weapons, explosives, assault vehicles, aircraft and mecha (if warranted).

**Monthly Wages:** 2000 credits per month for enlisted men at levels 1-5, 2800 credits per month for 6th level and higher, while high ranking officers make 3500 to 4300 credits per month.

**Personal Savings:** 4D6 × 100



# REF FIELD SCIENTIST O.C.C.

The REF field scientist is very much an extension of the RDF field scientist. The character is an intelligent, inquisitive person who craves both knowledge and adventure. A "jack-of-all-trades," the scientist uses his varied skills for analysis, investigation, identifying and cataloging alien specimens, and for developing new concepts and applications for robotechnology.

The intergalactic Robotech expedition and encountering of alien life and cultures has made the necessity of having scientists among the REF troops critical. A field scientist will be a member of most REF outposts, expeditions, and reconnaissance patrols. As with the communications engineer, it is wise for the scientist to master at least one mecha. However, the character also suffers similar restrictions. He can only learn to pilot a VAF-6R Reconnaissance Alpha, VR-038 Light Cyclone, and/or RDF or REF Gladiator, Excaliber or Raider X. The best possible mecha combat training is *BASIC*. Each mecha type/model selected will cost two "other" skill selections; one to learn to pilot that specific mecha and one for basic mecha combat (the player must spend the two skill selections to provide the character with any proficiency with a mecha).

In addition to the O.C.C. skills listed, the character also gets a variety of "other" skills and a few special ones too.

## SPECIAL SKILLS (Exclusive to the Scientist)

### 1. Recognizing Alien Artifacts

**Base Skill:** 50% + 4% per level of experience.

This special skill enables the scientist to recognize an item not of Earth/human origin and surmise its probable purpose/use. Furthermore, the field scientist can recognize Robotech Master, Zentraedi, and Invid technology/items.

### 2. Use Alien Technology

**Base Skill:** 22% + 5% per level of experience.

The scientist can analyze and try to use devices of alien design. This may require building it into a human made device, modifying it, or using it as is, such as perfectly good alien weapon, vehicle, etc.

Analysis time will vary with the complexity of the item, its purpose, and level of technological sophistication. Likewise, something that is completely new, that is to say, super bizarre/unlike anything created by humans, will be even more difficult to figure out.

#### Time Restrictions:

- Low technology, humanoid design: 1D4 hours + 10% to base skill.
- Medium technology, humanoid design: 2D6 hours.
- High technology, humanoid design: 1D4 × 10 hours.
- Super technology, humanoid design: 4D6 × 10 hours.

#### Penalties (all penalties are accumulative):

- Non-humanoid design: -15% and add 1D6 × 10 days.
- Mentally activated/operated: -10% and add 4D6 hours.
- Mystical properties: -12% and add 3D4 × 10 days.
- Completely alien technology: -30% and add 4D6 × 10 days.
- Each failed attempt: -5%

**Note:** Add a bonus of +10% when dealing with Robotech Master, Zentraedi and Invid technology/devices.

A failed roll means the item remains a mystery and can not be used despite the hours, days or weeks of analysis. Of course, the scientist can try again, rerunning the old tests or performing a battery of new ones. The field scientist can try as many times as he may need to figure it out, but each time there is more confusion and frustration (a -5% skill penalty is added for each new try).

**Attribute Requirements:** I.Q. 12. A high M.E. is helpful, but not required.

#### O.C.C. Skills:

Computer Operation (+15%)  
Computer Programming (+10%)  
Medical: Paramedic\* (+10%)  
Mathematics: Basic & Advanced (+10%)  
Pilot Automobile (+5%)  
W.P. Energy Rifle  
Hand to Hand: Basic\*\*

\*Medical: Paramedic can be changed to Medical Doctor, but counts as two "other" skill selections.

\*\*Hand to Hand: Basic can be upgraded to Hand to Hand: Expert, but costs one "other" skill selection, or to martial arts at a cost of two "other" skills.

**Other Skills:** Select 18 other skills. Plus two at level three, two at level six, and two at level twelve. All new skills start at level one proficiency.

Communications: Any (+5%)

Domestic: Any

Electrical: Any (+5%)

Espionage: Land Navigation and Wilderness Survival only.

Mechanical: Any (+5%)

Medical: Any (+10%)

Physical: Any

Pilot: Any conventional or military vehicles; mecha are restricted as previously described.

Pilot Related: Any

Rogue Skills: Any

Science: Any (+15%)

Technical: Any (+10%)

W.P.: Any, except W.P. Gallant and Cyclone Weapon Systems.

Wilderness: Any (+3%)

**Standard Equipment:** Mini-tool pack, specimen pack, portable computer, portable microscope, surgical instruments and gloves, oxygen mask, first-aid kit, wrist radio, extra uniform, overalls, surgical gown, and basic military equipment which includes a Wolverine assault rifle, Sal-9 laser pistol, four extra ammo clips for each, survival knife, flashlight and six signal flares.

**Authorized Clearance Upon Assignment:** Special sensory and lab equipment, portable laboratory, surveillance equipment, video and photo equipment, optical enhancements, and access to full laboratory and medical facilities. Military items include additional weapons, explosives, CVR-3 body armor, land vehicles, aircraft and mecha.

**Monthly Wages:** 2200 credits per month for the enlisted men at levels 1-5, 3000 credits per month for 6th level and higher, while high ranking officers make 3400 to 4600 credits per month.

**Personal Savings:** 4D6 × 100

# THE SENTINEL ALIENS AS PLAYER CHARACTERS

## THE SENTINELS

The Federation of Aliens which calls itself **The Sentinels** are composed of heroes, freedom fighters, and refugees from across the universe. Their one common bond is that their homeworlds have been destroyed or invaded by the Invid. Their joint goal: to free their planets and all other slave worlds from the maniacal Invid. To do this, they believe they must ultimately destroy the Invid Regent (and perhaps the Regis as well). It is a desperate plan for the Invid forces number into the billions, but a plan that the Sentinels valiantly cling to.

It is a special delegation of Sentinel ambassadors and elite troops which encounter the REF at the Robotech Masters' homeworld. The two groups of heroes quickly form an alliance to rid the universe of the Invid threat.

The following are the most notable alien races who join the REF in their campaign against the Invid.

## THE BEARMEN OF CARBONARA

The Carbonarite people are hulking masses of fur, fangs, muscles, and claws. Despite their animal, bear-like, appearance they are not related to bears at all, and are a fairly intelligent and gentle, caring people. They lived a peaceful existence in a semi-industrial society that possessed an odd mix of low and high technology. Low technology can be seen by their simple machines and musket-like weapons, and high-tech as in their achievement in interplanetary communications and space travel, albeit extremely crude by Earth standards.

The planet, Carbonara, was rich with an ore that could be used as a source of energy. Unfortunately, the Carbonarites became dependent on the ore as their sole form of energy and main commercial commodity. The tragedy came in that using the ore produces an immense amount of pollution. Filth and soot that still clogs the skies of Carbonara. This polluting aspect made the ore unattractive to otherworldly consumers who were, one by one discovering cleaner alternative forms of energy. Sales of the ore plummeted and the Carbonarite society stagnated. It was near this time that the Robotech Masters arrived with the promise of new technology and a new, totally "clean" energy (protoculture); the Carbonarites accepted it all with open arms. Little did they realize that they would be trading one dependency for another. Nor did they ever dream that the presence of protoculture would one day enslave their planet to invaders from a distant star.

The planet Carbonara was just one of many worlds that fell to the Invid as they made their way across the myriad galaxies reclaiming the precious protoculture/Invid Flower of Life. Those Carbonarites who were not killed or who fled were enslaved. Those who fled joined *the Sentinels* and now fight for the freedom of their world and others like it.

### The Carbonarites as Playing Characters

The bearmen are powerfully built and courageous warriors. They fight with a dedication wrought by a passion to see no life form subjugated to slavery and evil. They tend to prefer hand to hand combat and hand held weapons. They do not personally care for the confines of mecha, but do enjoy fast moving vehicles and space travel. Thus, they make excellent pilots of space and aircraft. Their favorite REF land vehicles are the speedy hover cycle and the roomy MTA Titan.

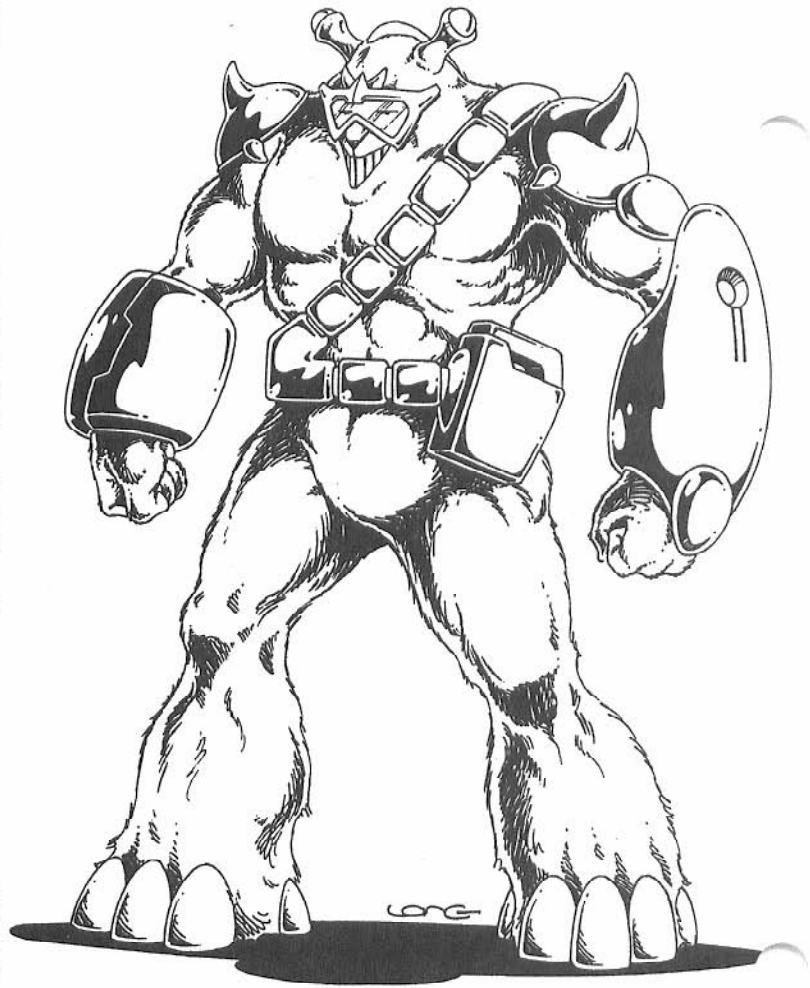

Carbonarites wear a form fitting, fur covered helmet which completely covers their mushroom like horns and face. The darkly tinted goggles protect their light sensitive eyes, and filter the air. A short-range radio is also built into the helmet. The part of this strange headgear that covers the bearmen's huge canine teeth creates an almost cartoon caricature of a giant, friendly teddy bear with a huge exaggerated smile that belies their true ferocity.

### To Create A Carbonarite Alien, Roll on the Following Tables

#### Gender

01-65 Male  
66-00 Female

Or use the gender of choice.

**Alignment:** Any, but tend toward good alignments.

**Height:** 7ft plus 4D6 inches

**Weight:** 200lbs (90kg) plus 3D6 × 10lbs (10lbs = 4.5kg)

**Physical S.D.C.:** 40 plus 1D4 × 10

#### The Eight Attributes:

I.Q. 2D6  
M.E. 3D6  
M.A. 2D6  
P.S. 5D6  
P.P. 3D6  
P.E. 4D6  
P.B. 2D6  
Spd. 3D6

As usual, a roll of 16, 17 or 18 provides a bonus roll of 1D6 (a roll above 18 does not provide a bonus roll). Likewise, a roll of 11 or 12 on a 2D6 also gets a bonus 1D6 roll.

# THE AMAZONS OF PRAXIS

The people from Praxis very much fit the description of Earth's mythical Amazons. Beautiful, athletic, human looking women who tower nearly seven feet tall and who are skilled in combat from an early age. One must wonder if some distant ancestor of the Praxian women could have traveled through space to visit Earth during its prehistoric days, and hence created the Amazonian myth. This is a possibility because the Praxians were once a great civilization, with a super science that easily equaled the Robotech Masters'. A race that had captured gravity and dared to toy with the very building blocks of man. It is clear that they had mastered genetics, cloning and the likes. The perfect women of Praxis and a handful of artifacts attest to this. But then something went seriously awry. Perhaps war, or more likely a genetic mishap or super virus created in a genetics lab. Nobody knows. ALL records of that time are gone and even the myths and legends offer no hint to the cataclysm that destroyed a civilization.

Now, no one knows why many eons later, there are only women on Praxis. The women themselves are genetic anomalies, the obvious result of genetic manipulation. Physically, they are perfect in every way, including the capability for child birth. However, they possess dominant genes, Doctor Lang called them super genes, that tend to crush all other genes with different traits, including the male gender. Consequently, even though a human or Zentraedi male can mate with them and produce natural offspring, the child would almost certainly be female. Only one in every 1000 children born from natural parent couplings will be male.

On Praxis, males have been absent for thousands of years. The women were able to continue to propagate their race by artificial insemination. The sacred "Place of Life" is apparently one of the few remnant of the previous super civilization and it continues to function with automated bliss all these centuries later. It was probably some sort of genetics complex designed to keep the race pure and perfect. Presumably, it never had the capability for producing male infants or that supply was contaminated or destroyed.

It is little wonder then, that the Praxians are very taken by human males. A mixed male and female environment is a new and exciting experience for the Praxians. However, although the women warriors are discovering their sexuality, they also find men to be rather alien.

The Praxians are bold, cocky, and selfreliant. They observe none of the formalities of Earth's ("alien") customs and are the furthest thing from prissy, helpless handmaidens. They are extremely aggressive, outspoken and arrogant. Like the Amazons of myth, they strive to be the very best in everything, especially the arts of combat. This is extremely disturbing to the Zentraedi, especially the male Zentraedi, who seem to feel threatened by these powerful warrior women. The two races seem to be eternally competing with each other and constantly impugn the abilities of the other. Sarcasm, jokes, barbs and intolerance fly when these two get together. Since both partake in these affronts as much as the other, one can only believe it is the macho way two rival warrior races regard each other. To have one acknowledge the other in a more pleasant way might be construed as weakness and/or recognizing them as being superior. Or at least that's Lisa Hayes's theory.

The Praxians wear very little clothing or battle armor, usually a helmet, some chest protection, arm bands and leggings. A shield, dagger, gauntlets, naginata style pole arm and/or crossbow completes the traditional warrior garb. The Praxian society of today is a low technology, hunting/warrior civilization not unlike Earth's ancient Greeks or Romans. The planet's hospitable subtropical environment greatly reduced the need to protect oneself from the environment. Buildings are a mix of ancient ruins, open buildings and monuments to feats of physical excellence and war.

**Note:** Eyes are extremely sensitive to light from centuries of living in a dark, polluted world. **Vision in light** is a mere 30ft (9.1m) without goggles (normal human vision with goggles). **Nightvision** is 80ft (24.4m); can see in the dark like a cat. **Clawed Hands:** Inflict 2D6 S.D.C. plus P.S. bonuses.

**Available REF O.C.C.s** are limited to Communications Engineer or Military Specialist. Otherwise, the character is a . . .

## CARBONARITE WARRIOR

**Attribute Requirements:** None

**O.C.C. Skills:**

Radio: Basic (+10%)

Land Navigation (+5%)

Pilot Space Shuttle (+10%)

W.P. Blunt

W.P. Rifle

W.P. Energy Rifle

W.P. Energy Pistol

Hand to Hand: Basic\*

\*Hand to Hand: Basic can be changed to Expert at a cost of one "other" skill selection.

**Other Skills:** Select 12 other skills, plus two additional at level three, one at level six and one at level twelve. All new skills start at level one proficiency. The Carbonarite's thick fingers and claws make delicate work very difficult.

Communications: Radio: Scramblers and T.V./Video only

Domestic: Any (+10%)

Electrical: Basic Electronics only

Espionage: None

Mechanical: Basic Mechanics only

Medical: First Aid only (+5%)

Physical: Any

Pilot: Any, except Mecha skills (+10%)

Pilot Related: Any (+10%)

Rogue Skills: None

Science: Math only

Technical: Computer Operation and Photography (+5%) and Computer Programming (but -5%) only.

W.P.: Any except Gallant H-90 and Cyclone Weapon Systems.

Wilderness: Any

**Standard Equipment:** Protective body armor, includes helmet, shoulder and arm plates, chest, back and leg plates; energy rifle of choice, energy pistol of choice, 8-10 extra energy clips for each, blunt weapon of choice (staff, club, mace, etc.), 8 to 12 cobalt grenades (loves them), 2 to 6 cobalt limpet mines, 3 signal flares, binoculars, canteen and food rations for two weeks.

**Note:** *The Carbonarite's body armor* has a general main body M.D.C. 75, but the large arm plates are made of a tough, laser resistant alloy, enabling the giant aliens to parry laser blasts (no damage from lasers successfully parried). They can also be used to parry/block other energy blasts, but will take full damage. Each arm shield has 40 M.D.C. The armor is incredibly heavy (200+ lbs) and even a Zentraedi of Breetai's size would have great difficulty using it.

**Authorized Clearance Upon Assignment:** As allies, the REF will make available additional weapons (the bearmen love grenade and missile launchers), ammunition, explosives, vehicles and their assistance.

**Monthly Wages:** Sentinels are on a moral crusade and do not accumulate wealth. Those who may join the REF will receive the same payment as the Cyclone Rider.



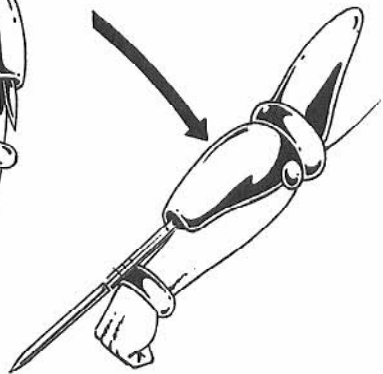
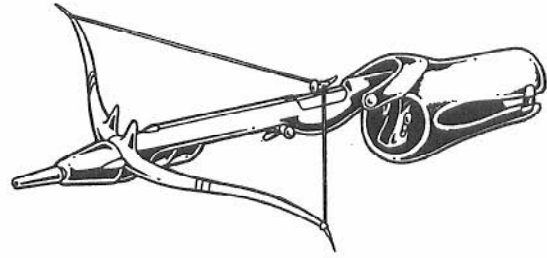
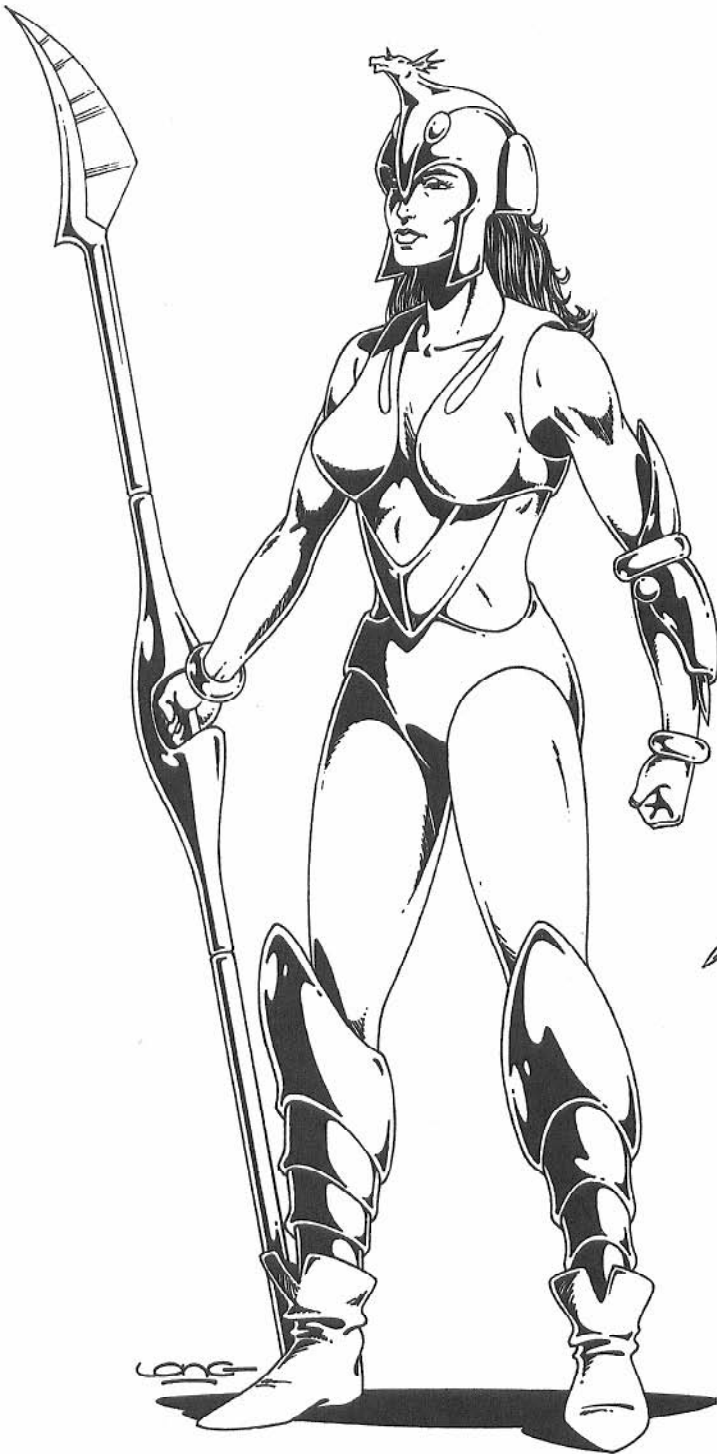

when infiltrating a Hive base. Their skill at stealth and resistance to using protoculture powered devices makes them almost invisible to the invid, enabling them to carry out sabotage and lead guerilla combat-style assaults.

**To Create a Praxian Alien Roll on the Following Tables . . .**

**Gender:** Female only!

**Alignment:** Any

**Height:** 6ft + 4D4 inches

**Weight:** 110lbs + 1D6 × 10lbs

**Physical S.D.C.:** 40 + 4D6

**The Eight Attributes:**

I.Q. 3D6

M.E. 3D6

M.A. 2D6

P.S. 4D6

P.P. 4D6

P.E. 4D6

P.B. 5D6

Spd. 4D6

As usual, a roll of 16, 17 or 18 provides a bonus roll of 1D6. A roll above 18 from 4D6 or 5D6 does not provide a bonus roll.

**Available R.E.F. O.C.C.s** are limited to Cyclone Rider or Military Specialist (but can not fly an Alpha). Otherwise, the character is a . . .

### PRAXIAN WARRIOR

**Attribute Requirements:** None

**O.C.C. Skills:**

Escape Artist ) + 15%

Detect Ambush (+ 5%)

Detect Concealment (+ 5%)

Warriors, in the ancient sense of hand to hand combat, the Praxians admire the power of mecha and the marvels of high technology, but still prefer to engage the enemy face to face and hand to hand. Consequently, they have remained resistant to the use of mecha, energy weapons, and assault vehicles. Much of this is a sense of heritage and values passed down for hundreds of generations.

However, the Praxians are not techno-phobic and have expressed great excitement over the *VR-041 Saber Cyclone* (specifically in battloid mode with CADS-1) and love to use the *mecha Pegasus* developed by Doctor Lang especially for them. The Praxians have also adopted the Wolverine assault rifle as the high-tech weapon of choice. Cobalt grenades and cobalt limpet mines have also won a place in their hearts.

The REF has found that the Praxians make *superb scouts* and it now uses them for reconnaissance, spying, sabotage, infiltration and other covert operations. They can be especially effective against the invid

Tracking (+10%)  
 Wilderness Survival (+20%)  
 Prowl (+15%)  
 Climbing (+10%)  
 Swimming (+20%)  
 Horsemanship (+12%)  
 W.P. Knife  
 W.P. Staff  
 Hand to Hand: Martial Arts

**Other Skills:** Select 12 other skills, plus two additional at level three, one at level five, one at level seven and one at level eleven.

Communications: Radio: Basic only

Domestic: Any (+5%)

Electrical: Basic electronics only

Espionage: Any (+10%)

Mechanical: Basic Mechanics only

Medical: First Aid or Paramedic

Physical: Any

Pilot: Conventional land vehicles (although it's not likely that a Praxian would learn to pilot more than one vehicle) and cyclone/cyclone combat (VR-041 Saber Cyclone) only.

Pilot Related Skills: None

Rogue Skills: Any (+10%)

Science: Math only

Technical: Computer operation and the two demolition skills only.

W.P.: Any, but tend toward ancient and rifles.

Wilderness: Any (15%)

**Standard Equipment:** Praxian body armor (15 M.D.C.), naginata style pole arm (does 1D8 S.D.C.), crossbow with explosive arrowheads (types include: light explosive — 1D4 M.D., high explosive — 2D4 M.D., or smoke, or conventional — 2D6 S.D.C.), shield (15 M.D.C.), canteen, food rations for two weeks, and 2 dagger arm bands (conceal a retractable blade; inflicts 1D6 S.D.C.).

Allies working with the REF may also have a Wolverine assault rifle with 6 extra ammo clips, and 24 grenades (for the Wolverine), 1D6 cobalt grenades, 2D4 cobalt limpet mines, binoculars, optical enhancement for the rifle, grappling hook and 100ft of rope, flashlight, a wrist radio and a Pegasus mecha unit.

**Authorized Clearance Upon Assignment:** As allies, the REF will make available additional weapons, explosives, ammunition, radio equipment, vehicles, the VR-041 Saber Cyclone and their assistance.

**Monthly Wages:** The Sentinels are on a moral crusade and do not accumulate wealth. The Praxians desire only fame and glory and to free their homeworld from Invid oppression. Those who may join the REF will be considered military specialist O.C.C. and receive the same amount of pay.

## RAT-1 PEGASUS RECONNAISSANCE ALL-TERRAIN MECHA UNIT

The RAT-1 Pegasus is an all-terrain reconnaissance mecha developed by Doctor Emile Lang specifically for the Praxians. The warriors seemed so enamored with the concept of a flying horse and so resistant to conventional mecha that Dr. Lang decided to create a mecha unit that resembled a horse, a flying horse. His ploy worked because the Praxians went wild for it!

The horse incorporates one of the Praxians' only other existing artifacts from their past, antigravity modules. The mechanism is really quite simple, a mechanical horse that moves like a real horse. A simple computer intelligence enables the rider to give simple verbal commands like: stop, go, run, faster, turn left, turn right, fly, et cetera. The most difficult element was incorporating the alien antigravity modules to give it flight capabilities. Once that was accomplished, the rest just fell into place.

The antigravity unit is also a separate spy device that can rise up, out of the horse's back, wings and all, and fly ahead to reconnoiter. The spy unit has two roving eye cameras that can record what they see and/or transmit the images to a hand held monitor or communications

RAT-1 PEGASUS

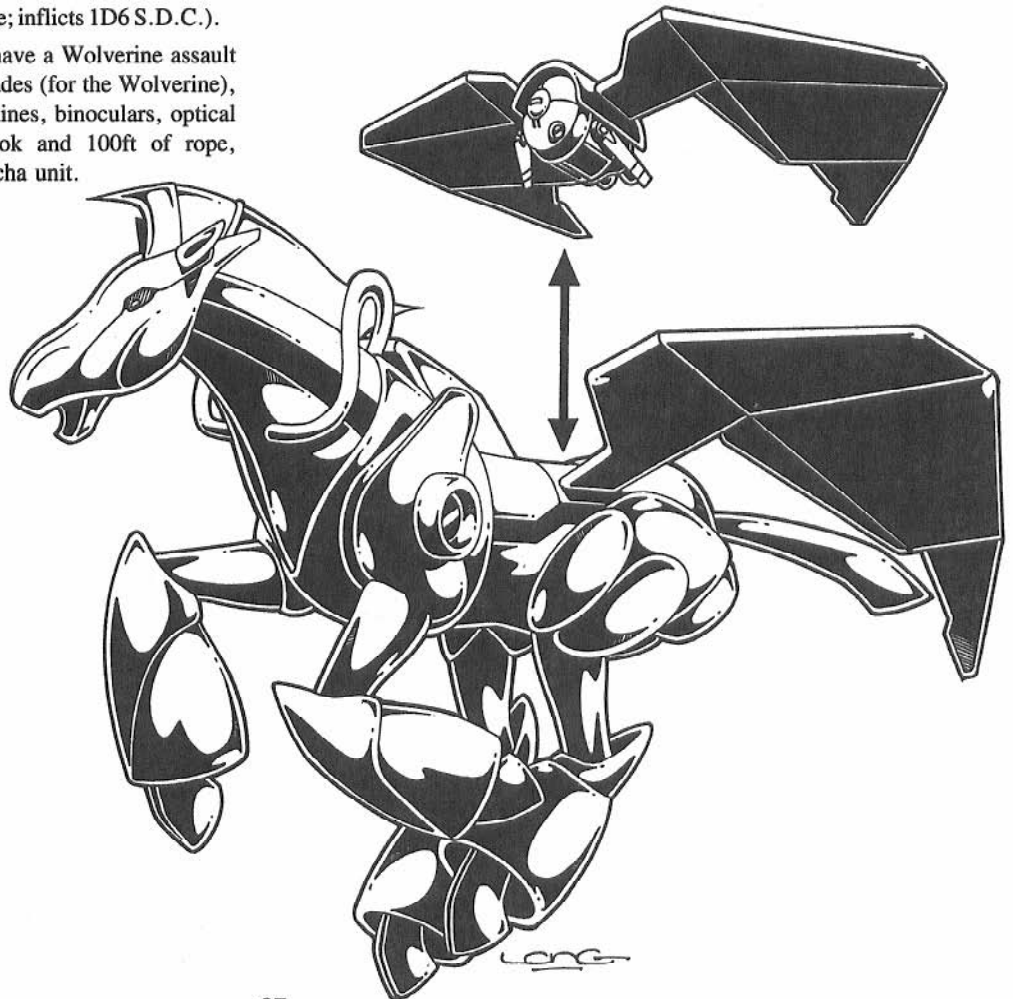

network. Range of the camera eye, with telescopic and infrared optics, is 1600ft (488m). Range of the transmission is 10 miles (16km). It can also record and transmit sound 10 miles.

Its other sensory abilities include the detection and measuring of radiation, and temperature and it monitors its speed, altitude, direction, and the number of miles it has travelled.

#### RAT-1 PEGASUS

**Class:** Destroid; experimental robot unit

**Crew:** One rider, but a second person can also be accommodated.

**M.D.C. by Location:**

\*Head — 75

Legs (4) — 50 each

Wings (2) — 50 each

Spy Unit (1) — 50

\*\*Main Body — 200

\*Depleting the M.D.C. of the head will destroy the robot's optics; all bonuses are lost and speed is reduced by 10%.

\*\*Depleting the M.D.C. of the main body will completely destroy the mechanical horse, but the spy unit may continue to function.

**Speed:** Running: 60mph (96kmph)

**Leaping:** 50ft (15.2m) across or 30ft (9.1m) high.

**Flying:** Flight is by antigravity and hidden directional air jets. Speed is a comparatively slow 40mph (64kmph). However, the device can hover completely stationary and there is no limit to its operating altitude.

**Space Propulsion:** The Pegasus functions equally well in space, but can still only muster a maximum speed of about 70mph (112kmph). Of course, the rider must wear a spacesuit or protective armor.

**Note:** The wings have absolutely nothing to do with flight. They are for show and for the protection of the rider (they fold up to 'box' the rider in on both sides when under attack). The RAT-1 Pegasus will fly perfectly even if the wings are completely destroyed.

However, if one leg is destroyed, running speed is reduced by 20%. If two or more legs are destroyed the mecha can travel only via antigravity flight.

**Height:** 6ft (1.8m) at shoulders

**Width:** 4ft (1.2m) at shoulders

**Length:** 8ft (2.4m)

**Weight:** 1.8 tons

**Cargo:** Can carry up to 1.5 tons.

**Weapon Systems:** Hand to Hand only.

1. **Hand to Hand Combat** is limited to kicks and stomps, in addition to the rider's attacks.

**Damage:** Kick with front legs — 1D4 M.D.

Kick with rear legs — 2D4 M.D.

Stomp with foot — 1D4 × 10 S.D.C.

Ram — 1D4 × 10 S.D.C.

**Bonuses:** +2 to strike, +3 to dodge.

**Note:** The horse is powered by four *protoculture cells* with an approximate life of one year. The flight capabilities and the spy unit do not use protoculture, just the Praxian antigravity device and conventional mechanics. Consequently, the spy unit can not be detected by protoculture sensors, nor can the whole horse unit if shut down while flying (propelled by the antigravity device).

The pegasus and spy unit can communicate vocally and via radio, but they can not formulate ideas or make suggestions, only report data and respond to commands.

Any character with horsemanship skill can ride the RAT-1 Pegasus, although it is usually reserved for Praxians.

## THE CAT PEOPLE OF GARUDA

The Garudans have been described as cat-like or fox-like. Either description fits these sleek, fur covered aliens with long, fluffy tails and quick movements. Unlike the bulky Carbonarites, the Garudans are human size, slender and move with the speed and agility of a panther. However, they are not natural predators, but a sleepy, relaxed people who have special rapport with their environment. They attribute this to what they call "Hin," their dream state; a sort of psychic or mystical union with nature and psychic forces which seems to be analogous to the "Dream Time" of the Australian aborigines of old Earth.

Whatever the cause of this "Hin" dream state, whether it be an innate psi-ability or a result of chemicals in the atmosphere of Garuda, the cat people are definitely gifted with phenomenal insight. They can "feel" danger and glimpse the "possible future," in addition to other psychic sensitive abilities.

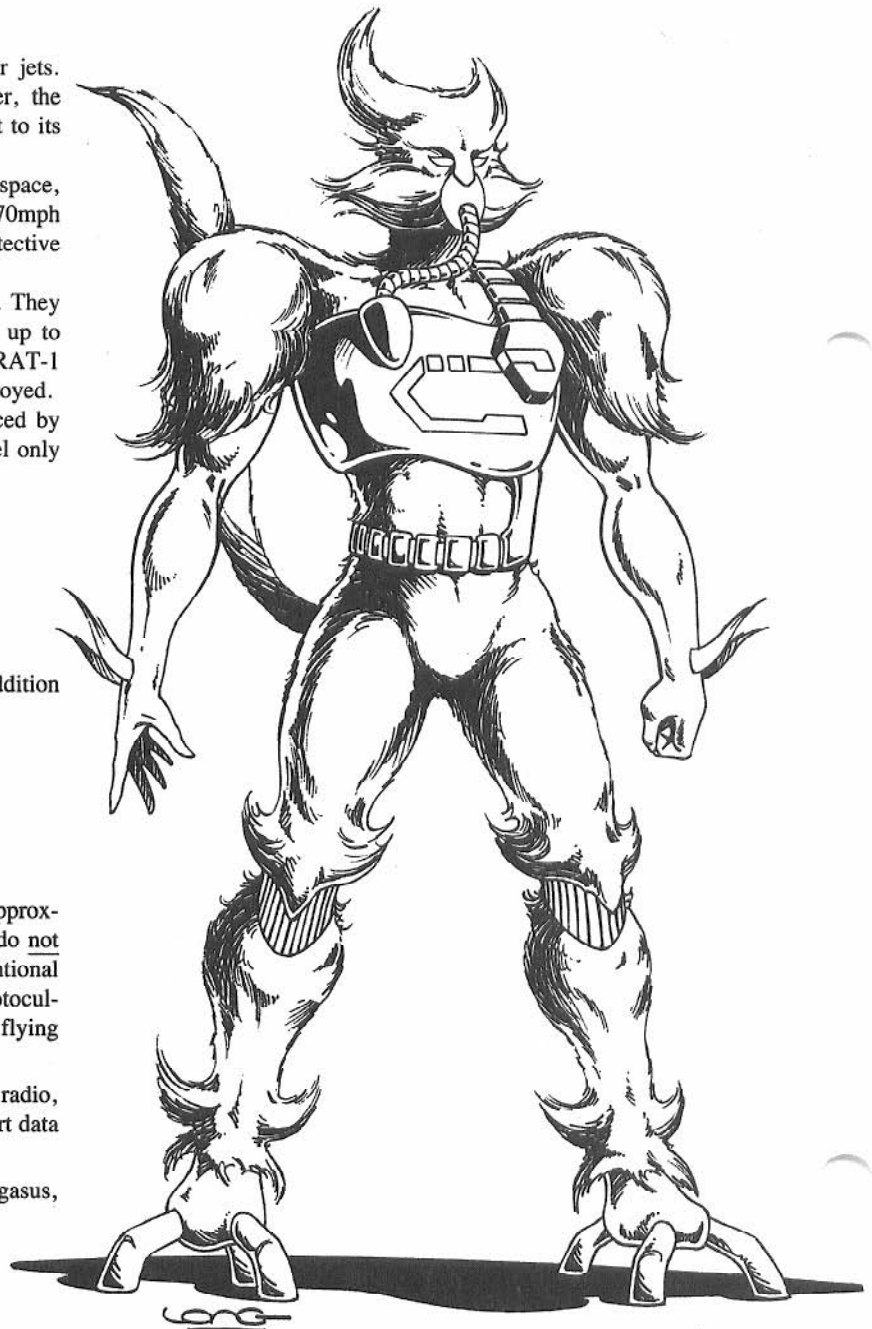



Unfortunately, the Garudans need to breathe their own air, and must live in a specially prepared environment if off-planet or wear air tanks. The Garudans have developed a special air tank system that can purify and mix the air of many worlds (especially oxygen, nitrogen and carbon dioxide based atmospheres) with elements of their own air to create a breathable air. The air of the Garudans can be breathed by humans, but will cause a heavy, labored breathing and some discomfort. Prolonged exposure will cause death.

The cat people come from a medium technology level world about equal to Earth 1950s, but have quickly adapted to high technology. Unlike the Praxians, the Garudans are anxious to use mecha, energy weapons, spacecraft and most marvels of technology. They are extremely intelligent and learn quickly. Likewise, the peaceful, idle cat people have adapted to combat with equal ease. Although they loathe war and aggression, they realize that they face an enemy who knows no compassion. If the enemy must be destroyed completely, so be it. And the Garudans will go forth to do so as efficiently as possible and with firm resolve.

## THE GARUDANS' PSI POWERS

Every time a psionic power is used it draws upon the astral body or *inner strength* of the individual. Each specific psionic power will indicate exactly how many Inner Strength Points (I.S.P.) are required to perform that ability. When a Garudan has exhausted all of his I.S.P. he is unable to perform any more psionic feats until he has had sufficient rest.

**Determining I.S.P.** is simple. A Garudan's base I.S.P. is his Mental Endurance (M.E.) $\times$ 2, plus the roll of one eight-sided die. As the character grows in experience his/her I.S.P. increases at a rate of 10 per each additional level of experience.

**The recovery of I.S.P.** can be done in one of two ways: 1) *Total relaxation and/or sleep* at a rate of 2 I.S.P. for every hour. 2) *Meditation* is an automatic skill ability in which the psionic places himself in a simple trance, providing superior relaxation and a peaceful joining of the "dream state." Meditation recovers 4 I.S.P. per hour.

**Saving throws against psionic attacks:** Psionic combat works similarly to hand to hand combat. The intended victim must roll a twenty-sided die to make a mental parry against the mind assault or probe. A human or non-psionic must roll a 15 or higher, but Garudans need only to roll a 12 or higher. Superior psionic beings need to roll a mere 10 or higher. The regent and regis are superior psi beings. A high roll will successfully save against the mental assault, meaning the attack is foiled (no damage nor effects). **Attacks Per melee:** Psionics can be used up to three times per melee unless there is a time restriction.

Garudan males have *no* psionic attacks. Their psi-abilities fall into the category of psychic sensitive: power that instills an unnatural awareness and sensitivity about their environment and the beings around them. *The female Garudans* possess completely different psionic powers. Powers that can be used as a means of attack and manipulation. Fortunately, most Garudans are normally passive and make it a policy to not use their powers against friends and allies. Of course, enemies are a completely different story.

The exception to this rule is a *female rogue!* Garudans have a natural compulsion to mate. Once mated the couple will stay together for life and a strange psychic bond is established between the two. If one should die the other will know it, even if separated by light years. The death of a female mate will cause the male to become somewhat more lethargic and melancholy. He will tend to become a loner and will often immerse himself in study and exploration.

The change in the female is much more dramatic. She will become aggressive and domineering, turning into the predatory animal they so resemble. On Garuda, a rogue female is said to be "imbalanced" and is cast from the tribe. She will instinctively become a tough hunter, completely self-reliant and deadly. Hot-tempered and competitive, the

rogue will use her psi-powers without hesitation against friend, foe, or momentary antagonist. They are not irrational or cruel, just terribly aggressive, bold, and action oriented (very daring, almost to the point of recklessness). **Note:** Characters of a good alignment must change their alignment to unprincipled or anarchist.

## MALE GARUDAN PSI POWERS

Clairvoyance — Cost: 10 I.S.P.

Mind Block — Cost: 4 I.S.P.

Presence Sense — Cost: 5 I.S.P.

Sixth Sense — Cost: 2 I.S.P.

Speed Reading — Cost: 5 I.S.P.

### Clairvoyance

**Range:** Self, although the image could pertain to people or places thousands of miles away.

**Duration:** 6D6 Melees

**I.S.P.:** 10

**Base Skill:** 58% + 2% per level of experience.

This allows the psychic to see or feel glimpses of the possible future. This is achieved through meditation or intense concentration in which the clairvoyant thinks about a particular person, event or place. Add +5% to the base skill if the person involved is a friend or loved one. Clairvoyance is unpredictable and can not be turned on and off like a light bulb. Sometimes it works (if the roll is under the base skill) and sometimes it does not (when the roll is above the base skill). A failed roll means the psychic received no insight to the future.

A clairvoyant trance can be attempted as often as *twice every day*. The message can be a sudden feeling that somebody is in need ("... something's wrong. It's... it's... Janet! I've got to see her!") or, more often, a sudden flash of insight, a sudden image that races through the mind. The image is like a snippet of film from a movie or a dream. Often all the details are not clear, but the potential danger is. For example, "The psychic character is in a trance or meditation, thinking about his/her friend Janet. Suddenly, the mind is flooded with an image of Janet rushing down a crowded street. It's dusky, like morning, twilight or evening. She seems very upset. The traffic light changes to amber. Janet races into the street, ignoring the light. It turns red. There's a car, squeal of tires, Janet screams. The image ends. Is Janet hurt? Killed? Unknown, but the danger is clear. There are also other hints of information: the time of day, Janet seeming upset, rushing, etc. The glimpse into the future could be twenty minutes, eight hours, 24 hours, or a week. The psychic has no way of knowing. Of course, he has the advantage of recognizing the potential danger as it begins to unfold and may be able to avoid it, stop it or change the outcome. The image may last a few minutes or be a sudden flash lasting but a few seconds. The flash could be a peculiar noise, a face, or a specific image, like a particular door or object.

It is important to note that sometimes a clairvoyant image will occur unintentionally, without the psychic trying to do so. These most often manifest themselves as dreams or nightmares during sleep. The clairvoyant dream is exactly like the image from a meditative trance described previously. The precognitive flash of the future may also occur unbeckoned while awake, but this is extremely rare. These brief glimpses of the possible future happen because the clairvoyant is acutely attuned to his world. Anything that might hurt or change that world (including people and places) will often be foretold in a flash of insight.

**Game Masters:** Be careful of revealing too much. Use the examples provided as a guide. Remember, these are brief glimpses of the possible future, not a motion picture. The psychic can NOT engage in any actions, combat or otherwise, during a moment of clairvoyance or the image will instantly stop. It usually requires 2D4 melees of concentration or meditation before the image occurs. Remember, a failed base skill roll means absolutely nothing happens, but still burns up the 4 I.S.P. and time.

## Mind Block

**Range:** Self

**Duration:** 10 minutes per level of experience.

**I.S.P.:** 4 (per each duration period)

This is the ability to completely close or block oneself from all psychic/mental emanations. When intentionally closed to the psionic forces the character can not sense anything, can not use psychic abilities, nor be influenced by others. A mind block will prevent penetration of telepathy, empathy, hypnotic suggestion, and empathic transfer. It can be an invaluable protective mask when dealing with malevolent psychic forces. Adds a bonus of +1 to save vs all psychic and mental attacks.

## Presence Sense

**Range:** 120ft/36m area

**Duration:** 2 minutes (8 melees) per level of experience.

**I.S.P.:** 5

**Saving Throw:** None

Presence sense is a sixth sense which will alert the character to the presence of other creatures in the area. The ability can not pinpoint the location of the presence, but will give the character the impression of whether it is near (within 50ft/15.2m) or far (beyond 90ft/27.4m). It will also give the character a vague idea of how many presences there are; one (1 or 2), a few (3 to 6), several (7 to 14), or many (15 or more).

## Sixth Sense

**Range:** 90ft/27.4m

**Duration:** Until the danger passes or happens.

**I.S.P.:** 2

**Savings Throw:** None

The sixth sense is a power that gives the psionic character a precognitive flash of imminent danger to himself or somebody near him (within 90ft). The character will not know what the danger is or where it will come from, nor who it will be directed at when in a group. All he will know is that something life threatening will happen within the next 60 seconds (4 melees)! The sixth sense is triggered *automatically*, without the consent of the psychic, whenever his life is in great peril or the life of somebody he greatly cares about (friend, loved one, etc.). The sixth sense is only triggered by an *unexpected, life threatening* event which is already set into motion and will happen any second. The power *can not* be called upon at will to sense for traps or ambush. Instead, it works like an automatic reflex. If the character has used all his I.S.P., the sixth sense is temporarily rendered inoperative.

### Bonuses:

The sudden flash of insight provides the following bonuses. All bonuses apply only to the initial *melee* when the attack occurs.

+6 on initiative roll

+2 to parry

+3 to dodge

The character can not be surprised by a sneak attack from behind.

## Speed Reading

**Range:** Self

**Duration:** 3 minutes per level of experience.

**I.S.P.:** 5

This is the ability to read and comprehend the written word extremely quickly. Speed of reading is 30 pages per minute/4 melees. The psychic will retain the information as he would normally. Highly technical texts will reduce the speed reading by half (15 pages per minute) and may require two readings.

## FEMALE GARUDAN PSI POWERS

Empathic Transmission — Cost: 8 I.S.P.

Mind Bolt — Cost: 4 or 30 I.S.P. See the Invisible — Cost: 4 I.S.P.

Suggestion — Cost: 4 I.S.P.

## Empathic Transmission

**Range:** 60ft (18.2m)

**Duration:** 2D6 minutes (2 to 12 minutes)

**I.S.P.:** 8

**Attacks Per Melee:** Two maximum

**Saving Throw:** Standard

This incredible ability enables the Garudan to instill a powerful emotion into another living creature; person, animal or supernatural being. Each psychic attack/transmission can only affect one creature at a time.

**Despair or Sorrow:** Invokes great emotional upheaval, deep sorrow and a sense of loss. There is a 50% chance of the victim surrendering or leaving without a battle; furthermore, victims are -2 to parry and dodge.

**Confusion:** Disorients the person so badly that he has no sense of direction, time, or of what is exactly going on. Victims are -3 to strike, parry and dodge, and lose initiative in any combat.

**Fear:** Invokes unreasoning terror in all those affected. Victims are -3 to strike, parry and dodge, plus there is a 66% chance that those affected will turn and run.

**Hate or Anger:** Will prompt those affected to act rashly, charge, attack, argue violently, etc. Victims are likely (60% chance) to attack, kill, harm, or betray those they dislike; +1 (yes, that's plus) to strike, -1 to parry and dodge.

**Love or Peacefulness:** Will induce a deep feeling of serenity, dispelling anger, hatred, sorrow, and so on. Hostile opponents are likely (60% chance) to reconsider their actions, deciding not to attack, show mercy, leave without being overtly cruel or destructive, halt a rampage, and so on. It does NOT make its victims docile sheep, but curbs hostility.

## Mind Bolt

**Range:** 90ft (27.4m)

**Duration:** Instant

**I.S.P.:** 4 or 30

**Attacks Per Melee:** Two

**Saving Throw:** Dodge only

The psionic is able to tap into electromagnetic forces and hurl an energy bolt. The target must be within the character's line of vision.

**Damage:** 2D6 S.D.C. (costs 4 I.S.P.)

2D6 M.D. (costs 30 I.S.P.)

**Strike Bonus:** +4

## See The Invisible

**Range:** 120ft/36m, line of vision.

**Duration:** 1 minute per each level of experience.

**I.S.P.:** 4

**Saving Throw:** None

The character can see forces, objects and creatures which can turn invisible or are naturally invisible. Even if the creatures have no form per se, the psychic will be able to discern the vaporous image or energy sphere which is the being. This includes ghosts, entities and the astral body.

## Suggestion (Hypnosis)

**Range:** 12ft/3.6m, with eye contact.

**Duration:** Varies with each circumstance and subject; rarely more than a few hours maximum.

**I.S.P.:** 4 per idea or attempt to implant an idea.

**Saving Throw:** Standard

The power is limited to relaxing/calming somebody down, putting a person or animal in a light sleep, helping a person to relax and focus on a particular thought (good for helping someone to remember things)

and implanting subtle ideas. The implanting or "suggestion" of an idea must be subtly worked into a comment. The suggestion must be kept simple and clear, such as "You know you can *trust* me" or "You feel like you *have a fever*. Yes, you do have a *fever*. You're burning up (with *fever*). You should *lie down*." or "You don't want to go there." The power of suggestion can also be used to make the victim imagine sounds and images. "Did you hear that? Listen! *Footsteps!* You hear the *footsteps* . . . yes, you do!" Or, "At *midnight the spectre appears*. Everybody who is ever present *sees the spectre at midnight*." The poor individual who fails his saving throw will indeed imagine he sees something at midnight.

The power of suggestion can *not* make a person think he's a chicken, nor does it turn a person into the psionic's charmed zombie slave that obeys his every command. It simply soothes or implants a notion into someone's thoughts. Sometimes that little bit can be an important edge.

**Note:** A successful save against a suggestion means the idea is not implanted. The psychic may try again (at the cost of another 2 I.S.P.).

#### To Create a Garudan Alien Roll on the Following Tables . . .

**Gender:** 01-50 Male  
51-00 Female

**Alignment:** Any, but usually good or selfish.

**Height:** 6ft + 1D6 inches

**Weight:** 110lbs + 1D6 × 10lbs

**Physical S.D.C.:** 20 + 3D6

#### The Eight Attributes:

I.Q. 4D6

M.E. 4D6

M.A. 3D6

P.S. 3D6

P.P. 3D6

P.E. 3D6

P.B. 3D6

Spd. 4D6

As usual, a roll of 16, 17 or 18 provides a bonus roll of 1D6. A roll above 18 from 4D6 does not provide a bonus roll.

**Available REF O.C.C.s** include Veritech Pilot, Destroid Pilot, Cyclone Rider, Military Specialist or Communications.

Otherwise, the character is a . . .

#### GARUDAN WARRIOR

**Attribute Requirements:** None

#### O.C.C. Skills:

Paramedic (+ 10%)

Radio: Basic (+ 10%)

Climbing (+ 10%)

W.P. Energy Rifle

W.P. Energy Pistol

Hand to Hand: Basic\*

\*Hand to Hand: Basic can be upgraded to Expert, but costs two "other" skill selections.

**Other Skills:** Select 18 other skills, plus two at level three, two at level six and two at level ten.

Communications: Any (+ 5%)

Domestic: Any (+ 15%)

Electrical: Basic Electronics or Electrical Engineer (+ 5%, but counts as two skill selections).

Espionage: Forgery, Intelligence, Interrogation, Land Navigation, and Wilderness Survival only (+ 10%).

Mechanical: Basic, automotive or locksmith only or Mechanical Engineer (+ 5%, but counts as three skill selections).

Medical: Criminal Sciences and Pathology (+ 5%) or Medical Doctor (+ 5%, but counts as three skill selections).

Physical: Any except Martial Arts and Boxing.

Pilot: Any, except mecha which is restricted to REF O.C.C.s. (+ 5%)

Pilot Related: Any

Rogue Skills: None for males and mated females; however, *rogue females* may select any (+ 10%).

Science: Any except Astrophysics

Technical: Any

W.P.: Any except Cyclone Weapon Systems and the Gallant H-90.

Wilderness Skills: Any

**Standard Equipment:** Air tank and filter, Garudan body armor (chest plate, shoulder guards and thigh plates: 30 M.D.C. total), energy rifle of choice, sidearm (pistol) of choice, utility belt, and back-pack.

Allies working with the REF may also have 4 to 6 cobalt grenades, 2 to 6 cobalt limpet mines, additional energy weapon and ammunition, a CVR-3 body armor, wrist radio, a conventional vehicle (usually a dune buggy, land rover, motorcycle or hover cycle; the latter is a Garudan favorite) and other common combat items.

**Authorized Clearance Upon Assignment:** As allies, the REF will make available additional weapons, explosives, ammunition, tools, communication equipment, optical enhancements, vehicles and their assistance.

**Monthly Wages:** The Sentinels are on a moral crusade and do not accumulate wealth (a rogue female may hoard valuables). Those who join the REF will receive the same amount of credits as their human counterparts in that O.C.C. A Garudan warrior receives the same as a Cyclone Rider.

## THE STONE MEN OF SPHERIS

Perhaps the most unusual aliens encountered by the crew of the SDF-3 are the crystal/stone Spherians. These strange beings are actually creatures of energy and crystal formed out of their homeworld. At birth a roughly human size humanoid is pushed out of the planet's rocky surface like a child from its mother's womb. The newborn Spherian is immediately conscious and fully matured. Knowledge of Spherian culture, science, and life is already instilled, making the being ready to begin its life among others of its kind.

Although asexual (the Spherians have no apparent means of reproduction), the Spherians assume male and female shapes when they sculpt their craggy crystal bodies into the smooth, glassy bodies familiar to most off-worlders. The sculpting occurs immediately after birth. The shaping, whether male or female, seems to come instinctively, without any conscious thought on the part of the Spherian newborn. How or why this occurs is as much a mystery as the Spherians themselves. Despite their racial memory, instilled knowledge and intelligence, they know virtually nothing about themselves or their planet. Nor are they curious about it. The stonemen's philosophy of life is: "We exist, what matter how it is we come into being?" They simply do not question their origins, nor any other aspect of their existence.

Although their appearance is that of a solid, crystalline humanoid, they are actually energy beings who live inside such bodies. As energy beings they draw their sole nourishment from light energy. They can also repair and regenerate the limbs of their crystal bodies. Remember, the bodies are physical encasements that contain the true energy essence inside them. The humanoid body functions as a means of movement, protection, and to work with other humanoid life forms (Dr. Lang has suggested that the Spherians may have evolved from humanoid life and the crystalline human shape is an aspect of that distant past.) Con-



sequently, Spherians can have a limb or limbs blown off and feel no pain. Even the head can be decapitated without the slightest discomfort, because it is only a cosmetic ornamentation, like a hat. A Spherian can suffer only from lack of nourishment (light) or if its entire body is destroyed.

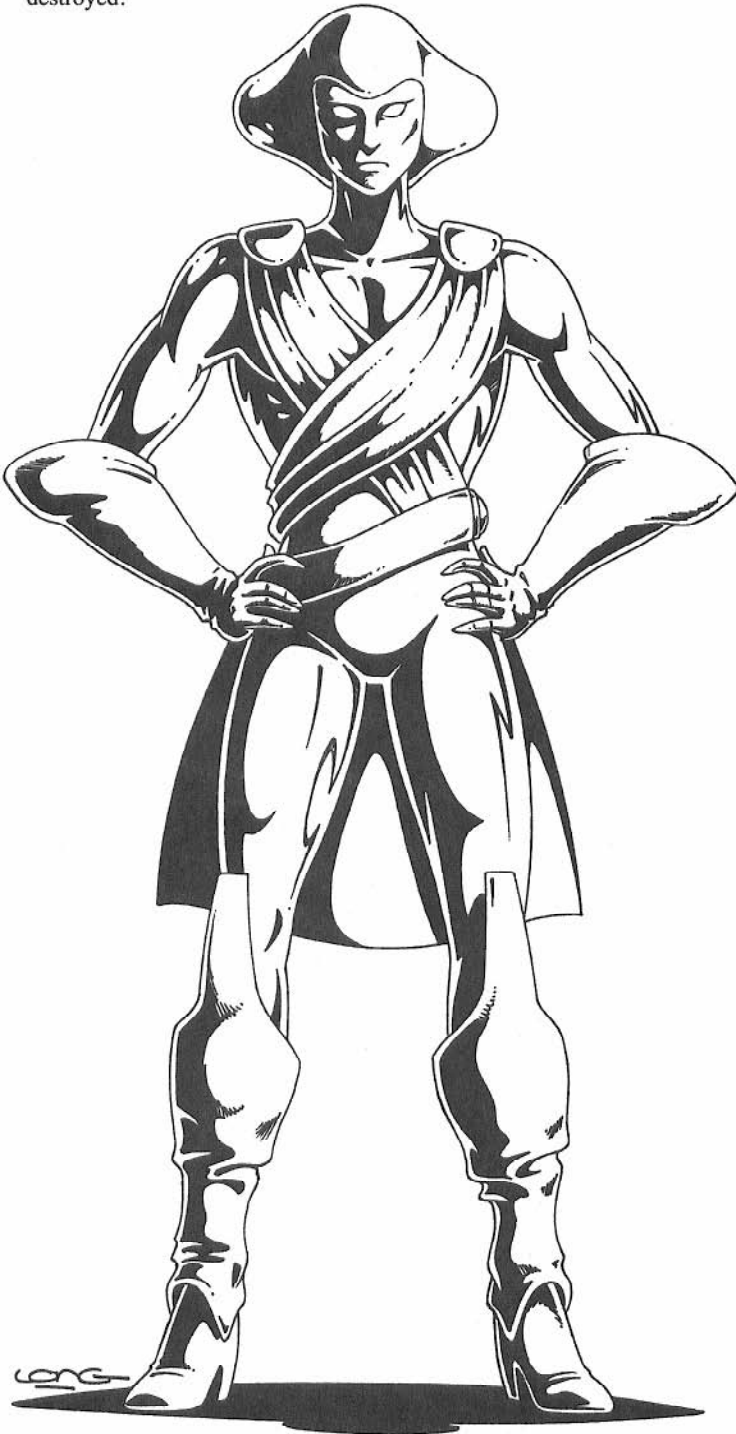

When a body part is destroyed, the energy being can completely regenerate a new one in just a few hours. To do this, the Spherian must slip into a deep trance and be bathed in a full spectrum of light for the entire regeneration period. The regeneration period is also used to repair minor damage to the body's trunk and limbs. If the trunk of the body is destroyed (that's the chest and torso), the energy being can be destroyed! Its only chance to survive is to flee its body by merging with natural crystal stone, such as quartz. As long as there is crystal of some kind within 1200ft (366m), the Spherian can live (even underground) and regenerate an entirely new body. However, without crystal to contain it, the Spherian energy is disrupted and dies.

Lack of light will slowly kill a Spherian by starvation. A starving Spherian will become sluggish, less alert and easily disoriented. Its physical body will become visibly brittle and parts, like ears and fingers, will break off. A malnourished Spherian loses all regenerative powers. Like a living solar battery, the Spherian must have light! Artificial light is satisfactory and will keep the energy being alive and healthy for months. However, natural light is the most healthy.

A Spherian will never fatigue as long as it is exposed to light. Only being deprived of light can affect it. No or insufficient light (too dim, very cloudy/overcast day) for more than three days will cause an obvious weakness; reduce speed by 10%, -1 on initiative, -5% on all skills. No light for another three days will see the speed reduced to half, -2 on initiative, and -10% on all skills. Two weeks (14 days) of light deprivation will reduce speed to 20%, -5 on initiative, -3 to strike, parry, and dodge, and -40% on all skills; the body is brittle, small parts begin to fall off and all regenerative powers are gone. An additional 4 weeks (28 days) of no light will *kill* the alien. **Exposure to intense natural light will restore** the Spherian to full strength within 2D4 hours. (1D4 days of continuous exposure to artificial light will have the same effect).

The Spherian people, as a whole, avoid prolonged contact with other races and rarely involve themselves in the affairs of others. Those who have joined the Sentinels are rare exceptions. These few hundred creatures can no longer ignore the Invid threat to their world and surrounding galaxies. Over the years they have grown to enjoy the company of mammals and the thrill of adventure. The aloofness common among the Spherians has been replaced with sharp emotions, desires, and self-identity. These stone men are destined to be the restless explorers and adventurers of their race. Their place now belongs in the light of the stars.

#### To Create a Spherian Alien, Roll on the Following Tables . . .

**Gender Appearance:** 01-50 Male  
51-00 Female

**Alignment:** Any, but often unprincipled, anarchist or miscreant.

**Height:** 5ft + 4D6 inches

**Weight:** 200lbs + 4D4 × 10lbs

**Physical S.D.C.:** Special M.D.C. crystal body.

#### M.D.C. by Location:

Head — 50

Arms (2) — 50 each

Legs (2) — 100 each

Main Body — 220

*Note:* All Spherians are *impervious* to lasers.

#### The Eight Attributes:

(Physical and Mental equivalents to humans)

I.Q. 3D6 + 1

M.E. 4D6

M.A. 2D6

P.S. 4D6

P.P. 3D6 + 1

P.E. not applicable

P.B. 2D6

Spd. 3D6 + 2

Do not roll bonus dice as normally done.

**Available REF O.C.C.s:** Destroid Pilot, Cyclone Rider or Communications Engineer.

**Otherwise, the Character is a . . .**

#### SPHERIAN ADVENTURER

**Attribute Requirements:** None

**O.C.C. Skills:**

Math: Basic & Advanced (+5%)

Computer Operation (+5%)

Radio: Basic (+10%)

Laser Communications (+15%)  
Electrical Engineer (+15%)  
Navigation: Air, Land, Water (+15%)  
Navigation: Space (+15%)  
Hand to Hand: Basic\*  
W.P. Energy Pistol

\*Hand to Hand: Basic can be upgraded to Expert, but costs two "other" skill selections.

**Other Skills:** Select 10 other skills, plus one at level three, two at level six, and one at level eleven.

Communications: Any  
Domestic: None  
Electrical: Any (+5%)  
Espionage: None  
Mechanical: Any, but is -10% on each.  
Medical: Any, but is -10% on each.  
Physical: Climbing, Fencing, Gymnastics, and Prowl only.  
Pilot: Any except Mecha skills (mecha skills are restricted to REF O.C.C.s).  
Pilot Related: Any  
Rogue Skills: Any, but is -5%.  
Science: Any, but is -5%.  
Technical: Any (+5%)  
W.P.: Any, except Cyclone Weapon Systems.  
Wilderness: Any, but is -5%.

**Note:** The Spherians have many skills with penalties because they are not human, nor flesh and blood, and have difficulty understanding certain concepts. Their rock bodies also lack the degree of sensitivity that mammals possess and this also affects their skill abilities. These penalties should be reflected in REF O.C.C.s as well. Spherians have a natural affinity when working with lasers, electricity and other forms of energy.

**Standard Equipment:** Spherian laser rod, energy pistol of choice, energy rifle is an optional choice, short-range radio, flashlight, and a bag, pouch, or back-pack for specimens collected on adventures. (Spherians are very curious about other life forms.)

Allies working with the REF may also have additional or special weapons, ammunition, explosives (most Spherians dislike and avoid the use of explosives), CVR-3 body armor, and vehicles.

**Authorized Clearance Upon Assignment:** Additional equipment, military vehicles and the REFs assistance.

**Monthly Wages:** The Sentinels are on a moral crusade and do not accumulate wealth. However, the Spherian adventurer will have encrusted its entire personal living quarters (walls & ceiling) with crystal rocks it has gathered on its journeys. Among them will be a variety of gem stones (diamonds, sapphires, emeralds, etc.) worth 4D6 x 10,000 credits in human markets. The Spherian will also have its crystal laser rod and a variety of specimens and artifacts collected from numerous adventures.

Spherians hired by the REF will receive the usual amount in credits for that particular O.C.C. A Spherian adventurer receives the same as a Cyclone Rider.

## SPECIAL NOTES ABOUT SPHERIANS

1. **The Spherian Laser Rod** is an innocuous looking weapon that resembles a foot long (0.3m) jagged icicle. It has no trigger, no apparent power source or energy clip. The device enables the Spherian to focus energy through it, intensifying that energy and releasing it as a laser bolt.

**Range:** 2000ft (609m)

**Mega-Damage:** 2D4 M.D. or 6D6 S.D.C.

**Rate of Fire:** Equal the Spherian's hand to hand attacks.  
Effectively unlimited in light. 30 charges in darkness.

**Note:** No other creature can operate a Spherian laser rod. Doctor Lang says it is an extension of the aliens.

2. **Spherians can** disincorporate themselves, temporarily transforming their stone bodies into energy and **travel through solid rock and earth**. The beings call it "crystal hopping" and explain that they can transmit their energy self through solid earth by bouncing from one natural crystal to another, not unlike bouncing radio signals from one satellite to another.

**Range:** About 1200 to 2000ft (366 to 609m) from one crystal to another. They can instinctively sense the presence and location of any crystal based stone.

**Speed of Travel:** .08 the speed of light

**Maximum Depth:** Unlimited as long as there is crystal stone to transmit to. However, to reach the surface the crystal relay must be less than 1200ft (366m) from the surface.

**Destination:** Unlimited

**Notes:** Can not communicate while in energy form underground. Nor can it carry along any physical possessions other than its laser rod. Nor can it know what is happening on the surface. The transformation is unnerving, as the Spherian appears to melt into or out of the ground. The actual transformation only requires a few seconds, about one third of a melee (3-5 seconds). Failure to find a crystal relay network will prevent traveling underground. Likewise, a Spherian could find itself temporarily trapped or forced to make a detour if the intended destination does not have crystal near the surface. The crystal must be at least the size of a shoe box to act as a relay transmitter. The Spherian can not hide itself in a gem unless the gem is the size of a football. Of course, it can meld into the crystal walls of its room.

3. **Their Crystalline bodies** are super tough (see M.D.C.) and laser resistant (lasers do no damage to Spherians).

---

# THE MYSTICS OF PERYTON

The history of Peryton seems to be locked in fanciful myth about dueling wizards and an age of magic. How much is real and how much is fantasy is unknown.

The present day Perytonians claim to be the mutant survivors of a cataclysmic war. This, they say, explains the odd physical differences among their race, such as horns, extra fingers, no hair, et cetera.

They also claim their original secrets of magic have been lost. If this is true, then the Perytonians were once a powerful race, for their present-day magic is quite impressive. Doctor Lang believes that the Perytonian's "magic" is actually an ability to store and manipulate energy and radiation, creating what appear to be feats of magic. Lang always chuckles and adds, "Of course, how they can do this is beyond our present comprehension and it might as well be called magic."

The Perytonian civilization is fairly developed, with technology roughly equivalent to Earth's (2020). Of course, magic and mysticism play a large part in their lives and sciences.

**To Create a Perytonian Alien, Roll on the Following Tables . . .**

**Gender:** 01-64 Male  
65-00 Female

**Alignment:** Any

**Height:** 5ft + 3D6 inches

**Weight:** 130lbs + 2D4 x 10lbs

**Physical S.D.C.:** 20 + 2D6

### The Eight Attributes:

I.Q. 3D6  
M.E. 3D6  
M.A. 3D6  
P.S. 3D6  
P.P. 3D6  
P.E. 3D6  
P.B. 2D6  
Spd. 3D6

Bonus dice rolls same as human characters.

**Available REF O.C.C.s:** None. Perytonian Warriors consider themselves to be wizards and will not select any other O.C.C.

## THE PERYTONIAN WARRIOR WIZARD

*Also Known as Energy Wizards*

**Attribute Requirements:** None

### MUTATION TABLE

*Roll for Two Mutant Traits*

#### 01-10 Odd color skin

01-25 Pale, almost white  
26-50 Reddish-tan  
51-75 Greenish tint  
76-00 Grey skin

#### 11-20 Large Round Ears

#### 21-35 Large Pointy Ears

#### 36-50 Unusual Eyes

01-25 Glow white yellow  
26-50 Glow red  
51-00 White, no apparent pupil or iris.

#### 51-60 Extra Thumb and Sixth Finger

#### 61-80 Large, 12 to 20 inch, Horns

#### 81-90 Retractable Claws (inflict 1D6 S.D.C. damage in combat)

#### 91-00 Small Horns; 3 to 6 inches.

**Note:** All Perytonians normally have small pointed ears, no body hair, elongated cone shaped heads, and caucasian skin tones.

## MAGIC POWERS

A Perytonian can cast as many as *two magic spells per melee*, plus one additional at level five and another at level twelve. All characters should start at level one.

*The total number of spells* a wizard can cast per day (per 24 hours) is limited because of the physical and mental strain magic places on the body. At first level the Perytonian wizard can cast only six spells per day. At third level he/she can add four more spells (10 total), plus two additional at fourth level (12 total). Each additional level (5 and so on) *one* more spell can be cast.

### MAGIC POWERS known to most Perytonian Wizards

#### 1. Call Lightning

**Range:** 600ft (183m)

**Duration:** Instant

**Damage:** 2D6 M.D. plus 1D6 for each additional level of experience.

The wizard amplifies, controls and directs electrical energy into a massive energy bolt. **Special Bonus:** Automatically hits its target (must be visible to the wizard). Intended victim can attempt to dodge, but is -12 to do so.

#### 2. Energy Bolt

**Range:** 200ft (61m)

**Duration:** Instant

**Damage:** 1D6 M.D., plus add 1D6 at levels 3, 6, 9 and 12.

The Perytonian can hurl an energy bolt from his fingertips or eyes. This is a less powerful blast than the lightning bolt. As usual, the target

must be within the wizard's line of vision. **Special Bonus:** +5 to strike.

#### 3. Field of Invisibility

**Range:** Self or area up to 100ft away (30.5m).

**Area of Influence:** Self or 6ft (1.8m) area per each level of experience.

**Duration:** 8 minutes plus 4 minutes per each additional level of experience.

**Damage:** None

An energy field that reflects light is created to make everything within the field, or bubble, invisible to the human eye.





#### 4. Globe of Daylight

**Range:** Within 30ft (9.1m), but can be controlled by the wizard to follow him or fly within 30ft of him.

**Duration:** 10 minutes per level of experience.

**Damage:** None

The basketball size sphere of light can illuminate a 50ft area as bright as day.

#### 5. Impervious to Electricity

**Range:** Self

**Duration:** 10 minutes per level of experience.

The wizard creates an electrical damper field around himself which makes him impervious to electricity.

Electricity does no damage.

Energy blasts do half damage.

Lasers do full damage.

#### 6. Invisible Armor

**Range:** Self

**Duration:** 10 minutes plus 5 minutes per each additional level of experience.

**M.D.C. of Armor:** 100 plus 10 per each additional level of experience.

The energy wizard creates an invisible energy field around himself that blocks all energy attacks, as well as physical. Gas is not blocked.

#### 7. Levitation

**Range:** Self up to 1000ft (305m)

**Duration:** 3 minutes per level of experience.

By manipulating different forces the Perytonian can levitate into the air. Movement is restricted to up, down, and hover stationary.

#### 8. Magic Barrier

**Range:** 100ft (30.5m)

**Duration:** 2 minutes per level of experience.

**M.D.C. of Barrier:** 60 plus 10 per each additional level of experience.

Like the invisible armor, the wizard creates a temporary energy field that can be erected to block an area like a wall. The size of the magic barrier is limited to 30ft long by 30ft tall (9.1m) and can be curved. Unlike the armor, the barrier can be erected up to 100ft (30.5m) away and left behind. The barrier disappears when all its M.D.C. has been depleted or the duration time elapses.

#### 9. Stun Blast

**Range:** 100ft (30.5m)

**Duration:** 2D4 melees

**Damage:** 1D6 S.D.C., and a 1-55% chance of temporarily stunning one's opponent.

A victim of a stun blast will remain conscious, but loses control of his body. The victim remains dazed for 2D4 melees and is -10 to strike, parry, and dodge, and has only one attack per melee. The stun blast can not be used against persons inside vehicles, mecha, or environmental body armor like CVR-3; the blast simply can not penetrate the armor. **Bonus:** +3 to strike.

#### 10. Swirling Lights

**Range:** 10ft radius cast up to 40ft away

**Duration:** 2 minutes per level of experience.

**Damage:** Blinds victim.

The wizard can create a wall of swirling, dazzling light that will blind and confuse all who look at it. The wall is a combination of brilliant swirling lights, blinding strobe lights, high intensity flashes and sparks. Victims will be temporarily blinded for 2D6 melees every time they look at the lights. Running through the lights will cause 4D6 S.D.C. damage and has a 75% likelihood of stunning all who run through it.

**Note:** Humans or other aliens can *not* learn magic from a Perytonian. The so-called magic is a natural ability of Perytonians.

#### O.C.C. Skills:

Radio: Basic (+10%)

Computer Operations (+10%)

Computer Programming (+10%)

Concealment (+15%)

Palming (+15%)

Pick Locks (+10%)

Pick Pockets (+10%)

W.P. Energy Pistol

Hand to Hand: Basic\*

\*Hand to Hand: Basic can be upgraded to Expert, but costs one "other" skill selection.

**Other Skills:** Select 12 other skills, plus two at fourth level, two at eighth level and two at twelfth level.

Communications: Any (+5%)

Domestic: Any

Electrical: Any except mecha (+5%; Electrical Engineer costs two skill selections).

Espionage: Disguise, Escape Artist, Impersonation and Sniper only. (+5%)

Mechanical: Basic Mechanics, Automotive, Computer Repair and Locksmith only. (+5%)

Medical: Any (Medical Doctor counts as three skill selections)

Physical: Any except Wrestling and Martial Arts

Pilot: Any, except mecha

Pilot Related: Any

Rogue Skills: Any (+10%)

Science: Any (+5%)

Technical: Any

W.P.: Any

Wilderness: None

**Standard Equipment:** Robe with many secret pockets sewn into the lining, energy pistol of choice, 2 to 6 extra energy clips, 1 or 2 knives, lock picking tools, wrist radio, mini-personal computer (about the size of an old Earth hand calculator), flashlight, food rations, canteen and personal items.

Allies working with the REF may also have 1D6 cobalt grenades, 1D6 limpet mines, energy rifle of choice and ammunition, CVR-3 body armor, and a conventional vehicle (usually a hover cycle or land rover).

**Authorized Clearance Upon Assignment:** As allies, the REF will make available additional weapons and ammunition, explosives, optical enhancements, surveillance items, communications equipment, computer, military vehicles and their assistance.

**Monthly Wages:** The Sentinels are on a moral crusade and do not accumulate wealth. However, the Perytonians may have a secret stash of valuable items, including gems (2D4 x 1000 credits) and weapons and ammunition. A Perytonian warrior wizard who joins the REF will receive the same pay as a Military Specialist.

## AN ALIEN GAME NOTE

The aliens from **Haydon** have been intentionally left out. Mr. Macek's notes clearly imply that *Sarna* and *Veidt* were "one of a kind," highly advanced robots/androids.

# SKILLS LISTED BY CATEGORY

Note: *New Skills are in Italic*

## COMMUNICATIONS

Cryptography  
Laser  
Optic Systems  
Radio: Basic  
Radio: Scramblers  
Radio: Satellite  
Surveillance  
T.V./Video

Note: Read Sensory Instruments is found under Pilot Related Skills.

## DOMESTIC

Cook  
Dance  
Fish  
Sew  
Sing

## ELECTRICAL

Basic Electronics  
Electrical Engineer  
*Mecha Electronics*: Same as RPG skill, but includes new mecha.

## ESPIONAGE/MILITARY

Detect Ambush	Interrogation
Detect Concealment	Land Navigation
Disguise	Pick Locks
Escape Artist	Pick Pockets
Forgery	Sniper
Intelligence	Tracking
Impersonation	Wilderness Survival

## MECHANICAL

Automotive Mechanics  
Aircraft Mechanics  
*Armorer*  
Basic Mechanics  
Computer Repair  
Locksmith  
Mecha Mechanics  
Mechanical Engineer  
*Veritech Mechanics*: The same skill, but it now includes the new Alpha, Beta, and Vindicator.

## MEDICAL

Criminal Science/Forensics  
First Aid  
Medical Doctor  
Paramedic  
Pathology

## PHYSICAL

Hand to Hand Basic  
Hand to Hand Expert  
Hand to Hand Martial Arts  
Body Building  
Boxing Prowl  
Climbing Swimming  
Fencing Swimming: S.C.U.B.A.  
Gymnastics Wrestling

Note: Mecha Combat is found under Pilot Skills.

## PILOT (Ground, Air, and Water)

Automobile  
Mecha Battloid (Southern Cross)  
Mecha: E.B.S.I.S. Battloid (Southern Cross)  
*Mecha: Cyclone*  
*Mecha: Destroids*  
*Mecha: Zentraedi Battle Pods*  
*Mecha: Veritech*  
Mecha: Combat  
*Mecha: Combat Basic*  
Military Hover Cycle (Southern Cross)  
Military Hover Vehicles (Southern Cross)  
Motorcycle  
Jet Pack (Southern Cross)  
*Truck: Small*  
*Truck: Large*  
*Titan Transport*  
Tank  
Airplane; old style, single or twin engine  
Helicopter  
Jet *Spacecraft*  
Lancer Space Fighter *Space Shuttle*

## PILOT RELATED SKILLS

Navigation (Air, Land, Water)  
Navigation: Space  
Read Sensory Instruments  
Weapon Systems (missiles, lasers, etc.)

## ROGUE SKILLS

*Concealment*  
*Palming*  
Pick Locks  
Pick Pockets  
Prowl  
*Safe-Cracking*  
*Streetwise*

## SCIENCE

Astrophysics  
Biology  
Botany  
Chemistry  
Chemistry: Analytical  
Mathematics: Basic  
Mathematics: Advanced

Note: Computer is found under Technical.

## TECHNICAL

Computer Operation  
Computer Programming  
Demolitions  
Demolitions: Disposal  
Photography

Note: Instrument Reading; see Pilot Related Skills.

## WEAPON PROFICIENCIES (W.P.)

*Ancient Weapons*  
W.P. Blunt  
W.P. Chain  
W.P. Knife  
W.P. Sword  
W.P. Staff  
Also see Fencing under Physical Skills.

*Modern Weapons:*

W.P. Revolver  
W.P. Automatic Pistol  
W.P. Semi & Fully Automatic Rifle  
W.P. Rifle  
W.P. Sub-Machinegun  
W.P. Heavy  
W.P. Energy Pistol  
W.P. Energy Rifle  
*W.P. Gallant H-90*  
*W.P. Cyclone Weapon Systems*

Note: Weapon Systems; see Pilot Related Skills.

## WILDERNESS SKILLS

*Archery*  
*Boat Building*  
*Carpentry*  
*Identify Plants and Fruits*  
*Horsemanship*  
*Hunting*  
*Skin & Prepare Animal Hides*  
*Track Animals*

# SKILL DESCRIPTIONS

**NOTE:** For your convenience, we have reprinted the old skill descriptions with the new. This way you don't have to continually flip through TWO different books.

## COMMUNICATIONS

**Cryptography:** Skill in recognizing, designing, and cracking secret codes and messages. After ten minutes of studying a code the character can attempt to decipher it, but at a  $-10\%$  chance. Otherwise, the character must study for two hours before every additional roll. **Base Skill:**  $30\% + 5\%$  per level of experience.

**Laser:** This skill provides the character with an in depth knowledge of laser communication systems. **Base Skill** is  $40\% + 5\%$  per level of experience.

**Optic Systems:** Training covers a wide variety of optic systems, from video to optical enhancements devices, to laser optics. The character will understand the meaning of optical readings, recording, transmission, and use of special equipment like thermo-imagers, passive light intensifiers, infrared, ultraviolet, etc. **Base Skill:**  $50\% + 5\%$  per level of experience.

**Radio Communications:** All these skills enable the character to effectively use various communications equipment and techniques.

**Radio: Basic:** This is the knowledge of the operation and maintenance of field radios and walkie-talkies, wire laying, installation, radio procedure, communication security and visual signs/communications, as well as knowing Morse code. **Base Skill:**  $50\% + 5\%$  per level of experience.

**Radio: Scramblers:** This is training in the use of electronic masking and scrambling (unscrambling) equipment, and codes, for increased security. **Base Skill:**  $40\% + 5\%$  per level of experience.

**Radio: Satellite Relay:** This is an understanding of the methods and operation of satellite transmissions. **Base Skill:**  $25\% + 5\%$  per level.

**Surveillance Systems:** This is the study and understanding of the operation, methods, and techniques involved in the use of surveillance systems. Includes motion detectors, simple alarm systems, complex alarm systems, video and camera equipment, amplified sound systems, miniature listening devices (bugs, telephone tapping), recording methods, and some optical enhancement systems (specifically as they relate to camera lenses). **Requires:** Electronics (basic) or electrical engineering. Photography skills, prowl, and investigative skills may also be useful, but not required. **Base Skill:**  $40\% + 5\%$  per level of experience.

*Tailing*, or following someone without their knowledge, is another form of surveillance. This also includes stake-out procedures. A failed surveillance roll indicates that the tail was spotted and the subject is aware of being observed/followed. A failed roll in the use of equipment indicates a ruined or garbled recording/film (not usable) or malfunction. Bugging equipment can be easily located or noticed during the course of casual activity if a character fails his surveillance roll while planting it.

**T.V./Video:** This is the understanding of the techniques involved in video and audio, filming, editing, special effects transmissions and equipment. **Base Skill:**  $40\% + 5\%$  per level of experience. Spending two skills on this one skill area makes the character of professional film quality/abilities. A one time bonus of  $10\%$  applies in this case.

## DOMESTIC

**Cook:** Skill in selecting, planning and preparing meals. A cooking roll failure means that the cooked food is either inedible (burnt!) or distasteful. **Base Skill:**  $50\% + 8\%$  per level of experience. Spending two skill selections on this one skill area makes the character of professional quality. One time bonus of  $10\%$  applies in this case only.

**Dance:** A practiced skill in the art of dancing. **Base Skill:**  $40\% + 6\%$  per level of experience. Spending two skills will produce professional quality dancing skill. One time bonus of  $15\%$  if this is the case.

**Fish:** These are the fundamental methods (and enjoyment) of the relaxing sport of fishing. Areas of knowledge include the use of lures, baits, poles, line, and the cleaning and preparation of fish for eating. **Base Skill:**  $60\% + 5\%$  per level of experience.

**Sew:** The practiced skill with the needle and thread, to mend, layout, cut and sew simple patterns, and do minor alterations. This is not a tailoring ability unless the player spends two skills. **Base Skill:**  $40\% + 5\%$  per level of experience.

**Sing:** The simple ability to read music and carry a pleasant tune. **Base Skill:**  $40\% + 5\%$  per level of experience. The character's singing ability is nice, but not of professional quality, unless two skills are spent. Add  $20\%$  bonus if this is done. Minmei watch out!

## ELECTRICAL

**Basic Electronics:** This is a rudimentary understanding of the principles of electricity, simple circuits, wiring, and so on. This person can do basic wiring, repair appliances and read schematics. **Base Skill:**  $40\% + 5\%$  per level of experience.

**Electrical Engineer:** Knowledge of electricity. Characters can diagnose and locate electrical problems. It is also possible to put together electrical equipment. The character can attempt to bypass security systems and burglar alarms at a  $-25\%$ ; if Surveillance Systems is also taken, then there is a  $+10\%$  bonus instead. **Base Skill:**  $45\% + 5\%$  per level of experience. **Note:** Characters who are not electrical engineers must have Basic and Advanced Mathematics to select this skill.

**Mecha Electronics:** First hand knowledge of the electrical systems built into RDF and REF mecha. The character knows exactly how they interact with protoculture and the intricacies of Robotechnology. Other skills in electrical systems do not apply to mecha, making this an invaluable skill for repairing the famous war machines. **Base Skill:**  $35\% + 5\%$  per level of experience. **Note:** There is a  $-15\%$  penalty when working on the old RDF destroids and the mecha of the Southern Cross due to a lack of experience with these more primitive and overly complicated protoculture and fusion generator systems.

## ESPIONAGE/MILITARY

**Detect Ambushes:** Training which develops an eye for spotting locations and terrain suitable for ambushes and being ambushed. It also provides a rudimentary knowledge of guerrilla tactics used by the enemy. **Base Skill:**  $50\% + 5\%$  per level of experience.

**Detect Concealment:** This is a skill which enables the individual to spot and recognize camouflage, tricks, concealed huts, buildings and vehicles, as well as the ability to construct unobtrusive shelters that blend into the environment. **Base Skill:**  $40\% + 5\%$  per level of experience.

**Disguise:** The character knows how to apply make-up, wigs, skin putty, and other special effects, in order to alter his own appearance or the appearance of somebody else. **Base Skill:**  $40\% + 3\%$  per level of experience.

**Escape Artist:** The character will know the methods, principles, and tricks of escape artists. By tensing and relaxing muscles, flexing and popping joints, the character can try slipping out of handcuffs, straightjackets, etc. Also includes a knowledge of knots and the ability to conceal small objects on the person. Picking Locks is a separate skill. **Base Skill:**  $30\% + 5\%$  per level of experience.

**Forgery:** The techniques for making false copies of official documents, signatures, passports, I.D., and other printed material. The character must have an original or photocopy to work from in order to make an accurate copy. Skilled forgers can recognize other counterfeits at  $-6\%$ . **Base Skill:**  $30\% + 5\%$  per level of experience.



**Intelligence:** This is the specific training in the practices and principles of recognizing and analyzing sources of information about the enemy, observation techniques, counter intelligence measures and proper procedure. This includes the practical assessment of sights and sounds, estimation of ranges, what to report, handling prisoners of war, and handling captured documents and equipment (tagging, and reporting to group leader or proper authority).

This means the character will be able to accurately estimate ranges; the number of enemies/troops, direction, purpose; and assess the importance of specific information, documents and prisoners.

Further intelligence training includes a working knowledge of indigenous guerrilla warfare practices, concealment techniques, appearance, and current activities. This will enable the intelligence officer to recognize suspicious activity as guerrilla actions and identify guerrilla operatives. **For Example:** A particular booby trap, or weapon, or mode of operation, may be indicative of guerrilla activity in that area. It may be up to the character to confirm the existence of guerrillas, and their strengths and numbers in a particular area.

Another area of training made available to intelligence is the identification of enemy troops, officers and foreign advisors. This means the person learns the many distinguishing ranks and marks that identify specific military units, special forces, and officers of the enemy. Such identification can pinpoint and confirm enemy operations, goals and movement, as well as confirm outside intervention/aid. **Note:** A failed roll in any of the intelligence skills means that evidence is inconclusive, or the character has incorrectly assessed the information/situation and is uncertain. A failed roll involving individual clues may mean the intel officer has dismissed it entirely as being meaningless. (GMs, use your discretion). **Base Skill:** 45% + 5% per level of experience.

**Impersonation:** This skill enables a person to impersonate another person or type of soldier (in general). This means the person must have a rudimentary (if not comprehensive) knowledge of the person or general type of personnel that he is impersonating. This is likely to include a knowledge of enemy/subject of impersonation, military procedure, dress, command, and rank, and will usually require speaking the language fluently. This means the character can convincingly impersonate a general type of person/soldier/advisor by accurate disguise, proper action, and language.

The **Base Skill** is 40% to impersonate general personnel and 20% to impersonate a specific individual (which may require weeks of study and special disguise), +4% per level of experience.

The success of one's impersonation/disguise can only be determined after exposing oneself to those whom you wish to trick. A successful impersonation requires the player to roll under his skill for each of his first THREE encounters. Afterward, the character must roll under his skill for *each* encounter with an officer. If interrogated/questioned, he must successfully roll for every other question or be revealed as an impostor. A **failed roll** means his impersonation has failed and he is recognized as an impostor and is in immediate danger.

**Interrogation:** This skill includes training in the questioning of prisoners, captives and informers, and the assessment of that information. **Base Skill:** 40% + 5% per level of experience.

**Land Navigation:** This skill allows the person to stay on course while traveling over land by means of observation. This includes mentally marking/recognizing geographic landmarks, estimating distance and movement, recognizing sounds, and other navigation tricks. Techniques include night travel. The player should roll once for approximately every three miles traveled. A failed roll means the character is drifting off course by 200-2000 yards (roll 2D10 × 100 yards). Do not roll again until the next three miles. A successful roll at that time will allow the character to recognize his error and correct it. Of course, errors mean lost time and traveling through

unknown or potentially dangerous areas. A second (and third) failed roll means the character continues to travel 2D10 × 100 yards further off course. All failed rolls are cumulative unless corrected.

**Note:** A group of average men can cover approximately 5 miles an hour at a brisk, but relaxed pace, through grassland, along dirt roads or paved streets. Travel through dense forest or jungle at a cautious pace, with eyes open for danger, is about one mile per hour. At this pace, one can easily watch for booby traps, snipers, ambushes, wild animals, tracks, and clues, make other observations, without fear of traveling too fast (and missing them). Only at a faster pace will one begin to miss details and court death. **Base Skill:** 45% + 5% per level of experience.

**Picking Locks:** The character knows the methods, techniques and tools for picking/opening, key, and basic, tumbler type locks.

It takes 1D6 melee rounds for each attempt to pick a lock. A failed roll means the lock holds; try again. **Base Skill:** 35% + 5% per level of experience.

**Pick Pockets:** An ability to remove items from a person without their being aware of it. If a pick pocket attempt fails, the item has NOT been removed and there is a 67% likelihood of the intended victim recognizing the intent of the action. **Base Skill:** 30% + 5% per level of experience.

**Sniper:** This skill represents special training in long-range rifle firing, and marksmanship. The character must first have a semiautomatic rifle or bolt-action rifle skill to which the sniper skill bonus of +2 to strike can be applied.

**Tracking:** Visual tracking consists of the identification of tracks, and following the paths of men or animals by the signs they leave on the ground and vegetation. Tracking is a precise art, requiring much practice. The skill includes the evaluation of tracks, which may indicate whether the person being tracked is loaded down with equipment, running, moving slowly (by measuring the space between steps), male, female, walking backwards, injured (staggered footprints), and so on. By these means, the tracker can estimate the person's rate of movement, apparent direction, the number of persons in the party, and whether the person knows he's being followed. Other methods of tracking require recognizing other telltale signs, such as blood and other stains, broken and displaced vegetation, overturned rocks; litter, such as cigarette butts, ration cans, candy wrappers, soiled bandages and remains of campfires, and even odors carried by the wind.

Tracking also includes the recognizing of dangerous animals by their tracks, habits and feces. Likewise, tire tracks of vehicles can reveal much, such as size and type of vehicle, weight of load, etc.

**Counter-Tracking** techniques are also known, such as covering one's trail; avoiding obvious pitfalls, such as littering, misdirection, parallel trails, and others.

A **failed roll** means that the signs are inconclusive, vague or misleading. Additional signs must be found to verify or clarify (roll again). Three consecutive failed rolls means the tracker has completely lost the trail. Roll once every 40 yards when FOLLOWING a trail. Persons attempting to follow a skilled tracker are -20% to follow his trail if he is deliberately trying to conceal that trail (however, his rate of travel is reduced by half). **Base Skill:** 35% + 5% per level of experience.

**Wilderness Survival:** Techniques for getting water, food, shelter, and help when stranded in wild forests, deserts or mountains. Characters without this skill will not be able to stay healthy for more than a few days out in a wilderness area. **Base Skill:** 40% + 5% per level of experience.

## MECHANICAL

**Automotive Mechanics:** Ability to repair, rebuild, modify, and redesign conventional vehicles with internal combustion (gas) engines. Includes body work, turbine engines, and diesel truck engines. **Base Skill:** 50% + 5% per level of experience.

**Aircraft Mechanics:** The understanding, ability to repair, rebuild, modify and redesign conventional aircraft, including single and twin engine airplanes, fan-jets, jets, fighter jets, helicopters and shuttle craft. The Veritech Fighter is not a conventional aircraft and does *not* apply. **Base Skill:** 45% + 5% per level of experience.

**Armorer (NEW):** This is the military version of a weapon's engineer. The character can maintain, fix, modify, mount and figure out most military weapons. This ranges from repairing assault rifles and recharging energy clips to installing a MM-60 Multi-Missile system into an Alpha. **Base Skill:** 35% + 5% per level of experience.

**Basic Mechanics (NEW):** This is a rudimentary understanding of how machinery operates. This person can repair and maintain simple mechanisms and common motorcycles, automobiles and similar vehicles. Special modifications, souping-up vehicles, and working on aircraft and mecha are out of the question! **Base Skill:** 30% + 4% per level of experience.

**Computer Repair:** Knowledge of the internal electronics of computers and related devices (terminals, printers, etc. . . .). The character can attempt to repair, sabotage, or fix computers. Note that figuring out a repair problem requires one roll; the character must roll again to actually fix it. No computer operation or programming skills are included; many computer repair personnel don't even know how to turn the machines on! **Base Skill:** 40% + 5% per level of experience.

**Locksmith:** The practiced study of lock designs, and the ability to repair, build, modify and "open" locks. The methods, techniques, and tools of lock picking include the old-style key and tumbler, combination, and modern electronic locking systems. **Time Requirements:** 1-4 melees to open an antiquated key type lock; 1-6 minutes to open an elaborate tumbler type; 2-16 minutes to open a simple electronic lock (usually by patching in a bypass system); and 1-6 hours to break a complex, state-of-the-art electronic lock system, such as those used in high security and restricted areas.

If an unsuccessful skill roll is made, the lock is *not* opened and the process must be repeated. If an attempt to open an electronic lock fails, roll to see if the lock has been irreparably damaged; 32% chance. If damaged, the lock CANNOT be opened. **Base Skill:** 25% + 5% per level of experience. **Special Bonus:** Add a one time bonus of 5% if the Electronics Skill is also taken.

**Mecha Mechanics:** A comprehensive knowledge and ability to repair, build, and modify Mecha, including the *Logan*, *AJACS*, *Battloids* and the old and new destroids, alphas, betas, vindicators, cyclones, and Southern Cross mecha. A lack of familiarity with Southern Cross and Zentraedi mecha makes working on them more difficult, -10% penalty, but hardly impossible. **Base Skill:** 40% + 5% per level of experience.

**Mechanical Engineer:** A training, understanding and knowledge of how machinery is designed, operated, built, and maintained. Characters can attempt to redesign, modify, sabotage, repair, or construct mechanical devices. The first percentage is for how to operate/analyze/design machinery; the second is for how to repair, construct or sabotage. **Base Skill:** 45% + 5% per level of experience. **Special Bonus:** +5% to Locksmith skill and +5% to Surveillance Systems skill.

**Veritech Mechanics:** A very specialized skill dealing with the repair, building and maintainance of the *transformable* mecha. Without this skill, a character with mecha mechanics could effect structural repairs and limb replacement, but the delicate transformation system would be out of whack and prevent the veritech from changing into different

configurations. This includes all veritech mecha, including the cyclones, alphas, betas, VF series veritechs and vindicator. The somewhat different Southern Cross mecha, logan, AJACS and hover tank, imposes a -5% penalty. **Base Skill:** 30% + 5% per level of experience.

## MEDICAL

**Criminal Sciences & Forensics:** Basic knowledge of police skills. Includes simple criminal law, fingerprinting, ballistics (matching bullets to weapons and angles of impact), and general investigative techniques. Forensic medicine is also included, enabling the character to find evidence of time of death, cause of death, and other details when examining a corpse. **Note:** Biology, Chemistry, Chemistry: Analytical and some Mathematics are all required before taking Criminal Sciences & Forensics. **Base Skill:** 35% + 5% per level of experience.

**First Aid:** Rudimentary medical treatment which includes how to bandage wounds, stop bleeding, administer CPR/artificial respiration, and use antiseptics, and common anti-inflammatory drugs and painkillers. **Base Skill:** 50% + 6% per level of experience. A failed roll means the patient has not responded to treatment or that treatment was improperly applied.

**Paramedic:** An advanced form of emergency medical treatment which includes *all* first aid techniques, the setting of broken bones, suturing of wounds, use of oxygen and emergency equipment, use of drugs, knowledge of how to move a critically injured person, and other lifesaving techniques. A **failed roll** means the patient has not responded to treatment or that the treatment has been improperly administered. **Note:** For serious injury or coma, roll three times, consecutively, on percentile dice. A roll of two successful out of three means the wound has been properly treated or the patient's condition has been stabilized. Failure means the patient's condition is unchanged. Another character can immediately attempt to apply medical aid or the same player can try again, but only after he or she has spent six minutes for examination and/or concentration. **Base Skill:** 50% + 6% per level of experience.

**Medical Doctor:** The character has a Ph.D. (doctorate degree), with a Master's of Science, to be a practicing doctor.

Areas of training/study include: clinical skills, medical discipline, code of ethics, laboratory skills, techniques, methods of data collection, physiology (muscles, respiratory, blood, body fluids); fundamentals, principles and procedures of pathology (diseases, their structure and function), rudimentary pharmacology (use, reaction, and interaction of drugs). The medical doctor (M.D.) is also trained in surgical procedures (he is a surgeon). **Note:** the first percentile number indicates the ability to diagnose a problem and the second is the ability to successfully treat it. **Base Skill:** 70/60% + 5% per level of experience.

**Pathology:** This is that branch of medicine that deals with the nature of diseases, their causes and symptoms, and the functional and structural changes caused by disease. Training includes anatomy, physiology, cell biology, manifestation of disease, tissue injury and repair, abnormal cell structure, metabolism, diagnosis of human disease, tissue culture methods and applications, analysis of drugs in biological samples and laboratory research, investigative methods, and use of the instruments tools and equipment. **Requirements:** Chemistry. **Base Skill:** 45% + 5% per level of experience.

## PHYSICAL

**Hand to Hand Combat:** There are three major kinds of fighting techniques available to all characters:

**Hand to Hand: Basic:** This provides the fighting techniques taught in military basic training or in self-defense classes. Students learn elementary methods of attack and self-defense. Counts as one skill. *See the combat section for listing of specific abilities.*

**Hand to Hand: Expert:** An advanced form of self-defense and unarmed combat usually taught to commandos. Counts as two skills. *See the combat section for listing of specific abilities.*

**Hand to Hand: Martial Arts:** This is some form of oriental fighting skill (karate, kung-fu, etc.) that teaches advanced hand to hand combat. Counts as three skills (except for the Military Specialist and special conditions for upgrading Hand to Hand Combat). *See the combat section for listing of specific abilities.*

**Body Building & Weight Lifting:** By working out with weights and body building machines the character increases body strength and muscle.

+2 to P.S.

+10 on S.D.C.

**Boxing:** Classic art of fighting with fists. Training helps build the body and develop reflexes. Skilled boxers will *Automatically* Knock-out opponents on a natural twenty for 1D6 melees rounds. Unlike normal Knockout/Stun, this does NOT have to be declared before the strike roll.

One additional attack per melee.

+1 to Parry/Dodge

+1 to Roll with Punch/Fall

+2 to P.S.

+3D6 on S.D.C.

**Climbing:** Knowledge of the tools and techniques for climbing up sheer surfaces. Players should roll once for every 20ft (6m) of a vertical climb. Every "skilled" climber gets a second roll to recover his/her hold. **Base Skill:** 50% + 8% per level of experience.

*Rappelling* is a specialized rope climbing skill used in descending from helicopters, scaling walls and cliff facings. For game purposes, rappelling will include ascending and descending climbs. Minimum base effectiveness is 30% + 5% per level of experience. A failed roll means a slip or fumble; roll again to regain hold or fall.

**Fencing:** The ancient arts of Hand to Hand Weapons are learned from fencing teachers. This includes not only Olympic-style fencing with foil, epee or saber, but also Kendo (use of the Samurai sword) and other weapons. Adds a bonus of +1 to strike and parry when combined with W.P. Sword. **Note:** Paired Weapons is a separate skill. *See the W.P. Tables in the Combat Section for details.*

**Gymnastics:** Learning to do falls, rolls, tumbles, cartwheels, and to work on rings and parallel bars. Characters with Gymnastics can leap 4ft up or 4ft across, with an additional 2ft per level. **Note:** Characters with Leap Attack can use these distances in a strike. Provides the following abilities:

60% + 5% per level Sense of Balance.

70% + 4% per level Climb Rope.

20% + 6% per level Climbing (or adds a bonus of +10% to a climb skill).

70% + 8% per level Back Flip.

30% + 5% per level Prowl.

+1 to Roll with Punch/Fall.

+1 to P.S.

+1 to P.P.

**Prowl:** This skill helps the character to move with stealth; quietly, slowly and carefully. Techniques include balance and footing, short steps and pacing, rifle positioning, prone positions for low visibility, and crawling. A failed Prowl roll means that the character has been seen or heard. If the Prowl is successful, then the character is not seen and may make a Sneak Attack. **Base Skill:** 40% + 5% per level of experience.

**Swimming:** The rudimentary skill of keeping afloat, diving, lifesaving, and swimming techniques. **Base Skill:** 50% + 8% per level of experience. The percentile number indicates the overall quality of form as skill of execution. A special bonus of +1 to parry and dodge while in water applies. **Note:** A character can swim a distance

equal to  $3 \times$  his P.S./Strength in yards/meters per melee. This pace can be maintained for a length of time equal to his P.E./Endurance in melees.

**S.C.U.B.A.:** The letters S.C.U.B.A. stand for Self-Contained Underwater Breathing Apparatus. Characters learn the methods of skin diving, and underwater swimming; and the use of oxygen tanks/apparatus, mask and flippers. **Base Skill:** 50% + 5% per level of experience and reflects the degree of skill and expertise at S.C.U.B.A. **Note:** A character can swim a distance equal to  $2 \times$  his P.S./Strength in yards/meters per melee. This pace can be maintained for a length of time equal to the character's P.E./Physical Endurance in melees.

**Wrestling:** As taught in High Schools and Colleges, wrestling is more of a sport than a combat skill, but it does provide useful combat training.

Pin/Incapacitate on a roll of 18, 19 or 20.

Crush/Squeeze does 1D4 damage.

Body Block/Tackle does 1D4 damage and opponent must Dodge or Parry to avoid being knocked down.

+1 to Roll with Punch/Fall

+1 to P.S.

+1 to P.E.

+4D6 on S.D.C.

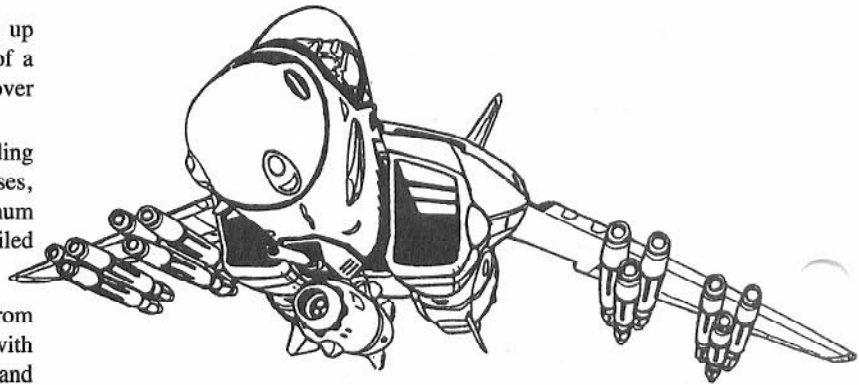

## PILOT SKILLS (Ground, Air, Water)

**Automobile:** Manual & Automatic transmission, includes dune buggies and jeeps. **Base Skill:** 80% + 4% per level of experience.

**Mecha (Battloid only):** (NEW): Characters with this skill are taught the fundamentals of maneuvering giant Battloids. All Southern Cross battloids are designed very similarly, so a trained pilot can operate any of them. However, the E.B.S.I.S. battloids and the old Destroids operate differently and require separate training (each is a separate skill). The training program focuses on piloting, not combat. Thus, mecha combat for battloids must be taken, but it does include all Southern Cross non-transformable battloids. **Base Skill:** 60% + 5% per level of experience.

**Mecha (E.B.S.I.S.)** (NEW): This skill is identical to the one before it, but applies to Soviet Battloids only. **Base Skill:** 55% + 5% per level of experience.

**Mecha Cyclone** (NEW): This is a separate mecha pilot skill because of the many unique capabilities and the different "power armor" type operation of this man-sized mecha unit. Training focuses on transformation and piloting, not combat. Thus, *Mecha Combat: Cyclone* must be taken to enjoy the full combat bonuses available. **Base Skill:** 50% + 5% per level of experience.

**Mecha Destroids** (NEW): Characters are taught the fundamentals of piloting destroids. Usually one specific model and type is learned per each skill selection. Only the Destroid O.C.C. learns to pilot all destroids (with at least three specific types selected as areas of expertise). **Base Skill:** 50% + 5% per level of experience.



**Mecha Veritech (NEW):** The piloting skills required to fly the big transformable mecha. Training focuses on the transformation process and the strengths and weaknesses of each mode of operation (jet, guardian and battloid). This skill is generally reserved for the Veritech Pilot O.C.C. exclusively. **Base Skill:** REF Veritechs: 50% + 5% per level of experience. RDF Veritechs (VF): 40% + 5% per level of experience. Southern Cross Veritechs: 35% + 5% per level of experience.

**Mecha: Zentraedi Style Battle Pods (NEW):** This skill is needed to pilot the REF Battle Pods. The operation of these new mecha is fairly simple, but very different from the Earth mecha. Only the Zentraedi Warriors and Destroid Pilot O.C.C.s are allowed to select this skill. **Base Skill:** 50% + 5% per level of experience.

**Mecha Combat:** Each mecha, the alpha, beta, cyclone, vindicator and all the others, has a different weapon system, hand to hand aptitude, and personality quirks that make each specific mecha unique. Because each handles differently, the pilot must select a separate mecha combat skill for each specific mecha type (cyclone, alpha, beta, etc.) to enjoy its maximum combat effectiveness (bonuses).

The Hand to Hand Bonuses from **Mecha Combat Training** list the exact combat abilities, damage and bonuses for each mecha. They are found at the end of this section. Mecha Combat is usually reserved for mecha pilots. Each specific mecha type, new and old, counts as a separate skill selection. **Note:** In addition to the specific mecha, the veritech pilot can operate all other aircraft style mecha, but only at the basic level. The cyclone rider can use all cyclones with equal skill.

**Mecha Combat BASIC (NEW):** Readers will also see a stat block for *basic* mecha combat. These abilities apply to general training in mecha combat available to many O.C.C.s. The basic combat training enables the character to use the mecha well, but not quite at peak efficiency.

**Military Hover Cycle:** The practiced skill of riding the speedy Southern Cross hover cycle. Surprisingly, the hover cycle is still fairly common on the war torn American continents. **Base Skill:** 50% + 4% per level of experience.

**Military Hover Vehicle:** Include a variety of trucks and armored vehicles that were once the equipment of the Southern Cross. However, few of these vehicles seem to have survived the invad invasion. **Base Skill:** 54% + 4% per level of experience.

**Jet Pack and Space Booster Pack:** : These are two special items that were used by the Armies of the Southern Cross. Both are fairly uncommon and require Southern Cross body armor to use. **Base Skill:** 45% + 5% per level of experience.

**Motorcycle:** The practiced skill of riding a motorcycle. **Base Skill:** 60% + 4% per level of experience.

**Truck (Small) (NEW):** Manual or automatic transmission; includes pickup trucks, small cargo trucks, vans and trailers. **Base Skill:** 60% + 4% per level of experience.

**Truck (Large) (NEW):** These are the manual transmission, eight to sixteen-wheeler transport trucks. The biggest of these trucks can easily haul mecha (weight capacity — 60 tons). **Base Skill:** 42% + 4% per level of experience.

**Tank:** The piloting of armored assault vehicles; includes armored all terrain vehicles, amphibious recon, and other armored heavy vehicles and construction vehicles.

**Titan Transport (NEW):** The very special aspects of piloting the all-terrain mecha assault unit (a.k.a. GMU) are learned. **Base Skill:** 40% + 5% per level of experience.

**Airplane:** Includes the old propeller, single and twin engine types. **Base Skill:** 70% + 4% per level of experience.

**Helicopter:** Includes the small, two-seater observation types; large transport and assault. **Base Skill:** 60% + 4% per level of experience.

**Jet:** Includes the fan-jet, commercial jet and jet fighter. **Base Skill:** 60% + 4% per level of experience.

**Lancer Space Fighter:** **Base Skill:** 60% + 4% per level of experience.

**Space Shuttle:** **Base Skill:** 60% + 4% per level of experience.

**Spacecraft (NEW):** This piloting skill is applicable to all large Earth spacecraft, including the Garfish and Ikazuchi carriers. **Note:** The Horizon is considered a space shuttle. **Base Skill:** 50% + 5% per level of experience. Also adds a +5% bonus to the Navigation: Space skill.

**Boats: Sail Type:** **Base Skill:** 80% + 4% per level of experience.

**Boats: Motor Type:** Large and small (not ships). **Base Skill:** 70% + 4% per level of experience.

**SPECIAL NOTE:** The following rules apply to all types of automobiles, trucks, vans, motorcycles and even armored vehicles/tanks.

**Special Maneuvers: Conditions and Penalties: Evasive Action:**

Fleeing or dodging another vehicle, obstacle, missile or some other attack by moving out of the way. Evasive action often involves weaving, zigzagging and sudden turns at high speeds. A successful roll means the pilot has successfully dodged out of the way. **Skill Penalty:** -15%; pilot/driver can not attack, passengers are -6 to strike in an attack. **A failed roll** means an ineffective evasive maneuver which, in turn, means the vehicle has been struck, blasted, and/or the attacker is still hot on his tracks. **THREE CONSECUTIVE**, successful evasion rolls means the pilot has completely lost the pursuer.

**Reverse Driving:** This is simply driving in reverse/backward. **Skill Penalty:** -25% if driving over 65mph, and roll for each turn, swerve or evasive action. Pilot can not attack, but passengers are only -2 to strike. **A failed roll** means a minor collision.

**Stunts:** Includes sharp turns at high speeds, sudden on-the-dime-stops, sudden U-turns at high speeds, propelled leap (such as riding up over an incline or object, sailing 20ft in the air, land and keep on going) and similar maneuvers. **Skill Penalty:** -25%; lose all attacks that melee. **A failed roll** means the stunt is incomplete and serious difficulties encountered. Roll on the following table:

#### Loss of Control (Stunt and Sideswipe)

1-38 Minor collision; momentarily stopped. Reduce vehicle's S.D.C. by 1/3. Occupants shaken, but okay.

39-59 Stunt maneuver botched; reduce speed by half.

60-80 Engine or structural problems develop, requiring pilot to pull over and stop. Vehicle needs 2-12 hour's worth of repairs.

81-97 Collision. Vehicle is totaled; pilot and occupants receive 3D6 points of damage (subtract from hit points).

98-00 Collision/crash; all killed.

**Sharp Curves:** 90 degrees, high speed. **Skill Penalty:** -10%.

**Sideswipe:** This maneuver can be used against a stationary object, moving vehicle or person. The purpose of a sideswipe is to strike another vehicle, object or person with a glancing blow from the body of your vehicle. **To strike**, the swiping player rolls under his Pilot skill minus the 20% skill penalty in attempting this dangerous maneuver. **Note:** The target, if controlled by another person, can attempt to dodge via "evasive action" or "stunt" driving. **Skill Penalty:** -20%; no other attack possible. **A failed roll** to sideswipe means an automatic miss, and the player must roll under his Pilot skill, -20%, to maintain control of the vehicle. If control is lost, roll on the **Loss of Control Table** under stunts. **Damage** from a sideswipe is 2D6 for every 20 miles of speed. The sideswipe also damages the vehicle, which is equal to 1/3 the damage inflicted to

the target. Thus, if the sideswipe inflicted 24 points of damage to the target, it would also do 8 points of damage to the vehicle.

**Note:** GM may substitute rules from *Road Hogs*, the TMNT supplement.

**SPECIAL NOTE:** *The following rules apply to ALL aircraft.* Roll under your pilot skill for each maneuver:

**Special Maneuvers: Conditions and Penalties: Evasive Action:**

Fleeing or dodging another aircraft, obstacle, missile or other attack by moving out of the way. All attacks are lost while engaged in evasive action; unless something suddenly flies directly in front of the vehicle, and even then the pilot is -4 to strike. **Note:** This tactic will lose *any* attacker(s), meaning they cannot attack unless the attacker(s) engage in a "dog tail" chase. **Skill Penalty:** -12% (no attack possible) Maneuver consumes one full melee. **A failed roll** means an ineffective evasive maneuver, attacker(s) still in strike position and/or have struck. The player's attacks are still forfeit even though the evasive action failed.

**Tilt Dodge:** This is a difficult maneuver in which the pilot attempts to avoid an attack by quickly tilting or jerking out of the way at the last minute. In this way, the pilot can stay on course and continue his own attacks (if any). **Skill Penalty:** -35%; -2 to strike. **A failed roll** means no dodge, aircraft is hit and takes full damage. A tilt dodge can be used to attempt to avoid each individual attack. A tilt dodge can *not* avoid more than one blast from a multiple/simultaneous assault; evasive action is necessary.

**Stunts:** These are sudden, severe or highly difficult maneuvers, including dives, sharp turns, dead-man's drops (nearly straight down, high speed drop), tumbles, summersaults and similar actions. **Skill Penalty:** -30%; lose all attacks that melee. **A failed roll** means the stunt is incomplete and serious difficulties encountered. Roll percentile dice on the following table:

- 1-40 Engine chokes; stalled out and descending. Must make an emergency landing unless the vehicle can be restarted (Pilot skill -25%; can try once every melee). All attacks are defensive only, -4 to strike.
- 41-70 Stunt maneuver botched; speed and altitude reduced by 1/3.
- 71-88 Engine difficulties; forced to make an emergency landing. Repairs will require 4-24 hours.
- 89-00 Engine and/or vehicle damaged beyond repair; crash inevitable. Character must parachute to safety. Optional: Can direct vehicle on a suicide crash into an immediate target. Pilot skill, -20%, to strike.

**Emergency Landing:** Executed when the vehicle or pilot is damaged and flight can not be maintained. **Skill Penalty:** -30%; loses all attacks. **A failed roll** will result in a crash landing. Roll on the following table for Crash Landing:

- 1-31 Pilot and/or passengers survive; minor injury.
- 32-57 Crash; pilot and passengers take 5D6 damage.
- 58-80 Pilot and passengers in critical condition/coma, require immediate, extensive medical treatment. Treat as surviving death and coma.
- 81-83 No survivors; vehicle exploded.
- 84-00 Passengers survive with minor injury, pilot dead. Optional: Pilot can opt to parachute to safety rather than attempting a landing.

**Shadow:** Is a maneuver in which the air vehicle pursues another vehicle without detection. This is usually done by flying above and behind the pursued, using clouds as cover. The pursuer will mimic the vehicle pursued in every way, so that they will be thought to be a radar shadow or aberration. **Skill Penalty:** -20%; no attacks possible without revealing true position and nature. While imitating the evasive actions, stunts, and so on of the craft being shadowed, roll for each maneuver being copied.

**Dog Tail:** This is an offensive maneuver in which the pilot closely pursues an enemy air vehicle while locked in combat. This is the only maneuver that can pursue a vehicle taking evasive action. By hanging on the enemy's tail, or "dog tailing," the attacker can usually strike with little or no fear of a counter-strike. **Skill Penalty:** -15%; no strike penalty.

**A failed roll** means the target has momentarily slipped out of the striking range/area. Roll once every other melee to maintain dog tail position, *or* for every evasive or stunt action.

## PILOT RELATED SKILLS

**Navigation:** Skills in map reading, star charts, course computation, following landmarks, and use of navigational equipment. Includes air, land and water navigation, as well as piloting by instruments alone. **Note:** Basic mathematics and read sensory equipment are required to navigate. **Base Skill:** 60% + 5% per level of experience. A failed roll means the pilot is off course. Roll 2D6 x 100 for aircraft, 4D6 x 100 for Veritech Fighters, and 1D6 x 100 for land vehicles to determine how many miles/kilometers they are off course by. Roll for every hour that one is off course.

**Navigation - Space:** Basically the same as normal navigation techniques. The only difference is the use of stars, and some of the sensory equipment. **Base Skill:** 60% + 5% per level of experience.

**Read Sensory Instruments:** Individuals with this training can maintain, understand, operate, and "read" or interpret sensory data from all types of conventional sensor devices. These devices include radar, sonar, motion detectors, surveillance equipment, optical enhancements, instrument panels and so on. **Base Skill:** 40% + 5% per level of experience. **Note:** Characters without a sensory skill cannot understand nor operate air vehicles, radar or detection/surveillance equipment.

**Weapon Systems:** This is the complete understanding of weapon units and systems incorporated in *vehicles* and *Mecha*. It includes the Battroids, and a vast variety of weapons, lasers, particle beams, auto cannons, missile launchers, and so on. **Special Bonus:** +2 to strike. This does not include hand-held weapons which require individual W.P. training. **Note:** Characters without the weapon systems skill will be able to operate them only if skilled in piloting that vehicle (like Pilot Mecha or Helicopter, etc.), but they will have no bonus to strike and never have the initiative. **Base Skill:** 70% + 5% per level of experience.

## ROGUE SKILLS (NEW!)

**Concealment:** Is the practiced ability to hide something on one's body or in hand, usually by continually moving it around from hand to hand or place to place unnoticed. Objects must be no larger than 14 inches in height and length and 6 inches in width, and weigh 10lbs or less. The smaller and/or lighter the item, such as a knife, gem, small sack, scroll, etc., the easier it is to conceal. Larger items such as a book, club, statue or other similarly larger and heavier objects are more difficult to conceal on one's person for obvious reasons. A penalty of -5% applies to items over 7 inches (remember, 14 inches maximum) because they are of a more difficult size. Items larger than 14 inches are impossible to conceal. **Base Skill:** 20% + 5% per level of experience.

**Palming:** Simply the ability to pick up and seemingly make a small object such as a coin, key, playing card, knife, etc., disappear by concealing it in one's hand. Adds a bonus of +5% to pick pockets skill. **Base Skill:** 25% + 5% per level of experience.

**Pick Locks:** The character knows the methods, techniques and tools for picking/opening key, and basic, tumbler type locks. It takes 1D6 melee rounds for each attempt to pick a lock. A failed roll means the lock holds; try again. **Base Skill:** 35% + 5% per level of experience.

**Pick Pockets:** An ability to remove items from a person without their being aware of it. If a pick pocket attempt fails, the item has NOT been removed and there is a 67% likelihood of the intended victim recognizing the intent of the action. **Base Skill:** 30% + 5% per level of experience.

**Safe-Cracking:** Knowledge of various safes, lock boxes and security rooms, along with the methods for illegal entry. The character knows the methods, techniques and tools for opening ('cracking') tumbler and combination type locks.

It takes one melee round to open a simple combination lock and five melee rounds for a complicated safe lock. To open a safe/complicated tumbler lock, the player must successfully make a skill roll (roll under) two out of three times. Failing the roll means that the lock holds, but this can be attempted again. **Base Skill:** 50% + 2% per level of experience.

Blowing a safe with explosives requires sophisticated knowledge, as well as the following tools: Electric drill, blowtorch, (or laser drill), plastic explosives, etc. . . . Roll just once. Failure means the safe has been blown shut and cannot be opened without heavy machinery. **Base Skill:** 60% + 3% per level of experience. **Note:** Must also roll under the Demolitions skill to successfully use and detonate the explosives.

**Prowl:** Same as the physical skill.

**Streetwise (NEW):** This skill instills an understanding of the darker side of city streets and the low-life who roam those streets. The character who is streetwise will be able to recognize gang members by their dress, symbols and mannerisms; guess at whether they are low level gang members or upper echelon, recognize a brawl situation (impending attack), and know some of the more typical gang rituals and codes of ethics, as well as likely hangouts.

Similarly, the streetwise skill will help the character to recognize and communicate with fences, criminal arms dealers, bandits and other criminal types. These skill abilities are used to avoid trouble and dangerous situations more than anything else. **Base Skill:** 30% + 5% per level of experience.

## SCIENCE

**Astrophysics:** Knowledge of stellar astronomy and how it relates to nuclear physics, quantum mechanics, relativity, and other explanations for the creation of deep space phenomena, like quasars and black holes. **Note:** Basic and advanced Mathematics are required before taking Astrophysics. **Base Skill:** 30% + 5% per level of experience.

**Biology:** Basic understanding of cells, anatomy, physiology, evolution and genetics. The character will know the basic use of a microscope, how to cultivate bacteria and how to classify new organisms. **Base Skill:** 40% + 5% per level of experience.

**Botany:** Plants, their categories and functions, are studied extensively. Characters will know the basics of cross-fertilization, germinating and growing experimental plants. **Base Skill:** 40% + 5% per level of experience.

**Chemistry:** Basic understanding of chemical principles and formulae. Characters know enough chemical laboratory procedures for analyzing and synthesizing chemical compounds to be competent assistants. **Base Skill:** 60% + 5% per level of experience.

**Chemistry – Analytical:** Chemical engineering theory, useful in the analysis of compounds and their practical applications. Characters will be highly skilled in the use of laboratory equipment, and can analyze and synthesize chemicals. **Note:** Basic and advanced mathematics are prerequisites. **Base Skill:** 50% + 5% per level of experience.

**Mathematics – Basic:** Includes basic addition, subtraction, multiplication, division, fractions and algebra. **Base Skill:** 80% + 4% per level of experience.

**Mathematics – Advanced:** Includes geometry, trigonometry, calculus and techniques for advanced mathematics. **Base Skill:** 64% + 4% per level of experience.

## TECHNICAL

**Computer Operation:** A knowledge of how computers work, along with the skills to operate peripherals like keyboards, printers and modems. Characters can follow computer directions, enter and retrieve information, and similar basic computer operations. However, this does NOT include programming. **Base Skill:** 60% + 5% per level of experience.

**Computer Programming:** Designing, programming, debugging, and testing computer programs/software. **Note:** Computer Operation is required before taking computer programming. **Base Skill:** 40% + 5% per level of experience.

**Demolitions:** Demolitions provides the person with an advanced knowledge in the use and workings of explosives and detonation devices for the purpose of blowing up bridges, buildings and sabotage. This includes *all* types of explosives, such as mines, dynamite, plastics, nitro, blasting caps, etc. It also includes a basic understanding of the strategic placement of mines and booby traps. This will increase a character's awareness of suspicious rope, string and wire. **Base Skill:** 60% + 5% per level of experience. A failed roll means a dud; no explosion.

**Demolitions: Disposal (or Explosive Ordnance Disposal):** This skill enables the character to safely defuse unexploded mines, bombs, explosive booby traps, dud artillery rounds, dud explosive charges, or any other explosive devices. **Base Skill:** 60% + 5% per level of experience. A failed roll means the item has exploded without warning.

**Photography:** Taking black and white or color still pictures. Characters will know how to load, develop and enlarge film. **Base Skill:** 50% + 5% per level of experience.



## WEAPON PROFICIENCIES

There are two categories of weapon proficiencies (W.P.): Ancient and Modern.

**Ancient Weapon Proficiencies:** Each skill area provides combat training with a particular type of weapon. The result is hand to hand combat bonuses to strike and parry, but only when that weapon is used. Each W.P. counts as one skill. The character may select several W.P.s **Note:** Characters without a W.P. CAN use any weapon, but without bonuses.

**W.P. Blunt:** A skill with any type of blunt weapon, including maces, hammers, cudgels, pipes, staffs and clubs. **Bonuses:** +1 to strike and parry at **level one**, add another +1 to strike and parry at **level four** and +1 to parry at **level eight**.

**W.P. Chain:** Includes ordinary lengths of chain, mace and chain, flail, nunchaku, etc. **Bonuses:** +1 to strike at **level one**, add another +1 to strike and parry at **level four**, and +1 to parry at **level eight**.

**W.P. Knife:** Combat skill with all types of knives. **Bonuses:** +1 to strike when thrown, **level one**; +1 to strike and parry at **level two**, +1 to parry at **level five**, +1 to strike at **level six** and again at **level nine**.

**W.P. Sword:** Combat skill with large and small swords. **Bonuses:** +1 to strike and parry at **level one**; an additional +1 to strike and parry at **level four**, and again at **level eight**.

**Modern Weapon Proficiencies:** These are areas of training and practiced skill with a particular type of modern weapon. Each W.P. counts as one skill. Characters may have several W.P.s Each provides a bonus to strike. See the Combat Section for details.



## WILDERNESS SKILLS (NEW!)

**Archery:** The practiced use of the bow and arrow and crossbow. The archery skill is effectively a weapon proficiency with bow weapons. *Bonus to strike* with bow and arrow/crossbow: +1 at first level plus +1 to strike for each additional TWO levels of experience. *For Example:* Level one, +1; level three, +2; level five, +3 and so on.

*Rate of Fire:* Two at level one and ONE for each additional TWO levels of experience. *For example:* Level one, 2 shots per melee; level three, 3 shots; level five, 4 shots and so on.

Bow Types and Ranges	S.D.C. Damage Per Arrow
Short Bow — 420ft	1D6
Large Bow (longbow) — 700ft	1D8
Compound Bow — 800ft	2D6
Crossbow — 700ft	1D8

The skill also includes the ability to select the proper wood and make a quality bow. **Base Skill** to make a bow is 40% + 5% per level of experience. A *failed roll* means the bow is poorly crafted, is -1 to strike and has a 50% chance of cracking every time it is fired.

**Boat Building:** Is a great skill that enables the character to build a variety of rafts, small rowboats and large flatbed boats and even a canoe. A small raft can be made within 1D6 + 1 hours if the lumber or other suitable materials are available — a large raft within 4D6 hours. A canoe will take 2D6 days, rowboats — 4D4 days, large flatbed boat — 1D4 × 10 days. Time is doubled or even tripled if trees must be cut down and wood prepared. Of course, the amount of time can also be reduced with several people working on the project. **Base Skill:** 25% + 5% per level of experience. A failed roll means the boat has leaks. Try patching it up for 4D4 hours and try again (this time, with a +10% bonus).

**Carpentry:** This is a fundamental knowledge of working with wood. The character can build chairs, tables, chests, stairs, repair wood items and so on. **Base Skill:** 30% + 5% per level of experience.

**Identify Plants/Fruits:** This is a skill to recognize the many different types of plants and fruits. This is a particularly handy skill when gathering herbs, edible mushrooms, and edible fruits and berries. **Base Skill:** 25% + 5% per level of experience.

**Horsemanship:** A familiarity with horses, how to ride them and take care of them.

**Riding/care/feeding:** A fundamental knowledge in the care and grooming of horses.

**Recognize quality/breed:** The percentile number indicates the success ratio of recognizing the quality (age, speed, health, etc.) and breed (race horse, way, riding, etc.) of horses in general.

**Jump:** The percentile number indicates the success ratio of NOT being thrown from the horse when jumping (or backing). Character must roll under the percentage to remain in the saddle and in control.

(+) **Plus to parry and dodge:** Applies to the rider, not horse. The rider gains a combat advantage from height and speed of being mounted.

**Charge Attack:** Adds +3 to damage with any ancient weapon, -2 to strike with guns or bow and arrow.

**Horse Attack:** Having the horse kick and rear. Two attacks per melee; front legs do 2D6 damage, rear do 4D6 damage (S.D.C.).

**Bonuses:** Attacking while mounted on a horse gives the character the advantages of height and speed. Plus +1 to parry and dodge, +2 to damage (S.D.C.).

**Raise/Breeding Horses:** This is a fundamental knowledge in the raising, training and breeding/mating horses.

**Base Skill:** 40% + 4% per level of experience. A failed roll means the character fails at what he was attempting. Make control rolls for difficult moves like charge attacks, leaps, and other sudden movements. A failed roll means the rider falls off his mount.

**Hunting:** A practiced skill at hunting, killing and preparing a variety of animals for food or sport. Includes a *W.P. Rifle* (bolt-action, not

automatic) and a *skill bonus* of +2% for prowl, +5% for track animals, +5% to skin animals, and +5% to cook the catch. No base skill.

**Skin and Prepare Animal Hides:** This is the ability to carefully skin an animal, large and small, and be able to prepare/preserve/tan its hide for leather or fur. This ability also adds a +5% bonus to the sewing skill. **Base Skill:** 40% + 5% per level of experience.

**Track Animals:** This skill enables the character to identify an animal's tracks, scent, spore and likely habitat. The character can also follow the animal's tracks and other signs. This also means he/she can estimate how old the tracks are and what direction it headed.

Tracking humans with this skill is possible, but is done with a penalty of -20%. **Base Skill:** 30% + 5% per level of experience.

# COMBAT

## COMBAT TERMS

**A.R.:** This is a character's **Armor Rating**. The A.R. indicates what an attacker must roll in order to do damage to the character. Any roll of 5 or better will strike a character with no body armor. Characters with **Artificial Body Armor**, metal armor, bullet-proof vests, etc., can easily be successfully attacked by rolls falling under the artificial armor's A.R., doing damage to the S.D.C. of the *body armor*, but not to the S.D.C. of the defender. Or, by striking above the armor's A.R., damage the character's personal S.D.C. and/or hit points. **Example:** A defender has a natural A.R. of 5 and is wearing body armor with an A.R. of 8. If the attacker rolls 9 or better, then damage is done directly to the defender. A roll of 5, 6, 7, or 8, would only hurt the body armor, not the wearer. A roll of 1, 2, 3, or 4, would totally miss.

### Damage Table (Basic)

Human Fist	1D4
Human Kick	1D6 or 1D8
Blackjack	1D6
Bull Whip	1D8
Thrown Small Objects	1D4
Falling	1D6 per 10ft
Collision	1D8 per 10mph
Smashing through Glass	1D4
Dropped or Thrown Large Objects	1D8 per 100lbs 1D8 per 40ft, and 1D4 per 4mph

**Death Blow:** An automatic kill. The defender can try to roll with death blow by rolling over the attacker's strike. If the defender is not killed, then the current S.D.C. and hit points are reduced to half. This attack is available only under certain conditions.

**Dodge:** A character dodges by moving out of the way of the attack. Dodging always takes up one attack/action per melee round. To Dodge, the defender must roll higher than the attacker's strike roll on a twenty-sided die.

**Entangle:** A defender can attempt to trap the weapon or arm of an attacker. This is done instead of parrying or dodging, and takes up one attack per melee. An entangle is successful if the defender rolls above the attacker's strike roll. It takes one attack and a roll to entangle to keep an opponent's arm or weapon entangled every melee round. In order to get free, the entangled opponent must roll a dodge against the entangle roll.

**Hand to Hand Combat:** Fighting skills that provide the characters with attacks per melee, bonuses, and techniques. Characters without combat training have only one attack per melee and have *no* automatic chance to parry.

**Hit Points:** This is the number of points of damage a character can take before dying. Characters don't lose hit points until their S.D.C. is down to zero. A character's base hit points is the P.E. plus 1D6. Another 1D6 of hit points is gained every time the character advances an experience level. Lost hit points are not recovered without medical attention.

**Initiative:** Whoever gets to attack first is considered to have the Initiative. Initiative is automatic in sneak attacks and long range attacks. In most other cases, each opponent rolls a twenty-sided, highest roll gets the initiative. Rolling for initiative takes place at the beginning of each melee round of combat.

**Kick Attack:** This is a karate-style kick. It is a normal attack that does 1D4 damage for the untrained, or higher with hand to hand skills. Anyone trained in hand to hand combat can do a kick attack.

**Knockout/Stun:** Anyone hit by a knockout or stun attack will be temporarily incapacitated. The victim is not necessarily unconscious, just dazed.

**Jump Kick:** A Jump Kick is performed by leaping completely off the ground and attempting to land foot-first on an opponent. Jump Kick can be used only by those skilled in hand to hand martial arts. The advantage of a jump kick is that it works as a *critical strike* and doubles the normal damage inflicted. The disadvantage of a jump kick is that no other attack may be performed in that melee round (all attacks for that melee are used up in the kick). The jump kick must be the character's first attack of that melee round. For the rest of the melee round, the character can only parry, dodge or move into position.

**Leap Attack:** An airborne assault where the weapons or fists are wielded in mid-leap. A leap attack must be made only at the beginning of a melee round and, like the jump kick, uses up *all* attacks for that melee. Usually, only a single strike can be made during a leap attack. However, if two opponents are close together, the attacker can leap between them and strike both of them at the same time; roll to strike for each character. After the leap, the character may not attack again until the next melee round, but can parry or dodge or move into position. Automatic parries work in mid-leap, but dodges are impossible. A successful leap attack is a critical strike and does double damage.

**Long-Range Attack:** By using a long-range weapon from a distance, an attacker can perform an undetected *first strike*. Provided the attacker is not seen, the defender automatically loses initiative and may not dodge the first attack that melee round.

**Melee or Melee Round:** Exactly 15 seconds. The segment of time combatants have to strike, counter and/or return strike. Generally, playing characters have two or more attacks per melee.

**Multiple Attackers:** Takes place when an opponent is faced by more than one attacker. Characters with hand to hand combat skills can attempt to parry any attacks within their line of sight. The defender from multiple attackers can strike at only one target at a time (see leap attack for a rare exception).

**Natural Twenty:** This is the result of 20 when rolling a twenty-sided die. A strike with a natural twenty will always be a critical strike. If someone with a strike bonus of +2 rolls an 18, then they have an attack roll of 18 *plus* unnatural bonus modification; NOT a natural twenty, and it is not a critical strike. A natural twenty beats all other rolls and can only be parried or dodged by *another natural twenty*.

**Paired Weapons:** Certain kinds of weapons, such as Sais, Nunchaku, knives, clubs and swords, can be used as paired weapons. Users of paired weapons can strike and parry simultaneously, can do twin strikes against a single target or against a pair of targets, and can

parry two different opponents at the same time. In other words, warriors skilled in paired weapons often can do two actions for every one of their melee attacks. BUT, every time they use twin actions they LOSE their automatic parry.

**Parry:** A defender can attempt to parry most physical attacks. This is done by blocking the attacker's blow with a weapon or hand. Characters trained in hand to hand combat can parry without losing melee attacks. Bullets and energy attacks *cannot* be parried!

**Pull Punch:** The ability to control the force of a hand to hand attack. Usually used to reduce the blow to less than killing force. The character can choose to half damage, quarter damage, a single point or no damage at all. A character must declare a pulled punch. The player must roll 11 or better on a twenty-sided die; failure means full damage is inflicted.

**Roll with Punch/Fall:** Hand to Hand combat fighters can reduce the damage from blows and falls by rolling. If the defender is successful, then only half damage is taken. Roll with punch/fall does not work against energy blasts, bullets, fire, bladed weapons, psionics or radiation. Victims must roll higher than the attacker's roll. *Falling* characters must roll a 14 or higher, on a twenty-sided die, to roll with the fall.

**Saving Throws:** Occasionally, characters must roll to save against exotic attacks like poison, gas, insanity, psionics, etc.

Lethal Poison	14 or better
Non-lethal Poison	16 or better
Harmful Drugs	15 or better
Acids	No save possible — Dodge!
Insanity	12 or better
Psionics	15 or better for non-psionics 10 or better for psionic

**S.D.C.:** This stands for *Structural Damage Capacity*, which is the amount of damage an object can absorb before breaking. Living creatures also have S.D.C.; it represents their physical resistance to damage. All the S.D.C. of a living thing must be reduced to zero before the hit points can be affected. Note: A cousin to S.D.C. is M.D.C. or Mega-Damage Capacity. M.D.C. applies to Mecha, and is explained in the Mecha Combat section which follows shortly.

#### S.D.C. Table (Basic)

Below are the S.D.C. values for a variety of objects. When an object's S.D.C. is reduced to zero, it is considered broken. Game masters should exercise common sense in applying these values. For example, a normal human cannot break through a vault door with bare fists, no matter how many times natural twenties are rolled.

The S.D.C. of different weapons is applied *only* if someone is actually attempting to break the weapon. A properly wielded sword can inflict or parry many times its S.D.C. On the other hand, using the sword to wedge open a door could easily snap it off.

It is also important to note that the S.D.C. applies to the entire object. A bullet can penetrate many objects with only a small fraction (about 2%) of S.D.C. loss. For example, if a bullet punching through an exterior brick wall hit a target, it would inflict normal damage minus the 4 points of S.D.C. it wasted getting through the wall.

Box, Cardboard	2 S.D.C.
Box, Wood Shipping Crate	12 S.D.C.
Box, Metal Shipping Crate	48 S.D.C.
Car, Compact	250 S.D.C.
Car, Luxury	450 S.D.C.
Car, Door Only	150 S.D.C.
Car, Windshield Only	100 S.D.C.
Door, Interior Wood	100 S.D.C.
Door, Exterior Wood	170 S.D.C.
Door, Metal Grill	350 S.D.C.
Door, Solid Metal	600 S.D.C.

Door, Metal Safe	800 S.D.C.
Door, Bank Vault	5000 S.D.C.
Handcuffs, Regular	60 S.D.C.
Handcuffs, Heavy	120 S.D.C.
Lock, Common Latch	40 S.D.C.
Lock, Dead Bolt	100 S.D.C.
Lock, Heavy Padlock	75 S.D.C.
Motorcycle	100 S.D.C.
Truck, Medium Sized Pick-up	450 S.D.C.
Truck, Half-Ton Pick-up	550 S.D.C.
Truck, Freight Hauler	650 S.D.C.
Wall, Interior Plaster	120 S.D.C.
Wall, Exterior Wood	150 S.D.C.
Wall, Exterior Brick	200 S.D.C.
Wall, Cinder Block	300 S.D.C.
Wall, Reinforced Concrete	400 S.D.C.
Weapon, Hard Wood	40 S.D.C.
Weapon, Metal Sword	100 S.D.C.
Weapon, Small Pistol	35 S.D.C.
Weapon, Assault Rifle	75 S.D.C.
Weapon, Artillery Piece	1500 S.D.C.
Window, Ordinary Glass	20 S.D.C.
Window, Plexiglass	35 S.D.C.

**Simultaneous Attack:** Instead of defending with a parry, dodge or entangle, a character can choose to do a simultaneous attack. In this case, the character does not defend ("Go ahead, hit me; I can take it!") and simply attacks in response. The advantage of a simultaneous attack is that *neither* opponent can parry, dodge or entangle. In all probability, both will take damage. *Exception:* An opponent with paired weapons can engage in simultaneous attack (with one weapon) AND parry (with the other), OR, both the paired weapons can be used to strike with NO parry.

**Sneak Attack:** An attacker may lie in wait (ambush), attack from behind, or sneak up (prowl) on an opponent. If the foe does not discover the attacker, then the sneak attack is successful. The sneak attacker always has initiative, and the defender is not able to parry or dodge the sneak attack.

**Strike:** Anyone attempting to hit an opponent must roll to strike. As with all combat rolls, a roll to strike is made with a twenty-sided die.

**Throw:** Simply, this means throwing a weapon. Rolling to throw is exactly the same as rolling to strike, except that there are different bonuses per weapon type. See Weapon Proficiency.

**NOTE:** A character may use ANY type of weapon, but gets no combat bonuses, such as strike or parry, unless he has a Weapon Proficiency (W.P.) in that particular weapon. This applies to modern and ancient weapons.

## DETERMINING PHYSICAL S.D.C. FOR CHARACTERS

Each O.C.C. provides a base physical S.D.C. from training. They are as follows:

- Veritech Pilot: 20
- Cyclone Rider: 40
- Military Specialist: 25
- Bio-Maintenance Engineer: 20
- Destroid Pilot: 25
- Field Scientist: 30
- Communications Engineer: 20

Additional physical S.D.C. can be gained from physical skills such as Boxing. *All S.D.C. points are accumulative.*

## HAND TO HAND: BASIC

- Level 1** Two attacks per melee; +2 to pull/roll with punch, fall or impact.
- 2 +2 to parry and dodge.
  - 3 Kick attack does 1D6 points damage.
  - 4 One additional attack per melee.
  - 5 +1 to strike.
  - 6 Critical strike on an unmodified roll of 19 or 20.
  - 7 +2 to damage.
  - 8 Judo-style body throw/flip; does 1D6 damage, and victim loses initiative and one attack per melee.
  - 9 One additional attack per melee.
  - 10 An additional +2 to pull/roll with punch, fall or impact.
  - 11 An additional +1 to parry and dodge.
  - 12 An additional +1 to strike.
  - 13 Critical strike or knockout from behind.
  - 14 An additional +2 to damage.
  - 15 An additional attack per melee.

## HAND TO HAND: EXPERT

- Level 1** Two attacks per melee; +2 to pull/roll with punch, fall or impact.
- 2 +3 to parry and dodge.
  - 3 +2 to strike.
  - 4 One additional attack per melee.
  - 5 Kick attack does 1D6 damage.
  - 6 Critical strike on an unmodified roll of 18, 19 or 20.
  - 7 Paired weapons.
  - 8 Judo-style body throw/flip; does 1D6 damage, and victim loses initiative and one attack.
  - 9 One additional attack per melee.
  - 10 +3 to damage.
  - 11 Knockout/stun on an unmodified roll of 18, 19 or 20.
  - 12 An additional +1 to parry and dodge.
  - 13 Critical strike or knockout from behind (triple damage).
  - 14 An additional attack per melee.
  - 15 Death blow on a roll of natural 20.

## HAND TO HAND: MARTIAL ARTS

- Level 1** Two attacks per melee; +3 to pull/roll with punch, fall or impact.
- 2 +3 to parry and dodge; +2 to strike.
  - 3 Karate-style kick does 1D8 damage.
  - 4 One additional attack per melee.
  - 5 Jump kick (critical strike).
  - 6 Critical strike on an unmodified roll of 18, 19 or 20.
  - 7 Paired weapons.
  - 8 Leap attack (critical strike).
  - 9 One additional attack per melee.
  - 10 Judo-style body throw/flip; does 1D6 damage, victim loses initiative and one attack.
  - 11 An additional +4 to damage.
  - 12 An additional +2 to parry and dodge.
  - 13 Knock-out/stun on an unmodified roll of 18, 19 or 20.
  - 14 An additional attack per melee.
  - 15 Death blow on a roll of a natural 20.



# MODERN WEAPON PROFICIENCIES

The original system for modern weapons presented in **Heroes Unlimited** and **Teenage Mutant Ninja Turtles & Other Strangeness** consist of fairly accurate and effective rules. However, they tend to bog down the speed of play with numerous dice rolls for damage and time determining how many rounds fired actually strike. I've since developed a quick playing, alternative set of rules, which appears for the first time in a formal, large press publication. (The same rules saw print earlier this year in a special, promotional pamphlet). Game masters should feel free to substitute these rules, if they prefer, with those from the previously mentioned game books or even those from the **Revised RECON**. All are modern weapon rules that would work just as well in **ROBOTECH™**.

**Weapon Proficiencies (W.P.)** are areas of training and practiced skill with a particular type of weapon, such as revolver or sub-machinegun. This skill provides special bonuses to strike when using that weapon. Do not add this strike bonus to your character's hand to hand or Mecha combat skill bonuses to strike.

Weapon Proficiencies provide the following bonuses:

**Aimed:** +3 to strike.  
**Burst:** +1 to strike.  
**Wild:** No bonus or penalty.

**Training** also enables the character to easily reload, disassemble, unjam, clean and otherwise maintain the weapon. **Recognizes weapon quality** — 30% at level one and +6% per each additional level of experience. Add a bonus of +1 to strike for every THREE levels of experience beyond level one. When firing a weapon, there are three main modes or categories of attack: *aimed, burst or wild*.

## AIMED

An **aimed shot** means a person takes the time to carefully aim and squeeze off one well placed shot. Each individual shot takes one full attack. Thus, if a character has four attacks per melee he/she can shoot FOUR aimed shots. This applies to all weapons. Roll to strike for each shot.

**Bonus to Strike** is +4 with a revolver or +3 for all others.

## BURST

A **burst** is the shooting of several rounds, one immediately after another. Aim is more hasty and the recoil moves the weapon with each shot, reducing the accuracy. Semiautomatic/automatic weapons, machineguns and sub-machineguns are designed for burst firing. The concept is that, while accuracy is reduced, the odds of hitting one's target with multiple rounds is increased because more shots are fired. **Bonus to Strike** is +1 with all weapons.

**Note:** Roll to strike once to see if the entire burst hits. Do not roll for each individual bullet. If the burst misses its target, then all the rounds in that burst miss.

**Short bursts** fire 20% of the entire round magazine; i.e., 30 round magazine — 6 rounds/bullets are fired. **Damage:** Roll the normal damage dice for ONE round  $\times 2$ . Uses up one attack. Can be fired at only one target.

**Long bursts** fire 50% of the entire round magazine; i.e., 30 round magazine — 15 rounds/bullets are fired. **Damage:** Roll the normal damage dice for ONE round  $\times 5$ . Uses up one attack. Can be fired at only one target.

**Entire magazine:** Shooting off the entire clip/magazine within a melee round is possible. 100% of the rounds are fired. **Damage:** Roll the normal damage dice for ONE round  $\times 10$ . Uses up *two* attacks that melee. Can be fired at only one target. Machineguns are the only exception to this rule.

**Spray:** Shooting a burst at several targets at once is possible, but is the same as shooting wild. You must fire a *long burst or an entire magazine* in order to spray. See shooting wild.

## SHOOTING WILD

Shooting wild occurs when a trained character shoots without taking time to aim. This usually applies when the person is blinded, angry, running, rolling, leaping, shooting from a moving vehicle, etc.

**Bonus to Strike:** With a W.P., there is no bonus or penalty; with no W.P., the person strikes at  $-6$ . Long bursts or the entire magazine must be fired. Counts as two attacks. Can be fired at one target or in a spray. **Damage for shooting wild at one target:** Roll normal damage dice for ONE round  $\times 2$ . Roll once to strike with the wild burst. **Hitting an innocent bystander** is a real possibility when shooting wild; 20% chance. Roll for each wild burst fired. **Damage** is the normal damage from one round (a wild shot).

**Spraying an area** with bullets can be dangerous and is considered to be shooting wild. The object of a spray is to hit several targets simultaneously. **First**, roll once to determine if you strike the target area; 1D20; 5 or higher strikes as usual. Then roll 1D4 to determine how many individual targets are struck within the target area. However, each target gets a roll to dodge to avoid getting shot. **Damage** is the normal damage from one round. **Hitting an innocent bystander** is even more likely; 50% chance. Damage is from one round (a wild shot.)

**Bursts or Sprays from a machinegun** are different only in the number of rounds fired, targets struck, and chance of hitting a bystander. Machineguns have a much greater ammunition capacity, so they do not have to empty the same percentage of their entire clips.

**Short burst/one target:** 10% of rounds/magazine; inflicts normal round damage  $\times 2$ . Counts as one attack.

**Short burst spray:** 10% of rounds/magazine; inflicts normal damage from ONE round, hits 1D4 targets.

**Long burst/one target:** 30% of rounds/magazine; inflicts normal damage  $\times 5$ . Counts as one attack.

**Long burst spray:** 30% of rounds/magazine; inflicts normal damage from ONE round, hits 1D8 targets. Counts as one attack.

**Empty the entire magazine/one target:** All rounds fired; inflicts normal round damage  $\times 20$ . Counts as all melee attacks/one full melee.

**Empty the entire magazine in a spray:** All rounds fired; inflicts normal round damage  $\times 2$ , hits 2D8 targets. Counts as ALL melee attacks/one full melee. Chance of hitting innocent bystanders is 70%.

## A Special Note About Shotguns:

Shotguns can fire once or twice per melee (double-barreled). It can fire both rounds simultaneously or one at a time. Buckshot scatters, and will strike the specific target plus 1D4 others within its blast area (approximately a 15ft/4.6m area).

**Note:** *Conventional Weapons* will do absolutely NO DAMAGE to Mecha or mega-structures (M.D.C.), even if the combined damage from a burst is over 100 S.D.C. Only weapons that inflict mega-damage (M.D.) can damage a mega-structure.

**No Weapon Proficiency** means the character shoots without bonuses to strike.

**W.P. Gallant H-90:** This is a separate weapon proficiency because of its unique multi-configurations, and damage capabilities.

**W.P. Cyclone Weapon Systems:** This skill is exclusive to the cyclone rider O.C.C. and gives the character a +1 bonus to strike when using any of the standard cyclone weapons. They include the CADS-1 Saber system, EP-37 60mm beam cannon, EP-40 rocket cannon, RL-6 rocket cannon, GR-97 forearm missile launcher, GR-103 mini-missile launcher and missile launcher sidecar.

**W.P. Heavy:** Includes the use of grenade launchers, rocket launchers, the RL-6 rocket cannon, and other bazooka-like weapons.

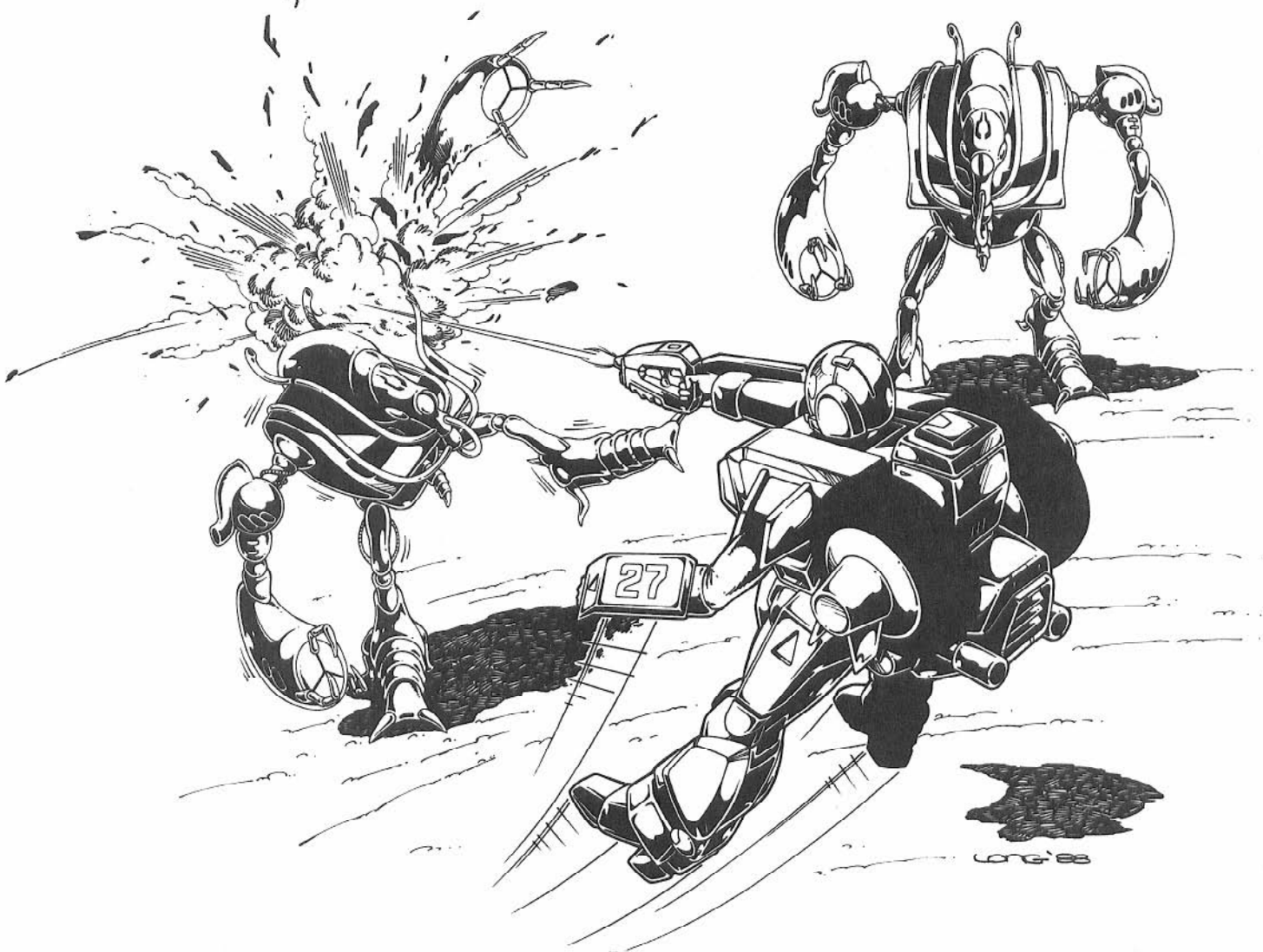

# MECHA COMBAT RULES

The following are the rules that are used when playing mecha. You will find that the basic rules are only minor modifications of the standard, **Palladium Books'** combat rules just described. The use of giant war machines requires some special considerations, modifications and clarification.

## WHAT IS MECHA?

Mecha is the term used to describe the giant, robot, battle armor, and machines used by the humans and Zentraedi aliens. Generally, Mecha are giant, robot-like constructions or armored battle suits, that respond to the pilot's every movement as if the construction was an extension of his or her own body. Weapon systems, such as lasers, auto cannons and missile launchers, are built directly into the Mecha, providing the pilot with more firepower than a dozen tanks.

**Examples of Mecha** include: The Veritech Fighter, which can transform; Destroids/Battloid,s and Zentraedi Battle Pods and Power Armor. For game purposes, the giant sized Zentraedi, 40 to 60 feet tall, will be regarded the same as Mecha in combat.

## RESOLVING COMBAT

The basic steps of resolving combat are essentially unchanged. Players must still determine initiative, roll to strike, defender may parry or dodge, damage is determined, defender may attempt to roll with the

punch or impact. These are always the basic combat actions. See the previous combat descriptions for details. What follows are modifications, additional details, and conditions as they apply to Mecha.

## MEGA-DAMAGE, S.D.C. & M.D.C.

It is crucial that players clearly understand the concept of Mega-Damage and Mega-Damage Capacity (M.D.C.). Basically, M.D.C. indicates a super tough armor or physical structure. A structure so tough, that normal weapons will not damage it. To damage Mega-Damage Capacity (M.D.C.) structure you must use something that inflicts Mega-Damage (M.D.).

Consider this example with a contemporary M.D.C. structure we all recognize, a tank. There you are, sitting inside a tank; a powerful, heavily armored (M.D.C.) weapon. A kid walks up to your tank and begins to bounce a hard rubber ball against the hull of the tank. He can do this all day long without damaging the tank in the tiniest way. The kid picks up a rock and throws it, hard, against the tank. Again, no damage is done other than a tiny nick in the paint. Now, pounding with all his might against the hull with a baseball bat, the kid is scuffing the daylights out of the paint job, but still does *no* damage. Yet, all of these items could affect and damage most items with a normal Structural Damage Capacity (S.D.C.).

You're still sitting in your tank when somebody waltzes up and lets go with a .357 Magnum at point-blank range. The bullets bounce off the tank's armored hull, leaving only large gouges in the paint and scratched armor. No damage is done. His two buddies whip out an Uzi sub-machinegun and an M-16 assault rifle, and spray the tank with a hail of bullets. The combined attack must number into the *hundreds* of S.D.C. damage. But the tank's hull is undamaged because it is super tough . . . M.D.C.! Normal weapons, even when combined, can not damage a mega-structure. Only a weapon that inflicts mega-damage (M.D.) can harm the tank.

A car skreeches to a halt 60ft away. Two men with a heavy duty bazooka take cover behind their compact car. *Now the tank is in trouble!* Why? Because the bazooka is a mega-damage weapon. You think: "Who are all these lunatics in this example and why are they beating on my tank?!" COMBAT: Player of the tank pilot rolls a twenty-sided die (1D20), the player of the bazooka team does likewise, to determine *initiative*. The high roll goes to the bazooka team; they have initiative, which means they strike first. Again, a 1D20 is rolled, this time to *strike*. A seven is rolled. Since the tank is too large and too slow to *dodge* the bazooka team shoots and successfully strike and do damage. If the tank is lucky, it will take minimal damage (a low damage roll). If unlucky, the shell will inflict severe damage (a high roll of damage).

The tank is damaged, but can still operate because the total M.D.C. has not been depleted. As the bazooka team gets ready to fire another shell, it's the tank's turn to strike/counterattack. It aims, and the cannon is fired at the compact car the two men are hiding behind. The car has a Structural Damage Capacity (S.D.C.) of 300 and an Armor Rating (A.R.) of 6. However, the tank's cannon inflicts mega-damage, so the Armor Rating does not apply. A successful roll to strike is quickly followed by a damage roll. The roll is low. A measly 4 M.D. points. The car is a burning mass of twisted metal. Why? Because the 4 M.D. points of damage are equal to 400 S.D.C. The car is destroyed.

#### Quick Mega-Damage and M.D.C. Reference Chart

- 1 M.D. Point equals approximately 100 S.D.C. points.
- 1 M.D. Point equals 100 Hit Points.
- Armor Ratings do *not* apply when up against a weapon that inflicts mega-damage. This is always true!
- Normal weapons do absolutely no damage to mega-structures (M.D.C.), even if the total damage is over 100 S.D.C.
- Only weapons that do M.D. can damage M.D.C.

Also See *Mega-Damage and M.D.C. explanation in the beginning of the book.*

## ARMOR RATING

Armor Ratings do not apply to Mecha or Mega-Damage Capacity (M.D.C.). Either you strike and do damage, or you miss.

Armor Ratings apply only to conventional combat and S.D.C. Armor ratings do *not* apply when struck/attacked by a weapon that inflicts mega-damage. Of course, one can always attempt to dodge or roll with an attack to avoid or minimize damage.

## DETERMINING THE NUMBER OF ATTACKS PER MELEE AND COMBAT BONUSES

All Mecha possess a design element, protoculture, which creates a symbiotic link between the pilot and the machine. This symbiotic relationship enables the Mecha to respond with almost human reflexes, agility, dexterity and mobility. No, the Mecha does not have an I.Q. or will of its own, but the pilot's physical abilities to strike, parry, dodge, roll and attack, *do* combine with the Mecha which can effectively double all hand to hand combat abilities.

This is how it works. Players will find two skills that exclusively determine the Mecha's number of attacks: 1) The pilot's normal, hand to hand combat skill, and 2) The pilot's Mecha Combat skill. Simply combine the number of attacks gained from each skill. The total number indicates the total attacks per melee possible. Most first level pilots, with both skills, will have a total of FOUR attacks per melee.

*The same is done to determine the pilot's/Mecha combat bonuses to strike, parry, dodge, etc. This means, if the pilot has a +2 bonus to dodge in Hand to Hand Combat and a +1 bonus to dodge in Mecha Combat, the two are added together for a total of +3 to dodge. Note:* Attribute bonuses are also applicable and are added to the total bonus to strike, parry or dodge.

**The combining of number of attacks and combat bonuses apply ONLY when piloting Mecha!** When outside of the massive battle armor, the pilot must rely *exclusively* on his or her Hand to Hand skills and *not* the combined abilities of the two skills. Why? Because the Mecha Combat skill is not a physical training, but a mechanical proficiency which relies on eye/hand coordination, reflex and dexterity as they relate directly to the Mecha. The Mecha Combat skill does not build physical strength, endurance or combat techniques.

#### Unskilled Characters and Mecha

If the pilot has only the normal, hand to hand combat skill, those are the exact abilities that apply to the Mecha in combat. There are NO additional bonuses added. A first level character will usually have two attacks per melee.

If the pilot does not have normal hand to hand combat, but *does* have Mecha combat, then he/she possess all of those combat skills and bonuses. Nothing more. A first level character will usually have two attacks per melee.

If the pilot does not have hand to hand combat training nor Mecha combat, he or she is limited to one attack per melee and no special bonuses. **Note:** If the character has any physical attribute bonuses they *are* transferred to the Mecha.

## WEAPON SELECTION

The Mecha pilot usually has several modes of attack available to him. These may include lasers, machineguns, grenade launchers, missiles and hand to hand combat. Weapons or modes of attack, can be used in any combination. You are limited only by the number of attacks per melee and possible, payload and rate of fire restrictions. **For example:** a character piloting a *Gladiator* has five attacks per melee. The character fires a volley of four missiles (attack #1), fires its top laser turret (attack #2), fires a long burst from its auto cannon (attack #3), followed by another long burst from its auto cannon (attack #4), and punches the Zentraedi Battle Pod which has just lunged out from around the corner (attack #5). All this in one melee round or 15 seconds.

Wait a minute, you say. This character has FIVE attacks, but, in the example he fires a volley of four missiles and then continues to attack four more times. Isn't that EIGHT attacks. No; and here's why.

## VOLLEYS & BURSTS

One volley or one burst *counts as one attack*, even if a dozen, yes 12, missiles are launched. How? Because it requires only one attack/action to fire several missiles or rounds, *simultaneously*, at *one* specific target. Roll to strike and dodge as usual.

#### Disadvantages

1. **The entire volley or burst must be directed at ONE specific target.** The character can *not* divide a volley or burst between several targets. To attack more than one target the pilot must take time to aim and fire at each, which means each is a separate attack that melee. **For Example:** A Veritech Fighter is up against four Zentraedi Battle Pods. The pilot decides to launch four of his 12



missiles at *one* Battle Pod. That's one attack, leaving three more that melee. He can *not* fire the four missiles simultaneously at all four of the Pods. To strike all four Pods, the pilot must fire at *each*, individual Pod separately. However, this will take up all four of the pilot's attacks that melee.

2. **Must roll to strike for the entire volley or burst, as if it were one unit.** This generally means that the entire volley or burst, either strikes and does multiple damage (roll for each missile in the volley) or the entire volley misses, doing no damage at all. Do *not* roll to strike for each, individual missile or round. Also see Missiles for related combat data.
3. **Continuous fire of bursts** can often be maintained for the entire melee. While the full melee burst counts as one attack and does significant damage, that particular weapon can not be used against any other targets for that full melee.
4. **Payload:** Volleys and bursts usually deplete a limited number of missiles or rounds quickly. Once the payload is expended, the weapon is temporarily useless.

**Note:** Unless limited by volleys, bursts or other, listed restrictions, the same weapon can be fired repeatedly in the same melee or in tandem with others.

## HOW TO STRIKE

The procedure for ascertaining a strike is unchanged. The attacker rolls a 20 sided die (1D20). A roll of 1, 2, 3, or 4, is an automatic miss. A roll of 6 or higher is a strike/hit.

The only way a target can avoid being struck is by dodging out of the way or parrying the attack, if possible.

Remember, Armor Ratings (A.R.) do not apply to Mecha, or when up against weapons that inflict mega-damage (M.D.).

## STRIKE BONUSES

Bonuses to strike can be gained by skills, such as hand to hand combat and/or Mecha combat and/or from a high Physical Prowess (P.P.) attribute. All bonuses are accumulative. Remember, bonuses from Mecha combat apply only when Mecha is being piloted.

## CRITICAL STRIKE

A critical strike occurs when a player with hand to hand combat skill makes an extremely high die roll to strike without the aid of bonus modifiers. An unmodified "natural" 20 is always a critical hit, regardless of hand to hand training.

Critical strikes do double damage. Optional damage tables have been provided for additional side effects from critical strikes. Their inclusion in the game is up to the GM and/or players.

## CLOSE PROXIMITY STRIKE BONUSES

Technological advances have made war a long- range affair, with soldiers firing missiles at opponents 20 miles away, who appear, as tiny blips on a radar screen. However, the creation of battle armor, such as the Veritech Fighter, Destroids and Battle Pods, has restored the strength of the infantry, making close range combat possible. Thus, if opponents are within close proximity of one another (within 500ft/152m), they gain a bonus of +1 to strike. This bonus applies to all combatants, skilled and unskilled, using weaponry or hand to hand combat with Mecha. It does not apply to normal hand to hand combat among humans.

## CALLED SHOTS

A character may attempt to shoot a specific target or area. This is done by clearly stating what the exact target is before the roll to strike is made. Once the shot is "called", the player rolls the usual 1D20 to strike. A successful roll, above a 12, hits exactly whatever the intended target was, unless the opponent dodges.

Called shots can be an important strategy enabling characters to *disable* Mecha rather than destroy the whole unit. This means a character can destroy specific targets on Mecha and vehicles, such as radar antennas, weapon barrels, sensors, mechanical legs, arms, etc.

**Note:** Any shot which is not called will strike what is identified as the *main body* of the Mecha or vehicle. The main body is the largest, bulkiest part of the target and most likely to be hit. If a player calls his shot, but misses by rolling under 12, but above 4, he/she still strikes, but hits the *main body* instead of the specific, "called" target.

I avoid random hit location tables because I feel the randomness is too fluke and unrealistic.

## TO ROLL WITH A PUNCH, FALL, OR IMPACT

This is a saving throw of sorts, or a second dodge, to minimize damage. Players of Heroes Unlimited will already be familiar with this rule. It is much like the hand to hand combat rule. In this case, if the player fails his dodge to roll and is about to be hit by a missile(s), he has a sort of second dodge or saving throw, where the character tries not to resist the explosive impact and rolls *with* it. A successful roll with impact works like a dodge. The player must roll 1D20 and match or better the roll to strike. A success means the character suffers only half damage. A failed roll means a direct hit doing full damage. In ROBOTECH™, a character can roll with the impact from explosive missiles, punches, body blocks, falls, and similar impact damage.

You can *not* roll with the impact of attacks from auto cannons, machineguns, energy weapons, or plasma/napalm missiles.

## THE DODGE

The dodge for Mecha is identical to its hand to hand counterpart. The defender must roll a twenty-sided die (1D20), and match or better his attacker's roll to strike. A successful roll means he has moved out of the way and takes no damage. A failed roll means the dodge was not a success and the character is hit, taking full damage.

As Mecha pilots, there are some new situations that effect one's ability to dodge. They are as follows:

## DODGING THE BIG GUNS

Pilots of fast moving vehicles, like jets, and Mecha, like Veritech Fighters and Zentraedi Battle Pods, can dodge the massive energy beams and cannon blasts from starships. Since these weapons are designed to strike and destroy large targets, such as massive starships, space stations, and even planets; small, mobile vehicles can avoid them with relative ease.

Veritech Fighters, Jets and Zentraedi Pods are +6.  
All other Mecha and Helicopters are +2 to dodge.

## MISSILES

In translating Japanese text about the Macross T.V. Series, we unearthed a wealth of specific names and numbers for missiles, like the GH-30 or GA-95. It seems the Japanese love to name everything. Unfortunately, hard data regarding range and type of warhead was limited to short, medium, long, and nuclear or "many". Meanwhile,

the producers of the English language, ROBOTECH™ T.V. series (adapted from the Japanese Macross), have added specific labels to the missiles, such as reflex, proton torpedo, plasma torpedo, and so on. To avoid mass confusion, I have broken the missiles into basic, generic types and ranges. This method maintains the integrity of both versions of the animated series and satisfies all game requirements.

The descriptions of war machines in this game, such as the Veritech Fighters, Destroids, Zentraedi Pods and war vehicles, will specifically state if they can launch missiles. It will also denote the type of missile as *short, medium, or long range*. In some cases, a Mecha or vehicle can fire two types of missiles, such as medium *and* long range. Under each range category you will find a selection of specific types of warheads, such as high explosive, fragmentation, plasma, reflex, and so on. Not all missile warheads are of a destructive nature and can be smoke, tear gas or chemical (i.e. fire retardant, and knockout gas). Mecha and vehicles can fire one warhead type, or any combination of missile types, as long as they are listed under the appropriate range category.

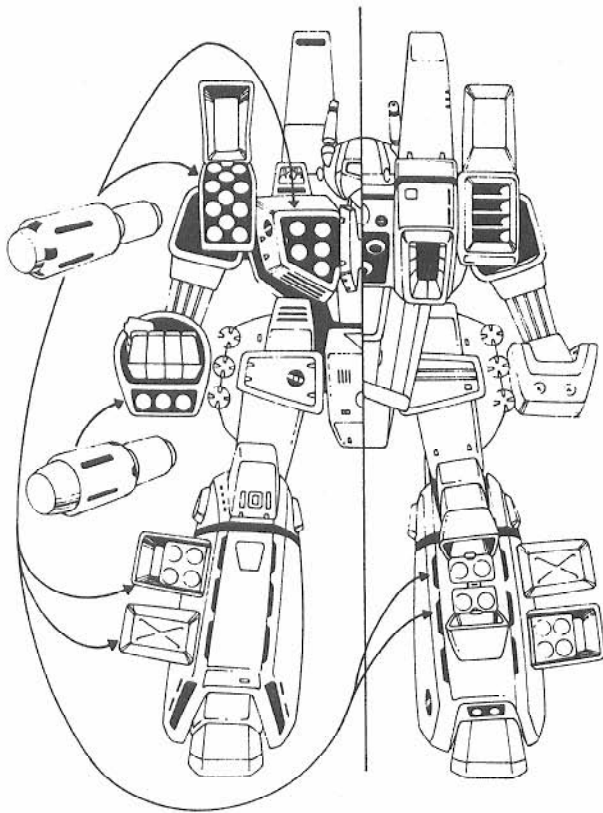

## STRIKES: GUIDED MISSILES

Missiles do not enjoy the pilot's combined bonuses to strike. Since they are all self-guided, missiles are launched as separate units with their own bonus of +3 to strike. Reflex missiles, which are smart bombs, are +5 to strike.

Rolls to strike are made on the usual, twenty-sided die. Missiles can be launched one at a time (roll to strike for each), or in volleys of two or more (roll once to determine whether the entire volley strikes its target).

It is possible to dodge one, two, or even three missiles. However, it is impossible to dodge a volley of four or more missiles. It is also possible to shoot a missile(s) down before it hits you. *See Volleys and Bursts, and Dodging Missiles for more details about missile combat.*

## DAMAGE FROM MISSILE STRIKES

**Direct hits** do full damage. A volley of missiles inflicts full damage from each and every missile in the volley.

**Near misses** do half damage. There are two ways one can take damage from a near miss. **The First** is by being within the blast radius of the target struck by a direct hit. **For example:** Your companion, standing 10ft away, is hit by a high explosive missile with a 30ft blast area. He takes full damage from a direct hit, but you are also caught in the blast because you were standing too close together. Fortunately, your character takes half damage since he was not caught directly in the blast. Damage can be reduced by half again if the player makes a successful die roll to "roll with punch, fall or impact".

**The Second way** one takes half damage from a near miss is by successfully "rolling with the punch, fall or impact" of the attack. In this case, the player fails his dodge roll and is about to be hit by a missile(s). However, he has a sort of second dodge or saving throw, where the character tries not to resist the explosive impact and rolls with the impact. A successful roll with impact works just like a dodge. The player must roll 1D20 and match or better the roll to strike. A successful roll means the character suffers half damage. A failed roll means a direct hit doing full damage.

## DODGING GUIDED MISSILES

**ALL the missiles** used by the Zentraedi Mecha, and most other military forces, are self-guided missiles. Generally, most are preprogrammed to respond to specific images (video camera/sensor mounted in the nose of the warhead), or specific heat or radiation levels which clearly identify the enemy.

**Reflex Warheads** are smart bombs that can identify the enemy and chase it down. Reflex missiles will keep going until they find a target, or are destroyed. They can actually dodge attacks directed at them, and turn around to attempt to hit a target if it misses, or if the target dodges the first attack.

**Conventional Guided Missiles:** +3 to strike.

**Reflex Missiles:** +5 to strike, +4 to dodge; Two attacks per melee (until it hits). All missiles always strike the *main body*.

Contrary to what one might think, you *can* dodge one, two and even three, guided missiles. It happens in the T.V. series all the time. The dodge rules are the same as always. However, it is impossible to dodge a volley of four or more missiles launched simultaneously. A volley of four or more missiles will strike every time, with each and every missile in the volley hitting and inflicting damage. The character has two options to avoid or minimize the damage of a massive missile volley; try to roll with the impact, taking half the normal damage; or shoot the missiles down before they strike.

## SHOOTING MISSILES

Shooting and depleting the M.D.C. of a missile can detonate and destroy it. However, there are restrictions.

1. The character must have an attack(s) available to him/her that melee to assail the missile. If all the attacks for that melee have already been used up, the character can not shoot at the missile(s).
2. Can only shoot at *one* missile, within the volley, at a time. A volley of six missiles would require six attacks, which is impossible at the speed missiles travel. This means the player has only one or two attacks (GM's discretion) to shoot at one or two missiles within the volley. However, if one missile is detonated, there is a 45% chance (1-45%) that its explosion will detonate the other missiles in the entire volley.

The player can also use his own missiles, if available, to shoot down a missile volley. Under this circumstance, there is a 75%

(1-75%) likelihood of detonating the entire volley of missiles.

3. If the M.D.C. of the missile is not completely depleted, it is damaged, but does not detonate and will still strike its target, inflicting full damage.
4. Attacks on a missile count as a normal attack.

## SPECIAL MISSILE DEFENSE TACTIC

If a missile can not be dodged, the Mecha can sacrifice its arms by covering its main body with them, thus allowing the arms to take the damage instead of the body. The disadvantage of this tactic is that the arms are likely to be blown to smithereens. If the arms are not destroyed, I strongly suggest the GM, or player, rolls on the *Optional Critical Damage Tables* under "arms", to determine specific damage and side effects.

## OTHER COMBAT TERMS

**Payload:** Indicates the finite number of missiles or rounds. Energy weapons are generally considered to have unlimited payload.

**Range:** The maximum effective range or distance a weapon can fire; or a missile or vehicle can travel.

**Rate of Fire:** This will indicate any limitations as to how many times a weapon can be fired pre melee, and/or the number of rounds or missiles in a burst or volley.

Generally, a weapon, especially energy weapons, can be fired repeatedly, equal to the pilot's combined, hand to hand and Mecha combat skills. Any combination of weapons can be used per melee.

## MISSILE NOTES

1. **The terms**, light, med. or medium and heavy, found in parenthesis after the warhead type, refers to the destructive force of the warhead.
2. **All missiles** are self-guided; +3 to strike.
3. **Reflex missiles** are self-guided smart bombs which can be programmed to seek out and attack a specific target. It can change course, adjust speed to conserve fuel, dodge attacks aimed at it, and turn around to try to strike a target again if it misses the first time. +5 to strike (instead of +3), +4 to dodge; 2 attacks per melee. Radar 100 mile range.
4. **Multi-warhead missiles** are usually a cluster of medium range missiles housed inside the casing of a large, long range missile. When the body casing runs out of fuel or reaches its target, it fires the four medium range missiles.
5. **Plasma** is a new, concentrated, liquid heat, ten times hotter than normal napalm.
6. **Fragmentation** missiles are missiles that send out fragments, or shards of metal, upon impact, affecting a larger area.
7. **Fire Retardant missiles** explode, releasing a chemical foam that puts out fires.
8. **Smoke missiles** release large, billowing clouds of smoke, filling the blast radius. They are used to provide cover or to mark an area.
9. **A Proton Torpedo** is a longer range, more powerful, explosive, energy missile.
10. **The maximum** range is the maximum effective range of the missile.
11. Missiles have been assigned a **M.D.C.**; depletion of the M.D.C. from attack will detonate the missile.
12. **The speed** is provided to give players an idea of how fast the missiles travel.
13. **The blast radius** is the full area damaged by the missile impact. The specific target of the missile takes **FULL DAMAGE**, while all else in the blast radius takes half damage.

## MINI-MISSILES

The only real difference is the inclusion of **mini-missiles**. The cyclones and some special REF heavy weapons and vehicles utilize mini-missiles; small, powerful bazooka type rockets that inflict mega-damage. Range is generally half as great as the standard RDF short-range missiles, but the mega-damage is comparable.

Unlike its larger predecessors, the mini-missile is not self-guided and has no special bonuses to strike. **Strike bonuses** are the same as *modern weapon proficiencies*; **aimed** (firing no more than two missiles, +3), **bursts** (firing a volley of missiles in any quantity, 3 to 60) and **wild** (firing a missile or volley of missiles without taking time to stop and aim). A character can also add in any strike bonus from a high Physical Prowess (P.P.) attribute.

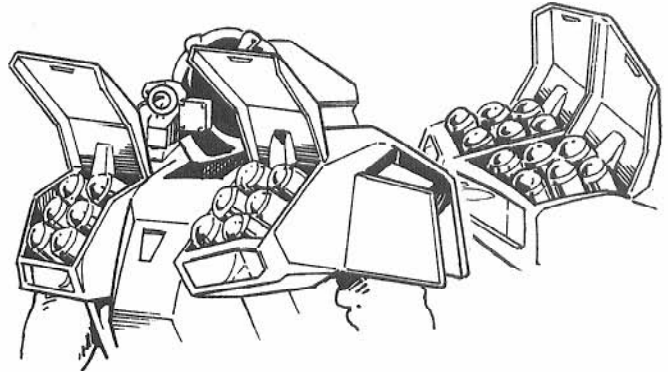

## MECHA IN SPACE

A good number of conflicts are likely to occur in space. Consequently, the following rules and modifications apply.

### Veritechs, Missiles, and Laser Beams

Without an atmosphere to slow them down, veritech fighters, missiles, invid, and other *jet propelled* vehicles can travel about 75% faster than they can in an atmosphere. Most of the space worthy vehicles found in Sentinels will present a "space propulsion" data block. For the RDF veritechs and those without this information, it's safe to assume the item rockets 75% faster. This does not apply to running speeds. The weightlessness of space will make running impossible. And while leaps can be 10 times longer, they are done in slow motion.

Lasers, amplified light energy, will have its normal range doubled; 4000ft range is increased to 8000ft (2438m) effective range.

### Destroid Space Propulsion System

A special propulsion system has been devised for Destroids, the *Space Maneuvering and Propulsion Pack*. It is only useful in the zero G vacuum of space. The large, bulky propulsion unit can be bolted to the back of any destroid *except* the M.A.C. II. Forward movement at *top speed* is limited to a mere **mach one (670mph/1070kmph)**; weight: 1.8 tons; M.D.C.: 110.

*Changing direction with the space pack* requires an ability that only destroids have, the legs can pivot independently from the body. In a free-fall condition, pivoting the legs clockwise will ALWAYS twist the body counterclockwise, and vice versa. Thus, piloting to the left requires one to spin his legs to the right, and hitting the gas.

The destroids also have special electromagnets built into the bottom of their feet that help them stay attached to ships when firing missiles. The magnets lock it in place to prevent any possible kickback. This does **NOT** give destroids the ability to walk up walls, but will anchor them to floors when switched on.



## Spacecraft and Mega-Lasers

Many of the spacecraft, human and alien, have heavy missiles, mega-lasers, and other energy weapons that inflict mind boggling amounts of damage, like the forward laser of the Ikazuchi carriers or main cannons of the SDF-3. These weapons are designed to be anti-spacecraft measures or planetary assault weapons that inflict thousands of points of mega-damage. While they are a serious threat to other spacecraft, they are easily avoided by the comparatively tiny mecha, one person fighters. Consequently the "big" guns are seldom used against mecha. To do so would be like trying to kill a fly with a howitzer. The small fighters can easily avoid/dodge the massive blast leveled at them.

Instead, other equally small fighters are swiftly released to engage the tiny enemy; whether it be alphas or battle pods, betas or invad shock troopers. The combination of devastating long-range weapons and extremely mobile, high-powered, close combat mecha, creates a extremely effective and versatile combat force.

The following tables apply only to the use of the big super weapons of the space cruisers.

Bonuses to strike apply when the target is especially large, 1000 feet (350m) or bigger. The skill and expertise of the operator does not apply to the heavy armaments of the giant warships.

Penalties to strike apply when the target is especially small, 990 feet (301m) or smaller. The big guns of the Zentraedi battle cruisers are not designed for use against tiny adversaries.

## BONUS AND PENALTY TABLE

Bonus or Penalty To Strike	Target's Approximate Size
+14	20,000ft (6096m) or larger.
+10	10,000ft (3048m) to 19,990ft (6090m)
+6	5000ft (1524m) to 9990ft (3045m)
+4	2000ft (609m) to 4990ft (1520m)
+1	1000ft (304.8m) to 1990ft (600m)
-4	400ft (122m) to 990ft (301m)
-8	150ft (45.7m) to 390ft (119m)
-12	140ft (42.6m) or smaller (Veritech Fighters are only around 45ft (13.7m) and extremely difficult to hit).

**Note:** All small spacecraft/mecha/vehicles (990ft or smaller) get an automatic dodge against large energy blasts/volleys.

## A MODIFIED DODGE FOR LARGE VESSELS

Large vessels, 1000ft or bigger, can not dodge or move completely out of the path, but may be able to maneuver enough to avoid full impact. The roll to dodge is unchanged. The defender must roll a 20 sided die (1D20), and match or better his attacker's roll to strike. A **failed roll** to dodge means the vessel takes full damage. A **successful roll** to dodge means the vessel is able to maneuver away enough to be struck by a glancing blow, taking only *one third* the normal damage.

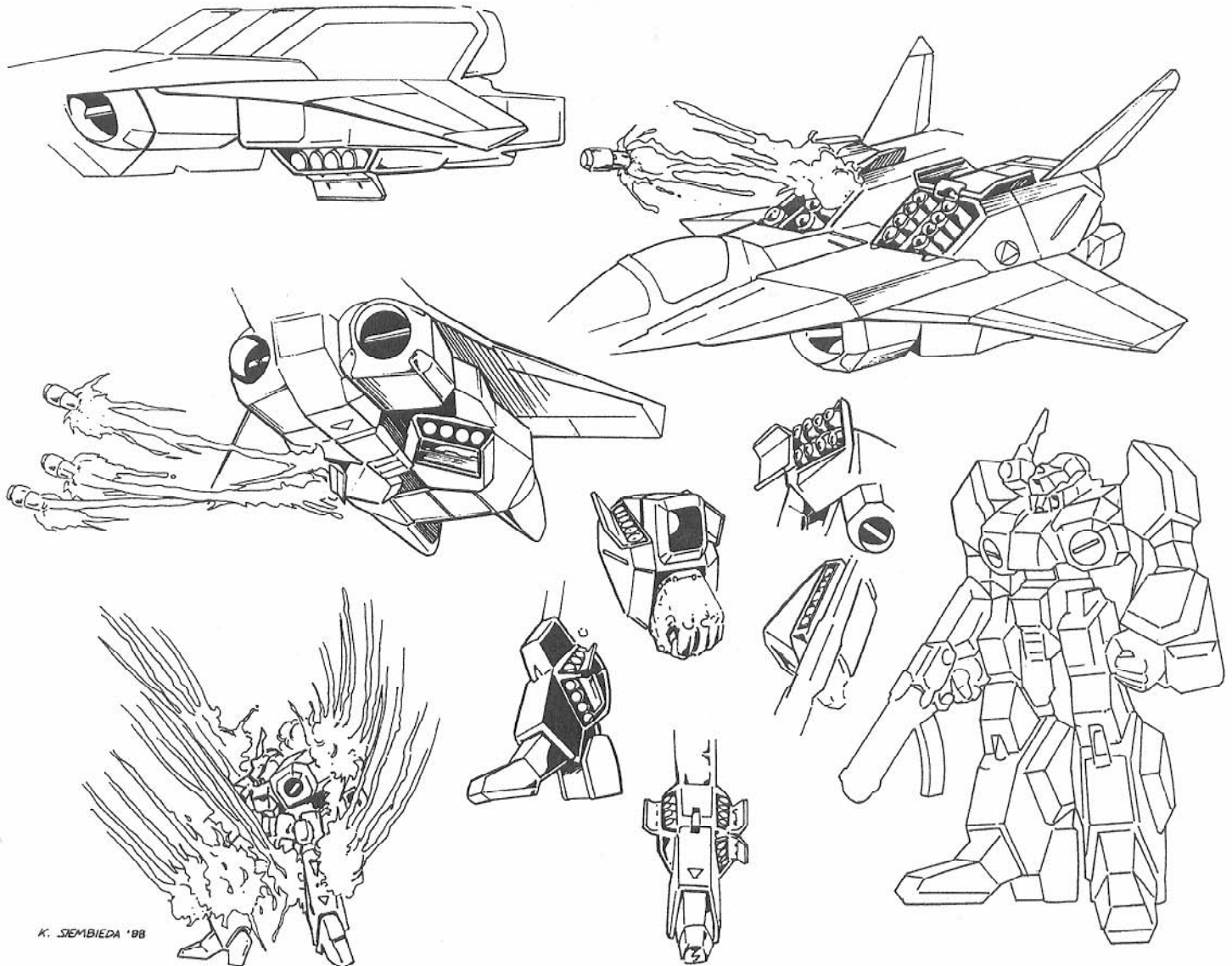

K. SIEMBIEDA '88

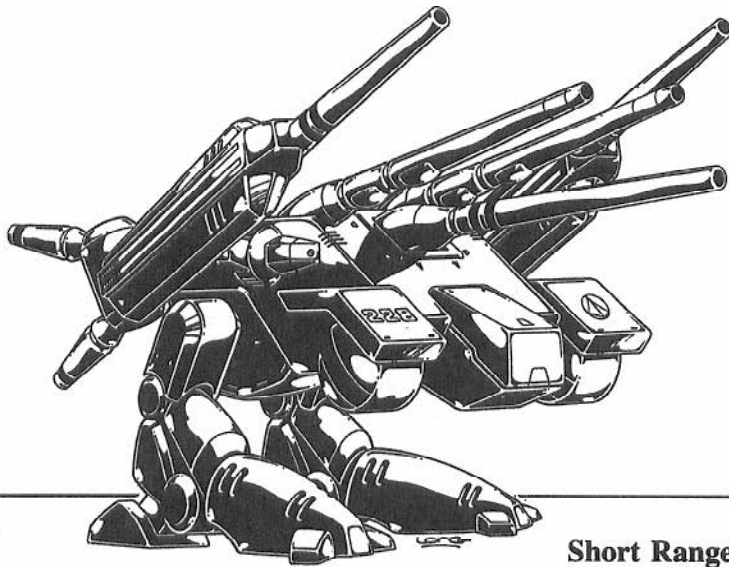

## MISSILES RANGES WARHEADS DAMAGE

### Short Range Missiles

<u>Warhead</u>	<u>Mega-Damage</u>	<u>Speed</u>	<u>Maximum Range</u>	<u>Blast Radius</u>	<u>M.D.C.</u>
High Explosive (light)	1D4 × 10	500mph (804kmph)	3 miles (4.8km)	10ft (3m)	5
High Explosive (Med.)	1D6 × 10	500mph (804kmph)	2 miles (3.2km)	15ft (4.6m)	5
Fragmentation (light)	1D4 × 10	450mph (724kmph)	2 miles (3.2km)	20ft (6.1m)	5
Armor Piercing (Med.)	1D6 × 10	650mph (1045kmph)	5 miles (8km)	5ft (1.5m)	5
Plasma/Napalm (Med.)	1D6 × 10	500mph (804kmph)	3 miles (4.8m)	15ft (4.6m)	5
Tear Gas	None	200mph (321kmph)	½ mile (.8km)	10ft (3m)	5
Knock-Out Gas	None	200mph (321kmph)	½ mile (.8km)	10ft (3m)	5
Smoke (colors available)	None	300mph (482.7kmph)	1 mile (1.6km)	20ft (6.1m)	5
Fire Retardent	None	200mph (321kmph)	½ mile (.8km)	20ft (6.1m)	5

### Medium Range Missiles

<u>Warhead</u>	<u>Mega-Damage</u>	<u>Speed</u>	<u>Maximum Range</u>	<u>Blast Radius</u>	<u>M.D.C.</u>
High Explosive (light)	1D6 × 10	1200mph (1929kmph)	50 miles (80.4km)	20ft (6.1m)	10
High Explosive (Med.)	2D4 × 10	1200mph (1929kmph)	40 miles (64.3km)	20ft (6.1m)	10
High Explosive (Heavy)	2D6 × 10	1200mph (1929kmph)	40 miles (64.3km)	30ft (9.1m)	10
Fragmentation (Med.)	2D4 × 10	1000mph (1608kmph)	40 miles (64.3km)	40ft (12.2m)	10
Armor Piercing (Med.)	2D4 × 10	1600mph (2571kmph)	60 miles (80.4km)	20ft (6.1m)	10
Plasma/Heat (Heavy)	2D6 × 10	1400mph (2251kmph)	40 miles (64.3km)	40ft (12.2m)	10
Multi-Warhead	2D4 × 10	1200mph (1929kmph)	80 miles (128.7km)	20ft (6.1m)	10
Smoke	None	1000mph (1608kmph)	40 miles (64.3km)	40ft (12.2m)	10

### Long Range Missiles

<u>Warhead</u>	<u>Mega-Damage</u>	<u>Speed</u>	<u>Maximum Range</u>	<u>Blast Radius</u>	<u>M.D.C.</u>
High Explosive (Med.)	2D4 × 10	1600mph (2571kmph)	500 miles (804km)	30ft (9.1m)	20
High Explosives (Heavy)	3D4 × 10	1600mph (2571kmph)	500 miles (804km)	40ft (12.2m)	20
Fragmentation (Heavy)	3D4 × 10	1400mph (2251kmph)	400 miles (643km)	80ft (24.4m)	20
Armor Piercing (Med.)	2D4 × 10	2010mph (Mach 3)	800 miles (1286km)	30ft (9.1m)	20
Plasma/Heat (Med.)	2D6 × 10	1400mph (2251kmph)	500 miles (804km)	40ft (12.2m)	20
Plasma/Heat (Heavy)	3D6 × 10	1400mph (2251kmph)	500 miles (804km)	50ft (15.2m)	20
Proton Torpedo (Heavy)	4D6 × 10	2010mph (Mach 3)	1200 miles (1928km)	50ft (15.2m)	25
Reflex (Med.)	2D6 × 10	1800mph (2892kmph)	1000 miles (1608km)	40ft (12.2m)	20
Reflex (Heavy)	3D6 × 10	1800mph (2892kmph)	1000 miles (1608km)	50ft (15.2m)	20
Reflex Multi-Warhead	4D6 × 10	1800mph (2892km)	1800 miles (2893km)	50ft (15.2m)	25

### Mini Missiles for the Cyclone and Special Armaments

<u>Warhead</u>	<u>Mega-Damage</u>	<u>Speed</u>	<u>Maximum Range</u>	<u>Blast Radius</u>
High Explosive	5D6	500mph (804kmph)	1 mile (1.6km)	5ft (1.5m)
Fragmentation	5D6	500mph (804kmph)	½ mile (0.8km)	20ft (6.1m)
Armor Piercing	1D4 × 10	1400mph (2251kmph)	1 mile (1.6km)	3ft (0.9m)
*Plasma/Heat	1D6 × 10	1200mph (1929kmph)	1 mile (1.6km)	15ft (1.5m)
Smoke	None	500mph (804kmph)	20ft (6.1m)	

\*Plasma/heat can only be used in the GR-97 forearm missile launcher of the Cyclone Battler.

# THE NEW ROBOTECH DEFENSE FORCE DESTROIDS AND MECHA COMBAT BONUSES

**Note:** The original Macross Destroids' combat bonuses can be found in the *Robotech RPG: Book One*. Southern Cross Mecha can be found in *Book Four: Southern Cross*.

## HAND TO HAND BONUSES FROM DESTROID BASIC COMBAT TRAINING

- Pilot all Destroids *except* Zentraedi models.
- One hand to hand attack per melee (plus those of the pilot)
- Body block/tackle/ram — 1D6 M.D. plus a 50% chance of knocking opponent down (this will cause the victim to lose initiative and one attack that melee). Counts as TWO attacks.
- No body flip
- No kick
- +1 to strike at second level
- +1 to parry at second level
- No dodge
- +1 to roll with punch, fall or impact (explosion), reducing damage by half.
- Critical strike same as pilot's hand to hand.
- One additional hand to hand attack at level six.
- One additional hand to hand attack at level twelve.

**Damage:** Standard per each specific destroid.

**Note:** Training in a *specific* Destroid will get the character the full range of bonuses and abilities possible from that mecha. Basic training is just a rudimentary knowledge of piloting destroids with little actual piloting time.

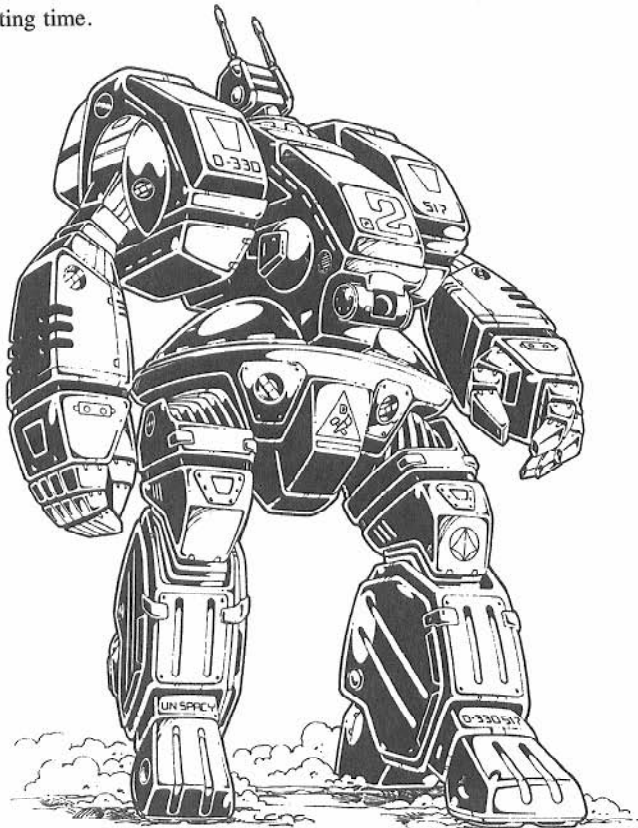

## HAND TO HAND BONUSES FROM EXCALIBUR COMBAT TRAINING

- Two hand to hand attacks per melee (plus those of the pilot).
- Body flip/throw — 1D4 M.D. plus victim loses initiative and one attack that melee.
- Body block/tackle/ram — 1D6 M.D. plus a 75% chance of knocking opponent down (this will cause the victim to lose initiative and one attack that melee). Counts as TWO attacks.
- Kick attack
- +1 to strike
- +2 to parry (P-Beam cannon arm can be used to parry)
- +2 to dodge
- +2 to roll with punch, fall, or impact (explosion), reducing damage by half.
- Critical strike same as pilot's hand to hand.
- One additional hand to hand attack at level six.
- One additional hand to hand attack at level eleven.

**Damage:** **Restrained Punch** — 1D4 M.D.

**Full Strength Punch** — 2D4 M.D.

**Kick** — 1D6 M.D.

**Leap Kick** — 2D6 M.D. (counts as two attacks)

**Body Flip** — 1D4 M.D.

**Body Tackle** — 1D6 M.D.

**Stomp** — 1D4 M.D.; effective only against small objects (12ft/3.6m tall or smaller).

Remember, these bonuses are in addition to the pilot's own hand to hand training and attribute bonuses. They do *not* apply to the pilot's physical abilities outside the mecha.

## HAND TO HAND BONUSES FROM GLADIATOR COMBAT TRAINING

- Three hand to hand attacks per melee (plus those of the pilot).
- Body flip/throw — 1D4 M.D. plus victim loses initiative and one attack that melee.
- Body block/tackle/ram — 2D4 M.D. plus a 76% chance of knocking opponent down (this will cause the victim to lose initiative and one attack that melee). Counts as TWO attacks.
- Kick attacks
- +1 to strike
- +3 to parry
- +2 to dodge
- +2 to roll with punch, fall, or impact (explosion), reducing damage by half.
- Critical strike same as pilot's hand to hand.
- One additional hand to hand attack at level five.
- One additional hand to hand attack at level ten.

**Damage:** **Restrained Punch** — 1D4 M.D.

**Full Strength Punch** — 2D6 M.D.

**Power Punch** — 3D6 + 4 M.D.

**Tear or Pry with Hands** — 1D6 M.D.

**Kick** — 1D6 M.D.

**Leap Kick** — 3D6 M.D.

**Body Flip/Throw** — 1D4 M.D.

**Body Block/Tackle** — 2D4 M.D.

**Stomp** — 1D4 M.D.; effective only against small objects (12ft/3.6m tall or smaller).

Remember, these bonuses are in addition to the pilot's own hand to hand training and attribute bonuses. They do *not* apply to the pilot's physical abilities outside the mecha.



## HAND TO HAND BONUSES FROM M.A.C. III COMBAT TRAINING

- Two hand to hand attacks per melee (plus those of the pilot).
- Body flip is impossible.
- Body block/tackle/ram — 2D6 M.D. plus an 82% chance of knocking opponent down (this will cause the victim to lose initiative and one attack that melee). Counts as TWO attacks.
- Kick attack is impossible
- +1 to strike
- +1 to parry
- No roll with fall or impact bonus.
- Critical strike same as the pilot's hand to hand.
- One additional attack at level six.
- One additional attack at level eleven.

**Damage:** **Bunt or swatting blow** — 1D6 M.D.

**Body Block** — 2D6 M.D.

**Stomp** — 3D4 M.D.; effective only against small objects (18ft/5.4m tall or smaller).

Remember, these bonuses are in addition to the pilot's own hand to hand training and attribute bonuses. They do *not* apply to the pilot's physical abilities outside the mecha.

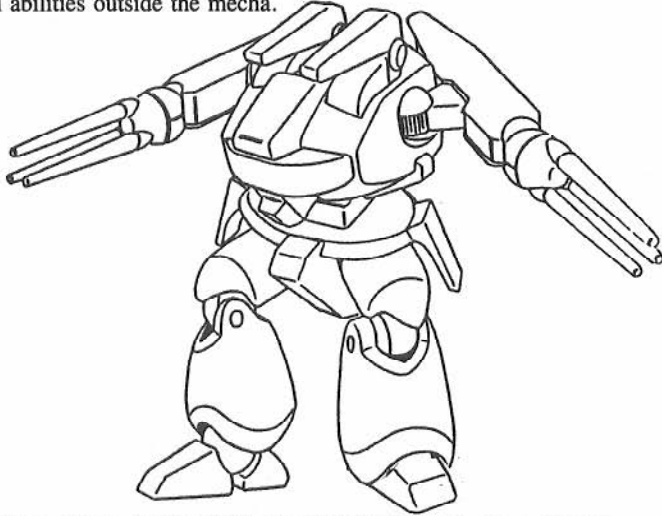

## HAND TO HAND BONUSES FROM RAIDAR X COMBAT TRAINING

- Two hand to hand attacks per melee (plus those of the pilot)
- Body flip is not possible.
- Body block/tackle/ram — 1D6 M.D. plus a 65% chance of knocking opponent down (this will cause the victim to lose initiative and one attack that melee). Counts as TWO attacks.
- Kick attacks
- +1 to strike
- +1 to parry
- +2 to dodge
- +2 to roll with punch, fall or impact (explosion), reducing damage by half.
- Critical strike same as pilot's hand to hand.
- One additional hand to hand attack at level six.
- One additional hand to hand attack at level eleven.

**Damage:** **Swatting Blow** — 1D6 M.D.

**Kick** — 1D6 M.D.

**Leap Kick** — 2D6 M.D. (counts as 2 attacks)

**Body Block** — 1D6 M.D.

**Stomp** — 1D4 M.D.; effective only against small objects (12ft/3.6m tall or smaller).

Remember, these bonuses are in addition to the pilot's own hand to hand training and attribute bonuses. They do *not* apply to the pilot's physical abilities outside the mecha.

## HAND TO HAND BONUSES FROM SPARTAN COMBAT TRAINING

- One hand to hand attack per melee (plus those of the pilot).
- Body flip is not possible.
- Body block/tackle/ram — 1D6 M.D. plus a 60% chance of knocking opponent down (this will cause the victim to lose initiative and one attack that melee).
- Kick attack (no leap kick possible)
- +1 to strike
- +1 to parry
- +1 to dodge
- +1 to roll with punch, fall, or impact (explosion), reducing damage by half.
- Critical strike same as pilot's hand to hand.
- One additional hand to hand attack at level five.
- One additional hand to hand attack at level ten.

**Damage:** **Punch with retractable arm** — 1D4 M.D.

**Kick** — 1D6 M.D.

**Body block/tackle** — 1D6 M.D.

**Stomp** — 1D4 M.D.; effective only against small objects (12ft/3.6m tall or smaller).

Remember, these bonuses are in addition to the pilot's own hand to hand training and attribute bonuses. They do *not* apply to the pilot's physical abilities outside the mecha.

## HAND TO HAND BONUSES FROM BATTLE POD COMBAT TRAINING

- Two hand to hand attacks per melee (plus those of the pilot).
- Body flip/throw — 1D4 M.D. plus victim loses initiative and one attack that melee.
- Body block/tackle/ram — 1D6 M.D. plus a 72% chance of knocking opponent down (this will cause the victim to lose initiative and one attack that melee).
- Kick attack
- Leap kick
- +1 to strike
- +1 to parry
- +3 to dodge
- +5 to roll with punch, fall, or impact (explosion), reducing damage by half.
- Critical strike same as pilot's hand to hand.
- One additional hand to hand attack at level five.
- One additional hand to hand attack at level ten.

**Damage:** **Restrained punch** — 1D4 M.D.

**Full Strength Punch** — 2D4 M.D.

**Kick** — 1D6 M.D.

**Leap Kick** — 3D6 M.D. (counts as 2 attacks)

**Body flip/throw** — 1D4 M.D.

**Body block/tackle** — 1D6 M.D.

**Stomp** — 1D4 M.D.; effective only against small objects (12ft/3.6m tall or smaller).

Remember, these bonuses are in addition to the pilot's own hand to hand training and attribute bonuses. They do *not* apply to the pilot's physical abilities outside the mecha.

**Note:** Training in Zentraedi Battle Pods is not part of the Destroid pilot's standard training. It can be selected as an "other" skill (but counts as TWO skill selections).

## HAND TO HAND BONUSES FROM OFFICER'S POD COMBAT TRAINING

- Two hand to hand attacks per melee (plus those of the pilot).
- Body flip not possible.
- Body block/tackle/ram — 1D6 M.D. plus a 72% chance of knocking opponent down (this will cause the victim to lose initiative and one attack that melee). Counts as TWO attacks.
- Kick attack (leap kick is not possible).
- +1 to strike
- +2 to parry
- +2 to dodge
- +3 to roll with punch, fall or impact (explosion), reducing damage by half.
- Critical strike same as pilot's hand to hand.
- One additional hand to hand attack at level six.
- One additional hand to hand attack at level twelve.

**Damage: Restrained Punch** — 1D4 M.D.

**Full Strength Punch** — 2D6 M.D.

**Kick** — 1D6 M.D.

**Body block/tackle** — 1D6 M.D.

**Stomp** — 1D6 M.D.; effective only against small objects (12ft/3.6m tall or smaller).

Remember, these bonuses are in addition to the pilot's own hand to hand training and attribute bonuses. They do *not* apply to the pilot's physical abilities outside the mecha.

**Note:** Training in Zentraedi Battle Pods is not part of the Destroid Pilot's standard training. It can be selected as an "other" skill (but counts as TWO skill selections).

## HAND TO HAND BONUSES FROM CYCLONE BASIC TRAINING

This category applies to all characters who were not officially trained by the RDF, Southern Cross or Expeditionary Force in mecha combat.

- One hand to hand attack per melee (plus those of the pilot).
- Body flip/throw: 1D4 M.D. plus victim loses initiative and one attack that melee. Possible in battloid mode only.
- Body block/tackle/ram: 1D4 M.D. plus a 60% chance of knocking opponent down (this will cause the victim to lose initiative and one attack that melee). Counts as TWO attacks.
- Kick attack.
- Leap attack; counts as two attacks.
- +1 to strike.
- +1 to parry.
- +1 to leap dodge. An automatic dodge just like the parry, with no loss of attacks per melee.
  - +2 to dodge. This is the regular type of dodge applicable when in motorcycle mode.
- +2 to roll with punch, fall or impact (explosion), reducing damage by half.
- Critical strike same as pilot's hand to hand.
- One additional hand to hand attack at level six.
- One additional hand to hand attack at level eleven.

**Damage: Punch** 1D4 M.D.

**Kick** 1D4 M.D.

**Leap Kick** 2D4 M.D.

**Body Flip/Throw** 1D4 M.D.

**Body Block/Tackle** 1D4 M.D.

Remember, these bonuses are in addition to the pilot's own hand to hand training and attribute bonuses, and apply **ONLY** when piloting a

cyclone in battloid mode. These mecha combat bonuses do *not* apply to the pilot's physical abilities when outside the mecha. **Note:** Changing modes counts as one attack/action that melee round.

## HAND TO HAND BONUSES FROM CYCLONE COMBAT TRAINING

- 2 hand to hand attacks per melee (plus those of the pilot).
- Body flip/throw: 1D4 M.D. plus victim loses initiative and one attack that melee. Possible only in battloid mode.
- Body block/tackle/ram: 1D4 M.D. plus 70% chance of knocking opponent down (this will cause the victim to lose initiative and one attack that melee). Counts as TWO attacks.
- Kick attack.
- Leap kick; counts as two attacks.
- +1 to strike.
- +2 to parry.
- +3 to leap dodge. An automatic dodge just like the parry, with no loss of attacks per melee. The cyclone is so mobile that the pilot can leap, hop, and skip out of the way without penalty.
- +3 to dodge. This is the regular type of dodge, applicable when in motorcycle mode.
- +3 to roll with punch, fall or impact (explosion), reducing damage by half.
- Critical strike, same as pilot's hand to hand.
- One additional hand to hand attack at level five.
- One additional hand to hand attack at level ten.

**Damage: Punch** 1D4 M.D.

**Kick** 1D4 M.D.

**Leap Kick** 2D4 M.D.

**Body Flip/Throw** 1D4 M.D.

**Body Block/Tackle** 1D4 M.D.

The Cyclone also has a physical strength (P.S.) equal to P.S. 40 (+25 S.D.C. damage bonus).

**NOTE:** The VR-038-LT (Light Combat) cyclone enjoys the following *additional bonuses:*

- +1 to parry
- +1 to leap dodge (automatic)
- +1 to dodge in motorcycle mode
- +1 to roll with punch, fall or impact
- +1 on initiative.

P.S. of the VR-038-LT is equal to P.S. 30.

Remember, these bonuses are in addition to the pilot's own hand to hand training and attribute bonuses, but apply **ONLY** when piloting a cyclone in battloid mode. These mecha combat bonuses do *not* apply to the pilot's physical abilities when outside the mecha. **Note:** Changing modes counts as one attack/action that melee round.



## HAND TO HAND BONUSES FROM ALPHA BASIC TRAINING

This category applies to all characters who were not formally trained by the RDF, Southern Cross or Expeditionary Force in mecha combat.

- One hand to hand attack per melee (plus those of the pilot).
- Body flip/throw: 1D4 M.D. plus victim loses initiative and one attack that melee. Possible only in battloid mode.
- Body block/tackle/ram: 1D4 M.D. plus a 60% chance of knocking opponent down (this will cause the victim to lose initiative and one attack that melee.) Counts as TWO attacks.
- Kick attack.
- Leap attack; counts as two attacks.
- +1 to strike.
- +1 to parry.
- +1 to dodge in battloid and guardian modes, +3 to dodge in jet mode.
- +2 to roll with punch, fall, or impact (explosion), reducing damage by half.
- Critical strike, same as pilot's hand to hand.
- One additional hand to hand attack at level seven.
- One additional hand to hand attack at level twelve.

**Damage:** **Punch** 1D6 M.D. in battloid.

**Punch** 1D4 M.D. in guardian.

**Kick** 1D6 M.D. (possible only in battloid).

**Leap Kick** 2D6 M.D. (possible only in battloid).

**Body Flip/Throw** 1D6 M.D.

**Body Block/Tackle** 1D6 M.D.

**Stomp** 1D4 M.D. in Battloid; effective only against small objects (12ft/3.6m tall or smaller).

Remember, these bonuses are in addition to the pilot's own hand to hand training and attribute bonuses. These mecha combat bonuses do *not* apply to the pilot's physical abilities when outside the mecha.

## HAND TO HAND BONUSES FROM ALPHA COMBAT TRAINING

- 3 hand to hand attacks per melee (plus those of the pilot).
- Body flip/throw: 1D4 M.D. plus victim loses initiative and one attack that melee. Possible only in battloid mode.
- Body block/tackle/ram: 1D6 M.D. plus a 70% chance of knocking opponent down (this will cause the victim to lose initiative and one attack that melee). Counts as TWO attacks.
- Kick attack.
- Leap kick; counts as two attacks.
- +2 to strike.
- +2 to parry.
- +3 to dodge in battloid & guardian modes; +5 to dodge in jet mode (this is a conventional dodge).
- +3 to roll with punch, fall or impact (explosion), reducing damage by half.
- Critical strike, same as pilot's hand to hand.
- One additional hand to hand attack at level six.
- One additional hand to hand attack at level eleven.

**Damage:** **Punch** 1D6 M.D. in battloid.

**Punch** 1D4 M.D. in guardian.

**Kick** 1D6 M.D. (possible only in battloid).

**Leap Kick** 2D6 M.D. (possible only in battloid).

**Body Flip/Throw** 1D6 M.D.

**Body Block/Tackle** 1D6 M.D.

**Stomp** 1D4 M.D. in Battloid

Remember, these bonuses are in addition to the pilot's own hand to hand training and attribute bonuses. These mecha combat bonuses do *not* apply to the pilot's physical abilities when outside the mecha.

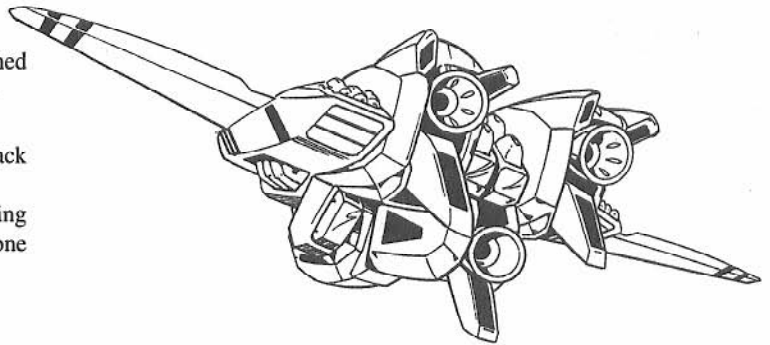

## HAND TO HAND BONUSES FROM BETA BASIC TRAINING

This category applies to all characters who were not formally trained by the RDF, Southern Cross or Expeditionary Force in mecha combat.

- One hand to hand attack per melee (plus those of the pilot).
- Body flip/throw: 1D4 M.D. plus victim loses initiative and one attack that melee. Possible only in battloid mode.
- Body block/tackle/ram: 1D4 M.D. plus a 60% chance of knocking opponent down (this will cause the victim to lose initiative and one attack that melee.) Counts as TWO attacks.
- Kick attack.
- +1 to strike.
- +2 to parry.
- +1 to dodge in battloid and guardian mode, +3 to dodge in jet mode.
- +1 to roll with punch, fall, or impact (explosion), reducing damage by half.
- Critical strike same as pilot's hand to hand.
- One additional hand to hand attack at level seven.
- One additional hand to hand attack at level thirteen.

**Damage:** **Punch** 1D6 M.D. in battloid.

**Punch** is not possible in guardian (no arms).

**Kick** 1D6 M.D. (possible only in battloid).

**Leap Kick** is not possible.

**Body Flip/Throw** 1D6 M.D.

**Body Block/Tackle** 1D6 M.D.

**Stomp** 1D4 in Battloid

Remember, these bonuses are in addition to the pilot's own hand to hand training and attribute bonuses. These mecha combat bonuses do *not* apply to the pilot's physical abilities when outside the mecha.

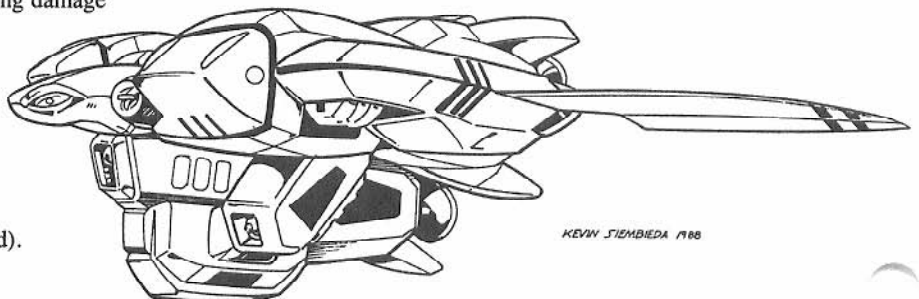

KEVIN SIEMBIEDA 1988



## HAND TO HAND BONUSES FROM BETA COMBAT TRAINING

- 2 hand to hand attacks per melee (plus those of the pilot).
- ▶ Body flip/throw: 1D4 M.D. plus victim loses initiative and one attack that melee. Possible only in battloid mode.
- Body block/tackle/ram: 1D6 M.D. plus a 73% chance of knocking opponent down (this will cause the victim to lose initiative and one attack that melee). Counts as TWO attacks.
- Kick attack.
- +1 to strike.
- +3 to parry. Can use arm shield to block missile attacks.
- +2 to dodge in battloid & guardian modes; +4 to dodge in jet mode (this is a conventional dodge).
- +2 to roll with punch, fall or impact (explosion), reducing damage by half.
- Critical strike, same as pilot's hand to hand.
- One additional hand to hand attack at level seven.
- One additional hand to hand attack at level thirteen.

**Damage:** **Punch** 1D6 M.D. in battloid.

**Punch** is not possible in guardian (no arms).

**Kick** 1D6 M.D. (possible only in battloid).

**Leap Kick** is not possible.

**Body Flip/Throw** 1D6 M.D.

**Body Block/Tackle** 1D6 M.D.

**Stomp** 1D4 M.D. in Battloid

Remember, these bonuses are in addition to the pilot's own hand to hand training and attribute bonuses. These mecha combat bonuses do *not* apply to the pilot's physical abilities when outside the mecha.

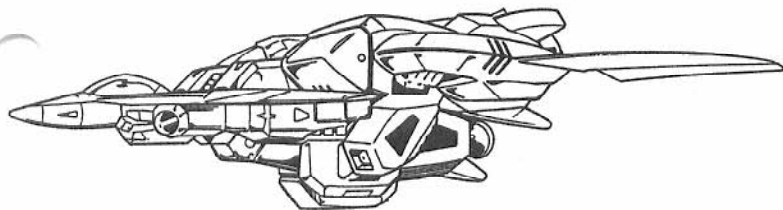

## HAND TO HAND BONUSES FROM VERITECH COMBAT TRAINING

- 2 hand to hand attacks per melee (plus those of the pilot).
- +3 to roll with punch, fall or impact (explosion), reducing damage by half.
- Body flip/throw; 1D4 damage plus victim loses initiative and one attack that melee. Possible only in Battloid mode.
- Kick attack.
- +1 to strike.
- +2 to parry and dodge\*
- Critical strikes same as pilot's hand to hand.
- One additional hand to hand attack at level six.
- One additional hand to hand attack at level eleven.

**Damage:** **Punch** 1D6 mega-damage (M.D. in *Battloid mode*)

**Punch** 1D4 M.D. in *Guardian mode*.

**Body Flip/Throw** 1D4 M.D.

**Kick** 1D6 M.D.

**Stomp** 1D4 M.D.\*\*

\* +4 to dodge in Guardian mode; +6 to dodge as Jet Fighter.

\*\* Effective only against small objects (12ft or smaller).

Remember, these bonuses are in addition to the pilot's own hand to hand training and attributes, and apply *ONLY* when piloting a Veritech Fighter. These bonuses do *not* apply to the pilot's physical abilities when outside the mecha.

## HAND TO HAND BONUSES FROM VINDICATOR COMBAT TRAINING

- Two hand to hand attacks per melee (plus those of the pilot).
- Body flip/throw: 1D4 M.D. plus victim loses initiative and one attack that melee. Possible only in battloid mode.
- Body block/tackle/ram: 2D4 M.D. plus an 80% chance of knocking opponent down (this will cause the victim to lose initiative and one attack that melee.) Counts as TWO attacks.
- Kick attack.
- +1 to strike.
- +2 to parry.
- +2 to dodge in battloid mode.
- +4 to dodge in guardian mode.
- +6 to dodge in jet mode.
- +3 to roll with punch, fall, or impact (explosion), reducing damage by half.
- Critical strike same as pilot's hand to hand.
- One additional hand to hand attack at level six.
- One additional hand to hand attack at level eleven.

**Damage:** **Punch** 1D6 M.D. in battloid.

**Punch** 1D4 M.D. in guardian mode.

**Kick** 1D6 M.D. (possible only in battloid).

**Leap Kick** 1D6 M.D. (possible only in battloid).

**Body Flip/Throw** 1D6 M.D.

**Body Block/Tackle** 1D6 M.D.

**Stomp** 1D4 M.D.; effective only against small objects (12ft/3.6m tall or smaller).

Remember, these bonuses are in addition to the pilot's own hand to hand training and attribute bonuses. These mecha combat bonuses do *not* apply to the pilot's physical abilities when outside the mecha.

## HAND TO HAND BONUSES FROM VINDICATOR BASIC COMBAT TRAINING

- One hand to hand attack per melee (plus those of the pilot).
- Body flip/throw: 1D4 M.D. plus victim loses initiative and one attack that melee. Possible only in battloid mode.
- Body block/tackle/ram: 2D4 M.D. plus an 80% chance of knocking opponent down (this will cause the victim to lose initiative and one attack that melee.) Counts as TWO attacks.
- Kick attack.
- No strike bonus.
- +1 to parry.
- +1 to dodge in battloid mode.
- +2 to dodge in guardian mode.
- +2 to roll with punch, fall, or impact (explosion), reducing damage by half.
- Critical strike same as pilot's hand to hand.
- One additional hand to hand attack at level seven.
- One additional hand to hand attack at level thirteen.

**Damage:** **Punch** 1D6 M.D. in battloid.

**Punch** 1D4 M.D. in guardian mode.

**Kick** 1D6 M.D. (possible only in battloid).

**Leap Kick** 1D6 M.D. (possible only in battloid).

**Body Flip/Throw** 1D6 M.D.

**Body Block/Tackle** 1D6 M.D.

**Stomp** 1D4 M.D.; effective only against small objects (12ft/3.6m tall or smaller).

Remember, these bonuses are in addition to the pilot's own hand to hand training and attribute bonuses. These mecha combat bonuses do *not* apply to the pilot's physical abilities when outside the mecha.

# THE MECHA OF THE REF

## VERITECHS (Transformable Mecha)

### OLD RDF MODELS

**VF Series Veritech Fighters** (VF-1A, VF-1J, VF-1S, the Super VF and armor; see Robotech RPG).

### NEW REF MODELS

**Alpha Fighters** (VAF-6C, VAF-6J, VAF-6R, VAF-7A Shadow Fighter).

**Beta Fighters** (VBF-1A and VBF-1S)

**Vindicator Fighter** (VF-1V)

**Cyclone Riding Armor** (VR-052, VR-041, VR-038-LT)

**Hover Tank** (VHT-01-SCA; a special complement limited to the command of Lt. J. Wolfe).

## DESTROIDS (Non-Transformable Mecha)

### OLD RDF MODELS

**Excaliber** (MK VI; see Robotech RPG)

**Gladiator** (MK II; see Robotech RPG)

**M.A.C. II** (MK II; see Robotech RPG)

**Raidar X** (MK X; see Robotech RPG)

**Spartan** (MK XII; see Robotech RPG)

### NEW REF MODELS

**Excaliber** (MK VII)

**Gladiator** (MK III)

**M.A.C. III** (MK III)

**Raidar X** (MK XI)

**Spartan** (MK XIII)

**Tactical Battle Pod** (TBP-Z1)

**Officer's Battle Pod** (OBP-Z2)

**Theatre Scout** (a.k.a. Cyclops; CRP-Z3)

## THE REF DESTROIDS

Destroids are the *non-transformable* mecha made famous by the RDF. The original Destroids were lumbering, mechanized giants, each more powerful than a 20th century tank division. Together with the versatile VF series veritech fighters, they came to symbolize humankind's strength and stubbornness to survive against a relentless foe.

It is little wonder that the Robotech Expeditionary Force (R.E.F.) took most of these juggernauts with them on their interstellar quest for peace. Only a handful of destroids were left on Earth. The newly designed transformable hover tanks and the other mecha of the Southern Cross were assigned the task of Earth's protectors. The destroids that had so faithfully served the RDF had an appointment with destiny in a distant galaxy.

The RDF destroids are among the most powerful machines of war ever created. However, as the secrets of Robotechnology are unravelled, even greater possibilities are discovered. One example is the super lightweight, but incredibly strong, alloys used to create the Southern Cross and Cyclone body armor (and new mecha). Another is the development of protoculture energy cells which have replaced the much larger

protoculture engines built into the old destroids and VF series veritechs. The use of protoculture cells has made it possible to create smaller, lighter, faster mecha with as much, and sometimes greater, firepower as the older, larger mecha. The most spectacular example of this is the REF Cyclone.

The new breakthroughs in robotechnology have been spearheaded by Doctor Lang and Doctor R. Burke. These new destroids will eventually replace their larger brothers and are in full production by the third month of the REF's war with the invid.

### A New Look to Familiar Mecha

The new REF destroids are the next generation of Earth mecha. Like the Alpha fighters, the destroids have been reduced in size by 30%, but are more maneuverable and more powerful than their predecessors. One common modification is the addition of hands and arms to all models (some are concealed). The lack of any type of appendage was often a handicap for the RDF mecha. Another change is that most of the REF destroids have identical legs and lower bodies, increasing the speed of production and repairs. Despite the substantial changes, most still resemble their earlier models enough to be recognized at a glance.

## Standard Sensors and Equipment for All REF Destroids (non-transformable Battloid mecha)

### Radar

Range: 30 miles (48km); conventional operation.

### Radio/Video Communications

Long range, directional communications system. Range: 600 miles or can be boosted indefinitely via satellite relay.

### Combat Computer

Calculates, stores, and transmits data onto the cockpit computer screen or head-up display (H.U.D.) of the pilot's helmet. Patches in with the targeting computer.

### Targeting Computer

Range: 30 miles (48km). Assists in the identification and tracking of enemy targets. The system has 10,000 images stored in memory and can be programmed to include 1000 new targets. Can identify and track 144 targets simultaneously.

### Laser Targeting System

Range: 100 miles (160km). Assists in the striking of enemy targets and is partly responsible for the mecha's strike bonus.

### Thermo-Imager

Range: 2000ft (609m). A special optical heat sensor that allows the infrared radiation of warm objects to be converted into a visible image. Enables the pilot to see in the dark, shadows, and through smoke.

### Nightvision Optics

Range: 2000ft (609m). A passive image intensifier, meaning it emits no light of its own, but relies on ambient light which is electronically amplified to give a visible picture.

### Infrared and Ultraviolet Optics

Range: 2000ft (609m). This optical system projects a beam of infrared light that is invisible to the normal eye. The infrared beam enables the pilot to see in the dark and to see other infrared beams. The ultraviolet system enables the pilot to see into the ultraviolet spectrum of light and is mostly used to detect the light beams of ultraviolet detection systems. The infrared light beam can be seen by anybody who also has infrared

optics, and the line can therefore be traced back to its source. Also smoke impairs the vision/beam, rendering it temporarily useless.

### External Audio Pickup

Range: 300ft (91.5m). A sound amplification listening system that can pick up a whisper 300ft away (91.5m).

### Loudspeaker

Loudspeaker system that can amplify the pilot's voice up to 90 decibels.

### Heat and Radiation Shields

Special shielding prevents the penetration of life threatening heat and radiation. Includes radiation detection system and alarm.

### Independent Oxygen Supply and Circulatory System

Automatically engages in an oxygenless environment or when toxic gases are sensed. Can recirculate breathable air for up to six weeks before getting stale.

### Heating and Cooling System

Regulates the temperature of the pilot's compartment. And includes a small refrigeration unit for preserving food, water and specimens. Refrigerator is approximately 26 inches wide.

### Voice Actuated Locking system

The destroid's access hatch is sealed by an automatic locking system. A six digit spoken code will open the hatch. A manual key pad is provided in case of system failure.

### 180 Degree Rotation

All destroids except the MAC II can rotate at the torso 180 degrees.

### Fuel Capacity

Each destroid requires 16 protoculture energy cells. 16 fully charged cells will give the mecha an active combat life of about two years. The vehicles can operate with half as many cells (8) for up to 16 months, but the maximum speed is reduced by half and the ranges of energy weapons are also reduced by half.

---

# THE EXCALIBER MK VII

The REF Excaliber is still used as an assault and defense, heavy weapons system. Like its predecessor, the REF Excaliber has long-range and short-range armaments. The major change is the replacement of one of its particle beam cannons with a Gladiator type mecha arm. The addition of the arm and hand gives it greater versatility in hand to hand combat and reconnaissance. The pilot can now pick up and carry items, and perform articulated work. A second hand has also been added to the particle beam cannon, although it is a bit clumsy.

Its many conventional S.D.C. weapons have been replaced with mega-damage weapons in anticipation of a more powerful foe. A walking dreadnought made even deadlier with its battery of missiles, lasers, particle beam cannon and increased speed and mobility.

## THE EXCALIBER

**Model Types (2):** Excaliber MK-VI (See *Robotech RPG*, pgs 56-58).  
Excaliber MK-VII (REF).

**Class:** Destroid Tomahawk MBR-04-VII series.

**Crew:** One or Two

**M.D.C. By Location:**

\*Tri-Laser Head — 100

Laser (of Head) (3) — 30 each

Mini-Missile Launchers (2) — 100 each

Missile Pods mounted on shoulders (2) — 150 each

Particle Beam Forearm (1) — 100

Hands (2) — 75 each

Right Forearm (1) — 100

Upper Arm (2) — 70 each

Legs (2) — 200 each

\*\*Main Body — 300

Reinforced Pilot's Compartment — 200

\*Depleting the M.D.C. of the head will disable the lasers (none can shoot).

\*\*Depleting the M.D.C. of the main body will shut the mecha down completely, rendering it useless.

**Speed:** Running: 75mph (121kmph) maximum; cruising speed about 35mph (56kmph).

Leaping: 80ft (24.4m) lengthwise or 40ft (12.2m) high/up.

Climbing: Is possible but awkward, with a skill ability of 30% + 3% per level of the pilot's experience. Add +10% if the pilot has the climbing skill.

**Height:** 26ft (10.97m)

**Width:** 18ft 6in (5.6m)

**Length:** 11ft 2in (3.4m)

**Weight:** 20.6 tons fully loaded.

**Cargo:** Minimal space is available in the pilot's compartment, but there is enough room behind the two seats for additional weapons, grenade cases, ammo boxes, and et cetera. Approximate space is 5ft by 3ft by 3ft (1.5×0.9×0.9m).

## WEAPON SYSTEMS

1. **Particle Beam Cannon, PBC-12**, comprises the left arm. The beam cannon is the Excaliber's most powerful, and long range, weapon.

Primary Purpose: Assault/defense

Range: 10,000ft; nearly 2 miles (3km)

Mega-Damage: 5D10 + 25 per blast

Rate of Fire: Four times per melee maximum

Payload: Effectively unlimited

2. **Head Lasers:** Three lasers are built into a head-like housing. Each can turn in a 90 degree arc (up and down) and can be controlled and fired independently or simultaneously. *Independent* control means that only *one* laser can be fired (any of the three) and can be rotated to any position, without disturbing the other two. *Simultaneous* means that all three move and fire at once.

Primary Purpose: Assault

Range: 4000ft (1200m)

Mega-Damage: One blast does 3D6 M.D. Three simultaneous blasts directed at the same target inflict 1D6×10 M.D. and counts as one melee attack.

Rate of Fire: Equal to the pilot's combined number of attacks.

Payload: Effectively unlimited

Note: If the mecha is immobilized (main body depleted), or if it runs out of protoculture energy, the weapons will not fire.

3. **GR-100 Mini-Missile Launchers (2).** Mounted above and behind each of the shoulders is a mini-missile launcher system with automatic reload. The cap flips up to reveal six missiles which can be fired



REF EXCALIBUR MK VII

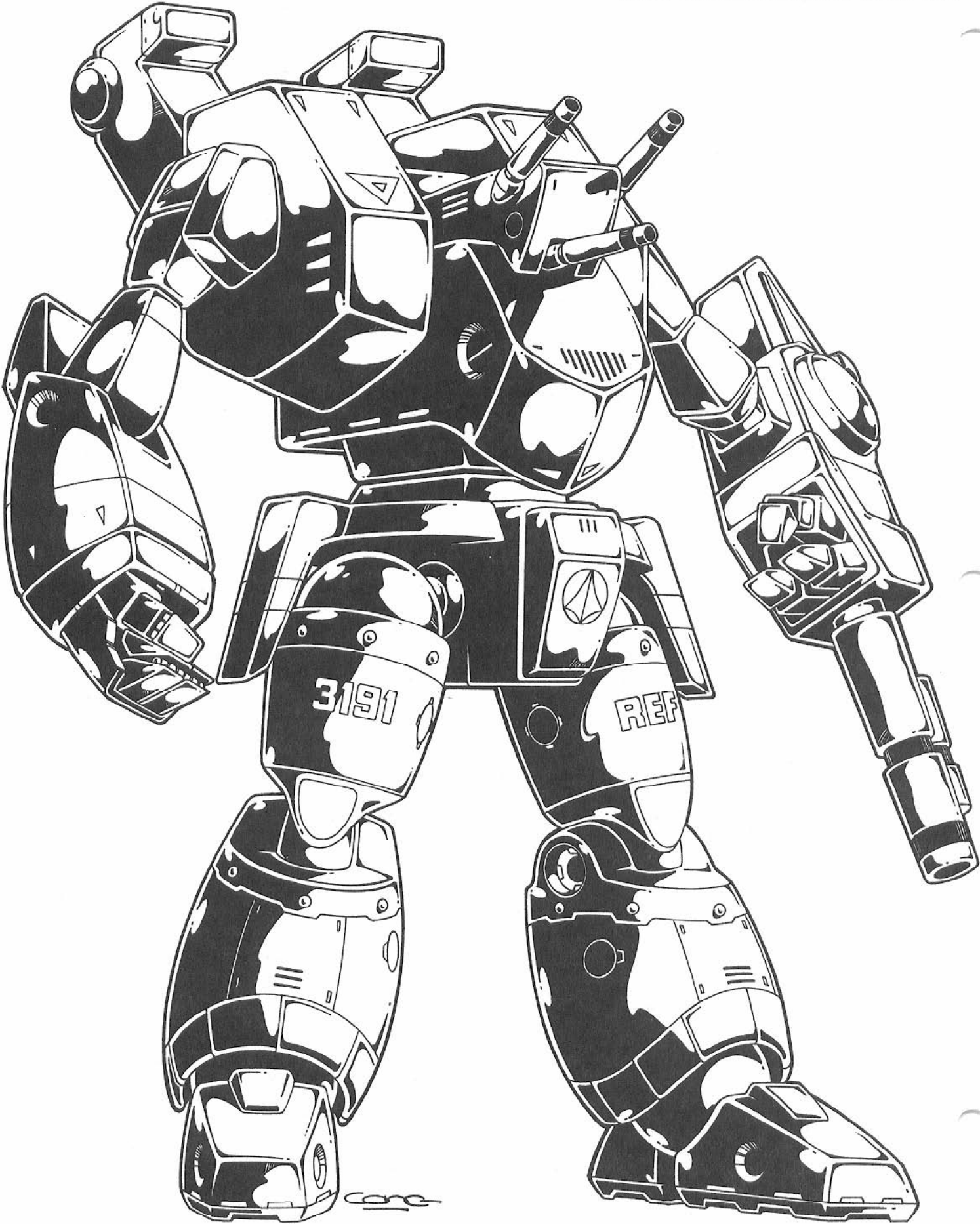

in volleys of two or all six. The mini-missile is immediately replaced the moment it is launched. The additional missiles are housed in the length of the launcher attached to the back.

**Primary Purpose:** Assault

**Secondary Purpose:** Antipersonnel

**Missile-Type:** Any mini-missile except plasma, but fragmentation and/or high explosive are standard issue.

**Mega-Damage:** Varies with missile type.

**Rate of Fire:** Volleys of 2, 4 or 6. Remember, a volley counts as *one* attack regardless of the number of missiles in the volley.

**Range:** About one mile

**Payload:** 18 mini-missiles per each launcher, for a total of 36.

**Note:** The mini-missiles can NOT be launched when the larger shoulder missile pod's are being used. The shoulder pods protective lid blocks the mini-missile launcher. If the mini-missiles are launched while the shoulder pod is in use, it will damage the lid (80 M.D.C.) and has a 50% chance of wrecking the firing mechanism of the GR-100 launcher (will not fire).

4. A **Missile Launcher Pod** is mounted on each shoulder. The missile compartments/ launchers are heavily armored, protecting the missiles from detonation by enemy fire. The missile pods also serve to protect the shoulder joints. Player's note: These are identical to those on the RDF Excaliber MK-VI.

**Primary Purpose:** Assault/defense

**Secondary Purpose:** Anti-aircraft

**Missile Type:** Standard RDF short range guided missiles. Specific types of warheads vary with the situation. Since it will generally be going into a heavy combat environment, armor piercing and plasma are the standard issue.

**Mega-Damage:** Varies with missile type.

**Rate of Fire:** One at a time or in volleys of two or four per each melee attack.

**Payload:** Each shoulder pod contains 12 short range missiles, for a total of 24.

5. **Hand to Hand Combat:** Rather than fire any weapons, the Excaliber can engage in hand to hand combat. Punch does 2D4 M.D., Flip — 1D4 M.D., Body Block — 1D6 M.D., or Stomp — 1D4 M.D.

6. **Optional Use of Hand-Held Weapons:**

**GU-11 Gun Pod.** See *Robotech RPG*.

**GU-XX Gun Pod.** See *Sentinels: Alpha Fighter*

**E-20 Gun Pod.** See *Southern Cross*.

**EU-11 Gun Pod.** See *Southern Cross*.

## THE GLADIATOR MK III

The gladiator, along with the M.A.C. III, is one of the most changed in appearance and armaments. The metal leviathan is still the fastest of its brothers and still mainly a frontline combat unit, but its weapon systems are completely different from the famous MK II of the RDF. The shoulder missile pods have been replaced with high-powered laser cannons, the chest mounted weapon cluster has been replaced by a dual laser turret and mini-missiles, while short range missiles are now stored in the legs like the Alpha and Beta fighters. Like the earlier RDF model, the new gladiator retains its ability as a powerhouse in hand to hand combat. Its punch can puncture M.D.C. armor or shatter the walls of a building.

## THE GLADIATOR

**Model Types (2):** Gladiator MK II (RDF; see *Robotech RPG*, pgs 58-60). Gladiator MK III (REF).

**Class:** Destroid Spartan MBR-07-MK III

**Crew:** One or two.

**M.D.C. by Location:**

\*Laser energy pods (2, shoulders) — 120 each

Laser Cannons (2 top-mounted) — 100 each

Laser Turret (1) — 50

Chest Mini-Missile Pod — 150

Arms (2) — 120 each

Hands (2) — 60 each

Upper Leg (2) — 100 each

Lower Leg (2) — 150 each

Leg Missile Pods (4; two each leg) — 60 each

\*\*Main Body — 300

Reinforced Pilot's Compartment — 200

\*Depleting the M.D.C. of a shoulder energy pod will render the laser cannon mounted on top of it useless. The unit must be completely replaced to function again.

\*\*Depleting the M.D.C. of the main body will shut the mecha down completely, rendering it useless.

**Speed:** Running: 120mph (193kmph) maximum; cruising speed about half, 60mph (96kmph). The Gladiator's feet are designed for running, climbing and traveling rough terrain.

Leaping: 100ft (30.5m) up and across.

Climbing: Is possible as a skill proficiency of 40% + 4% per level of the pilot's experience. Add +10% if the pilot has the climbing skill.

**Height:** 27ft (8.4m) with laser cannons lowered.

**Width:** 13ft 9in (4.2m)

**Length:** 11ft 4in (3.47m)

**Weight:** 19.2 tons fully loaded

**Cargo:** Minimal, with a small, 5ft × 3ft × 3ft (1.5m × 0.9m × 0.9m) area behind the two pilot seats.

## WEAPON SYSTEMS

1. A **high-powered GRA-10 Laser Cannon**, is mounted on each shoulder. The cannons can be fired individually or simultaneously at the same target. Both have a 120 degree arc of fire (up and down). The laser cannons can be positioned individually or together simultaneously.

**Primary Purpose:** Assault/defense

**Secondary Purpose:** Anti-aircraft

**Range:** 4000ft (1200m)

**Mega-Damage:** 3D6 M.D. per individual blast or 6D6 per simultaneous dual blast.

**Rate of Fire:** Equal to the pilot's combined hand to hand melee attacks.

**Payload:** Effectively unlimited

2. **Rapid-fire laser turret** built into the chest. The weapon is fixed forward, but can rotate up and down in a 90 degree arc.

**Primary Purpose:** Assault/defense

**Secondary Purpose:** Anti-ground personnel

**Range:** 2000ft (609m)

**Mega-Damage:** *Single "aimed" dual shot* (+3 to strike), 2D6 M.D.; *short burst* (+1 to strike), 1D4 × 10 M.D.; *long burst*, shooting at one target (no bonus to strike; lasts the entire melee), 2D4 × 10 M.D. Burst shooting wild/spraying (-1 to strike; can be short or long burst) inflicts 2D6 M.D. to everything it hits. See "shooting wild" in the modern weapon proficiency section. Single dual shots and short bursts count as ONE melee attack.

**Rate of Fire:** Single dual blasts or short bursts can be fired equal to the pilot's combined hand to hand. Long burst or spraying an area counts as ALL melee attacks for that melee.

**Payload:** Effectively unlimited.

# REF GLADIATOR MK III

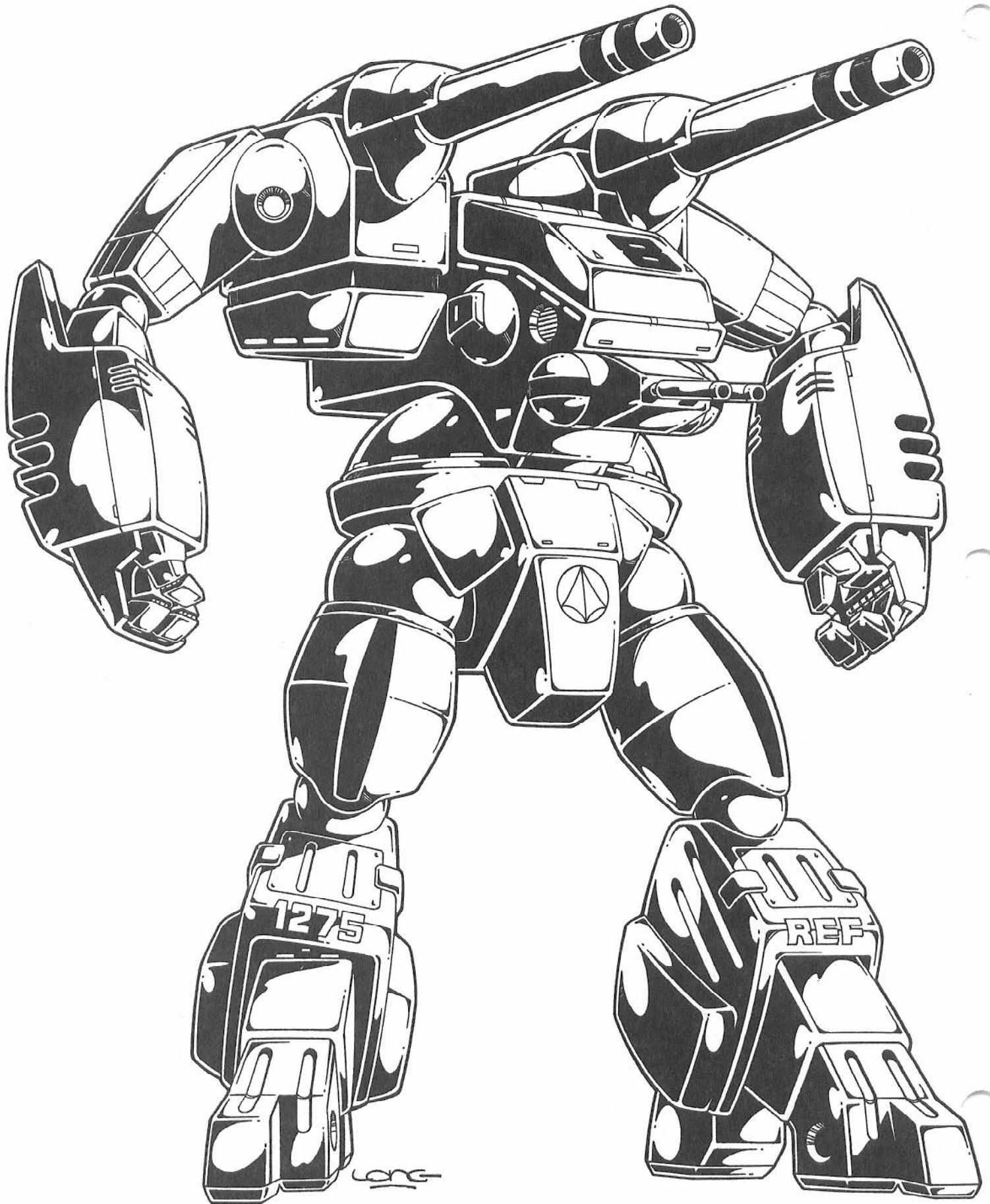



3. **GR-102 Mini-Missile Launcher Pod** is built into the chest area. The lid flips open to fire.

Primary Purpose: Assault/antipersonnel

Secondary Purpose: Anti-aircraft

Missile Type: Any mini-missile except plasma. Fragmentation or high explosive are standard issue.

Mega-Damage: Varies with missile type.

Rate of Fire: One at a time or in volleys of 2, 4, 6 or 8

Range: About one mile.

Payload: 36 mini-missiles

4. **MM-50 Multi-Missile System.** Both lower legs of the Gladiator have short range missile launchers similar to those of the Alpha Fighter. Each missile launcher (two on each leg) contains four short range missiles, for a total of eight per each leg.

Primary Purpose: Anti-aircraft

Secondary Purpose: Assault/defense

Missile Type: Standard RDF short-range missiles, usually armor piercing or plasma.

Mega-Damage: Varies with missile type.

Rate of Fire: One at a time or in volleys of 2, 4 or 8. The number of missile volleys a character can fire per melee is equal to his/her combined hand to hand melee attacks.

Range: Varies with missile type; 1 to 5 miles.

Payload: 16 total short range missiles (eight per each leg, four per each missile launcher).

5. **Hand to Hand Combat.** The Gladiator can opt to engage in hand to hand combat with devastating punches. Punch does 1D4 or 2D6 M.D., Power Punch — 3D6+4 M.D., Tear or Pry — 1D6 M.D., Stomp — 1D4 M.D., or Body Block — 1D6 or 2D6 M.D.

6. **Optional Use of Hand Held Weapons:**

**GU-11 Gun Pod.** See *Robotech RPG*.

**Battle Mace.** See *Robotech RPG*

**E-20 Gun Pod.** See *Southern Cross*

**EU-11 Gun Pod.** See *Southern Cross*

**GU-XX Gun Pod.** See *Sentinels; Alpha Fighter*.

## THE M.A.C. III

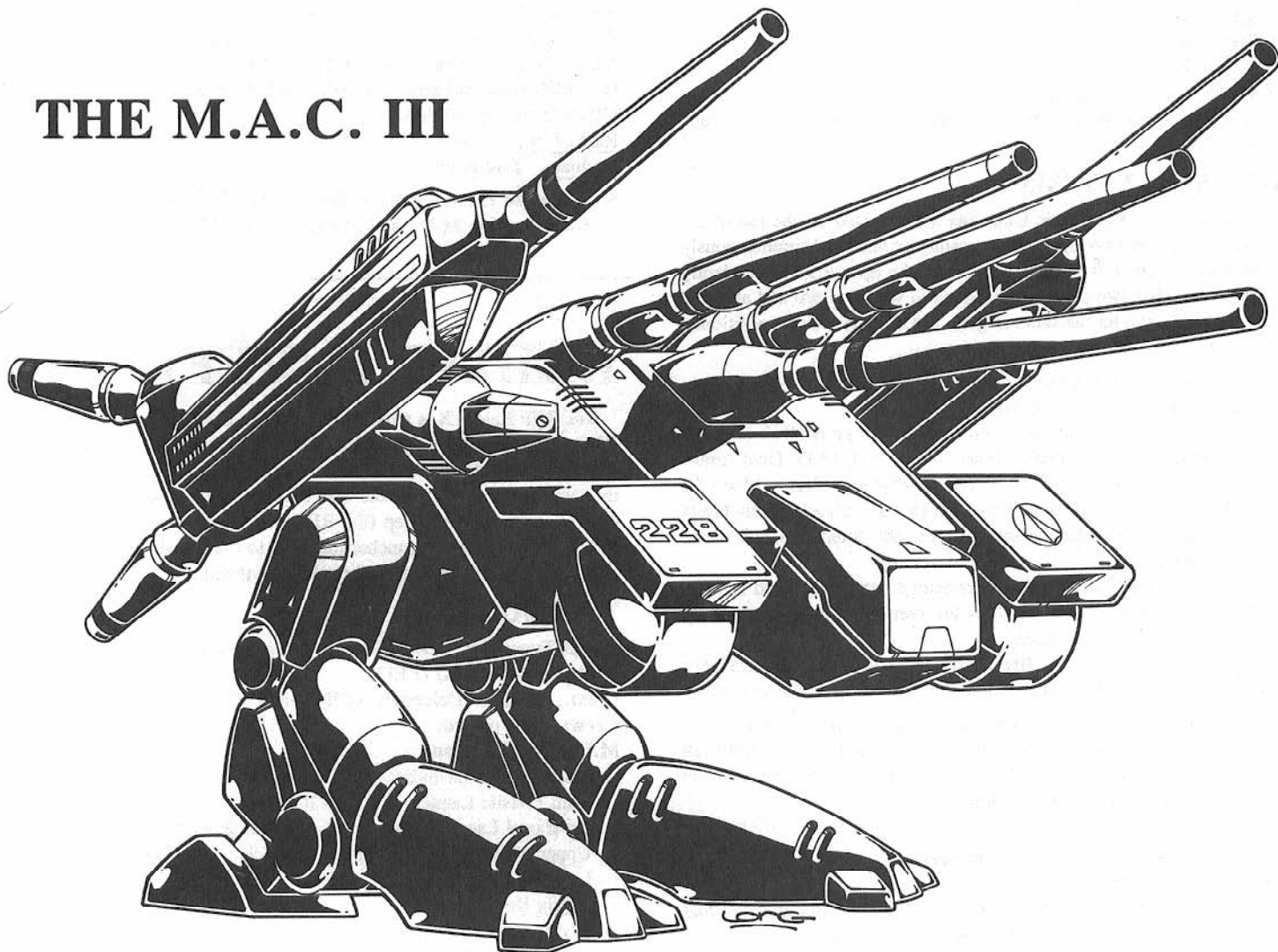

The largest of all the destroids is the M.A.C. II, followed by the M.A.C. III (REF). Both units were developed to be mobile fortresses with the firepower of a 20th century battleship.

The M.A.C. III is just as powerful as the M.A.C. II, and more maneuverable. One of the drawbacks to the old RDF model M.A.C.

was that it was terribly slow, a maximum speed of 20mph (32kmph). The new M.A.C. III is lighter, shorter and faster with a greater variety of weaponry, while sacrificing little M.D.C. or firepower.

## THE M.A.C. III

**Model Types (2):** M.A.C. II (RDF; See *Robotech RPG*, pgs 60-62).

M.A.C. III (REF).

**Class:** Mobile Assault Cannon (M.A.C.) HWR-00-MK-III; also known as the "Little Monster."

**Crew:** Two or three, and can seat four additional passengers.

**M.D.C. by Location:**

Three Main Cannons — 100 each  
Forearm Particle Beam Cannons (2) — 100 each  
Upper Arms (2) — 75 each  
Forward Missile Pod (1) — 200  
Drum Bombs (2) — 100 each  
Legs (2) — 200 each  
\*Main body — 400  
Reinforced Crew Compartment — 250  
Note: No head unit.

\*Depleting the M.D.C. of the main body will shut the mecha down completely, rendering it useless.

**Speed:** Running: 45mph (72kmph) maximum; cruising speed is about 30mph (48kmph).

Leaping and Climbing: Impossible

**Height:** 48ft 6in (14.8m)

**Width:** 38ft (11.6m)

**Length:** 41ft (12.5m)

**Weight:** 110 tons fully loaded

**Cargo:** A spacious 8ft×6ft×6ft area is available for storage (2.4m×1.8m×1.8m).

## WEAPON SYSTEMS

1. **Three 40cm Automatic Cannons** are mounted on the top of the main body. The two top guns are positioned and fired simultaneously as a dual system. The third cannon can be operated independently from the other two cannons or locked in with the two and all three fired as one (all hit the same target). The cannons can be positioned in a 45 degree arc (up and down).

Primary Purpose: Long-range assault

Secondary Purpose: Anti-aircraft

Range: 10 miles (16km); minimum effective range is 600ft (183m).

Mega-Damage: One individual blast — 1D6×10 M.D. Dual simultaneous blasts — 2D6×10 M.D.. Triple simultaneous blast — 3D6×10 M.D. Blast radius is approximately 20ft (6.1m). Simultaneous blasts (2 or 3 rounds) all strike the same target, but count as ONE melee attack (volley).

Rate of Fire: Equal to the pilot's combined number of hand to hand melee attacks. Dual and triple blasts are considered to be one volley and therefore, one melee attack.

Payload: Each cannon can fire 20 rounds each. The two top guns always fire together. Only the middle cannon can fire independently.

2. **Particle Beam Cannons, PBC-20**, comprise the forearms of the M.A.C. III. Each can fire individually or simultaneously. Both can rotate in an 180 degree semicircle, enabling the "Little Monster" to fire straight up and directly behind it.

Primary Purpose: Anti-aircraft

Secondary Purpose: Assault and defense

Range: 5 miles (8km)

Mega-Damage: Single blast — 3D6×10 M.D. or a simultaneous dual blast — 4D6×10 M.D. (counts as one melee attack).

Rate of Fire: Equal to the pilot's total number of hand to hand attacks per melee.

Payload: Effectively unlimited.

3. **Front Mounted Missile Pod** contains six *medium range* missiles.

Primary Purpose: Anti-aircraft

Secondary Purpose: Assault and defense

Missile Type: Any standard RDF medium range missiles, but high explosive (heavy: 2D6×10 M.D.) and/or plasma (2D6×10 M.D.) are standard issue.

Mega-Damage: Varies with missile type.

Rate of Fire: One at a time or in volleys of 2, 3, 4, or 6 (all). Can fire as often as equal to the pilot's combined hand to hand attacks per melee. A volley counts as one melee attack.

Range: Varies with missile types, but no less than 40 miles (64km).

Payload: Six (6) medium range missiles.

4. **Two Drum Bombs** are mounted in the front of the M.A.C. III. Each is protected by a heavy top shield, plus the cylindrical bomb encasement has 100 M.D.C. to prevent detonation by enemy attack. (Note: A direct shot at the bombs must be a called shot and is minus 2 to strike).

The bombs can be released at any time, dropping to the ground. They are not propelled by any means, so the M.A.C. III pilot should allow himself enough time to get out of the blast radius. The bombs have a timer that can be programmed, from the crew compartment, for 10 seconds to 90 minutes.

Primary Purpose: Assault on enemy installations.

Secondary Purpose: Self-destruction

Weight: 2 tons

Bomb Type: Plasma; M.D.C. of the released bomb — 10.

Mega-Damage: One bomb will inflict 1D6×1000 M.D. to everything in a 500ft (152.5m) area and 1D6×100 M.D. to an additional 1000ft (305m) area beyond that.

Rate of Fire: Can drop one or both. Counts as one melee attack.

Payload: Two bombs.

5. **Hand to Hand** combat is limited to Body Blocks — 2D6 M.D., Bunts — 1D6 M.D., and Stomps — 3D4 M.D.

## RAIDAR X (REF)

The REF Raidar X is a more versatile, smaller version of the famous RDF model. Like its predecessor, the new Raidar X is primarily designed to combat aircraft and other flying menaces. To give it extra versatility, the laser arms not only rotate 360 degrees, but can also move left to right in a 45 degree sweep (the RDF model could not swing left and right). A mini-missile launcher identical to the Excaliber's is mounted on each shoulder, providing short-range capabilities.

## THE RAIDAR X

**Model Types (2):** Raidar X, MK X (See *Robotech RPG*, pgs 63-64).

Raidar X, MK XI (REF).

**Class:** Destroid Defender, ADR-04-MK XI

**Crew:** One or two.

**M.D.C. by Location:**

Radar Sensor (semidisc in chest) — 60  
Mini-Missile Launchers (2) — 100 each  
Tri-Barrel Laser Cannon Arm — 100 each barrel (6)  
Upper Arm Connection (2) — 100 each  
Legs (2) — 200 each  
\*Main Body — 250  
Reinforced Crew Compartment — 200  
Note: No head unit.

\*Depleting the M.D.C. of the main body will shut the mecha down completely, rendering it useless.

**Speed:** Running: 100mph (160kmph) maximum; cruising speed about 50mph (80kmph).

Leaping: 80ft (24.4m) lengthwise or 40ft (12.2m) high/up.

Climbing: Impossible

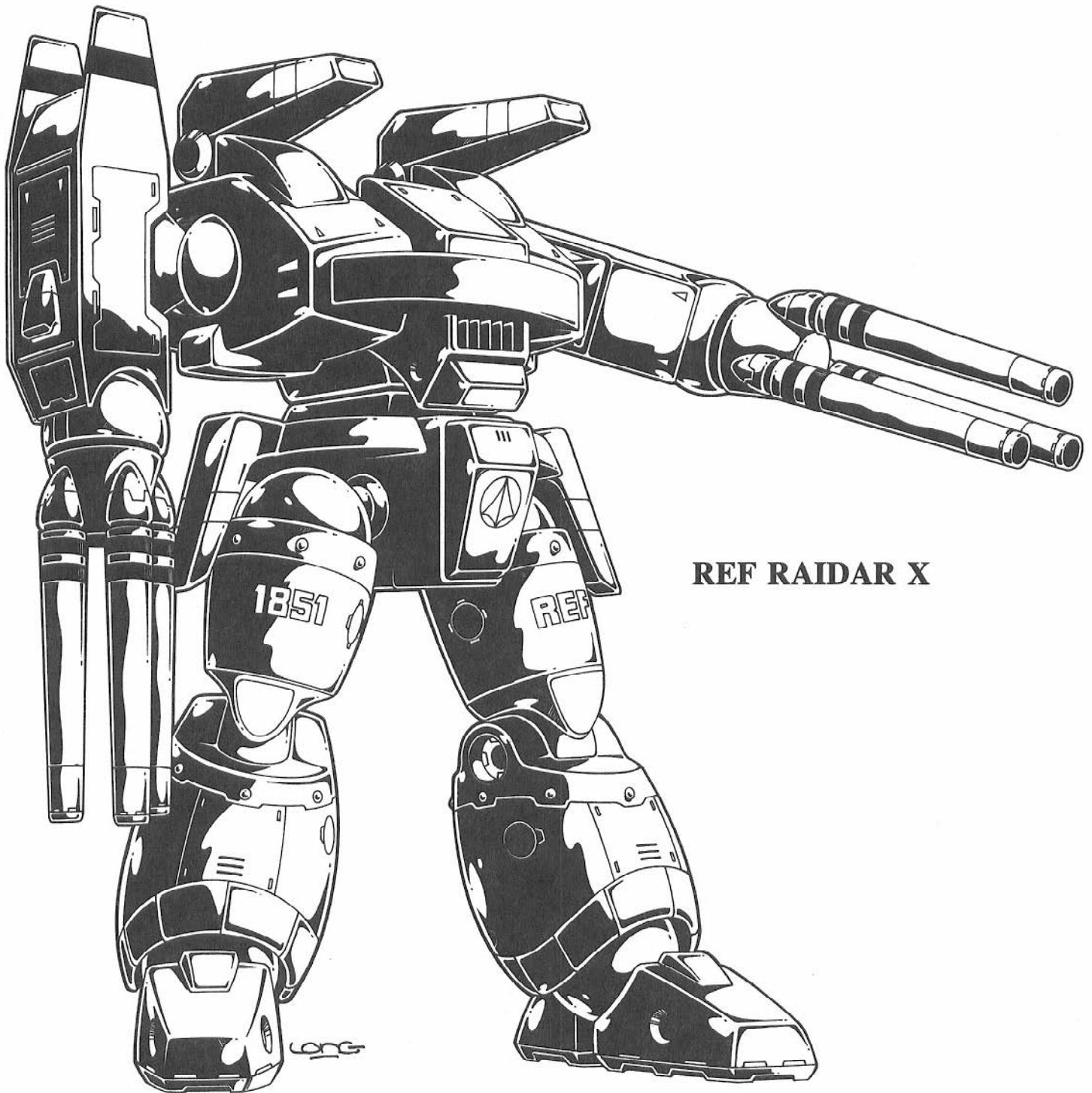

## REF RAIDAR X

**Height:** 24ft 9in (7.6m)

**Width:** 18ft (5.5m)

**Length:** 11ft 7in (3.6m)

**Weight:** 17 tons

**Cargo:** Minimal space, consisting of a 5ft × 3ft × 3ft (1.5m × 0.9m × 0.9m) area behind the seats.

### WEAPON SYSTEMS

1. **Tri-Barrel Rapid-Fire Laser Cannons** comprise both arms. An advanced computer targeting/radar system increases the Raider X's accuracy. **Bonus:** +2 to strike only while the radar sensor disc protruding from its chest is functioning. Depleting its 60 M.D.C. will prevent the bonus and reduce radar range to 50 miles (80km).

**Primary Purpose:** Anti-aircraft

**Secondary Purpose:** Assault

**Range:** 8 miles (12.8km)

**Mega-Damage:** Single blast — 3D6 M.D., double blast — 6D6 M.D., triple blast — 1D4 × 10 M.D. Six blasts (both arms fired simultaneously at one target) 2D4 × 10 M.D.

**Rate of Fire:** Equal to the pilot's total number of attacks per melee. Both arms can fire one, two or all three of their laser cannons simultaneously. Or both arms can operate as one dual unit, firing all six cannons simultaneously. Simultaneous firing of cannons is considered a volley regardless of how many cannons are shooting. Each volley counts as one melee attack.

**Payload:** Effectively unlimited.

2. **GR-100 Mini-Missile Launchers (2).** Mounted above and behind each of the shoulders is a mini-missile launcher system with automatic reload. The cap flips up to reveal six missiles which can be fired in volleys of two or all six. The mini-missile is immediately replaced the moment it is launched. The additional missiles are housed in the length of the launcher attached to the back.



Primary Purpose: Assault

Secondary Purpose: Antipersonnel

Missile-Type: Any mini-missile except plasma, but fragmentation and/or high explosive are standard issue.

Mega-Damage: Varies with missile type.

Rate of Fire: Volleys of 2, 4 or 6. Remember, a volley counts as *one* attack regardless of the number of missiles in the volley.

Range: About one mile

Payload: 18 mini-missiles per each launcher, for a total of 36.

3. **GRL-Defense Lasers.** Built into the under-belly of the mecha is a triangular protrusion directly under and dead center of the radar disc. When besieged by ground troops, the protective covering flips down to reveal a battery of light lasers. The lasers always point downward, but can be positioned to hit targets almost directly under it or up to 200ft away.

Primary Purpose: Defense

Secondary Purpose: Antipersonnel

Range: 200ft (61m)

Mega-Damage: Aimed shot — 3D6 M.D., burst — 6D6 M.D., wild shooting/spray — 2D6 M.D. per hit (see shooting wild in modern weapon proficiency section). **Note:** The light lasers can be fired in a continuous, full melee wild burst while using the big laser cannons at the cost of one melee attack, but they are -4 to strike anything.

Rate of Fire: Equal to the pilot's combined hand to hand melee attacks. Or a full melee spray (wild), which counts as one attack.

Payload: Effectively unlimited

4. **Hand to Hand Combat** is limited to swats with the cannon arms doing 1D4 M.D., Body Blocks — 1D6 M.D., and Stomp — 1D4 M.D.

## SPECIAL EQUIPMENT

1. **Advanced Radar and Sensory Unit** mounted in the chest.

Radar: Range: 200 miles (321km), and can identify 300 individual targets and simultaneously track 100.

Heat Sensor: Can pick up and pinpoint heat emanations. Track by heat impressions — 55%, can pinpoint up to 100 targets.

Motion Sensor: Detects and registers movement within a 600ft (180m) area. Can pinpoint and track up to 100 targets.

Radiation Sensor: Detects and identifies the presence of over 50 types of radiation, measures their levels and can pinpoint their source. Range: 600ft (180m).

2. **On-board computer system** to record and analyze data.

3. **Long-range laser communications system:** Range: 1000 miles, and can be relayed indefinitely via satellite.

4. **Spotlight** mounted on each laser arm. Range of light beam is 300ft (91m).

5. **Retractable utility arms (3)** are housed in the compartment at midbody atop the sensor disc. The three arms are for delicate work, repairs and examination of items. The reach of the arms is limited to 26ft (7.9m). Each arm has 3 M.D.C. and a strength equal to a P.S. 20.

# THE SPARTAN MK XIII

The new REF Spartan is, like its predecessor, still the long-range powerhouse of the Destroids. As an artillery support unit, the Spartan is unsurpassed, but even with its additional defensive armaments and hands, it remains the least versatile of all of the mecha.

The most obvious change from its predecessor, is the more rounded body and the elongated trunk of the main body that protrudes like a mechanical head of a killer whale or shark. The bottom half of the "shark" head can open up like a gaping maw to unleash another battery of missiles (short range). The two spotlights on both sides of the body resemble eyes, completing the illusion of a monstrous head. Hence its nickname, "the Shark".

## THE SPARTAN

**Model Types:** Spartan MK XII (RDF; See *Robotech RPG*, pgs 65-66).

Spartan MK XIII (REF)

**Class:** Destroid Phalanx, SDR-04-MK XII; also known as "the Shark".

**Crew:** One or two

**M.D.C. by Location:**

Searchlight (top) — 30 (whole unit)

Shoulder Joints (2) — 100 each

Missile Pods (2) — 150 each

Revealed Mini-Missile Launcher — 50

\*Lower Jaw of Main Body — 150

\*\*Main Body (head) — 250

Reinforced Crew Compartment — 250

Legs (2) — 200 each

Retractable Hands (2) — 40 each

\*Depleting the M.D.C. of the lower jaw-like area will immobilize it, preventing the short range missiles from being launched.

\*\*Depleting the M.D.C. of the main body will shut the mecha down completely, rendering it useless.

**Speed:** Running: 70mph (112kmph) maximum; cruising speed is about 35mph (56kmph).

Leaping: 40ft (12.2m) lengthwise or 20ft (6.1m) high/up.

Climbing: Slow and difficult, with a skill ability of 20% + 3% per level of the pilot's experience. Add +6% if the pilot has the climbing skill.

**Height:** 28ft 3in (8.6m)

**Width:** 20ft (6.1m)

**Length:** 16ft 4in (5m)

**Weight:** 37 tons fully loaded

**Cargo:** Minimal capacity of 5ft x 3ft x 3ft (1.5m x 0.9m x 0.9m) is available behind the seats.

## WEAPON SYSTEMS

1. **Missile Pod Arms** are its main weapon. Like the earlier Spartan, "the Shark" can fire medium or long range missiles from its barrel arms. The missile pods can rotate 360 degrees to meet any threat. All the missiles are self-guided, standard RDF types.

Primary Purpose: Anti-aircraft

Secondary Purpose: Assault/Defense

Missile Type: Any medium or long range missiles.

Mega-Damage: Varies with missile type.

Range: Varies with missile type.

Rate of Fire: Can fire missiles one at a time or in volleys of 2, 4, 6, 8 or 10. One volley counts as one attack regardless of the number of missiles. Total attacks per melee is equal to the total hand to hand attacks of the pilot.

Payload: 20 missiles per each arm, for a total of 40 (four less than the RDF version). The missile arms can be reloaded using special

# REF SPARTAN MK XII

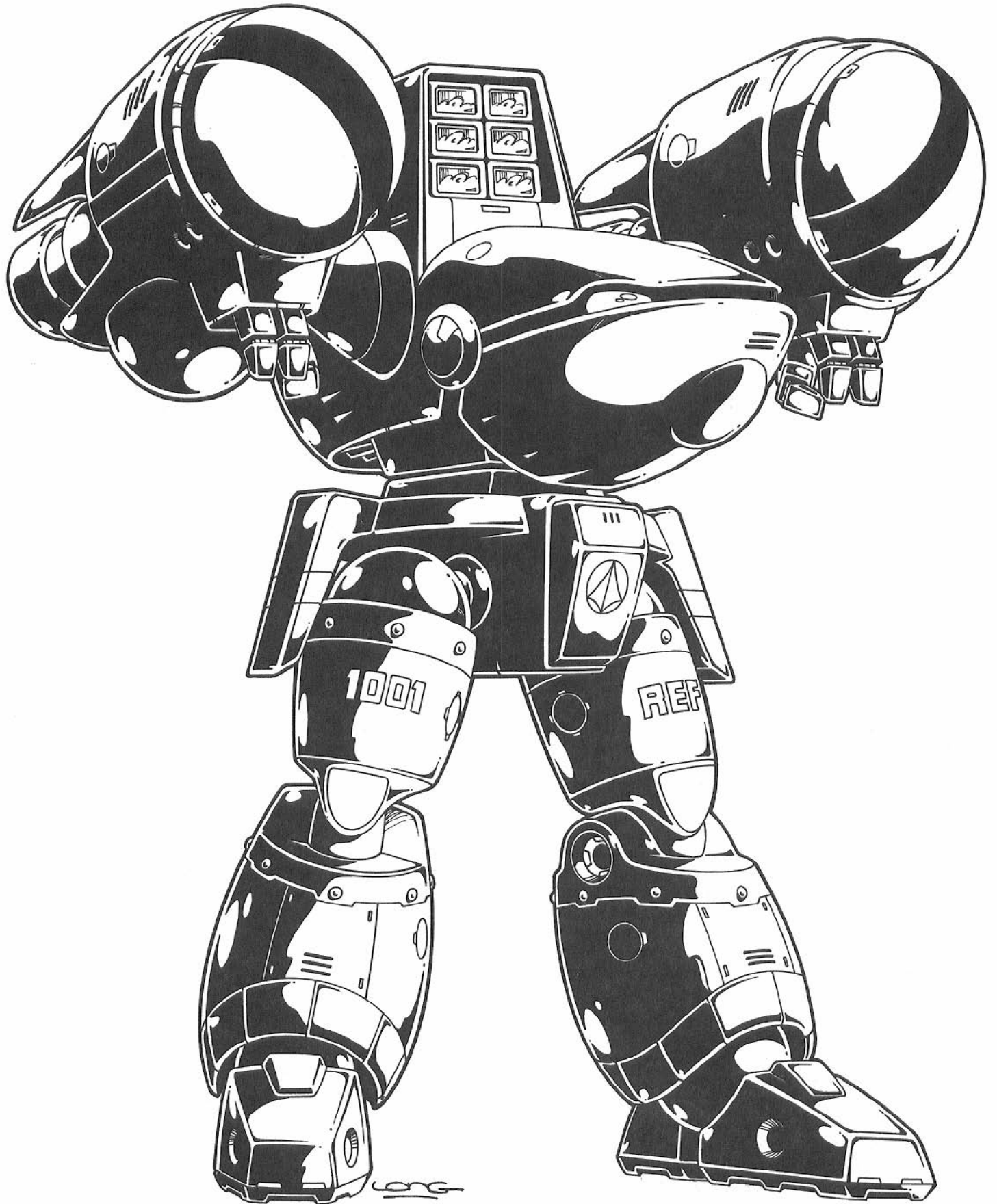

vehicles and equipment, but requires a full five minutes (20 melees).

2. A **GR-101 Multiple Mini-Missile Launcher** has been built into the lower head-like area to provide the mecha with short-range capabilities. These missiles are mainly intended for defense and antipersonnel. The automatic loading system replaces missiles immediately.

**Primary Purpose:** Defense

**Secondary Purpose:** Antipersonnel

**Missile Type:** *Plasma only.* The other *mini-missiles* will not fit unless specially modified and that will reduce their range by half.

**Mega-Damage:** The plasma mini-missile inflicts 1D6 × 10 damage to a 15ft (1.5m) radius.

**Range:** One mile (1.6km)

**Rate of Fire:** One at a time or in volleys of 2, 4, 6, 8, 10, 12 or 24. Remember, a volley counts as one melee attack. Total melee attacks are equal to the combined hand to hand attacks of the pilot.

**Payload:** 48 launch tubes, but with reloads a total of 96 plasma mini-missiles.

**Note:** A high intensity spotlight is mounted like an eye on either side of the head. Range of the spotlight is 1600ft (488m).

3. **Hand to Hand Combat** is possible, but limited. The spindly retractable arms only have 20 M.D.C. each and inflict low mega-damage. Punch — 1D4 M.D., Body Block — 1D6 M.D., and Stomp — 1D4 M.D. Note that the hands and retractable arms are designed for added versatility, enabling the new Spartan to pick up, hold and carry items, climb and similar uses. The arms can detract to reach up to 28ft (8.5m).

**Special Equipment:** Atop the main body is a high intensity searchlight. The two top lights are *infrared* unleashing a light beam invisible to normal vision and enabling “the Shark” to see in the dark. Of course, anybody with infrared optics can see the light and avoid it. The other four lights are conventional, *visible, searchlights*.

**Range:** 4000ft (1220m) for all lights. The lights can be tilted 30 degrees up and down, and left and right. The adjustments occur inside the housing unit.

---

## THE REF ZENTRAEDI MECHA PROGRAM

Twenty-nine percent of the Robotech Expeditionary Force is composed of loyal micronized Zentraedi, all of whom are skilled warriors. Unfortunately, the micronized giants can no longer operate their huge war machines, because “they” are too small. You may recall, the operation of the Zentraedi battle pods is very different from the Earth mecha. The Zentraedi pilot sits curled inside the bulbous body cavity. The legs are controlled by foot pedals meaning the pilot is actually walking inside the mecha, similar to pedaling a bicycle. Weapon systems are operated by sets of simple hand levers.

Years of indoctrination and minimal knowledge of Earth skills made Earth mecha incomprehensible to the Zentraedi. This meant it would take too long and demand too much manpower to retrain them. The dilemma arose in that the REF had thousands of eager warriors at their disposal but no suitable mecha.

Repairing the old, giant mecha meant returning the aliens to their giant size. This was impossible, because of the food and space requirements needed to support an army of 50ft giants. Besides, the old pods offered the pilots little protection. The Robotech Masters, who designed the Zentraedi mecha, had little regard for life, thus the Zentraedi warriors

and their mecha were seen as *disposable* commodities. An unacceptable condition by human standards. Furthermore, some feared the aliens might strike against humankind if restored to giant stature and given fully powered mecha.

After much deliberation, Rick Hunter offered the only feasible solution: Scrap the Zentraedi mecha and build a new, smaller version like what had been done with the Veritech VF series and the new Alpha series. Retain the old Zentraedi system of movement, just scale it down.

Doctor R. Burke seized the suggestion as a personal challenge. At first he envisioned producing miniaturized versions, identical to the larger originals, with added armor. However, Doctor Burke quickly realized that he could improve upon the original design without sacrificing the simplicity the Zentraedi soldiers expected. The result was a hybrid of Zentraedi and human design.

**Note:** The Zentraedi mecha are intentionally *less* heavily armored and equipped (no missiles, for example) than the human mecha as a precautionary measure against insurrection. This condition was a compromise that Admiral Rick Hunter grudgingly agreed to in order to get approval for the *Zentraedi Destroid Program*. Zentraedi mecha are generally reserved exclusively for Zentraedi warriors.

## THE REF TACTICAL BATTLE POD (TBP-Z1)

The old Tactical Battle Pod has been replaced with the smaller, but deadlier, TBP-Z1 (nicknamed “Tid-Bitz”). The mecha’s formidable weapons, speed and balance emulate its giant predecessor. However, there are numerous differences in style and design. The top mounted particle beam guns are long and slender, a trademark of Earth design. Its small rear lasers have been replaced with larger, more powerful lasers and the auto cannons replaced with a Gladiator style auto cannon drum. The battle pod’s familiar egg-shaped main body is also gone, in favor of a squat, rectangular shaped form.

The most dramatic changes are the addition of arms and its drastically reduced size. Arms give this infantry unit the advantage of hand to hand combat, grappling, holding and carrying. The size is a comparatively minuscule 23ft (7m). The pilot is safely nestled in the armored midsection of the main body.

### THE REF TACTICAL BATTLE POD

**Model Type:** TBP-Z1

**Class:** Destroid; Tactical Battle Pod — Zentraedi type One.

**Crew:** One, but can seat one additional.

**M.D.C. by Location:**

Top-Mounted Particle Beams (2) — 50 each

Rear Lasers (2) — 50 each

Front Auto Cannons (2) — 25 each

Upper Arm (2) — 50 each

Forearm (2) — 75 each

Hands (2) — 30 each

Legs (2) — 150 each

Rear Engine Thrusters (2) — 100 each

\*Sensor Eye (1-front) — 50

\*\*Main Body — 170

Reinforced Pilot’s Compartment — 200

\*Depleting the M.D.C. of the sensor eye will knockout all optical systems; -1 to strike penalty. Note: The TBP-Z1 has all the standard REF Destroid sensors and equipment.

\*\*Depleting the M.D.C. of the main body will shut the mecha down completely, rendering it useless.



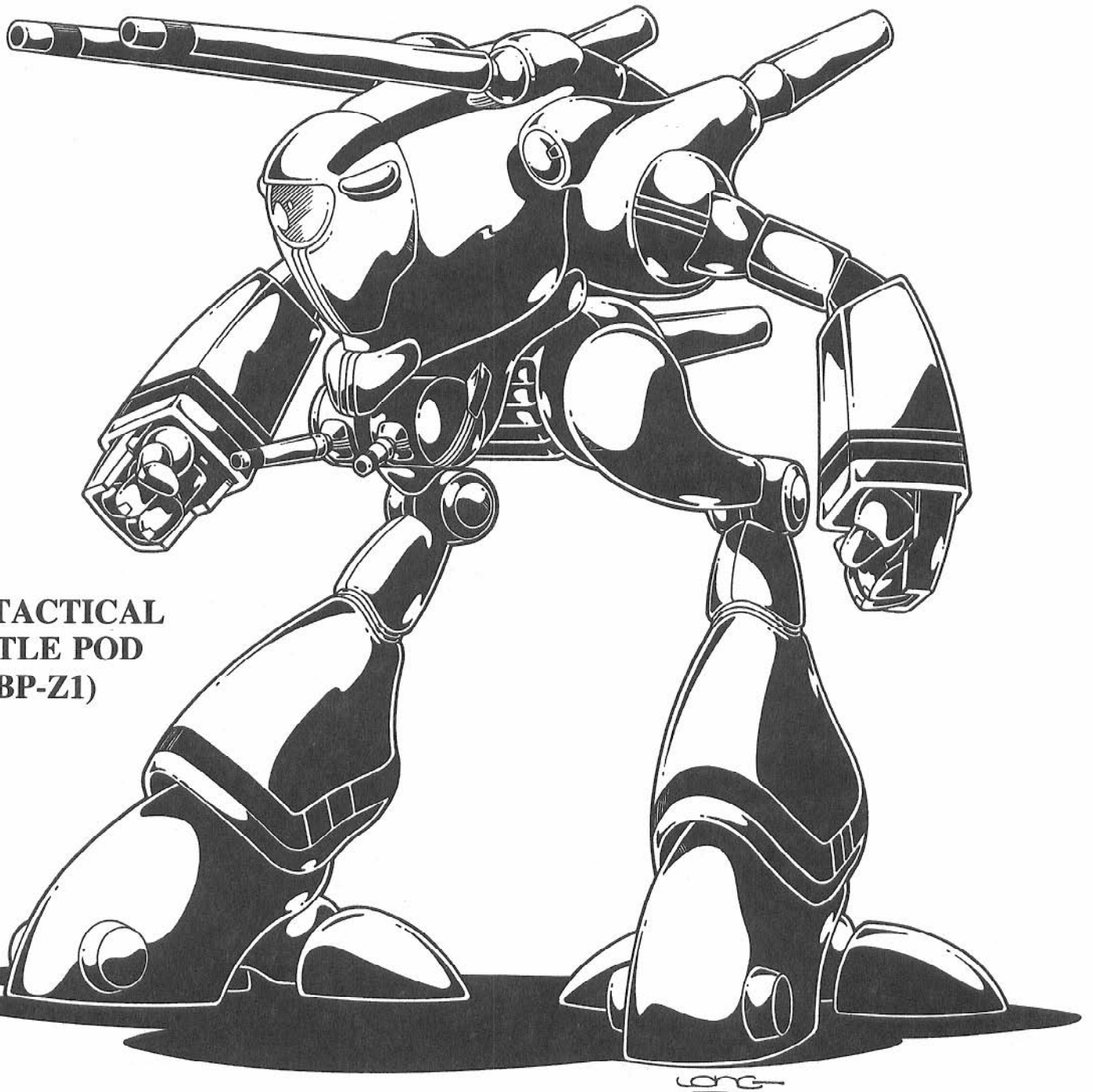

## REF TACTICAL BATTLE POD (TBP-Z1)

**Speed:** Running: 175mph (281kmph)

Leaping: 100ft (30.5m) up or across without booster assistance, or 300ft (91.5m) with jet booster assistance.

Climbing: Is possible, but awkward. The mecha skill ability is 20% +3% per level of the pilot's experience. Add +13% if the pilot has the climbing skill himself.

Hover: The battle pod can hover stationary up to 300ft high for short periods of time (about three minutes/12 melees), then quickly floats to ground level. The jet boosters are also used to slow its momentum in a fall. The TBP-Z1 can not fly!

Underwater Propulsion: Cruising speed is 50mph (80kmph) and can rocket itself to speeds of up to 300mph (482kmph) in short bursts lasting two or three minutes. **Note:** Needs at least a 10 minute rest between each 300mph burst. Walking underwater is reduced by 75%.

Space Propulsion: The same propulsion system can rocket the Battle Pod through space at a maximum speed reaching near mach one, 650mph (1040kmph). The mecha can maintain this speed for 1D4 hours before requiring a rest of at least one hour. Intermittent use,

a few minute burst of speed here and there, will enable the TBP-Z1 to operate in space indefinitely, without pause. Likewise, traveling at speeds of less than 300mph (482kmph) does not tax the propulsion system, providing indefinite space flight.

**Height:** 23ft (7m)

**Width:** 14ft (4.3m)

**Length:** 14.6ft (4.45m)

**Weight:** 12.7 tons

**Cargo:** Minimal storage space could accommodate one additional passenger or about 500lbs (226.8kg).

### WEAPON SYSTEMS

1. **Dual-Mounted Particle Beam Cannons** are mounted on the top of the TBP-Z1. Each cannon can move independently of the other or in one synchronized movement. This means the cannons can be fired independently of each other at different targets or simultaneously at the same target. Both P-Beam cannons can only shoot forward, with a movement arc of 80 degrees up and down.

Primary Purpose: Heavy assault

Range: 6000ft (1829m).

Mega-Damage: Single blast — 4D10 M.D., double simultaneous blast — 8D10 (counts as one attack).

Rate of Fire: Equal to the pilot's combined number of attacks; usually 4 or 5 per melee.

Payload: Effectively unlimited

**2. Top-Mounted Lasers (2)** are located in the rear near the shoulders.

They can be positioned up and down in an 80 degree arc.

Primary Purpose: Defense

Range: 4000ft (1200m)

Mega-Damage: 3D6 M.D. per individual blast, or 6D6 per simultaneous volley (both lasers fire in one attack).

Rate of Fire: Equal to the pilot's combined number of attacks per melee.

Payload: Effectively unlimited

**3. 32mm Auto Cannons (2)** are located in the lower part of the body.

The drum configuration allows an 180 degree rotation, enabling the weapon to fire upwards, down at its feet, and even under its legs to the rear. Both fire simultaneously.

Primary Purpose: Antipersonnel

Range: 2000ft (609m)

Mega-Damage: 2D6 M.D. — short burst, 4D6 M.D. — long burst, or 2D4 × 10 M.D. — full melee burst.

Rate of Fire: Equal to the pilot's combined attacks per melee.

Payload: Limited to 480 rounds. 24 shells are fired per full melee burst, 12 in a long burst and 6 in a short burst.

**4. Hand to Hand Combat.** Rather than fire weapons, the Battle Pod can engage in hand to hand combat. A punch does 2D4 M.D., Flip — 1D4 M.D., Body Block — 1D6 M.D., Kick — 1D6 M.D., Leap Kick — 3D6 M.D. (counts as two attacks), or Stomp — 1D4 M.D.

**5. Optional Use of Hand Held Weapons.**

**GU-11 Gun Pod.** See *Robotech RPG*.

**GU-XX Gun Pod.** See *Alpha Fighter*; restricted to Breetai and his elite forces.

**NOTE:** The shape of the TBP-Z1's body and legs provides it with an exceptional ability to roll with a punch, fall, or impact. See *Bonuses from Battle Pod Training*.

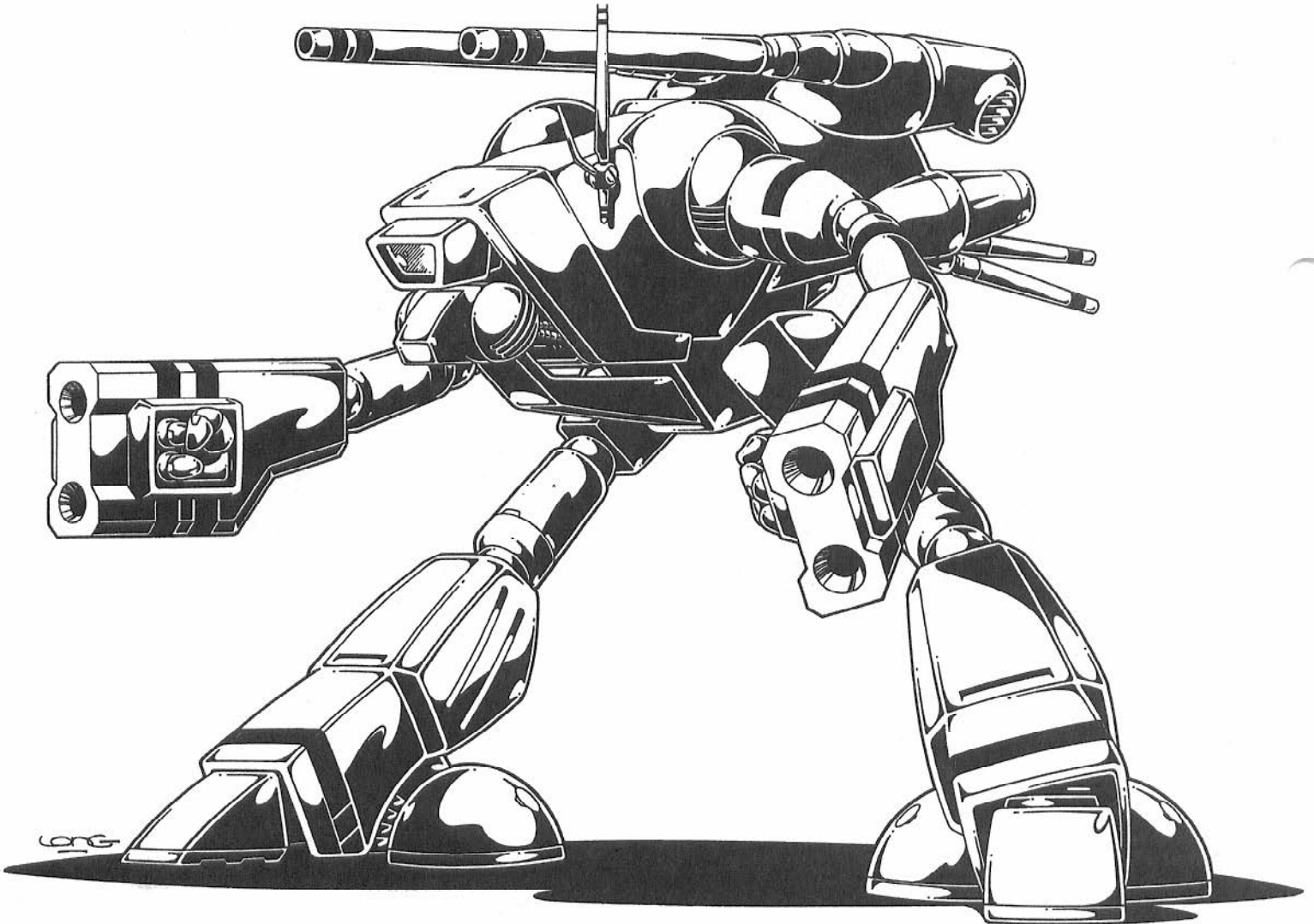

## THE REF OFFICER'S BATTLE POD (OBP-Z2)

The new Officer's Battle Pod is a smaller, sleeker version of the original Zentraedi design. Except for the basic body shape, this formid-

able war machine has been completely redesigned. The body is less round and more linear. The arms are high mounted and more sturdy. The legs are completely different, bending more like destroid legs, rather than the ostrich-like variety on the original Zentraedi Pods. This has reduced its running speed, but given it better diversity of movement.

Mounted atop the deadly machine are *two* particle beam cannons replacing the one of the old-style pod. The familiar weapon arms are

still present, but an infrared spotlight has been added, along with retractable two-fingered hands for climbing, grasping and carrying. The hands can extend 8ft (2.4m) out of their forearm housings. The front mounted impact cannons have been moved to the rear and missiles are no longer part of its arsenal.

Rear jet engine thrusters provide limited flight capabilities and greater speed and mobility in space. Concealed maneuvering jets are found in its legs and body. **Note:** The Officer's Pod Armored Vehicle is still available for maximum speed transatmospheric capabilities. See *Robotech RPG*, pg 90.

## THE REF OFFICER'S BATTLE POD

**Model Type:** OBP-Z2

**Class:** Destroid; Officer's Battle Pod — Zentraedi type Two

**Crew:** One

**M.D.C. by Location:**

Top-Mounted Particle Beams (2) — 50 each

Rear Impact Cannons (2) — 25 each

Weapon Forearms (2) — 100 each

Searchlight (2) — 25 each

Upper Arms — 70 each

Retractable Hands (2) — 25 each

Legs (2) — 100 each

Rear Engine Thrusters (2) — 100 each

\*Sensor Eye (1) — 50

\*\*Main Body — 220

Reinforced Pilot's Compartment — 200

\*Depleting the M.D.C. of the sensor eye will knockout all optical systems; -1 to strike penalty (must rely solely on instrument readings). However, the sensor eye is a small, protected target, so the opponent can only hit it on a "called shot" and is -3 to strike.

Note: The OBP-Z2 has all the standard destroid sensors.

\*\*Depleting the M.D.C. of the main body will shut the mecha down completely, rendering it useless.

**Speed:** Running: 175mph (281kmph)

Leaping: 50ft (15.2m) up or across without booster assistance, or 400ft (121m) with jet boosters engaged.

Hover: The Officer's Pod can hover stationary, up to 1000ft (300m) high, indefinitely.

Flying: Unlike the TBP-Z1, the officer's pod can fly. Cruising speed is 100 to 300mph (160-482kmph); maximum speed in an atmosphere is mach one (670mph).

Space Propulsion: Has full mobility in space; maximum speed is mach two (1340mph).

Underwater Propulsion: Cruising speed: 50mph (80kmph), and can rocket itself up to speeds of 300mph (482kmph) for as long as an hour. Walking underwater reduces running speed by 75%.

**Height:** 26.4ft (8.05m)

**Width:** 15.2ft (4.6m)

**Length:** 20ft (6.1m)

**Weight:** 17 tons

**Cargo:** Minimal storage space behind the pilot seat can squeeze in one additional passenger or 500lbs (226.8kg).

## WEAPON SYSTEMS

1. **Dual-Mounted Particle Beam Cannons** are mounted on the top of the OBP-Z2. Each cannon can move independently of the other or fire simultaneously. This means the weapons can be directed at the same target or at two different targets. Unlike the TBP-Z1, the officer's pod can position its cannons along a 90 degree arc up, down and from side to side.

**Primary Purpose:** Heavy assault

**Range:** 6000ft (1829m)

**Mega-Damage:** Single blast — 4D10 M.D., double simultaneous volley — 8D10 M.D. (counts as one attack).

**Rate of Fire:** Equal to the pilot's combined number of attacks.

**Payload:** Effectively unlimited

2. **Weapon Arms** are a dual weapon system consisting of two forearms, a second particle beam cannon and an auto cannon.

**Primary Purpose:** Anti-armored vehicle and antipersonnel.

**Range:** P-Beam — 4000ft (1200m), auto cannon — 2000ft (609m)

**Mega-Damage:** P-Beam — 4D10 M.D. per blast, auto cannon — 2D6 M.D. per blast.

**Rate of Fire:** The pilot can fire either the particle beam cannon or the auto cannon or both simultaneously (note the reduced range of the auto cannon). Equal to the pilot's combined number of attacks.

**Payload:** P-Beams — effectively unlimited. Auto cannons (2) — 50 blasts each.

3. **Two Rear Impact Cannons** are mounted in the rear between the two thruster engines. Both can be moved simultaneously or independently in a 90 degree arc up, down, and side to side.

**Primary Purpose:** Defense

**Range:** 2000ft (609m)

**Mega-Damage:** Single blast — 2D6 M.D. or double simultaneous blast — 4D6 M.D., or 1D6 x 10 M.D. from a dual burst.

**Rate of Fire:** Equal to the pilot's combined attacks per melee.

**Payload:** Each cannon has 60 rounds; a single blast is one round, a dual blast is 2 (one round each cannon) and a dual burst is six rounds (3 from each cannon).

4. **Hand to Hand Combat.** Rather than fire weapons, the pod can engage in hand to hand combat. Punch does 2D6 M.D., Kick — 1D6 M.D., Body Block — 1D6 M.D. or Stomp — 1D4 M.D. The use of hand-held weapons is awkward, but possible (-2 to strike penalty).

---

## THE REF CYCLOPS (CRP-Z3)

The Zentraedi's largest mecha-vehicle is the Theatre Scout (also known as the Cyclops). This humongous mecha was used by the Zentraedi as an *all-terrain reconnaissance vehicle* and has been adopted by the REF for the same purpose.

The Cyclops (renamed by the REF) is a walking sensor, radar, and communications network housed in an armored mini-fortress. The cyclops is primarily used to probe uncharted enemy territory and to maintain/relay communications during battle. Outfitted with its heavy armor, battery of sensors, armaments, and great versatility of movement the cyclops can prowl around in the most deplorable conditions, unescorted. Its great versatility enables it to adapt to its environment and it packs enough firepower to handle most random encounters.

Externally, the REF Cyclops looks exactly like its Zentraedi counterpart. It is the internal modifications that hold the surprises. Once outfitted to accommodate a crew of four 50ft warriors, the cyclops now accom-

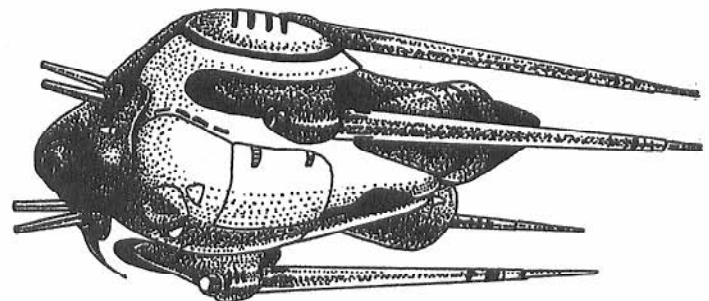



modates 4 to 12 human sized soldiers. The minimum crew is a pilot and copilot, both are also Alpha and/or Beta pilots, and two communications engineers. Often a field scientist or military specialist are part of a basic crew. Any other combination of personnel can be added, but rarely exceeds twelve, the maximum number of crew members which can be evacuated if necessary.

A storage area allows for the inclusion of four to twelve cyclones, (usually the VR-052 Battler), and a separate storage bay, measuring 10×10×10ft (3m), to contain specimens, supplies, prisoners, or additional personnel (as many as 20 standing).

The major difference is the replacement of the 100ft (30.5m) escape capsule with an *Alpha* fighter connected to a *Beta*. The copilot usually pilots the Alpha (detaching only to defend the other crewman in the Beta), while the cyclops pilot operates the Beta. The Beta can seat two others in the cockpit, while the remaining crew (8) are seated in the specially modified bomb bay compartment. This means the Beta does not carry its usual supply of bombs, but all other weapon systems are fully armed. Likewise, the Alpha is fully armed for combat. Unlike the slow, weaponless escape pod, the Alpha and Beta can reach a speed of Mach 8 connected, and can also disconnect to become two devastating war machines.

## THE REF CYCLOPS RECONNAISSANCE POD

**Model Type:** CRP-Z3

**Class:** Destroid, Cyclops Reconnaissance Pod—Zentraedi type Three

**Crew:** 4-12

**M.D.C. by Location:**

Dual Barreled P-Beam Turrets (2) — 50 each

\*Sensor Eye (1) — 100

Legs (4) — 75 each

Rear Thrusters (2) — 200 each

\*\*Main Body — 600

\*Depleting the M.D.C. of the sensor eye will knockout all optical systems. The pilot must then rely only on instrument readings (–1 to strike, –10% pilot skill).

\*\*Depleting the M.D.C. of the main body will shut the mecha down completely, rendering it useless. Only the emergency escape hatch can be opened, allowing the Alpha/Beta to escape.

**Speed:** Walking or cruising speed — 40mph

Running: 80mph (128kmph); can not leap.

Hover: The cyclops can hover stationary at any height or fly as low as 100ft (30.5m) above the ground.

Flying: Cruising speed is about 300mph (482kmph), but can reach and maintain 1005mph (1616kmph) or Mach 1.5.

- 7. Ground Sensor System.** Uses seismic and laser sensors to detect the ground movements of troops or vehicles, as well as other natural and unnatural seismic activity. Range: 10 miles (16km).
- 8. Radiation Detector.** Detects, identifies, and measures radiation. Range: 1000ft (300m).
- 9. Heat:** Picks up and measures heat emanations. Can be focused on an area as small as 20ft (6.1m). Range: 1000ft (300m).
- 10. Motion Detector:** Registers movement and pinpoints location of the source of movement. Range: 1000ft (300m).
- 11. The Sensor Eye** is an elaborate optical enhancement system used for reconnaissance (spying). All data is instantly transmitted to at least one separate monitor and the targeting and combat computers simultaneously. Any crew member can elect to record the data with a simple flip of a switch. The sensor eye has the following capabilities. The range of each is 2000ft (609m) unless otherwise stated.

Thermo-Imager

Night Sight (passive light intensification system)

Ultraviolet Sight

Infrared Sight

Infrared Spotlight (emits from the eye)

Telescopic Sight

Video Camera (records and/or transmits, has telephoto capabilities).

Photography (still pictures, has telephoto capabilities)

Spectrograph (light analysis system)

- 12. Normal Light Spotlights (8):** Two are located underneath the P-Beam turrets, two above the turrets and one under each leg joint. Range of beam: 1000ft (1600m).

Space Propulsion: Can reach speeds of nearly Mach 3, about 1995mph.

Underwater Propulsion: Cruising speed is 50mph (80kmph), but it can reach and maintain a speed of 400mph (643kmph). Walking underwater is reduced by 50%.

**Height with legs fully extended:** 200ft (60m) from the ground to the belly of the cyclops.

**Height of Body Housing:** 110ft (33m)

**Width:** 160ft (48.7m)

**Length:** 400ft (120m)

**Weight:** 320 tons fully loaded.

**Cargo Bay:** 10×10×10ft area holds up to 30 tons.

## WEAPON SYSTEMS

- 1. Two Front Mounted, Rapid-Fire Particle Beam Cannons** are mounted on either side of the sensor eye. The turrets are capable of 90 degree rotation in all directions.

Primary Purpose: Defense

Secondary Purpose: Anti-Missile

Range: 2000ft (609m)

Mega-Damage: 1D4×10 per blast or 5D4×10 for a full melee blast (per each turret).

Rate of Fire: Six each turret (2), or equal to the pilot's combined number of attacks per melee, whichever is higher.

Payload: Effectively unlimited

- 2. Medium Range Missiles** can also be fired from the sides of the cyclops.

Primary Purpose: Defense

Range: Varies with missile type.

Mega-Damage: Varies with missile type. Any medium range missile can be used, but high explosive, plasma, and multi-warhead are usually standard issue.

Rate of Fire: One at a time or in volleys of 2 or 4.

Payload: 24 missiles total. Two are always smoke.

- 3. Alpha and Beta "escape" vehicle.**

## SENSORY EQUIPMENT

- 1. Advanced Radar/Sonar.** Range: 200 miles (321km). Can identify 600 individual targets and simultaneously track 250.

- 2. Combat Computer.** Calculates, stores and transmits data onto four different computer screens in the cockpit or onto the head up displays (H.U.D.s) of specific crew members. The combat computer can recognize and identify over 3000 different targets, calculates, speed, trajectory, purpose, intent and E.T.A.

- 3. Cyclops Targeting Computer.** Range: 100 miles (160km). This unit is linked to the mecha's combat computer and weapon systems. It will alert the pilots to the approach of potentially dangerous targets, collision and assaults. It will also suggest defensive or retaliatory action.

Combat Bonuses: +1 on initiative +1 to dodge

+1 to strike Hide/Prowl 50% (a base ability)

- 4. Laser Communications:** Long-range, directional. 10,000 mile (16,000km) range (unboosted).

- 5. Full Radio and Video Communications System,** including transmitters, receivers, boosters, scramblers, decoder, recording, duplicating, and editing facilities. **Satellite Relay.**

# THE CYCLONE

## Veritech Riding Armor

The Cyclone is the latest achievement in human robot technology. The mecha unit is a light, but heavy-duty motorcycle that can transform into a battloid mecha that's almost as formidable as the old Veritech Fighter. The veritech riding armor is composed of new super alloys that are incredibly light, making the creation of a heavily armored, man-sized mecha possible. The mecha is so lightweight (200lbs/90kg) and compact that it can be folded down and placed inside a storage unit in an Alpha Fighter. Despite the fact that it is lightweight, the armor provides 200 M.D.C. protection, better than the Southern Cross' Logan and almost equal to the 40ft (12.2m) VF series Veritech.

The Cyclone is designed to be the ultimate land combat system for the RDF foot soldier. In **motorcycle mode**, the cyclone offers high mobility, maneuverability and speed. The motorcycle can travel over the worst terrain with minimal difficulty and is a much smaller target than a more conventional four-wheeled vehicle. This makes the cyclone ideal for clandestine operations, reconnaissance and one-man missions, as well as for massive troop movements.

In **battloid mode**, the cyclone becomes a suit of protective power armor. The seven foot (2.1m) mecha provides a variety of devastating weapon systems, easy conversion from M.D.C. weaponry to S.D.C. weapons, superhuman strength, superhuman speed and even limited flight. As power armor, the battloid is like a second skin that responds to the wearer's slightest movement. Combined with the unique bond between man and machine created by its protoculture power cells, the mecha can leap, roll and dodge with lightning speed. (See *Hand to Hand Bonuses from Cyclone Combat Training for specific bonuses in close combat.*)

To maximize the versatility of the Cyclone Veritech, the mecha can operate on both protoculture and gasoline. However, the limitations of liquid fuel prevents flight and inhibits its maximum speed and mobility. The liquid fuel is included as a back-up system to be used when the protoculture energy cells are running low or are, not available.

A **fully powered protoculture cell** will last about two months of constant combat and riding. Moderate use of the motorcycle mecha can stretch that by two or three times. Flying depletes the energy twice as quickly. Cells not in use will stay at full power for decades.

There are three styles, or models, of Cyclone Veritech Riding Armor. The first and most common is the **VR-052 Battler Cyclone**. The Battler is designed to be a frontline combat unit with heavy assault capabilities. It comes standard with GR-103 front loaded mini-missiles and a pair of GR-97 forearm missile shields. The cyclone rider can use any variety of conventional or M.D.C. weapons as sidearms. Standard issue is the **Gallant H-90**, a multipurpose sidearm that can be used as an automatic pistol (S.D.C.), energy pistol (M.D.C.) or energy rifle (M.D.C. and long range). The Battler Cyclone has been included in the Alpha Fighter as a combat/survival mecha unit for downed pilots. It also gives the pilot the extra versatility to conduct air and ground combat maneuvers.

The **VR-041 Saber Cyclone** is identical to the Battler, with minor stylistic changes. The one significant difference is the replacement of the forearm mini-missile launcher system with the newly developed Close Assault and Defense System (C.A.D.S.), Model One. CADS-1 are a pair of disc-like arm shields that contain a retractable, high-frequency pair of mega-damage blades. The sabers can slice through M.D.C. structures as easily as a conventional sword cuts through S.D.C. structures. The original concept was to create a weapon system suitable for special forces assigned to clandestine operations. The silent, but deadly weapons are ideal for espionage. The only sound they make is a low hum. Approximately one in every 50 cyclones are fitted with CADS. Note: Other hand-held weapons can also be used by the pilot.

The third type of veritech riding armor is the **VR-038-LT (Light Combat Unit)**. The "38 Lite," as it is often called, is a lighter version of its predecessor (about 110lbs/50kg). It is designed specifically to accommodate the many valiant female soldiers in the RDF. The Light Combat Cyclone is less heavily armored (lower M.D.C. of 150) and does not come equipped with any type of missile system. However, the Light Combat Cyclone is even more maneuverable than the other cyclones. (See *Hand to Hand Combat Bonuses from Cyclone Combat Training special note.*) To compensate for its lack of built-in armaments, the 38-Lite comes equipped with the RL-6 Heavy Rocket Cannon, a sort of high-tech, multi-round bazooka. The weapon is hand-held and can be fired in the cyclone armor, or without the armor as a shoulder supported weapon like a LAW rocket launcher. Most cyclone designed weapon accessories are too heavy or awkward to be used without the cyclone armor.

## CYCLONE

**Model Types (3):** VR-052 Battler (Scott Bernard type)  
VR-041 Saber (Lancer type)  
VR-038-LT (Light Combat; Rook type)

**Class:** Military Operation Soldier Protection Emergency Aviation Drive Auto.

**Crew:** One

**M.D.C. by Location:**

Headlight (front) — 2

Front Tire — 2

Rear Tire — 2

Storage Box (2) — 2

Rocket Thrusters (rear) — 50

\*Main Body — 200

\*Depleting the M.D.C. of the main body will shut the mecha down completely, making it useless.

**M.D.C. by Location in Battloid Mode:**

Tires (2, mounted behind shoulders) — 2 each

Rocket Thrusters (rear, lower back) — 50

\*\*Forearm Shields (2) — 50 each

Legs (2) — 100 each

Head — 50

\*Main Body — 200

\*Depleting the M.D.C. of the main body will shut the mecha down completely, rendering it useless. An emergency release system allows the person inside to shed the immobilized armor. Remember, the wearer of the cyclone armor is also wearing ride-armor underneath it for added protection. Note: The VR-038 Light Combat Cyclone has a Lower Main Body M.D.C. of 150.

\*\*The forearm shields of the VR-052 cyclone mecha (Scott's) have a GR-97 short-range missile system (standard for the VR-052). They have still 50 M.D.C. each arm.

**Speed:** Motorcycle Mode: 210mph (336kmph) maximum. *Typical cruising speed* is around 80mph (128kmph). The mecha is equipped with heavy shock absorbers and reinforced M.D. body to easily handle rough terrain at high speeds. *Turbo boost* by the rear jet enables the motorcycle to make leaps of up to 40ft (12.2m) across or hurl itself 20ft into the air.

Battloid Mode, Running: 60mph (96kmph) maximum.

Battloid Mode, Flying: Hover stationary up to 30ft (9.1m) above the ground and fly up to 200ft (61.5m) high and at a maximum speed of 180mph (288kmph). However, flight uses up protoculture energy cells three times faster than normal. Flight is not possible without protoculture.

Battloid Mode Leaping: The powerful legs of the cyclone mecha can leap up to 20ft (6.1m) high or across unassisted by the thruster. A *thruster assisted leap* can propel the mecha up to 100ft (30.5m) high or lengthwise.

**Height:** Battloid Mode: 7ft (2.1m)  
 Motorcycle Mode: 3.6ft (1.09m)

**Width:** Battloid Mode: 3.4ft (1.03m)  
 Motorcycle Mode: 1.6ft (0.5m)

**Length:** Battloid Mode: 3.10ft (0.94m)  
 Motorcycle Mode: 5ft

**Weight:** VR-052 Battler & VR-041 Saber — 200lbs (90kg)  
 VR-038 Light Combat — 110lbs (49kg)

**Cargo:** Has detachable cargo boxes (2) that can be connected to the rear of the bike like saddlebags. The size of each container is 18 inches tall by 20 inches wide by 18 inches deep (18×20×18). A passenger can also ride seated behind the driver. **Maximum cargo weight limit**, in addition to the rider is 250lbs (113kg). Reduce maximum speed by 20% for every additional 50lbs (22kg) and -1 to dodge. **NOTE:** The storage boxes and passenger drop off the motorcycle when it changes into a cyclone battloid. Valuables in the storage box must be retrieved later or carried in one hand. *Storage box weight per pair:* 10lbs (4.5kg) empty. One storage box can hold 12 mini-missiles (weight — 24lbs).

## WEAPON SYSTEMS

### Weapon Systems by Model Type

#### The VR-052 Battler (Scott Bernard Type)

**1. GR-103 Mini-Missile Launcher (2):** This standard weapon is built into the VR-052 and VR-041 cyclones. In motorcycle mode, the two missile launchers are side by side in the nose of the cycle. In battloid mode, the missile launchers are divided, with one on each side of the chest/shoulder area. Both launchers hold six missiles (usually armor piercing).

Primary Purpose: Assault

Secondary Purpose: Anti-Aircraft (ground to air missiles)

Missile Type: *Mini-missiles* designed for cyclone mecha and a handful of special bazooka-like rifles. Any of the available types of missiles can be utilized, but *armor piercing* is standard issue for the VR-052 Battler.

Mega-Damage: Varies with type of missile.

Rate of Fire: One at a time or in volleys of 2, 4, 6 or all. The number of missile volleys which can be fired per melee is equal to the pilot's

combined number of hand to hand attacks. Remember, each volley, even a volley of 4 or more missiles, counts as one attack.

Range: Varies with missile type, but always around one mile (1.6km).

Payload: Each missile launcher holds six (6) each, for a total of twelve (12).

**2. GR-97 Forearm Missile Launcher:** The VR-052 Battler comes automatically equipped with a pair of missile launchers built into the forearm shields of the cyclone. These appear as two cylinder shaped canisters that run the length of the arm shield. Each canister contains one mini-plasma missile. The missiles can be fired one at a time or in pairs. **NOTE:** When the cyclone is in motorcycle mode, the launchers are stored at the base of the front wheel.

Primary Purpose: Assault

Secondary Purpose: Anti-Aircraft (ground to air missiles)

Missile Type: Plasma mini-missiles only!

Mega-Damage: 1D6×10 M.D.

Rate of Fire: Individual or a volley of two (2) fired simultaneously.

Range: One mile (1.6km)

Payload: Four (4) total, but up to 12 additional missiles can be securely fitted in one cyclone storage box. Each missile weighs 2lbs (0.9kg).

**Note:** The GR-97 can be used by any of the other cyclone models as an *optional* weapon system in place of its standard weapon. Likewise, the VR-052 Battler Cyclone can discharge the GR-97 missile launcher and then use any of the other arm/shield weapon systems. **ALL** cyclone weapon systems are interchangeable.

#### VR-052 BATTLER CYCLONE

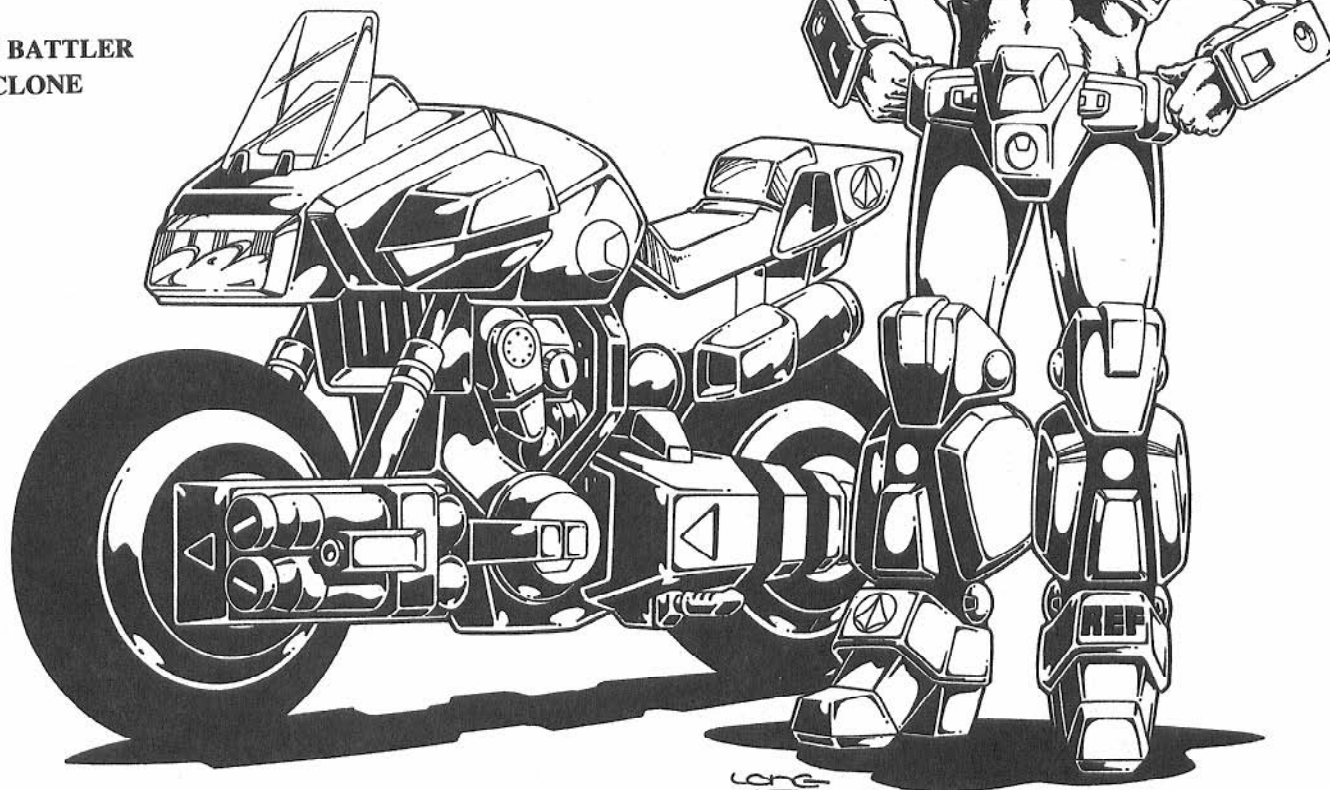



3. **Gallant H-90 Multi-Weapon System:** The Gallant H-90 is a standard sidearm issued to all cyclone, alpha and beta pilots of the RDF Expeditionary Force. It is a versatile weapon that can be used as a S.D.C. automatic pistol, M.D.C. pistol, or M.D.C. high-powered rifle complete with attachable rifle stock. *See the Gallant description in the weapon section for more details.*

Primary Purpose: Assault

Range: Varies. S.D.C. semiautomatic — 200ft (61m); Pulse Energy Pistol — 500ft (152m); Pulse Energy Rifle — 1400ft (427m).

Mega-Damage: Varies. S.D.C. semiautomatic — 4D6 S.D.C. damage per shot. Although bursts of energy are fired on the semiautomatic setting, they do only S.D.C. damage, not M.D. Pulse Energy Pistol — 1D6 M.D. per blast. Pulse Energy Rifle — 4D6 M.D. per blast.

Rate of Fire: Aimed, burst or wild. *See Modern Weapon Proficiencies.*

Payload: The S.D.C. damage pistol draws so little energy as to be considered unlimited with a single energy clip (estimate 1000 blasts).

Pulse Energy Pistol: 20 blasts per energy clip. The Gallant can be switched from a S.D.C. pistol type weapon to an energy pistol with the flick of a switch. However, to convert it into an energy rifle, the rifle stock and “extra” rifle energy clip must be attached.

Pulse Energy Rifle: 30 blasts per rifle energy clip. An additional energy clip and rifle stock container must be attached to use as a rifle.

Note: The Gallant uses protocluture energy.

4. **Hand to Hand Combat:** Rather than fire any weapons, the cyclone can engage in hand to hand combat. Punch does 1D4 M.D., kick does 1D4 M.D. (cyclone mecha has an equivalent strength of P.S. 40 ) Leap kick — 2D4 M.D., body flip — 1D4 M.D., or body block — 1D4 M.D.

## OPTIONAL WEAPON SYSTEMS

1. **Missile Launcher Sidecar:** The sidecar can be attached to the cyclone in motorcycle mode only, or onto any type of larger, conventional motorcycle. The sidecar will automatically detach and drop away from the cyclone when it changes into battloid.

Primary Purpose: Assault

Secondary Purpose: Anti-Aircraft (ground to air missiles)

Missile Type: Any mini-missiles except plasma. Usually high explosive or fragmentation are used.

Mega-Damage: Varies with missile type.

Rate of Fire: One at a time or in volleys of 3, 6 or 9 (all). As always, a volley, regardless of the number of missiles, is counted as one attack.

Range: Varies with missile type, but always around one mile (1.6km).

Payload: Holds a total of nine (9) mini-missiles.

2. **EP-37, 60mm Beam Cannon:** A large energy rifle designed for the cyclone foot soldier as an additional weapon system. The weapon is stored on the right or left side next to the front wheel hub in motorcycle mode, but must be carried in battloid mode. It can be used by normal humans not in cyclone mecha like a rifle, but is heavy and awkward, and imposes a penalty of -3 to strike.

The EP-37 system comes complete with a built-in telescopic, passive, light amplifying (night sight) targeting system.

Primary Purpose: Assault

Range: 4000ft (1200m)

Mega-Damage: 1D4 × 10 M.D. per blast.

Rate of Fire: Aimed, burst or wild. *See Modern Weapon Proficiencies.*

Payload: 10 blasts per energy clip.

Weight: 14lbs (6.4kg). M.D.C. of Weapon: 5

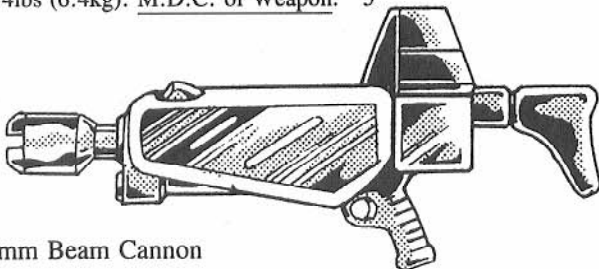

EP-37 60mm Beam Cannon

3. **EP-40, 40mm Pulse Beam Gun (Rand's cyclone weapon).** Another energy weapon designed specifically for use with cyclone mecha. The weapon appears to be a large pistol that can be stored on either side of the front wheel hub in motorcycle mode and is mounted on the forearm shield, in place of a GR-97 missile launcher, for storage in battloid. The EP-40 must be held in hand to be fired while in battloid mode.

In motorcycle mode, the weapon can be rotated upward in a 45 degree angle and fired by pressing a trigger in the handle bars.

The EP-40 system comes complete with a built-in laser targeting system that provides a bonus of +1 to strike. Unfortunately, its weight and awkward design makes it almost impossible for it to be used by humans not in cyclone mecha. Strike penalty for humans is -10, and it can only be used as a two-handed weapon.

Primary Purpose: Assault

Range: 2000ft (609m)

Mega-Damage: 4D6 M.D. per blast

Rate of Fire: Aimed, burst or wild. *See Modern Weapon Proficiencies.*

Payload: 30 blasts per energy clip.

Weight: 22lbs (10kg). M.D.C. of Weapon: 10.

Special Bonus: +1 to strike — thanks to the laser targeting system.

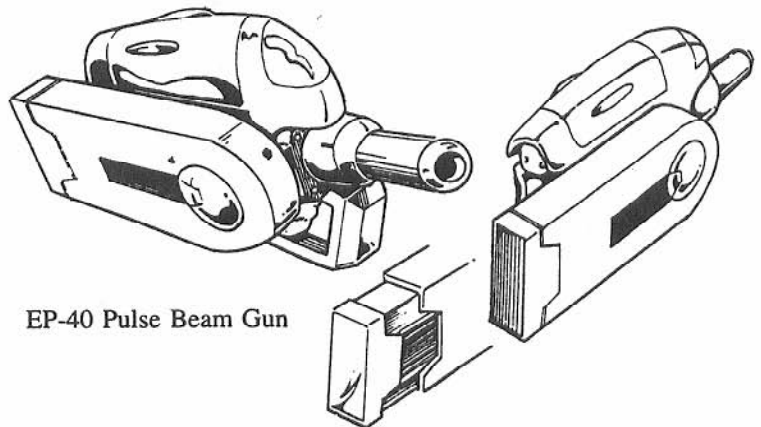

EP-40 Pulse Beam Gun

4. **RL-6, Heavy Rocket Cannon** (*See VR-038-LT Cyclone*).
5. **CADS-1** (*See VR-041 Saber Cyclone*), but not recommended.
6. **Any type of hand-held weapon** can be fired while in cyclone mecha.

## The VR-041 Saber (Lancer Type) Weapon Systems

1. **Close Assault and Defense System (CADS-1)** is the most advanced hand to hand weapon system built for mecha. In place of the other types of forearm shield weapons available, the Saber Cyclone is fitted with large disc-like shields that contain the CADS-1 system. With the press of a manual stud control or by voice activation (a spoken 4 digit code), one or both of the retractable high-frequency sabers will spring out for instant use. The sabers are double-edged, sword-like weapons with a high-frequency energy field around them, creating a mega-damage blade weapon. Hence, the “Saber” part of this mecha’s name.

The blades are powered by the cyclone’s own power supply and can not be removed without tools. Frequent use of the blades will drain the protocluture cell twice as quickly.

Detached from the cyclone mecha, a CADS-1 is a worthless weapon, weighing far too much to wield even as a two-handed weapon and it no longer has mega-damage capability (does 2D6 S.D.C., but is -10 to strike and parry).

Primary Purpose: Hand to Hand Combat

Secondary Purpose: Clandestine operations (silent and deadly).

Range: Within reach

Mega-Damage: Slash — 2D6 M.D., Punch — 3D6 M.D., or Power Punch — 6D6 (counts as two attacks).

Number of Attacks Per Melee: Equal to combined hand to hand attacks.

Weight: 25lbs each (11.4kg)

M.D.C. Special: 50 when retracted, but a renewing force field provides the blades and forearms with unlimited M.D.C. when extended (this only protect the saber blades and forearms).

Special Bonus: Adds +2 to parry in hand to hand combat and even enables the character to attempt to *parry/block energy blasts*, but with absolutely no bonuses (natural, unmodified dice rolls only).

Note: The CADS system comes standard with the VR-041 Saber Cyclone (one for each arm). Opting for a different weapon system or split systems is not advised and uncommon. In motorcycle mode, the CADS are located on either side of the front wheel hub. Penalty: The inclusion of the CADS-1 system on the other two cyclones will reduce their maximum speeds by 20% per each unit.

2. **GR-103 Mini-Missile Launcher (2):** This is identical to the VR-052 Battler Cyclone (#1).
3. **Gallant H-90 Multi-Weapon System** is issued as the sidearm. Identical to the VR-052 Battler Cyclone (#3).
4. **Hand to Hand Combat:** Same as the VR-052 Battler, or the CADS can be used in place of a punch. Blades can not be used in motorcycle mode.

#### VR-041 SABER CYCLONE (Motorcycle Mode)

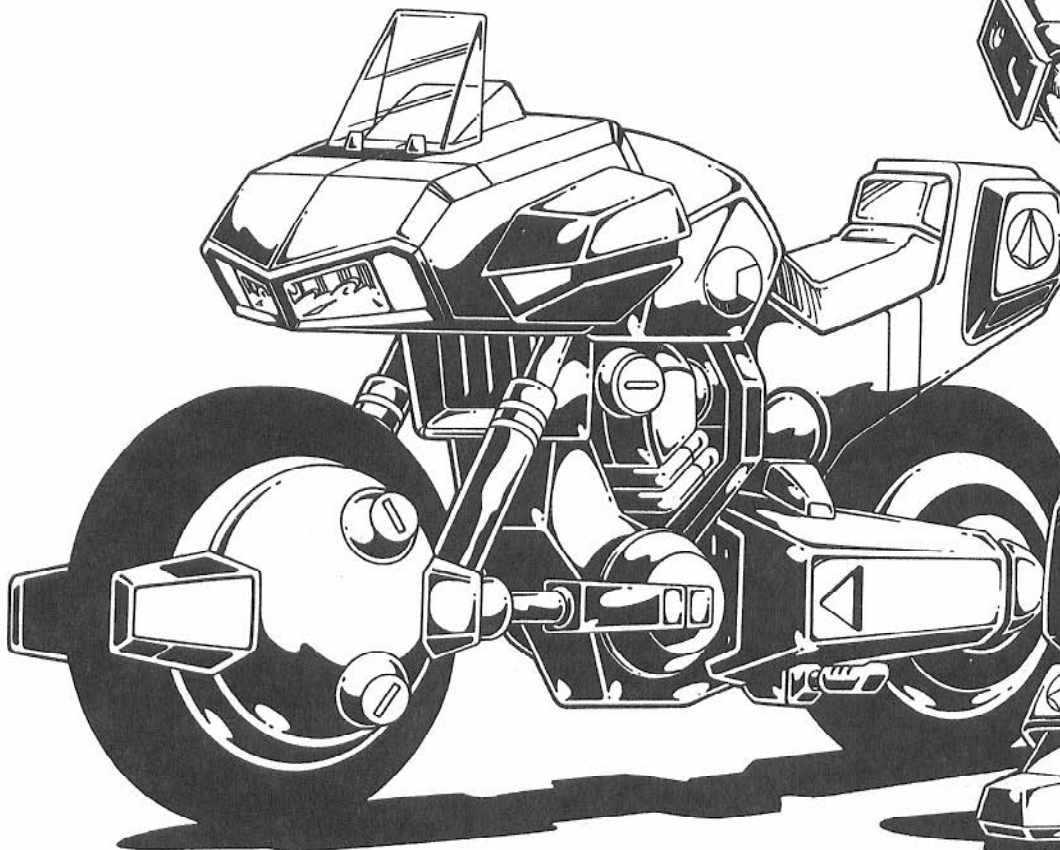

#### OPTIONAL WEAPONS

- 1) **GR-97, Forearm Missile Launcher** is not recommended, but can be *substituted* for the CADS.
- 2) **Missile Launcher Sidecar.** See Battler.
- 3) **EP-37, 60mm Beam Cannon.** See Battler.
- 4) **EP-40, 40mm Pulse Beam Gun** is not recommended, but can be *substituted* for the CADS.
- 5) **RL-6 Rocket Cannon.** See VR-038-LT Cyclone.
- 6) **Any type of hand held weapon.**

**Special Equipment:** Same as VR-052 Battler Cyclone.

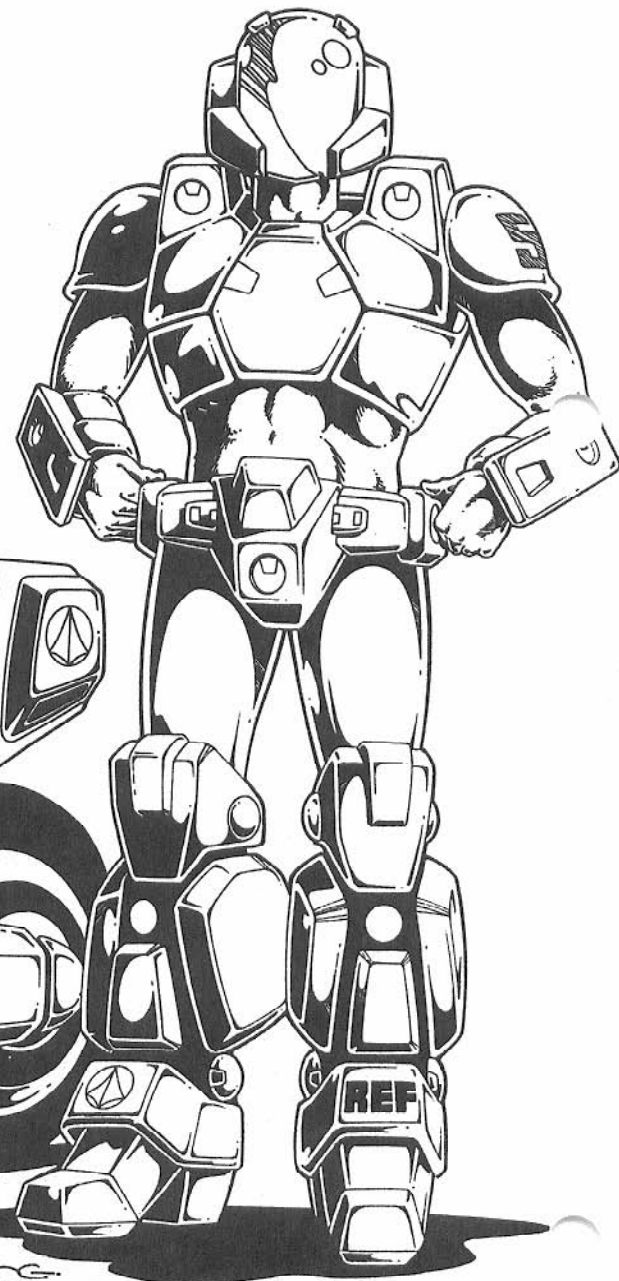

## The VR-038 Light Combat Cyclone (Rook's Type) Weapon Systems

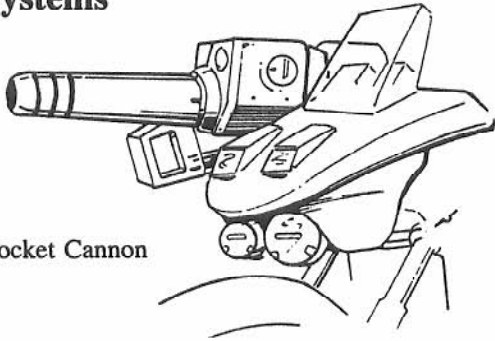

RL-6 Heavy Rocket Cannon

1. **RL-6 Heavy Rocket Cannon.** The RL-6 is standard issue with the Light Combat Cyclone. Unlike some of the other weapons, the RL-6 rocket cannon can be mounted on the cycle's undercarriage for storage or top mounted on the right or left side. In the top mounted position, the rocket cannon can be easily fired, but in a fixed forward position.

The mini-missile rockets are carried in a six (6) round box magazine. Reloading of all six missiles requires one full melee. The RL-6 Rocket Cannon is a futuristic version of a recoilless rifle and can be used by normal humans wearing no mecha as a shoulder supported weapon.

Primary Purpose: Assault

Range: 4000ft (1200m)

Mega-Damage: Varies with mini-missile type, but usually uses armor piercing, high explosive or fragmentation. Can use any mini-missiles *except* plasma.

Rate of Fire: Up to all six can be fired in a single melee, but only one at a time.

Payload: Six (6) mini-missiles.

Weight: 16lbs (7.3kg) M.D.C. of Weapon: 3

2. **Gallant H-90 Multi-Weapon System** is issued as the sidearm to all RDF Cyclone riders. Identical to the description under VR-052 Battler Cyclone (#3).

3. **Hand to Hand Combat:** Same as the VR-052 Battler, but with additional *bonuses* for mobility and light weight (See *Hand to Hand Bonuses for Cyclone Combat Training*).

**Note:** The GR-103 mini-missile launcher is NOT available to the light combat cyclone.

### OPTIONAL WEAPONS

- 1) **GR-97 Forearm Missile Launcher.** See VR-052 Battler for description.
- 2) **Missile Launcher Sidecar.** See VR-052 Battler Cyclone for description.
- 3) **EP-37, 60mm Beam Cannon.** See VR-052 Battler.
- 4) **EP-40, 40mm Pulse Beam Cannon.** See VR-052 Battler.
- 5) **CADS.** See VR-041 Saber for description.
- 6) **Any type of hand-held weapons.**

**Special Equipment:** Same as VR-052 Battler Cyclone.

### VR-038-LT CYCLONE Female CVR-3 Body Armor

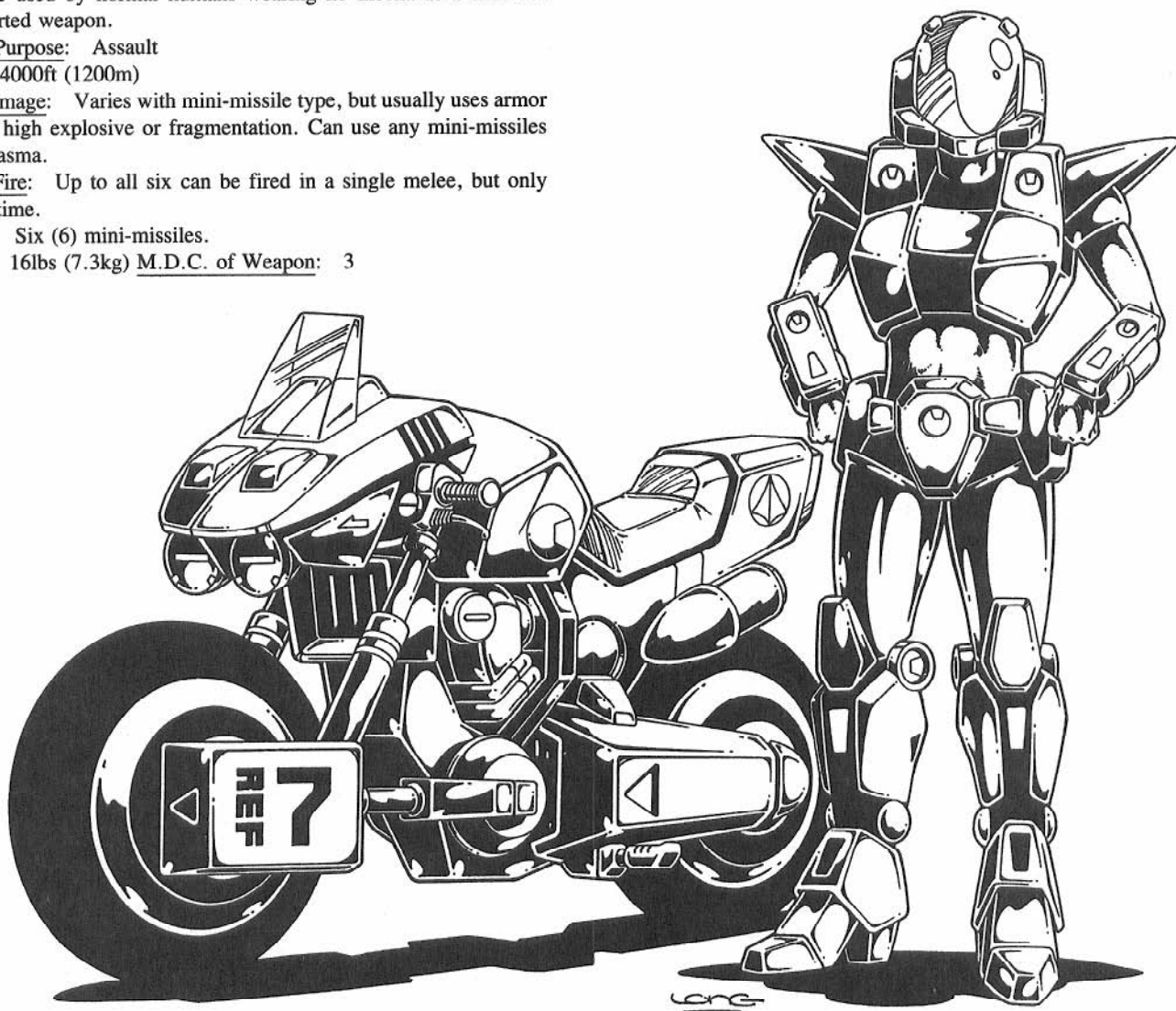



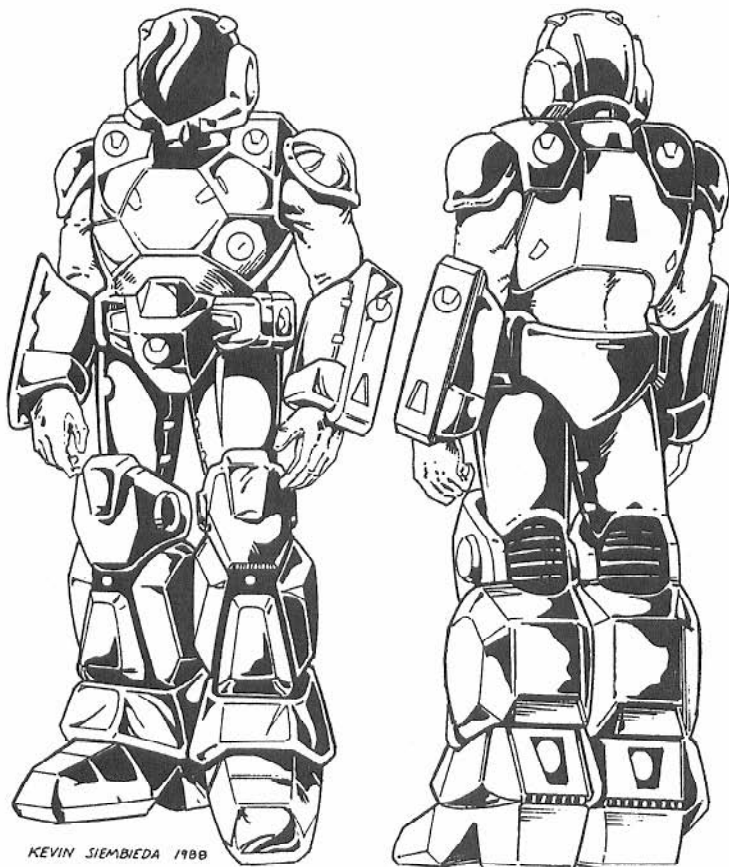

KEVIN SIEMBIEDA 1988

Male Cyclone Body Armor

## SPECIAL EQUIPMENT

### Standard for ALL Cyclone Mecha

- 1) **Protoculture Engine:** All cyclones have a protoculture powered engine. One protoculture energy cell will keep a cyclone running for about **two months** before needing refueling. *Flying* and hovering will drain the protoculture cell very quickly (3 times as fast). But *occasional* bursts of flight, thruster assisted leaps will have minimal draining of energy. Game Masters use your own judgment in regard when the energy cell is running low. Be certain to give players advance warning so that their characters will have an opportunity to scrounge up extra protoculture cells to refuel. **Note:** The energy cells can **not** be detected by invid when motors are turned off/not running. The unusual energy can only be detected when a cyclone (or Gallant) is turned on. Turning an engine off will not necessarily make a character invisible to an invid; they do have vision after all. A cyclone can **not** be turned off unless it is in motorcycle mode.
- 2) **Conventional Fuel Conversion System:** All cyclones can use regular liquid fuel like a conventional motorcycle. This is provided as a back-up system. **Fuel Capacity** is four gallons. **Estimated Range:** 200 miles (321km) without refueling. **Modifiers:** **Maximum speed:** 150mph (240kmph). Hovering and flight are not possible.
- 3) **Short-Range Radar with Head-Up Display System** (displays radar screen inside the helmet). Can identify and track up to 20 different targets. **Range:** One mile (1.6km).
- 4) **Computer Targeting System** with infrared capabilities is located in the right shoulder of the cyclone in battloid mode. **Bonuses:** Adds +2 to strike with missiles, adds +1 to strike with other weapon systems (pistols, rifles, etc). **Range:** 4000ft (609m) by line of sight.
- 5) **Radio Communication System:** Wide band and directional, with voice command actuation (4 digit code). Earphones are built into the helmet. **Range:** Two miles (3.2km).

- 6) **Miscellaneous Indicators** for speed, height, fuel, time and date are standard for all models.
- 7) **Tinted Helmet Visor.**
- 8) **CVR-3 Cyclone Body Armor** is a durable, lightweight blend of metal alloys and ceramics. It is a standard item issued to all Cyclone Veritech riders and Alpha pilots. In addition to its mega-damage protection and self-contained environmental capabilities (it's just like a spacesuit when the helmet is sealed,) the body armor is an integral part of the cyclone veritech system. The body armor is designed with special connectors and braces where the cyclone attaches itself to its battloid operator. Without the body armor, the VR-motorcycle can *not* convert into battloid mode. That means a pilot with no CVR body armor can not use the battloid aspect of the mecha until he/she finds some CVR body armor. Southern Cross or old RDF armor can *not* be substituted. Until the CVR body armor is obtained, the character can only use the cyclone as a souped-up combat motorcycle.

*Despite stylistic differences, all of the CVR-Body Armors have the same basic properties:*

- M.D.C. 50 and laser resistant (lasers do 1/2 damage).
  - Complete Environmental Battle Armor (E.B.A.) suitable for use in space and other hostile environments.
  - Computer controlled life support system.
  - Internal cooling and temperature control.
  - Humidifier.
  - Gas filtering and artificial circulation.
  - Independent oxygen supply and purge system which automatically engages in low oxygen or polluted environments. Eight hour oxygen supply, maximum.
  - Insulated, high temperature resistant weave of nylon, synthetic fibers, and metal mesh.
  - Fire resistant up to 300 degrees centigrade. Normal fires do no damage, but plasma and nuclear fires have full effect.
  - Radiation shielded.
  - Helmet with removable face plate.
  - Directional, short-range radio built into the helmet. Range is 4 miles (6.4km)
  - Tinted, light sensitive visor.
  - Utility belt/holster.
- 9) **Standard Survival Kit:** This is a small reinforced box about the size of a briefcase. The main compartment is locked with an individual, combination-type lock mechanism. The kit usually contains a first-aid kit, pocket knife, matches or lighter, flashlight, vitamins and two week's worth of freeze-dried foods. **Approximate Weight:** 10lbs (4.5kg) — fully loaded. **S.D.C. of Kit:** 12 S.D.C.

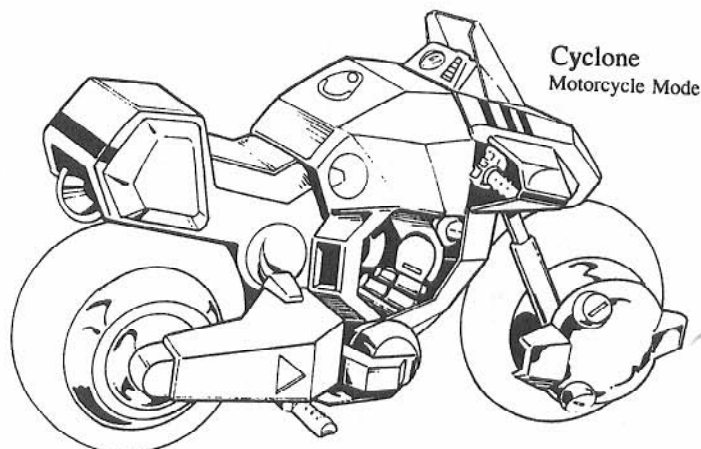

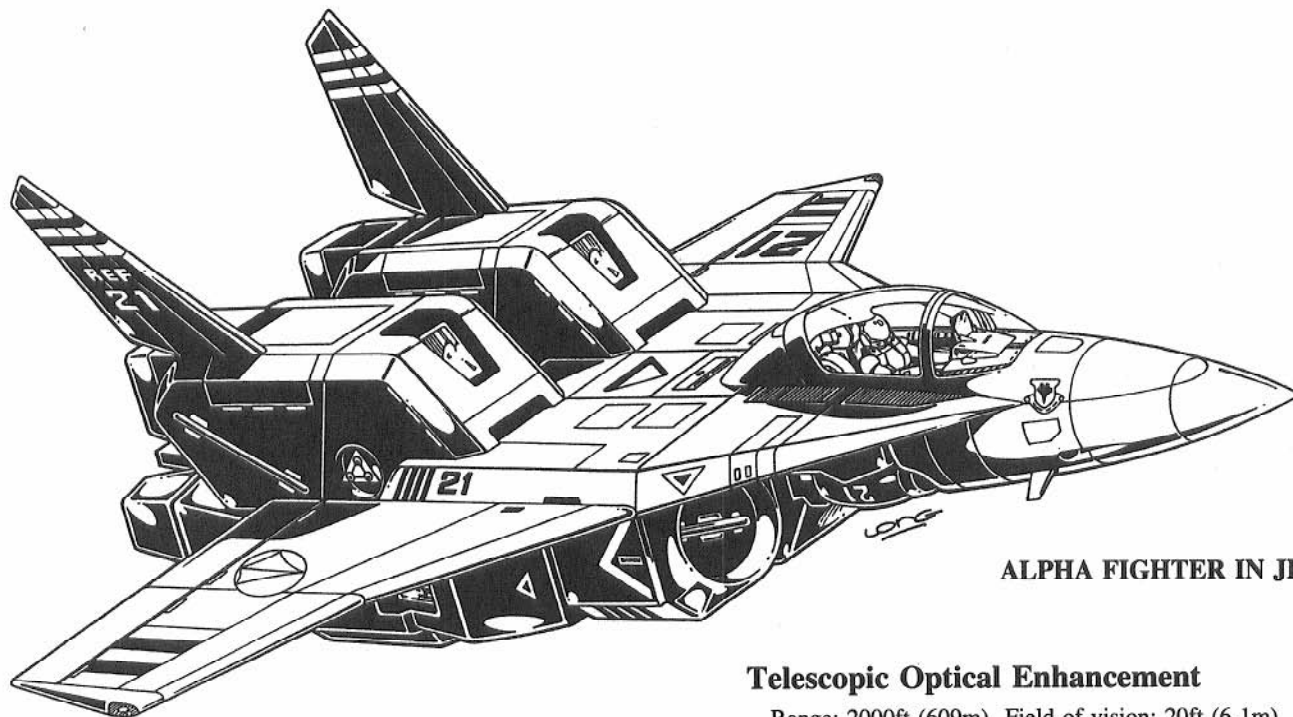

ALPHA FIGHTER IN JET MODE

## Standard Sensors and Equipment for All Veritech Alpha and Beta Fighters

### Fuel Capacity

The new veritechs have a smaller fuel capacity that utilizes micronized protoculture cells. 16 fully charged protoculture cells will give it an active combat life of about one year. The vehicles can function with half as many cells (8) for about 10 months, but the maximum speed is reduced by half and it is -1 to strike, parry and dodge. **Note:** Invid protoculture cells attained from an invid protoculture processing plant can be easily adapted for use in Earth mecha.

### Radar

Range: 10 miles (16km). Can identify and track up to 48 targets simultaneously.

### Radio Communications

Wide band and directional radio and video telecast capabilities. Range is 600 miles (945km) or can be boosted indefinitely via satellite relay.

### Laser Communications

Long-range, directional communication system. Effective range: 100,000 miles.

### Combat Computer

Calculates, stores, and transmits data onto the cockpit computer screen or head up display (H.U.D.) of the pilot's helmet. Patches in with targeting computer.

### Targeting Computer

Range: 100 miles (160km). Assists in the tracking of enemy targets and is partly responsible for the Alpha's high strike bonus.

### Laser Targeting System

Range: 100 miles (160km). Assists in the striking of enemy targets and is partly responsible for the Alpha's high strike bonus.

### Motion Detector & Collision Warning System

Close Range: 200ft (61m); sounds an alarm and red light warns pilot of impending collision and/or immediate target.

### Telescopic Optical Enhancement

Range: 2000ft (609m). Field of vision: 20ft (6.1m)

### Head Spotlights

Range: 600ft (182m)

### Loudspeaker

Loudspeaker system that can amplify the pilot's voice up to 90 decibels.

### Ejector Seat

In case of an emergency, the pilot can be instantly ejected. In battloid mode, the pilot is ejected out of the mecha's back.

### Self-Destruct

A last ditch effort to prevent the capture of a Veritech unit (usually preceded by the pilot's ejection from the veritech) is self-destruction. Explosive damage is fairly contained. An Alpha or Beta without missiles (or few) does 1D6 x 10 M.D., but a veritech with all or most of its missiles (40 or more) will do 2D6 x 100 M.D. to a 50ft (15.2m) radius.

### Smoke Screen System

The Alpha and Beta can emit a thick cloud of smoke from its rear to create immediate cover. The smoke screen system can discharge a maximum of 4 bursts before needing replacement (smoke missiles can be converted to function in the system). Each burst will cover a 60ft area (19.8m).

### Heat and Radiation Shields

Special shielding prevents the penetration of life threatening heat and radiation.

## Special Surveillance Equipment for the VAF-6R Reconnaissance Alpha (Green Lancer Type)

### Infrared Spotlight (head)

Range: 2000ft (609m). The infrared spotlight sits in the front of the sensor head like the giant, red eye of a cyclops. It emits an infrared light beam that is invisible to the normal eye (including invid). However, an enemy with infrared optics can easily see the beam of light and track it to the Alpha. Smoke impairs vision/beam.

### Thermo-Imager (Head)

Range: 2000ft (609m). A special optical heat sensory unit that allows the infrared radiation of warm objects to be converted into a visible image. It also enables the pilot to see in darkness, shadows and through smoke.

### Nightvision Optics (Head)

Range: 2000ft (609m). An image intensifier that is passive, meaning it emits no light of its own, but relies on ambient light which is electronically amplified to give a visible picture. Nightvision can *not* work in absolute darkness (but infrared can).

### External Audio Pickup (Head)

Range: 300ft (91.5m). A sound amplification listening system that can pickup a whisper 300ft away.

### External Video Surveillance System (Head)

Range: 600ft (183m). The box on the side of the head is a video camera system with telescopic capabilities: 6× magnification. The video images can be relayed to a cockpit monitor and stored on removable video disks. Maximum disk capacity is 24 hours. Disks can be erased and reused.

## Special Cloaking Device Exclusive to The Alpha VAF-7A Shadow Fighter

### Shadow Cloaking Device

The Shadow Fighters are equipped with Doctor Lang's and Robotech scientist Cabell's latest masterpiece, a cloaking device that makes the Alpha Fighter invisible to instrument detection. The cloaking device hides the veritech from enemy radar, invid protoculture sensors/targeting, and scrambles all other detection methods such as microwaves and lasers. Only conventional optical systems and the opponent's own vision can be used to see a Shadow Fighter. Consequently, the Alpha Shadow Fighters can zoom in on a target completely undetected by radar or other sensor. It is only when they come into visual range that they can be detected.

Bonuses: +3 on initiative, +1 to strike.

Note: There is a 50% chance that the shadow cloaking device will fail with every hit that is below half the main body's M.D.C. (below 150 points). Shadow Fighters are also very rare, and most were sent to Earth and destroyed during the Robotech Expeditionary Force's first wave attack against the invid (the REF underestimated the strength and number of invid opponents).

## THE ALPHA Veritech Fighter

The Alpha and Beta Veritech Fighters are the latest developments of Doctor Lang and his Robotech research specialists. The initial idea was to create a smaller, transformable veritech fighter. Something very much like the old 45ft (13.7m) VF-Veritech series, but half the size for greater combat mobility. A smaller mecha could go places its larger predecessors could not. It would also make the vehicle a smaller target.

The Alpha is a small jet fighter that stands about 28ft tall in battloid; a full 16ft 5 inches shorter than the Super Veritech. Doctor Lang contends that he can reduce the size another eight feet (2.4m), but at the sacrifice of the formidable weapon systems.

Although the Alpha Fighter is slower than the VF series veritech, it is much more maneuverable and loaded with five times as many short range missiles (60 as compared to the VF's 12). Like the VF series veritech, the Alpha Fighter also has a standard GU style gun pod called the GU-XX. One GU-XX is standard issue, but two can be stowed on the Alpha in jet and guardian modes. Or one can be mounted on the top and one on the undercarriage. Unlike the old veritechs, the GU-XX can be fired while in jet and guardian modes (used as a hand-held weapon in battloid mode only).

Perhaps the most outstanding aspect of its design is its compatibility with the Beta Fighter. The Alpha can attach itself to the larger Beta fighter, becoming a larger, faster, more formidable war machine. The Beta's powerful jet boosters can be used to blast the two veritechs, merged into one, into space. This transatmospheric aspect gives the Alpha total environmental flexibility. Even more impressive is that the Alpha can transform into battloid mode and remain attached to the Beta for the speed and maneuverability of a jet, but with the full combat potential of the battloid. The two vessels can separate from one another at any time. The effect is that one large aircraft can separate and become two separate and incredibly powerful fighting mecha. If escape is necessary, the two can speed off separately or attach back into one vehicle to blast off at Mach 8. At Mach 8, the Alpha and Beta can easily blast into outer space. Both veritechs can function on land, in air, in space or underwater. *See Beta Veritech Fighter for full data on it.*

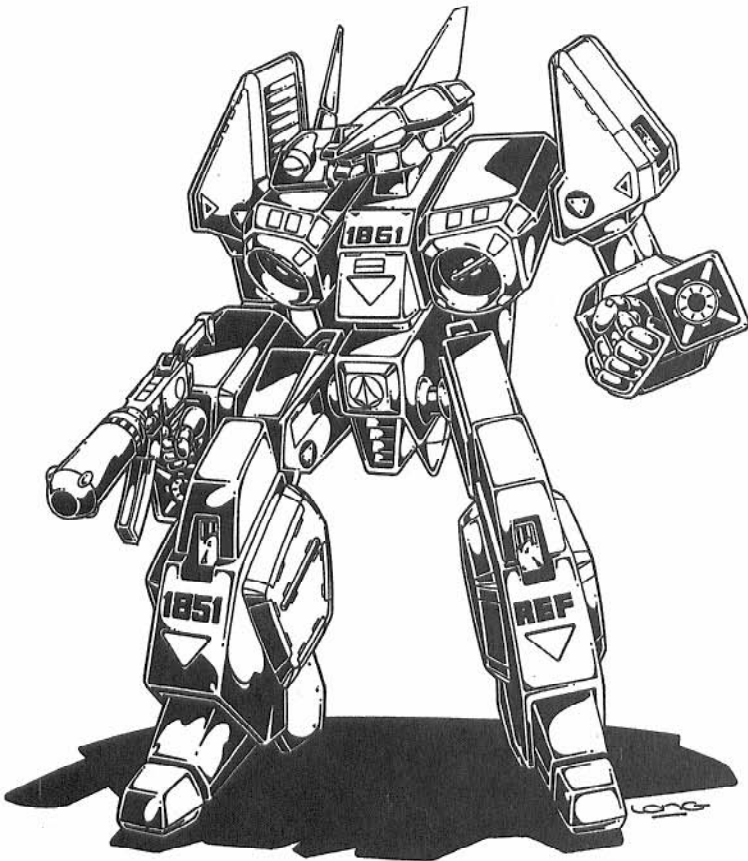

VAF-6J ALPHA FIGHTER IN BATTLOID MODE



**ALPHA FIGHTER IN GUARDIAN MODE**  
**Holding a GU-XX Gun Pod**

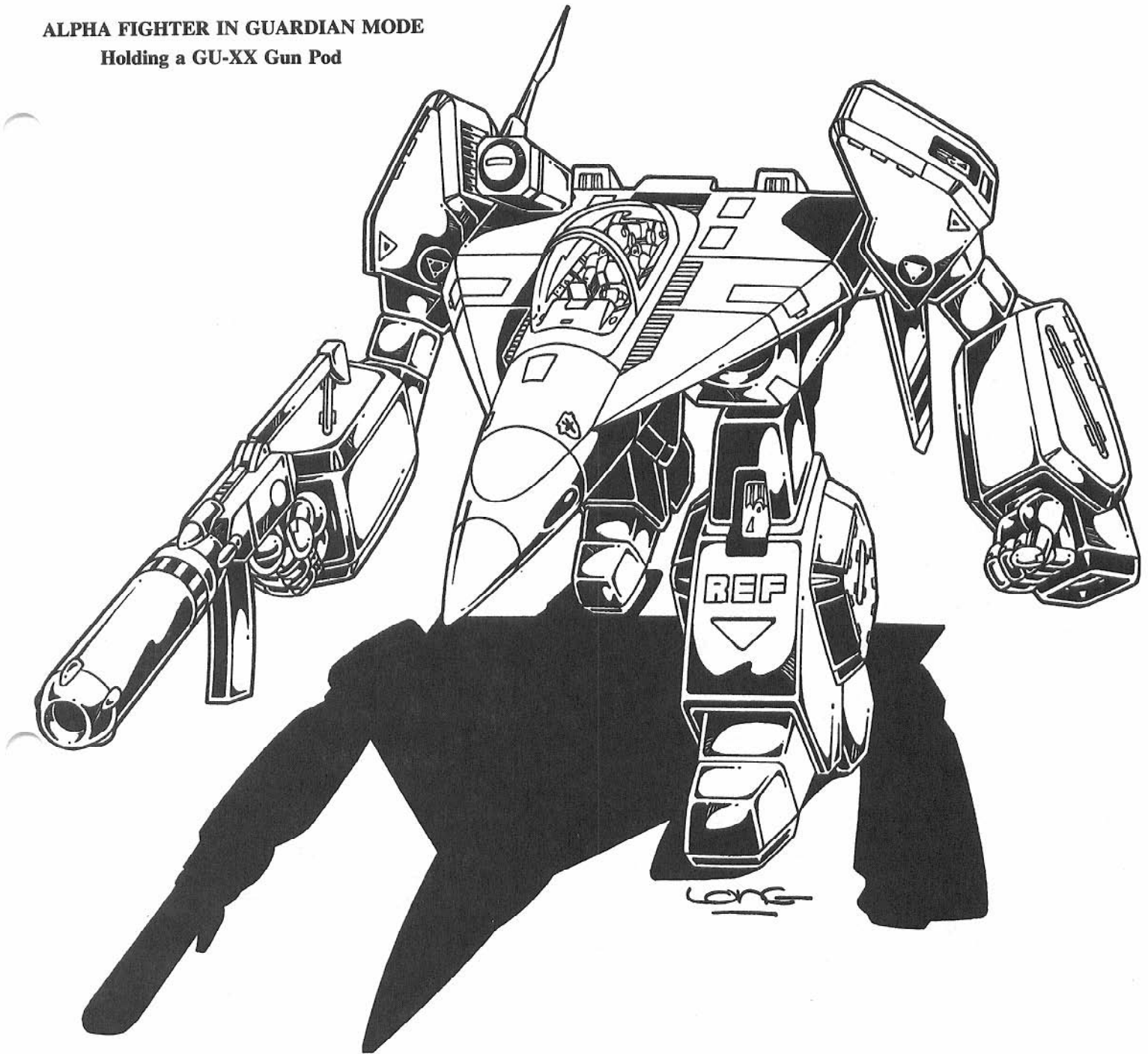

**ALPHA FIGHTER**

**Model Types (4):** VAF-6C (Blue, Scott Bernard Type)  
 VAF-6J (Red, Rook Type)  
 VAF-6R (Green, Lancer Type)  
 VAF-7A Shadow Fighter (Dark Blue-Black, and Grey)

**Class:** *Veritech Fighters VAF Series*; VAF-6C Combat Alpha, VAF-6J Jupiter design and manufacture, VAF-6R Reconnaissance Alpha and VAF-7A Shadow Fighter (special invid stealth fighter). The VAF-6C and VAF-6J are identical in every way except color and head stylization, and the fact that the 6J was manufactured by Jupiter Base.

**Crew:** One

**M.D.C. by Location:**

Head — 50  
 \*Head Sensor Unit (1) — 30  
 Hands (2) — 30 each  
 Forearms/Missile Pods (2) — 40 each

Shoulders/Missile Pods (2) — 60 each  
 Legs, Upper (2) — 100 each  
 Lower Legs/Thrusters/Missile Pods (2) — 100 each  
 Wings (2) — 100 each  
 Tail (2 Fins) — 50 each  
 \*\*Main Body — 300  
 Reinforced Pilot's Compartment — 150  
 GU-XX Gun Pod — 75

\*Depleting the M.D.C. of the head sensor will impair the pilot's sensory and targeting equipment. *Long-range radar* is severely diminished, leaving an effective range of one mile (1.6m). *Radio and laser communications system* are lost. *Short-range radio back-up system* provides a 60 mile (96km) range. *Laser targeting* is destroyed; -1 to strike.

\*\*Depleting the M.D.C. of the main body will shut the mecha down completely, rendering it useless.

**Speed:** Jet Mode: Mach 2.3 (1541mph/2465kmph) maximum. Altitude ceiling of 60 miles (96km).

Jet Cruising Speed: About Mach 1 (670mph)

Guardian Mode: Hover stationary to Mach 1 (670mph/1072kmph)

Battloid Mode Flying: Hover stationary to about 300mph (482kmph), with a maximum altitude of about 10,000ft (3048m), around 2 miles/3.2km.

Battloid Mode, Running: 120mph (160kmph)

Battloid Mode, Leaping: 100ft (30.5m) up or across without booster assistance. 300ft (91.5m) with booster jets' assistance.

**Height:** 28ft 7in (8.75m) in battloid mode.

15ft (4.6m) in jet mode including tail fins.

**Width:** 13ft (4.3m) in battloid mode.

22ft (6.7m) in jet and guardian modes.

**Length:** 34ft (10.3m) in jet and guardian modes.

**Weight:** 11 tons without missiles; 16.4 tons fully loaded.

**Cargo:** No available space for cargo unless the cyclone is removed from its storage compartment. The cyclone storage compartment can hold about 500lbs (226.8kg).

### ALPHA COCKPIT IN JET AND BATTLOID MODE

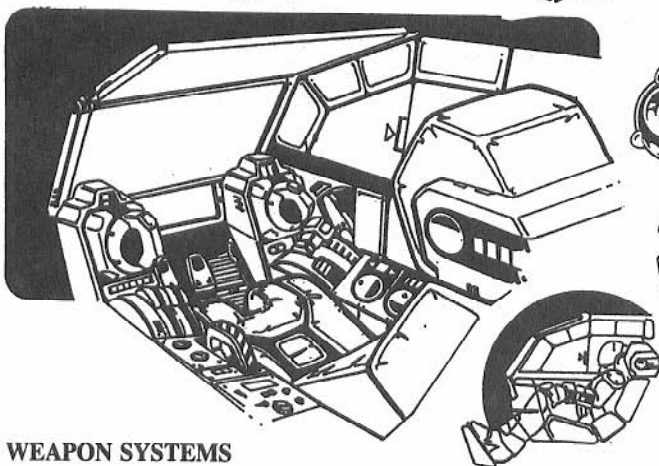
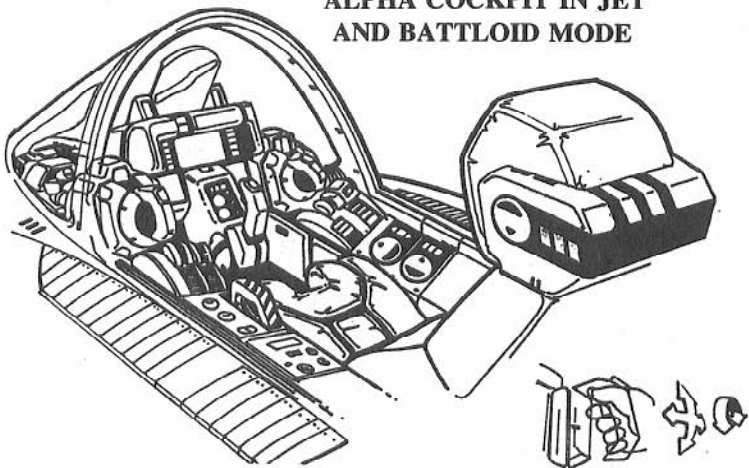

### WEAPON SYSTEMS

**1. MM-60 Multi-Missile System:** The Alpha is bristling with short-range missiles, 60 in all.

Shoulders: 8 each

Forearms: 10 each (5 on both sides of the arm)

Lower Legs: 12 each (3 missile launchers on each leg).

Primary Purpose: Assault

Secondary Purpose: Anti-Aircraft

Missile Type: Standard RDF short-range missiles, usually high explosive, armor piercing, or plasma. A typical combat mix of missiles is 30 armor piercing, 20 high explosive or plasma, 8 fragmentation, 2 smoke.

Mega-Damage: Varies with missile type.

Rate of Fire: One at a time or in volleys of two, four, eight, sixteen, thirty or all. The number of volleys a character can fire per melee is equal to his/her combined hand to hand attacks. Remember,

a volley, regardless of the number of missiles, counts as one melee attack.

Range: Varies with missile type; 1 to 5 miles.

Payload: A maximum capacity of 60 short-range missiles. Mini-missiles or medium and long range missiles can not be used.

Note: The war torn world makes the availability of missiles an extremely rare event. Players should be careful not to expend all their missiles because it may be a long time before more are found.

**2. GU-XX, 35mm Tri-Barrel Gun Pod:** This is the standard armament issued to all Alphas except the Shadow Fighters. Normally, one GU-XX is provided, but two can be used and carried. The GU-XX can be mounted on top or on the undercarriage of the Alpha in jet or guardian mode. Unlike the old GU-11 gun pods, the GU-XX can be fired from its fixed mounted position(s) while in jet or guardian mode. The weapon(s) are hand-held in battloid mode.

Primary Purpose: Assault/Defense

Range: 4000ft (1200m)

Mega-Damage: Does 4D6 M.D. short burst, 1D4 × 10 medium burst, 2D4 × 10 M.D. full melee burst.

Rate of Fire: Short or medium bursts count as one attack. The pilot can fire as many bursts as his combined hand to hand attacks per melee. A full melee burst takes the place of all other attacks.

Payload: Can fire . . .

40 short bursts or . . .

20 medium bursts (equal to 2 short bursts) or . . .

10 full melee bursts (equal to 4 short bursts).

Note: TWO GU-XX ammo clips can be stored in the legs (one clip in each). It requires two melee actions/attacks to reload a clip.

**3. Hand to Hand Combat (optional):** Rather than fire any weapons, the Alpha can engage in hand to hand combat. Punch does 1D6 M.D., Kick — 1D6 M.D., Leap Kick — 2D6 M.D., Body Flip — 1D6 M.D., or Body Block — 1D6 M.D.

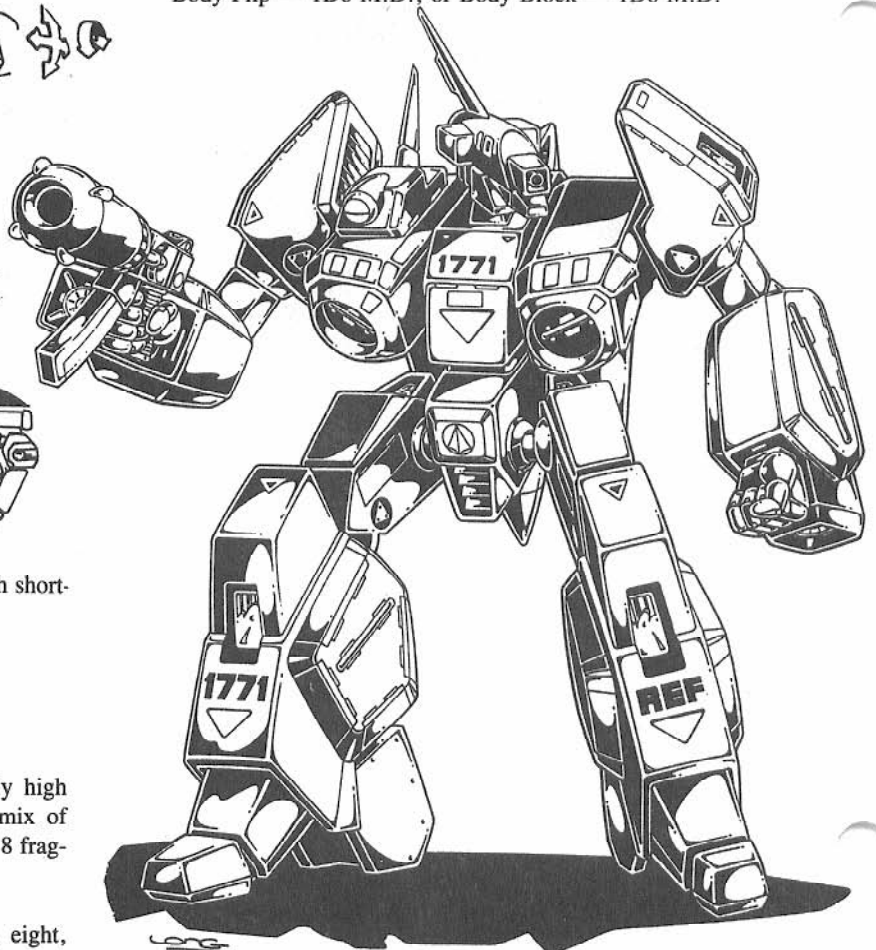

VAF-6R ALPHA FIGHTER

# THE SHADOW FIGHTER

## Veritech Alpha Fighter VAF-7A

The Shadow Fighter is like the other Alpha Fighters in general shape, design, speed, function and armaments. Other than stylistic and color differences, the SF-7, a nickname, is identical to its brothers. There are only three items that make it different and more lethal.

The Shadow Fighter derives its name from a newly developed cloaking device which obscures it from radar, sonar, and most sensors other than enhanced optics. This means the enemy will not see the SF-7 coming on radar or by use of conventional detection systems. Thus, one minute the sky is empty and peaceful, the next moment, a black and grey fighter jet is streaking into view (normal sight or telescopically enhanced) with weapons blazing. The opponent rarely has time to react let alone attack. It's like a sneak or prowling attack at Mach Two speeds. The opponent doesn't know what hit him until it's too late. **NOTE:** Unless somebody sees the Shadow Fighter coming, the SF-7 always has the initiative (strikes first) for the first melee round. After that, everybody rolls initiative (the Shadow is +3) for each melee of combat.

The "shadow cloaking device" was initially created to combat Invid. It was discovered, after some initial encounters with the REF, that the Invid did not have the same kind of sensors or optics that humans used. Instead, the Invid had protoculture sensors that instantly and accurately alerted them to the presence of protoculture energy. To make matters worse, the Invid mecha all possessed protoculture targeting systems that can lock in on the source of protoculture emanations like a heat seeking missile locks in on and homes in on a heat source. This made sneak attacks impossible and escape difficult. The Robotech Expeditionary Force (REF) suddenly found themselves betrayed by their own weapons. The solution was to find an alternative energy source, which was impossible considering the circumstances, or to find some way to cloak the energy. Fortunately, Doctor Lang and Cabell were able to do just that. Soon the Shadow Fighters were invisible to protoculture sensors of any kind, as well as conventional detection systems. This development would ultimately give the REF the edge they needed in their battles with the Invid Regent.

Another device that is exclusive to the Shadow Fighter Alpha and VF-1V Vindicator is a powerful energy weapon called a "Destabilizer." The destabilizer is another invention specifically designed to thwart the Invid. Mounted on the shoulder and drawing on the additional energy of the Veritech, it can unleash an energy bolt that will disrupt the Invid's, otherwise invincible, force fields. The disruption punches a 10 + 2D6ft hole in a force field, allowing troops to enter. The weapon can also be used as a hand held weapon like the GU series gun pods, only more powerful.

**Vehicle Type:** Special Assault

**Class:** Veritech Fighter. VAF Series Alpha, model VAF-7A.

**M.D.C. by Location** and all other data is identical to the Alpha Fighters previously discussed.

### WEAPON SYSTEMS

1. **MM-60 Multi-Missile System:** See Alpha Fighter.
2. **GR-12 Shoulder Launch System:** Only the Alpha Shadow Fighter has an additional pair of missile launchers built into the upper chest area. The system is similar to those of the Destroids and adds an extra 24 short-range missiles to its armaments.

**Primary Purpose:** Assault/Defense

**Missile Type:** Standard RDF short-range missiles, usually high explosive or fragmentation.

**Mega-Damage:** Varies with missile type.

**Rate of Fire:** One at a time or in volleys of two, four, six or twelve (all). One volley counts as one attack, regardless of the number of missiles launched in the volley. The number of volleys fired per melee is equal to the pilot's combined hand to hand melee attacks (usually five or six).

**Payload:** 12 in each shoulder launch unit, for a total of 24.

3. **EU-13 Destabilizer:** A powerful energy weapon that is standard issue for the Alpha Shadow Fighter. *One* Destabilizer can be mounted on the top of the Alpha when in jet and guardian modes. Or carried by hand in battloid or guardian modes. Like the GU-XX, the Destabilizer can be fired while in jet and guardian modes from its fixed mounted position.

**Primary Purpose:** Assault/Defense

**Range:** 4000ft (1200m)

**Mega-Damage:** Does 1D4 × 10 per each blast (bursts are not possible)

**Rate of Fire:** Equal to the pilot's combined hand to hand attacks per melee (usually four or five).

**Payload:** 40 blasts.

**Note:** Two EU-13 energy clips can be stored in the legs (one in each leg). It requires two melee actions/attacks to reload a clip. Only the big REF ships and facilities on the Moon and Mars bases can recharge an EU-13 energy clip.

4. **Optional GU-XX Gun Pod.** See Alpha Fighter.
5. **Optional EU-11 Gun Pod.** See Southern Cross.
6. **Optional GU-11 Gun Pod.** See Robotech RPG.
7. **Optional Gladiator Mace.** See Robotech RPG.
8. **Optional Hand to Hand Combat.** Same as Alpha Fighter.

**Beta Note:** The Shadow Alpha can connect with a Beta (usually painted in matching colors) just like a regular Alpha.



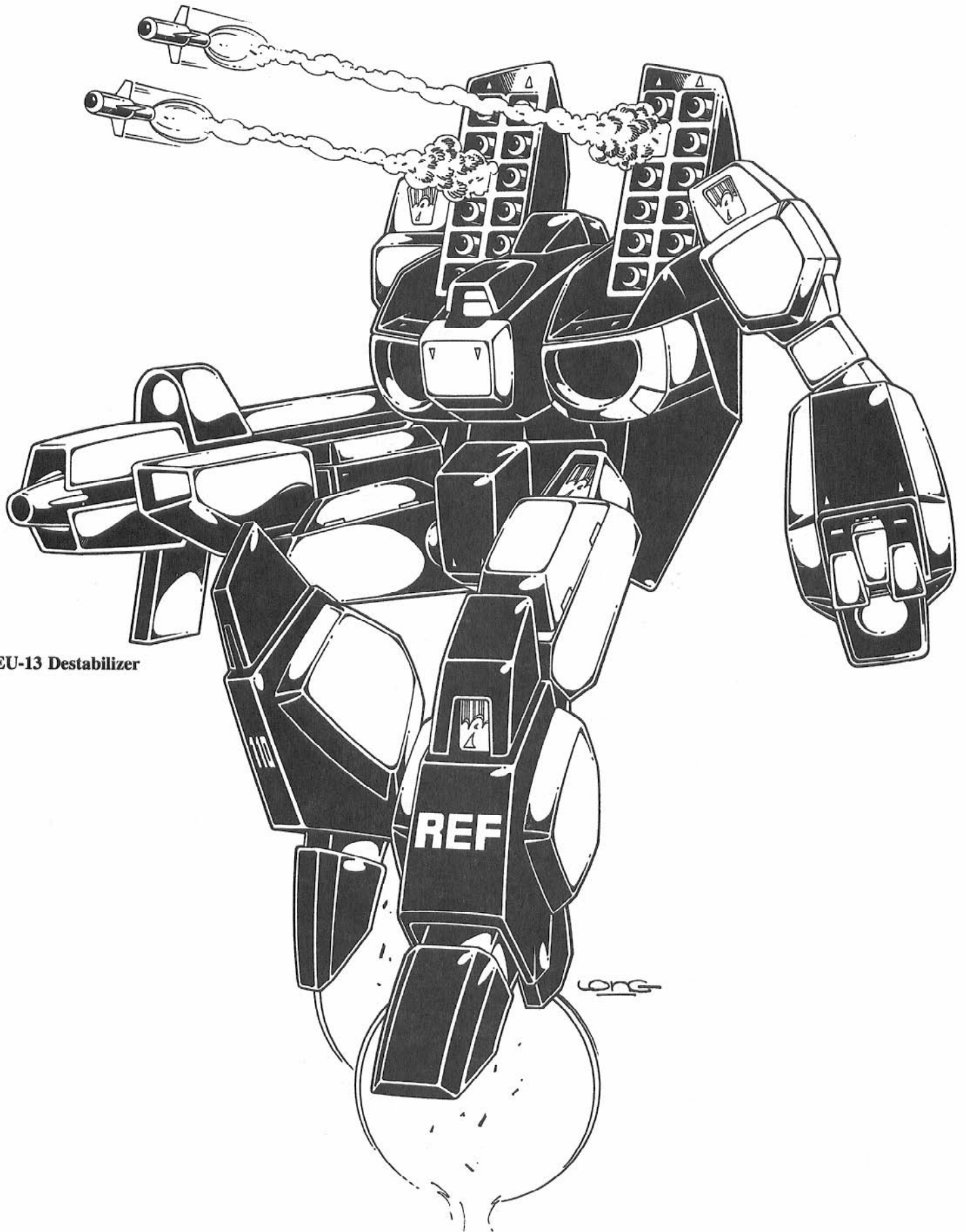

EU-13 Destabilizer

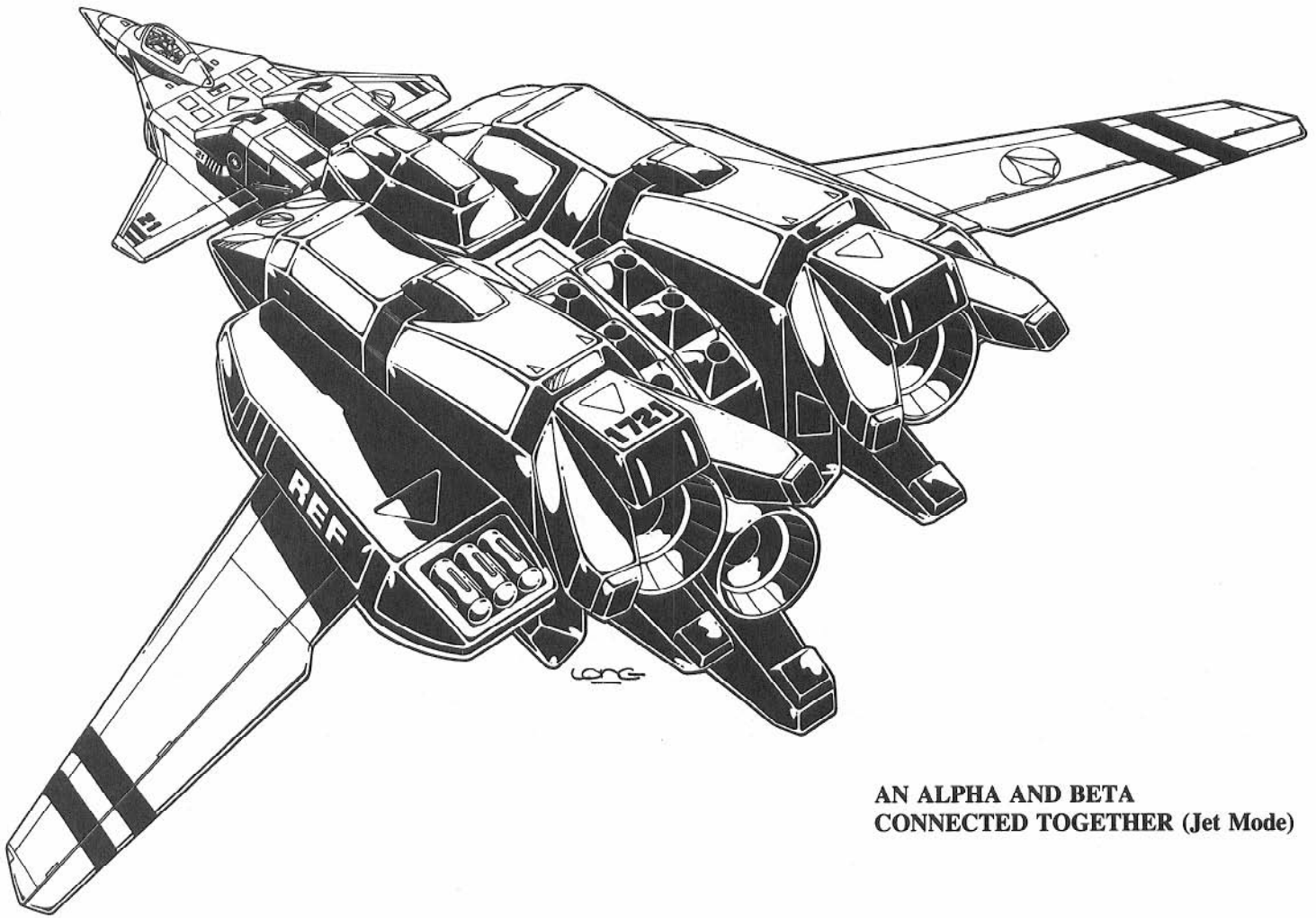

AN ALPHA AND BETA  
CONNECTED TOGETHER (Jet Mode)

## THE BETA Veritech Fighter

The Beta is part of the new modular veritech combat system. Like the Alpha, it is a separate and distinctive veritech fighter. However, it can connect to the Alpha, effectively becoming one large war machine. Together, the Beta adds greater speed, transatmospheric flight, and heavy missiles. The Alpha adds a barrage of short-range missiles and the flexibility of a battloid mode transformation while still attached to the Beta. When the situation demands it, the two veritechs can detach and fight as two completely independent combat units.

The Beta and Alpha combination is usually used when entering a planet's atmosphere from space (or exiting an atmosphere), first strike (then separate to engage in separate combat, effectively doubling the number of veritechs) and space combat.

The armaments of the Beta Fighter are similar to the Alpha's, but with greater range and destructive potential. A GU-XX is built into the center of the fuselage that can be fired in a fixed position only in jet and guardian modes. Its automatic feed gives it many times more rounds than the hand-held GU-XX of the Alpha. Short, medium and long-range missiles can be fired from several positions. Two heavy missiles from the front, six medium range missiles from the top mounted rack and eight short-range missiles (plus reloads) from each of its retractable top missile bays (chest in battloid mode). Plus, the Beta can drop bombs from its cargo/bomb bay while in jet mode and has an additional 20 short-range missiles in battloid mode (10 in each leg). **Note:** The hands and arms are designed in such a way that the Beta can not hold a GU or EU style gun pod. It must rely on missiles, hand to hand combat and speed (not maneuverability).

The Beta Fighter is designed specifically to be a heavy back-up or counterpart to the speedy Alpha. Consequently, the Beta is much larger and laden with explosives. Although its rocket boosters can attain a speed of Mach 8, maneuverability is minimal. The Mach 8 speed is provided as a means to escape gravitational forces (breach Earth's atmosphere), and make hasty retreats and attacks. The Mach 8 speed also matches the speed of some of the invad vessels which the Alpha and Beta were designed to combat. The best speed the Beta can muster without the rocket thrusters is just under Mach 2. The Beta is also less maneuverable than its half pint Alpha counterpart. As a team, the Beta provides the muscle and extra oomph, while the Alpha provides the speed and agility. **Note:** The only difference between all Betas is their color and distinguishing insignia. Even the Shadow Beta is the same except that it is blue-black and grey in color and has the "shadow cloaking device" which makes it invisible to protoclature sensors and radar. (See *Shadow Fighter Alpha and the shadow cloaking device.*)

### BETA FIGHTER

**Model Types (2):** VBF-1A (Blue, Red or Green)  
VBF-1S (Shadow Beta, blue-black and grey)

**Class:** Veritech Fighter, VBF series.

**Crew:** One pilot, but can seat two others in cockpit. (Optional: One can operate the weapon systems, the other, communications and sensory equipment, while the pilot flies. Or the pilot can do it all). The cargo/bomb bay area can hold passengers instead of bombs. Up to six can fit comfortably, ten cramped.

# BETA FIGHTER IN BATTLOID MODE

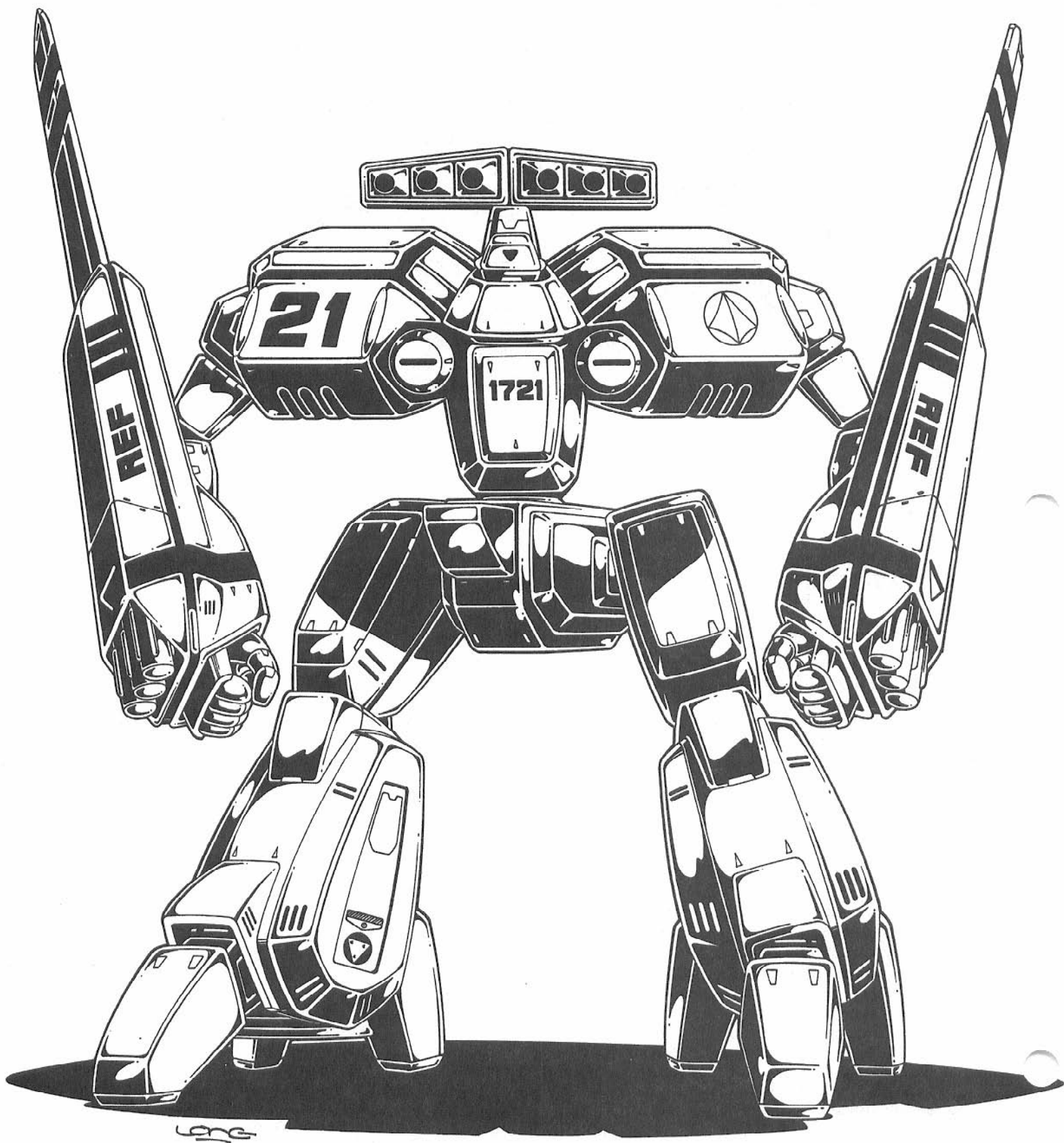



### M.D.C. by Location:

\*Sensor Head — 50  
Hands (2) — 50 each  
Shoulder/Chest Retractable Missile Bays (2) — 150 each  
\*\*Big Forearm Shields (2) — 300 each  
Upper Arms (2) — 80 each  
Top Missile Racks (2, side by side) — 50 each  
Upper Leg Missile Bays (2) — 100 each  
Lower Legs/Feet (2) — 150 each  
Wings (2) — 100 each  
Bomb Bay (Jet Mode only) — 200  
Rear Jet Thrusters (Pair, side by side) — 60 each  
Rocket Thrusters (3) — 150 each  
\*\*\*Main Body — 350  
Reinforced Pilot's Compartment — 200  
\*\*\*\*GU-XX (Jet & Guardian Modes only) — 75

\*Depleting the M.D.C. of the sensor head will knockout long-range communications (reduce to 60 miles/96km range), long-range radar (reduce to one mile) and laser targeting (-1 to strike).

\*\*The forearm shields can be used to shield the main body or body parts from damage. The character can try to block incoming attacks of any kind, punches, blasts, and even missiles, by blocking with one or both arms (missiles require both arms). Roll a parry. If successful, only the arm shields take damage. NOTE: Depleting the arm shields to below their M.D.C. will destroy the wing connection joints and damage the wing(s), making transformation into jet or guardian modes *impossible!* Likewise, the loss of an arm is the loss of a wing and connection unit, making transformation impossible.

\*\*\*Depleting the M.D.C. of the main body will completely shut the mecha down.

\*\*\*\*The GU-XX of the Beta is built into it and protected by the main body. Because it is such a difficult target, attackers are -4 to strike it.

**Speed:** Jet Mode with Jet Thrusters: Mach 1.8 or 1206mph (1930kmph) maximum. Altitude ceiling is 50 miles (80km).

Jet Mode with Rocket Thrusters: Mach 8.3 (5561mph/8900kmph), making the Beta transatmospheric (able to blast into outer space under its own power.)

Jet Mode Cruising Speed: 600mph (960kmph)

Guardian Mode: Hover stationary to 600mph (960kmph)

Battloid Mode Flying: Hover stationary to about 300mph (482kmph), with a maximum altitude of 8,000ft (2440m), about a mile and a half (2.8km).

Battloid Mode, Running: 80mph (128kmph)

Battloid Mode, Leaping: 80ft (24.4m) up or across without booster assistance. 300ft (91.5m) with jet booster assistance.

**Height:** 35ft (10.7m) in battloid mode.

20ft (6.1m) in jet mode.

28ft (8.5m) in guardian mode.

**Width:** 28ft (8.5m) in battloid mode.

64ft (19.5m) in jet and guardian modes.

**Length:** 24ft (7.3m) in battloid mode.

32ft (9.7m) in jet & guardian modes.

**Weight:** 14 tons without missiles, 19.5 tons fully loaded (including missiles and bombs).

### WEAPON SYSTEMS

- 1. MM-40S — Super Multi-Missile System:** The Beta has two MM-40 systems built into each chest/shoulder area in battloid and accessible on the right and left of the cockpit in jet or guardian mode. The retractable systems raise their missile launchers from protective storage bays to fire volleys of short-range missiles. The two MM-40 systems can fire independently or simultaneously. The automatic reload system enables the pilot to fire his entire payload of 80 missiles in one melee (this is possible by firing both MM-40 systems simultaneously, launching 16 missiles, 8 each, each melee attack up to five times.

Note: Can be launched in all modes.

Primary Purpose: Assault

Secondary Purpose: Anti-Aircraft

Missile Type: Standard RDF short-range missiles, usually high explosive, armor piercing or plasma. Different types are rarely mixed, so all 40 missiles per launcher would be the same. Of course, missiles can be mixed if desired.

Mega-Damage: Varies with missile type.

Rate of Fire: One at a time or in volleys of two, four, six, eight (or sixteen if both launchers are fired simultaneously). One volley counts

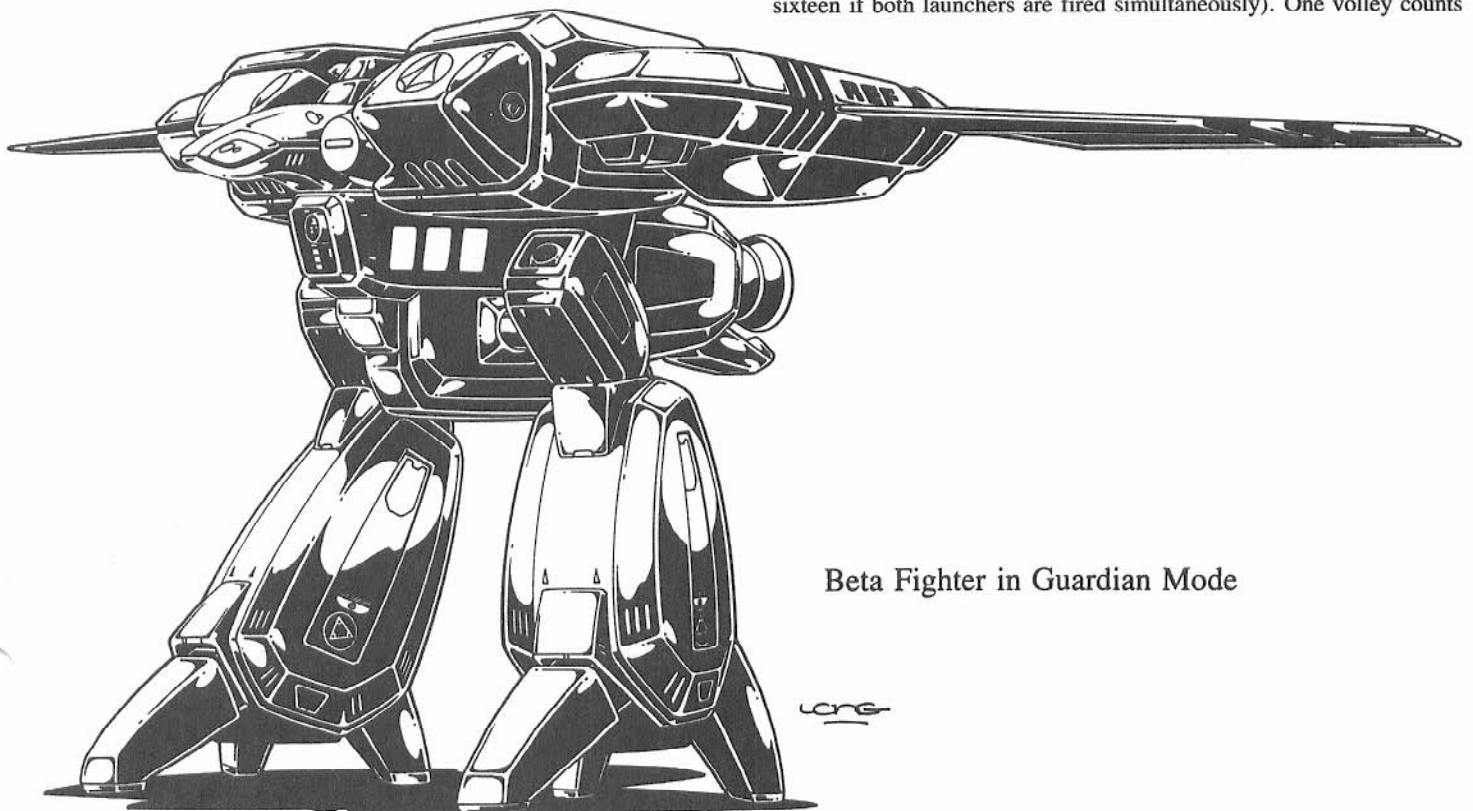

Beta Fighter in Guardian Mode

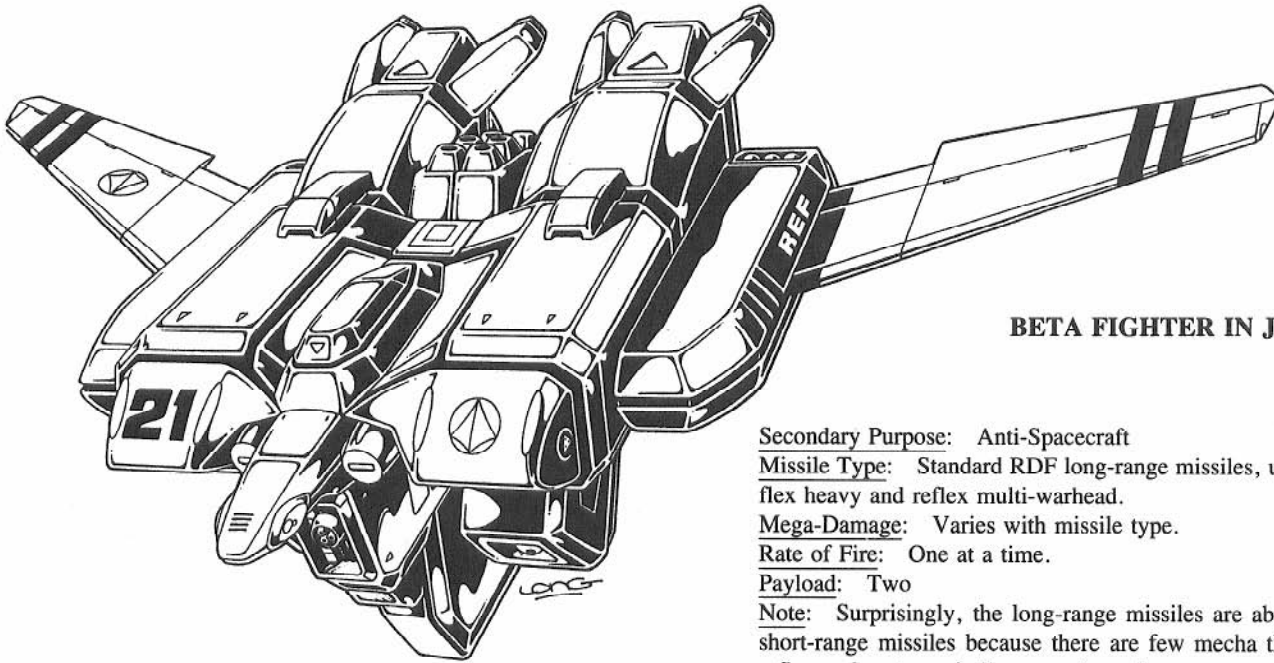

**BETA FIGHTER IN JET MODE**

as one attack. The number of attacks per melee is equal to the pilot's combined hand to hand attacks per melee (usually 4 or 5).

Payload: 40 missiles per each launcher, for a total capacity of 80.

Note: The war torn world makes the availability of missiles an extremely rare event. Players should be careful not to expend all their character's missiles too soon, because it may be a long time before more are found.

**2. Short-Range Leg Missiles:** Each leg has a short-range missile launcher built into the thigh. These missiles can be launched only in battloid mode.

Primary Purpose: Assault/Defense

Secondary Purpose: Antipersonnel

Missile Type: Standard RDF short-range missiles, usually high explosive or fragmentation.

Mega-Damage: Varies with missile type.

Rate of Fire: One at a time or in volleys of two, four, six, eight or ten (all). One volley counts as one melee attack, regardless of the number of missiles in the volley. The number of attacks per melee is equal to the pilot's combined hand to hand attacks per melee (usually 4 or 5).

Payload: Ten in each leg, for a total of 20.

Note: Leg missiles can only be launched while in battloid mode. Remember, the availability of missiles is scarce.

**3. Medium Range, Top Mounted Missiles:** These are the missile racks seen on top of the Beta in battloid mode and recessed into the rear of the Beta in jet or guardian modes. The missiles can be launched while in any configuration.

Primary Purpose: Assault

Secondary Purpose: Anti-Mecha

Missile Type: Standard RDF medium range missiles, usually high explosive, plasma or armor piercing. Of course, any medium range missiles can be used.

Mega-Damage: Varies with missile type.

Rate of Fire: One at a time or in volleys of two or three.

Payload: Three missiles per each launcher (2), for a total of six.

Note: Medium range missiles are more scarce than short range.

**4. Two Long-Range Missiles** can be seen in the mid-chest area of the Beta in battloid or on either side of the cockpit in jet and guardian modes. These can be launched only from jet or guardian mode.

Primary Purpose: Heavy Assault

Secondary Purpose: Anti-Spacecraft

Missile Type: Standard RDF long-range missiles, usually proton, reflex heavy and reflex multi-warhead.

Mega-Damage: Varies with missile type.

Rate of Fire: One at a time.

Payload: Two

Note: Surprisingly, the long-range missiles are about as rare as the short-range missiles because there are few mecha that use them. All reflex and proton missiles are extremely rare.

**5. The Beta Can also drop bombs.**

Primary Purpose: Ground Assault

Missile Type: Bombs are equal to short or medium range missiles. Usually fragmentation or high explosive.

Mega-Damage: Varies with the type of bomb.

Rate of Fire: Volleys of 2, 4, 6, or 8.

Payload: The bomb bay can hold up to sixteen bombs.

Note: These are bombs not guided missiles. As such they are minus -4 to strike a stationary ground target, -6 to strike a moving target(s) and -10 to hit a small moving target like an invad scout or vehicles. Bombs are usually used against large stationary targets.

**6. Beta GU-XX, 35mm Tri-Barrel Gun Pod with auto-feed.** This weapon is exactly like the GU-XX handgun used by the Alpha Fighters. The difference is that it is built into the body of the Beta and has an automatic feed and a greater ammunition payload. To reload the Beta GU-XX requires tools, a mechanic and 4D4 minutes. The person must crawl into the gun bay and undo the ammo compartment and reload. To modify the ammo from a conventional GU-XX gun pod requires an additional 1D4 hours per clip.

Primary Purpose: Assault/Defense

Range: 4000ft (1200m)

Mega-Damage: Does 4D6 M.D. per short burst, 1D4 × 10 M.D. for a medium burst and 2D4 × 10 for a full melee burst.

Rate of Fire: Short and medium bursts count as one attack (total attacks equal to the pilot's combined hand to hand attacks per melee). A full melee attack takes the place of all other attacks.

Payload: 160 shorts bursts, or 80 medium bursts (equal to 2 short bursts) or 40 full melee bursts (equal to 4 short bursts).

Note: Can *not* fire in battloid mode.

**6. Hand to Hand Combat:** In addition to Punch — 1D6 M.D., Kick — 1D6 M.D., Body Flip and Body Block — 1D4 M.D., the Beta can attempt to parry energy blasts and missiles with its giant shield arms. Roll to parry as usual (roll 1D20), plus bonuses. A successful parry of energy blasts, missiles and explosives means only the arm shields take damage. In mecha hand to hand combat, a parry will block the opponent's punch or kick without damaging the arm shields.

Depleting all the M.D.C. of the shield arm (300 points each) destroys the coupling mechanism for the wing, making it impossible to change out of battloid mode. Depleting the shields will also damage or destroy the wing(s) housed inside them.

**VF-1V VINDICATOR IN BATTLELOID MODE**

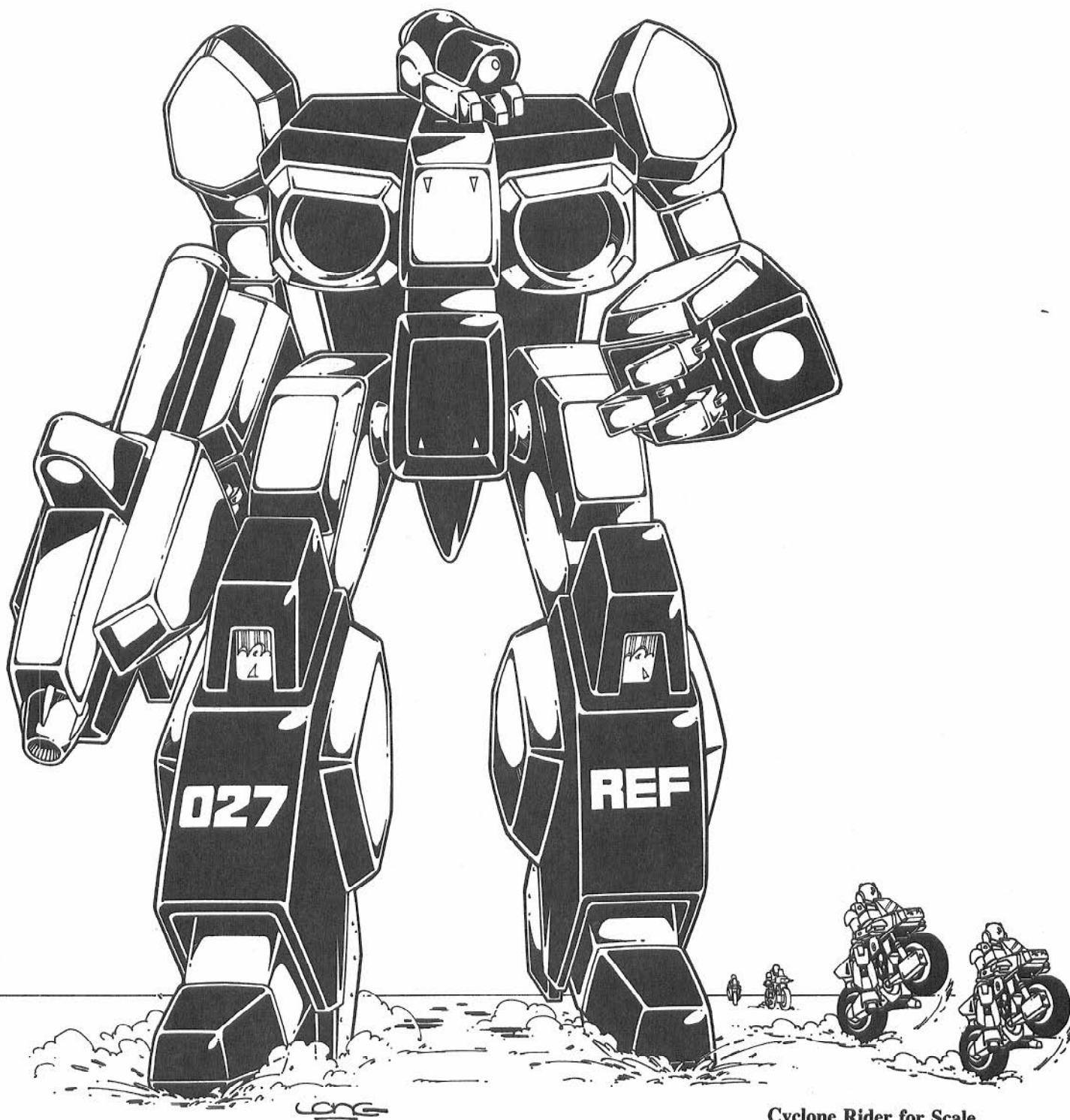

**Cyclone Rider for Scale**



# THE VF-1V VINDICATOR

## Veritech Fighter

The last of the VF series Veritech Fighters is the Vindicator. It is actually a cross between an Alpha and a VF veritech. The Vindicator has the size and mass of the old VF series veritech, but the basic shape, styling and armaments of the Alpha Fighter. Although it towers 46ft (14m), the REF added it to its active mecha as a first strike assault unit that fights alongside the Shadow Fighters. Doctor R. Burke, the mecha's co-designer, has coined the nickname "Zentraedi Buster" because it was originally intended to combat any Zentraedi warriors who may still serve the Robotech Masters.

The Vindicator also uses an earlier, larger version of the destabilizer energy weapon and has the "shadow cloaking device" built into it. In fact, at a quick glance, the Vindicator appears to be a larger version of the Shadow Fighter.

The VF-1V is super scarce on the war ravaged Earth. It was designed in space and never added to the RDF's or Southern Cross' mecha forces. Instead, it was kept exclusively part of the REF forces. Only a handful of Vindicators survived the REF's assault on Reflex Point.

### VINDICATOR FIGHTER

**Model Type:** VF-1V, (blue-black and grey color, identical to the Alpha Shadow Fighter).

**Class:** Veritech Fighter, VF series;  
Nickname: "Zentraedi Buster."

**Crew:** One pilot. A passenger can fit in the cockpit, but must sit in the pilot's lap.

#### M.D.C. by Location:

\*Sensor Head — 70  
Hands (2) — 40 each  
Forearms/Missile Pods (2) — 60 each  
Shoulders/Missile Pods (2) — 100 each  
Upper Legs (2) — 100 each  
Lower Legs/Thrusters/Missile Pods — 150 each leg  
Wings (2) — 150 each  
Tail (2) — 50 each  
\*\*Main Body — 400  
Reinforced Pilot's Compartment — 200  
Destabilizer (gun) — 100

\*Depleting the M.D.C. of the head sensor will impair the pilot's sensory and targeting equipment. *Long-range radar* is greatly diminished, leaving an effective range of one mile (1.6km). *Radio and laser communication systems* are lost. *Short-range radio back-up system* provides a 60 mile (96km) range. *Laser targeting* is destroyed; -1 to strike.

\*\*Depleting the M.D.C. of the main body will shut the mecha down completely, rendering it useless.

**Speed:** Jet Mode: Mach 3.3 (2211mph/3537.6kmph), with an altitude ceiling of 60 miles (96km).

Jet Cruising Speed: About Mach One (670mph/1072kmph).

Guardian Mode: Hover stationary to Mach One (670mph/1072kmph), with a maximum altitude of 30,000ft (9150m), or about 4 miles.

Battloid Mode Flying: Hover stationary to about 400mph (640km), with a maximum altitude of about 10,000ft (3048m).

Battloid Mode, Running: 80mph (128kmph).

Battloid Mode, Leaping: 100ft (30.5m) up or across without using jet boosters, 300ft (91.5m) with jet boosters.

**Height:** 46ft (14m) in battloid mode.  
29.6ft (9m) in guardian mode.  
22ft (6.7m) in jet mode.

**Width:** 20ft (6.1m) at shoulders in battloid.  
46ft (14m), jet and guardian modes with wings fully swept.

**Length:** 47ft (14.3m) in jet and guardian modes.

**Weight:** 21 tons

**Cargo:** No available space unless cyclone storage bay is emptied. Can hold up to 1000lbs.

### WEAPON SYSTEMS

1. **MM-70 Multi-Missile System:** Same as the Alpha MM-60 except it can hold more missiles due to its size.

Shoulders: 10 each arm

Forearms: 12 each arm

Lower Legs: 13 each leg

Primary Purpose: Assault

Secondary Purpose: Anti-Aircraft

Missile Type: Standard RDF short range missiles, usually high explosive, armor piercing, or plasma. Of course, any short range missiles can be used.

Mega-Damage: Varies with missile type.

Rate of Fire: One at a time or in volleys of two, four, eight, sixteen, thirty-two or all (70). The number of volleys a character can fire is equal to the pilot's combined hand to hand attacks per melee. One volley counts as one attack regardless of the number of missiles in the volley.

2. **EU-12 Destabilizer:** A powerful energy weapon that is standard issue for the Vindicator. The EU-12 is a larger version (twice as big) of the Shadow Fighter's EU-13. One destabilizer can be mounted on the top of the Vindicator when in jet or guardian mode and can be fired from its fixed housing. In battloid mode, the weapon is hand-held.

When mounted on the shoulder, the EU-12 draws additional energy from the Vindicator and can fire a special burst of energy that will disrupt force fields. Against the invad hives' force fields, one blast has an 80% chance of creating a 6D6 foot hole in the field. The hole will last 4D6 minutes. One blast from an EU-12 destabilizer will obliterate the force field used to block exterior hive entrances for a duration of 4D6 + 20 minutes. It has identical effects against Zentraedi force fields.

Primary Purpose: Assault

Secondary Purpose: Force field disruption.

Mega-Damage: 1D6 x 10 per blast (bursts are not possible).

Rate of Fire: Equal to the pilot's combined hand to hand melee attacks (usually 4 or 5).

Payload: 40 blasts Range: 4000ft (1200m)

Note: Two EU-12 energy clips can be stored in the legs (one in each leg). It requires one full melee (15 seconds) to reload a clip. Only the biggest REF ships and facilities on the Moon and Mars bases can recharge an EU-12 energy clip.

3. **Hand to Hand Combat:** Punch — 1D6 M.D., Kick — 1D6 M.D., Leap Kick — 2D6 M.D., Body Flip and Body Block — 1D6 M.D. and Stomp — 1D4 M.D.

**NOTE:** Although the VF-1V may resemble an Alpha, it does not have a giant Beta counterpart.

Remember, only a handful of Vindicators exist on Earth. They are extremely rare.

# THE VERITECH HOVER TANK (VHT)

The Hover Tank is specifically designed for the Armies of the Southern Cross and is the back bone of Earth's defense. Although never intended to be part of the Robotech Expeditionary Force's compliment of mecha, a few dozen were included at the request of Colonel Wolfe. It was Wolfe and his men who acted as test pilots for the experimental mecha. Wolfe had such an aptitude and liking for the mecha that he placed a formal request for it. His request was honored and his infamous "Wolfe Pack" was born.

The Veritech Tank's reduced size and transformable configuration gives it a versatility of movement and range of capabilities unequalled by any of the earlier mecha, with the possible exception of the VF series of Veritech Fighters. The Veritech Hover Tank is designed specifically for ground/urban combat and civil defense. This means it can easily maneuver among the concrete canyons of a city. Unlike the larger mecha, the VHT is more in scale with a city and can engage in combat without fear of tumbling buildings down with every wrong move. Likewise, the Hover Tank can engage in high speed pursuits, fit down any street (even alleyways) and modify its size, available weapon systems and mode of transportation by transforming into a different configuration.

**The three modes of the Veritech Hover Tank are Transport, Tank and Battloid.** In the *transport mode* the mecha is an armored transport vehicle capable of speeds of up to 100mph (160.90kmph), and easily traverses the most rocky and rugged terrain. In this mode the mecha hovers on powerful jets of air, 3 to 10 feet (.9m to 3m) above the ground. The EU-11 gun pod rests in a special housing in the center, front of the tank. In this mode it serves as the mecha's only armament.

A quick transition into *tank mode* (also referred to as "guardian" mode) sends the mecha into its most lethal configuration. The main cannon is now exposed and ready to unleash its devastating ion blasts. Its secondary weapon, a triple-barreled, auto cannon is also ready to wreak havoc. The EU-11 gun pod is tucked away and can not be fired in this mode. The main disadvantage of the tank mode is that all movement is incredibly restricted. Maximum speed is a dreadful 8mph (12.8kmph).

*Battloid mode* provides all the already known advantages of the humanoid form: all-terrain capabilities, climbing, running, grasping, leaping, kicks, etc. A new twist to combat is the feasibility of an ancient defensive weapon, the shield. Like the knights of old, the Veritech Hover Tank, and Logan Veritech Fighter, are equipped with especially tough, some say nearly impervious, shields built onto the arms. On the VHT it is the weapon housings of the main cannon and the tri-cannon serve as shields. In battloid mode the two huge housing units appear to be attached at the shoulder and can be manipulated by arm movement. These so-called shields are so tough that they can block/parry armor piercing shells and energy beams (including particle beams). A successful parry means that damage is sustained only by the shielding that was used to parry the attack. Each arm shield has twice as much M.D.C. as the main body.

The still mysterious symbiotic relationship between man and machine, infused by protoculture, enables the massive mecha to react with the same quickness as a top athlete. The disadvantages of the battloid mode are reduced speed and the immediate availability of only one weapon, the EU-11 gun pod. The main cannon can be extended out of its arm shield housing to fire, but it is the ONLY, one, attack possible that melee. No other attacks or aggressive actions are possible regardless of how many attacks per melee might normally be available. Parries and dodges are still possible.

A new development in armor is a laser resistant ceramic which is used to coat *all* new mecha, as well as the many suits of battle armor.

What this means is that laser weapons do only half damage. This does NOT include any other energy attacks such as particle beams or ion blasts.

## VERITECH HOVER TANK a.k.a. Spartas ATAC-01-SCA

**Vehicle Type:** Veritech Tank (transformable).

**Crew:** One. Two passengers can be placed in the back seat.

**M.D.C. by Location:**

Head — 60  
Headlights (2 on top) — 5 each  
Hands — 50 each  
Arms — 150 each  
Arm Shield (2) — 600 each  
Legs — 200 each  
Retractable Hover Jets (2) — 55 each  
\*Rear, Lower Hover Jets (2) — 50 each  
Retractable Utility Arms (3) — 3 each  
Main Cannon — 120  
Tri-Auto Cannon — 75  
EU-11 Gun Pod (rifle) — 100  
Reinforced Pilot's Compartment — 200  
\*\* Main Body — 300

\*Note that the rear, lower hover jets are located on the rear underbelly or bottom in transport mode, rear underside in tank mode, and lower back when in battloid mode. The *front retractable hover jets* are targets only in the transport mode. Loss of both prevents movement in that mode.

\*\*If the M.D.C. of the main body is depleted, the unit shuts completely down.

**Speed:** Hover in transport and tank/guardian modes (stationary) — 3 to 10 feet above the ground (.9m to 3m). Maximum speed in transport mode is 100mph (160.90kmph), maximum speed in tank/guardian mode is 8mph (12.8kmph), and running in battloid mode is 35mph (56kmph). *Special maneuvers:* The VHT can leap or propel itself straight up into the air 80ft (24.4m) in ALL modes. In battloid mode the mecha can leap up to 120ft (36.6m) high with the assistance of the booster jets built into its feet and 80ft length (24.4m). In space the jets in the feet help movement.

**Height:** 20ft 4in (6.2m) Battloid, 14ft 8in (4.5m) Tank/Guardian mode and 7ft 4in (2.25m) Transport mode.

**Width:** 14ft 4in (4.4m) Battloid, 7ft 4in (2.25m) Tank/Guardian mode and 9ft (2.7m) in Transport mode.

**Length:** 6ft 6in (2.0m) Battloid, 25ft 4in (7.75m) in Tank/Guardian mode and 19ft 7in in Transport mode.

**Weight:** 16.4 tons

**Main Engine:** MT 842 Fusion Reactor.

### Weapon Systems

**1. Main Cannon:** A rapid-fire ion cannon is located in the left weapon housing shield/arm. Although it can not rotate or move right to left, it can move up and down in a 45 degree angle. The main cannon is only exposed in the Tank/Guardian mode, but can also be used (one attack per melee) in battloid mode if extended from the weapon housing of the left arm.

**Primary Purpose:** Assault/Defense

**Secondary Purpose:** Anti-Aircraft

**Range:** 8000ft (2400m)

**Mega-Damage:** 3D4 × 10 per each blast.

**Rate of Fire:** In *Tank/Guardian mode* it can fire as many times equal to the pilot's combined number of hand to hand attacks per melee. In *Battloid mode* the use of the big gun cancels all other attacks leaving the mecha with only ONE attack per melee regardless of the pilot's total number of attacks per melee.

**Payload:** *Conditionally Unlimited.* The main gun can shoot up to 30 times within one hour or less (actually, within minutes if necessary). Unfortunately, the energy drain is incredible. Thus, if all 30 shots are fired in an hour or less the cannon will temporarily be drained and can not fire again for at least one hour. The ion generator recharges at a rate of 10 blasts per one hour (up to a total of 30 blasts).

**2. Triple-Barreled Auto Cannon:** This is the secondary weapon of the VHT in Tank/Guardian mode, firing 32mm rounds. It can fire only in this mode. Its fixed forward mounting limits the direction of the auto cannon to straight ahead. However, the upper torso of the Hover Tank can move in a 45 degree angle to the left and right, as well as up and down. Also, a quick flick of the booster jets in the feet and the VHT can turn in any direction, including completely around.

**Primary Purpose:** Assault/Defense.

**Secondary Purpose:** Antipersonnel

**Range:** 4000ft (1200m)

**Mega-Damage:** 6D6 M.D. per burst.

**Rate of Fire:** Equal to the pilot's combined number of hand to hand attacks per melee.

**Payload:** 40 bursts can be fired before reloading is required. Reloading is automatic, but takes one full melee. All VHT auto cannons have enough ammo for 5 reloadings (that's 200 bursts).

**3. The EU-11 Gun Pod:** This is standard issue for the Veritech Hover Tank. It is a rapid-fire energy rifle similar in function to the old GU-11 gun pods. In transport mode the weapon is mounted, fixed forward, in the front center of the tank. In Battloid mode it is a hand held rifle. It can not fire in Tank/Guardian mode.

**Primary Purpose:** Assault/Defense

**Range:** 6000ft (1800m)

**Mega-Damage:** 1D4 x 10

**Rate of Fire:** Equal to the pilot's combined number of hand to hand attacks per melee.

**Payload:** Effectively unlimited.

**4. Optional use of the GU-XX Gun Pod.** This is not a standard issue weapon, but can be used if needed and if available.

**5. Optional Hand to Hand Combat:** Rather than fire any weapons, the VHT can engage in hand to hand combat. Restrained punch does 1D4 M.D., full punch — 2D6 M.D., power punch — 2D6 + 6 M.D., body block — 2D6 M.D., kick — 1D6 M.D., leap kick — 2D6 M.D. and stomp — 1D4 M.D.

*Remember*, as with ALL mecha, the weapons or types of attack can be used in any combination as long as they do not exceed the total combined number of the pilot's hand to hand attacks per melee.

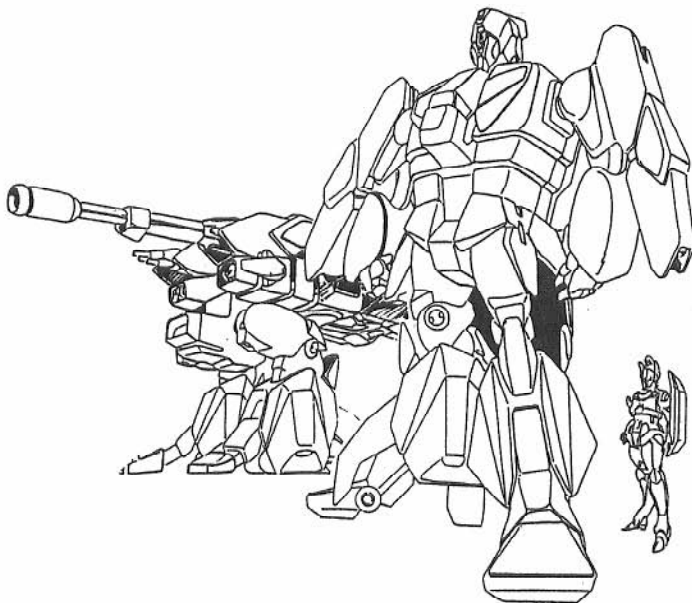

# THE SPACECRAFT OF THE REF

## HORIZONT DTTS-12 Dive Transatmospheric Troop Shuttle

The Horizont is the smallest vessel in the REF fleet. Unlike the larger combat spacecraft, the Horizont is a troop carrier. Its purpose is to transport troops, mecha, and supplies to and from the battlefield. To accomplish these tasks, the shuttle carries two armored supply bunkers which can be "dropped," detached, at landing. Troops and supplies can be unloaded while the Horizont flies into space to get another load/bunkers. The troop bunkers do not have to be detached for the troops to disembark; however, a "hot" landing zone (LZ) seldom offers the luxury of time to land, wait for the unloading and fly off without the shuttle taking damage. The detachable bunkers enable the Horizont to quickly land/hover, drop its two bunkers and fly to safety before the enemy has time to focus an attack. In many respects, the Horizont can be thought of as the space-age equivalent to the helicopter in the Vietnam War (Earth, circa 1964-70).

The transport shuttle is operated by a pilot, copilot, two communications engineers and an alpha and beta pilot. The crew is located in the nose of the spacecraft. If necessary, the nose can detach from the rest of the vessel, functioning as an emergency escape pod. The escape pod can function only in space (drops like a rock in an atmosphere) and can accommodate only 5 or 6 additional human-size passengers.

Inside the neck of the Horizont is a troop compartment which can hold twelve (12) cyclone riders (in armor) with the cyclone mecha folded and stowed in compartments above each soldier (*see illustrations*).

The rear section is all engine except for the passageway that connects to the Alpha and Beta Veritech Fighters attached to the belly of the Horizont. The two veritechs represent the only defense and assault weapons at the shuttle's disposal.

They are especially important when delivering troops or rescuing wounded in a "hot LZ," a landing area under heavy attack. As the shuttle makes its final landing approach, the Alpha and Beta (connected together) detach to lay down suppressing fire and distract the enemy. If the situation requires it, the Alpha and Beta will detach from each other and attack as two separate units. Staying with the Vietnam War analogy, the Alpha and Beta act as two "combat" Huey helicopters engaging the enemy while a transport chopper picks up the wounded or drops off troops. Once the Horizont's job is done it leaves, with the two veritechs flying escort. The Alpha and Beta can connect and reattach to the shuttle at any time.

### HORIZONT DTTS-12

**Vehicle Type:** Space and atmospheric troop carrier.

**Crew:** Pilot (1), copilot (1), alpha pilot (1), beta pilot (1), and two communications engineers (2). Also can carry 12 soldiers in the neck compartment as additional crew or troops.

**Troops:** 12 Cyclone Riders with full gear *inside* the neck compartment. The two armored *transport bunkers* can carry as many as 96 Cyclone Riders with cyclones and full gear, or 8 to 14 mecha in each of the bunkers. Of course, other personnel, vehicles, equipment and supplies can be cargo as well; up to 300 tons per bunker.



**M.D.C. by Location:**

- \*Nose/Crew Compartment (escape capsule) — 400
- Neck Section — 300
- Bunker Cargo Compartments (2) — 500 each
- Bunker Hatch (2) — 100 each
- Wings (2) — 300 each
- Main Thrusters (3) — 150 each
- \*\*Main Body — 600

**HORIZONTAL WITH SUPPLY BUNKER ATTACHED**

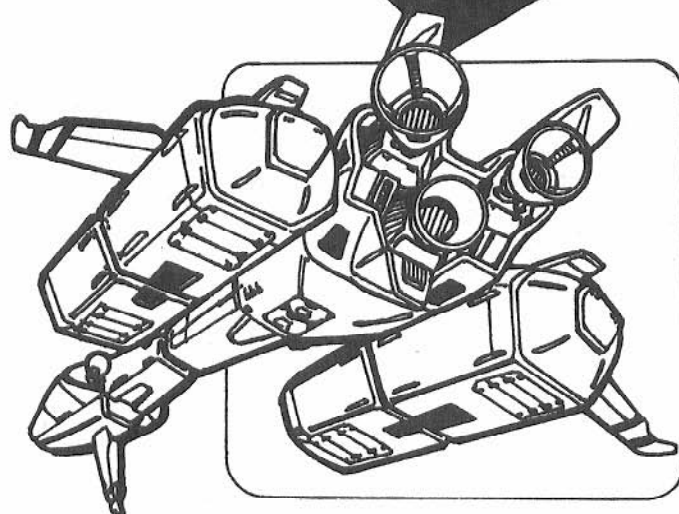
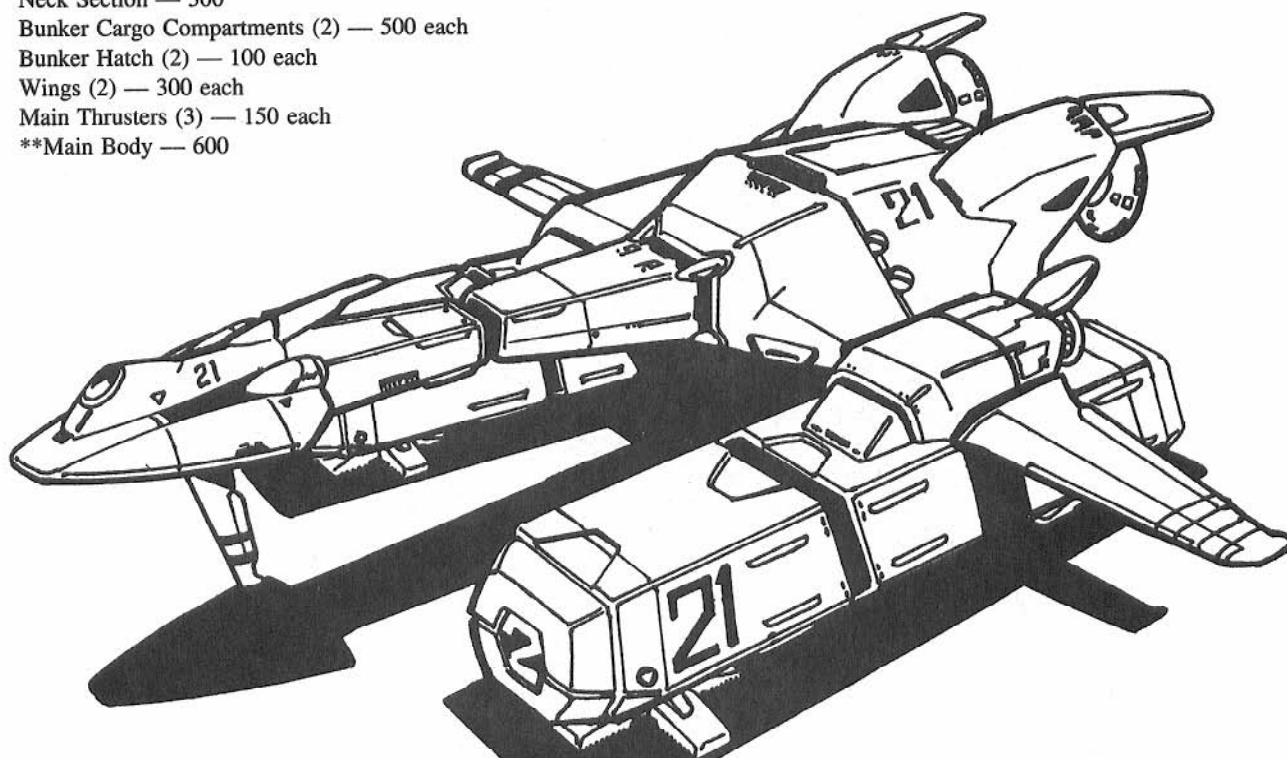

**Landing Gear**

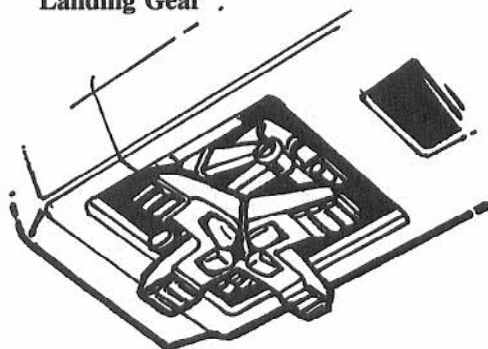

**Supply Bunker**

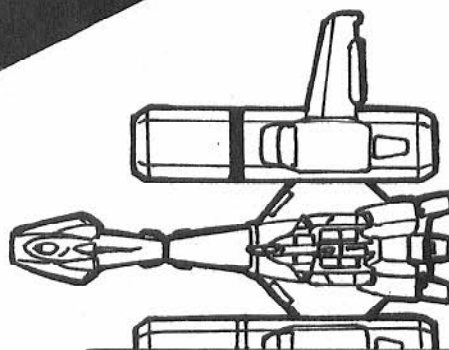
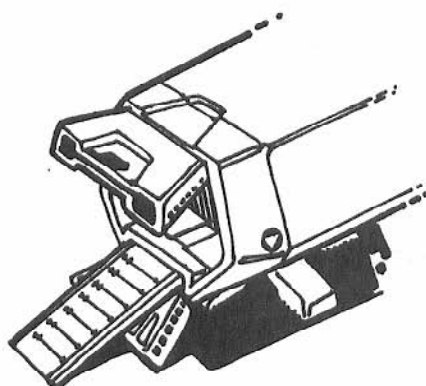
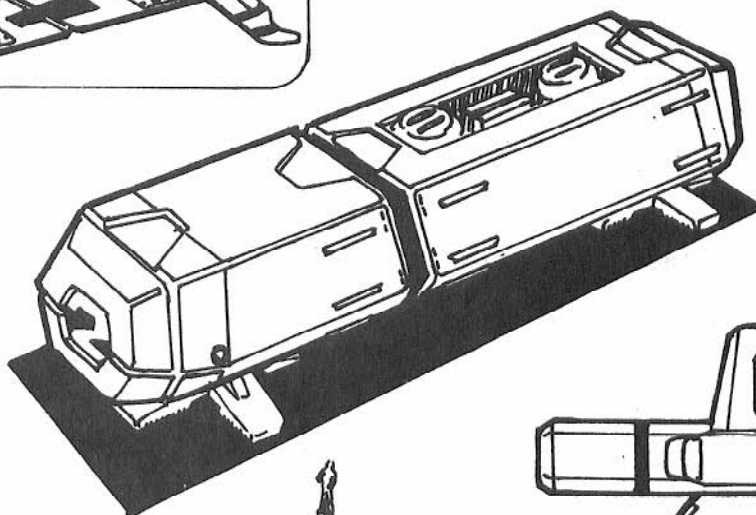

## ALPHA FIGHTER Access Inside the Horizont

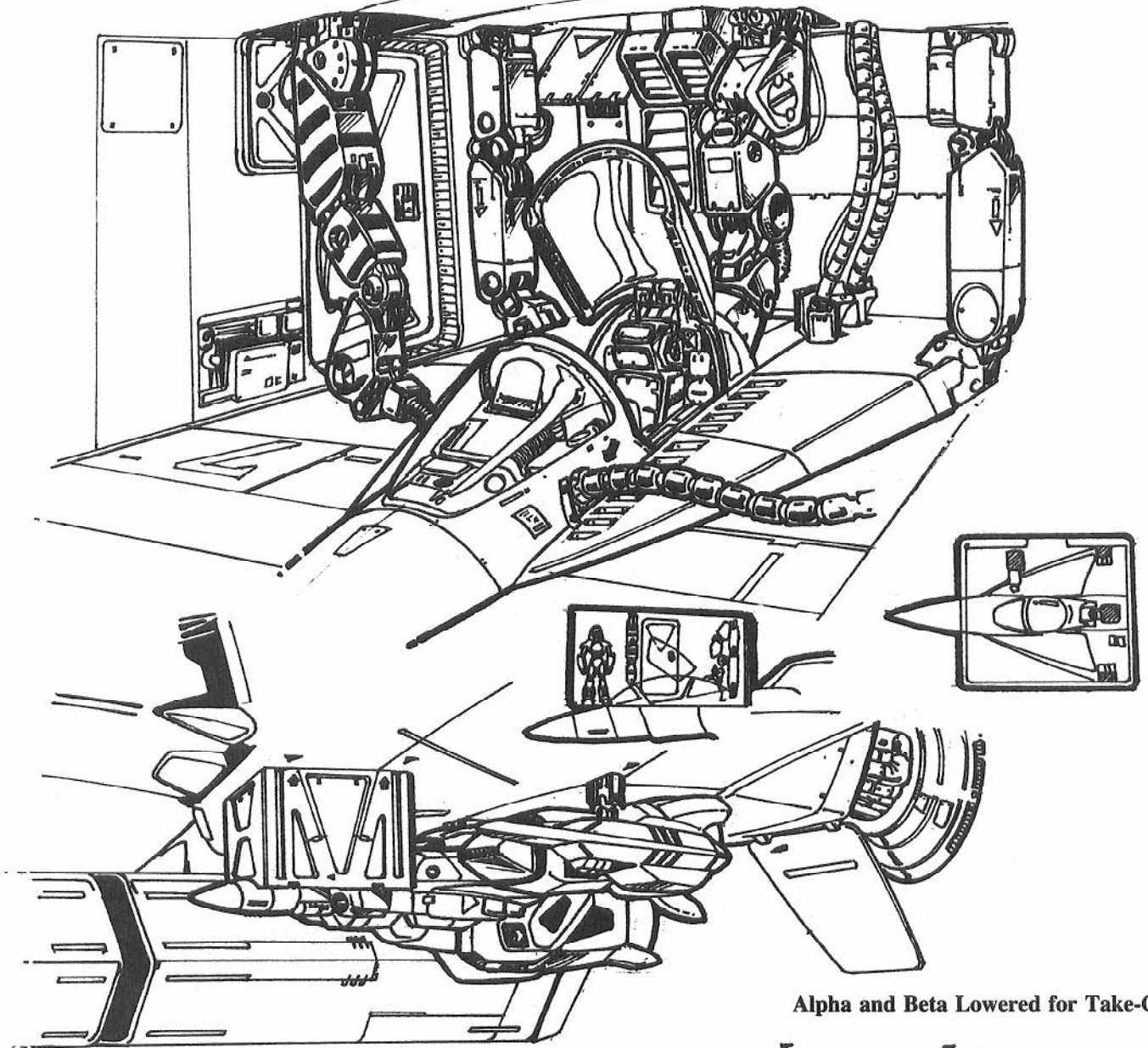

Alpha and Beta Lowered for Take-Off

\*Depleting the M.D.C. of the nose/escape capsule/crew compartment will completely immobilize the vessel. In space it will float dead (of course, any personnel in the neck and cargo bunks are still alive). In an atmosphere the shuttle will crash to Earth (the chance of the people in the armored bunks surviving is a mere 9%), and even then they will suffer 4D6 *hit points* of damage each).

\*\*Depleting the M.D.C. of the main body will completely destroy the vessel. However, the nose/escape capsule will be functional, as well as the Alpha and Beta. The two bunks will also be salvageable in space (but drop to Earth in an atmosphere).

**Speed:** Hover stationary at any height and travel via hover mode at a speed of up to 100mph (160kmph).

Flying in an atmosphere, the Horizont can attain a cruising speed of about Mach 2 (1340mph/2144kmph) maximum. Additional bursts of speed of up to Mach 6.2 are possible and necessary to escape earth's atmosphere (its transatmospheric capability).

Space Propulsion: Maximum cruising speed is Mach 4, maximum burst of speed can reach Mach 10.

Underwater: Impossible, sinks.

**Maximum Range:** Effectively unlimited. Protoculture engines, but does not have spacefold capabilities.

**Length:** 198ft (60.3m)

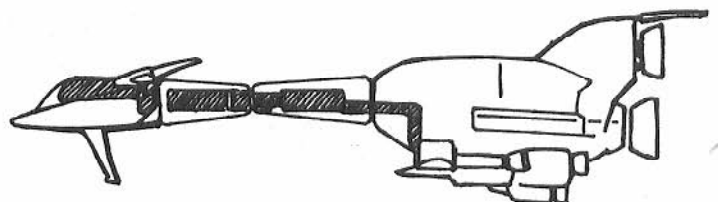
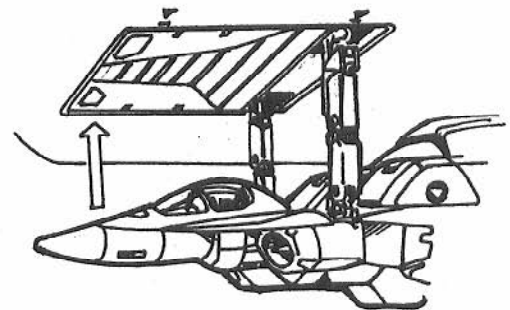

Crew and Troop Area

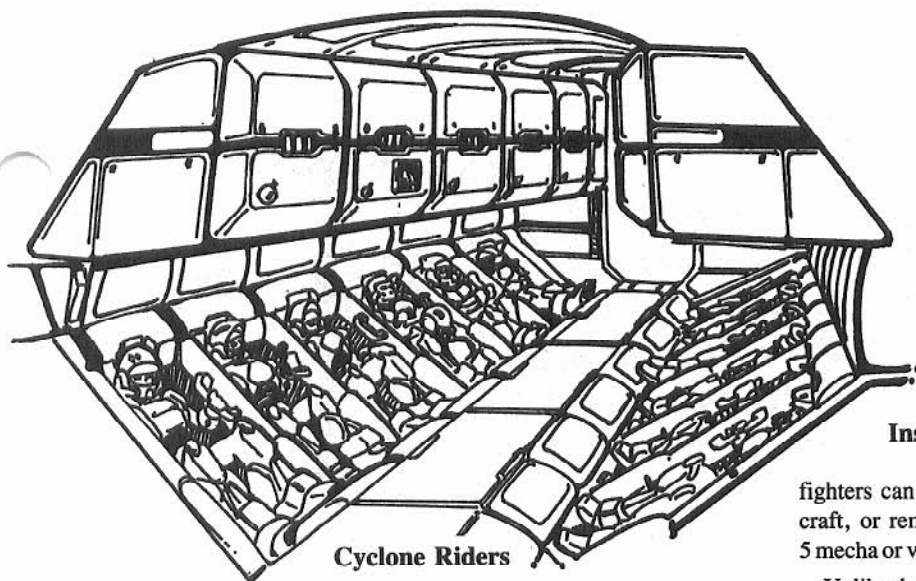

Inside View of the Armored Supply Bunker

**Height:** 60ft (18.3m)

**Width:** 224ft (68.3m). Wing tip to wing tip.

**Weight:** 2200 tons

**Storage Bunkers:** Length — 130ft (39.6m)

Height — 33ft (10m)

Width — 34ft (10.4m)

Weight — 60 tons (unloaded)

Cargo — Can hold up to 300 tons

**Weapon Systems:** None, other than the Alpha and Beta.

**Special Equipment:** Long-range communications, combat computer, radar (200 mile range), and the usual life support systems for spacecraft.

## GARFISH HSTC-27

### High Speed Troop Carrier

The second largest spacecraft in the REF fleet is the Garfish troop carrier, about twice the size of the Horizon shuttle. Yet, despite its size, the Garfish is the fastest, most maneuverable ship in the fleet.

The bridge of the vessel is located in the nose, with a crew consisting of a captain, pilot, three copilots, and four communications engineers. Nestled in the midsection is the command deck. This is where all combat operations are directed and an auxiliary bridge is located. Thus, if the forward section is destroyed the ship is still fully functional. The command crew consists of a commander of operations, two military advisors, a pilot, two copilots, four communications engineers, six aids and four security officers (cyclone riders in full gear).

A medical team, one doctor, two paramedics and two nurses, along with a mecha team of three bio-maintenance engineers, two mechanical engineers, two electrical engineers and eight assistants, are also part of the regular crew. Plus a kitchen team of eight.

In addition to the crews, the Garfish carries troops. Typically, those troops will include 96 cyclone riders, 288 other military personnel (any O.C.C.), and a handful of vehicles, such as the ARRAV rocket launcher, AAT-40 assault transport, and a dozen ML-3 forklifts.

Mecha troops will always include one or two M.A.C. IIs or IIIs, two Gladiators, one or two Excalibers, one or two Z1-Battle Pods and nine Alpha and Beta fighters. The Alphas and Betas are stored in hangar bays suspended underneath the main body of the Garfish. The veritechs are launched with the Alphas and Betas connected together. The two

fighters can separate at will, instantly doubling the number of assault craft, or remain linked as one heavy-duty fighter. An additional 4 or 5 mecha or vehicles can be squeezed in with the carrier's usual forces.

Unlike the Horizon, the Garfish carrier has its own defensive weapons system. This includes long-range missiles launched from the fore-section, a retractable laser turret in the nose section and a tri-barreled laser turret at the base of the forward section.

### GARFISH HSTC-27

**Vehicle Type:** Space, high speed troop carrier.

**Crew:** 55 (see previous description of bridge and command deck).

**Troops:** 96 Cyclone Riders, 288 mixed personnel, 6 to 8 destroids (at least one will be a M.A.C. II or III), 9 to 11 Alpha and Beta Fighters. An additional 96 troops could be added in an emergency, but this will create extremely cramped conditions. Also used to transport one Titan.

#### M.D.C. by Location:

Nose Section — 900

Retractable Laser Turret — 100

Tri-Laser Turret — 300

Veritech Hangars (3) — 800 each

Main Thrusters (3) — 800 each

Secondary Thrusters (3) — 500 each

\*Main Body — 2700

\*\*Hull per 40ft area (12.2m) — 150

Interior Walls (per 20ft section) — 30

Interior Hatches — 30

Outer Hatches — 100

\*Depleting the M.D.C. of the main body will completely destroy the vessel. Only those in life support armor, space suits, and mecha may survive.

\*\*Depleting the M.D.C. of a specific area of the hull will *punch a hole* into it. This will cause decompression and air will rush into space, forcing that section of the ship to be sealed off. It will also allow the enemy to enter. **Note:** Spacecraft are divided into small sections so that these sections can be easily sealed if the hull is ruptured.

**Speed:** Hover stationary while positioning to land. Has vertical take-off and landing (VTOL) capabilities.

**Flying** in an atmosphere is not what this vehicle is designed for. Flight should be limited to landing and take-off. An antigravity system helps it to maneuver on planets. The Garfish can attain a speed of about Mach 8 to breach Earth's atmosphere.

**Space Propulsion:** Cruising speed is usually Mach 2 to 4, but it can reach a maximum speed of Mach 14. A special drive system can be engaged to push the vehicle into the *sublight range*, about .20 light or 32,000 miles per second.

**Underwater Propulsion:** Although not intended for underwater travel, the carrier can operate underwater. Maximum speed is 100mph (160kmp/h).



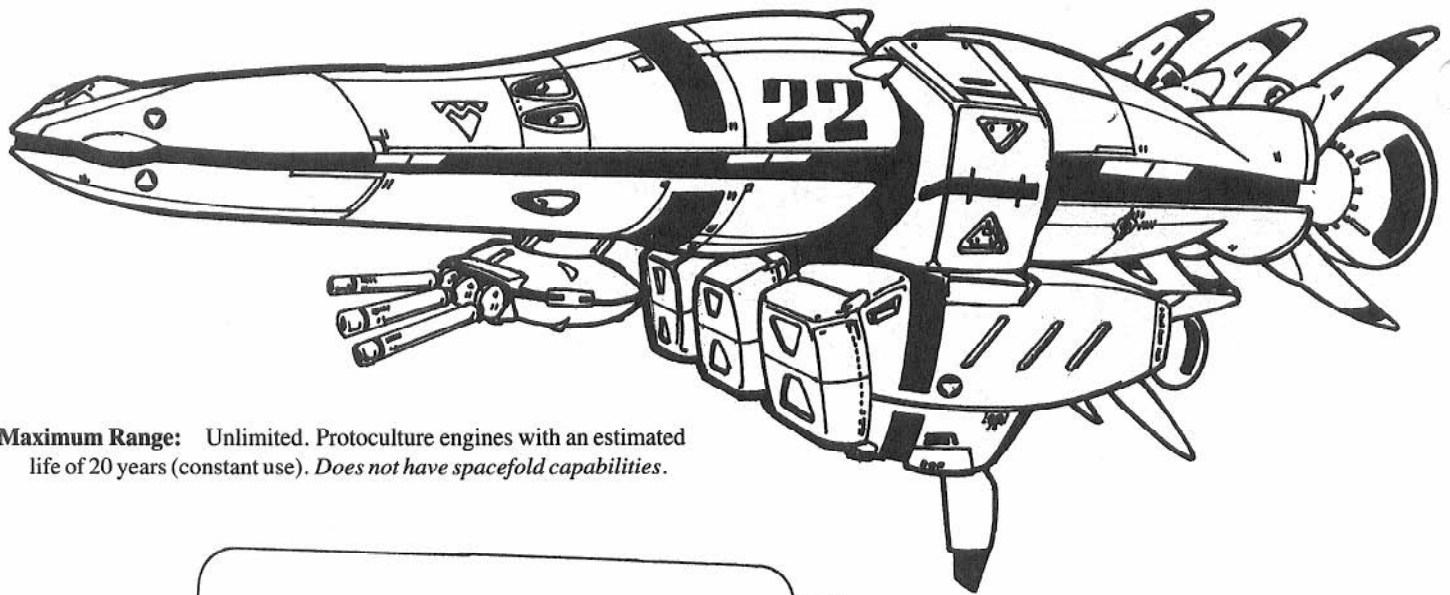

**Maximum Range:** Unlimited. Protoculture engines with an estimated life of 20 years (constant use). *Does not have spacefold capabilities.*

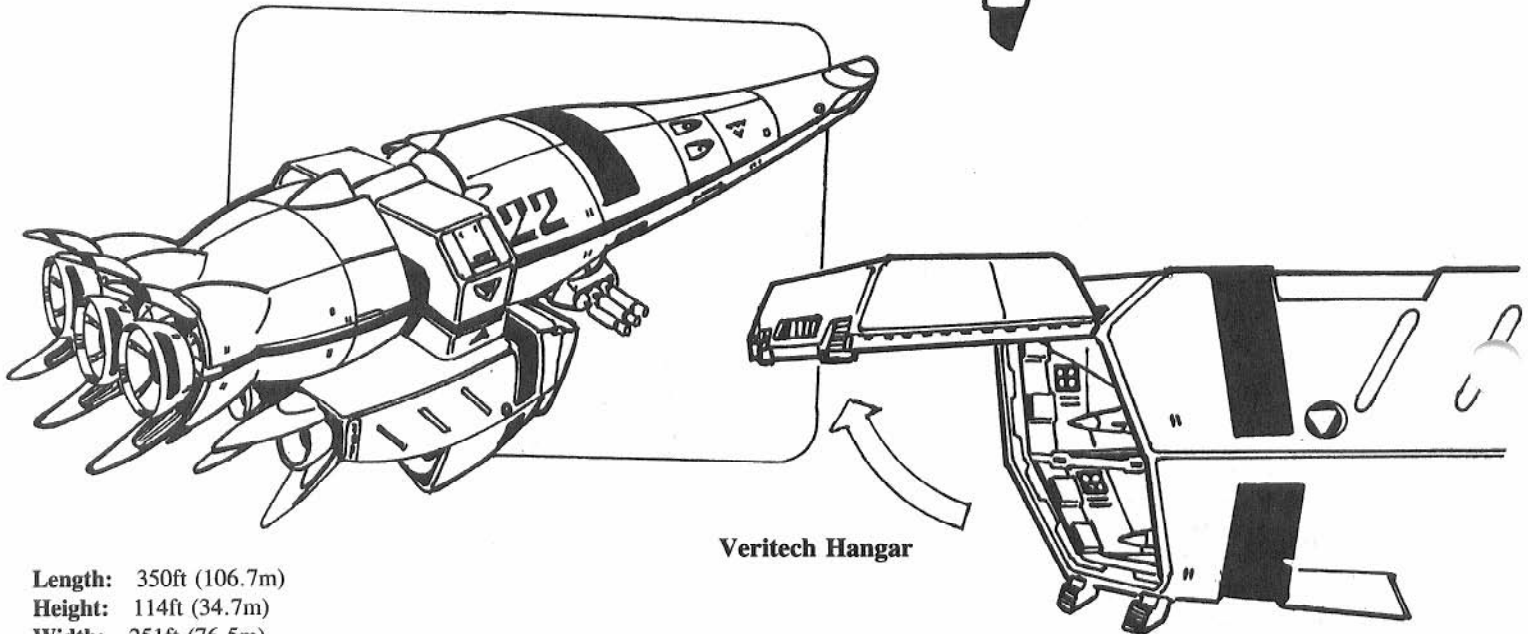

**Veritech Hangar**

**Length:** 350ft (106.7m)

**Height:** 114ft (34.7m)

**Width:** 251ft (76.5m)

**Weight:** 18,500 tons

**Main Engine:** Reflex, heat pile system.

**Gravity Control System:** Internal

## WEAPON SYSTEMS

**1. Tri-Laser Turret:** A heavy-duty, long-range weapon system usually operated from the command deck. It has an 190 degree rotation and a 45 degree arc of fire.

**Primary Purpose:** Anti-spacecraft

**Range:** 30 miles (48km) in an atmosphere

60 miles (96km) in space

**Mega-Damage:** 3D6 × 20 M.D. per triple blast.

**Rate of Fire:** Five per melee

**Payload:** Effectively unlimited

**Bonus for "close" combat (within 8000ft/2438.4m):** +4 to strike

**2. Retractable Forward Laser Turret:** A small, hidden laser turret that is primarily used for defense from direct assaults (close combat). The turret is located in the undercarriage about 40ft (12.2m) from the nose tip. It can rotate 360 degrees with a sweeping arc of 180 degrees. Operated from the bridge or command deck.

**Primary Purpose:** Defense against small attack vehicles in close range.

**Range:** 4000ft (1200m) in an atmosphere.

8000ft (2438.4m) in space.

**Mega-Damage:** 2D6 × 10 per blast

**Rate of Fire:** Six per melee

**Payload:** Effectively unlimited

**Bonus for "close" combat:** +2 to strike

**3. Six Missile Launchers** rim the base of the forward section almost directly above the tri-laser turret.

**Primary Purpose:** Anti-spacecraft

**Secondary Purpose:** Assault

**Missile Type:** Long-range of any type, but usually heavy missiles such as the plasma (heavy), proton torpedo (heavy), reflex (heavy), and reflex multi-warhead.

**Mega-Damage:** Varies with missile type.

**Range:** Varies with missile type; 500 to 1800 miles.

**Payload:** 36 total.

**Special Equipment:** Long-range laser and satellite relay communications, combat computer, targeting computer, long-range radar, anti-gravity systems, sublight engines, and standard life support systems.

# IKAZUCHI SFC-7000 COMMAND CARRIER

The most formidable vessels in the REF fleet, with the exception of the SDF-3, are the Ikazuchi command carriers. The massive, half mile long, spacecraft was designed by the Ikazuchi Robotech Design Group under the supervision of Doctor Lang. Its principle purpose is to function as a mobile space station supporting the bulk of the Robotech Expeditionary Force's personnel, mecha, vehicles, weapons and supplies.

The secondary purpose of these big ships is assault. Since the likelihood of combat with the Robotech Masters was very real, the giant carriers are heavily armed, like an aircraft carrier in space. The big gun is a Zentraedi style mega-laser that can slice another Ikazuchi in half. Then there is a battery of laser turrets, missiles, and, of course, its complement of nearly 700 mecha.

The contingent of veritech fighters is comprised mostly of the new alpha and beta fighters although a handful of the old RDF VF-veritechs and vindicators are also present. Alpha fighters in battloid mode are launched from the six *alpha launch bays* that appear as armored bunkers protruding from the side of the vessel (3 on each side). Each launch bay can release 24 alphas, for a combined force of 144 fighters (see illustration). In addition to the six launch bays, the three lower decks are also hangars that can release an equal force of veritechs in minutes.

Deck ten has two hangars in the very nose, releasing its mecha forward and from side hangar doors. In the center is the main hangar. It is here and on the two decks below it, that the bulk of mecha can be found. Mecha hangar compartments, repair and maintenance garages, storage and crew quarters surround the big release hangars on either side of the ship. Decks eleven and twelve service the Horizont troop shuttles, as well as the fighters. Deck eleven also has two side hangars

toward the nose used for the release of alphas and betas. Deck twelve is suspended underneath the carrier and is a comparatively tiny hangar for the Horizont shuttles. A huge shield covering protects the main hangar section of decks 10-12. The shielding slides to the rear when fighters or spacecraft are to be launched. The majority of destroids, cyclones, vehicles, missiles, and equipment are also stored on the hangar decks.

As a "command" carrier, each Ikazuchi will coordinate and direct a fleet of smaller spacecraft such as the Horizont and Garfish. The carriers can even house two to four of the Horizont dive transatmospheric troop shuttles inside their immense hangars and dock with the Garfish. The command carrier will also contain two to six of the titan ground mobile transports. Each Ikazuchi carrier commands over 5000 troops, plus those of the smaller spacecraft. With the superior alpha and beta fighters and other mecha, the Ikazuchi - 7000 command carriers are tougher than the Zentraedi Destroyer (Thuverl Salan) and nearly equal to their landing ships (Quiltra Queleual). Combined with the power of the SDF-3, the REF fleet is a force to be reckoned with.

## IKAZUCHI SFC SERIES

**Vehicle Type:** Space; space fold command carrier.

**Crew:** Bridge Crew: Ship's captain (1), first officer and second in command (1), communications team (20), bridge security (4 cyclone riders in VR-041 saber cyclones; battloid mode).

Military Command Crew: General (1 in charge of troop deployment, strategy and tactics), 2 major generals (seconds in command), military advisory team (10), veritech commander (1), destroid commander (1), pinpoint barrier operators (4), communications team (10), command security (10 cyclone riders, 5 in VR-041 saber cyclones and 5 in VR-038-LT cyclones; battloid mode) and ship's weapons crew (8).

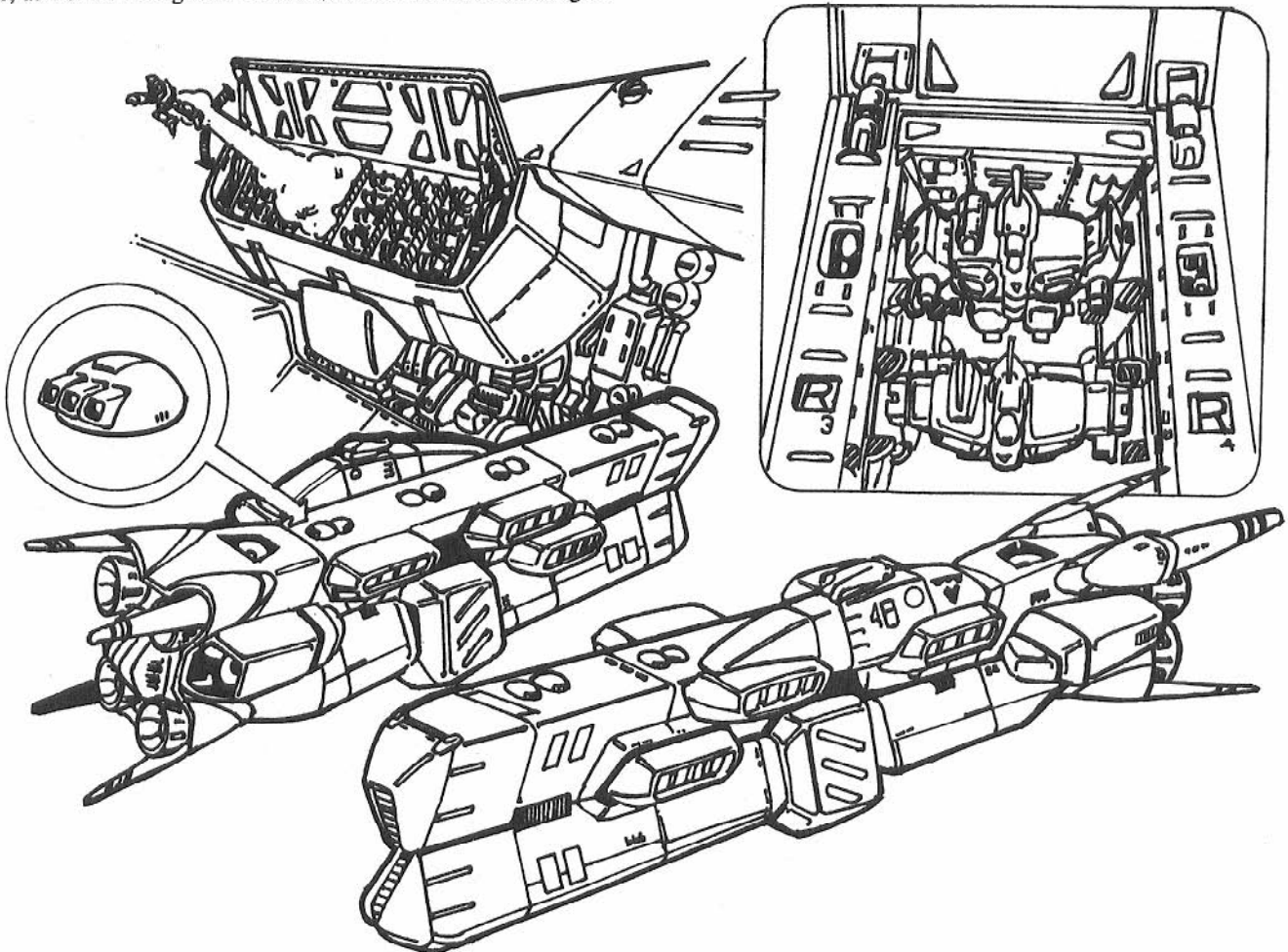

Remaining Ship's Crew (under the ship's captain's command): **Engineering** 440 (24 ship's engineers, 48 mechanical engineers, 48 electrical engineers, 120 bio-maintenance engineers and 200 assistants), **Medical Team** 208 (48 doctors, 64 paramedics, 96 nurses/assistants), **Security** 48 (this is in addition to bridge and command security; all wear VR-038-LT cyclones), **Dietary** 100 cooks, **Maintenance** 250 laborers, and **Internal Communications** 48.  
**TOTAL CREW:** 1117

**Troops:** Veritech Pilots: 466 combat ready (284 alpha pilots, 140 beta pilots, 36 VF veritech pilots, and 6 vindicator pilots), plus 93 beta and 140 alpha in reserve.

Destroid Pilots: 228 combat ready (24 of which are cyclops crewmen) plus 200 in reserve.

Cyclone Riders: 1824 combat ready, plus 1000 in reserve.

Additional Military Personnel: 2000 of any O.C.C.

Total Troops: 5951

**Total of Crew and Troops:** 7068, plus an additional 800 personnel can be accommodated if necessary.

#### **Mecha Complement:**

Veritech Fighters: 466 total

284 Alpha Fighters; 144 are housed in six Alpha launch bays (24 in each).

140 Beta Fighters

36 VF Veritechs

6 VF-1V Vindicators

Destroids: 196 total

48 Excalibers

48 Gladiators

6 M.A.C. IIs or IIIs

24 Raidar X

24 Spartans

36 Z-1 Battloids

6 Z-2 Battloids

4 Z-3 Cyclops

Cyclones: 3000 total

2000 VR-052 Battler Cyclones

200 VR-041 Saber Cyclones

800 VR-038-LT Light Cyclones

**Vehicles of Note:** 4 to 6 Titans, 4 Horizon Transatmospheric Carriers, 10 to 24 AAT-40 Assault Transports, 10 to 24 AAT-30s, 2 to 6 AMR-10 Mecha Retrieval Vehicles, 6 to 12 ARRAV Rocket Launchers, 50 TCH Tractor Haulers and over 100 ML-3 Forklifts.

#### **M.D.C. by Locations:**

Laser Turrets (16 - 8 top and 8 bottom) — 150 each

Missile Bays (8 hatches) — 100 each

Forward Mega-Laser (nose) — 800

Alpha Launch Bays (6) — 1200 each

Hangar Doors (18) — 500 each

Main Hangars Sliding Shield (2) — 3000 each

Airlock Access Hatches (many) — 100 each

Outer Hull (per 40ft area) — 100

Interior Walls (per 20ft) — 40

Command Tower (1) — 4500

Forward Section (1/3) — 20,000

Midsection (1/3) — 20,000

\*Rear Section (1/3) — 25,000

Main Thrusters (4) — 6000 each

Secondary Thrusters (2) — 2500 each

\*\*Pinpoint Barrier (force field)(4) — 5000 each

\*Depleting the M.D.C. of the rear section means the back third of the carrier has been destroyed. This includes all engines/thrusters, two of the alpha launch bays, half of the main hangars, and all personnel, mecha, and equipment in those sections when it was destroyed. The vessel will be adrift in space without any means of propulsion, and on auxiliary life support. However, the command

tower, pinpoint barrier, forward hangars, mega-laser (forward) and even the space fold system are still fully operational.

\*\*The pinpoint barrier field continually renews itself; see description.

**Speed:** Conventional Space Propulsion: Maximum speed is Mach 7.

Sublight: .16 the speed of light.

Space Fold: A hyperspace system that catapults the vessel through space and time. The space fold system is used for traveling from one galaxy to another quickly. Range: Unknown, presumably limitless. Note: When a command carrier uses its space fold, it will also transport all vessels within a two or three mile area. Typically, the carrier can transport 80 to 100 of the smaller spacecraft with it during a space fold operation.

Planet Bound: The Ikazuchi carriers can land on a planet if absolutely necessary, but are **not** designed to maneuver in an atmosphere; in other words just land and leave.

**Maximum Range:** Unlimited. Protoculture engines give it an estimated life of 30 years of constant use. Sublight and space fold offer infinite range.

**Length:** 2832ft (863.2m)

**Height:** 766ft (233.5m)

**Width:** 480ft (146.3m)

**Weight:** 20,000,000 tons

**Main Engine:** Reflex, heat pile system.

**Gravity Control System:** Internal

## **WEAPON SYSTEMS**

1. **DS-1 Pinpoint Barrier Defense System:** The Ikazuchi does not have a full force field to protect it like the SDF-3, but uses the pinpoint barrier system as a special defense.

*The pinpoint barrier system was developed by Doctor Lang on the SDF-1. It is a mini-force field, measuring about 200ft (61m) in diameter, that can be moved and positioned wherever it is needed. The advantage of the pinpoint barrier over the full force field, is that it requires one third as much energy and one quarter of the space needed for the energy generator.*

The PPB defense operators monitor enemy attacks on the command carrier aided by a special combat strategy and tactics computer and sensory data. Generally, they will ignore assaults from small, one or two man fighters, like the Zentraedi battle pods or Invid shock troopers. It is the job of the *other* weapon systems and mecha pilots to engage the enemy in close combat. Instead, the PPB defense operators diligently search out long range and heavy assaults by missile volleys and devastating energy beams that could rend the ship, like a blast from a Zentraedi command ship's main laser (1D4 x 1000 mega-damage). If there is no apparent or potential danger from a larger vessel, the operators can then turn their attention to defense against smaller, less threatening spacecraft. The prime areas of defense will be: 1) the bridge and command decks located in the command tower in the center top of the Ikazuchi, 2) main thrusters, 3) hangar bays and 4) the main laser cannon, in that order of importance.

Four operators man the pinpoint barrier weapons console, each controlling *one* disc of energy. This allows each operative to split up to protect four different areas of the carrier or to combine their energy in joint efforts to protect a larger area. The four energy barriers are moved by the use of a *ball control* manipulated by either hand. The ball control is built into the weapons console and works exactly like the old Earth arcade games such as Centipede and Missile Command. A roll with the palm upwards will move the barrier up, a roll to the left will move it left. The movement and position of the barrier is indicated on a computer monitor. The speed in which the barriers move are identical to the speed and dexterity of its operator. Thus, they can be moved across the full length of the Ikazuchi in a split second.



The marvel of the barrier is that it is continually renewed approximately every 5 seconds (equal to THREE melee attacks each). This means that damage to its M.D.C. is repaired every four seconds. Thus, if one of the barriers took 3000 M.D.C. damage, it is restored to its full 5000 M.D.C. four (4) seconds later. If completely destroyed, the barrier will rematerialize within four seconds.

The only attack the pinpoint barrier system will crumble under is the *heavy particle beam* onslaught from a Zentraedi flagship or Robotech Masters' mothership (this is the same disintegration beam fired by the SDF's main gun). The Ikazuchi's only hope in surviving such an attack is to have all *four* pinpoint barrier shields grouped together to block the full brunt of the beam. A missed roll to parry (block the beam) means complete vaporization! Even if the attack is successfully blocked the barrier system will collapse immediately after from the strain. *Roll percentile dice to determine the severity of damage.*

01-15 Lucked out, system will be operational in 4D6 hours.

16-30 Requires major repairs; system will be operational within 4D6 × 10 hours (yes, days of work).

31-70 Completely destroyed; there is no hope for repair!

71-97 Horribly damaged; will require 4D6 weeks of repair, with a 1-50% chance it will require an additional 4D6 weeks to bring it up to fully operational (another blast like that last one will completely destroy the system).

98-00 It's a miracle! Systems will be operational in 2D4 hours.

Primary Purpose: Defense. The pinpoint barrier can not be used as a weapon.

Range: 300ft (91.5m) from the surface of the vessel.

Mega-Damage: Inflicts none, but can sustain 5000 mega-damage every four seconds.

Rate of Movement (parry/block attacks): Counts as a parry. *The trained operators* can attempt to parry/block an attack up to eight (8) times per melee, and are +7 to parry. *Untrained* characters can move the barrier equal to their number of hand to hand attacks (4 attacks = 4 attempts to parry with the PPB); only attribute and hand to hand parry bonuses will apply.

Payload: Nearly inexhaustible.

2. **The Main Laser Cannon (a.k.a. Mega-Laser)** is built into the nose of the carrier, with no apparent appendage, nozzle or opening to give away its location.

Primary Purpose: Anti-spacecraft/assault

Range: 100,000 miles (160,000km) in atmosphere

200,000 miles (320,000km) in space

Mega-Damage: 1D4 × 1000 M.D.

Rate of Fire: Once every other melee

Payload: Effectively unlimited

3. **Sixteen (16) Zentraedi Style laser Turrets** line the top and bottom of the Ikazuchi Command Carriers. The turrets are operated by the weapons crew in the command tower. Each turret can rotate 360 degrees with a 180 degree arc of fire.

Primary Purpose: Defense

Secondary Purpose: Anti-spacecraft

Range: 100,000 miles (160,000km) through atmosphere.

200,000 miles (320,000km) in space.

Mega-Damage: 1D4 × 100 M.D.

Rate of Fire: Each turret can fire twice (2) per melee

4. **Eight Missile Bays** are strategically placed in the carrier along its sides. They are undetectable by casual inspection until their hatches slide open.

Primary Purpose: Defense

Secondary Purpose: Anti-missile and anti-spacecraft

Missile Type: Long-range reflex multi-warhead or proton torpedo only! Of course, any long-range missile could be substituted if necessary.

Range: Proton — 1200 miles (1920km)

Multi-Warhead — 1800 miles (2880km)

Mega-Damage: Both inflict 4D6 × 10 M.D.

Rate of Fire: Two (2) times per melee, but can fire missiles one at a time or in volleys of 2 or 4.

Remember, a volley counts as one melee attack regardless of the number of missiles launched.

Payload: Each missile bay has 100 missiles (800 total).

5. **Mecha troops** are deployed for defense and assault. *See troops.*

**Special Equipment of Note:** Hyperspace communications, long-range laser and satellite relay communications, long-range radar, antigravity systems, sublight engines, space fold, and pinpoint barrier system.

## COMMAND CARRIER FLOOR PLANS

Since many characters will find themselves stationed on board an **Ikazuchi Carrier** from time to time, the basic deck plans have been provided. *Major* compartments, facilities and air locks/access hatches are denoted.

### THE COMMAND TOWER Observation Deck

This 177ft (54m) long deck is lined with super-tough windows on three sides for personal observation of the outside, and is also used as a conference room. A computer and 42 inch screen can be utilized to call up combat data or satellite pictures. An elevator and stairs connect it to the bridge. The deck is automatically sealed if its hull is ruptured. Accessible from the bridge only.

### Bridge Deck

1. **Communications:** A large area surrounded by an array of monitor screens, large and small, displaying essential data such as enemy movement, radar, sensory data, combat data, radio/video/laser communications, etc. The ship's captain is usually seated in this area.
2. **Internal Communications Network**
3. **Captain's Lounge:** Contains a small conference table, six chairs, two couches and a bed.
4. **Elevator to the lower decks.**
5. **Elevator to observation deck** with adjacent stairs. Bridge *security* is usually stationed near the elevators.

### Command Deck

1. **Pinpoint Barrier** defense operations.
2. **Ship's Weapons Operations:** This area houses the weapons crew that operate the laser turrets, and other defense/assault systems of the Ikazuchi.
3. **Combat Bridge:** Surrounded by view screens and communication monitors. This is where the General, his advisors and officers direct the ship's troops.
4. Open area with **elevator and stairs** connecting to the other decks. *Security* is stationed here and in the combat bridge.

### DECK ONE

1. **Forward Weapon System** (laser and independent generator).
2. **Elevator Bay**
3. **Deck One Mess Hall**
4. **Deck One Kitchen**
5. **Showers**
6. **Waste Disposal System**
7. **Crew Quarters.** All crew quarters are dormitory type arrangements that house six to eight soldiers. Because of the long journey in

space and the close confines of the ship each crew compartment is roomy, more like an apartment than a barracks. There are four bedrooms with bunk beds (2 people in each room), plus a living room, dinette with a sink and shelves (no cooking facilities), two sitting rooms and a study.

8. **Lounge**
9. **Conference Room**
10. **Officer's Quarters:** The highest ranking officers live alone or with their families. Low ranking officers must share their quarters with one or two fellow officers.
11. **Storage Room**
12. **Officer's Quarters**
13. **Weapons Locker:** Contains 36 VR-052 Battler Cyclones, 96 suits of CVR-3 body armor, 24 spacesuits, 24 jet packs, 72 Gallant H-90s, 72 Fal-2s, 24 Sal-9s, 48 Wolverine assault rifles, one crate of cobalt grenades (72), one crate cobalt limpet mines (48), and one MRL Forklift.
14. **Crew Quarters:** Dormitory style. Six soldiers share the 44ft (13.4m) living area.
15. **Latrine and Shower**
16. **Navigation and Guidance**
17. **Lounge and Recreation Room**
18. **Officer's Quarters**
19. **Officer's Quarters**
20. **Officer's Quarters**
21. **Officer's Quarters**
22. **Deck Officer's Quarters**
23. **Deck Officer's Quarters**

#### COMMAND WING (Deck One)

24. **Command Deck Officer's Quarters**
25. **Command Deck Officer's Quarters**
26. **Command Deck Officer's Quarters**
27. **Conference Room**
28. **Cafeteria**
29. **Conference Room**
30. **Officer's Library/Study**
31. **Captain's Quarters**
32. **Bridge and Command Deck Security Office**
33. **War Room:** Strategy and tactics are planned and implemented here. In the center is a huge holographic tactics table surrounded by computer console chairs (32) for officers and military advisors. Suspended from the ceiling and imbedded in the walls are view screens and data monitors.
34. **Officer's Lounge:** Contains a small conference table, chairs, two couches, four beds, and a bar.
35. **Storage Room**
36. **Latrine and Shower**
37. **Gravity Control and Auxiliary Life Support.**
38. **Engine and Propulsion System**

## DECK TWO

1. **Forward Weapon System**
2. **Crew Quarters:** Dormitory style. Accommodates six to eight soldiers.
3. **Elevator Bay**
4. **Latrine**
5. **Lounge**
6. **Latrine**
7. **Showers**
8. **Weapons Locker:** Contains 96 VR-052 Battler Cyclones, 24 VR-038-LT Cyclones, 144 Gallant H-90s and 288 H-90 energy clips, 144 Fal-2 Laser Rifles and 288 energy clips, 72 Sal-9 Laser Pistols and 144 energy clips, 144 Wolverine assault rifles, 864 25mm grenades for the Wolverine, 35,000 rounds for the Wolverine, a

dozen AM-2 anti-mecha land mines, 300 suits of CVR-3 body armor and one RDF Gladiator fully loaded.

9. **Lounge**
10. **Shower and Latrine**
11. **Mess Hall**
12. **Kitchen**
13. **Electronics Repair Shop**
14. **PX — Candy and Tobacco Shop**
15. **Video Library (rentals)**
16. **PX — Shop:** Sells personal item, small appliances, electronics, clothing, books, booze, et cetera.
17. **Gymnasium and Showers**
18. **Latrine**
19. **Crew Quarters**
20. **Laundry**
21. **Recreation Room** with arcade games, pool tables, etc.
22. **Lounge**
23. **Alpha Launch Bay (4):** Each bay contains 24 Alpha fighters which are launched in battloid mode. The Alpha Launch Bays and the connecting Alpha Hangar are all enclosed by reinforced hull/walls (120 M.D.C. per 40ft area).
24. **Alpha Launch Bay Hangar:** Prepares and stores the 96 Alpha fighters on combat alert, and 12 in reserve. Other vehicles include a dozen ML-3 Forklifts and a half dozen TCH-4 tractor haulers.
25. **Command Station for the Alpha Launch Bays.**
26. **Missile Storage** for the Alphas; approximately 7200 missiles.
27. **Open area** with elevators and stairs.
28. **Navigation**
29. **Engine and Propulsion System**

## DECK THREE

1. **Forward Weapon System**
2. **Elevator Bay**
3. **Lounge**
4. **Officer's Quarters**
5. **Crew Quarters**
6. **Storage**
7. **Laundry**
8. **Mess Hall** for the enlisted men.
9. **Latrine and Shower**
10. **Officer's Dining Hall**
11. **Kitchen**

#### HIGH COMMAND LIVING QUARTERS (Deck Three)

12. **Ship's Security Office**
13. **Private Gymnasium** with swimming pool.
14. **Private Dining**
15. **Private Kitchen**
16. **Recreation Room:** Pool tables and games
17. **Conference Chamber:** Very plush. Also has several computer consoles and view screens to evaluate data.
18. **Communications Room:** Another auxiliary communications room used by the General and his staff to receive up to the second data and maintain communications with the bridge and command deck.
19. **Officer's Quarters,** the General's staff
20. **Officer's Quarters,** the General's staff
21. **Officer's Quarters,** the General's staff
22. **Officer's Quarters,** the General's staff
23. **Officer's Quarters,** the General's staff
24. **Officer's Lounge**
25. **The General's Quarters**
26. **Private Library**
27. **Video Entertainment Lounge (Private)**
28. **Officer's Bar and Lounge**

**Note:** The officer's living quarters all include a private bathroom,

bath/shower, dinette with refrigerator, large study with a personal computer, bar, and room division per each officer's desire. Some accommodate a family.

#### ENGINEERING SECTION (Deck Three)

29. Life Support System
30. Auxiliary Gravity Control System
31. Hyperspace Communications
32. Storage
33. Engineering Crew Quarters: Dormitory style, with 10 crewmen per living area.
34. Cafeteria
35. Lounge
36. Engineering Crew Quarters
37. Latrine and Shower
38. Engine and Propulsion System

#### DECK FOUR

1. Forward Weapon System
2. Elevator Bay
3. Officer's Quarters
4. Crew Quarters: Six to eight soldiers share this comfortable 44ft (26.8m) living area.
5. Latrine
6. Lounge and Game Room
7. Mess Hall
8. Kitchen
9. Officer's Quarters
10. Practice Range with a maximum target distance of 500ft (152m).
11. Gymnasium
12. Shower and Latrine
13. Recreation Center containing a variety of games.
14. Laundry
15. Cafeteria (open 24 hours)
16. Simulator Arena: This room contains a dozen holographic simulators designed to simulate mecha combat for training and practice.
17. Movie Theatre
18. Latrine
19. Swimming Pool
20. Crew Quarters: Accommodates six to eight soldiers in a dormitory type living area.
21. Lounge and Bar
22. PX Store: A place where the soldiers can purchase personal items, electronics, appliances, music, videos, books, cloth, candy, etc.
23. Officer's Lounge
24. Weapons Locker: Contains 432 Wolverine assault rifles, 432 Fal-2s, 144 Gallant H-90s, 144 Sal-9 laser pistols, 72 oxygen tanks and masks, 288 CVR-3 body armor, 24 VR-052 Battler Cyclones, 12 hover cycles, 2 ML-3 forklifts and one RDF Gladiator fully loaded.
25. Crew Quarters
26. Latrine
27. Lounge
28. Storage
29. Mecha Elevator
30. Mecha Storage: Contains 10 to 18 new destroids (no M.A.C. IIIs).
31. Kitchen
32. Mess Hall
33. Officer's Quarters
34. Engine and Propulsion

#### DECK FIVE

1. Forward Weapon System
2. Elevator Bay
3. Crew Quarters: Accommodates 6 to 8 soldiers in each dormitory style room.
4. Briefing Room
5. Officer's Quarters
6. Latrine and Showers
7. Mess Hall
8. Kitchen
9. Storage
10. Latrine
11. Lounge
12. Officer's Quarters
13. Officer's Quarters
14. Laundry and Tailor
15. Connecting Corridor
16. Crew Quarters: Dormitory style, as usual.
17. Lounge
18. Officer's Quarters
19. Latrine and Showers
20. Storage: 144 VR-052 Battler Cyclones, 48 VR-041 Saber Cyclones, 24 VR-038-LT Cyclones, 432 CVR-3 body armor, 144 Gallant H-90s, 144 Fal-2 laser rifles, 144 Wolverine assault rifles, 72 EP-37 beam cannons, 72 EP-40 pulse beam guns, 72 RL-6 heavy rocket cannons, 4600 various mini-missiles, 1800 energy clips, 2900 Wolverine clips, 288 cobalt limpet mines, 288 cobalt grenades, 48 hover cycles, 1-4 destroids, and other miscellaneous items.
21. Crew Quarters
22. Latrine
23. Lounge and Game Room
24. Crew Quarters
25. Briefing Room
26. Mess Hall
27. Kitchen
28. Crew Quarters
29. Storage
30. Crew Quarters
31. Officer's Quarters
32. Mecha Elevator
33. Mecha Storage: Contains 8 to 10 mecha (No M.A.C.s).
34. Recreation Room
35. Officer's Lounge
36. Showers and Latrine
37. Mecha Storage: Two destroids, 72 VR-052 Battler Cyclones, 72 VR-038-LT (Light) Cyclones, 144 suits of CVR-3 body armor, 144 Gallant H-90s, 1440 H-90 energy clips, 48 EP-40 pulse beam guns and 480 mini-missiles (variety, but mostly armor piercing).
38. Officer's Quarters
39. Engine and Propulsion

#### DECK SIX

1. Forward Weapon System
2. Elevator Bay
3. Storage: From mecha to equipment.
4. Storage
5. Pinpoint Barrier Defense System generators
6. Pinpoint Barrier, engineering and maintenance.
7. Auxiliary Deck Systems: Includes internal and long-range communications (not hyperspace communications), and the auxiliary life support, auxiliary gravity control and emergency lighting/generator for deck six (applicable *only* to deck six).
8. Connecting Corridor



9. **Recreation Room and Latrine**
10. **Lounge Area**
11. **Cafeteria and Latrine**
12. **Alpha Pilots' Crew Quarters:** Six pilots share each compartment (72 pilots total).
13. **Connecting Corridor**
14. **Connecting Corridor** between the two Alpha Launch Bay Hangars. The walls of the two hangars and launch bays are reinforced.
15. **Alpha Launch Bay Hangar:** Contains 24 combat ready Alpha Fighters plus 12 in reserve. 10 to 16 ML-3 forklifts, 2 THC-4 tractor haulers and maintenance crew are also found here.
16. **Alpha Launch Bay Hangar:** Same as #15
17. **Storage**
18. **Mess Hall**
19. **Kitchen**
20. **Showers and Latrine**
21. **Crew Quarters**
22. **Lounge**
23. **Officer's Quarters**
24. **Mecha Storage:** Can hold 16 to 22 destroids or battloid mode Alphas and 4D4 × 10 cyclones (all VR-052 Battlers).
25. **Mecha Elevator** (connects decks 4, 5, 6)
26. **Mecha Storage:** Can hold 66 to 72 destroids or veritech fighters in battloid mode, and 500 cyclones (70% are Battlers, 25% Light, and 5% Saber). Plus 3D4 ML-3 forklifts and 1D4 THC-4 tractor haulers. All mecha are prepped and fully armed for combat.
27. **Secondary Engines and Propulsion System**
28. **Main Engine and Propulsion**

## DECK SEVEN

1. **Forward Weapon System**
2. **Elevator Bay**
3. **Medical Wing:** A three story facility complete with hospital, surgery and dispensary.
4. **Laboratory Facility**
5. **Quarantine Block**
6. **Storage**
7. **Lounge**
8. **Latrine and Showers**
9. **Crew Quarters**
10. **Officer's Quarters**
11. **Latrine**
12. **Mess Hall**
13. **Kitchen**
14. **Laundry**
15. **Recreation Room**
16. **Cafeteria and Lounge**
17. **Space Fold System:** Surrounded by a double reinforced hull. A restricted area open to command, bridge and engineering personnel.
18. **Ship's Engineering Section**
19. **Secondary Engine and Propulsion**
20. **Main Engine and Propulsion**

## DECK EIGHT

Deck Eight is *identical* to Deck Five.

## DECK NINE

Deck Nine is *identical* to Deck Six.

## DECK TEN

1. **Hangar:** Alpha and Beta fighters can exit through the front and sides. Can hold as many as 60 Alphas and/or Betas in jet mode or twice as many in battloid mode.
2. **Mecha Maintenance and Repair**
3. **Hangar:** Veritech fighters can exit from the front and side. Can accommodate about 30 Alphas/Betas.
4. **Vehicle Garage and Hangar Crew**
5. **Mecha Hangar:** Contains approximately 48 *Destroids*, approximately 400 cyclones (70% VR-052 Battlers, 30% VR-038-LTs), missiles for destroids and forklifts.
6. **Connecting Corridors and Air Locks**
7. **Crew Quarters:** Accommodates approximately 660 soldiers, half of which are veritech pilots.
8. **Shower**
9. **Latrine**
10. **Officer's Quarters**
11. **Officer's Dining, Lounge and Bar**
12. **Lounge and Recreation Room**
13. **Officer's Quarters**
14. **Briefing Room**
15. **Mess Hall**
16. **Kitchen**
17. **Latrine and Shower**
18. **Connecting Corridor and Hatchway**
19. **Veritech Hangar:** Can hold 30 to 40 Alpha or Beta Fighters.
20. **Mecha Elevator:** Connects to the two decks below it.
21. **Mecha Elevator:** Connects to the other two decks below it.
22. **Mecha Hangar:** usually a *mix* of Veritechs getting "prepped" for combat and destroids. Can accommodate approximately 30 mecha units.
23. **Veritech Launch Hangar:** At least 24 veritechs (alpha, beta, or other) are always combat ready. Can launch as many as 48 fighters in less than a minute.
24. **Mecha Hangar:** Often reserved for *Beta Fighters*. This is the area where the fighters are prepared and checked prior to combat. Can comfortably accommodate as many as 64 Beta Fighters.
25. **Mecha Hangar:** Usually reserved for *Alpha Fighters*. This is the area where the fighters are prepared and checked prior to combat. Can comfortably accommodate about 64 Alpha Fighters.
26. **Veritech Launch Hangar:** At least 24 veritech fighters (alpha, beta or others) are always ready to scramble. As many as 48 fighters can be launched in less than a minute.
27. **Mecha Hangar:** This is a giant storage bay for destroids and veritechs of all kind. Up to 100 mecha in battloid mode can be safely stowed.
28. **Mecha Repair and Maintenance:** Includes space for the storage of missiles and maintenance vehicles like forklifts.
29. **Vehicle Storage:** Military and work vehicles are stored here.
30. **Maintenance Crew Quarters**
31. **Showers**
32. **Latrine**
33. **Storage**
34. **Cafeteria**
35. **Lounge and Recreation Room**

## DECK ELEVEN

1. **Crew Quarters:** Mostly veritech and destroid pilots.
2. **Connecting Corridor**
3. **Latrine**
4. **Showers**
5. **Lounge and Game Room**
6. **Latrine**
7. **Kitchen**

8. Mess Hall
9. Officer's Quarters
10. Mecha Storage and Maintenance: Mostly destroids. One wall is lined with storage compartments for 300 cyclones (50% VR-052 Battlers, 40% VR-038-LTs, 10% VR-041 Sabers).
11. Connecting Corridor
12. Connecting Corridor
13. Veritech Hangar: Can hold up to 68 Alphas or other veritech fighters. Usually a mix of fighters can be found.
14. Veritech Hangar: Same as #13
15. Connecting Corridor
16. Crew Quarters
17. Maintenance and Storage of veritech missiles.
18. Mecha Elevator Bay: Connects the deck above and below.
19. Veritech Launch Hangar: At least 24 veritech fighters (alpha, beta, or other) are always ready to scramble. As many as 48 fighters can be launched in less than a minute.
20. Maintenance Crew's Office
21. Maintenance Crew's Office
22. Mecha Garage and Maintenance/Repair
23. Protoculture Energy Cell Storage for cyclones and other mecha.
24. Missile storage

25. **Horizont Troop Shuttle Hangar:** Can hold two of the 200ft long shuttles, as well as a dozen transport bunkers. 4D6 veritech fighters (any type) and 1D6 destroids and numerous work vehicles will also be found in this hangar.
26. **Assault Vehicle Garage:** Includes four Titan Troop Carriers and other vehicles.
27. **Vehicle and Mecha Garage.** Includes the AAT-30 and AAT-40, ARRAV rocket launcher, forklifts, cyclones, other vehicles and missile storage.
28. **Crew Quarters, Maintenance and Hangar Crew**
29. **Cafeteria and Lounge**
30. **Shower and Latrine**

## DECK TWELVE

1. **Horizont Docking Bay/Hangar:** Can hold one Horizont and four transport bunkers. 1D6 veritech fighters (any type) will also be present.
2. **Horizont Docking Bay/Hangar:** Same as #1.
3. **Mecha Elevators:** Connect to the two other hangar decks.
4. **Storage/Work Area:** Includes two REF Gladiators for work and as guards.
5. **Deck Twelve Crew**

# IKAZUCHI SFC-7000 COMMAND CARRIER

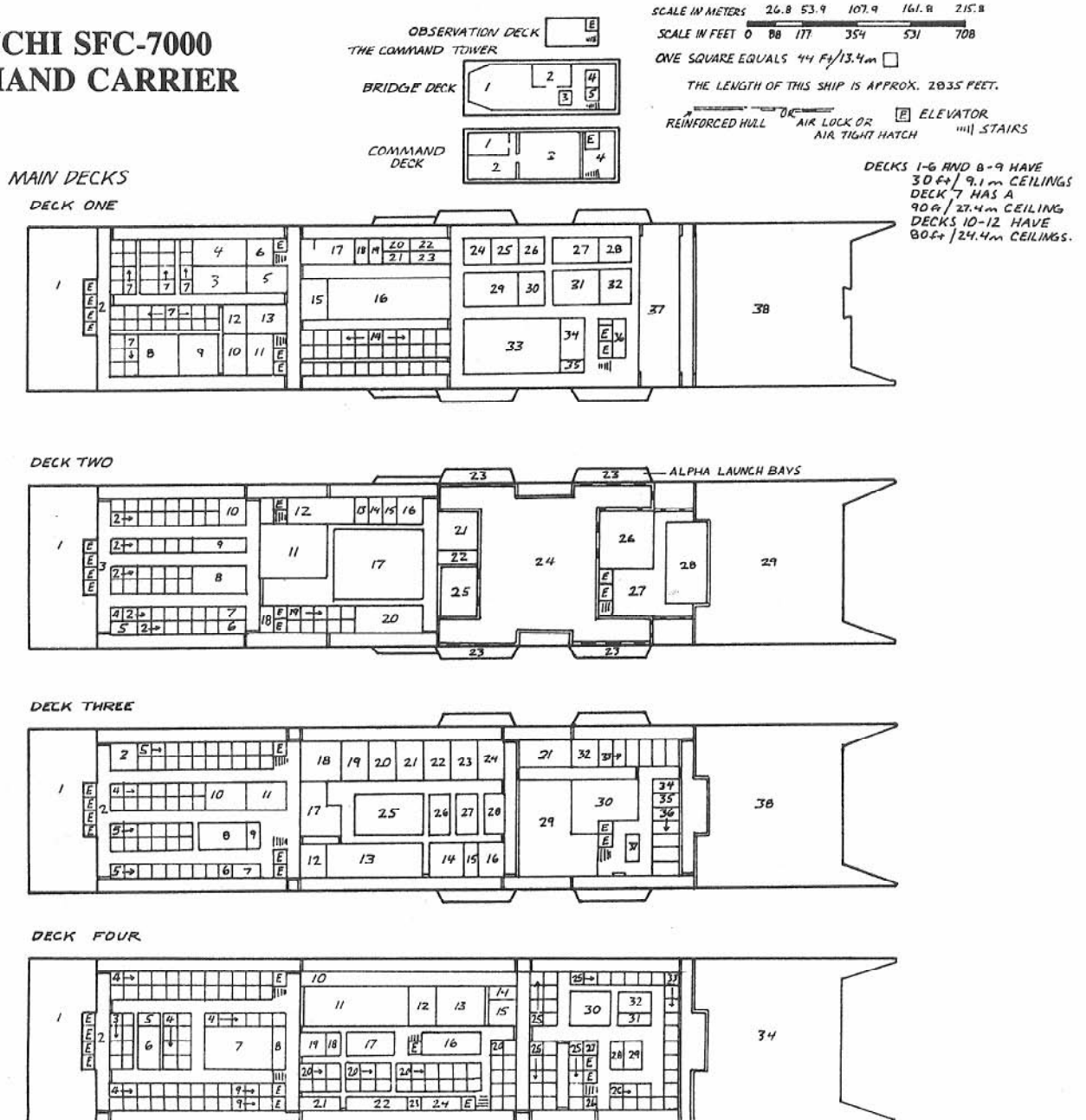

DECK FIVE

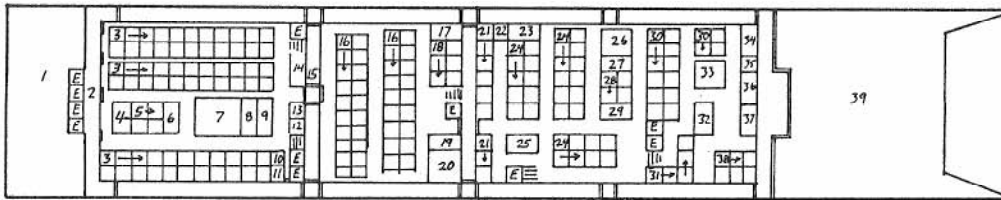

DECK SIX

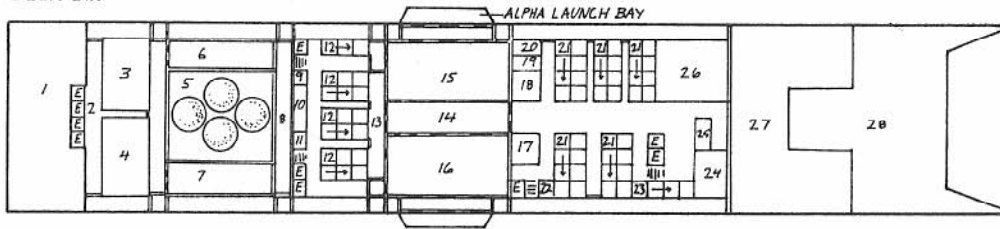

DECK SEVEN

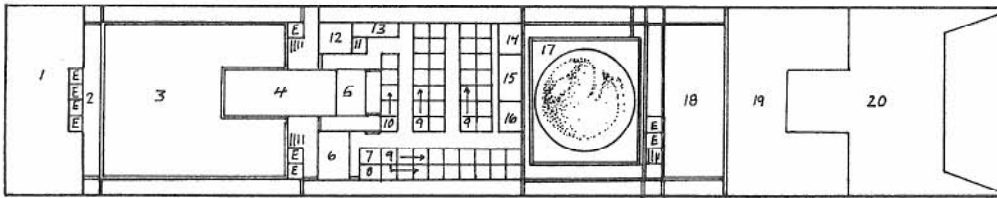

DECK TEN

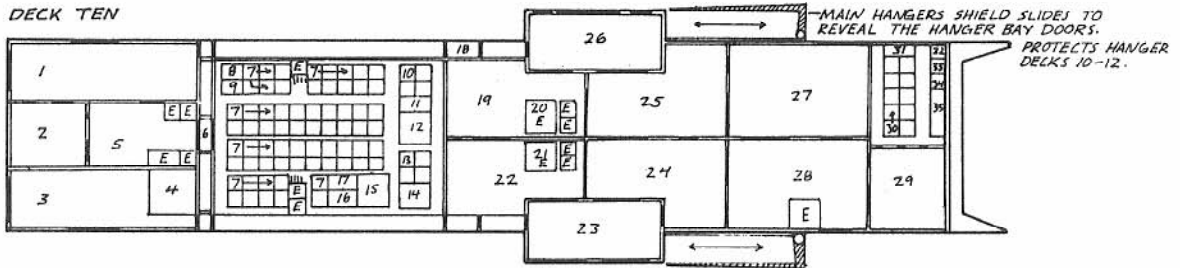

DECK ELEVEN

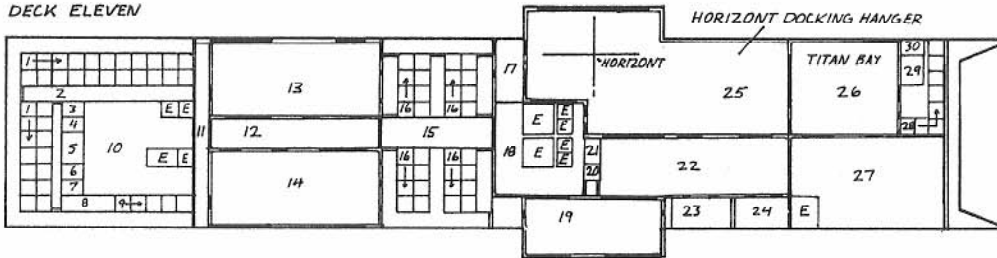

DECK TWELVE  
HORIZONTAL DOCKING BAY

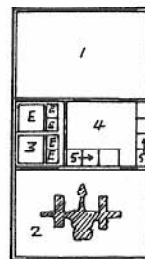

A COMPARATIVE SCALE OF REF SPACECRAFT

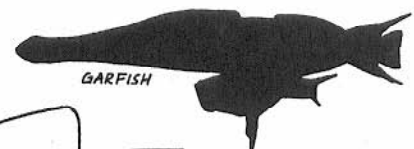

THE BRIDGE TOWER  
OF AN IKAZUCHI

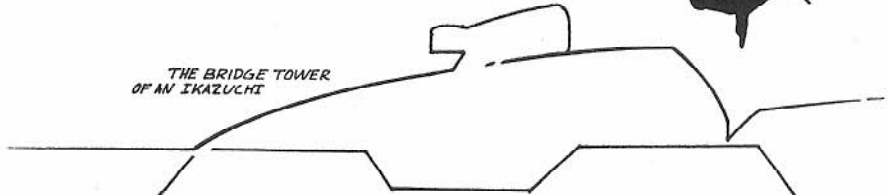



# VEHICLES

## RDF ARMORED ASSAULT TRANSPORT AAT-30

The Assault Transport vehicle is a cross between a jeep, a truck and a dune buggy. It is a rugged, four-wheel drive vehicle designed specifically for traversing the wastelands. The front seat accommodates the driver and one passenger comfortably. The rear is a cargo bed like a pickup truck's that can be easily modified to carry troops (seats 6 to 8 comfortably) or cargo (three ton limit).

Inside the cargo bed is an enclosed rectangular box that appears to be a storage bin, complete with a top opening access hatch. In reality, this is a concealed mini-missile launcher. What appears to be an access hatch raises up to reveal the retractable missile launcher. The missile launcher is fixed forward, at a 45 degree angle. The mini-missiles are the same type as those utilized by the cyclone.

The AAT-30 was originally used by RDF reconnaissance patrols and for supply runs in the wastelands. Since the invad invasion, the vehicle has become a favorite of bandits because of its harmless appearance and durability.

**Vehicle Type:** Military all-purpose transport.

**Crew:** One pilot and up to 10 passengers.

**A.R.:** Not Applicable

**M.D.C. by Location:**

- \*Main Body — 90
- Missile Launcher — 30
- Wheels (6) — 2 each
- Headlights (2) — 1 each

\*Depleting the M.D.C. of the main body destroys the vehicle.

**Speed:** 180mph (288kmph)

**Range:** 800 miles (1280km). Uses any type of gasoline.

**Length:** 24ft (7.3m)

**Weight:** 2.8 tons

**Cargo:** 3 tons can be hauled.

**Special Equipment:**

**Radio:** Range: 50 miles (96km). Wide band & directional.

**High Intensity Headlights:** 50ft beam (15.2m)

**Mini-Radar:** Range: One mile (1.6km), but only 75% accurate and easily obscured by hills, mountains and forest.

### WEAPON SYSTEMS

1. **The GR-30-AAT Mini-Missile Launcher:** A standard weapon for the AAT-30 that fires the small missiles originally developed for the cyclone.

**Primary Purpose:** Defense/Assault

**Missile Type:** Mini-missiles. Any can be used but fragmentation and high explosive are standard issue.

**Mega-Damage:** Varies with missile type.

**Rate of Fire:** One at a time or in volleys of 2, 3, or 5. Five is the maximum number in a volley. The automatic reload system replaces missiles as soon as they are fired. One volley counts as one attack.

**Range:** Varies with missile type, but about one mile (1.6km).

**Payload:** 30 total (up to 5 can be fired per volley).

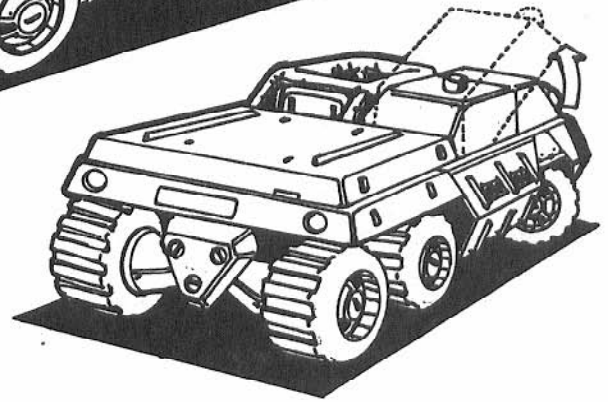
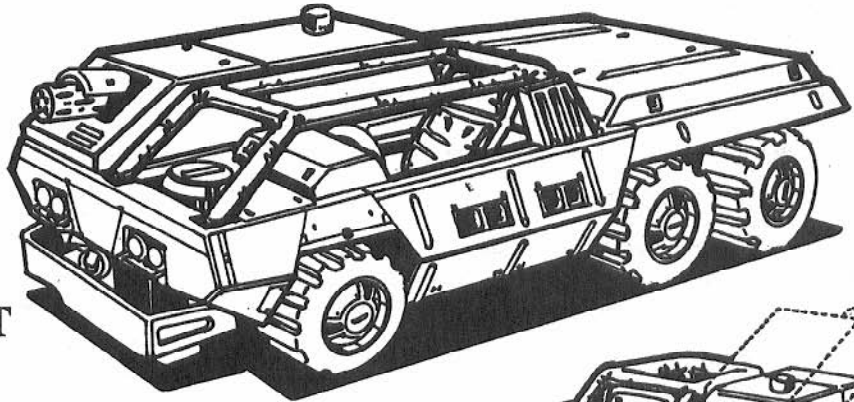

## REF ARMORED ASSAULT TRANSPORT AAT-40

The AAT-40 is an elongated cousin to the AAT-30, a cross between a jeep, a truck, and a dune buggy. It is a heavily armored, six wheeled, assault vehicle designed for traversing the most difficult terrain. The driver's seat is open to the air, but protected by a roll bar and armor and designed to make him a difficult target (attackers must make a called shot to strike the driver and even then, they are -4 to strike at low speeds, 30mph/48kmph or less, and -6 to strike at greater speed).

The rear of the AAT-40 is a larger open-air cargo bed that can haul supplies, heavy machinery or 10 to 15 troops. Another 3 to 6 troops can ride by hanging onto the roll bar.

Perceived as a rescue vehicle, the powerful transport has a front winch and towline that can be used to haul other vehicles to safety. Up to 18 tons can be towed by the AAT-40.

Sealed in the armored compartment to the right of the driver is the vehicle's weapon system, a rapid-fire, rotary laser similar to the tri-cannon of the Logan veritech. The laser cannon is fixed forward, but can be positioned up and down in a 45 degree angle.

**Vehicle Type:** Military all-purpose transport.

**Crew:** Two; driver and gunner. A third man, usually a back up driver, can be seated in the weapon compartment.

**M.D.C. by Location:**

- Front Headlights (2) — 1 each
- \*Laser Cannon (1) — 35
- Laser Gunner's Compartment — 100
- Wheels (6) — 20 each
- \*\*Main Body — 120

\*The laser cannon is -3 to strike.

\*\*Depleting the M.D.C. of the main body destroys the vehicle.

**Speed:** 150mph (240kmph)

**Max. Range:** 800 miles (1287km). Uses any type of gasoline.

**Length:** 36ft (10.97m)

**Height:** 5.7ft (1.7m)

**Width:** 10ft (3.0m)

**Weight:** 8.6 tons

**Cargo:** 20 tons (reduces maximum speed by 30%) or can tow up to 18 tons.

### Special Equipment:

Heavy-duty towline and winch.

High Intensity Headlights: 50ft beam (15.2m).

Radio: 50 mile range (96km), wide band and directional.

Mini-Radar: One mile range (1.6km), but only 75% accurate and easily obscured by hills, mountains, forests, and buildings.

## WEAPON SYSTEMS

1. **The ERL-40 Rapid-Fire Laser Cannon.** "The Earl," as it is commonly called, is an experimental laser weapon exclusive to the AAT-40. The laser cannon can fire controlled bursts of high intensity energy of incredible power.

Primary Purpose: Assault

Range: 4000ft (1200m)

Mega-Damage: Short Burst — 1D6×10 M.D., long burst — 2D6×10 M.D. (counts as one attack).

Rate of Fire: Equal to the pilot's combined number of attacks.

Payload: Effectively unlimited; however, there is a 50%+2% per melee chance that the ERL-40 will temporarily overheat and stop functioning after 8 melees of constant use (3 bursts per melee or more). Will require 2D4 minutes to cool down. The curse of the experimental weapon.

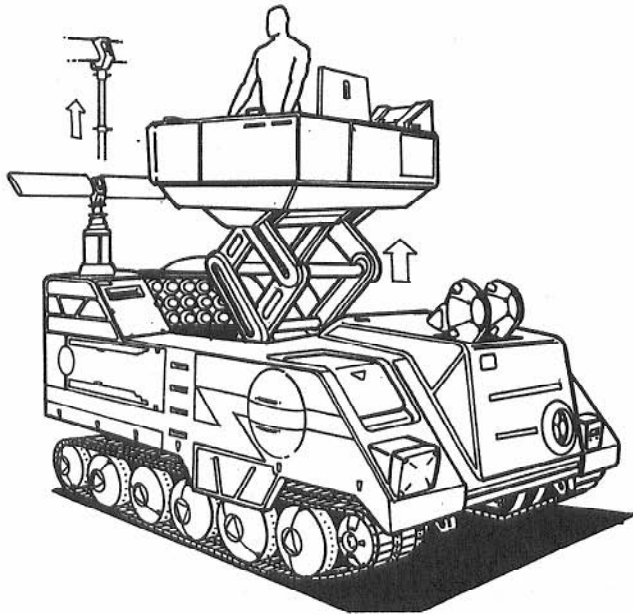

## ARRAV – ROCKET LAUNCHER ARMORED ROCKET AND RADAR ASSAULT VEHICLE

The latest design in mobile rocket launchers is the ARRAV, nicknamed "Arv." It is a tough, lightly armored assault vehicle designed for the harshest terrain. The treads provide superior traction and stability, enabling the tough little vehicle to climb inclines as steep as 70 degrees. Its airtight crew compartment provides protection from gases, noxious atmospheres and exposure to alien microbes. The right front section of the vehicle seats the pilot and copilot, with seats to accommodate two additional passengers. The elevated compartment to the left of the pilot is the radar, communications, and sensory system. On top of it are mounted two high intensity searchlights (range: 2000ft/609m).

In the center of the vehicle is an open-air compartment that can be raised up out of the vehicle, extending to a maximum height of fourteen feet (4.3m) above the ARRAV, (that's a total of 23ft/7m above the ground). This lightly armored, retractable platform can be used for observation, mecha repair, mecha reloading, or as an elevated weapons

platform. A gunner's seat and shield (50 M.D.C.) are built into the platform, complete with an adjustable weapons mount that can hold a Fal-2, or Gallant H-90, or most laser rifles and machine guns. The shielded weapon's seat can rotate 360 degrees with a 120 degree arc up and down. A portable spotlight can be moved along on a track to provide better light (has a 90 degree tilt). The platform can be operated manually from inside the compartment or by the crew inside the vehicle.

"ARV's" payload of medium range missiles is launched from the rear of the vehicle. Volleys of 2, 4, 6, 8, 12, or 18 can be fired. Once the full rack has been launched (all 18), the unit is automatically reloaded and ready to fire again within *two melees (30 seconds)*.

*The radar/communications unit gives the ARRAV the flexibility to act independently and extends its range of communications. The retractable radar/communications antenna is located in the rear.*

## ARRAV – ROCKET LAUNCHER ARMORED ROCKET AND RADAR ASSAULT VEHICLE

**Vehicle Type:** Military mobile rocket launcher.

**Crew:** Two, but can seat two additional passengers.

**Speed:** 90mph on land (144.8kmph); 10mph in water (16kmph).

**Max. Range:** 700 miles (1126km) before needing to refuel.

**Length:** 22ft (6.7m)

**Width:** 13ft (3.96m)

**Height:** 7.6ft (2.3m)

**Weight:** 11 tons; 14 tons fully loaded.

### M.D.C. by Location:

Treads (2) — 70 each

Front Headlight (1) — 2

Top-Mounted Searchlights (2) — 5 each

Observation Platform — 50

Platform Spotlight (1) — 2

Platform Support Struts (2) — 20

Radar Antenna (1) — 20

\*Rocket Launcher (1) — 50

\*\*Main Body — 150

Reinforced Crew Compartment — 50

\*Depleting the M.D.C. of the rocket launcher will prevent the launching of missiles. However, it is difficult to hit. Attackers must make a "called shot" and are -5 to strike.

\*\*Depleting the M.D.C. of the main body will shut the mecha down completely, rendering it useless.

## WEAPON SYSTEMS

1. **Medium Range Rocket Launcher.** Used as a mobile artillery unit.

Primary Purpose: Assault

Missile Type: Medium range missiles of any variety can be launched. Usually high explosive (heavy), fragmentation (medium), plasma (heavy) and multi-warhead are the missiles of choice.

Range: Varies with missile type; 40 to 80 miles.

Mega-Damage: Varies with missile type.

Rate of Fire: One at a time or in volleys of 2, 4, 6, 8, 12, or 18. One volley counts as one attack regardless of the number of missiles fired.

Payload: 18 per each full rack of missiles. Can be automatically reloaded twice, for a missile total of 54. Requires two melees (30 seconds) to reload.

2. **Optional Mounted Rifle or Machinegun** can be used on the elevated observation platform. Any rifle type weapon can be inserted into the slot and mount of the protective shield. The sniper's seat and shield can rotate 360 degrees.

## TANKS

The MBT-62 "Dark Knight" tank and the LCT-73 "Tornado" combat tank (and anti-mecha mines) can be found in both the RDF Manual and the Invid Invasion role-playing game books. Optional Road Control/Movement/Combat rules can also be found in the Invid Invasion (pgs 64-66).

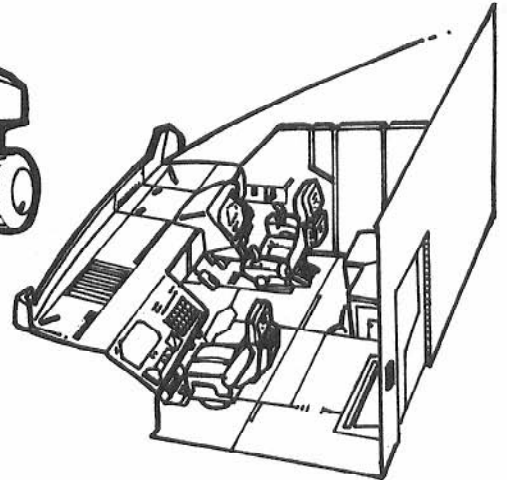
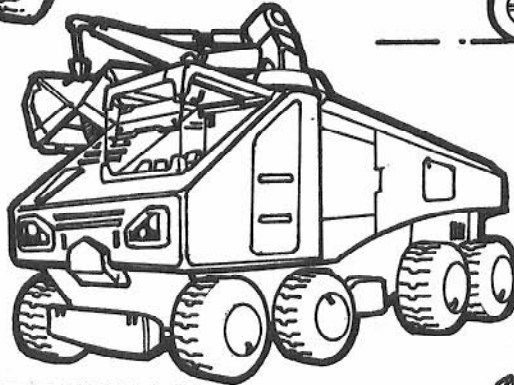
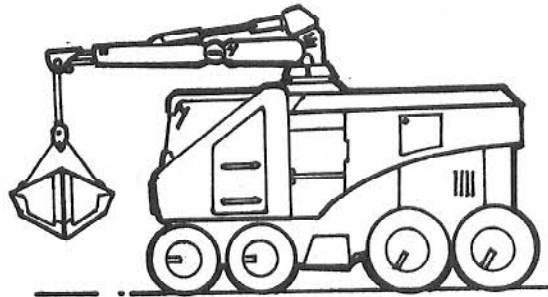
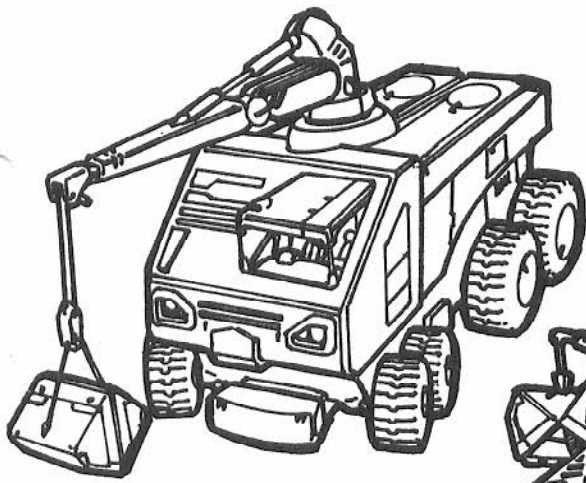

## AMR-10 ARMORED MECHA RETRIEVAL TRANSPORT VEHICLE

The biggest ground cargo transport vehicle is the AMR-10. This monster stands 24ft tall (7.3m), with a crane mounted on top of it providing an additional 28ft (8.4m) of height (52ft/15.8m total reach of crane). Its primary purpose is to repair, retrieve, and maintain mecha. However, it is also used to haul cargo, transport troops, excavation, mining, and construction.

The crane can be fitted with a number of accessories, including a utility arm, electro-magnet, scaffolding, shovel jaw, drill and others. It is also fitted with a towline and winch in the front and back.

**Vehicle Type:** Military Armored Mecha Retrieval Transport Vehicle.  
**Crew:** Two; although another 2 or 3 passengers can easily fit in the pilot's compartment.

### M.D.C. by Location:

- Front Headlights (2) — 2 each
- Wheels (8) — 20 each
- Pilot's Compartment — 75
- Crane — 110
- Access Hatches (5) — 50 each
- \*Main Body — 250

\*Depleting the M.D.C. of the main body will shut the mecha down completely, rendering it useless.

**Speed:** 60mph (96kmph)

**Max. Range:** 300 miles (482km). Uses any type of gasoline.

**Length:** 50ft (15.2m)

**Height:** 24ft (7.3m)

**Crane Reach:** 50ft (15.2m) high, 28ft (8.4m) length.

**Width:** 22ft (6.7m)

**Weight:** 18 tons

**Cargo:** 32ft×20ft×16ft (9.7m×6.1m×4.8m) armored cargo bay can carry 56 troops comfortably (80 cramped), or 40 cyclone riders in full gear, or 50 tons of weight. Can also tow up to 50 tons.

**Weapon Systems:** None. Crane can be used with minimal effectiveness in hand to hand, inflicting 1D4 M.D. Ram at full speed does 6D6 M.D. to both the target and the AMR-10.

**Special Equipment:** Long-range radio with 50 mile range (80km). Also, a front and rear towline and winch.

## TCH-4 ALL-PURPOSE TRACTOR HAULER

The tractor hauler is another cargo transport vehicle primarily used in fitting mecha. It is a much larger and more powerful vehicle used to load missiles into destroids, dismantle mecha, and haul and tow mecha/vehicles/debris. Its huge claw-like hands have a maximum reach of 32ft (9.8m) and can hold as much as 6 tons in one hand or 20 tons using both.

The tractor treads provide mobility in rugged terrain and maximum traction when towing mecha or vehicles in distress. The tow strength is an impressive 35 tons.

Although the TCH-4 has no weapon systems, it is far from defenseless. The vehicle is heavily armored, surprisingly maneuverable, and jokingly said to be unstoppable (not quite true, but extremely durable). Its hands/arms can become lethal weapons when piloted by an expert. The clawed hands can tear and slash into mecha armor and its thumb can retract completely to use the two fingers like a sharpened crowbar or battering rams. The claws can crush rock, smash through concrete, snap steel beams and dig through earth. (It is often used to assist in mining and excavation operations.)

**Vehicle Type:** Military heavy-duty all-purpose cargo transport and excavation vehicle.

**Crew:** One, but up to 18 men can ride by hanging onto handhold bars along its outer body.

### M.D.C. by Location:

- Hands (2) — 110 each
- Arms (2) — 200 each
- Pilot's Compartment — 100
- Treads (2) — 100 each
- Front Spotlight (1) — 2
- \*Main Body — 300

\*Depleting the M.D.C. of the main body will shut the mecha down completely, rendering it useless.

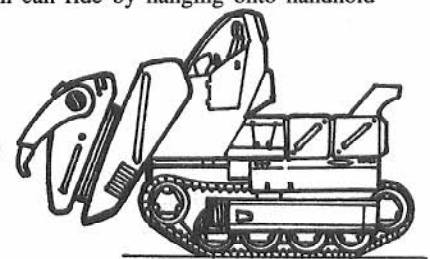



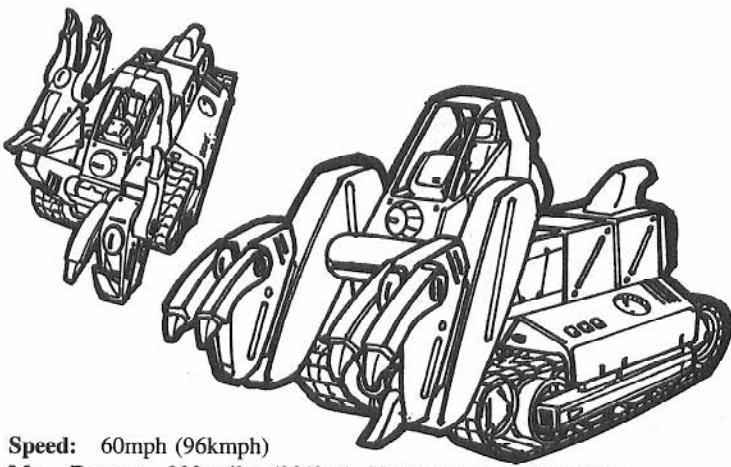

**Speed:** 60mph (96kmph)  
**Max. Range:** 200 miles (321km). Uses any type of gasoline.  
**Length:** 44ft (13.4m)  
**Height:** 19ft (5.8m)  
**Arm's Reach:** 32ft (9.8m) high or 20ft (6.1m) outstretched.  
**Width:** 16ft (4.9m)  
**Weight:** 14 tons  
**Cargo:** Can lift and carry 6 tons in one hand or 20 tons using both hands, or tow up to 35 tons (reduce max. speed by half). An additional cargo bed can be hooked up to the rear.

**Weapon Systems:** Clawed cargo hands

*Hand to Hand Combat:*

*Crush, tear, rip — 2D6 M.D.*

*Jab/punch — 4D6 M.D.*

*Ram at full speed — 1D4 × 10 M.D.*

*Run over with treads — 2D4 M.D.*

**Destroid Pilot Bonuses:**

Characters who are also the Destroid Pilot O.C.C. get the following combat bonuses (do not include their mecha bonuses).

+2 to strike

+2 to parry

+1D6 M.D. from punch or crush/tear.

**Special Equipment:** Long-range radio, 50 miles range (80km). Also a front and rear towline and winch.



## M.O.V. "MOLE"

The Mining Operations Vehicle is used by the REF in mining, construction, and salvage. A variety of accessory arms can be changed with relative ease. They include shovel, drill, utility arms and others. The pilot's compartment has its own air supply and purification/circulatory system, as well as special sensors ideal for mining.

**Vehicle Type:** Military mining and salvage.

**Crew:** One

**M.D.C. by Location:**

Infrared Headlights (front) — 2

Conventional Headlights (2) — 1

Wheels (4) — 10 each

Digging Arm Unit — 50

Pilot's Compartment — 50

\*Main Body — 60

\*Depleting the M.D.C. of the main body will completely destroy the vehicle.

**Speed:** 50mph (80kmph). Digging speed varies with the soil, but usually about 500ft (152m) per hour under the best conditions and 60ft (18.3m) under the worst.

**Max. Range:** About 8 hours of fuel or 250 miles of conventional surface travel (400km).

**Length:** 18ft (5.5m) including appendage/tool.

**Height:** 11ft (3.3m)

**Arm's Reach:** 8ft (2.4m)

**Width:** 6ft (1.8m)

**Cargo:** Can haul/tow up to 5 tons.

**Weapon Systems:** None

**Special Equipment:**

Short-Range Radio; 4 miles (6km)

Independent Oxygen Supply

Infrared Optics

Night Sight Optics

Ground Sensor System (seismic; one mile/1.6km range).

Oxygen tank, goggles and protective suit.

Radiation Shielded

Towline in front and rear.

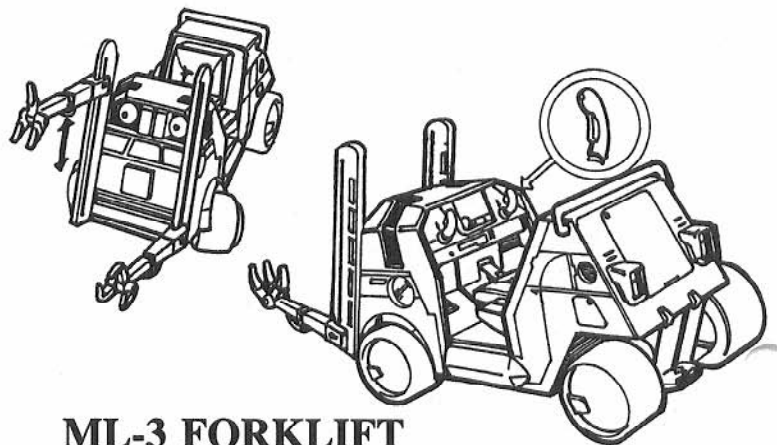

## ML-3 FORKLIFT

The ML-3 is a one-man missile loading forklift commonly used to arm mecha, especially veritechs. Both forks of the lift have grasping hands to better hold and position missiles. The fork arms can move individually or simultaneously. Maximum height of reach is eight feet (2.4m). It is also used for transporting other cargo and loading.

**Vehicle Type:** Military cargo transport.

**Crew:** One

**Speed:** 50mph (80kmph)

**Max. Range:** 150 miles (240km) before needing to refuel.

**Length:** 14ft (4.2m) including arms.

**Width:** 4ft (1.8m)

**Height:** 7ft (3.2m)

**Weight:** 2 tons

**Cargo:** Can lift/carry up to 4 tons.

**M.D.C. by Location:**

\*Main Body — 50

Arms/Lifts (2) — 20 each

Wheels (4) — 5 each



\*Depleting the M.D.C. of the main body will destroy the vehicle.

**Weapons:** None

**Special Equipment:** Short-range radio: 4 mile range (6.4km).

## HOVER CYCLE

The hover cycle is an extremely mobile, high speed combat and transport vehicle developed exclusively for the Armies of the Southern Cross. The cycle's quiet engine and ability to traverse extremely rocky and rugged terrain makes it ideal for reconnaissance patrols. Its tri-hover jets make the cycle more stable than a conventional motorcycle, enabling

its pilot to make sharp turns, jumps of up to 30 feet (9m) high, and attain speeds of up to 210mph. At normal cruising speed the hover cycle rides on jets of air, three to four feet off the ground. During high speed chases or on rugged, broken terrain, the vehicle adjusts to accommodate the environment, altering its height from three to ten feet high on short spurts. This amazing vehicle can even leap crevasses or chasms up to 60ft (18m).

It is important to note that the hover cycle has no mounted or built-in weapons, but the driver may carry and fire any hand held weapon. The two storage compartments mounted on the rear hover jets can hold knives, pistols, hand-held radio equipment, first-aid kit, water, nylon cord, and other items. Compartment size is 20 inches long, 12 inches wide and 17 inches deep (533.4 x 304.8 x 444.5cm). Suggested weight allowance is 40lbs (18kg) each.

**Vehicle Type:** Personal ground transport.

**Crew:** One pilot; one passenger is possible.

**M.D.C. by Location:**

Headlight (1) — 2

\*\*Front Hover Jet — 50

\*\*Rear Hover Jets (2) — 40 each

\*Main Body — 80

\*Depleting the main body M.D.C. will totally destroy the vehicle.

\*\*Destroying the front hover jet makes the hover cycle inoperative. Destroying one of the rear hover jets reduces speed and jumps by half. Destroying both makes the vehicle inoperative.

**Speed:** Hover (stationary) 3 to 10ft (.9 to 3m) off ground, cruise speed — 70mph (112.63kmph), maximum speed — 210mph (337.8kmph). *Special maneuvers:* Boost/jump — 30ft (9m) high and up to 60ft (18m) long. Note: This vehicle can NOT fly in any sense of the word. Nor can it ride on bodies of water.

**Height:** 4ft (1.2m)

**Width:** 2ft 8in (.8m)

**Length:** 8ft 9in (2.6m)

**Weight:** 370lbs (166kg)

**Engine:** 1000cc Gas Turbine; not prototechnology!

**Range:** 1000 miles (1609km) at cruising speed, 800 miles (1287km) at maximum speed.

**Weapons:** None

**Special Equipment:**

**High Intensity Headlight:** 50ft Beam (15.2m)

**Mini-Radar:** Range: 4 miles (6.4km), but only 75% accurate and easily obscured by hills, mountains and forest.

**Storage Compartments** above the two rear hover jets.

**Radio/Video Communication:** 100 mile range.

**Instrument Display:** Digital speedometer, fuel indicator.

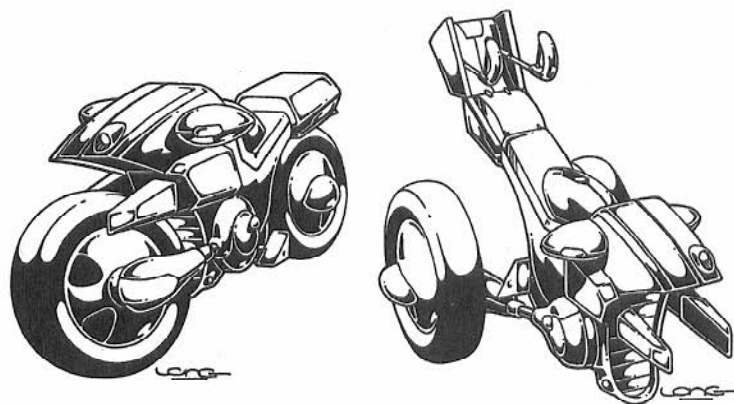

## CHARIOT MOTORCYCLE

One of Doctor Lang's funkier ideas was to create a motorcycle that could transform into a chariot type seat and attach to the RAT-1 Pegasus. This allows the Pegasus to pull or fly with an additional passenger (and a disguised land vehicle).

**M.D.C.:** 50 main body, wheels 2

**Speed:** In motorcycle mode — 160mph (256kmph)

**Range:** 500 miles (804km)

**Length:** 6ft (1.8m)

**Weight:** 250lbs (113kg)

**Crew:** One driver

**Note:** Suitable for rough terrains; only a -5% skill penalty on badlands.

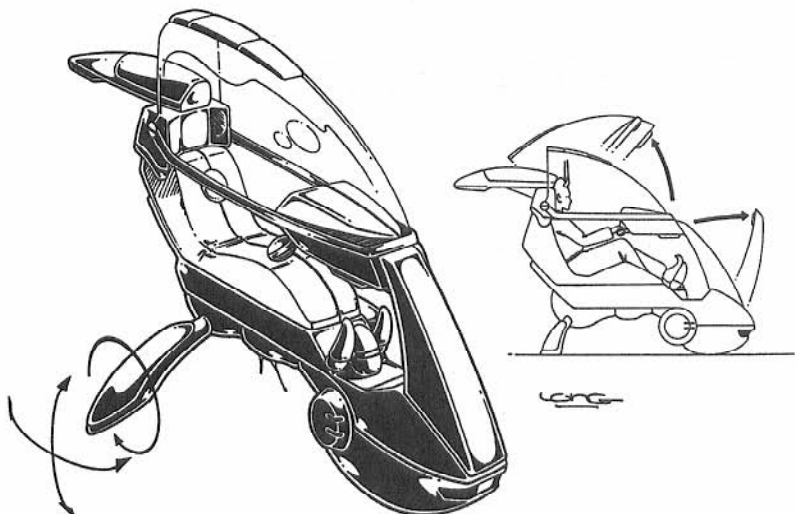

## PERYTONIAN LAND SPEEDER

A one-person personal transport vehicle. Its most appealing feature is its limited flight capabilities. It is powered by some unidentifiable (presumably magic) antigravitational system.

**M.D.C.:** Main Body — 50

**Speed:** Hover Stationary: Makes vertical take-offs and landings, and can attain a maximum height of 300ft (91m). Suggested cruising height is 50 to 100ft, but the vehicle can hug the ground as low as 2ft (0.6m).

**Maximum Speed:** An astounding 240mph (384kmph).

**Range:** Effectively unlimited.

**Length:** 9ft (2.7m)

**Height:** 6ft (1.8m)

**Weight:** 800lbs (363kg)

**Crew:** One pilot, but one additional, small or slender person may be able to sit in the pilot's lap.

**Weapons:** None

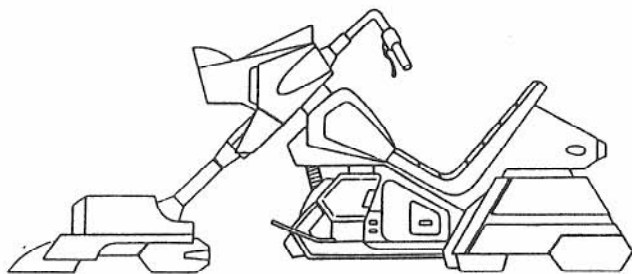

8ft 9in (2.6m)

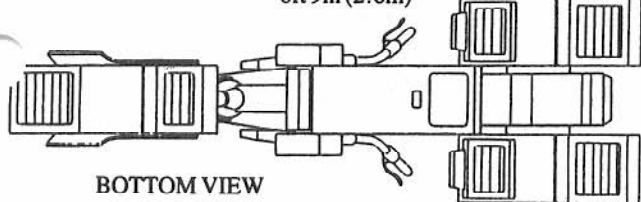

BOTTOM VIEW

## PERYTONIAN ASSAULT HOVER CYCLE

A sleek hover cycle type vehicle used by the Sentinels that is a simple combustible fuel craft of Perytonian design. The only major difference between it and the REF hover cycle is the lasers mounted in front.

### Lasers (fixed forward):

Range: 2000ft (609m)

Mega-Damage: 1D4 M.D. or 2D4 for a simultaneous blast (counts as one attack).

Rate of Fire: Equal to the pilot's hand to hand combat.

Payload: 30 before needing to recharge.

Requires six hours to recharge.

### M.D.C. by Location:

Front Lasers (2) — 3 each

Side Hover Jets (2) — 20 each

Rear Thruster — 30

\*Main Body — 50

\*Depleting the M.D.C. of the main body completely destroys the vehicle.

Speed: Hover Stationary: 3 to 20ft (.9 to 6.1m) above the ground.

Maximum Speed: 200mph (322kmph); a little slower than the Southern Cross cycle.

Range: 800 miles (1280km)

Length: 9ft (2.7m)

Weight: 350lbs (158kg)

Crew: One pilot

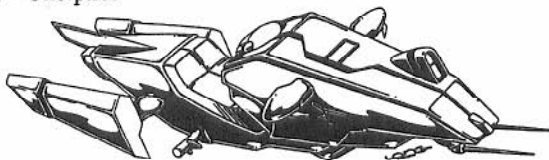

## PERYTONIAN AIR SKIMMER

Another unique vehicle used by the Sentinels is the Perytonian air skimmer. It is a vehicle that resembles a hover cycle, but is actually a one-person low altitude aircraft. It's means of propulsion is the same mystical antigravity system as that on the land speeder. A single fixed forward laser is located in the front of the vehicle.

### M.D.C. by Location:

Forward Laser (1) — 10

Side Hover Jets (2) — 20 each

Rear Antigrav. Thruster (1) — 50

\*Main Body — 100

\*Depleting the M.D.C. of the main body completely destroys the vehicle. Destroying the antigravity system will knock it out of the sky (can not fly).

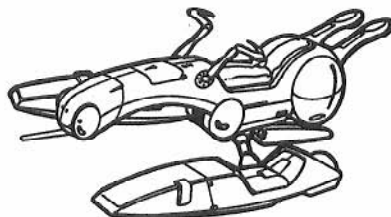

Speed: Hover: As low as 2ft above the ground or as high as 10,000ft (3000m).

Maximum Speed: 400mph (643kmph).

Range: Effectively unlimited.

Length: 11ft (3.4m)

Weight: 900lbs (408kg)

Crew: One pilot, although two or three others could ride at very low speeds (under 40mph) by hanging onto the two hover jets.

### Weapons:

Forward Laser (1)

Range: 4000ft (1200m)

Mega-Damage: 3D6 M.D.

Rate of Fire: Equal to the pilot's hand to hand.

Payload: Effectively unlimited.

Note: The pilot may also try to use a hand-held weapon, but is -2 to strike and is -20% on flying/pilot skill when flying and shooting at the same time.

## PERYTONIAN OBSERVATION SHUTTLE

The Perytonians also have a slow-moving space shuttle powered by the same mysterious magic antigravity system as the small vehicles. The actual decks are located inside the metallic cone of the vessel. The crew deck is first, followed by a passenger and/or cargo deck and a cargo bay (last deck). The top of the strange vehicle is flat, with a transparent dome over most of it. This is the observation deck used for meditation and observation.

As its appearance might suggest, the vessel is ponderously slow by REF standards. However, its unusual antigravity system enables it to slip through the gravitation of other planets, making it a sophisticated transatmospheric vessel. The Sentinels use it for transporting troops and cargo, as well as exploration.

### M.D.C. by Location:

Observation Dome — 1200

Cargo Hatch (1, side) — 600

\*Antigravity Spheres (6) — 500 each

\*\*Main Body — 4000

\*Destroying all the spheres will cripple the shuttle completely, setting it adrift. It can fly/move as long as it has two antigrav spheres, but at half speed.

\*\*Depleting the M.D.C. of the main body destroys it completely.

Crew: Pilot, copilot, communications and two assistants, but it can accommodate an additional 6 to 8 passengers on the bridge.

Cargo Decks: Can accommodate about 64 soldiers comfortably. The lower cargo bay is large enough to house six destroids. Cargo weight capacity is an unbelievable 300,000 tons.

Speed: Hover: Stationary, and can make *silent* vertical take-offs and landings. No altitude limit, can breach any gravity (except a black hole) and hover as low as three feet (0.9m) above the ground.

Fly: Mach One (670mph/1078kmph) in space or in an atmosphere.

Underwater: Speed is about 300mph (482kmph).

Height: 240ft (73.2m) from top to bottom.

Width: 160ft (48.8m) overall; 100ft (30.5m) is the actual body of the shuttle.

Weight: 50,000 tons

Weapons: None

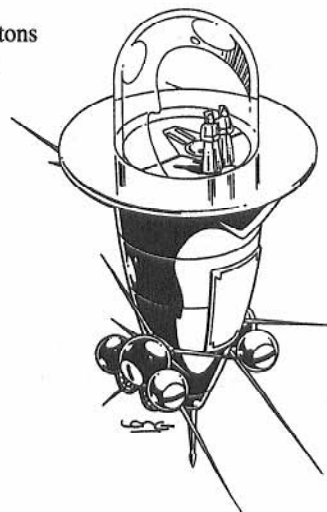



# ROBOTECH

## MECHA TRANSPORT

PALADIUM TECHNICAL SYSTEMS  
SENTINEL DESIGNS GROUP  
MECHA TRANSPORT ATV.

SHEET ONE OF 4

T O P I C A L : E X T E R I O R F O R M A T  
T E C H N I C A L

T E C H D E S I G N S C H E M A T I C / N E L S O N

TOP SURFACE

EARTH SURFACE

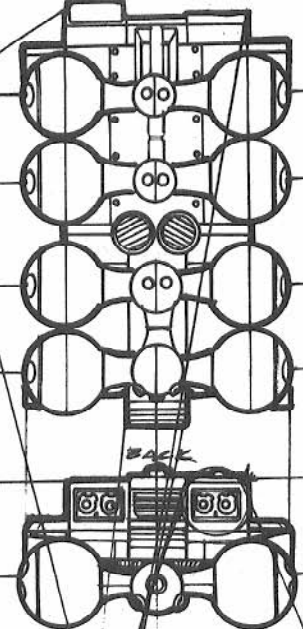
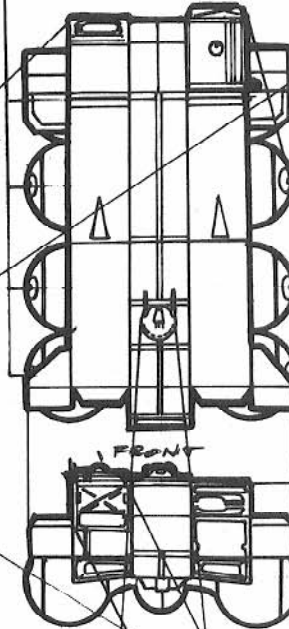

FRONT

BACK

THRUSTERS

PILOT

WEAPONS TURRET

BRIDGE

SENSOR ARRAY

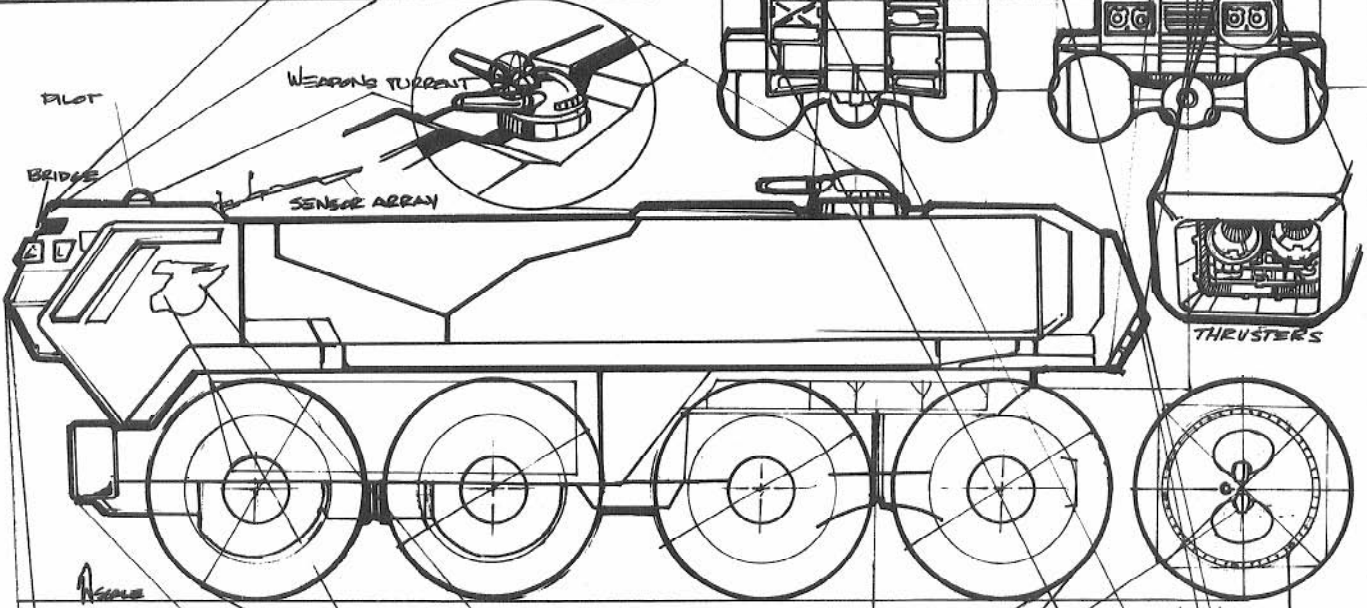

PROFILE

EQUIPMENT ACCESS

SURFACE MOUNTED  
SURFACE SYSTEMS/  
THRUSTERS

CANNON (FOLDED)

ARMOR SHIELDS

BRIDGE/PILOT

WEAPONS TURRET

Bay Hatch II

PILOT

MECHA RID/TRACE

CANNON FLUSH LOCK

COPILOT/CREW

SKY SIDE

EARTH SIDE

MAIN THRUSTERS

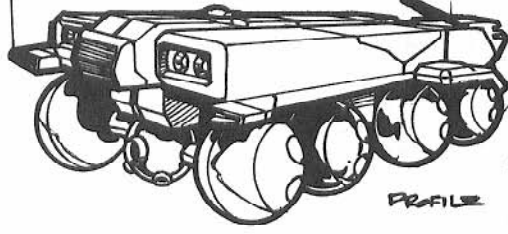

ARMOR PLATING

PROFILE



REST SINK / FLUSH  
EASTWARD THRUST.

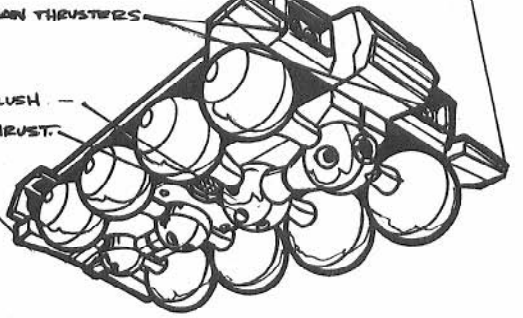

# MTA-TITAN MECHA TRANSPORT & ASSAULT VEHICLE

The juggernaut of the Robotech Expeditionary Force is the MTA-Titan, an all-terrain mecha transport and assault weapon. This marvel of Robotechnology can function with equal ease on land, underwater and in space. In space and underwater, its two rear thrusters rocket it along, while directional thrusters, found in the semicircular structures that line the *center* of the undercarriage, keep it stable and change direction.

On land, eight huge sphere-wheels enable it to ride over the most inhospitable terrain. However, the wheels are more than just wheels, they are actually six-man command modules. Inside each are six fully armored Cyclone riders seated at a consul that floats freely inside the wheel. This means they are always sitting upside right and are not affected by the rotation of the wheel. When the Titan stops, the cyclone riders can safely exit to engage the enemy or investigate.

Entry into the sphere is through a series of access hatches and channels from within the Titan. Exit to the outdoors is from the sphere only. Likewise, the mecha warriors can regain entrance into the sphere from one of its four outer hatches. The use of the spheres as troop compartments gives the Titan a total of eight cyclone rider teams (48 men and cyclones) who can be released in force or as needed. It also allows for the teams to operate as independent units, each with their own specialty or objective.

The main body looks deceptively like a troop or cargo carrier. In reality, it is a massive rapid-fire laser cannon. The Titan can undergo an instant "modular transformation" in which the cannon slides up and forward into firing position while two protective shields also rise into position and the engine thrusters flip sideways.

The cannon is very similar to those incorporated into the defense systems of the SDF series battle cruisers. It is intended to be a heavy artillery support and assault field unit. Atop the cannon is a particle beam turret to defend it from aerial assault. The turret can be operated by a pilot inside it, or by the crew on the bridge.

Other defenses include a forward laser turret mounted atop the crew compartment and missile launchers located in the tuned engine thruster unit (can only fire when the laser is extended and the thrusters are turned sideways).

In addition to its formidable weapons, the MTA-Titan has a mecha bay containing six to ten destroids or veritechs, depending on the needs of the assignment and availability. Only the M.A.C. III and old-style mecha are too large to fit. It can also carry 96 troops. At least half those troops will be cyclone riders, if not all.

The bridge of the Titan is an elaborate communications network that monitors and directs its troops, as well as the systems of the Titan itself. When combined with its troops of mecha, the MTA-Titan (also known as a Ground Mobile Unit/GMU) becomes a rolling fortress of mind boggling power.

## THE MTA-TITAN

**Vehicle Type:** Military All-Terrain Mecha Transport and Assault Vehicle, a.k.a. GMU.

**Crew:** 26 minimum; pilot (1), copilots (2), commander of ground operations (usually a Military Specialist or Mecha Pilot O.C.C. with the rank of captain), Military advisor (usually a Military Specialist), communications team (4), medical team (7; a medical doctor, three paramedics and three aids), mecha repair team (2 to 4 Bio-Maintenance Engineers), security team (4 Cyclone Riders in full gear), and 4 to 12 additional personnel (any O.C.C. okay, usually grunts). A field scientist or additional communications personnel may be desired. *Maximum capacity crew:* 36, and can still accommodate 10 additional passengers. Note that the troops are separate from the crew.

**Troops:** 48 Cyclone Riders (6 in each of the 8 wheels)  
96 Soldiers (all or half are cyclone riders)  
6-10 heavy Mecha units and crew.

**Note:** The mecha units are usually Destroids or Veritech Fighters. A typical mix is 2 Gladiators, 2 Excalibers, 2 Raider X and 1 Spartan. If flyers are needed, the mix might be 2 Beta Fighters, 4 Alpha Fighters, 1 Gladiator or Excaliber, and 1 Raider X or Spartan. REF *Battle Pods* can be substituted.

### M.D.C. by Location:

Front Headlights — 2 each  
Front Small Turret (1) — 100  
Communication Antenna (1) — 100  
Rear P-Beam Turret (1) — 200  
Missile Launchers (2) — 150 each  
Access Hatches — 100 each  
Small Directional Thrusters (10) — 50 each  
Main Thrusters (2) — 400 each  
Sphere Units/Wheels (8) — 300 each  
Bridge/Command Section — 800  
Mecha Bay Section — 600  
Main Cannon — 800  
Protective Shields (2) — 800 each  
\*Main Body — 1200

\*Depleting the M.D.C. of the main body will shut the vehicle down completely, rendering it useless. Destroying the *Bridge/Command section* will seriously impair the vehicle, resulting in the loss of all sensors, long-range communications, crew and commander. However, the Titan can be piloted from any one of the eight sphere (wheel) units, but speed and attacks per melee are reduced by half.

**Speed:** Land speed varies with the terrain, but can reach speeds of up to 210mph (336kmph).

Hover: The Titan can rise off the ground and hover by using its powerful directional thrusters. Maximum height is about 500ft (152.2m).

Flying is possible, but limited. To fly, the pilot must engage both the directional thrusters (hover) and the rear main thrusters (to push forward). Maximum speed is a slow 100mph (160kmph); maximum altitude is 500ft (152.2m).

Space Propulsion: Maximum speed is nearly mach one, 650mph (1040kmph).

Underwater Propulsion: Ride on the ocean floor at speeds of about 40mph (64kmph) maximum. Through water like a submarine at speeds of up to 100mph (160kmph). Maximum ocean depth (Earth equivalent) is 2.2 miles (3.5km).

**Maximum Range:** Effectively unlimited. Protoculture powered with an estimated life of two years constant use.

**Length:** 224ft (68.3m); with cannon extended, 245ft (74.6m)

**Height:** 76ft (23.2m); with cannon extended, 131ft (90m).

**Width:** 105ft (32m); same with cannon extended.

**Weight:** Approximately 1150 tons fully loaded.

**Cargo:** Mecha bay can contain 6 to 10 mecha and about 30 troops comfortably or 250 tons.

## WEAPON SYSTEMS

1. **The huge Rapid-Fire Laser Cannon** is one of the most devastating weapons in the REF's arsenal. It is fixed in a forward position, but can be raised to point along a 120 degree arc up and down. The weapon is primarily a mobile heavy assault unit designed to eliminate aircraft, spacecraft, missiles and armored vehicles.

Primary Purpose: Troop Support

Secondary Purpose: Anti-aircraft and assault.

Range: 8 miles

Mega-Damage: Short burst — 3D6×10, long burst — 6D6×10 (counts as one attack).

# ROBOTTECH

## MECHA TRANSPORT



SENTINEL DESIGN GROUP  
MECHA TRANSPORT ATV.  
PLATINUM TECHNICAL SYSTEMS  
SHEET TWO OF 4  
TECH DESIGN SCHEMATIC / NEURON.  
TOPICAL : INTERIOR FORMAT

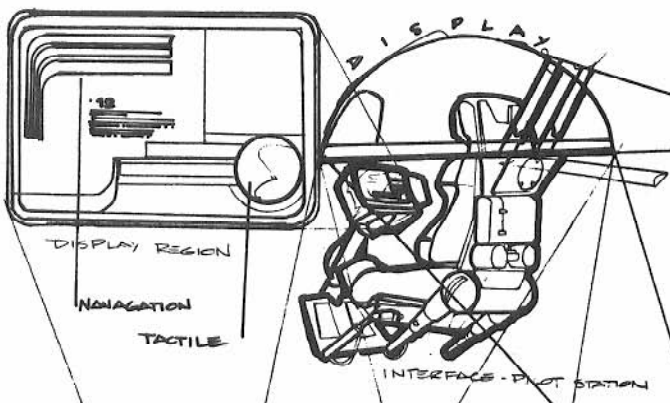
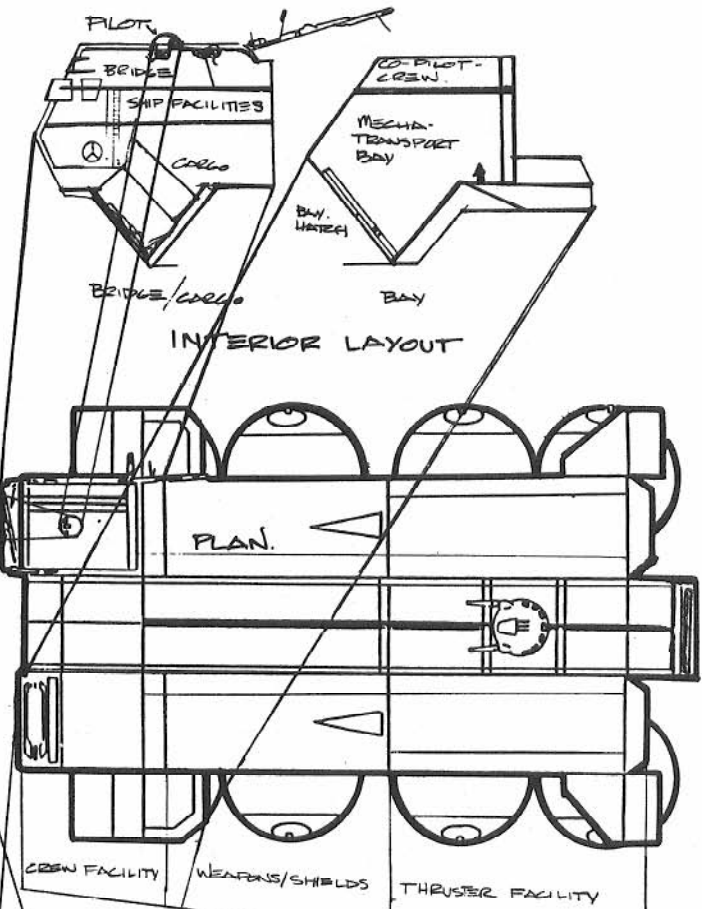

### PILOTS CONSOLE

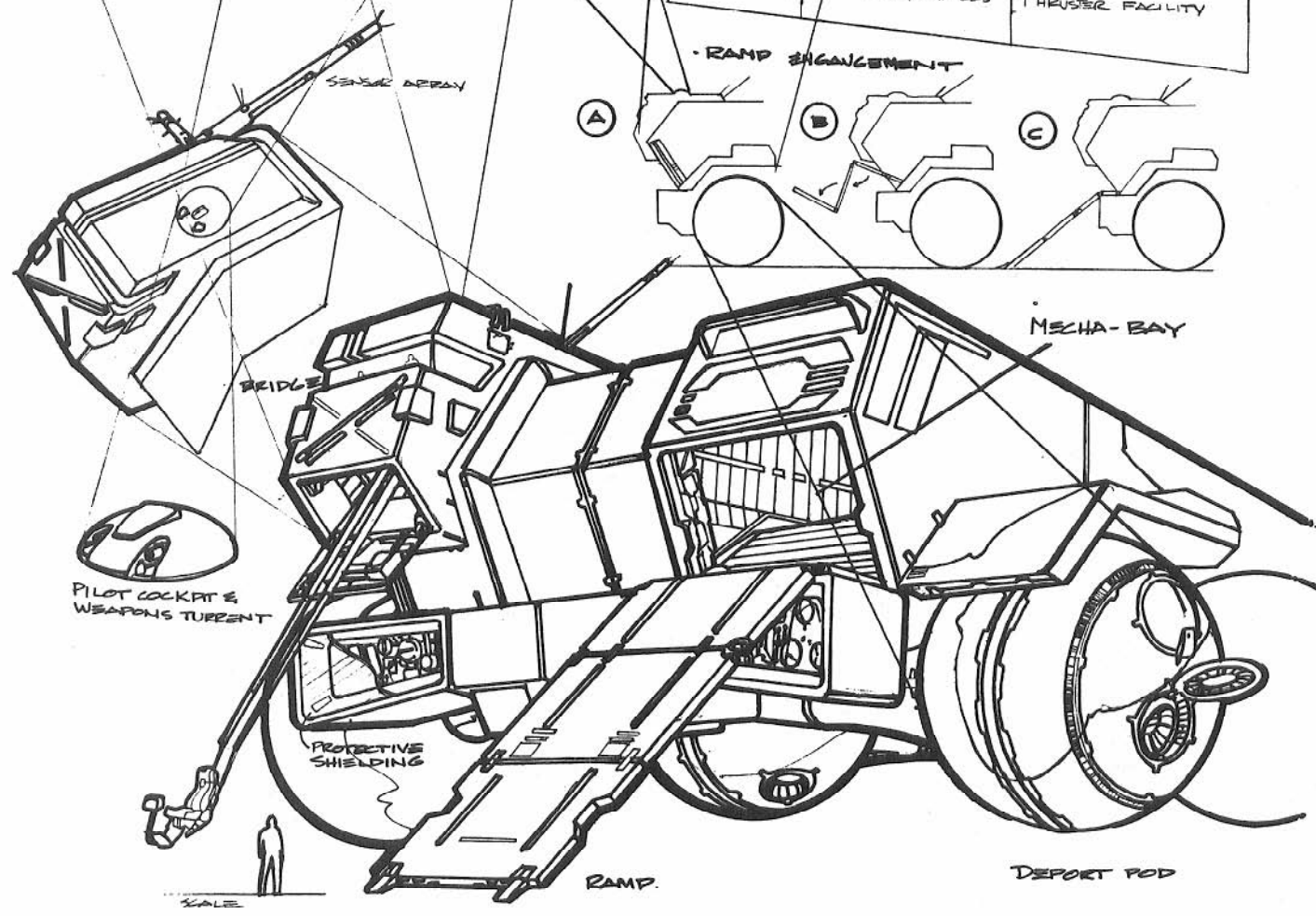
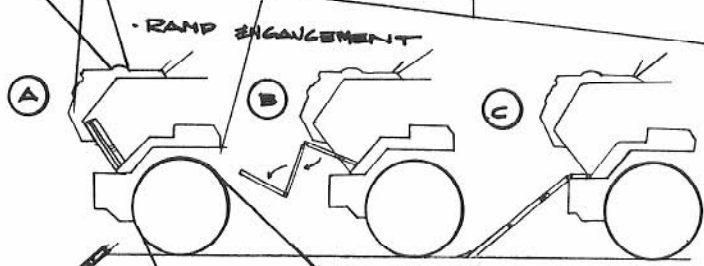



# ROBOTTECH

## MECHA TRANSPORT



PALADIUM TECHNICAL SYSTEMS.  
SENTINEL DESIGNS GROUP  
MECHA TRANSPORT A.T.V.  
TYPICAL WEAPONS SYSTEMS  
SHEET THREE OF 4  
TECH DESIGN SCHEMATIC/NELSON.

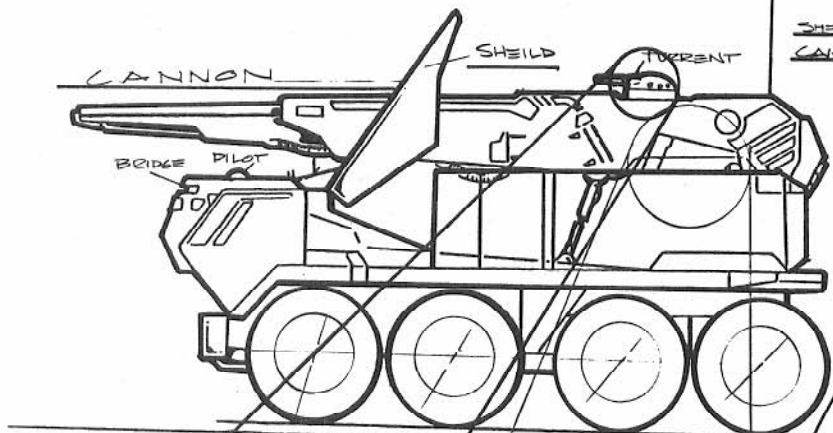

PROFILE

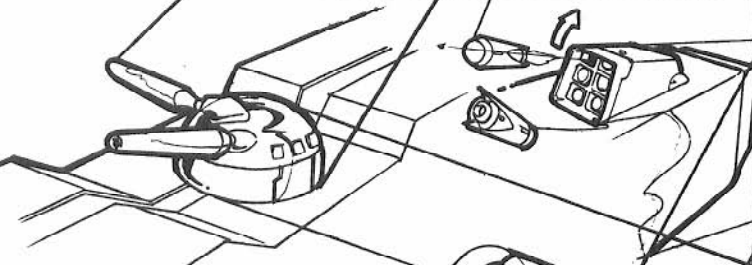

WEAPONS TURRET

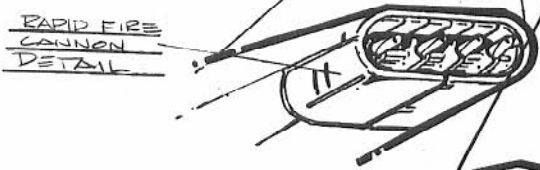

BEAR VIEW OF CANNON

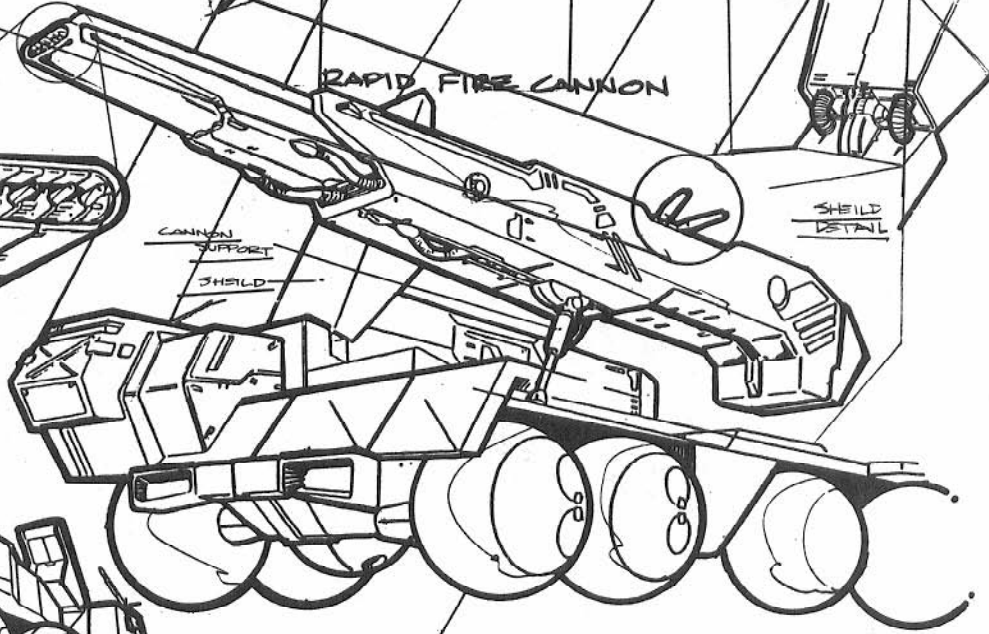

MECHA PODS

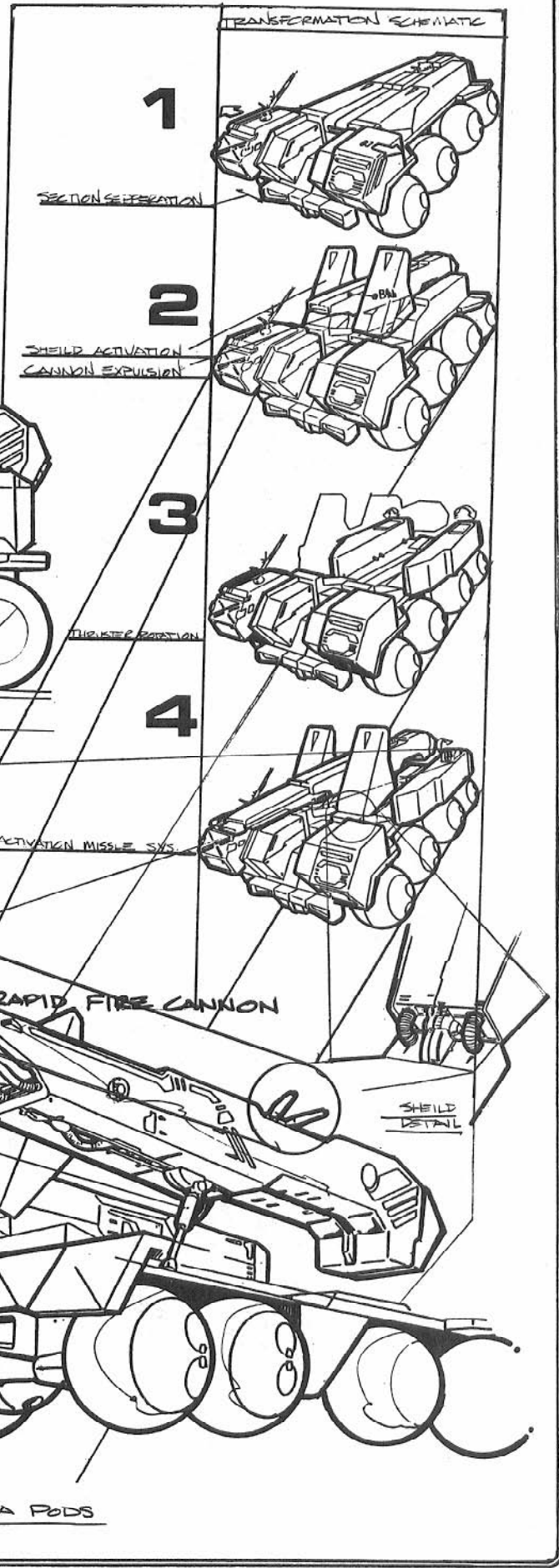

# ROBOTTECH

## MECHA TRANSPORT

PALADIUM TECHNICAL SYSTEMS

SENTINEL DESIGNS GROUP  
MECHA TRANSPORT A.T.V.

TYPICAL: DEPART PAD: INT./EXT.

SHEET FOUR OF 4

TECH DESIGN SCHEMATIC / NELSON.

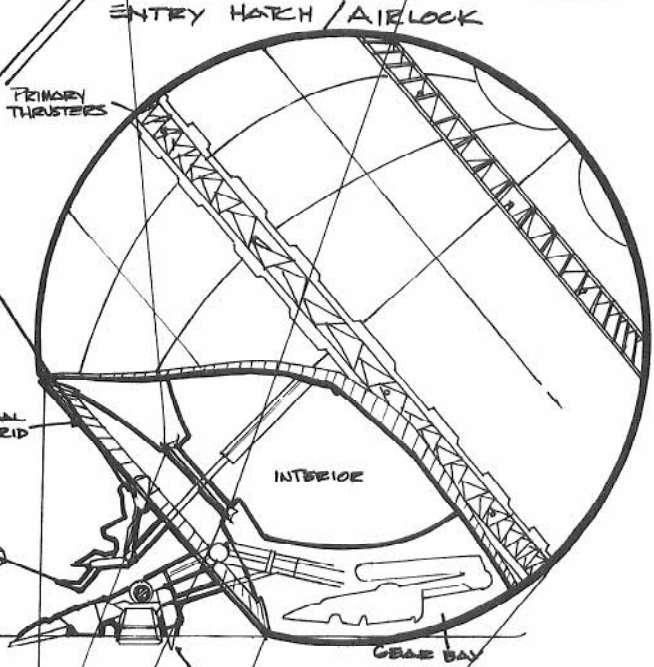
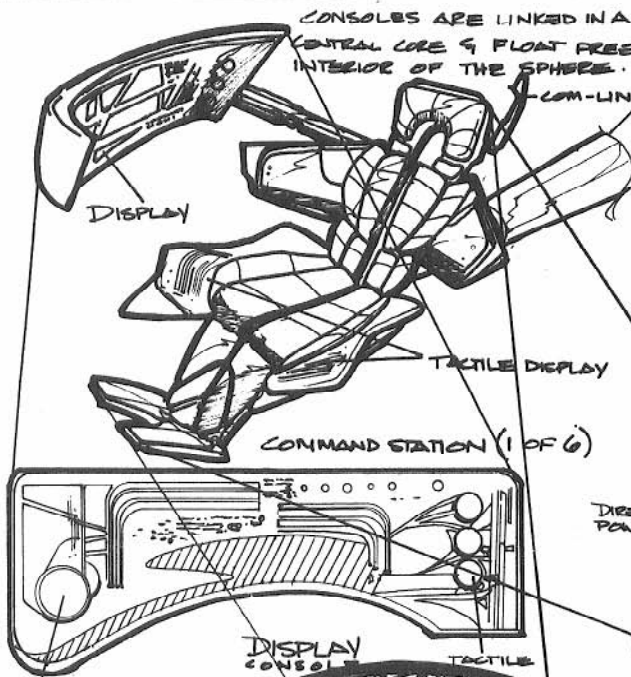
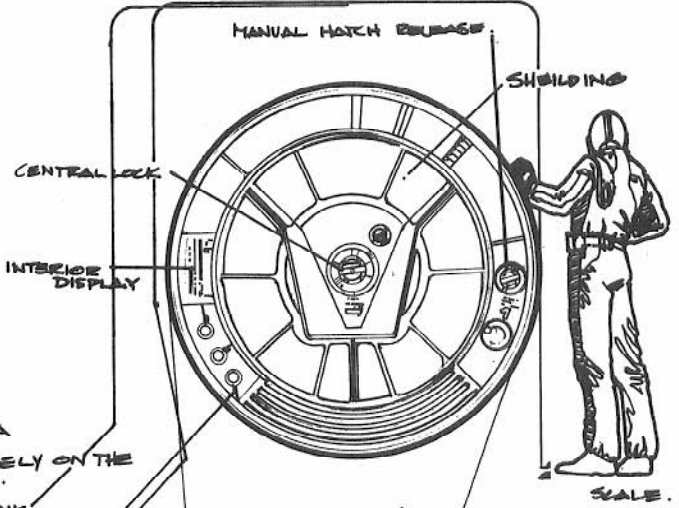

NOTE: SEATED CONSOLES ARE CONNECTED TO CENTRAL SUPPORT WHICH IS FREEFLOATING WITHIN SPHERE.

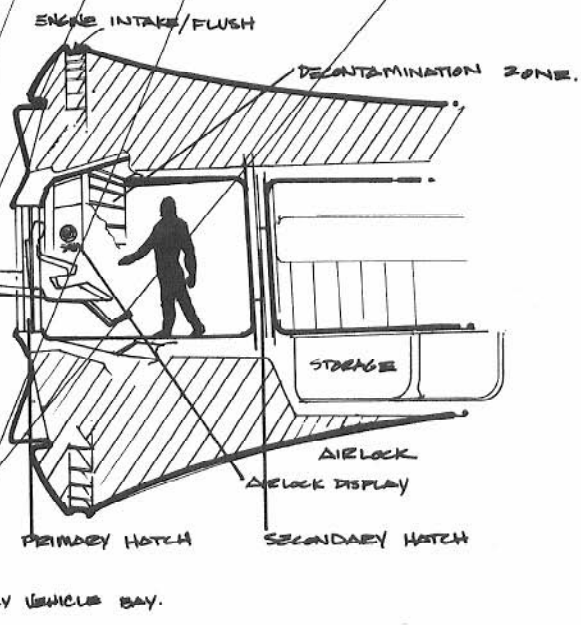
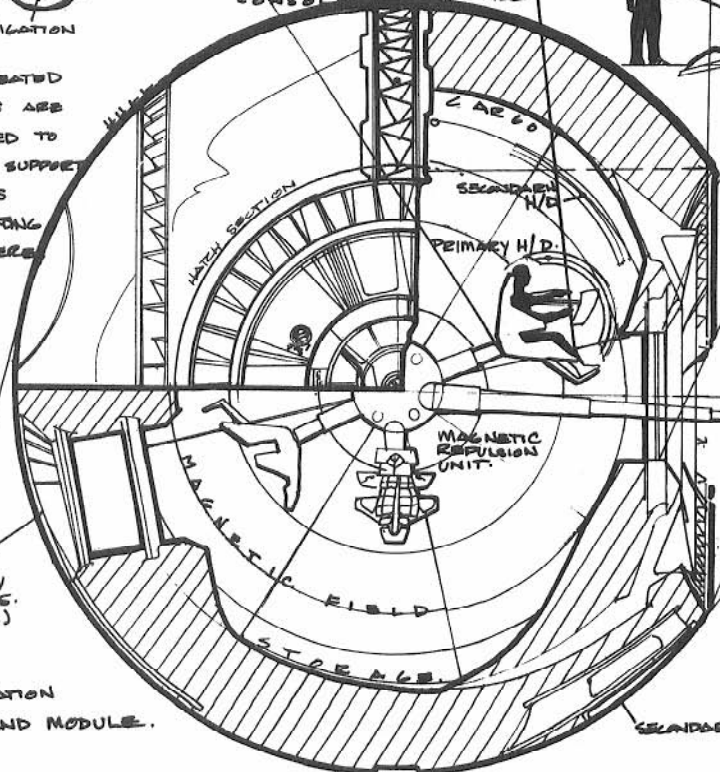

# WEAPONS

Rate of Fire: Six bursts per melee, long or short.

Payload: Effectively unlimited

Note: The modular transformation requires one melee.

2. **The PBT-M2 Particle Beam Turret** mounted on the top of the laser cannon can fire when the cannon is extended or concealed. It is located toward the rear of the vehicle, can rotate 360 degrees to fire at all sides and has a 180 degree arc of fire.

Primary Purpose: Defense

Secondary Purpose: Assault/anti-missile

Range: 6000ft (1829m)

Mega-Damage: 2D6 × 10 per twin blast; 1D6 × 10 should one of its barrels be destroyed (each P-Beam barrel has 50 M.D.C.)

Rate of Fire: Six per melee. Can be operated by a pilot inside the turret or via remote control from the bridge.

Payload: Effectively unlimited

3. **Front, small Particle Beam Turret (PBT-S1)** is for the defense of the bridge/command section of the MTA-Titan. It is able to rotate 360 degrees and within an 180 degree arc of fire.

Primary Purpose: Defense

Secondary Purpose: Assault

Range: 4000ft (1200m)

Mega-Damage: 1D4 × 10 M.D. per blast

Rate of Fire: Six per melee

Payload: Effectively unlimited

Note: The PBT-S1 is unmanned and usually operated by one of the copilots or bridge crew members.

4. **Mecha Troops:** The Titan will always have at least the *minimum* crew (36), 48 Cyclone Riders (sphere units), 96 Soldiers (often all or mostly Cyclone Riders) and 6 to 10 mecha (any combination of new destroids or new veritech fighters).

Acting as a *ground mobile command unit*, the Titan will orchestrate the movement of much greater troops. **Typically**, this will include one or two Cyclops (for reconnaissance and defense of the Titan), 24 to 48 Alpha Fighters, and an equal number of Beta Fighters, 6 to 12 Vindicators, 24 to 48 old VF series Veritechs, Mecha troops of 24 to 72 Destroids (any combination of old and new, but rarely more than one or two M.A.C. II or III destroids will be included), an additional 72 to 144 cyclone riders, and as many as another 400 ground troops. In such a situation, the Titan's troops are usually directed to special objectives, act as rescue/reinforcements, and/or come to the defense of the Titan.

Of course, the MTA-Titan is also sent out on reconnaissance, rescue, defense and mop-up *alone* with its standard complement of troops.

5. **MTA-Missile Launchers (2):** A long range missile launcher is built into each of the side bars along the sides of the Titan. They can fire simultaneously or individually. Note: The missiles can only be launched when the Rapid-Fire Laser Cannon is extended.

Primary Purpose: Assault

Secondary Purpose: Anti-Spacecraft

Range: Varies with missile type; 500-1800 miles.

Mega-Damage: Varies with missile type. Standard payload is a mix of heavy missiles and reflex multi-warhead missiles.

Rate of Fire: One at a time or in volleys of 2, 4, 6, 8, 10 or 12 (all). Can be fired as often as equal to the pilot's combined hand to hand attacks per melee. A volley counts as one attack.

Payload: 24 missiles (12 for each launcher)

6. **Other Modes of Attack:**

Ram — Low Speeds — 1D4 × 100

Ram — High Speeds — 1D6 × 100

Run Over with Wheels — 2D6 × 100\*

\*Object must be 30ft (9.1m) or smaller to be run over.

## SYNCHRO CANNON

A truly incredible mechanism of destruction is the REF Synchro Hover Cannon, a miniature version of the SDF-3's reflex cannon. The device is about twice the size of an old 150mm artillery cannon and is mounted on a hover platform. No synchro cannons are known to exist on Earth (one is seen and destroyed in Robotech episode #83).

Note: The synchro cannon was a late REF development in the Invid wars and even then production was minimal, perhaps two dozen were created at most. They are very difficult and expensive to build. Nicknamed "the Terminator."

Primary Purpose: Assault

Weight: 10 tons

Mega-Damage: Obliterates EVERYTHING in its path of fire. Fires a destructive beam about 50ft wide (15.2m)

Rate of Fire: TWO times per melee

Effective Range: 10,000ft (3048m)

Payload: Effectively unlimited.

Speed: Slow. 30mph (48kmph), with a maximum altitude of 600ft (183m).

Note: Nicknamed "the Terminator."

## COBALT LIMPET MINE

The cobalt limpet mine is a marvel of micronization. The entire device is less than a foot long (0.3m) and weighs a mere 5lbs. The explosives, detonation device and timer, with digital readout, are all contained in a sturdy metal casing (20 S.D.C.). The timer can be set for up to 60 minutes and stopped up to 5 seconds before detonation.

Weight: 5lbs (2.3kg)

Mega-Damage: 1D4 × 10

Blast Radius: 20ft (6.1m)

**THE COBALT GRENADE:** Weight: ½lb (0.2kg). Effective Throwing Range: 90ft (27.4m). Damage: 1D6 M.D. Blast Area: 12ft (3.6m). Cost: 500 credits.

## RDF 9mm "WOLF" AUTO-PISTOL

This is a light, conventional S.D.C. weapon in the RDF arsenal that is fairly common. The weapon became infamous as Col. Wolff's favorite weapon of choice and was renamed the "Wolf 9mm." Gangs often use the Wolf 9mm as a symbol of rank, with only the leader and upper ranking gang members being allowed to carry them. Ammunition is plentiful since it fires a standard 9mm cartridge.

Its most unusual feature is the double automatic feed that provides a bigger payload. Some argue that this feature makes the Wolf auto-pistol a sub-machinegun.

Weight: 3½lbs (1.6kg)

S.D.C. Damage: 2D6 S.D.C. (not M.D.) per round.

Rate of Fire: See modern weapon proficiencies. Aimed, burst, wild.

Effective Range: 800ft (244m)

Payload: 20 round magazine



## SAL-9 SINGLE SHOT LASER PISTOL

This is a simple laser pistol that functions much like a semiautomatic pistol. The person can squeeze off shots as quickly as he can move his trigger finger (9 maximum), unlike an automatic weapon that will con-



tinue to fire as long as the trigger is depressed. The Sal-9 is also very common and popular among nomads, rogues and gangs. It is considered to be a weapon of skill and often used like the Colt 45's of the old west for gunfights and duels.

Weight: 4lbs (1.8kg)

Mega-Damage: 1D6 M.D. per blast.

Rate of Fire: A maximum of 9 blasts per melee can be fired, but counts as shooting wild. See modern weapon proficiencies. Aimed, burst, wild.

Effective Range: 800ft (244m)

Payload: 45 per energy clip.

Note: Can be easily recharged using conventional generators, proticulture cells and/or RDF or Southern Cross facilities (if one can be found that is still working).



## INFANTRY, M-37 "WEASEL" AUTO-PISTOL

Another non-energy hand gun that fires high explosive cartridges similar to the M-36.

Weight: 3¼lbs (1.6kg)

Mega-Damage: 1D4 M.D.

Effective Range: 200ft (61m)

Rate of Fire: See Modern Weapon Proficiencies. Aimed, burst, wild.

Payload: 5 round magazine

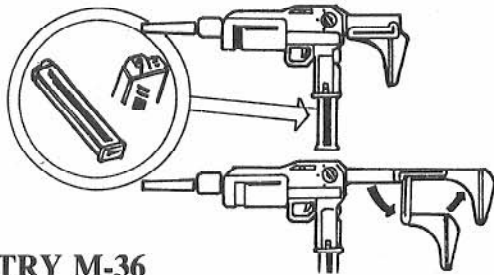

## INFANTRY M-36 "BADGER" SUB-MACHINEGUN

The badger is a heavy duty sub-machinegun designed to use conventional rounds and special high explosive armor piercing shells. It is often used on reconnaissance patrols in Invid occupied territories and infiltration of Invid hives, because it can not be detected by proticulture sensors.

Weight: 5½lbs (2.6kg)

Mega-Damage: Varies; the Badger can fire 9mm cartridges — 2D6 S.D.C. Armor Piercing Explosive cartridges — 1D4 M.D.

Effective Range: 600ft (183m)

Rate of Fire: See Modern Weapon Proficiencies. Aimed, burst or wild.

Payload: 30 round magazine.

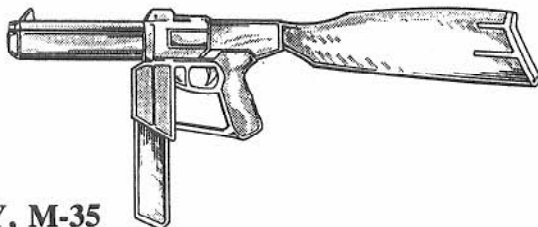

## INFANTRY, M-35 "WOLVERINE" ASSAULT RIFLE

The M-35 "Wolverine" has become the RDF's main assault weapon. Developed by Doctor R. Burke, it can be set for single shot, semiautomatic or full automatic, and fires 4.45mm caseless rounds. The auto-firing grenade launcher can fire four 25mm high explosive grenades per melee before needing reloading. A 4.45mm ammo clip can be replaced in 5 seconds (one action), but the grenades will require one full melee (15 seconds). The weight and uniqueness imposes a penalty of -2 to strike

without a Modern Weapons W.P. The M-35 comes equipped with a bipod and infrared telescopic sight.

Type: Human Assault Rifle

Primary Purpose: Assault/Defense

Mega-Damage: 25mm Grenade Launcher does 2D6 M.D.; the 4.45mm ammo does no mega-damage (4D6 S.D.C.).

Range: 1150ft (350m)

Rate of Fire: Auto-grenade launcher — up to 4 per melee; the 4.45mm, caseless, 60 round ammo clip.

Payload: Auto-grenade launcher holds 4 grenades. The 4.45mm caseless has a clip of 60 rounds.

Weight: 19lbs (8.6kg)

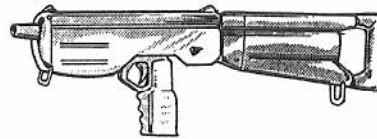

## FAL-2 AUTOMATIC PULSE LASER RIFLE

The Fal-2 was designed as an infantry assault weapon and enjoyed widespread popularity worldwide before the Invid invasion. The Soviet version, the Koskov 47, is virtually identical to the Fal-2 and became a favorite weapon of the black market throughout the South American Sector. The appeal of the Fal-2 is that it is exactly like a sub-machinegun, but does mega-damage.

Weight: 6lbs (2.7kg)

Mega-Damage: 2D6 M.D. per blast

Rate of Fire: Aimed, burst, wild. See modern weapon proficiencies. Can fire full clip in one melee.

Effective Range: 1200ft (366m)

Payload: 40 blasts per energy clip.

Note: The Fal-2 is still quite common. One reason for this is that it can be recharged with proticulture cells or at conventional RDF or Southern Cross energy clip recharging facilities (but none are known to exist). One proticulture cell is good for about 20 rechargings. To recharge an energy clip, the character must have the electrical engineer or mechanical engineer skill and a sufficient energy source.

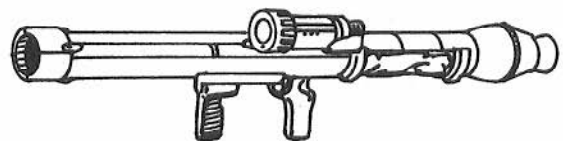

## RL-2 SUPER ROCKET CANNON

The RL-2 "super" is a disposable rocket launcher that can fire two plasma mini-missiles. It is designed to be used by armored and non-armored troops for heavy assaults. Comes equipped with a detachable telescopic, night sight scope.

Weight: 16lbs (7.3kg)

Mega-Damage: 1D6 × 10 M.D.

Rate of Fire: Twice maximum

Effective Range: 1 mile (1.6km)

Payload: Two plasma mini-missiles



## GALLANT H-90 MULTI-WEAPON SYSTEM

The Gallant H-90 is the *standard* all-purpose weapon of the Robotech Expeditionary Force (REF) and subsequently, the RDF as well. Its primary manufacturer was the Gallant Company located at Mars Base (RDF).

The weapon is unique because of its versatility and durability in the field. The durability is evident in that the weapon rarely jams, needs minimal maintenance, operates equally well in all climates (including sub-zero, humid and hot), and can even be submerged underwater for hours and still fire immediately thereafter.

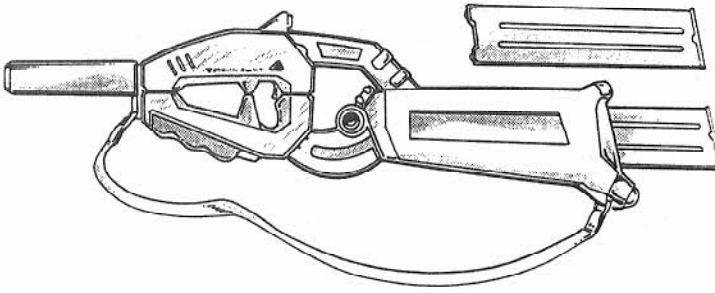

The Gallant's amazing versatility lays in that it can be instantly transformed from a S.D.C. damage weapon into a Mega-Damage (M.D.) weapon with the flick of a switch. And then, the power and range of the M.D. weapon can be increased by adding a rifle stock containing a booster energy clip. Comes equipped with built-in sight and a detachable flash suppressor/cooling nozzle accessory.

**Weight:** 1½lbs (0.7kg) without stock, 7lbs (3.2kg) with stock.

**Primary Purpose:** Assault

**Range:** Varies. S.D.C. semiautomatic — 200ft (61m); Pluse Energy Pistol — 500ft (152m); Pulse Energy Rifle — 1400ft (427m).

**Mega-Damage:** Varies. S.D.C. semiautomatic — 4D6 S.D.C. damage per shot. Although bursts of energy are fired on the semiautomatic setting, they do only S.D.C. damage, not M.D. Pulse Energy Pistol — 1D6 M.D. per blast. Pulse Energy Rifle — 4D6 M.D. per blast.

**Rate of Fire:** Aimed, burst or wild. See *Modern Weapon Proficiencies*.

**Payload:** The S.D.C. damage pistol draws so little energy as to be considered unlimited with a single energy clip (estimate 1000 blasts).

**Pulse Energy Pistol:** 20 blasts per energy clip. The Gallant can be switched from a S.D.C. pistol type weapon to an energy pistol with the flick of a switch. However, to convert it into an energy rifle, the rifle stock and "extra" rifle energy clip must be attached.

**Pulse Energy Rifle:** 30 blasts per rifle energy clip. This additional energy clip and rifle stock container must be attached to use as a rifle.

**Note:** The Gallant uses protoculture energy.

## MISCELLANEOUS WEAPONS

**WEAPON NOTES:** In this postwar setting, the old weapons of the RDF and Southern Cross and conventional arms still exist, but the availability of ammunition and specific types varies greatly. Some places may have a lot of weapons, others none or few. Some may have a lot of ammunition, but no weapons to use it with. Game Masters should use their discretion when making RDF and Southern Cross items available. Mecha, tanks and military equipment of all kinds are scarce. The more common sidearms will be the most numerous.

Also see *Cyclone Mecha* for . . .

**Missile Launching Sidecar (VR-052)**

**EP-37 60mm Beam Cannon (VR-052)**

**EP-40 40mm Pulse Beam Cannon (VR-052)**

**RL-6 Heavy Rocket Cannon (VR-038-LT)**

**Conventional Weapons:** See *Robotech RPG*

**Conventional Equipment,** such as optical, sensors, etc.: See *Robotech RPG*.

**Energy Rifles:** See *Southern Cross* and/or *Sentinels RPG* for various available energy rifles.

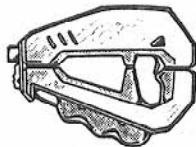

## HANDGUNS

**THE PPL-12 PANTHER PULSE LASER** is a lightweight precision laser pistol which has become the *standard* weapon of the Southern Cross Armies. **Weight:** 4½lbs (2kg). **Effective Range:** 1200ft (366m). **Damage:** 1D6 M.D. per blast. **Cost:** 2000 credits. **Feed:** 12 shots per E-Clip.

**THE TRI-LASER:** This powerful, rapid-fire pulse laser can be fired one handed, or held with two hands by a retractable handgrip for greater stability. **Weight:** 6½lbs (2.9kg). **Effective Range:** 800ft (244m).

**Damage:** 3D6M.D. per triple blast (fires three simultaneous pulses, one from each barrel). **Cost:** 3600 credits. **Feed:** 10 triple blasts per E-Clip.

**THE RFL-100 RAPID-FIRE PULSE LASER** is an incredible weapon that can fire individual blasts, or shoot in a burst or spray like a machine-gun (same combat rules apply). This heavy weapon is reserved for the most deadly situations and only upon authorization. **Weight:** 12lbs (5.4kg), **Effective Range:** 800ft (244m). **Damage:** 1D6 M.D. per individual blast (up to 10 blasts can be fired per melee as aimed shots) or fired in *bursts*. (Use the same rules as *machinegun* under the *Modern Weapon Proficiencies* section, page 30, in the *ROBOTECH™ RPG*). **Cost:** 15,000 credits. **Feed:** 100 shots per E-Clip.

**THE PUTMAN STUN-GUN** fires an energy charge that short-circuits the nervous system. **Effects:** There is a 60% chance of rendering its victim unconscious. Even if still conscious, the person will be dazed: — 10 to strike, parry and dodge for 2D4 melees.

**Savings Throw:** Because people are different, some can fight off the effects of a stun blast. Roll to save vs toxin (14 or higher) against each blast. A *successful save* means that blast had no debilitating effect other than giving you a splitting headache and a nauseated feeling.

**Weight:** 1lb (.5kg). **Effective Range:** 200ft (61m). **Damage:** Stun. **Cost:** 1500 credits. **Feed:** 6 blasts per E-Clip.

## RIFLES

**THE LR-20 LASER RIFLE**, with a telescopic, thermo-imager sight, is the main frontline combat rifle. **Weight:** 8lbs (3.6kg). **Effective Range:** 2000ft (600m). **Damage:** 1D6 M.D. at 1000 to 2000ft, 2D6 at 999ft (348m) or less. **Cost:** 5600 credits. **Feed:** 20 blasts per E-Clip.

**THE PR-30 PULSE RIFLE** is a heavy assault rifle **Weight:** 8lbs (3.6kg), **Effective Range:** 1400ft (427m). **Damage:** 2D6 M.D. per blast. **Cost:** 6000 credits. **Feed:** 30 shots per E-Clip.

**THE LR-30 LASER ASSAULT RIFLE** is a main light assault weapon of the armed forces. **Weight:** 9lbs (4.1kg), **Effective Range:** 1400ft (427m). **Damage:** 1D6 M.D. at 800 to 1400ft, 2D6 M.D. at 790ft or less. **Cost:** 5400 credits. **Feed:** 30 shots per E-Clip.

**Note:** The time required to change an E-Clip is one *melee* (15 seconds).

## BODY ARMOR ACCESSORIES

### BACK PACKS

**EXTRA OXYGEN TANKS:** A sturdy, lightweight oxygen tank pack that provides an additional 6 hours of oxygen.

**Approximate Weight:** 30 pounds (13.61kg).

**M.D.C. of Back Pack:** 15

**SPACE BOOSTER PACK:** A jet pack attachment for flight in space.

**Approximate Weight:** 70 pounds (31.75kg).

**M.D.C. of the Back Pack:** 30

**Speed:** 100mph (160kmph) in space. Not suitable for flight in an atmosphere, but it is acceptable for underwater use; 30mph (48kmph) — maximum.

**Duration:** Six hours of continual use before fuel is depleted.

**Bonuses:** +1 to dodge in space or underwater.

**JET PACK:** A small jet pack capable of sustained flight in an atmosphere.

**Approximate Weight:** 57 pounds (25.88kg).

**M.D.C. of the Back Pack:** 25

**Speed:** 60mph (95kmph) in an atmosphere; 80mph (128kmph) in space. It is not suitable for underwater travel.

**Duration:** Approximately two hours of use, with an effective range of 340 miles. Maximum altitude is 2000 feet (609m).

**Bonuses:** +1 to dodge when flying.

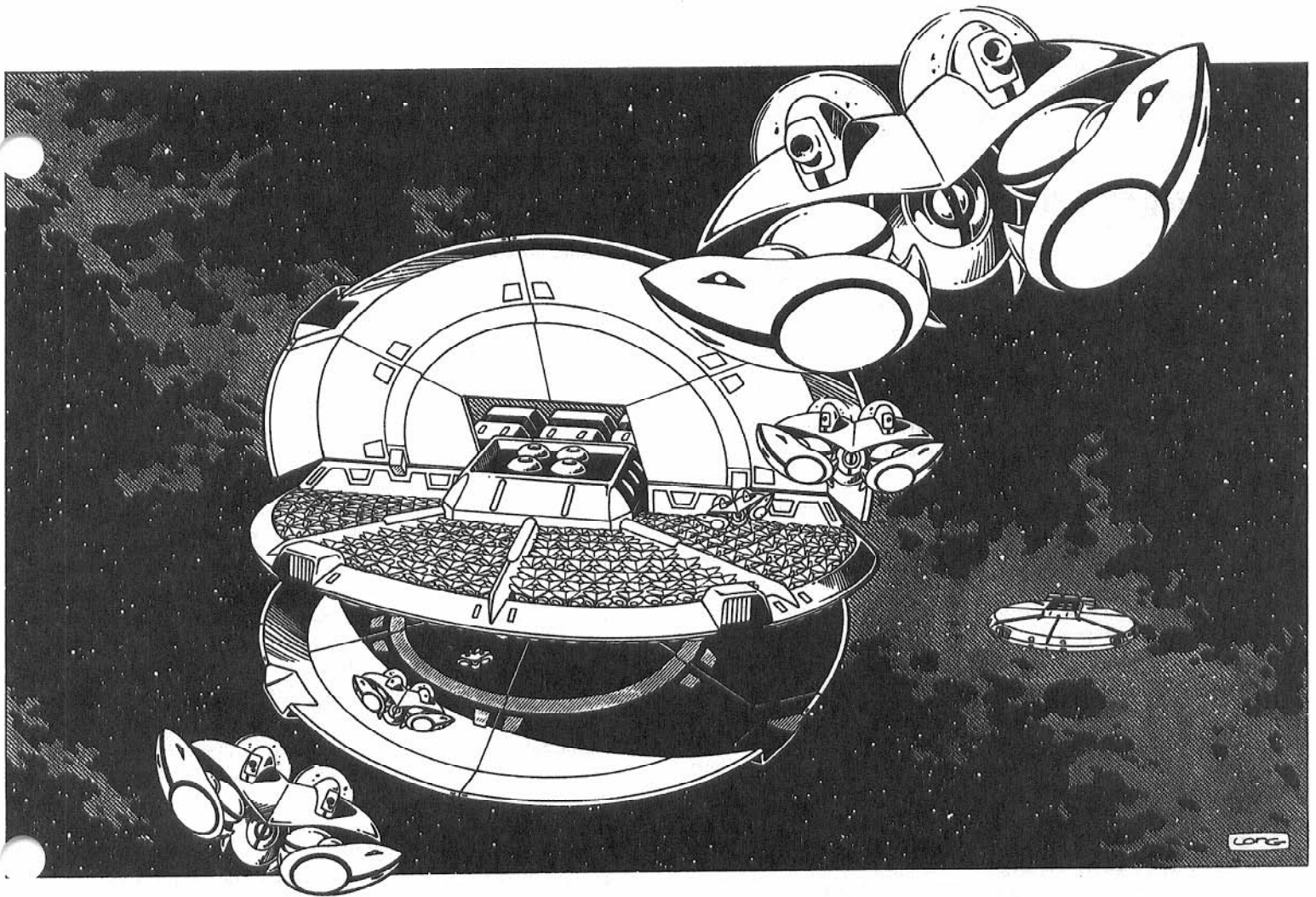

# THE INVID

The Invid are the children of betrayal and war. When Zor first discovered the Invid's homeworld it was a simple, lovely planet inhabited by creatures who were spiritually one with their world, the Invid. The Robotech Master scientific genius, Zor, befriended the central intelligence of the Invid and together they made many great scientific discoveries. Among those achievements was the secret of proticulture. A secret that Zor's power hungry superiors would not share. Without warning, the Robotech Masters lashed out at the helpless Invid. Genocide would have been too merciful; instead the evil Masters destroyed the planet through defoliation, killing all vegetation and leaving the defenseless Invid to die of starvation.

However, this maleficent action would spawn a nightmare race of monsters dedicated to revenge. Unknown to the pernicious Robotech Masters, the Invid were creatures of great power and masters of a metaphysical science the equal of their own. From the ashes of ruination rose the Invid War machine. Billions of creatures locked inside insect-like mecha, consumed with hatred. They would scour the universe to find the Robotech Masters and destroy them.

Sadly, the creatures became a shadow of the Robotech Masters evil, for the Invid lost their souls to hate, just as the Masters had lost theirs to greed. They became as evil and unmerciful as the beings they so loathed.

Any world, any beings found with the sacred Invid "Flower of Life" (proticulture) were destroyed or ravaged and enslaved. No questions were asked. No presumption of innocence. If proticulture was found,

that world must suffer. Destruction and subjugation was the price to be paid by any who would ally themselves to the malevolent Robotech Masters. Or so the Invid believed. Blinded by hatred, they did not know or care that these worlds knew nothing of the Robotech Masters' treachery. Nor that they were often the desperate victims of the Robotech Masters' merchant empire as much as the Invid.

The Invid hordes were led by two ruling beings, the Regis and the Regent. The two powerful leaders were both created simultaneously when the Robotech Masters laid waste to their homeworld. The shock of that moment caused the one central intelligence to split into two separate beings. The masculine Regent and the feminine Regis. Together the two led the Invid swarms against countless worlds spanning hundreds of years. However, the Regis and Regent have grown into two very different entities. The Regis, although as unfeeling and hateful, seeks to find a new world and begin a new life. To grow and evolve into superior creatures. However, she still strikes out at any creatures, other than Invids who dare to defile the sacred plant (proticulture/flower of life). The reaction is immediate and thoughtless. Non-Invid who use or possess any aspect of the planet are destroyed or enslaved. The difference between her and the Regent is that she no longer actively seeks out these criminals. She is tired of hate and war. Her time is dedicated to evolution and higher pursuits.

The Regent is lost to hate and power. He has grown to enjoy this conflict more than anything else. Like the Robotech Masters, he craves to carve out an intergalactic empire. An empire composed of crushed



and defeated worlds whose survivors must obey and worship the Invid (specifically the Regent). It is the Regent and his minions whom the SDF-3 and the REF engage in mortal combat. **Note:** See *Book Five: The Invid Invasion* for a more detailed history of the Invid's origin and the Regis.

## THE REGENT

The Regent is a hate filled tyrant driven by revenge and desires of conquest. He has turned into a power-crazed megalomaniac who cares about nothing but conquest. Entire races of beings have met with extinction at his hands and he revels in that accomplishment. Even the fate of his own Invid people is dwarfed by his insane dreams of power. The Regent is no longer motivated by vengeance against the Robotech Masters, but by a psychotic need to dominate or destroy all non-Invid life forms. Why stop with the punishment of those who would dare possess the sacred flower when you could be the lord of all life! This is the madness of the Regent!

Although the Regent and the Regis have been branded "the twin evils," it is the Regent who represents evil incarnate. While the Regis has grown callous toward other life forms and instinctively lashes out at those who possess protoculture, she is not evil and has left the Regent because she does not share his mad dream for intergalactic conquest. Indeed, should the Regent succeed in his plans, it is inevitable that he and the Regis will clash in a battle to the death.

The Regent is certainly the Regis' equal. What he lacks in intellect he compensates for in ferocity and cruelty. He is a good tactician and an unrelenting foe. He controls "his" Invid exactly the same way as the Regis. In this insect-like society, the Regent is the king bee that all lesser invid obey without question nor hesitation. He has absolute power over his people. Life and death are his to command. It is the Regent who gives life purpose to those under his domination. Without him they would seek out the Regis or continue to follow his decree of conquest like a mindless war machine. Sadly, the Regent has abandoned his responsibilities to his people to satisfy his own lust for absolute power.

## THE REGENT

### Invid All-Father

#### Characteristics in Humanoid Form

**Hit Points:** 100,000 (or 1000 M.D.C.)

**Physical S.D.C.:** 20,000 (or 200 M.D.C.)

**Alignment:** Diabolic

**Attributes:** I.Q. 14, M.E. 12, M.A. 24, P.S. 30, P.P. 24, P.E. 30, P.B. 4, Spd. 12

**Age:** Unknown; presumably thousands of years (at least 10,000 years old).

**Weight:** 300lbs (136kg) **Height:** 10ft (3m)

**Disposition:** Tough, self-reliant, indomitable; cruel and sadistic in the extreme, loves to inflict pain and suffering on other creatures (psychological, as well as physical). He is incredibly arrogant, envisioning himself to be a god. Super aggressive and unrelenting. Hates the Robotech Masters and Zentraedi and will attack them on sight.

**Insanity:** Suffers from megalomania, obsessed with attaining absolute power! Also obsessed with completely destroying the Robotech Masters (Tirolians too) and the Zentraedi. Sadistic too.

**Level of Experience:** No appropriate category; the Regent is the supreme intelligence and power of his people.

**Skills (equivalent to Earth skills):** The complete understanding of the metaphysical powers of the Flower of Life/Protoculture — 98%, Protoculture Alchemy/Transmutation Powers — 98%, Radio: Basic — 92%, T.V./Video — 92%, Basic Electronics — 98%, Basic Mechanics (general) — 96%, Invid Mecha Mechanics — 98%, All Espionage Skills — 55%, All Navigation Skills — 98%, Pilot Invid

Mecha (all) — 98%, Pilot Space Shuttle — 98%, Pilot Spacecraft — 98%, Demolitions and Demolitions Disposal — 90%, Computer Operation — 60%, W.P. Blunt, W.P. Energy Pistol, W.P. Energy Rifle, Hand to Hand: Expert and Wrestling (all at 10th level proficiency).

**Attacks Per Melee:** Five; includes hand to hand skill attacks.

## SPECIAL ABILITIES:

**Transmutation of Invids:** The bio-engineering ability to create clones and evolve them into any of the four invid pilots. This power can also be used to completely transform an invid into other life forms as seen in the *Genesis Pits*. The transformation of an invid into a different stage requires a mere few minutes (1D4 minutes each). The radical transformations of the Genesis Pits require days each, sometimes longer, and can not be changed back into a regular invid again.

The transmutation power can also be used on the Regent himself to create his current humanoid/slug appearance or any other form he may desire, even human. +30% on disguise skill if a transmutation is done. **Note:** This power works only on invid.

**Transmutation of Mecha:** The alchemical ability to create the various invid mecha out of thin air (or so it seems). This power is also used to repair mecha instantly, almost magically. The Regent has created millions of mecha and inorganics which are then placed in a stasis bubble to be perfectly preserved until needed. The process of creation requires days of mental preparation and protoculture, but once begun, an actual mecha can be created within minutes (1D4 minutes each).

**Transmutation of Hives:** The alchemical technology used to create the hives. The creation of a hive with its complete workings requires 1D4 days each.

**Transmutation to Warp Speed:** The knowledge of protoculture used to transform himself and all available invid into a form of living energy which can travel the cosmos at incredible speeds (space fold). The process can be executed by the Regent after 1D6 × 10 minutes; add 4D6 minutes for every million invid he takes with him. This power can be thought of as a type of super-teleport. Range: Unlimited.

**Stasis Bubble:** The Regent can create a stasis bubble around something, preserving that object in a state of suspended animation indefinitely (approximate time limit: 400 years). The Regent, Regis or Invid Brain can take the item out of stasis at any time. Likewise, an Enforcer of the invid Royal Guard (serving the Regent directly) can be placed in command of a hive and can use the hive's automated systems to take an item *out* of stasis. But only the Regent or Regis can place an item *into* stasis.

The stasis bubble actually appears more like an oval or "egg" shape that fits snugly around the item. The stasis field is semitransparent so the item it contains can be seen through it. The stasis field has 200 M.D.C. Disrupting the field by inflicting damage has a 90% chance of destroying the item inside. Size limit of an item (living or inanimate) is 60ft (18.3m).

## PSIONIC ABILITIES:

**Psionic Attacks Per Melee:** Two; each psi-attack takes the place of one physical attack.

**Telepathic Communication:** A mental ability by which the Regent can communicate with any or all of his *invid*. Range: indefinite; light years away. This power does not include reading minds or mental probes. Telepathy can be used to communicate with humans and other creatures, but the range is reduced to about 100 miles (160km) when dealing with non-invid.

**Sense Protoculture Energy:** The Regent can psychically feel the presence of protoculture energy being used anywhere near him



(within a 100 mile/160km radius). This sense is so strong that it will also register the presence of living Flowers of Life within 500 miles (804km). The exact numbers and general location (within 600ft/183m) can also be determined.

**Empathy:** The ability to sense the emotions of any living creature. The Regent can read the emotions of up to 24 individuals or the general emotions of a large group. This power does not include empathic transfer. Range: 500ft (150m) for individuals, up to two miles for a group.

**Levitation (self):** Can lift and suspend himself up into the air. Limited to up and down movement only. Maximum height: 300ft (90m).

**Telekinesis:** Same as the Invid Brain, but is +3 to strike and parry.

**Mind Bolt:** A bolt of electromagnetic force can be hurled at an enemy. The bolt can do as little as 1D6 S.D.C., 2D6 S.D.C., 4D6 S.D.C., 1D4 x 10 S.D.C. or as much as 2D6 M.D.C.!! The bolt can be fired as often as three times per melee (all three psionic melee attacks). Range: 1000ft (300m). Bonus to Strike: +5.

**Force Field:** A temporary force field can be erected around himself for one melee. The force field offers 50 M.D.C. protection. Each time the shield is created, it counts as one psionic attack. The Regis can only erect one force field per melee.

**Bio-Regeneration (self):** The Regent can regenerate 2D6 x 10 hit points or 3D6 x 10 S.D.C. once every 15 minutes.

**Bio-Transmutation (heal other invid):** He can alchemically heal another invid, restoring 1D4 x 10 hit points or 1D4 x 10 S.D.C. once every minute. This power can be used on non-invid (humans) as well, but only restores 1D6 hit points or S.D.C.

**Mind Block:** A mental wall that prevents the penetration of telepathy, empathy and other mind probes.

**Notes:** I.S.P. for psionics is not included because the Regent's power is effectively unlimited. The Regent can not turn into an energy form except to travel via transmutation to warp speed.

## THE REGENT'S POWER ARMOR

The Regent has constructed himself a suit of power armor so that he may enter into the joys of combat without fear of mortality. Yet, in many respects, the suit is more of a personal means of transportation than a weapon. It resembles the Enforcer's body armor, complete with hidden lasers in the forearms and jet thrusters in the back. Additional maneuver jets in the feet, chest and back give the Regent greater mobility in space and flight.

### The Regent's Personal Armor

**Vehicle Type:** Power Armor

**Crew:** One, the Regent.

#### M.D.C. by Location:

Hands (2) — 30 each

Forearms (2, laser concealed within each) — 100 each

Upper Arms (2) — 100 each

Legs (2) — 100 each

Jet Thrusters in Feet (2 units) — 50 each

Jet Thruster (rear) — 100

\*Head — 200

\*\*Main Body — 250

\*Depleting the M.D.C. of the head destroys the environmental aspect of the suit and opens the Regent to physical harm (S.D.C. & Hit Points).

\*\*Depleting the M.D.C. of the main body wrecks the suit, rendering it useless and opening the Regent to physical harm.

**Speed:** Flight: 400mph (643kmph) or hover completely stationary.

**Space Propulsion:** Mach 1.2 (about 700mph)

**Running:** 50mph (80kmph)

**Leaping:** 30ft (9.1m) high or across without boosters. 200ft (61m) high or across with booster assistance.

### WEAPON SYSTEMS

1. **Concealed lasers** in forearms, identical to the Enforcer's.
2. **Energy Rifle:** Optional use of the Enforcer's energy rifle.
3. **Energy Shield:** Optional use of an Enforcer's shield.
4. **Hand to Hand Combat:** Adds two attacks per melee, +1 to strike, parry and dodge. Plus 2D6 M.D. in hand to hand combat (punches and kicks) and can carry 5 tons.

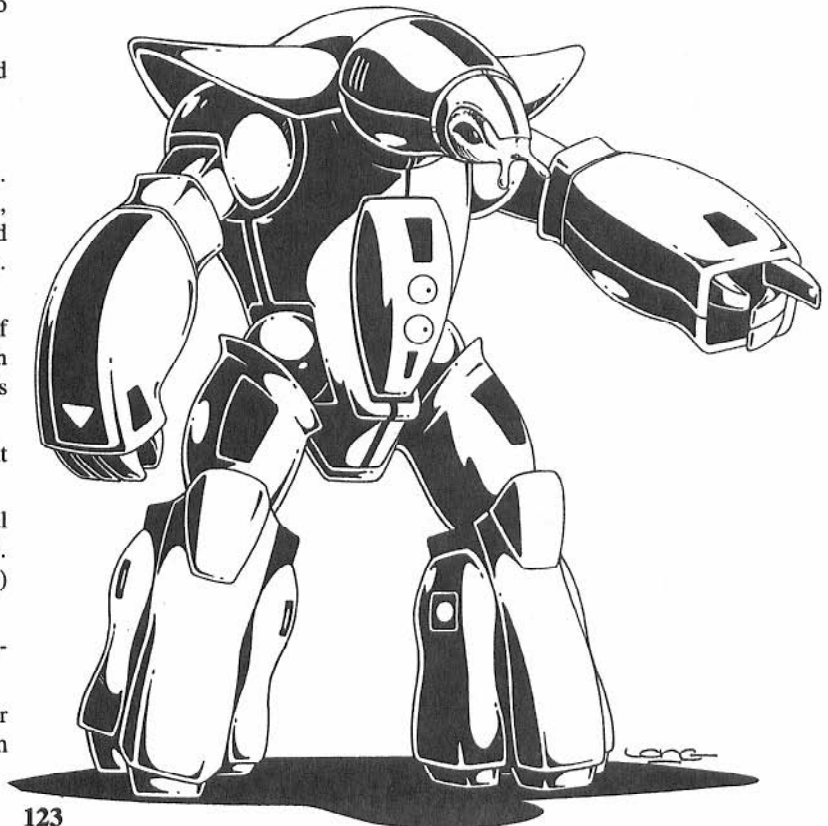

# INVID PILOTS

Although humans generally perceive the invid to be giant, mechanized, insect-like creatures, the invid are actually flesh and blood humanoids. The giant insect appearance is created by the *mecha* which is piloted by the invid organism inside.

Each of the various types of invid mecha are piloted by an invid at a different stage of genetic evolution. All invid pilots, except the stage five pilot, have virtually no emotions, therefore, they do not experience fear, hate, love, etc.

## Stage One Invid Pilot

The stage one invid pilot is the most primitive, alien, and slug-like in appearance. It's a small creature with a thick, round, trunk, from which a pair of stubby arms and legs protrude. The limbs appear to resemble the chunky flippers of a walrus rather than human appendages and provide minimal movement. The hands are only partially articulated and walking is almost impossible.

The stage one pilot is one with its mecha, giving it high maneuverability and all of its limited attention. The stage one invid is incapable of independent thought and is the drone of the hive. The ugly little creature spends its entire life in its mecha and will die in a matter of minutes if it is ever plucked from the life support system of the mecha.

**Pilots:** Invid Scouts and Armored Scouts

**Hit Points:** 10 S.D.C.: 0

**Attributes:** Subhuman; I.Q. 3, M.A. 3, M.E. 10, P.S. 3, P.P. 3, P.E. 10, P.B. 3, Spd. 3

**Attacks Per Melee (outside of mecha):** None

**Note:** Can not live or function outside of invid mecha. Dies within 1D6 melees. Not capable of independent thought.

## Stage Two Invid Pilot

The second stage invid pilot is larger, almost twice as big (about 4ft/1.2m tall), with greater upper torso development and humanoid appendages. At this stage, this invid looks just as gruesome as the former. However, the hands are much more articulated, with an opposable thumb, and walking is possible.

This is the worker invid who doubles as a warrior. Like the stage one invid, it can not survive outside of its mecha, nor is it capable of independent thought.

**Pilots:** Trooper/Worker and Shock Trooper

**Hit Points:** 14 S.D.C.: 2

**Attributes:** Subhuman, I.Q. 5, M.A. 5, M.E. 10, P.S. 6, P.P. 6, P.E. 10, P.B. 3, Spd. 6

**Attacks Per Melee (outside of mecha):** One, hand to hand ONLY.

**Note:** Cannot live or function for long outside of mecha. Dies within 2D6 melees. Incapable of independent thought.

## Stage Three Invid Pilot

The third stage invid stands erect, with clearly defined arms, hands (fully articulated), legs and feet. Height is 5ft (1.5m). Although humanoid, this invid is still obviously an alien, with sagging, bulky musculature, brownish-grey skin and slug-like head.

Unlike its predecessors, the stage three pilot is capable of independent thought. This means it can make observations, analyze a situation, draw its own conclusions and take action. Of course, the stage three invid pilot always follows the directives of the Regis or Invid Brain. The thinking capabilities of the stage three invid qualify it to be the lieutenant of the invid troops. Thus, it is a stage three invid pilot, in its command mecha (pincer), that will lead a troop of scouts or shock troopers into combat or on a seek and destroy mission. It is also the stage three invid who is left to handle rebels and to lead defense forces at protoculture processing plants and farms, and hive perimeters.

**Hit Points:** 20 S.D.C.: 5

**Attributes:** I.Q. 8, M.A. 5, M.E. 10, P.S. 8, P.P. 8, P.E. 14, P.B. 6, Spd. 8

**Attacks Per Melee (outside the mecha):** Two, hand to hand ONLY.

Damage is 1D6 from a punch or kick, no bonuses.

**Note:** Like its predecessor, the stage three pilot can not live or function long outside of its mecha and dies within 4D6 melees. Capable of independent thought.

## Stage Four Invid Pilot

The fourth stage invid pilot is a completely humanoid being and represents the invid in their natural form. Although humanoid, this invid still looks alien, with a long, muscular neck, slug-like head, large bulbous eyes and saggy, grey-brown skin. The body is barrel chested, with thick, bulky limbs. Height is about 5 to 6ft (1.5 to 1.8m) at the shoulders/neck.

This is the captain and technician (in the loosest sense of the word) of the lesser invid. Its intellect is high and it is capable of independent thinking and reasoning similar to humans. This means it can assimilate information and act on it. Of course, the stage four invid is completely loyal and dedicated to the Regis and Invid Brain.

It is the stage four invid that operate as hive guards and technicians, in that they transport vessels, assist in biological experiments/operations on humans, assist in the genesis pits, and perform various skilled functions in the hive itself. Known as Enforcers, they maintain and service the hive and protect the Invid Brain or Regis from invaders who penetrate the hive. Their high intelligence also places them in charge of operations at protoculture farms and processing, storage and transportation facilities. A stage four invid may lead any of the lesser invid on any type of operation (under the direction of higher authority). They also pilot the clam-shaped invid transport.

**Pilots:** Enforcer (power armor) and Invid Transport.

**Hit Points:** 20 S.D.C.: 4D6

**Attributes:** I.Q. 12, M.A. 12, M.E. 12, P.S. 12, P.P. 12, P.E. 16, P.B. 9, Spd. 9

**Attacks Per Melee (outside of mecha):** Two, hand to hand or by weapon. Damage from punch or kick is 1D6.

**Bonuses:** +1 to strike, parry and dodge; +1 to save vs poisons/toxins.

**Penalty:** -2 on initiative.

**Skills (equivalent to Earth Skills):** Radio: Basic — 60%, T.V./Video — 50%, Pilot Enforcer Mecha (power armor) — 90%, Pilot clam-shaped Transport Ship — 90%, Pilot Space Shuttle — 80%, Navigation (land, air, water) — 88%, Navigation: Space — 98%, W.P. Energy Pistol (+2 to strike), W.P. Energy Rifle (+1 to strike). The two energy weapon W.P.s apply only to hand held weapons that are not part of the Enforcer's power armor. Surgical and medical skills are telepathically transmitted from the Regis or an Invid Brain and are not a remembered skill ability. The Regis or Invid Brain basically takes control of the stage four pilot and uses him as an extension of itself.

**Note:** The stage four invid pilot can survive without mecha, but rarely does so. The Enforcer power armor is like a second skin, or natural exoskeleton, that it wears constantly. See *Invid Mecha: The Enforcer*.

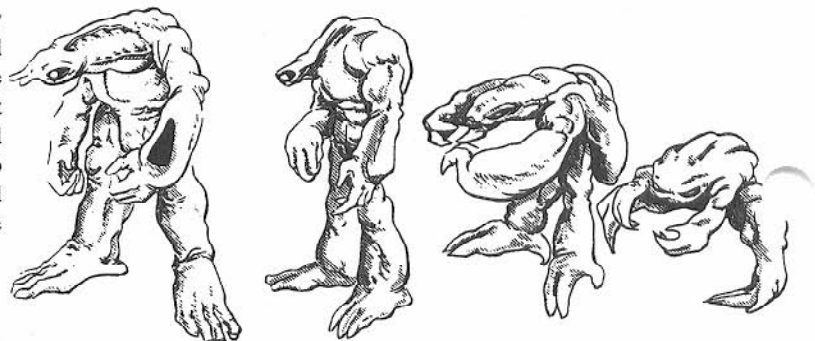



# THE INVID BRAIN

The Invid Brain serves as the Regent's generals, commanding and maintaining hive operations and directing the mindless inorganics. The inorganics are killing machines which the Regent uses to police the worlds he has conquered. The sole controlling force behind inorganic detachment is an Invid Brain.

The Invid Brain appears to be a protoplasmic mass of pink flesh. The organism is huge, measuring 20ft across (6.1m) and 12ft tall (3.6m). It is the brain, acting under the direction of the Regent, who delegates the many chores and responsibilities of the hive to the legion of invid under its command. The brain functions like a surrogate Regent, telepathically directing all operations in the area. For example, if the brain has been instructed to establish a protoculture farm and/or processing facility, it will spend all its efforts on establishing, maintaining and protecting that facility. If the prime directive is to suppress insurrection, it will focus on the hunting down and neutralization of all rebels who use protoculture or dare to oppose the invid. Likewise, it is the Invid Brain who coordinates genetic and biological experimentation on aliens, supervises and protects Genesis Pits and all daily routines and maintenance of the hive.

Other than the Regent or a specially appointed Red Enforcer, only the Invid Brain has the authority to revive invid pilots from stasis and place them in their mecha as it deems necessary. Only the Invid Brain (and Regent) has any real knowledge or skills such as medical/surgical, biology, genetics, mechanical and electrical. Like the Regent, the Invid Brain acts as the controlling intelligence of all other invid and inorganics. As a result, the brain can completely control 2D4 invid pilots, usually type four, to perform delicate skills. Or it may use one of the inorganics.

Unlike most invid, the brain has some rudimentary emotions and is capable of independent thought and decision making abilities. However, the emotions are somewhat repressed and the thought processes linear. Observations and decisions are colored by its alien perspective, which can sometimes blind it to the obvious. *For Example:* It will have difficulty recognizing and determining the exact purpose and function of unusual human devices. Consequently, while it is likely to recognize a vehicle, weapon or clothing, it will find a blender or microwave oven a complete mystery.

An Invid Brain commanding a hive is always nestled away, deep within the *Hive's Center*. Nearby will be the Invid Stasis Chamber. A dozen or more (12 plus 2D6) Enforcers are *always* present to serve and protect the brain. An additional 1D6 Enforcers, 1D6 Troopers and 1D6 Armored Scouts are nearby (will arrive in 4 melees/one minute). All will fight to the death to defend the brain. Intruders (any non-invid creatures) are automatically captured (to be interrogated by the brain), experimented on, or destroyed. Hostile forces are immediately destroyed or chased out of the hive. **G.M. NOTE:** The Invid Brain can instantly communicate with any and *all* of the invid under its command. Consequently, it can summon scores of invid to its aid in a matter of minutes. In a typical hive, the response would go something like this. **First Wave responds in 1D4 minutes:** 4D6 Invid Scouts, 4D6 Invid Armored Scouts, 4D6 Troopers, 4D6 Enforcers. **Second Wave responds 2D4 minutes later:** 1D4 × 10 Armored Scouts, 1D4 × 10 Scouts, 1D6 × 10 Troopers, 1D4 × 10 Shock Troopers, 4D6 Cougars, 2D6 Odean, 1D6 Scrim and/or Crann.

If the brain is destroyed, the hive will continue to function via automation. The invid forces of the hive will continue to act on the last few prime directives issued by the brain, but they will be unorganized and take no new initiatives on their own. The invid will function this way until a new brain is provided by the Regent or until a Red Enforcer appointed leader.

**Commander:** Controls the hive and directs the invid of that hive. Or controls inorganics from a secret place.

**Hit Points:** 600 S.D.C.: 200

**Alignment:** Aberrant; totally loyal to Regent and Invid life.

**Attributes:** I.Q. 17, M.A. 20, M.E. 20, no physical attributes.

**Physical Attacks Per Melee:** None, but can take two actions or make three commands per melee. **Special Attack:** In the last throes of death the Invid Brain can fling (via telekinesis) parts of its protoplasm essence on top of an opponent, covering him or her in glop. The gloppy covering will prevent movement and suffocate its victim. A person will pass out from lack of oxygen within six melees (1½ minutes) and *die* of suffocation within a total of 12 melees (3 minutes).

**Psionic Attacks Per Melee:** One per melee. *The Brain has the following psionic abilities:* **Telepathic Communication** (Invid Range: 300 miles/482km; human range: 300ft/91.5m), **Sense Protoculture Energy** (Range: 14 miles/22.5km), **Bio-Regeneration** (self; 2D4 × 10 hit points or 2D6 × 10 S.D.C. once every half-hour), **Levitation** (can lift itself or up to 4 tons straight up or down in the air, up to 300ft/91.5m high), **Telekinesis** (The ability to move objects with the mind. Can move weights of up to 100lbs/45kg. Range: 100ft/30.5m. Hurling objects between 1 to 20lbs do 1D6 damage, 25 to 50lbs do 4D6 damage, 55-100lbs do 1D4 × 10 damage. *All damage is S.D.C. damage.* Up to FOUR objects can be telekinetically controlled at one time), **mind block** (prevents the psychic probe of others) and **meditation**. **NOTE:** The telepathy and sense protoculture energy are automatic and natural. Thus, they do not count as one psionic action and can be done continuously throughout the melee. *Invid Telepathic Communication* is the ability to talk to another being in his head, sort of like a radio transmission. It does not include reading minds nor telepathic probes. *Sense Protoculture Energy* enables the Invid Brain to feel the presence of protoculture energy in use and pinpoint the exact number of protoculture devices in use and their general location (a 600ft/183m area). Protoculture energy does not radiate in detectable traces when the device/mecha is turned off. I.S.P. are not listed because the brain's power is effectively inexhaustible.

**Skills (equivalent to Earth skills):** Radio: Basic — 90%, T.V./Video — 90%, Basic Electronics — 90%, Basic Mechanics (very general) — 70%, Invid Mecha Mechanics — 80%, Medical Doctor (surgical) — 90%, Forensics — 70%, Pathology — 90%, Biology — 92%, Botany — 92%, Chemistry — 90%, Bionics (a special medical and biology skill) — 80%, Interrogation — 70%, Detect Ambush — 70%, Detect Concealment — 50%, Intelligence — 50%, Navigation (all) — 70%.

# INVID MECHA

## INVID MECHA TYPES

**Cougar:** Inorganic cat-like creation.

**Odeon:** Inorganic humanoid

**Crann:** Inorganic humanoid

**Scrim:** Inorganic humanoid

**Scout:** Piloted by stage one invid.

**Armored Scout:** Piloted by stage one invid.

**Trooper/Worker:** Piloted by stage two invid.

**Shock Trooper:** Piloted by stage two or three invid.

**Enforcer:** Piloted by stage four invid.

**Royal Hive Guards (Red Enforcers):** Stage four invid.

**Note:** The Regent does not have Pincer Command Units or Royal Command Battloids. These are the sole creation of the *Regis*. The Regent will send an Enforcer or Red Enforcer in their place. Likewise, the *Regis* does not have any inorganics, because they were specifically created by the Regent.

## Standard Sensors, Equipment and Notes for All Invid Mecha

### PROTOCOLTURE SENSOR

**Range:** One mile (1.6km). This is a powerful sensor that can register protocluture energy, indicate how many protocluture energy based targets there are (up to 40 individual targets) and their approximate location (within a 600ft/183m area). The sensor will also track each target, indicating general direction and approximate speed of travel.

**At close range,** 600ft (183m), the sensor can pinpoint the target's *exact location* and can track the energy behind walls, through buildings and even 100ft (30.5m) underground. The energy signal(s) is displayed on a radar-like screen, with each target indicated as a small yellow blip.

Although quite formidable, the sensor's Achilles' heel is that it can only register and track protocluture energy that is *in use* (even tiny amounts of protocluture, such as used in the Gallant handgun will register). This means if the protocluture device is *turned off* the signal disappears. The best the invid can do is fly over to the general location of the last reading and do a visual search. Since the invid do not understand human machinery (it all looks the same to them, except for size), a human could stop his cyclone mecha in the middle of a field, turn it off (stopping the protocluture signal) and run and hide in the woods to the side of the field. The invid may or may not notice the cyclone (probably not if it is camouflaged) and will have no idea where the human pilot may be hiding. If the cyclone is spotted, there is a chance the invid may recognize it and destroy it and/or do a more extensive search for the pilot. *See Perception Section under notes.*

### PROTOCOLTURE TARGETING SYSTEM

**Short Range:** 2000ft (609m); +3 to strike bonus.

**Medium Range:** 4000ft (1200m); +2 to strike bonus.

**Long Range:** 11,000ft (3350m or about 2 miles/3.2km); +1 to strike bonus.

The protocluture targeting system locks onto any target that is *actively using protocluture energy*. This would apply to the Alpha, Beta, Cyclone, Veritech Fighters (Macross VF series), Destroids (Macross and Sentinels), and protocluture powered spacecraft, vehicles and weapons. **Note:** *Southern Cross* mecha can use protocluture or fusion turbines. In fact, all non-transformable battroids rely only on fusion reactors and about half the remaining Southern Cross transformable mecha are fusion powered. That means the protocluture targeting system can **not** be used on them (no strike bonus). The same is true of the conventional combat vehicles, such as the Commanchero assault helicopter, jets and tanks. **Remember,** the strike bonus from this targeting system is only applicable to *protocluture powered* devices and mecha.

### OPTICAL ENHANCEMENT SYSTEM

The invid have a fairly unimpressive optics system. **Normal vision** is roughly equal to a human's, with a limited **telescopic magnification** capability that increases the range to about 1600ft (488m) with a 20ft (6.1m) field of vision and a 4x magnification. **Nightvision** is another feature which amplifies ambient light to give a visible picture. **Range:** 300ft (91.5m).

The invid see everything through a red haze, as if looking through a ruby filter. This is not to be construed to be infrared vision. The invid do **not** have infrared, ultraviolet, nor thermo-imaging optics/sensors. Only the stage five invid pilot and Regent have full color vision like humans.

### EXTERNAL AUDIO PICKUP

A sound amplification listening system. **Range:** 200ft (61m).

## COMMUNICATION

The invid do not use radio waves. Instead, telepathic transmissions are used to communicate. All invid can communicate among themselves up to a range of about 2000ft (609m). Only the Invid Brain and Regent have a much greater range. **Note:** The stage one and two invid pilots have no vocal cords and can **not** speak.

### NOTES

Invid Mecha do **not** have radar, infrared, thermo-imagers, motion detectors, or radio. Consequently, the invid lack the skill to use these devices.

Most invid spend their lives inside their mecha. The pilot's compartment is a life support system, complete with a life-giving *nutrient pool* in which the pilot sits completely immersed. The green nutrient fluid is derived from the processed husks of the Flower of Life. The only exceptions are the stage four invid pilots who can live in and out of the nutrient, and the type five invid humanoids who do not require the fluid. Of course, the Regent and Brain can function without need of the nutrient pool.

**Perception Factor (P.F.):** The ability to recognize the purpose of human machines. If recognized as a combat device, there is a 64% likelihood the invid will destroy it. (A roll of 65-00 means it just left it there, unharmed.)

**Invid Scout & Armored Scout:** P.F. 1-20%

**Trooper/Worker & Shock Trooper:** P.F. 1-24%

**Red Enforcer:** P.F. 1-52%

**Enforcer:** P.F. 1-40%

**Invid Brain:** P.F. 1-50%

**Crann:** 1-42%

All Other Inorganics: 1-20%

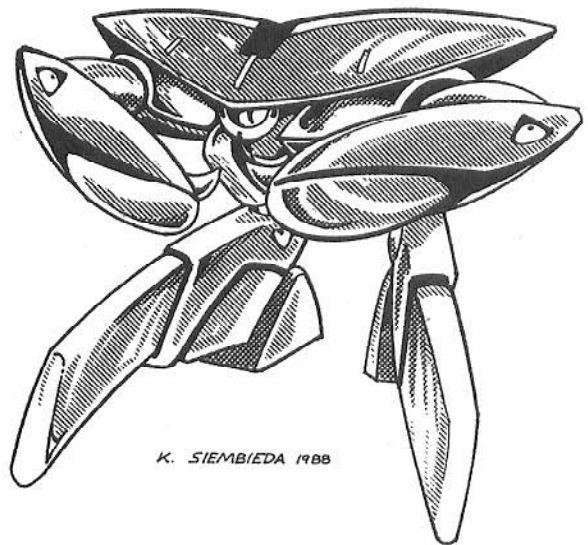

## THE INVID SCOUT

The most common Invid is the Invid Scout. Keeping with the analogy of bees, the Invid Scout is like the little worker bee, busily buzzing about in search of protocluture and enemies. Although the least capable in combat, the small red scout is astonishingly fast, maneuverable and fearless. The scout carries no long-range armaments, but its claws and forearm shield blades (the black design portion of the arms) can slice through an opponent with appalling ease.

The Invid Scouts randomly patrol the surface of the Earth, as well as sporadic patrols in space and around the moon. Whenever protocluture is found, the patrol zooms in to destroy it and its users. If strong resistance is encountered, one or two scouts will break away and speed off to get reinforcements. The remaining Invid Scouts will engage the

enemy and fight to their last dying breath. Reinforcements will usually include a shock trooper or pincer with 2D4 armored scouts (or regular scouts or troopers).

**Invid Scout (also known as "Tigaa")**

**Crew:** One; stage one invid pilot.

**M.D.C. by Location:**

- Hand/Claw (2) — 5 each
- Forearms (shields) (2) — 50 each
- Upper Arms (2) — 20 each
- Legs & Feet (2) — 25 each
- Main Engine Thruster (rear) (1) — 25
- \*Sensor Eye (1) — 10
- \*\*Main Body — 50
- Reinforced Crew Compartment — 20

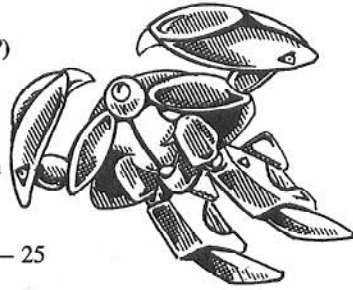

\*The sensor eye is the most vulnerable place on the invid's mecha body. Destruction of the sensor eye will kill/destroy the mecha and pilot (goes right through crew compartment). However, it is a small target protected by surrounding shielding, thus, to hit it the player/character must make a "called" shot and is -3 to strike.

\*\*Depleting the M.D.C. of the main body will shut the mecha completely down. Depleting the main body M.D.C. and crew compartment M.D.C. will blow the invid into pieces.

**Speed:** Flight: Stationary hover to 2345mph (3772kmph), maximum (Mach 3.5) with a 50 mile ceiling.

Flight: Cruising speed for reconnaissance: 60 to 150mph (96 to 240kmph).

Ground, Running: 40mph (64kmph).

Ground, Jumping: 100ft (30.5m).

**Height:** 8.3ft (2.5m)

**Width:** 12.3ft (3.75m)

**Length:** 10.7ft (3.25m)

**Weight:** 4.5 tons

**Cargo:** Can carry up to one ton.

**WEAPON SYSTEMS**

**Hand to Hand Only!**

Attacks Per Melee: Four

Hand to Hand Bonuses: +2 to strike, +3 to parry, +2 to dodge on the ground, +4 to dodge in flight, +6 to dodge at maximum speed (Mach 3.5), to roll with impact +1.

Related Abilities: Prowl — 45%, Detect Ambush — 40%, Detect Concealment — 30%, Track — 30%.

**Types of Attacks:**

**Punch/Claws** do 1D6 Mega-Damage (M.D.)

**Forearm Blade** does 2D4 M.D. (the black design area is a special concealed blade).

**Stomp** does 1D4 M.D., but the target must be 7ft (2.1m) tall or smaller. Kick attacks are not possible.

**Body Block/Ram** does 2D6 M.D., but counts as two attacks.

**Note:** The scout can wear a booster rocket for greater speed. See *Space Booster*.

# THE INVID ARMORED SCOUT

The Armored Scout enjoys the same popularity as the Invid Scout. Both are almost identical in every way, except that the armored scout is a little more durable and has a pair of plasma pulse blasters mounted on what appear to be shoulder plates. Otherwise, the two units, scout and armored scout, look identical.

The real difference is its combat capabilities. In addition to the hand to hand combat of the regular scout, the Armored Scout is equipped with plasma weapons, adding the versatility of distance attacks. Its body armor is somewhat heavier, making for a tougher combat unit, but without a loss of mobility. The design concept is to have a *small*, quick combat unit suitable for reconnaissance, defense and offense.

**Invid Armored Scout (also known as "Tigau")**

**Vehicle Type:** Combat and Reconnaissance

**Crew:** One; stage one invid pilot.

**M.D.C. by Location:**

- Hand/Claw (2) — 5 each
- Forearms (2) — 50 each
- Upper Arms (2) — 25 each
- Legs & Feet (2) — 25 each
- Main Engine Thruster (rear) (1) — 30
- Pulse Beam Cannon (2) — 30 each
- \*Sensor Eye (1) — 20
- \*\*Main Body — 70
- Reinforced Crew Compartment — 20

\*The sensor eye is the most vulnerable place on the invid's mecha body. Destruction of the sensor eye will kill/destroy the mecha and pilot (goes right through crew compartment). However, it is a small target protected by surrounding shielding, thus, to hit it the player/character must make a "called" shot and is -3 to strike.

\*\*Depleting the M.D.C. of the main body will shut the mecha completely down. Depleting the main body M.D.C. and crew compartment M.D.C. will blow the invid into pieces.

**Speed:** Flight: Stationary hover to 2345mph (Mach 3.5) maximum, with a 50 mile ceiling.

Flight: Cruising speed for reconnaissance is 60 to 150mph (96 to 240kmph).

Ground, Running: 40mph (64kmph).

Ground, Jumping: 100ft (30.5m) up or across.

**Height:** 9ft (2.7m)

**Width:** 12.3ft (3.75m)

**Length:** 10.7ft (3.25m)

**Weight:** 5 tons

**Cargo:** Can carry up to one ton.

**WEAPON SYSTEMS**

1. **Two Pulse Beam Cannons** (Plasma Energy) mounted on the top shoulder areas of the main body covering. Both plasma cannons are usually fired simultaneously as a dual system, but can be fired individually. Each cannon can move up and down in a 90 degree arc.

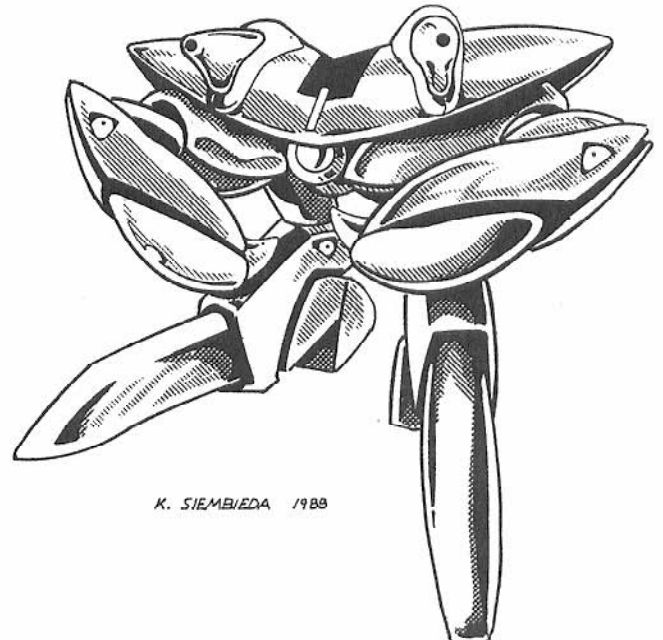

K. SIEMBIEDA 1988



**Primary Purpose:** Assault

**Range:** 4000ft (1200m)

**Mega-Damage:** One single blast 1D6 M.D. (rarely fired in single blasts), dual blasts 2D6 M.D. (two simultaneous shots are standard) or burst 4D6 M.D. (approximately 4 to 6 pulse blasts fired in bursts is typical of the invid armored scout. There is no need to determine if the burst is 4 or 6 pulses as the both do 4D6 M.D. as a burst).

**Rate of Fire:** Four attacks per melee. Dual blasts and bursts count as ONE attack.

**Payload:** Unlimited

**Bonuses to Strike with Beam Cannons:** +1; hand to hand bonus does not apply.

## 2. Hand to Hand Combat

**Attacks Per Melee:** Four

**Hand to Hand Bonuses:** +2 to strike, +3 to parry, +2 to dodge on the ground, +4 to dodge in flight, +6 to dodge at maximum speed (Mach 3.5), to roll with impact +1.

**Related Abilities:** Prowl — 45%, Detect Ambush — 40%, Detect Concealment — 30%, Track — 30%.

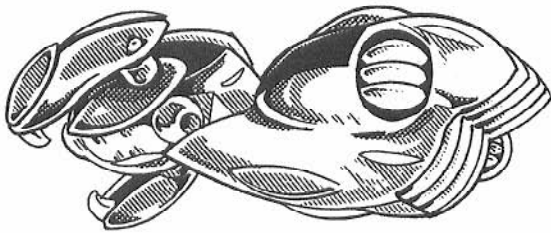

## SPACE BOOSTER (Optional)

### Exclusively used by the Scout and Armored Scout

The Invid Scouts can attach themselves to a booster rocket sled for even greater speed. The use of the booster rocket attachment is reserved for high speed space combat, pursuit or interception, and to escape the gravitational pull of a planet. For example, the space booster enables the invid scouts to break free of Earth gravitation, becoming a transatmospheric vessel able to rocket into space and return like a space shuttle.

#### Space Booster

**Vehicle Type:** Optional rocket system.

**Crew:** None; controlled by the invid scout pilot.

#### M.D.C. by Location:

Small Thrusters (2; one on each side) — 30 each

Main Thruster — 100

\*Main Body — 150

\*Depleting the M.D.C. of the main body will destroy the booster sled.

**Note:** Destroying *both* small thrusters will reduce the maximum speed by 25% and -1 to dodge. Destruction of the main thruster will reduce speed by 75% and -3 to dodge.

**Speed:** Flight: Increases the scouts speed to a maximum of 4020mph (Mach 6) in an atmosphere and to Mach 8 in space. **Bonuses:** +2 to dodge.

**Height:** 8ft (2.4m)

**Width:** 12.3ft (3.75m)

**Length:** 14.6ft (4.45m)

**Weight:** 3.5 tons

**Cargo:** None

**Weapon Systems:** None

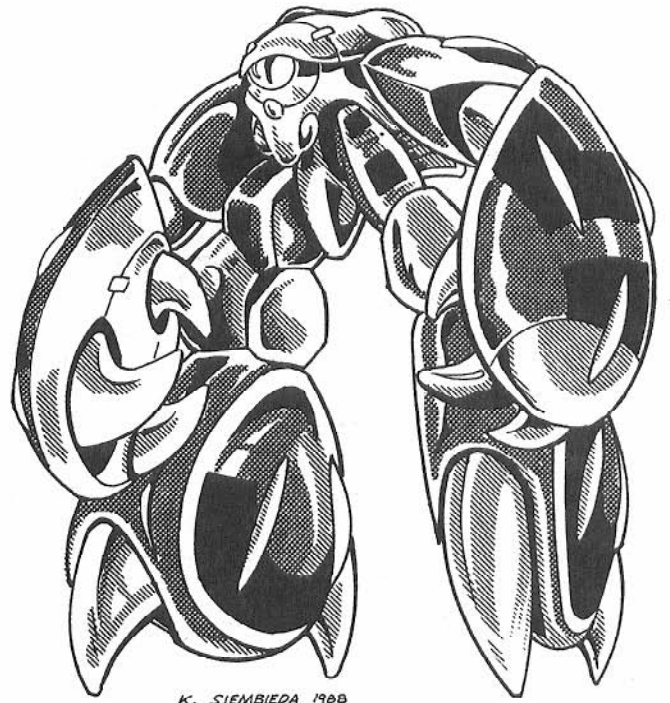

## THE INVID TROOPER

The trooper is a big, 16 and a half foot tall, purple brute who doubles as warrior and drone worker. Like all invid, the trooper can hover and fly, but it is much slower than the invid scouts. However, the trooper is physically tougher and stronger than its little brothers. Its huge clawed hands can cut through mecha like a knife cuts butter.

The trooper is often used to *capture* human rebels for enslavement, experimentation or interrogation, and to police and monitor towns of humans who are invid sympathizers, as well as to guard and work at protoculture farms and processing plants, patrol hostile areas, heavy labor and engage in combat. As the lumbering foot soldier and strongman of the Invid army, the trooper and shock trooper are the next most common of the invid mecha.

#### Invid Trooper/Worker (also known as "Gurab")

**Vehicle Type:** Combat and labor

**Crew:** One; stage two invid pilot.

#### M.D.C. by Location:

Hand/Claw (2) — 50

Forearm (shields) (2) — 80 each

Upper arms (shielded) (2) — 80 each

Legs & Feet (2) — 80 each

Rear Thruster (1) — 30

\*Sensor Eye (1) — 20

\*\*Main Body — 80

Reinforced Pilot's Compartment — 40

\*The sensor eye is the most vulnerable place on the invid's mecha body. Destruction of the sensor eye will kill/destroy the mecha and pilot (goes right through crew compartment). However, it is a small target protected by surrounding shielding, thus, to hit it, the player/character must make a "called" shot and is -3 to strike.

\*\*Depleting the M.D.C. of the main body will shut the mecha completely down. Depleting the main body M.D.C. and crew compartment M.D.C. will blow the invid into pieces.

**Speed:** Flight: Stationary hover to 300mph/(482kmph) maximum, with an altitude ceiling of about 10,000ft (3048m).

Ground, Running: 60mph (96kmph).

Ground, Jumping: 30ft (9.1m) up or across.

**Height:** 16.6ft (5m) **Width:** 13ft (4m) **Length:** 15ft (4.6m)

**Weight:** 10 tons **Cargo:** Can carry up to three tons.

### WEAPON SYSTEMS **Hand to Hand Only!**

**Attacks Per Melee:** Four

**Hand to Hand Bonuses:** +1 to strike, +3 to parry, +1 to dodge on the ground and in flight, +1 to roll with punch, fall or impact.

**Punch/Claw:** 3D6 Mega-Damage (M.D.)

**Crush with Hand:** 1D6 M.D.

**Body Block/Ram:** 2D6 M.D., but counts as two attacks.

**Stomp:** 2D6 M.D., but the target must be 10ft (3m) tall or smaller.

## THE INVID SHOCK TROOPER

The shock trooper is a "trooper" outfitted with two powerful plasma cannons attached to the main body above the shoulders. The cannons can swivel up and down in a 90 degree position, making them effective against ground and air attacks. The body is identical to the trooper/worker in every way.

The shock trooper is usually assigned to similar duty as its unarmed brother, with an emphasis on combat. This is the invid foot soldier.

### Invid Shock Trooper (also known as "Gurab")

**Vehicle Type:** Combat (labor, when necessary)

**Crew:** One; stage two invid pilot.

#### M.D.C. by Location:

Plasma Cannons (2) — 80 each

Forearms (2) — 80 each

Upper Arms (2) — 80 each

Legs & Feet (2) — 80 each

Reinforced Pilot's Compartment — 40

Rear Thruster (1) — 30

\*Sensor Eye (1) — 20

\*\*Main Body — 80

\*The sensor eye is the most vulnerable place on the invid's mecha body. Destruction of the sensor eye will kill/destroy the mecha and pilot (goes right through crew compartment). However, it is a small target protected by surrounding shielding, thus, to hit it, the player/character must make a "called" shot and is -3 to strike.

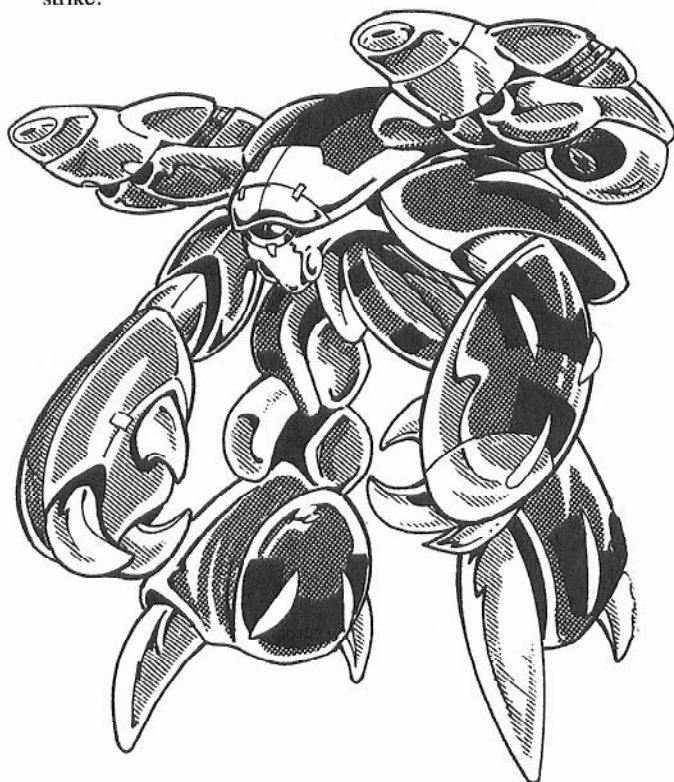

\*\*Depleting the M.D.C. of the main body will shut the mecha completely down. Depleting the main body M.D.C. and crew compartment M.D.C. will blow the invid into pieces.

**Speed:** Flight: Stationary hover to 300mph/482kmph maximum, with an altitude ceiling of about 10,000ft (3048m).

Ground, Running: 60mph (96kmph).

Ground, Jumping: 30ft (9.1m) up or across.

**Height:** 19ft (5.8m)

**Width:** 15ft (4.6m)

**Length:** 15ft (4.6m)

**Weight:** 11.5 tons

**Cargo:** Can carry up to three tons.

### WEAPON SYSTEMS

1. **Twin Plasma Cannons** exclusive to the Shock Trooper. One is mounted over each shoulder and can fire independent of each other or simultaneously. The plasma is fired in energy bolts often referred to as "annihilation discs." The plasma cannons can be positioned to point up or down in a 90 degree arc.

**Primary Purpose:** Assault

**Secondary Purpose:** Anti-Aircraft

**Range:** 4000ft (1200m)

**Mega-Damage:** One single blast — 2D6 M.D., two simultaneous blasts — 4D6, simultaneous burst — 6D6 M.D., one continuous stream (lasts entire melee, trained on one target) — 1D6 x 10 M.D., strafing run (wild burst shooting) — 2D6 M.D.

**Rate of Fire:** Four attacks per melee (equal to hand to hand). Two simultaneous blasts and bursts count as ONE attack.

**Payload:** Unlimited

**Bonus to Strike:** Only *protoculture targeting system* bonuses are applicable against protoculture powered devices. Hand to hand bonuses do not apply to energy weapons.

**Note:** The mouths of the twin cannons always glow white just before they are about to shoot.

### 2. Hand to Hand Combat

**Attacks Per Melee:** Four

**Hand to Hand Bonuses:** +2 to strike, +3 to parry, +2 to dodge on the ground, +4 to dodge in flight, +6 to dodge at maximum speed (Mach 3.5), to roll with impact +1.

**Related Abilities:** Prowl — 45%, Detect Ambush — 40%, Detect Concealment — 30%, Track — 30%.

## THE INVID ENFORCER

The Invid Enforcers are stage four invid pilots encased in a powerful exoskeleton of armor (power armor). Their main role is to "enforce" the will of the Regent. Unlike the lesser invid, the Enforcers are intelligent and capable of independent thought and decision making. They can command invid scouts, armored scouts, troopers, shock troopers and Inorganics.

It is the Enforcers who serve and aid the Invid Brains and the Regent. Consequently, they are also known as "Royal Hive Units" or "Hive Guards." However, their duties are not limited to the hive. An Enforcer may lead a reconnaissance patrol or assault team, or direct operations at a protoculture farm or slave camp. The Enforcers are also the invid's interrogators, surgeons (experimenting on humans) and technicians, handling all the more delicate and precision tasks. They act as direct contacts with invid sympathizers and help coordinate traps to capture/kill freedom fighters. It is also the Enforcers who operate the Genesis Pits.

Perhaps the most unusual aspect of the Enforcers is that the Invid Brain (and Regent) can seize complete control over a handful, like possession, and use them as extensions of itself. This is the process used for carrying out biological experiments and other scientific or delicate procedures.

As warriors, they appear deceptively small (7ft/2.1m), sluggish, and vulnerable. This is a clever ploy, as they are armored and have a number of hidden weapons at their disposal. Both arms house a concealed laser, a rifle-like weapon is a deadly bazooka type item and the shield, mounted on the arm or back, generates a force field that can absorb great amounts of damage. A jet thruster is built into the back, adding flight capability to the unit.

Despite the Enforcer's versatility, or perhaps because of it, they are found mostly in and around Invid Hives and Genesis Pits, and participants in special operations (usually as coordinators). One in every 1000 troopers or shock troopers will be an enforcer.

#### Invid Enforcer (also known as Hive Guards)

**Vehicle Type:** Power Armor

**Crew:** One; stage four invid pilot

#### M.D.C. by Location:

Hands (2) — 5 each

Forearms (laser concealed within) — 20 each

Upper Arms (2) — 20 each

Legs (2) — 30 each

Jet Thruster (rear) — 20

Energy Rifle (1) — 10

Energy Shield — 150

\*Head & Sensor Eye — 20

\*\*Main Body — 50

**Note:** No reinforced pilot's compartment.

\*The sensor eye is the most vulnerable place on the invid's mecha body. Destruction of the sensor eye will kill/destroy the mecha and pilot (goes right through crew compartment). However, it is a small target protected by surrounding shielding, thus, to hit it, the player/character must make a "called" shot and is -3 to strike.

\*\*Depleting the M.D.C. of the main body will shut the mecha completely down. Depleting the main body M.D.C. and crew compartment will blow the invid into pieces.

**Speed:** Flight: Stationary hover to 200mph/321kmph, with a maximum altitude of about 6000ft (1828.8m).

Ground, Running: 30mph (48kmph).

Ground, Jumping: 30ft (9.1m) without boosters, or 100ft (30.5m) up or across with a boost from jet thrusters.

**Height:** 7ft (2.1m)

**Width:** 4ft (1.2m)

**Length:** 3ft (.9m)

**Weight:** 500lbs (226kg)

**Cargo:** Can carry up to one ton.

#### WEAPON SYSTEMS

**1. Concealed lasers in forearms:** Two small lasers are built into the arms of the Enforcer power armor. Both are fixed in one position, able to shoot only in the direction the arm is pointed. Destruction of the forearm (20 M.D.) destroys the laser.

**Primary Purpose:** Defense

**Range:** 500ft (152m)

**Mega-Damage:** A single blast does 2D6 M.D. or a burst doing 3D6 M.D.

**Rate of Fire:** Equal to hand to hand melee attacks (three per melee). A burst is considered one attack, but is not as accurately fired as a single aimed shot. See *Modern Weapon Proficiencies*.

**Payload:** Unlimited

**Bonus to Strike with the Concealed Lasers:** +2 to strike at all times against any target, protoculture powered or not. Add the bonuses for the *protoculture targeting system* when up against protoculture powered enemies.

**2. Energy Rifle:** The Enforcer Energy Rifle is used exclusively by the Enforcers. The rifle is attached to the right arm where it can draw energy from the enforcer's power armor. When not in use, the rifle is attached to the back.

**Primary Purpose:** Assault/defense

**Range:** 2000ft (609m)

**Mega-Damage:** 4D6 M.D. per blast or a burst doing 5D6 M.D.

**Rate of Fire:** Equal to hand to hand melee attacks (three per melee).

A burst is considered one attack, but is not as accurately fired as a single aimed shot.

**Payload:** Unlimited

**Bonuses to Strike with the Rifle:** +2 to strike at all times against any target, protoculture powered or not. Add the bonuses for the *protoculture targeting system* when up against protoculture powered enemies.

**3. Energy Shield:** A large, round energy shield is standard issue for the Enforcers. It can be stowed on the back or held in hand (usually left hand).

**Primary Purpose:** Defense

**Range:** Self/hand to hand

**Mega-Damage:** Can be used to hit or ram an opponent. Damage is same as hand to hand.

**Special Features:** M.D.C. of shield is 150. Adds a bonus of +3 to parry and can be used to parry/block energy blasts and mini-missiles. Size: 4ft (1.2m) round. M.D.C. capability (150 M.D.C.) can be recharged at a rate of 20 M.D.C. per hour. **Note:** The shield can not function unless attached to the body armor. The Enforcer armor can NOT be modified for human use.

#### 4. Hand to Hand Combat

**Attacks Per Melee:** Three (3)

**Hand to Hand Bonuses:** +2 to strike, +2 to parry (+5 with shield), +2 to dodge on the ground, +4 to dodge in flight (both are normal dodges), +4 to roll with punch, fall or impact.

**Types of Attacks**

**Punch:** 1D4 Mega-Damage (M.D.)

**Power Punch:** 2D4 M.D. (counts as two attacks)

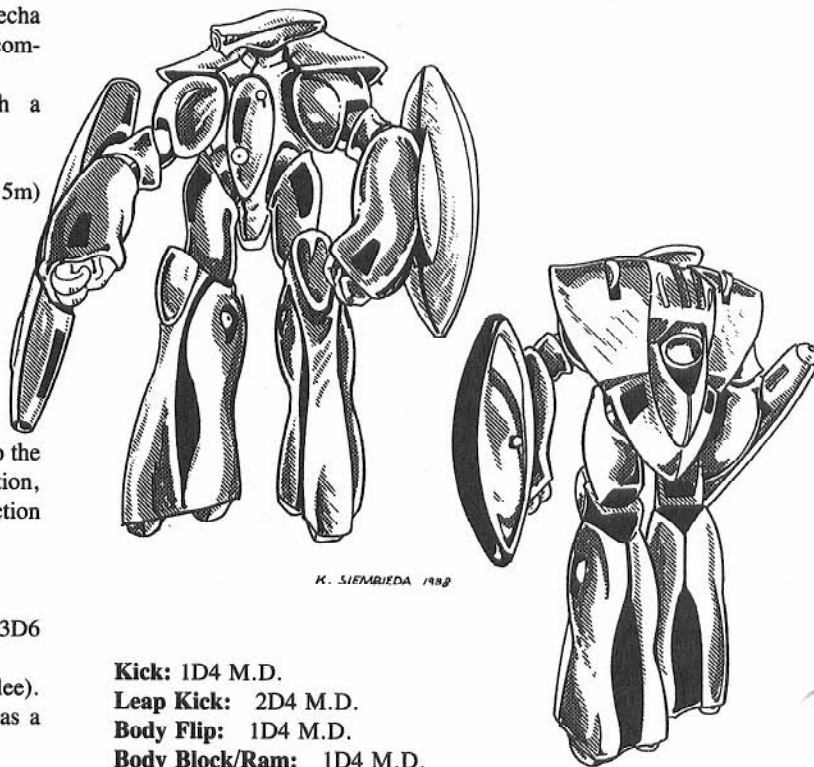

**Kick:** 1D4 M.D.

**Leap Kick:** 2D4 M.D.

**Body Flip:** 1D4 M.D.

**Body Block/Ram:** 1D4 M.D.

**Hand Crush/Squeeze:** 1 M.D. (100 S.D.C.)



# THE RED ENFORCERS

The Red Enforcers are the elite Royal Hive Guards (stage four pilots) and aides to the Regent. They are *identical* to the regular Enforcers (grey and black color), with the exceptions of size (twice as large), M.D.C. and rank.

## M.D.C. by Location:

Hands — 20 each  
Forearms (2) — 40 each  
Upper Arms (2) — 40 each  
Legs (2) — 50 each  
Jet Thruster (rear) — 30  
Energy Rifle (1) — 10

Energy Shield (1) — 150  
Head & Sensor Eye — 40  
Main Body — 100  
**Height:** 14ft (4.3m)  
**Width:** 6ft (1.8m)  
**Length:** 5ft (1.5m)  
**Weight:** 1000lbs (453kg)

## OTHER INVID VEHICLES

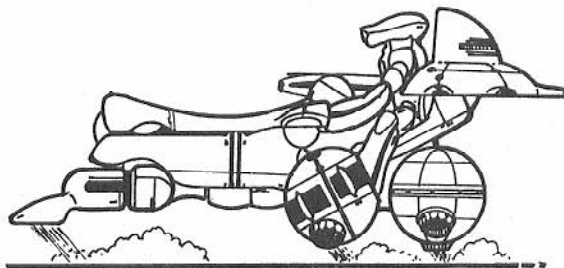
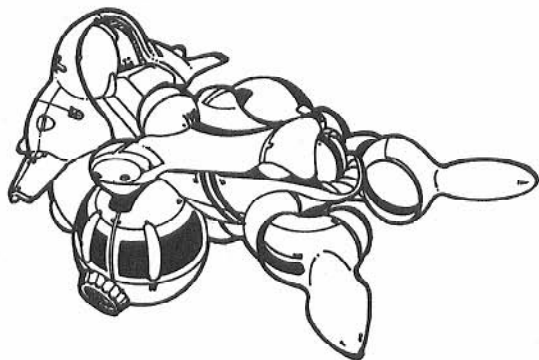

## THE INVID ASSAULT SPEEDER

The Red Enforcers are the pilots of the Invid Assault Speeder. An incredibly fast and maneuverable hover jet propelled vehicle suitable for all terrains, including space. The bizarre speeder has no weapons, but is designed for precision flying and ramming/sideswiping attacks.

**Vehicle Type:** Assault/transport

**Crew:** One stage four invid pilot.

### M.D.C. by Location:

Headlights (2) — 10 each  
Front Jets (2) — 100 each  
Rear Jet Spheres (3) — 200 each  
Front End — 200  
Front End Force Field — 200  
Cockpit Force Field — 100  
\*Main Body — 400

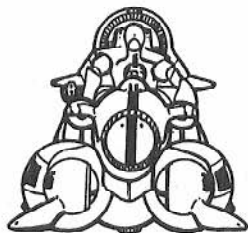

\*Depleting the M.D.C. of the main body will completely destroy the vehicle.

**Speed:** Jet Mode: (maximum speed) Mach 2.3 (1541mph/2465kmph).

Cruising Speed: About 600mph (960kmph). Can also hover stationary and make vertical take-offs and landings.

Underwater: Max. Speed is about 200mph (240kmph)

Space Propulsion: Mach 4

**Range:** Unlimited; protoculture powered.

**Height:** 12ft (3.7m)

**Width:** 5.5ft (1.7m)

**Length:** 24ft (7.3m)

**Weight:** 6 tons

**Cargo:** Not really designed for cargo, but can carry or pull up to 1000lbs. There is enough room for two human size passengers to squeeze into it.

## WEAPON SYSTEM

1. **Heavily Armored Front End and Force Field** enables the vehicle to plow right into or through an opponent. The head and limbs are usually the targets of these rams and sideswipes. The self-renewing force field prevents the vehicle from suffering any damage from

ram attacks. Note that the force field does NOT protect the main body. The open cockpit is protected by an invisible force field (limited to a total of 100 M.D.C.).

**Primary Purpose:** Elite transport

**Secondary Purpose:** Assault

**Range:** Body contact/hand to hand.

**Mega Damage:** Damage varies with the speed of the blow. Speeds under 100mph — 1D4 × 10 S.D.C., speeds 100 to 300mph — 3D6 M.D., speeds 301 to 600mph — 6D6 M.D., speeds Mach 1 to Mach 1.5 — 1D6 × 10 M.D., speeds Mach 2 — 2D6 × 10 M.D.

**Rate of Attack:** Two per melee

## INVID RETRIEVAL DRONE

The retrieval drone is a smallish, disc shaped object that resembles a flying saucer (seen in T.V. Episode #72). The hover vehicle is completely domed, with five triangular protrusions around its rim. These protrusions contain retractable arms for touching and grasping small items. The bottom of the disc is yellow, with a diamond mosaic pattern. This is the directional antigravity generator that creates a tractor beam for the retrieval of invid mecha and other items. Its main function is to retrieve invid mecha and invid pilots to be awakened from stasis. They are seldom seen outside the hive.

**Invid Retrieval Drone (also known as "Aiga" or The Disc).**

**Vehicle Type:** Labor and transport.

**Crew:** One; stage one invid pilot.

### M.D.C. by Location:

Retractable Arms/Hands (5) — 5 each  
Arm Housings (5) — 10 each  
Tractor Beam (bottom) — 40  
\*Main Body (domed top) — 50  
Reinforced Pilot's Compartment — 40

\*Depleting the M.D.C. of the main body will completely shut down the vehicle. Destroying the antigravity tractor beam will cripple the vehicle, preventing flight or movement.

**Speed:** Flight: Stationary hover to 60mph (96km) maximum. Altitude is limited to 300ft (91.5m) above any surface.

Ground movement other than hover/flight is impossible.

**Height:** 10ft (3m)

**Width:** 15ft (4.6m)

**Length:** 15ft (4.6m)

**Weight:** 4 tons

**Cargo:** Up to 30 tons can be held and carried in the tractor beam. To break out of the tractor beam, the vehicle/mecha must have a

thrust of 300mph or greater (482km).

**Weapon Systems:** None

## SPECIAL EQUIPMENT

1. **Antigravity Tractor Beam** is emitted from the bottom of the glowing yellow disc. The invisible tractor beam can pickup and carry up to 30 tons, with a size limit of about 80ft (24.4m). The beam is strong, but not so strong as to be inescapable if caught in it. Any vehicle that can travel at speeds of 300mph (482kmph) or faster can easily break free of the tractor beam within 1D4 melees of effort. It is important to note that the retrieval drone is rarely used to gather living or moving items. Furthermore, the stage one invid pilots are not capable of independent thought or reasoning. Thus, they will not react against an intruder or hostile force unless ordered to do so. This means that a retrieval drone will continue to perform its duty even with combat going on all around it. It will not sound an intruder alert unless it is attacked directly.

**Primary Purpose:** Mecha and pilot retrieval from stasis for activation.

**Secondary Purpose:** Cargo hauler.

**Mega-Damage:** None, no weapons.

2. **Five Retractable Arms** are located along the rim. The arms are used for grasping. They have no mega-damage strength and are not suitable for combat.

**Actions Per Melee:** Six

**Length of Reach:** 30ft (9.1m)

**Damage Capabilities:** (S.D.C.) Hit/Punch — 2D6 S.D.C., Crush/Squeeze — 6D6 S.D.C. Can lift and carry 500lbs (226kg) each.

## INVID TROOP CARRIER

The invid troop carrier is a large, clam shaped, flying saucer-like vehicle designed for flight in space, atmosphere and even underwater. Its three huge rear thrusters give it enough power and speed to easily breach Earth's atmosphere. An antigravity system controlled by the four domes seen on its top, provides maximum maneuverability and power. The bizarre transport vehicle opens like a clam to release its 200 plus troops.

**Invid Troop Carrier (also known as the Clam Ship)**

**Vehicle Type:** Troop transport.

**Crew:** Four stage four invid pilots in full enforcer armor. Only one pilot is needed, the other three are back-up.

**M.D.C. by Location:**

Maneuvering Jets (12 small) — 100 each

Maneuvering Jets (4 large) — 200 each

Main Thrusters (3 rear) — 500 each

Antigravity Domes (4) — 300 each

\*Main Body — 2000

**Note:** No reinforced pilot's compartment.

\*Depleting the M.D.C. of the main body will completely destroy the troop carrier. Destroying all 4 of the antigravity domes will reduce speed by 30% and allow for forward movement only.

Destruction of the three main thrusters will reduce speed by 70%.

**Speed:** Flight: Stationary hover to Mach 10.

Has full trans-atmospheric capabilities.

Flight: Cruising speed is about Mach 1.

**Height:** 110ft (33.5m)

**Width:** 500ft (152.4m)

**Length:** 600ft (183m)

**Weight:** 140 tons

**Cargo:** 250 scouts or armored scouts, or . . .

200 troopers or shock troopers, or . . .

140 Pincers or Royal Command Battloids

**Weapon Systems:** None

**Special Bonus:** +6 to dodge (automatic like parry).

## ALL-TERRAIN INVID ASSAULT CARRIER

The Regent, his royal guard (red enforcers) and stage four invid pilots/enforcers are housed in an all-terrain vehicle that looks more like a humungous insect than a spacecraft. The Scorpion, as it's called by the REF, has two monstrous weapon appendages that resemble heads. Each can fire a laser bolt that can tear a spaceship in half. Shorter range energy beams are also fired from the eye-like portals.

Its twin scorpion tails are actually laser cannons, but can also be used like gigantic swords to cut open the hull of an enemy vessel or swat down mecha. Its eight legs provide all-terrain land capabilities.

There are only a handful of "Scorpion" vessels in the invid's fleet, perhaps as few as 200. The Regent commands one (about 20% larger than the others), while the others are commanded by invid brains and a legion of invid troops, much like a hive in space.

**Invid All Terrain Assault Carrier**

(Also known as the "Scorpion")

**Vehicle Type:** Assault and transport

**Crew:** Piloted by six stage four invid pilots in full enforcer armor.

Two operate the weapon heads, one the laser tails. 1D6 red enforcers to help supervise and direct troops and *one invid brain*.

**Typical Troops:**

1D4 × 10 Red Enforcers (each has a speeder)

2D4 × 10 Enforcers

3D4 × 10 Armored Scouts

3D4 × 10 Shock Troopers

1D6 × 10 Odeons

1D6 × 10 Scrims

4D6 Cranns

4D6 Cougars

**M.D.C. by Location:**

Weapon Head Necks (2) — 2000 each

Weapon Head Main Lasers (2) — 4000 each

Weapon Head Secondary Lasers (2 each head) — 300 each

Tail Lasers (2) — 1000 each

Observation Deck (1, center of head) — 2000

Legs (8) — 800 each

Bottom Thrusters (12) — 400 each

Dome Hangar (top) — 2000

Air Hatches (10) — 100 each

\*Main Body — 40,000

\*Depleting the M.D.C. of the main body destroys the vessel.

Note: The Regent's spacecraft can generate a protective force field, adding an additional 20,000 M.D.C.

**Speed:** Ground: 200mph maximum (320kmph)

Sublight: .16 the speed of light.

Conventional Speed: Mach 10; about Mach 5 in an atmosphere.

**Height:** 145ft (44.2m)

**Width:** Body only — 180ft (54.9m), overall — 240ft (73.1m).

**Length:** 492ft (150m)

**Weight:** 100,000 tons

**Note:** Protoculture powered.

**WEAPON SYSTEMS**

**Total Combined Attacks Per Melee:** Eight; any combination of weapons can be used.

1. **Weapon Heads** are located on either side of what appears to be a third, center, head (observation deck). Each is a powerhouse assault system. The devastating main lasers (identical to the forward laser of the REF's Ikazuchi carriers) fire when the head opens like a gaping maw. The secondary laser ports are the two eye-like areas. These can fire only when the maw is shut.

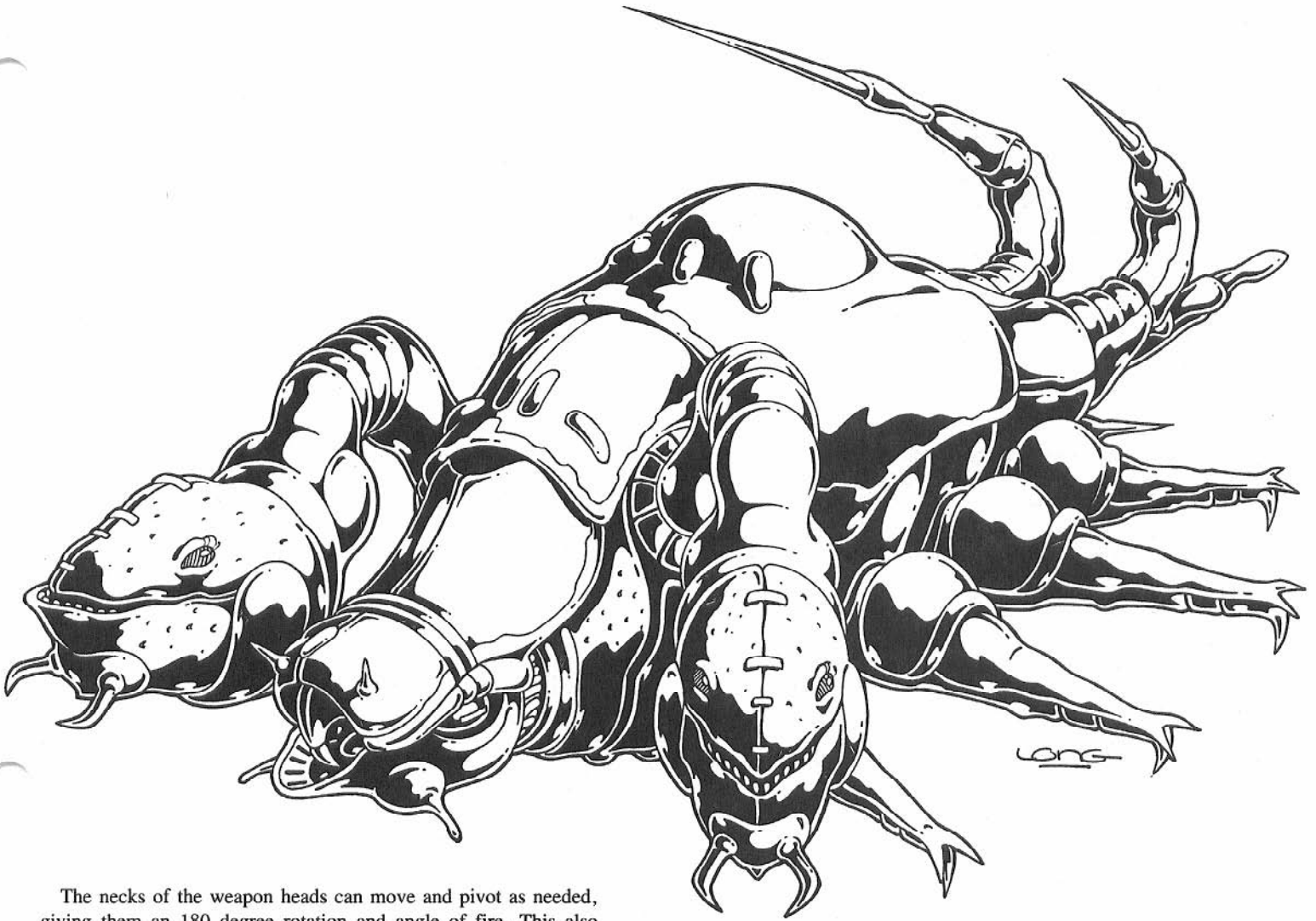

The necks of the weapon heads can move and pivot as needed, giving them an 180 degree rotation and angle of fire. This also enables the heads to attempt to dodge an attack (+2 to dodge).

**A. Main Laser** of the weapon head. Must open its jaw to fire.

Primary Purpose: Assault

Secondary Purpose: Anti-spacecraft

Range: 100,000 miles (160,000km); double in space.

Mega-Damage: 1D4 × 1000 M.D.

Rate of Fire: Each head can fire once every other melee. The weapons are operated individually and can not fire a simultaneous volley, although both can shoot at the same target. A common strategy is to fire one in alternate melees, providing one heavy laser blast each melee rather than two every other melee.

Payload: Effectively unlimited.

Note: As with all of these big guns, they are most effective against other large spacecraft or leveling cities. They are quite ineffective against small targets under 100ft (30.5m) in size.

**B. Secondary Eye Lasers** can be fired from both weapon heads when the main lasers are not being used and the maw is shut.

Can fire straight ahead or along a 45 degree angle.

Primary Purpose: Assault

Secondary Purpose: Defense

Range: 50,000 miles (80,000km) in space, but only 20,000 miles (32,000km) in atmosphere.

Mega-Damage: 2D4 × 100

Rate of Fire: Equal to the total attacks per melee.

Payload: Effectively unlimited.

Bonuses: +2 to strike.

**2. Laser Tail Cannons** comprise the rear defense. The tails are very maneuverable and can point over the top of the vehicle, underneath, directly to the rear and side to side.

In addition to firing a laser beam, the tails can be used like gigantic swords to impale or slice an enemy. This tactic can be used against large spacecraft or small mecha like the veritech fighters.

Primary Purpose: Defense

Secondary Purpose: Assault

Range: 8 miles (12.8km)

Mega-Damage: Single blast — 2D6 × 10 M.D.; volley — 4D6 × 10 (counts as one attack, but has no bonuses to hit).

Rate of Fire: Up to eight times; limited by the total number of attacks.

Payload: Effectively unlimited

**3. Hand to Hand Combat** using the tails as blades.

Number of Attacks: Equal to the total number of ship attacks (8 possible)

Mega-Damage: 3D4 × 10 stab/puncture

2D4 × 10 slice/swat

1D4 × 10 stomp by leg; effective against objects 20ft (6.1m) tall or smaller.

Bonuses: +2 strike, +4 to parry, +4 to dodge, +1 on initiative.



# THE INORGANICS

The inorganics are marvels of Invid alchemy; non-living, robot-like creations that serve as an army of killing machines. Since the inorganics are not alive, they do not feel emotions or pain. There is no hesitation in combat because they do not fear destruction. There is no doubt, no remorse, no random thoughts to distract them. They are simple machines. And like any weapon, they respond to the commands of their operator. In this case the operator is the insane Regent, or his loyal Invid Brain, and the weapon; an army of drones. Robots of doom that will not stop until they have accomplished their mission of destruction. Or until the one who commands them is slain.

The inorganics entire design is dedicated to the extermination of humanoids, with Robotech Masters and Zentraedi largely in mind. Inorganics are primarily used for preliminary reconnaissance assaults to test the strength of an enemy, extermination (seek and destroy), and as an occupation force on conquered worlds.

As a **preliminary strike force**, the creatures are directed at a specific target so that the Regent can observe and assess the strength of his opponent. All these inorganics will fight till destroyed. Shortly afterward, the Regent will send in his true invid troops, along with a much more formidable inorganic army. The initial reconnaissance test force of inorganics may be a few hundred or several thousand, depending on how many the Regent believes will require an accurate measure of his enemy.

An **extermination patrol** of inorganics is usually sent out to eliminate guerilla fighters, enemy patrols, and secret users of protoculture. The squad is divided into two units. The first is composed of several cougars that run ahead to sniff out the enemy. When the cougars find their target, they will attack immediately. Meanwhile, the second half of the patrol will arrive moments later (1D6 minutes) to destroy the enemy. This will include odeons, scrimms, and cranns. A **typical small patrol** will consist of 1D6+1 cougars, 2D4 odeons, 2D4 scrimms and 1D4 cranns. A **large extermination patrol** will consist of at least 3D4 cougars, 4D4 odeons, 4D6 scrimms, and 2D4 cranns. There is also a 50% chance that a large patrol will be accompanied by an Enforcer (probably in an assault speeder), two armored scouts and 1D4 shock troopers.

An occupation force could number into the tens of thousands; 20% will be cougars, 35% odeons, 35% scrimms and 10% cranns. The director of operations will be Invid Brains strategically placed, each with its own force of inorganics. Typically, one Brain will control all the inorganics within a 1000 mile (1600km) area and send patrols out another 1000 miles beyond that. Although its forces may cooperate with an Invid hive command base, the Brain of an inorganics policing force is expected to act independently. For this reason the Brain will not be found in a hive, but hidden in some inconspicuous ruin. Underground locations seem to be their favorite (65%), but this is not always the case. An inorganic command brain could select any location, from a barn to a skyscraper.

Wherever the brain may be hidden, it will always be protected. Outside, within a 2000ft (609m) area, will be 1D4+1 cougars on patrol. If a cougar spots an interloper the brain is instantly alerted. If the intruder(s) possesses any protoculture or weapons, he is immediately attacked by the cougar. Meanwhile, inside its hiding place, the invid brain is preparing its defense and summoning other inorganics to come to its aid. It is almost impossible to surprise an invid brain because it sees, hears, and feels *everything* any of its inorganics experience. Thus, if a group of cyclone riders is spotted prowling around, the brain knows this and prepares a defense or attack. **If the brain is destroyed**, all of the invid under its control become instantly inoperative and collapse. They will remain immobile until a new invid brain is brought in to control them.

There are always several invid around the brain at all times. Typically, this inner sanctum of troops contains 2D4 enforcers, 1D4 shock troopers, 2D6 odeons, 2D6 scrimms, and 1D4 cranns. An additional 2D6 cougars, 4D6 odeons, and 4D6 scrimms will arrive in 1D4 minutes and another FIVE times as many (plus 3D6 cranns) can arrive within 4D6 minutes. **Total Troops** per 1000 mile (1600km) region will vary greatly depending on the amount of enemy resistance. 1D6 × 1000 is fairly common, but many more could be present in a turbulent territory.

**Note:** When an inorganic occupation force has been left behind to police a territory, there will be few invid hives or invid troops in the area or on the entire planet (probably no more than four or five thousand).

The policing of slave planets is a reign of terror. Policy is simple: Anybody found breaking the laws set forth by the Regent is found and terminated. If spitting on the sidewalk is a crime, the perpetrator is executed on the spot. There is no judge or jury, no warning or fine, only the swift, deadly enforcement of the Regent's will. Crimes against the Regent include the use of protoculture, rebellion, aiding or harboring rebels, attacks against inorganics or invids (even rock throwing), vandalism, failure to obey a command, communication with off-worlders, and similar. All are punishable by death.

Although inorganics resemble mecha, they are not mecha and they are not constructed of metal. They are hollow exoskeletons created from an unknown alchemical substance. When destroyed (all main body M.D.C. is depleted), the body and all remains crumble into dust.

## THE COUGAR

The cougar resembles a mechanical prehistoric saber-toothed tiger and functions much like the feline predator. The monstrous cat can sense protoculture and can zero in on its source like a bloodhound. It can also track humanoid prey by smell.

**Cougar Invid Inorganic (also known as "Hellcat")**

**Crew:** None; robot-like automaton linked to and directed by an Invid Brain.

**M.D.C. by Location:**

\*Head — 50  
Legs (4) — 30 each  
Tail — 10  
\*\*Main Body — 60

\*Depleting the M.D.C. of the head will knockout the creature's sensory system, preventing it from tracking or seeing; -8 to strike, parry and dodge.

\*\*Depleting the M.D.C. of the main body will completely destroy it, crumbling into dust.

**Speed: Running:** 160mph (256kmph)

**Climbing:** Excellent; equal to a skill of 90%, reduce speed by half.

**Leap:** 80ft (24.4m) high or lengthwise.

**Swimming:** 40mph (64kmph)

**Space:** Although it has no means of propulsion, it can function in space and without air.

**Note:** The cougar does not breathe and can not be affected by gases, drugs, or stun blasts.

**Height:** 4ft (1.2m) at the shoulders

**Width:** 3ft 6in (1m)

**Length:** 7ft (2.1m)

**Weight:** 1200lbs (544kg)

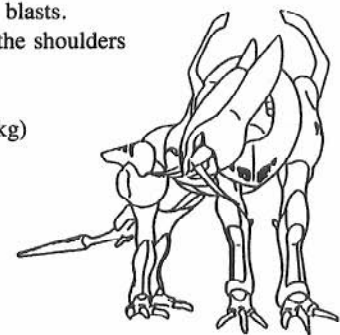

# COUGAR INORGANIC

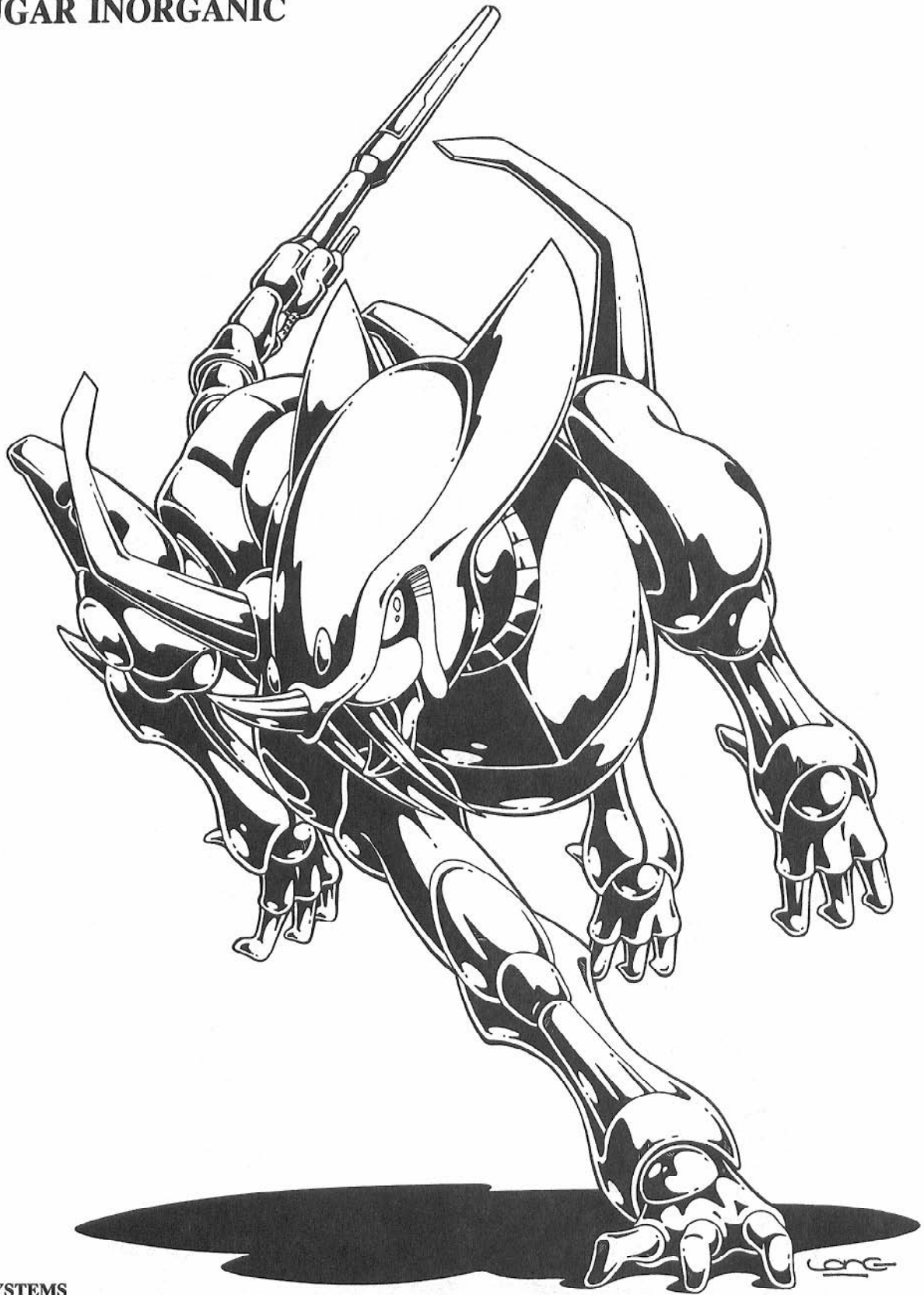

## WEAPON SYSTEMS

### 1. Hand to Hand Combat Only

Attacks Per Melee: Five

Mega-Damage: Bite — 1D6 M.D.

Swatting Blow — 1D6 M.D.

Full Strength Claw — 3D6 M.D.

Leap attack, clawing with all 4 claws — 1D4 × 10  
(counts as two attacks).

Bonuses: +4 to strike, +4 to parry, +6 to dodge, +4 on initiative  
and +2 to roll with punch, fall or impact.

### Special Sensors and Abilities:

The usual invid sensors plus:

Tracking: Humanoid, mecha, or land vehicle — 70%

Tracking: Protoculture powered mechanism — 88%

Land Navigation — 90%

Prowl — 70%

Nightvision (passive night sight) — 2000ft (609m)

External Audio Pickup — Range: 300ft (91.5m)

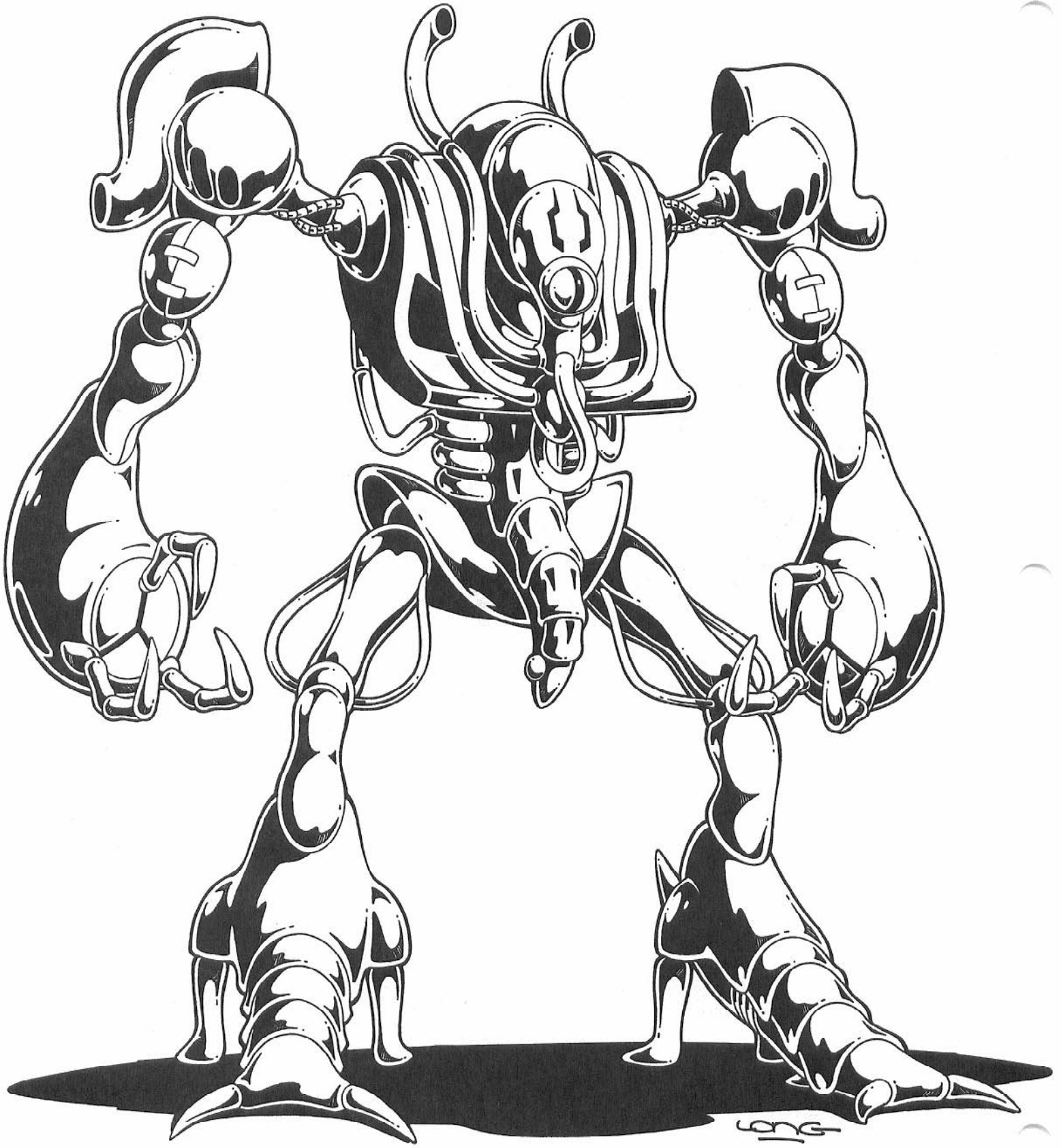



# THE ODEON

One of the most common inorganics is the Odeon, a humanoid with a huge barrel chest, slender insect legs, twisted arms and one unblinking eye. The Odeons are used for labor, construction, and intricate work in addition to being a frontline assault unit.

Unlike the incredibly agile and quick cougar, or crann, the Odeon is a lumbering, but seemingly unstoppable giant. To augment its poor hand to hand capabilities, the Odeon can operate a powerful hand-held blaster. Odeons are the slowest of all the inorganics, but are also nearly indestructible. They can endure a frightening amount of damage without slowing their telltale plodding gait. They could be thought of as the armored (tank) division of the invid's zombie legions.

## Odeon Invid Inorganic

**Crew:** None; a robot-like automaton linked to and directed by an Invid Brain.

### M.D.C. by Location:

Hands (2) — 75 each  
 Arms (2) — 200 each  
 Legs (2) — 300 each  
 \*Head — 300  
 \*\*Main Body — 600  
 Handgun — 150

\*Depleting the M.D.C. of the head will blind the creature, but it retains other artificial senses so the penalties are only -4 to strike, parry, and dodge.

\*\*Depleting the M.D.C. of the main body will completely destroy it, crumbling into dust.

**Speed:** Running: 40mph (64kmph)

Climbing: Good; equal to a skill of 70%.

Leaping: 10ft (3m) high or lengthwise.

Swimming: 5mph (8kmph)

Space: Although it has no means of propulsion, it can function in space and without air.

Note: Gases, drugs, disease or stun blasts have no affect on it. The Odeon, like all inorganics, is not alive.

**Height:** 17ft (5.2m)

**Width:** 8ft (2.4m)

**Length:** 4ft (1.2m)

**Weight:** 3,200lbs (1452kg)

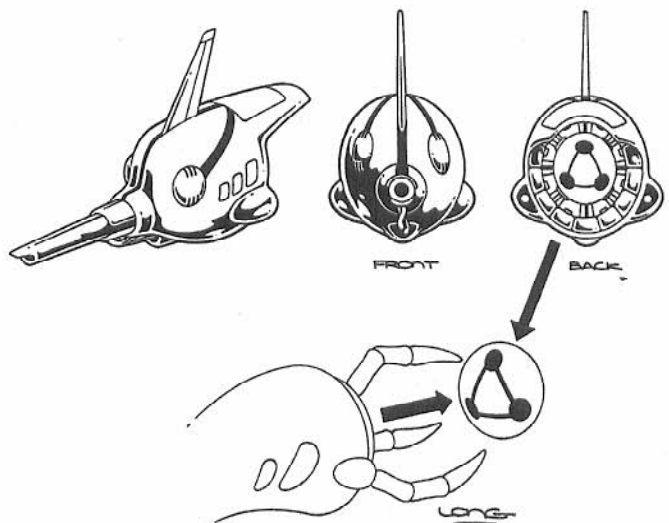

## WEAPON SYSTEMS

### 1. Hand to Hand Combat

Attacks Per Melee: Two

Mega-Damage: Swatting Punch — 1D4 M.D.

Full Strength Punch — 3D6 M.D.

Crush — 2D6 M.D.

Tear/Pry — 1D6 M.D.

Kick — 2D6 M.D.

Stomp — 1D6 M.D.; effective only against small objects (7ft or smaller)

Bonuses: +2 to strike, +2 to parry (no dodge bonus), and +2 to roll with punch, fall or impact. Strength is equal to P.S. 40 (+25 S.D.C. damage).

Note: It has all the same sensory equipment as the invid mecha.

2. **Tri-Finger Laser:** The weird looking laser weapon fits right onto the Odeon's fingers like holding a bowling ball. It is a very powerful weapon.

Primary Purpose: Assault

Range: 4000ft (1200m)

Mega-Damage: Three settings — 2D6 M.D., 4D6 M.D. or 1D6 x 10 M.D., but this most powerful setting reduce the range by half (2000ft/609m).

Rate of Fire: Four times per melee.

Payload: Effectively unlimited.

Bonus to Strike: Only protoculture targeting system bonuses are applicable.

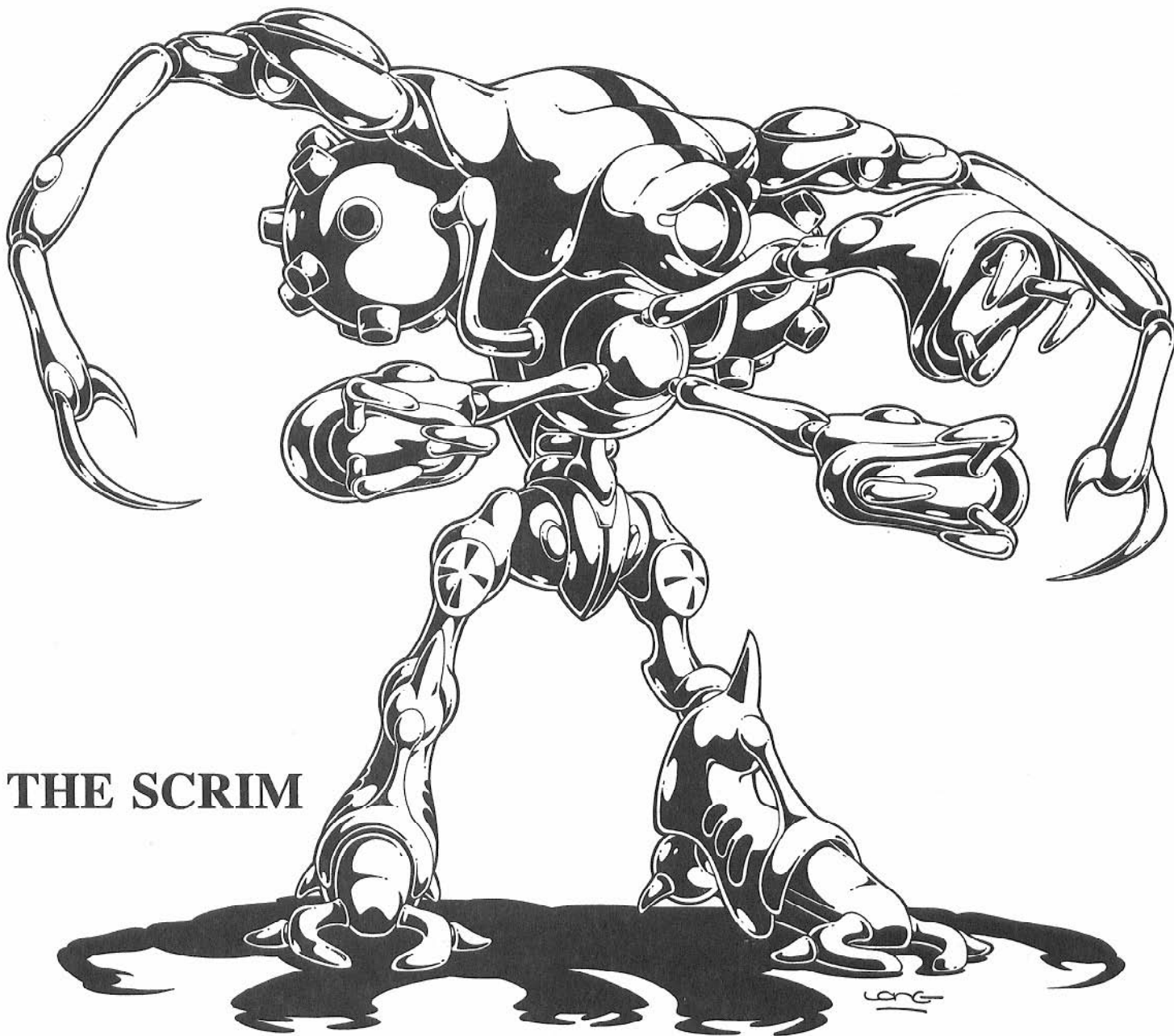

## THE SCRIM

The Scrim is the next most common killing machine in the invid's zombie army of automatons. Although smaller than the Odeon, it is far faster and more deadly. The two huge arm-like appendages sport two blade-like claws that operate like the CADS-1 of the human's Saber cyclone. Underneath these slashing claws is a large globe that resembles the underwater mines of old Earth's World War I. From these a toxic gas is emitted that will kill most mammals who breathe it. In the center of this nightmare are three lashing claws, giving it the advantage in hand to hand combat. Above the arms is its one sensor eye. An ugly spike adorns each knee plate to inflict greater damage from a knee jab. This monster is the ultimate warrior of the inorganics.

### Scrim Invid Inorganic (nicknamed "Jack Knife")

**Crew:** None; a robot-like automaton linked to and directed by an Invid Brain.

#### M.D.C. by Location:

- Gas Globes (2) — 100 each
- Blade Claws/Arms (2) — 150 each
- Chest Arms (3) — 100 each
- Hands (3) — 75 each
- Legs (2) — 200 each
- \*Head — 200
- \*\*Main Body — 350

\*Depleting the M.D.C. of the head will blind the fiend, but it retains other artificial senses so the penalties are only - 4 to strike, parry and dodge.

\*\*Depleting the M.D.C. of the main body will completely destroy it, crumbling into dust.

**Speed:** Running: 100mph (160kmph)

**Climbing:** Fair; equal to a skill of 50%.

**Leaping:** 30ft (9.1m) high and lengthwise.

**Swimming:** 5mph (8kmph)

**Space:** Although it has no means of propulsion, it can function in space and without air.

**Note:** The Scrim is not alive, consequently gases, drugs, disease, stun blasts and lack of air have no affect on it.

**Height:** 11ft (3.4m)

**Width:** 7ft (2.1m)

**Length:** 6ft (1.8m)

**Weight:** 2700lbs (1224kg)

### WEAPON SYSTEMS

#### 1. Hand to Hand Combat

**Attacks Per Melee:** Six

**Mega-Damage:** Blade Claws — 4D6 M.D.  
Punch — 3D6 (per each arm)  
Tear/Pry — 2D6 (per each arm)  
Knee Kick — 2D6  
Kick — 2D6  
Leap Kick — 3D6 (counts as two attacks)  
Stomp — 1D4 M.D.; effective only against objects that are 4ft (1.2m) tall or smaller.

**Bonuses:** +4 to strike, +6 to parry, +4 to dodge, +3 on initiative, +2 to roll with punch, fall or impact; critical strike (double damage) on a roll of 18, 19 or 20. Strength is equal to a P.S. 30.

2. **Nerve Gas:** Can be emitted from the spiked globes once every 10 melees. The gas will affect everybody in the area who is not in a spacesuit, body armor, mecha or some other form of environmental suit with its own oxygen supply.

**Range:** 100ft (30.5m) area around the scrim.

**Duration:** Gas cloud lingers for 4D4 minutes.

**Damage:** Kills most of its victims unless a saving throw is made; inflicts 3D4 × 10 S.D.C./Hit Point damage.

**Saving Throw vs. Lethal Poison:** A roll of 14 or higher (don't forget P.E. bonus if any). Victims who save vs poison still suffer 2D6 S.D.C./Hit Point damage and have burning and watering eyes, nausea, and a -1 to strike penalty for two melees.

**Rate of Fire:** Once every 10 melees.

**Payload:** 10 blasts of gas.

**Note:** The scrim can NOT use the tri-finger laser weapon.

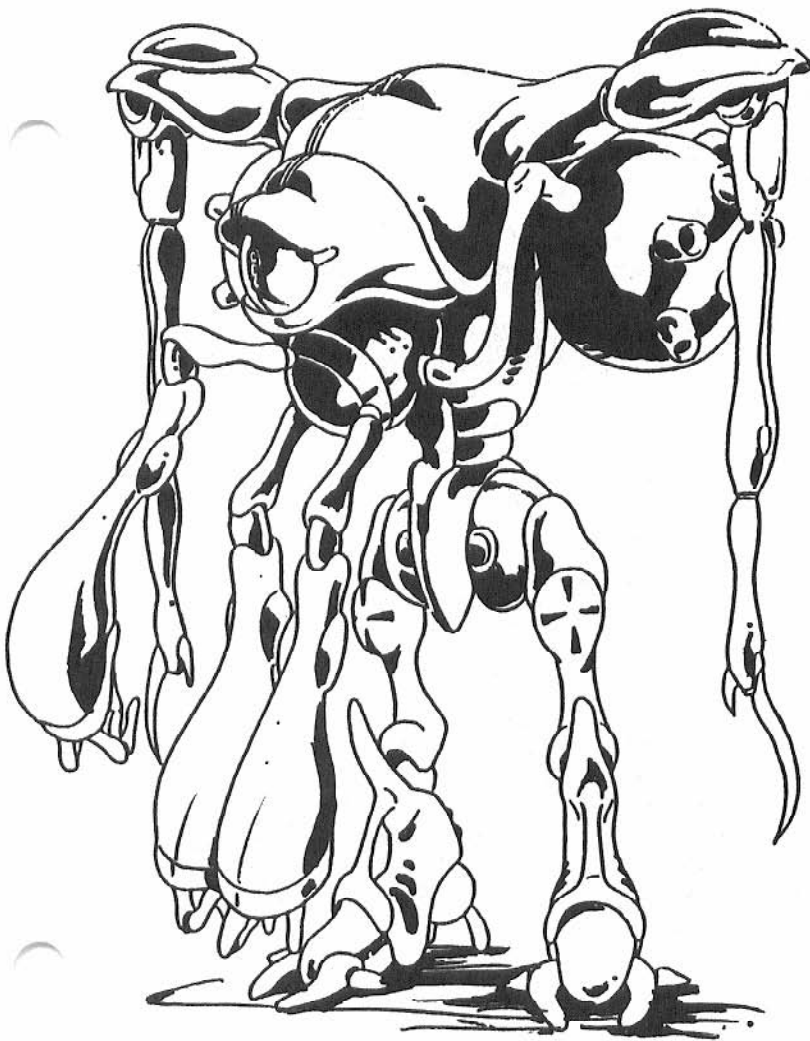

# THE CRANN

The Crann is a reconnaissance assault unit. It is quicker and more agile than its humanoid brothers and is imbedded with multiple sensor units. A huge sensor eye is located in its lower abdomen, head unit, and both of its hands. The hands can detach from the arms and crawl along on their three fingers like something out of a grade-B science fiction movie. Everything the hand sees, the Crann and its controlling Brain also see.

Unlike the other combat oriented inorganics, the Crann is programmed to observe the enemy, transmitting valuable data to the Invid Brain. It will engage in combat only to defend itself, to defend an Invid Brain or if commanded to do so by a Brain, the Regent or a Red Enforcer.

**Crann Invid Inorganic (Earth nickname: "Blue Eyes")**

**Crew:** None; a robot-like automaton linked to and directed by an Invid Brain.

**M.D.C. by Location:**

Head/Sensor Eye — 100  
Lower Body Eye — 200  
Hands/Sensor Eyes (2) — 100 each  
Arms (2) — 100 each  
Legs (2) — 200 each  
Top Mounted Laser — 50  
Energy Tongue — 100  
\*Main Body — 200

\*Depleting the M.D.C. of the main body will completely destroy it, crumbling into dust.

**Speed:** Running: 110mph (176kmph); hands crawling: 20mph (32kmph).

**Climbing:** Good; equal to a skill of 63%.

**Leaping:** 50ft (15.2m) high and lengthwise.

**Swimming:** 5mph (8kmph)

**Space:** The crann has maneuvering jets built into its back, feet and arms. Maximum speed is 80mph (128kmph).

**Note:** The crann is not alive, consequently gases, drugs, disease, stun blasts, and lack of air have no affect on it.

**Height:** 11ft (3.4m)

**Width:** 6ft (1.8m)

**Length:** 6ft (1.8m)

**Weight:** 2600lbs (1179kg)

## WEAPON SYSTEMS

### 1. Hand to Hand Combat

**Attacks Per Melee:** Three

**Mega-Damage:** Punch — 2D6 M.D.

Crush — 1D6 M.D.

Tear/Pry — 1D4 M.D.

Kick — 1D6 M.D.

Leap Kick — 2D6 M.D. (counts as two attacks)

Stomp — 1D4 M.D.; effective only against objects that are 4ft (1.2m) tall or smaller.

**Bonuses:** +3 to strike, +3 to parry, +4 to dodge, +3 to roll with punch, fall or impact.

**Special Abilities:** Prowl — 58%, hand(s) only Prowl — 80%, night-vision (each sensor eye) — 2000ft (609m)

2. **A Top-Mounted Laser** is located above the sensor head between the shoulders. Fixed forward position means the Crann must move its whole body to position it.

**Primary Purpose:** Defense

**Range:** 2000ft (609m)

**Mega-Damage:** 3D6 M.D.

**Rate of Fire:** Equal to hand to hand attacks; 3 per melee.

**Payload:** Effectively unlimited.



# THE CRANN

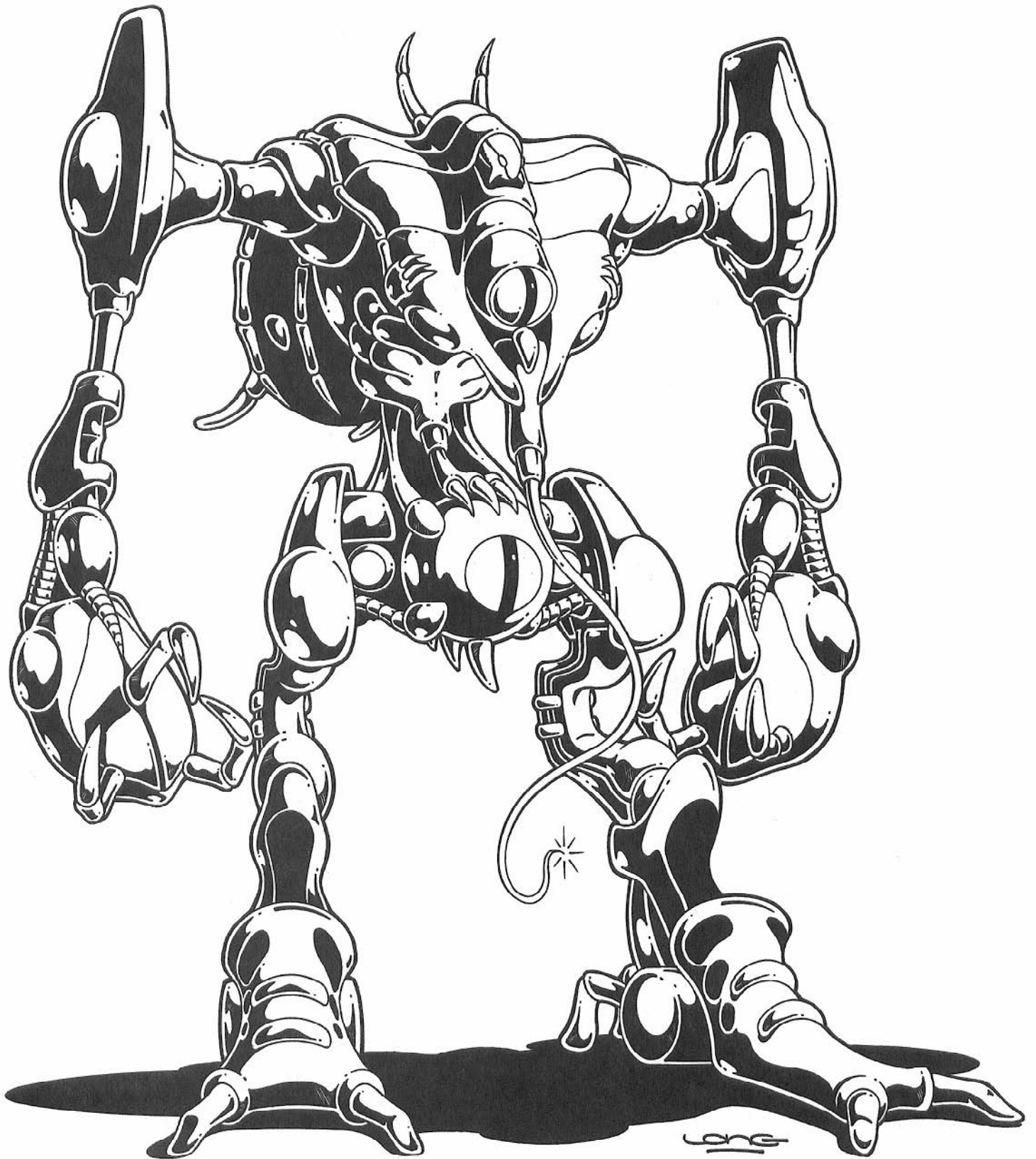

3. **Energy Tongue:** This is a close range weapon that functions like a whip. It is completely retractable.

**Primary Purpose:** Defense

**Range:** 20ft (6.1m) reach.

**Mega-Damage:** 1D4 × 10 M.D.

**Rate of Fire:** Counts as a hand to hand attack; 3 total.

**Payload:** Unlimited use.

**Bonuses:** +2 to strike.

## NOTES ABOUT INVID HIVES

The basic structure and layout of the two types of Invid Hives remain unchanged (see the *Invid Invasion*, pgs 89-93). However, the troops are somewhat different between the Regent and the Regis. The pincer command unit, royal command battloid, and stage five invid pilot are all exclusive creations of the Regis, and therefore, are not found among the Regent's hive troops. Likewise, the royal (red) enforcers and inorganics are of the Regent's creation and exclusive to his troops.

### Modifications for the Regent's Hives

- Replace the pincer command units with enforcers or 50/50 mix of odeon and scimm.
- Replace royal command battloids with red enforcers with their assault speeders.
- Add a small force of inorganics: 1D6 × 10 cougars, 1D6 × 10 odeons, 2D4 × 10 scrimms, and 4D6 cranns.
- The perimeter defenses are basically unchanged, except that 1D6 cougars and two or three cranns *may* also roam the area.

## TYPICAL INVID FORMATIONS

### Standard Invid Reconnaissance Patrol

3 Armored Scouts  
7 Scouts

### Mini-Patrol

1 Armored Scout (lead)  
2 Scouts

### Heavy Invid Reconnaissance Patrol

This patrol is sent out into hostile areas.

1 Red Enforcer or Enforcer  
3 Shock Troopers  
6 Armored Scouts

### Invid Raiding Patrol

This is an assault group that will attack small groups of human mecha and resistance fighters.

1 Red Enforcer on speeder (lead)  
4 Enforcers  
9 Shock Troopers  
9 Armored Scouts  
May also include 1D4 cougars, 1D6 odeons, 1D6 scrimms and 1D4 cranns.

### Inorganic Mini Extermination Patrol

1D4 Cranns  
1D6 + 1 Cougars  
2D4 Odeons  
2D4 Scrimms

### Hive Perimeter Patrol (when intruders are anticipated)

1 Enforcer

10 Troopers

10 Shock Troopers

Plus 1D6 *Mini-Patrols* flying over the area and 4D4 *Shock Troopers* buried 3ft (0.9m) underground in strategic locations (they'll spring out when a active protoculture device is sensed in the immediate area or if disturbed by heavy ground movement). In addition, 1D6 cougars, 1D6 cranns, and 1D6 scrimms will also patrol around the hive and attack any intruders on sight.

### Hive Interior Invid Patrol

4 Enforcers

4 Troopers

2 Scouts or Armored Scouts

### Hive Interior Inorganic Patrol

1 Crann

4 Scrimms

1 Cougar

4 Odeons

### City Invid Patrol

A routine patrol in a quiet city.

1D4 Enforcers

1D4 + 1 Troopers

1D4 + 1 Armored Scouts

### Mini City Inorganic Patrol

1 Crann

2 Scrimms

2 Odeons

### City Inorganic Patrol

Remember, inorganics are left behind to police cities that have been conquered by the Regent, while the invid move on to conquer other worlds.

1 Crann  
2D4 Cougars  
2D4 Odeons  
2D4 Scrimms

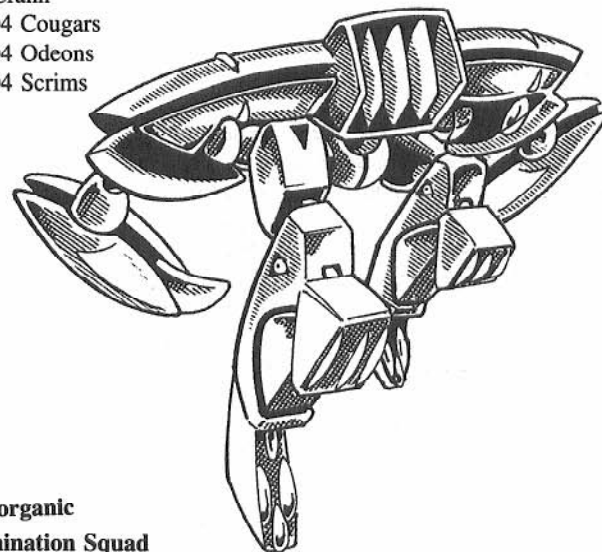

### Inorganic

#### Extermination Squad

Usually sent out against mecha and organized resistance.

2D4 Cranns  
3D4 + 1 Cougars  
4D4 Odeons  
4D6 Scrimms

May include an Enforcer or Red Enforcer, 2 Armored Scouts and 1D4 Shock Troopers.

**Note:** Of course, an Invid Brain will dispatch as many invid or inorganics as it believes necessary to crush an enemy. Invid forces of any kind will usually outnumber their opponents by at least two to one.

For additional data regarding the Regis, Invid history, and Invid Earth activity, see *Robotech RPG Book Five: Invid Invasion*. To see the Invid's and inorganics' (cougars and odeons) attack on the Robotech Masters homeworld, see **The Sentinels Video Tape** (available from Palladium Books®).

# SENTINEL ADVENTURES

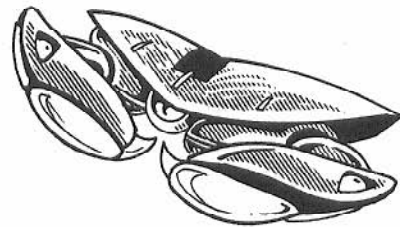

## A Universe of Possibilities

As mentioned earlier, Sentinels is a war story. Alex has compared it to the U.S. campaign in the South Pacific during World War II. U.S. troops hopping from one island to another, liberating each from enemy occupation, just as the REF hops from planet to planet. Many isolated battles in completely different environments. The same enemy, but always a different force to battle, led by a different general at a different location. For the REF, the distant galaxies around the Robotech Masters' homeworld is the ocean, and the planets, large and small, are the occupied islands. Their mission: To seek out the enemy and crush him wherever he is found.

This opens a universe of possibilities, from space combat to planetary exploration. Some conflicts will be out and out battles from the onset. Others will be covert operations like sabotage of a hive or the freeing of slaves from a protoculture factory or farm. The presence of innocent lives (the people enslaved by the invid) will often prevent outright battle, limiting the types of weapons and forces to be used. This is when a special team (the player characters) may have to infiltrate the enemy's lines to prepare for an assault. They may have to pinpoint the location of innocent people, as well as the enemy's strongholds. Or they may have to rally the people to join in the attack, or help them escape beforehand, or help them find refuge during it. Or the team may have to cause a diversion or knockout a weapon system or hive before the battle can begin.

The arms of the invid are long and have wrapped many planets in their deadly embrace. The Sentinels have identified over a dozen worlds enslaved by the invid, but how many others the invid may dominate are unknown, perhaps hundreds. In addition to slave colonies, there are invid outposts; military bases waiting to attack any fools who dare to challenge them. Genesis pits, where torture and hideous genetic and biological experimentation can create monsters. There will be survivors of invid assaults who will need to be rescued or delivered aid. Again, this is when a special team of characters will have to be sent in to investigate. The assignment may be reconnaissance, covert, mop up after a battle, or seek and destroy. Unfortunately, the invid will not surrender; they fight and carry out the will of the Regent to their graves.

## BLUE TEAM (adventure)

### Player Background:

You're part of a reconnaissance force assigned to investigate a tiny planet in the Robotech Masters' galaxy. It is a world that is green and lush, with tropical jungles, swamps, insects, and small animals. The environment reminds most everybody of what the Earth must have looked like millions of years ago when there were only dinosaurs. Fortunately, this world has no dinosaurs. The closest thing to a "thunder lizard" are the zillions of foot long, salamander-like critters that seem to be everywhere. Better yet, no invid!

Everybody has nearly completed their sweeps. A clean planet. No trouble. A nice break from the ravages of war. Of course, just when people started to relax, trouble hit. Blue team disappeared. They were a good group of veterans, that started calling themselves "swamp rats." Well liked, except for Lt. Lewis, an obnoxious, cocky alpha pilot who loved to kill. Mean when he was sober and meaner when he was drunk.

Word's out that he doesn't care about anything or anybody except himself and personal glory. A regular power tripper. But even if you hated Lewis, you had to admit he was good. Too good to get lost in a swamp populated with harmless salamanders.

### Mission Briefing:

"As you already know, Blue Team is M.I.A. (Missing In Action). We've received no communications and flybys over their last known coordinates have yielded nothing. There is no evidence of foul play, yet Blue Team is missing. They can't have gone AWOL and there is no sign of foul play.

"Your job is to go into that damn swamp, search under every lily pad, and find them and drag their sorry butts back to operations. The swamp will mean there will be little if any physical trail to follow (-50% on tracking skill). We don't know what to expect men. Just do your best. I know we all thought this planet was safe, but we don't know that. We must presume that something out there has taken Blue Team out. So proceed with caution. You may all take your standard equipment and fully loaded mecha units. Those without mecha will be assigned a hover vehicle, probably a 'cycle or one of the Perytonian antigrav babes. Demolitions will not be needed.

"Your mecha are checked and waiting. Scramble! I want you out there within the hour. Let's bring our men home, shall we! Good Luck."

1. **Method of Insertion:** Drop by Horizont.
2. **Available Support:** Full mecha resources of three orbiting Garfish Carriers. Base of operations can dispatch two veritech squads within 15 minutes.
3. **Terrain and Weather Report:** Area is a marsh and light jungle. Weather is clear and sunny. The atmosphere is toxic to humans. An oxygen unit/spacesuit or CVR-3 must be worn.
4. **Special Rules:** Tracking skills are -50% in the marsh, and -30% in the jungle. Prowl is -10%. No special equipment other than optics will be issued.
5. **The Missing Personnel Include:** Alpha Pilot Sgt. Betty Andrews; Beta Pilot Sgt. Carl Santini; Gladiator Pilot Lt. Joseph Dietrich; Field Scientist Lee Won and Alpha Pilot Lt. James Lewis; 5 total.
6. **Method of Extraction:** Walk out; but a Horizont is standing by if needed.

### The Swamp

The characters find no opposition at the site. Swamp weeds come up to an alpha's waist. Searching the swamp reveals nothing. However, the broken underbrush in the densest part of the jungle confirms that Blue Team entered dry land there. A character with tracking may be able to follow the trail in under an hour. Otherwise, it will take the group 1D4 hours to reach *the cave*. **G.M. Note:** Don't leave the characters searching around for hours of real time. Move them up to this point quickly, even though at least two or three hours have been spent searching.



## The Cave

The cave is hidden by a canopy of jungle vegetation, obscuring it to even treetop reconnaissance. However, on ground level, the characters can see that vegetation has been cleared away to reveal the mouth of a cave. A character with tracking abilities will be able to determine that the foliage has been broken within the last 48 hours and find sure evidence of REF mecha having gone into the cave.

The cave is large enough to accommodate mecha walking single file (G.M., get a marching order. Who's the point man in front.) The cave is wet and musty as it curls downward. After about 1000 yards, the cave dead ends, but the floor drops into a steep, mist covered incline (a 90 degree incline). Mecha can easily slide or hover down into the mist (Yes, it appears that a destroid can climb back out.) The drop goes down about another 1000 yards/meters. Halfway down, the mist seems to be vibrating with energy and beyond that, returns to normal. At the end of the incline is an underground world. A huge, dense jungle that seems to stretch for miles. Characters may correctly surmise that they have just entered an invid genesis pit, but they have no way of knowing for certain. **Note:** The energy membrane of the pit will prevent any radio transmissions to the surface. The group is cut off.

## ENCOUNTERS

**The first encounter** will be with 1D6 × 10 salamander men. Five foot tall humanoids brandishing crude spears and stone hatchets. They are amazed and frightened of mecha. Computer translation of their gibberish will grab only bits and pieces of dialogue, such as, "The gods have come" "It is the great clash of the gods . . . we must run and warn the others." Interrogation will only produce a salamander man begging for the gods not to kill him (the characters inside and out of their mecha will evoke the same response). If pressed, the humanoid will take the characters to the "other" gods. No invid are seen.

**2. If there be gods . . .** Eventually, the characters will find a large clearing near a shallow lake. At the lake's edge is a large group of salamander men. Most are armed with spears, but two are armed with Wolverine assault rifles and one with a Fal-2 (fair shots, but no bonuses to strike). In the center of the group is a huge, humanoid mound of pink flesh. The thing resembles a giant Sumo wrestler with a head half the size for its body. (G.M. **Note** that the head is still recognizable as field scientist Lee Won.) The horrid creature will bellow and begin to stomp its feet. The salamander men imitate their 20ft (6.1m) tall leader's actions while chanting "Eewon, Eewon, Eewon . . ." Any act of aggression on the part of the player characters will send the giant into a frenzy, attacking the nearest opponent to him. His punches will damage mecha.

An instant later, two creatures will rise out of the lake like sea serpents and join in the battle. The monsters measure 100ft long, and are armed with eight tentacles and a gigantic mouth rimmed with teeth. They will attack the largest targets first, entangling mecha with their tentacles and pulling them underwater. The creatures will fight until destroyed or until the humanoid thing that was once Lee Won is destroyed.

### THE MUTANT LEE WON

**Size:** 20ft tall (6.1m)

**Weight:** 2 tons

**M.D.C.:** Head — 10

Main Body — 50

**Attacks Per Melee:** 4 hand to hand

**Mega-Damage:** Punch — 2D6 M.D.

Kick — 1D6 M.D.

**Notes:** Poor Lee Won has fallen victim to the invid's evolutionary/genetic experimentation. He has been transformed into an aggressive, mindless predator. Lee controls the sea serpent creatures telepathically. Both the mutant Lee and the creatures will fight to the death. Mr. Lee Won is beyond saving.

## THE SEA SERPENTS

**Size:** 1D4 × 100ft (over 30.5m)

**Weight:** 20 tons

**M.D.C. by Location:** Head (armored) — 80  
Tentacles (8) — 30 each  
Main Body — 200

**Attacks Per Melee:** Three

**Mega-Damage:** Bite — 4D6 M.D. The tentacles are used only to ensnare and hold their prey, P.S. of the tentacles is about equal to an alpha's. Only a gladiator is stronger. **Bonuses:** +2 to strike, +3 to dodge, +2 on initiative.

**Note:** Will grab the first available prey, drag it underwater and chomp on it until it or its prey is slain. They will fight until the mutant Lee tells them to stop or he is killed. Neither the creatures nor mutant Lee Won will travel more than 1000 yards/meters from the bank of the lake. The creatures can reach their prey 500ft (152m) from the edge of the lake. **Lee Won can summon another 1D6 creatures within four minutes (16 melees).**

**3. This encounter will be with Lt. James Lewis.** The fight at the lake or the first group of salamander men will alert him to the player group's presence. He's suited up in his CVR-3 armor, but holds the helmet under his arm. 200ft (61m) behind him, in the jungle brush, is an entourage of over 100 salamander men.

Lewis will greet them, smiling, with arms open wide. He carries no weapons and there are no mecha in sight. "Welcome to paradise," he'll shout, and try to calm the player characters, inviting them to relax and come down out of their mecha. If asked about Lee Won he will laugh it off, saying something like, "Lee didn't understand. He resisted the idea of godhood. Spat in the faces of our benefactors till the end. And they still made him a godling." Questions about the benefactors or the invid will get a reply something like, "The invid are our friends. Oh sure, they mean to rule the universe, but the chosen ones can rule right beside them. They understand power. Power courses through their veins! The REF doesn't understand that. Admiral Hunter is a weak man who has never hungered for power, so he's blind to it. But we have our chance now! They will make you a god if you choose to fight with them. Gods!!" With that Lewis will grab the nearest tree trunk and break it in two.

"Power you can only imagine," he reiterates with an insane chuckle. "I don't need mecha. I don't need a puny life support system to breathe this air." With a hand gesture, the crowd of salamander men part. Four of them push forward, dragging a battered and dazed Sgt. Betty Andrews. Pointing to her, smiling, he chortles, "I can take what I want. I have the power to take anything and so can you!"

At this point, action depends on how the players want to handle things. Lt. Lewis has clearly joined the invid. In return, they have made him more than human. But what he is and what are his new powers remains a mystery. Is he unafraid of a mecha squad because he is that powerful or that insane? It's also obvious now that this is a genesis pit, meaning invid must be present, although none have been seen. Also, remember radio transmissions can not reach the surface to call in reinforcements.

If the REF team attacks Lt. Lewis and his amphibian minions, they will have proven that they will not join the invid. Lewis will respond by attempting to destroy the group. Two shock troopers, 1D4 troopers, and 1D4 armored scouts, hidden a half mile back in the jungle, will join in combat, as will the salamander people. If battle the turns against Lt. Lewis, he will grab Sgt. Betty Andrews (unless she's already been rescued) and flee to the invid research hive. If things go very badly, Lewis will use the woman as a hostage (Yes, he will kill her if he believes he is about to die.)

If the group *pretends* to like the idea of godhood, but wishes to leave and return later, Lewis will dismiss the idea and demand they come

with him now! The whole group (every member *seen* by Lewis) must accompany him. Resistance will cause the battle previously described.

If the group *pretends* to agree to join the invid, and offer little or no resistance, Lewis will lead them to the pit's research hive. Characters are allowed to accompany him inside their mecha, but he would prefer otherwise. If at least one person leaves his mecha behind, it will convince Lewis of their sincerity. Otherwise, he will remain suspicious and alert. A relaxed Lt. Lewis will gab about his many new powers in detail.

ALL player characters must leave their mecha and weapons at the hive entrance. This includes cyclones, although CVR-3 body armor will be tolerated. Resistance will be met with a serious warning that he/she/they will be destroyed, followed by "Trust me, you'll be safe." Refusal to comply will cause an immediate battle to the death. Lewis will bellow "You fools have betrayed me!" and will lash out in full fury. Simultaneously, invid and inorganic hive protectors will lunge out of the shadows they've been hiding behind. In addition, the patrol which had been following Lt. Lewis will arrive two melees later (2 shock troopers, 1D4 troopers, 1D4 armored scouts). **G.M. Note:** This onslaught will occur at any point, whenever it is that the characters attack Lewis, an invid, or the invid brain. Fortunately, for the characters, this is a forgotten genesis pit and the hive is practically deserted by normal standards.

**First Wave Assault:** The alerted Lt. Lewis and 2 odeons, 2 cougars, 1 scrim, 1D4 + 1 enforcers in full gear, 1D4 troopers.

**Second Wave:** 30 seconds later, the 2 shock troopers, 1D4 troopers and 1D4 armored scouts arrive from the jungle.

**Third Wave:** 2D4 troopers, 1D6 shock troopers, 1D6 scouts.

If the player characters flee toward the exit/cave, only the members of the first two attack waves will follow. **Note:** Unless the cave entrance into the pit was marked, it will require 2D6 × 10 minutes to locate it. Furthermore, the invid have a welcoming party hidden at the caves; 2 enforcers, 4 shock troopers, 1D6 armored scouts and an odeon.

If the players stand and fight, there will be no more invid attacks. Venturing into the hive will bring about a number of encounters. If Lewis is captured, he will offer no help, even under torture. He will only try to escape and/or destroy the group.

## G.M. NOTES

Unknown to the REF team, the invid brain sees and hears everything a conscious Lewis experiences. Consequently, game masters should set up all future attacks as ambushes. Attacks that obviously show that the invid know where they are (at least the ones with Lewis) and what they are planning. G.M.s may devise your own assault groups based on this data, or use the random table that follows. Remember, the brain's resources are very limited. For an exact layout of a typical hive, see the *Invid Invasion*, pg 91. At this point, the group should be concerned with finding Sgt. Santini and Lt. Dietrich and/or killing the invid brain. Of course, they can leave, regroup, get help or fresh mecha and come back. However, the longer they wait, the more likely the two soldiers will be killed or worse.

**Lt. Dietrich** can be found in good condition on level five, room E.

**Sgt. Santini** is unconscious, but alive on level six in the invid brain's chamber (6-D). The brain will be protected by at least 10 enforcers, 1D4 shock troopers and 2D4 troopers.

**Wandering through the hive** will reveal great decay. The mecha stasis chambers will be empty or full of dead invid (a malfunction decades ago killed 80%). The second invid brain, found in the genesis pit research hive, is also dead. **G.M. Note:** Unless you have other plans.

**Killing the invid brain** and/or rescuing the other soldiers will not end this invid threat completely, but will buy them time. The group (or other REF/Sentinels) will have to return to blow up the hive. Destroying the hive will destroy the genesis pit. However, the fate of the mutant salamander men must be decided before the pit is destroyed. Command

is likely to want them gathered and evacuated to the surface where they can live. This can be a whole *other* adventure, with the surviving invid hive troops ambushing and attacking the Sentinels while they try to save the salamander people (these people don't know that they need saving and will fight and hide).

## RANDOM HIVE ENCOUNTERS

**01-10** 2D4 + 1 invid troopers.

**11-20** 2D4 + 1 invid scouts, plus 2 armored scouts.

**21-30** One scrim and 1D6 cougars.

**31-40** 1D4 shock troopers and 2D4 troopers lead by one enforcer.

**41-50** 1D4 enforcers, 1D6 cougars, 1 odeon, 1 scrim, and 1D4 shock troopers.

**51-56** 3D4 cougars

**57-61** 3D4 enforcers

**62-66** 1D4 + 1 shock troopers

**67-71** 1D6 shock troopers and 1D6 armored scouts.

**72-80** 2D4 troopers, 1D4 shock troopers, 1D4 armored scouts, 1D6 scouts, and 1 enforcer.

**81-85** One crann on recon; it will run away.

**86-90** 3D4 armored scouts plus 1D4 scouts.

**91-95** 3D6 shock troopers

**96-00** 1D4 odcons, 1D4 scrim and 1 enforcer.

## THE TRANSFORMED LT. LEWIS

**Cyborg:** Lewis is more machine than human. His arms and main body have been replaced with super-powerful artificial ones created by invid alchemy.

**M.D.C. by Location:**

Arms (2) — 50 each

Main Body — 200

Lewis also wears a CVR-3 helmet to protect his head and CVR-3 suit of body armor to protect and conceal his *improvements*. The main body M.D.C. is superior over most invid cyborgs.

**Hit Points:** 36 S.D.C.: (head & legs) 30

**Alignment:** Miscreant

**Attributes:** I.Q. 12, M.E. 9, M.A. 10, P.S. 24, P.P. 20, P.E. 30, P.B. 9, Spd. 12. **Note:** The P.S., P.P. and P.E. are the attributes from the bionics.

**Age:** 29 **Weight:** 370lbs with bionics.

**Disposition:** Cruel, treacherous, cunning; he is tough, resourceful and deadly.

**Insanity:** Obsessed with powers; suffers from delusions of godhood.

**Level of Experience:** Fourth level Alpha Pilot.

**Skills of Note:** Hand to Hand: Martial Arts, Wrestling, W.P. Gallant H-90, W.P. Energy Rifle, W.P. Energy Pistol, and Pilot/Combat Alpha and Beta at full bonuses and Battler Cyclone at basic.

**Personal Profile:** Lt. Lewis *has* gone off the deep end and truly believes that the invid will make him a god. He will try to destroy the REF/Sentinels team with every ounce of his strength if they threaten to jeopardize his delusion.

Lewis is completely untrustworthy, although he can put up a convincing act to the contrary. He will kill without hesitation or remorse, unless he has time to extract torturous pleasures. The invid brain trusts him implicitly and, as a result, Lewis is allowed to use his cyclone battler and alpha whenever he chooses. The cyclone is in perfect condition. The alpha has only half its missiles and has lost 50 M.D.C. from its main body. Both are stored in the hive on level four (ground level of the domed hive).

**Note:** For greater detail about invid hives and genesis pits, see *Robotech RPG, Book 5: Invid Invasion*.

## A TYPICAL SALAMANDER HUMANOID Roll for the following:

**Hit Points:** 6D6 S.D.C.: 4D6

**Alignments:** Any. At this point, mostly Anarchist; but obey Lewis and the invid without question.

**Attributes:** They are like an average human except for a higher physical endurance. To create a Salamander Alien, roll as follows: I.Q. 2D6 + 1, M.E. 2D6, M.A. 3D6, P.S. 3D6, P.P. 3D6, P.E. 5D6, P.B. 3D6, Spd. 3D6

**REF Skills:** Six can be learned at level one, four at level three, two at level four, two at level six, two at level nine and two at level twelve. Only the simplest skills are the easiest for these creatures to learn. Select only from: Communications — Radio: Basic and Scramblers, Domestic: Any, Medical: First Aid only, Physical: Any (+10% to climb and swim), Pilot: Any except mecha and spacecraft, Pilot Related: Any, (-5%), Rogue Skills: Any (+2%), W.P.: Any except cyclone and gallant, Wilderness: Any (+5%).

**Natural Abilities:** Can hold breath for up to 20 minutes, has a keen sense of smell (adds +2% to tracking skill), and can make self buoyant/float in water (they love water and play on the floor of lakes, but do not automatically know how to swim). High P.E. and have a 3ft (0.9m) tail.

**Size:** 5ft + 1D6 inches

**Weight:** 90lbs + 1D6 × 10

**Disposition:** Curious, but afraid. Believe invid are gods.

**Weapons:** Crude spears and axes.

---

## HIDE & SEEK (adventure)

This is a fairly simple adventure that will challenge the characters into using their heads and strategies, as well as force.

### Player Background:

The invid have ravaged the cities on an outpost planet (G.M., select or invent the alien race.) The REF/Sentinels are removing all survivors for hospitalization and evacuation as it is feared the invid may return.

Your group, and the dozen refugees under your protection, are the last to go. While you wait for an Horizon to pick you up, a priority radio message breaks the stillness.

The communications officer addresses the entire team. "An invid force of undeterminable size has entered the planet's orbit. We are executing evasive maneuvers and may space fold. Our priority must be the safety of refugees. You are to take immediate cover. Protect yourselves and the refugees under your care. Do not engage the enemy except to defend yourselves. Repeat, defensive engagements only. Your responsibility is to protect the civilians. We will return as soon as we can. When? We do not know. At least six hours, maybe 12. Until then, you are on your own."

### G.M. DATA

The invid force is NOT an occupying force, but just happened upon the REF/Sentinels at this location. The humans presence will instigate a scan of the planet. The city ruins and surrounding areas will be the sites of the most intense scrutiny. But even then the invid will not be as thorough as they could. They believe they have extinguished life on this world and will not work hard to prove otherwise. If the player characters stay hidden, don't use protoculture and quickly and quietly destroy any invid who see them, they will be alright.

If discovered, it may be wise to split into two groups. One to stay with the refugees and the other group to engage the invid to draw them

away. It's best to stay together as long as possible.

The ruins of the city should provide plenty of places to hide. The mecha will be able to dig into basements and subways, and rearrange debris and so on to make effective cover. Ambushes and cross fires should also be easy to arrange.

Equipment of the player characters should include mecha and standard items only! No heavy explosives or special gear because combat was not anticipated.

The types of invid and their numbers will vary with each patrol and is left up to the game master. Most patrols will be small, 1 to 4 units, because the invid do not anticipate trouble either. The heavy-duty combat inorganics, such as the odeon and scrim, are not likely to be deployed. Cougars, cranns, scouts, armored scouts, troopers and shock troopers are what will be prowling around.

The situation will escalate only when a member of the group is discovered (which should happen toward the end of the game). This is when invid will start swarming out of the woodwork. At first, two or three invid at a time, probably the faster ones like the cougars and scouts. Then in greater number and then in greater variety.

This is a great opportunity to trap the characters into an "Alamo" type last stand. Let them fight valiantly, using up all or most of their ammunition, before the cavalry arrives (the REF/Sentinels to the rescue). Of course, do not let the players know that they will be rescued in the nick of time. Play it up for high drama. Someone may even die.

Use the refugees to intensify the situation by making them sweet, innocent, caring, brave and appreciative, even in the inevitability of death. The refugees should be predominately children and young women.

If the player characters save all the refugees and do a great job, they should all receive commendations.

---

## FREE-FOR-ALL (adventure)

Here's an outline for a wild, heavy-duty adventure that could easily turn into a two or three parter.

### Player Background:

Your characters have been scrambled into a briefing room aboard the Ikazuchi carrier. One of the General's advisors addresses you. Note: The characters will have been suggested by the group's NPC commanding officer because they are the best, or because he despises them.

### Mission Briefing

"Gentlemen, I'll be brief and to the point. At precisely 0900 hours (about an hour ago) we received a hyperspace distress call from a Robotech Masters' Mothership (see *Southern Cross for Robotech Master and Bioroid data*). Naturally, we responded. About 8,000 clicks (5000 miles) from our present location is a Robotech Masters cruiser orbiting an unknown planet. It is under siege by a moderate force of invids. However, we have traced the source of the communique to the planet's surface. Intelligence believes that the Robotech Masters have escaped to the planet's surface and are currently unknown to the invid.

"Intelligence also believes that a small team of mecha can slip by the invid undetected and retrieve the Masters. That, gentlemen, is your assignment!"

Unless there are questions, the advisor will wish them luck and dismiss them. The characters are to depart immediately! They have 15 minutes to prepare, not a second longer. Their mecha are already prepared and waiting.



If questions are asked, the advisor will try to answer them as quickly as possible. No more than five minute's time will be allotted for questions.

1. **"The planet** is a dead world. A satellite probe suggests its surface is rock and dust, with an average temperature of 110 degrees Fahrenheit. The atmosphere is poison, so all of you will be issued spacesuits to be worn under your battle armor. The atmosphere is always overcast. Winds are erratic, sweeping up to 60mph (96kmph). That means you'll probably encounter several dust storms and visibility will be poor. But that's a blessing, gentlemen, because it will obscure you from the enemy (It will also obscure the Robotech Master's escape vehicle and limit combat)."
2. **The location of the Masters** has been narrowed to an 800 klick area (500 miles). With the aid of sensors and mach speed, intelligence estimates you should locate the vessel within four hours.
3. **"The exact size of the moderate** invid assault force is estimated at 15,000 troops."
4. **"We do not want** the presence of our carrier to jeopardize your mission, so we will take an evasive position in an asteroid field, ah . . . , several thousand miles away. It may even be necessary for us to . . . fold to an entirely different location. But not to worry. We will rendezvous at this location every eight hours. At that time we will be able to send you a shuttle or immediate assistance in less than 60 minutes."
5. **Any other questions** will be answered in a yes or no fashion and then dismissed at the end of five minutes. Some may include: Are invid on the planet: "NO!" Well not yet anyway. Do the invid know about the escape shuttle on the planet's surface: "NO!" But this is conjecture, there's no way intelligence could know this. Should the rescue team radio in when the Robotech Masters are in custody? "No, wait until the rendezvous time. If possible rendezvous without radio contact."
6. **Method Of Insertion:** One non-protoculture CTC Troop Carrier shuttle (see *Southern Cross*, pg 84). It can carry as many as 20 mecha, so it can easily accommodate the mecha team, assault vehicle(s) and extra missiles/ammunition. GM option: One extra destroid and/or one extra veritech.
7. **Available Support:** Full availability of mecha, heavy armaments, heavy weapons; even shadow fighters and vindicators will be issued if requested. Anything the team requests in the way of arms and armor is likely to be granted (no titan or Horizont). All team personnel will be issued a spacesuit, CVR-3 armor and a cyclone if they can pilot one, in addition to the bigger mecha and armored assault vehicles (for those who can not pilot mecha). An additional set of spacesuits and CVR-3 armor will be issued for back-up (stored in the shuttle unless the characters put it inside their mecha or vehicle; there is room). The full support of the Ikazuchi carrier is available every eight hours (stays for one hour and leaves), but it will take at least 40 minutes for help to arrive (possibly an hour). **G.M.'s Option:** If you desire, you can provide the group with one or two REF/Sentinel non-player characters (NPCs) to help bolster the team's strength. This is especially advisable if the group is smaller than six. Definitely provide a shuttle pilot.
8. **Special Rules:** At least 2 or 3 dust storms will engulf the team, reducing sensor and radar range to one third normal and limiting line of sight to about 20ft (6.1m). The storm will last 5D6 minutes.

## GAME MASTER SECTION

Now the fun starts. The invid do know about the escape capsule and will send a small detachment to investigate. They arrive about a half-hour after the REF/Sentinels team.

Better yet, a Zentraedi Landing Ship (*Quiltra Queleual*; see *Zentraedi*, pgs 39-42) with its 30,000 troops has popped out of space fold

in answer to the hyperspace distress call by their Robotech Master lords. The ship's troops have engaged the invid in orbit and have sent a force of battle pods to the planet to rescue the Robotech Masters.

Yes, these are true blue, killer, I love the Robotech Masters, Zentraedi. There still are several hundred Zentraedi ships and troops scattered throughout the universe (a pittance compared to the 4 million Zentraedi warships destroyed in Earth orbit). These warriors do know about humans, although they have never seen one. They will also recognize all the Sentinel aliens. Unfortunately, humans and their allies are considered to be archenemies and will be attacked without question. The Zentraedi arrive on the planet about 45 minutes after the REF/Sentinels team.

But, that's not all!! Bioroid troops also search for the Robotech Masters! Just like the Zentraedi, they will shoot humans and their aliens on sight. The inclusion of the Bioroids may not be applicable if the GM does not have Robotech Book Four: Southern Cross (pgs 90-102). In that case, substitute invid.

After the humans and Zentraedi (or bioroids) have clashed at least once, a fun story twist could be that both arrive at the site of the Master's escape shuttle at the same time. Just before they are about to attack each other a huge invid force arrives, attacking them both. Suddenly, the REF team and Zentraedi find themselves thrown together, forced to fight a common foe if they are to survive. The question that follows is, what happens when the invid are destroyed? Do the Zentraedi fight the very people who just fought at their side (probably)?

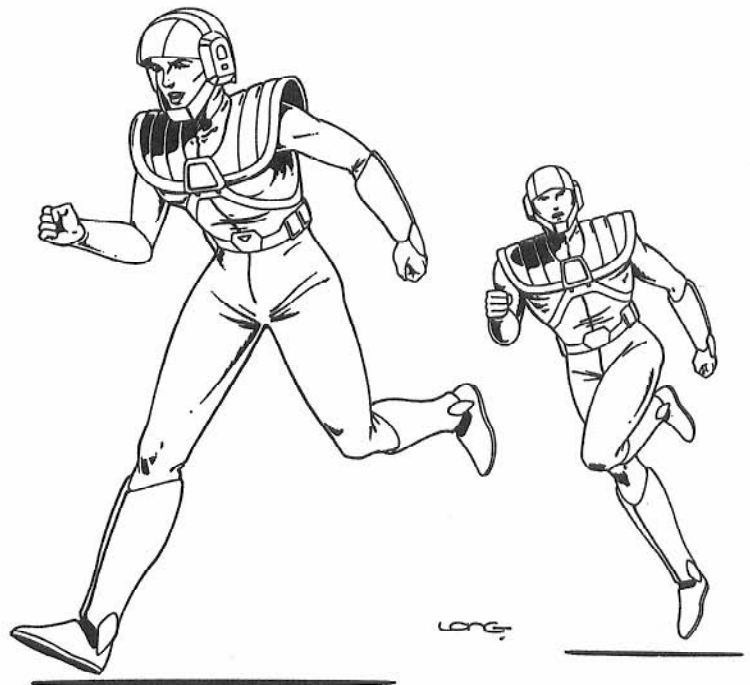

## RANDOM ENCOUNTERS

Roll once for every 20 minutes (or as desired) the characters are on the planet (that's adventure time, not real time). Of course, the G.M. can create his own encounters. These are provided for ideas and quick playing.

- 01-05 2D4 oeon, 2D4 cougars, 1D6 scirms and one crann.
- 06-10 2D6 shock troopers and 1D6 troopers.
- 11-15 2D4 red enforcers on invid speeders accompanied by 1D4 + 1 armored scouts.
- 16-20 3D4 armored scouts and 1D4 scouts.
- 21-23 One lone crann on reconnaissance.
- 24-28 Can it be !?! 4D4 Zentraedi tactical battle pods, two light artillery pods, and one recon scout pod.

# SENTINEL CHARACTERS

- 29-31 A pack of 2D4 + 10 cougar inorganics.
- 32-36 1D4 + 1 Zentraedi fighter pods and one female power armor; all are FULLY armed and in a mean mood.
- 37-41 An enforcer leading 1D6 shock troopers, 1D6 troopers and 1D6 armored scouts.
- 42-45 1D6 + 1 Zentraedi foot soldiers in battle armor and armed with assault rifles. Where are these Zentraedi coming from?
- 46-50 1D4 tactical battle pods, one scout pod, one heavy artillery pod and one officer's pod.
- 51-55 1D4 + 1 green bioroids led by a red bioroid. All are armed with weapon drum blasters and ride on hover platforms.
- 56-60 One crann followed by 1D4 enforcers and 1D6 + 1 shock troopers about 600ft behind it.
- 61-65 1D4 + 1 blue bioroids on foot, armed with standard bioroid blasters.
- 66-70 1D6 + 1 Zentraedi in male power armor and p-beam cannon shoulder mounts. A fighter pod scouts ahead 4000ft (1200m); it is fully armed.
- 71-75 Bioroid invid fighters (3).
- 76-80 Inorganic extermination squad composed of one crann, two odeons with blasters, 1D4 + 1 scrim, 1D6 + 1 cougars.
- 81-84 Zentraedi theatre scout escorted by 1D4 fighter pods.
- 85-87 Crashed Robotech Masters Assault Carrier still smoldering from the invid blasts that knocked it out of the sky. Scores of bodies of invid scouts, shock troopers, and bioroids litter the ground for a 6000ft (1800m) area. 2D6 bioroid terminators, 2D4 red bioroids, 4D6 blue bioroids, and 1D4 sets (3 each) of bioroid invid fighters are still spoiling for a fight. Half are on hover sleds. **Note:** 1D6 × 10 invid shock troopers and 1D4 × 10 armored scouts will arrive in 4D4 minutes.
- 88-91 1D6 shock troopers, and 1D6 troopers led by one red enforcer on an invid speeder.
- 92-96 2D4 + 2 green bioroids led by one red bioroid.
- 97-00 Zentraedi mixed team: one reconnaissance scout pod, 1D6 + 1 tactical battle pods, one light and heavy artillery pods, 1D4 male power armor with p-beam cannons and one officer's pod.

## THE END?

Between bad weather and combat, it will take the REF/Sentinel team at least six hours to find the Robotech Masters' escape shuttle. When they do, it will be half buried in dust and sand. Hills, huge, 100ft (30m), boulders and stalagmite type jutting rock formations surround the vessel. (GM, is this the place for another encounter/battle?)

The shuttle door can be easily forced open. Upon entering, a recorded message will boom over a loudspeaker. "You have done well, my Zentraedi warriors. Your arrival and this decoy vessel will have given us the opportunity to make our real escape. Now crush our dreaded enemy and leave this place." A search of the vessel will confirm that it holds no occupants.

Does the adventure end here with a swift and uneventful rendezvous with the Ikazuchi carrier? It could, but there are other possibilities. The characters could be pursued in space by Zentraedi or Invid. Furthermore, a related adventure could involve the Zentraedi landing ship and/or the Robotech Masters' mothership. What if the Masters didn't get away and they're still on board their vessel? Who wins? Zentraedi or Invid? And how does the victor respond to the presence of the REF/Sentinels? Is this going to result in a space battle? Perhaps the Zentraedi defeat the Invid (they should because they outnumber them 2 to 1), but their ship is crippled. The Robotech Masters' ship is a drifting wreck, but there are likely to be survivors. Does the Ikazuchi come to their rescue? Will the Zentraedi and Tirolians allow themselves to be rescued? Will more invid arrive? The possibilities are yours to explore.

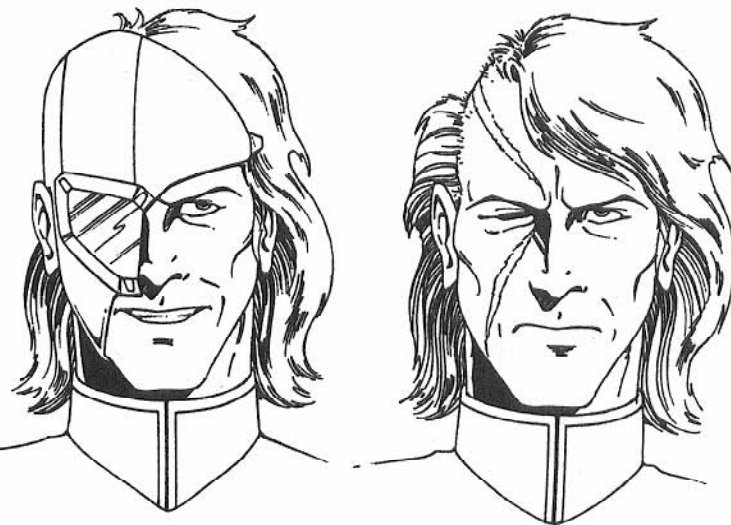

## COLONEL THOMAS RILEY (T.R.) EDWARDS

**Military Advisor and Commander of the REF Ground Troops and fourth in the chain of command.**

**Hit Points:** 48 S.D.C.: 31

**Alignment:** Diabolic

**Attributes:** I.Q. 15, M.E. 10, M.A. 9, P.S. 18, P.P. 21, P.E. 14, P.B. 8, Spd. 11

**Age:** 45 at the start of the Sentinels.

**Weight:** 180lbs **Height:** 6ft 2 inches

**Disposition:** Snide, arrogant, pushy, bully type. A brooding loner with a martyr complex. But a very clever, cunning, and excellent tactician.

**Insanity:** Obsessed with power. His hate for Rick is approaching a full obsession (hates Rick because he reminds him of Roy Fokker whom Edward's despised). Tends to be paranoid.

**Level of Experience:** 10th level rogue Veritech Pilot (VF series).

**Skills of Note:** Pilot Jet — 98%, Pilot Veritech Fighter — 98%, Mecha Combat: Veritech, Mecha Combat: Alpha, Mecha Combat: VR-052 Basic Cyclone, Weapon Systems — 90%, Navigation — 98%, Space Navigation — 98%, Read Sensory Instruments — 98%, Pilot Automobile — 98%, Pilot Helicopter — 98%, Pilot Space Shuttle — 98%, Pilot Airplane — 98%, Palming — 75%, Safe-cracking — 70%, Streetwise — 80%, Boxing, Swimming — 98%, Computer Operation — 80%, Demolitions — 80%, Demolitions Disposal — 80%, W.P. Knife, W.P. Energy Rifle, W.P. Energy Pistol and Hand to Hand: Expert. All W.P.s are at 10th level proficiency.

**Rank:** Colonel and Commander of REF ground troops.

**Personal Profile:** Edwards is one of the most treacherous humans in the REF. He is a veritech ace who is said to be Roy Fokker's equal (Edwards will violently insist that he's Roy's master.) He has an excellent military mind and a good head for strategy. Sadly, he is a superb leader, but a horrible team player. If Edwards is not in charge he will never give his all and will try to make his superiors look bad at the cost of innocent soldiers' lives.

He is a mean, conniving individual who has joined the REF for personal glory and schemes of power. His immediate goal is to show Rick Hunter and friends to be the incompetent wimps that he knows them to be. He's a "chicken shit" officer who would rule his troops with an iron fist. He has little tolerance for failure and will punish

those under his command for the slightest infractions and failures. The lives of his troops mean nothing. It is victory that counts.

Colonel Edwards is a bitter loner disliked by all and feared by many. His scarred face (a trophy from a dogfight with Roy Fokker) and the metal face plate he wears to conceal it, serve to reflect the bitter, merciless inner essence of the man himself. **Note:** In the script outline for the Sentinels T.V. series, Edwards attempts to seize control of the REF, kill Rick and Lisa, and all others who may stand in his way with his plans to conquer the planet Earth, making himself the supreme ruler. To accomplish this he even strikes a deal with the invid. And sabotages our heroes. Edwards is the worse kind of human scum.

## COLONEL JONATHAN WOLFE

**Commander of the famous "Wolf Pack" Veritech Squadron**

**Hit Points:** 46 S.D.C.: 42

**Alignment:** Unprincipled (later changes to anarchist)

**Attributes:** I.Q. 14, M.E. 9, M.A. 22, P.S. 20, P.P. 21, P.E. 12, P.B. 23, Spd. 15

**Age:** 33 at the start of Sentinels.

**Weight:** 210lbs **Height:** 6ft 4 inches

**Disposition:** A lady's man, charming, confident, cool, and clever; an excellent leader who cares about his men and leads by example. It is only after the tragedies on Earth that the war weary legend becomes melancholy and temporarily sells out to the invid. Even then, his intention, misguided as it is, is to save the lives of many by sacrificing a few (*Invid Invasion T.V. Episode #68, Eulogy*).

**Level of Experience:** 7th level Veritech Ace and test pilot.

**Skills of Note:** Pilot Jet — 98%, Pilot all Veritechs (specifically, VF series fighters, Alpha and Hover Tank), Mecha Combat: VF Veritechs, Mecha Combat: Alpha, Mecha Combat: Hover Tank, Mecha Combat: VR-052 Cyclone, Weapon Systems — 98%, Navigation — 98%, Pilot Automobile — 98%, Pilot Hover Cycle — 82%, Pilot Space Shuttle — 98%, Pilot Lancer Space Fighter — 98%, Pilot Helicopter — 86%, Read Sensory Instruments — 83%, Operate Computer — 95%, Radio: Basic — 85%, Surveillance — 75%, Basic Electronics — 75%, First Aid — 92%, Dance — 82%, Sing — 75%, Gymnastics, Body Building, Climbing — 96/65%, Prowl — 75%, W.P. Energy Pistol, W.P. Gallant H-90, W.P. Energy Rifle, and Hand to Hand: Martial Arts.

**Rank:** Colonel

**Personal Profile:** Col. Wolfe is a classic hero of epic proportions. He is daring, ingenious, loyal, trustworthy, honest, brave, merciful, kind, and a concerned leader who would risk his own death to save a life. The flamboyant swashbuckler has risen through the ranks of the RDF, which have given him ten years of combat experience in the Zentraedi Control Zone and other trouble spots.

His skills as a Veritech pilot were legendary before the SDF-3's departure. A skill that was utilized in the testing of mecha prototypes. It was his test runs with the experimental Veritech Hover Tank (Wolfe and a hand-picked team were the first to pilot the tank) that introduced him to the marvelous machine. Wolfe fell in love with it and personally petitioned to have a squadron included as part of his troops; a request that was honored. Thus, only Col. Wolfe and his "Wolfe Pack" have the option of piloting hover tanks.

**Note:** In the script outline, Col. Wolfe stays with the REF and the Sentinels for most of their adventures. It is years later that Col. Wolfe returns to Earth as the leader of a reconnaissance assault wave against the occupying invid on Earth.

## AIRMAN JOHN "JACK" BAKER

**Alpha Veritech Pilot**

**Hit Points:** 20 S.D.C.: 30

**Alignment:** Scrupulous

**Attributes:** I.Q. 12, M.E. 12, M.A. 15, P.S. 14, P.P. 19, P.E. 14, P.B. 15, Spd. 12

**Age:** 17 at the start of Sentinels.

**Weight:** 150lbs **Height:** 5ft 6 inches

**Disposition:** A combination of confidence and self-doubt, because he is young and inexperienced. However, Jack could be a young Rick Hunter or Jonathan Wolfe, charismatic, courageous, compassionate, responsible, honest and loyal.

**Level of Experience:** Starts at level one, but is 6th level by the end of Sentinels.

**Skills of Note (at 1st level):** Pilot Jet — 84%, Pilot Veritech Fighters (specifically, Alpha, Beta and Vindicator) — 75%, Mecha Combat: Alpha, Mecha Combat: Beta, Mecha Combat: Vindicator, Mecha Combat: VR-052 Cyclone, Weapon Systems — 80%, Read Sensory Instruments — 50%, Navigation — 80%, Radio: Basic — 55%, First Aid — 56%, Pilot Automobile — 84%, Pilot Hover Cycle — 58%, Pilot Jet Pack — 60%, Body Building, Swimming — 58%, Climbing — 58/35%, Computer Operation — 65%, Computer Programming — 45%, W.P. Blunt, W.P. Gallant H-90, W.P. Energy Pistol, W.P. Energy Rifle and Hand to Hand: Expert.

**Personal Profile:** Jack is a likable orphan from the first Robotech War who joined the RDF to get revenge against Zentraedi. However, he has learned to live with his grief and move forward, rather than long for vengeance. Jack is a true RDF knight who has adopted the RDF code of ethics as his own moral code. His only bad traits are being overzealous, lacks self-control and often acting on his heart and not his head.

**Note:** In the script outline, Jack recognizes Col. Edwards to be the treacherous fiend he is, and the two have several verbal confrontations. Jack's friendship with Rick Hunter is enough reason for Col. Edwards to hate him, and Jack's suspicions ("I'll be watching you Edwards.") puts Airman Baker on the top of Edward's hate list, right under Rick, Lisa and Max.

Jack is also in love with Karen Penn. It is a tumultuous, one-sided relationship. Jack joins the Sentinels, along, Rick, Max, Lisa, Karen, Miriya, and Wolfe.

## AIRMAN KAREN PENN

**Alpha Veritech Pilot**

**Hit Points:** 18 S.D.C.: 20

**Alignment:** Anarchist

**Attributes:** I.Q. 15, M.E. 20, M.A. 8, P.S. 12, P.P. 18, P.E. 13, P.B. 15, Spd. 11

**Age:** 17 at the start of Sentinels

**Weight:** 120lbs **Height:** 5ft 6 inches

**Disposition:** Intelligent, inquisitive, resourceful; in search of adventure and excitement. She tends to be rude, abrupt, and aloof to low ranking soldiers and men in general. She sees herself as a warrior/adventurer, but feels she must play tough loner to prove herself. She is honest, loyal and trustworthy.

**Level of Experience:** Starts at level one, but is 6th level by the end of Sentinels.

**Skills of Note (at 1st level):** Pilot Jet — 84%, Pilot Veritech Fighters (specifically, Alpha and Beta) — 75%, Mecha Combat: Alpha, Mecha Combat: Beta, Mecha Combat: VR-052 Cyclone, Weapon Systems — 80%, Read Sensory Instruments — 50%, Navigation — 80%, Radio: Basic — 55%, Pilot Automobile — 84%, Fencing, Climbing — 58/35%, Computer Operation — 65%, Demolitions —



65%, Demolitions Disposal — 65%, Math: Advanced — 68%, W.P. Sword, W.P. Knife, W.P. Energy Pistol, W.P. Energy Rifle, W.P. Gallant H-90, and Hand to Hand: Martial Arts.

**Personal Profile:** Karen is a tough, adventurous young woman spirited by unbridled enthusiasm. There is nothing that is too dangerous or difficult for her. She volunteers for every challenge she faces, although she is secretly insecure and fearful. Karen feels anger toward Jack Baker because he is genuinely confident and she's envious of that. Yet despite Airman Penn's misgivings, she is a courageous soldier who learns to temper her aggressiveness and competitiveness with compassion and forethought.

**Note:** According to the Sentinels script outline, Karen is constantly pestered by the lovesick Jack Baker. She sees Jack only as her major competitor and treats him coldly. Her idol is Miriya Sterling, who she sees as the ultimate warrior woman. It is Miriya who helps to teach her that kindness and emotions are not weaknesses, but the true strengths of a warrior.

Karen, along with the other central cast of characters, joins the Sentinels.

## ROBOTECH MASTER SCIENTIST: CABELL

### Field Scientist

**Hit Points:** 57 S.D.C.: 40

**Alignment:** Scrupulous

**Attributes:** I.Q. 28, M.E. 20, M.A. 18, P.S. 12, P.P. 13, P.E. 12, P.B. 10, Spd. 9

**Age:** 379 at the start of Sentinels; looks about 60.

**Weight:** 250lbs **Height:** 6ft 5 inches

**Disposition:** Warm, friendly, authoritative, inquisitive, sharp, analytical mind, he is absorbed in uncovering all the secrets of protoculture. Confident, but not arrogant.

**Level of Experience:** 14th level

**Skills of Note:** Astrophysics — 94%, Biology — 98%, Botany — 98%, Chemistry — 98%, Chemistry: Analytical — 98%, Math: Basic & Advanced — 98%, Computer Operation — 98%, Computer Programming — 98%, Optic Systems — 98%, T.V./Video — 98%, Radio: Basic — 98%, Cryptography — 59%, Electrical Engineer — 98%, Mechanical Engineer — 98%, Mecha Mechanics — 98%, Locksmith — 84%, Paramedic — 98%, Pilot Hover Vehicle — 98%, Jet Pack — 98%, Read Sensory Instruments — 98%, Weapon Systems — 98%, Palming — 79%, Streetwise — 79%, W.P. Energy Rifle, Hand to Hand: Basic (3rd level).

**Rank:** Robotech Master Scientist (elite)

**Personal Profile:** Cabell is the only Robotech Master Scientist left on the moon Fantoma, the Master's homeworld. He has chosen to stay behind to continue with his protoculture experiments with his assistant and friend Rem. Cabell believes he may be on the verge of unlocking Zor's lost secrets about protoculture. Without a doubt, Cabell is a genius and "the" authority regarding protoculture.

Cabell is a dedicated scientist whose curiosity is tempered with patience and compassion for all life. In this respect he is an aberration in the society ruled by the heartless Robotech Masters. It was this perceived weakness in his character that convinced the Masters to leave him to his work on Fantoma (rather than accompany them to Earth). **Note:** The script outline develops the father-son friendship between Cabell and Rem. Both join the REF to help destroy the Invid. Doctor Lang and Cabell quickly become friends and allies. It appears that Cabell dies in the arms of Rem about halfway through the series (revealing that Rem is a Zor clone).

## REM (A Zor Clone)

### Field Scientist (Cabell's apprentice)

**Hit Points:** 32 S.D.C.: 30

**Alignment:** Scrupulous

**Attributes:** I.Q. 22, M.E. 19, M.A. 17, P.S. 19, P.P. 21, P.E. 14, P.B. 14, Spd. 15

**Age:** Undetermined; appears about 15.

**Weight:** 180lbs **Height:** 6ft 4 inches

**Disposition:** Intense, extremely cunning, quick thinker. Friendly, but somewhat arrogant and aloof.

**Level of Experience:** 4th level at the start of Sentinels.

**Skills of Note:** Biology — 83%, Botany — 83%, Chemistry — 98%, Chemistry: Analytical — 93%, Math: Basic & Advanced — 98%, Computer Operation — 98%, Computer Programming — 78%, Radio: Basic — 78%, Optic Systems — 78%, Electrical Engineer — 73%, Mechanical Engineer — 73%, Mecha Mechanics — 68%, Mecha Electronics — 63%, Medical: Paramedic — 82%, Pilot Hovercycle — 70%, Pilot Hover Vehicle — 74%, Pilot Jet Pack — 75%, Read Sensory Instruments — 68%, Navigation — 88%, Gymnastics, Hand to Hand: Expert, W.P. Energy Pistol, W.P. Energy Rifle, Pilot Bioroid (Red).

**Rank:** Robotech Master Scientist in training.

**Personal Profile:** Rem is the last of the Zor clones. He's been placed under Cabell's tutelage in hope that his work with protoculture will stimulate memories of the original Zor or that Rem may stumble upon the same discoveries. Cabell was a dear friend of Zor's and takes his responsibilities toward Rem very seriously. Their relationship is one of father and son, with much affection between the two. Like most youths, Rem is an idealist with great expectations for himself.

In combat Rem proves himself to be as brave and capable as any soldier. Following his mentor, he joins the REF and the Sentinels to crush the Invid.

**Note:** According to the script outline, Rem becomes a close friend of Rick and Lisa Hunter, as well as the android Janice. He becomes a major force among the Sentinels in their fight to free the universe of Invid tyranny. Toward the end of the series he hatches a scheme to travel back through time to change the past and prevent the horror brought about by the Invids and the Masters. Whether or not Rem does travel back through time is unclear (it does state that "his plan ultimately fails.").

## JANICE ROBOTECH ANDROID

### Veritech Pilot (Special)

#### M.D.C. by Location:

Arms (2) — 50 each

Legs (2) — 100 each

Head — 150

Main Body — 350

**Alignment:** Principled

**Attribute Equivalents:** I.Q. 19, M.E. 19, M.A. 19, P.S. 19, P.P. 19, P.E. (not applicable), P.B. 19, Spd. 19.

**Weight:** 170lbs **Height:** 5ft 10 inches

**Disposition:** Friendly, cheerful, confident, loyal and brave.

**Level of Experience (equivalent):** 6th level Ace.

**Skills of Note:** Pilot Jet — 89%, Pilot all Veritechs — 85% (specifically, Alpha, Beta, Shadow Fighter & Vindicator), Mecha Combat: ALL Veritechs (not Cyclones or Destroids), Pilot Automobile — 98%, Pilot Spacecraft — 85%, Pilot Titan — 80%, Pilot Jet — 89%, Weapon Systems — 98%, Navigation — 98%, Space Navigation — 98%, Read Sensory Instruments — 80%, Operate Computer

— 98%, Radio: Basic — 85%, Dance (pro) — 96%, Sing (pro) — 95%, Prowl — 80%, Hand to Hand: Martial Arts, Demolition — 98%, Demolition Disposal — 98%, ALL W.P.s

**Rank:** Special Operative

**Personal Profile:** Janice was a beautiful pop singer, the caliber of Minmei. She and Minmei (friends) were accidentally trapped on board the SDF-3 when it made its space fold. Everybody was shocked to discover that Janice was a one of a kind android created by Doctor Emil Lang.

She is a secret artificial intelligence found aboard the SDF-1, which is housed inside an android body (also of Robotech Master origin). The intelligence has no memory of its past as a tool for Zor or the Robotech Masters. It has a female persona, is friendly, and totally loyal to humans. A sophisticated holographic system can create the appearance of being human. Janice is programmed to be a REF warrior.

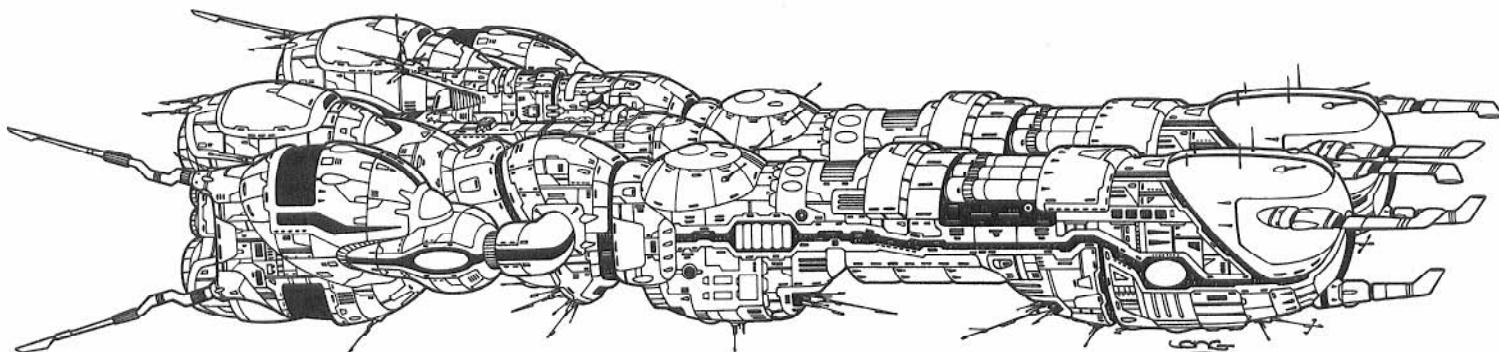

## THE SDF-3

The flagship of the REF fleet is the mile long (1.6km) SDF-3. This third incarnation of Zor's experimental vessel is much more true to the original design, making it very different than its famous predecessor.

The most *obvious* change is its outward appearance. The vessel is a quarter of a mile larger, red in color, and bears little resemblance to the famous SDF-1. The original Robotech Masters' design is clearly apparent, as exhibited in its more rounded, organic design. The *arms* of the SDF-1 & 2, which bore the Daedalus and Prometheus type submersible carriers, are gone. In their place are two oval shaped "laser arms." The flat forward deck and main reflex cannon have been replaced with a tubular dual cannon providing twice as much firepower than the SDF-1's. Small lasers and communications antennas bristle from the outer surface like dozens of hairs.

The most surprising difference is that the SDF-3 can not transform. This is completely intentional and not a design flaw. The modular transformation capabilities of the first two battle fortresses was a human modification. Since Robotechnology seemed to focus on a symbiosis between man and machine and the transformability of machines, the humans assumed the battle cruiser possessed these same features and created the multilevel metamorphosis ability of the SDF-1. However, while the metamorphosis of the SDF-1 was dramatic and did serve to save the mighty vessel on several occasions, it is not an effective combat mode. The humanoid shape slows movement and provides no combat advantage.

The non-transformable SDF-3 is faster, more mobile, covered in a variety of deadly weapons (designed for close range and long range battle), and better designed for space travel. In addition to its space fold system, the spacecraft utilizes antigravity, sublight, and conventional means of propulsion.

The purpose of the SDF-3 is to provide heavy support for its fleet/ troops and to function as a mobile base of operations or space station. It is not just a giant space gun. Inside its belly is a massive manufacturing facility that builds and repairs mecha, missiles, weapons, vehicles, and additional equipment. Other facilities manufacture clothing, electronics,

and process food. An intergalactic campaign requires a foundation, a haven that offers shelter, food and comfort. Without it, the fleet could never sustain a military or exploratory campaign for more than a few months. Without a doubt, the SDF-3 is the heart of the REF fleet. The roots that holds and sustains the entire fleet.

To operate the SDF-3 and all of its production facilities requires a crew of 10,000. **Among the crew are the leaders of the Robotech Expeditionary Force, many of whom are heroes from the First Robotech War.** They include **Rick Hunter:** the Commander in Chief of the entire REF, **Lisa Hayes-Hunter:** Second in Command and Captain of the SDF-3, **Max Sterling:** Commander of the Veritech Fighter Division and Leader of the Skull Squadron, **Miriya Sterling:** Veritech Fighter Ace and Second in Command of the Skull Squadron (the VF-1V Vindicator and Beta Shadow Fighter are her personal mecha of choice), **Johnathan Wolfe:** Famed Veritech Ace and leader of the REF Infantry (Alpha Fighters or Hover Tank are preferred mecha), **Jean Grant** (mother of Bowie Grant and sister-in-law of the late Claudia Grant, SDF-1 hero): Head of Medical, **Vince Grant** (brother of Claudia Grant and Bowie's father): Head Bio-Maintenance Engineer and MTA Titan Commander (infantry), **Doctor Emil Lang:** Leader of the REF Diplomatic Mission, REF Chief of Staff and Head of Robotechnology Research and Operations (a vital member of the REF), **T.R. Edwards** (a self-serving villain who turns traitor): Strategic Commander of the Ground Troops and 4th in the chain of command, **Lynn Minmei:** Pop music star and hero of the First Robotech War is accidentally swept away during the SDF-3's space fold (civilian), **Janice:** Android who became a Veritech Ace and Hero. **Breetai,** the Zentraedi commander loyal to humans, was one of the principal people involved in the creation of the REF. He is the Field Commander of the REF troops and third in command. Breetai also leads an elite force of micronized Zentraedi warriors. These troops have been hand picked by Breetai and are completely loyal to him and the REF (all are 4th to 8th level officers, male & female; can pilot any of the REF Zentraedi Pods). **Exedore** is a REF Ambassador and Advisor. He is also involved with Robotechnology Research and operations.

Exedore, Breetai and all the REF Zentraedi have been micronized. However, a protoculture chamber is on board the SDF-3 in case it is necessary to enlarge the Zentraedi, or to micronize other Zentraedi they may encounter. A small number of full size Zentraedi mecha have also been brought along should they be needed.

The SDF-3 stays out of combat only because of its strategic significance and not for any lack of arms. The "Battle Fortress" is lined with laser turrets and missile launchers, has the two super powerful laser arms and its unstoppable twin disintegration cannons, in addition to its force of over 2000 mecha. Of course, if lives are in deadly peril, the SDF-3 will come to the rescue with weapons blazing. It may also be part of a heavy assault and/or defend against enemy spacecraft.

In addition to the battle fortress's formidable weaponry, the vessel is protected by a force field. Should the force field fail, the Command Tower is protected by a reserve Pinpoint Barrier Defense System operated from the bridge. Comparing the SDF-3 to the Zentraedi warships, she is at least twice as powerful as a Nupetiet-Vernitzs Flagship. Ironically, the SDF-3 is initially hidden inside the shell of Zentraedi flagship (3½ miles/4.8km long) to disguise the REF's true might from the Robotech Masters. As it turned out, the Robotech Masters were not on their homeworld, Fantoma, (they were on their way to Earth) and the clever ruse was ineffective against the Invid marauders who were ravaging it.

## THE SDF-3 BATTLE FORTRESS

**Vehicle Type:** Space; space fold command carrier.

**Crew:** Command Tower: Ship's captain (1), first officer and second in command (1), Commander Breetai (1), 472 CT crew members, 114 troops (security).

Laser Arms: 700 crew, 448 troops, 400 mecha on *each* of the two arms.

SDF-3 Main Decks: 340 communications personnel, 792 dietary, 632 engineering, 1800 bio-mechanical engineers, 2552 maintenance/factory/labor, 1864 medical and sciences, 649 security.

**Troops:** Veritech Pilots: 696 combat ready, plus 396 in reserve (1092 total).

Destroid Pilots: 324 combat ready, plus 324 in reserve (648 total).

Cyclone Riders: 324 combat ready, plus 324 in reserve (648 total).

Zentraedi Warriors: 1080 (40% are officers)

Additional Military Personnel: 480

**Total Troops:** 3948

**Total of Crew and Troops:** 13,948

## STANDARD MECHA COMPLEMENT

**Veritech Fighters: 1166 total**

484 Alpha Fighters

72 Alpha Shadow Fighters

348 Beta Fighters

72 Beta Shadow Fighters

58 Vindicator VF-1V

96 VF Series Veritechs

36 Hover Tank Veritechs

**4000 Cyclones** (50% are VR-052, 25% are VR-041, 25% are VR-038-LT)

**Destroids: 1664 total** (626 Destroids, 1038 Zentraedi mecha)

18 RDF Excalibers

132 REF Excalibers

36 RDF Gladiators

132 REF Gladiators

8 RDF M.A.C. IIs

24 REF M.A.C. IIIs

18 RDF Raidar-X

132 REF Raidar-X

18 RDF Spartans

108 REF Spartans

726 Z-1 Battle Pods

302 Z-2 Officer's Pod

10 Z-3 Cyclops

## Special Complement of Full Size Zentraedi Mecha

36 Battle Pods

36 Officer's Pods

6 Reconnaissance Pods

48 Male Power Armor

48 Female Power Armor

24 Fighter Pods

**Vehicles of Note:** 6 to 12 Titans, 8 to 12 Horizont Troop Shuttles, 30 to 60 AAT-30s, 20 to 40 AAT-40s, 500 Hover Cycles.

### M.D.C. by Location:

Laser Turrets (48) — 150 each

Missile Launchers (14 hatches) — 100 each

Main Lasers (4; 2 on each arm) — 1000 each

Deck One Dome Hangars (2) — 4000 each

Airlock Access Hatches — 150 each

Main Hangar (Bottom) Sliding Doors (2) — 4000

Outer Hull (per 40ft area) — 100

Interior Walls (per 20ft area) — 40

Command Tower (1) — 10,000

Laser Arms (2) — 20,000 each

Main Thrusters (4) — 10,000 each

Secondary Thrusters (8) — 2500 each

\*Forward Section Main Guns (½) — 30,000

Midsection (½) — 30,000

\*\*Rear Section (½) — 32,000

2 Main Hangars (Decks 20 & 21 bottom) — 10,000 each

Force Field (encircles the entire ship) — 60,000

\*Depleting the M.D.C. of the forward section means the main cannons of the SDF-3 are destroyed (10,000 M.D.C. each), as well as Decks 20A & 21A.

\*\*Depleting the M.D.C. of the rear section will destroy all engines and half of the Command Tower. The SDF will be adrift in space without means of propulsion. Note: The "Laser Arms" are considered separate parts of the battle fortress and not included in the rear or mid-sections.

**Speed:** Conventional Space Propulsion: Maximum speed is Mach 10.

Sublight: .16 the speed of light.

Space Fold: A hyperspace system that catapults the vessel through space and time. The space fold system is used for traveling from one galaxy to another quickly. **Range:** Unknown, presumably limitless. Note: When the SDF-3 uses its space fold, it will also transport all vessels/objects within a two mile area. The area affected by the SDF-3's space fold can be expanded up to a 50 mile (80km) area. Typically the SDF-3 can transport several thousand other vessels.

Planet Bound: The SDF-3 can land on a planet if absolutely necessary, but is not designed to maneuver in an atmosphere (uses anti-gravity and conventional propulsion).

**Maximum Range:** Unlimited. Protoculture engines give it an estimated life of 60 years of constant use. Sublight and space fold offer infinite range.

**Length:** 5322ft (1622m or about one mile)

**Height:** 1190ft (362.7m)

**Width:** 924ft (281.6m)

**Weight:** 46,850,000 tons

**Main Engine:** Reflex, protoculture.

**Gravity Control System:** Internal and external.

## WEAPON SYSTEMS

- DS-2 Full Barrier System:** The SDF-3 has a full force field to protect it from enemy assaults. The force field encompasses the entire ship, which presents a bit of a problem in that the SDF-3 can not fire its weapons or launch mecha while the force field is up.



The force field can be erected within 5 or 6 seconds, which means the barrier can be dropped and replaced immediately. The DS-2 Barrier Defense System can regenerate its M.D.C. at a rate of 10,000 M.D.C. per hour.

2. **DS-1 Barrier Defense System** is used to protect the Command Tower when the main force field is down. The DS-1 is used to protect the Command Tower only. *See the Ikazuchi Carrier, pgs 100-101, for description.*
3. **Forty-Eight (48) Zentraedi style Laser Turrets** line the top, bottom and sides of the SDF-3. Two can be found on each of the dome hangars, 10 on the nose of each main gun (forward section) and the rest distributed around the ship. Each turret can rotate 360 degrees with an 180 degree arc of fire.

Range: 100,000 miles (160,000km) through atmosphere.  
200,000 miles (320,000km) in space.

Mega-Damage: 1D4 × 100 M.D.

Rate of Fire: Each turret can fire twice per melee.

4. **Twenty-Four (24) Missile Bays** are strategically placed on the vessel. These are retractable units that are concealed until activated to fire. The Command Tower has three missile launchers, another three are located by both dome hangars and another three at the main hangar and Horizont Hangar.

Missile Type: Reflex Multi-Warhead, although any can be used in an emergency. Range: 1800 miles (2880km).

Mega-Damage: 4D6 × 10

Rate of Fire: Volley of 2, 4 or 8.

Payload: Each missile bay has 104 missiles.



5. **LA-4 Laser Cannons (Laser Arms):** The so-called laser arms are actually decks with combat ready mecha troops. Mounted on each arm is a large antenna type appendage which are really two giant lasers. Each arm can rotate 360 degrees (gravity control prevents the crew from tumbling all over). The actual lasers can rotate 45 degrees.

Primary Purpose: Defense

Secondary Purpose: Anti-Spacecraft

Range: 100,000 miles (160,000km) in an atmosphere.  
200,000 miles (320,000km) in space.

Mega-Damage: 1D6 × 1000

Rate of Fire: Each of the four LA-4 lasers can fire ONCE per melee.

6. **The Main Guns/Reflex Cannons:** The SDF-3 has two of the devastating reflex cannons rather than one. The advantages are that both can be fired simultaneously to create a larger beam area or their firing can be staggered, giving the battle fortress two blasts per every ten minutes instead of one. The flaws in the old SDF-1 style weapon have been eliminated so that the weapon is 100% reliable.

Primary Purpose: Assault

Secondary Purpose: Anti-Space Station/Spacecraft

Mega-Damage: Absolutely destroys EVERYTHING in its path of fire. One cannon fires a two mile (3.2km) wide beam, or a combined, four mile (6.4km) wide beam.

Range: 60,000 miles (96,000km) in an atmosphere.  
120,000 miles (192,000km) in space.

Payload: Each of the two reflex cannons can fire once every TEN minutes. A common tactic is to fire the second gun 5 minutes after the first, effectively reducing the time limit by half.

7. **Mecha Troops** are deployed for defense and assault. *See Troops.*

## SDF-3 NOTES:

1. Decks 1-9 have a general ceiling height of 40ft (12.2m), this makes multi-floor facilities possible.
2. Decks 10-15, the crew decks, have a 25ft ceiling height, making the two floor buildings possible.

3. Decks 16-18 have a 60ft (18.3m) ceiling height.
4. Deck 19 has a 130ft (39.6m) ceiling height to hold the Garfish and Horizont troop carriers.
5. Decks 20 and 21 have a ceiling height of 70ft (21.3m).
6. The Command Tower decks each have a ceiling height of 35ft (10.7m).
7. The Laser Arm Decks have a 90ft (27.4m) height.
8. Crew Quarters: All crew quarters are divided into dormitory style apartments, with a living room, dinette, two sitting rooms, a study and four bedrooms. Each living area is shared by eight (8) crewmen. Officer's quarters are inhabited by the officer and his family or by 2-4 single officers.

## SDF-3 FLOOR PLANS

**Note:** The scale of the mile long (1.6km) SDF-3 prevents the inclusion of tiny details, such as elevators, stairs, hatches, and small latrine and closet/storage compartments.

## THE COMMAND TOWER

The Command Tower is located on top of the SDF-3 toward the rear section.

### CT DECK ONE: Communications

1. **Central Communications:** A huge area filled with computer terminals, monitor screens, and rows and rows of communications operators. This is the main communications network that links the SDF-3 to the rest of the REF and directs its troops.
2. **Communications Analysis:** A subsection of the central communications network that helps to collate data and transmissions, scramble and unscramble coded messages, and disseminate information.
3. **Hyperspace Communications Network.**
4. **Broadcast Central:** Another subsection of the central communications network. This sector is tied directly into the multi-system radio and sensory tower atop the command tower. These engineers operate satellite relay communications, laser communications, and all types of long range or special communications, as well as monitor sensor data such as radar.

### CT DECK TWO: The Bridge Deck

1. **Observation Deck:** A large open area enclosed by a tough, transparent bubble. A computer network and several monitors can be used to call up communications and combat data. Comfortable chairs and a conference table with a personal computer and a 4ft monitor suspended from the ceiling are found toward the rear of the room for briefings and up to the second information.
2. **The Bridge** is a reinforced command deck filled by view screens and communication monitors. This is where the Captain directs her ship, crew and troops.
3. **The Captain's Quarters** is a spacious living area divided into two bedrooms, large living room, large study with a connecting library (a special computer terminal, and three monitors, and intercom can link the captain directly to central communications. The library includes books and video disc data.), dining room and dinette complete with refrigerator, private bathroom with shower, and recreation room (also used for private conferences). *Two top security guards (4th level or higher) clad in full VR-041 saber cyclone armor guard the captain's quarters at all times. The number of guards may be doubled or tripled during combat to protect the sensitive data contained in the room (not to mention the captain).*
4. **Briefing Room**
5. **Officers' Kitchen and Dining.**
6. **Officers' Lounges (4)** provide an area where bridge personnel can relax or sleep. Each includes two couches, big easy chair, table with

six chairs, desk, two pull out beds and a private shower.

- Command Tower Weapons Operations:** Houses the weapons crew that operates the Command Tower's weapon systems. This includes the DS-1 pin point barrier defense system (same as Ikazuchi carrier, pg 100), used to defend the Command Tower only, and retractable CT Missile Launchers (3).

## CT DECK THREE: Bridge Crew

- Sensory Collation Network**
- War Room:** Strategy and tactics are plotted here. Suspended from the ceiling and imbedded in the walls are view screens and data monitors. A huge holographic tactics table is in the center of the floor.
- Connecting Reinforced Corridors** with dividing hatchways.
- Command Tower Crew Quarters:** Mostly low ranking officers and engineers, accommodates about 160 crewmen.
- Kitchen and Dining Hall.**
- Conference Room** also used as a lounge.
- Shower and Latrine.**

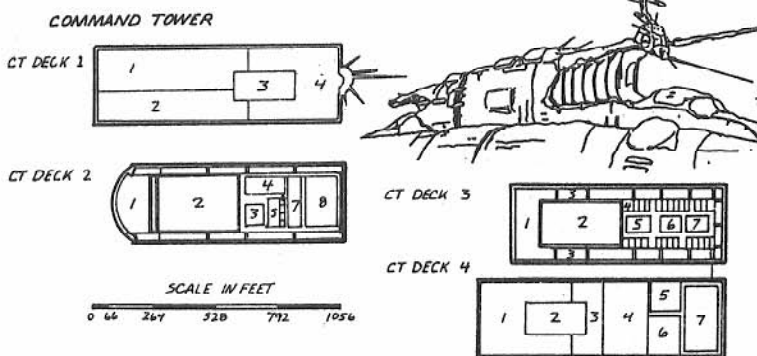

## CT DECK FOUR: Auxiliary Systems

- Internal SDF-3 Communications.**
- Independent Life Support Auxiliary System** specifically for the Command Tower only!
- Independent Artificial Gravity Auxiliary System** for the Command Tower only!
- Pinpoint Barrier Defense System Generator:** The Pinpoint Barrier is used to defend the command tower when the main ship force field is down. Defends Tower only!
- Commander Breetai's Living Quarters:** In addition to his own spacious living quarters (almost identical to Deck Two, #3), there are two separate living quarters that house eight of his most trusted officers who serve as his personal aides and guards. Four Z-2 Officer's Battle Pods are also stored here.
- Command Tower Security Office:** In addition to administration, the security force contains 24 VR-041 cyclone operatives (in battloid mode), 12 VR-038-LT cyclones, 6 VR-052 battler cyclones, 24 security soldiers in CVR-3 body armor (armed with a 9mm "wolf" auto pistol and Fal-2 laser rifle), 30 security soldiers in plain uniforms (armed with Gallant H-90s) and four Gladiators and two Z-1 Battle Pods.
- Combat Computer:** The crew of this room study all available data (sensory, communications, troop movements, etc.) regarding combat. They collate and analyze the strengths, weaknesses, progress, actions, movement, weapons, personnel and all other aspects of REF and opposing forces. This helps to provide a full picture of the conflict so that strategies and tactics can be formulated quickly and effectively. All data is available to the bridge, war room, captain's room and Breetai's room.

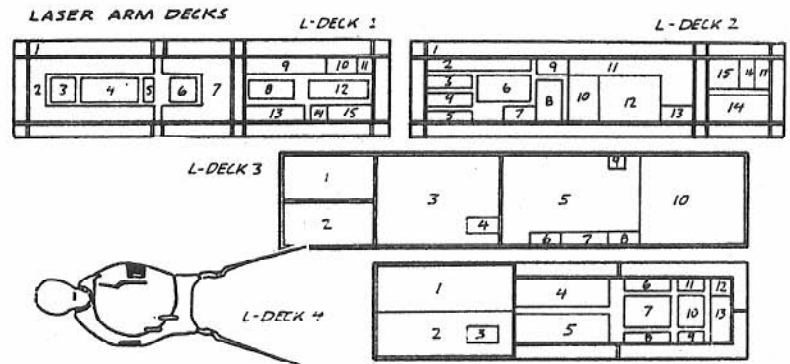

## LASER ARMS

The SDF-3 has two large arm-like attachments with two powerful lasers. Although these sub-wings of the vessel contain troops and crew, they are referred to as the "Laser Arms" or "SDF Annexes." Both are identical in every way.

### L DECK ONE: Crew

- Reinforced Connecting Corridor.**
- Crew Quarters:** All crew quarters are dormitory type compartments designed to be fairly spacious and cozy, like an apartment, not a barracks. A typical living compartment will contain four bedrooms with bunk beds (2 people in each bedroom), a living room, dinette with a sink and shelves, two sitting rooms and a study. Each crew quarters houses eight soldiers. Accommodates approximately 256 crewmen.
- Recreation Room**
- Kitchen and Mess Hall**
- Latrine**
- Security and Brig:** This is more to keep order among the troops than fight intruders. 18 M.P.s are on duty at all times. Armed with Putnam Stun Guns and Gallant H-90s (pistol mode). Six suits of VR-038-LT cyclone mecha are also kept here. 24 prison cells can hold up to 150 prisoners comfortably.
- Crew Quarters:** Same as #2; houses 132 crewmen.
- Medical**
- Crew Quarters:** Houses about 72 crewmen.
- PX-Store** making available books, video discs, electronics, candy, cloth, and personal items.
- Bar and Lounge.**
- Crew Quarters:** Houses 56 soldiers.
- Crew Quarters:** Houses 56 soldiers.
- Lounge**
- Latrine and Showers.**

### L DECK TWO: Crew and Life Support

- Connecting Reinforced Corridors.**
- Crew Quarters:** Houses 96 crewmen.
- Crew Quarters:** Houses 40 crewmen.
- Crew Quarters:** Houses 40 crewmen.
- Latrine and Showers.**
- Mecha Storage Bay:** Contains 200 CVR-3 body armor, 68 VR-052 battler cyclones, 24 VR-038-LT cyclones, 4 gladiators, 4 ex-calibers, 2 raider-x, 2 spartans, and 2 alpha fighters in battloid mode. All mecha are the new REF models. Weapons include 576 Fal-2 rifles, 288 gallant H-90s, 144 wolverine assault rifles and 144 misc. others.
- Mecha elevator** to the next two decks.
- Kitchen and Mess Hall.**
- Lounge with Bar and Game Room.**
- Communications Network** for the Laser Arms.
- Independent Life Support System** for the Arms.
- Independent Gravity Control System** for the Arms.

13. Cafeteria and Lounge (with Latrine).
14. Crew Quarters: Houses 72 soldiers.
15. Mini-Gymnasium
16. Latrine and Showers (with sauna).
17. Recreation Room

## L DECK THREE: Mecha Hangar

1. Hangar Bay for mecha that have been prepped and are ready to depart. Accommodates approximately 24 Alpha and 18 Beta fighters.
2. Hangar Bay. Identical to #1.
3. Hangar for preparing and storing fighters. It can accommodate about 48 Alpha and 24 Beta fighters and 6 VF veritech comfortably, but can hold an additional 48 Alphas or 24 VFs or Betas if necessary and still have a minimal amount of maneuvering space.
4. Mecha Elevator accesses decks 2 and 4.
5. Mecha Storage Hangar used for preparing and repairing Veritech fighters for combat. Usually contains 1D4×10 Alphas and 4D6 Betas, 2D6 VF-series veritechs, and 1D4×10 REF Zentraedi Battle Pods.
6. Electrical Engineer's area.
7. Bio-Maintenance Engineer's area.
8. Engineer's Lounge and Cafeteria.
9. Additional Maintenance Crew.
10. Mecha Garage for Repair.

Note: About 200 crewmen service this deck.

## L DECK FOUR: Mecha and Crew

1. Mecha Storage: Contains 48 Alpha Fighters, 12 Beta Fighters and a mix of 48 destroids; usually 40% Raidar-X, 20% Spartans, 20% Excalibers, 10% Gladiators, 10% others (such as Battle Pods), and 144 VR-052 Battler Cyclones.
2. Mecha Storage: Contains 18 Beta Fighters, 2D6 Raidar-X, 2D6 Excalibers, 2D6 Gladiators, and 1D6×10 VR-052 Cyclones.
3. Mecha Elevator
4. Crew Quarters: Houses 128 Veritech Pilots.
5. Crew Quarters: Houses 128 Veritech Pilots.
6. Crew Quarters: Houses 32 Destroid Pilots.
7. Kitchen and Mess Hall
8. Latrine and Showers.
9. Lounge
10. Recreation Room
11. Officer's Lounge and Bar.
12. Video Library
13. Crew Quarters: Houses 40 crewmen.

## THE SDF-3 MAIN DECKS

### DECK ONE: Officers' Quarters

1. Forward Weapon System (main gun).
2. Mecha Hangar: Contains 24 VF series veritechs, 12 Alpha Fighters, 12 Betas, 12 Vindicators, 12 M.A.C. IIIs, 6 M.A.C. IIs, 96 Z-1 Battle Pods, and 48 Officer's Pods. There are also numerous TCH-4 Tractor Haulers and ML-3 Forklifts, and a handful of hover cycles.
3. Hangar Dome: Contains 32 combat ready Alpha and Beta Fighters linked together.
4. Ceiling Hatch
5. Hangar Dome: Contains 32 combat ready Alphas and Betas linked.
6. Ceiling Hatch
7. Maintenance Crew
8. Maintenance Crew
9. Maintenance Crew
10. Connecting Passageways.
11. Crew Quarters: Houses 120 pilots.

12. Crew Quarters: Houses 96 Zentraedi warriors.
13. Lounge, Bar and Recreation Hall frequented mostly by Zentraedi (micronized).
14. Latrine & Showers
15. Crew Quarters: Houses 40 Zentraedi warriors.
16. Crew Quarters: Houses 56 Zentraedi officers.
17. Kitchen & Cafeteria.
18. Lounge frequented mostly by Zentraedi.
19. Swimming Pool and Sauna.
20. Latrine and Showers
21. Gymnasium
22. Target Range
23. Lounge and Bar
24. Laundry Service
25. Video Theatre
26. Lounge
27. Library
28. Security: 24 M.P.s at all times. Three cells can hold up to 24 prisoners comfortably. M.P.s are equipped with uniforms, Putnam stun guns and Gallant H-90s (pistol mode).

### OFFICERS' WING

29. Private Swimming Pool, Saunas and Showers.
30. Conference Room
31. Lounge with Cafeteria and Bar.
32. Private Library
33. Lounge
34. Video Entertainment Lounge (Private, Officers only).
35. T.R. Edwards' Living Quarters
36. Private Dining & Kitchen
37. Max & Miriya Sterlings' Living Quarters
38. Exedore's Living Quarters
39. Officers' Quarters: High Command
40. Officers' Quarters: High Command
41. A Park complete with trees, flowers, and picnic tables. A holographic sky simulates night and day.
42. Engines

## DECK TWO: Engineering and Crew

1. Forward Weapon System
2. Crew Quarters: Houses 180 crewmen.
3. Crew Quarters: Houses 180 crewmen.
4. Crew Quarters: Houses 144 crewmen.
5. Latrine & Showers
6. Main Mess Hall & Kitchen
7. Lounge
8. Crew Quarters: Houses 144 crewmen.
9. Crew Quarters: Houses 168 crewmen.
10. Latrine & Showers
11. Secondary Mess Hall & Kitchen
12. Video Library
13. Crew Quarters: Houses 96 crewmen
14. Gymnasium
15. Latrine
16. Crew Quarters: Houses 144 crewmen.
17. Recreation Room
18. Crew Quarters: Houses 168 crewmen.
19. Artificial Gravity System
20. Connecting Corridors
21. Engineering
22. Engines

## DECK THREE: Recreation

1. Forward Weapon System.
2. Theater: Live Arts and Film.
3. Book Library
4. Chinese Restaurant
5. Dance Hall



6. **Security:** 24 M.P.s armed with putnam stun guns and nightsticks.
7. **A Park** with grass and trees, flowers, and park benches. A holographic sky simulates day and night.
8. **A PX-Store** of monstrous proportions (2 stories tall). Sells everything from cloth and electronics to hardware and food.
9. **Arcade** filled with games.
10. **Tennis Courts:** Open air so they seem like part of the park.
11. **The Wayward Star Night Club:** A favorite entertainment spot. Lynn Minmei and Janice often perform there. Other acts include comedy, various bands and music (rock, country, jazz, etc.) and amateur nights.
12. **Fast Food Coney Island Restaurant.**
13. **Mini-Theater:** Live acts and films.
14. **Refreshments and Salad Bar:** Specializes in non-alcoholic fruit drinks.
15. **Italian Restaurant.**
16. **Candy Store**
17. **Bakery:** Fresh bread and pastry.
18. **Ice Cream Parlor**
19. **Hobby and Craft Store**
20. **Small Mexican Restaurant**
21. **Bowling Alley**
22. **Arcade**
23. **Engines**

**Notes:** All restaurants, theaters, PXs, and bowling alleys have two floors.

## DECK FOUR: Administration

1. **Forward Weapon System**
2. **Main Life Support System**
3. **Internal SDF-3 Communications Network**
4. **Ship Administration**
5. **Officers' Quarters:** Houses 48 officers.
6. **Crew Quarters:** Houses 160 crewmen.
7. **Mess Hall & Kitchen**
8. **Latrine & Showers**
9. **Recreation Room**
10. **Lounge**
11. **Officers' Dining Hall & Kitchen**
12. **Officers' Lounge**
13. **Officers' Quarters:** Accommodates 24 high ranking officers and their families.
14. **Crew Quarters:** Houses 208 crewmen.
15. **Latrine**
16. **Theater:** Film and live shows.
17. **Engines**

## DECK FIVE: Medical Control

1. **Forward Weapon System**
2. **Hangar** for the transportation of patients, wounded and supplies. Usually houses 4 to 6 Alpha Fighters, 1 or 2 Beta Fighters and an old-style RDF shuttle.
3. **Hangar:** Identical to #2.
4. **Open Area**
5. **Three Story Crew Quarters:** Houses 288 medical personnel.
6. **Three Story Lounge:** Many rooms and areas for quiet games like chess.
7. **Kitchen & Cafeteria (3 stories)**
8. **Latrine & Showers (3 stories)**
9. **Hospital:** Complete, high-tech, three floor, medical facility that can accommodate up to 2800 patients. Typical staff is 400 per shift.
10. **Latrine & Showers**
11. **Three Story Crew Quarters:** Houses 432 medical personnel.
12. **Lounge and Cafeteria.**
13. **Isolation Laboratory**

14. **Quarantine Lab and Medical Facility.** Can accommodate up to 200 individual patients in isolation. Another 3 story facility.
15. **Engines**

## DECK SIX: Medical Annex

1. **Forward Weapon System**
2. **Pathology and Forensics Laboratory**
3. **Chemistry Laboratory**
4. **Nuclear Medicine**
5. **Medical Clinic**
6. **Lounge & Cafeteria**
7. **Recreation Facility** with many separate rooms for card playing, chess, backgammon, darts, pool and other games.
8. **Crew Quarters:** Houses 256 medical personnel.
9. **Crew Quarters:** Houses 320 medical personnel.
10. **Film Theater**
11. **Bar**
12. **Mess Hall & Kitchen**
13. **Lounge**
14. **Crew Quarters:** Houses 196 medical personnel
15. **Storage Area**
16. **Latrine & Showers**
17. **Engines**

## DECK SEVEN: Robotechnology Labs

1. **Forward Weapon System**
2. **Robotechnology laboratory (2 floor)**
3. **Storage**
4. **Crew Quarters:** Houses 128 lab techs.
5. **Protoculture Chamber:** This is one of the few remaining chambers used by humans to micronize or enlarge the Zentraedi.
6. **Cafeteria**
7. **Lounge**
8. **Doctor Lang's Living Quarters:** A huge two story area with a private laboratory, state of the art computer system, private library/personal records, as well as a spacious living area with bath and shower. Two VR-038-LT cyclone guards protect the premises.
9. **Security:** This deck is a top security deck requiring special security clearance. Only authorized personnel and the high command have access to these facilities (99% of the player characters will not). **Standard security staff includes:** 48 plain clothes M.P.s armed with putnam stun guns and gallant H-90s (pistol mode), 24 in CVR-3 body armor armed with stun guns and gallant H-90s (rifle mode), 24 suited in VR-041 saber cyclones, 12 suited in VR-038-LT cyclones, two RDF gladiators, two REF gladiators, two REF excalibers.
10. **A small Robotech Factory** for Lang's research; building experimental systems such as the RAT-1 Pegasus.
11. **Protoculture Energy Cell Storage.**
12. **Engines**

**Note:** All buildings on this Deck have two floors.

## DECK EIGHT: Research

1. **Forward Weapon System**
2. **Huge Storage Area** with modular walls to divide the space as needed.
3. **Crew Quarters:** Houses 112 science and medical personnel.
4. **Latrine**
5. **Recreation Hall**
6. **Auxiliary Life Support**
7. **Medical Laboratory**
8. **Stasis Chamber** used to store especially delicate specimens (yes, people can also be placed in stasis).
9. **Chemical Laboratory**
10. **Conference Room**

# THE SDF-3

SCALE IN FEET  
 0 66 264 528 792 1056

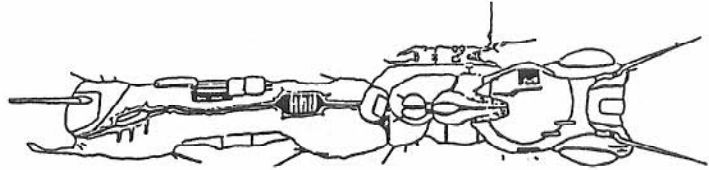

DECK ONE

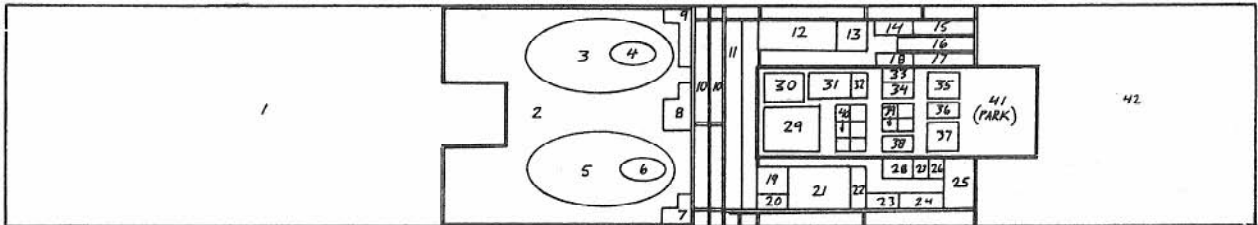

DECK TWO

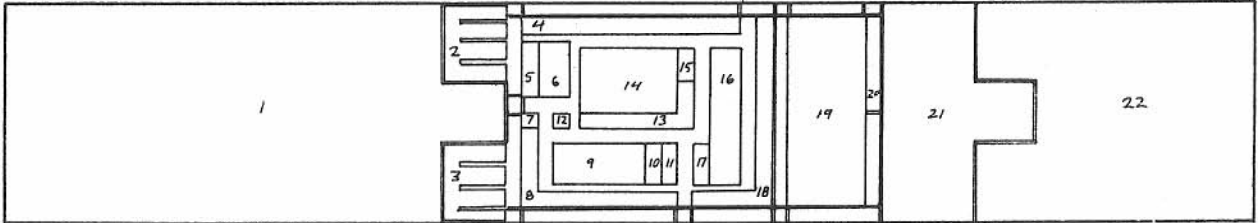

DECK THREE

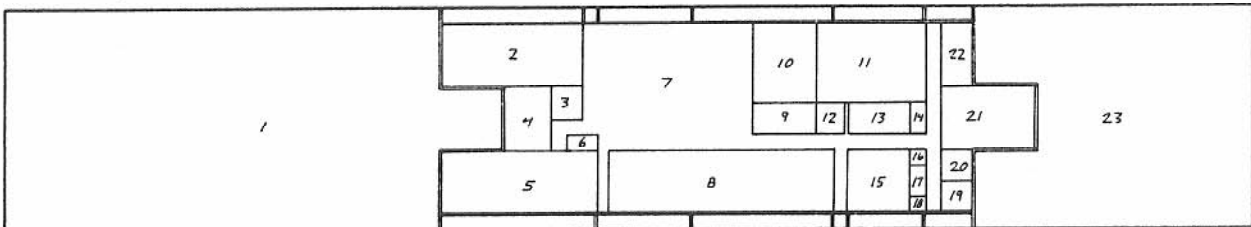

DECK FOUR

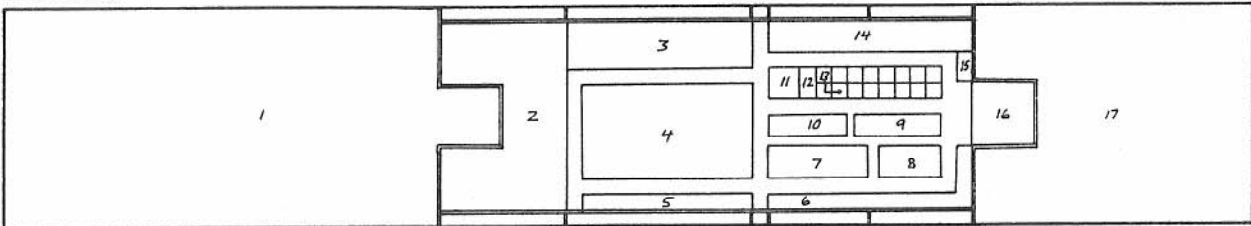

DECK FIVE

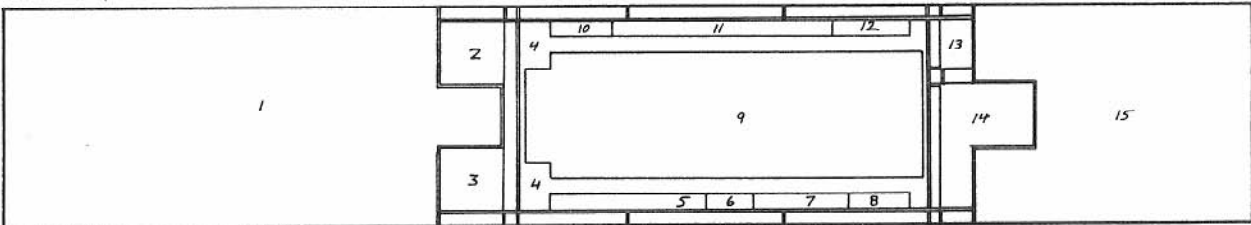

DECK SIX

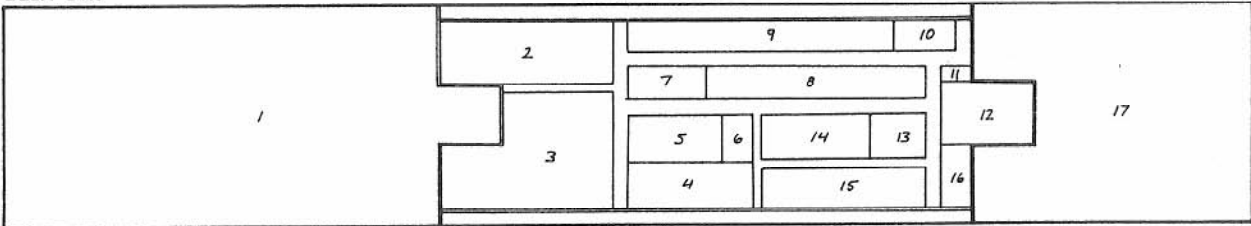

DECK SEVEN

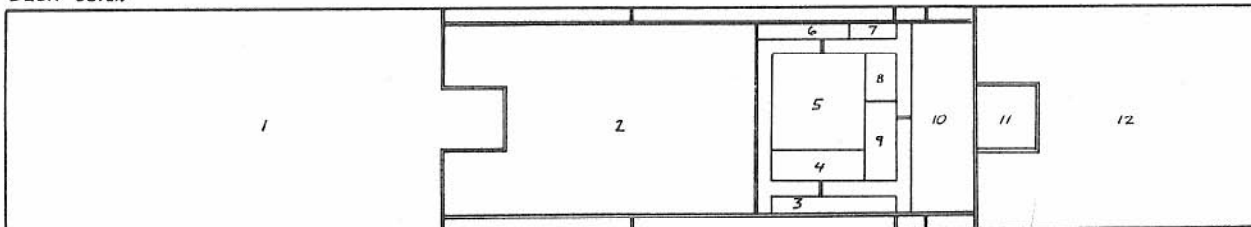

11. Radiology
12. Medical Library: Stored on computer & video discs.
13. Crew Quarters: Houses 240 science personnel.
14. Security: 48 plain clothes officers armed with putnam stun guns and gallant H-90s (pistol mode), 24 in CVR-3 body armor armed with stun guns and gallant H-90s (rifle mode), 12 in VR-041 Saber cyclones and 12 in VR-038-LT cyclones. 4 prison cells can hold up to 32 prisoners.
15. Mess Hall and Kitchen
16. Latrine & Showers
17. Biology Laboratory
18. Engines

## DECK NINE: Space Fold

1. Forward Weapon System
2. SDF Weapons Systems Operations, with independent life support system, maintains and controls the ship's many weapons.
3. Latrine & Showers
4. Mess Hall & Kitchen
5. Hyperspace Auxiliary Communications System
6. Auxiliary Sensory Network
7. Navigation and Ship's Engineering: Specifically designated for sublight travel and space fold operations.
8. Security: Consists of 48 plain clothes M.P.s armed with putnam stun guns, nightsticks and gallant H-90s with rifle stocks, providing full weapon capabilities. 12 in CVR-3 body armor and same weapons, 24 in VR-041 saber cyclones, 24 in VR-038-LT cyclones, 6 in VR-052 battler cyclones. Plus two REF gladiators.
9. Lounge
10. Lounge
11. Recreation Hall & Cafeteria
12. Force Field Generator
13. Space Fold System: Very restricted area. Must be authorized by both Doctor Lang and SDF-3 Captain Lisa Hayes-Hunter (or Rick Hunter or Breetai or Col. Edwards). The area is constantly guarded by a security team of 2 REF gladiators, 2 REF excalibers, 2 Z-1 Battle Pods and 6 VR-041 saber cyclones.
14. Auxiliary Gravity Control System
15. Engines

**Note:** Characters must have special clearance to be allowed on decks seven, eight and nine.

## DECKS 10-15: Crew Quarters

1. Forward Weapon System
2. Crew Quarters: Houses 480 crew members.
3. Lounge
4. Latrine & Showers
5. Recreation Hall
6. Theater: Live performances and films.
7. Recreation Hall
8. Lounge
9. Mess Hall & Kitchen
10. Crew Quarters: Houses 160 crew members.
11. Crew Quarters: Houses 160 crew members.
12. Night Club and Lounge with live singers, bands, comedy, acts and amateur nights.
13. Latrine
14. Crew Quarters: Houses 160 crew members.
15. Recreation Hall focusing on games; card games, board games, computer games, etc.
16. Lounge
17. PX-Store (small)
18. Swimming Pool
19. Showers & Sauna
20. Movie Theater
21. Target Range
22. Gymnasium & Combat Holographic Simulators
23. Engines

## DECK SIXTEEN: Storage

1. Water Storage Tanks
2. Connecting Corridors
3. Huge Storage Bay
4. Mecha & Vehicle Elevator
5. Storage
6. Water Treatment & Processing Plant
7. Sublight Engines & Conventional Propulsion

## DECK SEVENTEEN: Factory Level

1. Connecting Corridors 66ft (20m) wide.
  2. Destroid Factory: There are always 2D4 active RDF Gladiators assisting in heavy labor.
  3. Mecha Elevator connects to the next several decks.
  4. Lounge
  5. Latrine & Showers
  6. Cyclone Mecha Factory: A four story production facility. Cyclone proticulture cells are also stored here.
  7. CVR-3 Body Armor Factory & Storage: A four story production facility. It has approximately 24,000 CVR-3 in storage, along with field communications equipment and field accessories (such as holsters, canteens, etc.).
  8. Recreation Hall
  9. Storage Bay
  10. Mess Hall & Kitchen
  11. Lounge
  12. Latrine
  13. Crew Quarters: Houses 128 factory workers.
  14. Crew Quarters: Houses 128 factory workers.
  15. Destroid Storage: Typically will contain one M.A.C. III, 11 Spartans, 20 Gladiators, 20 Excalibers, and 20 Raidar-X. All are REF variety.
  16. Deck Security: 48 plain clothes security personnel armed with putnam stun gun, nightstick and gallant H-90 with rifle attachment; 48 officers in CVR-3 body armor armed with gallant H-90 with rifle attachment and Sal-9 laser pistol, and have a *jet back-pack* attached to their CVR-3 armor. **Mecha Units Include:** 24 VR-052 Battlers armed with the EP-40 Pulse Beam Gun and EP-37 60mm beam cannon; 2 RDF Gladiators, 2 REF Gladiators, 2 RDF Excalibers, 2 REF Excalibers and 4 Z-1 Battle Pods.
  17. Weapons Factory: Produces the "REF" weapons and energy clips (Southern Cross and old RDF weapons are not manufactured by the REF. What few of those weapons were brought from Earth). This is a four story facility. Storage contains 200,000 energy clips, 22,000 gallant H-90s, 12,000 M-35 wolverine assault rifles, 8,000 Fal-2s, 6,000 Sal-9s, 6000 wolf auto pistols, 2000 M-37 weasel auto pistols, 2000 M-36 badger sub-machineguns, 2,000 RL-2 super rocket cannons, 4,000 RL-6 rocket cannons, 1,000 EP-37s, 1,000 EP-40s, and 300 putnam stun guns.
  18. Storage
  19. Storage
  20. Auxiliary Water Plant
  21. Water Storage Tanks
  22. Sublight Engines & Conventional Propulsion
- Note:** Ceilings are 90ft tall, with the exception of multi-floor complexes (20ft ceilings for 3 & 4 story buildings).

## DECK EIGHTEEN: Factory Level

1. Connecting Corridor 66ft (20m) wide.
2. Bio-Maintenance Engineering: Mecha repair and maintenance of mecha. A two story facility with a 60ft (18.3m) first floor ceiling height and a 40ft (12.2m) second floor. 1D6 x 10 mecha are present for repairs at any time.
3. Mecha Elevator with two smaller (66ft/20m) elevators next to it.
4. Huge, 198ft x 132ft (60.3 x 48.2m), mecha elevator.



5. **Crew Quarters:** Houses 128 crewmen.
6. **Crew Quarters:** Houses 128 crewmen.
7. **Crew Quarters:** Houses 128 crewmen.
8. **Mess Hall & Kitchen**
9. **Vindicator Factory:** It also produces spare parts for the VF series veritech fighters. Guarded by six vindicators. 2 stories, 50ft (15.2m) ceilings. 4D4 vindicators and 4D4 VF series veritechs will be stored here at most times.
10. **Alpha Fighters:** A three story structure (33ft/10m tall ceilings) that produces alpha fighters and their various weapon systems. 3D4 alphas will be stored here at most times, along with a couple hundred weapon systems. Six shadow fighters guard the facility.
11. **Storage Area**
12. **Connecting Corridor** that's 132ft (48.2m) wide.
13. **Storage Area**
14. **Protoculture Factory:** A three story facility that produces the critical protoculture cells and protoculture microchips for mecha. The facility is heavily guarded by 24 security officers in CVR-3 armor and jet packs, armed with putnam stun guns and Fal-2 rifles, as well as mecha units consisting of 12 VR-041 saber cyclones, 24 VR-038 Light cyclones (with EP-37s), 4 Z-1 battle pods, 4 shadow fighter alphas.
15. **Crew Quarters:** Houses 128 crewmen.
16. **Protoculture Cell Storage:** Contains approximately 500,000 cells, as well as other protoculture related items, at any given time. Guarded by 2 RDF gladiators, 2 REF gladiators, 2 REF excalibers, 2 alpha fighters in battloid mode, 6 VR-041 saber cyclones, and 4 Z-1 battle pods.
17. **Storage Area**
18. **Security:** Identical to Deck 17, #16.
19. **Zentraedi Battle Pod factory.**
20. **Missile Factory**
21. **Missile Storage**
22. **Storage Area**

## DECK NINETEEN: Main Hangar

1. **Connecting Corridors 66ft wide (48.2m).**
2. **Mecha Storage Area:** A three story structure; floor one has an 80ft high ceiling, floor 2 and 3 have 35ft high ceilings. Floor 3 contains: 18 armored storage bunkers for the Horizont troop shuttle, storage of equipment and supplies packed and ready for delivery to the field and several forklifts. Floor 2 contains: 80 Z-1 battle pods, 30 Z-2 battle pods, 30 REF excalibers, 30 REF gladiators, 30 REF raidar-X, 30 spartans and 150 VR-052 battler cyclones. Floor One (ground floor) contains: 6 M.A.C. IIIs, 20 excalibers, 20 gladiators, 20 raidar-x, 20 spartans (half are RDF models), and 350 VR-052 battler cyclones. Plus, two fully loaded with mecha, combat ready, MTA titan transports. Leaving room for up to about 20 more destroids or vehicles.
3. **Mecha Elevator** with two smaller elevators next to it.
4. **Vehicle Storage Bay:** A three story structure very similar to the previous one (#2) in ceiling height and design. Floor 3 contains: 150 hover cycles and 200 other small vehicles such as land rovers, jeeps, forklifts, etc. Floor 2 contains: About 120 different combat vehicles such as the AAT-30, AAT-40, tanks, etc. Floor 1 contains: Four MTA titans (fully loaded with mecha), 30 REF excalibers, 30 REF gladiators, 30 REF raidar-x, 30 spartans, 48 Z-1 battle pods, 24 Z-2 officer's pods, and 48 misc. RDF destroids.
5. **Mecha Elevator**
6. **Secondary Veritech Hangar:** Combat prepped and ready fighters; 32 alpha fighters, 24 vindicators, 24 VF series veritechs, 48 alphas and betas linked together, 48 Z-1 battle pods, and 24 Z-2 officer's pods.
7. **Airlock** with individual release hatches.
8. **Maintenance Crew Area**
9. **Main Hangar:** A huge facility with a 130ft (39.6m) ceiling. The hangar is so large that it can hold two entire 350ft long *Garfish Troop Shuttles*, while two additional Garfish can dock at the giant

hangar doors in the floor. Other smaller shuttle craft and mecha also use the hangar. Typically contains: Four Z-3 cyclops, one garfish shuttle, four M.A.C. IIs, 36 VF series veritechs, 24 alpha fighters, 24 alphas and betas linked together, 6 RDF gladiators (used primarily for labor), 6 REF gladiators, 4 REF excalibers, 6 REF raidar-x, 24 Z-1 battle pods and dozens of work vehicles and crewmen.

10. **Small Floor Hangar Doors:** 264ft × 640ft (80.4m × 195m)
11. **Large Floor Hangar Doors:** 460ft × 700ft (140m × 213.3m)
12. **Beta Factory and Veritech Repair/Maintenance**
13. **Vehicle Storage**
14. **Missile Storage**
15. **Vehicle Factory & Maintenance**

## DECK TWENTY-A:

### Skull Squadron & Wolfe Pack

1. **"Wolfe Pack" Wing:** Storage bay containing 24 hover tanks, 4 vindicators, 48 VR-052 battler cyclones, 48 CVR-3 armor, 12 hover cycles and miscellaneous item for combat such as cobalt limpet mines, weapons, etc.
2. **"Wolfe Pack" Wing:** Veritech fighter storage bay containing 6 vindicators, and 24 shadow alphas and shadow betas linked.
3. **Pilots' Lounge**
4. **Pilots' Cafeteria**
5. **Storage Area**
6. **Hangar Area:** Usually reserved for the "Wolfe Pack."
7. **Hangar Area:** Reserved for the "Skull Squadron." 12 shadow alphas and shadow betas linked together are always combat ready. Plus an additional 6 alpha fighters, 4 betas, and 4 VF series super veritechs are kept here.
8. **Hangar Maintenance Crew**
9. **Veritech Maintenance Garage**
10. **Storage Area:** Usually houses equipment and supplies, few mecha.
11. **Gigantic Elevator** for Horizont Space Shuttle.
12. **Main Hangar:** Can hold 2-4 Horizont space shuttles, 12 armored supply bunkers, 20 REF raidar-x, 10 REF spartans, 10 REF gladiators, 10 REF excalibers, and 2 M.A.C. IIIs, all fitted with space propulsion units. Also 12 VF series veritech fighters and 6 alpha fighters.

## DECK TWENTY-B: Zentraedi Warriors

1. **Battle Pod Hangar:** Contains 100 Z-1 battle pods and 44 Z-2 officer's pods, all combat ready.
2. **Battle Pod Hangar:** Same as #1.
3. **Latrine & Showers**
4. **Officers' Lounge**
5. **Crew Quarters:** 256 Zentraedi warriors
6. **Recreation Area**
7. **Mess Hall & Kitchen**
8. **Storage**
9. **Battle Pod Storage:** 100 Z-1 Battle Pods and 44 Z-2 Officer's Pods.

## DECK TWENTY-ONE-A: Horizont Hangar

1. **Main Hangar:** Can hold 9 horizont shuttles and 32 armored supply bunkers. Also holds 4 RDF gladiators, and 2 REF gladiators for labor and defense. Of course, the hangar can also be used to launch mecha.
2. **Hangar Crew**
3. **Storage Area:** Mecha, vehicles, supplies.
4. **Horizont Elevator to 20-A**

## DECK TWENTY-ONE-B: Zentraedi Warriors

1. **Storage**
2. **Mecha Repair & Maintenance**
3. **Crew Quarters:** 466 Zentraedi warriors
4. **Mecha Storage:** 60 Z-1 battle pods, 20 Z-2 officer's pods.
5. **Crew Quarters:** Houses 128 human crewmen.
6. **Crew Quarters:** Houses 128 zentraedi warriors.

DECK EIGHT

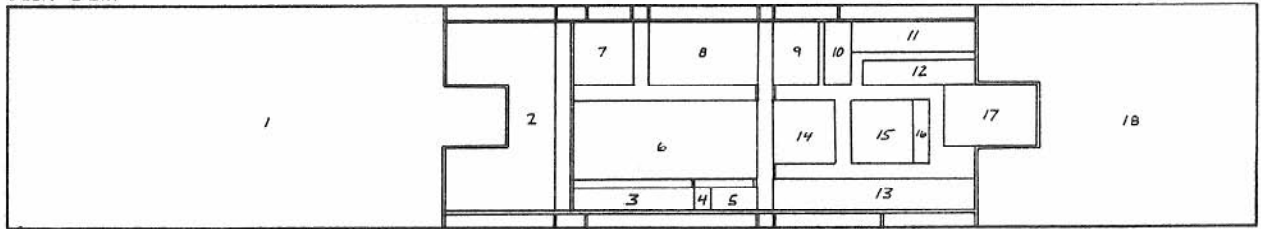

DECK NINE

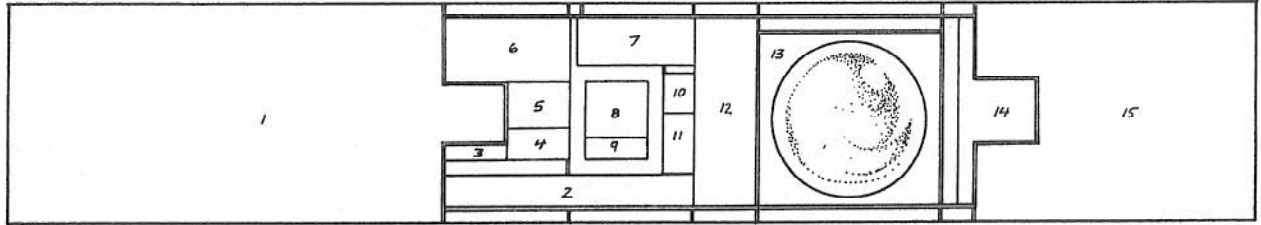

DECKS 10-15

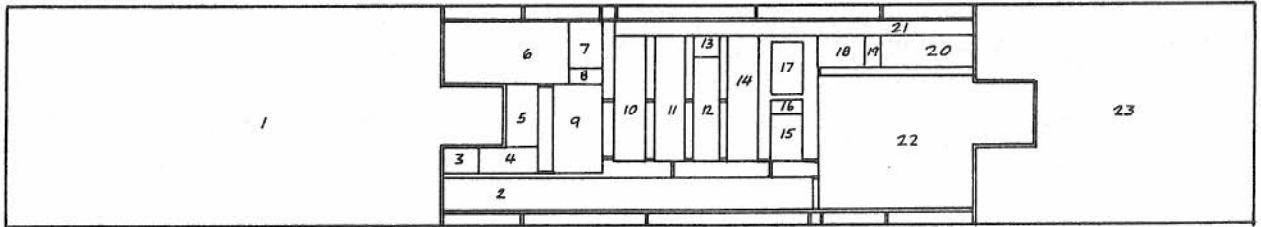

HOUSE 960 CREW MEMBERS EACH DECK CEILING HEIGHT 25 Ft (7.6m)

DECK SIXTEEN

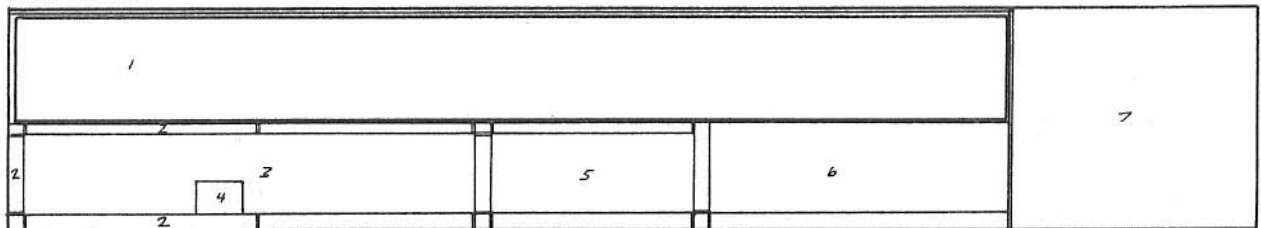

DECK SEVENTEEN

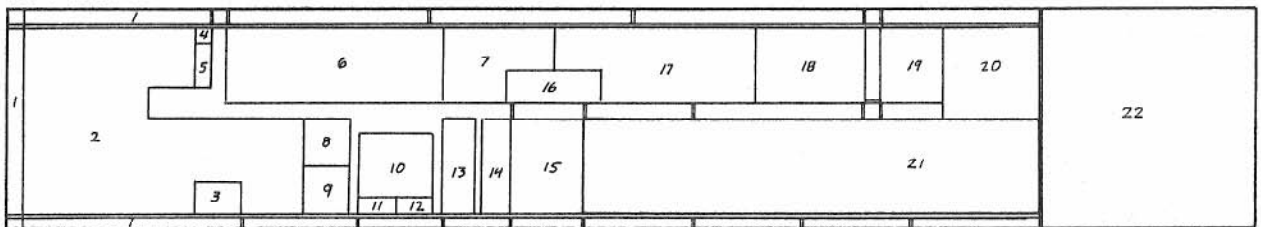

DECK EIGHTEEN

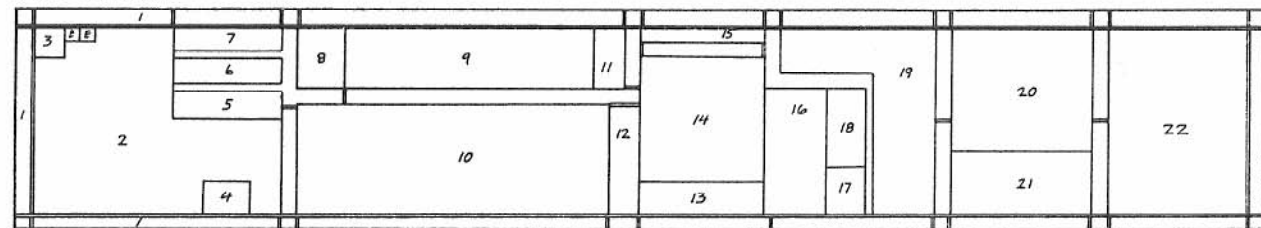

DECK NINETEEN

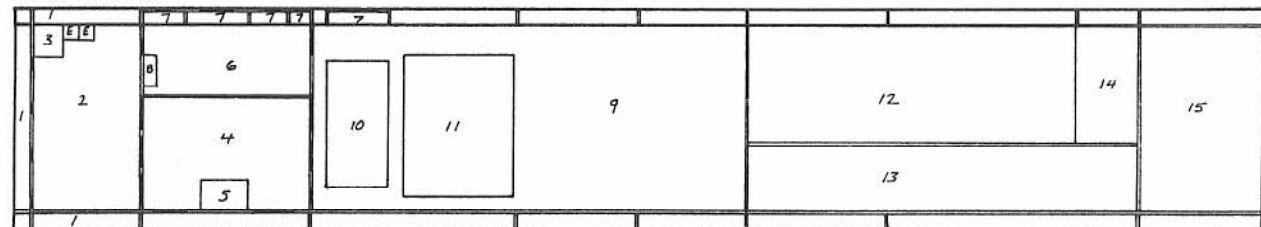

CEILINGS ON DECK 19 ARE 130 ft (39.6m) TO ACCOMMODATE GARFISH TROOP CARRIERS.

- Recreation Area
- 8. Mecha Storage: 60 Z-1 battle pods, 20 Z-2 officer's pods.
- 9. Lounge for Officers only.
- 10. Mess Hall
- 11. Lounge

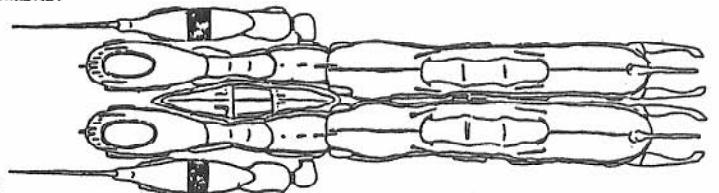

DECK 20-A

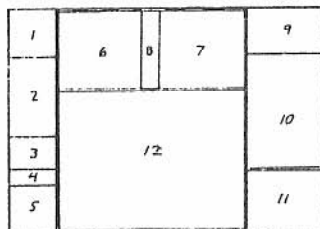

DECK 20-B

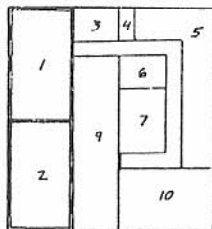

DECK 21-A

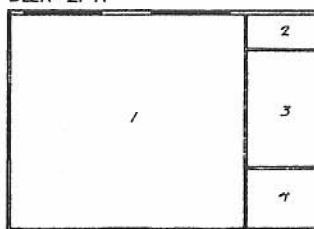

DECK 21-B

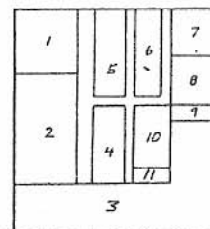

SCALE IN FEET

0 60 267 320 712 1056

# RIFTS®

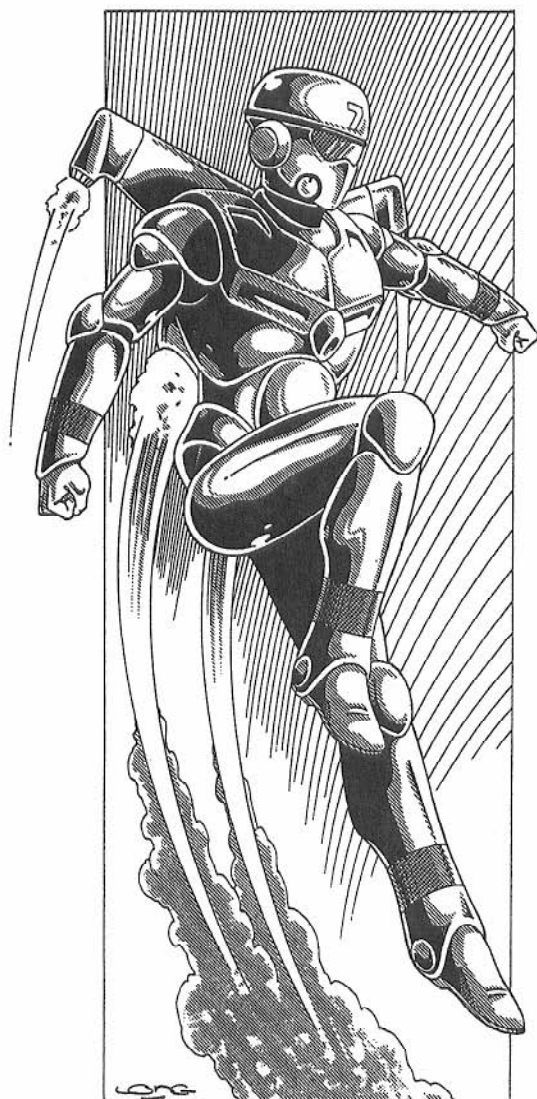

Copyright © 1992 Kevin Siembieda  
Palladium Books®, Rifts®, Megaverse®, and the Mechanoids® titles  
are registered trademarks owned by Kevin Siembieda.

Rifts® captures the elements of magic and the supernatural and combines them with science fiction and high technology.

The Palladium mega-damage system applies to both magic and technology, creating super powerful characters of all kinds. The fact that the same basic RPG system links *alloy* of our games means that players can bring in any Palladium character from any Palladium role-playing game. Aspects of multi-dimensional travel is a constant element of the game.

The Earth has been inadvertently transformed by a cataclysmic event that nearly obliterated humankind. It is approximately 200 years later (nobody knows for sure). Human beings are emerging out of a dark age to reclaim the planet. A strange and alien Earth inhabited by unimaginable, and sometimes terrible, creatures.

#### Highlights Include:

- Nearly 30 exciting and unique Occupational Character Classes, including the Cyber-Knight, Borgs, Glitter Boys, Psi-Stalkers, Dog Pack (mutant humanoid dogs), Crazies and many others.
- Supernatural creatures. Some, like the Dragon, are actually, player characters, others are horrifying menaces from the rifts.
- Bionics and cybernetics offer a vast range of mechanical augmentation. Super-technology with mega-damage body armor, energy weapons, rail guns, power armor, and robots.
- Psionics, magic, and an entire savage world of the fantastic and super-technology is within reach of your fingertips.

- Art by Parkinson, Long, Siembieda, and MacDougall.
- 254 pages — \$24.95 plus \$2.00 for postage and handling.

**Rifts Sourcebook™ Number One:** 124 pages of bots, power armor, the Triax Corp., the Coalition, monsters and adventure. \$1 plus \$1.50 for postage and handling.

**Rifts World Book One: Vampire Kingdoms™:** 174 pages, includes complete stats on vampires (presented in a new light), optional vampire player characters, vampire hunters, new aliens and monsters, the vampire kingdoms, the mysterious Yucatan, cities and more. \$15.95 plus \$1.50 for postage and handling.

**Rifts Conversion Book™:** 224 pages filled with information and complete conversions for most of Palladium Books® role-playing games. Emphasis on the Palladium RPG™, Heroes Unlimited™, Beyond the Supernatural™, but covers the entire Palladium megaverse®. \$19.95 plus \$2.00 for postage and handling.

**Mutants in Orbit™ — For Rifts® and After the Bomb® (TMNT):** What secrets lay beyond the thin veil of Earth's atmosphere? More than one might think, and it's all here. 124 pages, \$11.95 plus \$1.00 for postage and handling.

**Rifts World Book Three: England:** The fantastic realms of Great Britain and Ireland and a new twist on the Arthurian legends. 152 pages, \$15.95 plus \$1.50.

**Complete Palladium Catalog:** 75 cents

**Palladium Books® — Dept. P**  
12455 Universal Dr — Taylor MI 48180





\$15.95

Cat. No. 557

I.S.B.N. 0-916211-33-9

Compatible with the Robotech® RPG, Invid Invasion,  
and all the other Robotech® RPG source books.

ISBN 0-916211-33-9



9 780916 211332