

Palladium Books® Presents:

# Rifts<sup>®</sup> Chaos Earth<sup>™</sup>

A complete role-playing game

By Kevin Siembieda

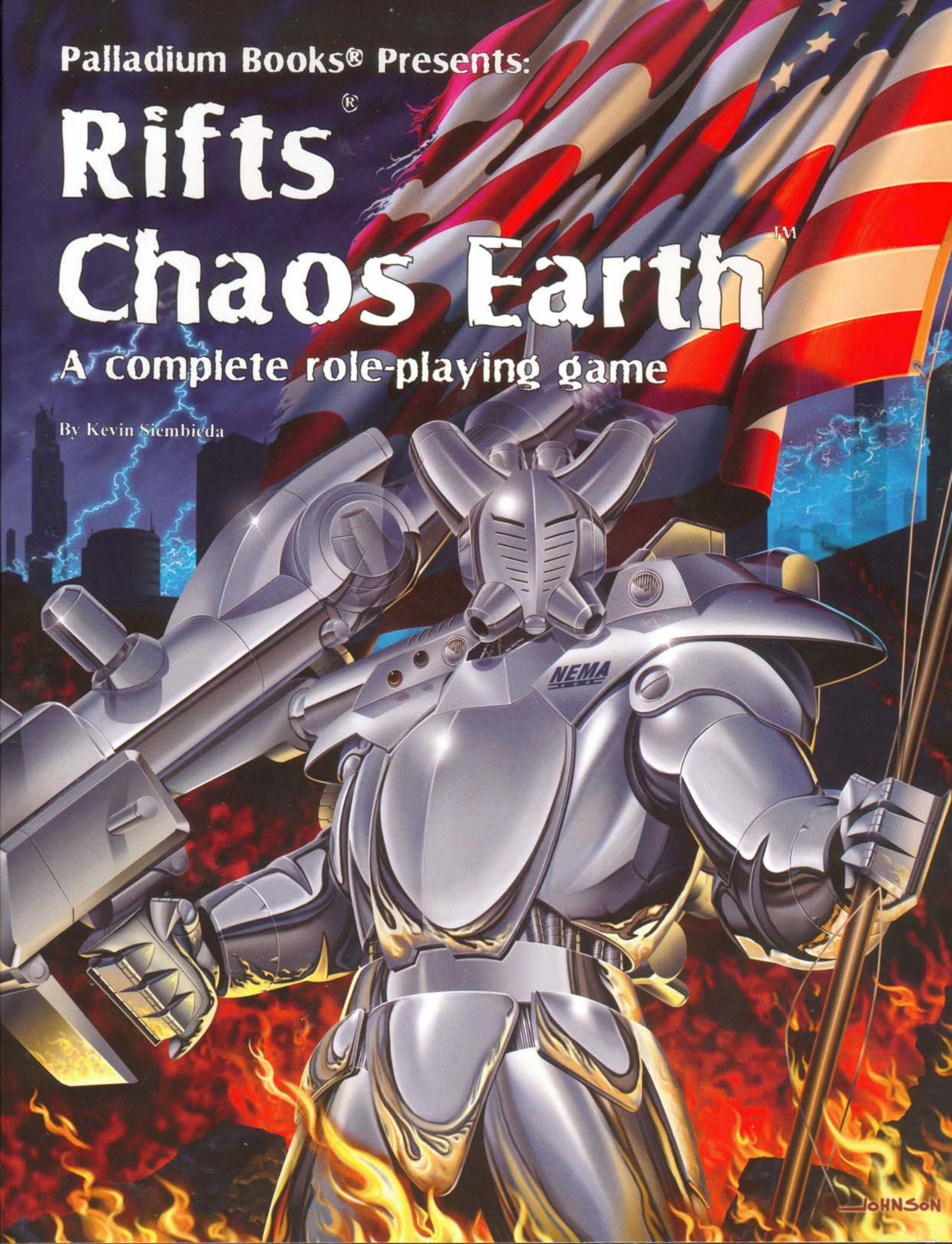





# Warning!

## Violence, War, Magic & the Supernatural

The fictional world of Chaos Earth™ is violent, deadly and filled with supernatural monsters. Other-dimensional beings often referred to as “demons,” torment, stalk and prey on humans. Other alien life forms, monsters, gods and demigods, as well as magic, murder, insanity, global destruction, the end of the world, robots and war are all elements in this book.

Some parents may find the violence, magic and supernatural elements of the game inappropriate for young readers/players. We suggest parental discretion.

Please note that none of us at Palladium Books® condone or encourage the occult, the practice of magic, the use of drugs, or violence.

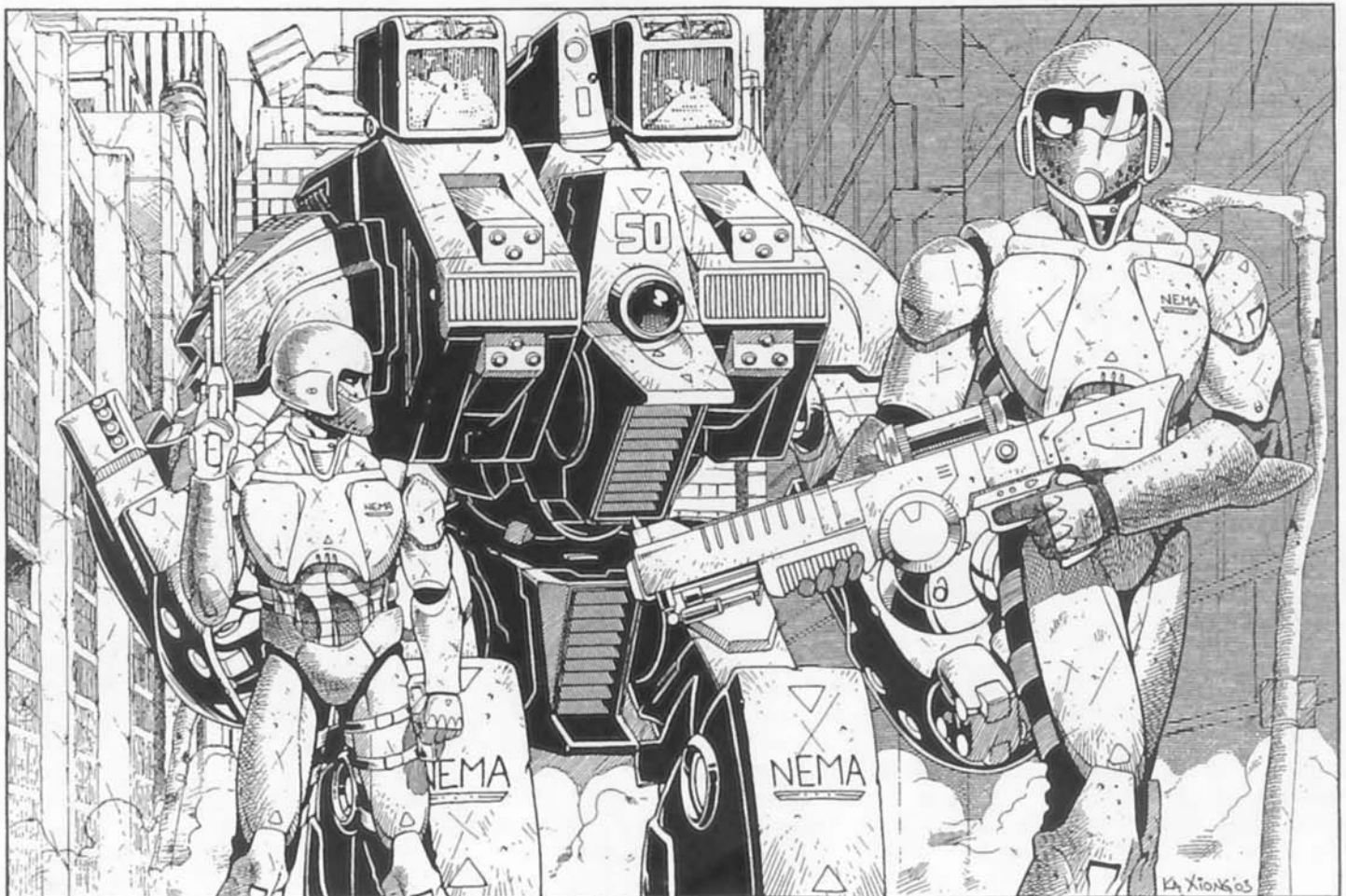

***Chaos Earth*™ is a complete role-playing game.**

**A prequel to *Rifts*® and compatible with most titles from that science fiction line.**

## Dedication

To Palladium's Magnificent Seven – you know who you are – we did the impossible and triumphed over chaos. Keep fighting the good fight and smile.

– Kevin Siembieda, June 2003

### **For Rifts® ...**

**Rifts® Role-Playing Game**

**Rifts® World & Adventure Books like the following . . .**

**Rifts® Adventure Sourcebook: Chi-Town 'Burbs™: Forbidden Knowledge**

**Rifts® Adventure Sourcebook: The Black Vault™**

**Rifts® Adventure Sourcebook: The Vanguard™**

**Revised Rifts® Conversion Book One**

**Rifts® Dark Conversions (Nightbane, demons & more).**

**Rifts® Bionics Sourcebook**

**Rifts® Game Master Guide™**

**Rifts® Book of Magic™**

**Rifts® Aftermath™**

**Rifts® Adventure Guide™**

**Rifts® Vampire Kingdoms™**

**Rifts® Coalition Wars® (Tolkeen) #1-6**

**The Rifter® Sourcebook series and more.**

The cover is by artist *Scott Johnson* depicting a flag wielding Chromium Guardsman standing strong in the heart of fiery chaos. A similar illustration appeared on the cover of **The Rifter® #18** and as a limited edition print (still available) with the image flipped. This is how the artist originally intended the illustration to look.

### **First Printing – June 2003**

No part of this publication may be scanned, OCR'd or reproduced in any way for electronic publication on the web/internet or any other medium.

Copyright 2003, 1990 Palladium Books Inc. & Kevin Siembieda

All rights reserved, worldwide, under the Universal Copyright Convention. No part of this book may be reproduced in part or whole, in any form or by any means, without permission from the publisher, except for brief quotes for use in reviews. All incidents, situations, institutions, governments and people are fictional and any similarity, without satiric intent, of characters or persons living or dead, is strictly coincidental.

Rifts®, The Rifter®, Coalition Wars®, Megaverse®, The Mechanoids®, The Mechanoid Invasion®, Nightbane®, After the Bomb®, Phase World®, and Palladium Books® are registered trademarks owned and licensed by Palladium Books Inc. and Kevin Siembieda.

Chaos Earth, Rifts Earth, NEMA, Northern Eagle Military Alliance, Lt. General Lindsey Sawyer, Armored Sentinel, NEMA Peacekeeper, Intel-Agent, Para-Arcane, DW Hunter, Vibro-Blades, Chromium Guardsmen, Silver Eagle, SAMAS, Gunbuster, Bull Bog, Mastiff, Big Dog, Skelebots, Combat Drone Soldier, CDS, Combat Hound, Pup, Street Bruiser, Glitter Boy, Coalition States, Coalition War Campaign, Coalition Navy, Cyber-Knights, Federation of Magic, Juicer Uprising, Mutants in Orbit, Mystic Russia, Pyscape, Heroes Unlimited, Beyond the Supernatural, Rifts® Conversion Book, Rifts® Game Master Guide, Rifts® Book of Magic, Rifts® Mercenaries, New West, Spirit West, Splynn Dimensional Market, Triax, Vampire Kingdoms, Warlords of Russia, Mystic Russia, Xiticix Invasion, 'Burbs, Xiticix, Dog Boy, Dog Pack, Wolfen, Biomancer, Bio-Wizardry, Ley Line Walker, Mind Melter, Mind Bleeder, Techno-Wizard, Shifter, Millennium Tree, Headhunter, Psi-Stalker, Simvan, Cyber-Knight, Bio-Systems, Bioware, Psynetics, Headjack, Full Conversion Cyborg, E-Clip, Mega-Damage, M.D.C., S.D.C., I.S.P., P.P.E., Brodkil, Black Faerie, Witchling, and other names, titles, character names, character likenesses and slogans are trademarks owned by Kevin Siembieda and Palladium Books Inc.

Palladium On-Line: [www.palladiumbooks.com](http://www.palladiumbooks.com)

**Rifts® Chaos Earth™ Role-Playing Game** is published by Palladium Books Inc., 12455 Universal Drive, Taylor, MI 48180. Printed in the USA.



**Palladium Books® Presents:**

# **Rifts<sup>®</sup> Chaos Earth<sup>™</sup>**

**A complete role-playing game**

Written & Created by: **Kevin Siembieda**

Many robot and power armor visual designs by: **Wayne Breaux Jr.**

Editors: **Alex Marciniszyn**  
**Wayne Smith**

Proofreader: **Julius Rosenstein**

Cover Painting: **Scott Johnson**

Interior Artists: **Wayne Breaux Jr.**

**Apollo Okamura**  
**Brendan Clark (DSS)**  
**Ryan Csaszar (DSS)**  
**Mark Dudley (DSS)**  
**LAR (DSS)**  
**Mike Majestic (DSS)**  
**Ramon Perez**  
**Freddie Williams II**  
**Michael Wilson**  
**Ka Xiong (DSS)**

Art Direction & Keylining: **Kevin Siembieda**

Typography: **Wayne Smith**

Based on the RPG rules, text, characters,  
concepts and Megaverse® created by **Kevin Siembieda**.

**Special Thanks** to Wayne Breaux, Freddie Williams, Ramon Perez, Mike Wilson, Apollo Okamura, and Drunken Style Studio (DSS) for their incredible artistic contributions in bringing the chaos to Earth. To Scott Johnson for a great cover and to Alex, Wayne, Steve, Julius, and Hank for putting up with me this past month or two while we dealt with our own brand of Chaos.

– *Kevin Siembieda, 2003*

# Contents

<b>Apocalyptic Rifts</b> . . . . .	7
A world of its own . . . . .	7
Existing Sourcebooks . . . . .	7
<b>The calm before the storm</b> . . . . .	8
The North American Alliance . . . . .	9
The last days of a Golden Age . . . . .	9
<b>The Great Cataclysm</b> . . . . .	10
Day One: December 22, 2098 . . . . .	10
The Origin of Chaos . . . . .	12
Day Two: December 23, 2098 . . . . .	13
Day Three: December 24, 2098 . . . . .	14
Day Four: December 25, 2098 . . . . .	14
Day Ten: December 31, 2098 . . . . .	15
NEMA . . . . .	15
January 1, 2099 . . . . .	16
<b>Hell on Earth</b> . . . . .	16
Heroes stand tall . . . . .	16
Armageddon Christmas Day Blues . . . . .	17
<b>NEMA</b> . . . . .	19
The Role of NEMA . . . . .	19
NEMA on the move . . . . .	20
Imagine you are NEMA . . . . .	21
An aggressive position . . . . .	22
Lieutenant General Lindsey Sawyer . . . . .	23
<b>NEMA Heroes in Chaos</b> . . . . .	25
NEMA Occupational Character Classes . . . . .	27
NEMA Response Teams . . . . .	27
Chromium Guardsman O.C.C. . . . .	27
NEMA Silver Eagle Pilot O.C.C. . . . .	30
NEMA Armored Sentinel O.C.C. . . . .	33
NEMA Soldier/Peacekeeper O.C.C. . . . .	34
MOS Programs . . . . .	35
NEMA Field Engineer O.C.C. . . . .	36
NEMA Fire & Rescue O.C.C. . . . .	38
Special MOS skills . . . . .	39
NEMA Intel-Agent O.C.C. . . . .	40
NEMA Military Specialist O.C.C. . . . .	42
MOS Programs . . . . .	42
NEMA Para-Arcane O.C.C. . . . .	44
Special Para-Arcane Skills . . . . .	45
NEMA Demon & Witch Hunter O.C.C. . . . .	46
Special DW Hunter Skills . . . . .	47
NEMA Volunteer Militia Fighter O.C.C. . . . .	49
Magic & Psychic O.C.C.s . . . . .	50
<b>NEMA Weapons &amp; Equipment</b> . . . . .	50
Neural Mace . . . . .	50
Vibro-Blades . . . . .	51
Laser Scalpel . . . . .	51
Laser Torch . . . . .	52
Mega-Damage Explosives . . . . .	52
Fusion Blocks . . . . .	52
Hand Grenades . . . . .	53
NEMA S.D.C. Firearms . . . . .	53
<b>NEMA Mega-Damage Firearms</b> . . . . .	54
Police Special Laser Pistol . . . . .	55
“Terror Stopper” Laser Grenade Rifle . . . . .	57
“Hot Seat” Plasma Rifle . . . . .	57
“Incinerator” Plasma Cannon . . . . .	58
“Destroyer” Mini-Missile Rifle . . . . .	59
“Lightning” Rail Gun . . . . .	60
<b>NEMA Body Armor</b> . . . . .	61
Armored Long Coat . . . . .	61
Standard NEMA Body Armor . . . . .	62
Fire & Rescue Enhanced Body Armor . . . . .	63
<b>NEMA Vehicles</b> . . . . .	64
Street Tornado Hovercycle . . . . .	64
Hover Platform . . . . .	66
Combat Bike . . . . .	67
Combat ATV . . . . .	68
Armored Personnel Carrier . . . . .	69
<b>Robots &amp; Drones</b> . . . . .	71
Combat Drone Soldier . . . . .	71
Combat Hound . . . . .	75
Pup Scout . . . . .	77
Spider Probe . . . . .	78
Flying Probe . . . . .	80
<b>NEMA Robot Vehicles</b> . . . . .	81
Bull Dog . . . . .	81
Mastiff . . . . .	84
“Big Dog” Super-Mastiff . . . . .	86
<b>NEMA Power Armor</b> . . . . .	88
Chromium Guardsman . . . . .	89
Gunbuster . . . . .	93
Silver Eagle . . . . .	94
<b>The Game Mechanics</b> . . . . .	98
Character Creation . . . . .	98
Step 1: Eight Attributes & Bonuses . . . . .	98
Attribute Bonus Chart . . . . .	99
Speed Chart . . . . .	99
Attributes Beyond 30 . . . . .	99
Augmented Humans . . . . .	100
Robot Strength & Damage . . . . .	100
Supernatural Physical Strength . . . . .	101
Weight & Movement . . . . .	101
Step 2: Determining Hit Points & S.D.C. . . . .	102
Armor Rating . . . . .	103
Recovery of Hit Points & S.D.C. . . . .	103
Surviving Coma & Death . . . . .	104
Step 3: Mega-Damage & M.D.C. . . . .	104
Step 4: Determining Psionics . . . . .	105
Potential Psychic Energy (P.P.E.) . . . . .	105



Step 5: Pick an O.C.C. & Skills	106
Skill Bonuses	106
Skill Penalties	106
Step 6: Pick an Alignment	107
Good Alignments	107
Selfish Alignments	108
Evil Alignments	109
<b>Experience Level System</b>	<b>110</b>
Experience Points Award Table	111
Character Experience Tables	111
<b>Skills</b>	<b>114</b>
Skill Descriptions	116
Communications Skills	116
Domestic Skills	116
Electrical Skills	117
Espionage Skills	117
Horsemanship Skills	118
Mechanical Skills	120
Medical Skills	121
Military Skills	122
Physical Skills	125
Pilot Skills	127
Pilot Related Skills	128
Rogue Skills	128
Science Skills	130
Technical Skills	131
Weapon Proficiencies: Ancient	134
Weapon Proficiencies: Modern	136
Wilderness Skills	137
<b>Combat Rules</b>	<b>138</b>
Hand to Hand Combat	138
Combat Sequence	139
Spreading out combat	140
Two against one	140
Horror Factor	141
<b>Hand to Hand Combat Tables</b>	<b>141</b>
No Hand to Hand Combat Skill	141
Hand to Hand: Basic	141
Hand to Hand Expert	142
Power Armor Basic	143
Key Combat Terms	143
Automatic Dodge	143
Paired Weapons	146
<b>Ranged Combat</b>	<b>147</b>
Aimed Shot	147
Understanding High-Tech Weapons	148
Definitive Dodging Rules vs Ranged Weapons	149
Shooting Wild	150
Missile Combat	151
Dodging Missiles	151
Shooting Missiles	152

Missile Chart	153
Optional Robot Combat Damage Tables	154
Psychic Combat	155
<b>Adventure in Chaos</b>	<b>156</b>
NEMA Missions & Encounters	156

## Quick Find

A.R.C.H.I.E.	14
CDS (see Combat Drone Soldier)	71
Cyberworks	13
Chromium Guardsman	27
December 21, 2098, Last Day of Golden Age	8
December 22, 2098, The Great Cataclysm	10
Demolitions Expert/EOD, Peacekeeper MOS	35
DW Hunter (see Demon & Witch Hunter)	46
Experience Tables for NEMA O.C.C.s	111
Glitter Boy (Chromium Guardsman)	27 & 89
Great Cataclysm, The	10
Great Cataclysm, Origin of	12
Heavy Weapons Expert/Pigman MOS	35
Magic Consultant (see Para-Arcane)	44
Medic, Peacekeeper MOS	35
M-Spec, Military Specialist	42
NEMA	19
NEMA Characters	25
NEMA, D-3R (Response, Rescue, Recovery)	20
NEMA, Formation	9
NEMA O.C.C.s start	27
NEMA Peacekeeper	34
NEMA Power Armor starts	88
NEMA Protocols for Disaster	20
NEMA Robot Drones start	71
Pigman, Peacekeeper MOS	35
Point Man, Peacekeeper MOS	35
Power Armor Pilots	30 & 88
Robot Commander (see Military Specialist)	42
Robot Pilots	27 & 30
Roscoe (Fire & Rescue)	38
Roscoe Light Power Armor	63
SAMAS (Silver Eagle)	30 & 94
Skelebot (see Combat Drone Soldier)	71
Skill List with Base Percentages	114
Skill Descriptions	116
Skills: Lore	132
Skills: Hand to Hand Combat Tables	141
Skills: Modern Weapons	136
Spy, NEMA Intel-Agent	40

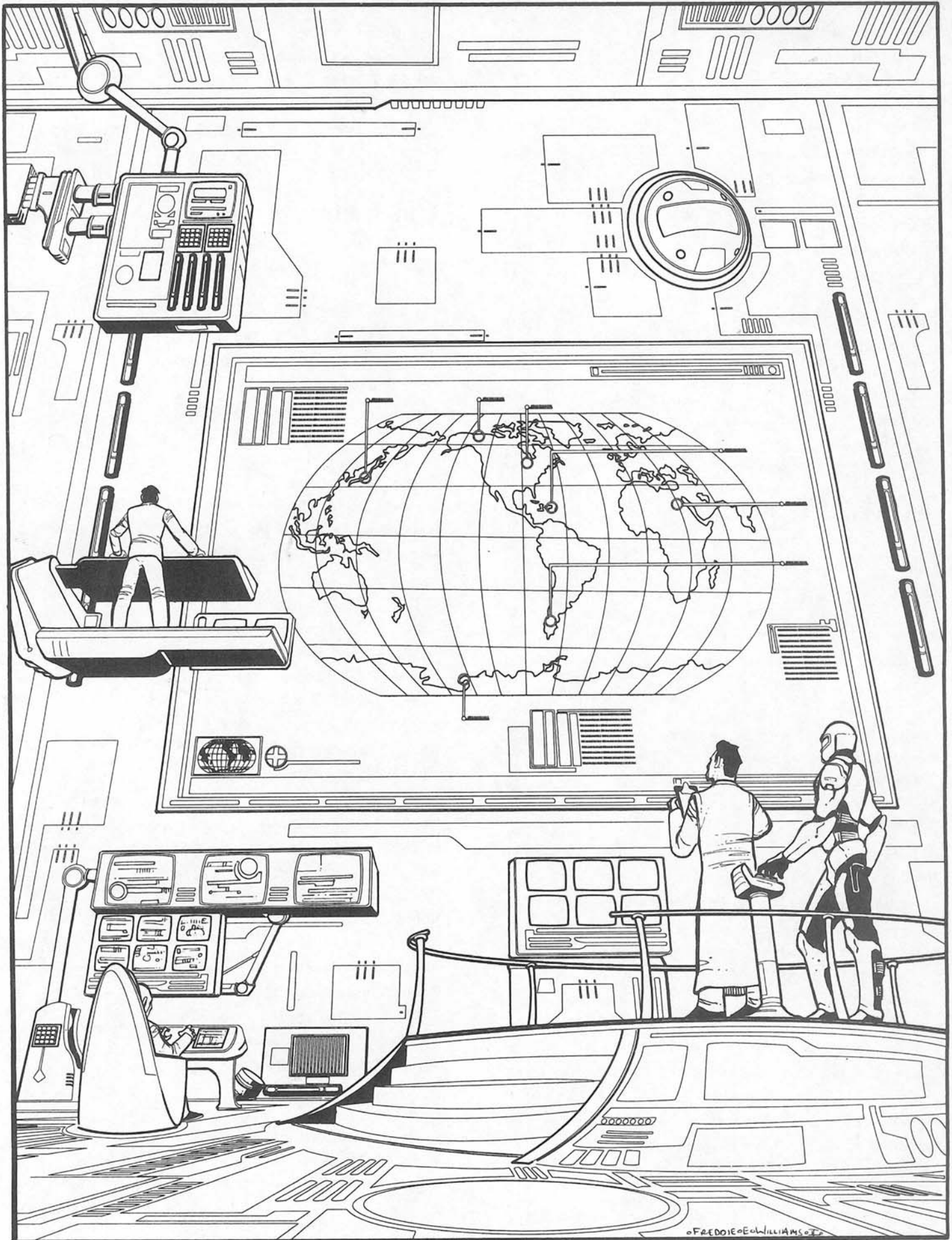

© FREDERICK WILLIAMS CO.

NEMA Command Center Midwest Operations



# Apocalyptic Rifts®

This book is something different.

On one hand, it is part of something that already exists, the sprawling centerpiece of the Palladium Megaverse, **Rifts®**. Thus, **Chaos Earth™** is instantly larger than itself. It is part of an epic story that stretches across space and time. It is the genesis of all we already know, and that which is yet to come.

On the other hand, **Chaos Earth™** is *new* and different. A complete game and stand-alone setting unlike that of Rifts Earth. It is the beginning. The very moment of conception that gives birth to what readers have come to know as *Rift Earth*, but that's over 200 years from now. This is Armageddon. The Apocalyptic end of the world as it was once known. And your characters are there. There in the final moments of human civilization's demise, and there for the cataclysmic rebirth of a world transformed.

One day, the world was as it had always been, a planet dominated by human beings. A world of science and machines. A civilization that had struggled through world wars and its own inhumanity to achieve unparalleled greatness. A world – not just one nation, but a world – that had come to know a “golden age” of peace, science, wisdom and achievement. Humankind had conquered most diseases, hunger, and even the human genome. The possibilities seemed endless and the future nothing but sunshine and promise. That's the life most people knew when they went to bed that December night, expecting the next day to be full of life and wonder and very much like the day before it. Instead they woke up to Hell. The Golden Age turned into Armageddon.

There was no gradual decline of human civilization. Humankind didn't die with a whimper, it was smashed in a spectacular display of cataclysmic transfiguration beyond human comprehension. Not since the creation of the planet have such levels of energy erupted from the Earth. Once started, nothing could stop the onslaught of change.

This is the world setting stretched out before you. The ultimate survivors' challenge – living through the Apocalypse. Not the “post-apocalyptic” setting that is Rifts Earth and the theme of scores of books, films and games. No, your characters stand at the very moment of decimation and rebirth. Caught in the conflagration, living in chaos, and never knowing what is coming next.

Characters really only have two choices: Survival or death. That's all. And some would argue that death is the quick, easy answer.

Your characters have chosen survival, and this is their story.

## A world of its own

The presentation of **Rifts® Chaos Earth™** is that of a stand-alone role-playing game. It takes place nearly 300 years before the time-line of the **Rifts® RPG**. It precedes the advent of the Coalition States by more than 200 years and takes place before the Dark Age. For the player characters, and all of humanity that has survived the initial throes of transfiguration, what comes later has no meaning. It all boils down to one thing, live or die.

*The heroes* are the ones who chose to live with some measure of dignity, honor and compassion for their fellow man. They are the ones who pool their resources and try to help others. They clutch at an obsolete sense of goodness and morality, and refuse to succumb to absolute barbarism and selfishness. Sadly, much of humanity quickly plunges into an animal state of mind, becoming frantic, crazed monsters in a dog eat dog nightmare-world of hopelessness and savagery.

You, dear readers, are the heroes.

You hold in your hands the fundamental playing information you need to start your battle against Chaos. The basic creation, combat and other rules for Palladium's universal game system are all presented in this book along with the overall setting. The Palladium game system remains fundamentally the same for each of our games, meaning you can move from one world setting to another with little modification or complicated transitions. Or you can draw upon characters, powers, magic, devices and ideas from one game and use them in another. It is also your doorway and foundation to an infinite Megaverse® of adventure and world settings. Endless possibilities limited only by your imagination.

**A different format.** Most of Palladium's role-playing games open with the rules and statistical information one needs to play: Character creation, skills, combat, etc. In **Chaos Earth™** I've decided to start with the world and character information, followed by equipment and monsters, and then the *rules* (starts on page 98). The idea is to keep the momentum and sense of drama by presenting the environment, the heroes and the antagonists first. Then, after you know the setting and pause to catch your breath, you can turn to the rules and design the champions who spit in the face of evil and fight against all odds.

**Future sourcebooks** shall expand upon the world, player characters, powers, abilities, monsters, enemies and adventure scenarios.

*Chaos Earth™ Sourcebook: Hell on Earth.* A demon plague sweeps the planet, and it seems as if Hell has truly come to Earth. This sourcebook presents a multitude of never before seen horrors that have crawled out of the Rifts and threaten to wipe humankind out of existence. Focus is North America.

*Chaos Earth™ Sourcebook: Magic Awakens.* This sourcebook presents a number of *new* magic character classes, spells, and powers and how they fit into the apocalyptic setting of Chaos Earth.™

## Existing Sourcebooks & Resources available now!

Because **Chaos Earth™** is the *origins* of Rifts Earth, and because it too uses the Mega-Damage system of damage, Game Masters may allow any of the magic, psionic powers, supernatural beings, monsters and even many of the Dimensional Beings (D-Bees) presented in many of the World Books and sourcebooks for **Rifts®**. Only technology and Occupational Character Classes (O.C.C.s) set in the *future* time period when **Rifts®** takes place are not applicable. However, supernatural beings, magic and related elements are universal and have existed for eons before and after the Coming of the Rifts, so they may be applied to the **Chaos Earth™** setting smoothly and without any dramatic conversions.

The following are some of the most comprehensive and immediately useful **Rifts®** titles that offer a wealth of material that can be transplanted into **Chaos Earth™** without effort.

- **Rifts® Book of Magic.** 352 pages, and jam packed with hundreds and hundreds of different spells from different disciplines and teachings of magic. Also includes various magical items and weapons. Note: Only Techno-Wizardry, Splogorth Bio-Wizardry and other “technology” based magicks are inappropriate for **Chaos Earth** because they are developed in the future **Rifts®** setting.

- **Rifts® Conversion Book One** offers stats and information on more than 100 monsters, 40+ optional player races, including Giants, Wolfen, and others, plus conversion notes and other data.

- **Rifts® Dark Conversions™** offers stats and information on more than 120 monsters including demons, undead legions, were-beasts, entities, Voodoo Xombies, Elementals, and others, plus **Nightbane®** conversions.

- **Rifts® World Book One: Vampire Kingdoms™** presents everything you'd ever want to know about vampires but were afraid to ask. And vampires are a very serious problem in **Chaos Earth**, especially in Mexico.

- **Rifts® World Book 15: Spirit West™** packed with information about Native American magic, totems, fetishes, spirits and gods, including spirits and gods that are completely statted out and O.C.C.s. such as a variety of shamans, Totem Warriors and others suitable for use in **Chaos Earth**.

- **Rifts® World Book 18: Mystic Russia** offers a variety of different Russian magicks, the Necromancer and 25 different demons and spirits.

- **Rifts® World Book 20: Canada** is only moderately useful in **Chaos Earth** because a solid half or more is dedicated to the **Rifts®** time period. However, there is a sizable section on Sasquatch, D-Bees and other mortal and supernatural beings, including those taken from Inuit myth, that would fit nicely in **Chaos Earth**.

Now go out and wreak havoc.

– Kevin Siembieda, 2003

national space stations locked in orbit around the Earth. The moon is home to the *Cyberworks Aerospace Network*, a mega-corporation that specializes in space research, robotics, artificial intelligence and virtual reality robot systems and is a leader in space exploration. Other small colonies also exist on the moon, and a tiny outpost has even been established on Mars.

Back on Earth, massive megalopolis-style cities cover the globe. Skyscrapers regularly exceed 100 floors and ribbons of highways cover the landscape. Hovercraft of seemingly infinite variety are the latest in automotive technology and have all but replaced conventional “wheeled” vehicles. Hover vehicles are cars, motorbikes and platforms that ride on a cushion of air, a foot or two above the ground, providing superior maneuverability and causing considerably less wear and tear on the roads. Then again, the highways and byways of the civilized world (which is 80% of the planet) are made of a new concrete that lasts ten times longer than anything known in the 20th Century. What “wilderness” remains in North America and much of the world, are nature parks, cultivated logging territories and government sponsored preserves.

Even more impressive is the fact that after 27 years of terrorism, vendettas, treachery and war across the globe from 2001-2028, the major nations of the world put aside their differences to bring about a new age of peace and science. The world had finally become the “global village” people had talked about ad infinitum during the latter part of the 20th Century. All the major powers shared their ideas, technology and resources – truly working together. Trade goods came and went from all across the planet. The United States of America, Canada, and Mexico formed the *North American Alliance* that would become the blueprint for other nations to build strong, multi-national cooperatives. Many of the world's nations rose to prominence to enjoy prosperity the likes of which had never been known. Germany, India, China, Japan, Korea, Mexico, Argentina and Canada became the *new* super-powers, the USA and Russia thrived at the head of the pack, and human civilization flourished like never before.

Poverty, inequity, injustice and war still existed, and there remained impoverished and hostile “third world nations,” but they were in the minority, and generally considered exceptions, outcasts and backwater places.

There were many contributing factors leading to the new “global age of prosperity and learning,” but three had the greatest impact. One was a universal weariness of constant strife and war, another was the North American Alliance Pact, and the third was an unexpected series of explosive technological breakthroughs that set the world on its ear and sparked the imaginations of people everywhere. The sharing of knowledge, the mutual exploitation of ideas, and the sharing of technology among many friendly nations led to an unprecedented succession of advancements and breakthroughs that had a domino effect, spawning more innovative ideas, breakthroughs and rapid exploitation of those ideas that gave birth to a new age of science, technology, cooperation and excitement. It seemed like a new incredible discovery in medicine, technology or science was being announced every week. Medicine led the way with breakthroughs to extend life, preserve the mind, defeat disease, slow the aging process and *improve* the human body. Advancements in genetic manipulation and augmentation, cloning, cy-

---

## The calm before the storm

---

### Earth, December 21, 2098

The future holds nothing but promise.

Humankind has enjoyed an age of science, learning and relative peace for over fifty years. The human genome has been mapped, explored and tweaked. Medical cloning, genetic manipulation, nanotechnology, and advanced bionics are all a reality. Most diseases have been cured, the *average* life expectancy is 180 years (20% live past 200) and new breakthroughs in medicine promise to extend life 50% longer than that. Thus, a ninety-year old looks and feels like a thirty-year old, the mind sharp and the body strong.

The ocean depths are a new frontier being plumbed for secrets in medicine, farming and history. The fringes of outer space are also being conquered, with several national and inter-



bernetic and nano-technology filled the media. New technology in the micronization of electronics, communications systems and energy brought about explosive changes. Each major discovery unleashed a chain reaction of offshoots, new discoveries and applications in diverse areas. In fact, some pundits of the day claimed that people were too excited and busy creating new wonders to be concerned with petty differences or war. Besides, every new advancement and the scores of new applications that followed made individuals, businesses and nations rich, sometimes overnight. If this were not the *Golden Age of Humankind* or the *Age of Prosperity*, it was without doubt the age of wonder. Humankind felt unchained, and now believing anything was possible, looked to conquer the universe before them. Old age, sickness, and human frailty were all washed away, outer space and the inner space of the oceans and the human body became the new frontiers, and the impossible seemed within reach in every direction.

## The North American Alliance (NAA)

The North American Alliance Pact of 2035 was a daring treaty that united and bound the North American nations of *Canada*, *Mexico* and the *United States of America* in a sweeping social, economic and military coalition of unparalleled scope and cooperation. It rose out of an era of economic and political strife that had lasted nearly thirty years – a roller coaster period of terrorism, retribution, war and economic uncertainty that had stifled growth and personal freedoms for more than a generation. On the heels of renewed peace and an upturn in the market, the *North American Alliance Pact* unified three of the (arguably) most powerful and promising nations in the world. It was an act that jump-started the global economy and helped to bring about a new era of unparalleled cooperation and scientific advancement. Some would credit the Alliance for bringing about what would be dubbed the “Golden Age of Man.”

The NAA heralded a new age of international cooperation spearheaded by the North American nations “starting in their own backyard.” The NAA had the following immediate and lasting effects:

1. The opening of national borders (borders virtually disappeared).
2. Strident efforts to create economic parity between the three allied nations.
3. True and equitable sharing of ideas, technology and information.
4. Open trade and universal regulations, laws and measures.
5. The trilateral incorporation of the NAA “credit/debit system” of monetary exchange; effectively one common monetary unit for all three nations.
6. The creation of NEMA; the Northern Eagle Military Alliance.

## Northern Eagle Military Alliance (NEMA)

Effectively an elite police-paramilitary agency with jurisdiction in all three of the allied nations, charged with the defense of North America as a whole. NEMA had its own army and agents who could come and go across national borders with impunity

to battle crime, terrorism, espionage, etc. NEMA incorporated an equal number of operatives from each of the allied nations and functioned like a sort of tri-national FBI, CIA and NSA rolled into one.

This joint military operation for homeland defense quickly became one of the most efficient and advanced in the world, virtually replacing the FBI. It worked with both federal and local authorities and was involved with all matters involving two or more nations, international terrorism, and the homeland defense of each of the three allied nations. As an elite police and military force, NEMA was given access to many of the most advanced crime fighting, investigative, rescue and military innovations and equipment (including prototypes) in North America.

## The last days of a Golden Age

It is said that all good things must come to an end, and so it is that the Golden Age became tarnished over the last twenty years.

One of science’s and society’s obsessions centered around the area of *human augmentation*. The quest to create the perfect human, physically, emotionally and psychologically. All sorts of research and technology involving genetic manipulation, cloning, chemical augmentation, brain implants, nano-machines, cybernetics and robotics had been developed in the quest to make the ultimate human. Many offered diverse and diametrically opposing views. Many claimed to be superior to the others for one reason or another, and each was pitted against the other in a fierce social-economic war to win the world market. The ever increasing pressure of intense competition, the desire for personal recognition and unbridled greed put a quick end to two generations of international exchange and cooperation. It put a chill on the Golden Age of Science and ushered in a new age of secrecy, ruthless business maneuvering, and the reckless application of crackpot theories and shortcuts in problem solving and product testing.

This turn of events made nations and corporate powers reexamine other areas of technology and pull back on the availability and exploitation of their scientific discoveries. This caused a slowdown in technological development which translated into a sharp decline in the global economy. Businesses booming only yesterday suddenly faltered and failed, the international stock markets crashed, unemployment and poverty soared, nations began to suffer, and a new “technological elite” began to surface. Worse, after two generations of peace, many of the “wonders of the Golden Age” were now being applied to the military. Robotics, cybernetics, lasers, super alloys and other advancements, even genetic engineering, cloning and other medical discoveries, held vast potential for *war*.

Even the vast majority of world powers who did *not* rush toward military supremacy looked at their fabulous creations with a twinge of horror. For two generations, they were so busy creating, building and developing scientific wonders for the sake of pure innovation and excitement that they had not realized they had unleashed a thousand Genies from their bottles. Now that the fingers were being pointed, and sharing had turned to competition and exploitation, the scientific community, governments and people paused to catch their breath and to review what had come to pass. Suddenly, they realized how recklessly they had

thrown themselves into science without completely thinking through the global ramifications and the potential for misuse and outright evil. It was this realization that caused the real problem as nations and corporations scrambled to establish new laws, restrictions, and protocols to contain and rebottle at least some of the most potentially dangerous Genies they had unleashed. But as the fairy tale warns, once unleashed, the Genie can not be easily put back.

The rate of new discoveries and innovations ground to a crawl. The sense of wonderment was replaced with fear. Heroes of science and business were now condemned for being short-sighted, greedy and even outright villains concerned only about fame and profits (many were). As unexpectedly as it had begun, the age of enlightenment was over. The nations that had thrown themselves into creating marvels and building a better world took a new look at themselves, their neighbors and their not so friendly rivals, and shuddered. Though many had prospered, there remained areas of tremendous disparity. Some found themselves clutching onto technological secrets they now refused to share. Technology that gave them political, scientific, manufacturing, communications and/or military superiority over their rivals. And suddenly, "rivals" is how they looked at one another. Envy, suspicion, paranoia and disharmony raged, reshaping the landscape.

What many were calling the "new Cold War" era had arrived with a vengeance. Once friendly allies now bickered and argued over the "safe" application of their respective technologies. Proposed laws and restrictions intended to keep the world safe were demonized, condemned and rejected as measures that insured the technological elite held onto their power base and kept those without under their thumbs. Accusations flew fast and furious. Industrial and international espionage rocketed to new heights. New walls and barriers were erected, and emotions burned hot. All this contributed to a global recession, with the poorest and least technologically advanced countries suffering the hardest. Widespread poverty erupted among the third world nations, and even some of the most advanced and powerful nations suffered crippling blows from new trade restraints, confining laws, and competition from rivals who stole their secrets and exploited their innovations better than they could. Some pointed to this as deliberate economic leveraging of the leading world tech-powers and unfair competition. Others saw it as a first step toward war. Civil unrest rose.

Still, all in all, the world was a better place than anything known in previous centuries. Technological marvels continued, prolonging life, binding governments together, and bolstering the desire for world peace and international trade. Other than a few hot spots and trouble zones in the world, peace prevailed and people lived the good life. Most believed this decade of reduced growth simply represented a natural slowdown, stabilization and necessary move toward *responsibility* that would turn into an even greater age of advancement and prosperity. After all, the economy and civilization are living things with cycles of difficult transition and change. This was one of those transitional periods.

Life was good. The future bright. And it would all end tomorrow.

# The Great Cataclysm

## Day One: December 22, 2098

Central & South America feel it first. North America, thirty seconds later. Europe, Asia, Australia and the entire planet are shaken a few minutes thereafter. All are engulfed by a disturbance caused by lines of energy erupting out of the ground and shooting three miles (4.8 km) into the sky. An energy stream that crisscrosses the globe, with isolated networks clustered at places long held to have magical, spiritual or supernatural significance. However, before anybody can even recognize the event, the planet spasms, human civilization collapses, and the world is reshaped into something new and alien.

Contact with half the world is lost in a matter of two heartbeats. When the reports do start to rush in, they come in too fast and are too frightening to internalize.

**In the United States**, New York City, Washington D.C., Boston, Baltimore, Savannah, Orlando, Miami and the entire Eastern Seaboard are . . . gone. Tens of millions of lives snuffed out in a matter of minutes! The West Coast shares the same fate.

People in the central part of the country get the best view of the global cataclysm, though few can believe it. If the initial reports can be believed, the oceans have swelled to swallow coastal areas all around the world. Dormant volcanoes erupt with explosive fury, earthquakes along every fault line rend the earth and topple cities with primordial fury. Savage and freak storms covering half a continent appear without warning.

**Cuba, Haiti, and southern Florida** are engulfed in a Level Five hurricane the size of Texas. Most of the **Carribbean Islands** vanish under the sea. Tidal waves a thousand feet (305 m) tall rush 100 miles (160 km) *inland*, smashing and washing away *everything* – cities, forest, and people – in their path. That includes the cities of Boston, Manhattan, Savannah and Miami in the east, San Diego, Los Angeles, San Francisco, Seattle and Vancouver in the west.

The waters known as the legendary **Bermuda Triangle** are... well, nobody can quite find the words to explain it. A triangular zone of white mist and crackling blue energy. Any air or water vessels to enter the Triangle vanish – never to be seen or heard from again.

**The President of the United States**, away in Colorado to make a speech, survives the initial carnage and is spirited away to NORAD in the Cheyenne Mountains. The Vice President, half of Congress, the Senate, and the President's family are not so fortunate.

NEMA and the nation's military go on high alert and scramble for action.

Reports coming out of **Detroit** and **Windsor** border on the absurd. Walls of blue energy have appeared from which "demons and monsters" are said to be pouring into the streets. Both cities burn out of control – presumably from rioters and a panic stricken public. It is absolute bedlam.





EEC



**Chicago** and **Toronto** also report the appearance of blue energy lines, rioting, fires, unexplained phenomena and hysteria about “monsters.” So do a hundred other cities and towns across the country, especially in the Midwest and Northeast.

**St. Louis**, Missouri and Illinois seems to be the epicenter of unexplained phenomena and more hysteria about “monsters and demons.” Rioting, fires and destruction rage throughout southern Illinois, Missouri, Indiana and Ohio.

**The Mississippi River** suddenly surges over its banks to flood every community along its shores from the Gulf Coast to Minnesota. Likewise, the **Rio Grande** reaches water levels never seen in modern times.

**The West Coast** (US, Mexico and Canada) and **Alaska** are hammered by massive tidal waves, savage storms, and successive earthquakes ranging from 7 to 9 on the Richter Scale!

**Mount Saint Helens erupts**, as do nine other volcanoes in the west.

**Calgary** (in the northwest) is the scene of rioting and mass hysteria. Reports coming out of it claim the city is being invaded by demonic or alien invaders that seem to be riding in on the winds of a freak storm that has parked itself over the city. Then contact is lost.

**The Northern Provinces of Canada** are engulfed in a winter storm that stretches from British Columbia to Manitoba, and up into the arctic.

Communities on the Provinces of **Nova Scotia**, **New Brunswick** and the coast of **Newfoundland** are obliterated by the raging Atlantic Ocean. **Prince Edward Island** vanishes under the waves.

**Mexico City** is reduced to rubble in a series of powerful earthquakes and volcanic activity that is off the scale. Half the population, ten million, perish in the first three hours. Elsewhere, Mexico’s coastal communities are wiped from the face of the Earth. Fourteen volcanoes erupt across that nation.

**The rest of the world** bears a similar fate in what will later become known as the *Great Cataclysm* and the *Coming of the Rifts*.

The Cataclysm comes without warning, and seemingly without reason. Certainly without mercy. And it is only the beginning.

---

## The Origin of Chaos

---

Most of the world will *never* know how or why the planet changed in the blink of an eye. Even the sketchy information and outline of events presented here is known in its entirety to only a handful of elite personnel in the world’s militaries and governments. Virtually all of it will be lost to posterity over the next few years. But you, gentle reader, will be counted among the privileged who know.

Ironically, despite humankind’s predisposition toward self-destruction, we play a tiny role in the convulsive birth of **Chaos Earth**. Most of the events leading up to it are pure coincidence and unfortunate timing.

Unknown to human science, there has always existed a sublime energy source that courses throughout the planet, and indeed through the infinite Megaverse. In the days of ancient man

this primordial energy was known as “magic.” The ancient Chinese identified the lines of energy as “Dragon Tracks” and places of magic – the abode of good and evil spirits. From this knowledge grew the mystic art of Feng Shui. People and primitive cultures in other parts of the world also knew something about magic and “earth energy.” The druids of England and France, the dowsers and mystics past and present, all spoke of “earth energies,” “lines of power,” and “places of healing and magic,” and “evil.” Some even spoke of doorways to Hell and other dark realms. However, with the advent of *science* and the industrial revolution, magic, the mystical, and even the psychic were replaced with science and technology. The notions of spiritualism, magic and the supernatural were rejected by most modern people and relegated to the realm of fantasy, fiction and fairy tales. Consequently, the *genuine* existence of Dragon Tracks or ley lines was ignored. In fairness to science, the magic energies of Earth had faded over the eons and by the Renaissance Age in Europe, had dwindled to virtually nothing. Even the most powerful nexus points such as Stonehenge and the Bermuda Triangle were scarcely measurable even by those *spiritually or psychically attuned* to such shadows of magic. However, while the mystic energies lay quiet and forgotten, they still flowed. It is these lines of energy that explode to renewed life and never before known levels of power at the onset of the Great Cataclysm, but it is mankind who provides the spark that ignites them.

As noted earlier, the Golden Age had given way to a period of unrest and renewed hostilities. Considering humankind’s past, it was a comparatively small stumbling block along the way to a better, gentler civilization.

South America, much of which had enjoyed a boom-time during the Golden Age, reeled from economic hardship and civil unrest when it came to an end. While most of the nations struggled peacefully through the downturn, others became violent and unstable. Two such small nations clashed repeatedly. One was supported by the USA (with an uncanny knack for backing the wrong horse). Under protest, NEMA was ordered to provide this South American ally with a dozen suits of *USA-G10 power armor* (i.e. Glitter Boys) to support its sagging military defenses. The G10s were only to be used for “defense under extreme duress,” but after an altercation with its enemy, the nation defied the conditions of the loan and sent the G10 squad against enemy forces active inside their border. The invading rebels were routed, pursued *across* the border, and into the neighboring nation. There the enemy forces were slaughtered by the superior technological might of the G10s. Fueled by blood lust, generations of hate, and a sense of invincibility provided by the power armor, the troops pressed on to attack and decimate several innocent villages. The nation under siege responded by dispatching a full army battalion. When the battle ended, one short hour later, 12,000 soldiers and the town of Gauda Marta were obliterated. 24,000 townspeople were killed, only 1,800 soldiers and 13,000 civilians managed to escape. All this destruction at the hands of the twelve USA-G10 power armor troops. Mega-Damage war machines versus an S.D.C. opponent, the 12 could have destroyed a force three times that size. While several of the power armor units were severely damaged, only one had been completely destroyed. The new Mega-Damage super alloy of the armor and the powerful shoulder mounted cannon worked beyond expectations with devastating results.

The invading nation withdrew, but refused to apologize or make any overture to their enemy, claiming "self-defense" and the need to "neutralize the potential threat" posed by their enemy. The injured nation appealed to the world, condemning NEMA and the USA specifically and calling for worldwide sanctions against such weapons of destruction and vowing bloody revenge. When they were ignored and their neighbor threatened a repeat of the destruction unless they silenced themselves, tensions rose to a fever pitch.

On December 22, 2008, the two South American nations struck at each other with a limited (very limited) exchange of outdated nuclear weapons. Millions of lives perished in a heartbeat. The brutal event in and of itself would have been horrible, but an isolated incident with minimal direct impact on the rest of the world. What nobody could appreciate was the nature of the *ley lines* and *magic* that had laid dormant for millennia.

Ley lines are, for lack of a better word, channels of "magic" energy. This energy has always existed as part of the natural order of things, like electromagnetic energy and light rays. It is virtually identical to what psychic researchers had come to label Potential Psychic Energy or P.P.E. for short. Both ley line energy and P.P.E. can influence and supplement each other. Ancient rituals of human and animal sacrifice were actually designed to draw upon that energy, for at the moment of death, the P.P.E. inside a living creature is unleashed at double its normal magnitude. If a priest or sorcerer knows how, he can capture the escaping energy to work feats of healing and magic. Likewise, the energy level at ley lines ebbs and flows, increasing during certain times of the day or year, often coinciding with the position of the sun and the planets.

As fate would have it, the planets were aligned, causing the ley line energy to surge at its highest possible levels to begin with. The hour was midnight, a peak time when ley line energy spikes, and the first city nuked was built on a pair of intersecting ley lines, with other ley lines nearby. When the bombs went off, a million lives perished in flash, their magnified P.P.E. energy, doubled at the moment of death, poured into the already active and magnified energy of the ley lines, causing them to burst with energy like a dam that could no longer contain the waters it held. This had a ripple effect on the neighboring ley lines, causing them to surge and flare with energy not seen in 150 million years. A moment later came the retaliatory strike that sent the life's energy of a million more lives into the lines of mystic energy, causing them to erupt with power starting a chain reaction that could not be stopped. The surging ley line energy raced across the land like electricity racing across an open circuit, igniting other ley lines worldwide. As the wave of energy covered the planet (in under three minutes), the uncontrolled magic energy touched off massive natural, unnatural and dimensional disturbances, causing sudden freak storms of immense power, maximum strength earthquakes, volcanic eruptions, huge tidal waves, flooding and all manner of disasters, killing hundreds of thousands more, every time. The succession of mass deaths (human and animal) fed the ley lines, making them more powerful with every passing second, which, in turn, created greater disasters and death by the millions. This fed the ley lines even more, like a furnace stoked with fuel and heated beyond its limits, causing them to erupt and run wild, tearing open the very fabric of reality, unleashing more destruction and death joined

by supernatural horrors from hellish dimensions. Once started, the cycle of devastation and death could not be stopped. In a matter of minutes, half of all life on the Earth was destroyed, though it would take weeks before anybody would realize it.

The massive powering of the ley lines, however, would have other ramifications beyond the understanding of the scientific mind. The life energy of trillions of living creatures, human and animal, had turned the once invisible and forgotten ley lines into raging conduits of mystic energy that would last for thousands of years. The ley lines now radiated with such power that the Earth was being realigned on a cosmic scale, becoming a trans-dimensional nexus spanning the Megaverse. Where two or more ley lines crossed, power was increased, creating a nexus point where space and time are meaningless. Doors to other worlds, other dimensions, other realities opened and closed at a hundred locations around the world with every shudder of the planet, linking the Earth to alien worlds and the realms of the supernatural. It is through these dimensional portals, these *Rifts* in reality, that true demons, monsters, and alien beings have been able to step into our world as they please whenever they find such a door open to them.

## Day Two: December 23, 2008

The world is in the throes of a great cataclysm of biblical proportions.

**Satellite and Moon Base** reports confirm that the Saint Louis area has erupted with an estimated 200 energy lines with at least 13-18 points of super-activity and flares of energy that seem to correspond with reports of strange phenomena and even alleged dimensional and chronol distortion. The **Detroit-Windsor** area, among others, is similarly the site of intense activity of inexplicable energy and unknown disturbances that can be seen from space like giant flares of cosmic energy. The **Ohio Valley** is another center of energy and disturbances. Other places around the planet exhibit similar or worse anomalies, with the so-called *Bermuda Triangle*, *British Isles* and *China* among the most spectacular.

Initial reports from orbital satellites, space stations and moon bases present a clearer global picture of the situation, confirming the appearance of over 5000 lines of unknown energy and thousands of intersections that appear to be focal points for that energy. Exactly what these lines of energy have to do with the worldwide calamities is, as of yet, unknown. The picture from space also confirms 33 volcanic eruptions, 119 tidal waves, the appearance of 47 freak "storm events" and mass destruction over the last 24 hours. One observer summed it up as well as any when she said, "It's as if the very planet is convulsing. Tearing itself apart." Indeed, the planet is undergoing convulsive change. As for the lines of energy, what role they might play in the cataclysm, what the energy does or means, and the nightmarish disturbances at their epicenters are beyond anyone's understanding. For now, data is collected as quickly as possible, but there is too much too fast to assess or to formulate a meaningful response. The ongoing devastation is so relentless and widespread that every nation on Earth is overwhelmed and lost to chaos.

Data from most North American and European satellites are patched through the global corporation, Cyberworks and its



“A.R.C.H.I.E.” super-computers – a trio of revolutionary *neural cell, synthetic artificial intelligences* that can think, learn and formulate subjective thought – the most advanced computer systems currently known to man. **A.R.C.H.I.E. Three**, the earliest working prototype, survives the carnage buried deep inside the underground military complex in Aberdeen, Maryland. **A.R.C.H.I.E. Four** is believed to be in the safest location at the Cyberworks Aerospace Network (CAN) *moon base* (A.R.C.H.I.E. 5, 6 & 7 are built later by the moon’s survivors). It links with its Aberdeen counterpart in an effort to assimilate and process all incoming data as quickly and efficiently as possible. All data is shared with **A.R.C.H.I.E. Two** located at NORAD (NORTH American Aerospace Defense Command) in the Cheyenne Mountains of the Colorado Rockies. **Problem:** “The disturbance” is felt even on the moon as solar storms and heavy doses of radiation bombard it as well as the orbital space stations and hundreds of man-made satellites. An estimated 32% of all satellites are knocked offline, space stations scramble to respond to crashing systems, and the moon itself shudders and quakes! Fortunately, damage to the CAN moon base is minimal; only 5% of its personnel are lost. The most disturbing news is that **A.R.C.H.I.E. Four** appears to be damaged and malfunctioning. The extent of the damage is yet to be determined; it continues to function at 69% capacity, but deteriorating.

At 9:45 p.m., the *Yellowstone super-volcano* erupts. Its magma pool rockets 20 miles (32 km) into the stratosphere. Sulfur fills the air, and rock, lava and volcanic ash begin to rain down across the United States and southwestern Canada from the Pacific coast to Nebraska. This half of the country will feel the worst of it, but the rest of the continent and the entire world will suffer the consequences as temperatures plummet 30 degrees Fahrenheit worldwide. Summer will not be coming in 2099.

## Day Three: December 24, 2098 Christmas Eve

The world is in a panic. Contact with all but one’s nearest neighbor is lost. In the United States, the West Coast is pulverized by a roller coaster of earthquakes and tidal waves and is now being buried under tons of hot ash already over seven feet (2.1 m) deep. Everything from the Rockies to the Midwest is likewise being buried by a storm of ash. Winter storms and strange “disturbances” only complicate matters. Contact with the Eastern Seaboard and numerous cities and states is completely lost.

Current estimates suggest one third of the world’s population has been lost. Computer models project an additional 30-40 percent will perish, worldwide, within the next six months.

Many believe it is the end of the world.

## Day Four: December 25, 2098 Christmas Day

Nobody is celebrating Christmas, although a multitude of people are praying. People everywhere seek refuge at places they believe to be safe havens or close to God. Others struggle to escape and flee the holocaust, though there is nowhere to go.



KA Xiong '03



At 7:53 a.m. comes the last direct communications from Earth to the colonists in space. It is a garbled message that reports continuing disasters, panic and "extreme chaos." The space stations and moon outposts are helpless witnesses to what they fear may be the last days of their civilization. The spreading ash and particles spewed into the atmosphere by the super-volcano and other volcanic activity, storms and strange disturbances now cloak 98.9% of the planet, blocking the planet's surface from their telescopes and sensors. For all intents and purposes, the Earth is *gone*. Those in orbit around their home world are left blind, deaf and mute to what transpires below. It is an excruciating loss that anaesthetizes the mind and suffocates the human spirit. After a few days of numbed pain and disbelief, the space community suffers its own bout with panic and hysteria. Thousands take their own lives and cause disaster before some measure of order and hope is restored.

## Day Ten: December 31, 2098 New Years Eve

Nations, states and provinces, even cities, are cut off and isolated. Left alone and terrified to deal with events as they unfold. Government agencies, police, fire, rescue and similar departments struggle to maintain any sort of order and engage in rescue operations, but the carnage seems endless and beyond control.

The world continues to heave and convulse. It is a much colder, darker place now. The ashen skies blot out the sun and reflect its heat, making winter in North America and Europe like those in Siberia. Looking out from a window one can not tell whether it is snowing or whether it is ash that falls – one or the other falls continually. Wherever public utilities fail and power is lost, people freeze to death. There is not enough manpower or coherent government left to mount rescue operations, so entire cities toppled by seismic turmoil and other disasters are left to dig themselves out.

If there is any good news, it is that the volcanic ash (already 15 feet/4.6 m deep in the western *half* of the USA and Canada, and two to three feet (0.3 to 0.9 m in the rest – and still falling) is burying the millions of dead, preventing serious outbreaks of disease that come with decay, but that is the only good news.

**The planet Earth is enshrouded with ash**, sulfur and particles that reflect the sun. Ash falls as far away as Hong Kong, Australia and New Zealand, although it is only a thin dusting. However, even here, at the bottom of the world, the sky turns grey and the sun disappears.

**Across the globe temperatures drop** by 30-40 degrees Fahrenheit (16-22 Celsius), turning it into a frozen world of snow and twilight. On the brightest day in the warmest places (barely reaching 60-70 degrees), the sun is but a pale hint of yellow in a darkening grey sky.

**Vegetation is the first to suffer** in the chilling transformation. Entire ranges of forest, jungle and farms wither away. Crops begin to fail before most people know what has hit them.

**Worldwide communications collapse.** There is no Internet. No satellite feed, no far reaching television, and no telecommunications. Interference comes not just from the ash filled heavens, but from the walls of blue energy, raging storms, cables

severed by earthquakes and the collapse of communication systems and the businesses and relay stations that maintained them only yesterday.

In most cases, communications are so shattered that city blocks are cut off from their nearest neighbors. Events happening only a few streets away go on without media coverage or news reports. Radios and televisions buzz with static or garbled noise. When a voice is heard, it usually offers tales of new terror, mass destruction or a plea for help.

Feeling isolated, alone, and lost, bedlam and terror reigns. Those who do not huddle together to seek shelter or pray for divine intervention, try to flee or lash out violently.

Rumors of every conceivable subject abound. Some say the country's leaders have survived and are working on a response at the very moment. Others that the government is gone and no help is coming. Many believe the planet is under attack by space aliens. Others warn of "demons" and speak of Armageddon. Many see the Great Cataclysm as the end of the world. For billions, it is.

**In North America**, the military and NEMA have mobilized, and where their forces are obvious, there is some sense of hope, law and order. The new, *USA-G10 power armor* called *Chromium Guardsmen* (known to future generations as the "Glitter Boy") are deployed by the thousand. They are walking tanks made of laser reflective chrome serving as highly visible sentinels that bring comfort to the frightened multitudes. As do the *Flying Eagle SAMAS power armor*, with those from each branch of NEMA painted with the colors of its national flag (USA, Canada and Mexico). The Flying Eagles are exclusive to NEMA and function as all-terrain air, ground and water combat and rescue vehicles. Both the Flying Eagles and Chromium Guardsmen are well suited for urban environments, riot control, rescue and quick response for a wide range of combat and humanitarian operations. Both reflect the latest innovations in North American technology. However, their deployment and the sense of security they bring are the exceptions rather than the rule.

Most communities across North America (and the world) are left to their own devices with little or no guidance, protection or resources from their national or regional government. Some people unite to help one another. Leaders rise from the local government, police force, fire departments, churches, businesses and neighborhoods.

Those places that have suffered the least destruction, generally, fare the best and mount the best rescue and recovery. However, the majority of cities, especially along the coastlines, are lost to tragedy, destruction and terror. Where the devastation has been the worst, entire states and provinces lay in rubble and people do what they must to survive.

Elsewhere, riots, looting and panic tear apart communities that have survived the initial wave of destruction. Mob rule is law. At this point there is nothing resembling gangs or organized groups of any kind, only panic stricken mobs and madmen.

The world is dark, cold and turned upside down.

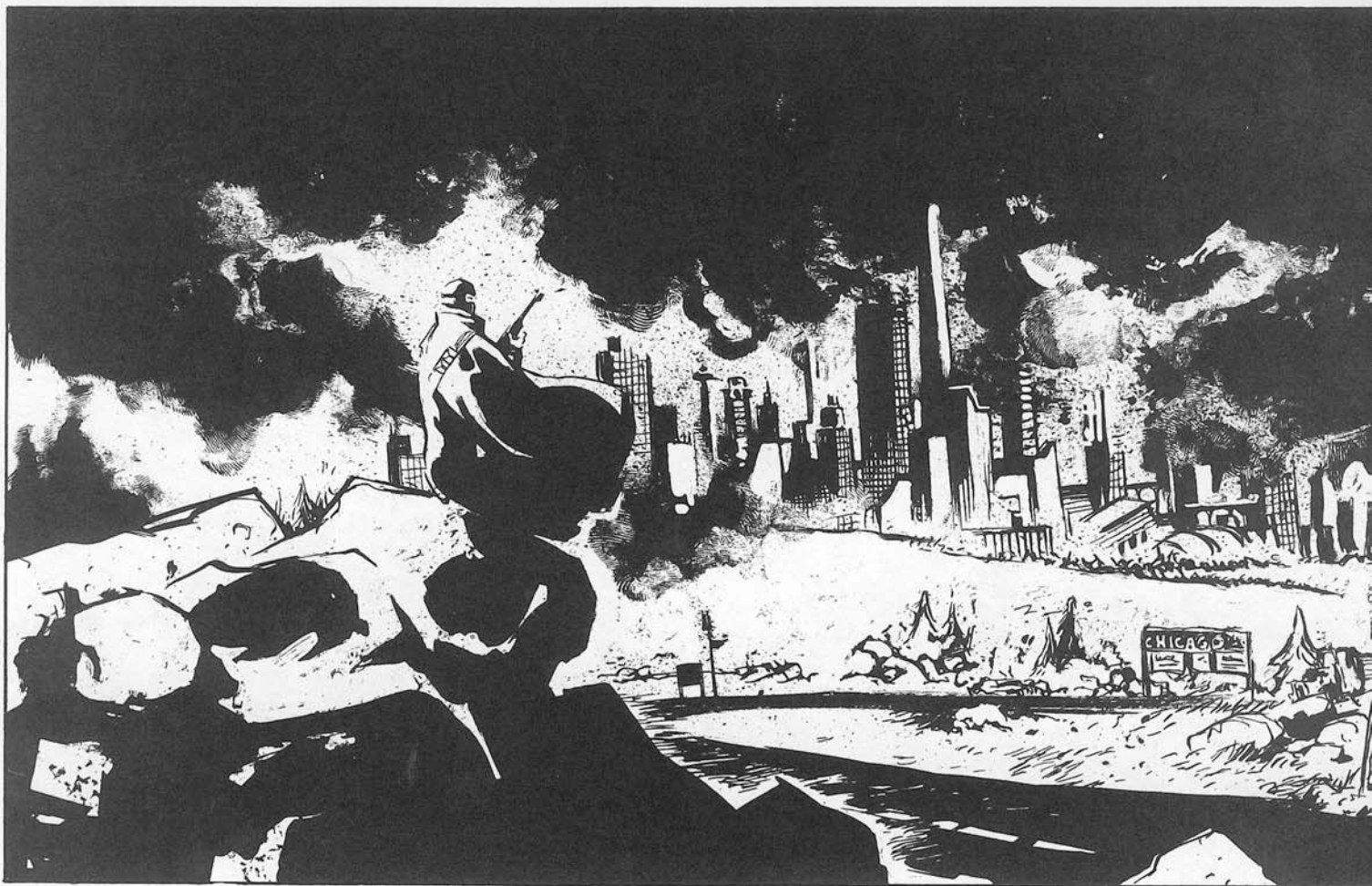

## January 1, 2099 A new era begins – Chaos Earth

The Apocalypse is here. The chaos continues. Our emphasis is on North America: The United States of America, Canada and Mexico in general, and the Midwest in particular.

## Hell on Earth

Pandemonium. Bedlam. Chaos. Armageddon. Apocalypse. Madness. Pick one, any apply.

It has only been a few days since the Great Cataclysm began, and the Apocalypse is in full swing. The very term “apocalypse” means “a turbulent and chaotic end.” Fire and brimstone. Demons and death. Treachery and betrayal. Destruction on a global scale.

More than half of the world population is already dead. The unnatural storms, earthquakes and volcanoes continue to ravage the landscape. Communications are gone. World governments are shattered. The destruction is of biblical proportions.

And things are getting worse.

Living through the Apocalypse means just when you think things can’t get any worse, they do. It means when you think you’ve hit bottom, the floor drops out from under you. It means when you’ve dispatched the last horror, a new threat lurks around the corner.

On top of everything else, the Rifts disgorge weird and horrific creatures that can only be described as demons. Hellish monstrosities bent on creating more havoc, fiends who delight in pain, suffering, death and destruction. Supernatural creatures possessing fantastic powers, and an instinct for terror. Many tease and torment the survivors of humanity. Others hunt them as prey, some enslave, and still others work behind the scenes to sow the seeds of depravity, evil and madness for their own sadistic amusement.

Driven mad by desperation, some survivors engage in a dog-eat-dog frenzy to survive, and in so doing, sacrifice their own humanity. Worse, there are those who listen to the evil whispers that come from the abyss. Soft words promising power, greatness and life for the small price of their eternal soul. These become the witches, necromancers and other dark sorcerers who gain power from malignant forces beyond the veil to become servants of evil and traitors to humankind.

## Heroes stand tall

**Player characters** find themselves on the ragged edge and must find a way to survive in the eye of the hurricane. One’s greatest challenge is more than survival and battling monsters, but keeping one’s very soul!

They represent the men and women who refuse to give up no matter how desperate the situation. They cling to their sense of right and wrong, goodness and evil, and fight to save not only



themselves, but those around them. They are unwilling to succumb to doom or bend to the will of some misshapened abomination from the pits of Hell. They'd rather die fighting for what they believe than give up or turn to the darkness that envelops the Earth. This makes them heroes and the last bastion of goodness, idealism and honor. Others are just too stupid or stubborn to give up, give in and succumb to evil or let themselves die easily. They stand and fight, and in many cases, *they* are all that stands between the helpless masses and the devouring hordes.

It is a clear cut battle between good and evil, monsters and humans. One must kill or be killed. Stand united or fall to the gathering storm. And the men and women of NEMA stand at the forefront of the conflict and bleed most bitterly in their relentless pursuit for survival and justice.

## Armageddon Christmas Day Blues

Lieutenant General Lindsey Sawyer looked out the window of the 73rd floor and watched the city of Atlanta burning below her.

*It's Christmas in Hell.* she thought to herself. *This must be what Christmas is like in Hell.*

Funny, three days ago, life was good. The world was beautiful, and she was planning for the holidays with her family. Then . . . this.

Looking at the blue lines of energy dancing above the fire, the weird sky, the blue lightning without rain, Lt. General Sawyer couldn't help thinking it was like something out of a special

effects movie. It was definitely surreal. *Unreal. Hellish. Like something out of a movie.*

She hated herself for thinking it. That's all everyone was saying. She heard it a million times in the last three days, "It's like something out of a movie."

But it was. As stupid and trite as it sounded, it *was* like something in one of those *end of the world* science fiction flicks she used to love as a kid. Somehow the real thing wasn't so much fun.

New York, Philly, D.C., hell, according to NEMA intelligence the entire Eastern Seaboard was gone. The west coast too. Half the country was in flames. The other half was just . . . gone. And half her family with it.

"General! Did you hear me? It . . . it's worse than anything we ever imagined!" That was Colonel Jared Nelson. She had forgotten he and his three assistants had come into the room with the latest report.

"New York?" She asked out of routine.

"Gone."

"Survivors?"

"None."

"None, at all?"

"It's impossible to know, but as far as we can tell, none."

"Washington?"

"Confirmed, gone."

"Virginia?"



"The entire Eastern Seaboard is gone, General. From the Gulf Coast to Greenland it's . . . it's all . . . gone. Same story for all coastal communities. Gulf States too."

"What about our allies?"

"Canada's parliament is mostly intact, so is their branch of NEMA, but they're scrambling to respond to the devastation on the Atlantic and Pacific coasts. Mexico is a shambles. Quakes destroyed the heart of that country. If NEMA remains intact in any capacity, they have their hands full. Last communiqué from Mexico was a request for immediate aid and support. Since then, nothing's clear. Garbled reports, but nothing official. As you know we couldn't send any support, so they're on their own."

"NORAD?" General Sawyer asked. "Any word?"

"Gone . . . it . . . nothing confirmed, my sources say it's gone. Super-volcano."

"A what?" She didn't know why she even asked. At this point, she really didn't care, and it certainly didn't matter anymore.

"The Yellowstone super-volcano. When it blew, it took out the entire park, part of the Rockies, and they think it took out NORAD with it."

"And the President."

"And the President, too, yes, Ma'am."

"Who are your 'sources'?"

"Um, nothing official, but . . . um, you know, the grapevine."

"But there's been no word in . . . what now?"

"Almost 48 hours. No, Ma'am."

"We lost the President?" It was a rhetorical question.

"It would, um, appear so. Yes, Ma'am."

*Christmas in Hell. That's what it was,* the General thought to herself.

"We can't handle this, Ma'am. We've . . . we've . . . never been trained for anything like this! Not like this!! The whole world's gone crazy. Satellite photos show it's like this everywhere. Everywhere! My god, China . . . we can't even guess what's going on there! And, and . . ."

*Great. Colonel Nelson was hysterical. She wanted to turn around and slap him across his face. Hard. Only that would be like something out of a movie too, wouldn't it? Why was everything like a movie cliché?*

"Detroit, Windsor, St. Louis and I don't know how many others," continued Colonel Nelson in a shrill voice, "all report demons! Demons, General! Honest to God demons coming outta . . . I don't know? Holes in the sky!! Demons!"

*Of course there were demons,* she thought, still looking out the window as Atlanta burned all around her. *What do you expect? Demons live in Hell, you idiot! Don't you understand, the world is gone and we're all living in Hell?* At least, that's what popped into her head. The General bit her tongue, thought for a minute and turned around. Colonel Nelson was still blithering on.

"And . . ."

"That's enough, Colonel Nelson."

"But there's more . . . it's . . . it's . . ."

"I said that's enough!"

Colonel Nelson looked up from his hand-held mini-computer, his eyes practically spinning. His hands trembling.

"Is this Armageddon, Ma'am?" Asked one of the assistants.

"Yes." replied Lt. General Sawyer. "Yes, it is."

"Are we going to die?"

*Yes,* is what she thought.

"I don't know." she said.

"It seems like the end of the world, doesn't it? I mean, for everyone."

*It sure as hell looks like it,* the General thought to herself.

"Maybe . . . yes . . . I don't know."

"Is there anything we can do?"

General Sawyer turned to gaze out the window again. Even up on the 73rd floor she could hear the sirens, the sounds of gunfire and screams below.

"Haven't you been listening?" snorted Colonel Nelson. "Half the world is gone! We've lost contact with the High Command. The President's probably dead. There's nothing but panic and rioting everywhere! Half our troops are AWOL! It's over! It's all over!!"

"That is quite enough!" shrieked General Sawyer, punctuating her words by pounding her fists on the glass window.

"What's the status of Chicago, Milwaukee, Minneapolis? The Midwest's still holding its own, isn't it?"

"Well . . . yes . . . but it's only a matter of time before . . ."

"But nothing. We go where we can do the most good. We take the Chromium Guardsmen and other power armor on the 'choppers, join the Midwest forces, and establish a fighting core. Our base of operations, Ladies and Gentlemen, is the Heartland of the country. Once that's secure, we work our way out and around the perimeter to rescue civilians elsewhere."

"That's crazy! What's the point?" shouted Colonel Nelson.

"Pardon me, soldier?"

"Um, with all due respect, General . . ."

"The point, soldier," snarled a defiant General Sawyer, "is we have a job to do. Lives to save. People are counting on us. Atlanta is toast. We go where we can do some good. Maybe we can make a difference in Chicago. It's as simple as that."

"A difference? In that!?"

The General had to force down the desire to kick Colonel Nelson's teeth in, this time.

"We're NEMA! Just being out there in those glittering Chromium suits is doing plenty. Just seeing that 'we' haven't given up will give people hope, Colonel. Right now, that may be just about all we can do."

"You're crazy. It's pointless, there's nothing . . ."

Before the Colonel could finish his sentence, General Sawyer had unholstered her sidearm and slapped the energy pistol in Col. Nelson's hand.

"If you're so sure this is the end, then do it. Do it now. I mean it, Colonel. Put the weapon in your mouth and end it here and now so we don't have to hear your sniveling garbage anymore."

"Maybe this is Armageddon." she continued. "I don't know. None of us do. It isn't my place to figure it out. Maybe we'll all be dead in an hour. Maybe you're right. Maybe it's hopeless,

but if I'm going out, I'm going out doing something. Not standing around like some whipped puppy wetting herself. Come with me or don't. Crawl in the corner and wait for a choir of angels, pull that trigger, or come with me . . . us, but shut the hell up and do something in what may be your last hours on Earth! Me, I'm going to do something good. I'm going to take whatever troops will follow me and save lives. Maybe even waste some of your 'honest to God demons.' If this isn't the end of the world, then we'd better get our cans in gear and do something about it!! If we're going to die, let's die like soldiers."

"Um . . . yes . . . of course, Ma'am." stammered Colonel Nelson as he handed the pistol back. "Sorry, Ma'am." His assistants just smiled and nodded in agreement with the General. If they had to die, they'd do it like NEMA soldiers trying to help people.

The Lieutenant General had hoped forcing Colonel Nelson to look down the barrel of a gun would shock him out of his panic and focus him back to the job. Nelson was a good man in a bad situation. No one ever knows how they'll react when facing an

impossible situation. They were all more than a little strung out. Staring out of a window and pondering Hell on Christmas day wasn't exactly rational or productive leadership. But it was time to snap out of it and do something. The way she saw it, there really were only two choices. Lay down and die or try to make a difference. Gathering her NEMA troops and going to where they could do the most good was the only logical choice. They were in over their heads here in Atlanta. Way over. It didn't seem right turning their backs on their Georgia post, but to stay meant certain death, and that didn't benefit anybody. Going to the Midwest, *Chicago*, she thought, and pooling their resources where civilization still struggled to keep it together *was* the thing to do. They needed a starting point . . . a base of operations, and this wasn't it. If NEMA could help establish order in the Chicago area, they could build a solid base to conduct D-3R operations to help the rest of the country.

*It was as good a plan as any*, thought General Sawyer. *Now, let's see what happens in Hell when you choose to fight back.*

\*\*\*\*\*

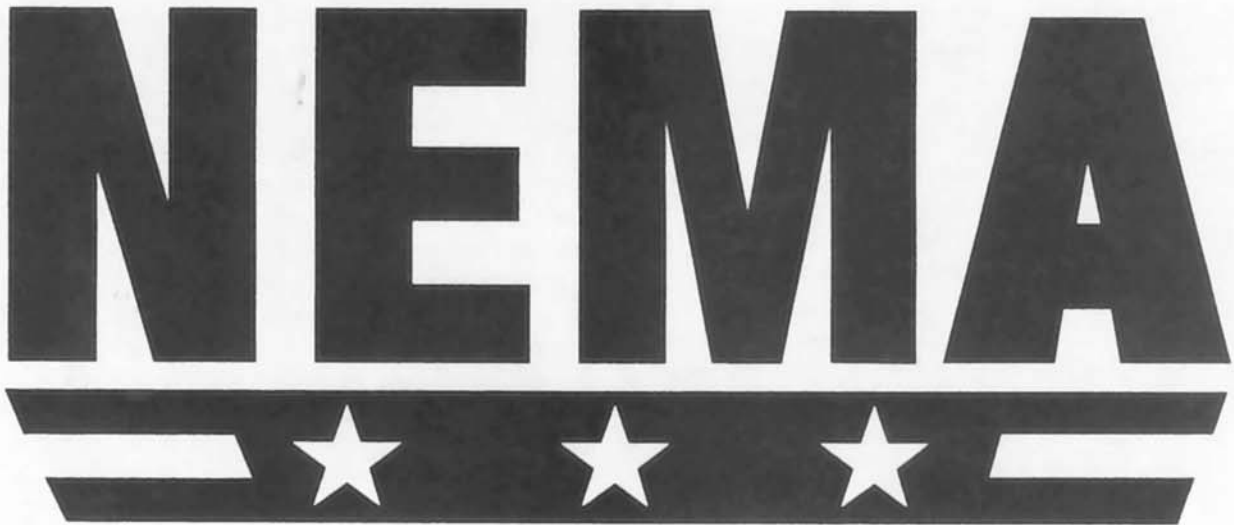

## The Role of NEMA

In the United States of America, the US government is gone. The President, who had survived the initial conflagration, was swept away to what appeared to be a safe haven at NORAD. Only NORAD is missing in action – blasted to atoms or buried by a trillion tons of rock when the Yellowstone super-volcano erupted.

Local governments, regional law enforcement, and factions of the US military all struggle to respond to the crisis in their jurisdiction, effectively splintering the United States into thousands of *isolated* communities left to their own devices.

NEMA, the Northern Eagle Military Alliance, is probably America's best hope, however, the organization, like everyone else, is not prepared for a crisis of this scale. The magnitude of devastation and conflict is beyond any organization's means to deal with, even if they were at full strength. National and local

leaders have gone missing in action. Without them, many of the military and law enforcement personnel lack effective direction or have deserted to fend for themselves or seek out loved ones. The prevailing sense is that this *is the end of the world*, causing many to desert their posts.

NEMA is the least affected by desertion. For one, it is a multi-national organization with very strong operational and procedural guidelines. For another, its agents and operatives are all volunteers dedicated to the defense and protection of North America. They are the elite of the continent's heroes trained for Disaster Response, Rescue and Recovery (D-3R) of every magnitude, including military response and global "end of the world" scenarios. Consequently, even without a High Command to direct them or definitive orders to guide them, NEMA forces hold together extremely well and take immediate action.

Sadly, many perished in the initial cataclysm and others who rushed to the front lines have been lost in subsequent disasters or battling monsters from the Rifts. The rest of NEMA is divided and scattered across the continent. Those assigned to a particular nation (i.e. USA, Canada, and Mexico) tend to stay at their assigned national designations, although mixed forces are found working together along the borders. Unlike Lieutenant General Sawyer, many NEMA forces try to make a stand alongside remnants of the military and local fire/rescue or police departments. The lucky ones manage to create a beachhead stronghold in a tide of chaos, the others are the first to die.

Remember, the **Northern Eagle Military Alliance (NEMA)** is an elite police-paramilitary agency composed of special law officers and military personnel from the USA, Canada, and Mexico charged with the defense of North America as a whole. Though agents are assigned to a specific nation, they have jurisdiction in all three of the allied nations and can come and go from one country to the next with impunity.

NEMA's mission is to keep North America safe from crime, terrorism, espionage, and subversion intended to undermine the sovereignty, security and prosperity of the allied nations. NEMA incorporates an equal number of operatives from each of the three allied nations to deal with all sorts of crimes and trouble across national borders as a sort of tri-national FBI, CIA and NSA all rolled into one. In fact, NEMA had proven so successful that it virtually replaced the FBI and worked with both federal and local authorities in all matters that involved two or more nations, or a threat to homeland defense. As an elite police and military force, NEMA has access to the most advanced crime fighting, investigative, rescue and military "resources" in the country, including high-tech, Mega-Damage power armor, special weapons and vehicles and prototype equipment.

In the **Chaos Earth™ RPG**, our initial focus is the *United States* and *North America*. In a world gone mad, that means NEMA is rushing to the forefront of homeland defense, rescue and recovery. Consequently, most *player characters* are likely to be **NEMA operatives** or law officers, soldiers, scientists and civilian *volunteers* working with NEMA.

At least in theory, NEMA has protocols for handling disasters, including global holocaust. As a result, the agenda for these heroes is fundamental and straightforward, though a nearly impossible task to accomplish.

**1. Base of operations.** Secure and establish a (reasonably) defensible stronghold as a base of operations. Preferably, a major city or military compound.

**2. Command.** Establish a clear and strong chain of command within the regional NEMA forces. During times of disaster it is critical to have a clear line of authority and established rules of conduct and law. Likewise, it is vital that NEMA operatives remain united and loyal to the cause, the NEMA organization and each other.

**3. D-3R.** Upon securing an operations base camp and establishing of a clear channel of command, engage in D-3R – Disaster Response, Rescue and Recovery – starting from the center and working one's way out.

Response: Prioritize and tackle the immediate problems first.

a) Establish and secure a base camp and staging area. Never compromise the base of operations.

b) Establish field hospitals and relief camps even if they are the most basic of shelters.

c) Take command of the situation. Be visible, be strong and be decisive. Provide direction, order and support. Survivors will be looking to *NEMA* for leadership and strength.

d) Establish lines of communication.

e) Create lanes for travel, conveyance, escape and evacuation.

f) Assess the situation and respond to, and neutralize, threats. Includes containing and fighting fires, shutting down natural gas lines, etc., as well as dealing with hostile forces.

g) Engage in rescue operations.

Rescue: Just like it sounds, go forth and engage in rescue and relief.

*Stage One:* Assess the situation and respond accordingly. First, save those who have the best chance of being saved, i.e. mobile survivors and the walking wounded. Lead and transport to the secured areas and provide medical attention and comfort.

*Stage Two:* Come back for those in "dire circumstances" – i.e. dig out those pinned and buried under debris or otherwise trapped in life-threatening situations.

*Stage Three:* Provide food, shelter, and basic amenities.

Recovery: NEMA's work does not end with pulling people from the rubble and slapping on a band-aid, but all aspects of rescue and recovery. That means continuing to put out fires, re-establishing basic services like providing adequate shelter, food and drinking water, arranging for sewage/waste disposal, continued medical treatment, recovery and disposal of the dead (interment or cremation), salvage operations, the stockpiling of supplies, and providing security and defense, including combat operations against invaders, bandits and, in this case, monsters.

**4. Find and restore law, order and leadership**, even if it is a local or military authority. Recovery in a widespread holocaust must include rebuilding and reestablishing government, law, order and civilization. NEMA is to avoid taking the role of civilian leader, even if it is in charge of defense and security. It is NEMA's role to defend, protect, and rescue civilians under the auspices of the regional/local government until the federal government can be restored. NEMA is never to usurp governmental authority, although it may act to "restore" it by any means necessary and act on its behalf as a proxy government authority and protector. This last protocol will prove to be the most impossible to establish and maintain.

## NEMA on the move

Using these basic guidelines, NEMA's purpose and agenda are clear cut and the troops respond accordingly. Some stand their ground and try to deal with localized disasters. For example, USA and Canadian NEMA troops are quick to respond to conflicts at Detroit and Windsor, working in tandem to save lives and battle the monstrous invaders. Many NEMA operatives perish before abandoning the cause to regroup, probably in Toronto and the capital city of Ottawa. (Montreal and Quebec will also see considerable NEMA activity in eastern Canada.)

**In the United States of America**, the *Midwest* is quickly becoming recognized as the defensible "core" and NEMA operatives are beginning to gravitate toward some of the largest



central cities. *Minnesota, Iowa, Wisconsin, Illinois, Missouri, Arkansas,* and parts of *Texas* and *Michigan* are comparatively unscathed by the worst of the destruction. Tucked away inland, they survive the devastation of the coastal states. Likewise, the Midwestern States fare much better than the western part of the country which is torn apart by earthquakes and spewing volcanoes that haven't shook the planet like this since before the age of the dinosaurs and which are burying the plain and mountain states alive. The ash filled heavens choke the engines of aircraft and ground vehicles, making rescue in the west impossible and travel by foot the only avenue of escape. However, escape on foot is unrealistic unless one can trudge through the blizzard of blinding, hot ash and debris already 20-30 feet (6.1 to 9.1 m) deep in a 300 mile (480 km) radius around the Colorado epicenter. Most people in the west have already succumbed to the suffocating flakes. The airborne ash reaches much farther than that, however, as the rest of the United States, Canada and Northern Mexico are also blanketed with 1-6 feet (0.3 to 1.8 m) of ash, the sun is blotted from the sky, and temperatures drop by 5-10 degrees Fahrenheit. Meanwhile, high winds create dust storms and rain creates rivers of mud that swallow entire cities and towns. The eruption of the super-volcano is actually felt worldwide and has a lasting effect. The scores of other volcanoes erupting around the globe only contribute to making a bad situation worse, affecting weather patterns, global temperatures and life on Earth in a dozen different ways.

## Imagine you are NEMA responding to the impossible

NEMA operatives, soldiers, police officers, and volunteers plunge into the storm of chaos to help others. Following the protocols previously set forth, these heroes work to rescue those in need and battle any recognizable threats. This is rescue and warfare in what is becoming an increasingly alien, urban environment. The familiar is replaced with the weird and the monstrous. The sun is gone, the sky has turned to grey and a blanket of white ash (in some places, mixed with snow) covers everything. The streets are cast in an eerie gloom, lines of blue energy radiating from the earth add to the strangeness, and buildings now harbor supernatural creatures and alien invaders as well as looters, rioters, and bandits.

Imagine your own hometown cut off without warning from the rest of the world. Communications beyond city or county limits no longer exist. Except for local emergency broadcasts, there is nothing on the television, radio or internet but static. Telephones and cell phones are dead. Off in the distance you hear frequent bursts of shouting, screams, gunfire, sirens and strange noises you can't identify, followed by an unnerving silence. Now cover your hometown in a foot of snow, with more lightly falling every hour, nonstop for days. The landscape is transformed into something like a winter scene, only there is the stench of sulfur and death in the air. The white flakes are *ash* that chokes and burns the nose, lungs, and eyes. It also clogs the engines of vehicles and machinery. The ash turns into muck when mixed with snow or rain, becoming heavy and difficult to

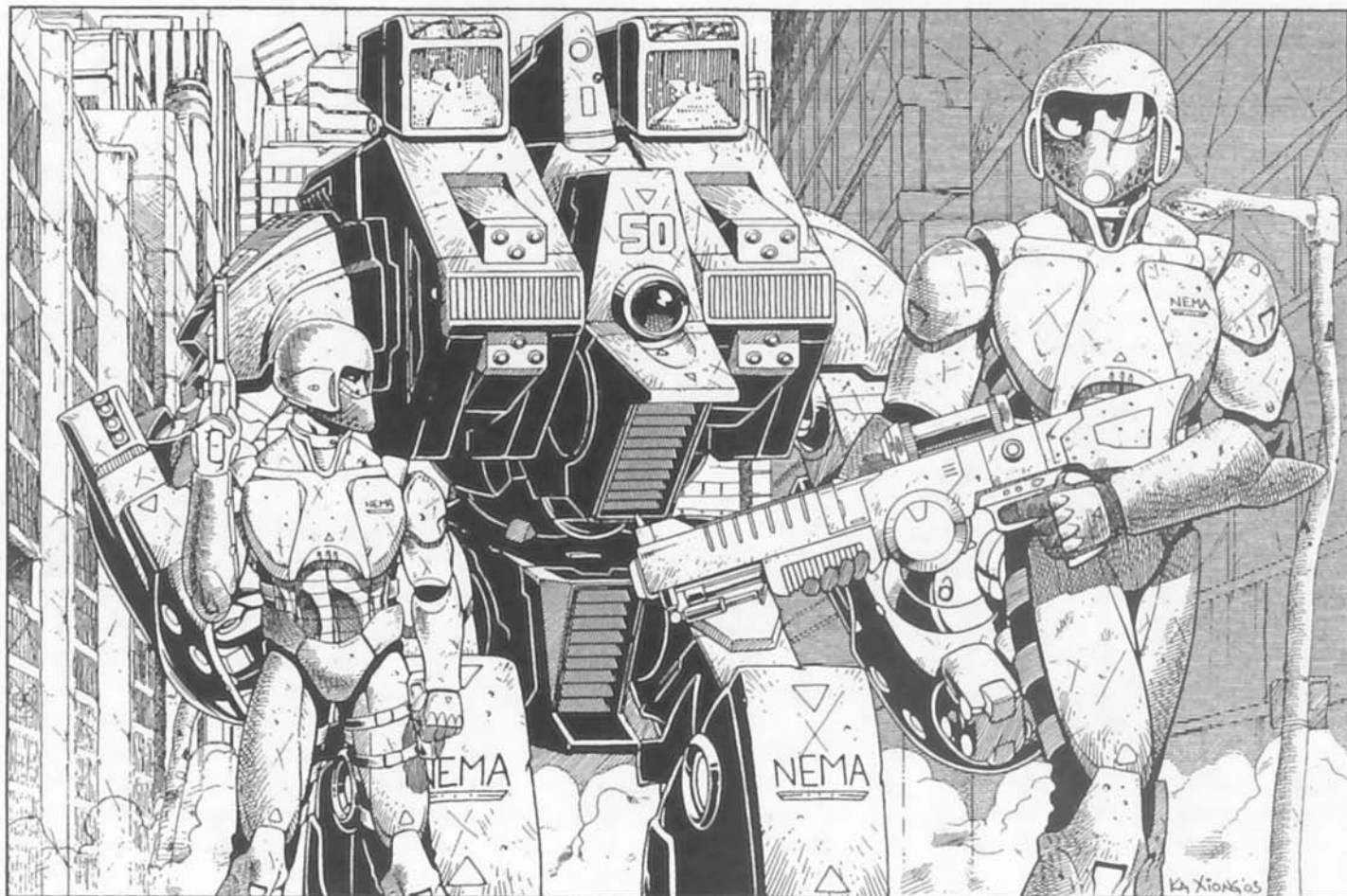

walk through. The sun hides behind a filter of ash and soot that turns the sky grey and creates a daytime that is at best *twilight*.

Rumors circulate that the President is dead, the government has collapsed, and that most of the United States has been obliterated. You feel terribly alone and frightened. A certain amount of rioting, panic and turmoil erupts at isolated locations, and evildoers and opportunists rise up to take advantage of the confusion. They don't represent unexpected threats or reaction, for man's inhumanity to man seems to be natural under such circumstances. It is the stories about monsters, demons and aliens that create a sense of the *unreal* and a mounting panic. In a few short days, these stories become widespread and more frightening as reliable friends, neighbors and authority figures report glimpses of strange creatures hiding in abandoned buildings, feeding on the dead and prowling the streets at night. Soon, there are "close encounters" and even outright battles with alien beings most accurately described as *demons*. The existence of such demonic creatures defies modern science and rational thought. There are no such things as ghosts and demons, or aliens from distant planets, or magic, or vampires, or zombies or ancient gods or dimensional doorways. They're impossible, right? Aren't they the stuff of fairy tales, comic books and Hollywood movies? How does one deal with things he cannot accept as real? Things that challenge or contradict everything he or she has ever known or believed? Their "in your face" appearance is a deep, debilitating shock to the system. Worse, these things that cannot be real are invading your community, killing people by the hundreds (or thousands) and causing more destruction.

Now picture yourself as a *NEMA protector and rescuer* who goes out to save lives and help people, whether they are lost, trapped under rubble or menaced by something terrible. Only the situation is more complicated than that. Visibility is terrible at a hundred yards/meters at best. Satellite communications and GPAs are nothing but dead air. Freak storms, the falling ash, inexplicable electromagnetic disturbances, the weird lines of blue energy and other inexplicable disturbances make even short-range communications garbled. At best your communicators work at half the normal range, more often than not, they can't transmit farther than a mile and even then the sound quality is poor. Other sensory equipment, optic systems and scanners are unreliable, working perfectly sometimes, and going haywire or dead at other times. That means you must cover ground by foot and rely on your own natural senses – senses that are bombarded by strange and dizzying sights, sounds, and smells, but they are all you have, and you do with what you've got. Thus, NEMA protectors go into the ash and snow filled streets to check every building, one by one, in search of those in need.

As experienced peacekeepers and front line troops, you expect the normal cavalcade of sleaze-bags who slither out from under their rocks during times of crisis. Rioters, thieves, killers, protestors, fanatics, and lunatics are all part of the expected scenario. What you aren't prepared for are the reports that *monsters* and *aliens* are real. They're not mass hysteria or wild animals, freaks or even genetic misfits, but truly strange and monstrous creatures. Most of which seem extremely hostile and unpredictable. *Demons*, living horrors that look like something out of a nightmare, are the most terrible in visage and action. Some are humanoid in appearance, others animal-like, still others defy

easy description. All seem to thrive on chaos and delight in torture and murder. Nothing in your training comes close to dealing with this kind of adversary. Nothing. And yet, there you are, facing down some Hell-spawned monstrosity with horns and a tail or six legs and the head of a hideous animal or insect. Most seem to possess superhuman abilities: some fly, some turn invisible, some breathe fire, and some conjure lightning or wind with a gesture or howl. Others can mesmerize a crowd of civilians and make them do their bidding, or move at the speed of a rocket bike, or have talons that can rip through body armor you once thought invincible, or scale walls like a bug, or disappear in shadows, or walk through walls like a ghost. And speaking of ghosts, how does one combat a spirit? Ghostly entities and spheres of energy move about as if alive. Again, some wield strange powers or cast magic while others are able to possess people or animate objects. How does even an elite disaster recovery team cope when every sound and flickering shadow could represent some new, horrible menace that defies logic and reason? And this is in your "hometown" where you know the lay of the land and feel safe. It's even worse entering an *unknown* city or the belly of a toppled skyscraper where monsters use the innocent people trapped within as bait to lure *you* into their spider's web of doom or terror.

The situation defies human comprehension, yet it is what the heroes of NEMA must face a dozen times every day. Dropped into the worst global disaster in the history of the world, they must also deal with hostile, man-eating monsters, demons and aliens. There are no rules for this. NEMA agents are flying by the seat of their pants and making up their response as they go along.

Imagine it, because that's who *you* are *playing*.

## An aggressive position

NEMA forces everywhere, but especially those in the Chicago area, under the command of Lt. General Lindsey Sawyer, have come to grips with their situation faster and better than one might expect. Though some NEMA forces have given up, fled or turned rogue, those who stand and fight do so admirably and with courage. Libraries, databases and accounts of first-hand encounters are scrutinized, analyzed and processed to find ways to fight the supernatural beings that plague them. Once the creatures' strengths and weaknesses are identified, strategies and tactics are developed to exploit them and destroy the enemy. Though General Sawyer's troops are among the most organized, relentless and ruthless, most NEMA forces take an aggressive and merciless approach to battling demons and monsters, typically destroying them without pause, by any means necessary. Humans who associate with demons or draw unnatural powers from infernal beings are treated with similar harsh measures.

As a general rule, no mercy nor quarter are given to the demonic, however, NEMA forces are given a large amount of leeway as to exactly how they conduct themselves in the field. Thus, some teams are more tentative and compassionate (particularly toward aliens who may *not* be supernatural fiends), while others are machines of destruction, especially when it comes to so-called demons, monsters and other unknown hostiles. NEMA operatives see the Earth as being under attack by demonic invaders, and are quickly adopting a "them and us," "kill or be



killed" attitude, especially when innocent human lives are at stake. From their point of view, NEMA is quite possibly the only authority functioning in North America. If they don't fight to defend their nation and help civilians, who will? The fact that the vast majority of so-called demons are blatantly evil, usually attack unprovoked and are bent on killing, torturing, enslaving and eating humans, only drives the heroic men and women of NEMA to fight all the harder. Inspiring NEMA operatives and pushing them beyond normal limits, each new horror and atrocity strengthening their resolve. Under the circumstances, extreme force against inhuman opponents, especially obvious demons and those possessing magical powers, is advised, and overkill encouraged. However, none of this has made NEMA troops hardened or bloodthirsty, at least not yet. The overwhelming majority exhibit a tremendous amount of patience, tolerance and compassion when helping innocent civilians. Meanwhile, the courage and resolve of NEMA squads are quickly becoming things of legend, as they frequently take on bands of demons, hideous monsters and overwhelming numbers to save a single child. That's how committed they are to *rescue*, and how devoted they are to *saving* lives. They have their work cut out for them too. Every day, more demons and monsters are disgorged by the Rifts. All seemingly monsters who stalk humans as prey and willfully slaughter dozens, sometimes hundreds and even thousands of innocent, unarmed civilians just for the pleasure of killing. NEMA doesn't know what may be happening around the world, but they assume they are on their own, and take the necessary measures to ensure the survival of their unit and the people under their charge.

## Lieutenant General Lindsey Sawyer

### Head of Midwest Operations

Lt. General Sawyer has already endured more than she could have ever imagined. She, like so many others in NEMA, has faced her own inner demons of fear, doubt, and despair. She suffered through shock and hopelessness and considered giving up or going out in a blaze of glory before coming to her current state of mind.

It took us six days to get to Chicago. I lost 10% of the NEMA troop under my command doing it, but we picked up 350 more along the way. Saved a few thousand civilian lives, too. Bunches of which should be making their way to Chicago as I write this.

On our trek from Atlanta to Chicago we found carnage and destruction of biblical proportions. Entire cities and towns toppled by quakes or burnt to the ground from one disaster or another. Many have been devastated by the elements – the freak storms, earthquakes and volcanic eruptions – but nearly as many suffer self-inflicted devastation. There is an incredible amount of damage from panic and paranoia, often laying waste to an entire community. It's unbelievable. The things we have born witness to have been more terrible than I can find words to describe.

The carnage is just everywhere and ongoing. It seems like only one in every ten cities have survived, and of those that have survived, they are shattered communities at war with fear, the elements and themselves. Most have fractured into a thousand different warring factions. Mobs of rioters, bands of looters, gangs of rapists, and madmen fill the streets looking for victims. Others wander around like zombies, oblivious to the horrors around them or sift through the wreckage of civilization searching for missing loved ones. It tears at your heart. No amount of training can prepare anyone for this.





The tastes. Death mixed with chalky ash falling from the sky like snow. Charcoal and the sweet tinge of burning flesh filling your mouth and nostrils with every gulp of acrid air.

The smells. The scents of burning brick and wood, bone and flesh, oil and rubber, sweat and blood, death and tears mixed in with the stench of sulfur, ozone and a thousand other odors that hammer the senses to make your head swim and your stomach wretch. NEMA troops in environmental body armor don't have it so bad, but the civilians, or if your suit is ruptured, oh God, the ash and grit is suffocating. Burns the eyes and fills your nose and mouth as if you're sucking in sand, and the smell . . . When it snows, there still isn't any relief, just wet gunk to choke down. The civvies try to protect themselves with goggles and scarves or air filters, but it only helps to a point.

The noise. The cacophony of sounds: Screams, shouts, crying, laughing, gunfire, explosions, sirens, the crackling of fire, the tumbling of buildings, the scream of steel, the sounds of digging, running footsteps, the pleas for help, the prayers to God, the bellows of hate, the moans of agony, the whimpers of fear and cry of . . . things not of this Earth.

The sensations. The constant rush of light and motion. The sting of hot ash carried by icy winds, the smorgasbord of odors, the fist in your stomach, the ache of your muscles, the throbbing of your temples, the dryness of your mouth (like a desert) and the annoying moistness of your perspiring hands. Sometimes you can't even feel your body and you barely notice your surroundings because you seem to be walking through a dream – a nightmare – and you are detached from everything around you, including yourself.

All of it crashing into one another. Never stopping and you can't escape. It's like nothing I have ever seen.

The inferno of St. Louis, on both sides of the river, made Atlanta seem like a little picnic barbeque. Reconnaissance Teams Three and Four estimated 200+ square miles around St. Louis were ablaze, another 100 miles (160 km) had already been reduced to smoldering rubble and the St. Louis Arch was crackling with energy and lightning around the clock. If Armageddon had come, I imagined it was starting in St. Louis.

In addition to the fires and chaos, there were these hordes of demonic creatures. Not demonic, I mean demons, the genuine articles. Technically, I guess we don't know what they were for sure, but we called them demons. Thousands of them. Each with the strength and power of a Chromium Guardsman and as fast and mobile as the Silver Eagles. Took an entire squad to take down just one of the most powerful ones, and if that squad didn't include a pair of Silver Eagles and a Bulldog we would not have won the conflict. Some of these "creatures" used melee weapons like swords and clubs. Most didn't have a taste for technology. Some seemed outright baffled by tech, not that it helped us much, because these demons had hides like titanium alloys and some could shoot fire or energy bolts from their eyes or hands. Others could call down lightning from a cloudless sky, open up fissures in the earth and some – some seemed to call upon what I can only call magic. I'm telling you some could fly, turn invisible, create clouds of gas out of thin air and ensorcel my men with swirling lights or verbal commands.

We got out of there by the skin of our teeth. Lost 23 out of 160 troops. Never did find the people who sent the distress call. The signal was dead by the time we arrived. My guess is so

were the poor souls who sent it. We did rescue about 120 people, and stragglers and refugees show up in Chicagoland every day.

Half of the places to the south and to the east are just as bad as St. Louis. It is my recommendation to cordon off lower Illinois, Indiana, Southern Michigan, Ohio and Missouri and make them a no-man's zone.

We came across a number of places where the entire community has decided this is the final reckoning foretold in the bible. Most of the people at these places have accepted their fate, so they gather in and around the churches and city hall where they wait and pray for the angels to come for them. We offered to escort them to Chicago, or to help set up some guidelines for survival and come back as soon as we can, but they refused. They are so sure this is "The" end that they refuse to lift a finger to help themselves, protect their children or even feed themselves. They just wait. Wait in prayer for the end to come. In some ways, this acceptance of doom was more painful to watch than riots and carnage. I lost a dozen or so of my own men who decided to join them and wait for the angels of death to claim them.

I don't think there will be any angels coming to carry the good folk to their heavenly reward. And I don't think God would want us to just give up the ghost. It's not His way, and it sure isn't mine. Giving up is too easy and final. I'm not ready to lay down and die. If there is a God in Heaven, then He must have let us survive for a reason.

We're NEMA. Our purpose is to protect and rescue, and that's exactly what I intend to do. As I see it, we're needed now, more than we have ever been. Maybe it is all futile and I'm just fooling myself, but that's how I see it. And I'm not alone. We're 3,600 strong with more NEMA troops rallying to us, here in Chicagoland, every day. When my troops followed me to the Midwest I never imagined I'd be the one to lead the way, but I'm up to the task. And God willing, we'll make a difference.

*– Selected Excerpts from the diary of Lt. Gen. Lindsey Sawyer, January 2099*

**Note:** More of the General's diary can be found in the pages of **The Rifter® #19**.

After forsaking her Atlanta post for the Midwest, General Sawyer was surprised to find herself the ranking officer in the region, and therefore expected to assume the position of Head of NEMA Midwest Operations. Though she was not expecting this responsibility, her years of experience and sharp mind make her perfectly cast in the role. The troops respect her, she is decisive, thinks fast on her feet, is very quick to assess a situation and adapt appropriately and has excellent organizational and management skills. This combined with her combat experience and head for strategy and tactics makes General Sawyer up to the task set before her. Lastly, the General embodies all that NEMA represents and she cares about those who serve under her, never jeopardizing her troops for glory or foolish gains. As a result, General Sawyer has a whopping 93% approval rating and forces would follow her into the bowels of Hell.

## Lieutenant General Lindsey Sawyer

### Head of NEMA Midwest Operations

**Alignment:** Scrupulous.

**Attributes:** I.Q. 20, M.E. 20, M.A. 23, P.S. 17, P.P. 14, P.E. 15, P.B. 20, Spd. 22

**Hit Points:** 44, S.D.C.: 30.

**Height:** 6 feet (1.83 m).

**Weight:** 130 pounds (59 kg).

**Age:** 35

**P.P.E.:** 9

**Level of Experience:** 9th level Military Specialist: Robot Specialist.

**Disposition:** Clever, resourceful, quick thinking, adaptive. A natural leader who can see the big picture and skilled at managing and organizing. She is not afraid to take a calculated risk and is good at strategy and tactics. Though strong willed, forceful and charismatic, General Sawyer has her share of insecurities. She also has a bit of a temper and is intolerant of whining, incompetence, and disloyalty. She lives by the goals of NEMA and enjoys using her abilities and the resources of NEMA to help others and save lives. General Sawyer is compassionate, caring and kind, however, her role as commander can sometimes make her appear stern, hardhearted and ruthless. Despite her obvious attractiveness, she has no time for romance and spends her every waking hour directing NEMA forces and addressing the current crisis. A hands on individual who enjoys action in the field, she'd rather be leading NEMA forces than sitting behind a desk and orchestrating operations. Though it breaks with protocol and concerns her advisors, General Sawyer often goes into the field to make first-hand inspections and evaluations as well as to address the troops. She is loved and respected by those under her command, and keeps their loyalty without hardly trying.

**Appearance:** Lindsey Sawyer is a tall, attractive woman genetically tweaked before birth to have a strong mind, long legs, a shapely figure, low fat, strong bones, good reflexes and body strength, blonde hair, full lips, blue eyes and soft complexion. She is striking and charismatic.

**Combat:** Hand to Hand: Martial Arts and Boxing.

**Attacks per Melee:** Seven.

**Bonuses:** +1 on initiative, +5 to strike, +6 to parry, +6 to dodge, +7 S.D.C. damage, +3 to roll with punch/fall/impact, +3 to pull punch, karate-style kick does 1D8, +3 vs psionics/insanity, +4 to save vs magic, +4 to save vs poison, +14% vs coma/death, and 50% to charm/impress.

**Skills of Note:** Speak, read & write American and Spanish 98%, speaks French 60%, Basic Math 98%, Advanced Math 96%, Military Etiquette 98%, Basic Electronics 98%, Mechanical Engineer 85%, Computer Operations 96%, Radio: Basic 90%, First Aid 96%, Disguise 86%, Intelligence 84%, Interrogation 91%, Land Navigation 78%, Power Armor Basic 91%, Power Armor Elite: Silver Eagle, Command Robot (all), Wilderness Survival 91%, Climbing 91/81%, Running, Swimming, W.P. Knife, W.P. Energy Pistol, and W.P. Energy Rifle.

**Psionic Powers:** None.

**Magic Knowledge:** None.

**Weapons of Note:** Any weapons, vehicles, equipment and resources available to NEMA are at the General's disposal. Uses whatever body armor and weapons are appropriate to the situation.

Standard gear when within the NEMA Command Center or safety zone: Standard issue officer's uniform with damage resistant mesh, utility belt, protective goggles, air filter, gas mask, and Ion Pistol with three extra E-Clips for a sidearm.

**Cybernetics:** Clock calendar and gyro-compass implants.

**Money:** The resources of NEMA are at her disposal. The General is unconcerned with personal gain, besides, the old monetary system may not be valid for much longer.

# NEMA

## Heroes in chaos

General Sawyer's genuine conviction and inspirational leadership have won the hearts and minds of not only the NEMA forces, but the majority of the civilian population (75%), giving them all a sense of hope and empowerment. These two emotions give NEMA and the civilians who fight at their side the courage to band together, press on, and fight against the many faces of a demonic and terrible foe. The General's leadership creates a high-octane mix of emotions that keeps morale soaring and the troops motivated and energized. A contagious optimism fuels NEMA Midwest Operations, giving the troops an inner strength and resolve that few others on the continent share. Each victory, no matter how small, bolsters confidence, courage, honor and commitment. The troops don't fear going out into the maelstrom, but relish each opportunity to go forth and save lives, rescue the innocent, and destroy evil. Many are downright gung-ho crusaders who risk their lives daily to push back the chaos. Under the leadership of General Sawyer, the fighting forces of NEMA are stepping up as true "knights in shining armor."

**These are your characters.** The men and women who refuse to accept defeat and spit in the face of leering monsters. They are bold and the brave, Heroes who sacrifice their own safety so that others can be saved. Heroes resolved to protect the innocent, preserve the human race, and to destroy evil in all its myriad forms, human and inhuman.

**Typical alignments,** therefore, are *Principled*, *Scrupulous* and *Unprincipled*, with the more pragmatic, pessimistic, disillusioned, embittered and self-serving gravitating toward *Anarchist* and *Aberrant evil* (the latter being savage, merciless and cruel against the enemy, but loyal to the cause and teammates). That having been said, a character may be any alignment the *player* chooses. However, *evil* player characters may find themselves at odds with the rest of the team if the player group is predominantly *good*.

**Age:** Humans of the future live longer and remain virile and youthful looking into what we, people of today, would consider old age. Consequently, an individual in his thirties or forties usually looks and feels to be in their twenties, 50-60 year olds to be in their mid or late thirties, 70-90 year olds to be in their forties or fifties, 100-120 year olds to look and feel like they were



in their sixties and beyond that the individual would start to look to be in his seventies or eighties. Average life expectancy in advanced, developed nations: 160 years for males, 185 for females; oldest documented age 225.

Longevity has to do with dramatic advances in medicine, genetic engineering and the high quality of life during the Golden Age. The new violence, collapse of human civilization and the appearance of hostile creatures resulting from the ongoing Apocalypse (and subsequent Dark Age) will dramatically reduce life expectancy, with violence being the number one cause of death (75%) for the next 200 years.

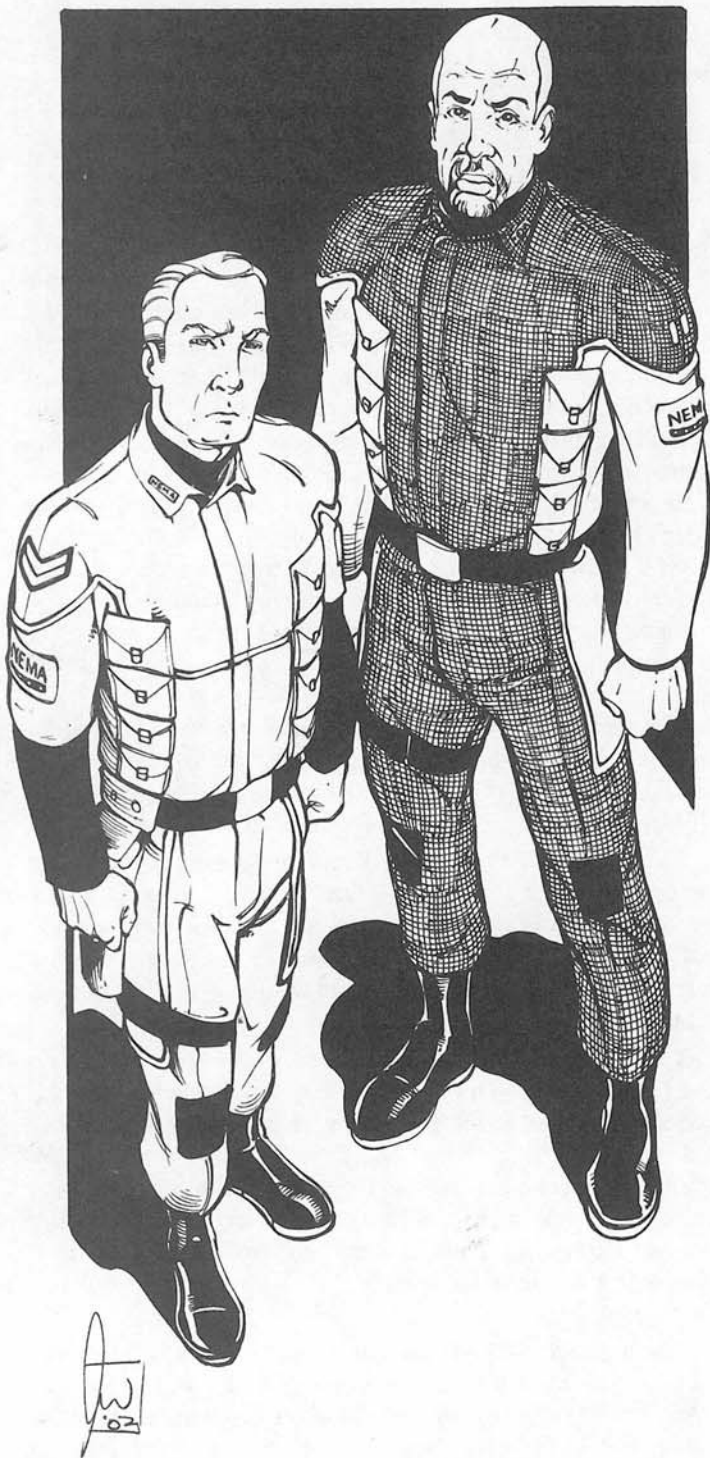

**Bonus from Genetics Engineering Augmentation:** Remember that genetic engineering and human augmentation were the rage during the Golden Age of Science. That means 70% of the last two generations to join NEMA or the US military were genetically "tweaked" in specific areas. These are not super-soldiers, but ordinary human beings who were modified and improved as a gestating fetus by parents who could afford the best for their children.

Pick one set of genetic bonuses or roll percentile for random determination.

01-10% +1D4 to I.Q. and +2 to M.E.

11-30% +2 to I.Q. and +1D4 to M.E.

31-55% +1D6 to P.S. and +1D4 to P.E.

56-75% +1D4 to P.S. and +1D6 to Spd.

76-00% +1D4+2 to P.B. and +1D4 to physical attribute of choice.

**M.O.S.:** This set of skills are areas of specialization. They may be combat oriented or some other area of expertise. These are in addition to O.C.C. Skills, O.C.C. Related Skills and Secondary Skills and reflect NEMA's paramilitary methods and organizational structure.

**Available Equipment:** For the time being, NEMA has reasonably good supplies of everything, even M.D.C. power armor and robots as well as food and medicine. In fact, there is a surplus of basic equipment like standard issue uniforms, field gear, weapons, ammunition, and the means to recharge E-Clips and energy packs. Furthermore, NEMA forces in the Central parts of North America also, for the moment, retain and defend a large number of manufacturing facilities that enable them to continue to repair and manufacture most goods. NEMA also has information identifying civilian armories, police stations, known military bases and even a few secret weapon/supply depots they can access as needed. However, the Apocalypse will burn up resources at an alarming rate and over time (and much more quickly than the heroes fear) the continuing holocaust will result in the destruction of manufacturing plants, defensive positions, equipment, weapons and gear, leading to severe supply shortages and supply line distribution and delivery problems of certain items. Power Armor and robots are especially finite, with only a few factories able to manufacture the Mega-Damage materials and advanced electronics. Over time, NEMA will find it cannot replace lost power armor, robots and heavy military vehicles with new ones and be forced to salvage and cannibalize parts to make repairs or rebuild a unit from used and damaged parts. General Sawyer, anticipating this inevitability, is already having her troops scavenge and stockpile all sorts of resources from blankets and medical supplies to spare parts and ammunition.

For the time being, NEMA held cities and communities continue to use the credit system of commerce, but as society continues to crumble (and even now), *barter/trade* of goods and services are likely to become the preferred method of exchange in most parts of the country outside of NEMA's influence.

Each specific O.C.C. lists basic starting equipment for that particular O.C.C. These items are always available when the character is created and first starts out. However, lost or damaged equipment may be difficult to replace and there may be situations where extra items, explosives, heavy weapons and



special gear ideal for the mission are not currently available and the group will have to make do with what they have.

**Unorthodox Weapons:** NEMA allows its operatives to use any “non” standard issue items, such as a knife, sword, club, revolver, pistol, shotgun, energy weapon, holy symbols, and even alien or magic items the individual might acquire along the way, on two conditions: 1) The item has been inspected and approved by command (usually a 24-48 hour process) and 2) the item does not pose any kind of danger to the rest of the team or the civilian population. Articles deemed unstable, too mysterious or dangerous are impounded and locked away or destroyed. Likewise, powerful and rare items may be confiscated and redistributed by NEMA leaders for the overall good of the organization and operations (i.e., a powerful alien energy weapon or magic item may be taken from the trooper who found it and given to an officer, specialist or other individual who command believes can put this item to better or maximum use).

# NEMA Occupational Character Classes

## NEMA Response Teams

The following are key military and rescue O.C.C.s within the Northern Eagle Military Alliance (NEMA). They are trained for disaster relief, riot control and urban conflict, making them the ones people turn to in the chaos of the Apocalypse and vital to the survival of millions.

The exact combination of O.C.C.s per player “team” will depend on the players who create the characters to fill each role. One may argue that a diverse team with a variety of O.C.C.s is the most well rounded and best suited for *any* situation. On the other hand, there is something to be said for raw firepower or a squad that shares the same O.C.C. to serve as an elite team or specialists ideal for specific types of operations. The choices are yours. In play tests, groups with wide diversity seemed to have more avenues available to them, while groups that were all similar (i.e. a squad of four Chromium Guardsmen and two Silver Eagles, or four Peacekeepers, a Military Specialist and a power armor or two) may have had a few less options, but fared equally well. In fact, under certain situations, groups of all or mostly the same O.C.C. fared better. For example, in firefights, groups that were predominantly power armor, even the same type of power armor, could handle combat situations easily and take on more powerful opponents head on, while the diverse groups needed to consider more by way of strategy and tactics, and combat usually took longer. All in all, any combination of characters works well, and sometimes reinforcements or additional help and specialists are required for *any* group.

What follows, are a variety of dynamic characters, any of which should be a blast to play. Roll ‘em up and fight the good fight.

- NEMA Chromium Guardsman
- NEMA Silver Eagle Pilot
- NEMA Armored Sentinel (Power Armor Pilot)
- NEMA Soldier/Peacekeeper
- NEMA Field Engineer
- NEMA Fire & Rescue
- NEMA Intel-Agent/Spy
- NEMA Military Specialist/Commando
- NEMA Militia Volunteer
- NEMA Para-Arcane
- Demon & Witch Hunter

## Chromium Guardsman

### Chaos Earth version of the Glitter Boy Pilot

The laser resistant Chromium Power Suit was a breakthrough in numerous areas. The underlying concept behind all *power armor technology* is to make human troops walking tanks. The development of new, lightweight, super-strong alloys and materials (i.e. Mega-Damage materials) alongside breakthroughs in miniaturization, nano-technology and advanced robotics gave birth to the idea of creating manned robot combat vehicles and *environmental combat suits*, more commonly known as “power armor.” The term “power armor” was coined because these suits effectively make their wearers superhuman, providing robotic strength and speed, plus a wide range of optics and computer enhancements, heavy firepower and a metal body impervious to conventional S.D.C. weapons. In a world before the Coming of the Rifts, Mega-Damage body armor practically



© FREDDIE E. WILLIAMS ALL RIGHTS RESERVED

made the operator invincible and able to withstand the most dangerous and hostile of environments. Thus, the most advanced nations could dispatch a comparatively tiny number of troops, say a company, to handle thousands of rioters to a conventional field army.

The **Chromium Guardsmen** are excellent for riot control, raids, defense and pacification and containment operations. Their glittering chrome-like hides actually work to the CG's advantage because in police and riot situations the authorities want a "high profile" unit to, 1) intimidate wrongdoers (i.e. rioters/enemy/criminals/perpetrators), and 2) provide the innocent/victims with a sense of hope, relief and security knowing NEMA is on the job or to the rescue. Their appearance comes with such an aura of strength and power that the mere presence of the Chromium Guardsmen will help to instill a sense of calm, order and security in a crisis. NEMA's sterling reputation as an organization of heroes and warriors dedicated to defending their nations, helping the innocent and self-sacrifice make them something of modern day super-heroes or "knights," literally in shining armor.

"Guardsmen," "CGs," "Chromiums," "Chrome-domes," "Chromies," and "G-Men" are all common slang terms for the *Chromium Guardsmen*. "Guardsmen" and "G-Men" are two of the most popular, though few who use the latter in this modern age are aware that G-Man was a slang term for federal agents, namely the FBI, in the 1920's to about the 1950's. Back then, the "G" referred to "government" man or agent, as opposed to "Guardman." Considering NEMA has replaced the FBI, this moniker seems all the more appropriate.

Chromium Guardsmen, or G-Men, are soldiers and peacekeepers specifically trained in the use of the Chromium power armor suits. Though they may participate in rescue and excavations, these men and women are *soldiers* skilled in small unit and full-scale infantry operations, field combat, riot control, surgical strikes and military support. Consequently, a G-Man is more likely to stand guard over a rescue scene or escort the injured, protect the field hospital and hold off future enemy incursions than actual digging or rescuing.

CGs are not well equipped for hit and run tactics unless there is some method of insertion and extraction (helicopter, truck, etc.). However, they are superb in operations that require sweeping an area, pushing back and corralling or containing enemy forces or rioters, supporting infantry troops and rescue teams, and coordinated ground assaults, as well as armored patrols (like giant, robot patrolmen walking a beat), guard duty and holding the line. Remember, G-Men are not built for speed, but power, so they are most effective in situations where brute strength, armor and firepower are required.

In the Chaos Earth setting, Chromium Guardsmen are quickly becoming the front line defense against so-called demons, monsters, and alien beings. Not only patrolling the streets and guarding "safe zones" – cities and places under NEMA protection – but going out in the carnage on reconnaissance, monster hunts, salvage operations and straightforward rescue missions. The men and women inside the Guardsmen have proven to be brave and courageous under fire, standing firm under the most dire and frightening situations.

The pilots of these glistening power armors are usually as sterling as the coating on their armor. They have a strong under-

standing of the law, seek to establish order and safety, and are brazen and impudent in the face of the enemy. Their sense of loyalty to NEMA, their comrades and the citizens who count on them is unshakable. Most love and embrace the notion that they embody the spirit, nobility and chivalry of the knights of old, and strive to live up to that image. In or out of their power armor, they are stalwart warriors and heroes who work at helping and protecting others.

### **Chromium Guardsman O.C.C.**

**Attribute Requirements:** P.P. 10 or higher. A high I.Q. and M.E. are helpful but not required. About 65% are males, 35% females.

**M.O.S.:** The specialty of this O.C.C. is piloting the Chromium Guardsman power armor and heavy ordnance (i.e., heavy weapons).

Pilot: Power Armor Basic (+6%)

Pilot: Power Armor Combat Elite: Chromium Guardsman.

Pilot: Two of choice (+10% each), excluding power armor, robots and aircraft.

Read (& Operate) Sensory Equipment (+10%)

Weapon Systems (+10%)

W.P. Heavy

W.P. Heavy Energy Weapons (Rail Guns included).

**O.C.C. Skills:** These are in addition to M.O.S. and reflect basic training.

Math: Basic (10%)

Language, Native: Standard.

Language, Foreign: One of choice (+10%).

Literacy, Native: Standard.

Literacy, Foreign: One of choice (+10%).

Law (+20%)

Military Etiquette (+20%)

Radio: Basic (+5%)

First Aid (+5%)

Running

W.P. Automatic or Bolt-Action Rifle.

W.P. Energy Pistol

W.P. Energy Rifle

Hand to Hand: Basic, which can be changed to Expert at the cost of one "O.C.C. Related Skill" or Martial Arts (or Assassin if evil) for the cost of two skill selections.

**O.C.C. Related Skills:** Select six other skills. Plus select one additional skill at levels three, six, nine, and twelve. All new skills start at level one proficiency.

Communications: Any (+5%).

Domestic: Any.

Electrical: Basic only.

Espionage: Detect Ambush, Intelligence, Sniper and Wilderness Survival only.

Horsemanship: None.

Mechanical: Automotive and Basic Mechanics only.

Medical: Paramedic only (replaces First Aid).

Military: Any (+5%), except Command Robots, Trap Construction and Detection.



Physical: Any, except Acrobatics.  
Pilot: Any (+10%), excluding Robots and Aircraft.  
Pilot Related: Any (+5%).  
Rogue: Streetwise only.  
Science: Advanced Math and Astronomy only (+5%).  
Technical: Any.  
W.P.: Any.  
Wilderness: None.

**Secondary Skills:** The character gets two Secondary Skills at levels one, four, eight, and twelve. These are additional areas of knowledge that do not get the advantage of the bonus listed in parentheses. All start at the base skill level and normal restrictions apply.

**Standard Equipment:** Chromium Power Armor Suit (a slight variation on the classic USA 10 from *Rifts*®) is described in full detail in the Power Armor section, page 89. Standard NEMA M.D.C. body armor, energy rifle and energy side arm of choice, 4 extra E-Clips for each, two explosive grenades, two smoke grenades, two flares, survival knife (1D6 S.D.C.), First Aid medical kit, pocket computer, flashlight, disposable cigarette lighter, utility belt, air filter & gas mask, walkie-talkie, uniform, dress uniform, combat boots, canteen, and an additional non-energy, S.D.C. weapon of choice.

**Money:** The NEMA G-Man gets a roof over his head, food, clothing, and all other basics provided free as part of his pay, as well as access to NEMA offices and military facilities. Monthly salary was 3,200 credits, plus combat pay. Under the circumstance of Chaos Earth, the character only has access to basic equipment and services. Pay is one tenth normal (320 credits a month), mainly as an incentive for morale. Starts off with 1D4x1000 credits.

**Cybernetics:** Typically has a NEMA identification implant (under the skin of the forearm or back of the neck), headjack with a sound filtration system, gyro-compass and clock calendar implant.

## NEMA Silver Eagle Pilot

### Chaos Earth version of the SAMAS Pilot

The Silver Eagle is a man-sized suit of flying power armor. Players of *Rifts*® may recognize it as a stylistic variation of the SAMAS. The high flying Chromium SAMAS (known as the Silver Eagle in the USA) is a close second to the Chromium Guardsmen in popularity and being instantly identified with NEMA. It is an impressive sight to see them racing through the concrete canyons of a city's skyscrapers or diving out of the clouds, the sun like a halo at their back, and swooping down to snatch an innocent bystander from harm's way, or to surround civilians like a hovering, gleaming wall, or to charge into battle like screeching, silver angels. The Silver Eagles are made from the same laser resistant, Mega-Damage material as the Chromium Guardsmen, though they have considerably less M.D.C. Each carries a large gun, with the majority (60%) using a long-range rail gun specifically designed with the Eagle power armor in mind. With the prompting of the Para-Arcane, silver coated rounds are being manufactured for it.

The Silver Eagle Strike Force is designed for quick response and air to land and land to air combat and rescue operations. They handle exceptionally well and are ideal for urban combat, able to make tight turns, weave between buildings and stop on a dime. The Silver Eagle can take on ground targets from the air or on the ground, enter buildings from the roof or a top floor window, search for and destroy snipers and engage rooftop and aerial enemies. Many people are surprised to learn the Eagle can (reasonably) navigate inside most buildings, flying down wide corridors, but is also able to operate on foot, the wings folding down just past the shoulders to allow the pilot to squeeze through the average door and easily fit down hallways, staircases, and most other areas inside buildings and homes. However, this power armor is most effective outdoors, on the street and in the air.

The pilots of these flying power armors are usually bold, daring and courageous soldiers who put themselves in harm's way without hesitation to save a civilian or comrade. They have a strong sense of the heroic and see themselves as the elite among the power armor and robot troops. While this does tend to make them a bit arrogant and some are hot shots and show-offs, they never put themselves before others and never do anything to place others in danger. Like the machines they fly, they tend to have their heads in the clouds when it comes to their strong sense of duty and idealism. They truly believe they make a difference and rocket to face danger and save lives.

### Silver Eagle Strike Force O.C.C.

**Attribute Requirements:** I.Q. 10, P.P. 12, and P.E. 12 or higher. About 60% of the pilots are male, 40% female.

**M.O.S.:** The specialty of this O.C.C. is piloting the Chromium Silver Eagle power armor, quick response, surgical strikes, and air support.

Pilot: Power Armor Basic (+9%)

Pilot: Power Armor Combat Elite: Silver Eagle.

Pilot: Jet Packs (+20%)

Pilot: Helicopter or Jet Aircraft (+16%).

Parachuting (+15%)

Navigation (+20%)

Land Navigation (+20%)

Read (& Operate) Sensory Equipment (+10%)

W.P. Heavy Energy Weapons (rail guns included)

W.P. of choice.

**O.C.C. Skills:** These are in addition to M.O.S. and reflect basic training.

Math: Basic (10%)

Language, Native: Standard.

Language, Foreign: One of choice (+12%).

Literacy, Native: Standard.

Literacy, Foreign: One of choice (+10%).

Law (+20%).

Military Etiquette (+15%)

Radio: Basic (+10%)

Running

W.P. Energy Pistol

W.P. Energy Rifle

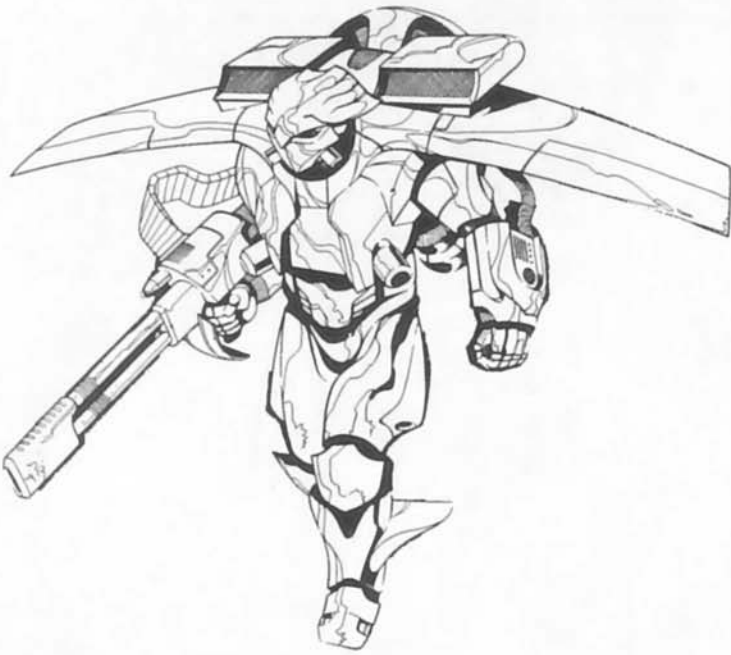

Hand to Hand: Expert, which can be changed to Martial Arts (or Assassin if evil or Anarchist) at the cost of one "O.C.C. Related Skill."

**O.C.C. Related Skills:** Select five other skills. Plus select two additional skills at level three, and one at levels six, nine, and twelve. All new skills start at level one proficiency.

Communications: Any (+5%).

Domestic: Any.

Electrical: Basic only.

Espionage: Detect Ambush, Intelligence, Sniper and Wilderness Survival only.

Horsemanship: None.

Mechanical: Automotive and Basic Mechanics only.

Medical: Paramedic (+5%) only.

Military: Any (+5%), except Command Robots, Trap Construction and Trap Detection.

Physical: Any, except Acrobatics.

Pilot: Any (+10%).

Pilot Related: Any (+5%).

Rogue: Cardsharp, Seduction and Streetwise only.

Science: Advanced Math (+5%) and Astronomy only.

Technical: Any (+5%).

W.P.: Any.

Wilderness: Any.

**Secondary Skills:** The character gets two Secondary Skills at levels 1, 4, 8, 11, and 15. These are additional areas of knowledge that do not get the advantage of the bonus listed in parentheses. All start at the base skill level and normal restrictions apply.

**Standard Equipment:** Chromium Eagle Power Armor Suit, standard NEMA M.D.C. body armor, energy rifle and energy side arm of choice, 4 extra E-Clips for each, two explosive





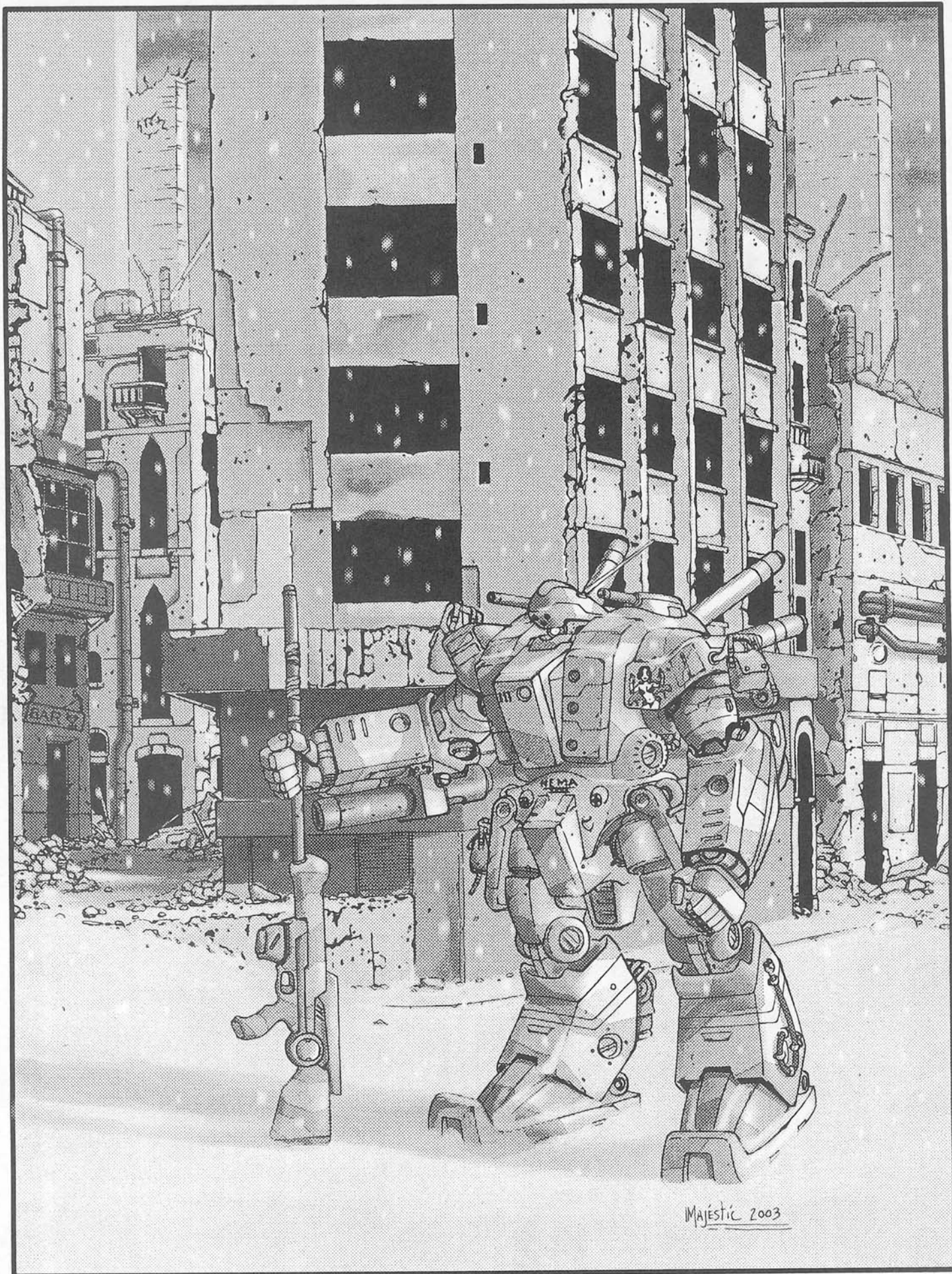



grenades, two smoke grenades, six flares, Vibro-Knife (1D6 M.D.) or Vibro-Sword (any) or Vibro-Axe (officers always have a Sword), survival knife (1D6 S.D.C.), First Aid medical kit, pocket computer, flashlight, disposable cigarette lighter, utility belt, air filter & gas mask, walkie-talkie, uniform, dress uniform, combat boots, canteen, and an additional non-energy, S.D.C. weapon of choice.

**Money:** All NEMA operatives get a roof over their head, food, clothing, and all other basics provided free as part of their service, as well as access to NEMA offices and military facilities. Monthly salary was 3,800 credits, plus hazard pay. Under the circumstances of Chaos Earth, access to equipment, medical supplies and services may be limited. Pay is one tenth normal (380 credits a month), mainly as an incentive for morale. The character starts off with 6D6x100 credits.

**Cybernetics:** Typically has a NEMA identification implant (under the skin of the forearm or back of the neck), gyro-compass, clock calendar, radar sensor and speedometer implant. See **Rifts® Bionics Sourcebook** for these and a slew of other cybernetics.

## NEMA Armored Sentinels Robot Pilots

The Sentinels are the robot combat pilots of NEMA and represent the "heavy artillery." They operate the *Bull Dog* and *Mastiff* robot vehicles and the *Gunbuster* power armor in defensive, military, and rescue operations. The big, heavy robots are equally adept at combat and excavation, able to take on tanks, aircraft and supernatural horrors, as well as dig through rubble like a bulldozer, punch through walls and flooring, and pull, drag and carry away large chunks of debris. This means the heavy robots can be used in construction and building or tearing down barriers and fortifications. The pilots are highly skilled and well versed in the robots and power armor they operate and, unlike the Chromium Guardsman and Silver Eagle O.C.C.s, can switch from one type of robot to another as the situation demands. These valiant men and women are also trained for endurance and often go 18-48 hours without rest or sleep; both combat and rescue can be a brutal, grueling experience that taxes the mind and body.

Armored Sentinels are also well versed in the law and frequently work with law enforcement personnel and other members of NEMA to squelch looting, raids, robberies and smuggling. However, where these powerhouse infantry units have come to play a dynamic role, is in battling giant monsters, demons, dragons and other gargantuan creatures, as well as swarming hordes of demons, animated dead and thronging D-Bees from the Rifts. The pilots, locked inside their self-contained and heavily shielded cockpits, are also usually protected from magic that involves touch or direct contact. Still, they remain vulnerable to illusions and magic that is directed at their machines (i.e., Call Lightning, Fire Ball, Magic Barriers, Storms, etc.). **Note:** The complete description and stats for these vehicles are found in the Power Armor and Robot sections of this book.

The pilots of these war and rescue machines are brave, strong and capable soldiers outside their robotic alter-egos. Most male pilots are tall and beefy, with ham-hocks for arms, strong, muscular upper bodies and powerful legs. Females have chiseled abdomens, trim, muscular bodies and good upper and lower body strength. Most Sentinels pride themselves on their physical attributes and enjoy physical contests and challenges. Most possess a don't quit work ethic, indomitable spirit and deep compassion for civilians. They are also developing a strong competitive attitude toward large and cunning supernatural creatures, dragons and other creatures of magic. They enjoy the competition and strive to beat the enemy at every turn.

### Armored Sentinel/Robot Pilot O.C.C.

**Attribute Requirements:** P.S. 14, P.P. 12, P.E. 14 or higher. Approximately 55% are male and 45% female.

**M.O.S.:** The specialty of this O.C.C. is piloting the big robots like the Bull Dog and Mastiff as well as the use of heavy ordinance (i.e., heavy weapons).

Excavation & Rescue (+10%)

Pilot: Power Armor Basic (+10%)

Pilot: Power Armor Combat Elite: Gunbuster.

Pilot: Robots Basic (+20%)

Pilot: Robot Combat Elite: Bull Dog.

Pilot: Robot Combat Elite: Mastiff (including the "Big Dog").

Land Navigation (10%)

Read (& Operate) Sensory Equipment (+15%)

W.P. Heavy

W.P. Heavy Energy Weapons (rail guns included).

**O.C.C. Skills:** These are in addition to M.O.S. and reflect basic training.

Math: Basic (10%)

Language, Native: Standard.

Language, Foreign: One of choice (+12%).

Literacy, Native: Standard.

Literacy, Foreign: One of choice (+10%).

Law (+30%)

Military Etiquette (+15%)

Radio: Basic (+10%)

Pilot: One of choice (+15%).

Body Building and Weightlifting

Climbing (+5%)

Running

W.P. Axe (including Vibro-Fire Axe)

W.P. Energy Pistol

W.P. Energy Rifle

Hand to Hand: Expert, which can be changed to Martial Arts at the cost of one "O.C.C. Related Skill" or Commando (or Assassin if evil) for the cost of two skill selections.

**O.C.C. Related Skills:** Select five other skills. Plus select one additional skill at levels three, six, nine, and twelve. All new skills start at level one proficiency.

Communications: Any (+5%).

Domestic: Any.

# NEMA Soldier/ Peacekeeper

Electrical: Basic only.

Espionage: Detect Ambush, Detect Concealment, Intelligence, Sniper and Wilderness Survival only.

Horsemanship: Any.

Mechanical: Automotive and Basic Mechanics only.

Medical: Paramedic (+5%) only.

Military: Any (+5%), except Command Robots, Trap Construction and Trap Detection.

Physical: Any.

Pilot: Any (+10%), except Power Armor Combat Elite for the Eagle and Guardsman.

Pilot Related: Any (+5%).

Rogue: Cardsharp and Streetwise only.

Science: Advanced Math (+5%), Archaeology and Astronomy only.

Technical: Any.

W.P.: Any, except Sharpshooting.

Wilderness: Any.

**Secondary Skills:** The character gets two Secondary Skills at levels one, four, eight, and twelve. These are additional areas of knowledge that do not get the advantage of the bonus listed in parentheses. All start at the base skill level and normal restrictions apply.

**Standard Equipment:** Gunbuster power armor and a Bull Dog or Mastiff (player's choice) as his two readily available war machines. These are assigned to the pilot and he is expected to make sure they get regular inspections and maintenance. The pilot can also personalize "his" bots with sayings, slogans, pictures, or designs, provided none of them are obscene or impair the machine in any way whatsoever. In addition, the Armored Sentinel may be assigned whichever robot he has not selected as one of his main vehicles as well as the Big Dog Mastiff (a giant version of the standard Mastiff).

Other equipment includes a standard suit of NEMA body armor, energy rifle and energy side arm of choice, 4 extra E-Clips for each, two heavy energy weapons of choice (and appropriate ammunition), two explosive grenades, two smoke grenades, four flares, Vibro-Knife (1D6 M.D.), Vibro-Axe (2D6+2 M.D.), survival knife (1D6 S.D.C.), First Aid medical kit, pocket computer, flashlight, disposable cigarette lighter, utility belt, air filter & gas mask, walkie-talkie, uniform, dress uniform, combat boots, canteen, and an additional non-energy, S.D.C. weapon of choice.

**Money:** Standard for NEMA operatives. Monthly salary was 2,400 credits, plus hazard pay. Under the circumstances of Chaos Earth, access to equipment, medical supplies and services may be limited. Pay is one tenth normal (240 credits a month), mainly as an incentive for morale. The character starts off with 5D6x100 credits.

**Cybernetics:** Typically has a NEMA identification implant (under the skin of the forearm or back of the neck), gyro-compass and clock calendar implant.

These front-line troops are always in the thick of the action and serve as infantry grunts, peacekeepers, police, riot control, anti-terrorist squads, and rescue personnel. They differ from one another only by their M.O.S. area of specialty. NEMA Peacekeepers are skilled, brave and capable, but do not know how to operate power armor or robot vehicles.

In peacetime, all NEMA Peacekeepers worked with and supported the police, customs and various law enforcement agencies (CIA, FBI, ATF, NSA and others), as well as the military in matters concerning national security, homeland defense, terrorism, smuggling, illegal immigration, and other crimes that either threatened national security or crossed international borders. These operations included riot control, peacekeeping/policing, hostage and rescue missions, surgical strikes, precision raids, breaking up drug and smuggling rings, bomb disposal, tracking down terrorists and taking them down, among many others. Wherever they were needed, they were there, and nine out of ten times, the Peacekeepers would find their way to the front of every crisis.

In addition to crimefighting, combat, and homeland security, NEMA Peacekeepers spent an equal amount of time involved in rescue and disaster relief operations both in North America and internationally (outside the continent). They and all members of NEMA responded to crises created by earthquakes, floods, mud slides, volcanoes, hurricanes, tornados, cave-ins, famine, and all manner of disasters. Taking on every role: Digging out victims, establishing field hospitals, administering to the injured, and establishing communications and/or supply lines as well as providing defense against hostile forces such as bandits, warlords and looters, and maintaining law and order, if not peace. Remember, NEMA is a joint cooperative between the USA, Canada and Mexico, which meant members from all three nations worked together closely as members of a unified, tri-national law enforcement and disaster relief and rescue agency, of which the NEMA Soldier/Peacekeeper played a crucial role.

While some readers may dismiss these characters at first glance because they don't pilot mechanical juggernauts, closer scrutiny will show that the range of characters available under this O.C.C. is considerable, specialized, important, and fun to play. Take a good look before moving on.

## NEMA Soldier/Peacekeeper O.C.C.

**Attribute Requirements:** None per se, though a high P.S. and P.E. are helpful but not required. Certain M.O.S. categories may require certain attribute minimums. About 60% are males, 40% females.

**M.O.S.:** Select one of the following areas of specialty or roll percentile to make a random determination. If the random method is used and the character does not have the required minimum attribute, select skills that will bump it up to the required amount, adjust a few attributes to meet the minimum, or roll again. All M.O.S. skills are in addition to O.C.C. and other skills. **Note:** The *Communications Expert* can use non-combat robot probes and the *Point Man* can use all types of robots from Combat Drones and Hounds to probes. The

exact robots made available to him will depend on the assignment. The *EOD Expert* will have one or more weapons replaced with explosives, including 1-4 Fusion Blocks.

#### 01-15% Communications Expert

Basic Electronics (+10%)  
Command Robots (probes only)  
Electronic Countermeasures (+10%)  
Optic Systems or Surveillance Systems (+10%)  
Radio: Basic (+20%)  
Radio: Scramblers (+10%)  
Read (& Operate) Sensory Equipment (+20%)  
TV/Video or Computer Programming (+10%)

#### 16-25% EOD/Demolitions Expert: Requires an I.Q. of 10 and a P.P. of 12 or higher.

Basic Electronics (+20%)  
Basic Mechanics (+15%)  
Demolitions (+10%)  
Demolitions Disposal (+15%)  
Demolitions: Underwater (+8%)  
Trap Construction or NBC Warfare (+5%)  
W.P. Heavy Energy Weapons

#### 26-50% Soldier/Grunt

Salvage (+5%)  
Land Navigation (+8%)  
One Physical skill of choice.  
One Pilot skill of choice (+5%).  
Upgrade First Aid to *Paramedic* (+10%).  
Law: General (+10%)  
W.P. Ancient of choice.  
W.P. Modern of choice.

#### 51-65% Point Man/Scout: Requires an I.Q. of 9 or higher; a high P.P. and Spd. are helpful.

Detect Ambush (+15%)  
Detect Concealment (+10%)  
Command Robots (any, but usually Combat Hound, Pup Scout or Probes)  
Find Contraband (+6%)  
Intelligence (+15%)  
Land Navigation (+14%)

Prowl (+10%)

Surveillance Systems/Tailing (+15%)

Wilderness Survival (+10%)

W.P. Automatic Assault Rifle or Automatic Pistol

#### 66-80% Pigman/Heavy Weapons: Requires a P.S. of 22 and a P.E. of 12 or higher.

Command Robots (Limited to one Combat Drone or Combat Hound to help carry heavy ammo drums, weapons and gear. Basically function as the second man in a two-man fire team.)

Recognize Weapon Quality (+25%)

Sniper or Sharpshooting

Weapon Systems (+10%)

W.P. Automatic Pistol or Revolver

W.P. Heavy Weapons

W.P. Heavy Energy Weapons (including rail guns)

W.P. One of choice (any).

#### 81-90% Transportation Specialist

Basic Mechanics (+10%)

Navigation (+10%)

Pilot: Automobile or Motorcycle (+20%)

Pilot: Hover Craft (ground) or Hovercycle (+20%)

Pilot: Tanks & APCs (+20%)

Pilot: Trucks (+15%)

Pilot: Helicopter or Airplane (+15%)

Pilot: One of choice (+10%), excluding robots/power armor.

#### 91-00% Medic: Requires an I.Q. and P.P. of 11 or higher.

Advanced Mathematics (+10%)

Brewing (+15%)

Biology (+15%)

Chemistry or Pathology (+10%)

Field Surgery (+15%)

Holistic Medicine or Chemistry: Analytical (+5%)

Medical Doctor (+5%)

**O.C.C. Skills:** These are in addition to M.O.S. and reflect basic training.

Math: Basic

Language, Native: Standard.

Language, Foreign: One of choice (+10%).

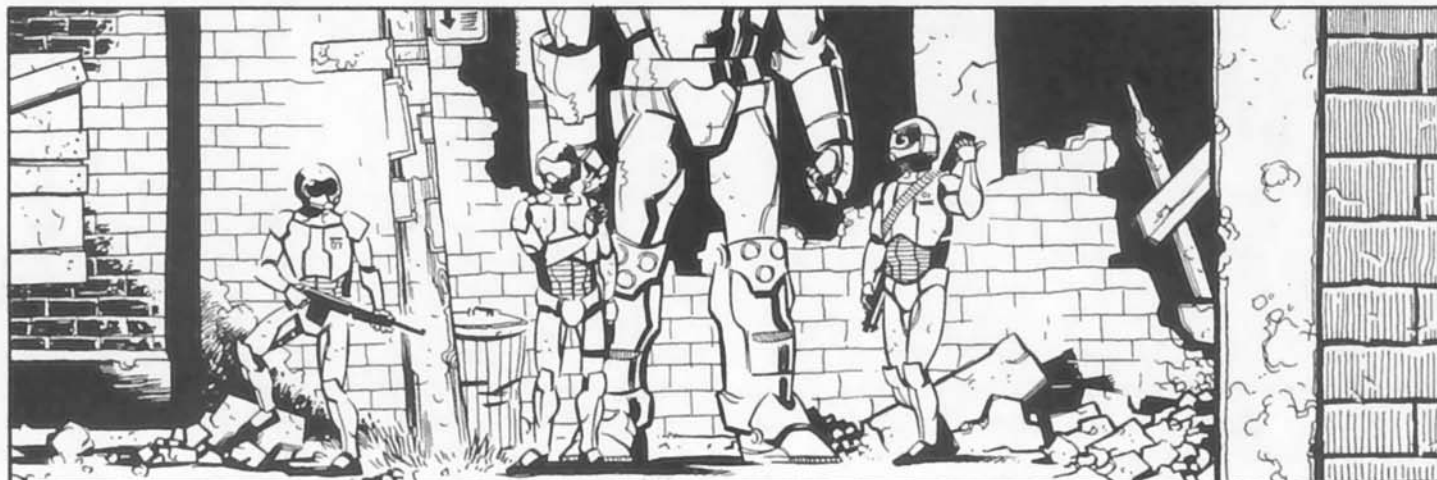



Literacy, Native: Standard.

Literacy, Foreign: One of choice (+5%).

Military Etiquette (+20%)

Radio: Basic (+5%)

Computer Operation (+10%)

First Aid (+10%)

General Athletics

Climbing (+10%)

Running

W.P. Knife (includes Vibro-Knives)

W.P. Energy Pistol

W.P. Energy Rifle

Hand to Hand: Basic, which can be changed to Expert at the cost of one "O.C.C. Related Skill" or Martial Arts (or Assassin if evil) for the cost of two skill selections.

**O.C.C. Related Skills:** Select four other skills. Plus select one additional skill at levels three, six, nine, and twelve. All new skills start at level one proficiency.

Communications: None.

Domestic: Any.

Electrical: Basic only.

Espionage: None, other than possible M.O.S. skills.

Horsemanship: Any.

Mechanical: Automotive and Basic Mechanics only.

Medical: None, other than possible M.O.S. skills.

Military: Any (+10%), except Command Robots, Trap Construction and Trap Detection, unless provided under an M.O.S.

Physical: Any, except Acrobatics.

Pilot: Basic vehicle types only; the average grunt does *not* know how to drive a tank.

Pilot Related: None, other than possible M.O.S. skills.

Rogue: Any.

Science: Advanced Math (+5%) and Astronomy only.

Technical: Any (+5%).

W.P.: Any, except Sharpshooting.

Wilderness: Land Navigation and Wilderness Survival only.

**Secondary Skills:** The character also gets two Secondary Skills at levels one, five, ten, and fifteen. These are additional areas of knowledge that do not get the advantage of the bonus listed in parentheses. All start at the base skill level and normal restrictions apply.

**Standard Equipment:** NEMA fatigues and dress uniform, standard M.D.C. body armor, LSR-250 Laser Rifle or LGR-360 laser rifle, conventional S.D.C. assault rifle and grenade launcher combo, PLP "Police Special" laser pistol, four extra E-Clips for each and one power pack, two smoke grenades, one tear gas grenade, two explosive grenades, three flares, one Vibro-Knife (officers get a Knife and Saber), survival knife (1D6 S.D.C.), utility belt, canteen, First Aid medical kit, pocket computer, flashlight, disposable cigarette lighter, air filter & gas mask, walkie-talkie, and some personal items.

Robots are available only to a couple specific M.O.S.s and the exact number (usually one or two) and type varies depending on the mission. Sometimes Command may decide

that no robots are necessary or available, other times they may provide more than usual, especially if the team faces stiff opposition.

Additional weapons, heavy weapons, explosives, gear and vehicles may be made available for special and specific assignments. The "team" or "squad" will usually have one basic military vehicle, such as a truck, jeep or hover jeep, available to it or some means of transportation provided. However, many assignments, including reconnaissance, city patrols and rescue missions, are on foot and may cover miles and miles of territory.

**Money:** The NEMA soldier gets a roof over his head, food, clothing, and all other basics provided for free as part of his employment benefits, as well as access to NEMA offices and military facilities. Monthly salary was 1,800 credits, plus combat pay, but the cataclysm makes available funds scarce. Under the circumstances, the character only has access to basic equipment and services, whatever special gear NEMA can muster for special missions (sometimes nothing) and pay is one tenth normal (180 credits a month), mainly as an incentive for morale. Character starts off with 5D6x100 credits.

**Cybernetics:** Typically has a NEMA identification implant (under the skin of the forearm or back of the neck), bio-comp self-monitoring system, gyro-compass and clock calendar implants.

See **Rifts® Bionics Sourcebook** for a slew of implants and bionics.

## NEMA Field Engineer

When it comes to building and fixing things, the NEMA Field Engineer is a Jack-of-all-trades, trained to handle situations in the field and under combat conditions. This means the character has basic combat training as well as mechanical engineering skills with an emphasis on military criteria. This individual is a troubleshooter looking to prevent and avoid danger by maintaining equipment and helping others. He or she can assess structural damage, figure out how to brace deteriorating walls and structures, pull victims out of debris without causing a collapse, make quick field repairs, perform jury-rigging, cobble together a patch that will hold long enough to make a rescue or escape, detect traps and crumbling structures, identify hazards and work miracles in the field, albeit often very short-term miracles, because the jury-rigging may not hold for more than a few minutes or a few hours at best.

To be a Field Engineer one must be resourceful, inventive and able to think on one's feet. Decisiveness is a must, because a quick decision is often necessary, and the choice might make the difference between life and death. In some ways, the character is a combination mechanical wizard and detective, only as a "detective" he studies physical and mechanical structures, searching them for weaknesses, flaws, aberrations, tampering, salvageable components, and trouble. This is the character who notices a lock has been picked, a machine has been tampered with, or a weapon modified, as well as finding traps, mines, hazardous materials, structural weaknesses in buildings and ways to escape or circumvent the danger.

## Field Engineer O.C.C.

**Attribute Requirements:** I.Q. 13 and P.P. 11 or higher. A high M.E. and/or P.S. is helpful, but not required. 70% are male, 30% female.

**M.O.S.:** The specialty of this O.C.C. is mechanics, repairs and the operation of machines and equipment. Robots are used both to defend the Field Engineer while he works and as extensions of his eyes and ears to inspect and observe and squeeze into places he cannot fit.

Basic Electronics (+15%)  
Command Robots (any/all)  
Computer Operation (+20%)

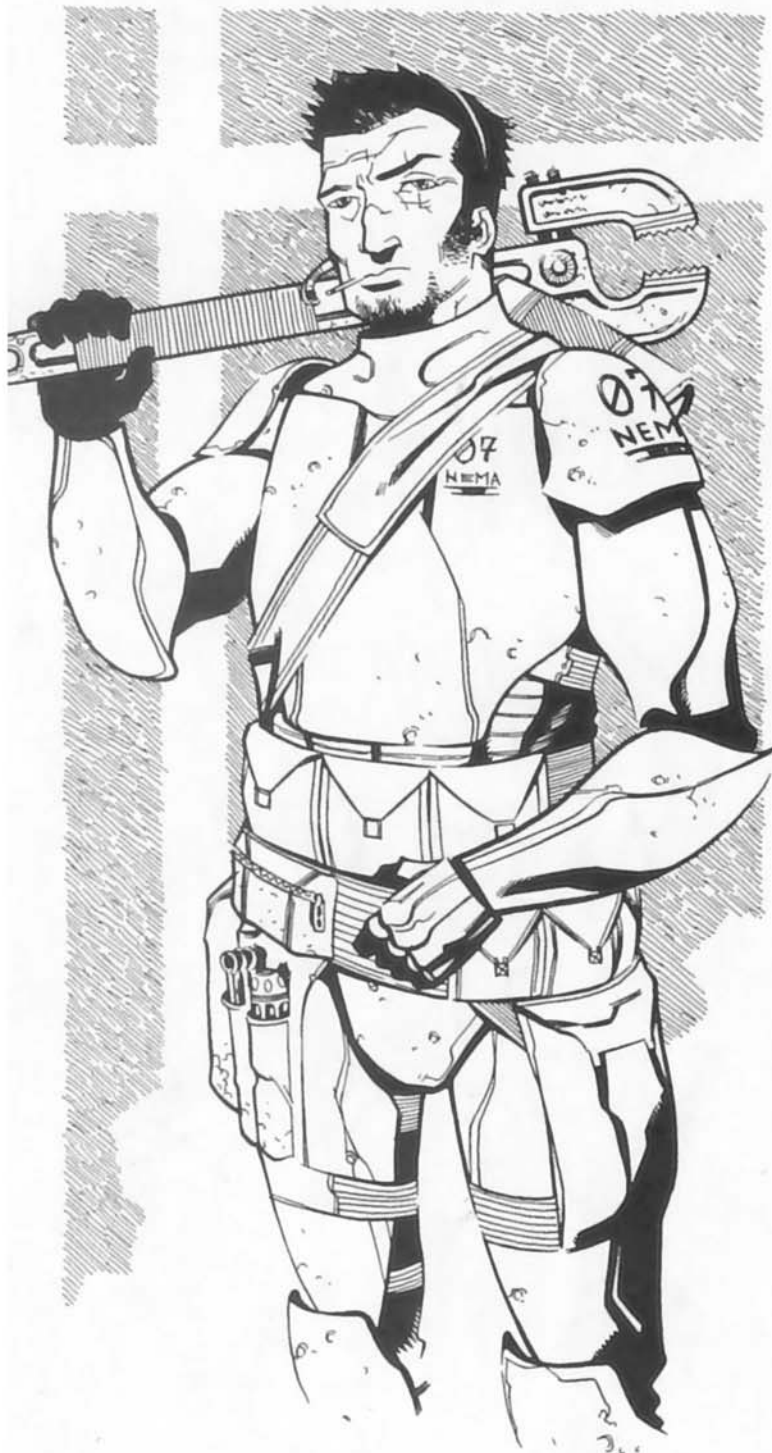

Electricity Generation (+10%)  
Excavation & Rescue (+15%)  
Jury-Rig (+20%)  
Math: Advanced (+15%)  
Mechanical Engineer (+15%)  
Military Fortification (+15%)  
Salvage (+20%)  
Read (& Operate) Sensory Equipment (+20%)  
Trap/Mine Detection (+20%)

### O.C.C. Skills:

Carpentry (+10%)  
Climb (+5%)  
Military Etiquette (+10%)  
Math: Basic (20%)  
Language, Native: Standard.  
Language, Foreign: One of choice (+12%).  
Literacy, Native: Standard.  
Literacy, Foreign: One of choice (+10%).  
Pilot: One vehicle of choice.  
Radio: Basic (+10%)  
W.P. Automatic Pistol  
W.P. Energy Rifle  
Hand to Hand: Basic, which can be changed to Expert at the cost of one "O.C.C. Related Skill."

**O.C.C. Related Skills:** Select four other skills. Plus select two additional skills at levels three, five, seven, nine, eleven and thirteen. All new skills start at level one proficiency.

Communications: Any.  
Domestic: Sewing, Brewing and Fishing only.  
Electrical: Any (+5%).  
Espionage: Escape Artist (+5%) only.  
Horsemanship: Any.  
Mechanical: Any (+10%).  
Medical: First Aid only.  
Military: Any (+5% to all others, but +15% to all Demolition skills and Trap Construction).  
Physical: Any, except Acrobatics and Boxing.  
Pilot: Any.  
Pilot Related: Any (+5%).  
Rogue: Computer Hacking and Pick Locks (+10%) only.  
Science: Any (+5%).  
Technical: Any (+5%; +10% to Computer, repair and machine based skills).  
W.P.: Any, except Sharpshooting.  
Wilderness: Boat Building (+5%) and Land Navigation only.

**Secondary Skills:** The character gets two Secondary Skills at levels one, four, eight, and twelve. These are additional areas of knowledge that do not get the advantage of the bonus listed in parentheses. All start at the base skill level and normal restrictions apply.

**Standard Equipment:** Mechanic M.D.C. body armor with a slightly different styling than the standard NEMA body armor and 10% more M.D.C. Also gets an energy rifle and four

E-Clips, S.D.C. automatic pistol or submachine-gun and four clips for it, two smoke grenades, six flares, survival knife (1D6 S.D.C.), portable tool kit, a utility belt with extra large pouches, a tool belt, hip pouch (Velcro pieces attach to utility belt and straps to hold it snug), shoulder satchel, backpack, tool kit/box with duct tape and a variety of tools, laser distancer, laser scalpel, laser pen, laser torch, soldering iron, pocket computer, pocket disc recorder, large flashlight, pen flashlight, disposable cigarette lighter, 20 feet (6 m) of rope/cord, 50 foot (15.2 m) ball of string and/or wire, 10 feet (3 m) of light M.D.C. chain (10 M.D.C.), notebook, four markers, two pieces of chalk, can of flourescent orange spray paint (for marking), protective goggles, air filter and gas mask, work gloves, six pairs of plastic surgical gloves, walkie-talkie, canteen, uniform, dress uniform, insulated combat boots, and an additional non-energy, S.D.C. weapon of choice.

Standard vehicle is a conventional jeep or small truck, motorcycle or hovercycle.

**Money:** Standard. Monthly salary was 2,700 credits, plus hazard pay. Pay is one tenth normal (270 credits a month), mainly as an incentive for morale, but starts with 6D6x100 credits. Under the circumstances, access to tools, spare parts, equipment, and services may be limited.

**Cybernetics:** Typically has a NEMA identification implant (under the skin of the forearm or back of the neck), clock calendar, air and surface temperature reader, and radiation sensor. Some also have bionic hearing and/or one multi-optics eye. All are described in the **Rifts® Bionics Sourcebook** along with a slew of other implants and bionics; \$13.95, 112 pages.

## NEMA Fire & Rescue

### Also known as "Roscoe"

When there are people trapped in a burning or collapsed building, flooded tunnel, or by a toxic spill, the NEMA Fire & Rescue operatives are an even more welcomed sight than the Guardsmen, Silver Eagles or Mastiff. The Fire & Rescue teams try to be trained and equipped for every type of crisis, emergency and disaster. They are, in effect, combat medics, firefighters and emergency rescue rolled into one. They are trained to stay focused in crisis and combat situations, how to deal with fire and smoke, identify pitfalls and trouble, detect structural weakness, and to save lives. Fire and Rescue crews also work well in team situations. Firefighting is one aspect of the job, rescue and medical treatment is another.

"Rescue" may involve more than pulling an individual from a pile of rubble or a burning building. It may require digging, cutting, lifting, and climbing just to reach and/or free the victim. Then the "vic" is likely to need medical attention, which is when Rescue must call upon their paramedic skills to stabilize and transport the injured to a medical facility. They often work in conjunction with Field Engineers and Peacekeeper Medics, and may be escorted, protected and assisted by Chromium Guardsmen, Silver Eagles, Gunbuster or other robot vehicle or combat force.

Slang for Fire and Rescue personnel is "Roscoe." It's shorter than Fire and Rescue operative, rolls off the tongue and seems

to fit with the character of these self-effacing heroes. Fire and Rescue operatives tend to be down to earth, hard working stiffs dedicated to fighting fires and pulling innocent people from the jaws of death. They can be silly goofs and macho-clowns off duty and between missions, but when part of a field team and during a rescue, they are nothing but serious and businesslike all the way.

In the carnage and continuing madness of Chaos Earth, Fire and Rescue crews are in constant demand. They are hard pressed to handle the overwhelming number of people in need and often work around the clock for two or three days at a time (grabbing a power nap here and there when they can). This puts all rescue personnel and those assisting them out in the thick of the chaos where they may be shot at or attacked by fellow humans, alien beings, or demonic creatures. Meanwhile, the Roscoes must be careful not to push themselves beyond the breaking point, for they are desperately important in this time of need. The hardest part for Fire and Rescue operatives, especially in the early weeks of the chaos, is choosing who they will at-

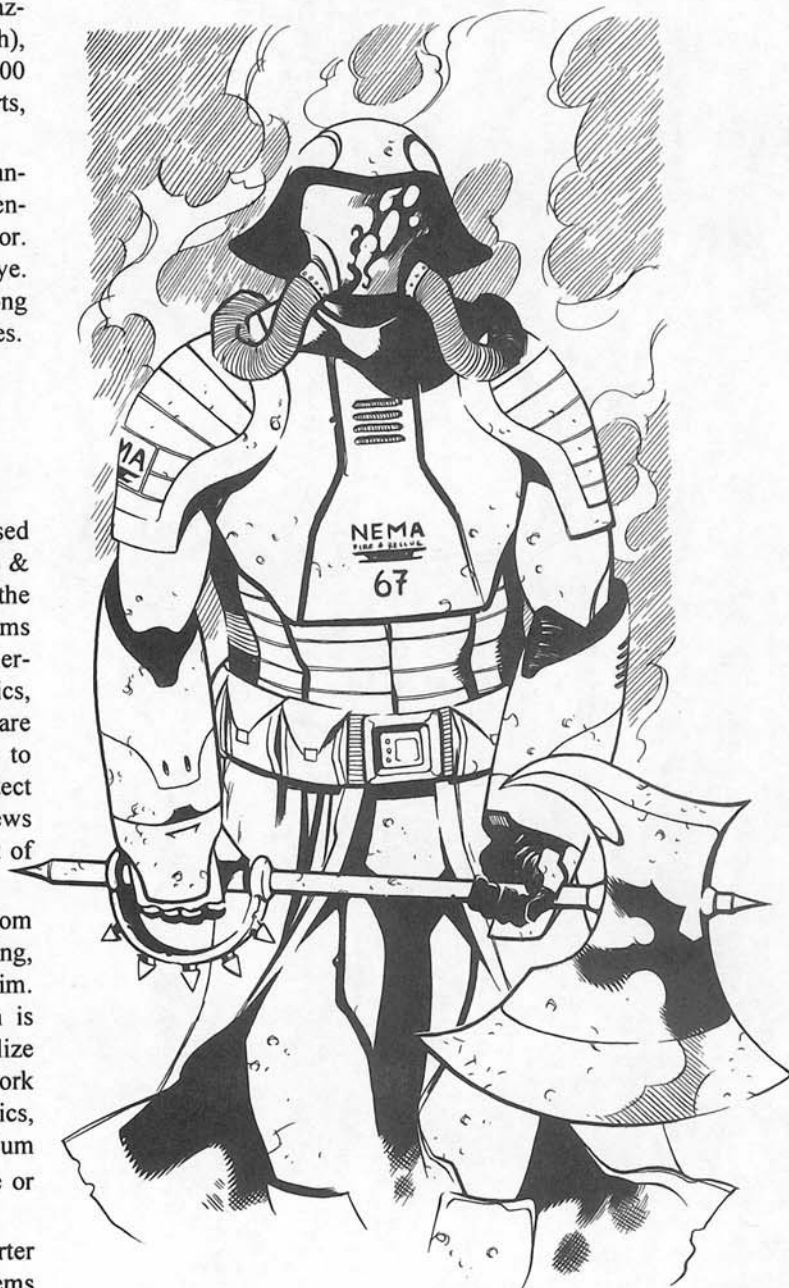



tempt to rescue and who they must abandon. Life is precious to these selfless heroes, and if they could they would leave no one behind.

### Special M.O.S. Skills

**1. Fire Assessment and Response:** Assessment enables the firefighter to estimate the approximate temperature, size, speed and direction(s) of the fire as well as the level of danger – i.e., back drafts, concealed fire in the walls, fire behind closed doors, vulnerable natural gas lines, smoke inhalation, toxic fumes, obvious structural degradation and the likelihood of collapse, and so forth. Has a reasonably good knowledge about accelerants, combustibles and common fire hazards.

“Response” is how to rescue others, survive yourself, escape and most importantly, how to *fight* fire. Includes methods and techniques in “firefighting” and how best to contain, control and extinguish fire, along with basic survival techniques and training in the use of firefighting gear, equipment, and vehicles. **Base Skill:** 40% +5% per level of experience (20% +3% for laymen; i.e. O.C.C.s other than this one who serve as volunteer firefighters).

**2. Fire Damage Assessment:** The ability to assess the degree of damage, its cost in credits, and the level of structural degradation, i.e., what is cosmetic and minor damage that can be cleaned up or easily repaired, and what is seriously compromised, weakened, and incapable of withstanding weight or any significant strain (i.e., is likely to collapse, snap, break, etc., when put under greater stress). This enables the firefighter to determine if the stairs or floor can bear his weight, whether support beams and weight bearing walls can continue to bear their loads or are on the verge of collapse, and even guesstimate how long the structure will last in minutes – give or take 1D4x10%. This means if the character assesses a wall will hold for another five minutes he *will* be off by 10% to 40%, meaning the wall might hold 10-40% *longer* or collapse 10-40% *sooner*. In this example, that could be 30 seconds to 120 seconds/two minutes one way or the other. The G.M. can arbitrarily decide longer or sooner, or roll percentile dice in which a random roll of 01-50% means *longer* and 51-00% means *sooner*. **Base Skill:** 30%/16% +4% per level of experience. The first number is the typical damage estimate. The second is any in the field “guesstimate.” Add a +6% skill bonus if the *Mechanical Engineering skill* is also known and +2% for Carpentry and/or Military Fortification (+10% if all three skills are known; also see Fire Forensics). This skill is *not* available to other O.C.C.s.

**3. Fire Forensics – Optional:** This skill is NOT automatically known to Fire and Rescue personnel, but can be selected for the cost of two. The in-depth knowledge of fire, how it starts, travels, lives and breathes. The character knows most techniques used in arson, methods to conceal arson, and with time, sufficient evidence and analysis can determine a fire’s point of origin, the cause, how it traveled and whether or not it was started by natural causes, accident or intentionally. Adds a bonus of +20% to the Fire Damage Assessment skill (no other skill bonuses apply). **Requirements:** Mechanical Engineering, Chemistry and Advanced Mathematics skills are required to take this skill. **Base Skill:** 30% +5% per level of experience. This skill is *not* available to other O.C.C.s.

**4. Additional M.O.S. Skills:** The specialty of this O.C.C. is rescue and basic engineering.

Basic Electronics (+15%)

Basic Mechanics (+15%)

Computer Operation (+15%)

Demolitions (+20%)

Excavation & Rescue (+20%)

Jury-Rig (+15%)

Mining (+15%)

Paramedic (+20%)

Nuclear, Biological, & Chemical Warfare (+15%)

Read (& Operate) Sensory Equipment (+15%)

Spelunking (+15%)

### Fire & Rescue Operative – “Roscoe” O.C.C.

**Attribute Requirements:** P.S. 14, P.P. 10, and P.E. 12 or higher. 65% are male, 35% female.

#### O.C.C. Skills:

Climbing (+15%)

Math: Basic (20%)

Language, Native: Standard.

Language, Foreign: One of choice (+12%).

Literacy, Native: Standard.

Literacy, Foreign: One of choice (+10%).

Radio: Basic (+10%)

Pilot: Truck and one of choice (+10% each).

Swim (+10%)

Running

W.P. Battle Axe (Conventional & Vibro-Blade)

W.P. Sword (Vibro-Blade)

W.P. Energy Rifle

Hand to Hand: Basic, which can be changed to Expert at the cost of two “O.C.C. Related Skills” or Martial Arts for the cost of three skill selections.

**O.C.C. Related Skills:** Select five other skills. Plus select one additional skill at levels three, six, nine, and twelve. All new skills start at level one proficiency.

Communications: Any (+5%).

Domestic: Any (+5%; +10% to Cook, only).

Electrical: Basic (+5%) only (or Electrical Engineer +10% is only available if a Fire Forensics Specialist only, and counts as two skill selections).

Espionage: Detect Concealment only.

Horsemanship: None.

Mechanical: Automotive, Basic Mechanics, and Locksmith only.

Medical: Any (+5%; +10% to Field Surgery only).

Military: Demolitions (any), Trap/Mine Detection and Military Fortification only.

Physical: Any, except Wrestling.

Pilot: Any (+5%).

Pilot Related: Any, except Tanks.

Rogue: Cardsharp and Streetwise only.

Science: Advanced Math and Chemistry (any), only.

Technical: Any (+10%).

W.P.: Any, except Heavy Weapons, Heavy Energy Weapons and Sharpshooting.

Wilderness: Carpentry, Hunting, Land Navigation and Wilderness Survival only (+5%).

**Secondary Skills:** The character gets three Secondary Skills at levels one, seven and twelve. These are additional areas of knowledge that do not get the advantage of the bonus listed in parentheses. All start at the base skill level and normal restrictions apply.

**Standard Equipment:** NEMA Firefighter's enhanced body armor (effectively light power armor), modified NEMA body armor (with the firefighter's helmet and oxygen system), Neural Mace, M.D. energy rifle and S.D.C. side arm of choice (typically a 9 mm automatic pistol), 4 extra clips for each, eight flares, two (colored) smoke grenades, Vibro-Knife, Vibro-Sabre, Vibro-Fire Axe, conventional fire axe (2D6+1 S.D.C.; large), hand axe (1D6 S.D.C.), pocket knife (1D4 S.D.C.), small mallet (1D4 S.D.C.), six pitons/spikes, 50 feet (15.2 m) of lightweight rope and pulley system, laser torch, large paramedic's medical kit (includes basic gear, 50 pairs of disposable surgical gloves, surgical kit, suture, bandages, antiseptic, painkillers and other medicine, defibrillator, oxygen, etc.), primary response pack/first-aid kit (essential equipment in a small portable case), nano-robot medical systems, mini-bio-comp system, compu-drug dispenser, breathing equipment, stretcher, backboard, utility belt, canteen, air filter & gas mask, walkie-talkie, portable high-intensity lamp, pocket flashlight, pocket mirror, uniform, dress uniform, utility belt, backpack, and a few personal items. Obviously, not all of this gear is carried all the time, much of it is held in reserve and stowed in the firefighter's vehicle. May also have a portable laboratory and other or additional medical and rescue equipment in the vehicle.

The vehicle is usually a simple hovercycle, hover vehicle, jeep/SUV, conventional firefighting or rescue vehicle (EMS, Fire truck, automobile), motorcycle or jet pack.

**Special Equipment Available Upon Assignment:** Fire truck and heavy-duty firefighting equipment, cutting/welding equipment, explosives, additional gear and perhaps a squad of NEMA troops or volunteers to assist in the rescue operation.

**Money:** Standard. Monthly salary was 2,200 credits, plus hazard pay. Pay is one tenth normal (220 credits a month), mainly as an incentive for morale, but starts with 5D6x100 credits. Under the circumstances, access to tools, spare parts, equipment, and services may be limited.

**Cybernetics:** Typically has a NEMA identification implant (under the skin of the forearm or back of the neck), clock calendar, air and surface temperature reader, radiation sensor, and the following lung implants: molecular analyzer, oxygen storage cell (30 minutes) and a toxic filter. Some also have amplified hearing and a sound identifier. 10% of the Roscoes are partial cyborgs. All are described in the **Rifts® Bionics Sourcebook** along with a slew of other implants and bionics; \$13.95, 112 pages.

## NEMA Intel-Agent

Intelligence Agents are investigators and purveyors of information who function as reconnaissance scouts, infiltrators, spies and undercover agents. It's their job to investigate, observe, track and uncover criminal, terrorist, and enemy activity and operations, as well as enemy locations, strengths and weaknesses. They then assess the information, examine the situation and determine a response that could involve infiltration, further observation, or liquidation (i.e., a raid or surgical strike to undermine, capture, or destroy the enemy). These agents have anti-terrorism and military combat training, but their main area of expertise lays in surveillance, investigation, research, and gathering and analyzing information. Intel-Agents are trained to be objective and to seek out facts, identify perpetrators, locate and identify the enemies, spies and threats, and to help formulate strategies, tactics and countermeasures. Whenever possible, it is the Intel-Agent's job to gather enough intelligence to preempt trouble and neutralize enemy operations before they can attack (or to be prepared for the attack).

These espionage agents must think quickly on their feet and be adaptive, resourceful and independent while, at the same time, able to see the big picture and work as a member of a team. In Chaos Earth, they are given the dirty jobs of tracking down looters, bandits, killers, rogue NEMA and military personnel, cults and dissidents, as well as investigating and gathering intelligence on strange phenomena and the so-called "alien invaders," "demons" and "monsters" that plague the Earth. They may also investigate crime scenes and work with Peacekeepers to solve crimes and bring those responsible to justice. Intel-Agents will play an important role in the months to come figuring out exactly what NEMA is up against, who are the real enemies, and how to best dispatch them. They are among the first to recognize, study and accept the existence of magic and supernatural creatures. More and more, Intel-Agents are working with Para-Arcane and psychics.

### NEMA Intelligence Officer/Spy/Undercover Agent

**Attribute Requirements:** I.Q. 10, M.E. 11, M.A. 11 or higher.

Roughly a 50/50 split between males and females.

**M.O.S.:** Select one of the following areas of speciality or roll percentile to make a random determination. All skills are in addition to O.C.C. and other skills.

#### 01-33% Intelligence & Reconnaissance

Camouflage (+15%)

Command Robots (probes only)

Detect Ambush (+10%)

Detect Concealment (+15%)

Find Contraband (+16%)

Land Navigation (+16%)

Prowl (+10%)

Tracking (+20%)

Wilderness Survival (+20%)

Wilderness Skill: One of choice (+15%)

#### 34-66% Research Specialist

Anthropology (+20%)

Computer Programming (+15%)

Computer Hacking (+10%)  
Cryptography (+20%)  
Forgery (+15%)  
Lore: Three of choice (+15% each).  
Photography (+15%) or TV/Video (+10%)  
One Communications or Espionage skill of choice (+10%).  
Research (+20%)

67-00% Spy or Undercover Agent

Command Robots (probes and Pups only)  
Disguise (+20%)  
Interrogation (+12%)  
Imitate Voices and Impersonation (+14%)  
Prowl (+10%)  
Seduction (+13%)  
Streetwise (+14%)  
Surveillance Systems (and Tailing) (+15%)  
Tracking (+10%) or Concealment (+12%)

**O.C.C. Skills:**

Math: Basic (+10%)  
Language, Native: Standard.  
Language, Foreign: Two of choice (+15%).  
Literacy, Native: Standard.  
Literacy, Foreign: Two of choice (+20%).  
Law (General, +25%)  
Intelligence (+20%)  
Computer Operation (+15%)  
Radio: Basic (+15%)  
Pilot: Two of choice (+5% each).  
W.P. Knife or Blunt (pick one)  
W.P. Pistol or Revolver (pick one)  
W.P. Energy Pistol  
W.P. Energy Rifle  
W.P. of choice (any).  
Hand to Hand: Expert or Martial Arts (or Assassin if an Anarchist or evil alignment), pick one.

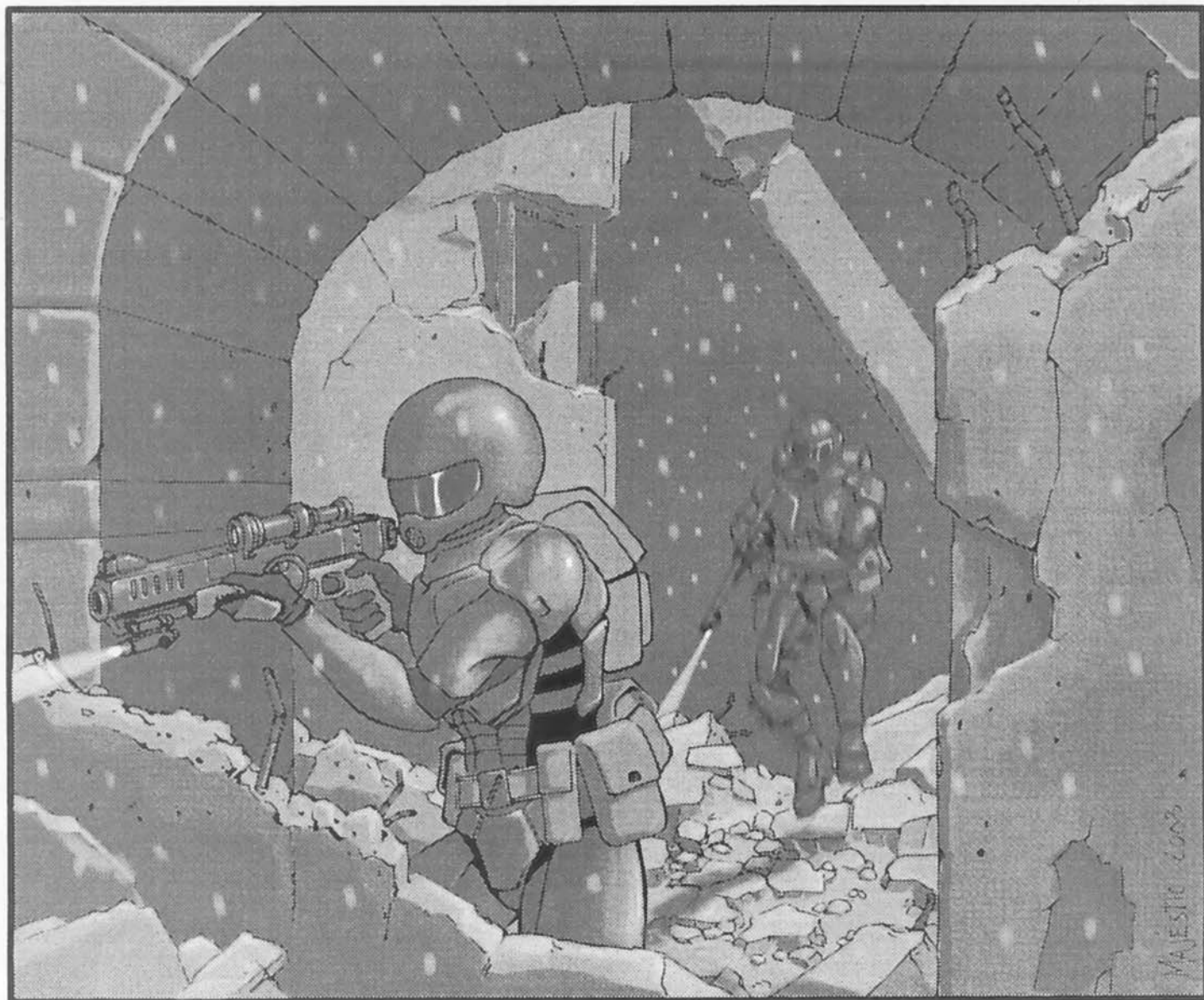



**O.C.C. Related Skills:** Select two Espionage or Rogue skills, and three other skills of choice (as limited below). Plus select Demon & Monster Lore and one additional skill at level three, Magic Lore and one additional skill at level five, and one additional Lore and one other skill at levels eight, and twelve. All new skills start at level one proficiency.

Communications: Any (+10%).

Domestic: Any.

Electrical: None.

Espionage: Any (+10%).

Horsemanship: Any.

Mechanical: Automotive and Basic Mechanics only.

Medical: First Aid only.

Military: Any (+10%), except Command Robots.

Physical: Any.

Pilot: Any, except Power Armor, Robots and Tanks.

Pilot Related: None.

Rogue: Any (+10%).

Science: None.

Technical: Any.

W.P.: Any, except Sharpshooting.

Wilderness: Any (+10%).

**Secondary Skills:** The character gets one Secondary Skill at levels one, four, eight, and twelve. These are additional areas of knowledge that do not get the advantage of the bonus listed in parentheses. All start at the base skill level and normal restrictions apply.

**Standard Equipment:** Standard NEMA body armor, energy rifle or energy side arm of choice and 4 extra E-Clips for each, S.D.C. side arm of choice (revolver, pistol or submachine-gun) with 144 rounds of silver coated bullets as well as conventional ammunition, pocket-sized silver cross (may be worn on a chain), eight inch wooden cross, silver plated dagger (1D6 S.D.C.), two plasma grenades, two flares, Neural Mace, make-up/disguise kit, pocket computer, language translator (for others he meets to use), pocket flashlight, notebook and four markers, lock picking tools, mini-tool kit, small crowbar, a dozen pairs of plastic surgical gloves, soft leather gloves, box of 96 small and medium plastic evidence bags, 40 large bags, disposable cigarette lighter, utility belt, backpack, canteen, satchel, briefcase, air filter & gas mask, walkie-talkie, long-range radio, small pair of binoculars, nightvision goggles, uniform, dress uniform, "civilian" wardrobe for undercover work, tinted goggles, sunglasses, and some other basic gear.

**Available Upon Assignment:** A vehicle appropriate for the mission, explosives (any), weapons, surveillance equipment (wire taps, bugs, etc.), additional video equipment, cameras, recorders, disguises and clothing, fake I.D., untraceable credit card for expenses, items for trade (if necessary), robot probes and other special equipment.

**Money:** Standard. Monthly salary was 3,000 credits, plus hazard pay. Under the circumstance of Chaos Earth, access to equipment, medical treatment, supplies and services may be limited. Pay is one tenth normal (300 credits a month), mainly as an incentive for morale. The character starts off with 6D6x100 credits.

**Cybernetics:** Starts with a Molecular Analyzer (lung), Amplified Hearing, Language Translator, Universal Headjack, Surveillance Ear, Tracer Bugs (four) and Tracker (cybernetic), Radio Bandit's Ear, Clock Calendar and two cybernetic systems of choice. No I.D. chip to avoid identification as a NEMA agent by the enemy.

If a partial cyborg, the agent will have one or two bionic arms with 1D4+2 different built-in capabilities (sensors, finger camera, weapons, etc.) for each, a bionic eye and even a pair of bionic legs. Remember, only 10% are cyborgs.

## NEMA Military Specialist

### Robot Commander

Military raids, sabotage, assassination, espionage, surgical strikes, jailbreak rescues from the clutches of the enemy, and covert operations are the specialty of the Military Specialist. Unlike the Intel-Agent who is very much a spy or undercover agent who remains hidden or behind the scenes to gather information, the Military Specialist is much more proactive. Though he too lurks in the shadows, he steps out of them to perform acts of sabotage, destruction and combat designed to harass, undermine or destroy the enemy. Specialists often work hand in hand with the Intel Officer who gathers intelligence about the enemy and points out strategic targets, routines, and key personnel – all information and advanced scouting that the Military Specialist (and other military units) needs to strike against the enemy. Military Specialists often lead teams on missions and serve as military advisors. They are effectively Commandos or Special Forces, and all are expert in one of four areas (see M.O.S.).

The Military Specialist is also the one NEMA O.C.C. that has complete access to *all* independent robot systems from probes to combat models, including the Combat Drone (what the Coalition States would turn into the Skelebot 250+ years in the future). As a rule, the M-Spec Officer will have two Spider Probes, one Flying Probe, one Combat Pup, one or two Combat Hounds and one or two Combat Drone Soldiers at his disposal for any given mission. Sometimes he must choose between the Combat Hound and the Combat Drone, not get both. On the other hand, for some seek and destroy missions and operations where there are only the M-Spec and 1-4 other human operatives, he may be given a squad of 4-6 Combat Drones to deploy against the enemy, and during heavy sieges or special missions, he might command as many as a dozen plus 2-4 Combat Hounds. This is why the M-Spec is also known as the Robot Commander.

### NEMA Military Specialist O.C.C., a.k.a. M-Spec Officer or just "M-Spec."

**Attribute Requirements:** I.Q. 10, M.E. 12, P.P. 10 or higher.

Approximately 60% are male and 40% female.

**M.O.S.:** Select one of the following areas of speciality or roll percentile to make a random determination. All skills are in addition to O.C.C. and other skills.

01-25% Electronic Intelligence

- Basic Electronics (+15%)
- Basic Mechanics (+10%)
- Command Robots (any, though usually probes and one Hound)
- Computer Hacking (+20%)
- Computer Programming (+15%)
- Electronic Countermeasures (+20%)
- Read (& Operate) Sensory Equipment (+15%)
- Surveillance Systems (and Tailing) (+15%)
- TV/Video (+20%) or Cryptography (+15%)

26-50% Man-Hunter/Assassin

- Command Robots (any)
- Land Navigation (+20%)

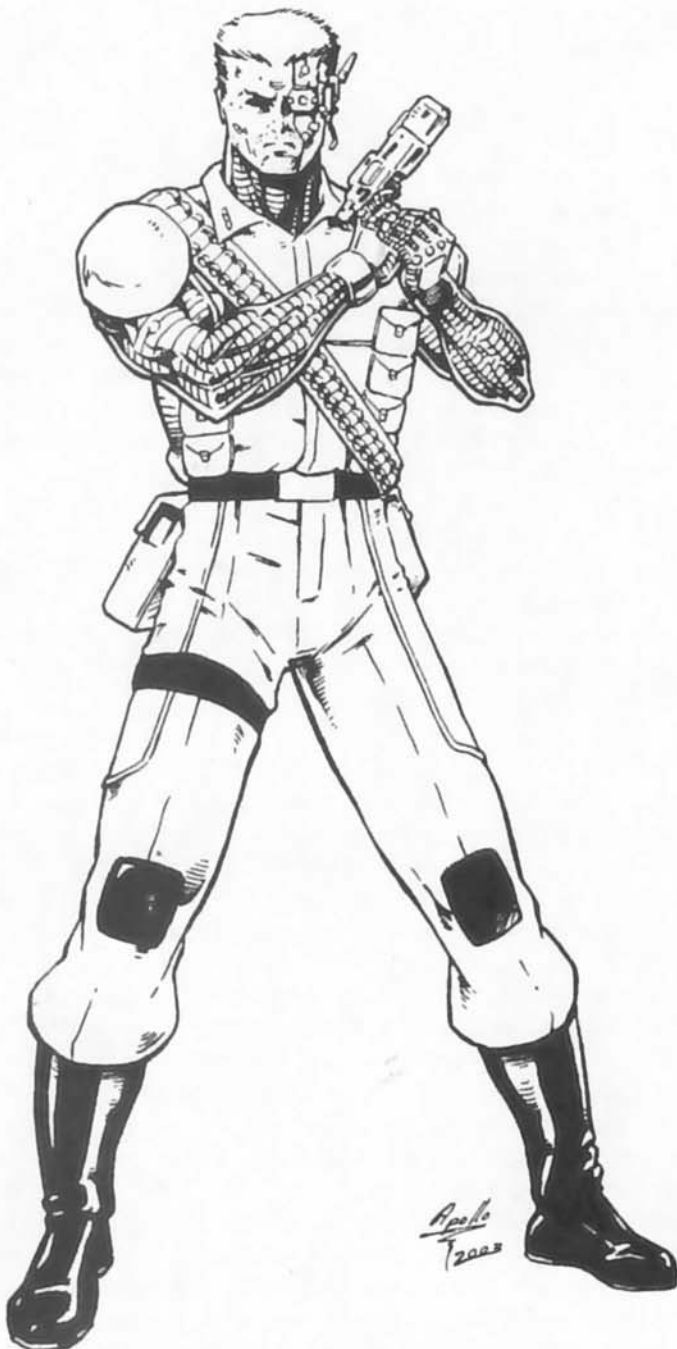

Recognize Weapon Quality (+15%)

Sharpshooting or Sniper

Prowl (+15%)

Tracking (+20%)

W.P. Bolt-Action Rifle

W.P.: Two of choice (any)

51-75% Sabotage & Harassment

Camouflage (+20%)

Command Robots (all)

Computer Programming (+10%) or Find Contraband (+10%)

Demolitions (+20%)

Demolitions: Underwater (+20%)

Demolitions Disposal (+15%)

Escape Artist (+15%) or Forgery (+20%)

Nuclear, Biological & Chemical Warfare (+15%)

76-00% Robot Specialist

Advanced Math (+10%)

Basic Electronics (+20%)

Command Robots (all)

Locksmith (+20%)

Mechanical Engineer (+10%)

Pilot: Robots Basic

Pilot: Robot or Power Armor Elite (choose one specific type; any)

Robot Mechanics (+25%)

Weapons Engineer (+10%)

**O.C.C. Skills:** All reflect the O.C.C.'s basic training.

Math: Basic (+20%)

Language, Native: Standard.

Language, Foreign: Two of choice (+12%).

Literacy, Native: Standard.

Literacy, Foreign: Two of choice (+12%).

Computer Operation (+15%)

Radio: Basic (+15%)

Radio: Scramblers (+10%)

Intelligence (+12%)

Law (General, +10%)

Military Etiquette (+15%)

Pilot: Two of choice (+5% each), any except Power Armor, Robots and Tanks.

Boxing or Athletics (General)

W.P. Knife or Blunt (pick one)

W.P. Energy Pistol

W.P. Energy Rifle

Hand to Hand: Martial Arts or Commando, or Assassin if an Anarchist or evil alignment, pick one.

**O.C.C. Related Skills:** Select two Espionage and four other skills of choice (as limited below). Plus select Demon & Monster Lore and one additional skill at level three, Magic Lore and one additional skill at level five, and one additional Lore and one other skill at levels eight, and twelve. All new skills start at level one proficiency.



Communications: Any (+10%).  
Domestic: Any.  
Electrical: None.  
Espionage: Any (+10%).  
Mechanical: Automotive and Basic Mechanics only.  
Medical: First Aid only.  
Military: Any (+10%).  
Physical: Any.  
Pilot: Any, except Power Armor, Robots and Tanks.  
Pilot Related: None.  
Rogue: Any (+10%).  
Science: None.  
Technical: Any (+5%).  
W.P.: Any.  
Wilderness: Any (+5%).

**Secondary Skills:** The character gets one Secondary Skill at levels one, four, eight, and twelve. These are additional areas of knowledge that do not get the advantage of the bonus listed in parentheses. All start at the base skill level and normal restrictions apply.

**Standard Equipment:** Standard NEMA body armor, energy rifle or energy side arm of choice and 4 extra E-Clips for each, S.D.C. side arm of choice (revolver, pistol or submachine-gun) with 144 rounds of silver coated bullets as well as conventional ammunition, pocket-sized silver cross (may be worn on a chain), eight inch wooden cross, silver plated dagger (1D6 S.D.C.), two plasma grenades, two smoke grenades, two flares, make-up/disguise kit, pocket computer, language translator, pocket flashlight, notebook and four markers, lock picking tools, mini-tool kit, small crowbar, a dozen pairs of plastic surgical gloves, soft leather gloves, box of 96 small and medium plastic evidence bags, 40 large bags, disposable cigarette lighter, utility belt, canteen, backpack, satchel, briefcase, air filter & gas mask, walkie-talkie, long-range radio, small pair of binoculars, nightvision goggles, uniform, dress uniform, tinted goggles, sunglasses, and some other basic gear.

**Available Robots:** 2 Spider Probes, 1 Flying Probe, 1 Combat Pup, 1 or 2 Combat Hounds and 1-2 Combat Drones (typically one of each combat type with a second only if one type isn't available or the assignment requires extra firepower). **Note:** G.M.s' do not go hog wild with assigning a ton of robots to this character. Furthermore, if the M-Spec routinely or casually wastes/destroys robots, especially under circumstances where the loss is unjustified, he may lose the privilege to use certain types, maybe even all robots.

**Available Upon Assignment:** A vehicle appropriate for the mission, explosives (any), heavy weapons, surveillance equipment (wire taps, bugs, etc.), video equipment, cameras, recorders, disguises and clothing, fake I.D., additional robots and other special equipment.

**Money:** Standard. Monthly salary was 3,000 credits, plus hazard pay. Under the circumstances of Chaos Earth, access to equipment, medical supplies and services may be limited. Pay is one tenth normal (300 credits a month), mainly as an incentive for morale. The character starts off with 3000 credits.

**Cybernetics:** Starts with 1D4 cybernetic implants of choice. No I.D. chip to avoid identification as a NEMA agent by the enemy.

If a partial cyborg (12% are), the agent will have one or two bionic arms with 1D4+2 different built-in capabilities (sensors, finger camera, weapons, etc.) for each, a bionic eye and even a pair of bionic legs.

## Para-Arcane

### Expert in the Paranormal

To combat the supernatural forces that besiege them, NEMA is accessing data bases and digging through libraries to find every scrap of information they can on old myths and legends about demons, devils, vampires, ghosts and superstitions to help them in their fight against the supernatural. Even old movies and role-playing games are being examined in the hope they may hold some bits of helpful information pulled from the pages of some forgotten book, myth or superstition that really works. NEMA is trying to get up to speed with how to address these "impossible" menaces and threats as quickly as possible, and are willing to turn to the most unlikely of sources. Enter the psychics and the Para-Arcane.

A Para-Arcane is an expert in the paranormal, mythology, history and monsters who serves as a consultant to NEMA forces in their battle against the supernatural. Most (95%) are "lay" people recruited by NEMA, the military or regional authorities to help explain and combat the magical and supernatural. Most are *scholars*, *historians* and *nerds* who have a keen knowledge about ancient gods, the occult and the arcane as well as historical knowledge about myths, legends, demons, ghosts, monsters, ancient gods, and old beliefs. These quasi-experts play a key role in identifying mythological creatures, demons, and monsters and warning NEMA troops about their behavior, practices, and, most importantly, their *weaknesses* and *vulnerabilities*. Such knowledge is crucial if NEMA is to have any hope of dealing with the demonic and creatures of magic.

Only 1% of the Para-Arcane are clinically trained parapsychologists and psychic investigators, 6% are Native Americans, 24% scholars and historical scholars, 20% Anthropologists, and most of the rest are "nerds" – scholarly laymen who have read and memorized tons of obscure data that is suddenly very useful. All serve as "technical advisors" enlisted to identify and counter the supernatural. Most are expected to be *field agents* who accompany the troops on reconnaissance, monster hunts, rescues, patrols and combat missions. Consequently, most Para-Arcane are given some very rudimentary training in Military Etiquette, basic combat, how to shoot a gun, use a radio and so on, along with a little physical conditioning.

Since the Para-Arcane are volunteers, some are physically fit, courageous and gung-ho adventurers proud to put their knowledge to work and help in a time of need. Others are well intentioned but young and inexperienced, old, flabby, or weak and sickly. Some are true scholars and amateur scientists, others are well-meaning bunglers, eccentrics and goof balls. On the other hand, there are the charlatans, opportunists and lunatic fringe trying to exploit the situation to their personal benefit, glory or agenda. The level of competence, first-hand experience and

range of knowledge varies dramatically from individual to individual.

### Special Para-Arcane O.C.C. Skills

**Ghosts.** Para-Arcane know all the theories pertaining to ghosts, entities (all) and other "haunting" or spectral creatures like Banshees and Nightmares.

**Monster Hunting.** Knows the habits, foibles, weaknesses, vulnerabilities and ways to fight and kill most (historically) "well known" (and some little known) demons, monsters,



undead, werebeasts, spirits and gods. Fascinated by the subject, the Para-Arcane is constantly studying the supernatural to learn more, and will commit to memory (and often a written journal) firsthand experiences and observations. Also see the Lore: Demons & Monsters skill and other Lores. Also knows how to use holy symbols and other things that repel the supernatural or evoke fear or hold them at bay.

**Simpatico with Magic.** Has a basic understanding and appreciation for *magic*, sometimes a burning fascination for it, and magic is seldom feared by them. The Para-Arcane can also read spell scrolls, use simple magic weapons and devices, recognize enchantment and possession (30% +2% chance per level of experience), recognize common and historical magic symbols, and has some measure of understanding about magic ceremonies, their purpose and end result. The character can perform an exorcism and magical rituals if given complete and clear instructions.

**Bonuses:** +1 to save vs magic, +2 to save vs possession, +1 to save vs Horror Factor, and has a base P.P.E. of 6D6 +P.E. attribute number plus 1D6 per level of experience.

### Para-Arcane O.C.C.

**Attribute Requirements:** I.Q. 11 or higher. A good M.E., P.S., and P.E. are helpful but not required.

**Note:** 45% are women and, oddly enough, few Para-Arcane (only about 5%) have any degree of psychic ability, and when they do, it is usually Minor or Major abilities, seldom Master. As the forces of magic and the supernatural take an iron grip on the world, one Para-Arcane per typical NEMA squad is seen as a must.

#### O.C.C. Skills:

- Anthropology (+15%) or Archeology (+15%)
- Math: Basic (+20%)
- Computer Operation (+15%)
- History (+20%)
- Language, Native: Standard.
- Language, Foreign: Two of choice (+12%).
- Literacy, Native: Standard.
- Literacy, Foreign: Two of choice (+12%).
- Lore: Demons & Monsters (+20%)
- Lore: Mythology (+25%)
- Lore: Two of choice (+15%).
- Military Etiquette (+5%)
- Pilot: One of choice (+5%).
- Photography (+10%) or Whittling (+10%)
- Radio: Basic (+5%)
- Research (+15%)
- Climbing (+5%)
- Running or Aerobic Athletics (pick one)
- W.P. Ancient or Modern S.D.C. weapon of choice.
- W.P. Automatic Pistol or Revolver
- W.P. Energy Rifle

Hand to Hand: Basic, which can be changed to Expert at the cost of two "O.C.C. Related Skills" or Martial Arts for the cost of three skill selections.



**O.C.C. Related Skills:** Select five other skills. Plus select two additional skills at levels four, eight, and twelve. All new skills start at level one proficiency.

Communications: Any (+5%).

Domestic: Any (+5%).

Electrical: Basic Electronics only.

Espionage: Intelligence, Escape Artist, Pick Locks and Disguise only.

Horsemanship: General or Exotic Animals only.

Mechanical: Automotive and Basic Mechanics only.

Medical: Animal Husbandry and First Aid only.

Military: None.

Physical: Any, except Acrobatics, Gymnastics and Boxing.

Pilot: Any, except military vehicles, robots and power armor.

Pilot Related: None.

Rogue: Computer Hacking, Palming and Streetwise only.

Science: Any (+5%).

Technical: Any (+10%).

W.P.: Any, except Heavy Weapons, Heavy Energy Weapons or Sharpshooting.

Wilderness: Dowsing, Land Navigation, Identify Plants, Preserve Food, Roadwise, Spelunking, and Wilderness Survival only (+5%).

**Secondary Skills:** The character gets two Secondary Skills at levels 1, 3, 6, 9, 12, and 15. These are additional areas of knowledge that do not get the advantage of the bonus listed in parentheses. All start at the base skill level and normal restrictions apply.

**Standard Equipment:** An M.D.C. long coat (32 M.D.C.), vest (25 M.D.C., usually worn under the coat), and helmet (70 M.D.C.), energy rifle with 3 extra E-Clips, an S.D.C. side arm of choice (typically a NEMA automag, 5D6 S.D.C. per bullet) with 144 conventional rounds and 144 silver coated bullets, Neural Mace or Vibro-Knife, six flares, silver plated dagger (1D6 S.D.C.), hand axe made of stone or bone (1D6 S.D.C.), conventional pocket knife (1D4 S.D.C.), small mallet (1D4 S.D.C.), 6-8 wooden stakes, a clove of garlic, a branch of wolfbane, a shaker of salt, an 8-12 inch wooden cross, a small silver cross, a canteen of holy water, canteen of regular water, disposable cigarette lighter, pocket mirror, utility belt, backpack, satchel or duffel bag, sleeping bag, notebook and two markers, a box of white chalk, a couple pieces of charcoal, air filter & gas mask, walkie-talkie, portable computer, pocket flashlight, nightvision goggles, pocket magnifying glass, and an official NEMA uniform (regular and dress) and I.D., along with a few personal items.

**Special Equipment Available Upon Assignment:** Additional weapons and ammunition, special ammunition (i.e. silver bullets, bow and arrows, wood or stone weapons, iron weapons, etc.), video equipment, cameras, recorders, and other equipment. Vehicles can include a simple hovercycle, car, jeep, truck or other means of transportation or military insertion and extraction.

**Money:** There was never a "Para-Arcane" consultant before the Great Cataclysm. Under the circumstances, they get limited access to NEMA equipment, supplies and services as well as a safe roof over their head, food, clothing, and all other ba-

sics provided free, plus limited access to NEMA military facilities. Pay is a meager 400 credits a month, mainly as an incentive for morale, but the consultant also enjoys the protection and camaraderie of the NEMA soldiers and the respect and glory of being a member of NEMA, which more than make up for the pitiful salary. The character starts off with 2D4x100 credits in savings.

**Cybernetics:** None to start with, but implantation of cybernetics and bionics is not restricted and may be awarded for exemplary service and heroics.

## NEMA Demon & Witch Hunter O.C.C.

Demon & Witch Hunters who are not part of NEMA are a growing problem in and of themselves. They cause problems indirectly by ignoring orders to stay clear of NEMA operations, giving away troop positions, alerting monsters to danger (usually by attacking them before NEMA troops are ready), endangering innocent lives, distracting NEMA agents, sometimes attacking NEMA agents out of indignation or by mistake or because they have deemed them to be the pawns of Satan, or by providing unreliable intelligence or stirring up mobs, riots and mass hysteria. Independent Demon & Witch Hunters may work alone, travel in pairs or in small groups of 3-6, or join (often as leaders) a larger group of like-minded people such as paranoid vigilantes and survivalists. Large groups almost always have a lynch mob mentality and may be beyond reasoning with. Force is often necessary to disperse these bloodthirsty fanatics. A full third are clinically insane, driven mad by the horrors and loss they have endured in the Great Cataclysm. Most are convinced this is indeed, the Biblical "Apocalypse." The end of the world, and that they, because they rebuke evil and magic, are among the chosen. Thus, they believe they fight as "soldiers of God."

Many are well intentioned misanthropes, paranoids, and just plain survivors looking for some payback against the monsters who have murdered their loved ones. Others among them are religious fanatics or sadists who enjoy the power over life and death they have as traveling judge, jury and executioners reminiscent of the old Spanish Inquisition. These self-styled inquisitors have learned enough about magic and monsters, however, that they really can sniff out supernatural menaces, lending them some measure of credibility to continue with their charade of justice and salvation among the public. The problem is many of these vigilantes are fanatics and madmen who see the handiwork of demons, devils, evil, magic and the supernatural everywhere, and serve out justice at the end of a rope or a silver plated blade before true guilt or innocence is determined (better safe than sorry). Furthermore, those who question their work or their judgements are themselves sometimes falsely accused of wrongdoing or at least belittled and maligned as a fool, or being too soft-hearted or a pawn of evil.

Strangely enough, it is from this lot of maniacs that NEMA recruits its own Demon & Witch Hunters (non-NEMA agents can be played as NPC heroes or villains).

**NEMA Demon & Witch Hunters** are recruited from this unsavory rabble to help the organization combat the supernatu-



ral and demonic. Demon & Witch Hunters (designated as "DW Hunters" or "DWH") who don't seem as overzealous and who are willing to follow orders (mostly) and work as a member of a team, are invited from independent civilian bands of these fire and brimstone fanatics. NEMA's recruitment pitch: "If you really want to make a difference, destroy evil and stop the hellspawned demons swarming through the Rifts (and the humans who worship and serve them), then do so by joining NEMA."



Even those selected by NEMA tend to be ruthless, self-righteous crusaders on a single-minded mission to destroy all that is evil, alien and supernatural. Consequently, DW Hunters charge into the heart of combat and enjoy getting their hands bloodied *fighting and destroying* the supernatural and demonic, not just "helping" as advisors and consultants in the field. Furthermore, their primary objective is to destroy supernatural evil, followed by slaying the treacherous humans who help and serve them. Rescuing innocent people and saving lives comes a distant third. In fact, some NEMA DW Hunters ignore the rescue part of the mission and sometimes even endanger innocent lives in their blood lust to destroy the supernatural. They are notorious for wandering off to follow a lead and disobeying orders when they think there is supernatural evil to slay. Similarly, they sometimes endanger their teammates by challenging or taking on supernatural opponents the group cannot handle, or cannot handle without serious injury or losses (of men or equipment). Those who learn to temper their fierce resolve with compassion, tolerance and teamwork can become true heroes and become a valuable asset to NEMA, earning the respect, friendship and loyalty of their comrades and the gratitude of the people.

### Special Demon & Witch Hunter O.C.C. Skills

**Monster Hunting.** Knows the habits, foibles, weaknesses, vulnerabilities and ways to fight and kill most (historically) well known (and some little known) witches, demons, monsters, undead, werebeasts, spirits and gods. Fascinated by the subject, the Demon & Witch Hunter is constantly studying the supernatural to learn more, and will commit to memory (and often a written journal) firsthand experiences and observations. Also see the Lore: Demons & Monsters skill.

**Arcane Knowledge.** Has a good understanding of *magic and the supernatural*, but fears, loathes and rejects it, giving the DW Hunter greater resistance to it. The character recognizes components and symbols used in magic, signs of evil, and magic rituals/ceremonies, as well as spell scrolls, simple magic weapons and devices, and enchantment and possession (36% +2% chance per level of experience). **Bonuses:** +1 to save vs magic, +3 to save vs possession, +4 to save vs Horror Factor, and has a base P.P.E. of 3D6 +P.E. attribute number.

**Think like the demonic enemy.** Like any good man-hunter, the DW Hunter starts to think like his prey, giving him or her the insight to profile and predict the enemy's behavior, haunts and targets. This gives the DWH gut intuition and hunches that, more often than not, prove to be correct. Some Para-Arcane have suggested that these "hunches" are more like psychic flashes or even a loose link to the supernatural, a hypothesis that the DWH emphatically dismiss. Whatever it is, it works. Game Masters, play this ability just the way it sounds, by telling the character things like, "you're on the right track, you know it," "something's not right here," "they're wrong, this isn't done yet," "there's another one, you know it," "it wants you to follow it, this could be a trap," "something's wrong, they don't give up that easy," "no, that's the wrong way - what's in the basement (or down the hall or in the corner room, etc.)," "something tells you, you want to look down (or up or the other way, etc.)," and so on.

**Bonuses:** +1 to save vs magic, +4 to save vs possession, +3 to save vs Horror Factor, and has a base P.P.E. of 3D6 +P.E. attribute number.

**Psionics:** About 35% of both male and female DW Hunters have Minor (2) or Major (6-8) psychic abilities. Determine I.S.P. and powers as usual. Psychic and magic characters for *Chaos Earth*® shall be presented in a future sourcebook. In the meanwhile; use the psionics and magic found in the *Rifts*® RPG and sourcebooks.

### **Demon & Witch Hunter O.C.C.**

**Alignment:** Any, but NEMA DWH tend to be 10% Principled, 15% Scrupulous, 29% Unprincipled, 36% Anarchist, 8% Aberrant evil, and 2% other.

**Attribute Requirements:** I.Q. 11 and P.E. 11 or higher. A high M.E. and P.S. are helpful but not required. Half are women.

#### **O.C.C. Skills:**

Math: Basic (+10%)

Computer Operation (+15%)

Language, Native: Standard.

Literacy, Native: Standard.

Lore: Demons & Monsters (+30%)

Lore: Magic (+15%)

Lore: Mythology (+15%)

Lore: Religion (+20%)

Lore: One of choice (+10%).

Pilot: Motorcycle or Hovercycle (+10%; pick one).

Pilot: One of choice (+5%).

Radio: Basic (+5%)

Land Navigation (+10%)

Tracking (+10%)

Climbing (+5%)

Aerobic Athletics or General Athletics (pick one)

W.P. Two Ancient of choice (sword, blunt and Archery are most common).

W.P. Automatic Pistol or Revolver

W.P. Automatic or Bolt-Action Rifle

W.P. Energy Pistol or Energy Rifle (pick one)

Hand to Hand: Expert, which can be changed to Martial Arts (or Assassin if Anarchist or evil) for the cost of two "O.C.C. Related Skills."

**O.C.C. Related Skills:** Select five other skills and one Physical skill at level one, and two additional skills at levels four, eight, and twelve. All new skills start at level one proficiency.

Communications: Any.

Domestic: Any.

Electrical: Basic Electronics only.

Espionage: Any (+5%).

Horsemanship: Any.

Mechanical: Automotive and Basic Mechanics only.

Medical: First Aid only.

Military: None.

Physical: Any, except Acrobatics, Gymnastics and Boxing.

Pilot: Any, except military vehicles, robots and power armor.

Pilot Related: None.

Rogue: Computer Hacking, Concealment, Gambling, Palming and Streetwise only.

Science: Any (+5%).

Technical: Any (+10%).

W.P.: Any, except Heavy Weapons, Heavy Energy Weapons or Sharpshooting.

Wilderness: Any (+5%).

**Secondary Skills:** The character gets one Secondary Skill at levels 1, 3, 6, 9, 12, and 15. These are additional areas of knowledge that do not get the advantage of the bonus listed in parentheses. All start at the base skill level and normal restrictions apply.

**Standard Equipment:** *Independents* start with a suit of light (probably riot control) M.D.C. body armor, M.D.C. energy rifle and one weapon for each corresponding W.P., 4 extra clips for each, six flares, silver plated dagger (1D6 S.D.C.) or sword (2D6 S.D.C.), conventional hand axe (1D6 S.D.C.), conventional pocket knife (1D4 S.D.C.), small mallet (1D4 S.D.C.), 6-8 wooden stakes, 1D6 cloves of garlic, a branch of wolfbane, a shaker of salt, an 8-12 inch wooden cross, a small silver cross, a canteen of holy water, canteen of regular water, disposable cigarette lighter, pocket mirror, utility belt, backpack, satchel or duffel bag, sleeping bag, notebook and two markers, a box of white chalk, a couple pieces of charcoal, air filter & gas mask, walkie-talkie, portable computer, pocket flashlight, and nightvision goggles.

*NEMA DW Hunters* begin with an M.D.C. long coat (32 M.D.C.), vest (25 M.D.C., usually worn under the coat), and helmet (70 M.D.C.), energy rifle with 3 extra E-Clips, an S.D.C. side arm of choice (typically a NEMA automag, 5D6 S.D.C. per bullet) with 144 conventional rounds and 144 silver coated bullets, Vibro-Knife, six flares, silver plated dagger (1D6 S.D.C.), conventional pocket knife (1D4 S.D.C.), small mallet (1D4 S.D.C.), 6-8 wooden stakes, a clove of garlic, a branch of wolfbane, a shaker of salt, an 8-12 inch wooden cross, a small silver cross, a canteen of holy water, canteen of regular water, disposable cigarette lighter, pocket mirror, utility belt, backpack, satchel or duffel bag, sleeping bag, notebook and two markers, a box of white chalk, a couple pieces of charcoal, air filter & gas mask, walkie-talkie, portable computer, pocket flashlight, nightvision goggles, NEMA uniform and I.D., small wardrobe, and a few personal items. Vehicle typically fits one of the character's Piloting skills.

**Money:** NPCs, villains and lone-wolfs start with 2D4x100 credits and whatever they can scrounge, trade for or take from the enemy (Anarchist and evil characters may steal from NEMA and others). They are on their own which is why they may establish a small underground or brotherhood organization of fellow DW Hunters and typically befriend and associate with militia groups and support networks of sympathizers and like-minded civilians. Most paranoid vigilantes and paranoid survivalists consider DW Hunters to be welcomed and exalted allies and traveling judges and heroes.

There was never a "Demon or Witch Hunter" in NEMA before the Great Cataclysm. Under the circumstances, they get limited access to NEMA equipment, supplies and services as well as a safe roof over their head, food, clothing, and all other basics provided free, plus limited access to NEMA military facilities. Pay is a meager 350 credits a

month, mainly as an incentive for morale, but the consultant also enjoys the protection and camaraderie of the NEMA soldiers and the respect and glory of being a member of NEMA, which more than make up for the pitiful salary. The character starts off with two 2D4x100 credits in savings.

**Cybernetics:** Typically starts with none and keeps it that way.



## NEMA Volunteer Militia Fighter

As volunteers, many have had no formal military training but most have physical skills and some weapons expertise. Volunteers with medical, communications or other formal skills are put to work in other capacities, the Militia Fighter is the poor

man's grunt. Mostly jocks, ex-military and athletes apply for this position. Many are well intentioned and want to help defend and protect the community. Others are either glory hounds or angry vigilantes looking for the means to get a little payback. Most are reasonably good at following orders. Duty usually includes city, neighborhood and perimeter patrols, guard duty, armed escort duty, assisting NEMA operatives in police and military operations, and defense, as well as assisting in manual labor such as loading and unloading supplies, construction, etc., and rescue work, namely hauling away debris, helping in digs, running for medical supplies, etc.

### Volunteer Militia

**Attribute Requirements:** A good P.S. and P.E., a fighting spirit, readiness to help and a willingness to follow orders. 60% are male, 40% female.

#### O.C.C. Skills:

- Math: Basic
- Language, Native: Standard.
- Language, Foreign: One of choice (+10%).
- Literacy, Native: Standard.
- Military Etiquette (+5%)
- Radio: Basic (+5%)
- First Aid (+10%)
- General Athletics or Aerobic Athletics
- Climbing or Spelunking (+5%)
- Running or Swimming (+10%)
- W.P. Knife (includes Vibro-Knives)
- W.P. Automatic Pistol or Revolver (pick one)
- W.P. Energy Rifle

Hand to Hand: Basic, which can be changed to Expert at the cost of one "O.C.C. Related Skill" or Martial Arts for the cost of two skill selections.

**O.C.C. Related Skills:** Select one Ancient W.P., one Modern W.P., and six other skills. Plus select one additional skill at levels 4, 8, 12, and 15. All new skills start at level one proficiency.

- Communications: Performance or TV/Video only.
- Domestic: Any (+10%).
- Electrical: Basic only.
- Espionage: None.
- Horsemanship: Any, except Cowboy.
- Mechanical: Automotive and Basic Mechanics only (+5%).
- Medical: Brewing and First Aid only.
- Military: None.
- Physical: Any.
- Pilot: Basic vehicle types only (+5%), no military vehicles, power armor, robots or jet aircraft.
- Pilot Related: Read (& Operate) Sensory Equipment.
- Rogue: Gambling (either) and Streetwise (either) only.
- Science: Any, except Artificial Intelligence.
- Technical: Any (+5%).
- W.P.: Any, except W.P. Heavy Weapons, W.P. Heavy Energy Weapons, and Sharpshooting.
- Wilderness: Any (+5%).



**Secondary Skills:** The character also gets three Secondary Skills at level one, and one additional at levels 4, 8, and 12. These are additional areas of knowledge that do not get the advantage of the bonus listed in parentheses. All start at the base skill level and normal restrictions apply.

**Standard Equipment:** Khaki fatigues for a uniform, M.D.C. armored vest (covers chest and belly, 30 M.D.C., A.R. 11), standard helmet with visor and air filter (70 M.D.C.), LSR-250 Laser Rifle and two extra E-Clips or conventional S.D.C. assault rifle, and any approved weapon from the volunteer's own collection, two smoke grenades, two flares, one Vibro-Knife or Neural Mace, survival knife (1D6 S.D.C.), utility belt, canteen, First Aid medical kit, flashlight, disposable cigarette lighter, air filter & gas mask, walkie-talkie, and some personal items. Additional weapons, heavy weapons, explosives, gear and vehicles *may* be made available for special and specific assignments.

**Money:** These are volunteers, they don't get paid, though they may enjoy the perks of free meals and medical treatment (the latter for them and their family members), and the occasional item given to them as a favor/reward. For most, the opportunity to fight alongside NEMA or to fight to defend their homes is payment enough. Character starts off with 5D6x100 credits.

**Cybernetics:** Typically none.

## Magic & Psychic O.C.C.s

Psychic and magic characters for *Chaos Earth*® shall be presented in a future sourcebook.

## Other Chaos Earth® O.C.C.s

Any common O.C.C. like a modern day soldier, policeman, doctor, etc., can be built using existing Palladium games and skills. Books like *Heroes Unlimited*™, *Ninjas & Superspies*™ and *Systems Failure*™ may be useful to this end. *Beyond the Supernatural*™ too, although parapsychology is a fledgling science viewed with suspicion even in the Golden Age of Humankind. Game Masters who might want to bring BTS characters into the mix can do so using spell casters as members of secret societies, cults and such, however, *magic* is considered fantasy and make-believe in this era. Thus, Earth's scientists and men of learning are ill-prepared for magic when it appears. None understand how it works and there are no sorcerers. The mystic arts come later.

---

# NEMA Weapons & Equipment

---

**Cost & Availability:** Most high-tech and Mega-Damage weapons, body armor, vehicles and equipment are exclusive to NEMA and the military of North American nations. Any such items outside of NEMA or rogue military operations were found or stolen and sell for tens of thousands of credits or the equivalent in trade. Furthermore, the costs of all high-tech and Mega-Damage weapons are high and soaring as the destruction continues and available resources dwindle.

Already, depending on where one is located, even ordinary items such as clean drinking water, food, medical supplies, and even clothing and basic goods are selling at prices two to ten times higher than before the Great Cataclysm. That means a dozen eggs or a single bottle of water might sell for 4-20 credits, a bottle of aspirin 10-50, a new blanket for 20 to 100, and so on. And it will only get worse as available supplies dwindle and manufacturing facilities fail or are destroyed.

**Social-Economic Note:** One of modern society's greatest weaknesses, especially nearly 100 years in the future, is that the average person has limited knowledge and skill in what were once considered common skills or even "arts and crafts." Consequently, a tiny percentage of people possess basic carpentry, building or survival skills, or know how to farm, hunt, sew, knit, weave, preserve food or even cook. Thus, even the most basic skills necessary in a wilderness or apocalyptic situation must be rediscovered and taught. This is a contributing reason why so many cities experience immediate panic as people used to restaurants and skilled professionals to provide their basic, day to day needs, are suddenly on their own. Without them they are lost and panic stricken.

## Neural Mace

A hand-held weapon used by NEMA, the military and police for riot control and special operations. The Neural Mace is effectively a stun weapon that releases an energy charge that temporarily short-circuits the nervous system.

**Damage:** Nonlethal; the victim who is *stunned* is -8 to strike, parry, and dodge plus the character's speed and number of attacks per melee round are reduced by half.

The accumulative effect on the nervous system of the body being repeatedly struck and stunned may knock the victim unconscious, even if he has previously saved. After being struck more than four times, the unprotected character may be stunned into unconsciousness for 2D4 melee rounds. When he recovers, he will suffer the stun penalties described under *Damage* for 1D4 minutes. Roll to save, a failed roll means there is a 01-42% chance of being rendered unconscious. Note that in this case, even if the individual remains conscious, the charge will impair his movement as per the penalties previously described.

Physical damage from the mace is 2D4 S.D.C. plus any applicable P.S. attribute bonus. However, the mace is made from M.D.C. materials and can be used to parry M.D. attacks from Vibro-Blades, cyborgs, power armor and tooth and claw attacks from monsters and demons.

**Duration of Stun Effects:** 2D4 melee rounds. The duration of the impairment is increased 2D4 melee rounds for *every* hit from the mace in which the character does not save.

**Save vs Neural Mace:** 16 or higher; the same as saving against non-lethal poison. The character must save each time he or she is struck. A *successful save* means the character loses initiative and one melee attack/action that round but is otherwise okay.

**Note:** The mace is *ineffective* against environmental, M.D.C. body and power armor, but is effective against characters in half suits or body armor without a helmet (not fully environmental without the helmet attached). Most mortal alien beings suffer the same penalties and effects as humans. Lesser supernatural beings, dragon hatchlings and minor creatures of magic (like Faeries and Pixies) suffer half the usual penalties for half the duration. Major supernatural beings, Elementals of all kinds, energy beings, adult dragons, some alien beings, most powerful Mega-Damage creatures (have more than 150 M.D.C.) and powerful creatures of magic are completely impervious to this weapon.

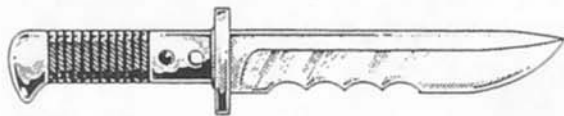

## Vibro-Blades & Other Hand Weapons

Vibro-Blades are a very recent creation specifically developed with NEMA in mind. These unique, relatively small and lightweight blades serve as both a *tool* and a close-combat *weapon*, but were initially conceived as “tools” enabling rescue teams to slice and chop through dense, hard S.D.C. materials and M.D.C. structures to get to victims trapped under or in them. A NEMA rescuer can, for example, cut through a heavy metal girder or concrete pillar with two to five strokes of a Vibro-Knife (depending on the size) and one or two strokes from a Vibro-Fire Axe or Vibro-Sword. Likewise, Vibro-Blades can hack through dangling wires, metal grating, security fencing, and similar debris barriers with a single stroke, like using a machete to slice through vines and vegetation in a jungle. Large blocks and walls of concrete can also be hacked into smaller, more manageable pieces, locks and sliding bolts sliced like butter, and even escape routes chopped through walls, floors and ceilings, though the latter can take several minutes. Consequently, *every* official NEMA operative has a Vibro-Knife, officers a Vibro-Knife and Sword (typically a Saber), and those who specialize in Rescue or Special Operations, a Vibro-Knife and a Vibro-Fire Axe or large Vibro-Sword. The military applications are obvious. Select officers and trusted rescue or medical personnel in the volunteer forces and militia who have proven themselves in the field *may* be given a Vibro-Knife and occasionally a Vibro-Fire Axe but nothing else.

**Medical applications:** The cut from a Vibro-Blade, when done correctly, can amputate a limb, even a leg, with a single stroke. The cut is so quick and clean that the patient feels only the slightest sensation of pain and medical personnel can immediately work to tie off arteries and seal the wound with an instant spray-on bandage to have the patient ready for transport in a matter of minutes. Some can even be evacuated on crutches under their own power. Unfortunately, the Vibro-Knife is as small as available technology can make a Vibro-Blade. Before the Apocalypse, several technology firms were working on developing a Vibro-Scalpel, though they were years away from perfecting one.

**Note:** All Vibro-Blades are weapons surrounded by an invisible high-frequency energy field that gives them Mega-Damage capabilities.

**Vibro-Fire Axe:** Axe Blade: 2D6+2 M.D. or 3D6 S.D.C. when used as a conventional blade weapon. Studded Handle: 2D4+2 (or 1D10) S.D.C., Spiked Handle (end): 2D4 S.D.C. for stabbing attacks, and Blunt Handle Strike: 1D6 S.D.C.; add P.S. attribute and/or Hand to Hand combat skill damage bonuses (if any) to S.D.C. based attacks.

**Vibro-Knife:** 1D6 M.D.

**Vibro-Saber (short sword):** 2D4 M.D.

**Vibro-Sword (larger, one-handed sword):** 2D6 M.D.

**Giant-Sized Sword:** 3D6 M.D.; sometimes used by oversized power armor suits.

**Vibro-Forearm Claws:** 2D6 M.D., usually two or three hooked blades sometimes attached to a forearm gauntlet or protective plate. Great for parrying and slashing. Typically used by military Special Forces, not NEMA.

**Note:** The corresponding ancient *Weapon Proficiency skills* (W.P. Knife, W.P. Sword, W.P. Axe) and bonuses from those skills apply to both conventional S.D.C. weapons and to Vibro-blades. Claws fall into the W.P. Knife category.

**Cost & Availability:** Exclusive to NEMA and the military elite of North America. Any Vibro-Blades outside of NEMA were found or stolen and sell for upwards of 10,000 credits or equivalent in trade; double for the larger weapons.

## Laser Scalpel

A medical tool designed for surgery of all kinds. At a quick glance it looks like a thick, high-tech pen or some kind of a laser pointer. Some models have a conventional scalpel blade on the other end.

**Weight:** 6 ounces (170 grams).

**Damage:** The scalpel has several settings for under one S.D.C./Hit Point of damage and can inflict as much as 2D4 S.D.C./Hit Points. It is not intended as a weapon.

**Range:** Two feet (0.6 m) maximum; usually inches.

**Payload:** Two hours of surgery without an additional external battery pack or the equivalent of twenty 2D4 S.D.C. energy blasts. 24 hours with an E-Clip or cell phone-sized battery pack; wireless, but the energy pack must be within six feet (1.8 m) of the scalpel. It is usually worn by the surgeon in a pouch attached to his belt or strapped to the shoulder.

**Cost & Availability:** 36,000 credits for the laser scalpel, 10,000 for the wireless battery pack. Poor availability even within NEMA; fair to good at hospitals, but limited quantities.



Note: Sometimes used by engineers and mechanics for delicate electrical work, cutting and soldering.

## Laser Pen (tool)

A mechanic's tool designed for cutting, soldering and burning away material to get at wires, etc. The range enables the user to reach areas that might otherwise be difficult to reach or inaccessible. Roughly the size of a screwdriver or small flashlight with a narrow tip. Used by NEMA for both rescue operations and mechanical repairs.

Weight: 9 ounces (255 grams).

Damage: The laser pen has several settings: 1D4, 1D6, 2D6 and 3D6 S.D.C./Hit Point damage, though it is not intended as a weapon.

Range: 10 feet (3 m) maximum; usually inches to a foot or two (0.3 to 0.6 m).

Payload: One hour of near constant use without an additional external battery pack or the equivalent of 50 2D6 or less blasts or 35 3D6 S.D.C. blasts. 18 hours with an E-Clip or cell phone-sized battery pack; wireless, but the energy pack must be within six feet (1.8 m) of the laser pen. It is usually worn by the operator in a pouch attached to his belt, stuck in a boot or strapped to the shoulder or chest.

Cost & Availability: 48,000 credits for the laser pen, 10,000 for the wireless batter pack. Poor availability outside of NEMA, but was available and used by high-tech factories and civilian and military engineers/mechanics.

## Laser Torch (tool)

An advanced welding and cutting tool that resembles a small, snub-nosed gun. S.D.C. models could use the new wireless battery technology, but M.D.C. energy levels cannot be transmitted without burning the operator, so Laser Torches with Mega-Damage capabilities are attached to a hip battery pack the size of a canteen with a thin, flexible cord. Military versions (NEMA has both) are powered by two standard E-Clips, the same kind as used in many of the energy weapons. Used by NEMA for both rescue operations and mechanical repairs.

Weight: One pound for the gun-like torch (0.45 kg) and 2.3 pounds (1 kg) for the battery pack.

Damage: The Laser Torch has several settings:

S.D.C.: 1D6, 2D6, 3D6, 6D6 and 1D6x10 S.D.C./Hit Point damage.

M.D.: 1D4, 1D6, 2D4, 3D6 and 4D6.

Range: 10 feet (3 m) maximum; usually inches to a foot or two (0.3 to 0.6 m).

Payload: Commercial S.D.C. version can use the wireless battery same as the Laser Pen, providing 20 minutes of constant use without an additional external battery pack or 20 3D6 or less damage energy blasts or ten 6D6 S.D.C. blasts (1D6x10 not possible). 10 hours with an E-Clip or cell phone-sized wireless battery pack, but the energy pack must be within six feet (1.8 m) of the laser torch. It is usually worn by the operator in a pouch attached to his belt, stuck in a boot or strapped to the shoulder or chest.

Heavy Industry and Military Grade Mega-Damage Laser Torch is attached to a hip-pack battery capable of 24 hours of S.D.C. level use or two hours of continuous M.D.C. level use. Capable of firing 100 energy blasts that do 2D6 M.D. or less, or 40 that do 3D6 or 4D6 M.D., but range is a pathetic 10 feet (3 m); never intended to function as a weapon.

Cost & Availability: 40,000 credits for the S.D.C. torch with wireless battery pack, and 68,000 for the M.D. torch and attached battery. Fair availability outside of NEMA for the commercial S.D.C. variety, poor availability of the M.D. torch outside of NEMA.

## Plasma Torch (tool)

An advanced Mega-Damage welding and cutting tool that resembles a larger, heavy version of the Laser Torch with a heavier cable and large, backpack-sized battery. Used exclusively by NEMA, the Military and manufacturers of Mega-Damage armor, robots, vehicles and materials. Used by NEMA for both rescue operations and mechanical repairs. A Plasma Torch can cut through even the hardest and densest S.D.C. materials like a hot blade though soft plastic and is essential for cutting through Mega-Damage armor and materials used by the military and as construction materials in the most advanced buildings. Furthermore, in the Chaos Earth setting, a Plasma Torch is also a useful defense against supernatural beings vulnerable to heat and fire, often inflicting double damage. Unfortunately, its limited range as a tool makes its effectiveness as a weapon suitable only in close combat situations.

Weight: 1.6 pounds for the gun-like torch (0.72 kg) and 12 pounds (5.4 kg) for the battery pack.

Damage: The Plasma Torch has several settings:

S.D.C.: 1D6x10 and 2D6x10 S.D.C./Hit Point damage.

M.D.: 1D4, 1D6, 2D6, 4D6 and 6D6.

Range: For welding and cutting, six inches to two feet (0.15 to 0.6 m), a concentrated precise point of energy. As a ranged weapon, the Plasma Torch can fire a flamethrower like blast up to 50 feet (15.2 m); can be an S.D.C. or M.D. energy blast of any magnitude indicated under damage.

Payload: Capable of 60 hours of S.D.C. level use or five hours of near continuous M.D.C. level use. Capable of firing 400 S.D.C. energy blasts (either) or 100 2D6 or less M.D. blasts or 50 of 4D6 or 6D6 M.D. energy blasts.

Cost & Availability: 90,000 for the M.D. Plasma Torch and attached battery pack. Very poor availability outside of NEMA or the military.

## Mega-Damage Explosives

### Fusion Blocks

A fusion block is a little square case about the size of a hand-held computer. On top of the block is a small key pad for programming the time of detonation. An automatic 30 second delay is built into each fusion bomb as a safety feature to avoid instant detonation.

Mega-Damage: There are three types of fusion block bombs.

Light: 1D4x10 M.D.; cost: 1000 credits.

Medium: 2D6x10 M.D.; cost: 3000 credits.



Heavy: 4D6x10 M.D.C.; cost: 8000 credits.

**Blast Radius:** Each has a contained blast radius of 10 feet (3 m).

**Range:** The blocks are made for placement, not throwing or shooting, however one can try throwing the explosive, typical range is 1D6x10 feet (3 to 18 m); fusion blocks are not aerodynamic.

**Cost & Availability:** Listed with damage, above. Exclusive to NEMA and the military, virtually unknown to the civilian population.

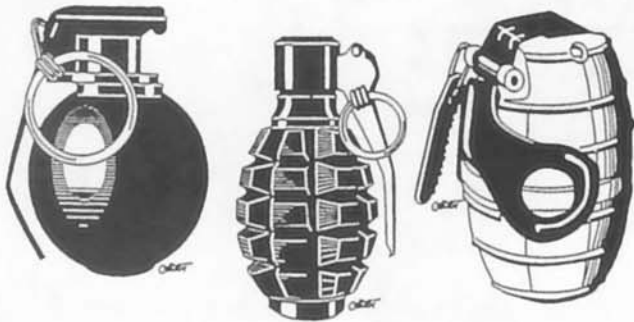

## Hand Grenades

Smaller explosive canisters designed for throwing and exploding.

**Fragmentation:** 2D6 M.D. to a 20 foot (6 m) area.

**Light High Explosive:** 3D6 M.D. to a 6 foot (1.8 m) area.

**Heavy High Explosive:** 4D6 M.D. to a 6 foot (1.8 m) area.

**Plasma:** 5D6 M.D. to a 12 foot area (3.6 m) area.

**Effective Range Throwing a Grenade:** About 40 yards/meters (120 feet/36 m).

**Cost & Availability:** 200 credits for fragmentation, 150 credits for light high explosive, 250 credits for heavy high explosive, and 300 credits for plasma. Exclusive to NEMA and the military, poor availability to the civilian population.

**Stun/Flash Grenade:** This riot/anti-terrorist weapon is designed to disorient and confuse criminals who are holding hostages in confined places. The grenade makes a loud exploding boom and emits a bright flash followed by a shower of white-hot sparkettes and some white smoke. The flash, burning sparks, and smoke should blind and startle any character without environmental armor or protective goggles. The victims of a stun/flash grenade are -8 to strike, parry and dodge, -1 on initiative and lose one melee attack/action for the next 1D4 melee rounds (15 to 60 seconds). Even those in armor should be momentarily distracted for 1D4 seconds and lose initiative. **Cost:** 75 credits.

**Tear Gas Grenades:** The gas will instantly affect all characters without protective masks or environmental body armor. The eyes burn, sting and water profusely, causing great discomfort and making clear sight impossible. The gas also makes breathing difficult and irritates exposed skin. The effects last for 3D4 minutes. The 25 foot (7.6 m) cloud dissipates in about five minutes unless blown away by wind (dissipating more quickly in 1D4 minutes). The victims of tear gas are -10 to strike, parry and dodge, -3 on initiative and lose one melee attack/action for each of the next 1D6+1 melee rounds. Those in environmental armor are completely safe and not affected. **Cost:** 100 credits.

**Smoke Grenades:** This type of grenade releases a thick cloud of smoke that cover a 20 to 40 foot (6 to 12 m) radius. The smoke obscures vision in and through the cloud from those on the outside of it. Infrared cannot penetrate a smoke cloud or be used inside a smoke cloud. Those inside the cloud will be blinded and have trouble breathing while inside it. Those who are not protected by environmental suits or gas masks and goggles will be -5 to strike, parry and dodge and -1 on initiative. Attackers firing into/through the cloud are shooting wild. Note that passive night scopes will work in a smoke cloud. **Cost:** 40 credits.

**Hand-Held Flare:** This is the type of item truck drivers and road patrols use to signal for help or to warn others of an accident or danger. The flare burns for 20 minutes. **Cost:** One credit each.

**Parachute Flares:** This pyrotechnic device usually comes in a hand-held, throw-away launch tube. Three seconds after launching, the flare ignites into a bright sparking light that slowly drifts back down to earth. While in the air, the flare burns for 60 seconds and illuminates an area of roughly 150 feet (45.7 m) in diameter. **Cost:** 10 credits each. **Note:** This is NOT a weapon, but if shot into a person, the flare does 6D6 S.D.C. each melee round for one minute (four rounds). There is also a 50% chance of causing combustibles to catch fire.

## NEMA S.D.C. Firearms

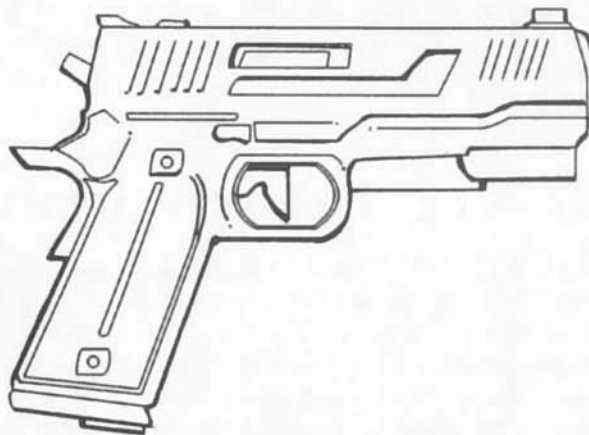

### NEMA Automag (AMT) Pistol

A heavy-duty, all-purpose S.D.C. weapon made of plastic and lightweight materials. The reduced weight and precision balance make skilled shooters more accurate. A standard side arm for officers and police operations in non-Mega-Damage situations.

**Weight:** 1.6 lbs (0.72 kg).

**Damage:** 5D6 S.D.C. per single shot or 1D6x10 S.D.C. per three round burst (one round typically misses or grazes the target). May substitute rubber bullets for riot control which do 1D4 damage per round or 2D4 per three round burst; reduce range by 30%.

**Rate of Fire:** Single shot or three round burst, either counts as one melee attack though the burst is less accurate.

**Maximum Effective Range:** 200 feet (61 m).

Payload: 18 round clip.

Bonuses: +2 to strike on an aimed/called shot only. No bonus for bursts and wild shooting.

Market Cost: 3,000 credits for the gun and 45 credits per box of 144 rounds. Poor availability outside NEMA.

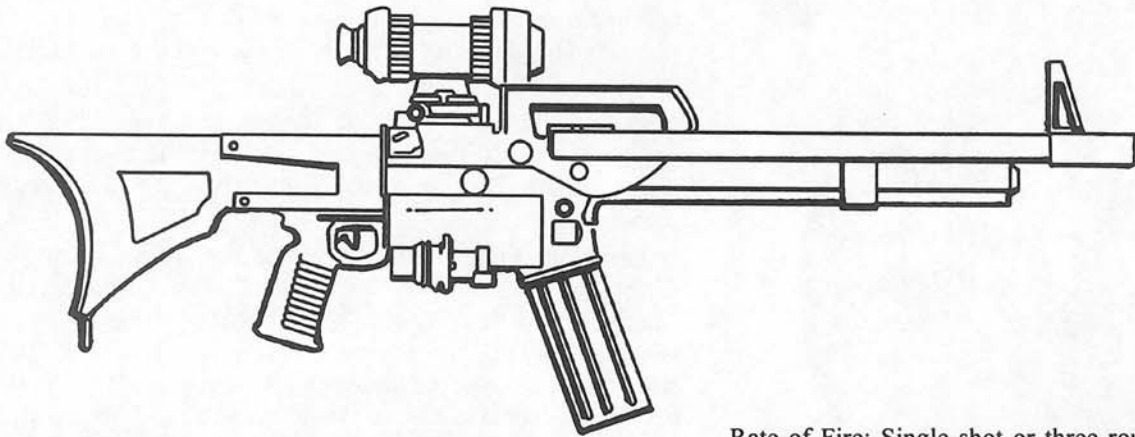

## NEMA 5.56 mm Assault Rifle

A heavy-duty, all-purpose S.D.C. weapon made of plastic and lightweight materials. The reduced weight and precision balance make skilled shooters more accurate.

Weight: 6 lbs (2.7 kg).

Damage: 5D6 S.D.C. per single shot or 1D6x10 S.D.C. per three round burst. May substitute rubber bullets for riot control which do 1D6 damage per round or 3D4+1 per three round burst, reduce range of rubber bullets by 30%.

Rate of Fire: Single shot or three round burst, either counts as one melee attack though the burst is less accurate.

Maximum Effective Range: 1400 feet (427 m).

Payload: Standard 48 round clip or 144 round drum.

Bonuses: +1 to strike on an aimed/called shot only. No bonus for bursts and wild shooting.

Market Cost: 6,000 credits for the rifle and 75 credits per box of 144 rounds. Poor availability outside NEMA.

Note: Quick learners, NEMA is manufacturing silver coated rounds for both the automag pistol and assault rifle.

## NEMA Mega-Damage Firearms

NEMA and the US military had Mega-Damage weapons, armor and vehicles as part of their standard issued armory. In the field, this made NEMA ground troops and rescue teams effectively supermen, and power armor units walking tanks who could ignore a hail of conventional S.D.C. bullets to focus on rescue operations, putting down riots or taking out terrorists with minimal fear of casualties. The implementation of Mega-Damage technology made NEMA incredibly effective, efficient and powerful.

In the past, NEMA would, of course, tailor its use of *force* according to the situation. They always used Mega-Damage armor, robots and vehicles, but weapons would be switched from non-lethal rubber bullets, Neural Maces, water cannons, and various smoke and gas weapons to S.D.C. batons and guns to heavy, anti-armor, anti-fortification Mega-Damage weapons. M.D. weapons were often deployed against terrorists because a single M.D. blast could stop even heavy conventional S.D.C. vehicles like a truck, bulldozer or aircraft in their tracks, and power armor and light M.D. weapons could punch through most walls, fortifications, and bunkers like they were made of cardboard. This enabled the NEMA anti-terrorist teams to strike quick, like lightning, shed bullets like raindrops and survive most homemade bombs and conventional grenades even at

point-blank range. For the most part, fewer than a dozen nations (the USA, Canada, Mexico, Germany, Japan, and in the last decade, Russia and China) possessed Mega-Damage capabilities and they were all very diligent about keeping the secrets of its manufacture and the actual weapons off the streets and out of the hands of other countries. When the Great Cataclysm struck, another half dozen nations, England, France and Australia among them, were just about to join the Mega-Damage community of nations.

In the current situation of Chaos Earth, NEMA has turned to the use of Mega-Damage weapons almost exclusively, particularly in combating supernatural beings, creatures of magic and military personnel turned rogue.

**Availability of Mega-Damage Weapons:** Exclusively the NEMA and the military. Any M.D. weapons in the hands of civilians are those found in abandoned weapon depots or national armories, or stolen. Rogue military and NEMA troops (i.e., soldiers who have abandoned their posts and gone AWOL or have turned into bandits, raiders or independent operators) may also possess Mega-Damage weapons, armor and vehicles and represent a secondary threat to NEMA security. These advanced weapons are highly coveted and NEMA agents and supply depots may find themselves targeted by thieves, rogues, and mercenaries.

All laser weapons, from pistols to cannons, have no “kick,” unlike projectile weapons which always have some noticeable degree of recoil and sound. Most laser weapons fire a short light beam or blast, rather than one long, continuous beam; mainly to conserve energy and to prevent the weapon from overheating. Range is double in outer space.

Lasers are also completely silent! The beams do not make any noise except for the click of the trigger, the soft hum of the energy clip and the sizzling “ssswhack” sound it makes when it hits (and sears through or into) its target. This is one reason lasers are preferred by assassins and snipers.

The sounds we, as players, *imagine* are the result of a lifetime of hearing movie and cartoon sound effects. From Star Wars and Star Trek to Lost in Space and Robotch, energy and laser-type weapons have always made cool sounds. Of course, explosions in space also have sound, but in real life, there would be no sound in space. The reason sound is added to these fictional portrayals is because the audience expects to hear something! And let’s admit it, we all love these sound effects. That having been said, I must admit that when I (KS) play Rifts, The Mechanoids or any game where energy weapons are used, I make sounds for them (I also do voices for characters, but that’s me). But this expectation holds true for the people of Chaos Earth too. Consequently, the manufacturers of laser weapons realize this, and for those who want them, actually build in cool *sound generators* for enhanced (psychological) effect and bigger sales. In most cases, weapons with sound generators, particularly all sniper laser rifles, have an “on and off” switch for the sound.

**Heavy energy weapons**, ion blasters, particle beams and plasma ejectors have some amount of recoil and typically a high-pitched whistle or whine of energy through the air, or a low thrum, or a short crack of energy as it erupts from the weapon.

**Rail guns** kick like a mule, sound like a machine-gun (along with a high-pitched whine the moment they are turned on), and weigh 5-10 times more than the average rifle. Some, like the Chromium Guardsman’s big, cannon-like gun, make a booming or exploding sound each time they are fired. Most characters with a P.S. lower than 20 cannot use a rail gun with any measure of accuracy (-4 to strike even on an aimed shot), unless the weapon is mounted on a tripod or vehicle turret, or braced against something solid and heavy like the hood of a vehicle, wall or boulder.

**E-Clips:** Energy Clips resemble the ammo clip for automatic weapons, except they don’t contain bullets, instead they are energy cells that provide the power to fire an energy blast whether it be a laser, ion or particle beam or plasma bolt. The greater the damage inflicted by the energy blast, the greater the drain on the E-Clip and the fewer shots available. Exclusive to NEMA and the military, who have three types of weapon energy cells or E-Clips. NEMA troops are provided with E-Clips and recharging as part of the military operation. Costs listed below are for those working outside of NEMA.

**Standard E-Clip:** The size of a typical ammo clip for an automatic weapon. Cost: 5,000-7,000 credits for a new, fully charged clip. 1,000-1,500 credits to recharge. Takes about 1D6+10 minutes to recharge. Typical Payload: 21 shots for light and medium weapons, 7-10 for heavy weapons.

**E-Canister:** A cylindrical canister typically used for heavy weapons, sometimes in conjunction with a standard E-Clip for greater versatility in the field of combat (i.e., if one kind of energy cell isn’t available the other can be substituted, or added to provide additional firepower). Typically offers 2-3 times the number of blasts available from a standard E-Clip. Cost: 10,000 to 20,000 credits and 3,000-5,000 to recharge. Takes about 3D6+30 minutes to recharge. Note: Only weapons designed to take a canister can use one.

**Power Packs:** Carried in a small backpack or hooked to a backpack, this energy cell is a canister or block with a power cable attached to an E-Clip that hooks into the weapon like usual, only the backpack pumps energy through the cable. Used to provide greater ammunition/shots (typically 5-8 times the number available from a standard E-Clip). Cost: 30,000 to 50,000 credits and 5,000-8,000 to recharge. Takes about 3D6+60 minutes to recharge. Note: Suitable for any energy weapon that takes a standard E-Clip. The weight of the backpack is 8 pounds (3.6 kg).

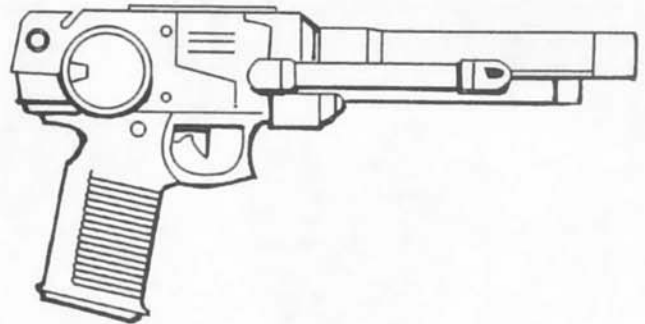

## NEMA PLP-20 “Police Special” Laser Pistol

This is the standard issue side arm for NEMA officers, peacekeepers, and Urban Assault teams for close quarter combat. Like all USA designed M.D. weapons, it is made of lightweight M.D.C. materials.

Weight: 2.6 lbs (1.2 kg).

Mega-Damage: 2D6 M.D. per single shot or 5D6 M.D. per triple pulse burst.

Rate of Fire: Single shots or short bursts, both count as one melee attack.

Effective Range: 1000 feet (305 m).

Payload: 21 single shots or 7 bursts per standard E-Clip; 168 single blasts or 56 bursts with a power pack.

Bonuses: +1 to strike on an aimed/called shot only, add another +1 to strike if the gun also has laser targeting. No bonus for bursts and wild shooting.

Cost & Availability: Exclusive to NEMA. Any laser pistols outside of NEMA were found or stolen and sell for upwards of 20,000 credits or equivalent in trade.

Note: 200+ years later, the Coalition States would copy this design as the C-18, though without the lightweight materials (no bonus) and a bit less fire power.



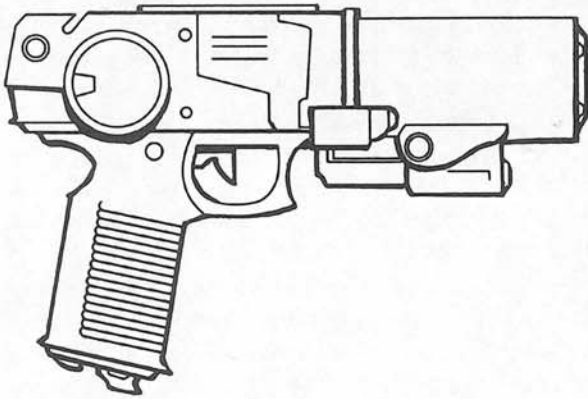

## NEMA MIP-21 "Crime Stopper" Maxi-Ion Pistol

A heavy, close combat weapon used by NEMA assault and extermination squads, Military Specialists and special teams who expect heavy enemy resistance. The infestation of supernatural monsters in the Chaos Earth setting makes this weapon highly coveted, and is standard issue for troops sent into "hot

zones" – places known or suspected to be thick with inhuman opponents. Standard issue to the Heavy Weapons/Pigman.

Weight: 3 lbs (1.35 kg).

Mega-Damage: Two settings: 3D6 M.D. per single blast or 1D4x10 M.D. per triple blast burst; both count as one melee attack/action, but a single blast gets benefit of maximum bonuses, a burst does not.

Rate of Fire: Single shot or three blast burst, either counts as one melee attack.

Effective Range: 800 feet (244 m).

Payload: 21 single shots or 7 bursts per standard E-Clip or 147 single blasts or 49 bursts using a power pack.

Bonus from Laser Targeting: Comes standard and provides a bonus of +1 to strike on an aimed shot; does not apply to burst attacks.

Cost & Availability: Exclusive to NEMA. Any ion pistol outside of NEMA was found or stolen and sells for upwards of 30,000 credits or equivalent in trade for the gun, 60,000+ for the backpack battery (which can be jury-rigged for other purposes).

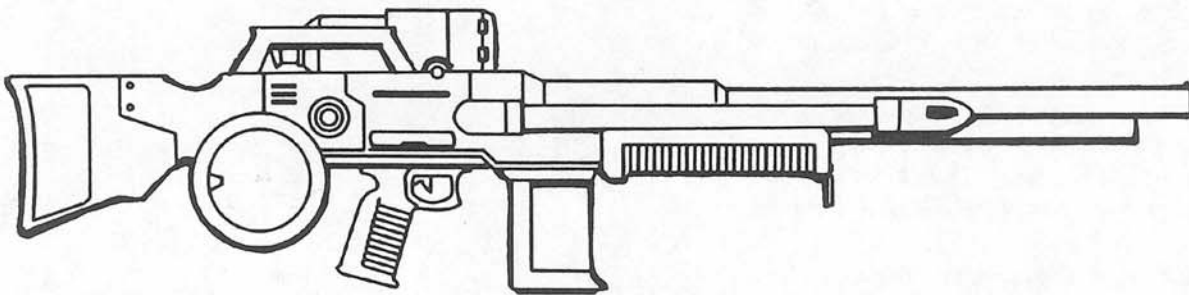

## NEMA LSR-250 Laser "Sharpshooter" Laser Rifle

This *was* the standard issue assault rifle for NEMA troops, however, with the Coming of the Rifts and supernatural beings with Mega-Damage hides, the LSR-250 has been replaced with heavier weapons. It remains a popular weapon because of its superior range, accuracy and durability, which makes it a favorite of snipers and Military Specialists. The LSR-250 is so reliable and durable that it can be left submerged underwater for more than 24 hours, take a beating and keep on working without losing its accuracy.

Weight: 5 lbs (2.3 kg).

Mega-Damage: Two settings: 2D6 M.D. and 4D6 M.D.

Rate of Fire: Single shot, with each blast counting as one melee attack.

Effective Range: 3000 feet (914 m).

Payload: 21 light blasts or 10 heavy per standard E-Clip or 168 light blasts or 84 heavy with a power pack.

Bonuses from Laser Targeting & Optics: Comes standard with laser targeting, telescopic and passive nightvision scope, which adds +3 to strike on an aimed shot, but only when the laser targeting system is functioning. Bonus is not applicable to wild shooting.

Cost & Availability: Exclusive to NEMA. Any laser rifle outside of NEMA was found or stolen and sells for upwards of 30,000 credits or equivalent in trade.

Note: 200+ years later, the Coalition States would copy this design as the C-10, though without the lightweight materials (no bonus), less fire power and shorter range.

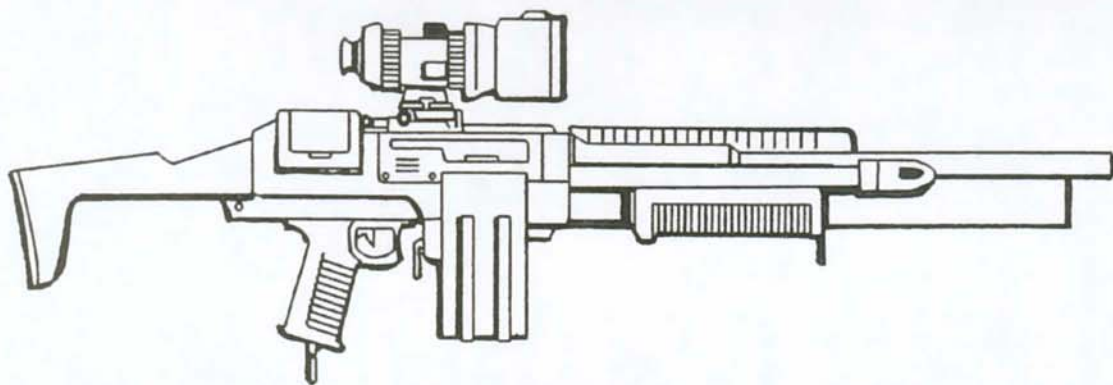

## NEMA LGR-360 "Terror Stopper" Laser Grenade Rifle

A durable and reliable assault rifle with dual functions that has replaced the LSR-250 as the standard weapon of NEMA's fighting forces. It can survive a great amount of combat abuse without mechanical failure. The rifle has a S.D.C. and M.D.C. settings, plus has a built-in, pump action, grenade launcher. Comes standard with a passive nightvision scope, telescopic sight and laser targeting. Its versatility (suitable for S.D.C. and M.D. situations) has made it a mainstay and favorite among most NEMA troops and militia volunteers.

Weight: 7 lbs (3.2 kg).

Damage: S.D.C. Damage: 5D6 S.D.C. per light energy blast or 3D6x10 per five round burst.

Mega-Damage: Laser: 3D6 M.D. per single shot or 6D6 M.D. per triple blast burst. Explosive grenades do 3D6 M.D. to a blast area of 12 feet (3.6 m), but may also fire smoke or gas grenades.

Rate of Fire: Single shot laser blast, laser burst or single shot grenade; each counts as one melee attack/action.

Effective Range: Laser: 2000 feet (610 m) – Grenade Launcher: 1200 feet (365 m).

Payload: Laser: 21 M.D. single blasts or 6 bursts from a Standard E-Clip, or 147 single blasts or 49 bursts using a power pack. Twenty times as many S.D.C. blasts.

Grenade Launcher: 8 plus an additional 24 to 48 grenades can be carried in a satchel or backpack, or 12 on a bandoleer style belt.

Bonuses from Laser Targeting & Optics: Comes standard with laser targeting, telescopic and passive nightvision scope, which adds +2 to strike on an aimed shot, but only when the laser targeting system and optics are in use. Bonus is not applicable to burst or wild shooting.

Cost & Availability: Exclusive to NEMA. Any laser rifle outside of NEMA was found or stolen and sells for upwards of 30,000 credits or equivalent in trade; rifle grenades go for 500+ credits each.

Note: 200+ years later, the Coalition States would copy this design as the C-14, though without the lightweight materials and with less fire power and versatility.

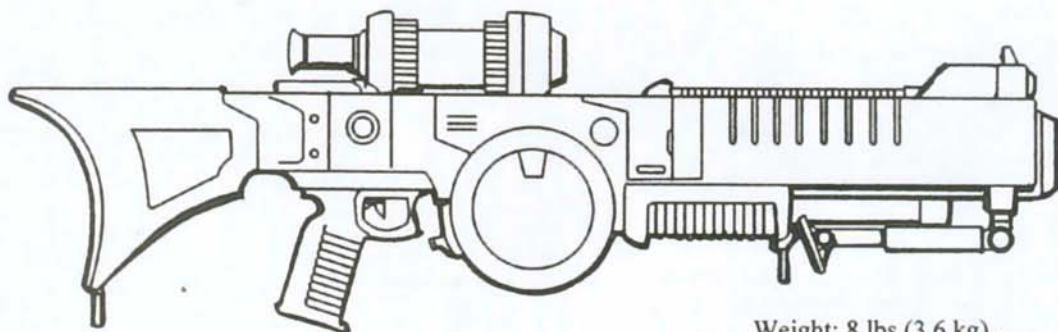

## NEMA PR-470 "Hot Seat" Plasma Rifle

The PR-470 is a heavy support infantry weapon seen as an anti-armor and anti-fortification weapon. Until the recent crisis, it saw very little action, but with the advent of the Coming of the Rifts and demon hordes, it has become a mainstay among NEMA troops, with at least one per squad. It is dependable and inflicts good levels of damage. Ideal against light to heavy M.D.C. armored troops, light vehicles, and, now, demons and monsters.

Weight: 8 lbs (3.6 kg).

Mega-Damage: 6D6 M.D.

Rate of Fire: Single shot, with each blast counting as one melee attack.

Effective Range: 1600 feet (488 m).

Payload: 7 single blasts per standard E-Clip, 21 using an E-Canister (can use both an E-Clip and an E-Canister for a combined 28 shots) or 147 blasts using a power pack (168 when combined with an E-Canister).

Bonuses from Laser Targeting & Optics: Comes standard with laser targeting, telescopic and passive nightvision scope, which adds +1 to strike on an aimed shot, but only when the laser targeting system is functioning. Bonus is not applicable to burst or wild shooting.



Cost & Availability: Exclusive to NEMA. Any heavy M.D. weapon outside of NEMA was found or stolen and sells for upwards of 60,000 credits or equivalent in trade.

Note: 200+ years later, the Coalition States would make a copy of this design known as the C-27 Plasma Cannon.

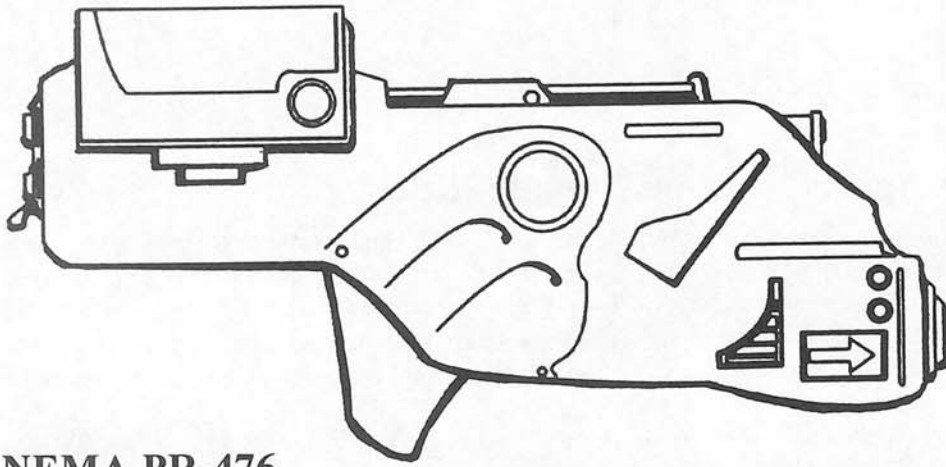

## NEMA PR-476

### “Incinerator” Plasma Cannon

The PR-476 is a unique heavy energy weapon that utilizes a new, experimental design. It is a little awkward and front heavy, but packs a wallop. It is a dual weapon system that fires single plasma blasts, plasma pulses (bursts) and a plasma mini-missile (the latter from the lower housing). Actually, it can fire any type of mini-missile, but plasma is the standard issue. Used primarily by the Military Specialist, Special Forces and the Heavy Weapons Pigman. Even NEMA has a limited supply of this weapon.

Weight: 12 lbs (5.4 kg).

Mega-Damage: 4D6 M.D. per single blast, 1D6x10 per triple blast burst, and 1D6x10 from the mini-missile.

Rate of Fire: Single shot or burst, with either one counting as one melee attack.

Effective Range: Plasma bolt: 1800 feet (548.6 m). Mini-Missile: One mile (1.6 km).

Payload: 10 single blasts or 3 bursts per standard E-Clip, 21 using an E-Canister (can use both an E-Clip and an E-Canister for a combined 31 shots), or 147 single blasts or 49 bursts using a power pack (168 or 56 bursts when combined with an E-Canister).

Bonuses from Laser Targeting & Optics: Comes standard with laser targeting, thermo-imager, telescopic and passive nightvision scope, which adds +1 to strike on an aimed shot, but only when the laser targeting system is functioning. Bonus is not applicable to burst or wild shooting.

Cost & Availability: Exclusive to NEMA. Any heavy M.D. weapon outside of NEMA was found or stolen and sells for upwards of 60,000 credits or equivalent in trade.

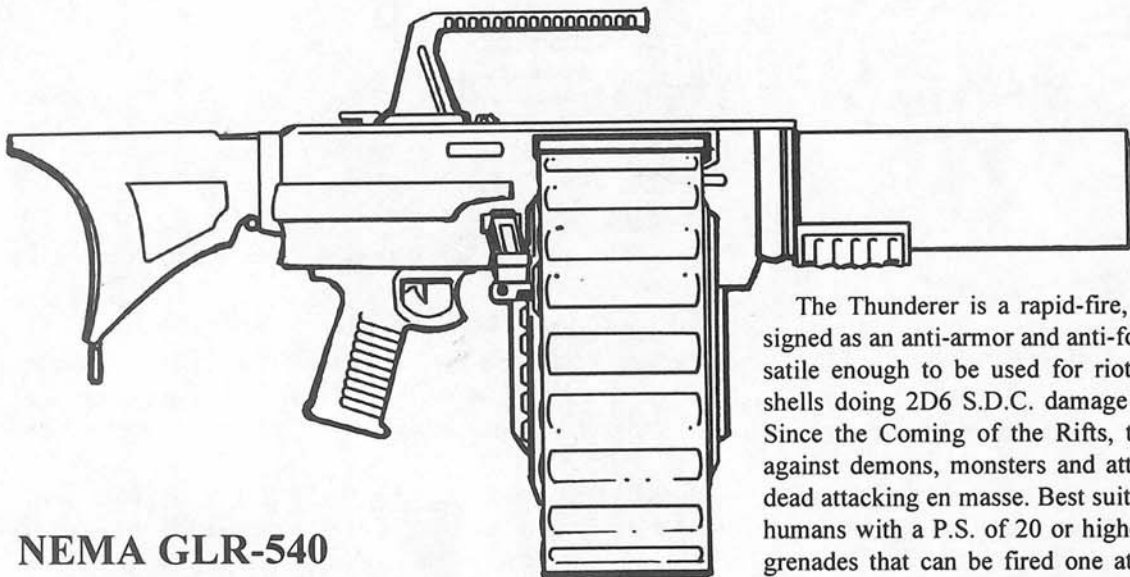

## NEMA GLR-540

### “Thunderer” Grenade Rifle

The Thunderer is a rapid-fire, heavy weapon originally designed as an anti-armor and anti-fortification weapon, but is versatile enough to be used for riot control (firing heavy rubber shells doing 2D6 S.D.C. damage or gas and smoke grenades). Since the Coming of the Rifts, this weapon has proven ideal against demons, monsters and attacks by drones and animated dead attacking en masse. Best suited for cyborgs and augmented humans with a P.S. of 20 or higher. Its big drum holds 60 rifle grenades that can be fired one at a time or in bursts of three. Used primarily by the Military Specialist, Special Forces and the Heavy Weapons Pigman.



Weight: 36 lbs (16.2 kg) fully loaded; 7 lbs (3 kg) without the grenades and ammo drum.

Mega-Damage: A single explosive grenade does 3D6 M.D. to a blast area of 12 feet (3.6 m), but a triple round burst does 1D6x10 damage to a 16 foot (5 m) diameter. Explosive rounds may be substituted with rubber shells or smoke or gas grenades, typically used in riot control.

Rate of Fire: Single shot or burst, with either one counting as one melee attack.

Effective Range: 1600 feet (488 m).

Payload: 60 grenades. One or two additional loaded drums are usually carried in a satchel or backpack. Individual grenades can be carried in any number and in any variety loose in a bag, backpack, satchel or carrying case.

Cost & Availability: Exclusive to NEMA. Any heavy M.D. weapon outside of NEMA was found or stolen and sells for upwards of 60,000 credits or equivalent in trade.

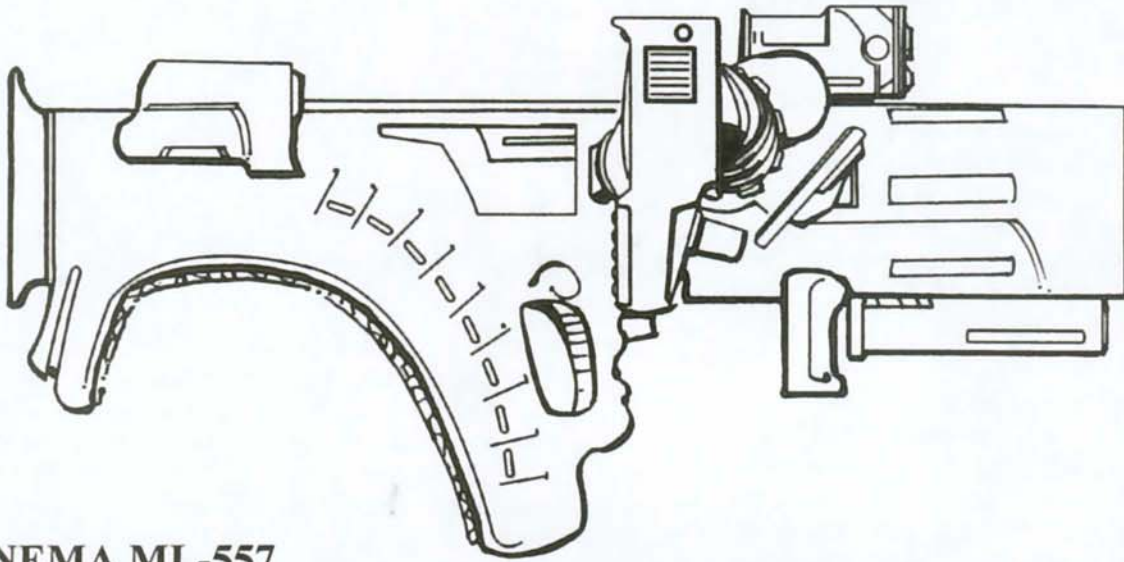

## NEMA ML-557

### “Destroyer” Mini-Missile Rifle

The ML-557 “Destroyer” is the latest heavy weapon to have been added to NEMA’s arsenal just a few months before the Coming of the Rifts. With the recent turn of events, it has proven to be a powerhouse defense against demons, dragons and other monsters, as well as swarming enemy attacks and power armor troops gone rogue. This weapon is physically heavy and best suited for cyborgs and augmented humans with a P.S. of 22 or higher (those with a P.S. of 18-21 are -2 to strike, those weaker than that are -5 to strike unless the weapon is braced). Mini-missiles (explosive rockets) are loaded in the back of the big gun, with three in the chamber ready to launch and three ready to cycle into launch positions. To use the weapon, it is hefted up onto one shoulder with one hand steadying and aiming using the forward handgrip and the other using the side mounted firing grip. A bipod is located in the front so the missile launcher can be braced on top of a vehicle, wall, window ledge, or other type of support (or cover) for better aim. Only characters with a P.S. of 28 or higher or supernatural strength can aim the weapon without bracing it on the shoulder and/or some other standing structure. May also be mounted on a vehicle, though not often. Used primarily by the Military Specialist, Silver Eagle SAMAS, Power Armor Pilots, Special Forces and the Heavy Weapons Pigman.

Weight: 40 lbs (18 kg) fully loaded; 27 lbs (12.1 kg) empty. Each missile weighs approx. two pounds (0.9 kg).

Mega-Damage: Any type of mini-missile can be used, but armor piercing (1D4x10 M.D.) and plasma (1D6x10 M.D.) are standard issue for maximum firepower against creatures with hides like iron.

Rate of Fire: Single shot or a burst of three missiles fired simultaneously (counts as one melee attack).

Effective Range: One mile (1.6 km).

Payload: Six mini-missiles fully loaded. An extra set of 6, 12 or 24 are available in a padded carrying case (the case has 35 M.D.C.), but the missiles need to be loaded by hand. Takes one melee round just to prepare for the loading process and two melee actions/attacks per each missile for the untrained, but a Pigman Grunt (a Heavy Weapons specialist), Chromium Guardsman, or Military Specialist can pop open the weapon in one melee action and load at a rate of one mini-missile per melee action.

Cost & Availability: Exclusive to NEMA. Any heavy M.D. weapon outside of NEMA was found or stolen and sells for upwards of 60,000 credits or equivalent in trade.

## NEMA R-660

### “Striker” Rail Gun

This is a light, all-purpose weapon designed to be used by a two-man human team, much the same as the two-man machine-gun teams used in the military for generations, or by cyborgs or genetically augmented troops or robots. The Striker rail gun is heavy and has a considerable “kick” to it, so only cyborgs and augmented humans with a P.S. 22 or higher can use the weapon without penalty (those with a P.S. of 18-21 are -2 to strike, those weaker than that are -5 to strike unless the weapon is braced). The Striker rail gun can use what is called a short clip with 200 rounds (10 bursts), light drum with 600 rounds (30



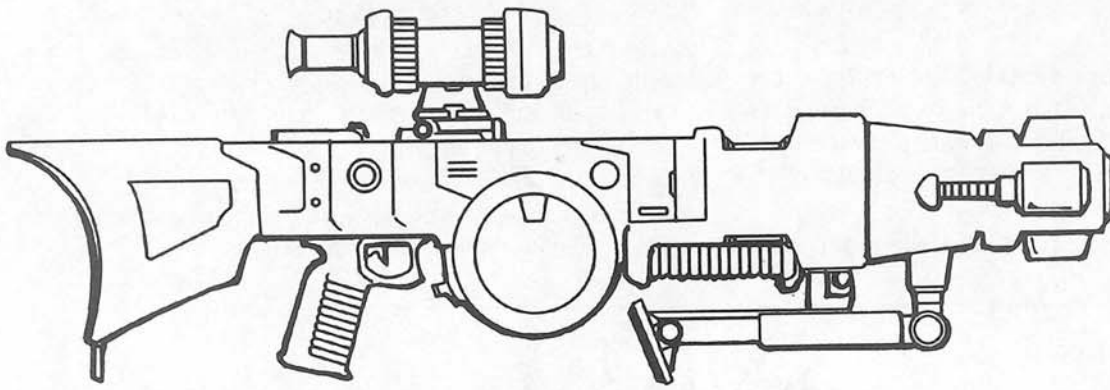

bursts), or a heavy belt-feed drum containing 2000 rounds (100 bursts). The latter is typically reserved for robots and cyborgs and is carried as a backpack or carried by the partner in a two-man power armor or cyborg team. The rail gun can also be mounted on a vehicle and used like an M.D. machine-gun. Used primarily by the Military Specialist, Power Armor troops, Special Forces and the Heavy Weapons Pigman.

Primary Purpose: Assault, anti-personnel.

Secondary Purpose: Defense, anti-light armor.

Weight: Gun: 40 lbs (18 kg), short clip: 10 pounds (4.5 kg), light ammo-drum: 30 pounds (13 kg), or a heavy ammo-drum: 100 lbs (45 kg). Ammo-drums are hooked to the back of body armor or on the back of a cyborg or robots. Combat Drones are used by Military Specialists and Pigmen to carry the heavy drum (and other equipment) like a humanoid mule or superhuman teammate in a two-man team. May also be mounted on vehicles or a tripod at a stationary position.

Mega-Damage: Short burst fires 10 rounds and does 2D6 M.D. A heavy burst fires 20 rounds and inflicts 4D6 M.D., a single round does 1D4 M.D.; each counts as one melee attack.

Rate of Fire: Single shot or burst.

Maximum Effective Range: 3000 feet (914 m).

Payload: The short clip holds 200 rounds and is capable of firing ten full damage bursts (20 rounds).

The light drum holds 600 rounds and can fire 30 bursts.

The 2000 round drum is capable of firing 100 full damage bursts (20 rounds each).

Reloading a drum will take about three minutes for those not trained, but a mere 30 seconds by a capable Field Engineer or Pigman: Heavy Weapons Specialist. A strength of 24 or higher is required to handle the heavy drum.

Special Features: Rail gun for human troops has its own laser targeting, telescopic and passive nightvision scope. The same weapon for the Combat Drone only has the laser targeting scope. Telescopic and laser targeting range is 6000 feet (1828 m). Targeting Bonus: +1 to strike.

Cost & Availability: Exclusive to NEMA. Any heavy M.D. weapon outside of NEMA was found or stolen and sells for upwards of 60,000 credits or equivalent in trade.

---

## NEMA R-670 "Lightning" Rail Gun

---

This is a heavy rail gun that fires a larger, heavier round. It is designed to be used by a two-man human team, or cyborgs, power armor troops, robots or mounted on a vehicle and used like an M.D. machine-gun. The Lightning is twice as heavy as the Striker and has a considerable "kick" to it. Only full conversion cyborgs and augmented humans with a P.S. 28 or higher can use the weapon without penalty (those with a P.S. of 22-27 are -2 to strike, those with a P.S. 18-21 are -5 to strike, and those weaker than that are -11 to strike unless the weapon is braced).

Used primarily by the Military Specialist, Power Armor troops, Special Forces and the Heavy Weapons Pigman.

Primary Purpose: Assault, anti-personnel.

Secondary Purpose: Defense, anti-light armor.

Weight: Gun: 82 lbs (37 kg), short clip: 20 pounds (9 kg), light ammo-drum: 60 pounds (27 kg), or a heavy ammo-drum: 200 lbs (90 kg). Ammo-drums are hooked to the back of power armor, full conversion cyborgs or robots. Combat Drones are used by Military Specialists and Pigmen to carry the heavy drums (and other equipment) like a humanoid mule or superhuman teammate in a two-man team.

Mega-Damage: Short burst fires 10 rounds and does 4D6 M.D. A heavy burst fires 20 rounds and inflicts 1D4x10 M.D., a single round does 2D4 M.D.; each counts as one melee attack.

Rate of Fire: Single shot or burst.

Maximum Effective Range: 3000 feet (914 m).

Payload: The short clip holds 100 heavy rounds and is capable of firing ten full damage bursts (20 rounds).

The light drum holds 600 rounds and can fire 30 bursts.

The 2000 round drum is capable of firing 100 full damage bursts (20 rounds each).

Reloading a drum will take about three minutes for those not trained, but a mere 30 seconds by a capable Field Engineer or Pigman: Heavy Weapons Specialist. A strength of 24 or higher is required to handle the heavy drum.

Special Features: Rail gun for human troops has its own laser targeting, telescopic and passive nightvision scope. The same

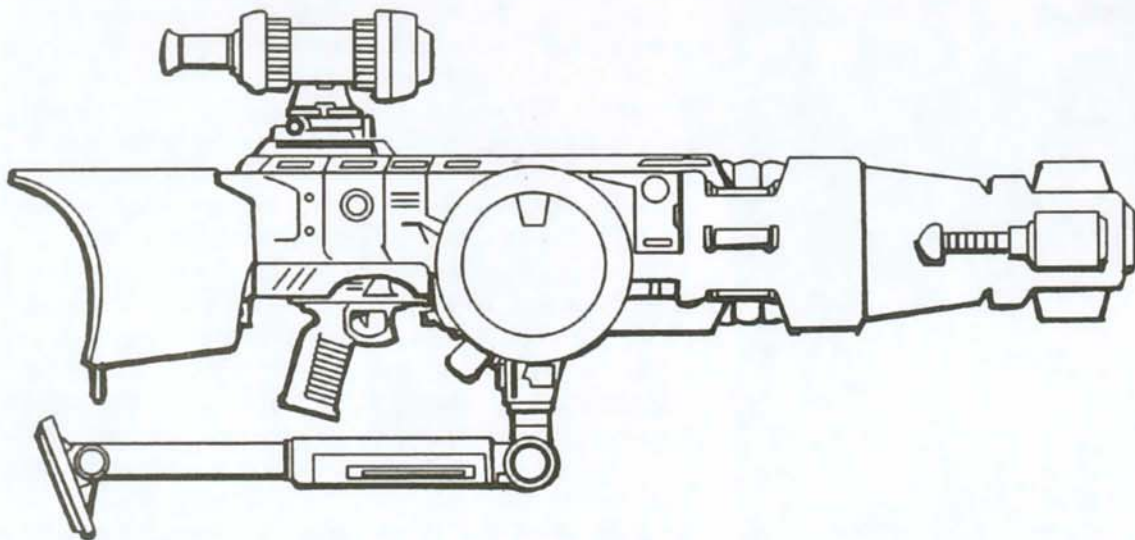

weapon for the Combat Drone or vehicles only has the laser targeting scope. Telescopic and laser targeting range is 6000 feet (1828 m). Targeting Bonus: +1 to strike.

**Cost & Availability:** Exclusive to NEMA. Any heavy M.D. weapon outside of NEMA was found or stolen and sells for upwards of 60,000 credits or equivalent in trade.

## NEMA Body Armor

### Armored Long Coat

The exact color and design varies to distinguish one division from another division, but the coat is basically the same underneath. It is a flowing long coat/trench coat style that ends just midway between the knee and the ankle. It is made of an M.D.C. fabric that combines spider's web with certain man-made miracle fibers and strategically placed lightweight padding and M.D.C. plating.

**Class:** LF-20 Light Armored Coat.

**Size:** Human equivalent.

**Weight:** 6 pounds (2.7 kg).

**Mobility:** Very good to excellent; -5% to climb, prowl, swim, acrobatics and similar physical skills/performance.

**M.D.C. by Location:**

Head/Helmet (optional; standard NEMA gear) – 70

Arms – 15 each

Legs (covered by coat) – 20 each

Main Body – 32

**Note:** An additional M.D.C. vest can be worn underneath for additional protection (30 M.D.C.). Use of the a helmet from the standard NEMA armor is highly recommended to protect the head and face, and to filter the polluted air.

**Special Weapon Systems or Features:** None other than color coded by division. There are also departmental and combat patches that may be worn on the uniforms, coats and armor.

**Power Armor Division:** Light blue and silver/puce.

**Robot Division:** Dark Navy blue and silver/puce.

**Peacekeepers/Combat Division:** Royal blue and light grey.

**Fire & Rescue Division:** Yellow and tan.

**Intelligence Division:** Black and grey.

**Military Specialists/Special Ops:** Completely black.

**Para-Arcane (volunteers):** Red and black.

**Demon-Hunter Division (volunteers):** Red and Grey.

**Militia Volunteers:** None; don't get an armored long coat; use military and police surplus.

**Cost & Availability:** Exclusive to NEMA and the military. Any long coats found outside NEMA or the military were found or stolen and sell for upwards of 20,000 credits or equivalent in trade.

### Mega-Damage Vest

**Class:** LV-10 Mega-Damage Vest.

**Size:** Human equivalent.

**Weight:** 6 pounds (2.7 kg).

**Mobility:** Excellent, no penalties.

**M.D.C. by Location:**

Main Body/Chest and upper torso (only) – 30

**Armor Rating:** 11 (A.R. 13 with helmet, A.R. 15 with additional strategic M.D.C. padding on the forearms, shoulders, knees and thighs; +10 M.D.C.). Any roll to strike above the A.R. (12 if vest only) hits the wearer and does full damage.

**Note:** Use of a helmet from the standard NEMA armor is highly recommended to protect the head and face, and to filter the polluted air.

**Special Weapon Systems or Features:** Comes in the colors white, tan, grey and black.

**Cost:** Exclusive to NEMA, the military and some federal and police agencies (SWAT teams). Availability on the street is poor, with the vest getting 8,000 credits and up.





## Standard NEMA Body Armor

NEMA armor is designed to provide maximum M.D.C. protection while affording good flexibility and mobility. The helmet is reinforced and padded, with a large poly-ceramic glass visor for clear line of vision and full peripheral vision. The visor is light sensitive, automatically darkening, like transition sunglasses in bright light, and UV coated to protect the eyes. Tar-

geting sights, coded messages, schematics, body armor system, damage reports, and other information is projected on the visor via the Heads Up Display (HUD) system. The built-in audio system with voice actuated radio makes hands-free communications easy and also provides a megaphone projection system to magnify the wearer's voice to address fugitives and criminals at a distance. Air filters and re-breather apparatus purge and clean the air. The overall helmet design is comfortable to wear.

The overlapping body plates are made of a new, lightweight, Mega-Damage material to provide lightweight maximum protection. The chest is reinforced and the abdomen is protected by a revolutionary flexi-plate system of armor that bends and slides to provide excellent mobility at the mid-section. The high armored collar protects the neck and the armor clips together like ski-boots, with Velcro strips and fasteners to hold pieces snugly in place. The armor is a clean, simple design of predominantly one color with a second color to denote trim and accents. The different colored armors simply denote different divisions within NEMA.

The armor offers Mega-Damage protection and complete environmental systems, making it a self-contained unit, like a spacesuit. Air filters, circulation and cooling, and independent oxygen supply (engages as needed) mean the wearer is protected from foul smells, toxic fumes, gas attacks, smoke, ash, pollutants and airborne particles. The suit is also radiation proof. The soldier becomes vulnerable only when the armored suit is breached or severely compromised. (Note: The armor's M.D.C. must be reduced to 15 points or less for a life threatening breach to appear and the environmental systems to fail. When the M.D.C. is reduced to zero, the armor is so battered and full of holes that it no longer offers Mega-Damage protection. At that stage it is equal to an A.R. 7, so even most S.D.C. attacks will penetrate and do damage direct to the body of the wearer.)

**Class:** EBA-130 Environmental Body Armor. Unisex design, same for males and females. Opponents cannot distinguish males from females until close enough to see the face, though females have slighter builds, and tend to be a bit smaller and shorter. Roughly 38% of all NEMA troops are females, some divisions are 50/50 or close to it.

**Size:** Human equivalent.

**Weight:** 12 pounds (5.4 kg).

**M.D.C. by Location:**

Head/Helmet - 70

Arms - 60 each

Legs - 80 each

Main Body - 120

**Mobility:** Good; -5% to climb and -10% to prowl, swim, perform acrobatics and similar physical skills/performance.

**Cost & Availability:** Exclusive to NEMA. Any found outside NEMA (or the military equivalent) was found or stolen and sells for upwards of 50,000 credits or equivalent in trade.

**Special Weapon Systems or Features:**

- Complete environmental battle armor (EBA) suitable for use in all hostile environments including underwater, toxic clouds of gas and outer space.

- Computer controlled life support system that monitors and displays bio-data of the wearer as well as the capacity and fail-



ure of life support systems and damage to the armor. The wearer will know *approximately* how much M.D.C. is remaining and whether or not the armor has been breached.

- A computer controlled, independent oxygen supply and purge system automatically engages in low oxygen or contaminated air environments. Five hour oxygen supply.

- Artificial air circulation systems, gas filtration, humidifier.

- Internal, voice actuated *support* computer and database. This secondary computer provides mathematical computations and serves as a database of basic military information, protocol, rules, laws and procedure. It also includes NEMA and military troop and vehicle recognition and identification based on verbal description or optical link (if it's not a friendly, it's probably an enemy). The computer can also read and do math for the soldier. This is done either by spoken word or with an optic link or multi-optic eye patch or bionic eye linked to the computer.

- Optional optic link attached to the armor, usually on the shoulder. This is a small camera about the size of digital camera or cell phone. It sends a constant live feed of everything the trooper sees and hears to a command post or mobile unit. Range of transmission is three miles (4.8 km), half that in or near ley lines due to dimensional and magical energy interference.

- Built-in loudspeaker; 80 decibels.

- Directional, short-range radio built into the helmet. Range is five miles (8 km).

- Internal cooling and temperature control.

- Insulated, high-temperature resistant shielding for up to 300 degrees centigrade. Normal fires do no damage. Nuclear, plasma, magic fires and Mega-Damage fire and heat do full damage.

- Radiation shielded.

- Polarized and light-sensitive visor with a tint that automatically adjusts to the level of available light.

- The helmet can be completely removed whole or just the top bowl and visor, or just the lower jaw portions with the air filter, re-breather and radio.

- Ammo and supply waist belt, shoulder belts, and shoulder holsters are all standard issue. Pilots and officers have the choice of shoulder or hip holster.

- Special optic and nightvision goggles can be slid into place over the helmet.

- Color: The different colored armor indicate different NEMA divisions:

Power Armor Division: Light blue with chrome highlights.

Robot Division: Dark Navy blue with chrome highlights.

Peacekeepers/Combat Division: Royal blue and with light grey highlights.

Fire & Rescue Division: Get their own unique body armor (description follows).

Intelligence Division: Grey with black highlights

Military Specialists/Special Ops: Completely black.

Para-Arcane (volunteers): Red with black highlights and accents.

Demon-Hunter Division (volunteers): Blood red and grey highlights.

Militia Volunteers: None. Volunteers use military and police

surplus or cobbled together armor of the owner's own design. Only top Militia officers are given NEMA EBA.



## Fire & Rescue Enhanced Body Armor

### Effectively a Light Power Armor

An experimental, enhanced, heavy body armor with an exoskeleton built into it makes the FR-EX 220. The exoskeleton enables ordinary humans to wear it and provides incredible armored protection and enhanced robotic strength and speed. This makes the EX wearer capable of lifting great weight, leaping over gaping holes and wielding heavy equipment with relative ease.

The suit also takes into consideration the extreme heat and conditions it and its occupant must endure. The reinforced helmet, with sloping flares, offers additional protection to the top, sides and back of the head and neck as well as deflects falling debris away from the body. The face plate is made of tinted, one-way ceramic glass; the wearer can see out, but others cannot see the face inside the armor. This is done to help conceal any signs of stress or worry and to add to the rescuer's aura of being



more than human. A pair of thick M.D.C. hoses (4 points each) extend from the side jaw area of the helmet and run to the back where they are attached to a supplemental oxygen tank attached to the back of the armor. The large, overlapping shoulder plates provide additional protection to the shoulders and collar bone, the chest plate is reinforced, and a long yellow smock made of M.D.C. materials hangs from the waist. The forearms are encased in thick armor with special built-in capabilities.

**Note:** The military was developing a similar enhanced body armor for use by Special Forces, commissioned officers, and heavy weapons specialists but the prototype was never put into field testing before the Great Cataclysm.

**Class:** FR-EX 220 Environmental Body Armor. Unisex design, same for males and females. Opponents cannot distinguish males from females, though females have slighter builds, and tend to be a bit smaller and shorter. Approximately 35% are female.

**Size:** Human equivalent; adds eight inches to the height of the wearer.

**Weight:** 70 pounds (31.5 kg), but the robotic exoskeleton disperses the weight and augments the wearer's strength so it feels lighter than the standard EBA.

**Color:** Yellow with silvery grey face plate and orange and black accents.

**M.D.C. by Location:**

Head/Helmet – 100

Upper Arms – 80 each

Forearms – 80 each

Legs – 90 each

Main Body – 150

**Mobility:** Good (augmented by exoskeleton); -5% to climb and -15% to prowl, swim, perform acrobatics and similar demanding physical skills/performance.

**Cost & Availability:** Exclusive to NEMA. Any found outside NEMA (or the military equivalent) was found or stolen and sells for upwards of 250,000 credits or equivalent in trade.

**Special Features:** Fundamentally the same as the standard NEMA body armor with the following additions.

**1. Light Laser Tool:** Used for cutting and welding. The triangulated beams fire from the two small holes in the top of the forearm casing to form one high-intensity beam.

**Mega-Damage:** Four settings: 1D6 S.D.C., 4D6 S.D.C., 2D4x10 S.D.C. and 1D4 M.D.

**Rate of Fire:** Single shot, each counting as one melee attack or a sustained beam to cut and weld.

**Effective Range:** 10 feet (3 m).

**Payload:** 20 shots per standard E-Clip.

**2. Laser Distancer:** Measures and indicates the exact distance of a target or item. Effective range: 1000 feet (305 m). Maximum range: 2000 feet (610 m) with a 20% margin for error. Built into the underside of the wrist in the forearm armor.

**3. HUD Multi-Screen:** A Heads Up Display (HUD) that can project data, charts or transmissions on the visor of the helmet for the wearer to see. As many as six different viewing sections/images can be projected without impairing the vision of the wearer.

**4. Optical Enhancements:** Hidden behind the face plate, the Roscoe can call upon a battery of optic systems that slide into place as needed. Passive nightvision (2000 feet/610 m range), telescopic (10x magnification, 6000 feet/1830 m range), macro-lens (6x magnification), thermo-imager (1000 feet/305 m range) and light filters.

**5. Exoskeleton Bonuses:** Adds the following bonuses and capabilities to the wearer: +10 to P.S. (equal to bionic strength), +14 to Spd, +10 feet (3 m) to the length and height of leaps, and reduce the rate of fatigue by 60%.

**6. Insulated, high-temperature resistant shielding** for up to 400 degrees centigrade. Normal fires do no damage. Nuclear, plasma, magic fires and Mega-Damage fire and heat do 10% less damage than usual.

---

## NEMA Vehicles

---

### NEMA HX-288

## “Street Tornado” Hovercycle

The Street Tornado is a fast, sleek hover vehicle that is a cross between a conventional hovercycle and a military rocket bike. It has one heavy-duty jet thruster in the back, plus four directional thrusters and ten tiny directional jets (mostly in the undercarriage) for excellent speed and control. Unlike most commercial hovercycles which do not exceed 200 mph (320 km) or a height of 20 feet (6.1 m), the HX-288 can rocket to speeds in excess of 300 mph (480 km) and an altitude of 2000 feet (610 m). This makes it suitable for high speed chases, street use, and able to reach the roof tops of buildings and skyscrapers. A special whisper mode quiets the powerful engine to purr softer than a new car, giving the rider some measure of stealth even on his hovercycle (-30% on the pilot's Prowl skill when flying along at 40 mph/64 km or slower). Weapon systems include a front laser turret and 4-6 mini-missiles, the latter mounted on the stubby wings. A very popular vehicle, second to the NEMA motorcycle.

### HX-288 All-Purpose Hovercycle

**Nickname:** The “Street Tornado” or just, “Tornado.”

**Class:** Aerial Military Combat Hover Vehicle.

**Crew:** One.

**M.D.C. by Location:**

\* Laser Turret (1; front) – 22

Front Windshield (1) – 10

\* Headlight (1) – 5

Rocket Jet (1; rear) – 65

Large, Rear Directional Jets (4, two on each side) – 15 each

\* Tiny Directional Jets (10) – 2 each

\* Tail Fin (1) – 25

\* Wings (2) – 35 each

\*\* Main Body – 118

\* Every item marked by a single asterisk is small and/or difficult to strike. An attacker must make a "called shot" to hit and even then he is -4 to strike.

Destroying one of the wings or tail inflicts a piloting skill penalty of -10% and reduces speed by 20%; accumulative damage and penalties for losing both wings and/or tail. Destroying one set of the rear directional jets negates the +2 to dodge bonus and reduces speed by 40% (or -20% per each of the four jets). Destroying both inflicts a piloting penalty of -70%. Destroying the rocket engine, only, means maximum speed is 250 mph (400 km). Destroying six or more of the tiny directional jets will eventually make the vehicle wobbly and -10% on piloting skill.

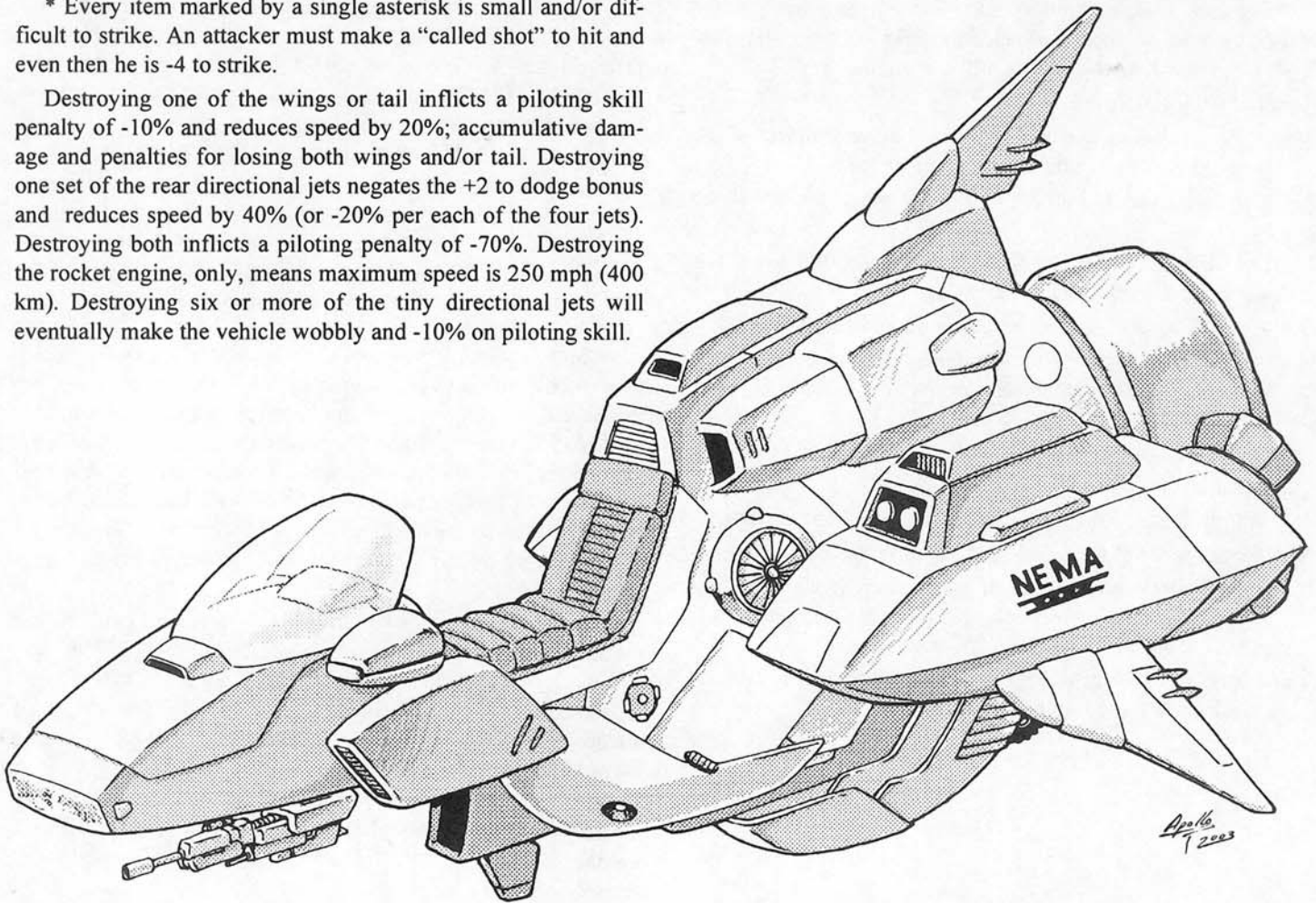

\*\* Depleting the M.D.C. of the main body completely destroys the vehicle.

**Speed:** Flying: 250 mph (400 km) maximum without the rocket thrusters engaged. 350 mph (560 km) with the thrusters engaged. Cruising speed, however, ranges between 70 and 150 mph (112 and 240 km). VTOL capable, can hover stationary, move in a straight line, up and down; retractable landing gear. Maximum altitude is limited to about 2000 feet (610 m).

Water: The Street Tornado can also skim across the surface of water at a speed of 210 mph (336 km/178.5 knots) or greater, but is not submersible.

Flying Range: The nuclear power supply provides the vehicle decades of life and it can be flown continuously for 12 hours without fear of overheating.

#### Statistical Data:

Height: 6 feet (1.8 m).

Width: 6 feet (1.8 m) from wing tip to wing tip.

Length: 13 feet (3.9 m).

Weight: 1000 pounds (450 kg).

Cargo: Only enough to stow an energy rifle, three E-Clips and a backpack (usually hooked to the outside), but it can pull up to one ton of cargo (reduce speed by 30% and rocketing is not possible without losing the cargo).

Power System: Nuclear, average cycle's energy life is 20 years.

Cost & Availability: Exclusive to NEMA and select Special Forces of regional police. Any found outside of NEMA were found or stolen and sell for upwards of 900,000 credits or equivalent in trade. Rare. **Note:** *Commercial hovercycles* usually have gasoline and electric engines or are solar powered, have a maximum speed of 200 mph (320 km), a maximum hover height of 20 feet (6.1 m; typically ride 3-5 feet/0.9 to 1.5 m above the ground), but could jump 100 feet (30.5 m) across and 40 feet (12.2 m) high. Main body has the equivalent of 6-12 M.D.C., with all other parts being S.D.C., there is no laser weapon, nor rocket thruster, and maximum range is 600 miles (960 km) per energy charge or 300 miles (480 km) per tank of gas. Solar engines recharge constantly, provided there is sufficient sunlight, with batteries topping off after six hours, but cost 20% more. Costs 400,000 credits, an extra 100,000 for maximum (12) M.D.C.

#### Weapon Systems:

**1. LHX-288 Rapid-Fire Pulse Laser (1):** A single-barreled laser built into the nose of the vehicle. Can rotate 180 degrees and has a 45 degree arc of fire.

Primary Purpose: Anti-personnel, assault and defense.

Mega-Damage: 2D6 per single blast, 6D6 per triple pulse. Each counts as one melee attack, but only the single shot can be aimed with precision.

Bonus: +1 to strike with a single, aimed shot, plus the shooter's usual bonuses to strike (use W.P. Energy Rifle), but only when



standing still. +1 to strike with no other bonuses when moving and firing a single shot. No bonus to strike with a pulse blast when moving, +1 when standing still and aiming.

Range: 2000 feet (610 m).

Rate of Fire: Equal to the number of hand to hand attacks of the pilot. Each shot or pulse counts as one melee attack.

Payload: Effectively unlimited; tied to the power supply of the vehicle.

**2. Mini-Missiles (4-6):** Two to three mini-missiles can be mounted on the underside of the wings.

Primary Purpose: Anti-armor, anti-aircraft, and anti-personnel.

Missile Type: Any type of mini-missile can be used, but standard issue is fragmentation (anti-personnel, 5D6 M.D.) and plasma (1D6x10).

Mega-Damage: Varies with missile type.

Range: About one mile (1.6 km).

Rate of Fire: One at a time or in volleys of two, three, or four.

Payload: Six missiles total, two or three on each stubby wing.

**3. Sensors/Communications:** Long- and short-range radio and short-range radar (can track 48 targets simultaneously), Heads-Up Display, and video communications.

**4. Bonuses:** +2 to dodge and +5% to do aerial tricks and maneuvers. Also see Pulse Laser for strike bonus.

combat troops as a means of transportation, observation and troop support. The vehicle is a slightly oblong, circular, open-air platform that can be covered with a light, semi-transparent bubble top (15 M.D.C.), but usually goes topless. Since most combat troops wear body armor of some sort, the cover is usually seen as a nuisance. Special drains and light M.D.C. materials protect the interior from weather damage. A large, high-powered spotlight is commonly mounted on a turret in the middle of the vehicle, but a weapon such as the Laser Cannon of the MX-366 Street Bruiser ATV, rail gun (any), mini-missile launcher or other weapon and smaller spotlight can be substituted. However, the standard four double-barreled laser turrets provide considerable fire power. Each laser turret is usually manned by an individual gunner for maximum fire power, but the pilot or co-pilot can fire one turret at a time from a master control. The center light and/or weapon system is usually operated by the pilot or co-pilot (it has 360 degree rotation and a 90 degree arc of fire). A pair of small lights are located at four locations around the platform and though recessed, can be pointed in a 30 degree arc in all directions to illuminate multiple areas at night.

The reliable and quiet platform can hover as close to the ground as two feet (0.6 m) or as high as 500 feet (152 m), has VTOL capabilities, and retractable landing gear. A trio of large jets are recessed in the undercarriage to provide lift and speed along with eight concealed maneuvering jets in the lower ring of the vehicle. The versatile hover vehicle is frequently used to insert and extract reconnaissance squads, haul cargo, evac the injured and function as an observation platform as well as being used by special teams, Intel-Agents and Military Specialists.

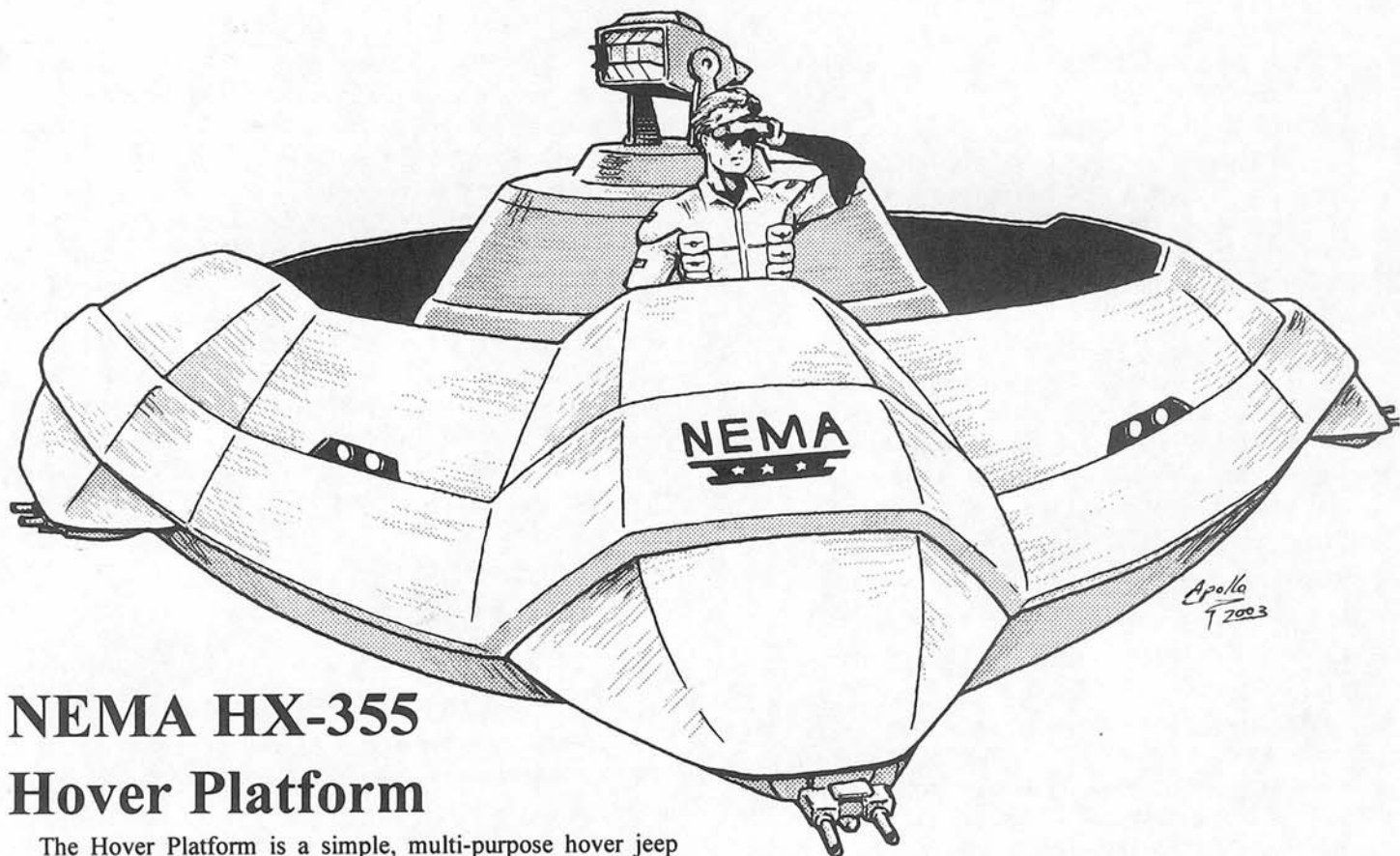

## NEMA HX-355 Hover Platform

The Hover Platform is a simple, multi-purpose hover jeep that is used by officers, field commanders, Intel-Agents and

## HX-355 Hover Platform

**Nickname:** "The Platform."

**Class:** Aerial Military Hover Transport and Combat Platform.

**Crew:** 1-6. One pilot is required to fly, but typically includes a co-pilot and 2-4 gunners. Can accommodate eight passengers comfortably, even with a full six-man crew, as many as 12-13 if the crew is reduced proportionately.

### M.D.C. by Location:

- \* Laser Turrets (4; undercarriage) – 25 each
- Large Spotlight (or weapon system; 1, center) – 50
- \* Recessed Lights (4 pairs) – 2 each
- \* Bottom Hover Jets (3) – 50 each
- \* Tiny Directional Jets (8; lower rim) – 2 each
- Bubble Top (optional) – 15
- \*\* Main Body – 180

\* Every item marked by a single asterisk is small and/or difficult to strike. An attacker must make a "called shot" to hit and even then he is -3 to strike.

Destroying one of the three bottom hover jets reduces speed by 30%, but the enemy must be under the vehicle to get at the jets.

\*\* Depleting the M.D.C. of the main body completely destroys the vehicle.

**Speed:** Flying: 150 mph (240 km), but cruising speed is considered to range between 40 and 75 mph (64 to 120 km). VTOL capable, can hover stationary (or fly) up to a height of 500 feet (152 m), but high altitudes are usually reserved for observation, a better vantage point, and to reach rooftops. Otherwise, typically travels at 10-50 feet (3 to 15.2 m) above the ground. Retractable landing gear.

Water: The Platform can also skim across the surface of water at a speed of 100 mph (160 km/85 knots). It is not a submersible and will sink like a rock if the hover jets are turned off.

Flying Range: The nuclear power system gives the vehicle decades of life and is able to fly continuously for 96 hours without fear of overheating.

### Statistical Data:

Height: 6 feet (1.8 m) for the vehicle itself, add 3-4 feet (0.9 to 1.2 m) with the center spotlight or weapon system included (which it usually is).

Width & Length: Approximately 15 feet (4.6 m) in diameter.

Weight: Two tons.

Cargo: Standing room only; seating for crew only. Additional storage space is minimal, about enough for a couple of backpacks or large satchels per passenger. More if space is taken up by cargo rather than personnel. Can carry up to three tons and pull up to 10 (but at half speed for maximum cargo load).

Power System: Nuclear, 20 years life.

Cost & Availability: Exclusive to NEMA and allied militaries. Any found outside of NEMA were found or stolen and sells for upwards of one million credits or equivalent in trade. Rare.

**Note:** No commercial version has ever been available.

### Weapon Systems:

1. **HXL-355 Laser Turrets (4):** Precision shooting capabilities for each double-barreled laser. Each turret can rotate 180 de-

grees and has a 90 degree arc of fire, up and down. Each turret operates separately. Only one can be fired at a time from the main control console. Requires a gunner for each and even then each operates independent of the other, even if engaged at the same time.

Primary Purpose: Anti-personnel, troop support and defense.

Mega-Damage: 2D6 M.D. per single blast or 4D6 M.D. per double blast.

Bonuses: Gunners with W.P. Heavy Energy Weapons get to apply the bonuses from that W.P. +1 to strike for single- or double-barrel blasts. Characters with the Weapon Systems skill only, get a +1 to strike bonus. No bonus for the pilot or co-pilot using the master controls.

Rate of Fire: Equal to number of combined hand to hand attacks of the gunner, plus one. Each single or double blast counts as one melee attack.

Maximum Effective Range: 2000 feet (610 m).

Payload: Effectively unlimited.

2. **Optional Weapons:** Rail guns, mini-missile launchers, and pretty much anything that can be mounted on a vehicle. Modular system allows for changing the center weapon or equipment turret quickly and easily (a matter of minutes with the right equipment). The turret can rotate 360 degrees and has a 90 degree arc of fire, up and down.
3. **Optional Crane:** Replaces the center spotlight or weapon system with a heavy-duty crane to haul cargo or haul away debris (up to 10 tons, but at half speed).
4. **Sensor/Communications:** Long- and short-range radio and short-range radar (can track 48 targets simultaneously), Heads-Up Display, and video communications.

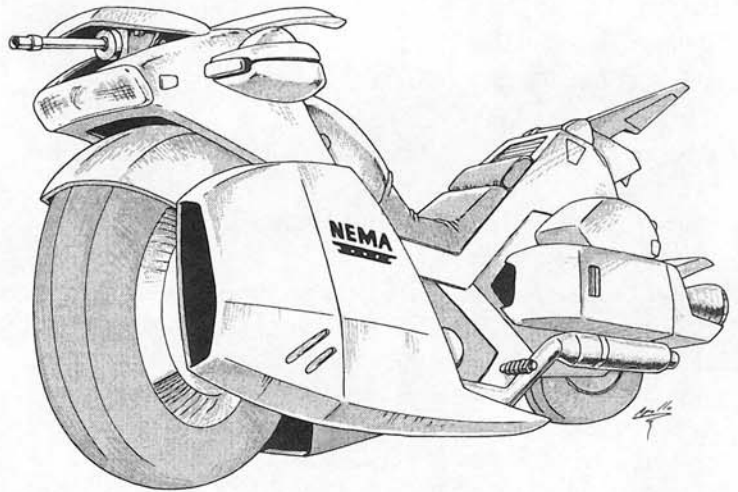

## NEMA MX-144 Combat Bike

A souped-up motorcycle made of M.D.C. materials, equipped with rear rocket thrusters, and armed with a light laser. It's a hugely popular street vehicle among NEMA operatives, even more so than the hovercycle, and is much easier to get authorization to use than the hovercycle. A special whisper mode



quiets the powerful engine to purr softer than a new car, giving the rider some measure of stealth even on his bike (-20% on the pilot's Prowl skill when rolling along at 30 mph/48 km or slower). The specially designed rocket thrusters enable the bike to reach speeds of 320 mph (512 km), and leap long distances. Even at great speed the pilot can maintain excellent control and mobility, and it stops on a dime (no penalties or skill modifier apply).

**Vehicle Type:** Motorcycle.

**Crew:** One: pilot.

**M.D.C. by Location:**

\* Forward Laser – 15

Forward Headlight (1) – 2

Front Tire – 4

\* Rear Tire – 4

Windshield – 6

Side Storage compartment (2; rear, one on each side) – 10 each

Rear Rocket Thrusters (2) – 30 each

\*\* Main Body – 72

\* A difficult target to hit, it requires a "called shot" and the attacker is -4 to strike. The rear tire is shielded by the rocket thrusters.

\*\* Depleting the M.D.C. of the main body destroys the motorcycle, turning it into scrap metal.

**Speed:** 230 mph (368 km) maximum without the rocket thrusters engaged. 320 mph (512 km) with the thrusters on, and can leap distances of 100+ feet across (30.5 m; +10 feet/3 m per level of experience but at -5% per each of those 10 feet/3 m on the motorcycle piloting skill) and up to 50 feet (15.2 m) high.

**Statistical Data:**

**Height:** 3 feet, 5 inches (1 m).

**Width:** 2 feet, 6 inches (0.76 m).

**Length:** 6 feet (1.8 m).

**Weight:** 227 pounds (102 kg); made of lightweight M.D.C. ceramic materials.

**Cargo:** The equivalent of two small duffle bags. A backpack or two could be tied to the rear.

**Power System:** Nuclear, average energy life is 10 years.

**Cost & Availability:** Exclusive to NEMA and select Special Forces of regional police. Any found outside of NEMA were found or stolen and sell for upwards of 500,000 credits or equivalent in trade. Rare. **Note:** A commercial, gasoline model, electric engine and solar powered bike was available to the consumer. It had a main body of 12 M.D.C., tires and all other parts are S.D.C., there is no laser weapon, nor thrusters, maximum speed is 200 mph (320 km), and maximum range is 700 miles (1120 km) per tank of gas or energy charge. Cost 60,000 credits.

**Weapon System:**

**1. MX-14 Laser Turret (1):** A single-barreled, low profile laser mounted in the front of the bike. Can only shoot forward.

**Primary Purpose:** Anti-personnel and defense.

**Mega-Damage:** 2D6 per single blast.

**Range:** 1800 feet (548.6 m).

**Rate of Fire:** Each blast counts as one of the pilot's melee attacks.

**Payload:** Effectively unlimited; tied to the bike's nuclear power supply.

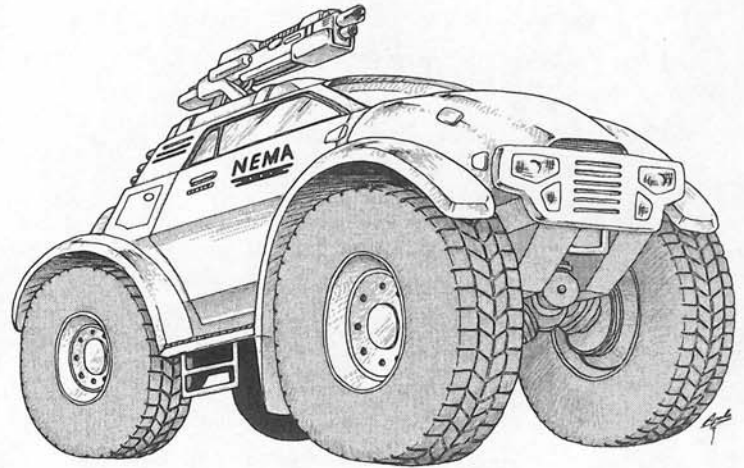

## NEMA MX-366 Combat ATV

**Also known as the "Street Bruiser"**

A big, durable ground vehicle designed to handle urban and rugged country conditions. The big wheels and reinforced chassis enable the "Street Bruiser" to ride up and over large pieces of debris, makeshift street barriers and even parked cars and pickup trucks. May be armed with a roof-mounted laser cannon, rail gun (any type), ML-557 Mini-Missile Rifle, GLR-540 Grenade Rifle or an S.D.C. machine-gun. The weapon can be hooked up to be fired by the pilot, a front seat gunner or fired manually by a gunner who sits up in the sunroof, points and shoots the weapon.

**Vehicle Model Type:** Four-wheeled All-Terrain Vehicle (ATV).

**Class:** Infantry and Scientific Transport Vehicle.

**Crew:** Pilot or pilot and gunner.

**Transport Capabilities:** Four or five. Seats four comfortably (one in the front, three in the back), five in full battle armor is a bit tight but doable.

**M.D.C. by Location:**

Tires (4; large) – 18 each

Windshields – 5 each

Forward Headlights (2) – 5 each

Top Mounted Laser Cannon (1) – 50

Doors (2, plus sliding sunroof) – 60 each

\*\* Main Body – 180

Reinforced Crew Compartment – 50

\*\* Depleting the M.D.C. of the main body renders it useless.

**Speed:** 130 mph (208 km) maximum on flat streets and terrain, reduce by 20% on rugged terrain and by 50% if bouncing

over boulders, very uneven surfaces or over streets filled with large debris. Can drive through water up to five feet (1.5 m) deep and up 45 degree inclines.

#### **Statistical Data:**

Height: 10 feet, 6 inches (3.2 m) tall from the bottom of the tires to the top of the laser cannon (reduce by three feet/0.9 m if there is no top-mounted gun). The gun can usually retract into a housing on the roof, reducing height, as necessary, by two feet (0.6 m). The belly of the vehicle sits four feet (1.2 m) above the ground.

Width: 6.6 feet (2 m). Length: 17 feet (5.2 m).

Weight: 5 tons fully loaded.

Cargo: It can carry passengers which or equivalent in cargo (up to two tons), the Street Bruiser can also pull up to six tons.

Power System: Nuclear, average energy life is 10 years or a combination fuel and electric or fuel and solar power engine.

Cost & Availability: Exclusive to NEMA and select Special Forces of regional police and military. Any found outside of NEMA were found or stolen and sell for upwards of 700,000 credits or equivalent in trade. Rare. **Note:** A commercial, gasoline model, fuel and electric engine or solar powered engine was available to the consumer before the Great Cataclysm. It has a main body of 32 M.D.C., but tires (100 points) and all other parts are S.D.C., there is no weapon system, and maximum range is 400 miles (640 km) per tank of gas or energy charge (solar engines recharge constantly, provided there is sufficient sunlight, with batteries topping off after six hours; cost 20% more). Cost 140,000 credits.

#### **Weapon System:**

1. **LC-366 Laser Cannon (1):** A single-barreled laser turret mounted on top of the vehicle. It can rotate 360 degrees and has a 70 degree angle of fire (up and down). May be fired by the driver or a front seat gunner using a console control that resembles a video game control pad, or a roof seated gunner.

Primary Purpose: Anti-personnel and light vehicles.

Mega-Damage: 3D6 per single blast or 1D6x10 per triple pulse.

Range: 3000 feet (914 m).

Rate of Fire: Each shot or pulse counts as one of the gunner's or driver's melee attacks.

Payload: Effectively unlimited if tapped into the vehicle's power supply, otherwise limited by the available number of power packs.

Bonuses: +1 to strike when fired by a front seat gunner, none for the driver of a moving vehicle (+1 if parked and aimed), or those of a roof seated gunner, provided he has the W.P. Heavy Energy skill (otherwise none).

## **NEMA MX-422**

# **Armored Personnel Carrier**

Two hundred years in the future, the Coalition Army would improve upon this design, but right now, it is NEMA's all-pur-

pose Armored Personnel Carrier (APC). The MX-422 is designed with both battlefield and urban combat in mind, and can handle a variety of different terrains (though nothing too extreme). It serves as a deadly front-line combat unit with excellent firepower and good mobility, and as troop support and transport. The eight, 9 foot (2.7 m) tall and five foot (1.5 m) wide, puncture-proof tires can plow through and ride over debris strewn streets, fallen power armor, cars and pickup trucks, as well as enemy troops.

An 11 foot (3.3 m) tall, heavy, air-hatch style door (one outer and one inner door) is located on both sides and the rear (3 total) for the exit of troops. A concealed exit hatch is also located in the ceiling of the crew compartment and in the weapon turret. The nose of this juggernaut unfolds to reveal a ramp for small vehicles, power armor and robots to enter and exit.

## **NEMA MX-422 APC**

**Class:** Infantry Assault and Transport Vehicle

**Crew:** Six: One pilot, a co-pilot, communications officer, intelligence officer, and two gunners.

**APC Troop Payload:** Just about any mix of troops is feasible, but typically carries a platoon of infantry soldiers or rescuers (40 troops), one special squads (8-12 troops each), and 4-12 Combat Drones (Soldiers or Hounds). Or 20 fewer troops and 6-10 power armor troops (Chromium Guardsmen, Gunbusters or Silver Eagles).

#### **M.D.C. by Location:**

Main Laser Cannon (1; rear turret) – 150

Missile Turret (1; forward turret) – 100

\* Recessed Mini-Missile Launcher (2; front) – 50 each

Dual Mini-Missile Launcher (2; turret) – 50 each

Smoke/Gas Dispenser (2; rear) – 8 each

\* Sensors (1; rear turret) – 20

\* Window Slits (2, large) – 60 each

Main Outer Hatch (3; both sides and rear) – 120 each

Main Inner Hatch (3; sides and rear) – 50 each

Folding Nose Ramp (1; front) – 180

Concealed Escape Hatch (1; top) – 70

Puncture-Proof Wheels (8) – 40 each

\* Forward Headlights (4; top front) – 3 each

Reinforced Crew Compartment – 100

\*\* Main Body – 330

\* Every item marked by a single asterisk is small and/or difficult to strike. An attacker must make a "called shot" to hit and even then he is -3 to strike.

Destroying the sensor cluster on top of the main turret means the pilot must rely on his own vision and instruments; radar and targeting (and accompanying bonuses) are lost.

\*\* Depleting the M.D.C. of the main body will shut the APC down completely, rendering it useless.

Destroying the APC's front plating reveals the inner reinforced crew compartment and makes it vulnerable to attack.

Destroying two wheels reduces speed by 20%. Destroying three on one side reduces speed by 40% and induces a penalty of -40% to the piloting skill. Destroying four wheels on one side reduces speed by 60%; same penalty.



**Speed:** Land: 80 mph (128 km) maximum. Water: 30 mph (48 km). Flying: None.

#### **Statistical Data:**

Height: 24 feet (7.3 m) overall; the body of the APC is 16 feet (4.9 m) tall, but the top weapon turret adds 8 feet (2.4 m) to the overall height.

Width: 11 feet (3.3 m).

Length: 40 feet (12.2 m).

Weight: 20 tons unloaded.

Cargo: Troops, power armor, robots, small vehicles and/or supplies can be carried inside the 30 foot (9.1 m) long troop bay area; roughly 300 square feet (27.8 sq. m) of cargo space with a ceiling height of 12 feet (3.6 m).

Color: Tan, grey, red and blue, or camouflage.

Power System: Nuclear, average energy life is 20 years.

Cost & Availability: Exclusive to NEMA and select Special Forces of regional police and military. Any found outside of NEMA were found or stolen and sell for upwards of 900,000 credits or equivalent in trade. Rare.

#### **Weapon Systems:**

**1. MX-422 High-Powered Laser Cannon (1):** The main weapon turret is a high-powered, long-range laser cannon. The cannon itself can move up and down in a 45 degree arc of fire, but the entire turret can rotate a full 360 degrees. As usual, all the weapon systems are powered by the vehicle's nuclear power supply.

Primary Purpose: Anti-aircraft, anti-armor, assault and defense.

Mega-Damage: Single barrel shot does 4D6 M.D. per blast, both barrels fired simultaneously do 1D4x10+2 M.D.

Rate of Fire: Equal to the number of combined hand to hand attacks of the gunner (usually 4-7). Each blast, whether double or single, counts as one melee attack.

Maximum Effective Range: 4000 feet (1219 m).

Payload: Effectively unlimited.

**2. Missile Launcher (1):** A missile launcher turret is located on the top forward section of the vehicle. It has its own gunner and operates independent of the main laser cannon. It can fire mini-missiles or short-range missiles; the turret rotates 360 degrees.

Primary Purpose: Anti-armor, assault and defense.

Mega-Damage: Varies with missile type.

Range: 1-4 miles (1.6 to 6.4 km), varies with missile type.

Rate of Fire: One at a time or in volleys of 2, 4 or 6 missiles. Each volley counts as one attack.

Payload: 12 short-range missiles or 24 mini-missiles.

**3. Vertical Mini-Missile Launchers (2):** Built into the nose of the APC are a pair of "stacked" vertical mini-missile launchers.

Primary Purpose: Anti-aircraft, anti-armor and anti-personnel.

Missile Type: Any type of mini-missile can be used, but standard issue is fragmentation (anti-personnel, 5D6 M.D.) and plasma (1D6x10).

Mega-Damage: Varies with missile type.

Range: About one mile (1.6 km).

Rate of Fire: One at a time, or in volleys of two, three, four or six.

Payload: 48 total; 24 per each launcher.

**4. Smoke Dispensers (2):** A pair of smoke dispensing units are mounted on the rear of the APC. The unit can release a dense cloud of smoke that covers an 80 foot (24 m) area behind it, or covers the APC if it is stationary. It can also release tear

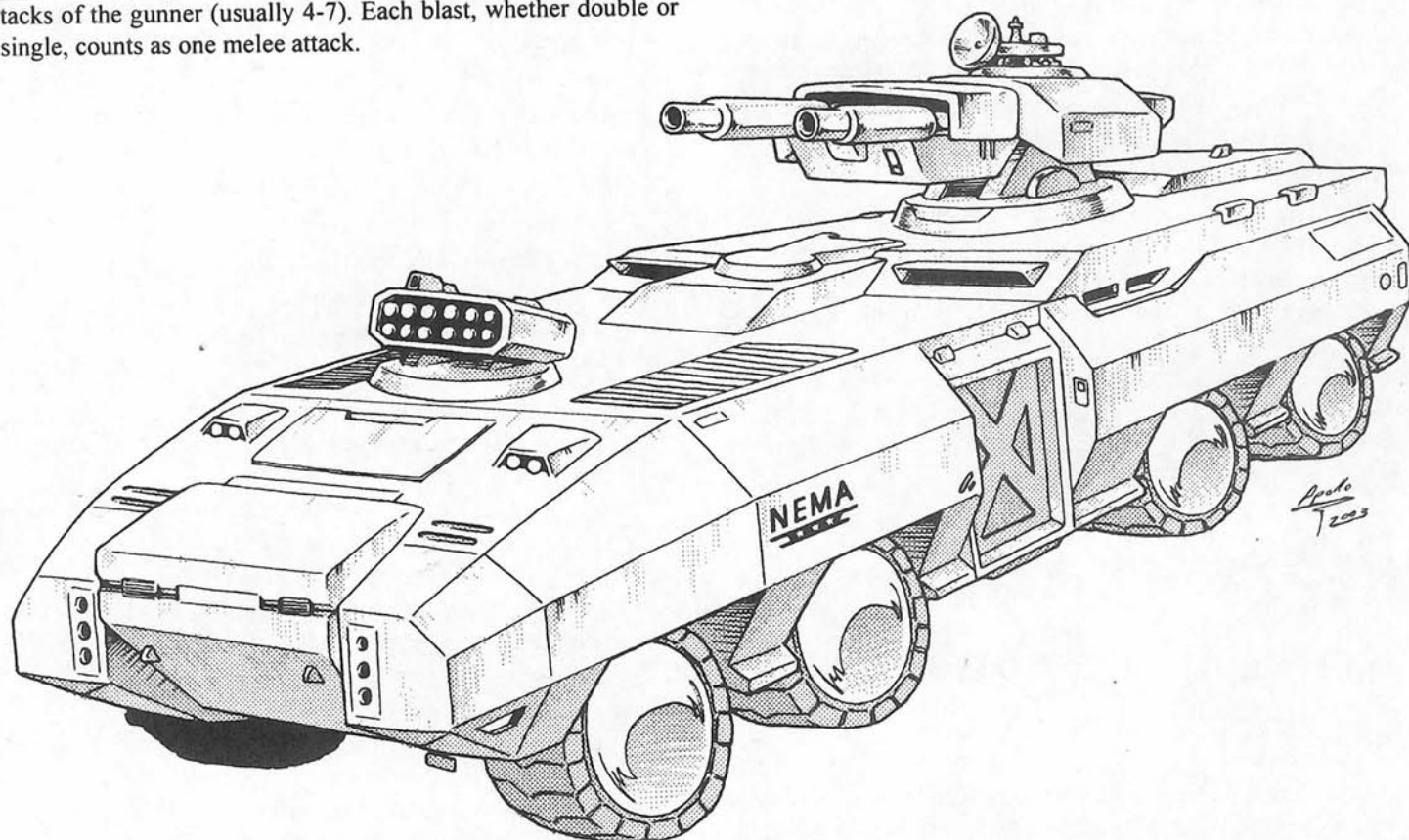

gas. Payload: 12 total, six each. The usual mix is 10 smoke and two tear gas.

- 5. Close Combat:** The APC may drive into and smash through light to moderate S.D.C. walls and structures as well as ram into and knock over giants and S.D.C. vehicles. It can also drive into and disperse enemy troops. The impact from a half speed ram is 1D4x10 M.D. or 1D6x10 MD. from a full speed ram. A ram attack against humans, even in body armor or man-sized power armor, inflicts 1D4x10 M.D. and hurls the character 4D6 yards/meters (victim loses initiative and three melee attacks). Human-sized characters who get run over suffer 1D6x10+20 M.D.

In addition, the combat troops being transported can be released from the APC to engage the enemy.

- 6. Sensor System Note:** Has all the standard optics, sensors, communications and basic features as robot vehicles. Plus:

- A. Eight high impact, puncture-proof tires.
- B. Automatic locking hatches opened by voice recognition and/or by a number code punched in on an eight digit key pad.
- C. Homing beacon and long-range radio communications.
- D. Standard field equipment includes portable long-range radio, portable short-range radar, medical kit, ten signal flares, ten sniper laser rifles and ten heavy weapons, two rail guns, 24 explosive grenades, two first aid kits, a 50 foot (15.2 m) length of cord, and three E-Clips for each weapon along with a two week supply of dehydrated food and water to supply 20 troops.

---

# Robots & Drones

---

## Combat Drone Soldier

Also known as “CDS,” “Combat Drones,” and “Robo-Grunts”

The Combat Drone Soldier (CDS) was developed jointly by the militaries of the United States of America and Canada, but shared with NEMA in order to test the robots in an urban environment. Each unit is identical except for the identifying number emblazoned on its chest and weapon, and the serial number etched into its internal I.D. plate. (Note: This NEMA robot design would be adapted by the Coalition States and turned into the infamous Skelebot some 250+ years in the future.)

The Combat Drone, also affectionately known as “Robo-Grunt,” but commonly called by the acronym of “CDS,” had been deployed in a variety of military and peacekeeping situations before the Great Cataclysm. Military use included front-line infantry troops (sent in to soften up the enemy or punch a hole in the enemy line), border patrols, seek and destroy missions, guard duty and base camp defense. NEMA had mainly deployed the robots in riot control and guard duty as well as digging, general assistance, armed escort (i.e., accompany rescuers and medical personnel to protect them from hostile forces while they work or evacuate disaster victims) and as rescue units sent into hostile environments too dangerous for human troops (i.e., bio-hazards, chemical spills, toxic clouds, crumbling buildings, structures booby-trapped to explode, etc.). Since the Coming of the Rifts, the Combat Drones have proven to be invaluable in all these capacities. If there is any concern about the robots, it’s that there aren’t enough of them to make a profound impact on the apocalyptic situation.

All Combat Drone Soldiers are programmed with rudimentary combat responses to function as members of large and small combat formations as well as lone hunter-seekers. The machines communicate silently between each other through scrambled radio transmissions, but have audio capabilities and a synthetic voice to communicate with their human counterparts. Furthermore, the voice can be tweaked to provide programmers with 1210 different tonal variations to give many of the robot

drones distinct voices to help differentiate them from one another. This is, of course, done for the sake of the human troops, the robots don’t notice or care about their “voice” nor any other distinguishing traits. They are machines, plain and simple. Expendable combat drones, they are purposely programmed to be devoid of characteristics that might make them *seem* alive to prevent humans from feeling any emotional attachments to the *machines*. Consequently, Combat Drone Soldiers have about as much personality as a wet sponge, possess an artificial, mechanical-sounding voice, speak as little as possible, and display no type of emotion or social capabilities. Note: *None* of the NEMA A.I. robots should be used as player characters. They are machines the same as a hovercycle or rail gun. A tool and a resource for the living player characters.

Each drone is programmed for standard strategic and tactical field maneuvers that are executed with expert efficiency (basic squadron, reconnaissance, assault, defense and rescue capabilities). They follow orders to the letter, but are smart enough to discern *intent* from poorly worded commands – they are not so idiotic as to take an order completely literally. If there is confusion, the Combat Drone will request “clarification.” When the command is understood, the combat computer automatically selects the best avenue of action to accomplish the task given it. Likewise, the CDS are programmed to work with other robots and humans as a team, as well as to work independently. The combat computer is programmed to recognize friendly personnel, meaning civilians, NEMA uniforms, insignias, weapons, power armor, robots and vehicles, but smart enough to tell when a NEMA weapon or vehicle is in the hands of “unauthorized personnel,” and whether said “unauthorized personnel” are hostile or not. Thus, it is tough to fool a Combat Drone Soldier simply by dressing up like NEMA personnel. It also considers the military of the three NEMA allied countries as “friends,” but can make the same distinction if the “friendlies” behavior is hostile or they are clearly *not* human by their actions or words, or are human but with apparent hostile or dangerous intent.

In the **Rifts® Chaos Earth** environment, virtually all D-Bees, demons, and other nonhumans are perceived as “unau-



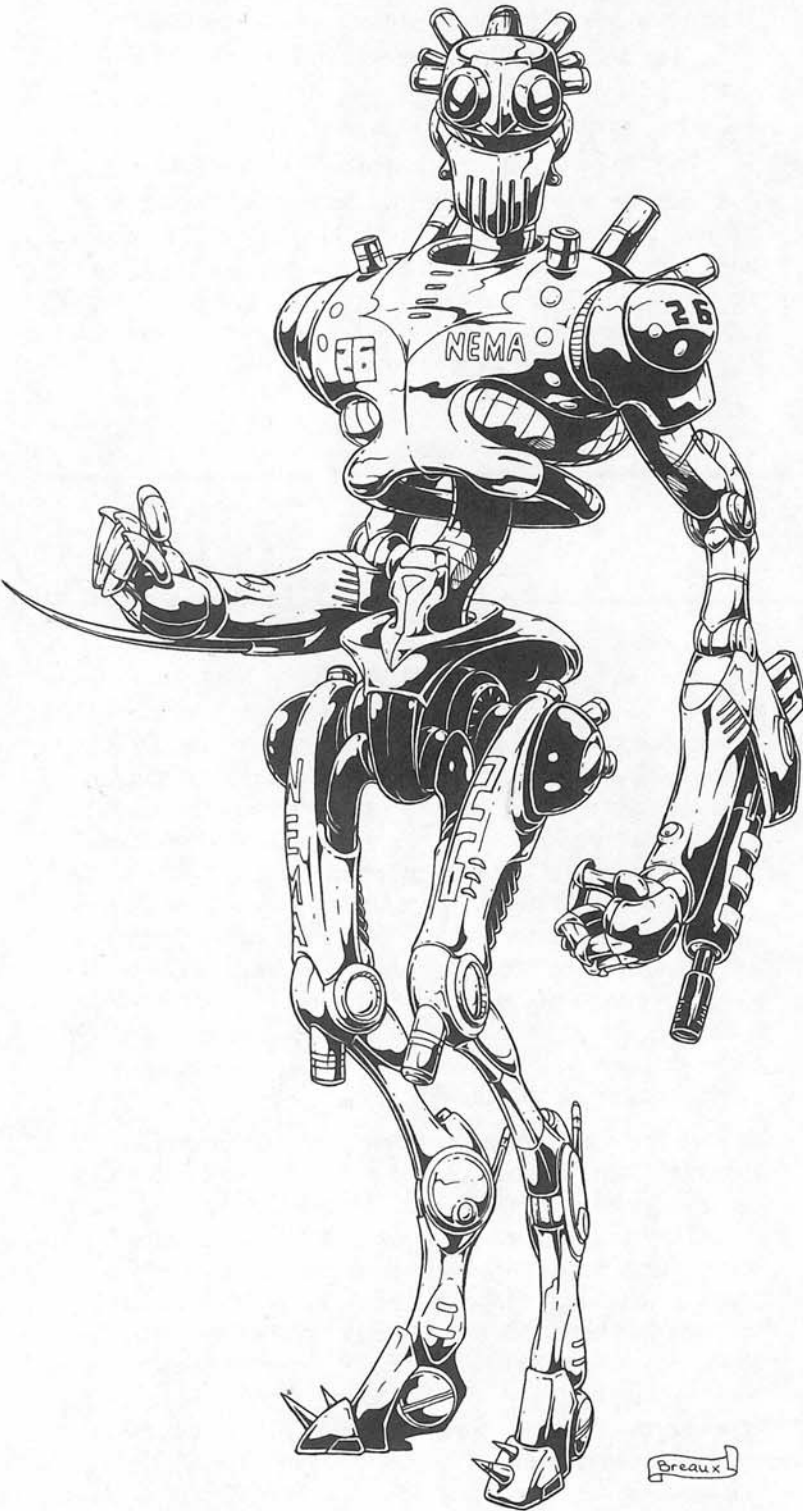

and otherwise force the “unauthorized personnel” to *leave* – to go beyond a set perimeter. The robots respond with lethal force only if they are attacked by the “unauthorized personnel.” Being robots, and the “unauthorized personnel” being deemed potentially hostile and certainly *undesirable*, the CDS may force them into the arms of a more deadly or malignant force without qualm or conscience, endangering or killing scores of innocent D-Bees without realizing it. The robots, after all, are simply following a preprogrammed response. It is also important to note that the CDS can make the distinction between “unauthorized personnel” (i.e., nonhumans) and an aggressive enemy or openly hostile opponent. Attackers are identified as “hostiles” or “hostile force” – i.e., “three hostiles engaged at Sector Alpha 23.” Armed, but nonaggressive D-Bees or human mercenaries would be identified as, “three heavily armed unauthorized personnel,” not “hostiles,” at least not until they attacked. However, once combat is initiated, the Combat Drones fight to kill as quickly and efficiently as possible. Quick “suppression of hostile forces” is part of the drones’ combat parameters in an effort to minimize potential collateral damage (i.e., destruction of property and civilian and troop casualties). The CDS relent only if their opponents manage to flee, escape their sight and hide, or run beyond the perimeter (border) prescribed by the NEMA authority that sent the CDS out in the first place. Otherwise, the Combat Drones shoot to kill. **Note:** All CDS will follow the orders of a recognized *NEMA officer* or *Robot Commander* or the specific individual it has been assigned to (such as a Point Man or Military Specialist) without hesitation or question, even if the order is contrary to its basic programming. The only exception is an order to execute unarmed (human) civilians, for while the CDS are fighting machines, they are programmed to protect and defend human life, not destroy it without cause.

**Safety measures** have been implemented to prevent the robot drones from running amok. First, the robots are designed to recognize all NEMA, USA, Canadian, and Mexican military troops, vehicles and personnel (via uniforms and insignia) and are not to attack such troops unless attacked first, and then, only if all reasonable means of identification have failed.

Second, all Combat Drones (CDS, Hounds and Pups) are programmed to recognize and obey Robot Commanders and NEMA officers above the rank of Captain, otherwise they ignore all other outside influences and follow their last order and their fundamental programming. Furthermore, these robots have radio communication capabilities so they can (and do) make regular radio reports and can request clarification and direction from NEMA Command (secret encryptions confirm that the instructions are, indeed, from NEMA Command). If radio contact is not possible (out of range, interference) the robot proceeds as per its protocol or returns to base.

Third, should a unit go berserk and act contrary to its programming, it can be tracked via an internal homing device and destroyed by detonation of the anti-tampering unit built inside all drones, including probes.

Fourth, the aforementioned anti-tampering device is designed to detonate if there is any attempt to breach the robots’ integrity without the proper pass codes. It is necessary to access the robot’s internal workings to subvert its programming or to effect physical repairs. A secret code and procedure is required to gain access to any of NEMA’s combat drones and probes without

thorized personnel” and potential “hostile forces.” Thus, a CDS squad encountering a group of D-Bees or a trio of demons are likely to report something like this to their human superiors:

“Three unauthorized personnel encountered in Sector Alpha 23. Intentions seem benign (or not). Proceeding to remove unauthorized personnel from area.”

Unlike the Coalition Skelebots of the future, Combat Drone Soldiers are not killing machines sent out on missions of genocide. Unless specifically programmed to *engage the enemy* or *seek and destroy* specified enemy targets/personnel as part of a Hunter-Seeker mission, “remove” means to chase, herd, prompt

causing failsafe detonation. As part of that safety feature, the explosion is contained by the unit's exterior armor, preventing injury to those around it, but completely destroying its internal workings, turning it into a piece of scrap metal.

Last, one or two human operatives (Robot Commander, Intel-Agent, Power Armor or Robot Vehicle with an officer) usually accompanies each robot squad or platoon. The presence of one or more humans as squad leader eliminates, in theory, any inappropriate combat action by the robots and adds the element of human experience and discretion to any given situation.

*Robots assigned to a specific human "partner" such as a Military Specialist, Intel-Agent, Field Engineer, Point Man or Pig Man, are typically programmed to respond only to that specific individual and no one else (except a recognized superior). If truly confused, or should its human commander be rendered inactive (killed or unconscious), the robot is to retrieve the body of the human and return to base camp, avoiding interaction with outside forces unless blocked or attacked.*

**Hunter-Seeker Missions.** There are two types of Hunter-Seeker missions for CDS, military and rescue. *The military object* may be a very narrow one, from a specific individual, class or rank, type of monster, race of demon, or enemy target (communications tower, sniper, type of vehicle, robot, or monster, etc.) to very broad ones, such as any hostile nonhuman or all enemy tanks or power armor, or any demon or dragon, and so on.

*Rescue missions* can also be very narrow, from a specific individual, class, or rank to very broad, like any human survivor in a disaster area, or all NEMA personnel, or medical teams, etc. The CDS (and probes) are surprisingly good at finding people trapped under rubble, though they are a bit too rough and clumsy to remove them from debris without causing additional injury. Consequently, the CDS typically find victims, radio their position and stand guard until human rescuers arrive on the scene. Then the Combat Drone Soldiers *assist* the human rescue team either by remaining to stand guard (engaging hostile forces) or doing whatever they are told to do ("slowly lift that metal girder," or "dig right here until I tell you to stop," etc.). If the rescue team is in no danger and does not need the CDS's assistance, the robot(s) can be sent off to "seek" out other survivors. Robot probes are also used in the capacity of seekers/locators and scouts.

Even though Combat Drone Soldiers serve and protect the humans under NEMA's protection, most civilians find them to be rather cold, imposing and unfriendly, making many people uncomfortable around them.

**Note:** NEMA finds the CDS to be an invaluable asset and desires to create and stockpile as many as possible. Unfortunately, robot manufacturing facilities are few and far between. Miraculously, Midwest Operations has two, and there are others known to exist at Area 51/Groom Lake (Nevada), Houston, Detroit, Montreal (Canada), and a massive, multi-purpose robot, power armor and vehicle manufacturing complex at Aberdeen Air Force Base in Maryland, but at present, all are unavailable and presumed destroyed or dominated by hostile forces. The defense and around the clock operation of the two Midwest factories are among the top priorities of NEMA Midwest Operations.

**CDS Tactical Deployment.** Even though NEMA Midwest Operations could gather enough Combat Drone Soldiers to build an entirely mechanized army division, it does not. Instead, the

CDS and other robots are spread throughout the rest of NEMA's trained and volunteer troops to bolster and support those forces. They effectively augment the human troops giving them more options, resources, flexibility and power. Consequently, while there is the occasional Combat Drone *squad* (8-12 robots) led by one or two humans and *platoon* (40-60; all the same or mixed) led by 4-10 humans, none of the robots are ever gathered into larger groups or left without human leadership. All of the robots, even the robot vehicles and robotic, power armor suits, are used to *support* the human operatives and fighting forces. Thus, a pair of Combat Drones or a Bull Dog robot vehicle gives a predominantly human squad the extra strength, firepower and capabilities of the robot unit(s) among them. The Bull Dog functions as a sort of walking tank, the two Combat Drones as a pair of tireless, fearless, armored comrades able to help the wounded, chop through debris like the machines they are, and to offer cover fire or sacrifice themselves without loss of *human life*.

**Limited M.D.C.** In the pre-Rifts world, the half dozen or so nations who held Mega-Damage technology controlled a superior technology. Thus, even a robot with only 20 or 30 M.D.C. was the equivalent of an S.D.C. tank, maybe even three or four tanks. That being the case, it wasn't necessary to make the Combat Drone Soldier heavily armored. After all, 95% of the opposition couldn't put a significant hurt on a Mega-Damage machine to begin with. However, in the Mega-Damage environment of Chaos Earth, the light amount of M.D.C. for all of NEMA's robots is a liability, and one that cannot be easily or quickly resolved (insufficient time, resources and experts). Still, they are an excellent addition and give NEMA a leg up that few others have.

## **Combat Drone Soldier – Robot/Artificial Intelligence**

**Model Type:** NEMA-RX 2020

**Class:** Fully Automated, Self-Sufficient Infantry and Rescue Robot.

**Crew:** None; artificial intelligence.

**M.D.C. by Location:**

Hands (2) – 22 each

Arms (2) – 40 each

Forearm Ion Blaster (1, left)

Vibro-Blade (1, right) – 25

Legs (2) – 65 each

Energy Rifle or Rail Gun (1; optional) – 50

\* Head – 60

\*\* Main Body – 128

\* Destroying the head of the robot eliminates all optics and sensory systems. In most cases the robot shuts down as a safety feature. However, in some cases, about one in ten, the robot continues to fight, blasting away blindly until its ammunition is expended, and even then it will continue to grope around, lashing out and hitting anything it touches. Under these conditions the robot enjoys no combat bonuses to strike, parry, or dodge.

The head is a small and difficult target to hit, especially on a moving target. Thus, it can only be hit when a character makes a "called shot," and even then the attacker is -3 to strike.



\*\* Depleting the M.D.C. of the main body effectively destroys the robot, shutting it down completely. **Note:** Additional body armor or power armor cannot be worn by Combat Drones.

#### **Speed:**

Running: 75 mph (120 km) maximum. Note that the act of running does NOT tire the robot and maximum speed can be maintained indefinitely.

Leaping: The robot legs, although strong, are not designed for leaping, thus leaps are limited to approximately six feet (1.8 m) high and eight feet (2.4 m) across.

Flying: None.

Range: The nuclear power pack gives the robot approximately two years of life even under the most strenuous and constant amount of use, three years under less active conditions. The robot is intentionally given a much shorter energy "life" as yet another failsafe and because of their high rate of mortality.

Underwater Capabilities: The CDS is not well suited for underwater operations. The best it can do is walk along the bottom of the sea at about 25% its normal running speed. Maximum Ocean Depth: 1000 feet (305 m).

#### **Statistical Data**

Height: 7 feet (2.1 m). Width: 3 feet (0.9 m). Length: 2 feet, 9 inches (0.8 m).

Weight: 360 lbs (162 kg).

Physical Strength: Equal to a Robot P.S. of 28.

Cargo: None.

Power System: Nuclear, average CDS energy life is two years.

Cost & Availability: Exclusive to NEMA and the militaries of the three allied nations (most of which are unaccounted for, the majority presumed to be destroyed). Any CDS outside of NEMA was found or stolen and sells for upwards of 5 million credits or equivalent in trade. Rare.

#### **Weapon Systems:**

**1. RX-2020 Forearm Ion Blaster (1):** The left arm typically has a built-in ion blaster for heavy, mid-range combat. A special connection in the handle allows the robot to link with the weapon. The link ties the weapon directly to the robot, its combat computer, sensors and nuclear power pack. The latter gives the weapon an infinite and constant energy supply. If the link is damaged the standard energy clip reserve with a 12 shot payload is all that's available and when used up, the weapon is "dry" (empty).

Primary Purpose: Assault.

Weight: 7 lbs (3.2 kg).

Mega-Damage: Two settings: 3D6 M.D. per single blast or 1D4x10 M.D. per triple blast burst; both count as one melee attack/action. A single blast gets benefit of maximum bonuses, a burst does not.

Rate of Fire: Single shot or three blast burst, either counts as one melee attack; the robot has five attacks per melee round.

Effective Range: 1200 feet (366 m).

Payload: Unlimited when tied to the robot's power supply. 21 single shots or 7 bursts per standard E-Clip, if that link is severed.

**2. RX-2020 18 inch (0.45 m) Vibro-Blade (1):** Tucked away in a special forearm housing is a narrow, curved, retractable

Vibro-Saber that extends outward for close combat. It can also be used for digging, chopping and cutting of debris in rescue efforts.

Primary Purpose: Assault and chopping through S.D.C. barriers.

Secondary Purpose: Defense and anti-personnel.

Weight: 2 lbs (0.9 kg).

Mega-Damage: 2D6 M.D.

Range: Hand to hand with about a 5.6 foot (1.7 m) reach when extended.

Rate of Attack: Five per melee; hand to hand combat skill.

Payload: Not applicable.

**3. Energy Rifles** and other normal weapons can be substituted or added to the robot's built-in weapon systems. NEMA 5.56 Assault Rifle (S.D.C.), MIP-21 Maxi-Ion Pistol, LGR-360 Laser Grenade Rifle, and the R-660 Striker rail gun are the most commonly issued weapons.

**4. Hand to Hand Combat:** Rather than use a weapon, the Combat Drone can engage in Mega-Damage hand to hand combat using its fists or Vibro-Blades.

Attacks Per Melee: Five.

Combat Style: Equal to Hand to Hand Expert.

Damage:

Restrained Punch: 2D6+15 S.D.C.

Full Strength Punch: 1D6 M.D.

Power Punch: 2D6 but counts as two melee attacks.

Kick: 2D4 M.D.

Body Block: 1D4 M.D.

Head Butt: 1D4 M.D.

Vibro-Saber (1): 2D6 M.D.

Bonuses: Includes all bonuses from programming, robotics and sensors: +2 to strike with an automatic rifle, energy pistol, or energy rifle, +3 to strike on an aimed shot (no bonus to strike with rail guns), +4 to strike with Vibro-Blades or hand to hand attack (punch, kick, etc.), +4 to parry with fists/arms, +6 to parry with Vibro-Blade, +4 to automatic dodge and attacks from behind (motion detectors and other sensors), +2 to roll with impact or fall, +2 to pull punch, critical strike on natural roll of 19 or 20. Impervious to poison, gas, and biological agents, as well as psionic and magic mind control, charms, bio-manipulation, and S.D.C. attacks. See sensors for optical capabilities.

#### **5. Sensor Systems of Note:**

**Optics:** The CDS have full optical systems, including the visible light spectrum, infrared, ultraviolet, polarizing filters, passive nightvision (light amplification), thermo-imaging, laser targeting, and telescopic.

Telescopic optics function like built-in binoculars with a range of about two miles (3.2 km). All the other optic systems have a range of about 3000 feet (914 m).

**Radar:** Can identify and track up to 48 targets simultaneously at a range of two miles (3.2 km). Applicable to flying targets at 500 feet (152 m) above the ground or higher only. Radar cannot track ground movement.

**Motion Detector:** 100 foot radius (30.5 m), adds to ability to parry and dodge (see bonuses).

**Radio Communication:** Medium-range directional radio for coded messages between the robot and its human commander or base camp. Range: 50 miles (80 km).

Can also scan and communicate via code on conventional radio channels/frequencies; same range, and eavesdrop on enemy transmissions and track transmissions (60% success level) to its source. Range 10 miles (16 km). **Note:** Understands English, French, Spanish, German, Russian, Chinese, Arabic, and 15 other languages; can identify all others but can not understand or communicate in them.

**Speech:** Full capabilities as noted in the description. Tends to be mechanical sounding and to the point.

6. **Skill Programs of Note:** Combat skills: W.P. Sword, W.P. Blunt, W.P. Automatic Rifle, W.P. Energy Pistol, W.P. Energy Rifle, W.P. Paired Weapons. Hand to Hand: Expert equal to 7th level skill. Other skills: Basic Math 98%, Pilot Automobile 96%, Pilot Hover Cycle 96%, Radio: Basic 96%, Intelligence 76%, Land Navigation 76%, Mining 76%, and Climb 96%/86% (4x faster than the average humanoid).
7. **Programming and memory** enable the robot to identify all NEMA, USA, Canadian and Mexican military ranks, uniforms, insignia, soldiers, robots, power armor, vehicles, weapons, equipment, and officers. Memory also includes the identification of 4000 different enemy targets, including new data on specific races, non-human features and powers, insignia, uniforms, enemy robot and vehicle designs, acts of aggression, and notorious enemies. Combat programming directs the actions and reactions to encounters and attacks.

## Combat Hound

The Combat Hound is designed to be a *combat support unit* providing additional firepower, participate in cross-fires, create diversions, and provide cover fire so that human operatives can perform a specific task or make good a rescue or escape. The Hound is used primarily in small squad combat situations and rescue operations in hostile zones where a guard, escort or protector is needed to fend off aggressors, leaving human operatives free to devote their attention to the rescue. Intel-Agents, Military Specialists, scouts and point men, frequently have a Combat Hound as their mechanized “backup,” enabling them to slip in and out of enemy territory on their own, with nothing but the low profile robot at their side. In many ways, the Combat Hound can be thought of as a “walking gun.” It trots along with its human partner, obeying his every command, scouting ahead, etc., but ultimately, it is there to guard a lone operative (pair, trio or team) and cover his back. When making an escape under fire, it is the Combat Hound that stays behind, shooting until the NEMA soldier has slipped out of harm’s way, and then lopes after him or to base camp, engaging the enemy as necessary.

Like the Combat Drone Soldier, the Combat Hound has no personality and does not mimic a real canine, only its shape and movement are reminiscent of a dog. The basic body configuration of a canine was selected because of its low profile and the balance and speed of being four-legged. Unlike the CDS, the Hound doesn’t speak or make any audible sound, though it does transmit data picked up by its sensors to the Heads Up Display on the helmet of the soldier to whom it is assigned. This “silent

speaking” is another reason it is used as a scout, reconnaissance and spy support unit, and those who regularly work with the Hound often begin thinking of it as an expendable, mechanical extension of their own senses or body. **Note:** The Combat Hound is seldom sent out on its own or in packs or squads on any kind of mission, including hunter-seeker missions. Instead, one or two are almost always assigned to a specific individual to function as an armed escort/protector, and sometimes doubles for a pack mule with heavy gear hung or strapped to its back, though that may impair its use of the weapon. The Hound does nothing on its own initiative, but follows orders well.

### Combat Drone Hound – Robot/Artificial Intelligence

**Model Type:** NEMA-RX 3030

**Class:** Fully Automated Self-Sufficient Infantry and Rescue Robot.

**Crew:** None; artificial intelligence.

#### M.D.C. by Location:

Legs (4) – 65 each

Back Mounted Weapon (1) – 50

\* Head – 65

\* Head Lasers (2) – 10 each

\*\* Main Body – 135

\* Destroying the head of the robot eliminates all optics, video, communications and sensory systems. In most cases the robot shuts down as a safety feature. However, in some cases, about one in ten, the robot continues to fight, blasting away blindly until it is completely destroyed. Under these conditions the robot enjoys no combat bonuses to strike, parry, or dodge.

The head is a small and difficult target to hit, especially on a moving target. Thus, it can only be hit when a character makes a “called shot,” and even then the attacker is -3 to strike. The head lasers are even smaller, -4 to strike on a “called shot.”

\*\* Depleting the M.D.C. of the main body effectively destroys the robot, shutting it down completely. **Note:** Additional body armor or power armor cannot be worn by Combat Drones.

#### Speed & Movement:

**Running:** 100 mph (160 km) maximum. Note that the act of running does NOT tire the robot and maximum speed can be maintained indefinitely.

**Leaping:** The robot legs, although strong, are not designed for leaping. Can leap five feet (1.5 m) high and 12 feet (3.6 m) across; increase by 50% with a running start.

**Climbing:** Fair, roughly equal to that of a real canine, good on inclines of up to 60 degrees and can navigate stairs (full speed) and ledges (half speed) well.

**Stealth:** Fair, equal to a Prowl skill of 45%; leaves distinctive tracks.

**Flying:** Not applicable.

**Underwater Capabilities:** The Hound is not designed for underwater operations and sinks like a rock. It can, however, walk along the bottom of a lake or sea at about 25% its normal running speed. Maximum Ocean Depth: 600 feet (183 m).

#### Statistical Data:

**Height:** About that of a large German Shepherd or Saint Bernard: Three feet (0.9 m) at the shoulders, 4 feet (1.2 m) tall including the back-mounted weapon turret.



Width: 2 feet (0.6 m). Length: 4 feet (1.2 m). Weight: 225 lbs (101 kg).

Physical Strength: Equal to a Robot P.S. of 26.

Cargo: None, other than what is fixed to the robot or dragged. Can carry up to 200 pounds (90 kg) and pull up to 600 pounds (270 kg).

Power System: Nuclear, average energy life is two years even under the most strenuous and constant amount of use, three years under less active conditions. The robot is intentionally given a much shorter energy "life" as a fail safe.

Cost & Availability: Exclusive to NEMA and the militaries of the three allied nations (most of which are unaccounted for, the majority presumed to be destroyed). Any Hound outside of NEMA was found or stolen and sells for upwards of one million credits or equivalent in trade. Rare.

### Weapon Systems:

**1. Back-Mounted Weapon Turret (1):** The weapon is mounted on a turret-like housing on the back that can rotate 360 degrees and has a 90 degree arc of fire. The exact type of weapon varies slightly. It can be the equivalent of a plasma rifle with greater stopping power but shorter range, or a laser rifle that does less damage but has better range. The operative it is assigned to can usually request the type of weapon mounting he prefers.

Primary Purpose: Assault and defense.

Mega-Damage: Laser: 3D6 M.D. per single blast and +2 to strike – or – Plasma: 6D6 M.D. (no strike bonus).

Rate of Fire: Single shot, each blasts count as one melee attack.

Effective Range: Laser: 2200 feet (670.5 m). Plasma: 1600 feet (488 m).

Payload: Unlimited; tied to the robot's power supply.

**2. Small Head Lasers (2):** A pair of small lasers are located on either side of the Hound's head. Both can move independent of one another or in unison. Can point up and down 90 degrees or in and out in a 45 degree angle. The lasers do minimal damage and have a short range, but can be effective in close combat and cutting through locks and light barriers.

Primary Purpose: Assault and defense.

Mega-Damage: 2D4 M.D. per single blast, 4D4 per simultaneous dual blast at the same target from both lasers.

Rate of Fire: Single shot or dual blast, both count as one melee attack.

Effective Range: Laser: 300 feet (91.5 m).

Payload: Unlimited; tied to the robot's power supply.

**3. Combat Capabilities:** Rather than use a weapon, the Combat Hound can engage in Mega-Damage hand to hand combat using its body and paws.

Attacks Per Melee: Six, mainly using its energy weapons.

Hand to Hand Damage: Limited.

Head Butt: 3D6+11 S.D.C.

Restrained Pounce Attack: 5D6+5 S.D.C.

Full Strength Pounce Attack: 1D6 M.D.

Paw Strike: 4D6+11 S.D.C.

Power Punch/Paw Strike: 1D4 M.D., but counts as two melee attacks.

Body Block: 1D4 M.D.

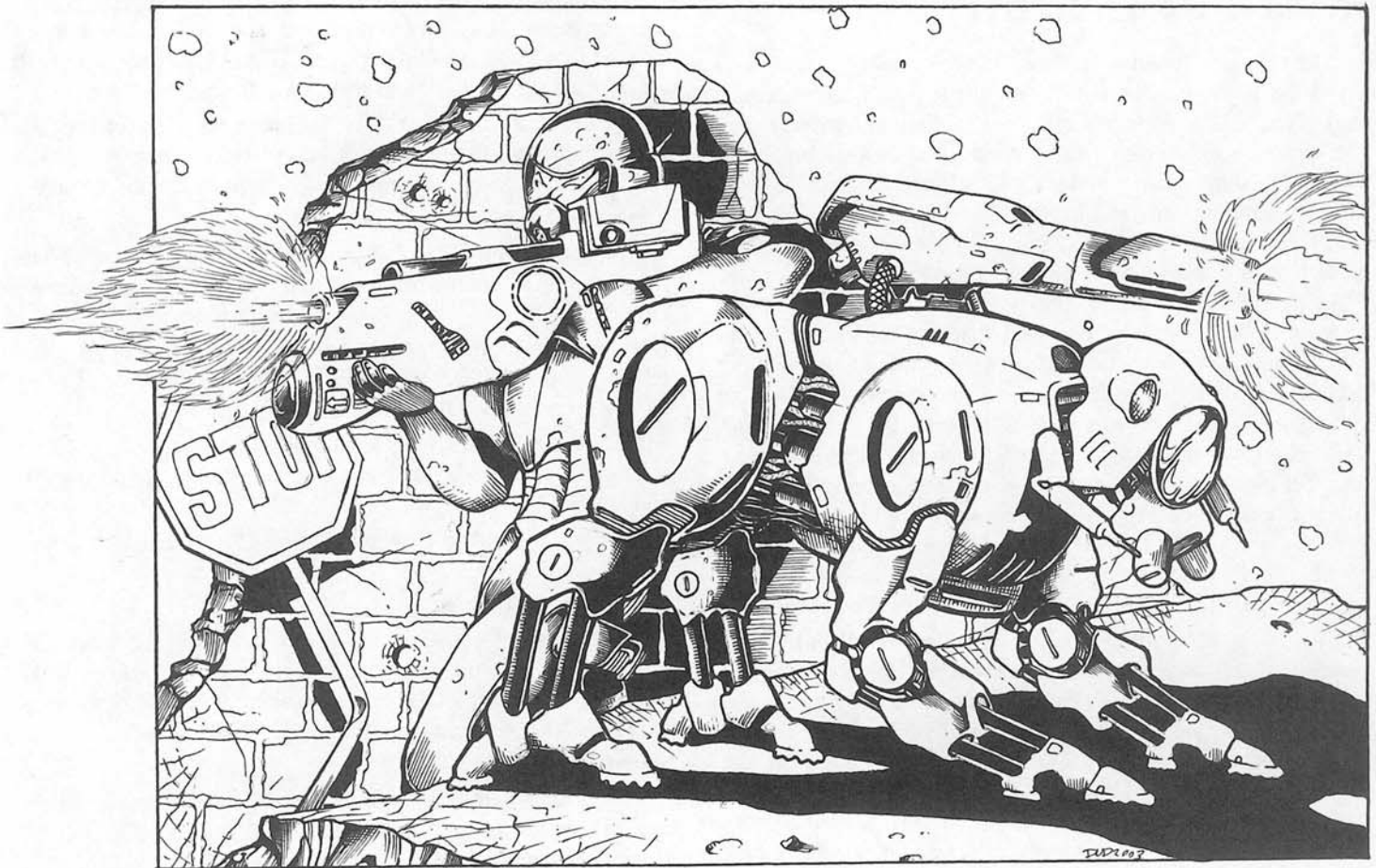

**Bonuses:** Includes all bonuses from programming, robotics and sensors: +2 to strike with heavy laser (main gun), +4 to strike with head lasers, +2 to strike with pounce or paw attacks, +1 to parry with paws, +4 to dodge, +2 to roll with impact or fall. Impervious to poison, gas, and biological agents, as well as psionic and magic mind control, charms, bio-manipulation, and S.D.C. attacks. See sensors for optical capabilities.

- Sensor Systems of Note:** Same as the CDS only the Hound does not have speaking capabilities, and it has a video camera and live transmission feed so its human partner can literally see what the Hound sees, projected on the helmet HUD display; audio can also be transmitted. A pair of small lights are mounted on the head where ears might be on a real dog. These are used to illuminate an area for searching or filming and can be turned on and off as necessary or desirable.
- Skill Programs of Note:** Basic Math 98%, Radio: Basic 98%, TV/Video (internal system), Prowl 45%, Detect Ambush 50%, Tracking 60%, Track Animals 50%, Intelligence 76%, Land Navigation 76%, and Mining 76%.
- Programming and memory** enable the robot to identify all NEMA, USA, Canadian and Mexican military ranks, uniforms, insignia, soldiers, robots, power armor, vehicles, weapons, equipment, and officers. Memory also includes the identification of 4000 different enemy targets, including new data on specific races, non-human features and powers, insignia, uniforms, enemy robot and vehicle designs, acts of aggression, and notorious enemies. Combat programming directs the actions and reactions to encounters and attacks.

## Pup Scout

A small robot patterned after the canine form. The Pup (so named due to its small size) is used for both rescue and reconnaissance. It is designed to be able to navigate through small spaces, crawl through tunnels and squeeze through cracks. In fact, its legs are designed so they bend at several points and can go completely prone (flat), enabling the Pup to crawl on its belly and through small openings (reduce speed by 60%). Padded feet allow for better stealth. Equipped with concealed multiple optics, sensors and video feed. Sometimes used to carry a medical kit, radio, food, water, tool kit, pistol, and other small items to those trapped in a pocket under debris or lost in the wilderness.

Light weapons or additional sensors, searchlight or video or communications packages can be mounted on the back, though such extras, even low profile ones, interfere with the Pup's ability to maneuver in and through narrow passages and openings.

### Pup Reconnaissance Drone – Robot/Artificial Intelligence

**Model Type:** NEMA-RX 3036

**Class:** Fully Automated Self-Sufficient Infantry and Rescue Robot.

**Crew:** None; artificial intelligence.

**M.D.C. by Location:**

Legs (4) – 20 each

Back Mounted Weapon or Sensors (1; optional) – 20-50

\* Front Sensor Discs (2; chest) – 3 each

\*\* Main Body – 50

\* Destroying the sensor discs in the chest of the little robot eliminates all optics, video, communications and sensory systems. In most cases the robot shuts down as a safety feature. However, in some cases, about one in ten, the robot continues to fight or tries to blindly find its way back to base camp. No combat bonuses to strike, parry, or dodge without sensors.

These sensor discs are small and difficult to hit, especially on a moving target. Thus, they can only be hit when a character makes a "called shot," and even then the attacker is -3 to strike.

\*\* Depleting the M.D.C. of the main body effectively destroys the robot, shutting it down completely. **Note:** Additional body armor cannot be worn.

### Speed & Movement:

**Running:** 45 mph (72 km) maximum. Note that the act of running does NOT tire the robot and maximum speed can be maintained indefinitely.

**Leaping:** Three feet (0.9 m) high and five feet (1.5 m) across; increase by 50% with a running start.

**Climbing:** Fair, roughly equal to that of a real canine, good on inclines of up to 60 degrees and can navigate stairs (full speed) and ledges (half speed) well.

**Stealth:** Fair, equal to a Prowl skill of 60%.

**Flying:** Not applicable.

**Underwater Capabilities:** The Pup is not designed for underwater operations and sinks like a rock. It can, however, walk along the bottom of a lake or sea at about 25% its normal running speed. Maximum Ocean Depth: 600 feet (183 m).





### Statistical Data:

**Height:** About that of a Terrier or Cocker Spaniel, one and a half feet (0.45 m) at the highest point as a basic unit, as tall as two or two and a half feet (0.6 to 0.76 m) with a weapon, transmitter or additional camera or sensor mounting on the back.

**Width:** One foot (0.3 m). **Length:** Two feet (0.6 m). **Weight:** 50 lbs (22.5 kg).

**Physical Strength:** Equal to a Robot P.S. of 20.

**Cargo:** Can carry up to 60 pounds (27 kg) and pull up to 160 pounds (72 kg, double if the load is on wheels and the terrain flat like a dirt or concrete road, hallway or short grass).

**Power System:** Nuclear, average energy life is two years even under the most strenuous and constant amount of use, three years under less active conditions.

**Cost & Availability:** Exclusive to NEMA and the militaries of the three allied nations (most of which are unaccounted for, the majority presumed to be destroyed). Any Pup outside of NEMA was found or stolen and sells for upwards of a half million credits or equivalent in trade. Rare.

**Weapon System:** None standard, but the equivalent of a pistol or light rifle or light machine-gun can be mounted on the back of the Pup.

**Combat Capabilities:** Rather than use a weapon, the Combat Drone can engage in Mega-Damage hand to hand combat using its body and paws.

**Attacks/Actions Per Melee:** Five, mainly using its body or an optional weapon mounting.

**Hand to Hand Damage:** Limited.

Restrained Pounce Attack: 2D6+2 S.D.C.

Full Strength Pounce Attack: 4D6+5 S.D.C.

Paw Strike: 1D6+5 S.D.C.

Power Punch/Paw Strike: 3D6+2 S.D.C., but counts as two melee attacks.

Body Block: 2D6 S.D.C.

**Bonuses:** Includes all bonuses from programming, robotics and sensors: +2 to strike with weapon mount (any), +3 to strike with pounce or paw attacks, +1 to parry with paws, +6 to automatic dodge (can dodge without losing an melee attack/action), +1 to roll with impact or fall. Impervious to poison, gas, and biological agents, as well as psionic and magic mind control, charms, bio-manipulation, and S.D.C. attacks. Also see sensors.

**Sensor Systems of Note:** Same as the Combat Hound, and like the Hound, does not have speaking capabilities, but does have a video camera and live transmission feed (range 15 miles/24 km) so its human partner can literally see what the Pup sees, projected on the helmet HUD display; audio can also be transmitted. Also has a radiation detector, air thermometer and molecular analyzer (all basically the same as the bionic equivalents).

**Skill Programs of Note:** Basic Math 98%, Radio: Basic 98%, TV/Video (internal system), Prowl 60%, Detect Ambush 50%, Camouflage 50%, Tracking 60%, Track Animals 50%, Intelligence 76%, and Land Navigation 86%.

**Programming and memory** enable the robot to identify all NEMA, USA, Canadian and Mexican military ranks, uniforms, insignia, soldiers, robots, power armor, vehicles, weapons, equipment, and officers. Memory also includes the

identification of 4000 different enemy targets, including new data on specific races, non-human features and powers, insignia, uniforms, enemy robot and vehicle designs, acts of aggression, and notorious enemies. Combat programming directs the actions and reactions to encounters and attacks.

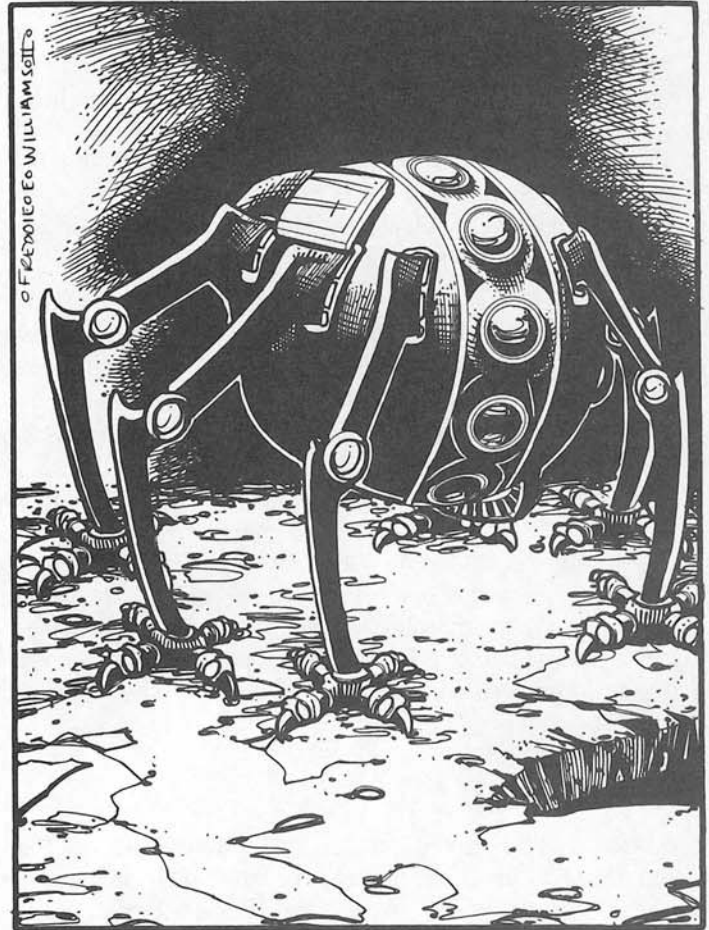

## Spider Probe

A small, six-legged, walking camera and optic system. (Yes, we know spiders have eight legs, but that's what they call it anyway. Editor Al.) The Spider Probe has two primary purposes. One is to locate victims trapped in collapsed structures, tunnels, and caves. The little bundle of optics and basic sensors is ideal for locating trapped, pinned or lost disaster victims, and transmitting basic data about the environment, the situation and the victims. Two, spy on and keep track of enemy personnel (following them and transmitting their location and activity, live). The probe is designed to be unobtrusive and able to hide and fit in small, narrow spaces including pipes, tubing, air ducts, cracks in walls, and crevices, under and behind furniture, etc. Its clawed, four-toed feet enable it to scale debris piles, climb steep inclines, hang on in strong winds or water currents, and even attempt to climb walls and ceilings. As a probe and spy unit, it is primarily deployed by Intel-Agents, Military Specialists and scouts.

**Spider Reconnaissance Probe – Robot/Artificial Intelligence**  
**Model Type:** NEMA-RPX 201

**Class:** Fully Automated Self-Sufficient Robot Probe.

**Crew:** None; artificial intelligence.

**M.D.C. by Location:**

Legs (6) – 3 each

\* Optic and Sensor Bulbs (10) – 1 each

\*\* Main Body – 12

\* Destroying one of the sensor bulbs in the main body destroys one of its many optic systems, cameras, communications and sensory systems. When eight or more are lost, particularly video feed, the probe leaves its post unless commanded to do otherwise, and returns to base camp. These sensor bulbs are small and difficult to hit, especially on a moving target. Thus, they can only be hit when a character makes a “called shot,” but the attacker is -5 to strike.

Destroying one leg reduces speed by 15% and Prowl by 5%; accumulative penalties for every lost limb. Cannot scale walls or ceilings with fewer than four legs.

\*\* Depleting the M.D.C. of the main body shatters the robot and destroys its electronic systems completely.

**Speed & Movement:**

**Running:** 6 mph (9.6 km) maximum. The act of running does NOT tire the robot and maximum speed can be maintained indefinitely.

**Leaping:** Two feet (0.6 m) high and four feet (1.2 m) across; does not increase with a running start.

**Climbing:** Excellent, roughly equal to that of a real insect; good on inclines of up to 75 degrees and rough textured surfaces straight up and down at half speed. Can navigate stairs and ledges (full speed), climb trees (half speed) and even climb walls, pillars and ceilings (one quarter speed) provided the material is soft enough for the robot to dig its claws into for support.

**Stealth:** Excellent. Equal to a Prowl of 72%; padded feet, small stature, dark color (black or camouflage).

**Flying:** Not applicable.

**Underwater Capabilities:** Cannot swim but is airtight and can walk underwater – along the bottom of a stream, water filled pipe or tunnel, etc., at about half its normal speed. Maximum Ocean Depth: 800 feet (244 m).

**Statistical Data:**

**Size:** Roughly the size of a softball or grapefruit with six legs extending from it; under eight inches in diameter.

**Weight:** 5 lbs (2.25 kg).

**Physical Strength:** Equal to a robot P.S. of 8.

**Cargo:** Can carry up to 10 pounds (4.5 kg) and pull up to 20 (9 kg).

**Power System:** Nuclear, average energy life is two years.

**Cost & Availability:** Exclusive to NEMA and the militaries of the three allied nations (most of which are unaccounted for, the majority presumed to be destroyed). Any Spider Probe outside of NEMA was found or stolen and sells for upwards of 50,000 credits or equivalent in trade. Uncommon.

**Weapon System:** None.

**Combat Capabilities:** None per se.

**Actions Per Melee:** Four, mainly observation and tracking.

**Hand to Hand Damage:** Limited.

Crush/Pinch with its clawed feet: 1D4 S.D.C.

Leap Attack or Drop from Ceiling: 1D6 S.D.C.; feels like getting struck by a brick.

**Bonuses:** Includes all bonuses from programming, robotics and sensors: +1 to strike on a pinch or leap attack, +3 to automatic dodge (can dodge without losing an melee attack/action), +3 to roll with impact or fall. Impervious to poison, gas, and biological agents, as well as psionic and magic mind control, charms, bio-manipulation, and S.D.C. attacks. Also see sensors.

**Sensor Systems of Note:** All optics and lenses are tied to the video transmission system and can be broadcast to a NEMA operator in the field monitoring the probe or base camp (if the latter is close enough). Robot Commanders and anyone working with probes will have a portable hand-held monitor and a larger monitoring unit (the size of a small laptop computer), plus the data can be transmitted and displayed on the helmet HUD display of NEMA body and power armor.

Each sensor or optic system is numbered to indicate the features of each one of the ten sensor bulbs. If individually targeted by an enemy (a rarity) or if the Spider Probe is damaged in some other way and loses one or more of its reconnaissance features, the G.M. can pick one (or some) or roll a 1D10 for random determination.

1. Multi-Optics system: Sees normal human and infrared and ultraviolet spectrums of light, plus passive nightvision. Range: 2000 feet (610 m).

2. Telescoping zoom lens. Range 2000 feet (610 m).

3. Micro-Magnifying lens with x2, x10, and x50 magnification.

4. Thermo-Optics and heat sensors, vital for finding warm bodies trapped under debris or hiding under camouflage or behind cover. Range: 1000 feet (305 m).

5. Camera/Video Eye with live transmission – live feed, no recording capability. Video camera and live transmission feed so its human partner can literally see what the probe sees. Range: One and a half miles (2.4 km).

6. Electronic Ear and audio transmitter with scrambler capabilities. Range: One and a half miles (2.4 km).

7. Laser Distancer: A light beam that accurately measures distance. Range: 1000 feet (305 m).

8. Radiation Detector. Range: 100 foot (30.5 m) diameter.

9. Air Thermometer: Measures the ambient air temperature around the walking probe. Range: 20 foot (6 m) diameter.

10. Molecular Analyzer: Detects and identifies impurities in the air. Mainly searches for toxic gases, pollution and chemicals harmful to humans. Range: 20 foot (6 m) diameter.

**Plus Radio Communications:** Directional radio for coded messages between the robot and its human commander or base camp. Can also scan and communicate via code on conventional radio channels/frequencies, same range, and eavesdrop on enemy transmissions and track transmissions (60% success level) to their source. Range: 10 miles (16 km). **Note:** Understands English, French, Spanish, German, Russian, Chinese, Arabic, and 15 other languages; can identify all others but can not understand or communicate in them.

**Skill Programs of Note:** Basic Math 98%, Radio: Basic 98%, TV/Video (internal system), Prowl 72%, Tracking 60%, and Land Navigation 86%.



**Programming and memory** enable the robot to identify all NEMA, USA, Canadian and Mexican military ranks, uniforms, insignia, soldiers, robots, power armor, vehicles, weapons, equipment, and officers. Memory also includes the identification of 4000 different enemy targets, including new data on specific races, non-human features and powers, insignia, uniforms, enemy robot and vehicle designs, acts of aggression, and notorious enemies. Combat programming directs the actions and reactions to encounters and attacks.

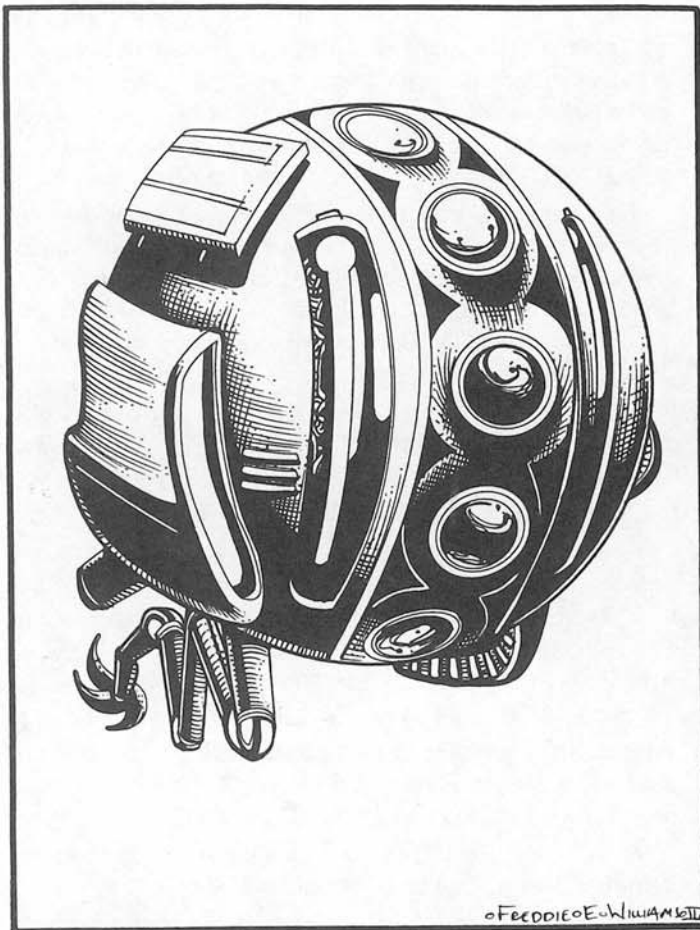

## Flying Probe

The latest in spy technology, the Flying Probe is exactly what it sounds like, a hover, flying version of the walking Spider Probe. That also means the Flying Probe is used to track, find, follow and spy on the enemy as well as locate victims of a disaster, only it quietly flies instead of scurrying across the ground. One of its different features is a retractable, folding arm that can end in a small mechanical arm and hand capable of picking up and carrying small, light objects such as a set of keys, pen, paper, knife, hand-held communicator, and similar items. In the alternative, it may end with a Pen Laser, mini-buzz saw (does 2D6 S.D.C.) or an 11th sensor probe of some kind. As a probe and spy unit, it is primarily deployed by Intel-Agents, Military Specialists and scouts.

**Flying Probe for Reconnaissance –  
Robot/Artificial Intelligence**

**Model Type:** NEMA-RPX 201

**Class:** Fully Automated Self-Sufficient Robot Probe.

**Crew:** None; artificial intelligence.

**M.D.C. by Location:**

Legs (6) – 3 each

\* Optic and Sensor Bulbs (10) – 1 each

\*\* Main Body – 12

\* Destroying one of the sensor bulbs in the main body destroys one of its many optic systems, cameras, communications and sensory systems. When eight or more are lost, particularly video feed, the probe leaves its post unless commanded to do otherwise, and returns to base camp. These sensor bulbs are small and difficult to hit, especially on a moving target. Thus, they can only be hit when a character makes a “called shot,” and the attacker is -5 to strike.

\*\* Depleting the M.D.C. of the main body shatters the robot and destroys its electronic systems completely.

**Speed & Movement:**

**Flying:** 20 mph (32 km) maximum, but typically travels at about 1-5 mph (1.6 to 8 km) when probing/examining/searching an area.

**Stealth:** Excellent. Equal to a Prowl of 75%; silent flight. Makes just a slight purr that is usually drowned out by even the slightest ambient noise, and makes a swishing sound as it flies by if traveling faster than 10 mph (16 km).

**Running, Leaping & Climbing:** Not applicable.

**Underwater Capabilities:** None.

**Statistical Data:**

**Size:** Roughly the size of a softball or grapefruit with a small hover system attached; roughly six inches in diameter.

**Weight:** 4.5 lbs (2 kg).

**Physical Strength:** Not applicable unless it has a retractable arm and hand (P.S. 6).

**Cargo:** None.

**Power System:** Nuclear, average energy life is two years.

**Cost & Availability:** Exclusive to NEMA and the militaries of the three allied nations (most of which are unaccounted for, the majority presumed to be destroyed). Any Flying Probe outside of NEMA was found or stolen and sells for upwards of 80,000 credits or equivalent in trade. Rare.

**Weapon System:** None.

**Combat Capabilities:** None per se.

**Actions Per Melee:** Five, mainly observation and tracking.

**Hand to Hand Damage:** Only if a cutting tool is part of its retractable arm.

**Bonuses:** Includes all bonuses from programming, robotics and sensors: +1 to strike with retractable arm, +4 to automatic dodge (can dodge without losing an melee attack/action), +1 to roll with impact or fall. Impervious to poison, gas, and biological agents, as well as psionic and magic mind control, charms, bio-manipulation, and S.D.C. attacks. Also see sensors.

**Sensor Systems of Note:** Same as the Spider Probe. May have one additional sensor for its retractable arm (or a tool).

**Skill Programs & Memory:** Same as the Spider Probe.

# NEMA Robot Vehicles

## All Robot Vehicles have the following features:

- 1. Nuclear Powered:** An effectively unlimited fuel capacity and power source with an average life of 15 to 20 years.
- 2. Radar:** Can identify 172 and track up to 132 targets simultaneously at a range of 50 miles (80 km).
- 3. Combat Computer:** Calculates, stores and transmits data onto the Heads Up Display (H.U.D.) of the pilot's helmet, as well as monitors on the control panel. It is linked to the targeting computer, weapon systems and radar.
- 4. Targeting Computer:** Assists in tracking and identification of enemy targets. 30 mile range (48 km).
- 5. Long-Range Laser Targeting System:** Assists in the selection and focusing of specific targets and adds a bonus of +1 on initiative and +1 to strike when using long-range weapons. Does not apply to hand to hand combat.
- 6. Radio Communication:** Long-range, directional communication system with an effective range of about 500 miles (800 km). The typical robot vehicle also has a directional, short-range radio with a 20 mile (32 km) range, plus a built in loudspeaker; 80 decibels.
- 7. External Audio Pickup:** A sound amplification listening system that can pick up a whisper 300 feet (91.5 m) away.
- 8. Spotlights:** Many have at least one or two spotlights used for illumination at night and inside buildings without electricity. The spotlight's use is usually for the benefit of the ground troops the robot is supporting, since most robot vehicles have passive nightvision and other optical enhancements. Typical range is 600 feet (182 m).
- 9. Ejector Seat:** In case of an emergency, the pilot (and crew) can be instantly ejected (about 1000 feet/305 m) and parachute to safety.
- 10 Self-Destruct:** A last resort measure that is fairly self-contained, destroying most of the internal systems with 3D6x10 M.D. Those within a ten foot (3 m) radius of the robot will suffer 6D6 M.D. from concussion and/or flying debris. It is, however, very likely, 01-88% chance, that the nuclear power system will rupture and spew forth deadly levels of radiation.
- 11. Voice Actuated Locking System:** The robot's access hatch is sealed by an automatic locking system. A six digit spoken code programmed to a specific voice(s) pattern (six voice memory) is standard operating procedure. A manual key pad is provided in case of system failure/override.
- 12. Complete Reinforced, Environmental Pilot and Crew Compartment:** Designed to function as an inner shell or womb to protect the pilot (and in giant robots, the 2-6 man crew). It is airtight, pressurized and suitable for use in all hostile environments, including underwater (typically half to one mile/0.8 to 1.6 km depth) as well as outer space.
- 13. Other standard, built-in features:** Computer controlled life support system. Internal cooling and temperature control. Air purification and circulation systems, gas filtration, and humidifier/dehumidifier automatically engage when needed. Can recirculate breathable air for up to four weeks before

getting too stale to breathe. The computer controlled, independent oxygen supply and purge system automatically engage in low oxygen or contaminated air environments. Twelve hour oxygen supply.

Insulated, high temperature resistant shielding for up to 450 degrees centigrade and radiation shielding. Normal fires do no damage. Nuclear, plasma, and magic fires do full damage.

Polarized and light sensitive/adjusting tinted windshields, when applicable, but the pilots of most robot vehicles "see" by means of cameras that display the images and scenes around them as if looking through a window with zoom lens capabilities, nightsight and thermo-imaging. Heads Up Display (HUD) systems are also part of the optics and display arrangement, bringing up a variety of data on screen as multiple windows and insets on the various screens (deleted with a press of a button on a keyboard or voice command).

Advanced, voice actuated (with keyboard backup) master computer system to manage all the various systems and to display information as it becomes available. It can also do mathematical calculations, clock, calendar, compass, word processing, radio coded and uncoded transmissions (spoken or typed), and pull up, display and file optical and sensor data (structural damage, internal systems, radar targeting, etc.) as needed.

Interchangeable and/or optional weapons. Some weapon systems are modular and can use two or more different types of weapons (though only one at a time). Others can carry or use optional weapons and equipment (sensor pods, searchlights, additional or different weapon, etc.).

## Bull Dog

The Bull Dog is the next step beyond power armor. It stands eleven feet (3.3 m) tall, bristles with weapons and sensors, and functions well in the dual capacity of a combat and rescue unit. The pilot sits safely tucked away inside the chest cavity where he operates the various controls surrounded by four monitor screens that wrap around him, displaying data and visual information. The displays are designed and positioned in such a way that they help make the cramped quarters seem more spacious and the visual scenes transmitted by a number of concealed cameras on the body of the robot actually create the illusion of looking out wraparound windows. Cross-hairs are superimposed on targets as necessary and zoom and wide-angle lenses pull in and out for close-ups to long, 180 degree views, providing the pilot with a superior sense of vision. Other optical enhancements enable the pilot to see well in the dark, see and track heat signals (thermo-imaging), filter out glare and haze, and function well under the worst and most varied of conditions. Additionally, a variety of data appears on screen as multiple windows and insets on the various screens. They are deleted or filed with a press of a button or simple voice command. **Note:** While *all*





robot vehicles have a similar optics and screen setup, the Bull Dog has a much wider array of optics and sensors than most, making it a giant version of the Spider Probe with combat capabilities.

As a rescue unit, the Bull Dog offers excellent speed and mobility, a battery of sensors and optics to probe and search its surroundings. It has good strength to pull away, punch through or dig under rubble and debris and its size is such that the Bull Dog

can navigate streets, alleyways, tunnels, hallways and other relatively narrow areas and openings.

In combat situations, the Bull Dog has a good selection of light, medium and heavy weapons with which to respond, plus it is the resounding champion when it comes to speed in hand to hand combat with more attacks per melee round than any other manned robot. Its size and design also make the Bull Dog well suited for urban combat, mobile infantry support, rescue, patrols, assaults and defense. It does equally well against ground troops and light to heavy armored vehicles, as well as reasonably well against low flying enemies and light aircraft. It is not unusual see one or two Bull Dogs standing guard at a strategic junction, crossroads, or entrance gate, or escorting troops or a convoy, accompanying a rescue team or reconnaissance squad or going out on a search and destroy mission. The versatile robot may, however, be assigned to almost any kind of military or rescue operation from search and rescue to standup combat or leading an assault.

## **NEMA Bull Dog – Manned Combat Robot**

**Class:** Light Infantry Assault & Rescue Robot.

**Crew:** One, pilot.

### **M.D.C. by Location:**

- \* Hands (2) – 50 each
- Arms (2) – 140 each
- Legs (2) – 170 each
- Feet (2) – 140 each
- Forearm Guns (2) – 60 each
- Shoulder Laser Turrets (2) – 70 each
- Mini-Missile Launchers (6; chest) – 55 each
- \* Sensor Head (1; small) – 60
- \* Sensor Rods (6; back) – 45 each
- \* Cameras and Electronic Eyes (17; tiny) – 2 each.
- \*\* Main Body – 310
- Reinforced Pilot's Compartment – 100

\* A single asterisk indicates a small and difficult target to strike, requiring the attacker to make a "called shot," but even then he is -3 to strike. The camera eyes are -5 to target and hit.

Destroying the sensor head knocks out only one sensor cluster, but does destroy long-range radio transmission capabilities (short-range only), laser targeting (no bonus for energy weapons) and reduces radar range by 25%. Destroying two or three sensor rods has no serious effect due to multiple redundancy systems, but does knock out 1D4+2 of the camera eyes and motion detector. Destroying four or five and the sensor head knocks out half the sensors and reduces the surviving short-range transmission range in half.

\*\* Depleting the M.D.C. of the main body will shut the robot down completely, rendering it useless.

### **Speed:**

**Running:** 70 mph (112 km) maximum. Note that the act of running does not tire its operator and maximum speed can be maintained indefinitely.

**Leaping:** The Bull Dog can leap 25 feet (7.6 m) high or lengthwise with a short running start. Cannot perform a leap kick.

**Underwater Capabilities:** Airtight and can walk along the bottom of the sea at about 25% its normal running speed. Maximum Ocean Depth: 6000 feet (1829 m).

### **Statistical Data:**

**Height:** 12 feet (3.2 m). **Width:** 7 feet (2.1 m). **Length:** 6 feet (1.8 m).

**Weight:** 11 tons fully loaded.

**Physical Strength:** Equal to a Robotic P.S. of 35.

**Cargo:** Minimal storage space, enough to stow a rifle, backpack and basic gear.

**Power System:** Nuclear; average energy life is 20 years.

**Cost & Availability:** Exclusive to NEMA and the militaries of the three allied nations (most of which are unaccounted for, the majority presumed to be destroyed). Any Bull Dog outside of NEMA was found or stolen and sells for upwards of 20 million credits or equivalent in trade. Rare.

### **Weapon Systems:**

**1. BDR-22 Single-Barreled Laser Turrets (2):** Mounted on the shoulders, above and a bit behind the chest missile launchers, are a pair of laser turrets. The turrets can rotate 360 degrees and have a 45 degree arc of fire, up and down.

**Primary Purpose:** Anti-personnel, air response and defense.

**Mega-Damage:** 3D6 M.D. per single shot or 6D6 per dual, simultaneous blast at the same target (counts as one attack).

**Range:** 2000 feet (610 m).

**Rate of Attack:** Equal to the hand to hand attacks of the pilot operating them. Each blast counts as one melee attack/action.

**Payload:** Effectively unlimited; tied to the robot's power supply.

**2. BDR-36 Plasma Forearm Weapons (2):** A heavy plasma ejector is standard issue, and its stats follow. **Note:** The plasma forearm weapon may be substituted for a heavy rail gun, like the R-670 (ammo drum hooked to the back or hip), a mini-missile launcher (four missile payload per weapon, but can be reloaded by hand), grenade launcher (100 round drum hooked to arm or hip feed canister; same as GLR-540 rifle), or heavy, long-range laser (3D6 M.D. per blast and a 3000 foot/914 m range). If desirable, one different forearm weapon can be used on each arm. In all cases, point and shoot.

**Primary Purpose:** Anti-armor, anti-personnel and assault.

**Mega-Damage:** Plasma 5D6 per single blast. The two forearm weapons cannot be used in tandem to fire at the same target as one melee attack. Both can be fired but each blast per arm counts as a separate melee attack.

**Rate of Fire:** Equal to the number of attacks per melee round of its pilot; each shot counts as one melee attack.

**Effective Range:** 1600 feet (488 m).

**Payload:** Effectively unlimited.

**3. BDR-60 Mini-Missile Launchers (6):** Located on both sides of the chest are stacked three sets of mini-missile launchers. The launcher covering must flip open to fire. The small circular lens in each is a camera/video feed not related to the weapon system.

**Primary Purpose:** Anti-armor and power armor, and anti-aircraft.



Missile Type: Any mini-missile can be used.

Mega-Damage: Varies with missile type.

Range: One mile (1.6 m).

Rate of Fire: One at a time or in a volley of two, three, four or six.

Payload: 36 total; six in each of the launchers.

**4 BDR-202 Long-Range Laser Cannon (1, hand-held; optional):** An experimental rifle-style weapon designed specifically with the Bull Dog in mind, though it can also be used by the Gunbuster and Chromium Guardsman power armor or mounted on a vehicle. The weapon is 12 feet (3.6 m) long, requires both hands to fire and is a precision, long-range laser cannon. Aim and shoot the same as one would a rifle. Only one third ever use this weapon, some only when the mission suggests it will be useful. It is shown in the illustration on page 32.

Primary Purpose: Anti-personnel, air response and sniping.

Mega-Damage: 4D6 M.D. per single shot.

Range: 4000 feet (1219 m).

Rate of Attack: Each blast counts as one melee attack/action.

Payload: 10 blasts per standard E-Clip or 84 heavy with a power pack. Unlimited if physically cabled to the robot's power supply, but this is not done very often because the weapon is too large and clumsy to be attached to the vehicle.

**5. Hand to Hand Combat:** Available only to those who take *Robot Combat Elite: Bull Dog*. Those not skilled in "Elite" use the *Robot Basic* stats. **Note:** All bonuses are in addition to the pilot's own hand to hand combat training and attribute bonuses. They do *not* apply to the pilot's physical abilities outside the robot.

+1 extra attack/action per melee round, *plus* those of the pilot at level one. Add one additional attack at levels 3, 6, 10 and 14.

Critical strike is the same as the pilot's.

+3 on initiative.

+1 to strike with energy weapons, in addition to W.P. skills (typically Weapon Systems and W.P. Heavy Energy are the only two that apply to robots and armored vehicles).

+2 to strike in hand to hand combat.

+3 to parry in addition to the hand to hand combat.

+1 to dodge standing, +2 to dodge running or leaping.

+1 to disarm a giant-sized opponent.

+2 to pull punch.

+3 to roll with impact, punch or fall.

Punch Damage: 1D4 M.D. on a restrained punch, 1D6 M.D. on a full strength punch.

Power Punch: 4D4 M.D., but counts as two melee attacks.

Tear or Pry with Hands: 1D6 M.D.

Kick Damage: 2D4 M.D.

Power Kick: 3D6 M.D., but counts as two melee attacks.

Body Block/Ram: 2D4 M.D.

Full Speed Running Ram: 4D6 M.D., but this attack uses up three melee actions.

Stomp: 1D6 M.D.; effective only against objects smaller than four feet (1.2 m) tall.

**6. Special Sensory Systems of Note:** All those standard in robot vehicles and all those found in the Spider Probe on a more elaborate scale, plus language translator, motion detector (40 foot/12.2 m diameter), and depth gauges.

Cameras and monitors. 17 total: 7 chest, 5 back, 2 hips, 3 head (front and back); each is the size of a tennis ball or tangerine, a few are slightly larger or a bit different, like those in the hip on either side of the NEMA logo. **Note:** Not only do the camera/video eyes send and record data to the Bull Dog, but it can also send live transmissions to ground troop partners, like an Intel-Agent or Military Specialist, other manned robots and/or a mobile base or even to Command, enabling one or all to literally see what the Bull Dog sees. Range is equal to that of its radio communications capabilities; that's 500 miles (800 km) when the long-range radio is intact and away from ley line interference (which can reduce transmission range to half or one third).

## Mastiff

A big bruiser at 15 feet (4.6 m), the Mastiff is a heavy combat and rescue vehicle of considerable power. It lacks the finesse, speed, and range of sensors of the Bull Dog, but makes up for it in raw power. In many respects, the Mastiff is a walking demolitions machine, heavily armored to take great punishment and withstand a pounding from an enemy barrage or heavy debris. Its hands and forearms are massive and oversized to give them hammering punching power to knock down walls and support beams, punch through fortifications, and tear apart buildings and other Mega-Damage structures and machines. To further its destructive purpose, it is armed with a battery of mini-missile launchers and can have a pair of heavy plasma or ion cannons mounted on its shoulders instead of the large searchlights that come standard issue. In a rescue capacity, the Mastiff can chop, pound, and remove debris in great chunks, blow open passage ways, punch through walls and barriers, brace support beams and defend against the largest and most fearsome monsters.

The pilot sits safely tucked away inside the chest cavity where he operates the various controls and is surrounded by monitors. Its size and slow speed make the Mastiff best as a heavy support or demolitions unit. It does well in urban combat, able to negotiate city streets and alleys, but not usually able to pursue opponents inside buildings unless it is authorized to tear the building apart doing so, tromping through walls and tearing up ceilings like they were made of paper. Against ground troops, light to heavy armored vehicles and giant monsters, the Mastiff is unmatched, except by the experimental "Big Dog." The Mastiff is most commonly found helping in construction or demolitions, standing guard at a strategic junction, or crossroads, or escorting troops or armored companies, but may accompany a rescue team or reconnaissance squad or go out on search and destroy missions, especially against monsters and high-tech invaders.

### NEMA Mastiff – Manned Combat Robot

**Class:** Heavy Infantry Assault & Rescue Robot.

**Crew:** One pilot.

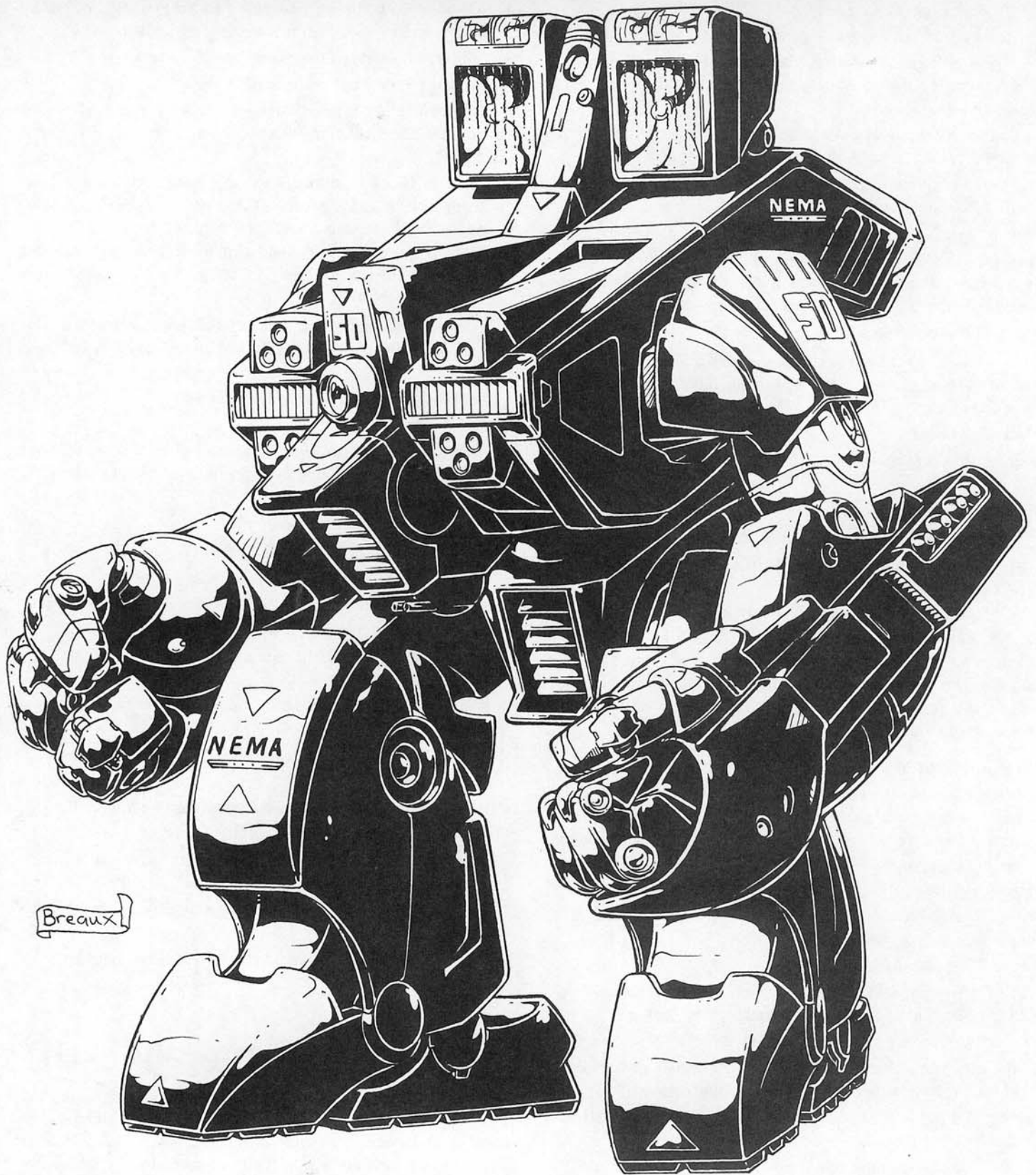

**M.D.C. by Location:**

Hands (2) – 200 each  
 Forearms (2) – 250 each  
 Upper Arms (2) – 180 each  
 Legs (2) – 290 each  
 Feet (2) – 240 each

Mini-Missile Launchers (4, chest) – 90 each  
 \* Forearm Mini-Missile Launchers (2) – 50 each  
 \* Belly Gun Turret (1) – 50  
 \* Sensor Eye (1; chest) – 60  
 \* Shoulder Searchlights (2; large, top mounted) – 30 each  
 \* Cameras and Electronic Eyes (4; concealed) – 2 each



\*\* Main Body – 600

Reinforced Pilot's Compartment – 100

\* A single asterisk indicates a small and difficult target to strike, requiring the attacker to make a "called shot," but even then he is -3 to strike.

Destroying the sensor eye knocks out radar, long-range communications, and reduces optics and sensor range by 60%.

\*\* Depleting the M.D.C. of the main body will shut the robot down, rendering it useless.

#### Speed:

Running: 40 mph (64 km) maximum. Note that the act of running does not tire its operator and maximum speed can be maintained indefinitely.

Leaping: Not possible.

Underwater Capabilities: Airtight and can walk along the bottom of the sea at about 25% its normal running speed. Maximum Ocean Depth: 6800 feet (2072.6 m).

#### Statistical Data:

Height: 15 feet (4.6 m). Width: 9 feet (2.7 m). Length: 8.5 feet (2.6 m).

Weight: 16 tons fully loaded.

Physical Strength: Equal to a Robotic P.S. of 52.

Cargo: Little storage space, enough to stow a couple rifles, two or three backpacks and basic gear.

Power System: Nuclear; average energy life is 20 years.

Cost & Availability: Exclusive to NEMA and the militaries of the three allied nations (most of which are unaccounted for, the majority presumed to be destroyed). Any Mastiff outside of NEMA was found or stolen and sells for upwards of 20 million credits or equivalent in trade. Rare.

#### Weapon Systems:

**1. MR-44 Double-Barreled Laser Turret (1):** Mounted on the belly, barely noticeable under an exhaust fan, is a light laser turret. The turret can rotate 180 degrees and has a 45 degree arc of fire, up and down.

Primary Purpose: Anti-personnel and defense.

Mega-Damage: 2D6 M.D. per single shot or 4D6 per dual blast (either counts as one attack).

Range: 2000 feet (610 m).

Rate of Attack: Equal to the hand to hand attacks of the pilot operating it. Each blast counts as one melee attack/action.

Payload: Effectively unlimited; tied to the robot's power supply.

**2. MR-606 Mini-Missile Launchers (4):** Located on both sides of the chest are a pair of mini-missile launchers.

Primary Purpose: Anti-armor and power armor, and anti-aircraft.

Missile Type: Any mini-missile can be used.

Mega-Damage: Varies with missile type.

Range: One mile (1.6 m).

Rate of Fire: One at a time or in a volley of two, three, four or six.

Payload: 48 total; six in each of the four launchers. Typically 12 Fragmentation (5D6 M.D.), 12 Armor Piercing (1D4x10 M.D.), 22 Plasma (1D6x10 M.D.), and two Smoke.

**3. MR-608 Mini-Missile Forearm Launchers (2):** Located at the elbow area of each arm is a mini-missile launcher.

Same Stats as Number Two, above, except as follows:

Mega-Damage: Varies with missile type.

Payload: 16; eight mini-missiles per arm. Typically four are Smoke, six Fragmentation (5D6 M.D.) and six High Explosive (5D6 M.D.)

**4. Hand to Hand Combat:** Available only to those who take *Robot Combat Elite: Mastiff*. Those not skilled in "Elite" use the *Robot Basic* stats. **Note:** All bonuses are in addition to the pilot's own hand to hand combat training and attribute bonuses. They do *not* apply to the pilot's physical abilities outside the robot.

+1 extra attack/action per melee round, *plus* those of the pilot at level one. Add one additional attack at levels 4, 9, and 14.

Critical strike is the same as the pilot's.

+1 on initiative.

+1 to strike with laser turret and laser guided mini-missiles in addition to any bonus from the Weapon Systems or W.P. Heavy Energy skills.

+2 to strike in hand to hand combat.

+2 to parry in hand to hand combat.

No dodge bonus.

+4 to pull punch.

+1 to roll with impact, punch or fall.

Punch Damage: 2D6 M.D. on a restrained punch, 6D6 M.D. on a full strength punch.

Power Punch: 2D6x10 M.D., but counts as two melee attacks.

Tear or Pry with Hands: 5D6 M.D.

Kick Damage: 4D6 M.D.

Power Kick: 1D6x10 M.D., but counts as two melee attacks.

Body Block/Ram: 4D6 M.D.

Full Speed Running Ram: 2D4x10 M.D., but this attack uses up three melee actions.

Stomp: 3D6 M.D.; effective only against objects smaller than six feet (1.8 m) tall.

**5. Sensory Systems:** Only those standard to robot vehicles.

## "Big Dog" Super-Mastiff

An experimental, bigger, more powerful version of the Mastiff. Only a dozen are in the possession of NEMA Midwest Operations and there is no means to build additional Big Dogs. Replacement parts are also difficult to come by. Consequently, these giants are used sparingly and with great care.

### NEMA Mastiff – Manned Combat Robot

**Class:** Heavy Infantry Assault & Rescue Robot.

**Crew:** Three, a pilot, co-pilot or communications engineer and a gunner, plus room for one passenger, though a tight fit.

**M.D.C. by Location:**

Hands (2) – 250 each

Forearms (2) – 350 each

Upper Arms (2) – 240 each

Legs (2) – 360 each

Feet (2) – 320 each

Missile Launchers (4, chest) – 100 each

\* Forearm Mini-Missile Launchers (2) – 80 each

\* Belly Gun Turret (1) – 50

\* Sensor Eye (2; chest and Center Beam between lights) – 60 each

\* Shoulder Searchlights (2; giant, top mounted) – 50 each

\* Cameras and Electronic Eyes (8; concealed) – 2 each

\*\* Main Body – 850

Reinforced Pilot's Compartment – 100

\* A single asterisk indicates a small and difficult target to strike, requiring the attacker to make a "called shot," and even then he is -3 to strike.

Destroying the chest sensor eye has no effect, but knocking out both the chest and the one above it between the searchlights takes out radar, long-range communications, and reduces optics and sensor range by 60%.

\*\* Depleting the M.D.C. of the main body will shut the robot down completely, rendering it useless.





### Speed:

Running: 30 mph (48 km) maximum. Note that the act of running does not tire its operator and maximum speed can be maintained indefinitely.

Leaping: Not possible.

Underwater Capabilities: Airtight and can walk along the bottom of the sea at about 25% its normal running speed. Maximum Ocean Depth: 10,000 feet (3048 m).

### Statistical Data:

Height: 30 feet (9.1 m). Width: 20 feet (6.1 m). Length: 16 feet (4.9 m).

Weight: 36 tons fully loaded.

Physical Strength: Equal to a Robotic P.S. of 61.

Cargo: Enough for each occupant to stow a couple rifles, two backpacks and basic gear.

Power System: Nuclear; average energy life is 20 years.

Cost & Availability: Exclusive to NEMA and the militaries of the three allied nations (most of which are unaccounted for, the majority presumed to be destroyed). Any Big Dog outside of NEMA was found or stolen and sells for upwards of 40 million credits or equivalent in trade. Super rare even for NEMA.

### Weapon Systems:

**1. MR-44 Double-Barreled Laser Turret (1):** Same as Mastiff. Mounted on the belly, barely noticeable under an exhaust fan, is a light laser turret. The turret can rotate 180 degrees and has a 45 degree arc of fire, up and down.

Primary Purpose: Anti-personnel and defense.

Mega-Damage: 2D6 M.D. per single shot or 4D6 per dual blast (either counts as one attack).

Range: 2000 feet (610 m).

Rate of Attack: Equal to the hand to hand attacks of the pilot operating it. Each blast counts as one melee attack/action.

Payload: Effectively unlimited; tied to the robot's power supply.

**2. MR-610 Missile Launchers (4):** Located on both sides of the chest are a pair of missile launchers capable of launching short- and medium-range missiles.

Primary Purpose: Anti-armor and fortifications, and anti-aircraft.

Missile Type: Any short- or medium-ranged missiles can be used.

Mega-Damage: Varies with missile type. See missile damage chart in weapons section; 2D4x10 to 5D6x10 M.D. depending on type.

Range: 1-5 miles (1.6 to 8 km) for short-range, and 40-80 miles (64 to 128 km) for medium.

Rate of Fire: One at a time or in a volley of two, three, four or six.

Payload: 48 total, regardless of type; six in each of the four launchers. The type of missile varies with the mission and availability of missiles.

**3. MR-608 Mini-Missile Forearm Launchers (2):** Located at the elbow area of each arm is a mini-missile launcher.

Missile Type: Any mini-missile can be used.

Mega-Damage: Varies with missile type. See payload.

Range: One mile (1.6 m).

Rate of Fire: One at a time or in a volley of two, three, four or six.

Payload: 32; 16 mini-missiles per arm. Typically 12 Armor Piercing (1D4x10), 12 Plasma (1D6x10 M.D.) and four Smoke.

**4. Hand to Hand Combat:** Available only to those who take *Robot Combat Elite: Mastiff*. Those not skilled in "Elite" use the *Robot Basic* stats. **Note:** All bonuses are in addition to the pilot's own hand to hand combat training and attribute bonuses. They do *not* apply to the pilot's physical abilities outside the robot.

+1 extra attack/action per melee round, *plus* those of the pilot at level one. Add one additional attack at levels 5, 10, and 15.

Critical strike is the same as the pilot's.

+1 to strike with laser turret and laser guided mini-missiles in addition to any bonus from the Weapon Systems and/or W.P. Heavy Energy Weapon skills.

+2 to strike in hand to hand combat.

+1 to parry in hand to hand combat.

+4 to pull punch.

No dodge, disarm or roll with impact bonuses.

Punch Damage: 2D6 M.D. on a restrained punch, 1D4x10 M.D. on a full strength punch.

Power Punch: 2D6x10+18 M.D., but counts as two melee attacks.

Tear or Pry with Hands: 6D6 M.D.

Kick Damage: 5D6 M.D.

Power Kick: 2D4x10 M.D., but counts as two melee attacks.

Body Block/Ram: 6D6 M.D.

Full Speed Running Ram: 3D4x10 M.D., but this attack uses up three melee actions.

Stomp: 5D6 M.D.; effective only against objects smaller than 11 feet (3.3 m) tall.

**5. Sensory Systems:** Only those standard to robot vehicles.

## NEMA Power Armor

Power armor are small, mobile units ideal for riot control and urban combat. The robotic infrastructure allows the wearer to don and operate a construct that is considerably heavier and better armored than a mere suit of environmental body armor. The robotic exoskeleton is such that the "wearer" does not actually have to carry much weight on his back, and allows for heavy weapon systems to be attached to, or built into, the thick armor shell. In some respects, the wearer becomes a walking tank or mechanical superman with good mobility, superhuman strength and firepower. Each type of power armor satisfies specific design parameters and may sacrifice one set of abilities (like flight or speed) for another (like heavier armor and greater firepower). All fit various needs and purposes for NEMA operations. Generally speaking, power armor is deployed for riot control, urban sieges, anti-terrorism operations, commando/SWAT

style raids, surgical strikes, reconnaissance, quick response, excavation, and search and rescue missions – all of which NEMA power armor addresses very well.

The **Chromium Guardsmen** are excellent for riot control, raids, guard duty, city patrols, defense, and pacification and containment operations.

The **Gunbuster** is a fast, multipurpose armor suitable for police, military and rescue operations. It can dig through debris, work construction, brace crumbling walls, engage in search and rescue operations, and, when its back mounted shoulder guns are in place, engage in combat, defense, riot control and military escort.

The high-flying **Silver Eagle Power Armor (SAMAS)** is perfect for quick response, surgical strikes, surprise raids, all types of land to air, and air to ground operations, aerial reconnaissance, aerial search and rescue, and evacuation missions.

## All Power Armor have the following features:

1. **Nuclear Powered:** Which means they effectively have an unlimited fuel capacity and power source with an average energy life of 15 to 25 years. Varies with the amount of use.
2. **Radar (upgraded):** Can identify 72 targets and track up to 48 simultaneously at a range of 10 miles (16 km).
3. **Combat Computer:** Calculates, stores, and transmits data onto the Heads Up Display (H.U.D.) of the pilot's helmet. It is linked to the targeting computer, weapon systems and radar.
4. **Targeting Computer:** Assists in the tracking and identification of enemy targets. Ten mile range (16 km).
5. **Laser Targeting System:** Assists in the selection and focusing of specific targets and adds a bonus to strike when using long-range weapons. Does not apply to hand to hand combat.
6. **Radio Communications:** Long-range, directional communications system with an effective range of about 500 miles (800 km). Also has a directional, short-range radio with a 20 mile (32 km) range.
7. **Built-in Loudspeaker:** 80 decibels.
8. **Complete Environmental Battle Armor:** Suitable for use in all hostile environments, including water (from several hundred feet to one mile/1.6 km, depending on the suit) and even outer space. The following features are included: Computer controlled life support system. Internal cooling and temperature control. Artificial air circulation system, gas filtration, humidifier. Computer controlled, independent oxygen supply, and purge system that automatically engages in low oxygen or contaminated air environments. Eight hour oxygen supply, but with the air recycling, circulatory system the wearer/pilot can remain inside the suit for days with breathable air.

Insulated, high temperature resistant shielding for up to 400 degrees centigrade (752 F) and radiation shielding. Normal fires do no damage. Nuclear, plasma, and magic fires do full damage, but impervious to heat and radiation.

Polarized and light sensitive/adjusting tinted visor (when applicable).

9. **Special Bonuses:** Unless stated otherwise, +2 on initiative and +1 to strike from combat computer and targeting systems. Other bonuses, or penalties, may be available from the skill, *Power Armor Combat Elite*.

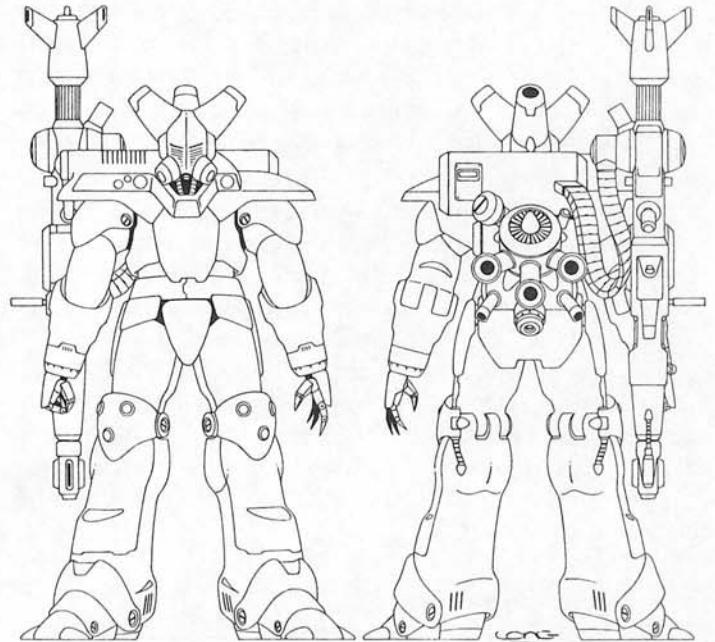

## Chromium Guardsman

The Glitter Boy of Chaos Earth, the Chromium Guardsman (and Silver Eagle), more than any other suit of power armor or giant robot, has come to represent and signify NEMA. Its strong bulky shape, glittering shine and incredible firepower cut a powerful and impressive figure that has come to convey strength and security. People feel safer just seeing one or two on the street corner and knowing that NEMA is out watching their back. For some reason, people seem to think the glittering power armor and the pilots inside ooze with power and confidence, perhaps because more than any other, the Guardsmen resemble a “knight in shining armor” and are designed to stand their ground, take incredible punishment and keep on fighting.

Three centuries from now, NEMA and the name, Chromium Guardsman, will be forgotten, but the Guardsman will survive, cutting a swath through history under the ignoble name of “Glitter Boy.” It will survive because of the power armor’s revolutionary high-density, laser resistant, Mega-Damage armor and because NEMA has so many (and will manufacture thousands more in the years to come). The power armor will become famous as the Glitter Boy during these early days and into the Dark Ages that are yet to come, and continue to have an impact on Rifts Earth as independent manufacturers and new nations unravel the secrets of its construction and perpetuate the design. However, there are CG/Glitter Boys that have been repaired and rebuilt and passed down for generations. Ah, but that’s the future, this is now.

The Chromium Guardsman is an amazingly small and mobile, one person, armored robot exoskeleton that stands approximately 10 feet tall (3 meters) and offers fully articulated hands and the mobility of the human body. The revolutionary,



super-dense chrome armor is constructed on a molecular level and can withstand more Mega-Damage than any other type of armor ever created. The robot frame is nearly indestructible, resilient, and virtually maintenance free. The armor shielded joints and padded pilot's compartment enable the machine to absorb impacts and cushion its pilot. It is also one of the few types of power armor designed to comfortably accommodate a pilot for days or even weeks if necessary. A refrigeration unit holds 10 gallons (38 liters) of drinking water, while another contains a high protein, multi-vitamin nutrient paste (about a four week supply), as well as a few other storage compartments where additional food or personal items can be contained. However, it is not recommended that the pilot remain inside for more than 24 hours at a time. The operator must exercise and stretch or muscles will begin to cramp and stiffen, especially the legs, which are the most restricted. Prolonged inactivity enclosed in the Glitter Boy or any power armor (three or more weeks) will also reduce muscle strength. (Note: Temporarily reduce P.S., P.P. and Spd. attributes by 1D4 until serious measures have been taken to restore strength by long hours of exercise and physical activity; at least four hours a day for 1D4 weeks.) Periodic walks, exercise, and activity outside of the body armor will prevent loss of muscle tone and strength.

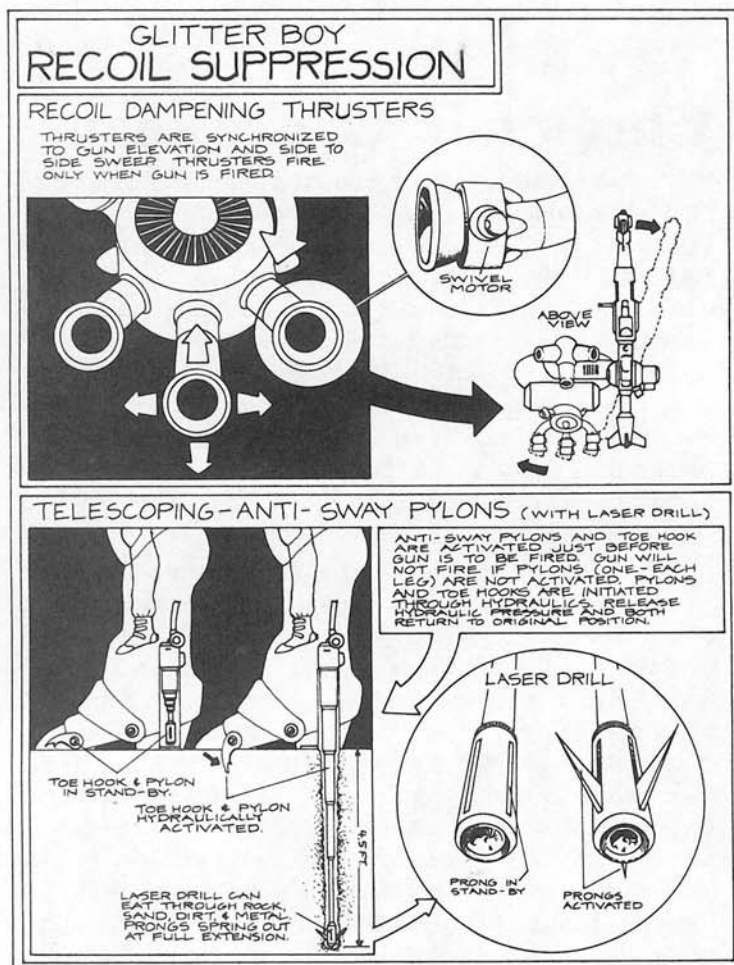

#### M.D.C. by Location:

- Rail Gun (a.k.a. Boom Gun) – 175
- \* Head – 290
- \* Hands (2) – 100 each
- Arms (2) – 270 each
- Legs (2) – 450 each
- Reinforced Pilot's Compartment – 150
- \*\* Main Body – 770

\* A single asterisk indicates a small and difficult target to strike, requiring the attacker to make a "called shot," but even then the assailant is -4 to strike.

\*\* Depleting the M.D.C. of the main body will shut the power armor down completely, rendering it useless. Note: Laser weapons do half damage!

#### Speed:

**Running:** 60 mph (96 km) maximum. Note that the act of running does tire its operator, but only at 10% of the usual fatigue rate.

**Leaping:** The robot legs can leap up to 12 feet (3.6 m) high or across. Add 10 feet (3 m) with a running start. Jet thruster assisted leaps can hurl the power armor 80 feet (24 m) up or across. If necessary, the thrusters can momentarily hold the G10 aloft as high as 12 feet (3.6 m) off the ground, but only for 1D6x10 seconds. The thrusters are not made for flying.

**Underwater Capabilities: Swimming:** The thruster system provides good mobility and control underwater but at a sluggish speed of 15 mph (24 km or 13 knots); roughly the same surface speed. It can also walk along the bottom of the sea or lake bed at about 25% of its normal walking/running speed. To fire its Boom Gun underwater it must be able to engage its pylon system into the sea floor, rocky outcropping or other means of firm support. (Note: Sinking the pylons into the hull of an M.D.C. ship or submarine takes several tries, using up 1D4+1 melee actions and signaling those inside that something is hammering its hull, and inflicts 1D4 M.D. and punches a pair of holes into the hull of the vessel.) Without suitable support, the force of the shock wave will propel the Guardsman backwards in a spiral for 1D4x100 yards/meters and cause it to lose initiative and its next 1D4+3 melee actions/attacks. Half this distance and 1D4 lost actions if sunken into typically soft underwater flooring. Maximum Ocean Depth: One mile (1.6 km).

#### Statistical Data:

**Height:** 10 feet, 5 inches (3.1 m). **Width:** 4 feet, 4 inches (1.3 m). **Length:** 4 feet (1.2 m).

**Weight:** 1.2 tons fully loaded.

**Physical Strength:** Equal to a Robot P.S. of 30.

**Cargo:** Minimal storage space; a foot compartment and storage for a rifle, handgun, survival knife and first-aid kit.

**Power System:** Nuclear; average energy life is 20 years.

**Cost & Availability:** Exclusive to NEMA and the militaries of the three allied nations (most of which are unaccounted for, the majority presumed to be destroyed). Any power armor outside of NEMA was found or stolen and sells for upwards of 40 million credits or equivalent in trade. Rare outside of NEMA.

## The Chromium Guardsman Power Armor

Model Type: USA-G10

Class: Laser Resistant Infantry Personnel Assault Unit.

Crew: One pilot.

## Weapon Systems:

### 1. RG-14 Rapid Acceleration Electromagnetic Rail Gun (1):

The famous "Boom Gun" is a unique rail gun that can accelerate its flechette style rounds to a speed of Mach 5 and actually creates a sonic boom when fired. The gun is the most powerful personal or vehicular weapon to survive the Great Cataclysm. The weapon is attached to the back and right shoulder of the power armor (may be reversed for those who are left handed). When not in use, the gun is flipped back and stored in an upward position. When needed for combat, the Guardsman's operator simply reaches back, grasps the handle and pulls forward.

The blast is so powerful that without the automatic stabilization system, the Chromium Guardsman would be thrown to the ground and knocked back 30 feet (9 m). The automatic stabilization system is a synchronous system of jet thrusters and retractable reinforcement pylons in the legs that hold the armor steady. The pylons and the jets fly into action the moment the Boom Gun is fired.

Primary Purpose: Assault, anti-armor and anti-aircraft.

Weight: Rail Gun: 867 lbs (390 kg).

Mega-Damage: One Boom Gun flechette round holds 200 slugs that inflict 3D6x10 M.D.!

Effects of the Sonic Boom: The power armor suit is specially insulated from the shock waves of its own Boom Gun, however, everyone within 200 feet (61 m) will be temporarily deafened (triple that range underwater). Characters without any type of sound/ear protection will be temporarily deafened for 2D4 minutes and are -8 on initiative and -3 to parry and dodge. Characters who are in protective body armor or power armor will have some protection, but are still temporarily deafened for 1D4 minutes; same penalties apply but for a shorter duration. Each sonic boom adds to the duration of the deafness.

The sonic boom also affects the physical surroundings by shaking buildings and shattering S.D.C. windows within a 300 foot radius (91 m) of the boom.

Rate of Fire: Each booming blast counts as one melee attack/action. *Bursts and sprays are not possible!*

Maximum Effective Range: 11,000 feet (about 2 miles/3.2 km).

Payload: 1000 rounds/shots and the Boom Gun can be reloaded by hand, one round at a time, by the pilot. Unfortunately, it takes about 15 minutes to reload 40 rounds. A carrying drum of 400 rounds is sometimes used to carry extra rounds. The drum has 30 M.D.C. and can attach to the hip/waist.

**2. Alternative Weapons:** For riot control a high-powered water cannon may be used in place of the Boom Gun (Damage: 1D6 S.D.C. plus knocks the human target off his feet and backward 10 feet (3 m), causing the victim to lose initiative and two melee attacks/actions) or a rail gun that fires rubber bullets, as well as a smoke and/or tear gas grenade launcher rifle and Neural Mace for close combat. In combat, any rail gun could replace the Boom Gun (though it is seldom desired or done) and the Guardsman can use any type of rifle or heavy weapon, though, again, they are seldom used, the pilot preferring to rely on the Boom Gun while inside the armor.

**3. Hand to Hand Combat:** Available only to those who take *Power Armor Combat Elite: Chromium Guardsman*. Those not skilled in "Elite" use the *Power Armor Basic* stats. **Note:**

All bonuses are in addition to the pilot's own hand to hand combat training and attribute bonuses. They do *not* apply to the pilot's physical abilities outside the robot.

+2 extra attacks/actions per melee round, *plus* those of the pilot at level one. Add one additional attack at levels 3, 7, and 11.

Critical strike is the same as the pilot's.

+2 on initiative.

+2 to strike when shooting Boom Gun and other rail guns and cannons, in addition to W.P. Heavy Energy Weapon skill bonuses.

+2 to strike in hand to hand combat.

+2 to parry in hand to hand combat.

+2 to dodge.

+1 to disarm.

+4 to pull punch.

+3 to roll with impact, punch or fall.

Punch Damage: 1D4 M.D. on a restrained punch, 1D6 M.D. on a full strength punch.

Power Punch: 2D6 M.D., but counts as two melee attacks.

Kick Damage: 2D4 M.D., Power Kick is not possible.

Running Leap Kick: 4D6 M.D.

Tear or Pry with Hands: 1D6 M.D.

Body Block/Ram: 2D4 M.D.

Full Speed Running Ram: 3D6 M.D., but this attack uses up three melee actions.

Stomp: 1D6 M.D.; effective only against objects smaller than three feet (0.9 m) tall.

Pylon Impalement: 1D6 M.D., not very useful in most combat situations.

**4. Special Sensory Systems of Note:** All those standard in power armor plus language translator, depth gauge and the following:

**1. Optical Systems:** Full optical systems, including laser targeting, telescopic, passive nightvision (light amplification), thermo-imaging, infrared, ultraviolet, and polarization.

**2. Advanced Laser Targeting:** As well as the usual *robot* standard features, the Boom Gun is +2 to strike.

**3. Distress Homing Beacon:** A scrambled radio homing signal for location and extraction from combat zones. However, there is a 30% chance of detection by the enemy, and some units assigned to reconnaissance and espionage operations have had the homing beacon disabled.

**4. Self-Destruct Mechanism:** Self-destruct mechanism to prevent the armor and its technology from falling into enemy hands.

**5. Laser Resistant Armor:** All Chromium Guardsmen are made from special alloys with a chrome-looking surface that is resistant to laser attacks (half damage).



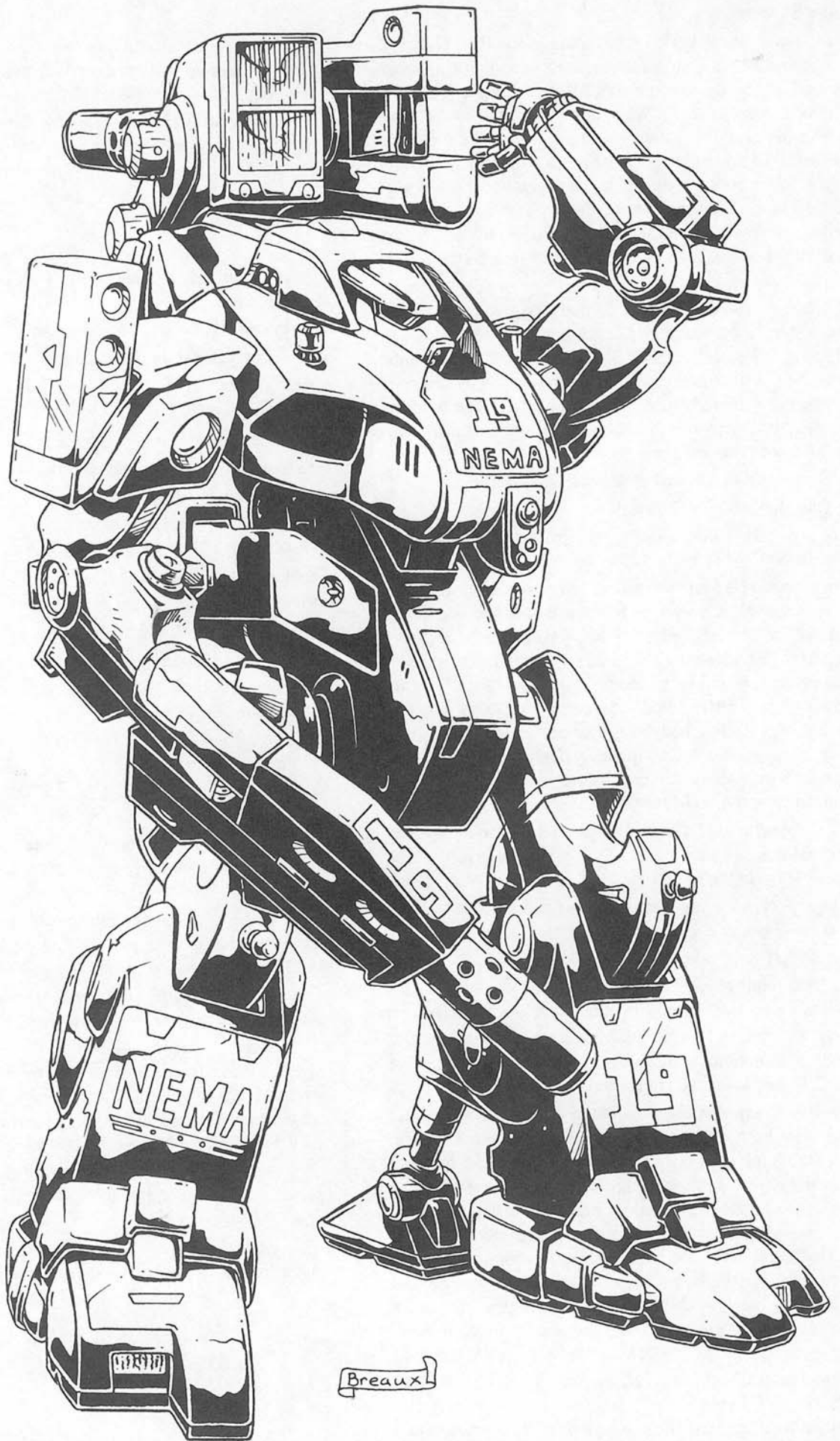

# Gunbuster

## All-Purpose Workhorse

The **Gunbuster** is a fast, multipurpose armor suitable for police, military and rescue operations. It can dig through debris to pull out those trapped underneath, work construction to brace crumbling walls, engage in rescue operations and, when its back mounted shoulder guns are in place, engage in combat and riot control. The shoulder mounted guns slide back and out of the way when stowed, similar to the Chromium Guardsman, but can be removed completely if the power armor needs to squeeze into a tight spot or requires less height or weight to help in excavation and rescue operations (sometimes guns get in the way). Furthermore, the modular design of the dual weapon system had encouraged designers to make several different types of guns (cannons really) for the Gunbuster to use in different situations.

Like most power armor, the pilot steps into an armored exoskeleton and effectively wears the suit. Because the Gunbuster is active in rescue, excavation and construction as well as combat, the pilot's head and chest are enclosed in a reinforced cage for additional protection. This also protects the pilot from snipers who might otherwise try to target these areas.

### The Gunbuster Power Armor

**Model Type:** USA-G20

**Class:** Laser Resistant Infantry Personnel Assault Unit.

**Crew:** One pilot.

**M.D.C. by Location:**

Dual Weapons (2 guns) – 100 each

Spotlight (1, above head) – 20

\* Head – 90

\* Hands (2) – 25 each

Arms (2) – 80 each

Shoulder Mini-Missile Launcher (1; right) – 30

Legs (2) – 170 each

Reinforced Pilot's Compartment – 140

\*\* Main Body – 280

\* A single asterisk indicates a small and/or difficult target to strike, requiring the attacker to make a "called shot," but even then the assailant is -5 to strike.

\*\* Depleting the M.D.C. of the main body will shut the power armor down completely, rendering it useless.

**Speed:**

**Running:** 70 mph (112 km) maximum. Note that the act of running does tire its operator, but only at 10% of the usual fatigue rate.

**Leaping:** The robot legs can leap up to 18 feet (5.4 m) high or across. Add 10 feet (3 m) with a running start.

**Underwater Capabilities:** Airtight, it can walk along the bottom of the sea or lake bed at about 25% of its normal walking/running speed. Most energy weapons see their range reduced by 30% underwater and projectile weapons 50%. Maximum Ocean Depth: 2000 feet (610 m).

**Statistical Data:**

**Height:** 9 feet (2.7 m) to the top of the head, the searchlight and stowed weapons add two feet (0.6 m) for an overall height of 11 feet (3.3 m). **Width:** 2.8 feet (0.85 m). **Length:** 4 feet (1.2 m).

**Weight:** One ton fully loaded.

**Physical Strength:** Equal to a Robot P.S. of 25.

**Cargo:** Minimal storage space; a foot compartment and storage for a rifle, handgun, survival knife and first-aid kit.

**Power System:** Nuclear; average energy life is 20 years.

**Cost & Availability:** Exclusive to NEMA and the militaries of the three allied nations (most of which are unaccounted for, the majority presumed to be destroyed). Any power armor outside of NEMA was found or stolen and sells for upwards of 20 million credits or equivalent in trade.

### Weapon Systems:

**1. Dual Modular Weapon Systems:** May select one of the following modular weapons. Both guns are always identical. Pick *one*.

**Type A: G-44 Magnum Rail Guns (2):** Mounted on each side of the searchlight is a specially designed, heavy rail gun.

**Primary Purpose:** Assault and defense.

**Weight:** Rail Gun: 120 lbs (54 kg) each.

**Mega-Damage:** Short burst fires 10 rounds and does 4D6 M.D. A heavy burst fires 30 rounds and inflicts 1D6x10 M.D., a single round does 2D4 M.D.; each counts as one melee attack.

**Rate of Fire:** Single shot or burst.

**Maximum Effective Range:** 3000 feet (914 m).

**Payload:** Two 2000 round drums hooked to the back of the power armor (one for each gun), capable of firing 66 heavy damage bursts (30 rounds each) or 200 short bursts each.

Reloading a drum takes about three minutes for those not trained, but a mere 30 seconds by a capable Field Engineer or Pigman: Heavy Weapons Specialist. A strength of 28 or higher (or Robot P.S.) is required to handle the heavy drum.

**Penalty:** Reduce speed by 10% due to the bulk and weight of the ammo drums.

**Type B: G-55 Plasma Cannon (2):**

**Weight:** 80 lbs (36 kg) each.

**Mega-Damage:** 5D6 M.D. per single blast, 1D6x10 per double blast at the same target.

**Rate of Fire:** Single shot only. A simultaneous double blast can be made at the same target but counts as two melee attacks, and both weapons can be pointed at different targets and fired simultaneously but counts as shooting wild; no bonuses.

**Effective Range:** 2000 feet (610 m).

**Payload:** Effectively unlimited, tied to the armor's power supply.

**Type C: G-66 Laser Cannon (2):**

**Weight:** 70 lbs (31.5 kg) each.

**Mega-Damage:** 4D6 M.D. per single blast.

**Rate of Fire:** Single shot only. A simultaneous double blast can be made at the same target but counts as two melee at-



tacks, and both weapons can be pointed at different targets and fired simultaneously but counts as shooting wild; no bonuses.

Effective Range: 3000 feet (914 m).

Payload: Effectively unlimited, tied to the armor's power supply.

**Type D: Heavy Submachine-Gun (2):** Suitable for firing S.D.C. rounds, rubber bullets (riot control), and silver coated bullets.

Weight: 55 lbs (24.7 kg) each.

Mega-Damage: 4D6 S.D.C. per single bullet or 2D4x10 S.D.C. per six round burst. Rubber bullets do one point of damage or 2D4 S.D.C. per burst.

Rate of Fire: Single (+1 to strike on an aimed shot) or short bursts of six rounds. A simultaneous double blast can be made at the same target but counts as two melee attacks, and both weapons can be pointed at different targets and fired simultaneously but counts as shooting wild; no bonuses.

Effective Range: 1200 feet (366 m).

Payload: Each gun holds 420 rounds for 70 bursts, plus a pair of machine-gun style ammo drums and feed can be attached (the drum hooked to the back of the power armor), providing an additional 2400 rounds for each gun (400 bursts each).

**Note:** May also use the same riot control items as the Chromium Guardsman, as well as Vibro-Blades, but usually stick to the main weapons above. For construction and excavation it can be fitted with the equivalents of any of the bionic tools found on pages 96 & 97 of the **Rifts® Bionics Sourcebook**.

**2: Shoulder Mini-Missile Launcher (1):** Mounted on the right or left shoulder is a box style mini-missile launcher.

Missile Type: Any mini-missile can be used.

Mega-Damage: Varies with missile type. See payload.

Range: One mile (1.6 m).

Rate of Fire: One at a time or in a volley of two, three, or four.

Payload: 4; typically all the same type, with Armor Piercing (1D4x10) being standard issue.

**3. Hand to Hand Combat:** Available only to those who take *Power Armor Combat Elite: Gunbuster*. Those not skilled in "Elite" use the *Power Armor Basic* stats. **Note:** All bonuses are in addition to the pilot's own hand to hand combat training and attribute bonuses. They do *not* apply to the pilot's physical abilities outside the robot.

+2 extra attacks/actions per melee round, *plus* those of the pilot at level one. Add one additional attack at levels 3, 8, and 12.

W.P. Paired Weapons.

Critical strike is the same as the pilot's.

+2 on initiative.

+2 to strike when shooting Dual Modular Weapon Systems, plus bonuses the pilot has from W.P. Heavy Energy Weapons skill.

+2 to strike in hand to hand combat.

+2 to parry (+4 when using the big guns to parry) in hand to hand combat.

+2 to dodge.

+2 to disarm.

+2 to pull punch.

+2 to roll with impact, punch or fall.

Punch Damage: 6D6 S.D.C. on a restrained punch, 1D4 M.D. on a full strength punch.

Power Punch: 2D4 M.D., but counts as two melee attacks.

Kick Damage: 1D6 M.D.

Power Kick: 2D6, but counts as two melee attacks.

Running Leap Kick: 2D4 M.D.

Tear or Pry with Hands: 1D6 M.D.

Body Block/Ram: 2D4 M.D.

Full Speed Running Ram: 3D6 M.D., but this attack uses up three melee actions.

**4. Special Sensory Systems of Note:** All those standard in power armor plus language translator, depth gauge and the following:

**1. Optical Systems:** Full optical systems, including laser targeting, telescopic, passive nightvision (light amplification), thermo-imaging, infrared, ultraviolet, and polarization.

## Silver Eagle Quick Response & Air Support

The Silver Eagle is a man-sized suit of flying power armor. Players of **Rifts®** may recognize it as a stylistic variation of the SAMAS. They are exclusive to NEMA. All three models are virtually the same with slight variations in styling and different insignia markings to designate each nation: *The Silver Eagle*: USA Model, *the Talon*: Canadian Model, and *the Condor*: the Mexican Model. Insignias and markings are small (tiny even) in order to take full advantage of the armor's reflective hide. The Silver Eagles are made from the same laser resistant, Mega-Damage material as the Chromium Guardsmen, though they have considerably less M.D.C.

The Silver Eagle is fast, maneuverable and deadly in all environments, from open combat to city streets. However, it excels in the urban environment, streaking through the concrete canyons of a city like a hawk, bobbing and weaving through tunnels and highway overpasses, whipping around corners or zooming over rooftops. The Silver Eagle can engage enemies on the street, on the roof or inside. It can make a surprise entrance via the roof or exterior windows, and is small and fast enough to navigate the hallways and stairwells of most commercial buildings (i.e., skyscrapers, office buildings, factories, warehouses, etc.) at full throttle. When on the ground or inside a building, the power armor can hover and fly, provided there is sufficient space, or land, fold the wings down and move forward on foot. Furthermore, the Silver Eagle can hover and fly with its wings in a partially folded position to rocket down even narrow corridors. The VTOL (Vertical Take-Off & Landing) design enables the Silver Eagle to land almost anywhere to engage the enemy, conduct a search or alternate from air to ground reconnaissance as is necessary or desirable. Like a busy bee, the Silver Eagle can land and takeoff repeatedly, hopping from one point to another before zooming away or charging an enemy.

This versatile power armor can engage in air patrols, aerial combat, air and ground reconnaissance, air and ground combat,

strafing runs, surgical strikes, surprise raids, front-line combat, troop support, seek and destroy operations, espionage, sabotage, rescue, EVAC, and defense. Though not as thick or heavily armored as the Guardsman, the addition of the laser resistant chromium armor provides some protection against laser attacks and greater armor protection than conventional Mega-Damage material, making it a true powerhouse.

**Silver Eagle SAMAS** (the Canadian and Mexican models are identical except for a few cosmetic differences).

**Model Type:** USA-106

**Class:** Strategic Armor Military Assault Suit (SAMAS).

**Crew:** One.

**M.D.C. by Location:**

Main Jet Thruster (1, back) – 100

Lower Maneuvering Jets (2, back) – 40 each

Intake Jets (2, top) – 40 each

Ammo Drum (rear) – 50

Main Weapon (1) – 100

Wings (2) – 150 each

\*Forearm Backup Computer-Communicator – 25

\*Head – 100

\*\*Main Body – 450

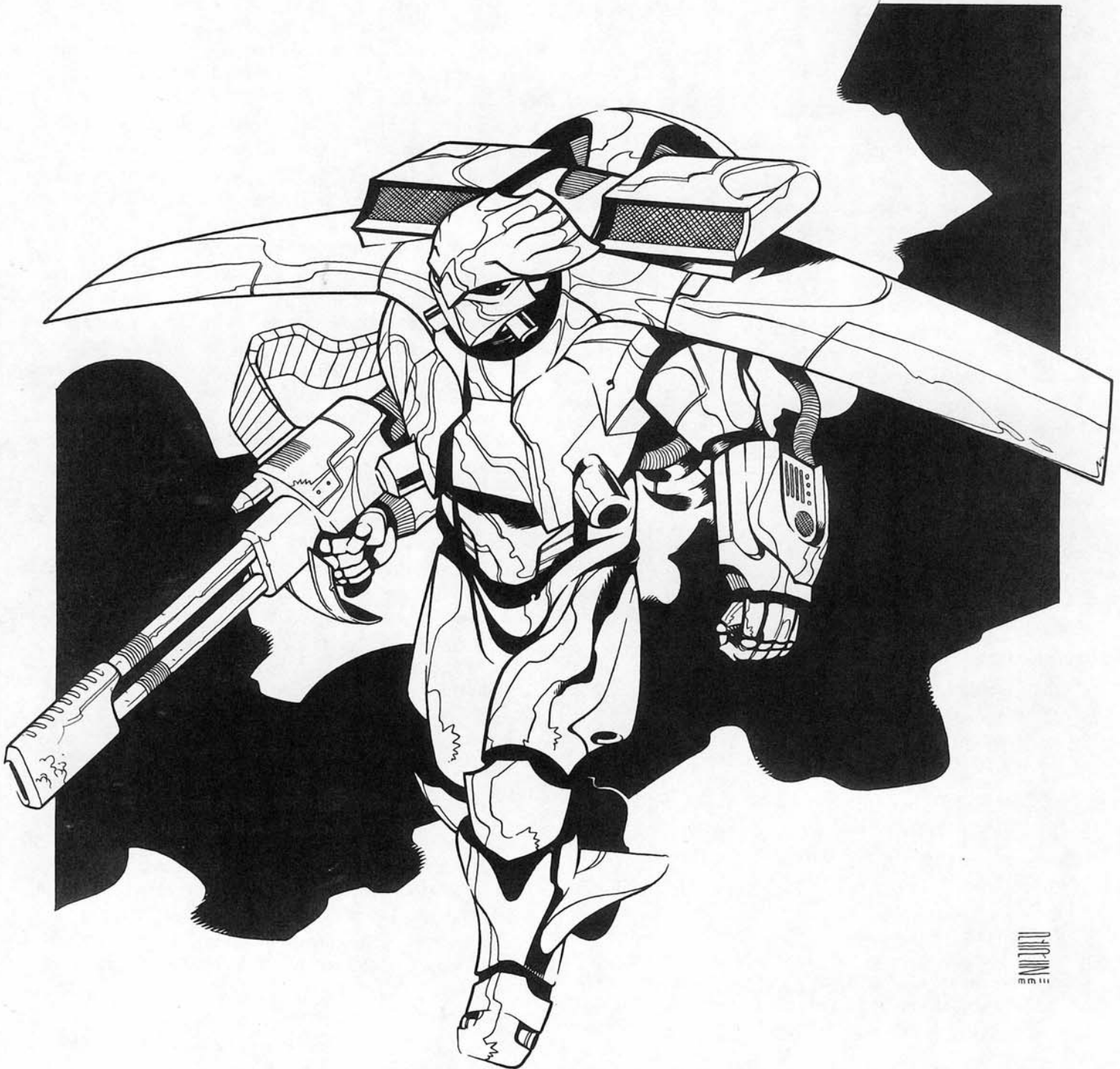

1302  
mm iii



(Note: A Non-Chromium version would have 300 M.D.C. for the main body and a third less for most other parts as well.)

\* Destroying the head/helmet of the power armor will eliminate all forms of optical enhancement and sensory systems as well as negate all power armor combat bonuses to strike, parry, and dodge. The pilot must then rely on his own human vision and senses. The head is a small and difficult target to hit (shielded by exhaust tubes and weapon drum). Thus, it can only be hit when a character makes a "Called Shot" and even then the attacker is -3 to strike. The left, forearm computer-communicator is an even smaller target and -5 to strike.

\*\*Depleting the M.D.C. of the main body shuts the armor down completely, making it useless.

Destroying a wing makes flight impossible. However, even with no wing(s) the SAMAS can make jet powered leaps and hover stationary above the ground.

#### Speed:

Running: 60 mph (96 km) maximum. Note that the act of running does tire out its operator, but at 10% the usual fatigue rate thanks to the robot exoskeleton.

Leaping: The powerful robot legs can leap up to 15 feet (4.6 m) high or across unassisted by the thrusters. A jet thruster assisted leap can propel the Silver Eagle up to 100 feet (30.5 m) high and 200 feet (61 m) across without actually attaining flight.

Flying: The rocket propulsion system enables the SAMAS to hover stationary up to 1000 feet (305 m; 50 feet/15.2 m with no wings) or fly. Maximum flying speed is 300 mph (480 km), but cruising speed is considered to be 150 mph (240 km). Maximum altitude is limited to about 5000 feet (1524 m).

Flying Range: The nuclear power supply gives the Silver Eagle decades of life, but the jet rockets get hot and need to cool after a maximum of 10 hours of flight when traveling at speeds above cruising, and 24 hours at cruising speed. Can go indefinitely with intermittent rest stops.

Underwater Capabilities: 4 mph (6.4 km/3.4 knots) using arms and legs to paddle. 50 mph (80 km/43.5 knots) using its jet thrusters to skim across the surface of the water, 30 mph (48 km/26 knots) using the thrusters underwater. Maximum Ocean Depth: 1000 feet (305 m).

#### Statistical Data:

Height: 8 feet (2.4 m).

Width: Wings down 3.5 feet (1.06 m).

Wings extended 10 feet (3 m).

Length: 4 feet 6 inches (1.4 m).

Weight: 340 lbs (153 kg) without rail gun.

Physical Strength: Equal to a P.S. 25.

Cargo: None. Only what can be carried.

Power System: Nuclear, average SAMAS energy life is 20 years.

Cost & Availability: Exclusive to NEMA and the militaries of the three allied nations (most of which are unaccounted for, the majority presumed to be destroyed). Any power armor outside of NEMA was found or stolen and sells for upwards of 20 million credits or equivalent in trade.

## Weapon Systems:

**1. USA-40R SAMAS Rail Gun (1):** This is standard equipment for the Silver Eagle and is considered to be one of the most accurate rail guns in the world.

Primary Purpose: Assault & defense.

Weight: Gun: 60 lbs (27 kg). One SAMAS Ammo-Drum: 190 lbs (85.5 kg).

Mega-Damage: A short burst is 20 rounds and does 4D6 M.D. A heavy burst is 40 rounds and inflicts 1D6x10 M.D., one round does 1D4 M.D.

Rate of Fire: Equal to number of combined hand to hand attacks (usually 4-6).

Maximum Effective Range: 4000 feet (1219 m).

Payload: 2000 round drum provides 50 heavy bursts or 100 short bursts. A second drum can be hooked to the undercarriage of the rocket jets, but must be manually removed by another power armor or character with a strength of 26 or higher to replace the used drum. Reloading a drum takes about 5 minutes for those not trained, but a mere one minute by somebody trained in the use of SAMAS power armor.

Bonuses: Laser targeting and the lightweight materials used by NEMA give this weapon a +3 bonus to strike with short bursts and +2 to strike with heavy bursts, plus bonuses the pilot has from the W.P. Heavy Energy Weapon skill.

**2. Neural Mace and Hand Grenades** are also standard issue. The mace is hooked to the waist, while 6-12 hand grenades can be carried in a shoulder bag or belt pouch. Riot control ordnance is typically one third smoke, one third tear gas and one third flash/stun grenades. Combat ordnance is typically one third smoke, one third high explosive and one third plasma. See the Weapon Section for descriptions of all items. **Note:** An additional side arm (pistol or Vibro-Blade) may also be carried into combat.

**3. Alternative Weapons:** Rather than use the standard rail gun, any of the following can be substituted, though this is only done about 20% of the time.

1. *Mega-Damage Laser Assault Rifle* (2D6 M.D., 20 shot payload per clip or can be "cabled" to the power armor for an unlimited payload, 2000 foot/610 m range).

2. *S.D.C. .50 Caliber Heavy Machine-Gun* (6D6 S.D.C. per round, 2D4x10 S.D.C. damage per four round burst, 3000 foot/914 m range, can fire 120 bursts).

3. *Any Heavy Weapons or Energy Rifles* as presented in the Weapon Section earlier in this book. Grenade launchers seem to be the most popular when a substitute is used.

**4. Hand to Hand Combat:** Available only to those who take *Power Armor Combat Elite: Silver Eagle SAMAS*. Those not skilled in "Elite" use the *Power Armor Basic* stats. **Note:** All bonuses are in addition to the pilot's own hand to hand combat training and attribute bonuses. They do *not* apply to the pilot's physical abilities outside the robot.

+1 extra attack/action per melee round, *plus* those of the pilot at levels 1, 3, 6, 9 and 12. Critical strike is the same as the pilot's.

+1 on initiative on the ground, +3 in the air.

+ 2/+3 to strike when shooting rail gun, see that weapon description.

- +2 to strike in hand to hand combat.
- +2 to parry.
- +2 to dodge on the ground, +5 in the air.
- +2 to disarm.
- +2 to pull punch.
- +3 to roll with impact, punch or fall.

Punch Damage: 6D6 S.D.C. on a restrained punch, 1D4 M.D. on a full strength punch.

Power Punch: 2D4 M.D., but counts as two melee attacks.

Kick Damage: 1D6 M.D.

Power Kick: 2D6, but counts as two melee attacks.

Running Leap Kick: 2D4 M.D.

Tear or Pry with Hands: 1D6 M.D.

Body Block/Ram: 2D4 M.D.

Full Speed Running Ram: 3D6 M.D., 5D6 flying ram, but both types of ram attacks use up three melee actions.

6. **Special Sensory Systems of Note:** All those standard in power armor plus language translator, depth gauge and the following:

1. **Optical Systems:** Full optical systems, including laser targeting, telescopic, passive nightvision (light amplification), thermo-imaging, infrared, ultraviolet, and polarization.

2. **Laser Reistant Armor:** Virtually all Silver Eagles are made from special alloys with a chrome-looking surface that is resistant to laser attacks (half damage). It is a lighter version of the material used on the *Chromium Guardsman*.

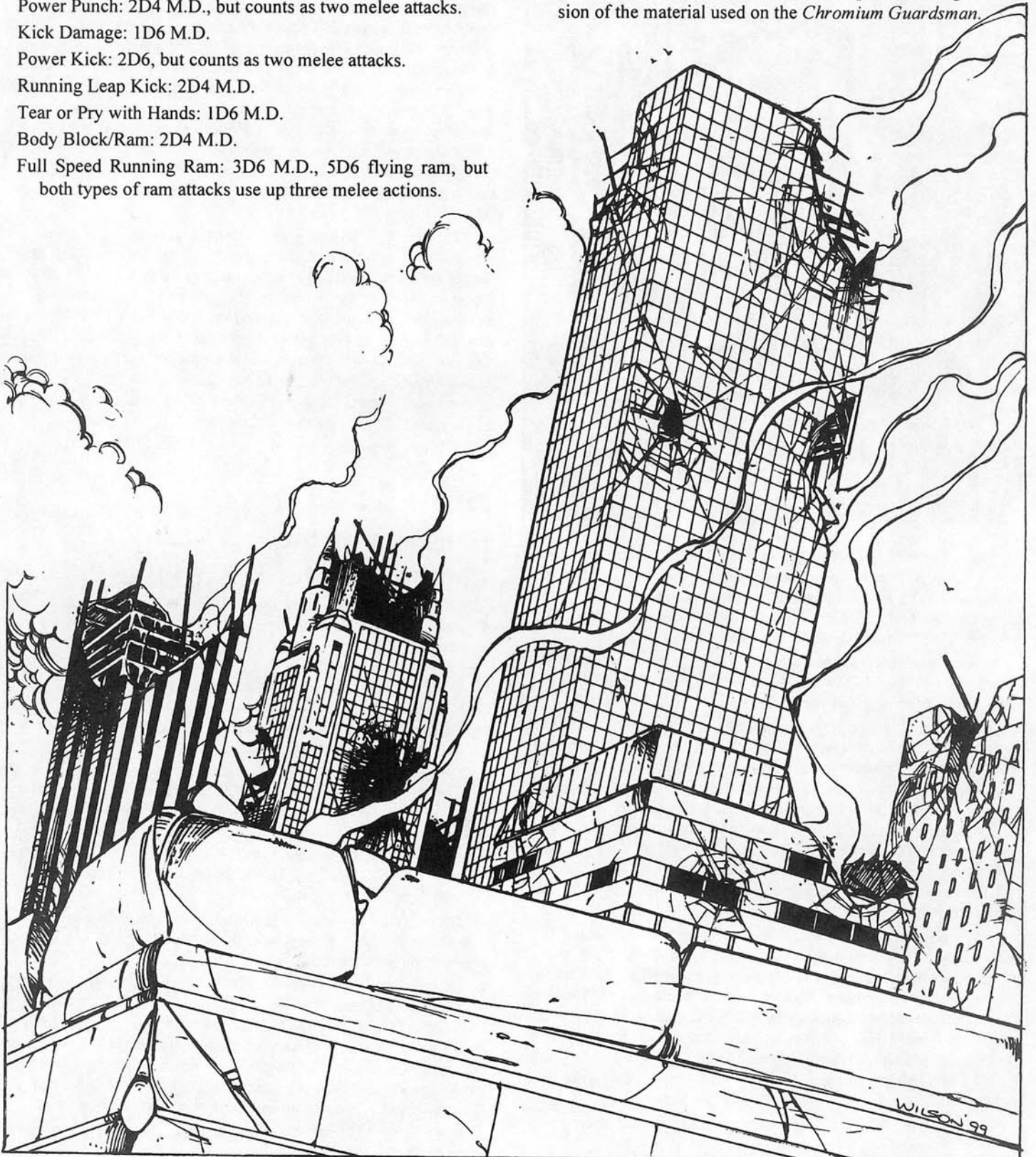



# The Game Mechanics

## Character Creation



**Chaos Earth™** is a prequel to the future world setting of **Rifts®**, but though it is distantly related to **Rifts®** it is a different and unique setting apart from **Rifts Earth** and a complete role-playing game. What follows are the basic rules for playing **Rifts® Chaos Earth™**; with the real meat of the game in the setting and adventures you'll help create.

If you have never played before, you're in for a treat, because there's nothing like role-playing games. *New players should follow one golden rule: Relax and have fun.*

At first glance, a role-playing game can look intimidating. Page after page of rules and information. How can you ever learn it all? Well, relax. First of all, you don't have to learn everything there is to know about this game. That's why you have this handy book as a companion and reference. Second, a lot of the material is fun to read, but it's not stuff you must know. As a player, you don't need to understand every little thing about the game (that's the Game Masters' job). All you need to know are the basics of how to create a character, how skills and special abilities apply to that character, how combat works and which dice to roll, when.

When you first start playing role-playing games, it's natural if it feels a little odd. The text with "D6" this and "D4" that, and lots of other strange terms may seem like an incomprehensible secret language that you can scarcely make heads or tails of. You might need help in rolling up your character, picking out skills and equipment, and rolling dice. Don't worry! This will pass quickly once you get the hang of it. By the third or fourth time you've role-played, you will probably stop feeling like a fish out of water, if you haven't already. Take your time and enjoy.

The more you play, the clearer things will get and the better you'll play.

The creation of a character is relatively simple, though a bit time consuming. It can take an hour or more thanks to the many choices you'll have to make (skill selection, adding up bonuses, etc.). This is, however, deliberate. The emphasis of the Palladium game system is *character* and *adventure*. We want to create strong, memorable characters with strong personalities and a range of skills, strengths and weaknesses, not a two-dimensional electronic game character, but a character that seems real and takes on a life of its own. That's what this time-tested creation system accomplishes. So while it takes a while to "build" and "mold" your character, when you're done, he or she is *yours*, designed to *your* specifications and unique to every other character in the batch.

The steps in creating a character are actually quite simple and reasonably straightforward. Role-playing games are really just an advanced form of electronic games. In fact, they are so advanced, they no longer need a computer screen or DSL line, just a couple sheets of paper and a pen for notes, dice, players, and *imagination*. You see, the action and visuals all take place in your mind, so any special effect is possible. And because it happens in the mind and it is a shared experience with every player (and the Game Master), providing the unpredictable emotions, reactions and cleverness of the human mind, anything can happen and the excitement is contagious.

Let's take it one step at a time.

### Step 1: Determining the Eight Attributes & Attribute Bonuses

All characters have eight prime attributes, three mental and five physical. *Attribute numbers* are used to evaluate the strengths and weaknesses of your character. For example: "P.P." means Physical Prowess – how smooth and agile a character may be, especially in combat. A P.P. of 4 indicates that the character is pretty clumsy. A P.P. of 8-11 indicates a character is fairly average. A P.P. of 16 or higher indicates a character with exceptional agility and reflexes. **Note:** Attributes are also called "Statistics" or "Stats."

The first step in creating a character is to roll up the eight attributes: **I.Q., M.E., M.A., P.S., P.P., P.E., P.B.,** and **Spd.** These represent your character's natural mental and physical abilities. Some of the *physical skills* and special abilities from an occupation may provide bonuses to increase a character's attributes, so it is important to write the numbers down and probably in pencil until all modifiers and bonuses are accounted for.

**Three six-sided dice (3D6)** are rolled to determine each attribute. The higher the number, the greater the ability. Start with I.Q. and work your way through the rest.

**Exceptional right off the bat:** If an initial attribute roll is a 16, 17, or 18, that attribute is considered *exceptional* and one additional six-sided die (1D6) is rolled and that resulting number added to the total for that attribute. If another six is rolled (a rarity), roll yet another 1D6 for that attribute! This bonus die is only rolled during initial attribute generation and does not apply to attributes raised to 16 or higher from skills, O.C.C.s/occupations, magic or special abilities.

Many of the *physical skills* provide the character with *attribute bonuses* that help them in the performance of skills, combat and life. For

example, Wrestling offers a +2 to P.S. and P.E. attributes, so if the player has already rolled a total of 15 for P.S., he adds another two points for a total of 17. If his P.E. was 8, the +2 would raise it to 10. All physical skill point bonuses are cumulative.

#### ATTRIBUTE BONUS CHART

	17	18	19	20	21	22	23	24	25	26	27	28	29	30
I.Q. add to all skills. One time bonus.	+3%	+4%	+5%	+6%	+7%	+8%	+9%	+10%	+11%	+12%	+13%	+14%	+15%	+16%
M.E. save vs. psychic attack/insanity	+1	+2	+2	+3	+3	+4	+4	+5	+5	+6	+6	+7	+7	+8
M.A. trust/intimidate	45%	50%	55%	60%	65%	70%	75%	80%	84%	88%	92%	94%	96%	97%
P.S. Hand to Hand Combat: Damage	+2	+3	+4	+5	+6	+7	+8	+9	+10	+11	+12	+13	+14	+15
P.P. parry, dodge and strike bonus	+1	+2	+2	+3	+3	+4	+4	+5	+5	+6	+6	+7	+7	+8
P.E. save vs. coma/death	+5%	+6%	+8%	+10%	+12%	+14%	+16%	+18%	+20%	+22%	+24%	+26%	+28%	+30%
save vs. poison & Magic	+1	+2	+2	+3	+3	+4	+4	+5	+5	+6	+6	+7	+7	+8
P.B. charm/impress	35%	40%	45%	50%	55%	60%	65%	70%	75%	80%	83%	86%	90%	92%

Spd: No special bonuses other than the raw, natural ability to run.

## The Eight Attributes

**Intelligence Quotient (I.Q.):** Indicates the character's intelligence. The exact I.Q. is equal to the I.Q. attribute multiplied times ten. Characters with an I.Q. of 16 or better receive a one-time bonus to all skill percentages, including Secondary Skills.

**Mental Endurance (M.E.):** Measures the amount of mental and emotional stress the character can withstand.

**Mental Affinity (M.A.):** Shows the character's personal charm and charisma. Natural leaders, with an M.A. of 16 or higher, have a bonus to invoke trust or intimidation in others. A person with a high M.A. may appear trustworthy to some, but intimidating to others. This may depend on the character himself or the circumstances of the situation. At the player's option, a character with a high M.A. may choose to be only especially trustworthy or only intimidating. This explains how your friendly neighborhood ice cream man and some knife-wielding thug might both have the same high M.A., but use it differently.

**Physical Strength (P.S.):** This is the raw physical power of a character. Any character with a P.S. of 16 or better receives a bonus to S.D.C. damage in hand to hand combat.

**Physical Prowess (P.P.):** Shows the degree of dexterity and agility of the character. A P.P. of 16 or higher is rewarded with bonuses to dodge, parry and strike.

**Physical Endurance (P.E.):** Demonstrates the character's stamina and durability. The amount of physical punishment and resistance to fatigue, disease, poison and magic are determined by P.E. Characters with a P.E. of 16 or higher receive bonuses to save vs coma/ death, magic and poisons/toxins.

**Physical Beauty (P.B.):** An indication of the physical attractiveness of the character. A P.B. of 16 or better will be rewarded with a bonus to charm or impress.

**Speed (Spd):** This is how fast the character can run. The character's Speed times 20 is the number of yards or meters he can run in one minute. Speed x5 is the number of yards/meters covered in a melee round (15 seconds). Dividing the distance covered in a melee round by the character's number of attacks indicates how far he can move on each attack.

**A note about bonuses:** Many skills and abilities provide characters with bonuses to strike, parry, dodge, save, etc. These bonuses are typically added to a particular combat or melee *action*. Always be sure to include your character's bonuses, since they may make the difference between life or death, or worse.

## SPEED CHART

The following is a simple conversion table of speed factors into *approximate* miles per hour (mph) and kilometer equivalents.

Speed Factor	Approx. MPH	Kilometers Per Hour
5	3½	5.6
11	7½	12
22	15	24
27	18½	29.7
33	22½	36
44	30	48
50	35	56
55	37½	60
58	40	64
66	45	72
77	53	85
88	60	96
110	75	120
132	90	148
220	150	241
293	200	321

## Attributes Beyond 30

**Intelligence (I.Q.):** Bonuses stop on the chart at 30, but the bonus continues.

**I.Q. skill bonus beyond 30:** +2 for every five additional I.Q. points, so I.Q. 35: +18%. I.Q. 40: +20, I.Q. 45: +22%, I.Q. 50: +24%, I.Q. 55: +26% and I.Q. 60: +28% and so on.

Moreover, characters with an I.Q. greater than 30 points have sharp memories, tend to notice details and are more likely to see through illusions. This translates into the following:

**Save vs Illusion:** I.Q. 30-33: +1, I.Q. 34-36: +2, I.Q. 37-39: +3, I.Q. 40-42: +4, I.Q. 43-45: +5, I.Q. 46-48: +6 and 49 or higher +7.

**Mental Affinity:** Any number *beyond 30* means a dynamic, charismatic person with a commanding and/or delightful presence. When the character enters the room, most people take notice. The individual can be very persuasive (in a charming or intimidating way).

**M.E. of more than 30 provides select skill bonuses:** +5% to Seduction, Gambling, Find Contraband, and Intelligence (gathering) skills; +10% to Interrogation and Performance.

**Mental Endurance (M.E.)** tops out at 30. Bonuses do not increase should the character have a number higher than thirty. The only exception might be a god. But for those rare individuals, demigods, godlings, gods, demon lords and other supernatural beings who might hit M.E. 30 or beyond, they get a bonus to save vs possession of all kinds.



Save vs Possession: M.E. 30: +1, M.E. 40: +2, M.E. 50: +3, M.E. 60: +4.

**Ordinary Physical Strength (P.S.):** The higher the number, the stronger the character and the more damage done with his punches (as indicated in the standard table). This strength applies to "ordinary" mortal men and women, so the damage is always Hit Point/S.D.C. damage even if it is beyond P.S. 30 or 40. **Note:** P.S. damage bonuses are always added to the physical damage done by *melee weapons* such as clubs, maces, knives, swords, and spears, but do not apply to arrows and guns.

Damage Bonus Continues: +1 point of Hit Point/S.D.C. damage per digit beyond 30. Thus a character with a P.S. of 31 does +16, P.S. 32 does +17, a P.S. of 40 does +25, and so on.

Throwing Bonus: For every five points above 30 (round down), the character can hurl a rock, ball or throwing weapon (dagger, spear, sling, etc.) or shoot an arrow an extra 30 feet (9.1 m) without losing accuracy (no penalties for the greater distance).

Lifting and Carrying Bonus: For every five points above 30 (round down), the strong character can lift or carry 30% more than usual.

**Physical Prowess (P.P.):** The bonus to strike, parry and dodge, stops at 30.

Initiative Bonus: However, for every three P.P. points beyond 30, the character gets a bonus on his *initiative roll*. P.P. 31-33: +1 on initiative, P.P. 34-36: +2, P.P. 37-39: +3, P.P. 40-42: +4, P.P. 43-45: +5, P.P. 46 and higher: +6.

**Physical Endurance (P.E.):** The bonus to save vs poison and magic stops at 30.

Save vs Coma & Death: However, the percentage to *save vs coma* continues at an increment of one point per each additional point beyond 30%. Thus, a P.E. of 31 provides a 31% chance to save vs coma, 32 is 32%, and so on. Additionally, a character with a P.E. of 30 or higher fatigues at half the normal rate.

Impervious to disease: Additionally, any character with a P.E. of 30 or higher is effectively impervious to disease. Only the most virulent virus (or designer bug) has a chance of affecting this character.

**Physical Beauty (P.B.):** Any number beyond 30 is divine perfection. A beauty beyond compare, angelic.

P.B. of more than 30 provides select skill bonuses: +5% to Cardsharp, Concealment, Palming, Pick Pockets and Performance skills (observers are so distracted by the beauty they don't notice any trickery or flaws in performance); +13% to Seduction. Penalty: -10% to Prowl (all eyes are on the beauty).

**Speed (Spd.):** Indicates the rate of speed at which a character can run and/or fly. Most ordinary humans never exceed 30. However, cyborgs, robots, mutants, D-Bees, augmented humans (like Juicers, yet to be revealed in Chaos Earth), supernatural beings and others *may* achieve mind-boggling running speeds. The Speed Chart continues on and on, with the listing ending at a Spd of 293 or 200 mph (320 km). Running fast is its own reward and ability.

## "Augmented" Humans (Juicers & Crazyes), Mutants, Cyborgs & Light Exoskeletons

Characters who possess an enhanced or increased P.S. because of unusual genetic mutation, chemical augmentation (Juicer), brain implants (Crazy), super abilities (aliens and D-Bees with superhuman strength), bionics (full conversion cyborgs), or exoskeleton (light power armor like the Roscoe Armor, androids or very light robots) can inflict Mega-Damage, but only when they use a *power punch*.

This type of enhanced strength is typically the result of mechanical augmentation. This table applies only when specific damage stats are not provided.

- **Augmented P.S. 24** inflicts one point of Mega-Damage when delivered as a power punch or power kick; counts as two melee attacks.
- **Augmented P.S. 25 to 27** inflicts 1D4 M.D. with a power punch or power kick; counts as two melee attacks.
- **Augmented P.S. 28 to 30** inflicts 1D6 M.D. with a power punch or power kick; counts as two melee attacks.
- **Augmented P.S. 31 to 40** inflicts 2D4 M.D. with a power punch or power kick; counts as two melee attacks.
- **Augmented P.S. 41 or 50** inflicts (not likely to exist) 3D4 M.D. with a power punch or power kick; counts as two melee attacks.
- **Augmented P.S. 51 or higher** (not likely to exist) inflicts 4D4 M.D. with a power punch or power kick; counts as two melee attacks.

### Power Punch Notes:

1. A power punch is a roundhouse punch in which the character winds up and punches with all of his might. In all cases, the power punch attack counts as two (2) melee attacks/actions whether the punch strikes or not. The player must announce that he is trying a *power punch/kick/attack* before he rolls to strike.

2. A *power bite* is not possible! The only exceptions may be select supernatural beings or giant robots, in which case it will be noted in the character stats. Likewise, a power head butt, elbow, knee, body throw/flip or body block/ram is not possible except as noted above and where specifically listed for that particular character or equipment.

3. *Cyborgs*, although mechanical and robot-like, do not generally possess the same physical strength and power as a complete (or giant) robot. Consequently, they do not usually deliver Mega-Damage punches except as power punches. Most *partial reconstruction 'Borgs* can only have a maximum P.S. of 20 and inflict no Mega-Damage. *Full conversion 'Borgs* of great strength can deliver a Mega-Damage power punch or kick if they have a P.S. of 24 or higher! Use the table above.

4. In all cases, a power punch/kick/attack counts as two melee attacks/actions.

## Robot Strength & Damage

The robots created by super-technology usually have Mega-Damage armor, super-powerful hydraulics and mechanical systems that give them greater physical strength than bionic limbs or cybernetic prosthetics. This means that robots and power armor can frequently deliver Mega-Damage attacks with their punches and kicks. Exactly how much depends on their Robot P.S. rating. Robotic strength, however, is not as powerful as Supernatural P.S., and cyborgs are not as powerful as robots. **Note:** Robots with a P.S. of 18+ can lift and carry 25 times their P.S. attribute. Thus, a robot with a P.S. of 40 can lift and carry 1,000 lbs (450 kg) (25x40 = 1,000). Robot P.S. below 18 is equivalent to normal human strength for purposes of lifting, pulling and pushing: P.S. x10 in lbs.

- **Robot P.S. 15 or less:** Only inflicts 1D6 S.D.C. on a restrained punch, 2D6 S.D.C. on a full strength punch and 4D6 S.D.C. on a power punch (counts as two melee attacks). P.S. bonuses are added to S.D.C. attacks. Kicks do 2D6 S.D.C., leap kicks 3D6 S.D.C.; these robots are roughly equal to a human. Mega-Damage attacks are not possible.
- **Robot P.S. 16 to 20:** Inflicts 2D6 S.D.C. on a restrained punch, one M.D. point on a full strength punch, 1D6 M.D. on a power punch (counts as two melee attacks). P.S. bonuses are added to S.D.C. attacks. Kicks do 1D4 M.D. and leap kicks 2D4 M.D.
- **Robot P.S. 21 to 25:** Inflicts 6D6 S.D.C. on a restrained punch, 1D4 M.D. on a full strength punch, 2D4 M.D. on a power punch (counts as two melee attacks). Kicks do 1D6 M.D. and leap kicks 2D4 M.D.
- **Robot P.S. 26 to 30:** Inflicts 1D4 M.D. on a restrained punch, 1D6 on a full strength punch, 2D6 M.D. on a power punch (counts as two melee attacks). Kicks do 1D6 M.D. and leap kicks 2D6 M.D.
- **Robot P.S. 31 to 35:** Inflicts 1D4 M.D. on a restrained punch, 1D6 M.D. on a full strength punch, 4D4 M.D. on a power punch (counts as two melee attacks). Kicks do 1D6 M.D. and leap kicks 2D6 M.D.

- **Robot P.S. 36 to 40:** Inflicts 1D4 M.D. on a restrained punch, 2D6 M.D. on a full strength punch, 4D6 M.D. on a power punch (counts as two melee attacks). Kicks do 1D6 M.D. to 2D4 M.D. and leap kicks 3D6 M.D.
- **Robot P.S. 41 to 50:** Inflicts 1D6 M.D. on a restrained punch, 3D6 M.D. on a full strength punch, or 1D6x10 M.D. on a power punch (counts as two melee attacks). Kicks do 2D6 M.D. and leap kicks 4D6 M.D.
- **Robot P.S. 51 to 60:** Inflicts 2D6 M.D. on a restrained punch, 6D6 M.D. on a full strength punch, or 2D6x10 M.D. on a power punch (counts as two melee attacks). Kicks do 4D6 M.D. and leap kicks 1D6x10 M.D.

#### Notes:

1. There are many different design and mechanical elements for every robot and suit of power armor, so there is a great deal of variation from one design to another. Some may have features that make a particular robot stronger or weaker than the above table suggests. The general rules, above, apply to robots and P.S. when a specific damage rating is not provided in its stats, and when adapting robots from other game books, settings and dimensions to the Mega-Damage world of **Rifts® Chaos Earth™**.

2. Combat moves: Body blocks and tackles typically inflict half the M.D. of a normal punch. Stomp attacks are applicable only to robots that are 18 feet (5.5 m) or larger and commonly inflict 1D4 or 1D6 M.D., seldom more. Tear or pry attacks are possible only if the mechanism is designed for that purpose. Such attacks usually deliver half the damage of a full strength punch.

3. Power armor is generally smaller and lighter than a true, 100% robot. In many cases, power armor is little more than an armored exoskeleton. As a result, a suit of power armor with an equivalent P.S. will frequently inflict less damage than an actual robot, especially giant robots. The weight and mass of a true robot vehicle is also a factor. Power armor seldom exceeds a P.S. of 40, many don't break 30.

## “Supernatural” Physical Strength

Most S.D.C./Hit Point beings, whether human, monster, or otherwise, inflict Hit Point/S.D.C. damage even when they have an incredible strength of 30 or higher. On the other hand, even scrawny *supernatural beings* like Vampires, Gargoyles, and demons, as well as “most” *creatures of magic*, such as dragons and Elementals, inflict *Mega-Damage*.

One might wonder why a strong human inflicts S.D.C. damage while these others, with a seemingly equivalent P.S., inflict *Mega-Damage* (M.D.). The answer is simple. Whether a being inflicts S.D.C. damage or M.D. depends on the “nature” of the creature.

Simply put, *supernatural beings* and *creatures of magic* are not human. They are something else, creatures that defy the laws of physics and draw upon arcane forces and energies (like magic) as part of their innate essence, making them *more* than human. More powerful physically and magically (and sometimes psionically as well). Their supernatural aspect gives them *Mega-Damage* strength, endurance, and, in many instances, makes them natural M.D.C. creatures (i.e. flesh like *Mega-Damage* steel). Thus, in addition to their incredible Supernatural Strength, they usually have bodies with skin like the armor of a tank, are impervious or resistant to ordinary cold, heat and fire, impervious to disease, and heal much more quickly (most practically regenerate and heal before one's eyes), because they are not human. **Note:** In an S.D.C. environment where magic energy is weak, these beings usually become Hit Point/S.D.C. creatures, though usually with superhuman amounts of Hit Points and S.D.C.

- **Supernatural P.S. 15 or less:** Only inflicts 1D6 S.D.C. on a restrained punch, 4D6 S.D.C. on a full strength punch or 1D4 M.D. on a power punch (counts as two melee attacks). P.S. bonuses are added to S.D.C. attacks.

- **Supernatural P.S. 16 to 20:** Inflicts 3D6 S.D.C. on a restrained punch, 1D6 M.D. on a full strength punch, or 2D6 M.D. on a power punch (counts as two melee attacks). P.S. bonuses are added to S.D.C. attacks.
- **Supernatural P.S. 21 to 25:** Inflicts 4D6 S.D.C. on a restrained punch, 2D6 M.D. on a full strength punch, or 4D6 M.D. on a power punch (counts as two melee attacks). P.S. bonuses are added to S.D.C. attacks.
- **Supernatural P.S. 26 to 30:** Inflicts 5D6 S.D.C. on a restrained punch, 3D6 M.D. on a full strength punch, or 6D6 M.D. on a power punch (counts as two melee attacks). P.S. bonuses are added to S.D.C. attacks.
- **Supernatural P.S. 31 to 35:** Inflicts 5D6 S.D.C. on a restrained punch, 4D6 M.D. on a full strength punch, or 1D4x10 M.D. on a power punch (counts as two melee attacks). P.S. bonuses are added only to S.D.C. attacks.
- **Supernatural P.S. 36 to 40:** Inflicts 6D6 S.D.C. on a restrained punch, 5D6 M.D. on a full strength punch, or 1D6x10 M.D. on a power punch (counts as two melee attacks). P.S. bonuses are added only to S.D.C. attacks.
- **Supernatural P.S. 41 to 50:** Inflicts 1D6x10 S.D.C. on a restrained punch, 6D6 M.D. on a full strength punch, or 2D4x10 M.D. on a power punch (counts as two melee attacks). P.S. bonuses are added only to S.D.C. attacks.
- **Supernatural P.S. 51 to 60:** Inflicts 1D6 M.D. on a restrained punch, 1D6x10 on a full strength punch, or 2D6x10 on a power punch (counts as two melee attacks). P.S. bonuses not applicable.

**Note:** Some supernatural creatures will have a greater or weaker damage than the above table provides. These are exceptions to the general rule and will be evident in the descriptions of specific creatures. *Biting attacks* typically inflict half the M.D. of a punch unless the maw is especially large or powerful, then a bite could inflict the same damage or more. *Tails and tentacles* frequently inflict half to the same amount of M.D. as a punch. Power punches are not usually possible with a tail, but are possible with a tentacle. *Kicks* usually inflict the same M.D. as a punch, but in some cases the kick may inflict 1D6 more *Mega-Damage*.

**Supernatural Damage and Hand Weapons:** When wielding a hand weapon, such as swords, clubs and knives, a supernatural being inflicts either the weapon damage plus P.S. damage bonus or its basic hand to hand damage (see previous table) plus P.S. damage bonus, whichever is greater. **Optional Rule:** Normal weapons are in danger of breaking when wielded by somebody with supernatural strength. A good rule of thumb is to assume a weapon is in danger of breaking whenever total damage inflicted exceeds more than *three times* the weapon's maximum base damage — in the case of a 2D4 sword, more than 24 points of damage might break it. Every time that much damage is inflicted, there is a 01-30% chance that the weapon will break. Heavy, sturdy weapons, and very well-crafted blades (a master smith's katana, for example) can withstand more damage, so do not roll unless damage exceeds *five times* the weapon's maximum damage. Magical weapons and artifacts are basically indestructible and are at no risk of breaking.

## Weight & Movement

Normal characters, with a P.S. of 3 to 16, can carry 10 times their P.S. in pounds (P.S.x10 = total in pounds). For Example: A character with a P.S. of 9 can carry 90 pounds (40.5 kg). A character with a P.S. of 15 can carry 150 pounds (67.5 kg).

Strong characters, with a P.S. of 17 or higher, can carry 20 times their P.S. in pounds. This means a character with a P.S. of 18 can carry 360 pounds (162 kg).

**Supernatural creatures**, including spirits, gods and demons, are even stronger than extraordinary humans. (Other creatures, like dragons, may also have Supernatural P.S.) Supernatural beings and crea-



tures of magic with a P.S. of 18 or higher can carry 50 times their P.S. Thus, a creature with a P.S. of 24 can actually carry over half a ton, 1200 pounds (540 kg)! Creatures with a strength of 17 or less are equal to humans; P.S. x10 in pounds.



**Lifting weight** is a little different than carrying weight. You may have noticed, yourself, that you can usually lift up a heavier amount than you can carry. I'm not talking about weight-lifting in a body building sense, nor lifting a heavy weight above the chest. Simply the ability to bend over and lift something that weighs more than you can carry. The simple rule is that a character can lift **TWICE** as much as he/she could carry. This means that the character with a P.S. of 9 can carry 90 pounds (40.5), but can lift 180 pounds (81 kg). Meanwhile, the supernaturally strong creature, with a P.S. of 24, can lift over one ton (2400 pounds).

**Throwing Heavy or Awkward Objects:** A character can not throw more than he can carry.

Add one foot (0.3 m) to the effective range for every P.S. point listed; e.g., P.S. 24 add 24 feet (7.3 m).

Objects such as bricks, bottles, and swords are not designed for throwing. Consequently, the effective range is limited regardless of the strength behind it.

Darts, knives and throwing axes are designed for throwing, but don't have the weight or balance for great distances. The same is true of most objects weighing less than half a pound. Javelins, more so than spears, are designed for distance throwing.

Miscellaneous items weighing over a pound (0.45 kg) and less than 10 pounds (4.5 kg), such as chairs, stools, lanterns, can be thrown about *half* as far as the one pound (0.45 kg) object.

**Normal and extraordinarily strong characters** can hurl a weight equal to the weight they can carry four inches per each P.S. point. This means the person with a P.S. 9 can toss 90 lbs (40.5 kg) up to 3 feet (0.9 m) away. The hero with a P.S. of 17 can toss 340 lbs (153 kg) up to 5 feet, 8 inches (1.7 m) away.

**Supernatural characters** can hurl their maximum carrying weight one foot (0.3 m) per P.S. point. So a supernatural character with a P.S. of 24 can hurl an incredibly heavy object (up to 1200 pounds/540 kg) a whopping 24 feet (7.3 m). Damage from these heavy thrown objects is 1D6 +1D6 S.D.C. points per every 20 pounds (9 kg), so a 100 pound (45 kg) item will inflict 6D6 points of damage! A thousand pound (450 kg) object 6D6x10 S.D.C. (Equal to 3 M.D., 4 if you round up.)

## Step 2: Determine Hit Points & S.D.C.

Hit Points might best be thought of as *life points* because they indicate how much physical damage (cuts, bruises, etc.) a character can withstand before he or she dies. These are the points that are observed during a battle (or melee round) to determine how much damage is inflicted on friend or foe. Each time a character is struck by a punch, kick, weapon, bullet or energy blast he takes physical damage. Each individual player keeps score of how many Hit Points his character has by subtracting the damage from his character's Hit Points each time that character is hit and injured. Likewise, the G.M. keeps score of how much damage the player inflicts upon his opponent. When a character has *zero* Hit Points, he is in a coma and will soon die without extensive medical help. When a character's Hit Points have been knocked far below zero, he is dead and beyond saving.

### Determining Hit Points

**1. Base Hit Points:** Having rolled up your eight attributes, you will recall that one is *Physical Endurance (P.E.)*. The Physical Endurance score indicates your character's base/starting amount of Hit Points. This number means that he or she can lose that many Hit Points before dying.

Some of you will have a character with many Hit Points, but don't get cocky. A laser, machine-gun or knife in the right hands can whittle you down to size in a melee round or two. To those who find themselves with a character who has only a handful of Hit Points, don't despair or feel cheated. You'll just have to use cleverness and cunning to avoid serious confrontations until you've built up your Hit Points (and S.D.C.; more on that later).

**2. Building Hit Points:** After determining your base Hit Points, pick up one six-sided die, roll it, and add the number to your Hit Point base. This is your total number of *starting* Hit Points.

As your character grows in knowledge and experience, he will gain more skill and expertise. At the same time he will also mature physically, increasing his Hit Points. Thus each time a character attains a new *experience level*, roll one six-sided die and add it to the existing Hit Points.

### S.D.C. or Structural Damage Capacity

There are two types of S.D.C. The first applies to living creatures and is a sort of supplement to Hit Points. The second applies to inanimate, non-living structures such as chairs, locks, doors, buildings, vehicles, body armor, and so on.

**Determining physical S.D.C.** is simple. Each of the O.C.C.s automatically provides a base S.D.C. rating. Additional physical S.D.C. may be gained from physical skills such as Body Building, Wrestling and Gymnastics. In this way you can build and toughen your character as much as you would like.

#### Starting S.D.C. by O.C.C.:

NEMA Chromium Guardsman – 3D6+10  
 NEMA Silver Eagle Pilot – 3D6+8  
 NEMA Armored Sentinel (Power Armor Pilot) – 2D6+12  
 NEMA Soldier/Peacekeeper – 3D6+20  
 NEMA Field Engineer – 3D6+14  
 NEMA Fire & Rescue – 4D6+24  
 NEMA Intel-Agent/Spy – 3D6+10  
 NEMA Military Specialist/Commando – 4D6+20  
 NEMA Militia Volunteer – 2D6+12  
 NEMA Para-Arcane – 2D6+8  
 Demon & Witch Hunter – 3D6+20

When a character is hurt, the damage is first subtracted from his or her S.D.C. points. S.D.C. damage is painful, but not deadly. It's like in an action movie where the hero takes a bullet or is stabbed, but is able to keep fighting as if nothing happened. Later, when the hero tends to his wounds, he just slaps a bandage on them and says something glib like, "It was just a scratch." S.D.C. in action.

It is only after *all* S.D.C. has been depleted that damage is subtracted from Hit Points. By comparison, Hit Point damage is serious and potentially life threatening.

Game Masters should use common sense with S.D.C. and Hit Points. Some situations (diving on a grenade, getting shot in the head at point blank range, falling from a great height such as 1,000 feet/305 m), will do damage "directly to Hit Points," skipping S.D.C. entirely.

## S.D.C. Type Two: Objects

Inanimate objects, such as the walls of buildings, vehicles, furniture, body armor, and so on, also have S.D.C. In this case, the S.D.C. indicates the total amount of damage that the object can withstand. These S.D.C. points function exactly like Hit Points, except that they apply to non-living things. Any damage sustained is subtracted from the S.D.C. When the S.D.C. is reduced to zero, it is broken or smashed beyond repair.

**G.M. Note:** The S.D.C. system just described is a standard rule in most Palladium Books games. From time to time we hear the complaint, "How can somebody be bashing or shooting into a door and the door is in perfect condition until all of its S.D.C. is depleted?" The answer is, it's not in perfect condition. Using the example of the door, the G.M. should explain exactly what's happening. "You bash into the door with your shoulder. It's a very solid door and you inflict minimal damage (give S.D.C. damage). You realize that it will take quite a while to gain entry this way and you may hurt yourself." Or, "You can feel the door give a little under your great strength (give S.D.C. damage). Another bash and the door's frame cracks and moans, but it still holds (give S.D.C. damage). It will take another couple of attempts (as the door's S.D.C. dwindles), but it's definitely giving." Or, "Your sub-machine-gun riddles the wood door with a dozen holes (something the player can look through) but the door is still locked and holding strong."

The point is, attacks on normal objects will scrape, dent, crack, splinter, crumble, punch holes through it, and so on, even if the object is not destroyed. To smash or destroy something may require multiple attacks, and in some cases, like being locked behind an iron door or bulkhead without a weapon, proper tools or a suitable special ability, it will be *impossible* to damage the item at all.

## Armor Rating (A.R.)

**Note:** Not often applicable to **Chaos Earth™** or **Rifts®**, so you can probably skip this unless the characters are regularly engaged in S.D.C. skirmishes.

**S.D.C. artificial armor**, such as bulletproof vests and bionic armor, also have an Armor Rating (A.R.) as well as S.D.C. The Armor Rating indicates exactly how much protection is afforded by the armor (or object) and how easily it is penetrated. The higher the A.R. the better. If an attack roll to strike with all bonuses is *less than* the A.R. of the armor or object (door, shield, etc.), the armor absorbs the attack — subtract the damage from the armor's S.D.C. When the armor's S.D.C. is depleted, it no longer affords protection and is useless. Any future attacks will hit the character's body.

If an attack roll to strike, including all bonuses, is *higher than* the A.R., it penetrates the armor and inflicts damage directly to the character's S.D.C. and/or Hit Points.

The defender always wins ties, so if the roll to strike is 16 against somebody with body armor that has an A.R. 16, the attack hits the char-

acter, but damages the body armor because it didn't surpass the A.R. protection. However, if that strike roll had been 17 or higher, the attack would have struck an area not covered by the armor or punched right through it, doing damage to the character underneath it.

**Natural Armor:** Some forms of armor are vastly superior to simple body armor. Such armors include vehicle armor, cybernetic armor, and *Natural Armor*.

Natural armor applies to aliens, most supernatural beings and augmented creatures who have protective skin or an exoskeleton with an Armor Rating. In these cases, a roll to strike that falls *under* the A.R. does hit, but inflicts no damage. Punches and bullets bounce off harmlessly, lasers are deflected, and combat continues. A roll above the Natural A.R. strikes and inflicts *full damage*, first to the physical S.D.C. and, once the S.D.C. is depleted, then to the character's Hit Points.



## Recovery of Hit Points and S.D.C.

After a battle, characters who have sustained physical damage must tend to their wounds. The attending of wounds can be administered by fellow characters, trained medical personnel or by oneself, provided the character has the First Aid skill and is not physically impaired.

First aid-type skills include basic and immediate treatment, such as bandaging and cleaning of wounds, stopping bleeding and so on, until the character can receive better medical care. This is fine for minor wounds, but serious injuries, like internal bleeding and broken bones, will require professional treatment (or magic). **Note:** Unless a character stops the bleeding of cuts and stab wounds, he will continue to lose blood and suffer damage at the rate of one Hit Point per minute. When all Hit Points are reduced to zero, the character falls into a coma and hovers near death.

**Recovery: Non-Professional Treatment.** This is basic, first aid type treatment by oneself, or non-medically trained people. This type of treatment may be used if the character is not able to seek professional treatment immediately. It is not necessarily inferior treatment, especially for not too serious of an ailment, but just lacks the full facilities



and experience of a major medical institution. **Rate of Recovery:** Two Hit Points per day (24 hours) and/or four S.D.C. per day.

**Recovery: Professional Treatment.** This is medical treatment from a doctor, clinic or hospital. **Rate of Recovery:** Two Hit Points per day for the first two days and four per each following day, until the character has regained all of his/her original Hit Points. S.D.C. points are restored at a rate of six per day.

## Surviving Coma and Death

When a character's Hit Points are reduced to zero (or less), he collapses and falls into a coma. How much damage below zero a character can withstand is determined by the Physical Endurance (P.E.) attribute. A character can take one point of damage below zero (to negative one, -2, -3, etc.) for each P.E. point. **Example:** A character with a P.E. of 9 will lapse into a coma at zero Hit Points, but still lives up to a negative 9. However, if the character receives more damage (which is very possible) than the P.E., he is dead with no hope of recovery. Thus, if a character with a P.E. of 9 takes 10 points or more below zero, exceeding his P.E., he is beyond medical help and dies. Note that some special abilities may extend the amount of damage below zero a character can endure, and in some cases, continue to function.

The length of time a character in a coma will survive without treatment is again indicated by the P.E. Add one hour for each P.E. point. **Example:** P.E. 9 = 9 hours, P.E. 10 = 10 hours, and so on.

Whether a character survives the coma and is stabilized (brought back to at least one Hit Point above zero), is determined by the roll of percentile dice. If the player rolls two successful recovery rolls out of three, the character breaks out of the coma and is no longer in danger of dying. This also means that he is brought up to one Hit Point above zero. Recovery of Hit Points from that time on is standard; see *Recovery of Hit Points*, above. **Note:** This can be attempted every hour until the character dies.

### Recovery Ratio (roll 2 out of 3)

Treatment from unprofessional individuals with medical skills: 01-18%

Treatment from an intern or nurse (R.N.): 01-32%

Treatment from a doctor without proper facilities: 01-46%

Treatment from a doctor at a clinic (fair facilities): 01-56%

Treatment from a hospital: 01-66%

Treatment from a major, large hospital: 01-70%

## Step 3: Mega-Damage & M.D.C.

*Mega-Damage* has added a new wrinkle and danger to human life in the Chaos Earth setting, because Mega-Damage is the equivalent of superhuman damage and a single M.D. point can squish a human like a bug or vaporize him as if he was never there. Mega-Damage body armor, power armor, robot vehicles and M.D. weapons help even the playing field for humans, but they (and most D-Bees) remain mortal, Hit Point/S.D.C. creatures. No matter how comfortable a suit of armor may be, a person has to come out of his M.D.C. shell sometimes. Consequently, Hit Points and S.D.C. apply when a character is out of his protective armor or brawling among fellow humans. Of course, in the story context, this makes the supernatural threat that much more dangerous for humans.

**Mega-Damage Capacity (M.D.C.)** is a damage system that may be new to some of you. It is a Structural Damage Capacity that reflects the staggering advancements in science and technology. A technology that has created new super-tough alloys, micronized and even nano-size circuits, parts, batteries, and weapons with more power, precision, and range than anything we can manufacture in the 20th or 21st Centuries.

In effect, M.D.C. is a super-structural damage capacity that far outstrips the normal S.D.C.

### M.D.C. versus S.D.C.:

1. Generally, 100 S.D.C. (or Hit Points) damage equals about *one* M.D.C. point.

2. This also means that one point of Mega-Damage does approximately 100 S.D.C./Hit Points of damage.

3. Most conventional weapons do absolutely no damage to a Mega-Damage structure, even when combined for a total of 100 or more. The only exception is when a single (probably explosive) attack does 100 or more S.D.C., then one M.D. point is inflicted for every 100 S.D.C. points of damage; round up to the nearest 100.

**Example:** A Silver Eagle power armor and two foot soldiers, in standard NEMA Body armor, are on a routine patrol. All are wearing M.D.C. armor. Suddenly, they are attacked by thirty human bandits. The bandits are armed with old S.D.C. weapons, mostly M-16 assault rifles and submachine-guns. The two soldiers in body armor are caught in a hail of bullets. Perhaps as many as 50 rounds hit for a combined amount of S.D.C. damage of about 300, but the soldiers just stand their ground, *all* the bullets bouncing off their Mega-Damage armor. The worst is a few scratches. They take no damage! Why? Because no one attack/bullet inflicted anywhere near 100 points of S.D.C. damage. The noise and smoke and movement may be a bit distracting, but the soldiers are in no danger.

Four bandits jump one of the soldiers before he can react. They pummel him with the butts of their rifles and steel clubs. The attack succeeds in knocking him down and, perhaps, pinning him, but there is no physical damage to the body armor or the character inside, because the fisticuffs and clubs don't inflict Mega-Damage or 100 S.D.C.

One of the bandits screams a warning and points at the power armor flying in for an attack. A few bandits jump into a souped-up dune buggy and try to make a run for it. The other NEMA Peacekeeper sees them and fires his Mega-Damage (M.D.) energy pistol, a successful strike is made and damage is inflicted. The roll from the M.D. energy pistol is pitiful, a mere three M.D.C. points is rolled, but the S.D.C. dune buggy is blown in half because the 3 M.D. points are equal to about 300 S.D.C., the full S.D.C. of the vehicle!

The Silver Eagle swoops behind a wall of debris where its pilot saw a battered robot assault vehicle hiding. Sure enough, the moment the power armor is visible, the bandits piloting the stolen robot fire. The bandits get the initiative and also roll a successful strike. The Silver Eagle is hit by a pair of mini-missiles that inflict 1D4x10 M.D. each, and takes a total of 50 points of M.D.C. damage. By comparison, if an S.D.C. missile inflicted 50 S.D.C. points there would be no damage, just a blast mark. However, if an S.D.C. missile inflicted 1D6x100 S.D.C. damage, and a full die roll (6) was rolled, the 600 S.D.C. would damage it, but only do 6 M.D., a scratch to the flying power armor.

Combat continues.

In the context of this specific world setting, M.D.C. applies to:

1. All NEMA and high-tech military vehicles including tanks, APCs, robots, power armor, aircraft, and the most advanced body armor.
2. Bionic body components and bionic body armor (Cybernetic implants are generally S.D.C. structures).
3. Some advanced alien/D-Bee technology (same as #1) and force fields.
4. Supernatural beings, including the lowliest demons and vampires.
5. Dragons and other creatures of magic (not quite the same thing as the supernatural).
6. Most magic created (and psionic) force fields, energy blasts, golems, zombies, and similar energy based spells and magically created constructs.

**Combat Note:** Typically, only a Mega-Damage weapon can harm an M.D.C. structure. S.D.C. missiles and explosives that can inflict over 100 S.D.C. points of damage do inflict the equivalent of Mega-Damage. In these rare cases, approximately every 100 S.D.C. points of damage equals one M.D. Always round to the nearest 100 S.D.C. damage (as an act of kindness and desperation). For example, a missile that inflicts 450 S.D.C. equals 4 M.D., but one that does 479 points of damage should inflict 5 M.D.

**M.D.C. Artificial Armor.** Throughout the history of humankind people have developed different forms of body armor. In days past, this armor would have been S.D.C. types, like bulletproof vests and chain mail, but in the world of **Chaos Earth™** (and **Rifts®**) the body armor is usually made of super-strong, yet lightweight, Mega-Damage material. A variety of M.D.C. body armor is described in the equipment section.

**M.D.C. Natural Armor.** Many supernatural beings (spirits, demons, and gods) and creatures of magic (dragons, sphinx, etc.) and certain otherworldly monsters have bodies or hides that are Mega-Damage. In these cases, normal S.D.C. weapons cannot harm the creature and the thing is treated as if it were a living M.D.C. robot or structure. They, like any other M.D.C. structure, are usually vulnerable to Mega-Damage weapons, as well as magic and psionic attacks. **Note:** Many possess some kind of vulnerability to ordinary S.D.C. materials, such as silver, or bone, or iron, or stone, or salt, or sunlight, etc. These S.D.C. items do the equivalent of Mega-Damage, i.e. a silver dagger that normally does 1D6 S.D.C. damage will inflict 1D6 M.D. to the vulnerable creature. Many demons, in particular, have an S.D.C. Achilles' heel.

**Physical Damage While Inside an M.D.C. Structure.** Mega-Damage armor can only protect its wearer so much. There are a few instances where a character can suffer physical S.D.C. and/or Hit Point damage while inside a Mega-Damage structure. Psionic and magic mind attacks and probes will penetrate most M.D.C. *body armor*, but not most power armor or vehicles.

A character in body armor or human-size power armor can also suffer **impact damage** from a fall at great height, high speed crash, explosive concussion, and physical hammering from a giant robot or an attacker with Supernatural P.S. Most body armor and power armor is carefully designed and padded so that the armor absorbs the majority of impact damage, however, the body inside is still rattled and slammed around. In most cases, the physical damage one suffers is minimal and leads to nothing more than a few bruises.

#### Impact Damage Rules Applicable to Body & Power Armor

**Fall:** One point of S.D.C. or Hit Point damage for every 10 feet (3 m) of height from a fall.

**High speed crash:** 1D4 points of S.D.C. or Hit Point damage for every 10 mph (16 km) of speed above 30 mph (48 km).

**Impact from an explosion:** One point of S.D.C. or Hit Points for every 10 M.D. points from an explosion.

**Chance of being stunned:** In each case there is a chance of being stunned. **Fall:** 1-40% chance of being momentarily stunned (no attacks, -9 to strike, parry, and dodge) for 1D4 melees from any fall above 100 feet (30.5 m). 1-79% chance of being stunned for 1D6 melees if the fall is 200 feet (61 m) or higher. **Crash:** 1-30% chance of being stunned for 1D4 melees if impact is more than 50 mph (80 km); add +5% for every additional 10 miles (16 km) above 50 mph. **Explosion impact:** There is a 1-60% chance of being stunned for 1D4 melees whenever hit by more than 40 M.D.C. at once.

Also, the force of an attack, especially from missiles and rail guns, may knock a character off his feet. Generally, this only happens when the individual is struck by 30 M.D.C.; Game Masters should use common sense in deciding when to use this element in combat. Characters who are knocked off their feet lose one attack/action that melee.

**Immobilized:** Though it doesn't outright *hurt* a character, people in M.D.C. body armor, in particular, and power armor, robots and vehi-

cles as well, may find themselves in situations where they are trapped, pinned, overpowered, stuck, mired down in mud, blocked, tangled or tied up, magically mesmerized or stuck, and otherwise immobilized or cornered.

## Step 4: Determine Psionics

Psionics is psychic powers, E.S.P. Most people in other world settings have psychic potential, but not the ability to tap into it. The gifted few may develop certain extrasensory abilities along the way, and extremely gifted individuals may exhibit impressive powers, but generally, psychic ability is a rarity.

However, **Chaos Earth** is *not* other world settings. The reappearance of magic, the eruption of the Rifts, and the presence of the supernatural have created a unique "hothouse" environment for the development of magic and psionics. The energies are so strong and pervasive, and the world so transformed and weird, that it has shattered many old beliefs and made people accept what once seemed impossible or pure fantasy. This suspension of disbelief and raw emotions are causing ordinary people to suddenly manifest psionic and magic powers, often beyond their control.

Chaos Earth Master Psychic characters and specific psionics (old and new) will be the subject of their own sourcebook (so will magic).

To determine if a character has Major or Minor psionic powers, roll on the random table that follows. Then, to use those abilities now, grab a copy of the **Rifts® RPG**, **Psyscape** or virtually any of Palladium's other role-playing games to select psychic powers until the official **Chaos Earth Psionics Sourcebook** is available.

### Random Psionics Table for Chaos Earth™

Roll percentile dice.

**01-15% Major Psionics.** Select a total of nine powers from any *one* category (*Sensitive*, *Physical* or *Healer*) or a total of seven powers with selections made from two or three of those categories. Base Inner Strength Points (I.S.P.) is the character's M.E. +4D6, +1D6+1 per level of experience.

**16-35% Minor Psionics.** Select three powers from any *one* of the following psionic categories: *Sensitive*, *Physical* or *Healer*. In the grand scheme of things, power of this level is considered inconsequential, though it may have a profound impact on the individual character's life. Base Inner Strength Points (I.S.P.) are the character's M.E. +2D6. At each level of experience, add +1D6 I.S.P.

**36-00%:** Not psychic. Sorry.

### Potential Psychic Energy (P.P.E.)

**P.P.E.** is the amount of Potential Psychic Energy (P.P.E.) a character possesses. Ironically, P.P.E. is the key power source for *magic* and spell casting, not psychic abilities. Unless a character is a magic or psychic based O.C.C., or a creature of magic, or supernatural being, the amount of P.P.E. in most humans is minimal. 2D6 for the *average* adult, 4D6 for the average teenager, but 6D6+10 for the average child under the age of 13. **Note:** Unless a character uses magic, a person's P.P.E. is not of great importance. The Chaos Earth™ sourcebook dealing with the **Rise of Magic™** will go into this subject in greater detail.



# Step 5:

## Pick an O.C.C. & Skills

A character's Occupational Character Class (O.C.C.) determines what he is right now. Most characters in the North American Chaos Earth setting will be a trained member of NEMA or an active volunteer (Militia, Para-Arcane or Demon & Witch Hunter).

Players should skim over the O.C.C. descriptions and range of available skills, equipment and purpose, and *select* the one they find most interesting, challenging or appealing. Generally, all NEMA O.C.C.s are heroic occupations with the goal of saving lives and battling evil.

**O.C.C. Requirements.** Most O.C.C.s will have a required minimum level in two or more attributes. Some O.C.C.s have higher requirements than others and generally reflect the physical or intellectual demands of that particular profession. To take that O.C.C., the character must meet the requirements. If the player is dead set on a particular character and is off only one point or two, the Game Master should allow the player to bump that attribute up to the minimum requirement to select that O.C.C.

**Experience:** As a character grows in experience, so does the level of his skills and abilities. See the *Experience System* section for details and *O.C.C. Experience Tables*.

**Staring Money, Bionics & Equipment** are also indicated by the O.C.C.

**Multiple Character Classes** or dual O.C.C.s are not an option at this point. A future supplement may address the possibility.

## Skills & Skill Selection

All O.C.C.s have three skill categories: O.C.C. Skills, Related Skills, and Secondary Skills. Military O.C.C.s may also have a fourth skill category, M.O.S.

**M.O.S.** is a character's area of *special* military training. The bonus in parentheses reflects that specialized training, and M.O.S. available skills may be outside the range that is normally open to that occupation except when selected as an M.O.S.

**O.C.C. Skills** are the areas of expertise and training that all characters receive when they select that profession. The bonus in parentheses reflects that specialized training.

**O.C.C. Related Skills** are additional areas of formal training and knowledge. In many cases, these skills will also reflect the character's occupation and interests. Not all skill categories are available for skill selection and some will be marked "none." Many of the skill categories that are available will indicate specific restrictions (if any) and possible skill bonuses. Skill bonuses will be indicated in parentheses. The skills that most relate to one's O.C.C. have the highest bonuses.

**Secondary Skills** are additional areas of knowledge that the character has learned through experience. They may be related to the person's occupation, but often relate to other interests, hobbies and entertainment. Secondary Skills usually are self-taught and generally do not command the same degree of expertise as those gained from a formal education or training. They are hobbies, interests, and abilities that a person has learned on his own. These skills are also selected from the list of available skill categories, but no skill bonuses are applicable. The bonus indicated in parentheses applies only to *O.C.C. Related Skill* selections. All Secondary Skills start out at the *base skill* level.

Below is a list of skills that can be selected as Secondary Skills. Because these skills are self-taught and do not include intensive training, certain skills (e.g., most Military skills) cannot be learned as a Secondary Skill.

**Communications:** Radio: Basic and TV/Video only.

**Domestic:** Any.

**Electrical:** Basic Electronics only.

**Espionage:** Wilderness Survival only.

**Mechanical:** Basic Mechanics and Auto Mechanics only.

**Medical:** Brewing, First Aid or Holistic Medicine, but the latter counts as two skill selections.

**Military:** Camouflage and Recognize Weapon Quality only.

**Physical:** Any, excluding Acrobatics, Gymnastics, Boxing and Wrestling. Hand to Hand: Expert counts as two skill selections and Hand to Hand: Martial Arts (or Hand to Hand: Assassin, if evil) counts as three skill selections. Commando is not available.

**Pilot: Basic:** Any.

**Pilot: Advanced:** None.

**Pilot Related:** None.

**Rogue:** None.

**Science:** Astronomy and Math skills only.

**Technical:** Any.

**W.P. Ancient Weapons:** Any.

**W.P. Modern Weapons:** Any, except Sharpshooting, Torpedo, Heavy Weapons and Heavy Energy Weapons.

**Wilderness Skills:** Any.

## Skill Bonuses

The base skill level is denoted in each skill description. Bonuses received by one's O.C.C. are added to that base skill. This is a one time skill bonus. Characters may also have an I.Q. attribute bonus and this too is added to the base skill level as a one time bonus.

Skill proficiencies increase as characters grow in experience. This is not so much a bonus as a designation of increased mastery over one's abilities. The amount that the skill level increases is also noted in each skill description. **For example:** The communication skill of Radio: Basic, reads: **Base Skill:** 50% +5% per level of experience. This means that a first level character without an O.C.C. bonus has a base skill proficiency of 50%. At second level +5% is added to increase the skill to 55%, at third level it increases to 60%, and so on. If a +10% O.C.C. bonus was applicable, the base skill starts at 60% +5% per level (i.e., 65% at second level, 70% at third, and so on.)

**Note:** Maximum skill level is limited to 98%, because there is always a margin for error no matter how skilled one may become.

## Skill Penalties

Ordinarily, a character's chance of performing a skill successfully is determined by his success ratio for that skill. However, when alien technology, magic, or pressure situations are involved, one's success ratio for *any* skill is lowered.

**Alien or Super-Advanced Technology:** As a rule of thumb, there should be a skill penalty of -30% or -40% when trying to figure out, operate, repair, or use such mechanisms and technologies. In some cases (G.M.'s discretion), the technology may be so different that the character will be unable to use the simplest of devices (-80% to -95% penalty). The Game Master (G.M.) should always use his or her discretion when dealing with alien or futuristic sciences.

**Pressure Situations:** Executing a skill when calm, cool and collected is one thing. Doing it under the gun is something else. For the following pressure situations, negative modifiers apply to characters trying to execute any Scholastic or Secondary Skill (excluding Hand to Hand combat skills).

Pressure situation, but no big deal: -5% to -10%.

Pressure situation, deadly: Time is running out, with dire consequences! -15% or -30% penalty if a life and death situation, especially if thousands of lives hang in the balance.

Countermeasures, traps and alarms are in place: Depending on their level of complexity and sophistication, -10% or -15%.

Difficult, complex or unfamiliar task: -10% to -15%.

Trying to do something while moving: -5% to -40%, depending on the situation and how bumpy the ride is.

Frightened or jumpy: -5% to -10%.

Seriously wounded: When a character's Hit Points are down by 50% or more, all skills have a -15% penalty.

**Note:** The G.M. may also impose a reasonable penalty to any situation where the character faces an unusual or difficult task. A reasonable penalty will range between -10% and -30%, but sometimes lower or dramatically higher penalties may be appropriate. G.M.s, use your discretion and be fair.



## Step 6: Pick an Alignment

All players *must* choose an alignment for their character. This defines a character's attitudes and moral center. There are three basic alignment categories: *Good*, *Selfish* and *Evil*.

Alignments are an important factor in developing a character and a key element of "role" playing. Whether we are consciously aware of it, every person has his or her own moral compass to guide him. Whether one calls it a code of ethics and morals, or justice and honor, alignments function as what the character sees as right and wrong, good and evil, acceptable behavior and not. It is this sense of right and wrong that helps build moral fiber, mold one's behavior, and dictate how one acts and reacts when faced with a moral choice.

Alignments should be seen as a *guideline* for the character that indicates how he or she is likely to react to any given situation. Try to have your character stay true to his alignment and act accordingly, even if it

goes against the grain. In fact, battling to stay true to one's alignment replicates the conscience and realistic moral decisions, i.e., being emotionally torn to do the right thing, or what feels good at the moment. An act of cruelty out of revenge or hate, for example, might sound good in the heat of the moment, but is not the good or right thing to do. A player battling with such a decision for his character emulates that emotional gut process.

When a player finds himself slipping (or slipped) out of character, the Game Master (G.M.) should stop the game for a moment and, as the referee/director of the story, point out that the player's intended actions go against his alignment. The G.M. should then warn that moving forward with that choice may cause the character to *change alignment*. For example: A Principled good character that acts out of hatred and deliberately tortures another being is likely to drop to the *Anarchist* or even *Miscreant evil* alignment depending on how cruel and vicious the act was, or how much the character enjoyed it. Similarly, a Principled character who decides to steal or "bend" the law is likely to drop to an *Unprincipled* alignment, and to *Anarchist* if he keeps stealing. Everyone makes a mistake from time to time, but repeated drops from alignment and/or no remorse for a wrongdoing will definitely cause a quick change. Likewise, a *Miscreant evil* character who has learned the value of friendship and begins to act kind, noble and compassionate, or forsakes his villainous ways, may go up to *Anarchist* or *Unprincipled*, and eventually, even higher if he keeps it up.

Playing in character (e.g., in alignment) can be a challenge, but it is always fun.

## No Neutral Alignments

There is no such thing as an absolute neutral alignment. A character with an absolute, true neutral position could not make a decision, fight tyranny, hurt others, go adventuring, or take any action of any kind without leaning toward good, evil, or self-gratification. It is humanly impossible, and therefore is eliminated in the context of this game.

There are some philosophers out there who might disagree with this, but that's a topic for another forum and not a factor of this game. Sorry, this is one of the very few definitive, unbending rules.

## Good Alignments

Good aligned characters (*Principled* and *Scrupulous*) are the straight-up heroes of this world. They generally place a high value on life and liberty, as well as law and order. Just because a character is of a good alignment, however, does not mean he's a saint or without bad habits. Good characters can be irritating, obnoxious and arrogant, even prejudiced and full of irritating quirks. Likewise, they may find themselves stepping outside the boundaries of the law in their quest to combat evil and injustice, but when push comes to shove, these characters can *always* be trusted to do the right thing, especially in a life and death situation.

### Principled (Good)

Principled characters are upright "boy scout" or "do-gooder" types who put others before themselves. This is the knight in shining armor, with the highest regard for the lives and well-being of others, freedom, truth, honor and justice. Principled characters will always *attempt* to work with and within the law, and have a high regard for (and trust of) authority, as well as for life and freedom. They are usually compassionate, merciful, cooperative and sincere.

#### A Principled character will . . .

1. Always keep his word.
2. Avoid lies.
3. Never kill or attack an unarmed foe.
4. Never harm an innocent.



5. Never torture for any reason.
6. Never kill for pleasure.
7. Always help others.
8. Always work within the law whenever possible.
9. Never break the law unless conditions are desperate. This means no breaking and entering (even in this post-apocalyptic setting), theft, torture, unprovoked assaults, etc.
10. Respect authority, law, self-discipline and honor.
11. Work well in a group.
12. Never take "dirty" money, or ill-gotten valuables or goods. This means any property that belongs to criminals or villains. It matters not how the bad guys got that property themselves; the hero will not touch it even if destitute.
13. Never betray a friend.

## Scrupulous (Good)

Scrupulous characters value life and freedom above all else and despise those who would deprive others of them. This type of hero is typically portrayed in many movies as the cop who plays by his own rules, forced to work beyond the law for justice (or retribution) and the greater good of the people. They are not vicious or vindictive characters, but are individuals driven by their sense of justice to right a wrong or take a (bloody) stand. These characters will always attempt to work with or within the law whenever possible.

### A Scrupulous character will . . .

1. Keep his word to any other good person.
2. Lie only to people of selfish or evil alignments.
3. Never attack or kill an unarmed foe.
4. Never harm an innocent.
5. Never torture for pleasure, but may use muscle to extract information from criminals or evil characters.
6. Never kill for pleasure, will always attempt to bring the villain to justice alive, no matter how vile he may find him.
7. Always try to help others.
8. Attempt to work within the law whenever possible.
9. Bend and, occasionally, break the law when deemed necessary. This means he may use strong-arm techniques, harass, break and enter, steal, and so on (but only against the bad guys).
10. Distrust authority; fears the law and government may not be an effective weapon against injustice and crime. However, he will try not to flagrantly disregard the law.
11. Work with groups, but dislike confining laws and bureaucracy (red tape).
12. Never take "dirty" money or items.
13. Never betray a friend.

## Selfish Alignments

Selfish characters (*Unprincipled* and *Anarchist*) are not necessarily evil, but they always have their own best interests at heart and their opinions in mind above all others. These are the mercenaries, rogues, vigilantes and anti-heroes of the world.

### Unprincipled (Selfish)

This basically good person tends to be selfish, greedy, and holds his personal freedom and welfare above almost everything else. He dislikes confining laws and self-discipline and distrusts authority. He views the law and government as well intentioned, but clumsy and ineffective. Keeping his best interests in mind, the character will always look out for himself.

This character is also likely to take "dirty" money and items, with the concept that it will help him in his crusade against evil. He may also destroy the property of known criminals. He will not deal in illegal wares, drugs, or take money from innocent or good people. The Unprincipled character may associate with both good and evil characters, and often has paid informants, spies and stoolies.

This is the noble scoundrel, the guy who is always looking for the best deal, associates with good and evil characters, is continually tempted to lie and cheat, and hates himself for being loyal, helping others and ultimately doing the "right thing."

### An Unprincipled character will . . .

1. Keep his word of honor.
2. Lie and cheat if necessary (especially to those of Anarchist and evil alignments).
3. Not kill an unarmed foe (but will take advantage of one).
4. Never harm an innocent.
5. Not use torture unless absolutely necessary.
6. Never kill for pleasure; will *attempt* to bring the villain to justice alive and ruin him rather than simply kill him.
7. Usually help those in need.
8. Rarely attempt to work within the law.
9. Blatantly break the law to achieve his (usually good-intentioned) goals.
10. Dislike and distrust authority, the law and bureaucracy. Feels they have been corrupted and abused.
11. Work with groups, especially if it serves his needs, is profitable, and/or he is in the limelight.
12. Take "dirty" money.
13. Never betray a friend.
14. Have a high regard for life and freedom.

### Anarchist (Selfish)

This type of character likes to indulge himself in everything. He is the insurgent, con-artist, gambler and uncommitted freebooter who adventures because he enjoys the thrill, fame and fortune it brings, rather than for any cause (like, defending humanity or rebuilding the shattered country). This character will at least *consider* doing anything if the price is right or the challenge is alluring enough.

Laws and rules infringe on personal freedom and were meant to be broken. He will not hesitate at using strong-arm techniques, breaking and entering, theft, harassment, destruction of private property, and so on. This can also include acting as judge, jury, and executioner. These characters are usually the daring anti-heroes who feel the end justifies the means. The Anarchist-aligned person is always looking for the best deal and self-gratification. He will work with good, selfish and evil characters to attain his goals. The Anarchist is continually teetering between good and evil, rebelling against and bending the law to fit *his* needs. Mercenaries and thieves often fall into this category.

### An Anarchist character will . . .

1. Keep his word, but only if it suits or pleases him.
2. Lie and cheat if he feels it necessary.
3. Not be likely to kill an unarmed foe, but certainly will knock out, attack or beat up one.
4. Never kill an innocent, although his rash or self-serving actions may injure or kill bystanders by accident.
5. Use torture to extract information, but is not likely to do so for pleasure.
6. Seldom kill for pleasure.
7. Not be likely to help someone without some ulterior motive (even if it's only to show off).
8. Rarely work within the law unless it serves his purpose.

9. Constantly break the law to achieve his goals.
10. Have little respect for authority, the law, or self-discipline.
11. Not work well within groups; tends to do as he pleases, despite orders to the contrary.
12. Take "dirty" money without hesitation.
13. Possibly betray a friend. Sorry, pal.



## Evil Alignments

All evil characters (*Aberrant*, *Miscreant* and *Diabolic*) are not necessarily bent on universal genocide or dominating all other living creatures. Nor are all evil characters sadistic, cruel, ugly or untrustworthy. Many evil characters may actually seem kind or likeable.

Evil alignments are a step beyond the self-gratification of the selfish alignments. Evil characters are ruthless individuals who are willing to say or do anything to achieve their goals. Most commonly, evil characters have goals that either entail making people suffer or cause suffering as a side effect (a side effect the evil character knowingly and callously disregards). Human life has little meaning to them, and friends tend to be (but not always) people to use and discard when they are no longer of value. Evil aligned characters do not automatically slay any good-aligned person because of different ethics and philosophy. All the better to use good to achieve their own goals, for the end always justifies the means.

**Note:** There is nothing wrong with *playing* a fictional, evil character, although he may not survive too long if he betrays or harms too many people, nor be liked or trusted by his "good" teammates. However, this is role-playing, not reality, so one can play any type of character he desires, just continue to play in character. That having been said, player characters in **Chaos Earth™** tend to be brave, self-sacrificing heroes.

## Aberrant (Evil)

The cliché that there is "no honor among thieves" is false when dealing with the Aberrant character. This is an individual who is driven to attain his goals through force, power, and intimidation. Yet the Aberrant character stands apart from the norm with his own personal (and twisted) code of ethics. He expects loyalty from his minions, punishing disloyalty and treachery with a swift, merciful death or banishment. An Aberrant character will always keep his word of honor and uphold any bargains. He will define his terms and live by them, whether anyone else likes them or not.

If an anti-hero, he will completely disregard the law and deal out justice as he deems fit. He will never be cruel or vindictive, and will always be absolutely positive that the person is guilty before he deals out his brand of justice. However, once he condemns a character, he will see to it that he is destroyed.

Whether a villain or a corrupt or extreme anti-hero, the Aberrant character looks upon people without honor or a sense of loyalty as worthless and disgusting lowlifes.

Do not think of the Aberrant character as a misguided good guy. He or she will break all laws with impunity, harass their victims, destroy property, assault, blackmail, torture and murder. Only their methods and degree of violence may vary.

### An Aberrant character will . . .

1. Always keep his word of honor (at least to those he deems worthy of it).
2. Lie and cheat to those not worthy of his respect; good, selfish or evil.
3. May or may not kill an unarmed foe.
4. Never kill an innocent, particularly a child, but may harm, harass or kidnap.
5. Never torture for pleasure, but will use it to extract information and intimidate others.
6. Never kill for pleasure, will always have a reason.
7. May or may not help someone in need.
8. Rarely attempt to work within the law.
9. Break the law without hesitation.
10. Have no use for the law or bureaucracy, but respects honor, self-discipline and the "concept" of laws and order.
11. Work with others to attain his goals.
12. Usually take "dirty" money, although his twisted code of ethics may prevent him from doing so in some instances.
13. Never betray a friend. Never.

## Miscreant (Evil)

This self-serving, unscrupulous character is out only for himself. Power, glory, wealth, position, and anything that will make his life more comfortable or pleasurable is his goal. It doesn't matter who gets caught in the middle, as long as he comes out smelling like a rose. The character will lie, cheat, hurt, and kill anyone to attain his personal goals.

If a Miscreant character becomes a vigilante, mercenary, or bounty hunter, it will be for some personal reason, a vendetta, money, glory or a love for danger and challenge. This character is a savage misanthrope out for himself.

### A Miscreant character will . . .

1. Not necessarily keep his word to anyone.
2. Lie and cheat indiscriminately (good, evil, selfish).
3. Kill an unarmed foe as readily as he would a potential threat or competition.
4. Use or harm an innocent.
5. Use torture for extracting information and pleasure.
6. May kill for sheer pleasure.



7. Feel no compulsion to help without some sort of tangible reward for him.
8. Have no deference to the law, but will work within the law if he must.
9. Blatantly break the law for his own goals and pleasure.
10. Dislike and distrust authority and the law.
11. Work with others if it will help him attain his personal goals.
12. Take "dirty" money, stolen goods, and illegal items (as well as steal valuables for himself whenever the opportunity arises).
13. Betray a friend if it serves his needs.
14. Have no respect or concern for the lives or welfare of others.



## Diabolic (Evil)

This is the category that most megalomaniacs, psychopaths, and violent and despicable characters fall into. This is the cruel, brutal killer who trusts no one and has no value for any life other than his own. A Diabolic character will crush anyone that gets in his way. The lowlife will lie, cheat, con, abuse and kill anyone less powerful than he is. Aberrant characters find these dishonorable people more revolting than a good aligned character.

### A Diabolic character will . . .

1. Rarely keep his word, and has no honor.
2. Lie to and cheat anyone.
3. Most certainly attack and kill an unarmed foe.
4. Hurt and kill an innocent without a second thought and for pleasure.
5. Use torture for pleasure and information, regularly.
6. Kill for sheer pleasure.
7. Be likely to help someone only on a whim (or to set them up for some evil deed later).
8. Rarely attempt to work within the law.
9. Blatantly break the law and mock authority.
10. Despise honor, authority and self-discipline. Views them as weaknesses.
11. Not work well within a group; constantly disregarding orders and vying for power/command.
12. Always take "dirty" money, drugs, stolen goods, etc., as well as steal from others.
13. Betray a friend without hesitation; after all, you can always find new friends.
14. Associate mostly with other evil alignments.

# Experience Level System

As the game designer, I personally find the Experience Point system to be a more realistic simulation for characters that grow and mature. I've known many brilliant people in my life, and some, despite their high I.Q. and raw natural talents, just don't do anything with them, or they go to school, learn the basics and move on to something completely different or let that knowledge stagnate. Learning through life experience is how real people grow, develop and improve. The old joke about, "practice, practice, practice," is very true. I've seen artists and writers, sports figures and others reach a "new plateau" at various points in their careers, where suddenly there is a marked improvement and greater skill in, or understanding about, what they do. To me, that's just like hitting a new experience level for our fictional characters, or vice versa, so I find the Experience Level System to be realistic, fun and a desirable simulation.

In the Palladium Experience Level System, one's character tends to grow more quickly during the early stages of learning and experience, which is also true to life. At first, everything is new and exciting and one learns rapidly. However, with each new level of experience, attaining the next, higher level becomes more complex and difficult. It takes more subtle practice, and most importantly, more time. That's why after seventh or eighth level it may take a character a year or two to reach the next level and two or more to attain the next. Typically, by 10th level, most player characters (already several years old), are not likely to advance much for several years at a time, which is realistic also.

## Experience Points are their own reward

Remember, in a game context, one of the tangible accomplishments and rewards the *player* receives is Experience Points for his or her fictional alter ego. Yeah, his or her character or the player group as a whole gets money, treasure, powerful weapons, artifacts and the adoration of those they rescue, and that's all cool, but the growth of the character via Experience Points for heroism, playing "in character," and using his smarts and cunning are the real achievement for the individual player.

I have run many a game where the player characters got the snot kicked out them, lost valuable equipment and got no or little financial reward, but the players were tickled pink because they saved the day (even if that was saving one orphan child), because they worked as a team, had fun doing it, defeated the bad guys, and *won* – and had the Experience Points (and self-satisfaction) to prove it. Somehow those things, with E.P. punctuating it all, made it all worth the effort, trouble and pain for their fictional characters. That is the other beautiful aspect of the Experience Point system, you are rewarded for your character's accomplishments.

## Experience Points & Their Application

The ultimate purpose of Experience Points and Experience Levels is to provide a means by which the player's character can grow and develop. The Palladium game system promotes a subjective method of using observation and logic to determine Experience Point rewards. Some other games with experience systems in the past have focused on the "kill factor," but what about the thought process? What about the decisions, plans and motives behind a particular action? Doesn't cleverness and a cool head count? Shouldn't the brilliant medical student playing a character with an I.Q. of 4 (and staying firmly in character,

saying and doing things as the dull-witted character would, even though he realizes the stupidity as a player) get experience for playing "in character?" Absolutely! Considering how flexible and subjective most of the other role-playing conditions and rules are, there isn't much logic in having a strict, limited Experience Point system.

Each player's character involved in a given situation or confrontation should receive the appropriate Experience Points. The G.M. should make a list of his players at the beginning of the game and jot down each player's Experience Points as they gather them throughout the course of the game. At the end of the game, the G.M. totals each player's points and gives them the total, so that they can keep track of their growing experience and skills.

The difficulty with this method of determining experience is its subjectivity. The G.M. must utilize the experience outline with some thought. **For Example:** Eight third level heroes armed to the teeth attack and subdue a lone fourth level villain. The eight players should receive Experience Points for subduing a minor menace. After all, the poor bad guy had no chance and presented no real threat to the characters. However, if one or two first or second level characters subdued or killed the same villain, they should receive experience for subduing a major, or possibly a great menace, because the danger and the ingenuity and teamwork required to defeat him was much greater for these low level characters.

This system should promote imaginative and creative playing and role-playing instead of mere hacking and slashing. Game Masters, don't feel that you have to shower your players with tons of Experience Points. Be fair and tolerant. Let your players truly *earn* their Experience Points, growing in skill, knowledge and power. If you have a group of players with characters rising rapidly in Experience Levels, you will know it's because they are bold, clever and imaginative. That's what this game is all about!

## Experience Points Award Table

### A guide to awarding Experience Points

25 points for performing the right skill (successful or not), at the right time for the right reason. For mid to high level characters (4th level and up) this might apply only to skills performed when they were most critical or done under stressful conditions.

25 points for a clever, but futile idea.

50-100 points for a clever, useful idea or action.

100 points for a quick thinking idea or action that was helpful.

200 points for a critical plan or action that saves the character's own life and/or a few comrades.

400-1000 points for a critical plan or action that saves the entire group and/or many innocent people.

100-300 points for endangering the character's own life (self-sacrifice) to help or save others.

500-700 points for a genuine life and death self-sacrifice in a situation where the character's heroism seemed likely (or almost certain) to cost him his life. Leaping in front of a fireball meant for someone else to save that person, even though the blast is *likely* to kill the hero, or offering his/her own life to save the group or an innocent person (and the exchange truly seems to be a death sentence with no apparent chance for escape). Odds are that the character *will* really die!

50-100 points for avoiding unnecessary violence.

100-200 points for insightful and helpful deductive reasoning or observation.

25-50 points for using good judgment.

50 points for playing in character bonus.

50-100 points for a successful daring or heroic action (whether it was clever or not).

25-50 points for killing or subduing a *minor menace*.

75-100 points for killing or subduing a *major menace*.

150-400 points for killing or subduing a *great menace*.

## Experience & Hit Points

Each time a character reaches a new level of experience, the player gets to roll one six-sided die (1D6) and adds the number rolled to the character's Hit Points. This indicates the physical development and maturity of the character.

## Per Level of Experience

"Per level of experience" or similar phrases indicate that the character can perform a skill, power or ability at his personal, highest level of experience. This often indicates the amount of damage that can be inflicted or a duration of an effect.

## Character Experience Levels

An experience table is provided for each Occupational Character Class (O.C.C.). A character involved in an adventure gains Experience Points for his thoughts, actions and deeds. As these Experience Points accumulate, the character will reach new plateaus indicating his continuing growth, development, and mastery over his abilities and skills. Each time a player's character gets enough Experience Points to reach the next "level," his skill increases accordingly. **For Example:** When a first level Intel-Agent has accumulated at least 2,101 Experience Points, he has attained Second Level, and all of his skills improve accordingly, meaning that he can perform them at a higher level of proficiency.

The maximum level a player character can reach is 15. We have found characters any higher than that tend to be difficult both to play and to G.M. Plus, given the typical scale of Experience Points used for this game, a player should have to run his character for years and years to get beyond even 10th level.

### Volunteer Militia Fighter

1	0,000 - 1,825
2	1,826 - 3,450
3	3,451 - 6,900
4	6,901 - 13,800
5	13,801 - 19,200
6	19,201 - 29,200
7	29,201 - 39,200
8	39,201 - 49,200
9	49,201 - 70,300
10	70,301 - 99,500
11	99,501 - 130,500
12	130,501 - 180,500
13	180,501 - 230,500
14	230,501 - 280,500
15	280,501 - 320,500

### Peacekeeper/Grunt

1	0,000 - 1,950
2	1,951 - 3,900
3	3,901 - 8,800
4	8,801 - 17,600
5	17,601 - 25,600
6	25,601 - 35,600
7	35,601 - 50,600
8	50,601 - 70,600
9	70,601 - 95,600
10	95,601 - 125,600
11	125,601 - 175,600
12	175,601 - 225,600
13	225,601 - 275,600
14	275,601 - 325,600
15	325,601 - 375,600

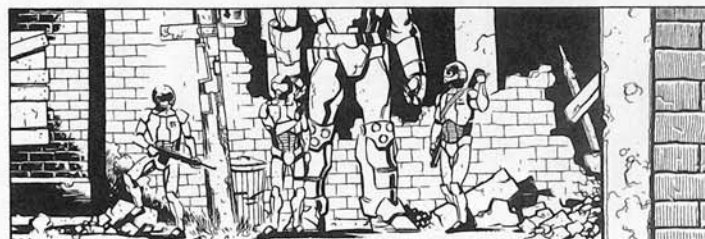



---

**Fire & Rescue (Roscoe)****& Intelligence Officer**

1	0,000 - 2,100
2	2,101 - 4,200
3	4,201 - 8,400
4	8,401 - 16,800
5	16,801 - 25,000
6	25,001 - 35,000
7	35,001 - 50,000
8	50,001 - 70,000
9	70,001 - 95,000
10	95,001 - 130,000
11	130,001 - 180,000
12	180,001 - 234,000
13	234,001 - 285,000
14	285,001 - 345,000
15	345,001 - 410,000

**Field Engineer**

1	0,000 - 1,925
2	1,926 - 3,850
3	3,851 - 7,450
4	7,451 - 15,000
5	15,001 - 21,500
6	21,501 - 31,500
7	31,501 - 41,500
8	41,501 - 54,000
9	54,001 - 75,000
10	75,001 - 105,000
11	105,001 - 140,000
12	140,001 - 190,000
13	190,001 - 240,000
14	240,001 - 300,000
15	300,001 - 350,000

**Military Specialist/Robot Commander**

1	0,000 - 2,120
2	2,121 - 4,240
3	4,241 - 8,480
4	8,481 - 16,960
5	16,961 - 24,960
6	24,961 - 34,960
7	34,961 - 49,960
8	49,961 - 69,960
9	69,961 - 94,960
10	94,961 - 129,960
11	129,961 - 179,960
12	179,961 - 229,960
13	229,961 - 279,960
14	279,961 - 329,960
15	329,961 - 389,961

**Armored Sentinel/Robot Pilot**

1	0,000 - 2,000
2	2,001 - 4,000
3	4,001 - 8,200
4	8,201 - 16,400
5	16,401 - 24,500
6	24,501 - 34,600
7	34,601 - 49,700
8	49,701 - 69,800
9	69,801 - 94,900
10	94,901 - 129,000
11	129,001 - 179,100
12	179,101 - 229,200
13	229,201 - 279,300
14	279,301 - 329,400
15	329,401 - 389,500

**Chromium Guardsman**

1	0,000 - 2,100
2	2,101 - 4,200
3	4,201 - 8,400
4	8,401 - 17,200
5	17,201 - 25,400
6	25,401 - 35,800
7	35,801 - 51,000
8	51,001 - 71,200
9	71,201 - 96,400
10	96,401 - 131,600
11	131,601 - 181,800
12	181,801 - 232,000
13	232,001 - 282,200
14	282,201 - 342,400
15	342,401 - 402,600

**Silver Eagle SAMAS**

1	0,000 - 2,150
2	2,151 - 4,300
3	4,301 - 8,600
4	8,601 - 17,200
5	17,201 - 25,500
6	25,501 - 36,000
7	36,001 - 52,000
8	52,001 - 73,000
9	73,001 - 98,000
10	98,001 - 134,000
11	134,001 - 184,000
12	184,001 - 240,000
13	240,001 - 295,000
14	295,001 - 365,000
15	365,001 - 425,000

**Para-Arcane**

1	0,000 - 1,970
2	1,971 - 3,940
3	3,941 - 7,880
4	7,881 - 14,880
5	14,881 - 21,880
6	21,881 - 31,880
7	31,881 - 41,220
8	41,221 - 54,440
9	54,441 - 74,660
10	74,661 - 104,880
11	104,881 - 139,220
12	139,221 - 189,440
13	189,441 - 239,660
14	239,661 - 290,880
15	290,881 - 335,000

**Demon & Witch Hunter**

1	0,000 - 2,050
2	2,051 - 4,100
3	4,101 - 8,250
4	8,251 - 16,500
5	16,501 - 24,600
6	24,601 - 34,700
7	34,701 - 49,800
8	49,801 - 69,900
9	69,901 - 95,000
10	95,001 - 130,100
11	130,101 - 180,200
12	180,201 - 230,300
13	230,301 - 280,400
14	280,401 - 340,500
15	340,501 - 400,600

# Explore the Palladium Megaverse®

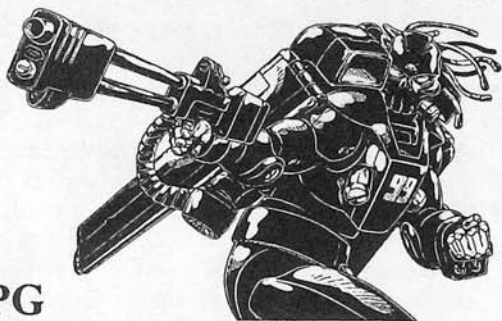

## Rifts® RPG

Dimensional *Rifts* are tears in the very fabric of space and time. Portals to other worlds. Doorways that allow the incredible, monstrous and magical to invade our world. Reshaping it into an alien landscape that is both frightening and wondrous, alien and yet strangely familiar.

Super-science, bionics, power armor and robots collide with the forces of magic, Techno-Wizardry, dragons and demons from the Rifts. Humankind struggles on the brink of extinction, and the possibilities are endless.

Discover a world where anything is possible and you are limited only by your imagination.

• \$24.95 — 256 pages, 16 full color paintings.

## The Palladium “Fantasy” Role-Playing Game®

A world of epic fantasy, incredible magic and amazing beings including the shape-changing Changelings, ferocious Wolfen, monstrous Melech, giants, trolls, dragons and creatures that defy description. Players can create scores of human and inhuman characters.

Combat is fast and fun.

Magic is different! There is spell casting wizardry, the wards of the Diabolist, the circles of the Summoner, and the powers of Druidism. Plus the mind-powers of the Mind Mage, elemental magic, the enchantments of the Alchemist, the blessings of the priest, the dark magic of the witch and magic items and creatures galore.

Sourcebooks define the world, offer new types of player characters, different player races and monsters, adventures and/or adventure ideas. This line is currently Palladium's second best seller (behind *Rifts*® and just edging out *Heroes Unlimited*™). • \$24.95 — 336 pages.



## Heroes Unlimited™ RPG, 2nd Edition

A big, fun, 352 page role-playing game that presents everything one needs to create a world of super beings.

Aliens, mutants, robots, cyborgs, super-soldiers, psychics, super-sleuths, martial arts masters, gun-toting vigilantes, super-geniuses, masters of magic, demigods, Mega-Heroes and more!

Over 100 super abilities, plus scores of sub-powers and 40+ psionic powers. Over 100 magic spells, plus enchanted weapons and objects.

Create robots, cyborgs, super-vehicles and gimmick weapons or play aliens, mutants, creative geniuses or vigilantes with special skills, training and physical abilities.

Everything one needs to play other than dice and friends are in this complete role-playing game. Cover by Jim Steranko. Written by Kevin Siembieda.

• \$26.95 — 352 pages.

## After the Bomb® RPG

Discover the world of mutant animals. Play it as a stand-alone game environment or combine it with *Heroes Unlimited*™, but check it out.

Mutant animal creation rules that make building your mutant characters fast, fun and challenging. Over 100 mutant animals presented. More than 40 animal powers and psionics; many more if you include weird abilities exclusive to certain animal species. Optional appearance and background tables. Plus *mutant human* creation rules and powers, world information, villains and “hot spots” in the world After the Bomb. Five adventures and additional adventure ideas. Written and designed by Erick Wujcik. • \$20.95 — 224 pages.

## Ninjas & Superspies™ RPG

Over 40 different types of martial arts, oriental mysticism, and superhuman abilities combined with spies, gizmos, super-vehicles, cybernetic implants and disguises, and more to create the ultimate spy and combat game. A complete role-playing game with everything you need to play. A complete game in itself as well as completely interchangeable with *Heroes Unlimited*™. Written by Erick Wujcik. • \$20.95 — 224 pages.

## Nightbane® RPG

The world has never been the same since Dark Day. Some say the world governments have been supplanted, taken over by ... god only knows what.

But the lords of shadow are not unopposed. There are creatures of light, as well as creatures born from darkness but who champion the light. These are the Nightbane. Ordinary people, many teenagers, able to shed their human facade and assume a supernatural alter ego. A monstrous, inhuman visage imbued with superhuman power and the stuff of magic. Written by C.J. Carella. • \$16.95 — 176 pages.

## Beyond the Supernatural™ RPG

The realm of the supernatural, magic and the unexplained more developed and defined than ever before. Set in our modern world . . . and realms beyond our understanding. New Occupational Character Classes, new psychic abilities, new menaces, strong direction and ideas for adventure. Deeper insight to the worlds within worlds, things that go bump in the night and creatures beyond our senses . . . beyond the supernatural.

- Over 200 pages. A complete stand alone role-playing game.
- Final price yet to be determined. Probably in the \$21.95 to \$24.95 price range. Written by Kevin Siembieda and Randy McCall. Lots of new artwork.

## Mechanoid Space™ RPG

The Mechanoid Invasion® taken to the nth degree, given a few twists and placed on a cosmic scale. The Mechanoids are back! And they are more dangerous than ever.

This new science fiction role-playing game is currently under development and being written by Kevin Siembieda. Already in development for two years, *Mechanoid Space*™ is so fresh and exciting that it has the potential of being a *Rifts*® scale mega-hit. Watch for it. Summer or Fall 2003 release.

## To learn about *all* of Palladium's role-playing games

To find out about *Beyond the Supernatural*™, *Systems Failure*™, *The Rifter*® and other Palladium role-playing games, sourcebooks, T-shirts and products check out our web site at [www.palladiumbooks.com](http://www.palladiumbooks.com) or request our 42 page catalog (free).

Palladium Books Inc. Taylor, MI 48180  
12455 Universal Drive [www.palladiumbooks.com](http://www.palladiumbooks.com)

Copyright 2002 Kevin Siembieda  
Palladium Books®, Rifts®, The Rifter®, RECON®, Nightbane®, The Palladium Fantasy Role-Playing Game®, After the Bomb®, The Mechanoids®, Mechanoid Invasion®, Phase World®, and Megaverse® are registered trademarks owned and licensed by Kevin Siembieda. *Heroes Unlimited*, *Ninjas & Superspies*, *Beyond the Supernatural*, *Mechanoid Space* and other titles and names are trademarks owned by Kevin Siembieda and Palladium Books.



# Skills

One of the great features about most Palladium role-playing games is the many different ways in which players can customize their characters. Skills play a big part in that, because they let each player tailor his character to his desires and make characters of the same O.C.C. different and unique.

The focus of this book is NEMA, so skills are narrowed to only those most appropriate for those characters and the Apocalyptic setting. Additional skills can be found in the **Rifts® Game Master Guide** and various other titles.

Also note that the **Base Skill** percentages for some skills are higher than in the **Rifts®** role-playing game. This reflects the considerably

higher level of education and training available in the Golden Age of Humankind that immediately preceded the Great Cataclysm and the Coming of the Rifts.

This section contains two presentations for skills.

**1. Skill List.** A comprehensive "list" of the names of every skill by category, followed by the skill's *base percentage* and the *additional percentage per level of experience*. The list is a quick and easy visual reference for picking skills and determining their percentage.

**2. Skill Descriptions.** Every skill is described in full. Again, only the skills most appropriate to the **Chaos Earth™** setting and NEMA characters are presented.

## Skill List

### Communications

Cryptography – 25%+5%  
Electronic Countermeasures – 30%+5%  
Laser – 30%+5%  
Optic Systems – 30%+5%  
Performance – 30%+5%  
Radio: Basic – 50%+5%  
Radio: Scramblers – 35%+5%  
Surveillance Systems – 30%+5%  
T.V./Video – 35%+5%

### Domestic Skills

Brewing – 25%/30%+5%  
Cook – 35%+5%  
Dance – 30%+5%  
Fishing – 40%+5%  
Gardening – 35%+5%  
Play Musical Instrument – 35%+5%  
Recycle – 30%+5%  
Sewing – 40%+5%  
Sing – 35%+5%

### Electrical Skills

Basic Electronics – 30%+5%  
Computer Repair – 30%+5%  
Electrical Engineer – 35%+5%  
Electricity Generation – 50%+5%  
Robot Electronics – 35%+5%

### Espionage Skills

Detect Ambush – 30%+5%  
Detect Concealment – 25%+5%  
Disguise – 25%+5%  
Escape Artist – 30%+5%  
Forgery – 25%+5%  
Imitate Voices & Impersonation – 36%/16%+4%  
Intelligence – 32%+4%  
Interrogation Techniques – 30%+5%  
Pick Locks – 30%+5%

Pick Pockets – 25%+5%  
Sniper (+2 to strike on an aimed shot)  
Tracking (people) – 25%+5%  
Wilderness Survival – 30%+5%

### Horsemanship Skills

Horsemanship: General – 40%/20%+4%  
Horsemanship: Cowboy – 66%/50%+3%  
Horsemanship: Exotic Animals – 30%/20%+5%

### Mechanical Skills

Aircraft Mechanics – 50%+4%  
Armorer/Field Armorer – 40%+5%  
Automotive Mechanics – 60%+3%  
Basic Mechanics – 40%+5%  
Bioware Mechanics – 30%+5%  
Locksmith – 35%+5%  
Mechanical Engineer – 30%+5%  
Robot Mechanics – 30%+5%  
Vehicle Armorer – 30%+5%  
Weapons Engineer – 30%+5%  
Weapon Systems – 40%+5%

### Medical Skills

Animal Husbandry – 56%+4%  
Brewing – 25%/30%+5%  
Criminal Science & Forensics – 35%+5%  
Field Surgery – 26%+4%  
First Aid – 45%+5%  
Holistic Medicine – 20%+5%  
Paramedic – 40%+5%  
Medical Doctor – 60%/50%+5%  
M.D. in Cybernetics – 40%/60%+5%  
Pathology – 40%+5%  
Xenology – 15%+5%

### Military Skills

Armorer/Field Armorer – 40%+5%  
Camouflage – 20%+5%  
Command Robots  
Demolitions – 60%+3%  
Demolitions Disposal – 60%+3%  
Demolitions: Underwater – 56%+4%  
Find Contraband,  
    Weapons & Cybernetics – 26%+4%  
Military Etiquette – 35%+5%  
Military Fortification – 30%+5%  
Nuclear, Biological &  
    Chemical (NBC) Warfare – 35%+5%  
Parachuting – 40%+5%  
Recognize Weapon Quality – 25%+5%  
Trap Construction – 20%+4%  
Trap/Mine Detection – 20%+5%

### Physical Skills

No Hand to Hand Combat Skill  
Hand to Hand: Basic  
Hand to Hand: Expert  
Hand to Hand: Martial Arts  
Hand to Hand: Assassin  
Hand to Hand: Commando  
Acrobatics (varies)  
Athletics (General)  
Body Building & Weight Lifting  
Boxing  
Climbing – 40%/30%+5%  
Gymnastics (varies)  
Prowl – 25%+5%  
Running  
Swimming – 50%+5%  
S.C.U.B.A. – 50%+5%  
Wrestling

## Pilot Skills

Airplane – 50%+4%  
Automobile – 60%+2%  
Bicycling – 60%+3%  
Boat: Motor & Hydrofoil – 55%+5%  
Boat: Sail Type – 60%+5%  
Boat: Ships – 45%+5%/44%+4%  
Boat: Warships & Patrol Boats – 40%+4%  
Combat Driving  
Helicopter – 52%+3%  
Hover Craft (Ground) – 50%+5%  
Hovercycle – 70%+3%  
Jet Aircraft – 60%+3%  
Jet Fighters – 50%+3%  
Jet Packs – 42%+4%  
Kayaking – 50%+5%  
Motorcycle – 60%+4%  
Power Armor Basic – 56%+3%  
Power Armor Combat Elite  
Robot Basic – 56%+3%  
Robot Combat Elite  
Submersibles – 60%+3%  
Tanks & APCs – 50%+3%  
Tracked Vehicles – 54%+4%  
Truck – 56%+4%  
Water Scooters – 50%+5%  
Water Skiing & Surfing – 40%+4%

## Pilot Related Skills

Navigation – 40%+5%  
Read (& Operate) Sensory Equipment – 30%+5%  
Weapon Systems – 40%+5%

## Rogue Skills

Cardsharp – 24%+4%  
Computer Hacking – 20%+5%  
Concealment – 20%+4%  
Find Contraband, Weapons & Cybernetics – 26%+4%  
Gambling (Standard) – 30%+5%  
Gambling (Dirty Tricks) – 20%+4%  
Palming – 20%+5%  
Pick Locks – 30%+5%  
Pick Pockets – 25%+5%  
Prowl – 25%+5%  
Safe-Cracking – 20%+4%  
Seduction – 20%+3%, plus attribute bonuses.  
Streetwise – 20%+4%  
Streetwise: Drugs – 25%+5%  
Ventriloquism – 16%+4%

## Science Skills

Anthropology – 40%+5%  
Archaeology – 40/20%+5%  
Artificial Intelligence – 30%+3%  
Astronomy – 30%+5%  
Astrophysics – 35%+5%  
Biology – 40%+5%  
Botany – 40%+5%  
Chemistry – 50%+5%  
Chemistry: Analytical – 35%+5%  
Mathematics: Basic – 72%+3%  
Mathematics: Advanced – 64%+2%  
Oxygen Systems – 58%+4%

## Technical Skills

Advanced Fishing – 30%+5%  
Art – 35%+5%  
Breed Dogs – 40%/20%+5%  
Computer Operation – 60%+3%  
Computer Programming – 50%+3%  
Cyberjacking – 50%+3%  
Excavation & Rescue – 40%+5%  
Gemology – 25%+5%  
General Repair & Maintenance – 45%+5%  
History – 60/40%+4%  
Jury-Rig – 25%+5%  
Language, Native – 88%+1%  
Language, Foreign – 60%+3%  
Law (General) – 35%+5%  
Literacy, Native Language – 86%+1%  
Literacy, Foreign Language – 50%+3%  
Lore: Cattle & Animals – 30%+5%  
Lore: Cities – 25%+5%  
Lore: D-Bee/Aliens – 25%+5%  
Lore: Demons & Monsters – 25%+5%  
Lore: Faerie – 25%+5%  
Lore: Indians – 25%+5%  
Lore: Magic – 25%+5%  
Lore: Mythology – 30%+5%  
Lore: Psychic & Psionics – 25%+5%  
Lore: Religion – 50%+3%  
Masonry – 40%+5%  
Mining – 35%+5%  
Photography – 35%+5%  
Prospecting – 20%+5%  
Recycle – 30%+5%  
Research – 40%+5%  
Rope Works – 30%+5%  
Salvage – 35%+5%  
Undersea Salvage – 30%+5%  
Whittling & Sculpting – 30%+5%  
Writing – 25%+5%

## Weapon

### Proficiencies (Ancient)

W.P. Archery & Targeting  
W.P. Battle Axe  
W.P. Blunt  
W.P. Bola  
W.P. Bow & Arrow  
W.P. Chain  
W.P. Crossbow  
W.P. Forked  
W.P. Grappling Hook  
W.P. Knife  
W.P. Mouth Weapons  
W.P. Net  
W.P. Paired Weapons  
W.P. Pole Arm  
W.P. Shield  
W.P. Slingshot  
W.P. Small Thrown Weapons  
W.P. Spear  
W.P. Staff  
W.P. Sword  
W.P. Trident  
W.P. Whip

## Weapon

### Proficiencies (Modern)

W.P. Revolver  
W.P. Automatic Pistol  
W.P. Bolt-Action Rifle  
W.P. Automatic and Semi-Automatic Rifles  
W.P. Submachine-Gun  
W.P. Flamethrower  
W.P. Grenade Launcher  
W.P. Harpoon & Spear Gun  
W.P. Heavy Weapons  
W.P. Torpedo  
W.P. Energy Pistol  
W.P. Energy Rifle  
W.P. Heavy Energy Weapons  
W.P. Sharpshooting

## Wilderness Skills

Boat Building – 25%+5%  
Carpentry – 25%+5%  
Dowsing – 20%+5%  
Hunting (SPECIAL)  
Identify Plants & Fruits – 25%+5%  
Land Navigation – 36%+4%  
Preserve Food – 25%+5%  
Roadwise – 26%+4%  
Skin & Prepare Animal Hides – 30%+5%  
Spelunking – 35%+5%  
Track Animals – 20%+5%  
Track & Hunt Sea Animals 35%/25%+5%  
Wilderness Survival – 30%+5%



---

# Skill Descriptions

---

## Communications Skills

**Cryptography:** The skilled eye to recognize, design, and crack secret codes and messages. The character must study the code for two hours to attempt to break it successfully. A failed roll means the individual must study the code for an additional two hours before he can try to break it again. The character may attempt to break the code sooner, after only 10 minutes of study, but suffers a penalty of -30%. **Base Skill:** 25% +5% per level of experience. **Requires:** Literacy.

**Electronic Countermeasures (Jamming):** Useful for preventing the enemy's communications from working. Since all armor, power armor and robot vehicles are linked by radio transmissions, jamming can cause unit confusion and disrupt communications. Military organization breaks down, causing a loss of effectiveness to all but the best units.

Just about any high-powered radio can be used for jamming. Armed with a radio, a small guerrilla unit can completely disrupt the maneuvers of large enemy groups. This skill also enables the radio operator to "follow" the enemy's attempted transmissions over jammed frequencies to trace their location or direction of travel. This tactic is extremely useful in finding and eliminating lone power-armor troopers, small squads and enemies in distress. **Base Skill:** 30% +5% per level of experience. **Note:** If the G.M. likes, he can make this part of the *Radio: Scrambler* skill, but still with a base of 30%.

**Laser:** This skill provides the character with an in-depth knowledge of sophisticated laser communication systems and fiber optic communications. **Base Skill:** 30% +5% per level of experience. **Requires:** The Radio: Basic, Electrical Engineer, and Computer Operation skills.

**Optic Systems:** Provides expert training in the use of special optical enhancement equipment such as telescopic lenses, laser targeting, thermo-imagers, passive light intensifiers, infrared and ultraviolet systems, polarization, light filters, optical scanners, video and digital cameras, holograms and related devices. **Base Skill:** 30% +5% per level of experience. Adds a special one time bonus of +5% to the T.V./Video skill if both are selected.

**Performance:** The method and ability used by entertainers, gladiators, pro-wrestlers and politicians to impress and sway the public. A character with this skill knows how to do things with *flair*. If a skill roll is successful, it works like an attempt to charm, impress or intimidate the audience. **Base Skill:** 30% +5% per level. **Note:** Obvious lies, inconsistencies and evidence to the contrary may ruin the effectiveness of the best performance. G.M.s, use your discretion.

**Radio: Basic:** This is the rudimentary knowledge of the operation and maintenance of field radios and walkie-talkies, wire laying, installation, radio procedure, communication security and visual signs/communications, as well as Morse code. It does not include the ability to make repairs. **Base Skill:** 50% +5% per level of experience.

**Radio: Scrambler:** Training in the use of electronic masking, scrambling and unscrambling equipment, as well as codes to help foil the detection, interception and interpretation of radio transmissions by the enemy. A radio operator who makes a successful scramble roll can transmit coded or scrambled messages without fear that the enemy will intercept or understand their transmission. **Base Skill:** 35% +5% per level of experience.

**Surveillance Systems (& Tailing):** The study and understanding of the methods, operation and techniques in using surveillance systems. Includes motion detectors, simple and complex alarm systems, audio/visual recording and display equipment, recording methods, amplified sound systems, miniature listening devices (bugs, line tapping),

and some optical enhancement systems (specifically as they relate to camera lenses).

**Tailing,** or following someone without their knowledge, is another form of surveillance. This also includes stake-out procedures. A failed surveillance roll indicates that the subject has spotted "the tail" and is aware that he is being followed/observed.

A failed roll in the use of surveillance equipment means that the equipment does not function as desired, impairing or preventing surveillance; i.e., bug does not transmit, recording or sound transmission is garbled, surveillance film is blurred or fails to record, etc.

A failed roll when hiding listening devices means the bug does not function and is easily discovered through the course of casual activity. **Base Skill:** 30% +5% per level of experience. **Requires:** Electronics: Basic or Electrical Engineering, plus Computer Operation and Literacy (the latter two are needed only for complex, high-tech systems).

**TV/Video:** In-depth training in the use of video, digital and audio recording equipment, filming, editing, dubbing, title making, duplication, and transmission. Includes the use of field equipment; i.e., portable video or digital camera and studio equipment. **Base Skill:** 35% +5% per level of experience.

## Domestic Skills

**Note:** Characters can attain professional quality by selecting the same Domestic skill twice. Add a one time bonus of +10% and note that the end result is of superior quality.

**Brewing:** The understanding and methods of making fermented alcoholic beverages from grains and fruits. This specifically includes wine, mead, ale, beer and moonshine. Stronger types of alcohol, such as brandy, rum, and whiskey, are not included, nor are champagnes or fine wines. The first percentile number indicates the chance of success (a failed roll means an undrinkable batch of booze). The second indicates the quality of the brew — the higher the number rolled the tastier the drink. **Base Skill:** 25%/30% +5% per level of experience.

**Cook:** Skill in selecting, planning, and preparing meals. A cooking roll failure means that the cooked food is not well prepared. It is edible but tastes bad (greasy, too spicy, sour, burnt, bland, leaves an aftertaste in mouth, etc.). **Base Skill:** 35% +5% per level of experience.

**Dance:** A practiced skill in the art of dancing. The character is especially smooth and graceful, a joy to dance with. Can learn new dance steps/moves much more quickly than somebody who can not dance. **Base Skill:** 30% +5% per level of experience.

**Fishing:** The fundamental methods and enjoyment of the relaxing sport of fishing. Areas of knowledge include the use of lures, bait, poles, hooks, lines, and the cleaning and preparation of fish for eating. Also includes a basic knowledge of freshwater fish, their habits and taste. **Base Skill:** 40% +5% per level of experience.

**Gardening:** A basic understanding of plant care and aesthetic garden design. It can be both the ability to grow enough food to eat well, and/or the skill of creating beautiful, decorative gardens with flowers, and other plants and decorative rocks. This can be practiced by anyone.

The "art" of *Zen Gardening* creates a feeling of tranquility and harmony with nature that is greatly appreciated in the modern culture. **Base Skill:** 35% +5% per level of experience. (*Zen Gardening* is 34% +4% per level of experience.)

**Play Musical Instrument:** The individual has learned to play a particular musical instrument with a fair amount of skill. The sound is generally pleasant (except when a bad roll is made). Note that each specific instrument requires the selection of this skill. For example: A character who can play the guitar, violin, and harmonica must select the Play Musical Instrument skill three different times, once for each instrument. **Base Skill:** 35% +5% per level of experience. There is a -10% modifier (at the G.M.'s discretion) when the character tries to learn a musical instrument indigenous to a particular region and the character

himself is not from that region (e.g., somebody from North America trying to learn a uniquely Australian instrument, like the didgeridoo). Likewise, particularly difficult instruments might also get a -10% modifier to play them.

**Recycle:** Recycling covers everything, but typically includes paper, lumber, plastic, glass, scrap metal, electrical wiring and components, circuit boards, bionics and machine parts. In an Apocalyptic world, recycling and rebuilding old and used items is a necessity, especially as available resources dwindle. This is not like the Jury-Rig skill; a character with Recycle cannot make something out of odd components but, given some time and equipment, he can strip down a damaged machine to its *basic component parts* or gather useful materials to repair an existing machine or build something new. Includes a very rudimentary understanding of metallurgy. **Base Skill:** 30% +5% per level of experience.

**Sewing:** The practiced skill with the needle and thread to mend clothing, do minor alterations, and layout, cut and sew simple patterns. This is not a tailoring ability, but can become tailoring if the player selects this skill twice. **Base Skill:** 40% +5% per level of experience.

**Sing:** The simple ability to read music and carry a pleasant tune. **Base Skill:** 35% +5% per level of experience.

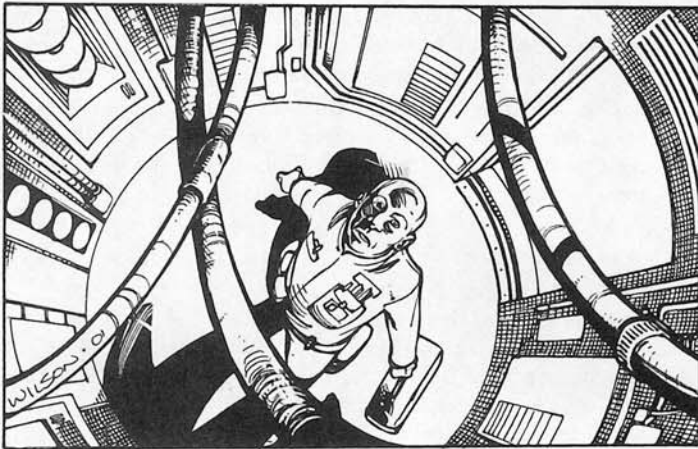

## Electrical Skills

**Basic Electronics:** This is a rudimentary understanding of the principles of electricity, simple circuits, wiring, and so on. This person can do basic wiring, repair appliances, and read schematics as well as assist electrical engineers. **Base Skill:** 30% +5% per level of experience.

**Computer Repair:** Knowledge of the internal electronics of computers and related devices (terminals, printers, modems, monitors, circuit boards, etc.). The character can attempt to repair or sabotage computers. Note that figuring out the repair or sabotage procedure counts as one roll, and the actual repair is a second roll. A failed roll means the repair is faulty and does not work (try again). No computer operation or programming skills are included nor required to fix computers. Many computer repair personnel don't even know how to turn the computer on! **Base Skill:** 30% +5% per level of experience.

**Electrical Engineer:** Knowledge of electricity. Characters can diagnose and locate electrical problems, repair complex electrical devices, wire entire buildings or vehicles, and build electrical equipment. The character can also attempt to bypass security systems, alarms, and surveillance systems, but at a penalty of -20% for simple systems and -50% for complex systems (reduce these penalties by half if the character also has the Surveillance Systems skill). **Base Skill:** 35% +5% per level of experience. **Requires:** Advanced Mathematics Skill and Literacy. (**Note:** There is a -30% penalty when working on alien or extremely unfamiliar electronics. This includes Techno-Wizard devices. The electrician may be able to puzzle out some of the basic aspects of a device created by Techno-Wizardry, and may be able to figure out how

to operate the machine, but will not be able to fully fathom how it works or how to repair it.)

**Electricity Generation:** Electricity is generated in a variety of ways: from sunlight, wind and hydro systems (using solar panels, windmills and water turbines) to batteries, combustion engines and generators. This skill gives the character the understanding of how and why these generation systems work and he is able to use, link and repair such motors, turbines and generator systems, but not to build them from scratch. He can even install small nuclear energy systems like those used in power armor and vehicles, as well as hook up a means to "recharge" E-Clips and E-Packs from generators. **Base Skill:** 50% +5% per level of experience. **Requires:** Basic Math and at least Basic Electronics and *Basic Mechanics*. -40% skill penalty when working on alien or magical systems.

**Robot Electronics:** This is the complex and specialized study of robotics, power armor, military engineering, micro-circuitry, and artificial intelligence. It includes knowledge of the NEMA power armor and robot assault units, exoskeletons, and robot systems. **Base Skill:** 35% +5% per level of experience. **Requires:** Electrical Engineering and Computer Programming. There is a -40% penalty when working on alien or extremely unfamiliar robot electronics.

## Espionage Skills

**Detect Ambush:** Training which develops an eye for spotting locations and terrains suitable for ambushes and being ambushed. It also provides a rudimentary knowledge of guerilla tactics used by the enemy. **Base Skill:** 30% +5% per level of experience.

**Detect Concealment:** A skill that trains the individual to notice evidence of concealment. The character can spot and recognize camouflage, hunting blinds, concealed structures/buildings, weapons and vehicles, secret doors and compartments, broken terrain, trip wires, unobtrusive shelters, and weapon caches that blend into the environment. **Base Skill:** 25% +5% per level of experience. **Bonuses:** +5% to the Camouflage and Detect Traps skills.

**Disguise:** The character knows how to apply make-up, wigs, skin putty, dyes, and other special effects to alter his appearance or that of somebody else. **Base Skill:** 25% +5% per level of experience. Also see Imitate Voices & Impersonation.

**Escape Artist:** The methods, principles, and tricks of escape artists. Includes muscle control (tensing and relaxing muscles), flexing and popping joints, knowledge of knots, and the ability to conceal tiny objects on the person. The character can try slipping out of handcuffs, ropes, a straightjacket, etc. **Note:** Picking locks is a separate and distinct skill. **Base Skill:** 30% +5% per level of experience.

**Forgery:** The techniques of making false copies of official documents, signatures, passports, I.D.s, and other printed material. The forger must have an original or photocopy to work from in order to make an accurate copy. Skilled forgers can recognize other counterfeits but with a skill penalty of -10%. **Base Skill:** 25% +5% per level of experience; +10% if the Art skill is also known to the forger.

**Imitate Voices & Impersonation:** The ability to imitate the voice, accent and expressions of another person or the people of a geographic region. This skill is common among spies, undercover agents and smugglers. The first number indicates the character's ability to change his voice and imitate accents, inflections and expressions from other regions. A successful roll means he has disguised his normal/true speaking voice and accent, and sounds convincingly like he is from another region or part of the world.

The second number indicates the character's ability to accurately imitate the voice, inflections and attitude of a specific person! This is much more difficult, and the character will either need to know the person being imitated very well or have spent hours studying him/her. **Base Skill:** 36%/16% +4% per level of experience.



**Impersonation Note:** When combined with the Disguise and Intelligence skills, the character is able to completely *impersonate* another person or type of occupation (soldier, ninja, priest, etc.). This is likely to include a knowledge of the enemy/subject of impersonation, military procedure, dress, command, and rank, and will usually require speaking the language fluently. This means the character can convincingly impersonate a general type of person, soldier, advisor, etc. with accurate disguise, proper action, and language. **Base Skill:** 16% +4% per level of experience; +12% to impersonate general personnel and occupations.

**Intelligence:** This is the specific training in the practices and principles of recognizing and analyzing *sources* of information as well as gathering, assessing, and processing that data. Intelligence involves observation techniques, counterintelligence measures and investigative processes and procedures. This includes the practical assessment of sights and sounds, determining the importance of specific information, what to report, the handling of prisoners of war and captured documents and/or equipment (tagging and analyzing) and reporting clearly and concisely to a group leader or the proper authority, linking information and evidence, and so on. A capable intelligence officer is active in the field quietly observing and able to accurately track enemy troop movement, estimate range/distance, their direction, speed, strength, numbers, skill level and probable objective.

A working knowledge of indigenous guerilla warfare, enemy practices and tactics, appearance, habits and current activities is all part of the intelligence methodology and knowledge. It enables the intelligence officer to recognize and categorize suspicious activity, the level of danger, and guerilla actions, and identify the likely operatives. For Example: A particular booby trap, or weapon, or mode of operation, may a) be indicative of guerilla, criminal or supernatural activity in general, and b) reveal the presence and identity of a specific (known) enemy, group or monster. It may be up to the character, however, to locate sufficient evidence or the actual enemy to confirm his existence in the area as well as to determine the enemy's strength, numbers, location, intentions and present activity.

Another aspect of intelligence training is learning the habits and trademarks of specific enemy forces and the identity of key leaders, officers, squads and foreign advisors. This includes learning ranks, insignias and marks that identify specific military units, special forces, and leaders. Such identification can confirm specific enemy operations, goals, outside intervention or enemy infiltration.

**Note:** A failed roll in any of the areas of intelligence means that evidence is inconclusive, or that the character has incorrectly assessed the information/situation and is uncertain. A failed roll involving individual clues may mean the person has dismissed it entirely as being meaningless (G.M.s, use your discretion). **Base Skill:** 32% +4% per level of experience.

**Interrogation Techniques:** A skill common among policemen, intelligence officers, Military Specialists, spies, assassins and bounty hunters, the character knows the techniques to get information from typically unwilling subjects. This includes such old methods as "good cop, bad cop" (one interrogator is threatening and intimidating, the other is sympathetic and friendly), deceiving and misleading the subject into giving away information, redundancy techniques to get the subject to contradict himself and catch him in a lie, and similar. The character can also judge if the subject is lying (the Game Master might assess bonuses and penalties depending on how good a liar the subject is, and/or on the victim's M.E., M.A. and/or P.B.; the higher any or each of these attributes, the more convincing the lies). This skill also includes some basic knowledge on methods of torture, from basic tactics like depriving the subject of sleep and food, to the use of "medieval" instruments, drugs and psionics. **Note:** Only evil characters will engage in actual torture. **Base Skill:** 30% +5% per level of experience.

**Pick Locks:** The character knows the methods and tools for picking/opening key and basic tumbler type locks. This does not include sophisticated computer or electronic locks.

It takes 1D6 melee rounds for each attempt to pick a lock. A failed roll means the lock holds; try again. **Base Skill:** 30% +5% per level of experience.

**Pick Pockets:** An ability to remove items from a person without their being aware of it. If a pick pocket attempt fails, the item has *not* been removed and there is a 67% likelihood of the intended victim recognizing the intent of the action. **Base Skill:** 25% +5% per level of experience.

**Sniper:** This skill represents special training in long-range rifle firing and marksmanship. Only rifles that can be made to fire a *single* round or energy blast can be used for sniping (no automatic weapons or burst firing attacks). **Bonuses:** +2 to strike on an aimed shot.

**Tracking (humanoids):** Visual tracking is the identification of tracks, and following the paths of humanoids, demons and monsters by the signs they leave on the ground and vegetation. Tracking is a precise art, requiring much practice. The skill includes the evaluation of tracks, indicating whether the subject being tracked is loaded down with equipment, running, moving slowly (by measuring the space between steps), and so on. By this means, the tracker can estimate the subject's rate of movement, apparent direction, the number of persons in the party, and whether the person knows he is being followed. Other methods of tracking require recognizing other telltale signs, such as blood and other stains, broken and displaced vegetation, overturned rocks, litter (such as cigarette butts, ration cans, candy wrappers, soiled bandages and campfire remains), and even odors carried by the wind.

Tracking also includes the recognizing of *dangerous animals* by their tracks, habits, and feces. Likewise, tire tracks made by vehicles can reveal much, such as size and type of the vehicle, the weight of its load, etc.

Counter-Tracking techniques are also known, such as covering one's trail, misdirection, parallel trails, avoiding obvious pitfalls like littering and others.

A failed roll means that the signs are inconclusive, vague or misleading. Additional signs must be found to verify or clarify (roll again). Three consecutive failed rolls means the tracker has completely lost the trail. Roll once every 40 yards/meters when following a trail. Persons attempting to follow a skilled tracker are -25% when following his trail if he is deliberately trying to conceal that trail (however, his rate of travel is reduced by half). **Base Skill:** 25% +5% per level of experience.

**Wilderness Survival:** Techniques for finding and getting water, food, shelter, and help when stranded in wild forests, deserts, or mountains. Characters without this skill will not be able to stay healthy for more than a few days in the wilderness once their supplies run out. **Base Skill:** 30% +5% per level of experience.

## Horsemanship Skills

In the devastated and mutated land of Rifts® Chaos Earth, the horse (and other riding animals) will become a popular means of transportation. The Horsemanship skill includes the basic principles of riding, the care and feeding of the animal, recognizing breed and quality, charging, and jumps. The percentile number is used whenever the character tries to determine the breed and quality, and when performing special jumps or maneuvers.

There are several levels and styles of Horsemanship skills. Each indicates a certain degree of training and expertise. The individual O.C.C. will indicate which of these applies to that occupation (general knowledge is most common).

There are three main types of horseback riding skills. **General/Standard** (the typical skill known by most civilized people), **Cowboy** (highly skilled equestrian ability) and **Exotic Animals** (the ability to ride unusual mounts, including alien and monstrous animals from other worlds). Unless stated otherwise, a character can only select *Horseman-*

*ship: General and/or Exotic Animals.* Cowboy is generally restricted to special O.C.C.s and R.C.C.s.

Each *Horsemanship skill* indicates a certain degree of training and expertise in riding and handling horses. Each type of horsemanship has the following skills and areas of knowledge. The higher the skill percentage the better the skill or ability. **Note:** Tricks and stunts are performed at half the rider's normal riding skill. To avoid being thrown from the horse when jumping, charging, kicking or performing some other difficult maneuver or trick, the character must roll under his second percentile to remain in the saddle and in control of his animal. Also note that the *American Cowboy* is, arguably, the most skilled and versatile horseman in the world with skills such as roping and herding as part of his repertoire of horsemanship related skills; all elements that are not usually available to other horsemen in the world.

**Riding & Care of Horses:** The first percentile number indicates the character's riding ability and a fundamental knowledge of the feeding, caring, and grooming of horses.

**Recognize quality/breed:** The first percentile number also indicates the success ratio of recognizing the breed quality, age, strength, speed, health, and general attributes/capabilities (race horse, workhorse, warhorse, etc.) of the animal.

**Breed Horses:** The second percentile number indicates the knowledge in the raising, breaking, training and breeding of horses. It includes shoeing horses, giving birth, and curing minor ailments and injuries.

**Jumping:** The second percentile number also indicates the success ratio of NOT being thrown from the horse when jumping, charging, kicking or performing some other difficult maneuver or trick. The character must roll under his percentage to remain in the saddle and in control of his animal. Damage from being thrown off a horse is typically 1D6.

**Racing:** The second percentile number also indicates the success ratio of maintaining control and getting maximum speed while racing at full gallop. A failed roll means the horse runs quickly but 10% short of its maximum speed, but the rider can coax that little extra spirit and speed out of the animal. Once every four minutes, the rider can get the horse to kick into overdrive and run at 25% faster than its normal maximum. However, this speed can only be maintained for one minute at a time and cannot be done more than three times in a 15 minute period. Maximum running speed can be maintained for a period of minutes equal to the horse's P.E. attribute. Pushing the horse beyond its endurance will cause it to slow down by 30% and after 4D4 minutes, collapse from exhaustion (requires at least a half hour rest and light activity for another hour).

**Combat:** All bonuses are in addition to other combat skills, weapon proficiencies, or attribute bonuses. Applies to the rider, not the horse. The rider gains a combat advantage from the height and speed of being mounted. This provides the following bonuses when charging on horseback, regardless of what Horsemanship skill the character has chosen: +1 to parry and dodge, +4 damage. Note that a person can not shoot a projectile weapon of any kind (bow and arrow or gun) with any degree of accuracy. An aimed shot is impossible on a moving animal! Bursts are possible if the horse is moving quickly, but not at a full gallop. At full gallop, the shooter can fire only as wild.

**A general note about horses:** The horse attack skill reference indicates that the rider is skilled enough to remain saddled while he attacks and has his horse rearing or kicking in simultaneous attack (roll under second percentile number).

**Attribute Notes:** Horses have a fairly high animal intelligence, roughly equal to that of a dog, and can generally carry or pull 500 pounds (225 kg). A war or work horse can carry about 600 pounds (270 kg) but pull up to five tons, and a pair of workhorses can pull up to 15 tons (but speed of working is a mere 15 mph/24 km).

**Speed:** Workhorses, Mules & Donkeys: Spd 22 or 15 mph (24 km). Ponies: Spd 36 +3D4 or approx. 25-30 mph (40-48 km). Riding Horse:

Spd 48+1D6 or approx. 35 mph (56 km). War horse: Spd 48+1D4 or approx. 35 mph (56 km). Race Horse: Spd 57+1D6 or approximately 40 mph (64 km) with a short burst (1D4 minutes long) of up to 50 mph (80 km), but cannot handle the hardships of the wilderness (reduce H.P. & S.D.C. by 20% for every month forced to function in the wilderness or as a workhorse).

**Average P.P.E.:** 5D6; sensitive to the supernatural, ley lines and strong magic.

**Average Life Span:** 7-9 years as a work or strong riding animal, after which the horse is worn out (reduce H.P., S.D.C. and Speed by one third), but can continue to be used for light work, light to medium riding and/or put out to stud for several years to follow; total average life span is 12-15 years.

**Hit Points & S.D.C.:** The typical riding and race horse has 4D6+6 Hit Points and 5D6+12 S.D.C. Warhorse: 5D6+10 H.P. and 6D6+16 S.D.C. Workhorses and Mules: 4D6+10 H.P. and 4D6+20 S.D.C. Pony and Donkey: 4D6 H.P. and 2D6+12 S.D.C. M.D.C. Horse Barding: Light offers 40-50 M.D.C. without penalty, heavy: 110 M.D.C. but reduce the animal's speed by 5%.

**Damage from Horse Attacks:** The exact damage from a horse's kick will vary with the size and breed of the animal; generally 2D6 S.D.C. from the front legs and 4D6 from the rear legs; +6 damage from warhorses.

**Attacks per melee round:** 2 or 3.

**Cost:** Donkey: 600-1000 credits. Mule: 800-2000 credits. Workhorse: 1000-2200 credits. Ponies: 800-2000 credits. Riding Horse: 2000-4000 credits. Warhorse: 3000-6000 credits untrained; 15,000-30,000 credits for a trained animal. Race Horse (for sport & gambling): 20,000-300,000 credits.

**Horsemanship: General:** All the basic skills as noted above. **Base Skill:** 40%/20% +4% per level of experience.

**Combat:** All bonuses are in addition to other combat skills, weapon proficiencies, or attribute bonuses. Applies to the rider, not the horse. The rider gains a combat advantage from the height and speed of being mounted.

+1 to parry or dodge while on horseback.

Inflicts +1D4 S.D.C. damage when on horseback.

Charge attack (running horse) with a pole-arm or spear: +1D6 damage. The attacker must roll under the second percentile number to avoid being dismounted. Charge attacks count as two melee actions/attacks.

Horse attack: This indicates that the rider is skilled enough to remain saddled while he attacks and has his horse rearing or kicking in simultaneous attack (roll under second percentile number). Damage from the kick of a horse will vary with the size and breed of the animal; generally 2D6 from the front legs and 4D6 from the rear legs.

**Horsemanship: Cowboy:** Unless stated otherwise, selection of this skill costs two skill selections. **Base Skill:** 66%/50% +3% per level of experience.

**Combat:** All bonuses are in addition to other combat skills, weapon proficiencies, or attribute bonuses. Applies to the rider, not the horse. The rider gains a combat advantage from the height and speed of being mounted.

+1 on initiative when on horseback at levels 2, 5, 10 & 15.

+2 to roll with fall or impact when knocked from a horse.

+2 to parry, dodge and rope/ensnare/entangle while on horseback.

Inflicts +1D4 S.D.C. or M.D. when on horseback, depending on the weapon (M.D. weapons like Vibro-Blades get the M.D. bonus; not applicable to ranged weapons like rifles and blasters).

Charge attack (running horse) with a pole-arm or spear: +2D6 S.D.C. damage. The attacker must roll under the second percentile number to avoid being dismounted. Charge attacks count as two melee actions/attacks.

Horse attack; see details under stats for horses.



**Special Related Skill: Herding:** The techniques and methods of leading, directing and controlling cattle in a contained and orderly herd. Also includes keeping animals calm, basic care and feeding, how to tend cattle, recognize disease and illness, give birth to young, how to survive and regain control of a stampede, gather strays, how best to pen and corral livestock, mend fences, etc. **Base Skill:** 30% +5% per level of experience.

**Special Related Skill: Roping:** The roping skill includes knowledge and training in how to use a lariat, lasso, tie knots, expertly handle roped animals after they are snared, bring them to a stop by taking quick turns of the lariat around the saddle horn (known as "dally" or "da la vuelta"), tethering animals, and how to "hog-tie" animals (after the animal has been lassoed, the horse backs up to make the rope taut while the cowboy "tips" over the animal and ties three legs with a half shank; used in separating stubborn animals from the herd, capturing wild animals, and branding). The rope/lariat can be used for the roping and tying of animals, including cattle, horses, similar alien animals, and even small dinosaurs and people. This skill with a lariat can be executed standing on the ground, but is designed and intended to be done from horseback (or hovercycle).

A failed roll to tie a knot means that it is loose, sloppy and easy to untie, slip out of, or likely to unravel or snap when strained. A failed roll to lasso an animal or stationary target means it misses its mark or slips off.

Against human and intelligent opponents, roll to lasso as if it were a combat attack to strike and ensnare. The intended victim can try to dodge; parry is not applicable. A successful strike means the character is caught in the lasso. *Ensnaring* a foot, leg or hand means the victim can be tripped, knocked down and pulled/dragged by hand or horse. Ensnaring the upper body means one arm is pinned (useless). Two or more lassoes around the upper body means both arms are pinned and attacks requiring the use of one's hands are impossible, and the lassoed individual can be pulled off his feet and dragged. Multiple lassoes can also be used to snare each limb and "spread-eagle" the character. It takes 1D4 melee actions to cut through a lasso, but it is impossible to draw a weapon and cut oneself loose if both arms are pinned or while being dragged. In this combat usage, the roping character is +1 to strike and entangle for every 20 points of skill, so a skill of 65% means +3 to strike/ensnare/entangle. **Base Skill:** 20% +5% per level of experience.

**Horsemanship: Exotic Animals:** Basically the same as the General Horsemanship skill, except that the character is experienced in riding "tame" animals other than the horse. This can include elephants, camels, llamas, pegasus, gryphons, dinosaurs, giant insects, and other monstrous beasts trained (or willing) to be riding animals. Wild, untamed creatures cannot be ridden, except by those others with special animal skills or powers. **Base Skill:** 30%/20% +5% per level of experience. **Note:** Characters with the traditional "Horsemanship" skill for riding horses and other very horse-like animals can quickly figure out how to ride exotic animals and alien riding beasts, but at a skill penalty of -12% to ride ground/running animals and -16% to ride flying or tree climbing and leaping animals. Similarly, beings from other dimensions not familiar with riding the fast and sleek Earth horse are -10% to ride them.

load/charge ammunition, and figure out most small arms. The armorer can repair all types of pistols and rifles, repair minor damage to body armor (20 M.D. maximum), adjust targeting sights, use and repair optical enhancements, reload missiles and ammo drums, recharge E-Clips, install/mount a rail gun or machine-gun on a vehicle, and even fix most simple robot and bionic weapons like forearm blasters and retractable blades, as well as make arrows and arrowheads, sharpen blades/weapons, make horseshoes and basic metal items (including nails, spikes, and chain links). He can also deactivate, reset and fix simple traps (roll for each attempt). **Base Skill:** 40% +5% per level of experience. **Note:** Automatically gets the Basic Mechanics skill at 30% +5% per level as part of this package.

**Automotive Mechanics:** The ability to repair, rebuild, modify, and redesign conventional vehicles with internal combustion (gas) engines. It also includes body work, turbine engines, methanol, ethanol and diesel truck engines. Working on hover jet systems for ground vehicles is possible, but with a -20% penalty. Working on reactor engines there is a -40% penalty. **Base Skill:** 60 +3% per level of experience.

**Basic Mechanics:** A general familiarity and understanding of basic mechanics. This character can fix a toaster, repair a bicycle, replace a belt on a motor, repair or replace a switch, handle or knob, replace a spark plug, change oil, assist in automobile repairs, maintain machinery, read a schematic and similar fundamental tasks. **Base Skill:** 40% +5% per level of experience.

**Bioware Mechanics:** "Bioware" is *cybernetics*. A character with this skill can identify, service and repair all cybernetic and bionic systems, from the simplest data plug to the most sophisticated of the artificial eyes. This, however, is limited to the actual *machine* and electronics of the cybernetics, not any actual designing or building of bionic components (unless part of a kit to be assembled) nor work on "bio-system" components like artificial skin, organic eyes or internal organs. However, when it comes to a cybernetic or even bionic machine part - hand, arm, leg, mechanical implant, and similar, this character can work on it. In fact, he can even assist a Medical Doctor or Cyber-Doc to install, add, remove or help transplant bioware fittings and cyber-implants. **Note:** The character can *not* perform surgery, or design or build new cybernetic items nor change the function of an existing piece. See *Rifts® Bionics Sourcebook* for a book filled with bionics and cybernetics. **Base Skill:** 30% +5% per level of experience. -20% when working with sophisticated bionic systems, including bionic weaponry or alien mechanisms. **Requires:** Mechanical Engineering and Basic Math skills.

**Locksmith:** The study of lock designs and the ability to repair, build, modify and open locks. The methods, techniques, and tools of lock picking include the old-style key and tumbler, combination, and modern electrical locking systems. **Time Requirements:** 1D4 melees to open an antiquated key type lock or simple tumbler/combination type, 1D4 minutes to open an elaborate tumbler type, 2D4 minutes to open a simple electronic lock (usually by patching in a bypass system) and 1D4 hours to break a complex, state-of-the-art electronic lock system such as those used in high security and restricted areas. Super high-tech systems, such as those used by the military and government, will require 3D4 hours and have a skill penalty of -20%.

If an unsuccessful skill roll is made, the lock is not opened and the process must be repeated. If an attempt to open an electronic lock fails, roll again. A second failed roll means that the lock is irreparably damaged and can not be opened! **Base Skill:** 35% +5% per level of experience. **Requires:** At least the Basic Electronics skill (-5% penalty when working on complex or high-tech locks) or Electrical Engineer (+5% bonus).

**Mechanical Engineer:** Training, understanding, and knowledge of how machinery is designed, operated, built, and maintained. Characters can attempt to redesign, modify, repair, construct, or sabotage mechanical devices (includes nuclear reactor driven turbines and atomic engines). The player must first roll to see if his character can figure out how to operate, analyze and design a machine. When a successful diag-

## Mechanical Skills

**Aircraft Mechanics:** The understanding of aerodynamics and the training to repair, rebuild, modify, and redesign conventional aircraft, including single engines, twin engine airplanes, jets, helicopters and hovercraft. Robot body armors and high-tech military vehicles are *not* included (see robot mechanics). **Base Skill:** 50 +4% per level of experience.

**Armorer/Field Armorer:** This is a somewhat simplistic and basic version of the weapons engineer as it applies to infantry weapons. A competent armorer character can maintain, fix, modify, mount, re-

nostic roll has been made, roll again to determine when the character can fix/change/build the mechanism. **Base Skill:** 30% +5% per level of experience. **Special Bonus:** Add a one time bonus of +5% to the Locksmith and Surveillance Systems skills if Mechanical Engineering is also known. There is a -30% penalty when working on alien or extremely unfamiliar mechanics. (Including Techno-Wizard mechanics. The mechanic may be able to puzzle out some of the basic aspects of a device created by Techno-Wizardry, and may be able to figure out how to operate the machine, but will not be able to fully fathom how it works nor how to repair it.) **Requires:** Basic or Advanced Mathematics, at least Basic Electronics, and Literacy.

**Robot Mechanics:** This is the specific study of advanced mechanics as it applies to robotics. Those skilled in this discipline can repair, modify, build, and sabotage robots, including the NEMA and military robots and power armor. There is a -30% penalty when working with alien or extremely unfamiliar mechanics. **Base Skill:** 30% +5% per level of experience. **Requires:** Mechanical Engineer skill and related requirements.

**Vehicle Armorer:** A specialized skill in which the character can do more than just tinker with the mechanics of a vehicle. He can add (and often conceal) vehicle armor, modify or completely reconfigure the body/housing of a vehicle, add weapon mounts and turrets, add ram prows and shielding, soup-up with heavy-duty shock absorbers, extend and shorten wheelbases, as well as operate, repair and modify weapons for mounting and use on vehicles; typically large caliber weapons, such as vehicle-mounted flame throwers, machine-guns and mortars, etc. Various other skills may relate to this skill. This skill appeals to scavengers and mercenaries who often have to "find" and acquire the correct parts and pieces. In fact, finding the correct parts may be half the adventure (see the Find Contraband skill). **Basic Skill:** 30% +5% per level of experience. **Note:** Automatically gets the Basic Mechanics skill at +20% as part of this package. Taking this skill in conjunction with Automotive Mechanics provides a +10% bonus to the automotive skill.

**Weapons Engineer:** This skill is usually reserved for military personnel. The character can maintain, repair, modify, mount, and figure out most weapon systems, including rail guns, energy weapons, and atomic power systems. He can repair an assault rifle and recharge E-Clips and E-Packs as well as repair and install a missile system into a vehicle. The engineer can also add and repair body armor and is an expert welder. **Base Skill:** 30% +5% per level of experience. **Requires:** Mechanical Engineering. -30% when working on TW or very alien weapon systems or vehicles.

**Weapon Systems:** This is the complete understanding of weapon units and systems incorporated into military vehicles, power armor, and robot vehicles. It includes lasers, particle beams, rail guns, missile and grenade launchers, cannons, and vehicle/robot weapon systems. Adds a special bonus of +1 to strike when using these types of weapons; this does not include hand-held weapons (see weapon Proficiencies). **Base Skill:** 40% +5% per level of experience.

## Medical Skills

**Animal Husbandry:** This area of study provides the character with a knowledge in the care, feeding, breeding, reproduction, treatment and behavior of domestic animals, as well as very basic veterinary skills for minor illnesses, setting a broken leg and giving birth. The animals included under this skill are cattle, sheep, goats, horses, mules, donkeys, ducks, chickens, and similar livestock and domesticated animals like dogs. (See Horsemanship skills for breeding horses.) The percentile number indicates the degree of knowledge and skill one has about animals and their care. Reduce the skill ability by half when caring for captive or injured wild animals. **Base Skill:** 56% +4% per level of experience.

**Brewing:** The understanding and methods of making fermented alcoholic beverages from grains and fruits. This specifically includes

wine, mead, ale, beer and moonshine, as well as teas, elixirs, tonics and other "brews" for medicinal purposes. Stronger types of alcohol, such as brandy, rum, and whiskey, are not included, nor are champagnes or fine wines. The first percentile number indicates the chance of success (a failed roll means an undrinkable concoction). The second indicates the quality of the brew; the higher the number rolled, the tastier the drink. **Base Skill:** 25%/30% +5% per level of experience. Adds a +5% bonus to the Holistic Medicine skill if both skills are known.

**Criminal Sciences & Forensics:** Basic knowledge of police skills including basic criminal law, fingerprinting, ballistics (matching bullets to weapons and angles of impact), and general investigative techniques. Forensic medicine is the methods and techniques which enable the character to find evidence regarding the cause of death, time of death, and other details when examining a corpse. **Base Skill:** 35% +5% per level of experience. **Requires:** Biology, Chemistry, Chemistry: Analytical, Advanced Mathematics, and Literacy.

**Field Surgery:** This skill reflects training in emergency, life-saving surgical procedures that can be performed "in the field" to keep critically wounded individuals alive. Given the proper tools, the field surgeon can perform amputations, suture torn arteries, check internal bleeding, cauterize wounds, give blood transfusions and even install cybernetic implants (the latter is done with a penalty of -15%). Field expedient surgery is a dangerous proposition that all too often results in the death of the patient. Because of the risk involved, field surgery is attempted only when it is the only chance the wounded character has for survival! If the operation is successful the patient lives and can be evacuated to a hospital, but a failed roll results in either the immediate death of the patient. **Base Skill:** 26% +4% per level of experience; +24% if an M.D. **Requires:** Biology and Paramedic skills.

**Optional Guidelines for Fatal Injury Treatment:** In the violent world of Chaos Earth, regular humans and similar non-Mega-Damage beings are at an extreme disadvantage. Once a human's body armor is destroyed, a single M.D. blast will usually obliterate him/her. These guidelines are provided to give player characters a chance, however slight, to survive a blast that would normally evaporate the character. If the G.M. agrees, the character can survive a Mega-Damage intensity wound if a trained medic makes a successful Field Surgery skill roll.

Unless the attacker made a called shot or rolled an unmodified 19 or higher, the character has the chance to live. The basic idea is that the M.D. blast was partially absorbed by nearby cover or body armor, or merely sheared off a limb (G.M.s, give some reasonable explanation). Within 1D4 melee rounds after the character's being hit, a medic character must attend to his/her injuries. If the field surgeon makes a successful skill roll the character is incapacitated but survives the attack, though just barely (reduce S.D.C. to zero and Hit Points are at 1D6 above zero). A failed roll means the injured character was beyond saving and dies an instant later. Even if the field operation succeeds, the wounded character is in shock, crippled, may require additional extensive surgery, as well as require cybernetic or bionic reconstruction and a long recovery period before he is able to adventure again (2D4+2 weeks). It may be appropriate to also determine an insanity and permanent physical side effects from the injury. **Note:** This optional survival rule is also applicable to Medical Doctors and Cyber-Docs.

**First Aid:** Rudimentary medical treatment which includes how to bandage wounds, stop bleeding, administer CPR/artificial respiration, and use antiseptics and common anti-inflammatory drugs and painkillers. **Base Skill:** 45% +5% per level of experience.

**Holistic Medicine:** Training in the recognition, preparation, and application of natural medicines usually made from whole plants and/or their parts (roots, leaves, fruit). The Holistic Doctor is basically a pharmacist and naturalist who creates drugs from herbs and vegetation, as well as studies and treats common ailments. He can find and use plants to create salves, balms, ointments, and lotions to soothe burns, boils, rashes, and insect bites, reduce swelling, as well as create local anesthetics, and salves to heal wounds faster (twice as quick as normal). Potions and tonics are created to settle upset stomachs, induce drowsiness,



or hallucinations. The individual can also make alcohol and poison (hemlock and mandrake for example).

The student of herbology also has a good knowledge of plant lore and when and where to find healing plants, edible fruit, roots, and bark, as well as how to use and/or avoid dangerous flora. The character can also preserve foods and knows how to set and mend bones, bandage cuts, and suture cuts. **Note:** Plants are seasonal and the right root or leaf may not be readily available in certain times of the year/season, or may be found exclusively in remote regions. Game Masters should use a certain amount of common sense and drama with this skill. **Base Skill:** 20% +5% per level of experience. A failed roll means the treatment or concoction did not work.

**Paramedic:** An advanced form of emergency medical treatment which includes all first-aid techniques, the setting of broken bones, suturing of wounds, use of oxygen and emergency medical equipment, administering of drugs, knowledge of how to move a critically injured person, the removal of cybernetic prosthetics, and other life-saving techniques.

A failed roll means the patient has not responded to treatment or that the treatment has been improperly administered. **Note:** For serious injury or coma, roll three times, consecutively, on percentile dice. A roll of two successful out of three means the wound has been properly treated or that the patient's condition has been *stabilized*. Failure means the patient's condition is unchanged and getting worse. Another character can immediately attempt to apply medical aid or the same player can try again, but the first character must spend 1D6 minutes of reexamination and/or concentration on the problem before he can try again. **Base Skill:** 40% +5% per level of experience.

**Medical Doctor:** The medical doctor is a trained surgeon and has a doctorate in the medical sciences. Areas of training include: clinical skills, medical discipline, code of ethics, physiology (muscle, respiratory, blood, body fluids), pathology (diseases, their structure and function), rudimentary pharmacology (use, reaction, and interaction of drugs), laboratory skills, and techniques and methods of data collection. The medical doctor (M.D.) is also a trained surgeon and has a basic knowledge regarding cybernetics. This means the M.D. can remove and attach most cybernetic mechanisms (although at a penalty of -10%, and -40% on bionics). **Base Skill:** 60%/50% +5% per level of experience. The first percentage number is the doctor's ability to accurately diagnose the problem. The second percentage number is the doctor's skill at successfully treating the problem. **Requires:** Biology, Pathology, Chemistry, Basic or Advanced Mathematics and Literacy.

**M.D. in Cybernetics:** This doctor is a specialist in the science of cybernetics and a master surgeon. The character has all the basic knowledge and requirements of the regular M.D., although his diagnostic skills are nowhere near as honed, but is a specialist in surgery and the removal of limbs and internal organs and the surgical attachment of cybernetic replacements (artificial organs and prosthetics). He can also repair cybernetic prosthetics (if not too badly damaged). **Base Skill:** 40%/60% +5% per level of experience. The first percentage number is the "Cyber-Doc's" ability to accurately diagnose and treat a non-surgical problem/illness. The second percentage number is the doctor's ability to perform complex surgery, remove and install all types of cybernetic organs and devices. The Cyber-Doc can also work on bionic implants and systems but suffers a -15% skill penalty. Bionic science is much more complex and machine oriented than cybernetics. **M.D. Note:** An M.D. in Cybernetics can become a bionics surgeon (M.D.B. in cybernetics) by selecting this cybernetics skill twice and Electrical Engineering (and must have all the M.D. requirements). This will make him a master in all of the cybernetic and bionic sciences. There is now no penalty for installing bionics and there is a special bonus of +10% added to the character's surgery skill. The M.D.B. can also repair, modify, design, and build bionic and cybernetic devices. **Bionic Note:** One can not create a bionic implant in a garage. The character will need access to a cybernetics or bionics laboratory and parts to build or modify an artificial implant. Even a high-tech medical facility will not have the

necessary components to create a cybernetic or bionic mechanism, although it may have access to them. See the **Rifts® Bionics Sourcebook** for a comprehensive collection of cybernetics, implants and bionics available to the people of Chaos Earth as well as Rifts Earth.

**Pathology:** This branch of medicine deals with the nature of diseases, their causes, and symptoms, and the functional and structural changes caused by disease. Training includes anatomy, physiology, cell biology, manifestation of disease, tissue injury and repair, abnormal cell structure, metabolism, diagnosis of human diseases, tissue culture methods and applications, analysis of drugs in biological samples and laboratory research, investigative methods, and use of instruments and equipment. **Base Skill:** 40% +5% per level of experience. **Requires:** Biology, Chemistry, and Literacy skills.

**Xenology:** The biological and physiological study of alien species (rather than their culture or society). This skill provides general medical and physiological information about the most commonly encountered species on Chaos Earth, how their body works, any natural weapons, poisons or toxins, strengths and weaknesses, presence of psionic or other natural abilities, etc. Without Xenology, any attempts to use a medical skill on another species are at -20% to skill rolls. **Base Skill:** 15% +5% per level of experience.



## Military Skills

**Armorer/Field Armorer:** This is a somewhat simplistic and basic version of the Weapons Engineer as it applies to infantry weapons. A competent armorer character can maintain, fix, modify, mount, reload/charge ammunition, and figure out most small arms. The Armorer can repair all types of pistols and rifles, repair minor damage to body armor (20 M.D. maximum), adjust targeting sights, use and repair optical enhancements, reload missiles and ammo drums, recharge E-clips, install/mount a rail gun or machine-gun on a vehicle, and even fix most simple robot and bionic weapons like forearm blasters and retractable blades, as well as make arrows and arrowheads, sharpen blades/weapons, make horseshoes and basic metal items (including nails, spikes, and chain links). He can also deactivate, reset and fix simple traps (roll for each attempt). **Base Skill:** 40% +5% per level of experience. **Note:** Automatically gets the Basic Mechanics skill at 30% +5% per level as part of this package.

**Camouflage:** The skill of concealing a fixed base position, vehicle, robot, equipment or individual, using natural and/or artificial materials. A fair amount of time is involved in the preparation of a larger position. Large cargo nets, cut branches or underbrush are used most often in camouflage. This skill is also used to conceal traps. **Base Skill:** 20% +5% per level of experience.

**Command Robots:** Knowledge in the operation, deployment and strategic use of NEMA reconnaissance and combat robots like the

Combat Drone (Skelebot), Combat Hound, Pup Scout, Spider Probe, and Flying Probe. 1-4 robots (typically one or two) are assigned to assist or protect the individual who commands it/them. This skill is available to only a few NEMA O.C.C.s, including the Military Specialist, Intel Officer and Field Engineer. **Base Skill:** Not applicable.

**Demolitions:** Demolitions provides the person with an advanced knowledge in the use and workings of explosives and detonation devices for the purpose of blowing up bridges and buildings, and sabotage. This includes all types of explosives, such as mines, dynamite, plastics, nitro, blasting caps, etc. It also includes a basic understanding of the strategic placement of mines and booby traps. This will increase the character's awareness of suspicious rope, string, and wire. **Base Skill:** 60% +3% per level of experience. A failed roll means a dud; no explosion.

**Demolitions Disposal:** This skill enables the character to safely defuse unexploded mines, bombs, explosive booby traps, dud artillery rounds, dud explosive charges, or any other explosive device. **Base Skill:** 60% +3% per level of experience.

**Demolitions: Underwater:** Fundamentally the same basic skills and training as Demolitions, but with an emphasis on using explosives in an underwater environment, including underwater techniques, area effect, sound wave damage, different types of explosives, as well as arming, disarming and repairing torpedoes and depth charges. **Base Skill:** 56% +4% per level of experience. **Note:** Any character with the Demolitions skill can use explosives underwater, but is -10%.

**Find Contraband, Weapons & Cybernetics:** The character with this skill knows where to find arms dealers, drug dealers, Black Marketeers, street gangs, smugglers, thieves, criminal Cyber-Docs and illegal medical treatment, and other purveyors of illegal or forbidden articles (may include magic and alien technology), as well as how to spot them. He is also familiar with their practices, hangouts, gang or criminal ties, code of conduct, pricing structures and modes of operation. Likewise, the character has a good idea of what Black Market weapons and cybernetics should cost and what dealers pay for contraband items (typically only 20% of the retail market price). The character also knows the penalty for being caught with an illegal item. This skill is especially appropriate in civilized communities, wild ones don't care about contraband and sell right out in the open. **Base Skill:** 26% +4% per level of experience. This skill should be considered separate and apart from Streetwise.

**Military Etiquette:** A clear understanding of the way the military works, including rules of behavior (when to salute, how to address superiors/subalterns, etc.), military procedures and routines, standard issue of equipment, special ordering procedures, proper display of rank and medals, advancement in rank (and the duties that come with it), proper troop formations, how to deal with military bureaucracy, the chain of command, proper channels, who to contact to get things done, and other useful information in matters of military protocol and bureaucracy. **Base Skill:** 35% +5% per level of experience. **Note:** All soldiers have a fundamental knowledge of military etiquette (base skill 30% with no improvement), but this skill is much more complete with a strong knowledge of what is expected, correct and the formal approach (e.g. by the book knowledge).

**Military Fortification:** This is the skill of designing and building defensive fortifications suitable for modern Mega-Damage combat. If provided with the time and materials the character can greatly increase the defensive value of natural terrain with murderous defenses that include obstacles to impede movement and protective structures to shield friendly forces from enemy fire. The character is trained to prepare minefields, barbed wire, tank obstacles, tangle foot wire, booby traps, trenches, tank ditches, foxholes/shell scrapes, reinforced concrete or earthen walls, bunker complexes, rail gun/mortar emplacements, tunnel systems and similar defensive constructions.

Even with the advent of Mega-Damage warfare the old standby fortifications listed above have useful applications. Obstacles like ditches

and minefields slow the advance of robots, infantry and tanks, exposing them for longer periods to defender firepower. Earthen walls and foxholes, made from S.D.C. materials, still afford soldiers some protection and can disperse energy blasts or deflect shrapnel from explosives. If these protective structures are built with Mega-Damage concrete and alloys they provide defenders with as much protection as any robot vehicle or tank! **Base Skill:** 30% +5% per level of experience.

**Nuclear, Biological, & Chemical (NBC) Warfare:** This is the knowledge of safety precautions to protect oneself and others from the effects of nuclear, biological or chemical warfare, waste and contamination. The character is also knowledgeable in the safe handling and "clean-up" and containment of such hazardous materials. **Base Skill:** 35% +5% per level of experience.

**Parachuting (uncommon):** The skill of parachuting includes the methods, procedures, and techniques of parachuting, packing the chute, skydiving techniques, precision landing, landing without injury, and practice of jumping from a high altitude aircraft. The advantage of parachuting is secrecy, since the troopers' insertion into enemy territory is silent and often goes unnoticed. The following three methods are the ones most commonly used by modern paratroopers:

**High-Altitude-High-Opening (HAHO)** jumps take place from a height of 25,000 to 30,000 feet (7620 to 9144 m). As the paratroopers drop they travel laterally to the desired drop zone (DZ) where they wish to land. This technique is used to "throw off" enemy units since they will probably search for paratroopers directly beneath the path of the aircraft.

**High-Altitude-Low-Opening (HALO)** operations also begin at 25,000 to 30,000 feet (7620 to 9144 m) but the paratrooper does not pop the chute until an altitude of 4,000 ft (1220 m), or even less. The jump takes place so rapidly that there is little chance for the paratroopers to be viewed after the chutes open.

The most dangerous method is **Low-Altitude-Low-Opening (LALO)** drops. The jump is made at the mere height of 300 to 500 ft (91.4 to 152 m). If there are any complications (a failed roll) the paratrooper is likely to be injured (broken bones) or killed (30% chance)! Even if the jump goes without a hitch, there is a 20% chance of taking 6D6 S.D.C. from an awkward landing, even if wearing M.D. armor.

Failure on a parachuting roll indicates that there are complications somewhere along the jump. This might mean an improperly packed chute, tangling of lines, etc. On a high altitude jump, the character gets a second roll for their reserve chute. If the second roll also fails then the character falls to his death! There is not enough time on a low altitude drop to use a reserve chute, so a failed roll means the character hits the ground (humans die!) without a second chance. Parachuting can be selected as a Military or Pilot Related skill. **Base Skill:** 40% +5% per level of experience.

**Recognize Weapon Quality:** The ability to accurately determine a weapon's durability, reliability, and quality by physically examining it. This includes knowing which manufacturers are reputed to make the best weapons, the ability to recognize damage or signs of misuse, modifications/customization or wear and tear, whether the weapon can be made as good as new with a little repair work and/or cleaning, whether it is a cheap (or quality) "knock-off" (copy/imitation), and so on. The character can also recognize if the weapon is stolen (serial numbers filed away, etc.), new, old, and if it has any other special features or properties as well as what the fair price should be. **Base Skill:** 25% +5% per level of experience. **Note:** Reduce the skill ability by half if the item is not actually handled (seen but not touched/examined).

**Trap Construction:** Training in the design and application of traps and mines used in anti-personnel and defense tactics. With readily available materials and simple tools, including shovels, knives, sticks, wire and rope, the character can build fiendish traps. Any who would scoff at the effectiveness of traps in modern Mega-Damage combat should reconsider. It is true that traps cannot be made to destroy or even damage M.D. equipment, unless explosives and the demolitions



skill are used, but these traps can hamper or disable enemy robots and vehicles, and injure or kill unarmored or lightly armored soldiers! Traps can also be used as an alarm to alert the trap maker to the presence of intruders or the enemy (fires a flare, activates a video camera and transmission, makes noise, etc.).

The greatest drawback of traps lies in the amount of time required to prepare them — it can take hours to prepare rock slides, large pits and similar traps — but, even this time can be shortened with help from others since only one character needs the skill to successfully direct workers. Ingeniously prepared traps can, and often do, shift the advantage of a battle to the side that prepared the field for combat. **Base Skill:** 20% +4% per level of experience.

The following are some examples of traps, complete with their effects; a character can create using the Trap Construction skill. All damage, penalties and considerations are based on a human-sized victim unless stated otherwise.

**Pit, Man-Sized:** Typically a simple pit/hole 7-14 feet (2.1 to 4.2 m) deep and concealed with twigs and leaves. Pits can slow an enemy advance by delaying troop movement (must pause to climb out of pit or to help comrade out of the pit), injuring the victim (typically twist, pull or bruise and sometimes break a leg or arm), damaging light (S.D.C.) equipment, trapping unfortunate soldiers and disabling robots (at least temporarily).

A person blundering into a pit trap falls, taking 1D6 S.D.C./Hit Point damage per every seven feet (2.1 m) of depth, even if wearing M.D. body armor (the impact has an effect on the person inside; no damage to power armor or robot pilots)! The same damage is applied to fragile S.D.C. items that tumble into the pit. The character also loses one melee attack/action in that act of falling and 1D4 melee actions gathering his wits and getting back on his feet; stun effect.

To climb out of the hole unassisted requires 1D6 melee actions. An especially deep pit will require a Climbing skill roll or somebody to give the character a hand. Robot vehicles that step into the hole have a 01-70% likelihood of tripping and falling. Crew members suffer 1D4 S.D.C. damage and must spend 1D4 melee rounds to right the vehicle. While trapped and/or while the victim(s) are attempting to recover, the trap maker and his allies usually launch a vicious attack or surround the victim. The pit trap is very common in the wilds of North America.

**Monster Pit:** In some instances, the trap designer will place a small (or large), vicious creature inside the pit. The creature will be terrified and/or angry and attack anything that falls into the pit. These creatures typically fight until slain. Lasae, Worms of Taut and M.D. monsters of similar size are often used in this capacity, as well as wild canines, felines, bears and snakes.

**Snake Pit:** A shallow pit, 4 or 5 feet deep (1.2 to 1.5 m), filled with poisonous snakes or small Worms of Taut. Characters who fall or stumble into the pit receive 1D4 bites. Regular snake bites inflict 1D4 S.D.C. damage plus 3D6 S.D.C. from poison if the creatures bite unprotected flesh. Creatures like Worms of Taut and other alien "crawly things" may inflict Mega-Damage. The trap is rarely used in North America and Europe, but is frequently used in the jungles of South America and Asia.

**Tank Trap/Giant Pit:** Basically the same as a man-sized pit but dug to a depth of 18 to 30 feet (5.4 to 9 m). Infantry ground troops who blunder into the hole suffer 1D6 S.D.C. for every seven feet (2.1 m) of depth from falling and need 2D4+2 melee attacks/actions to climb out, unless helped out by people outside the pit with rope and such.

Robot vehicles and tanks can also fall victim to these deep and often wide pits. The crew suffers 2D4 S.D.C. damage from getting jostled around. Humanoid robots and power armor suits can climb or pull themselves out of the pit with relative ease; must spend one or two full melee rounds (15-30 seconds) unless the vehicle or power armor can fly or leap out (counts as one melee action).

Tanks, trucks and other ground vehicles may have part or all of the vehicle stuck or wedged in the pit and require a crane or giant robot(s)

or several power armor troops to pull it out. Just how stuck and immobilized the vehicle is will depend on the size and depth of the pit.

**Mined Pit:** A pit with land mines or other explosive device(s) dug into or placed on the floor of the pit. It detonates when one or more victims hit the bottom.

**Punji Stake Pit:** Typically a pit 8-10 feet (2.4 to 3 m) deep, concealed with twigs and leaves. The bottom of the pit is lined with a bed of sharp wooden stakes. Roll 1D6 to see how many stakes the falling character lands on; each inflicts 1D6 S.D.C. damage plus damage and penalties from the fall (see the man-sized pit description). Vibro-Blades and special M.D.C. materials can be used to inflict Mega-Damage; roll 1D6 to see how many stakes the falling character lands on; each inflicts 1D6 M.D. plus possible damage and penalties from the fall.

Punji pits are extraordinarily effective against vampires and are found throughout Mexico! They are often used (camouflaged and open) as countermeasures along defensive perimeters and dug-in fortifications.

**Punji Sticks:** Sharp wooden stakes stuck into the base of trees, in tree branches, or on the ground at strategic locations, near settlements, defensive perimeters, off to the sides of paths and so on. People who stray off the path or go where they don't belong, may step on, stumble, trip, fall or lean into 1D4 stakes/spikes.

Each stake inflicts 1D6 points of S.D.C. damage. Wood and S.D.C. material punji stakes do no damage to characters in M.D. body armor and are rarely used for that reason.

As noted previously, Vibro-Blades and other Mega-Damage materials may be used, but are not as effective; Vibro-blades tend to hum, tipping off their location, and M.D.C. materials scrape but seldom puncture M.D.C. armor unless the victim falls onto or drives across them with some force. Punji sticks are a form of guerilla warfare designed for use against humanoid enemies. Traveling slowly and carefully, they are easy to detect and avoid, but if reckless or running, the character is likely to run into them headlong.

**Punji-Stick Drop-Fall Trap:** A large weight bristling with sharp, wood stakes is suspended in a tree. It is released by a trip wire and either drops down or swings across the target area. Characters can try to dodge but are -3 to do so. This trap inflicts 6D6 S.D.C. damage to unarmored victims. Those wearing M.D. body armor suffer 2D4 S.D.C. damage from the impact and are knocked off their feet; lose initiative and one melee action!

**Swinging Log:** A huge log or piece of debris (cannon barrels and the legs from a giant robot are also used) is suspended in a tree. When released by a trip wire or pressure plate, it swings across the target area. All characters in the path of its swing are struck and suffer damage unless they successfully dodge at a -3 penalty. Characters wearing M.D. body armor suffer 6D6 S.D.C. damage from impact, unarmored victims suffer 2D6x10 S.D.C. (or one M.D. point)! Individuals struck by the log are knocked out cold by the tremendous impact for 3D4 melee rounds. The trap is a favorite for attacking groups of soldiers walking in single file, as well as against power armor.

Robot vehicles struck by the huge weight have a 01-50% likelihood of being knocked off their feet; vehicles knocked off their path. The vehicle crew suffers 1D4 S.D.C. damage from being thrown around the cockpit.

**Barbed Wire Barrier:** Cords or rolls of barbed wire are laid across a pathway, entrance or particular area (concealed or not) to bar its path. While the wire will not hurt Mega-Damage body armor, it still hooks and entangles the feet and snags any fabric, thus impairing movement (the wire must be cut or pulled away) and makes noise. Power armor units and bots can often tear right through it or stomp it down with no penalties, but their passage will still make some noise.

**Rock Slide/Log Fall:** Rocks or massive logs or debris piled at the top of an incline are released to tumble into the target area. Every foot soldier, bot or vehicle in the area suffers 1D4 M.D. from the impact of rocks or M.D. debris or 1D6x10 S.D.C. from logs. Unless the victims

make a successful dodge at -8 and are able to dive for cover, they are struck and carried away by the tumbling rocks, logs or debris. Most will become pinned in or trapped beneath the fallen materials until rescued by companions.

Even those individuals who dodged successfully are trapped at the edge of the pile and need 3D4 melee rounds to work themselves free. Robots and vehicles, who are often targeted by this trap, have no chance to dodge and a 01-90% likelihood of getting knocked down or pushed 1D6x10 feet off the path. Furthermore, they are struck by more of the falling debris, suffer triple damage and are likely (01-75%) to need a crane, giant robot or several power armor troops to pull them free. The crew of the vehicle suffer 2D6 S.D.C. damage. During this time, the designers of the trap typically swarm the helpless vehicles, bots or soldiers, attacking or taking prisoners. In addition, the debris covered road/area is more difficult to travel over. This trap is very popular in hilly and mountainous regions.

**Crossbow Trap:** A crossbow attached to a tree or in a pit that shoots when a trip wire is pressed or broken. The bolt strikes the target on a 1D20 roll of 14 or higher. Damage from an ordinary bow and arrow is 2D6 S.D.C., but any of the high-tech types can be used. Often the crossbow will be loaded with an explosive high-tech bolt that inflicts 3D6 M.D. rather than a conventional projectile. Fairly common.

A variation can use an S.D.C. or energy pistol (typically fires only a single shot) by having the wire depress the trigger on the gun. However, this is a rarity because of the waste and cost of using a more sophisticated and high-tech weapon.

**Trip Snare:** Causes the character to trip. No damage, but the fall is embarrassing, the character loses initiative, two melee actions, and makes a loud noise that will alert nearby enemies and predators to the character's location. Usually the snare is set as part of an ambush, leaving the fallen character vulnerable to the opening volley of an attack. This type of trap is extremely common.

Variations include trip flares, with which in addition to the above, a rocket flare is shot into the sky and explodes. The flare indicates the exact location of the intrusion and, at night, illuminates the immediate area of the snare.

**Animal Snare:** A simple snare designed to catch or lasso the animal's foot or head. This is typically used to capture small animals.

**Rope Snare:** This is a concealed, lasso-style snare tied to a tree. When the snare is triggered, the lasso snares the foot or feet and whips the character or animal up and suspends it, dangling from a tree, usually 5-10 feet (1.5 to 3 m) above the ground. No damage, but the character loses two melee actions and needs another melee action or two to cut himself down. It is most effective in forested areas.

**Net Trap:** Rather than using a lasso-style snare, a net can be used in the above rope snare trap. The net is spread on the ground and camouflaged, but wraps around the target when triggered. The character or animal is whipped up and suspended from the tree 10 feet (3 m) above the ground. There is no damage caused by the trap but the character loses two melee actions and needs a further three melee actions to cut himself loose.

**Bear Trap:** A pair of large, clamping metal jaws that snap shut when the prey steps on the pressure plate. The metal jaws are typically chained to a tree or stake and require a combined P.S. of 24 to pry them open; a hand activated release switch will also open and reset the trap. Damage is 4D6 S.D.C., but holds its prey in place until the jaws are opened or the prey literally tears itself free; animals often bleed to death. This trap is effective against animals and unarmored humanoid prey. It is sometimes combined with a snare to trigger flares or drop a grenade.

**Grenade Trap:** A regular grenade, with its pin removed, is attached to a trip wire and placed in a can hanging from a tree. When the trip wire is pulled, the grenade falls from the can and explodes on or near the unfortunate victim. The explosion causes regular damage by grenade type, fragmentation (2D6 M.D.) and plasma grenades (5D6 M.D.)

are typically used. This is a fairly common trap. Variations include the use of riot control flash/stun grenades, tear gas and smoke grenades. Fusion blocks, plastique charges and land mines are all frequently used in booby traps throughout the world. However, the character must have the Demolitions skill to use them.

**Mini-Missile Trap:** Typically a snare that triggers the launch mechanism of a mini-missile! Fairly uncommon; another guerilla tactic.

**Trap & Mine Detection:** Knowledge of the strategic placement of booby traps and mines, the telltale trademarks and indications of traps and mines, how to avoid them, and the use of mine and explosive detection equipment. The character has been trained to watch for suspicious objects, dirt mounds, trip wires and camouflaging materials that may denote the presence of a trap. Simple snare traps and trip wires can be easily disarmed by the character, but the Demolitions Disposal skill is required to *disarm* mines, explosives or complex traps. **Base Skill:** 20% +5% per level of experience on visuals alone. Add +50% when using special detection equipment to locate *mines/explosives* or +10% to locate other types of traps with detection equipment.

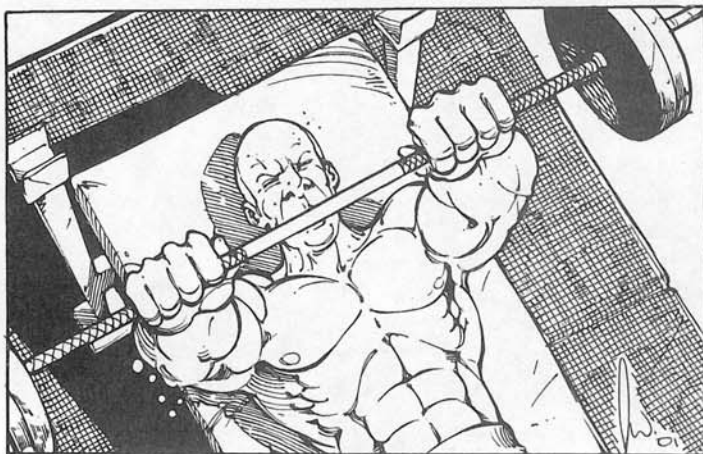

## Physical Skills

**Special Note:** One of the unique aspects of Palladium RPGs is that the player can increase his or her character's physical attributes (P.S., P.P., P.E., Spd., and S.D.C.) by selecting physical skills that build and develop the body. ALL attribute and skill bonuses are accumulative. However, a specific physical skill may only be chosen *once*, including Hand to Hand skills.

There are four major kinds of fighting techniques available to most characters in the Americas and Europe. They are: *Basic*, *Expert*, *Martial Arts*, and *Assassin*. Boxing and Wrestling *add* to the techniques and power of a specific hand to hand training.

*Commando* is a specialized style of hand to hand combat known to Military Specialists and Special Forces. Only a handful of O.C.C.s can select Hand to Hand: Commando.

**No Hand to Hand:** Characters *without* combat training of any kind have one hand to hand *attack* at level one or two non-combat melee "actions." Gets an additional *attack* at levels three and nine. Gets an additional non-combat melee "action" at levels three and nine, and two at level six. +1 to dodge at level three.

**Hand to Hand: Basic:** Provides elementary fighting techniques and methods of attack and self-defense as taught in military basic training or in self-defense classes. See the Hand to Hand Combat section for a listing of bonuses and special abilities.

**Hand to Hand: Expert:** An advanced form of self-defense and unarmed combat taught to professionals and the military elite. See the Hand to Hand Combat section for a listing of bonuses and special abilities.



**Hand to Hand: Martial Arts:** This is some form of general oriental fighting skill (karate, kung-fu, etc.) that teaches advanced hand to hand combat. See the Hand to Hand Combat section for a listing of bonuses and special abilities.

**Hand to Hand: Assassin:** This is an advanced form of combat with an emphasis on immobilizing or killing one's opponent quickly. See the Hand to Hand Combat section for a listing of bonuses and special abilities.

**Hand to Hand: CS Commando:** A quick-and-dirty form of martial arts that stresses maximum damage and minimum finesse. See the Hand to Hand Combat section for a listing of bonuses and special abilities.

## The rest of the Physical Skills:

**Acrobatics:** Aerial feats of agility and strength, such as walking a tightrope, high wire, trapeze, and stunts performed above ground. Other physical abilities include rolls, somersaults, leaps, and falls. Provides all of the following:

Automatic kick attack at first level; 1D8 (or 2D4) damage.

Sense of Balance (60% +5% per level of experience).

Walk Tightrope/High Wire (60% +3% per level of experience).

Climb Rope (80% +2% per level of experience).

Back Flip (60% +5% per level of experience).

Climbing (40% or +15%).

Prowl (30% or +5%).

**Bonuses:** +2 to roll with punch or fall, +1 to P.S., +1 to P.P., +1 to P.E. and +1D6 to S.D.C.

**Aerobic Athletics:** A type of aerobic exercise to build the body, develop reflexes and grace, and learn a few very basic self-defense moves.

Sense of Balance (30% +5% per level of experience).

**Bonuses:** +2D4 S.D.C., +1 to disarm, +1 to pull punch, and +2 to kick damage.

**Athletics (General):** Training in, and enjoyment of, vigorous exertion for competitive sports, exercises, and contests of strength, endurance, and agility. **Bonuses:** +1 to parry and dodge, +1 to roll with punch or fall, +1 to P.S., +1D6 to Spd. and +1D8 to S.D.C.

**Body Building & Weight Lifting:** The building of muscle tone and body strength through weight lifting and exercise. **Bonuses:** +2 to P.S. and +10 to S.D.C.

**Boxing:** Classic art of fighting with fists. Training helps build the body and reflexes. Skilled boxers will automatically knockout an opponent on a roll of a natural twenty. The victim of a knockout will remain unconscious for 1D6 melees. Unlike normal knockout/stun, the player does not have to announce that he is trying to knockout his opponent before making a roll to strike.

**Bonuses:** +1 additional attack per melee, +2 to parry and dodge, +2 to pull punch, +1 to roll with punch or fall, +2 P.S., and +3D6 to S.D.C.

**Climbing:** Knowledge of the tools and techniques for climbing up sheer surfaces. Players should roll once for every 20 feet (6 m) of a vertical climb. If the roll fails, it means he is losing his grip; however, every "skilled" climber gets a chance to regain his grip, roll again. Two consecutive failed rolls means the character falls. **Base Skill:** 40% +5% per level of experience.

Rappelling is a specialized rope climbing skill used in descending from helicopters, scaling walls and cliff facings. For game purposes, rappelling will include ascending and descending climbs. **Base Skill in Rappelling:** 30% +5% per level of experience. **Note:** Also see *Spelunking* under Wilderness Skills.

**Gymnastics:** Learning to do falls, rolls, tumbles, cartwheels, somersaults and to work the parallel bars and rings. This sport builds great upper body strength, grace, and balance. Provides all of the following:

Automatic kick attack at first level: 2D4 damage.

Sense of Balance (50% +5% per level of experience).

Work Parallel Bars & Rings (60% +3% per level of experience).

Climb Rope (70% +2% per level of experience).

Back Flip (70% +5% per level of experience).

25% base Climb ability or adds a +7% to Climb skill.

30% base Prowl ability or adds a +5% to Prowl skill.

**Bonuses:** +2 to roll with punch or fall, +2 to P.S., +2 to P.E., +1 to P.P. and +2D6 to S.D.C.

**Prowl:** This skill helps the character to move with stealth; quietly, slowly, and carefully. Techniques include balance (50%+5% per level of experience) and footing, short steps and pacing, rifle positioning, prone positions for low visibility, and crawling. A failed Prowl roll means that the character has been seen or heard. If the Prowl roll is successful, then the character is not seen or heard and may make a sneak attack. **Base Skill:** 25% +5% per level of experience.

**Running:** A routine of running and exercise to build speed and endurance. **Bonuses:** +1 to P.E., +4D4 to Spd, and +1D6 to S.D.C.

**Swimming:** The rudimentary skill of keeping afloat, diving, swimming and lifesaving techniques. The percentile number indicates the overall quality of form as well as skill of execution. A character can swim a distance equal to 3x his P.S. in yards/meters per melee round. This pace can be maintained for a total of minutes equal to his P.E./endurance. **Base Skill:** 50% +5% per level of experience.

**Swimming & Fatigue Note:** For humans and similar surface dwelling D-Bees, the act of swimming on the surface of the water has the same fatigue rate as running and medium to heavy exertion, especially at great speed or very long periods of time. Swimming underwater with S.C.U.B.A. equipment or other underwater equipment is considered to be light activity, unless extremely active, involved in combat or fast swimming (in which case it is considered strenuous or heavy activity).

For most aquatic life forms, including D-Bees and mutants, underwater activities such as fast swimming, diving, playing and underwater acrobatics are considered light activities and can be conducted for hours without fatigue. Pulling a heavy load and engaging in combat is considered medium to heavy activity.

The buoyancy of water reduces the weight of most items by 30% when carried underwater. This means the fatigue rate for carrying a heavy load is reduced by 30%, meaning 30% more can be carried at the normal fatigue rate. Characters can also lift 30% heavier weights.

**S.C.U.B.A.:** The letters S.C.U.B.A. stand for Self-Contained Underwater Breathing Apparatus. Individuals learn the methods and equipment needed for skin diving and underwater swimming. A character can swim a distance equal to 2x his P.S. in yards/meters per melee. This pace can be maintained for a total of minutes equal to his P.E./endurance. **Base Skill:** 50% +5% per level of experience. **Note:** The maximum safe depth one can go without getting the bends is about 120 feet (36.5 m). Deeper depths are possible with depressurization, special suits and submarines. Swimming is required for S.C.U.B.A.

**Wrestling:** As taught in old high schools and colleges, wrestling is more of a sport than a combat skill, but it does provide some useful combat moves. Provides the following:

### Wrestling Special Moves:

1. Body block/tackle does 1D4 damage (double if the wrestler is 8 to 12 feet/2.4 to 3.6 m tall, and 3D6 damage if larger). The opponent must dodge or parry (push away/deflect attacker) to avoid being knocked down. If knocked down, the opponent loses one melee attack/action and initiative for the rest of that round.

2. Pin/incapacitate on a natural roll of 18, 19, or 20. This means that the wrestler can hold his opponent in such a way that his opponent cannot physically attack or move. However, the character who is using the "pin" hold cannot attack or move without releasing his opponent.

3. Crush/squeeze does 1D4 S.D.C. damage per squeeze attack (double damage if 8 to 12 feet/2.4 to 3.6 m tall, and 3D6 damage if larger). Each "squeeze" counts as one melee action/attack.

**Wrestling Bonuses:** +1 to roll with punch, fall or impact, +2 to P.S., +1 to P.E. and +4D6 to S.D.C.

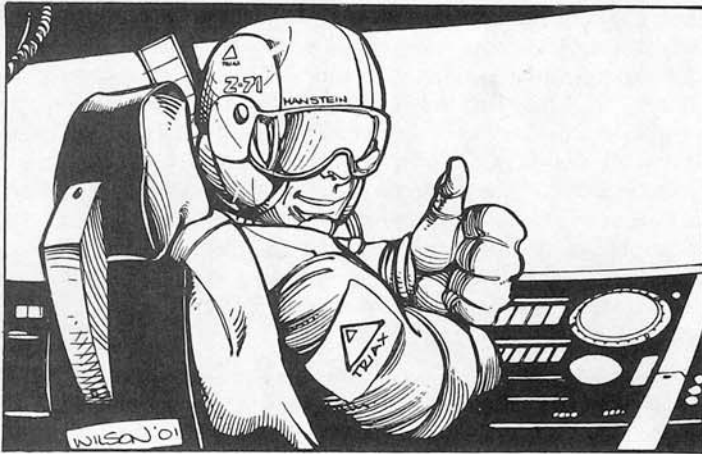

## Pilot Skills (Ground, Air, Water)

**Airplane:** Includes old propeller, single and twin engine types. **Base Skill:** 50% +4% per level of experience.

**Automobile:** Manual and automatic transmission; includes dune buggies, jeeps, and small trucks. **Base Skill:** 60% +2% per level of experience.

**Bicycling:** Means the character can ride over rough terrain, reach two times normal running speed and travel cross-country at normal running speed, and perform tricks and jumps (roll skill level; failed roll means a crash). Maximum speed can be maintained for a time equal to the P.E.x5 in minutes. Skill also includes basic maintenance/repairs. **Base Skill:** 60% +3% per level of experience.

**Boats: Motor & Hydrofoil Types:** These include all types of small motor driven boats and yachts. **Base Skill:** 55% +5% per level of experience.

**Boats: Sail Types:** Small sailing and medium-sized sailing yachts, and fishing boats. **Base Skill:** 60% +5% per level of experience.

**Boats: Ships:** This includes all large sailing and motor driven seafaring vessels. **Base Skill:** Sailing Ships: 45% +5% per level of experience. Motor Driven Ships: 44% +4% per level of experience.

**Boats: Warships & Patrol Boats:** Special training in the use of military warships, combat hydrofoils, patrol boats and amphibious beach craft/transports. Includes a basic idea of how to use sonar and targeting equipment, depth charges, torpedoes, and other common weapon systems, as well as evasive maneuvers and piloting. **Base Skill:** 40% +4% level. **Note:** Characters with the motorboat or ship skill can also pilot these vessels but at a -12% penalty.

**Combat Driving:** This skill supplements other driving skills by helping to make the character a master of the roads when driving ground vehicles (cars, motorcycles and ground hugging hover vehicles are included, but aircraft, robots and power armor are not). It helps to turn the character into an aggressive road-hog and cool-headed "chicken" player. In fact, tricks, dangerous maneuvers and car chases are challenging and fun for this daredevil, although his passengers are likely to fear for their lives.

In game mechanics, skill penalties for tricks, vehicular attacks (ram, sideswipe, etc.), and evasive maneuvers are reduced by half, plus the character is +2 to dodge when driving, +2 to survive a crash, fall or impact, can fire a weapon from a moving vehicle at only a -2 penalty, and can even make an aimed or "called shot" (at -2 to strike) while on a moving vehicle. This is a supplemental piloting skill applicable only to ground vehicles and does not have a base skill or level of progression

other than reduce penalties an additional one point per level of the driver's experience.

**Helicopter:** The specialized skill required to fly all types of helicopters, including combat 'copters (but must have the Weapon Systems skill to operate weapons on a combat helicopter). **Base Skill:** 52% +3% per level of experience.

**Hover Craft (Ground):** The knowledge needed in piloting hovercycles and other hover vehicles used for ground transport. These vehicles can be tricky, because they utilize several air jets and directional thrusters that push the craft along, above the ground, on a cushion of air. The vehicles can usually attain great speeds, are capable of driving over incredibly rugged terrains, and make sensational jumps over small craters and ravines. **Base Skill:** 50% +5% per level of experience.

**Hovercycle:** Characters who select the Pilot Hover Craft skill can drive hovercycles, hover cars, etc., however, those who specifically select the Pilot Hovercycle skill can pilot any type of hovercycle, rocket sleds, or jet propelled, one- or two-man hover vehicles with skill and finesse. They can also perform jumps, stop on a dime, perform dive-drops (i.e. soar off the edge of a cliff, keep control of the hovercycle and keep on going without crashing when they reach the bottom), and tricks without penalty (-20% to piloting rolls if the only skill is the general Pilot Hover Craft). **Base Skill:** 70% +3% per level of experience.

**Jet Aircraft:** Includes large and small commercial transport jets. **Base Skill:** 60% +3% per level of experience.

**Jet Fighters:** Training includes flying, maneuvering, aerial combat strategies, and typical fighter jet weapon systems. **Base Skill:** 50% +3% per level of experience.

**Jet Packs:** This is the piloting skill for backpack-like units that strap to the back of an individual to carry him airborne. The typical jet pack is a one person unit capable of hovering above the ground and flying at an average altitude of 300 feet (91.5 m). **Base Skill:** 42% +4% per level of experience.

**Kayaking & Canoes:** Allows the use of most paddled boats and canoes, rowboats and knee boards, as well as the Kayak. Speed in still water is usually equal to the character's P.S. attribute (treated for all purposes as Spd) and can be maintained for P.E. x5 in minutes without pause. The skill also includes basic principles behind using currents, maintenance, and even "tricks" like sculling and right-siding a flipped canoe, etc. **Base Skill:** 50% +5% per level.

**Motorcycle:** This skill includes the piloting of all two- and three-wheeled vehicles such as motorcycles of all types, dirt bikes, and mopeds as well as snowmobiles, jet sleds, miniature- ATVs and other scaled-down vehicles. **Base Skill:** 60% +4% per level of experience.

**Power Armor Basic:** Characters with this skill are taught the *fundamentals* of operating all types of power armor suits such as the Gunbuster, Chromium Guardsman and Silver Eagle. These are robot exoskeletons that are worn like a suit of armor. Power armor is usually much smaller, lighter and faster than a robot vehicle like the Mastiff. The emphasis of training is on piloting, not combat, hence the low bonuses, but the individual is able to operate all types of power armor on a basic level. To get additional combat bonuses, one needs to take the skill, *Power Armor Elite*, but training and bonuses apply to only one specific type of power armor, not all. **Base Skill:** 56% +3% per level of experience. **Note:** This skill is usually only available to O.C.C.s that specialize in piloting one or more types of power armor, and may be limited to only one kind. For example, the Silver Eagle O.C.C. only provides training in that one type of power armor. Then again, only that O.C.C. and the Military Specialist can pilot a Silver Eagle. Basic bonuses and abilities are detailed in the *Combat* section of this book.

*Power Armor* is typically man-sized and worn like body armor, though it is larger and bulkier with an exoskeleton that augments the pilot's abilities. In all cases, the power armor responds to the pilot's physical movements. Many types of power armor, including airborne



types, are suitable for use underwater, although flight/propulsion speed is reduced by 80%. Power armor without jet propulsion can travel underwater by swimming or walking along the bottom, but at -80% their normal land speed. Each specific description will indicate special aquatic capabilities, if any.

**Power Armor Combat Elite:** Hours of training in one specific type of power armor (available models may be limited by O.C.C.). This elite training provides in-depth knowledge and experience with that model and additional abilities and bonuses, detailed in the *Combat section* of this book. If more than one type of power armor is available to the O.C.C., then Power Armor Combat Elite must be selected for *each* in order to get the elite combat bonuses and special capabilities for each individual type. Otherwise, the character may have a basic understanding and skill in several, but superior, elite training in only one or two.

**Robot Basic:** Characters with this skill are taught the *fundamentals* of operating all robot vehicles such as the Mastiff and Bull Dog. These are robotic vehicles with legs (or other means of locomotion), arms, sensors and weapon systems. Even though most robots are bipedal humanoids in shape, the pilot sits inside the robot (usually in the belly) the same as he would a car or tank. Robot vehicles are slower than power armor and usually much larger, but they are also stronger, can take more damage and use heavier weapons. In fact, one may think of robot vehicles as walking tanks. The emphasis of training is on piloting, not combat, hence the low bonuses from basic training, but the individual is able to operate ALL types of robot vehicles on a basic level. To get additional combat bonuses one needs to take the skill, *Robot Combat Elite*, but training and bonuses apply to only one specific type of robot, not all. **Base Skill:** 56% +3% per level of experience. **Note:** This skill is usually only available to O.C.C.s that specialize in piloting one or more types of robots. Basic bonuses and abilities are detailed in the *Combat section* of this book.

**Robot Combat Elite:** Hours of training in one specific type of robot vehicle (available models may be limited by O.C.C.). This elite training instills in-depth knowledge and experience with that model and additional abilities and bonuses (what exactly they are is detailed in the *Combat section* of this book). If more than one type of robot is available to the O.C.C., then Robot Combat Elite must be selected for *each* in order to get the combat bonuses and special capabilities. Robot Combat Elite is usually reserved for specialists in NEMA or the military, however, just about anybody can learn to pilot and fight with a robot or power armor if they get the proper training.

**Submersibles:** The knowledge and skill of piloting all types of submersibles, including underwater sleds, mini-sub and most types of submarines, including military submersibles. **Base Skill:** 60% +3% per level of experience. **Note:** -20% when using alien or unusual submarines. Does not include power armor or deep sea diving suits.

**Tanks and APCs:** Military vehicles often have unconventional controls and handle differently than conventional vehicles, especially the many ton, armored combat vehicles such as tanks and armored personnel carriers (APC). Thus, special training is required to pilot them. **Base Skill:** 50% +3% per level of experience. **Note:** Those with this skill can also pilot other types of "tracked vehicles."

**Tracked Vehicles:** Includes landcrawlers, half-tracks, light tanks, tractors, and heavy construction vehicles (bulldozers, steam shovels, etc.). **Base Skill:** 54% +4% per level of experience. Can pilot tanks and APCs but at -15% penalty and -1 attack per melee round.

**Truck:** Specifically applies to driving large cargo and transport vehicles like eight- to sixteen- wheeled commercial trucks and multi-ton transports. **Base Skill:** 56% +4% per level of experience.

**Water Scooters:** The knowledge and skill of piloting all types of one- and two-man water sleds (underwater) and jet skis (surface sleds). **Base Skill:** 50% +5% per level of experience.

**Water Skiing & Surfing:** All water skiing techniques, methods and use of most types of recreational forms of "riding the waves," including skis, ski jet boots, water boards, surfboards and sail boards. **Base Skill:** 40% +4% per level of experience.

## Pilot Related Skills

**Navigation:** Training in map reading, star charts, course computation, following landmarks, and use of navigational equipment. Includes land, air, and water navigation, as well as piloting by instruments alone. A failed roll means the pilot is off course. Roll 2D6x100 for most aircraft, 4D6x100 for jets, and 2D6x10 for ground vehicles to determine how many miles/kilometers they are off course. Roll for every hour that one is off course. This skill enables characters to pilot ships and other water vessels that ride on the surface of the water by charting the stars and landmarks and using instruments. Likewise, the character can navigate submersibles using instruments and other data. Navigating marine vessels is an aspect of the standard Navigation skill. **Base Skill:** 40% +5% per level of experience. **Requires:** Basic Mathematics, Read Sensory Equipment, and at least minimal literacy.

**Read (& Operate) Sensory Equipment:** Individuals with this training can operate, maintain, understand, and "read" or interpret sensory data from all types of conventional, military and scientific sensor and devices. These devices include *radar*, sonar, motion detectors, surveillance equipment, optical enhancements, instrument panels, medical monitors, and so on. Note that characters without this skill can not understand or operate advanced aircraft or detection/surveillance equipment.

**Radar & Sonar Note:** The character can expertly use radar (radio echo bounces) and sonar (underwater sound echo bounces) equipment and correctly read the information to precisely locate and track aircraft, ships and submarines, as the case may be. In submarines (and radar for spaceships) there are two methods or types of operations, *passive* and *active*. To use active sonar, the sub must give a pulse of sound to bounce off any nearby ships or objects. This is very dangerous since it immediately gives away the position of the submersible (or spaceship) itself. Most vessels will not use active sonar unless absolutely necessary. Most will rely on passive sonar systems. This is much more difficult since the sonar operator must sift through the background noise to find any enemy ships. Sometimes they will not be able to distinguish the location of a ship from the background static. Despite this fact, passive sonar is used because it does not give away the location of the vessel. -15% skill penalty when using passive sonar or radar. **Base Skill:** 30% +5% per level of experience.

**Weapon Systems:** This is the complete understanding of weapon units and systems incorporated into military vehicles, power armor, and robot vehicles. It includes lasers, particle beams, rail guns, missile and grenade launchers, cannons, and vehicle/robot weapon systems. Adds a special bonus of +1 to strike when using these types of weapons; this does not include hand-held weapons (see Weapon Proficiencies). **Base Skill:** 40% +5% per level of experience.

## Rogue Skills

**Cardsharp:** A skill that involves the manual dexterity of hand and finger manipulation to perform tricks, palming, and other gimmicks of sleight of hand with playing cards. This includes dealing from the bottom or middle of the deck, stacking a deck (to the cardsharp's favor), hiding cards up the sleeve (and elsewhere), fancy and impressive methods of shuffling and dealing the cards, as well as "marking" cards, card counting and understanding the odds.

Marking cards often includes a complex series of Braille-like indentations, punctures or trimmed edges so that they are slightly concave or convex, all things that the delicate touch of the professional cardsharp can feel as he deals the cards. Other types of "marks" include incredibly subtle, almost indiscernible variations of the pattern on the back of cards, typically in the right, upper corner.

*A failed roll means* the character has fumbled the trick, missed (or misread) one of his secret markings, or was too obvious and is caught

cheating! **Base Skill:** 24% +4% per level of experience. Add +4% if the character also has the Palming skill.

**Computer Hacking:** This is a computer skill similar to Computer Programming (see Technical skills), however, the emphasis of this skill is breaking computer access codes to gain illegal access to other computer systems and steal or sabotage its data. The character is an expert in tracing computer data, bypassing defense systems, and breaking ("hacking") codes; add a one time bonus of +5% to the Cryptography, Cyberjacking, Surveillance Systems (not tailing), and Locksmith (electronic and computer controlled locks only) skills if the character is a hacker. **Base Skill:** 20% +5% per level of experience. **Requires:** Literacy, Computer Operation, Computer Programming, and at least Basic Mathematics.

**Concealment:** The practiced ability to hide small items on one's body or in hand, usually by continually moving it around from hand to hand or place to place unnoticed. Objects must be no larger than 14 inches (0.33 m) in height and depth, and six inches (0.15 m) in width. The weight must also be 10 pound or less (4.5 kg). The smaller and lighter the object, such as a knife, gem, key, credit card, etc., the easier it is to conceal (add a bonus of +5%). Larger items, such as a book, scroll, club, statue, or similarly large or heavy object, are more difficult to conceal on one's person for obvious reasons. **Base Skill:** 20% +4% per level of experience.

**Find Contraband, Weapons & Cybernetics:** The character with this skill knows where to find arms dealers, smugglers, drug dealers, illegal medical treatment, cybernetics, stolen goods, and other outlawed or dangerous items (perhaps including alien technology and magic), and how to spot them and their agents. He is also familiar with the criminal underworld, their practices, modes of operation, hangouts, criminal connections, code of conduct, and pricing structures (buying and selling). The character has a good idea of what black market weapons and cybernetics should cost and what these people pay for contraband items (typically about 10-20% of what they sell it for). The character also knows the penalty for being caught with an illegal weapon, implant or contraband. For most "civilized" societies, any M.D. weapons, concealed weapons and sidearms are forbidden inside large population centers. **Base Skill:** 26% +4% per level of experience. Note: This skill should be considered a separate skill apart from Streetwise.

**Gambling (Standard):** This skill enables the character to skillfully play several different games of chance. The character knows the rules of 1D4 games, plus one additional game for every 2 points of the character's I.Q. (rounded up). In addition to rules, the character understands the theories of mathematical "odds" (+5% bonus to math skill), some basic strategies and tactics for winning consistently, when to hold them, fold them, etc. **Base Skill:** 30% +5% per level of experience.

**Gambling (Dirty Tricks):** This is the other side of gambling in which the character is skilled at cheating in games of chance. This includes knowledge of dirty tricks such as counting cards, how to use marked cards, using trick/loading dice, stacking the deck (in one's favor), sleight of hand tricks to hide cards up sleeves or in the palm of the hand, dealing from the bottom of the deck, and other cheats (must have the Palming skill for the latter two). **Base Skill:** 20% +4% per level of experience.

**Palming:** Simply the ability to pick up and seemingly make a small object, such as a coin, key, or credit card, disappear by concealing it in one's hand. Adds a bonus of +5% to the Pick Pockets skill. **Base Skill:** 20% +5% per level of experience.

**Pick Locks:** The character knows the methods and tools for picking/opening key and basic tumbler type locks. This does not include sophisticated computer or electronic locks.

It takes 1D6 melee rounds for each attempt to pick a lock. A failed roll means the lock holds; try again. **Base Skill:** 30% +5% per level of experience.

**Pick Pockets:** An ability to remove items from a person without their being aware of it. If a pick pocket attempt fails, the item has NOT been removed and there is a 67% likelihood of the intended victim recognizing the intent of the action. **Base Skill:** 25% +5% per level of experience.

**Prowl:** This skill helps the character to move with stealth; quietly, slowly, and carefully. Techniques include balance and footing, short steps and pacing, rifle positioning, prone positions for low visibility, and crawling. A failed prowl roll means that the character has been seen or heard. If the prowl roll is successful, then the character is not seen or heard and may make a sneak attack. **Base Skill:** 25% +5% per level of experience.

**Safecracking:** This is a specialized skill in which the character studies the strengths, weaknesses, and construction of safes and how to open them without damaging the contents inside. The fingers of the safecracker are so sensitive that they can "feel" the subtle calibration of combination locks and other locking mechanisms. When using explosives, they can use their abilities to such precision that they can "blow" the lock off a safe, security door, safe deposit box and similar without creating a big, area affect explosion or inflicting damage to the contents (a failed Safecracking skill or Demolitions roll means the explosion was too much and the contents are damaged). **Base Skill:** 20% +4% per level of experience. **Bonuses:** Adds +5% bonus to the Pick Locks and Demolitions skills. The character gets a +4% bonus if a Locksmith and +6% if a Mechanical Engineer. **Penalties:** Requires focus, concentration and keen hearing, characters with an M.E. under 15 are -10% on this skill.

**Seduction:** This is the ability to make the opposite sex melt with desire. This skill is somewhat similar to the Interrogation skill in that the seducer knows how to ask the right questions to get information without being obvious. The seducer usually seems attentive, sympathetic, and alluring/sexy. Men and women who are seduced tend to have loose lips — meaning they tend to talk freely, say more than they should, and tell secrets. They also lose track of time, spend big money to impress and please their seducer, and lavish her or him with their affection, time and attention, while oblivious to everything else around them. Most of all, somebody who is seduced is vulnerable. The person who is successfully seduced is distracted, skill performance is half and takes twice as long to perform, the character has no initiative, does not notice people or events around him/her, and is easily caught off guard; no initiative and all bonuses are at half when attacked by a character other than the seducer.

Worse, the victim(s) of seduction is completely vulnerable to the seducer! The seducer always gets the first strike/attack/action (any roll above a 4 hits or is successful). The victim has no chance of self-defense against that first attack, plus loses one attack/action from surprise or horror. In addition, the seducer is +5% to pick the pockets of, palm, or plant things on, his/her victim of seduction, as well as +5% to the skills Cardsharp, Sing and Dance. Research has shown that the more alcohol the intended victim drinks, the easier he/she is to seduce (+5%). **Base Skill:** 20% +3% per additional level of experience. **Skill Bonuses:** +1% for every one M.A. attribute point above 20, and every two P.B. points above 17. So a character with a P.B. 23 (+3) and M.A. 24 (+3) would be +6% to successfully seduce. The seducer can influence more than one person at a time; one additional per every three levels of experience.

**Streetwise:** This skill instills an understanding of the darker side of city life and the scoundrels who roam the streets. The streetwise character will be able to recognize gang members by their actions and philosophies, gang colors (emblems and clothing that denote membership to a particular organization), gang symbols and mannerisms, and dangerous locations and gangland haunts. The individual will also recognize a potential brawl situation, assess a gang member's rank/power in the organization, and know some of the hangouts, modes of operation, rituals, ethics, and perhaps even notorious gang leaders of the more infamous street gangs. This skill also includes the ability to recognize and



locate black market dealers/organizations, illegal Cyber-Doc clinics, drugs and arms dealers, and similar criminal outfits. **Base Skill:** 20% +4% per level of experience.

**Streetwise: Drugs:** The following additional street knowledge can be included as part of the regular Streetwise skill or used as an additional Rogue skill; G.M.'s choice. If used as a separate skill, then **Base Skill:** 25% +5% per level of experience.

This skill gives the character the ability to recognize characters addicted to drugs, street corner pushers, big time dealers, drug smugglers, Juicers, Japes, and undercover agents looking to bust dealers. Similarly, the character has a good idea what drugs cost, how to use them and where to buy them (even if he doesn't use them himself). The character also knows most of the "street names" of common drugs, recognizes the drug when he sees it and knows the general effects and dangers it represents. He can also recognize the symptoms in others and can guess what drug a user may be high on with reasonable accuracy (roll under skill ability).

**Ventriloquism:** The practiced ability to throw one's voice. This can be used to create the illusion of not speaking while making a voice or verbal noise appear to be coming from someone or something else, such as a puppet, a tree, box, chair, etc. Maximum range is 10 feet (3 m) away. A failed roll means the voice is not well thrown or the ventriloquist's mouth is seen moving, so the trick does not work. **Base Skill:** 16% +4% per level of experience.



## Science Skills

**Note:** In the early years of *Rifts® Chaos Earth*, the majority of people are highly educated, conversant with computers and technology, read, write, and know arithmetic. Most of the Science Skills require Literacy as a prerequisite skill.

**Anthropology:** This is the behavioral study of man and other intelligent life-forms and their environments. Studies include societies, customs and beliefs, religions, and political structure, as well as rudimentary history and archaeological background. It is important to note that anthropology is more concerned with the study of *modern* races and societies than it is with ancient ones. This is especially important when dealing with alien races and cultures in order to avoid accidentally breaking taboos or codes of behavior. It also tells the anthropologist whether he may be dealing with a dangerous people (hate humans, fear technology or magic, are cannibals, worship demons, etc.).

The skill can also be used to examine artifacts and ancient or alien ruins to identify the probable people/race, purpose, culture and technological level. The character can identify the period of time the item was used (contemporary or ancient), and whether it is human or alien, but is not skilled enough to tell whether an artifact is authentic or

a forgery. In the world of *Rifts® Chaos Earth*, few humans know much about alien or demonic cultures, just as few of the aliens know anything about humankind or the world before the Coming of the Rifts. **Note:** The anthropological student is one of the few who is well versed in the myths and legends of the past, and may know a few things about ancient gods, the spirit world, Faerie Folk, dragons, demons and other creatures once thought to have been flights of fancy conjured by the imaginations of primitive people. Now, the anthropologists and historians know many really did walk the Earth, because they have returned. On the good side, those with a background in anthropology may know things that can help humans communicate with and fight these mythological beings. **Base Skill:** 40% +5% per level of experience. **Bonuses:** +5% to all Lore Skills and History.

**Archaeology:** This is the scientific study of relics from ancient civilizations by excavation and other means. The skill teaches proper excavation (dig) techniques, analysis, preservation, restoration, and dating methods (including carbon dating), as well as a rudimentary history and anthropology background.

Like the anthropological student, the archaeologist is one of the few who is well versed in the legends and facts of ancient humans, giving him a clue about demons and monsters seemingly spawned from ancient books and legend. The character can ascertain whether the item is an ancient artifact or of recent construction, and therefore, if an item is an authentic artifact or a forgery. He is also more likely to recognize genuine magic items, artifacts and articles that are important to alien peoples. **Base Skill:** 40/20% +5% per level of experience. The first percentage number applies to the character's historical and archaeological capabilities, the second is his ability to recognize magic items and alien weapons and items of significance, as well as his ability to figure out the purpose of the item through examination alone (i.e., without seeing it used in action). **Bonuses:** +2% to all Lore skills and +10% to History.

**Artificial Intelligence:** This an area of science that is usually available only to those who specialize in robotics and computers (which may include the *Field Engineer*, *Intel Agent* and *Military Specialist O.C.C.s*). True artificial intelligences (A.I.s) – robots that can think and learn for themselves – are incredibly rare even in the Golden Age of Science. The ARCHIE series is one example, and there are others, but most were experimental prototypes. A.I.s range from simple thinking computers and devices with problem solving capabilities and the ability to learn and think independent of an operator, to devices modeled on the neural network of the human mind that can think, learn, solve problems, create and even imagine.

A character with this science skill understands the many principles and theories behind advanced artificial intelligence, how it works, how the A.I. "thinks" and "understands" the world around it, how to communicate with the machines and how to reprogram them, either directly or by argument. **Requires:** Computer Operation. **Bonuses:** +5% to all other computer skills, including Programming and Hacking. **Base Skill:** 30% +3% per level of experience.

**Astronomy:** The study of the stars and other celestial bodies, their movements, positions, cycles, alignments, and interrelations with the Earth and each other. This knowledge can also be used to determine direction, approximate distances, identify seasons, and tell the time of day. **Base Skill:** 35% +5% per level of experience.

**Astrophysics:** Knowledge of stellar astronomy and how it relates to nuclear physics, quantum mechanics, relativity and other explanations for the creation of deep space phenomena, like quasars and black holes. **Requires:** Basic and Advanced Mathematics. **Base Skill:** 35% +5% per level of experience.

**Biology:** Basic understanding of cells, anatomy, physiology, evolution, and genetics. The character will know how to use a microscope, cultivate bacteria, and how to dissect, study, evaluate and classify new organisms. **Base Skill:** 40% +5% per level of experience.

**Botany:** Plants, their categories and functions, are studied extensively. Characters will know the basics of cross-fertilization and germinating, as well as growing experimental plants. **Base Skill:** 40% +5% per level of experience.

**Chemistry:** The basic understanding of chemical principles and formulae. Characters know enough chemical laboratory procedures for analyzing and synthesizing chemical compounds to act as competent assistants. **Base Skill:** 50% +5% per level of experience.

**Chemistry (Analytical):** Training in chemical engineering theories useful in the analysis of compounds and their practical applications. Characters will be highly skilled in the use of laboratory equipment and can analyze and synthesize chemicals. **Base Skill:** 35% +5% per level of experience. **Requires:** Chemistry, Advanced Mathematics, and Literacy. Computer Operation is strongly suggested but not required.

**Mathematics (Basic):** Knowledge of basic math, including the ability to count, addition, subtraction, multiplication, division, and fractions. **Base Skill:** 72 +3% per level of experience.

**Mathematics (Advanced):** Knowledge of all basic and advanced mathematics, including algebra, geometry, trigonometry, calculus, and techniques for using advanced mathematical formulae. In this highly educated and literate society, the base skill is considerable. **Base Skill:** 64% +2% per level of experience.

**Oxygen Systems:** A skill that helps a character to understand all the different ways of obtaining and recycling oxygen, and to build and repair the machinery and equipment necessary for both. This is applicable to underwater and contaminated environments (and outer space) where some kind of oxygen recycling system is necessary. Spaceships and underwater stations and closed environments may have a hydroponics plant, which they depend on for both food and recycled oxygen, while smaller vehicles, sealed compartments, and habitats may have a basic recycling, purification and filtering system, or equipment for converting water into oxygen and hydrogen. On a smaller scale, it includes re-breather apparatus, the use of oxygen tanks, gas masks, air filters, and similar systems used to clean or filter pollutants out of the air. This is not a very exciting skill, but in the polluted environment of Chaos Earth, can be necessary for one's survival. **Base Skill:** 58% +4% per level of experience.



## Technical Skills

**Advanced Fishing:** The normal fishing skill has to do with the recreational hobby and sport of fishing with a hook, line and pole. Advanced fishing is the knowledge of *commercial fishing techniques*, including the use of nets, cages (for lobsters and crabs), trolling, explosives, harpoon guns and other methods and techniques used in commercial fishing of mass catches from the ocean. It also includes a knowledge of baiting, as well as cleaning, preparing, storing and preserving catches for transport to market. **Base Skill:** 30% +5% per level

of experience. **Note:** -15% when dealing with alien creatures and mutants.

**Art:** The ability to draw, paint and/or sculpt or do craftwork. Selection as an O.C.C. Related Skill indicates a professional quality, while selection as a Secondary Skill indicates a talented amateur. **Base Skill:** 35% +5% per level of experience.

**Breed Dogs:** The first percentile number indicates the art of raising, mating/breeding, taming and training domestic and wild canines, as well as a knowledge about canines in general.

The second percentile number is used to attempt to tame a wild canine, teach a dog tricks, or to train the animal for a specific task like tracking, retrieving, pointing, herding animals, attacking on command, and so on. A failed roll means that the animal refuses to learn that particular trick or specialty. **Note:** These are trained work animals or pets, not familiars. **Base Skill:** 40%/20% +5% per level of experience.

**Computer Operation:** A knowledge of how computers work, along with the skills to operate peripherals like keyboards, printers, and modems. Characters can follow computer directions, enter and retrieve information, use the web/internet and similar basic computer operations. However, this does *not* include programming or hacking. **Base Skill:** 60% +3% per level of experience. **Requires:** Literacy.

**Computer Programming:** Advanced computer knowledge that includes designing, programming, debugging, and testing computer programs and software. Hacking is possible, but at a penalty of -40% unless the character also has the Computer Hacking skill (see Rogue Skills). **Base Skill:** 50% +3% per level of experience. **Requires:** Computer Operation and Literacy.

**Cyberjacking:** Some computers allow their users to go beyond the normal "interface" of a keyboard, joystick or mouse, and to communicate directly with the computer via a socket ("dataplug" or "headjack") implanted in the back of their neck. This means that the computer operator's *mind* effectively enters the computer, seeing its memory and processors as a kind of virtual reality. Once accessed, the Cyberjack can alter data, add data, change files, and redesign the computer's programs, all with his mind. If the computer is linked to others in a network, such as the Link that connects all the computers in and around the Freedom station, the user can communicate with other Cyberjacks within the network. If Cyberjacking is used in conjunction with a ship's weapons using a targeting computer, it will add +2 to strike.

Cyberjacking is much more direct and up to ten times faster than normal computer programming, but not without its perils: software bombs, viruses and Trojan horses may lurk within the computer's memory; other Cyberjacks can ambush you or design programs to trap your mind within the computer; and if the computer itself is artificially intelligent then anything might happen. Characters must have the Computer Operation skill to take Cyberjacking. Any player character starting with this skill automatically has a dataplug implant. Others must pay for the dataplug and its implantation later. **Base Skill:** 50% +3% per level of experience.

**Excavation & Rescue:** Specifically the methods and techniques involved in the removal of and sifting through debris, digging, tunneling, and locating and retrieving survivors trapped under collapsed earth and rubble. Includes building braces and support structures to ford up damaged load bearing walls, support beams, etc. and prevent deteriorating conditions to allow rescue crews to work without fear of structural collapse. **Base Skill:** 40% +5% per level of experience.

**Gemology:** Skill in identifying and appraising the value of precious metals (silver, gold, etc.) and stones (jade, emerald, ruby, sapphire, diamond, etc.). This ability also enables the person to identify fakes, but at a penalty of -10%. A failed roll means the character cannot tell whether or not the item is fake or real, or its value is grossly under or overestimated. **Base Skill:** 25% +5% per level of experience.

**General Repair & Maintenance:** Not everyone can be a Mechanic, blacksmith or carpenter, but many are good with their hands and capable of doing satisfactory repairs on simple mechanisms, gears,



pulleys, wheels, rope, and so on. The General Repair/Maintenance skill includes: sharpening blades, minor repairs on weapons, packing their own S.D.C. bullets, sewing tears in clothes (it may not look pretty, but does the job), replacing a wagon wheel, changing a tire, shoeing a horse, repairing furniture, painting, varnishing, nailing and assisting in basic woodworking, and even doing minor patchwork on armor (restores 1D6 M.D.C.). Roll once to see whether the character can figure out what is broken, what must be done to fix it, and whether it is beyond his meager abilities to repair. Roll again to determine success or failure in making the actual repair. If failure, the player may try again, but only twice. **Base Skill:** 45% +5% per level of experience. Reduce skill proficiency by half if the item is extremely damaged, complex, high-tech or alien.

**History:** The first percentile number represents a very general historical knowledge of the world and the most famous myths, legends, people and events.

The second percentile number indicates a more in-depth knowledge of a particular subject or region in the world (pick by nation or continent). For example: History of North America is a deep knowledge about the United States, Canada and Mexico, their origin, leaders, key figures in history and science, lore, religions, traditions, famous people, and so on, as well as the myths and legends of the indigenous people (i.e., Native American Indians, Inuit, Aztec, etc.). Narrowing the focus to just one of those countries (i.e., Mexico or the US or Canada) gives the character less knowledge of the continent as a whole, but deeper historical knowledge of that one particular country. An example of a historical "subject" might include Military History (or a more narrow but deeper subject might be the American Civil War, or Napoleonic War or World War II), industry, science, music, art, and so on. This skill may be taken repeatedly to cover multiple regions of the world or various subjects. Thus, a character who takes this skill three times might apply it to North America, Western Europe, and Russia. The base skill percentage indicates the approximate degree of information the character has learned or can remember accurately. **Base Skill:** 60/40% +4% per level of experience.

**Jury-Rig:** Jury-rigging is an essential part of life in the crumbling world of Chaos Earth. With two-thirds of human civilization wiped from the face of the Earth, and the rest of it under constant siege by the elements and inhuman invaders, skilled personnel, parts and tools are becoming more and more scarce with every passing day. When something breaks down it must be repaired quickly and with anything available. A character with this skill can repair almost anything, and even build something out of scrap components. There is no guarantee that the jury-rig will hold for very long (4D6 hours or 2D4 days, whichever is most appropriate), or will even work in the way intended (roll again, a failed roll means the system is only 50% functional), but it may well save a character's life until they can acquire the proper parts, buy a new unit or get a skilled mechanic to do the job right. **Requirements:** At least Basic Mechanics and Basic Electronics, engineering skills are even better. **Base Skill:** 25% +5% per level of experience (add an extra +10% bonus if the character is an Electrical or Mechanical Engineer or Field Armorer).

**Language, Native:** The common spoken language of the nation or country where the character was born and raised, includes common slang. **Base Skill:** 88% +1% per level of experience.

**Language, Foreign:** This is an additional language that the character is reasonably to very fluid in. Most NEMA operatives, for example, speak two, sometimes three languages, typically English/American, Spanish/Mexican, and French (Canada's second language). **Base Skill:** 60% +3% per level of experience.

**Law (General):** The character knows what constitutes a criminal act, the typical punishment and many legal precedents, procedures and decisions common throughout a particular nation, country or region. For example, NEMA characters know the fundamentals of law as it applies to North America (the USA, Canada, and Mexico). This can be an invaluable skill when trying to determine if someone is breaking the

law, how grave or petty the criminal act is, and in determining the level of action to take against it (i.e., a NEMA Peacekeeper might choose to ignore some kids vandalizing property with spray paint or give up the chase over a petty theft, but pursue a rapist or murderer relentlessly). The skill is also important for making a criminal charge stick, setting bail, using legal protocol, and defending those unjustly accused. The character also knows the legal protocol and proper conduct for conducting searches, police investigations and other aspects of law enforcement. **Base Skill:** 35% +5% per level.

**Literacy, Native Language:** In this highly educated and literate society, learning to read and write very well is part of a basic education; the predominant language of the nation where the character was born and raised. **Base Skill:** 86% +1% per level of experience.

**Literacy, Foreign Language:** This is an additional written language in which the character is reasonably to very fluid in reading and writing. Most NEMA operatives, for example, can read two, sometimes three languages, typically English/American, Spanish/Mexican, and French (Canada's second language; English being the first). **Note:** This skill may be taken repeatedly as an O.C.C. skill, O.C.C. Related Skill and Secondary Skill. Any foreign language may be selected, but NEMA characters based (and effectively trapped) in North America are not likely to find other languages especially useful. Other popular foreign languages in the years prior to 2099 include German, Russian, Portugese (the tongue of Brazil and Portugal), Japanese, Chinese and Indian. **Base Skill:** 50% +3% per level of experience.

**Lore: Cattle & Animals:** This is a general knowledge about cattle, horses, livestock, and other such animals. This knowledge includes what they eat, where they live in the wild, means of defense, the value of their meat, fur, hides and horns, and their natural predators, as well as the most notable tales about supernatural animals, spirits, gods and magic attributed to or involving animals. This skill is practiced most widely in the West of north America, but it is also known throughout parts of South America, Europe, Africa, Asia, and Australia. **Base Skill:** 30% +5% per level of experience.

**Lore: The Cities:** With civilization in near total ruin, nations and countries are quickly splintering into much smaller, isolated and independent kingdoms, cities and towns. With the passage of time, the number of these small principalities will grow and the division and diversity between them widen. This skill deals with the knowledge of these communities as they exist in a particular country, i.e., the United States of America, Canada and Mexico are each a separate country. To have City Lore for each would require a character to take this skill three times. Characters with the City Lore skill have gathered useful snippets of basic information regarding common laws, customs, economic factors, trade, politics, key leaders or personalities and even the fashion and appearance of city dwellers, particularly their military and police. As a result, the character knows what constitutes illegal trade and activities, is able to recognize soldiers, police officers, and vehicles from a particular city, predict troop movements and police response, understand standard procedure, and so on. **Base Skill:** 25% +5% per level of experience.

**Lore: D-Bee/Aliens:** The slang for Dimensional Beings appears quickly in the early days of the Great Cataclysm as a way to clearly distinguish mortal, "alien" beings from supernatural ones. D-Bees are just alien humanoids, on par with humans, but from another dimension, realm of existence or planet. To be classified as a D-Bee, the being must be remotely humanoid in appearance, usually a biped, have a human-like intelligence and not possess supernatural powers. Creatures who are not humanoid in appearance and have extremely monstrous or demonic appearances and/or strange powers, are usually considered to be monsters or supernatural horrors rather than D-Bees.

Lore: D-Bee is the general study of alien humanoids, their cultures, common types of beings, common traits and behavioral patterns, the distinction between instinctive predators and social oriented beings, and their general beliefs. The skill is often limited to those living in a specific geographic region (country) where the skill is being taught.

The region may be limited to small geographic locations, such as the D-Bees of Western America, the Midwest, or Southern Canada, to the entire country (i.e., all, or most, of the USA, Canada, Mexico). Actually, everything is so tumultuous during the Apocalypse that it is impossible to know all the D-Bees in an entire country, as new species appear and vanish on a regular basis. See the Anthropology skill for an in-depth approach to behavioral science. **Base Skill:** 25% +5% per level of experience.

**Lore: Demons & Monsters:** The study of demonic creatures and supernatural monsters via lore, myths, legends, religious text, and first-hand accounts throughout the ages and around the world. It includes the beliefs of ancient and primitive cultures, as well as documentation in the modern Apocalyptic world regarding demons, vampires, possession, places of magic, reputed places of demonic habitation or attraction, and the study of legendary and known supernatural beings and deities, including their known habits, appearance, weaknesses, strengths, powers, and abilities. The master of demon lore may be able to identify a particular type of monster by hearing its description or a description of its actions, seeing a drawing or photograph or footprint, or by how it acted, killed, or exhibited certain abilities. **Base Skill:** 25% +5% per level of experience.

**Lore: Faerie:** This skill is effectively the same as the previous Demon and Monster lore skill, except that the emphasis of the lore is on Faerie Folk. Since the Coming of the Rifts and magic, the Faeries of ancient myths have proven to be quite real and often encountered in the wild, especially near ley lines and nexus points. Faerie Folk include Faeries, Sprites, Pixies, Brownies, Bogies, Toad Stools, Pucks, Kelpies, Gnomes, Goblins, and a host of other creatures of magic (see the **Revised Rifts® Conversion Book One** for complete stats and descriptions). **Base Skill:** 25% +5% per level of experience.

**Lore: Indians:** Characters with this skill can recognize the different tribes and nations, warriors and shamans, totems, fetishes and warnings, identify the people by their housing, clothing and weapons, and has a fundamental understanding about the Native Americans' history, society, traditional beliefs, customs and laws (at least the most notable). They also know about Indian gods, spirits, and magic. **Base Skill:** 25% +5% per level. Characters of Native American descent get a +10% bonus.

**Lore: Magic:** This area of study does not give the character any magic powers, the ability to use Techno-Wizard devices, or the ability to read magic symbols. What it provides is general information about how magic works, common magical powers and spells (their effects, who possesses such magic, etc.), creatures of magic, and the various magic O.C.C.s and cults rising out of the chaos. Also knows myths and legends about magic and magic beings like the various types of dragons, sphinxes, unicorns, and so on. The character is likely to know legends about powerful magic items, places, curses and notorious practitioners of magic, too. Although the character cannot read runes or mystic symbols, he is likely to be able to recognize whether the symbol is a real magic ward, rune, warning, part of an inscription or spell, or a fake.

The following abilities come with this layman's skill: **Base Skill (general knowledge):** 25% +5% per level of experience. **Recognize Wards, Runes and Circles:** 15% +5% per level of experience. **Recognized Enchantment:** I.e. magic items, people under the influence of magic charms, possession, curses, mind control, and similar: 10% +5% per level of experience.

**Lore: Mythology:** Includes a general knowledge of the most well known world myths, including Greek, Roman and Egyptian, plus extensive knowledge of a particular country's or culture's myths relating to ghosts, spirits, demons, Goblins, Faerie Folk, monsters, dragons, immortals, undead, Elemental forces, supernatural animals, gods and magic. All countries have their share of unique myths. **Base Skill:** 30% +5% per level of experience. Adds a +5% bonus to Lore: Magic and +10% to Lore: Demons & Monsters.

**Lore: Psychics & Psionics:** Knowledge about psionic powers, how they are believed to work, how they affect people, their limitations, and who possesses them. This skill also provides a rudimentary knowledge about people and beings who possess psionic powers such as minor and major psychics, healers, mutants, and the most infamous supernatural creatures (vampires, possessing entities, Mindolar, Raksasha, etc.). The character may also have a passing knowledge about famous psychics in the region, mind control (via drugs, psychology, hypnosis, magic and psionics) and myths and legends about such places as the Astral Plane, Dreamstream, and Psyscape. The character does not have to be a psychic himself, but he should believe that psychic powers really exist. **Base Skill:** 25% +5% per level of experience.

**Lore: Religion:** The study of religions, gods and beliefs from around the world. This comprehensive skill provides a general knowledge of the religions of the world and a deeper knowledge of religious beliefs in a particular country or continent, such as North America, South America, Russia, Europe, Japan, etc. This knowledge includes regional beliefs, rituals, holy places, pantheons of deities, superstitions and supernatural creatures (demons, spirits, angels) and their stories of specific creation, myths and legends. The skill will help a character recognize specific rituals, their purpose, the deity(s) involved, and whether a blood sacrifice is necessary as well as recognize religious fetishes, charms, icons, holy symbols and similar. The percentile number indicates the degree of knowledge one has about a particular religion and his ability to remember it. **Base Skill:** 50% +3% per level of experience. Adds a +5% bonus to Lore: Mythology and Lore: Demons & Monsters.

**Masonry:** A rudimentary understanding of the principles of brick-laying and stone construction. The percentile number indicates the success ratio of recognizing deterioration, improper construction, the intended purpose of construction, styles of masonry, approximate age or period of construction, identify alien and human construction, and general data about mason guilds. The character can also mend masonry and assist in construction and demolitions. **Base Skill:** 40% +5% per level of experience.

**Mining:** Methods and practices used in prospecting, panning for gold, identifying minerals, digging mine shafts and finding and pumping water from underground sources. Includes the use of mining equipment, refining gear, and explosives. The use of explosives is a very basic use for the purpose of blasting (same as Demolitions but with a -20% penalty). A character with the Mining skill can also tell the quality of refined mineral products, and will know about many of the current mining operations in the area. **Base Skill:** 35% +5% per level of experience.

**Photography:** Training in the art of still photography, the use of lighting, cameras, lenses, filters, and other camera equipment, as well as storage, development, enlargement, and duplication of film/photos. **Base Skill:** 35% +5% per level of experience.

**Prospecting:** The character can recognize and evaluate precious and semi-precious metals (gold, fool's gold, silver, bronze, copper) in their natural ore appearance and as refined and polished jewelry. In addition, the character has a good idea where to look for such mineral deposits, and the fundamentals of "panning" for gold and the general knowledge of mining and how to use various types of simple mining equipment. Furthermore, the character can identify and appraise the value of precious metals (silver, gold, etc.) and stones (diamonds, rubies, etc.), and identify fakes, but at a penalty of -10%. A failed roll means the character cannot tell whether or not the item is fake or real, or he grossly under or overestimates its value. **Base Skill:** 20% +5% per level of experience.

**Recycling:** Recycling covers everything, but typically includes paper, lumber, plastic, glass, scrap metal, electrical wiring and components, circuit boards, bionics and machine parts. In an Apocalyptic world, recycling and rebuilding old and used items is a necessity, especially as available resources dwindle. This is not like the Jury-Rig skill;



a character with Recycle cannot make something out of odd components but, given some time and equipment, he can strip down a damage machine to its *basic component parts* or gather useful materials to repair an existing machine or build something new. Has a very rudimentary understanding of metallurgy. **Base Skill:** 30% +5% per level of experience.

**Research:** Training in the use of methods, techniques, and locations for finding information, including public records, libraries, federal information services, data bureaus, interviews, surveys, demographics, trade journals, clipping services, computer services, and legal searches. This skill is helpful in locating information about people, places and things. The *Game Master* will ultimately regulate the availability of accessible, known information regarding a particular subject. In some cases, there may be a ton of history and information, while in others, very little or nothing at all (which may reveal something by its sheer lack of info). The research skill simply gives characters access to available data. **Base Skill:** 40% +5% per level of experience. **G.M. Note:** A good rule of thumb is to let characters investigate/research something as much as they want, but keep the game moving along. If no information is available, find out where they are conducting research and say something like, "Despite the help of a clerk, and three hours of research, you still find nothing (or nothing unusual)." If the character(s) wishes to keep looking, let him, but quickly click off the hours; "Another hour and still nothing." If another player conducting research elsewhere says, "What do I find in the City County Building?" Make the answer "Nothing," or "Something quite surprising," and tell him/her something in private. Do not drag out the research aspect, but do consider a reasonable length of imaginary game time. Likewise, if the information is common knowledge or easy to locate, fast forward through what might be a couple of hours of research and tell the character what he has found.

ANY CHARACTERS CAN DO RESEARCH AND ASK QUESTIONS! However, the Research skill will reduce the amount of time it takes to find and gather available info to half the time of a character without it. Additionally, the "skilled" character is trained to notice relevant data that an untrained character is likely to overlook. Thus, for the truly mysterious, secret or difficult information, have the character with the Research skill try to uncover it. Only roll to determine success in finding data and on these difficult, rare, lost or secret bits of information, including addresses, unlisted telephone numbers, car license plate numbers, Identification Codes/data, military info, and obscure and suppressed data. Top secret information is usually protected and has a -20% skill penalty.

**Rope Works:** A skill that takes into account the various needs and uses of rope. The character knows a variety of ways to tie knots, the advantages to various types of ropes and cords, their tensile strength and how to weave/make rope. A failed roll to tie a knot means that it is loose and sloppy and easy to untie, slip out of, or likely to unravel or snap when strained. **Base Skill:** 30% +5% per level of experience. Characters bound/tied by this character are -10% to escape/slip knots.

**Salvage:** This skill allows characters to find, identify, pick up, strip down, evaluate and possibly sell, any debris, wreckage and junk that they can locate. They can also strip a piece of wrecked machinery for spare parts and may even be able to make something work again, given time, enough parts and the right skills. Overtime, everyone will find they cannot replace lost equipment, electronics and vehicles with new ones and be forced to salvage and cannibalize parts to make repairs or rebuild a unit from used and damaged parts. Many characters on Chaos Earth will begin to try to make a living out of salvage work and some degree of salvage and recycling will be part of almost everyone's lives. **Base Skill:** 35% +5% per level of experience.

**Undersea Salvage:** The character knows how to locate and identify objects (ships, armor, gold, etc.), recognize salvageable components and materials (valuable parts, electronic equipment, E-Clips, weapons, coins, magic items, precious metals and gems, etc.), retrieve (with min-

imal damage and effort), evaluate (estimate approximate resale value based on the item's condition), clean/restore (restoration gets top salvage price), and sell salvaged underwater artifacts, equipment, parts, and scrap metal. The salvage skill also offers methods of exploiting and capitalizing on some of the simple resources under the seas, including rudimentary mining, excavation, and gathering of coral, rocks, seaweed, sponges, clams, oysters, and starfish. The character is also familiar with underwater cutting tools, cranes, pulleys, and towlines, and can strip/cut apart and retrieve wreckage and machinery for use as scrap metal. Those with Mechanical Engineering can salvage working parts, make repairs on slightly damaged items, and even raise small sunken ships, subs, and robots! **Base Skill:** 30% +5% per level of experience; add a salvage bonus of +5% if a mechanical engineer.

**Whittling & Sculpting:** The art of carving wood, bone and horn into three dimensional figures/statues/toys, designs, and simple objects like wooden stakes, arrows, fishing hooks, walking sticks, staves, bowls, a simple flute or whistle, and similar. Many characters with this skill simply use it to pass time and don't necessarily make anything from their whittling. The percentile number indicates the quality of technique and the quality of the work/appearance. Taking the skill twice indicates a professional quality and gets a bonus of +10%. Selecting it once indicates a talented amateur. **Base Skill:** 30% +5% per level of experience.

**Writing:** The ability to write prose (stories), poems, or journalistically (articles, reports, news). Scholastic training indicates a professional quality, while the Secondary Skill indicates a talented amateur. A failed roll means an awkward and poorly written work that is boring and difficult to understand. Try again. **Base Skill:** 25% +5% per level of experience. **Requires:** Literacy.

## Weapon Proficiencies (Ancient)

**Note:** Each W.P. provides combat training with a particular type of weapon. The result is hand to hand combat bonuses to strike and parry whenever that particular weapon is used. All bonuses are cumulative. Each W.P. counts as one skill. The character may select several W.P.s or a few. Characters without a W.P. can use *any* weapon, but without benefit of the W.P. bonuses. There are two categories of Weapon Proficiencies, *Ancient* and *Modern*. These are somewhat misleading, since what they really refer to is unpowered melee type weapons (swords, spears, etc.) and modern, powered weapons (guns of every stripe).

**W.P. Archery and Targeting:** This is an expertise with thrown and bow weapons. It includes throwing spears, forks, slings, short bows, long bows, crossbows, and modern bows. **Bonuses:** Add 20 feet (6.1 m) to the normal effective range per level of the character, +1 to parry with that weapon (effective at level one), and +1 to strike at levels 2, 4, 6, 8, 11, and 14.

**Rate of Fire:** Two at level one, +2 at level three, +1 at levels 5, 7, 9, and 12.

**Combat Note:** Typically, a character loses all bonuses and rate of fire is half when riding on horseback or a moving vehicle.

### Thrown and Bow Type Weapons and Typical Ranges:

Boomerangs (1D6 damage): 60 feet (18 m)

Throwing Sticks & Irons (1D6 damage): 30 feet (9 m)

Sling (1D6 damage): 80 feet (24 m)

Spear (1D6 damage): 100 feet (30.5 m)

Short Bow (1D6 damage): 340 feet (104 m)

Long Bow (2D6 damage): 640 feet (195 m)

Modern Compound Bow (2D6 damage): 700 feet (213 m)

Traditional Crossbow (2D4 or 1D8 damage): 600 feet (182 m)

Modern Crossbow (2D6 damage): 700 feet (213 m)

**W.P. Battle Axe:** Training in all types of large axes and picks, including the battle axe and fire axe. **Bonuses:** +1 to strike at levels 1, 4, 8 and 12. +1 to parry at levels 2, 5, 8 and 13. +1 to strike when thrown at levels 3, 8 and 12. +1 to disarm at levels 2 and 7.

**W.P. Blunt:** Training with all types of blunt weapons including blackjacks, maces, hammers, cudgels, pipe, clubs and frying pans. **Bonuses:** +1 to strike and parry at levels 1, 4, 8 and 13.

**W.P. Bola:** The Bola is an old weapon of the South American Indians who taught its construction and use to the gauchos. The classic weapon was three rawhide thongs joined at one end and at the other, three cords tipped with metal or leather covered stones; the length of the cords varied from 3-10 feet (0.9 to 3 m). When thrown accurately, the bola could entangle the legs to bring down a running animal. One or two weighted balls were used for hunting small prey like rabbits and birds. **Damage:** 2D4 S.D.C. **Bonuses:** +1 to strike, disarm and entangle at levels 2, 5, 10 and 15.

**W.P. Bow & Arrow:** Includes short bow, long bow, Samurai bow, Mongol bow, and Ninja short bow, as well as modern compound bows. **Bonuses:** Start with +1 to strike and two shots per melee round. Add +1 to strike at levels 2, 4, 7, 10, 13 and 15. An extra shot per melee round is added at levels 2, 4, 5, 8, 10, 12 and 14.

**W.P. Chain:** Training with all types of chain weapons including ordinary lengths of chain, nunchaku, flail, and ball or mace and chain. **Bonuses:** +1 to strike at levels 1, 4, and 12. +1 to parry at levels 4, 8, and 13.

**W.P. Crossbow:** Includes both heavy and light crossbows. **Bonuses:** 1 shot per melee at first level. +1 to strike at levels 2, 4, 6, 8, 10, 12 and 14. An extra shot per melee round at levels 2, 5, 7, 9, 11, 13 and 15.

**W.P. Forked:** Includes sai, tiger forks and other weapons with tines except for tridents, which have their own separate W.P. **Bonuses:** +2 to entangle at level one and +1 at levels 2, 5, 8, 10, 12 and 14. +1 to strike at levels 1, 3, 5, 7, 9, 12 and 15. +1 to parry at levels 5, 9, and 13.

**W.P. Grappling Hook:** Trained use of a grappling hook for climbing, scaling walls (adds +5% to that skill), boarding vessels, tripping an opponent (by hooking the foot, ankle or leg. Does no damage, but knocks victim to the ground and he loses initiative and one melee attack) and impaling (does 1D6 damage). **Bonuses:** +1 to strike or entangle at levels 3, 6, 9 and 12. This weapon can NOT be used to parry!

**W.P. Knife:** Training with all types of knives. **Bonuses:** +1 to strike at levels 2, 4, 7, 10, and 13. +1 to parry at levels 1, 3, 6, 9, and 12. +1 to strike when thrown at levels 1, 3, 6, 8, 10 and 13.

**W.P. Mouth Weapons:** Includes blowpipes, mouth darts, and other weapons that depend on a person's lungs and aim out of the mouth. Weapons such as these are the hallmark of assassins worldwide, but especially of Japanese Ninja. **Bonuses:** Start with +1 to strike at levels 1, 4, 8 and 12. An extra shot per melee round is added at levels 3, 7 and 11.

**W.P. Net:** Primarily a gladiator or slaver's skill, the net is used to trip an opponent (same as grappling hook), parry or snare/entangle. **Bonuses:** +1 to strike or entangle at levels 2, 5, 8, 11 and 15. +1 to parry at levels 2, 4, 6, 9 and 12. In addition to the regular entangle attack, there are two other types of attacks possible with a net:

Snaring an opponent's weapon: The weapon becomes entangled and is pulled out of the opponent's hand. A natural, unmodified (no bonus) roll of 18, 19 or 20 will disarm an opponent in this way, unless he can roll an equally unmodified, high parry (no bonuses).

Snaring one's opponent by throwing the net over him: The intended victim must dodge or be netted — only characters with a spear, pole-arm or staff can parry a thrown net attack. If caught in the net, the victim is -8 to strike, -10 to parry and dodge, and running is impossible. It will require 1D4+1 melee rounds to cut free of the net.

If the character dodges or the net thrower misses, it is the net wielder who will suddenly find himself weaponless. Even if the net has

a drawstring attached to it, the thrower will need one melee action/attack to pull it back to him or to grab a different weapon; the throwing of a net to capture an opponent requires the use of two hands. However, if the net is being used to parry, entangle or whip an opponent, it can be used with one hand, while the other wields a sword or other weapon; parry the same as usual. Using the net as a whipping weapon does 1D4 damage.

**W.P. Paired Weapons:** Only weapons suitable for use one-handed can be used in any combination; for example, two short swords, or short sword and broadsword, sword and knife, mace and shield, etc. Two-handed weapons cannot be used as paired weapons. Those with W.P. Paired Weapons can do the following:

1. Strike and parry simultaneously. In other words, warriors skilled in paired weapons can often perform two actions for every one melee action/attack.

2. Twin, simultaneous strikes against the same target. Both weapons hit, but is considered ONE melee attack/action, (roll only once to strike). The defender can only try to parry one of the weapons with a defensive parry! The other *will strike*, unless the defender is using two weapons, or a weapon and a shield, and has the W.P. Paired Weapons skill to try to block both simultaneous attacks.

3. Strike two different targets or strike one and parry the other, simultaneously; both must be within reach.

4. Parry two different attackers; one with each hand-held weapon.

**W.P. Pole Arm:** Training in the large spear-like weapons known as pole arms. Also includes tridents. **Bonuses:** +1 to strike at levels 1, 5, 9, and 14. +1 to parry at levels 1, 3, 6, 9 and 12. +1 to strike when thrown at levels 2, 5, 9 and 14.

**W.P. Shield:** Combat skills with large and small shields used primarily for parrying and self-defense in close combat. **Bonuses:** +1 to parry at levels 1, 3, 6, 9, 12 and 15. A shield can be used in one hand and a weapon in the other. +1 to strike with a shield (1D4 damage) at levels 4, 8 and 12. No bonus to strike when thrown. Note: A shield cannot be used to block bullets, rail gun bursts or energy blasts, at least not easily. Any such attempt is done without any bonuses (straight die roll) and at -8 to parry.

**W.P. Slingshot:** Includes both ancient slings and modern slingshots. **Bonuses:** +1 to strike and 2 shots per melee at first level. +1 to strike and one extra shot per melee at levels 2, 4, 6, 8, 10, 12 and 15.

**W.P. Small Thrown Weapons:** Includes shuriken, throwing spikes, etc. **Bonuses:** Start with being able to throw three per melee round. +1 to throw at levels 4, 7, 10 and 13. Extra shot per melee at levels 2, 3, 5, 6, 8, 9, 11, 12, 14 and 15.

**W.P. Spear:** Combat skill with large and small spears. The use of a rifle equipped with a bayonet also falls into this category. **Bonuses:** +1 to strike and parry at levels 1, 4, 7, 10, and 13. +1 strike when *thrown* at levels 2, 4, 8, 12, and 15. **Maximum throwing range** is 150 feet (45.7 m), unless a woomera, atlatl, or other form of primitive spear-throwing device is employed. These simple but effective tools may be used only by those who already have W.P. Spear. They are hand-held wooden sticks or rods with a channel cut into their length and often with a hook at the end. The user slides the spear into place in the groove and then holds it there with a single hand. With a throwing motion, he whips the stick up and out, giving the spear a great deal of additional thrust, effectively doubling its throwing range. They are difficult to use (-1 to strike for all users) and take a lot of training.

**W.P. Staff:** Combat skill with large and small staffs. **Bonuses:** +1 to strike at levels 1, 3, 7, 10 and 13. +1 to parry at 2, 5, 8, 11 and 14. +1 to strike when thrown at levels 4, 8, and 14.

**W.P. Sword:** Combat skill with large and small swords, including fencing type training. Includes rapiers, sabers, two-handed, and short swords. **Bonuses:** +1 to strike and parry at levels 1, 3, 7, 11, and 14.

**W.P. Trident:** The practiced use of the trident as a weapon. **Bonuses:** +1 to strike and parry at levels one, three, seven, eleven and fif-



teen. "Catch" or "Pin" an opponent's arm, hand, foot or weapon between the prongs: +1 at levels two, five, ten and fifteen. If a limb is caught or pinned, the trident user can twist and swing the trident with a quick movement that will force the "pinned" opponent to follow the movement and be "flipped" off his feet or upside down underwater. The victim of a body flip is thrown to the ground/down/over and loses initiative and one melee action/attack. W.P. Trident provides the body flip move only when using the trident. Typical damage is 3D6 S.D.C. or 3D6 M.D.C.; can be thrown 50 feet (15.2 m) in the air or 30 feet (9 m) underwater.

**W.P. Whip:** Skill at "whipping" or snapping with long, flexible, light weapons. **Bonuses:** +1 to strike at levels 1, 3, 5, 7, 9, 11 and 13 levels. +1 to damage at 4, 8, and 12. +1 to entangle at levels 2, 6, 8, 10, and 14.



## Weapon Proficiencies (Modern)

These are areas of training and practiced skill with a particular type of modern weapon. Each W.P. counts as one skill selection. Modern W.P. bonuses are found in the combat section under Modern Weapon Proficiency Explanation. Characters with no knowledge of modern weapons can fire loaded weapons, but will take twice as long to reload and always shoot "wild," meaning they get NO bonuses to strike; straight dice roll, P.P. bonuses are NOT included.

**W.P. Revolver:** All cylinder style handguns; not automatic (trigger must be pulled each time the gun is fired). Most common range of damage: 2D6 to 5D6 S.D.C. Average range: 140 feet (42.7 m).

**W.P. Automatic Pistol:** All modern military automatic pistols (automatic means the weapon keeps firing while the trigger is depressed and until the trigger is released or the rounds are all expended). Most common range of damage: 2D6 to 5D6 S.D.C. Average range: 120 feet (36 m).

**W.P. Bolt-Action Rifle:** Includes most hunting and sniping rifles; not an automatic firing weapon. Most common range of damage: 4D6 to 6D6 S.D.C. Average range: 1000-1400 feet (305 to 426.7 m).

**W.P. Automatic and Semi-Automatic Rifles:** Includes all assault rifles like the M-16 and AK-47. Most common range of damage: 3D6 to 6D6 S.D.C. Average range: 800-1200 feet (244 to 366 m).

**W.P. Submachine-Gun:** Includes all small arms automatic weapons like the Uzi. Most common range of damage: 2D6 to 4D6 S.D.C. per round. Average range: 140 feet (42.7 m).

**W.P. Flamethrower:** A modern weapon proficiency (obviously), employed sparingly by the military, mercenaries and people who use

them. +1 to strike at levels 2, 6 and 14; generally, everything is set on fire. Most common range of damage: 3D6 to 6D6. Average range: 60 feet (18.3 m).

**W.P. Grenade Launcher:** Any device, including certain rifle models, that fire grenades. **Bonuses:** +1 to strike at levels 3, 7 and 11. Most common range of damage: 6D6, 1D4x10, 1D6x10 and 2D4x10 S.D.C. Average range: 800-1200 feet (244 to 366 m).

**W.P. Harpoon & Spear Gun:** Proficiency with the harpoon gun. The weapon can be used either with a plain pointed end (2D6 S.D.C. damage) or with an explosive head (4D6 M.D.). **Bonuses:** +1 to strike at levels 2, 4, 7, 10, and 15. Most common range of damage: 2D6 to 3D6. Average range: 60-100 feet (18.3 to 30.5 m).

**W.P. Heavy Weapons:** Includes machine-guns, bazookas, rocket launchers, and mortars. Anything heavier is likely to fall under the Weapon Systems skill in the Pilot Related Skills category. Most common range of damage: 6D6, 1D4x10, 1D6x10 and 2D4x10 S.D.C. per burst or explosive round. Average range: 2000-4000 feet (609.6 to 1219 m).

**W.P. Torpedo:** Maintenance and a keen understanding of a torpedo's speed, range, trajectory, and most effective use. **Bonuses:** +1 to strike at levels two, six and twelve. +1 to strike with a depth charge at level four. Most common range of damage: 6D6, 1D4x10, 1D6x10 and 2D4x10 S.D.C. Average range: 3000-6000 feet (914.4 to 1829 m).

**W.P. Energy Pistol:** Includes lasers and all types of energy firing small arms.

**W.P. Energy Rifle:** Includes all long-range energy firing rifles.

**W.P. Heavy Energy Weapons:** Includes plasma ejector, rail guns, and similar high-tech, Mega-Damage weapons.

**W.P. Sharpshooting:** Sharpshooting is a combination of special expertise and trick shooting with a particular type of weapon, typically revolvers, pistols and energy pistols, but sometimes includes rifles. This skill can be developed by any of the Men at Arms O.C.C.s but is fairly uncommon, except for those who specialize in guns like the *NEMA Peacekeeper*: *Point Man*, *Peacekeeper*: *Pig Man*, and *Military Specialist*.

W.P. Sharpshooting must be selected for each weapon type or category of weapon (revolver, pistol, energy pistol, rifle, etc.) in which the Sharpshooting expertise is desired. This means if the character wants to be a specialist with revolvers, that's one Sharpshooting selection at the cost of two O.C.C. Related skill selections, plus the W.P. selection (sharpshooting can be applied to O.C.C. weapon skills, but not Secondary Skills). If Sharpshooting is also desired for W.P. Energy Pistol, the skill must be selected again (at the cost of two O.C.C. Related skills). This process is repeated for each W.P. for which the added benefits of Sharpshooting are desired. Since each Sharpshooting selection costs the equivalent of two O.C.C. Related skill selections, even the best shooters seldom have more than one or two Sharpshooting specialties — most Men at Arms don't have any.

**Restrictions & Conditions:** All bonuses and tricks are only possible with the W.P. to which the Sharpshooting skill has been added. Thus, a character with Sharpshooting: Revolver does not get the Sharpshooting bonuses when firing an energy pistol.

The Sharpshooting skill can be added to all modern guns, from revolvers (six-shooters) to energy rifles, but does not include W.P. Heavy and W.P. Heavy Energy Weapons; i.e. it cannot be applied to rail guns, rocket launchers, mini-missile launchers, bazookas, artillery weapons, vehicle or robot weapons, hand grenades, or explosives. Likewise, Sharpshooting cannot be applied to weapons that don't shoot, such as clubs, maces, knives, swords, axes, whips, or even spears, knives, bolas and other weapons that can be thrown.

The Sharpshooting skill can be combined with the W.P. Archery & Targeting skill, but is applicable only to the sling, crossbow, and bow and arrow.

This skill is never available to robots, master psionics, practitioners of magic, dragons, demons or any creatures of magic or supernatural

beings. Juicers, Crazies, and 'Borgs are limited to only one Sharpshooting skill. Characters cannot trade in Secondary Skills for the Sharpshooting skill.

**W.P. Sharpshooting Bonuses:** All bonuses are in addition to the conventional W.P. bonuses.

**The Sharpshooter's "Aimed" Shot** (applicable to both the single shot and the aimed burst shot): +1 to strike with a P.P. 20 and for every additional five P.P. points above 20, but the bonuses are only applicable when the appropriate type of weapon is used. Aimed shots only. No bonuses for shooting wild.

**The Sharpshooter's "Called" Shot:** The Sharpshooter's "aimed" shot bonuses are NOT applicable when using this special "Called Shot." Instead the sharpshooter uses the following superior bonuses: +1 to strike with a P.P. 18 and for every additional three (3) P.P. points above 18, but the bonuses are only applicable when the appropriate type of weapon is used and this special called shot counts as two melee attacks/actions. Aimed shots only.

**Quick Draw:** +1 to initiative at a P.P. 18 and for every additional four (4) P.P. in addition to other initiative bonuses.

**The Bonus Attack:** +1 melee attack when using that specific weapon for the entire melee round.

**Trick Shooting:** Most Men at Arms can pick *one* of the following tricks (or roll 1D6 for random determination), but the *NEMA Peacekeeper: Point Man, Peacekeeper: Pig Man* and *Military Specialist O.C.C.s* (as well as professional assassins and gunslinger types) get *three*.

1. Can fire a traditional two-handed weapon, like a rifle, one-handed without penalty (normally the shooter loses all strike bonuses).

2. Can shoot over his shoulder by holding up a mirror and using the reflection to aim. Reduce the bonus to strike by half.

3. Accurately shoot while riding a horse or a moving vehicle (normally a wild shot), but strike bonuses are half and a "called" shot is impossible (-8 to strike and strike bonuses do not apply).

4. Shoot accurately while standing on head or hanging upside down; all bonuses applicable at full.

5. Dodge, roll or somersault and come up shooting (normally a wild shot), no bonuses or penalties to strike; straight roll of the dice.

6. Ricochet shot! The shooter can bounce bullets, arrows, slings, and other fired projectiles (depending on the specific W.P.) off of one surface and angle the shot in such a way that the projectile ricochets/bounces off and hits a different/second target! Inflicts only one point of damage to the first surface and full damage to the second. Reduce bonuses to strike by half.

This can also be done with laser weapons but the ricocheting surface must be mirrored or highly polished. Chromium Guardsmen and Silver Eagles are excellent reflective surfaces for performing a ricochet laser shot. Particle beams, ion blasters, rail guns, mini-missiles and other types of weapons cannot be used.

## Wilderness Skills

**Boat Building:** This skill enables the character to build a variety of rafts, small rowboats, large flatbed boats, and canoes. A small raft (two men) can be made within 1D6+1 hours if the lumber or other suitable materials and tools are readily available. A large raft will take about 4D6 hours, a canoe, 2D6 days, rowboat, 4D4 days, large flatbed, 1D4x10 days. Time is doubled or tripled if trees must be cut down and wood prepared. Of course, the time can be reduced if several knowledgeable people are working on the construction. A failed skill roll means the boat has leaks. Trying to patch it will require 4D4 hours. **Base Skill:** 25% +5% per level of experience.

**Carpentry:** A fundamental knowledge of working with wood. The character knows how to prepare, treat, and preserve wood, recognize

quality craftsmanship, can repair damaged wood and wood items, and build (chests, chairs, tables, cabinets, houses, etc.). Adds +5% bonus to the boat building skill if taken. **Base Skill:** 25% +5% per level of experience.

**Dowsing:** This is the ability to locate fresh water whether it be with a divining rod or by more scientific and logical means. For some it is a mystical ability, while for others, it is done through deductive analysis and knowledge of nature. The percentage number indicates the success ratio of locating fresh water. A person can roll once every melee to sense water, but must roll two consecutive successful rolls to locate the water. **Base Skill:** 20% +5% per level of experience.

**Hunting:** The skill of killing and preparing an animal for food. **Special Bonuses:** +5 to Cook (but only applies to freshly caught and killed game), +2% to Prowl, +5% to Track Animals, +5% to Skin Animals, and +5% to Wilderness Survival.

**Identify Plants & Fruits:** Training in the recognition of the many different types of plants and vegetation and where they grow. The emphasis is placed on edible, herbal, and poisonous plants. **Base Skill:** 25% +5% per level of experience.

**Land Navigation:** This skill enables the person to stay on course while traveling over land by means of observation. It includes mentally marking/recognizing geographic landmarks, estimating distance and movement, recognizing sounds, night travel, and other navigational tricks. The player should roll once for approximately every three miles (4.8 km) traveled. A failed roll means the character is drifting off course; 2D10x100 yards/meters. Consecutive failed rolls means the individual does not realize that he's off course and continues in the wrong direction. **Travel Note:** A group of average men can cover about five miles (8 km) an hour at a brisk, but relaxed, pace through grassland, along dirt roads or pavement. Travel through dense forest or jungle at a cautious pace, with eyes open for danger, is about one mile (1.6 km) an hour, sometimes slower! Heavy rain or snow, fog, swamps, etc., will also reduce speed. **Base Skill:** 36% +4% per level of experience.

**Preserve Food:** Knowledge in the preparation of foods for storage and later consumption. Includes canning fresh fruit and vegetables, making jams and honey, drying fruit, vegetables, and herbs, drying meat and fish, plus various smoking, salting, and pickling methods. **Base Skill:** 25% +5% per level of experience.

**Roadwise:** Characters with this skill can identify roads by name, use roads to help pinpoint their location, map out routes across the country, determine the safety of a road or region, find a shortcut and even predict who or what is likely to be found along particularly notorious roadways and regions. The skill is not just limited to the old roads either, it also applies to the new routes that have been forged by continuous travel or built by regional communities. Note that the skill is most effective on the character's home turf — the 200 mile (320 km) radius where he grew up (+20% for roads in that region). **Base Skill:** 26% +4% per level of experience. **Skin & Prepare Animal Hides:** Training in the methods and techniques in skinning, tanning, stretching, and preserving animal hides as fur or leather. Adds a +5% bonus to the Sewing skill. **Base Skill:** 30% +5% per level of experience.

**Spelunking:** The art of exploring and climbing underground cave systems. This skill enables the character to navigate a cave or underground cave network, retain a sense of direction (including up and down), have a sense of the cave's depth, know how to make subtle markings and note formations to find his way out and to better navigate the cave(s) at a later date, as well as rock climbing. The spelunker can answer questions about a cave system, such as what it is called (if it is a named landmark), where it may lead, how deep it continues, what type of rock it leads through and so on. This skill also lends familiarity with the correct equipment needed to go spelunking, and how to apply it. Characters without this skill have about as much chance surviving underground as they would climbing a mountain without information or equipment. **Base Skill:** 35% +5% per level experience. Add +5% if the character also has the Climbing skill.



**Track Animals:** This skill enables the character to identify an animal by its tracks, scent, spoor, and habits. The individual can also follow the animal's tracks and other signs. This means he can also estimate how fresh the tracks are, what direction they are heading, whether the animal is hurt or sick, and guess its age. The habits and habitats of animals and animal behavior are also learned. Tracking humans with this skill is also possible, but is done with a penalty of -20%. **Base Skill:** 20% +5% per level of experience.

**Track & Hunt Sea Animals:** General knowledge of the oceans and seas, with an emphasis on undersea habitats and environments, and the types of fish and animals attracted to such places. The character knows where to look for particular types of fish and sea creatures (i.e. in coral reefs, under rocks, inside caves, in warm water, cold water, etc.), the types of food the sea animals eat/prey upon, migration patterns of fish and sea mammals, and notable types of seaweed and their uses (edible, poisonous, etc.). **Basic Skill:** 35%/25% +5% per level of experience. The first number is the general knowledge, and the second is the character's ability to locate and capture small and large undersea creatures (crustaceans, fish, eels, sea mammals, etc.). **Note:** -20% when dealing with mutants and alien creatures.

**Wilderness Survival:** Techniques for living off the land, getting water, food, shelter, and help when stranded in wild forests, deserts, or mountains. Characters without this skill will not be able to stay healthy for more than a few days in the wilderness once their supplies run out. **Base Skill:** 30% +5% per level of experience.

---

# Combat Rules

---

## Hand to Hand Combat

The Palladium combat system is relatively simple, quick and realistic. It has been thoroughly play tested and has appeared in a dozen different RPGs with great success. It is designed to be fast-moving and easy to understand. All combat moves (strikes, parries, dodges, etc.) are resolved by rolling a *twenty-sided die* (1D20).

### STEP 1: Determine Initiative

Any time opponents square off for battle, the Game Master must determine who has the initiative. In other words, who will attack first. Successful *Sneak Attacks* or *Long-Range Attacks* will always have initiative for that melee round (15 seconds). Otherwise, whoever *rolls highest* on a twenty-sided die will attack first. In the case of a tie, re-roll. Initiative is rolled only once per melee round. That roll will determine the pace for the entire melee.

### STEP 2: Attacker Rolls Strike

The next step is for the first attacker to **roll a twenty-sided die**. If the result is a four or less (counting bonuses), the attacker misses. *Any roll above a four will hit the opponent*, unless the defender can parry or dodge the attack.

#### Body Armor

**Mega-Damage body armor** will absorb the damage from a successful strike. In the M.D.C. world of Chaos Earth, the armor is a char-

acter's last line of defense. All damage is taken off of the armor first. As it is slowly whittled away, however, the character gets closer and closer to death, because a single point of M.D. (the equivalent of 100 Hit Points/S.D.C. damage) will kill most *ordinary humans*, and two M.D. (the equivalent of 200 Hit Points/S.D.C. damage) most certainly will. When M.D.C. body armor falls below 20 points, the character is in serious danger. When it falls below 12 or 10, the armor is in tatters and he is flirting with death, because even an energy pistol can inflict enough damage to finish off the body armor. As a kindness and final warning to the player character, if there are at least two M.D.C. points left in the armor, I will let as much as 20 M.D. be deflected by it (21 or more points zaps the armor and the person inside), but the protection of the armor is then *completely gone* and the S.D.C. character faces an M.D.C. opponent. The next blast to strike him *will* be fatal, probably vaporizing the character.

Ultimately, combat continues back and forth until one side or the other surrenders (assuming his adversary will accept a surrender and take prisoners) or is slain. Mega-Damage combat works the same way against nonhuman creatures who are, by nature, Mega-Damage beings. When all their M.D.C. is gone, they die. However, unless the amount of damage was considerably more than their remaining M.D.C., they are not vaporized.



**S.D.C. body armor and combat** works a little differently. S.D.C. body armor *may* absorb the damage from a successful strike or the attack may penetrate or bypass the armor if the strike roll is high enough.

This is where Armor Rating (A.R.) comes into play. To hit the physical body of one's foe inside the armor, the roll to strike must be higher than the *Armor Rating (A.R.)* of the protective armor.

**For example:** Studded leather armor or a light bulletproof vest has an A.R. of 13, this means the attacker must roll 14 or higher to penetrate the armor and inflict damage directly to his foe's body (deduct damage first from the physical S.D.C. of the body, and when that is reduced to zero, deduct damage from Hit Points). In this case, a roll of 5-13 would strike, unless parried, but would only inflict damage to the body armor (reduce the S.D.C. of the armor accordingly). When all the S.D.C. of the armor is destroyed (reduced to zero), the armor is so tattered that it no longer provides any protection (no A.R. and no S.D.C.). Any attacks that are five or higher will strike and do damage to the character's body, unless they are parried or dodged. A roll of 1-4 is always a miss; that's true in hand to hand and long-range combat.

### STEP 3: Defender may Parry, Dodge or Entangle

Any time an attacker rolls a successful strike to hit, the defender can choose to parry, dodge, or entangle.

**Parrying** can be done automatically by anyone trained in any form of hand to hand combat. A parry *blocks* the attacker's strike, preventing damage from being inflicted. *For example*, a punch can be blocked by the character's hands or arms. A weapon attack (sword, axe, mace, etc.) can be parried/blocked by a shield, sword, or other weapon or object held in the defender's hand. A weapon should only be parried with another object. Trying to parry a weapon with one's hand or arm is likely to result in a failed parry and the usual amount of damage being inflicted by the weapon. Parrying a weapon bare handed is dangerous and all such attempts are *without* benefit of the character's parry bonuses.

A parry can be performed without using up a melee attack/action. Characters with no hand to hand combat training lose their next melee attack every time they parry.

Energy attacks from blasters or magic fire balls, dragon's breath, eye beams and so on, *cannot* be parried, but *can* be dodged. (The ability to *parry* energy bolts or bullets is a rarity and covered further on under ranged combat.)

Defending by dodging or entangling means automatically giving up the next melee attack. **Entangle** means the character actually pins or snares an opponent's weapon(s) or arm. A **dodge** means the character physically moves out of the path of the attack. Each dodge uses up one of the character's own attacks per melee round. So constantly dodging means the defender has no opportunity to attack. Only characters (and power armor) with the ability to *automatic dodge* can attempt a dodge (roll to dodge like always) without using up one of their own attacks. An automatic dodge is like a parry in that regard – it can be performed without loss of a melee attack.

**Note:** The defender can only defend against attacks within his *line of vision*. Attacks from the rear or which are not seen coming cannot be parried, dodged or entangled. The defender always wins ties when parrying, entangling or dodging.

### STEP 4: Attacker Rolls Damage

If a successful strike is not parried, dodged or entangled, the attacker strikes his intended target and rolls for the amount of damage inflicted. Human fisticuffs and S.D.C. weapons (an ordinary knife, club, chair, etc.) inflict S.D.C./Hit Point damage. Superhuman beings, robots, full cyborgs and creatures of magic inflict Mega-Damage, making a fight with them unfair unless one is wearing M.D.C. armor and using an M.D. weapon (Vibro-Blade, power armor, a magic item, Robot P.S., etc.). Each weapon description will indicate the type and number of dice to roll to determine damage. It will also indicate if the damage is

S.D.C. or M.D. An ordinary knife, for example, does 1D6 S.D.C. damage (roll one six-sided die), while a Claymore sword does 3D6 S.D.C. damage (roll three six-sided dice), but a Vibro-Knife does 1D6 M.D. (roll one six-sided die that does the equivalent of 1D6x100 S.D.C. damage).

**In S.D.C. combat, in addition to the weapon damage**, the attacker may also get damage bonuses from hand to hand combat skills, P.S. attribute, quality weapons, or magical enchantment. All bonuses are cumulative, so if the character has a P.S. of 20 he adds +5 to the damage he inflicts with his weapon or punch. If he is using a weapon that is also +2 to damage that is added to the damage, as well as +2 from his hand to hand combat skill. Thus the total amount of potential damage inflicted in this example is the weapon, say 2D6, +9 from cumulative bonuses (x2 if a critical strike).

**Critical strikes** do *double damage* whether the attack is S.D.C. or M.D. Combined critical strikes, like a natural 20 and a jump attack, do triple damage. Add the damage bonus to the roll before doubling or tripling damage. A natural, unmodified 20 is always a critical strike. A normal human punch inflicts 1D4 S.D.C. damage; a normal kick 1D6.

**A pulled punch**, whether with fist or weapon, inflicts as little S.D.C. damage as the attacker desires (down to one point), provided he was successful to strike and rolled an 11 or better on a 1D20. A failed attempt to pull a punch means full damage, bonus and all, has been inflicted.

Mega-Damage combatants can either roll a restrained punch doing minimal M.D. or even S.D.C. damage or a *pulled punch*. In this case, the super-powerful attacker can elect to inflict as little as one point of Mega-Damage or 2D6 S.D.C. – a Mega-Damage powerhouse cannot do less than 2D6 S.D.C. damage even if he wants to, he is just too strong and can only pull his punches so much.

### STEP 5: Defender May Attempt to Roll with Impact/Punch

If the attack is a physical impact from things like a punch, kick, club, mace, hammer, staff, thrown rock, fall, explosion, and similar, the defender can attempt to *roll with the impact/punch/fall*. In order to roll with the impact, the defender must roll a twenty-sided die and *match* or better the attacker's roll to strike. Successfully rolling with a punch/impact or fall, means the character takes *half* damage! Successfully rolling with a knockout punch means the character takes double damage, but is NOT knocked unconscious or stunned. Rolling with a death blow punch results in the loss of half of all remaining S.D.C. or Hit Point if S.D.C. is less than 12. Failing to roll with impact means the character has used up one of his melee actions/attacks and still takes full damage from his attacker. Roll with impact/punch/fall counts as one melee action/attack. **Note:** Hit Point/S.D.C. creatures can roll against S.D.C. based attacks and Mega-Damage attacks. However, unless the character is wearing M.D.C. armor or is an M.D.C. being, even the reduced Mega-Damage (half) will kill him. Characters in M.D.C. body armor, power armor, and M.D.C. robot vehicles, as well as cyborgs and robots, can usually attempt to roll with impact to reduce the Mega-Damage inflicted to their armor or to the robot or power armor.

### Combat Sequence

Whether S.D.C. or Mega-Damage combat, the typical combat sequence goes like this:

**Step One:** Everybody rolls for initiative. The character with the highest initiative roll strikes first, the ones next in line follow in descending order.

**Step Two:** The one with initiative rolls to strike a particular opponent and adds in any strike bonuses he may have.

**Step Three:** The character under attack can attempt to roll a parry or dodge. The high roll wins. Defender always wins ties.



**Step Four:** If the strike successfully hits, roll for damage and deduct it from the character's M.D.C.

If S.D.C. combat, determine if the strike penetrates the armor (A.R.) and roll damage dice. Deduct damage from the armor or the physical body, depending on which is struck and damaged (must be higher than A.R. number to strike the body).

*Option to parry* (or dodge) in hand to hand combat. If successfully parried, no damage is inflicted and the defender readies himself to counter-strike. M.D.C. hand-held weapons and armor can parry M.D. punches, kicks and other M.D. melee weapons (Vibro-Blade, magic weapon, a punch from a supernatural being, etc.).

In either case, the character being struck *may* opt to roll with impact, but to do so will counts as one of his melee actions/attacks.

**Step Five: Now it's the defender's time to return the attack:** The character who was under attack follows Steps 2-4, striking back (roll to strike), and his opponent may try to parry or dodge, then determine whether or not damage is inflicted (and how much) and repeat the process.

One on one melee combat goes back and forward like this for the entire melee round; first one strikes and one parries, then the other strikes and so forth. The melee round ends when each character has used up all of his attacks.

**Next melee round:** Start again by having everybody roll for initiative (step one) and repeat steps 2-5. This continues until one set of combatants is triumphant over the other. This can be when one side or the other are all slain, surrender, are captured or flee.

**Note:** The description always seems to make combat *sound* more complicated than it really is. In game play it is a fast, back and forth, the first guy (the one who won initiative) strikes, the defender parries or dodges, damage is rolled if struck, and then it is the defender's turn to strike. The opponent, in turn, can try to parry or dodge (or just take the damage) and then strikes back. The defender parries, dodges or stands and takes the damage, and then strikes back. Simple.

Oh, if one fighter has *more* attacks per melee than the other guy, this teeter totter combat continues until the one with more attacks has the advantage. At that point the one who is out of attacks can only try to parry the incoming attacks from his opponent. He may opt to dodge, but each dodge will take away one of his attacks from the next melee round, leaving him in an even worse situation until soon, all he may be able to do is run and dodge, which can happen. Watch a boxing match, the boxer who is faster will throw more punches (attempts to strike) than a slower or less experienced opponent. When both combatants have used up all their attacks that melee round is over and the next one begins. A melee round lasts approximately 15 seconds in fictional game time but can last several minutes in real, player time, especially if the player group is large.

## Spreading out combat among several pairs of fighters

Most gaming groups have 3-6 players, all of whom are likely to be matched up against their own adversary at the same time. That's 3-6 pairs of fighters in the same melee round. Some Game Masters play out the entire melee combat between one set of fighters (i.e., one NPC villain vs one player character) and then move on to the next player. This can work out okay, especially since the initiative roll determines who goes first, second, third, and so on. However, I find this approach is often anticlimactic, dull and boring for the rest of the players waiting their turn.

Instead, I *hop* from one set of combatants to the other, trying to leave the most dramatic or decisive clash for last. This means I let the first villain and player character take a whack or two at each other (i.e., one or two melee attacks), and say something like, "okay, you guys are going at it hot and heavy," or, "you're holding your own for now."

Then I turn to the next player to give him a turn, "The madman you're facing screams and charges, what do you do?" Inevitably he parries or strikes or dodges and his combat is engaged. I let two melee attacks unfold, put him on pause and turn to the next player and repeat.

This creates a sensation of *simultaneous action* for all the players. And psychologically, because each player is *waiting* for their next turn while watching the rest of the *team*, it creates a sense of anticipation, excitement and camaraderie. Likewise, if the character's teammates are doing well, it makes each individual player more anxious for his next turn to do just as well or better. If his teammates are doing poorly, it creates a sense of concern and immediacy that *he* must vanquish his foe *to help* his buddy(s). Wow, when done right, the action is pulse-pounding and even heart-stopping at pivotal intervals.

Use this pause, switch, return method along with *cliffhanger suspense* and try to build to a satisfying *climax*. For example, as one of the free player characters, having vanquished his adversary, looks on, he sees one of his teammates losing his fight. Things look bad.

The free character tells the Game Master that he is running over to help his buddy or taking aim on his buddy's opponent. The G.M. says, okay, but seems to otherwise ignore him, or says something like, "okay, you're charging over there (or taking aim), but in the meanwhile..."

The G.M. turns to the player whose character is under brutal attack and faring poorly. The G.M. allows another exchange between the villain and the beleaguered player character; after all, one melee attack and counterattack takes only two or three seconds.

If played out right, the *free character* is shouting, "I leap at the villain," or "I strike with my magic sword," or "I shoot, I shoot!" But the G.M., still looking at the beleaguered character, says, "The villain, caught in a blood fever, doesn't see or hear the free character. All he can think about is finishing you off. He raises his Vibro-Axe (or takes aim, or whatever) and . . ."

And *that's when* the G.M. turns to the free character and says, "roll to strike." Cool, huh? Very dramatic.

Of course, it should be orchestrated that the beleaguered character still has a parry or dodge option or a chance to strike should his teammate's attack miss or not finish the villain off. Likewise, give the down and out character other options. For example, "you hit," says the G.M. to the free character. "Surprised and enraged, the villain turns to face you" – or swings to fire a quick shot at the free character. Maybe the villain is staggered and ready to go down, but is so crazed with battle-rage he is fighting to the death. Or now the free character, surprised by how quickly and, perhaps, how devastating the villain's attack on him was, is the one in trouble. Ah, but here's the coup de grace, the beleaguered character has been forgotten, giving him a free shot at the bad guy! An attack that might be the last blast needed to finish the fiend off, or now facing both player characters, the two finish him off together, or the villain runs away (or tries to). However it turns out, there is a sense of *camaraderie*, *drama* and *triumph* that ends in a climactic and rousing way. I've actually had the rest of the group cheer when the down and out character delivers the final blow or the bad guy runs off with his tail between his legs. It's all about pacing and presenting the action in a dynamic way.

Remember, you, as the Game Master, are much more than a referee or the voice of a faceless bad guy, you *orchestrate* everything. It's your job to set up the action to deliver the most punch. Not manipulate and force the action, but to *arrange* and *orchestrate* how it all goes down.

## Two against one

More often than not, two or more player characters will gang up on one superhuman opponent. Whatever the case, the "one" will find himself dividing his attacks between his multiple attackers, perhaps first striking the closest or who is doing the most damage and then the other. However, use logic, if one of the multiple attackers is doing more damage than the others, or represents the greatest threat, then the "one" may

repeatedly direct all or most of his attacks at that opponent while ignoring the others.

The "one" can try to *parry* incoming attacks from as many as three adversaries, but a fourth attacker gets a free shot (no parry for the "one" on that attack). However, the "one" can only return his next attack at one of his opponents, which is why his counterattacks must, ultimately, be divided. (I'll hit the ugly demon this time – parry, parry, parry – and hit the winged monster next time.) Depending on how the battle goes, the "one's" strategy and targets may change, and at some point he may need to call for help or abandon the fight and try to run away.



## Horror Factor

All supernatural creatures, dragons and most monsters have a Horror Factor (this may be more like an awe factor when it comes to gods). The Horror Factor represents either the hideous appearance of the monster or its overwhelming aura of evil and power (or a combination of the two). Whenever a human/mortal encounters one of these monstrosities, the character must roll a 20-sided die to see whether or not he or she is momentarily stunned by the sheer horror of the thing. This Horror Factor roll might be thought of as a saving throw or mental parry. Fortunately, the character only needs to roll for the first melee round of each encounter, *not* every melee of combat.

To save vs Horror Factor (H.F) the player must roll a 20-sided die. Just like a parry, the roll must be equal to or higher than the Horror Factor. For example: A slobbering creature, with a Horror Factor of 10, emerges from a crypt. All characters who see it must roll to save against horror. In this case, a successful save is 10 or higher. Everybody but poor Tom rolls above a 10 and saves. Tom rolls a six, so his character is momentarily stunned with horror.

A failed roll means the character is so overwhelmed that he or she is temporarily stunned. In game terms this means the character loses initiative (don't even roll for it), loses one attack/melee action, and cannot defend himself (no parry or dodge) against the creature's *first* attack of that melee round. Fortunately, the character snaps out of the shocked stupor quickly and can join in the combat that same melee. By the second melee round, the character has completely recovered his senses and is functioning as normal; roll for initiative and combat as usual.

# Hand to Hand Combat

These are the standard level by level tables that present the *accumulative bonuses* offered by the common forms of hand to hand fighting currently known to be available on *Chaos Earth*. When characters advance a level, the player can come to this section to see what new bonuses apply to the character.

**Note:** ALL bonuses are accumulative. That means each new level offers new bonuses and combat capabilities that are *added* to those previously acquired. Certain Hand to Hand fighting styles also impart bonuses to one's physical attributes as well as perfection of the fighting form. Also see Boxing and Wrestling in the *Skill* section. Japanese martial arts are not usually known outside of Japan and the Orient; i.e. characters in the Americas, Europe, Africa and elsewhere will not know them.

## Characters with No Hand to Hand Combat Skill

**Level 1:** Starts with one hand to hand attack per melee round. This reflects the character's pitiful fighting skills.

HOWEVER, the character gets *TWO non-combat melee actions* at first level. A *non-combat action* involves some activity other than fighting (operating a machine, driving, locking a door, running, hiding, helping others, etc.).

**Level 3:** +1 attack per melee round and +1 to dodge. +1 *non-combat melee action*.

**Level 6:** +2 *non-combat melee actions*.

**Level 9:** + attack per melee round, for a total of three "attacks" per round (each attack counts as two melee *actions* for this character). +1 *non-combat melee action* for a total of six melee "actions." That's it.

## Hand to Hand: Basic

This is an elementary form of hand to hand combat training. Though it hardly stacks up against some of the more advanced forms of fighting, one who has trained in Hand to Hand: Basic still fights with combat skill compared to the simple, everyday folk who populate Chaos Earth.

- 1: Starts with four attacks/actions per melee round; +2 to pull punch and +2 to roll with punch, fall or impact.
- 2: +2 to parry and dodge.
- 3: Kick attack does 1D6 of points damage.
- 4: +1 additional attack/action per melee round.
- 5: +1 to strike.
- 6: Critical strike on an unmodified roll of 19 or 20.
- 7: +2 to damage.
- 8: Judo-style body throw/flip; does 1D6 damage, and victim loses initiative and one attack per melee.
- 9: +1 additional attack/action per melee round.
- 10: +2 to pull punch and +2 to roll with punch, fall or impact.
- 11: +1 to parry and dodge.
- 12: +1 to strike.
- 13: Critical strike or knockout from behind.
- 14: +2 to damage.
- 15: +1 additional attack/action per melee round.



---

**Number of attacks per melee:** To simplify matters, each type of Hand to Hand Combat indicates the number of attacks the character starts with, typically four.

---

## Hand to Hand: Expert

This fighting style is often taught to soldiers, bodyguards, thieves, and anybody else who will be expected to live by violence. While it lacks the mastery of the Martial Arts, an Expert fighter knows how to scrap quickly and efficiently. At high levels, especially, those with this skill can often hold their own against dedicated masters of the martial artists.

- 1: Starts with four attacks/actions per melee to start; +2 to pull punch, and +2 to roll with punch, fall or impact.
- 2: +3 to parry and dodge.
- 3: +2 to strike.
- 4: +1 additional attack/action per melee round.
- 5: Kick attack does 1D6 damage.
- 6: Critical strike on an unmodified roll of 18, 19 or 20.
- 7: W.P. Paired Weapons.
- 8: Judo-style body throw/flip; does 1D6 damage, and victim loses initiative and one attack.
- 9: +1 additional attack/action per melee.
- 10: +3 to damage.
- 11: Knockout/stun on an unmodified roll of 18, 19 or 20.
- 12: +2 to parry and dodge.
- 13: Critical strike or knockout from behind (triple damage).
- 14: +1 additional attack/action per melee round.
- 15: Death blow on a roll of natural 20.

## Hand to Hand: Martial Arts

Considered to be a generic form of martial arts, taking techniques from many sources.

- 1: Starts with four attacks/actions per melee to start; +3 to pull punch and +3 to roll with punch, fall or impact.
- 2: +3 to parry and dodge; +2 to strike.
- 3: +1 on initiative. Karate-style kick does 1D8 (or 2D4) damage.
- 4: +1 additional attack/action per melee round.
- 5: Jump Kick (critical strike) and Entangle (+1).
- 6: Critical strike on an unmodified roll of 18, 19 or 20.
- 7: W.P. Paired Weapons and +2 to disarm.
- 8: Leap Attack (critical strike).
- 9: +1 additional attack/action per melee round.
- 10: Judo-style body throw/flip; does 1D6 damage, victim loses initiative and one attack.
- 11: +4 to damage.
- 12: +2 to parry and dodge.
- 13: Knockout/stun on an unmodified roll of 18, 19 or 20.
- 14: +1 additional attack/action per melee round.
- 15: Death blow on a roll of a natural 20.

## Hand to Hand: Assassin

This style of fighting is a specialized science of killing generally taught by secret organizations such as organized crime cartels, secret government "wet working" bureaus, Black Ops, and so on.

- 1: Starts with three attacks/actions per melee round. +2 to strike. W.P. Paired Weapons.
- 2: +2 additional attacks/actions per melee round.
- 3: +3 to pull/roll with punch/fall.
- 4: +4 to damage. +1 on initiative.
- 5: +1 additional attack/action per melee round.
- 6: +3 to parry/dodge. Entangle (+2).
- 7: Knockout/stun on an unmodified roll of 17-20.
- 8: +1 additional attack/action per melee round. +1 on initiative.
- 9: +1 on initiative. Kick attack does 1D6 damage.
- 10: Critical strike on an unmodified roll of 19 or 20.
- 11: +2 to strike.
- 12: Death blow on a roll of a natural 20.
- 13: +1 additional attack/action per melee round.
- 14: +2 to damage.
- 15: +2 to strike.

## Hand to Hand: Commando

This style of combat is a quick and dirty form of martial arts available only to the Commando/Special Forces and Military Specialist O.C.C.s.

- 1: Starts with Four attacks/actions per melee round, W.P. Paired Weapons, body flip/throw, body block/tackle and +2 to save vs Horror Factor.
- 2: +1 on initiative, +1 to strike, +2 to parry and dodge, +3 to roll with punch/fall/impact, and +3 to pull punch. Backward sweep kick: Used only against opponents coming up behind the character. Does no damage; it is purely a knockdown attack (same penalties as body flip) but cannot be parried (an opponent can try to dodge it but is -2 to do so).
- 3: Disarm (+1), +1 to automatic body flip, +1 on initiative.
- 4: +1 additional attack/action per melee and karate kick attack. This is a conventional, karate-style, kick. It starts with bringing the knee, folded, up to chest level, then the foot is completely extended. Does 2D6 damage.
- 5: Automatic dodge and critical body flip/throw.
- 6: +2 on initiative, +1 to strike, parry and dodge, and +1 to body flip/throw.
- 7: +2 to damage, +1 to save vs Horror Factor, +1 to disarm, +1 to automatic dodge and +2 to pull punch.
- 8: +1 additional attack per melee, jump kick, +1 to body flip/throw, and +1 to roll with punch/fall/impact.
- 9: Death blow on a natural 18-20!
- 10: +2 to save vs Horror Factor, +1 on initiative and +1 to strike.
- 11: +1 to disarm, +1 to pull punch and +1 to body flip/throw.
- 12: +2 to damage, +1 to parry and dodge, +2 to automatic dodge.
- 13: +1 additional attack/action per melee.
- 14: Automatic body flip/throw.
- 15: Critical strike on a natural 17-20.

## Power Armor Basic

Characters with this skill are taught the *fundamentals* of operating all types of power armor suits such as the Gunbuster, Chromium Guardsman and Silver Eagle. These are robot exoskeletons that are worn like a suit of armor. Power armor is usually much smaller, lighter and faster than a robot vehicle like the Mastiff. The emphasis of training is on piloting, not combat, hence the low bonuses, but the individual is able to operate all types of power armor on a basic level. **Base Skill:** 56% +3% per level of experience. **Note:** To get additional combat bonuses, one needs to take the skill, *Power Armor Elite*, but training and bonuses apply to only one specific type of power armor, not all. When "Elite" combat is taken for a specific type of power armor, the bonuses from "Elite" combat training supercede those from basic training (i.e., use Elite bonuses only, do *not* add Elite to the basic ones below). The bonuses from basic training would apply only to power armor the character has no specific expert training in.

All bonuses are in addition to the pilot's own hand to hand combat training and attribute bonuses. They do *not* apply to the pilot's physical abilities outside the power armor.

+1 extra attack/action per melee round, *plus* those of the pilot.

+1 to strike in hand to hand combat.

+1 to parry in hand to hand combat.

+1 to dodge.

+2 to roll with impact, punch or fall.

Critical strike is the same as the pilot's hand to hand skill.

Strike bonuses for built-in weapons are limited to bonuses the pilot may have from the skills Weapon Systems and/or W.P. Heavy Energy Weapons (applies to rail guns and missile launchers, as well).

**Damage:** As per Robot P.S. Each power armor description will list the damage under the "Elite" hand to hand stat block. The basic skill, however, only lets the pilot do a *restrained and full strength punch* and an ordinary *kick*, no leap kick, stomp or special attacks.

**Body block/tackle/ram:** 1D4 M.D. plus a 01-50% chance of knocking an opponent down, causing him to lose initiative and one melee attack/action. Counts as two melee attacks.

## Robot Basic

Characters with this skill are taught the *fundamentals* of operating all robot vehicles such as the Mastiff and Bull Dog. These are manned robot vehicles with legs (or other means of locomotion), arms, sensors and weapon systems. Even though most robots are bipedal humanoids in shape, the pilot sits inside the robot (usually in the belly) the same as he would a car or tank. Robot vehicles are usually slower than power armor and much larger, but they are also stronger, can take more punishment and use heavier weapons.

The emphasis of training is on piloting, not combat, hence the low combat bonuses from basic training, but the individual is able to operate ALL types of robot vehicles on a basic level. **Base Skill:** 56% +3% per level of experience. **Note:** To get additional combat bonuses, one needs to take the skill, *Robot Combat Elite*, but training and bonuses apply to only one specific type of robot, not all. When "Elite" combat is taken for a specific type of robot, the bonuses from "Elite" combat training supercede those from basic training (i.e., use Elite bonuses only, do *not* add Elite to the basic ones below). The bonuses from basic training would apply only to robot vehicles with which the character has no specific expert training.

All bonuses are in addition to the pilot's own hand to hand combat training and attribute bonuses. They do *not* apply to the pilot's physical abilities outside the robot vehicle.

+1 extra attack/action per melee round, *plus* those of the pilot.

+1 to strike in hand to hand combat.

+1 to parry in hand to hand combat.

+1 to dodge.

Critical strike is the same as the pilot's hand to hand skill.

Strike bonus for built-in weapons are limited to bonuses the pilot may have from the skills Weapon Systems and/or W.P. Heavy Energy Weapons (applies to rail guns and missile launchers, as well).

**Damage:** As per Robot P.S. Each robot description will list the damage under the "Elite" hand to hand stat block. The basic skill, however, only lets the pilot do a *restrained and full strength punch* and an ordinary *kick*, no leap kick, stomp or special attacks.

**Body block/tackle/ram:** 2D6 M.D. plus a 01-65% chance of knocking an opponent down, causing him to lose initiative and one melee attack/action. Counts as two melee attacks.

## Robot & Power Armor Combat Elite

The bonuses for Power Armor Combat Elite and Robot Combat Elite is found under the description of *each* specific type of power armor or robot.



## Key Combat Terms

**Attacks per Melee:** Characters with no hand to hand combat training get only *one* attack/action per melee at levels 1, 6, and 12. No automatic parry or dodge and each attempt counts as one melee action. P.P. and W.P. bonuses apply to combat moves.

Characters with any kind of formal hand to hand combat training (Hand to Hand: Basic, Expert, etc.) usually start off with four. Each specific Hand to Hand Combat skill will indicate how many attacks the character starts with. This number grows with experience.

**Automatic Body Flip/Throw:** Certain martial artists can do a body flip/throw in place of a parry. This means that instead of blocking or deflecting the blow, the character attempts to leverage the attacker's own force into a flip. Success requires beating the attacker's roll to strike, just like a parry, but using the bonuses for body flip (not parry). Failure means taking full damage from the attack, without a chance to roll with punch/fall/impact. A successful roll means the character has grabbed his opponent and sent him flying in a judo-style throw.

**Automatic Dodge:** Certain O.C.C.s, R.C.C.s, power armor and robot combat, and other forms of combat enable the character to *automatically* dodge an attack without using up a melee attack/action. It is purely a defensive move. Roll for a dodge as normal (the automatic dodge is not an "automatic" success). An automatic dodge works just like a (automatic) parry in that the act of dodging does *not* use up any attacks to perform. Bonuses to auto-dodge come from the character's P.P. attribute and any special bonus specifically for it (the bonus, skill or enhancement will say "automatic dodge"). Unless it specifically says a character has an Automatic Dodge, he or she does NOT.



**Attribute Bonuses:** Combat and saving bonuses gained through physical or mental strengths that give a character an extra added degree of agility, strength, endurance, etc. (see the eight attributes).

**Back Flip:** The back flip involves throwing oneself backwards with the arms and shoulders, flipping the legs completely up, over, and back down on the ground into a standing position. The result is that one quickly moves backwards by a full body length. Doing a back flip counts as one melee attack/action and can be used as a dodge or for entertainment.

If used in place of a dodge, the character must roll higher than his opponent's strike roll using only the natural die roll (do not include any dodge bonuses). Failure to beat the strike means taking full damage *without a chance to Roll with Punch*. Success means avoiding the attack like a dodge.

**Back Flip: Escape.** If used in place of a strike (when it's the back-flipping character's turn to strike) this removes the character from combat and requires the opponent to use up an attack/action to move into range. This also gives the back-flipping character the initiative.

**Back Flip: Attack.** This is especially useful against someone attempting some kind of back strike. Once the opponent is detected in the rear, the back flip moves one back into combat range. A back flip can also be used as a combined Strike against an opponent to the rear of the character. Use with either an axe kick, snap kick, or backhand strike. If striking with a back flip use only the bonus to back flip (not strike). Cannot be used with death blow or knockout/stun.

**Blind:** Here are the definitive penalties and conditions for being blinded or fighting in absolute darkness without optical systems to see.

**Penalties:** Ignore all of the character's normal combat bonus (they don't count; natural rolls only, minus the penalties) and the blind character is -10 to strike, parry and dodge, disarm, pull punch and similar combat moves! Speed is reduced by 30-50% (or should be) only because the blind character is unsure of himself and running or moving quickly is likely to cause him to stumble or trip into something and fall down (lose initiative and one melee attack/action), slam into a wall (1D6 S.D.C. damage, triple that if running) or run right into the arms of his opponent or some other danger. Obviously any skills requiring *vision* are impossible to perform.

Attacks per melee round and initiative are unchanged, but the character is lashing out wildly and guessing where his opponent is. This means the blind character has a good chance of accidentally striking a friend or innocent bystander by his wild flailing about or "blind shooting."

**Body Block/Tackle:** This is a combination of moves that involves a body block and a knockdown attack (counts as two melee attacks). A successful body block strike does 1D4 damage plus P.S. damage bonuses, and the opponent is likely to be knocked down. A successful strike always inflicts damage (from a shoulder, elbow, or tucked head), unless his opponent dodges (no damage and no knockdown), but the victim who is hit can avoid being knocked down only by trying to maintain his balance; roll percentile dice, characters with no special balancing abilities must roll above 80% or be knocked down. Those with a special balancing ability like those from Acrobatics or Gymnastics must roll under their current skill level (if 45% they must roll under 45, if 80% they must roll under 80). A successful maintain balance means the victim is not knocked down but loses one melee attack, and takes full damage.

Being knocked down causes the character struck to lose initiative (if he had it) and one attack/action for that melee round, plus he is knocked 1D6 feet away from where he was standing at the moment of the attack. A roll with impact can reduce damage by half, but counts as one melee action.

**Body Flip/Throw:** A judo style throw or flip that uses an attacker's own momentum and leverage to "flip" or "throw" him off his feet and onto the ground. Damage is 1D6 points plus P.S. damage bonus (if any), and the victim also loses initiative (if he had it) and one melee at-

tack. A body flip counts as one melee attack. A victim of a throw can try to *roll with impact/fall* to diminish the damage (half if successful), but other penalties are unchanged.

**Body Flip/Throw: Critical:** Characters with this attack inflict double damage; typically 2D6 + P.S. bonuses by rolling a certain "natural" die roll (a high number not modified with bonuses). The victim of a critical body throw loses initiative and two melee actions/attacks as a result of being thrown. This move cannot be done with an automatic body flip/throw because it is an attack, while the latter is a defensive move.

**Break Fall:** Also known as "ukemi," this is an advanced version of roll with punch/fall/impact. The character takes no damage if the break fall is successful, and only half damage if the roll for break fall fails! It can also be used against a knockout attack. A successful roll against knockout means the character takes normal damage, but is not stunned or unconscious. Note: The break fall uses up one melee attack each time it is used.

**Cartwheel (Attack):** Holding the body rigidly extended, the character rolls like a wheel by using the arms and legs as spokes. This maneuver can be used to move quickly into combat range. A cartwheel can also be used as part of a combined strike against an opponent to the rear of the character when used with either an Axe kick, Wheel Kick or Knife Hand. If striking with a cartwheel, use only the cartwheel bonus. Must be used as the first attack in a melee round. Note: Cannot be used with death blow or knockout/stun.

**Combat Bonuses:** All appropriate bonuses available to the character are added to the various fighting abilities such as strike, parry or dodge, as well as initiative and saving throws. High physical attributes, certain physical skills, weapon proficiencies (W.P.), the occasional O.C.C. bonus, racial bonus, and magic *may* provide one or more combat bonuses. All applicable bonuses are combined and added to the character's dice rolls. Do not combine the strike bonus with the parry bonus, and so on; each combat maneuver is considered a separate category, so only the various bonuses to strike are added to the strike roll, bonuses to parry added to the parry roll and so forth.

**Critical Strike:** A powerful, special or nerve shattering strike that inflicts double the usual amount of damage. Critical strike damage can be inflicted with bare hands or with a weapon.

**Damage:** The following are some of the typical damage amounts inflicted by the various types of punches and kicks. Each inflicts roughly the same equivalent S.D.C. or M.D. damage depending on whether the attacker is an S.D.C. being (like humans) or a Mega-Damage being (like power armor, robots, dragons and supernatural beings). Remember to add P.S. attribute bonuses to damage.

**Hand Strikes:**

Backhand Strike: 1D6

Body Flip: 1D6

Human Fist (punch): 1D4

Knife Hand: 2D4

Karate Strike: 2D4

Palm Strike: 2D4

Elbow/Forearm: 1D6

Power Punch: Does double damage + any other damage bonuses, but counts as two melee attacks. Applicable to all hand strikes.

**Foot Strikes:**

Kick Attack: 2D4

Karate Kick Attack: 2D6

Jump Kick: 3D6x2

Roundhouse Kick: 3D6

Snap Kick: 1D6

Wheel Kick: 2D6

Knee: 1D6

**Backward Sweep:** No damage, but knocks down opponent if strike is successful (he loses one melee action and initiative).

**Tripping/Leg Hook:** No damage, but knocks down opponent if the strike is successful (he loses one melee action and initiative).

**Power Kick:** Does double damage, but counts as two melee attacks. Applicable to all kick/foot strikes that inflict damage, except leap and jump kicks.

**Miscellaneous:**

**Thrown/Dropped Small Objects:** 1D4 or 1D6

**Thrown/Dropped Large Objects:** 3D6 per 100 lbs (45 kg) +10 per 40 feet (12.2 m) **Falling:** 1D6 per 10 feet (3 m).

**Collision:** 2D4 per 10 mph (16 km).

**Death Blow:** A special attack designed to kill an opponent in one or two strikes! This attack is often limited in hand to hand combat to the roll of a "natural" high strike number; i.e. death blow on a natural 18-20. Whenever the words "death blow" are presented without limitation, the character can use a death strike whenever he desires; however, such a devastating attack counts as two melee attacks/actions.

**Human vs Human:** Against humans and S.D.C. creatures, the attack does double the normal damage, plus P.S. bonuses direct to Hit Points. This attack can be used with punches and kicks or hand-held weapons such as swords, clubs, etc. It is not applicable to guns and does not work through armor; the armor must be removed or penetrated.

**Mega-Damage creature vs Mega-Damage creature:** The attack does double normal damage, plus P.S. bonuses, and it is so devastating to the creature's body that it cannot bio-regenerate injury from a death blow for 1D4 hours! This attack is not applicable against M.D.C. robots, cyborgs and power armor, unless the M.D.C. attacker is making a called shot to the head or power supply, in which case double damage is inflicted to that part of the robot or armor.

**Dice:** A typical set for role-playing includes two four-sided, four six-sided, two eight-sided, two ten-sided, and two twenty-sided, maybe a twelve-sided as well. These can be purchased at most gaming and hobby stores and some comic book shops that also sell games and gaming supplies. Even many mainstream bookstores may carry these multi-sided, or *polyhedral* dice, or can special order them for you. Dice are also available at gaming conventions and can be ordered by mail or over the Internet.

Often we let you know how many dice to roll with an expression like, "roll 3D6." This means, roll three six-sided dice and add the results together. Dice are also available with four sides (D4), eight sides (D8), ten sides (D10), twelve sides (D12) and even twenty sides (D20). Dice with more than six sides generally are called *polyhedral* dice.

**Disarm:** The act of disarming is simply getting rid of the opponent's weapon; it does no damage. It can be used as a defensive move in place of a dodge or parry, or can be done as an attack/strike.

The disarm move is a strike, hold or grappling maneuver that causes an opponent to drop his weapon or whatever he's holding. Counts as one melee attack/action. Disarm does not give the weapon to the character making the disarm move. True, the item is forced out of the victim's grasp, but it is either knocked away or falls to the ground.

Typically an opponent is disarmed on a roll of a natural 19 or 20 when used as a defensive move. Roll a disarming strike to attack as usual – high roll wins. A failed disarming attack does no damage and means one's opponent remains armed, is probably mad, and ready to strike.

**Dodge:** A character dodges by moving out of the way of the attack. Dodging always takes up one attack/action per melee round. To dodge, the defender must roll higher than the attacker's strike roll on a twenty-sided die.

**Drop Kick:** This is the combination of falling to the ground, a dodge and a kick. The kick can be either a kick attack, a snap kick or a crescent kick. It's done in place of a dodge (or as an attack) as a defen-

sive move. First, make the roll to dodge. If successful, then roll to kick. The opponent can defend normally. No bonuses to dodge, strike, kick or damage apply for this move. Uses up one melee attack/action.

**Entangle:** A defender can attempt to trap the weapon or arm of an attacker. This is done instead of parrying or dodging, and takes up one attack per melee. An entangle is successful if the defender rolls above the attacker's strike roll. It takes one attack and a roll to entangle to keep an opponent's arm or weapon entangled every melee round. In order to get free, the entangled opponent must roll a dodge against the entangle roll.

**Hand to Hand Combat:** Fighting skills that provide the character with attacks per melee, bonuses, and techniques. Characters without combat training have only one attack per melee and have no automatic chance to parry.

**Hit Points:** This is the number of points of damage a character can take before dying. Characters don't lose Hit Points until their S.D.C. is down to zero. A character's base Hit Points is the P.E. attribute plus 1D6. Another 1D6 of Hit Points is gained every time the character advances an experience level. Lost Hit Points are not recovered without medical attention.

**Holds:** Using both hands, the attacker grabs on to some part of the opponent's body and attempts to immobilize him. If the strike is successful, then the victim is helpless until released. Holds do no damage. Neither the attacker nor the victim can attack, parry or dodge while the hold is working. It's easy for the attacker to hold the victim so that some third character can attack unopposed or attack from the rear.

Getting out of a hold requires agility. Both the victim and attacker roll twenty-sided dice and add in their P.P. attribute scores. The person doing the hold also gets to add in all his bonuses to hold and from the P.P. attribute (if any). High roll wins! If the attacker wins, then the hold continues. If the victim wins, then the hold is released and combat can continue.

Types of holds include:

**Arm Hold:** This involves twisting the arm around to the victim's back. Any items in the hand of the arm being held can be easily removed.

**Leg Hold:** The victim is on the ground with his leg held up. There's no way for him to get up until the hold is released.

**Body Hold:** Any number of wrestling holds. The victim can be held on the ground or in a standing position.

**Neck Hold:** The victim is held around the neck from behind. This leaves the victim totally vulnerable to attacks from any other character.

**Horror Factor (H.F.):** Some creatures are so alien, monstrous-looking and frightening, that they exude what is called a Horror Factor. The first melee round that such a creature is encountered, everybody who sees it must roll to *save vs Horror Factor* (a 20-sided die is rolled).

A successful save is a roll equal to or higher than the monster's H.F., and means the defender is not impressed and may attack without hesitation or penalty. He does not have to roll to save again until their next confrontation/meeting in the future.

A failed roll means the individual loses initiative and one of his melee attacks for that round. He is also the last to attack. He must roll again the next melee round. Another failed roll means the same penalties are repeated. When he finally saves, he manages to gather himself and can fight without penalty.

**Initiative:** Whoever gets to attack first is considered to have the initiative and is the "attacker." Initiative is automatic in sneak attacks and long-range attacks. In most other cases, each opponent rolls a twenty-sided, highest roll gets the initiative. Rolling for initiative takes place at the beginning of each melee round of combat.

**Kick Attack:** This is a karate-style kick. It is a normal attack that does 1D4 damage for the untrained, or higher with hand to hand skills (1D6, 1D8, 2D4, 2D6). Anyone trained in hand to hand combat can do a kick attack.



**Kick Attack & Flying Jump Kicks:** There are a whole range of foot-based attacks. Each kick attack works differently and does different amounts of damage.

**Kick Attack:** This is a conventional, karate style kick. It starts with bringing the knee, folded, up to chest level, then the foot is completely extended. Does 2D4 damage.

**Snap Kick:** A very short, very fast kick. Usually delivered low, striking the opponent somewhere below the waist. It works well in confined spaces and in grappling range but does relatively little damage; only 1D6 damage.

**Roundhouse Kick:** By turning the body and swiveling the hips, there's tremendous power packed into this kick. Can be used only once per melee round, and no other kicks can be used in that melee round. Does 3D6 damage.

**Wheel Kick:** A damaging kick that involves sweeping the leg completely around the body. Cannot come right before or right after another kick. Does 2D6 damage.

**Crescent Kick:** A swivel-hipped kick that sends the foot out on a sweeping arc. Does 2D4+2 damage.

**Axe Kick:** A very high kick that goes up and over the opponent, coming down on the neck or shoulder. Can't be used in the same melee round with any other kicks. Does 2D6 damage.

**Backward Sweep:** Used only against opponents coming up behind the character. Does no damage, it's purely a knockdown attack. Cannot be parried.

**Tripping/Leg Hook:** An attack on the opponent's legs. Does no damage, it's purely a knockdown attack. Cannot be parried.

**Jump Kick:** A jump kick is performed by leaping completely off the ground and attempting to land foot-first on an opponent. Jump kicks can be used only by those skilled in Hand to Hand: Martial Arts. The advantage of a jump kick is that it works as a critical strike and doubles the normal damage inflicted. The disadvantage of a jump kick is that no other attack may be performed in that melee round (all attacks for that melee are used up in the kick). The jump kick must be the character's first attack of that melee round. For the rest of the melee round, the character can only parry, dodge or move into position.

**Jump Kick:** Critical strike inflicting 6D6 damage!

**Flying Jump Kick:** Must be made from long range. The character launches into the air, taking a position that will smash one foot into the opponent. Does 4D6 damage but counts as two melee attacks.

**Knockdown:** Getting knocked down, falling or getting struck by a fast, heavy vehicle, or explosion, or falling or getting knocked back dozens of yards/meters (30 feet/9 m or more) will cause the character inside to take damage from the force of the impact. While most armors are padded, they only provide so much protection.

**Damage:** Inflicts 1D6 Hit Point/S.D.C. damage for every 20 feet (6 m) one falls or is knocked back. And figure 1D6 points of damage for every 20 M.D. in an explosion. Round down. If the fall/knock back is 100 feet (30.5 m) or more, there is a 01-65% chance of being temporarily knocked out for 1D6 melee rounds.

**Penalties:** In ALL cases, when a character is knocked down or off his feet he automatically loses initiative and one melee attack/action. This is true even if the character is knocked down right where he was standing or only a few feet/meters.

**Knockout/Stun:** Anyone hit by a knockout or stun attack will be temporarily incapacitated. The victim is not necessarily unconscious, just dazed.

**Leap Attack:** An airborne assault where the weapons and or fists are wielded in mid-leap. A leap attack must be made only at the beginning of a melee round and, like the jump kick, uses up all attacks for that melee. Usually, only a single strike can be made during a leap attack. However, if two opponents are close together, the attacker can leap between them and strike both of them at the same time; roll to strike for each character. After the leap, the character may not attack

again until the next melee round, but can parry or dodge or move into position. Automatic parries work in mid-leap, but dodges are impossible. A successful leap attack is a critical strike and does double damage.

**Long-Range Attack:** By using a long-range weapon from a distance, an attacker can perform an undetected, first strike. Provided the attacker is not seen, the defender automatically loses initiative and may not dodge the first attack that melee round.

**Maintain Balance:** When some kind of knockdown attack has succeeded, while the character is starting to fall over, this is his last chance to attempt to recover. A successful roll (over the opponent's strike roll) means that the character will immediately regain his balance and remain standing. He can continue to fight but the act of retaining balance means he used up one melee attack/action. When maintain balance is used, then roll with punch/fall/impact or break fall can't be used.

**Melee or Melee Round:** Exactly 15 seconds. The segment of time combatants have to strike, counter and/or return strike. Generally, playing characters have two or more attacks per melee.

**Multiple Attackers:** Takes place when an opponent is faced by more than one attacker. Characters with hand to hand combat skills can attempt to parry any attacks within their line of sight. The defender from multiple attackers can strike at only one target at a time (see leap attack for a rare exception).

**Natural Twenty:** This is the result of 20 when rolling a twenty-sided die. A strike with a natural twenty will always be a critical strike. If someone with a strike bonus of +2 rolls an 18, then they have an attack roll of 18 plus unnatural, bonus modification; NOT a natural twenty, and is not a critical strike. A natural twenty beats all other rolls and can only be parried or dodged by another natural twenty.

**Paired Weapons:** Certain kinds of weapons, such as sais, nunchaku, daisho, knives, clubs and swords, can be used as paired weapons. Users of paired weapons can strike and parry simultaneously, can do twin strikes against a single target or against a pair of targets, and can parry two different opponents at the same time. In other words, warriors skilled in paired weapons often can do two actions for every one of their melee attacks (i.e. strike and parry). However, a twin, simultaneous strike with both weapons means losing the automatic parry and leaves the character open to his opponent's next attack without benefit of a parry (dodge is optional but uses up a melee action).

**Parry:** A defender can attempt to parry most physical attacks. This is done by blocking the attacker's blow with a weapon or hand. Characters trained in hand to hand combat can parry without losing melee attacks. Bullets and energy attacks cannot be parried!

**Power Punch:** A haymaker thrown with everything the character has, his every last ounce of strength. A power punch ALWAYS counts as two melee actions. A power kick can also be done. For characters with normal P.S., it does double damage in Hit Points and/or S.D.C. (normal punch damage of 1D4 times two plus any possible P.S. or Hand to Hand Combat damage bonus on top of that). Characters with extraordinary augmented P.S. or Supernatural Strength clearly indicate the damage inflicted in the listings presented at the beginning of this section.

**Punch:** A normal punch does 1D4 damage. A karate style punch or chop does 1D6 damage. A power punch does double damage (1D4 or 1D6 damage x2 or 2D4 or 2D6 damage) plus any damage bonuses on top of that. Hand to Hand Combat skills provide additional bonuses to damage as does having a high P.S. attribute.

**Pull Punch:** The ability to control the force of a hand to hand attack, whether it be a punch, kick or with a hand weapon. Usually used to reduce the blow to less than killing force. The character can choose to do half damage, quarter damage, a single point or no damage at all. A character must declare a pulled punch, and the player must roll 11 or better on a twenty-sided die (1D20) to successfully pull his punch. A failed roll to pull means full damage is accidentally inflicted. **Note:** A normal kick does 1D6 damage, a karate style kick does 1D8 (or 2D4) damage.

**Roll with Punch/Fall:** Hand to hand combat fighters can reduce the damage from blows and falls by rolling. If the defender is successful, then only half damage is taken. Roll with punch/fall does not work against energy blasts, bullets, fire, bladed weapons, psionics or radiation. Victims must roll higher than the attacker's roll. Falling characters must roll a 14 or higher, on a twenty-sided die, to roll with the fall.

**Saving Throws:** Occasionally, characters must roll to save against exotic attacks like poison, gas, insanity, psionics, etc.

**Disease:** 14 or better.

**Lethal Poison:** 14 or better.

**Non-Lethal Poison:** 16 or better.

**Harmful Drugs:** 15 or better.

**Acids:** No save possible – dodge!

**Insanity:** 12 or better (sometimes higher).

**Psionics:** 12 for Major & Minor psionics; 10 for Master, 15 for ordinary folks.

**Magic:** 12 vs basic spell magic; 16 vs ritual magic. The save against magic will be higher (13, 14, 15, and even 16) if the spell caster is high level.

**S.D.C.:** This stands for *Structural Damage Capacity*, which is the amount of damage an object can absorb before breaking. Living creatures also have S.D.C.; it represents their physical resistance to damage. All the S.D.C. of a living thing must be reduced to zero before the Hit Points can be affected.

**Simultaneous Attack:** Instead of defending with a parry, dodge or entangle, a character can choose to do a simultaneous attack. In this case, the character does not defend (“Go ahead, hit me; I can take it!”) and simply attacks in response. The advantage of a simultaneous attack is that neither opponent can parry, dodge or entangle. In all probability, both will take damage. Exception: An opponent with paired weapons can engage in simultaneous attack (with one weapon) AND parry (with the other), OR, both the paired weapons can be used to strike with NO parry.

**Sneak Attack:** An attacker may lie in wait (ambush), attack from behind, or sneak up (prowl) on an opponent. If the foe does not discover the attacker, then the sneak attack is successful. The sneak attacker always has initiative, and the defender is not able to parry or dodge the sneak attack.

**Strike:** Anyone attempting to hit an opponent must roll to strike. As with all combat rolls, a roll to strike is made with a twenty-sided die.

**Throw:** Simply, this means throwing a weapon. Rolling to throw is exactly the same as rolling to strike, except that there are different bonuses per weapon type. See Weapon Proficiency. **Note:** A character may use *any* type of weapon, but gets no combat bonuses, such as strike or parry, unless he has a Weapon Proficiency (W.P.) in that particular weapon. This applies to modern and ancient weapons.



# Ranged Combat

## Quick & Dirty Rules for Modern Weapons

**No Weapon Proficiency (W.P.):** Anybody who does not have a W.P. in a particular weapon type CAN use the weapon but without benefit of any bonuses. The bonuses that follow do not apply to this unskilled character, but a weapon can still be a deadly tool in his hands. P.P. attribute bonuses and Hand to Hand combat bonuses do NOT apply to modern weapons.

**Modern Weapon Proficiency (W.P.):** Characters with a modern W.P. can fire an aimed shot, a “Called Shot” (aimed at a specific location within a larger target), Burst or Wild. W.P. training in a particular class of weapon also enables the character to easily reload, disassemble, unjam, clean and otherwise maintain the weapon.

**Aimed shot.** Only a single shot can be accurately “aimed.” The skilled shooter is +3 to strike and gets an additional +1 to strike at levels 3, 6, 9, 12, and 15. This applies to all energy rifles, pistols, and grenade launchers, as well as automatic pistols, rifles and shotguns.

The ordinary, S.D.C. damaging *revolver* is +3 to strike and gets an additional +1 to strike at levels 3, 6, 9, 12, and 15.

A “Called Shot” is an aimed shot that homes in on a specific part of a larger target such as the head, hand, gun, radio on a character or the radio antenna, sensor cluster, spotlight, tires, etc. of a vehicle. An aimed, “Called Shot” is necessary to strike the tiny bull’s eye of a target, the sensor eye of a robot, or the gun held in an attacker’s hand (the target is the gun, not the person holding it). To make a called shot, the player must “call” or “announce” his character’s intention; i.e. “I’m going to shoot the gun from his hand.”

Small difficult targets usually inflict a penalty of -3 or -4 to strike even on a carefully aimed, “Called Shot.” The Game Master might want to make the “head” of living beings an automatic difficult target at -4 to strike.

Bonuses for an aimed shot apply to a Called Shot and may help to negate the aforementioned penalty. A Natural Twenty *always* hits its target (unless the defender rolls a Natural Twenty to dodge).

Anybody can *attempt* an aimed or “Called Shot,” even with a burst. An outright miss is a roll of 1-5, otherwise a failed shot (6-11) is presumed to hit the *main body*. One must roll a 12 or higher to hit a small, *stationary* target. Moving or dodging targets are more difficult to hit and require a roll of 12 or higher to strike. Also see Dodging & Parrying Ranged Weapons..

**Burst:** Automatic or burst firing is not intended to be accurate. Automatic weapons were designed to be rapid fire. The idea is that if a shooter (i.e. a green soldier with 10-16 weeks or less of combat training and no real-world combat experience) fires say 15 or 30 rounds, one or two are likely to actually hit their target. And if they don’t, that’s okay because it keeps the enemy pinned down and afraid to move forward. Unlike lunatic role-playing characters who shrug off four or five slugs as “minor damage” and charge their adversary, in the real world *nobody* is going to stick his head out to get shot, let alone charge the shooter in a hail of bullets. True, most of the rounds fired are *likely* to miss. MOST. But what about the one or two that *hit*? Does anybody want to take that chance? Not in the real world. Think about how many times you have seen news reports on television of a “drive-by shooting” and accounts of how 30, 50 or 100 rounds were fired, but only one or two people were hurt or killed. A hundred rounds and only two hits, possibly not even fatal ones! I recently saw a report about a crazed kid who shot his daddy’s Uzi at his father who was trying to pull away in his car. 17 rounds hit the car. Only three hit his father inside, most of





the others didn't even come close. One round killed the man. That is how automatic weapon fire and *bursts* work in the real world. Maybe one in six hit. More like one in 10 or 20.

**Bursts in role-play:** A burst is any pulse or rapid fire of two, three or more nearly simultaneous or rapid succession rounds or energy blasts at the same target. **Bonus:** +1 on any "aimed" burst whether it is a triple pulse laser blast or 10-80 rail gun rounds. Rail guns, automatic assault rifles, submachine-guns, machine-guns and any burst firing weapon only get the +1 to strike bonus due to the nature of the weapon itself.

**Note:** Unless a weapon states it can fire a *burst* of two or more simultaneous or rapid fire shots, it is best to assume it *cannot*. Most energy pistols can not fire a burst. Many rifles, and most assault rifles can perform burst fire. If the weapon stat block lists "burst" as an option but does not list burst damage, the weapon can fire a *double pulse burst*. Two simultaneous blasts inflicting twice the damage of a single shot. Only the weapons identified as "pulse" weapons will usually fire a pulse/short burst and lists pulse damage. The new "pulse" weapons typically fire *three* quick blasts. A pulse typically counts as one melee attack. Thus, a carefully aimed or a called single shot counts as one attack per melee round and so does a pulse or short burst. The aimed shot has a better chance to strike, the pulse or burst is less accurate but does more damage.

**Wild:** No bonus. Straight, unmodified die roll. Either they hit or miss. This applies when the gunman is shooting wildly, spraying an area or shooting while running, leaping, flying or from a moving vehicle.

**Spray Fire:** This is possible when shooting a burst at several different people at once. This is the same as *Shooting Wild* (see below).

**Range and Targeting (the rolls to strike):** When shooting at *stationary targets* within 60 feet (18.3 m), a gunman need only exceed a roll of 5 on a roll of 1D20; 12 or higher if the target is small and a "Called Shot" is required.

In combat at a greater distance (61 feet/18.6 m and farther), gunners must roll an eight or higher to strike a stationary target. High-tech sen-

sors, optics, targeting sensors and human augmentation are so incredible that there are no penalties for shooting at great distances other than the limitations of vision and the weapon's firing range. **Note:** A gunner *can* fire beyond his weapon's range, but he incurs an additional -1 to strike for every 25 feet (7.6 m) beyond the weapon's maximum *effective* range.

Fast moving targets (40 mph/64 km or faster) or targets that take evasive action are more difficult to hit and require a roll of 10 or higher to hit, plus he/she/it may get to dodge.

The attacker shooting at somebody who is *dodging* must roll higher than the target character's roll to dodge. Defender wins ties.

**Attacks per Melee:** Each blast (individual shot or pulse/burst) counts as one of the shooter's melee attacks/action. Thus, if the character has five attacks per melee round, he can shoot as many as five aimed shots (five single bullets or energy blasts) or five pulse blasts/bursts.

**Main Body:** The main body is typically the largest area of body mass offered by the target. On people that is the upper torso. The main body of an automobile is the large body mass that covers the frame. Parts not considered to be part of the main body include the tires/wheels, legs, arms, hands, sensor cluster, mirrors, headlights, radiator grille, weapon turrets, hover jets, and so on. Each full description of bots and vehicles indicates what is the main body and what is not. To strike something other than the main body, the attacker must make an aimed, "Called Shot," or roll a natural twenty.

**Payload:** Is typically listed in single shot increments, so a pulse or burst uses up more energy or ammo. A listing of "unlimited" means the weapon draws from a larger power source from the power armor, robot or vehicle itself. Most pistols and rifles, however, use an E-Clip with a finite payload. E-Clips can be recharged but not usually on the field of combat (need a supply depot or field base).

## Understanding High-Tech Weapons

**Pulse Weapons:** Many high-technology weapons, automatic weapons and the energy weapons of the future can fire multiple simultaneous rounds or bursts. Some high-tech weapons, like the *pulse rifle*, are designed to automatically release three rapid-fire energy pulses, instead of one shot, every time the trigger is pulled. The three energy pulses are so quick that they appear as one blast and only *one roll to strike* is required.

Pulse weapons are *burst weapons* and the burst rule applies even to "aimed pulse" blasts (really three simultaneous energy blasts; i.e., burst: +1 to strike).

**Weapons capable of aimed shots** are often considered to be "assassin," "sniper" or "sharpshooter" weapons. Some have a switch that allows them to fire either a single shot or a burst/pulse. The aimed shot is always a careful and deliberate act of targeting and the shooting of one round/bullet or a single energy blast. The act of carefully aiming takes a bit of extra time but provides far greater accuracy and still counts as one melee attack per each aimed shot.

**Sniper rifles** are multipurpose weapons for use in field combat, sniping and assassination. Some can only fire one single shot per attack, others have the dual capability of firing a single shot or squeezing off automatic burst fire or a pulse energy blast. These rifles are designed for accuracy and usually enjoy an additional bonus to strike on a "Called Shot," or an aimed, single blast. Not all rifles can fire a single shot and many of those that can do not necessarily get a special strike bonus from the weapon itself. Weapons that are expertly balanced will indicate what the strike bonus is in its description (typically +1). Even amateurs get this bonus if it is built into the weapon itself.

**Pump weapons & grenade launchers** are not designed for accuracy or great range, but those specialists who have a W.P. in Heavy Energy Weapons do get the +3 bonus to strike on an *aimed shot*, but only if a *single* blast or grenade is fired. Shooting more than one pump blast

or grenade in rapid succession is considered a *burst* and gets only the +1 bonus to strike.

**A Special Note About Shotguns.** Shotguns can fire once or twice per melee (double-barrel). It can fire both rounds simultaneously or one at a time. Buckshot scatters, and will strike the specific target plus 1D4 others within its blast area (approximately a 15 foot/4.6 m area). A double barrel-blast counts as one melee action.

**Reloading.** Most conventional and energy automatic weapons require little time to reload. The process is a simple matter of retrieving a new, loaded ammo clip from its storage belt or compartment, removing the empty clip and slapping in the new, loaded clip. Except for extenuating combat conditions, the reloading takes a few seconds and counts as ONE melee attack/action.

Manually reloading grenade launchers, mini-missiles, shotguns, bolt-action rifles, revolvers and similar weapons requires more time because, typically, the spent cartridges must be removed and each new round must be loaded, by hand, one at a time. Even so, a revolver can be reloaded in about six to eight seconds and counts as two melee actions if the character has a W.P. in the weapon being loaded. Characters without a W.P. will need a full melee round or four melee attacks (whichever is shorter) to manually reload. Revolvers can be loaded in the time of one melee attack/action when a speed loader is used. Cost of the speed loader is 100 credits. The speed loader must be hand loaded in advance.

**Character P.P. Bonuses** do NOT count when shooting an automatic weapon, rail gun, shotgun, energy weapon or any modern weapon. The mechanical design and capability of the weapon makes its use and abilities quite standard. Only the *Sharpshooting skill* provides an additional P.P. bonus when using a mechanical, long-range weapon, be it gun or bow and arrow. And there are very few Sharpshooters in the world (available to select O.C.C.s).

**Natural Energy Blasts.** Supernatural beings whose power enables them to emit energy blasts, whether it be fire, electricity, or other forms of energy, can use their energy attack as often as their combined hand to hand attacks allow. For Example: If the creature has four hand to hand attacks, it can fire energy blasts as often as FOUR times per melee round (15 seconds). If the character has five or six hand to hand attacks, five or six blasts can be fired. As always, the types of attacks can be combined.

**Radar Notes:** Size: Most radar units can only detect targets that are the size of a goose (30 lbs/13.5 kg) or larger.

Low to the Ground: Most radar units lose "track" of targets flying at treetop level, roughly 100-150 feet (30.5 to 46 m). In an open, flat land it can detect flying objects (and people) as low as 50 feet (15.2 m).

**Suiting up in Body Armor** by a practiced man of arms takes 1D4+4 *melee rounds* (in about a minute and a half to two minutes). All others need 1D4+4 *minutes* to suit up. Both can strip down in about half that time.

**Suiting up in Power Armor** is about the same as body armor. The pilots who work for an army or military outfit usually have their power armor prepared and ready to go at a moment's notice and have a team of technicians to do prep work for them and to help them suit up. They can suit up in power armor in about *one minute*. Body armor still takes the 1D4+4 *melee rounds* because there are more pieces and dressing up to do.

## Definitive Dodging Rules vs Ranged Attacks

Incoming gunfire from rail guns, energy blasts, launched grenades, missiles, and other high-speed projectiles are so fast that they are really difficult to dodge and virtually impossible to parry. Only rare, select O.C.C.s offer superior dodge and parrying abilities against such attacks.

To attempt to dodge high speed attacks, the character must *realize* that he is about to be fired upon and *see* where the attack is coming from (i.e., the glint off the gun barrel from the sniper in the tree to the right, or the Silver Eagle flying in at 12 o'clock). In all cases, the attacker rolls to strike and the defender must roll to dodge on a D20 as usual. High roll wins. Defender always wins ties. So far, it works just like a normal dodge. Except one has to factor in certain penalties. And this is where things get sticky for the dodger.

**First,** NO attribute or skill bonuses to dodge apply against modern weapons! Only an unmodified die roll counts! There are a few rare exceptions like the Juicer and a couple of others where their O.C.C./R.C.C. gives them the ability and a possible bonus to dodge bullets and energy blasts.

All the usual, applicable bonuses apply for the shooter.

**Second,** the dodger is -10 to dodge at *close range* (within 400 feet/122 m) of the shooter, and -6 to dodge from long-range attacks when the shooter is more than 200 feet (61 m) away. No penalty to dodge if the shooter is not using a telescopic scope and attempting an aimed shot (bursts and wild shooting just aren't that accurate).

**Third,** high roll (to strike vs to dodge) wins and the defender always wins ties.

### Shooter Considerations & Penalties

1. Don't forget that a roll of 1-4 automatically misses even a stationary target. Moreover, only a roll to strike that is *12 or higher* (12-20) hits a *moving target*. A roll of 1-11 misses! Thus a roll of 12-20 is needed to hit and other penalties may reduce the odds to hit even more. Hitting a small or moving target is more difficult, for example (see #2).

2. Small targets are -3 or -4 to strike even with a carefully aimed or "Called Shot." That penalty also applies to burst attacks and shooting wild. That means the shooter must roll a 14 or 15 or higher to hit if he is a good distance away (making his human target small).

**Special dodge move, compensation:** If the character under attack forfeits *all* of his attacks that melee round and does nothing but dodge the *entire round*, from beginning to end, and runs from cover to cover to hide behind between moves, he is -4 to dodge at close range, -2 to dodge attacks from a distance and can apply his P.P. dodge bonus (if any). These modifiers do not apply in an open field without cover where the dodger is a sitting duck no matter how much he ducks and tumbles.

Sorry, it is virtually impossible to dodge an arrow or bullet, let alone an energy blast. That's why they invented body armor and tanks.

One might argue that it is completely impossible to dodge or parry a bullet or an energy blast, but here are two things to consider that makes the dodge appropriate. One, many of the **Chaos Earth™** player characters are superhuman, whether they are supernatural, alien or have been mechanically, chemically, magically or otherwise *augmented* beyond the normal range of human ability. Two, one might think of the dodge roll not so much as the character seeing and moving out of the way of an energy blast, but as a combination of an attacker's penalty for shooting at a moving target and the luck of the intended victim. It is always more difficult to hit a moving/dodging target than it is to hit a stationary target. Even today, people "dodge the bullet" by means of running in a zigzagging pattern, executing a quick movement, or by leaps and rolls behind cover.

In many instances, it is more luck than anything else. Obviously, the intended victim cannot see the bullet coming, but he can judge the angle of trajectory by observing the movement of his attacker and the direction of the attack, giving him a chance to try to move out of harm's way. Success may be luck, but it can work.

Yes, a dodge does count as a melee action. Each melee action counts as one melee attack, so each dodging action means the character loses one of his melee attacks. This could mean using up all of one's own attacks by dodging, which will place that individual completely on the defensive. But this happens in real life. The character under attack could spend the next 30 to 60 seconds running and dodging blasts from



an attacker until the attacker runs out of ammunition and has to pause to reload, gives up the attack or an ally takes him down. At that moment, the dodging person, on the defensive, can continue to run away, or hide, or turn and counterattack. At some point, the character may have to decide to stand and take his chances of getting hit in the fire fight in order to shoot back and inflict damage of his own.

**Shooting Wild modifier:** Shooting Wild includes shooting while running, riding a horse, or from a moving vehicle or an unstable/awkward position. Whenever "Shooting Wild," the *shooter* fires WITH-OUT benefit of bonuses, requiring an unmodified die roll on a 1D20.

If the target is small or partially *obscured* by other people, obstacles, ground cover, smoke, etc., the shooter is -4 to strike, so he must roll a 15 or higher to hit! At the G.M.'s discretion, that penalty could be increased to -6, but only if the target is *barely visible* (protected by dense cover) and only a tiny part of him can be seen for a second at a time.

**The -10 unmodified dodge rule** (straight roll of the dice) at *close range* (within 400 feet/122 m) works and makes sense, especially if the target is out in the open, or the two characters are *facing-off* gunslinger (or John Woo) style. Stop and think about it for a minute. We are talking about advanced weapons, with computer and/or laser targeting, and other special optics, and many weapons are energy blasters. If a character is in the cross hairs of a sniper's sight or close range, he *is* likely to get shot. Not killed, necessarily, but definitely shot. And if the shooter is standing still and making an *aimed* or *Called Shot*, he enjoys bonuses to hit as per his Weapon Proficiency (W.P.) skill. Guns are not elegant, personal, close-up and one-on-one weapons like swords, knives, maces, and other melee weapons. That is why guns replaced sharp sticks, clubs and blades centuries ago.

**Who can dodge a bullet.** Exceptional characters can *try* to dodge bullets and energy blasts. This can be extended to include the *Juicer*, *Crazy*, *Cyborgs* and other beings with a speed attribute of 120 or greater, and any O.C.C., R.C.C. or power armor that states the character gets an *automatic dodge*. HOWEVER, the character is not so much dodging the blast itself, but anticipating it and moving accordingly to avoid it.

The way I play this is to have the shooter and the dodger roll initiative. If the shooter wins the initiative roll, he fires before the defender/dodger can react. I then have the shooter roll to strike. Any roll above 10 at close range or at a (relatively) stationary target strikes; 12 hits if shooting at a moving target. Full damage is done to the intended target, but don't forget that a successful *roll vs punch, fall or impact* can *reduce damage* from projectiles and explosives by half. Energy blasts do full damage if they hit.

If the initiative roll of the defender/dodger is higher than the shooter, he anticipates the attack and is able to start moving a split second before the shot is fired. I then have both the shooter and the dodger roll again on a D20; high roll wins. If that is the dodger, then the gunfire misses him and the shooter wastes an attack. If the dodger's roll is below that of the shooter, he fails to dodge and is shot and takes full damage. In this case, only a roll of 1-4 will miss and no bonuses apply for either the shooter or the dodger, unmodified die rolls for both. Making it quick and straightforward. **Note:** For dramatic purposes, I *sometimes* use the same rules to see if a spellcaster or psychic can raise a force field, energy armor or barrier in time to block the gunshot, especially if the character is trying to save an innocent person rather than himself. This, rule can also be used to see if a character can dive and knock the intended target out of harm's way. However, the diving hero is likely to get shot in his place. After all, the character is trying to "save" somebody else and his focus and action is devoted to that purpose, making it impossible for "him" (or her) to dodge the attack. I usually reward such heroics by inflicting half the normal damage. Anybody can *attempt* to dodge an attack if they know they are under attack and can see their attacker (via optics, sensors, muzzle flash of the attacker, psychic intuition, etc.).

**Mitigating Circumstances.** As always, the G.M. should use common sense and think about the environment and situation. There are often (not always) *mitigating circumstances* to consider. For example, if the shooter is shooting "blind" he is -10 to strike. If there is a lot of ground cover, the shooter must roll a 12 or higher to hit his intended target, and is -4 to strike if he himself is moving while shooting or if the target is especially small (needs a 16 or higher to hit on an unmodified die roll).

Likewise, in environments where there are plenty of obstacles for the target to hide behind, I would allow the character (even unexceptional ones) the *chance* to dodge (probably diving) behind some kind of protective barrier. This applies *only* if the target knows he is about to be shot at, and the dodge attempted uses up *one melee action* whether it is successful or not. As always, the high roll wins. Defender/dodger wins ties.

## Parrying Energy Blasts

Similar to dodging ranged attacks:

**First**, to even consider a parry, the character must have a suitable weapon or shield to block the attack. If the attack is M.D. it must be an M.D.C. item (Psi-Sword and Psi-Shield work great). If the parry is successful, that *item* is struck and takes the brunt of the damage. If it is destroyed by the blast, any damage above the M.D.C. of the item goes to the character using it to block/parry the blast. Explosives can not be parried and do full damage.

**Second**, NO attribute or skill bonuses to parry apply against modern weapons! Only an unmodified die roll counts! There are a few rare exceptions like the Juicer, and Samurai and Ninja of Japan and a couple others where their O.C.C./R.C.C. gives them the ability and a possible bonus to dodge bullets and energy blasts.

**Third**, the character is -10 to parry at close range (within 400 feet/122 m) of the shooter, and -12 to parry from long-range attacks when the shooter is more than 500 feet (152 m) away. In this case, the character is not likely to see the attack coming until it hits.

**Fourth**, high roll (to strike vs to parry) wins and the defender always wins ties. **Note:** All the usual bonuses apply for the shooter.

**Some additional notes:** Men at Arms are +1 to parry at point blank range (within 30 feet/9.1 m).

Grenades, missiles, explosives and other area effect weapons/damage cannot be parried, but a dodge may be possible depending on the size of the area engulfed in the blast, the agility of the dodger, and the roll of the die.

## Shooting Wild

Shooting wild occurs under the following conditions.

- When a character is shooting in the general area of the intended target, but has not taken the time to carefully aim.
- Can not actually see his target. This includes shooting at targets concealed by trees or other forms of vegetation, concealed by smoke, shooting through a door or wall, shooting around a corner without looking, when blinded or if an opponent is invisible, and when shooting and trying to do something else like performing a different skill at the same time; i.e., running, leaping, flying, driving a vehicle, talking to somebody, or concentrating on a second task or action.
- When shooting from a moving position; i.e. a moving car, hover vehicle, horse or other moving platform. This does not include the firing of weapon systems built into power armor, robots, cyborgs, or mounted weapons or turrets built into combat vehicles. Nor is it applicable to super-heroes and mutants or monsters that can shoot energy beams, or similar powers, from their natural bodies. This rule applies to people who are shooting a hand-held weapon while hanging out of the window of a moving vehicle, dangling from an aircraft, standing on a moving platform, shooting from the back of a racing animal and similar conditions.

- When terrified or in a berserker rage. At the G.M.'s discretion, this may apply to characters who are shooting after having just recovered from a failed Horror Factor roll.
- Whenever the shooter is spraying a general area with random gunfire rather than focusing on a specific target.
- The subsequent blasts after the first burst from a Chromium Guardsman's Boom Gun if the Guardsman is NOT secured to the ground (the recoil suppression systems must be engaged; thrusters and pylons). If secured by a properly engaged recoil suppression system, the Boom Gun fires like a normal burst weapon.
- When the character does not have the W.P. skill for the weapon he is firing. Characters without a weapon proficiency (W.P.) can attempt to use any weapon. It is not difficult to pick up a gun and pull the trigger, anybody can do that. However, it is another thing to be able to use the weapon with any knowledge, skill or accuracy. Thus, a character who does not have a W.P. for the weapon NEVER gets any of the W.P. bonuses, not the +3 for aimed shots or the +1 for bursts. Any bursts/rapid shooting by somebody untrained in the required W.P. is considered shooting wild (-6 to strike). An untrained person trying to shoot a single aimed shot rolls the standard strike roll without benefit of bonuses.

The penalty for shooting wild is -6 to strike.

## S.D.C. weapons vs opponents in "partial" M.D.C. body armor

There are two possible sets of rules that could be used in this case.

The first is to require a "called shot" only to target openings in the body armor. 12 or better is required to strike a stationary target. 15 or higher to hit a moving target and 17 or higher to hit a fast moving target. If the opponent knows the attack is coming, he gets to dodge as normal; high roll wins, defender wins ties (which means the dodging character successfully dodges and escapes his S.D.C. parts getting hit).

If the called roll is successful then the M.D.C. armor has been bypassed through the gap in the armor and the character takes the damage. **Note:** Without the called shot strikes are presumed to hit the main body which would be covered by the M.D.C. armor.

The second option is to assign the armor an Armor Rating (A.R.) and to hit the character wearing the armor the attacker needs to roll above the A.R. of the target. Rolling below it means the armor takes the damage. **Note:** Ignore the A.R. if the attacker is using M.D. weapons as the lethality aspect will blast right through the armor, although the armor takes damage first. In some rare cases where S.D.C. armor numbers into the hundreds of S.D.C. a low intensity M.D. blast *might* be absorbed by the armor. In this case, every 100 S.D.C. points equals one M.D. point.

Both sets of options are considered to be equivalent, though coming from different points of view.

## Missile Combat

The descriptions of war machines in this game will specifically state if they can launch missiles. It will also denote the type of missile as short-, medium-, or long- range, or mini-missiles, and some can fire two or more different types of missiles. Under each of the above range categories is a selection of specific types of warheads, such as high explosive, fragmentation, plasma and so on (see missile chart). Not all missile warheads are of a destructive nature and can be smoke, tear gas or chemical (i.e. fire retardant, and knockout gas).

### Strikes: Guided Missiles

Missiles do not enjoy the pilot's combined bonuses to strike. Since they are all self-guided, missiles are launched as separate units with

their own bonus of +3 to strike. Smart bombs are +5 to strike.

Rolls to strike are made as usual, with a twenty-sided die (1D20). Depending on the launch system, payload and number of launchers, missiles can be launched one at a time (roll to strike for each missile fired), or in *volleys* of two or more (roll once to determine whether the entire volley strikes or misses).

It is possible to dodge one, two, or even three missiles. However, it is impossible to dodge a volley of four or more missiles. It is also possible to shoot a missile(s) down before it hits you. See Shooting Missiles, and Dodging Missiles for more details about missile combat.

## Damage From Missile Strike

**Direct hits** are when the missiles impact directly on the player character (or his robot, power armor, vehicle, etc.). A direct hit does full damage. A volley of missiles inflicts full damage for *each* missile in the volley.

**Blast radius or near misses.** Getting caught in a blast radius does half damage. Your companion standing 10 feet (3 m) away is hit by a high explosive missile with a 30 foot (9.1 m) blast radius. He takes full damage from a direct hit, but your character is also caught in the blast radius. Fortunately, distance buys your character some luck and he takes half damage since he was not caught directly in the blast. Damage can be reduced by half again if the player makes a successful die roll to "roll with punch, fall or impact."

**Roll with impact.** Whenever a character is struck by an explosive force or impact, he can attempt to roll with the force to minimize the damage. This is where roll with punch, fall or impact comes in. A successful roll means half damage. The number that must be matched or overcome is the attacker's roll to strike – or – if a strike number is not available (say from a booby trap, mine or automated system), a 14 or higher must be made to successfully roll with impact. A successful roll with impact, whether from a direct hit or blast radius, means the character suffers half the normal damage. A failed roll means full damage.

## Dodging Guided Missiles

ALL the missiles used by NEMA, the US military and most other high-tech forces, are self-guided missiles. Generally, most are preprogrammed to respond to specific images (video camera/sensor mounted in the nose of the warhead), or specific heat or radiation levels which clearly identify the enemy.

**Smart Bombs** are missiles that can identify an enemy target and chase it down. The missile will give pursuit and keep going until it finds a target, is itself destroyed or it runs out of fuel. Smart missiles can actually dodge attacks directed at them, swerve, and turn around to follow or hit a target, turning around and giving it another go if it misses the first time or if the target dodges the first attack.

**Conventional Guided Missiles:** +3 to strike.

**Smart Missiles:** +5 to strike, +4 to dodge, and has two attacks per melee (until it hits). All missiles always strike the main body.

## Dodging Missiles

Contrary to what one might think, a character can dodge one, two and even three guided missiles. The dodge rules are the same as always. However, it is impossible to dodge a volley of *four or more* missiles launched simultaneously. A volley of four or more missiles will strike every time, with each and every missile in the volley hitting and inflicting damage. The character has two options to avoid or minimize the damage of a massive missile volley: try to roll with the impact (taking half damage) or *shoot* the missiles down before they strike.

If a missile cannot be dodged and the defender is driving a robot vehicle, the pilot can sacrifice his robot's arms by covering its main body with them, thus allowing the arms to take the damage instead of the



## Shooting Missiles

Shooting and depleting the M.D.C. of a missile can detonate and destroy it. However, there are restrictions.

1. The character must have an attack available to him/her that melee to fire at the missile. If all the attacks for that melee round have already been used up, the character is out of luck and can't shoot at the incoming missile(s).

2. The character can only shoot at *one* missile within the volley, at a time. A volley of six missiles would require six separate attacks, which is impossible at the speed missiles travel. This means the character has only one or two melee attacks (G.M.'s discretion) to shoot at one or two missiles within the volley. However, if even if only *one* missile is detonated, there is a 01-45% chance that its explosion will detonate the other missiles in the entire volley.

The character can also use his own missiles, if available, to shoot down a missile volley. Under this circumstance, there is a 01-75% likelihood of detonating the entire volley of missiles (100% if the character fires an equal number of missiles to match those incoming).

3. If the M.D.C. of a missile is not completely depleted, it is damaged but does not detonate and *will* still strike its target, inflicting full damage.

4. Attacks on a missile count as a normal melee attack/action.

## Missile Terms

**Missile Payload:** Indicates the finite number of missiles contained by the launcher, robot or vehicle.

**Missile Range:** The maximum effective range or distance a missile can travel before running out of fuel and crashing to the ground. There is only a 01-33% chance the missile will explode on impact, which means it can be salvaged and reused. However, less than 5% fail to hit a target and detonate before running out of fuel.

**Rate of Fire:** This indicates how many missiles can be fired at a time. Note that most launch systems that can fire multiple missiles in a volley can also elect to fire one missile at a time. *A missile volley* counts as one melee attack and gets one roll attempt to strike. Either the entire volley hits or it misses, though if a near miss its intended target may still suffer collateral damage (half) for being caught in the *blast radius*.

**Missile Notes:** The terms, light, med. or medium and heavy, found in parentheses after the warhead type, refer to the destructive force of the warhead.

**The speed** is provided to give players an idea of how fast the missiles travel.

**The maximum range** is the maximum distance and effective range of the missile.

**Missiles have a low M.D.C.,** depletion of the M.D.C. from attack will detonate the missile.

**The blast radius** is the full area damaged by the missile impact. The specific target of the missile takes **FULL DAMAGE**, while all else in the blast radius takes half damage.

**All missiles** are self-guided; +3 to strike.

**Smart missiles** are self-guided smart bombs which can be programmed to seek out and attack a specific target. They can change course, adjust speed to conserve fuel, dodge attacks aimed at them, and turn around to try to strike a target again if they miss the first time. +5 to strike (instead of +3), +4 to dodge; 2 attacks per melee. Radar 100 mile (160 km) range.

**Multi-warhead missiles** are usually a cluster of medium-range missiles housed inside the casing of a large, long-range missile. When the body casing runs out of fuel or reaches its target, it fires the four medium-range missiles.

**Plasma** is a concentrated, liquid heat, ten times hotter than normal napalm.



body. The disadvantage of this tactic is that the arms are likely to be blown to smithereens, but the main body and remaining weapon systems and locomotion are left intact. If the arms are not destroyed, I strongly suggest the G.M., or player, roll on the Optional Critical Damage Tables under "arms," to determine specific damage and side effects.

### Short Range Missiles

<u>Warhead</u>	<u>Mega-Damage</u>	<u>Speed</u>	<u>Maximum Range</u>	<u>Blast Radius</u>	<u>M.D.C.</u>
High Explosive (light)	2D4×10	500mph (804kmph)	5 miles (8km)	10ft (3m)	5
High Explosive (medium)	2D6×10	500mph (804kmph)	5 miles (8km)	15ft (4.6m)	5
Fragmentation (light)	2D4×10	450mph (724kmph)	3 miles (4.8km)	20ft (6.1m)	5
Armor Piercing (medium)	2D6×10	650mph (1045kmph)	5 miles (8km)	5ft (1.5m)	5
Plasma/Napalm (medium)	2D6×10	500mph (804kmph)	3 miles (4.8km)	15ft (4.6m)	5
Tear Gas	None	200mph (321kmph)	1/2 mile (.8km)	10ft (3m)	5
Knock-Out Gas	None	200mph (321kmph)	1/2 mile (.8km)	10ft (3m)	5
Smoke (colors available)	None	300mph (482.7kmph)	1 mile (1.6km)	20ft (6.1m)	5
Fire Retardent	None	200mph (321kmph)	1/2 mile (.8km)	20ft (6.1m)	5

### Medium Range Missiles

<u>Warhead</u>	<u>Mega-Damage</u>	<u>Speed</u>	<u>Maximum Range</u>	<u>Blast Radius</u>	<u>M.D.C.</u>
High Explosive (light)	2D4×10	1200mph (1929kmph)	50 miles (80.4km)	20ft (6.1m)	10
High Explosive (medium)	2D6×10	1200mph (1929kmph)	40 miles (64.3km)	20ft (6.1m)	10
High Explosive (heavy)	3D6×10	1200mph (1929kmph)	40 miles (64.3m)	30ft (9.1m)	10
Fragmentation (light)	2D6×10	1000mph (1608kmph)	40 miles (64.3km)	40ft (12.2m)	10
Armor Piercing (medium)	3D6×10	1600mph (2571kmph)	60 miles (96.5km)	20ft (6.1m)	10
Plasma/Napalm (medium)	4D6×10	1400mph (2251kmph)	40 miles (64.3km)	40ft (12.2m)	10
Multi-Warhead*	5D6×10	1200mph (1929kmph)	80 miles (128.7km)	20ft (6.1m)	10
Smoke (colors available)	None	1000mph (1608kmph)	40 miles (64.3km)	40ft (12.2m)	10

### Long Range Missiles

<u>Warhead</u>	<u>Mega-Damage</u>	<u>Speed</u>	<u>Maximum Range</u>	<u>Blast Radius</u>	<u>M.D.C.</u>
High Explosive (medium)	3D6×10	2010mph (Mach 3)	500 miles (804km)	30ft (9.1m)	20
High Explosive (heavy)	4D6×10	2010mph (Mach 3)	500 miles (804m)	40ft (12.2m)	20
Fragmentation (light)	2D6×10	1400mph (2251kmph)	400 miles (643km)	80ft (24.4m)	20
Armor Piercing (medium)	3D6×10	2010mph (Mach 3)	800 miles (1286km)	30ft (9.1m)	20
Plasma/Heat (medium)	4D6×10	1400mph (2251kmph)	500 miles (804km)	40ft (12.2m)	20
Plasma/Heat (medium)*	5D6×10	1400mph (2251kmph)	500 miles (804km)	50ft (15.2m)	20
Proton Torpedo (heavy)*	6D6×10	2010mph (Mach 3)	1200 miles (1928km)	50ft (15.2m)	25
Nuclear (medium)*	1D4×100	2010mph (Mach3)	1000 miles (1608km)	40ft (12.2m)	20
Nuclear (heavy)*	1D6×100	2010mph (Mach 3)	1000 miles (1608km)	50ft (15.2m)	20
Nuclear Multi-warhead*	2D4×100	2010mph (Mach3)	1800 miles (2893km)	50ft (15.2m)	25

### Mini Missiles and Special Armaments

<u>Warhead</u>	<u>Mega-Damage</u>	<u>Speed</u>	<u>Maximum Range</u>	<u>Blast Radius</u>	<u>M.D.C.</u>
High Explosive	5D6	500mph (804kmph)	1 mile (1.6km)	5ft (1.5m)	1
Fragmentation	5D6	500mph (804kmph)	1/2 mile (0.8km)	20ft (6.1m)	1
Armor Piercing	1D4×10	1400mph (2251kmph)	1 mile (1.6km)	3ft (0.9m)	2
Plasma/Napalm (medium)	1D6×10	1200mph (1929kmph)	1 mile (1.6km)	15ft (1.5m)	1
Smoke (colors available)	None	500mph (804kmph)	1/2 mile (0.8km)	20ft (6.1m)	1

\*Available as smart bombs, +5 to strike.



**Fragmentation** missiles are missiles that send out fragments, or shards of metal, upon impact, affecting a larger area.

**Fire Retardant** missiles explode, releasing a chemical foam that puts out fires.

**Smoke** missiles release large, billowing clouds of smoke, filling the blast radius. They are used to provide cover or to mark an area.

A **Proton Torpedo** is a longer range, more powerful, explosive, energy missile.

## Mini-Missiles

Many of the smaller robots, power armor suits, and combat vehicles (even a few hand-held weapons) fire *mini-missiles*; small, powerful bazooka type rockets that inflict Mega-Damage. Range is generally one mile (1.6 km) and damage considerable for such a small rocket.

Unlike its larger predecessors, the mini-missile is not self-guided and has no special bonuses to strike. The shooter must aim, point and shoot; +3 to strike with an *aimed* or a *Called Shot*, +1 to strike with a burst/volley, no bonus for shooting wild.

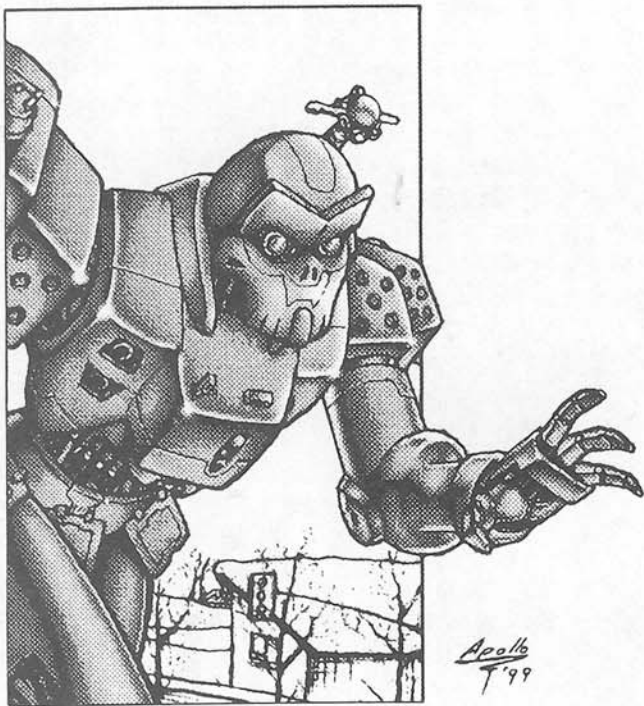

## Optional Robot Combat Damage Tables

Here are some optional hit location and damage tables for bots, robot vehicles and power armor. Rather than make the tables a completely random hit location and side effect table, I have opted for a table of side effects measured by the amount of damage the machine has endured. Obviously, if a robot's hand is blown off he loses the use of that hand.

### Side Effects by Location

The following optional tables can be rolled on when a specific hit location has suffered major damage (a loss of 60% of the M.D.C. in that location/limb).

## Hands

**01-30%:** Paralysis! Cannot flex fingers or pickup and carry or hold an object. The hand is in an opened position, the fingers spread slightly apart. Cannot make a fist, punch does half damage.

**31-50%:** Frozen in one position. The hand and fingers are locked in the configuration it was in when the damaging blast struck. This may mean locked in a fist, or clutching a weapon, etc. Punch does half damage unless in a clenched fist or karate style open fist.

**51-75%:** Structurally weakened. Cannot lift, carry or hold more than 200 pounds (90 kg). Punch does half damage.

**76-00%:** Joints lock at random times without warning. Roll every time the hand is used. 01-50% chance that the hand will suddenly lock-up/freeze and cannot perform the desired function (pick up, hold, etc.). Stays frozen for 1D4 melees.

## Arms

**01-20%:** Paralysis! Cannot move. Just dangles uselessly at the side of the robot. Cannot strike or parry with that arm.

**21-30%:** Frozen in one position. The arm is locked in the configuration it was in when the damaging blast struck. This may mean locked in a raised, outstretched or other position. Cannot make a strike or parry with that arm unless the robot moves its entire upper body to do so. Damage is half.

**31-50%:** Sluggish response. Penalty: -1 hand to hand attack per melee and -1 to parry.

**51-60%:** Structurally weakened. Cannot lift, carry or hold more than 300 pounds (135 kg). Punch does half damage.

**61-80%:** Joints lock at random times without warning. Roll every time the arm is used. 01%-50% chance that the arm will suddenly lock-up/ freeze and cannot perform the desired function (punch, move, etc.). Stays frozen for 1D4 melees.

**81-00%:** Any special weapon or sensor features built into the hand, arm, and shoulder do NOT respond. Special systems are completely inoperable; requires 1D6 hours of repairs.

## Legs

**01-20%:** Frozen in one position. The leg is stiff and unmoving. Cannot bend, reducing speed by 50%, and making leaps impossible. Climbing ability is also reduced by 25% and the robot is -1 to dodge.

**21-40%:** Sluggish response. Penalty: -1 to dodge and reduce speed and length of leaps by 25%.

**41-60%:** Structurally weakened. Kick attacks do half damage. 1-50% chance that the leg will buckle each time the robot is hit by more than 20 M.D.C. (anywhere on its body), dropping to one knee and losing one melee attack.

**61-80%:** Joints lock at random times without warning. Roll every time the leg is used to make a kick or leap, or is running at 45 mph (72 km) or higher (roll once for every five minutes of sustained running). 01-65% chance that the leg will suddenly lock-up/freeze and cannot perform the desired function. Same penalties as frozen in one position, number 01-20. Stays locked up for 1D6 melees.

**81-00%:** Any special weapon or sensor features built into the foot, leg, and hip do NOT respond. Special systems are completely inoperable; requires 1D6 hours of repairs.

## Main Body

The damage to the main body can be accumulative. Roll once when the main body has had 60% of its M.D.C. depleted. Roll again for every additional 40 M.D.C. points of damage.

**01-10%:** Dual images on radar screen showing twice as many radar blips as really exist; impossible to distinguish between real target and ghost image. Penalty: -8 to strike without visual confirmation.

**11-15%:** Radar and sonar are lost; requires 1D6 hours of repairs. Pilot must rely on visual contact.

**16-20%:** Spotlights/headlights lost; must be replaced.

**21-30%:** Laser targeting system lost. Penalty: -2 to strike; requires 1D6 hours to repair.

**31-40%:** Communications damaged; reduce range by half, requires 1D4 hours to repair.

**41-50%:** Communications and audio system lost; effectively deaf. Requires 2D6 hours to repair.

**51-60%:** Electrical system damage. Secondary control panels catch on fire, knocking out personal computer(s); emergency back-up system engages, but not before the pilot's compartment is filled with smoke. Penalty: Lose two attacks that one melee round, -4 to strike, parry and dodge until the smoke clears in 2D6 melees.

**61-70%:** Severe internal damage. Reduce speed by half, -1 attack per melee, -2 on initiative, -2 to dodge.

**71-80%:** Computer memory damage! Cannot remember how to perform one of the following (roll or G.M.'s choice):

**01-20%:** Flight if robot vehicle, one skill program if a fully automated robot.

**21-40%:** Life Control: Includes temperature control and air recycling and circulation. About six hours of breathable air in a very hot and stuffy compartment. Penalty: -1 on initiative, strike and parry (pilot is distracted). If a fully automated robot, the unit smells of burning rubber and rotten eggs.

**41-60%:** Weapon Systems: One weapon system is completely forgotten and therefore, unusable.

**61-80%:** Target identification is lost. Cannot distinguish between friend and foe, weapon systems must be manually operated and are -1 to strike and -1 on initiative. If a fully automated bot it cannot decide who is friend or foe and suffers a -3 initiative roll and usually will not attack until attacked first.

**81-00%:** Voice actuated access system does not recognize any voices or spoken codes. Access hatches, locks, and command functions must be handled manually. Furthermore, it cannot remember how to turn the self-destruct system on or off. If a fully automated robot it does not recognize, acknowledge or obey its master (if any) and suffers a -10% skill penalty to all skills.

**81-90%:** Engine damage! Cannot engage any jet thrusters, fly or perform jet thrust leaps, and there is a minor radiation leak if nuclear powered (not yet life threatening).

**91-00%:** Sensor system is down (88% dead) and all combat bonuses are lost. Requires 3D6 hours to repair.

## Psychic Combat

Psychic or psionic combat is quick and simple. Each psychic attack counts as one of your character's physical attacks. Thus, if the character has four hand to hand attacks per melee round, he or she can substitute up to four psionic attacks. Of course, a player can mix the physical and psychic in any combination; three physical and one psionic attack, or two physical and two psionic, and so on. Many psychic powers are not appropriate for combat, but during a combat sequence, each physical and psionic *activity* counts as one *combat action/melee attack*. Note that some psionic abilities require time to prepare, which might make any other attacks/actions impossible.

**A reminder:** Most *player* characters start off with *four* attacks per 15 second melee round. Additional attacks may be acquired as one advances in hand to hand combat experience and from the Boxing skill, special bonuses or magic. The average person, not trained in combat, will only have one attack per melee round. Experienced fighters will have an average of 4-6 attacks per melee, sometimes more.

## Saving Throws Against Psychic Attack

Psychic attacks which assail the mind, emotions or physiology of a person can always be fought off through the force of one's own will and mental endurance (M.E.). Psionic attacks that fall into this category include: Empathy, Empathic Transfer, Telepathy, Mind Control, Hypnosis, and Bio-Manipulation. Some psionic powers for which there is no saving throw are Telekinesis, Levitation, Pyrokinesis, Presence Sense and See Aura.

Even ordinary people have a chance of fighting or saving against psionic attacks. However, those who have psychic abilities have a much better defense against such attacks than the average person with no psychic powers.

To save against a psionic attack, a 20-sided die is rolled to mentally parry the attack. A high roll will successfully *save* against the assault, indicating that the person is NOT affected by the psi-power (no damage or reaction).

**Non-psychics** must roll a 15 or higher to save against psionic attacks. A roll of 14 or lower means failure to save.

**Minor and major psychics** must roll a 12 or higher to save against psionic attacks. A roll of 11 or lower means failure.

**Master Psionics**, only need to roll a 10 or higher to save. An unlikely roll of 9 or less means failure to save.

**Note:** Many characters also get a bonus to save vs psionic attack. Such bonuses are usually the result of a high M.E. attribute, special powers, or magic enchantment.

## Inner Strength Points (I.S.P.)

The use of a particular psionic ability draws upon the inner strength or will of the individual. Each specific power will indicate exactly how many Inner Strength Points (I.S.P.) are required to perform that ability. When a psionic has exhausted all of his I.S.P., he is unable to perform any more psionic feats until he has had sufficient rest.

**The recovery of I.S.P.** can be done in one of two ways: total relaxation and/or sleep at a rate of two I.S.P. for every hour of rest, or through meditation. *Meditation* is a skill ability known to all psychic character classes, in which the psychic places himself in a simple hypnotic trance. This meditative trance provides maximum relaxation, recovering six I.S.P. per hour.

**Note:** See the psionic powers and character class descriptions for more detail.





# Adventure Ideas

## NEMA Missions & Encounters

### Humankind's Last Bastion of Hope

NEMA and its operatives represent the last vestiges of government authority and order, but more than that, they represent hope and the human spirit. They stand tall when all around them crumbles. They fight evil and rise up to protect the innocent when no one else has the courage or the will to do so. And though they face impossible odds, they refuse to give up. They fight, not for themselves, but for every innocent man, woman and child who turns to them, and in so doing have come to represent them and their dreams of survival.

This has made NEMA warriors almost instant legends and heroes, and with no one else to turn to, millions look to them for help, guidance and protection. Surprisingly, rather than feeling overwhelmed, the warriors of NEMA have stepped up to the challenge. They embrace the ideas of being helpers and heroes, and find in them purpose and resolve. The fact that so many are counting on them inspires them to be better, stronger and kinder than they have ever been in their lives. Somehow the cataclysm and the needs of others have brought out the best in them and help NEMA operatives to find the sticking place for courage, honor and nobility in the face of monstrous evil and mass destruction.

### Innocent Lives

More than many other game settings, adventure scenarios in **Rifts® Chaos Earth™** should involve innocent civilians and helpless victims. Women, children, grandma, grandpa, heroic dad, loving mom, and lil' Sweet Nell should be a regular part of the scenario. These innocent people may be unsuspecting bystanders, gawkers, lost children, kidnap victims, people corralled and locked away as cattle to be eaten at a later time, enslaved by monsters, or shell-shocked lost souls aimlessly wandering the streets until they can get the help they need to regain their senses. Others may be vigilantes or survivalists who get into trouble fighting monsters on their own, or even NEMA volunteers or medical workers or fellow NEMA soldiers stalked, trapped or imprisoned by a supernatural menace, slobbering monster, or demented lunatic. And these are just some of the people our heroes might find as part of an adventure out in the wilds of Chaos Earth. Still others may be enthralled or mind controlled by a supernatural fiend or domination magic, or targeted as victims in a diabolical plot or act of villainy.

Then there is the civilian population that remains outside of NEMA's direct protection. Families who huddle in the shattered remains of their homes and churches. People in need of food, shelter and medical care. Every day a stable building is shaken and falls under attack by monsters, magic or the elements gone crazy, causing it to crumble, collapse and trap innocent people inside. Every day, a child goes missing. Every day a group of homeless people looking for shelter wander someplace they shouldn't be and get trapped by debris, swept away in a freak dimensional storm or stalked by monsters. Everyday people from far and wide turn to NEMA begging for their aid. Everyday there seems to be some new crisis somewhere. Often just around the next corner.

Other scenarios might include a shape-changer or demonic predator slipping into the NEMA base camp, getting into the part of the city NEMA has placed under its protection, or raids by looters, rogues and monsters, as well as all-out attacks by murderous creatures and alien in-

vaders. Not only must the NEMA heroes try to stop the monster or villain, but save bystanders who might get caught in the backlash of the conflict and others who may fall prisoner to the bad guys.

And speaking of aliens, Dimensional Beings (D-Bees) swept away against their will by magic or circumstance and whisked to Chaos Earth may look alien or monstrous, but they too may be innocent, kind, and in need of help to survive the carnage of the apocalypse. Innocent lives in peril should be a constant and reoccurring theme.

**Infinite Adventures.** The following are a handful of short, basic missions and encounters that can function as an *outline* for a host of full-fledged adventures. Specific locations are left vague or out entirely so they can be dropped into any city, anywhere, for any player group. Game Masters are encouraged to build on these outlines and add specific details, villains and monsters as well as twists and subplots to make these adventures uniquely your own.

### Defending Strategic Locations

More than ever, protecting and preserving vital resources is of the utmost importance and a top priority for NEMA. Power plants, water purification plants, hospitals and key manufacturing facilities, including food, pharmaceuticals, weapons, munitions, robots, and vehicle factories, among others, must be preserved at all costs. In the wake of the Great Cataclysm such resources are finite and irreplaceable.

**Mission Objective:** The exact scenario and variables may vary from complex to complex, but the fundamental mission remains the same, defend and protect the facility and the key personnel necessary to keep the facility operating, and keep it (and them) from falling into the hands of the enemy or being destroyed.

#### Mission Parameters:

1. Create a defensible outer perimeter that can repel enemy assaults.
2. Prevent the enemy from gaining access to, or control of, the facility.
3. Onsite defenses, and defensive positions if the enemy should penetrate the outer perimeter.
4. Defend at all costs. If parts of the facility must be lost (due to combat damage), try to keep damage to a minimum and away from vital areas of operation.
5. When under siege, evacuate all civilian personnel starting with people vital to the operation of the facility.
6. If the facility must fall, shut it down and retreat. A plan to *retake* the facility will be formulated for a future mission. With so much destruction and lost expert personnel, NEMA cannot afford to destroy the facility to keep it out of enemy hands. Besides, most of the "enemy" are demons and monsters who have no use for the facility and want it only by happenstance or because it is inhabited by humans (and they want the humans for slaves, food, amusement or killing), or sometimes, simply because humans want it, the demons want to take it away.

### Recovery of Strategic Facilities

When a vital facility is taken over by the enemy, it is NEMA's job to take it back. If that is not possible, NEMA makes a retaliatory strike out of revenge and to rescue human prisoners and/or to recover vital components, parts, or information that can be used elsewhere.

**Mission Objective:** Repel and/or exterminate the occupying force in an effort to retake the target facility. This requires a room to room search and destroy operation and may involve infiltration, sabotage, as-

sassination and surgical strikes before an all-out raid is launched. As a rule, all enemy personnel are to be terminated, no prisoners taken.

#### **Mission Parameters:**

1. Eliminate all enemy occupation. Use extreme prejudice. Extreme force should be contained to enemy personnel and unnecessary areas of the target complex in an effort to preserve as much of the operational capacity of the facility as possible. Likely to involve more than one team, reconnaissance, Special Forces, EOD, and numerous strategic strikes.

2. Rescue and evacuate human prisoners. Key personnel first. In fact, the entire adventure may involve the player group finding, protecting and implementing the escape of one or more vital personnel. Running through a gauntlet of opposition and danger.

3. When the enemy has been repelled or terminated and the building is secure, turn it over to a restoration and defense team (a new adventure opportunity). The sweeper team may, or may not be involved in future defense of said recovered facility, perimeter patrols or sweeping the facility one last time to make certain all threats have been found and neutralized (another adventure opportunity).

## **Fact Finding the Hard Way: Testing the Enemy**

Remember, our heroes know very little about the supernatural and alien beings they must battle. Even old books on history, myths and the occult provide only so much information and half of that is probably speculation on the part of the author. This means the player characters are frequently sent on fact finding missions designed to find out more about the enemy by observing their behavior and habits, and testing their strengths and weaknesses. Unfortunately, this requires first-hand encounters and deliberately provoking and fighting the horrific things.

A particular demon (any of those presented in future Chaos Earth™ sourcebooks or from existing *Rifts*® books can be used) is known to inhabit a particular area (toppled building, or the basement, or one of the floors of a standing building, cave, section of a sewer, collapsed tunnel, etc.). Whatever the exact environment is, it should be dark, ominous, debris filled and with plenty of twisting tunnels, chambers/rooms and places for the demon and other creatures to hide.

**Mission Objective:** To study and test the creature's capabilities, first-hand, by invading its lair and provoking combat.

#### **Mission Parameters:**

1. The NEMA team must sweep the suspected lair and *record* everything they see (notes, voice recordings, video/film, photographically, etc.). This is likely to include both film recording and live transmissions from miniature cameras mounted on shoulders, helmets and possibly weapon systems.

2. Personal observations and reactions. Troops are asked to make mental notes and report on their personal thoughts, impressions, and observations, including their gut reactions, feelings, sights, sounds, smells, etc.

3. If possible, they should map the lair, taking special note of elements that indicate routine, habits, and habitat – creatures of the same species tend to live and behave in the same manner, so learning the habits of one provides a road map for all future encounters. That having been said, cross referencing and confirmation of observations shall be *required* to find patterns and confirm behavior. Thus, the same NEMA team and/or others *will* be sent on the same basic mission to verify the data collected. This may be repeated a few times or many, and even after reliable intelligence has been gathered there may be missing bits of data or inconsistencies as well as creatures who defy the norm, requiring further "fact finding."

Once sufficient data is gathered, it will be used to guide other NEMA teams sent on sweeper missions and extermination missions to clear out areas, and to hunt and destroy individual monsters and entire nests known or suspected to inhabit other places.

## **Sweeper Teams & Extermination Squads**

It's not genocide or cruel to wipe out the enemy when that enemy is hostile aliens and battling demons. One of the nice things for NEMA is that three-quarters of the "bad guys" or "enemy" are clear cut monsters: demons and horrific creatures who prey upon humans for fun, sport or food. Consequently, there are no qualms about being ruthless and merciless against these diabolic evil beings.

**Mission Objective:** Seek and destroy. Sweep the specified area or building and exterminate demons, monsters and hostile aliens wherever they are encountered, and they are crawling all over the place. When a nest or lair is found, the sweeper team does a little reconnaissance (or is already acting on intelligence) and if their team can handle the situation, they go in and exterminate the buggers. Additional support from other teams, power armor and/or robot squads or specialists (Intel-Agents, Military Specialists, Para-Arcane, DW-Hunters and ground-pounding Peacekeepers) may be available, or one or two may be assigned to the team to begin with (NPCs or player characters).

**Mission Parameters:** These are simple and to the point.

1. Locate and identify an enemy stronghold, lair, nest or supply depot.

2. Observe and formulate a plan of attack.

3. Penetrate the stronghold and systematically neutralize the enemy. Extreme prejudice and force is advised. Complete extermination is recommended. Prevent escape. No prisoners or survivors.

## **Standard Sweeper Mission**

Sweeper teams are squads sent out to make sure an area has been secured, cleared of hostile forces. With new demons and monsters appearing out of nowhere on a regular basis, the team may find itself sweeping the same building or area over and over again, facing a new menace every time or a reoccurring menace. May also be responding to civilian reports of suspicious activity or sounds, a demon sighting, or an ongoing or real-time disturbance (i.e., investigate what's unfolding right now at...).

**Mission Objective:** Seek and destroy. Sweep a specific area and clear it of hostile forces. Usually involves a room to room, inch by inch, search.

#### **Mission Parameters:**

1. Search for evidence of enemy presence.

2. Confirm enemy presence.

3. Locate enemy.

4. Neutralize enemy.

It's as simple as that. Exactly who or what they find takes this basic mission into all kinds of different directions. Game Masters, this basic premise can be played two dozen times with each spiraling into a completely different type of adventure (uncovers a plot, turns into a rescue mission, face a superior (surprise?) enemy, run the gauntlet, prison break, kill the leader, an enemy trap, the hunters become the hunted, whisked away to a different dimension, etc.).

## **Search, Rescue & Recovery**

**Mission Objectives:** Preserving human life is priority number one. These missions often require stealth, quickness, cunning and power armor with robot back up.

#### **Mission Parameters:**

1. Locate: Find and confirm the target.

2. Rescue: Free and escape.

3. Recovery: Return to base and get those rescued to safety.

4. Defend against all hostile forces.



Those are the basics regardless of the situation, however, circumstances can have a profound impact on the execution of the mission, what needs to be done and how to do it.

**Liberating Prisoners:** The job is simple: Get in, locate the subject of the rescue, make the rescue, and get out. Of course, that means penetrating an enemy stronghold by stealth, subterfuge, surgical strike or Commando raid. As always, the priority is rescue, so the team is to use only whatever force is necessary to get the job done and they are not to go looking for trouble or create a major disturbance. In fact, the most successful prison rescue missions are the ones where a team gets in and out with the rescue subject before the enemy even knows that their defenses have been breached and their prisoner taken.

**Lost and Wounded/Missing in Action:** Another type of rescue mission involves searching for comrades gone missing in action or civilians lost in hostile territory (which is pretty much everywhere, these days). Again, the rescue team enters hostile territory so stealth, speed and resourcefulness are required. They are to avoid unnecessary confrontations with the enemy, find the missing party, apply whatever medical care might be necessary and bring the individual(s) out – again, if at all possible, avoiding contact with the enemy. In some cases, once the target is found, he and the rescue team can be EVACed out by air or met by a larger force, power armor or robots and escorted to base camp. Other times, the team is on its own and may have to fight their way through a gauntlet of resistance.

## Rescue Op from a Collapsed Building

With the continuing aftershocks of the Great Cataclysm, earthquakes, volcanic activity, mud slides, storms and weird dimensional phenomena, as well as open conflicts, batter buildings and cause their collapse. Finding victims in collapsed buildings and ruins has the same basic parameters but involves digging and excavation through the debris. In this scenario, a NEMA rescue team may find themselves entering a crumbling ruin that could fall down around their ears at any moment, searching the rubble or still standing structure for children and adults trapped, pinned, lost or too frightened to leave. They must deal with both the deteriorating conditions around them and the hostile forces that see disaster and human suffering as a call to dinner or an invitation to reap mayhem. Ghouls and other scavengers (animal, monster and demonic) come to feed on the dead, and hungry predators and come vindictive demons come to feed upon or torment the trapped, lost and dying. Others target the rescuers and volunteers for sport or malicious fun or because they are, themselves, agents of doom and don't appreciate heroes pulling survivors out of the jaws of death. NEMA rescue teams can find themselves battling these malignant nightmare beings as they search the rubble, administer to the wounded or escort survivors to freedom.

**Mission Objective:** A routine patrol or search and rescue op in a toppled apartment building, skyscraper or collapsed tunnel. Victims still breathing or found in pockets within the ruins are to be dug out, given basic first aid and evacuated to a medical facility or shelter.

Preserving human life is top priority. These missions often require care, compassion, medical treatment, digging, excavation and resourcefulness. Power armor and robot vehicles can be a huge asset.

### Mission Parameters:

1. Locate: Find and confirm the lost, trapped and wounded.
2. Rescue: Dig out and free. Apply medical treatment to stabilize for EVAC.
3. Recovery: Find or make a way out and escort refugees to safety.
4. Engage all hostile forces that threaten the team or survivors. Extreme force and prejudice advised.

This can be a fun and dramatic adventure with twists and turns and challenges as the heroes squeeze, push and dig their way through the unstable structure. They may have to brace walls, carefully use explosives and cutting torches to get to and free victims trapped within,

and/or to make their way out. They may have to deal with weakened walls, floors, and beams ready to collapse, as well as climb down tunnels, navigate underground sewers or streams (perhaps created by ruptured drain pipes or water lines), avoid holes and still tumbling debris, and every sort of trouble imaginable to first, find, and then extract people in unstable (effectively underground) structures. If the way they came in collapses, they'll have to find an alternate way out, and so on.

Then there is the human drama. Little, six-year old Suzie is lost somewhere in the bowels of a cavernous collapsed building or subway tunnel. The NEMA team finally finds her, but she insists Charlotte is still trapped in a pocket next door, or a tunnel below. The little girl is shaken, in shock or hysterical and can't provide much in the way of details, not even who Charlotte might be (Auntie, sister, cousin, friend, etc.). Little Suzie, tears streaming from her eyes, just keeps insisting she knows she's alive, and pleads for them to please save her. The group goes to work and deals with whatever fate throws at them (that's you, Game Masters). Finally, they find Charlotte. She can be a person, but an ironic twist might be that Charlotte is a dog, or a cat, or even a rag doll. A further irony, however, may be that they hear some people pounding on the wall in the adjoining room, or the fuzzy pet creature scurries away to lead them to an important discovery, cache of weapons or supplies, or a nest of monsters, or another group of children (or adults) trapped in the wreckage. On the way out, the group encounters a dangerous supernatural being who, after the onset of a skirmish and the NEMA team's heroic efforts, seems poised to tear them to shreds. Suddenly, Charlotte (the pet animal) attacks the creature, and, as strange as it may be, it turns out the monster is *afraid* of Charlotte and runs away, surrenders, or accidentally kills itself (or is somehow slain by Charlotte, because the demon is vulnerable to it), making the rescue of the critter now seem like an act of genius or divine intervention.

## Morgue Patrol, a.k.a. Body Bag Sweep

Getting rid of the dead is one of NEMA's least pleasant or heroic jobs. The deceased must be gathered and their remains disposed of to prevent pestilence and disease, not to mention a putrid stench. It's a grim, lousy job but someone has to do it. Bad as this is to begin with, the mystic energies overflowing from the ley lines sometimes *animate* the dead as walking, mindless zombies lashing out at whomever they encounter. Then there are cruel, mischievous and wicked supernatural beings, as well as human survivors who have found they can animate the dead, who deliberately animate corpses and skeletons to cause trouble, death and mayhem. Then there are the alien and monstrous scavengers and predators attracted by the scent of death, but who prey on the living.

**Mission Objective:** A routine bag and burn operation turns into armed combat as patrols go out to find, bag and return with the dead. These missions often require fighting monsters and demons, making it a combination bag, burn and exterminate operation. Power armor and robot vehicles can be a huge asset, as can heavy weapons and flame throwers.

### Mission Parameters:

1. Locate the remains of the dead.
2. Put remains in body bags and then on a transport vehicle.
3. Recovery: Bring them back to camp or drop-point where those who can be identified are, and the rest photographed and disposed of, usually incinerated or vaporized.
4. Engage and destroy all hostile forces that interfere with the process or threaten the team. Extreme force and prejudice is advised.

**Adventure Hook:** The NEMA teams finds one or two lovable, sympathetic characters or a fairly large group of people (most are not seriously injured, just trapped behind some debris). Our heroes are just about to free them, or have freed them, but the trek out to safety is a long and dangerous one. As they ready to head back there is movement

among some rubble. Another survivor? A hand pushes through and waves in the air. Presumably, one or more NEMA characters or NPC volunteers race over to offer assistance, but then another hand pops up in another location and a figure rises up out of the rubble. In a matter of moments (perhaps as a player character or volunteer gets himself grabbed), the team realizes that these "people" aren't survivors, they're dead! Animated corpses are rising up to harass and hurt them. If the animated dead don't have the raw power to hurt the NEMA team directly, they'll go after the folks the team just rescued, or threaten a support beam, etc.

Suddenly, the heroes find themselves fighting a legion of dead, perhaps with more (or more powerful ones) rising from the debris field. The team must stop the creatures from hurting the people under their protection or from causing serious structural damage that might cause a cave-in or some other disaster. Overall, the situation has a sort of *Night of the Living Dead* feel to it. **Note:** While the walking dead are the immediate problem, our heroes (or someone in the group) should have enough arcane knowledge or first-hand experience to know that someone or something must be controlling the dead. Find and incapacitate or kill that individual, and the army of walking dead return to being just dead bodies. Demons and the new Necromancers appearing on the scene have made gathering and incinerating the dead more urgent than ever.

## Graveyard Haunting

Something evil has invaded the graveyard (or mass grave or a site where hundreds, perhaps thousands of people perished and remain buried there) and is causing the dead to rise up to kill the living. At first only a few dead awaken and strike. They are easily found out, tracked down and dispatched. Then an army of dead rise up, and NEMA knows it is in trouble.

**Mission Objective:** Find and destroy whatever is responsible for the rise of the dead.

### Mission Parameters for the NEMA team:

1. Evacuate and protect innocent civilians from the danger zone.
2. Contain the enemy (i.e., don't let the animated dead out of the graveyard, hold them to the battle zone where they can do the least damage).
3. Find and neutralize the source of the problem.
4. Recover any captives, hostages or civilian victims.
5. The use of extreme prejudice and whatever measures necessary to contain and neutralize the problem are authorized (even recommended), provided civilian casualties are kept to an acceptable minimum.

**Note:** There may be other demons/monsters/menaces in the target zone working with or independent of the culprit (red herrings in the search). Nothing is ever straightforward or quite what it seems to be on Chaos Earth.

## Running the Gauntlet

Any mission can turn into a running the gauntlet situation where the heroes suddenly find themselves trapped, pinned or in a position where the only way they can get to freedom or to rescue a particular person (colleague, friend, important individual, child, innocent stranger, etc.) is to go through a gauntlet of villains and/or monsters or traps. The Aliens movie is a great example of a gauntlet type scenario, both when the Marines first go into the tunnels and find the Aliens for the very first time, and when Ripley goes to rescue Newt.

**Note:** This fundamental adventure conflict can be used over and over again to great effect and fun, provided the Game Master makes enough changes, and puts in enough twists and subplots to keep it from all becoming the same darn thing with different beasties. Likewise, every adventure should not end with or turn into running a gauntlet.

## Chaos Earth NEMA Assignments & Adventures

The following are just a handful of typical crisis situations NEMA operatives must face every day.

**Reconnaissance Patrol, Short-Range:** This is typically a perimeter patrol around NEMA held territory. May include neighboring towns and communities.

**Reconnaissance Patrol, Long-Range:** Typically a quiet excursion into regions not under NEMA control for the purpose of gathering intelligence (information). May stop to intercede and help, defend or rescue individuals along the way, but only if such action does NOT jeopardize the patrol.

**Seek and Destroy Mission:** NEMA operatives are charged with locating and destroying some enemy force. The target could be armed gunmen engaging in banditry, murder or other crimes, to demons and monsters.

**Hot Pursuit!** One type of hot pursuit is relentlessly chasing down a known fugitive (including vampires, demons and monsters), another is the unexpected chase. In the latter case, the squad happens upon an individual, group or monster who takes off the moment he/they/it spots the heroes. The NEMA squad gives chase to investigate what they were up to and why they are running (in the case of monsters and aliens the reason may be obvious). The group may want to split up, with one giving chase and the other faction investigating the area where the fleeing individual(s) was first spotted. It may be the scene of a crime, hideout or skullduggery.

**Standard Rescue Call:** Somebody in need requires rescue and likely medical treatment. NEMA responds. Can be almost anything, including a trap.

**Refugee Roundup:** Urban and rural patrols in which innocent people who are in shock, dazed, injured or lost are located, gathered into a group and escorted back to a NEMA held safe zone. Problem: Sometimes a large group (hundreds) of refugees will attract trouble or attack. During the early weeks of the Great Cataclysm, NEMA is on patrol and engaged in roundup operations around the clock!

**Rescue Operation Patrol:** A squad patrol out specifically to find people trapped in the debris, lost or in need of help. The squad will address immediate concerns, i.e. rescuing the innocent from captors, freeing people trapped by debris, providing medical treatment and then escorting them back to someplace safe, ideally a NEMA held safe zone. During the early weeks of the Great Cataclysm, NEMA is on patrol and engaged in rescue and recovery operations around the clock!

**Rescue Under-Fire:** This is when the NEMA squad falls under attack from rioters, bandits, maniacs, monsters, aliens or supernatural forces while engaged in a rescue operation. Not only must the squad fight to defend itself, but it must also work to protect and defend the innocents in need of rescue (trapped in a pit, pinned under debris, injured, etc.).

**Monster Hunt:** A Predatory monster is sighted and NEMA comes to investigate. Lone predators, mated pairs and small groups (3-6) prefer to establish their lairs in isolated, unpopulated areas with basements, sewers, abandoned buildings, and viaducts being among their favorite habitats. Small to large groups of monsters and those commanded by a powerful leader tend to be more aggressive and may challenge or attack humans and even NEMA defenders in populated areas. They may also have their lair in a populated area, though most prefer a secluded and remote place to hide. Whichever the case, it is time for NEMA agents to go monster hunting.

**Monster Raiders:** The squad is attacked by or must respond to a gang (large or small) of alien beings, monsters or supernatural creatures causing destruction and mayhem.

**Alien Invasion Force:** A small army of alien beings (mortals or supernatural) swarming over an area or threatening the civilian human



population or a NEMA safe zone. Troops respond to counter the enemy.

**Disturbance Investigation:** No perpetrator has been identified and no serious crime may have been committed, but something is going on that warrants NEMA investigation. It could be a shadowy figure or group of figures skulking round, strange noises or lights in an abandoned building or part of town or the woods, a grim or stomach turning discovery, etc. What it is may be anything from a lost or feral hermit or mentally challenged refugee to aliens trying to hide, evildoers, cultists, witches, monsters and the supernatural.

**Murder Investigation:** People have been showing up dead in a 20 block radius. Someone or something is responsible. Most victims show evidence of a struggle and suffer minor cuts and abrasions, but rarely anything that looks life threatening. Yet they are dead, as if their *life was drained* from them. Who or what is responsible needs to be found and dealt with.

**Murder Investigation:** Another victim of an apparent ritual sacrifice. Could be the work of one or more demons, witches, sorcerers of some kind or god only knows what. Death cults have been popping up ever since the planet went crazy and the Rifts appeared. Some welcoming and worshiping death, others trying to rediscover the ancient ways of magic and the occult. All are dangerous. This looks like the handiwork for some sort of "group" – 4-13 individuals for nefarious purposes yet to be discovered.

**Murder Investigation: Vampires!** No question about it. The tell-tale bite marks, blood loss . . . yeah, it's vampires alright. Could be one or two, could be a nest of them (4D6). Call out the Para-Arcane, it's NEMA's job to locate and exterminate them.

**Vigilante group is about to burn an accused witch.** The woman is a young mother who protests her innocence even after hours of brutal interrogation and beatings. Her three children, their fate yet to be determined, wail and cry not far from the stage where their mother is soon to be burned at the stake! Enter NEMA.

**A known vigilante leader or group** has accused somebody of consorting with or hiding witches, demons, monsters or some other evildoers. The credibility of this "tip" is questionable but NEMA must investigate. Does the vigilante group take matters into their own hands regardless of what NEMA determines? Can NEMA stop them before the accused is killed? Are the vigilantes correct or mistaken?

**Witch hunt!** A gang of vigilantes or a militia has come to a normally lawful and orderly community looking for witches and monsters. They claim to be able to sniff out trouble and the supernatural and are here to save the people from themselves.

**A note about aliens.** Not all aliens or dimensional beings are evil or menacing, however, they, like the people of Earth, are lost and terrified. Consequently, they may act in a threatening or suspicious manner (sneak around, hide, etc.) and steal to get what they need. Likewise, not all alien animals are predatory monsters, some may be sweet and cuddly, good eating, or cause trouble because of their size, eating habits, or nature. It is up to NEMA to decide who is a threat and how to respond to any given situation. As the Chaos continues, it is becoming apparent that Earthlings are no longer alone and that "aliens" have arrived. The question is what to do with them. If they are not evil invaders, how should NEMA respond? And if they are innocent, lost souls, what should be done with them and where to put them?

**Most ordinary people** do NOT have access to Mega-Damage weapons, armor, vehicles or military ordnance unless they have dug them out of the ruins or stolen or looted them from armories, police stations and military bases. This has happened in *some* places so there are bands of criminals, militias, free agents and individuals who have M.D. items. Most have S.D.C. weapons, armor and conventional equipment which gives NEMA a decided advantage over the average Joe and putting down riots. However, supernatural beings and high-tech aliens enjoy the same Mega-Damage advantage, making most people extremely vulnerable and NEMA their only true line of defense.

---

# Coming for Chaos Earth

---

## Creatures of Chaos™

Creatures, monsters and demons will be getting their own sourcebook, possibly as a *Mission Book* (source material and adventures). *Coming soon.*

Until then, remember that any of the creatures and supernatural beings presented in the pages of **Rifts® Conversion Book One**, **Rifts® Conversion Book Three: Dark Conversions** and any of the other **Rifts®** world and sourcebooks are directly compatible with **Chaos Earth™** – drop 'em right in, no conversions necessary.

## Chaos Earth™ Magic

Magic and related O.C.C.s, abilities and NPC groups will be getting their own sourcebook entitled **The Rise of Magic™**. Probably a 64-96 page magic sourcebook. *Coming soon.*

## Chaos Earth™ Psionics

Psionics and related O.C.C.s will be getting their own sourcebook entitled **The Psychic Storm™**. Probably a 64-96 page magic sourcebook. *Coming soon.*

## NEMA Mission Book One: Front-Line Defense

Adventure sourcebook with world information, adventures and other data.

## NEMA Mission Book Two: Black Ops – The Enemy Within

Rogue NEMA and USA military forces, including Juicers, Tranks and others. Adventure sourcebook.

---





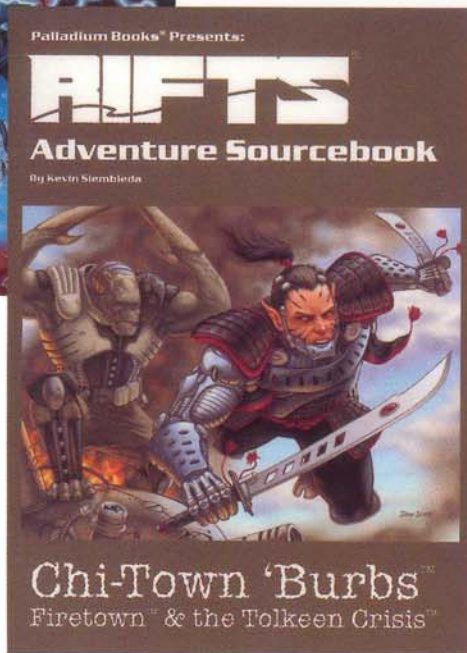

## Also from Palladium Books®

### The Rifter®

An ongoing sourcebook series for the entire Palladium Megaverse. Each issue has optional (sometimes official) material for **Rifts®** and other Palladium RPGs.

- Great source for new ideas and fun.
- Optional O.C.C.s, monsters, weapons, and skills.
- Optional magic and/or super abilities.
- Adventures, gaming tips and Q&A.
- Rifts® source material & fiction.
- HU2, Palladium Fantasy & Nightbane® typical.
- The latest news and sneak previews.
- \$9.95 – 96 pages.

### Rifts® G.M. Guide

- All skills listed & described.
- Stats for all weapons & armor to date.
- Vehicles, maps, indexes & much more.
- Rules clarifications and G.M. tips.
- \$26.95 – 352 pages.

### Rifts® Adventure Sourcebook Series Starting with the Chi-Town 'Burbs

- Overview of the 'Burbs.
- The 'Burb of Firetown, mapped & described.
- A ton of people, places and adventure hooks.
- 48-64 pages each. In stores now!

## Rifts® Chaos Earth™

**Chaos Earth™** is a complete role-playing game with its own, unique, stand-alone setting.

Player characters are heroes lost in the throes of the Apocalypse. Equipped with the most advanced robots, power armor and weapons in the world, they refuse to give up, and fight against overwhelming odds to save some fraction of humankind. Meanwhile, nightmarish creatures swarm to Earth through Rifts – tears in the very fabric of space and time – to torment and prey upon the survivors of the Great Cataclysm. Earth is quickly being transformed into an alien landscape, and the player characters are humankind's last and best hope for survival.

It is the end of the world as we know it and the dynamic prequel to the ever popular **Rifts® RPG** series. See how it all began and carve out your own place in Rifts® history.

- Overview and history of the Great Cataclysm.
- Introduction of NEMA – the heroes of the Northern Eagle Military Alliance who struggle to save lives and bring peace to chaos.
- 11 different character classes, including power armor and robot pilots, the Para-Arcane, Demon & Witch Hunter, Chromium Guardsman, Silver Eagle and more.
- Background setting, missions and adventure ideas by the dozen.
- Weapons, robots, power armor, vehicles and equipment.
- Monsters and madness.
- Compatible with **Rifts®** and all its sourcebooks.
- 160 pages by Kevin Siembieda.

\$17.95

Cat. No. 660

ISBN No. 157457-084-6

ISBN 1-57457-084-6



5 1795 >

9 781574 570847