

STAR WARRIORS™



BY EVAN WATERS, EDDY WEBB,
AND CYNTHIA CELESTE MILLER

STAR WARRIORS CREDITS

WRITERS

Evan Waters, Eddy Webb, and Cynthia Celeste Miller

EDITOR

Eddy Webb

LAYOUT AND DESIGN

Adam Jury

COVER ART

Oliver Castaneda and Eugene Perez

INTERIOR ART

**Andrew Cramer, Garry Hess, Ivica Taskovic,
Jason Scotti, Tom Gilbert III, and Bryce Gunkel**

ORIGINAL SPACE COMBAT RULES BY

Wolf Corbett

CONTACT INFORMATION

**Spectrum Games
3005 Appleton (#122)
Parsons, KS 67357
spectrum@spectrum-games.com
www.spectrum-games.com**

**Z-Man Games
PO Box 98
Eastchester, NY 10709
zmangames@shadowfist.com
www.zmangames.com**

Stock Code: ZMG 6003

**Copyright 2005 by Z-Man Games and Spectrum Game Studios.
This material is protected by the copyright laws of the United
States of America. Any reproduction or unauthorized use of the
material or artwork contained herein is prohibited without the
express written consent of Z-Man Games and Spectrum Game
Studios. The reference to any companies or products in this book
is not meant to challenge the trademarks or copyrights concerned.**



TABLE OF CONTENTS

CHANNEL ONE: INTRODUCTION	3	CHANNEL FIVE: GAME MASTER'S SECTION	35
WHAT'S INSIDE	3	OVERVIEW	35
BACKSTORY	4	THE SPACE OPERA GENRE	35
CHANNEL TWO: PLAYER'S GUIDE	6	ADJUSTING THE TONE	37
SERIES GUIDE	6	CHANNEL SIX:	
SERIES NUTSHELL	6	THE ENEMIES OF THE UNIVERSE	40
THE GENRE	6	HISTORY	40
SPACE COMBAT	7	MISSION	41
QUICK CHARACTER CREATION	10	ORGANIZATION	41
CHANNEL THREE: THE UNIVERSE LEAGUE .	13	HEADQUARTERS	41
HISTORY	13	TECHNOLOGY	42
THE STAR WARRIORS	14	CHANNEL SEVEN: ZARNON'S EMPIRE . . .	44
THE UNIVERSE LEAGUE	15	LORD ZARNON	44
SPECIES DETAILS	17	DR. ROBOTICUS	45
TECHNOLOGY	20	MUTATON	47
CHANNEL FOUR: THE STAR WARRIORS . .	24	CYBERCHIEF	49
CAPTAIN LANCE	24	INFURIANA	50
STARFIRE	24	CHANNEL EIGHT:	
DR. REX TOLKEN	25	THE BEST OF STAR WARRIORS	54
SHEILA SAPPHIRE	27	JEWELS OF THE JUNGLE PLANET —	
RED MAVERICK	28	A COMPLETE EPISODE	61
PSYCHLOS	30	APPENDIX 1: RECOMMENDED SOURCES. .	65
ROBOMAN	31	CARTOONS	65
BRUTAS	32	MOVIES	65
		ROLEPLAYING GAMES	65

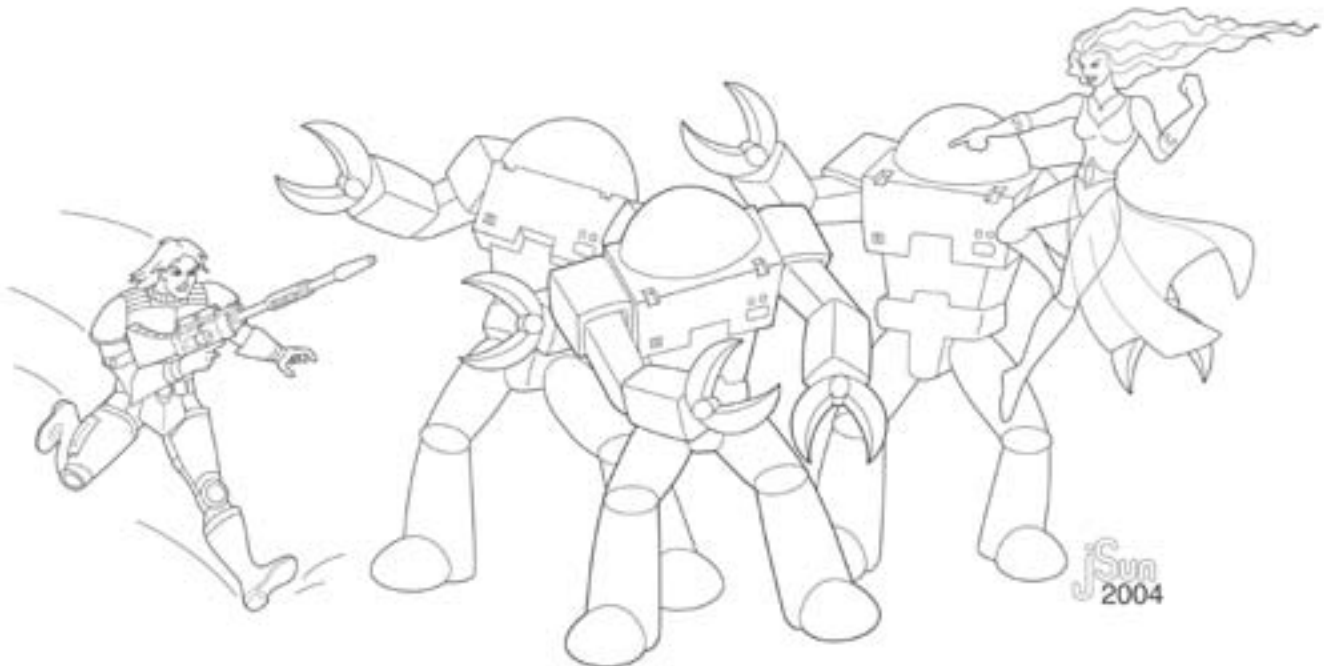

CHANNEL ONE

INTRODUCTION

Science fiction was perhaps the single most predominant genre in '80s cartoons. Even a modern-day action cartoon like *G.I. Joe* or a fantasy show like *He-Man* would incorporate sci-fi technology and plot devices to draw the attention of viewers. The popularity of sci-fi had been jump-started by the success of the *Star Wars* movies, which alone managed to create more demand for sci-fi movies, TV shows, and the like. Though some of this boom started in the late '70s (with shows like *Battlestar Galactica* and the attempted *Buck Rogers* revival), it stayed in full swing through much of the next decade. For kids on Saturday mornings, this translated into shows about robots (transforming or otherwise), aliens, strange worlds, spaceships, and various other staples of space opera and pulp sci-fi.

Star Warriors actually began life as a quick series idea which I conceived shortly after downloading and reading the original PDF version of *Cartoon Action Hour* in 2002. My recall of the classic cartoons was a bit hazy (though aided by web sites like X-Entertainment and the now-defunct Yesterdayland), but I managed to assemble a collection of conventions and cliches and turn it into something that might, someday, be playable. In conjunction with the original release, Spectrum Games was holding a "Design a Series" contest. I turned my scattered notes into a complete outline and submitted it — and, to my surprise, actually won. When Spectrum prepared its "dead tree" version of the game, they decided to include *Star Warriors* as one of the ready-to-run series. Eventually, the question of a series book came up, and here we are.

In order to help turn the setting into a book, I've had to expand a lot on my initial ideas, and it's been quite interesting watching the mythos expand — both the world of the *Star Warriors* and that of the fictional TV series, toy line, motion picture. Doing metafiction on these settings is quickly becoming a *Cartoon Action Hour* tradition, and I'm glad for it. A lot of '80s cartoon shows seem particularly good when one considers the pressures their makers were under, from lack of time and money to the need to sell toys to pressures from parental groups. Adding that element to my fictional series has made it more interesting, to me at least.

This book also contains some new rules that should be useful for running space opera style series in general, such as starship combat and planet generation. Of course, you can borrow bits and pieces from *Star Warriors* for use in a different series concept — it's something of a pastiche anyway. Just explore the universe now, and worry about what you'll do with it later.

WHAT'S INSIDE

If you're familiar with the other series books that have been released for *Cartoon Action Hour*, this one is arranged in a similar fashion. Here's the overview:

CHANNEL ONE – INTRODUCTION

You're halfway through it.

CHANNEL TWO – PLAYER'S GUIDE

Focused on creating characters in *Star Warriors* and other sci-fi settings. The basic series guide is included, as well as rules for space combat, a quick character generation section, and other things to get you started.

CHANNEL THREE – THE UNIVERSE LEAGUE

A look at the groups currently defending galactic liberty. In addition to backstory and notes on organization, this chapter also provides write-ups for much of the common equipment found in the setting.

CHANNEL FOUR – THE STAR WARRIORS

Seven detailed *Star Warriors* heroes, available for use as PCs or NPCs.

CHANNEL FIVE – GEMASTER'S SECTION

Notes on running space opera, and help with elements such as planet building.

CHANNEL SIX – ENEMIES OF THE UNIVERSE

An overview of Lord Zarnon's campaign to conquer the universe, complete with a detailed history of his extinct species and equipment write-ups for his diabolical weapons of war.

CHANNEL SEVEN – ZARNON'S EMPIRE

Full character details for Lord Zarnon and his somewhat-loyal henchmen.

CHANNEL EIGHT – THE BEST OF STAR WARRIORS

Twelve adventure seeds representing classic episodes from the show's four year history, plus a summary of the *Star Warriors* movie and a complete, ready-to-run episode!

BACKSTORY

The story of *Star Warriors* began in late 1984, when the struggling Juego toy company decided it needed a major action figure line to get back on its feet. The idea of having a toy line that tied into a series produced specifically to sell it had already been put to good use in the industry, and Juego wasn't about to miss out on the action. It contacted Osborne Animation Studios, a small production outfit in Los Angeles that had produced a couple of short-lived series, and jointly the two groups set out to create a concept it could sell to kids. Edward Bochmann, a writer on several episodes of Osborne's previous shows, was hired to create the premise and backstory, while Juego hired former comic artist Jack Miles to create the art and character designs. The two chief talents first agreed to make a straightforward space opera; anything relying on a gimmick would be too constraining for both. This decided, they worked closely together to flesh out the setting — Miles would come up with designs for mutants, robot soldiers, and the like, and Bochmann would link them together in the greater storyline.

The completed concept, *Star Warriors*, was met with enthusiasm by executives, and both series and toyline went into production in mid-1985, aiming for a Fall roll-out. Bochmann was made the show's supervising producer and script editor and effectively ran the show, though he had to answer to executives at both Juego and Osborne. Rights to the show were sold early to a major network, which placed it at the start of its Saturday morning programming (thus being the first thing many sugar-fueled children laid their eyes upon at the beginning of each weekend).

When the show made its debut that September, the first wave of action figures had already hit the shelves, and both the toys and cartoon were a solid hit. The show featured epic, dynamic action with surprisingly solid writing, and Miles' creative designs made for superb action figures. (The artist stayed on board the franchise as Chief Art Director, effectively working on all incarnations of the brand for the next four years). By Christmas, a second wave of toys, including vehicles and the Star Warrior Central playset, were on the shelves, and the fad had officially arrived.

For the show's second season, the writers focused on visits to new worlds and encounters with new species, thus keeping things fresh and increasing merchandising opportunities. Juego kept busy licensing the brand and characters out for all kinds of assorted merchandise, from board games to party favors to personal appearances at department stores. For the third season, again under pressure to continually introduce new material, the show presented the Mutant Horde, a new sub-group of baddies led by Mutaton, arguably the show's most popular villain character.

Despite this and other successes, the franchise didn't really peak until June of 1988, when Osborne Animation

Studios released *The Journey of the Star Warriors*, a full length theatrical motion picture. Written by Bochmann and series writer Karla Hunter, the film presented brand new versions of five of the main villains, who were transformed by energies on Lord Zarnon's home world of Zaronia. Meanwhile, the bold Roboman and the evil Dr. Roboticus were both apparently destroyed as part of the film's climactic battle (technically, the first deaths in the history of the franchise, though the fate of both characters was somewhat ambiguous.) Though the film received poor reviews at the time, it has since become a cult favorite, noted for its quality animation and strangely ominous tone. Merchandise for the film sold briskly, making up for a relatively modest box office take.

By the time the show entered its fourth season, however, there were signs that the franchise was nearing the end of its shelf life. Ratings began to slip along with toy sales, and Juego had already exploited just about every other kind of license possible. Sensing that the end might be near, Edward Bochmann decided to write an episode that could serve as a series finale. "Zarnon the Ruler" had the show's villain successfully take control of the Universe League, and the Star Warriors battled each of his henchmen individually before finally trapping Zarnon in a distant dimension from which there was no return. The end warned of other potential threats and adventures, leaving the series open, but at the end of the season Juego and Osborne did jointly discontinue the series, the toy line, and other related licenses.

For a time afterward, *Star Warriors* was effectively over. The show's first run had been cancelled and reruns were sporadic, and other attempts at merchandising never got off the ground due to legal tangles. Jack Miles returned to comics, while Edward Bochmann continued writing for television, and Karla Hunter made a name for herself as a science fiction novelist. Plans for a live action *Star Warriors* film in the early '90s were ultimately cancelled due to budget issues. Both Juego and Osborne have managed to stay in business, at least in part due to the past success of the franchise.

Very recently, the franchise has begun to show signs of life. The movie was released on DVD in 2000 to strong sales, and this prompted the release of the series starting in 2001. The show also began airing on cable. In 2002 Edward Bochmann, long having wanted to revisit the story, approached Juego Toys to begin discussions about the future of *Star Warriors* as a franchise. As a result of these negotiations, the classic toys have already been reissued, and a new series (and accompanying line of action figures) is in preproduction. Bochmann has already hinted that the new series may see the return of Zarnon, Roboman, and Roboticus, and possibly the introduction of an entirely new enemy force. Then there are the rumors of a comicbook...

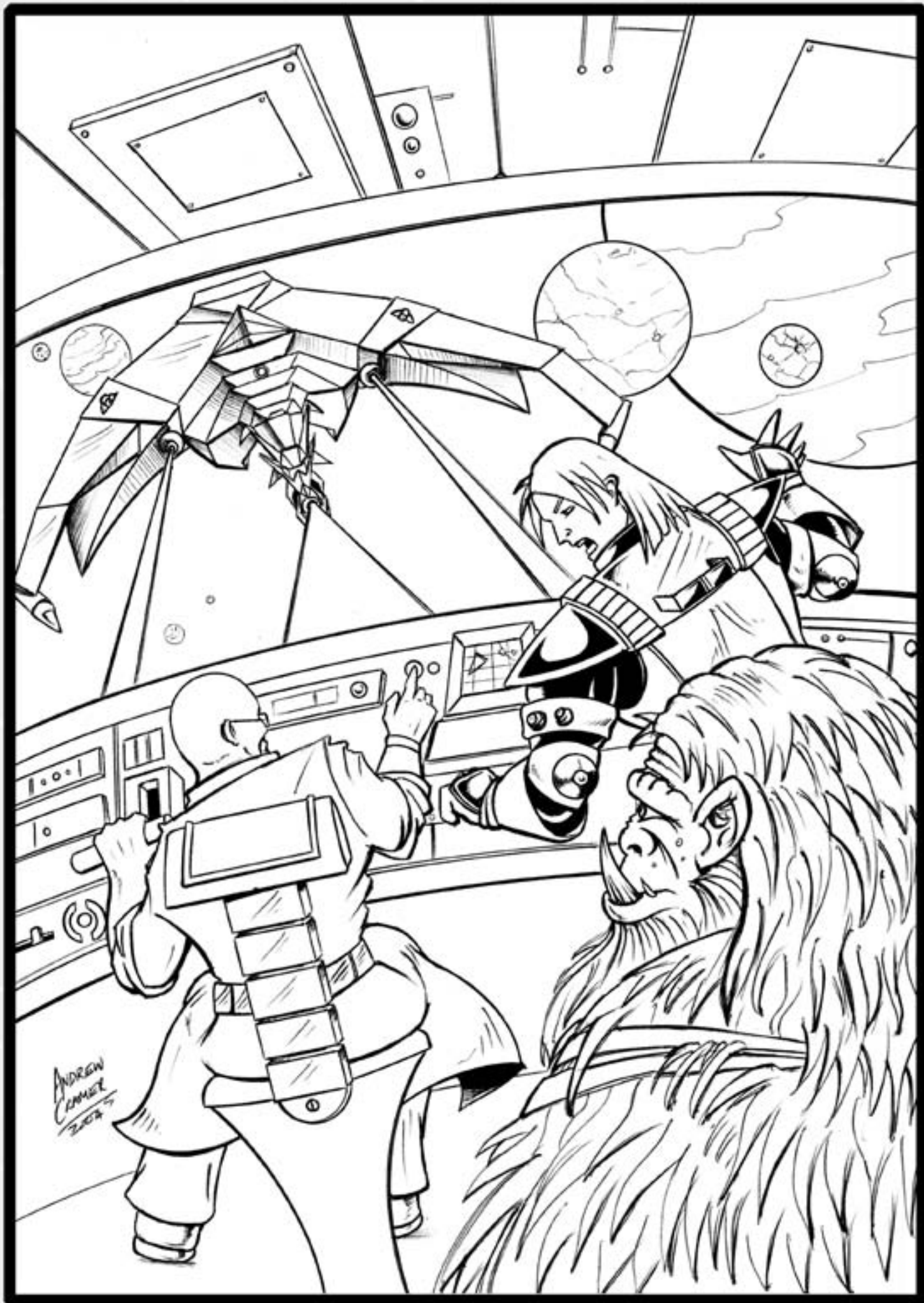

CHANNEL TWO PLAYER'S GUIDE

SERIES NUTSHELL

The peaceful Universe League is facing its most deadly threat. The evil Lord Zarnon, survivor of an ancient and wicked race, has sent his Cybertroops to conquer all of space. On the remote planet of Freedonia, former military commander Lance Starfire has gathered together an elite force of combatants who, using the latest in superscience, defend the universe against Zarnon and his evil warriors. Will Zarnon realize his evil dreams, or will the Star Warriors defeat him and his twisted servants?

The universe of *Star Warriors* is a vast, sweeping expanse of exotic planets where a constant war rages between the forces of good and evil. Starting from their secret base on Freedonia, characters may encounter the peaceful metropolis of Satrenia, the sinister fortress of Malitron, or even the ancient homeworld of Zaronia. Whatever worlds are visited, the emphasis is always on action and adventure!

THE GENRE

Star Warriors, as you're already noticed, is part of the space opera genre. Space opera is an established genre outside of the retro-toons, and while we cover how space opera is played in cartoons (see "The Space Opera Genre" on page 35), there are a few unique characteristics that should be taken into account when you play *Star Warriors*.

EPICS IN SPACE

Space is big — really big. As such, everything is epic in scope in space opera. You're not just defending your country — you're defending the entire universe! As you take in this massive scale, smaller details get a bit fuzzier — planets are only covered by one climate type (desert worlds, ice worlds, city worlds), races only have one distinctive thing about them (warrior race, psychic race, mutant race), and everything is amplified and expanded to gigantic proportions. Nothing is small potatoes in this genre.

FUTURISTIC TECHNOLOGY

Cybernetics, faster-than-light spaceships, laser guns, and planet-destroying weapons are all possible in space opera. Although certain series might have some technological limitations (such as "no teleportation" or "clones can't be self-aware"), there's always a lost civilization with even more advanced technology to discover. The only real limit to what technology can do is your imagination!

STRANGE POWERS

Often in space opera, there are races or groups with strange powers and abilities. They might be psychic powers developed by an alien race or the product of a mystical force that binds the universe together, but it's not unusual to find Special Abilities that resemble superpowers along with the ray guns and laser swords. However, usually those Special Abilities are restricted to certain groups or races who rarely teach outsiders — either to protect others or to keep all of the power for themselves.

THE WAR-TORN GALAXY

Space opera involves large-scale melodrama and action, and what's better for that than a really big war? While there are a few space opera examples that don't feature a massive war like *Star Warriors* does, there's always one group fighting another group across the universe. Whether it's a group of galactic police hunting down space pirates, two tribes of aliens whose war has spilled onto alien worlds, or an underground band of rebels trying to overthrow a tyrannical empire, in space opera there's always opportunities for action!

SERIES GUIDE

Character Points: PCs receive 100 CPs with which to create their characters.

Guidelines: PCs are members of the Star Warriors team. They should each have a certain specialty or fill a particular niche so that they work well as a group.

TRAITS

Maximum Trait Ratings: 4 normally, but up to 4(3) is allowed if playing an alien race, mutant, or enhanced human.

Required Traits: None.

Disallowed Traits: None.

New Traits: None.

SPECIAL ABILITIES

Maximum CPs for SAs: 60 CPs

Types of SAs Allowed: Gadgets, psionic abilities, racial abilities, weapons, superpowers, vehicles, and animal companions.

Other Guidelines: Normal human PCs are limited to gadgets, weapons, vehicles, and animal companions. Characters with other SA types must be aliens, mutants, cyborgs, and the like.

SPACE COMBAT

Space combat in *Star Warriors* means nimble, powerful fighters twisting in dogfights between mighty space dreadnoughts as they rain deadly barrages of missiles and energy rays at one another. The image is closer to WWII than any realistic form of space combat, and that's the way it should stay!

MODIFIED CONCEPTS

SPEED

The Speed Trait is pretty meaningless in space. With no air or gravity, there's nothing to stop or slow a spacecraft (unless you fail to avoid stray asteroids), so there is no top speed — you can go on accelerating until you run out of fuel. Nonetheless, for these rules we use the Speed trait to represent the acceleration and responsiveness of the speed controls of the spacecraft. You wouldn't travel so fast that you couldn't maneuver to avoid those asteroids, so it sets an effective maximum speed on space travel — any faster, and you wouldn't be safe or controllable. This differs from Maneuverability because we're talking about the maximum speed you can turn at, rather than how quickly you can change direction. When designing spacecraft, then, assign them a speed as normal, but don't worry if the listing on the table sounds too slow.

RANGE

Because we're not going to be using maps and measuring tapes here, the actual ranges don't really matter. Almost every space combat will take place at higher ranges than those on the *Cartoon Action Hour* table anyway. To use these ranges properly, we need a new table of ranges, broken down into *range bands*:

RANGE BAND DIFFICULTY DESCRIPTION

Range Band	Difficulty	Description
0: Contact!	0	You've rammed or docked. No ranged attacks possible.
1: Too Close!	2-3	The other ship is filling your vision, and your main concern is not colliding. Firing is easy, but maneuvering is at -2 because of this.
2: Short	4-6	The optimum firing range. No modifiers other than the DN.
3: Medium	7-9	The opposition can jink around a bit in your sights, but otherwise is an easy shot.
4: Long	10-12	You have to use a good bit of skill to hit from here, the target is just large enough to identify on your sighting instruments.
5: Visual	13-15	From here, you can only see a small moving dot.
6: BVR	DN +3	Impossible without specialized weapons and sights.

MODIFIERS FROM VEHICLE TRAITS

There will be many cases where character Traits are modified by their vehicle's capabilities. Pilots have an easier time maneuvering in spacecraft with a high Maneuverability Trait, but have a problem outmaneuvering enemy craft which have a higher Maneuverability, for instance. This table is used to determine the roll modifier — simply compare the opponent's Maneuverability with your own. The opponent will do the same on their roll (which should be a simple reversal of the modifier in most circumstances).

The same chart can be used if the fighters are trying to outrace one another — simply compare the Speed traits instead of the Maneuverability traits.

DIFFERENCE IN MANEUVERABILITY OR SPEED

OPPONENT'S MANEUVERABILITY/SPEED	MODIFIER
11 to 12 ranks higher	-6
9 to 10 ranks higher	-5
7 to 8 ranks higher	-4
5 to 6 ranks higher	-3
3 to 4 ranks higher	-2
1 to 2 ranks higher	-1
Equal	No modifier
1 to 2 ranks lower	+1
3 to 4 ranks lower	+2
5 to 6 ranks lower	+3
7 to 8 ranks lower	+4
9 to 10 ranks lower	+5
11 to 12 ranks lower	+6

Other ranged modifiers also apply, like cover (from asteroids and debris), obscured vision (gas clouds), and anything else decided by the GM. The modifiers for size should generally only be applied when some ships of *much* larger or smaller size (say, 3 categories) are involved, but could be used at any time. Realistically, modifications should be taken from the series' normal vehicle size. If the average vehicle is assumed to be Large, that size of vehicle would have a 0 modifier, since the sights will be set for that size of target.

PERCEPTION

With both characters and vehicles having a Trait called Perception, it's important to be sure which we're talking about. When we talk about vehicular Perception here, we're talking about the ship's sensors, and how the vehicle's computers are able to perceive enemies and allies.

While it makes sense that all spacecraft would be designed with sensors of some type (radar, electromagnetic, infrared, etc.), in *Cartoon Action Hour* you don't have to pay CP for a computer with Perception. Therefore, visual sighting will be the normal method of finding the enemy. The range

for visual sighting is, obviously, Visual range. If pilots are simply flying along straight and level, or are actively hunting for the enemy, roll the better of vehicular Perception and the character's Perception. If the pilots are busy piloting, roll the ship's Perception only (if the ship has no Perception, roll the character's Perception with a -3 modifier for a second action). Once you have seen an enemy ship, you don't have to look for it anymore, even if it has Stealth.

Vehicular Perception can be bought with the Major Advantage of BVR (Beyond Visual Range), which will give any spacecraft with this specialty an advantage of first chance to sight the enemy.

Stealth acts as an opposing Trait for all sighting attempts. Once you have seen a stealthy spacecraft, it is no longer effective, unless the enemy decides to use an action to make an active Stealth attempt, in which case the Stealth rating is pitted directly against Perception. Even this is only possible if the GM decides the stealth technology makes such an attempt possible (radar-absorbent paint does not, while a chameleon-like camouflage force field does, as an example).

COMBAT SEQUENCE

INITIAL CONTACT

Combats begin when, reasonably enough, one force finds another. Naturally, both may be well aware of one another before the fight begins, in which case combat commences immediately, but sometimes you have to find the enemy. Use the Perception rules to determine who sees who first. The ship which first makes a sighting roll determines the start of the encounter. If one has a BVR ability on its Perception, it has first try, but if neither or both do, they will both roll at once. If neither sees the other at maximum range, it's up to the GM to decide if the ships close and allow another chance at a closer range, or if they fly off and never see one another. Every range band closed allows another attempt to spot the enemy. For simplicity, it's easier to assume that once one ship has seen an enemy ship, all his friends have too.

Whoever has spotted the other must now decide what to do — close to battle or run for it! While unaware of an enemy, most craft will not be flying at full speed. Half speed (in terms of Trait ratings) is reasonable, but the GM will decide for any NPC craft.

CLOSING AND MANEUVERING

This is the complicated part of any combat. To simplify things, assume all ships see one another when they get within combat range, and start the dogfight!

When only one ship is aware of the other, roll a piloting roll (modified by Maneuverability or Speed) against the range band's DN. It's possible to both close and maneuver for position at the same time, but not efficient or easy (maneuvering means circling round the enemy, while

closing means heading toward it). Roll one at full value and the other at -3, as normal for two actions — which you make the more important is up to you.

While closing or opening range, it's the relative speed of the craft that really matters, although a good pilot can still avoid any enemy. Roll opposing Pilot rolls modified by respective Speed Traits. Ships with shorter ranged weapons will want to continue closing.

Now comes a decisive moment. If both sides agree to dogfight, range becomes unimportant! The winner of any round of dogfighting will, as part of winning, be in range of its weapons. On the other hand, if one chooses to run, range becomes important again.

Starting from whatever distance the first sighting was made from, craft will close or open range by one range band while in a range band higher numbered than their own Speed rating.

Example: A Speed 4 ship winning a chase roll against a Speed 2 ship from Visual range (range band 5) will close by only 1 range band, to Long Range (band 4).

When at or less than its Speed Trait in range bands to the enemy, the range will close or open by a number of range bands equal to the difference between the craft's Speed Traits.

Example: A Speed Rating 4 ship closing on a Speed Rating 2 ship, from an initial range of Long (band 4), will close by 2 range bands (to band 2, Short range) if the pilot wins the contest that round. He could just close to band 3, Medium range, if he wanted.

It is possible the slower ship will win by fooling the other into making a maneuver costly in speed, in which case the range opens or closes by 1 range band, regardless of the speeds of the two ships. If you want to ram, you must reduce range to 0.

If both sides close without maneuvering, each must declare at what range they will open fire (they don't have to roll to close). That then sets the range for the first combat round proper. In this case initial position is head-to-head as on the maneuver table below. Otherwise, if at least one ship attempted to open range, was unaware of the other, or maneuvered, range will be decided by the first to declare he's firing. If his opponent is still unaware of him, his position will be Tailing or Flanking (see below). To find out which, roll a contest between his Piloting (with Maneuverability modifier) and the opposition's current Speed (even if the target is unaware). On a win, the attacker is tailing, on a failure he's flanking.

FIRING

Most of the time, both sides will be aware of one another, especially after the first weapon fires! From then on, it's a dogfight, with both sides circling for position. These maneuvers depend on an opposed Pilot vs. Maneuverability roll, with the winner deciding on the

range he fires at and the positions each turn, according to the degree of their success.

MANEUVER RESULTS CHART

- 0 – +3 result:** No clear superiority. Winner may decide to open fire, but if he does, both ships may fire head-to-head at -1 to hit. Also, for anyone who fires, next turn's maneuver for position will be at -2. If he decides not to fire, the winner gets +1 to maneuver next turn.
- +4 – +6 result:** Flanking positions. The winner may decide to attack, at normal chance, for a deflection shot. Next turn maneuver will be normal if the winner fires, or at +2 for the winner and normal for the loser if he does not.
- +7 and up result** Winner achieves Tailing position. He may fire at +2, and will get a +3 on maneuver next turn whether he does or not!

WEAPONS FIRE

Whenever anyone decides to fire, normal weapon rules are used, plus a couple of new, extra rules.

Normal fire uses the pilot's Ranged Combat, with a DN chosen from the range band by the GM, plus any other situational modifiers.

All the rules so far have assumed the pilot is firing with weapons that are fixed to fire forward. Weapons should be defined as Fixed or Flexible.

Fixed weapons may be fired by the pilot at no penalty to Piloting or Ranged Combat, but only if the pilot wins the maneuver battle. If he loses, the weapons aren't pointed at the enemy, and are useless. So, if the pilot is maneuvering *and* firing, neither die roll is penalized.

Flexible weapons can be fired by anyone at any time, but are -3 if fired by the pilot (since it counts as a second action — if the pilot is already both closing and maneuvering, one of the rolls will be at -6!), and -2 if fired by anyone else. Other penalties from the maneuver results chart also apply. They are not very accurate without advanced sighting or controls — any rating of 1 or higher in Auto-Gunner removes the -2 penalty, while Minor or Major Advantages on the SA may reduce it. With these modifiers, weapons may fire normally according to their or their gunner's Traits.

A new Critical Hit chart is needed too.

DAMAGE ROLL (-VDM)

- 17+ Explosion! Nothing left but debris, and all occupants reduced to zero Hurt Points. Hope they have spacesuits...
- 15-16 Wreck! The spacecraft is reduced to a powerless, helpless hulk. All occupants take a large amount of damage, as decided by the GM.
- 13-14 Firepower Kill! The vehicle's weapons are knocked out.

- 11-12 Mobility Kill! The vehicle loses its drive capability. It can no longer close or maneuvers for position. However, it can still turn in place using jets – treat the spacecraft as having a -4 Maneuverability. Flexible weapons are unaffected.
- 10 Enclosed Personnel Hit
- 9 Exposed Personnel Hit
- 7-8 Spacecraft Shuddered. The Pilot is forced to make a Piloting check. If he fails, the spacecraft loses directional control. Make the next maneuver roll as though the Maneuverability trait was -3! After that, control is resumed as normal.
- 6- No additional effects

WINGS

Having more than one spacecraft trying to achieve a tailing position on a single enemy presents the possibility of collision or getting in each other's line of fire. Multiple craft attacking the same target independently provide a -1 handicap to each other for each additional craft. If a roll of 1 is made while under this handicap, two craft have collided (if maneuvering, use the ramming rules), or one has shot the other (make a hit on the last craft to make a die roll).

To prevent this, and to generally improve the efficiency of any combatants, spacecraft should group into combined units. Swarming around an enemy, they herd it into position to give their leader an easy shot, while looking out for other enemies. We'll call these formations *Wings*, even though that name usually means a greater number of craft.

To join into a Wing, simply choose a leader and make a simple Maneuverability roll against a difficulty of 2. All spacecraft must do this when they decide to join, but they need not all join at once. One of them is declared the leader, and the leader will make all the dice rolls from then on. The maximum number of craft which can join into a Wing is usually a matter of military doctrine, often three to six. The Wing will provide a bonus on maneuvering for position, closing range, firing (fixed or flexible weapons), and sighting. Most of the time, all the other craft will provide a +1 each on Traits they share with the leader, except in special circumstances:

- The lowest Maneuverability Trait of all craft in the Wing will be used.
- Craft with a *higher* Trait than the leader will add a +2.
- In circumstances where stealth or surprise is needed, each additional craft will reduce the chances by 1, and the lowest Trait will be used.

To attack a Wing, first decide on a target. When a target has been chosen, attack as normal, treating the whole Wing as a single target. Other craft in the Wing add to defenses, as they fall back to threaten the attacker, confuse sighting by changing formation, and so on. Of course, if both sides are Wings, both will have bonuses, and so they will at least partially cancel out.

GOONS IN SPACE!

Often, only the Wing Leaders will be player characters or important NPCs, and the rest of the Wing will be treated as a Mob of Goons. This makes things much easier for bookkeeping. However, some of the Mob rules have to be adjusted for the environment and the greater danger of spacecraft over ordinary armed men.

NUMBER OF WINGMEN	EFFECTIVE MODIFIER	COST IN CP
1	+1	2
2	+2	6
3	+3	10
4	+4	14
5	+5	18

The modifier is applied to every roll made by the Wing leader (it is reversed, as usual, for rolls like Stealth). Any hit on a Wingman that exceeds the Leader's craft's VDM will eliminate one Wingman! For simplicity, all Goon craft will be the same type as the leader.

Entire Wings of Goons are equally simple. Decide on a VDM — this is the Goon Factor. Since it costs 2 CP per Goon Factor, these are more expensive than normal Goons, but you get a whole Wing for the price! When fighting a Wing of Goons, one success will defeat the entire Wing, but not every Goon will actually be destroyed. Use the "Degrees of Success" advice (*Cartoon Action Hour*, page 52) to determine what has actually happened to them. A normal success will mean maybe half of them are destroyed or rendered unable to fight, and the rest have fled or been damaged. Extend the description of the fight to make it more dramatic.

If Space Goons actually win a fight, assume the hero's craft has suffered both a Mobility and Firepower Kill. It has no power to maneuver or fly anywhere, and is drifting helplessly in space, with the enemy craft swarming around it. Time for a rescue!

LARGE CRAFT

All the rules so far assume player characters will be piloting and fighting against small fighter craft. Of course, much larger craft can be involved. Most of the time, these will be under the control of the GM, and will be more of a plot device than an actual target, so exact ratings are unnecessary. They use the same rules, except for a few notes.

- Maneuverability Traits will be low, often very low. Most weapons will be flexibly mounted, usually with enhanced sighting modifiers. Therefore there won't be any point in dogfighting rolls.
- Their sheer size means they will be easier targets — use the target size modifiers.
- Armor and VDM will likely be enormous compared to fighters. The GM should design smaller, more vulnerable, sections for fighters to attack, if they are

to fight larger ships. Targets such as weapon turrets, engines, and bridges are suitable.

- Main Weapons will be sized for attacking ships their own size, not fighters. Reduce the chances by the Size Modifiers. Some weapons will be rated as anti-fighter, and will have no penalty shooting at fighters. They will, normally, be smaller and shorter ranged.

OPTIONAL RULE – NEW USE OF ARMOR

Sometimes, the massively armored behemoths in space opera appear to be invulnerable as they get peppered and pummeled, but one lucky shot can obliterate them. If you'd like to replicate this sort of combat, ignore all references to Armor reducing damage. Armor is now a trait that is rolled against. Whenever someone makes a Ranged Combat attack against a vehicle, the player rolls Armor as if he were rolling Athletics for a normal hand-to-hand attack. A successful attack does full damage to the vehicle, while a failed attack does nothing.

QUICK CHARACTER CREATION

If you don't have the time or desire to go through the full process of creating a character, you may elect to choose one of our customizable character templates instead. Each template gives you instructions for tweaking it to suit your personal tastes.

For additional variety, you might consider selecting one of the templates found in the *Cartoon Action Hour* rulebook (on pages 133-138). They are completely compatible with Star Warriors. Likewise, the templates found in this book are usable for games set in the *Warriors of the Cosmos* setting.

COMBATANT

"Up-close combat specialist"

TRAITS

Assign the ratings to the Traits however you wish.

Ratings: 1, 2, 2, 3, 3, 4, 4 (2)

Traits: Armed Combat, Athletics, Body, Perception, Stealth, Unarmed Combat, Willpower

OTHER STATS

Copy down these stats verbatim.

Size: Medium

Oomph: 3

Stunt Points: 2

Hurt Points: Hurt Points are calculated as described on page 15 of the *Cartoon Action Hour* rulebook.

SPECIAL ABILITIES

Choose any one of the following "SA Packages".

PACKAGE #1

Ninja Strike (OSA, Power Level: Medium)

Range: Point Blank

Damage Rating: 6 + Body

Bonus: Advantage, Major (if the enemy loses 16 or more Hurt Points from a single hit with this

SA, he must make a Body check versus a DN of 10. Failure means that he is stunned, and may take no action next turn.)

Hard to Hit (MiscSA, Power Level: Medium)

Whenever the character is to be the target of a ranged attack, add this SA's rating to the DN.

Rating: 4

Vanish into Thin Air (MSA, Power Level: High)

The character can instantly transport himself from his current position to another position up to 50 yards away.

Rating: 2 (used for action checks, not speed)

Mode of Travel: Teleportation

Bonus: Super-Scale Movement

Restriction: Disadvantage, Minor (the character may only disappear while standing in shadows)

PACKAGE #2

Mace (OSA, Power Level: Medium)

Range: Point Blank

Damage Rating: 8 + Body

Restriction: Item

Partial Armor (DSA, Power Level: Medium)

Protection: 8

Restriction: Fickle

Restriction: Item

Burst of Bad-Assness (MiscSA, Power Level: High)

Once per episode, the character goes all out, boosting his stats temporarily.

Duration: 1d12 turns

Trait Modification A: +3 Armed Combat

Trait Modification A: +3 Unarmed Combat

Trait Modification A: +3 Athletics

Trait Modification A: +3 Body

Restriction: Disadvantage, Major (can only be used once per episode)

PACKAGE #3

NOTE: Increase the character's Stunt Points to 3 and Oomph to 5.

Laser Sword (OSA, Power Level: Medium)

Range: Point Blank

Damage Rating: 7 + Body

Bonus: Armor Piercing 5

Restriction: Item

Light Armor (DSA, Power Level: Medium)

Protection: 6

Restriction: Item

Hot Temper (MiscSA, Power Level: Medium)

Whenever the character becomes angry, he becomes more determined to stomp some tail, thus improving his abilities.

Duration: 1d12 turns

Trait Modification A: +2 Armed Combat

Trait Modification A: +2 Unarmed Combat

Trait Modification A: +1 Body

Restriction: Disadvantage, Major (this SA only works when the character is angry)

BLASTER

"Ranged combat specialist"

TRAITS

Assign the ratings to the Traits however you wish.

Ratings: 1, 1, 2, 2, 2, 3, 3, 4, 4 (2)

Traits: Armed Combat, Athletics, Body, Demolitions, Ranged Combat, Stealth, Survival, Unarmed Combat, Willpower

OTHER STATS

Copy down these stats verbatim.

Size: Medium

Oomph: 3

Stunt Points: 2

Hurt Points: Hurt Points are calculated as described on page 15 of the Cartoon Action Hour rulebook.

SPECIAL ABILITIES

Choose any one of the following "SA Packages".

PACKAGE #1

Laser Rifle (OSA, Power Level: Medium)

Range: Long

Damage Rating: 7 + Body

Restriction: Item

Jetpack (MSA, Power Level: Medium)

Rating: 3

Mode of Travel: Flying

Bonus: Super-Scale Movement

Restriction: Charges, Moderate

Restriction: Item

Inspiring Presence (MiscSA, Power Level: Low)

By being in the character's presence, allies find themselves bolstered.

Trait Modification B: +2 Willpower

Bonus: Area of Effect (6 yards)

PACKAGE #2

Big Cannon (OSA, Power Level: Medium)

Range: Visual

Damage Rating: 9 + 2

Bonus: Vehicle Class

Restriction: Item

Light Armor (DSA, Power Level: Medium)

Protection: 6

Restriction: Item

PACKAGE #3

Laser Pistol (OSA, Power Level: Medium)

Range: Medium

Damage Rating: 5 + 2

Restriction: Item

Nightstick (OSA, Power Level: Medium)

Range: Medium

Damage Rating: 6 + Body

Restriction: Item

Full Armor (DSA, Power Level: Medium)

Protection: 10

Trait Modification A: -1 Athletics

Restriction: Item

BRAINIAC

"Highly intelligent thinker"

TRAITS

Assign the ratings to the Traits however you wish.

Ratings: 1, 1, 2, 2, 2, 3, 3, 3, 3, 4, 4

Traits: Coordination, Piloting, Ranged Combat, Computers, Detective, Inventor, Knowledge (choose an area of expertise), Perception, Science, Willpower, Repair

OTHER STATS

Copy down these stats verbatim.

Size: Medium

Oomph: 2

Stunt Points: 2

Hurt Points: Hurt Points are calculated as described on page 15 of the Cartoon Action Hour rulebook.

SPECIAL ABILITIES

Choose any one of the following "SA Packages".

PACKAGE #1

NOTE: Increase any single Trait rating by +1.

Mega-Computer (MiscSA, Power Level: High)

Rating: Knowledge (Random Trivia) 4 (2)

Rating: Knowledge (Planets) 4 (2)

Rating: Knowledge (Aliens) 4 (2)

Restriction: Item

Restriction: Disadvantage, Major (cannot be moved from place to place)

PACKAGE #2

Telepathy (MiscSA, Power Level: Medium)

Range: Beyond Visual

Rating: 4 (using this SA on an unwilling character requires an opposed action check versus the target's Willpower)

Mental Blast (OSA, Power Level: Medium)

Range: Medium

Damage Rating: 4 + 2

Bonus: Mental Attack

Restriction: Charges, Minor

PACKAGE #3

NOTE: The character automatically has Persuasion of 4.

Laser Pistol (OSA, Power Level: Medium)

Range: Medium

Damage Rating: 5 + 2

Restriction: Item

Flying Craft (Vehicle, Power Level: Medium)

Components:

Space Travel (Speed 3)

Air Travel (Speed 2)

Body 2

Maneuverability 1

Size: Large

Capacity: 2 Enclosed

SPs: 40

VDM: 4

WEAPON

Blaster

Damage Rating: 4+2

Range: Medium

Restriction: Item

Restriction: Charges, Minor

CHANNEL THREE

THE UNIVERSE LEAGUE

HISTORY

The story of the Universe League begins with the first contact between human and Menton space travellers in 2280. Both species had broken the light barrier in the past century, and had already founded substantial empires. Fortunately, contact between the two was peaceful; the sitting president of the Terran Star League was open to negotiation, and the Mentons had no demands to begin with. The two civilizations grew close, and decided that they would benefit the most from merging their power. In 2301, the neutral meeting world of Satrenia was converted into the capital of the newly-formed Universe League.

Other races soon saw the value of combining their resources, and over the next century many peoples, such as the Flamites and Deceptoids, joined the league to gain security and wealth. Needless to say, the interests of an ever-growing number of species did not always overlap, and the first hundred years of the Universe League were marked by constant debate and dissent. At times it seemed the

League would dissolve or war might break out, but cunning diplomacy and political maneuvering kept the union together. By the early twenty-fifth century, the Universe League had entered a period of peace and prosperity that would last for decades.

Then the Mutants returned. Technically, these leftover armies from the Zarian wars had never gone away; for untold aeons they shunned evolution and progress and continued beating each other up. Most of the civilized races had no knowledge of them, and those that did tried to forget. But in 2436, a Universe League freighter made an emergency landing on the remote world of Toxion, which happened to be the Mutant homeworld. As luck would have it, the combined intelligence of the local Mutants was enough to eventually work out how the warp drive was built. Soldering crude replicas into their already-crude spacecraft, the Mutants cobbled together a space fleet and began invading every inhabited world within a convenient distance. What they lacked in technical savvy, they made up for in sheer aggression. The Mutant Wars, as they came to be known, continued on and off for around 80 years, ending with the Universe League's victory at Derelus in 2517. The Mutants retained control over a small number of worlds which the original inhabitants had abandoned, and the Universe League, wary of future incidents, set up well-patrolled border zones on the edges of civilized space.

It was in 2525 that war veteran Captain Lance Starfire, while patrolling for a border outpost on the remote world of Malitron, discovered that an ancient warlord named Zarnon was planning an invasion. With the memory of the Mutant Wars still fresh, the Universe League alerted all its active troops, deployed its entire fleet, and prepared for battle again after a mere eight years of peace. This time, the enemy was not a pack of slaving barbarians, but an organized force led by a powerful and highly intelligent being from a mysterious lost race. The Universe League, and Captain Starfire in particular, realized that more would be needed to defeat the enemy. A new organization was formed, a small special operations team designed to directly confront Zarnon and his closest allies in order to foil their plans before they could be realized on the battlefield. Captain Starfire took command of this new force of "Star Warriors", and began assembling allies for the epic battle that was about to begin.



THE STAR WARRIORS

MISSION

The Star Warriors have been charged with directly confronting and defeating Lord Zarnon and his forces. They do not need to do this all by themselves, nor are they obligated to rush blindly into combat with Zarnon or his henchmen, but they are expected to take the fight to Zarnon as often as they can while the Universe League's military focuses on defending against his attacks.

ORGANIZATION

The members of the Star Warriors have no formal rank beyond any they have before entering the division (hence, Lance Starfire remains a Captain). Whenever the group interacts with the Universe League's military forces, the team's rank is that of its highest-ranked member, but this usually is not an issue, as both groups tend to get along. If there is no military officer in your group's version of the Star Warriors, Persuasion can be used to get allies to cooperate.

HEADQUARTERS

Star Warrior Central is located on the remote world of Freedonia. Nondescript as planets go, Freedonia is barren and uninhabited, despite the presence of a breathable atmosphere. The planet's significance derives wholly from its strategic position, in a dense cluster of stars near the borders of civilized space. It's close enough to the front that the Star Warriors can easily intercept Zarnon's forces, but conveniently hidden among the hundreds of worlds that Zarnon ignores as he strikes at the heart of the Universe League.

Star Warrior Central is a massive fortress, with facilities both below and above ground. The central meeting room on the ground floor is where the Star Warriors discuss plans and upcoming missions, and it houses the main terminal for the fortress' computer. A giant holo-screen allows the warriors to receive transmissions from across the known universe. Team quarters and living facilities are located nearby.

There are two major laboratories in the fortress, both connected to the main computer. Dr. Tolken's lab, on the top floor, is full of electronic equipment, chemicals, and other material for his research. Oddly the alien lives here, though Dr. Tolken sometimes regrets keeping him so close to the equipment. Sheila Sapphire's crime lab is a smaller area not far from the meeting room. It contains enough equipment for Sheila to test chemical samples, detect fingerprints, and research other evidence which can then be cross-referenced with the computer's criminal database.

The fortress is defended in many ways. If a hostile or unidentified ship approaches, the fortress instantly activates a force field to defend against weapons fire and block entry. Base controls can disable this field if needed, and the system has one weak point — an exposed generator is located on the central lookout tower. A precise hit could destroy it and bring down the field.

If a hostile or unidentified ship passes the radar "danger" threshold and ignores the automated warning signal, a line of concealed auto-lasers opens fire. A Star Warrior in the base (or an intruder who has bypassed the computer's security protocols) may disable the lasers at any time. Finally, the fortress' walls are made of mithrite, the most powerful metal alloy known in the universe. Mithrite blast shields can block hangar openings and windows for an extended siege. Such an attack has not yet taken place, but the Star Warriors are keenly aware of the possibility.

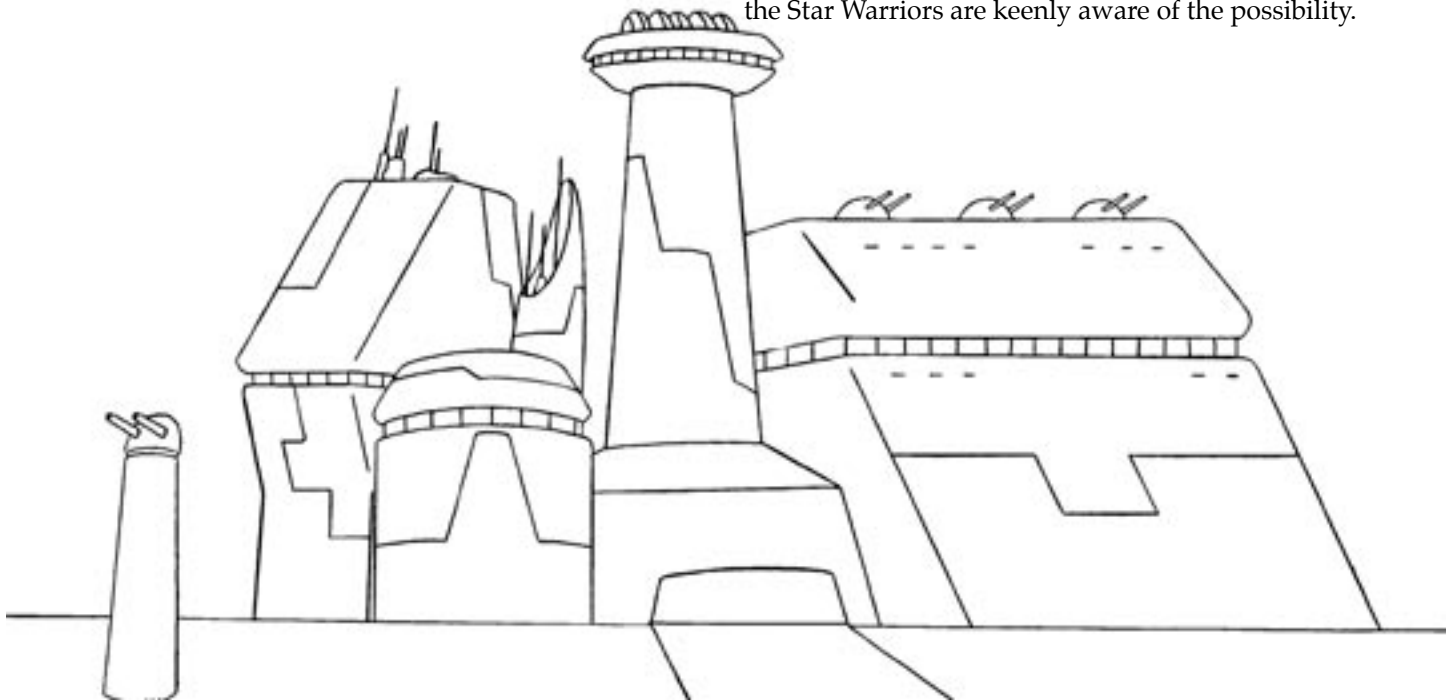

STAR WARRIOR CENTRAL: THE PLAYSET

The various features of Star Warrior Central as a base are modelled here using *Cartoon Action Hour's* vehicle rules, with one key difference — no movement modes have been added. In addition, Capacity can be taken to mean the number of people who can live in the structure, not merely how many can fit inside. Though a total cost is given for this "playset", characters do not have to pay for it — it is free to them, and balanced out by the fact that Zarnon's fortress is just as powerful. Any further improvements must be paid for with character points.

Star Warrior Central (Vehicle/Playset, Power Level: High)

The high-tech fortress of the Star Warriors!

Traits: Body 4(5), Armor 4(4), Auto-Gunnery 4, Computer 4, Perception 4(3), Medical 3, Knowledge 4, Repair 3, Science 3

Size: Colossal

Capacity: 10 enclosed

Structure Points: 850

VDM: 34

WEAPONS

Ground Defense Lasers (DR 5+2, Range: Long, Burst Fire, Vehicle Class)

Force Field (DSA, Power Level Medium, Protection 8)

Total cost: 46 (140 SCP)

THE UNIVERSE LEAGUE

MISSION

The Universe League was founded on a basic principle of equality of sentient beings, and exists for the protection of all races who wish to join. It avoids needless intervention in individual worlds or stellar nations, but inevitably must pass some league-wide laws and provide support to local and interplanetary law enforcement (via the Universe League Police). The Universe League is also dedicated to interstellar exploration, and sponsors many missions to seek out new planets and new life.

The Universe League military exists to provide the protection entitled to the Universe League's members. In peacetime it acts as a patrol force, both along the borders of the League to keep out enemies, and within to monitor possible civil wars or insurrections. Currently, almost all of the military is being used to defend against the attack of Zarnon's forces. As yet, none of the members of the Universe League have taken advantage of this confusion to cause trouble or grab for power.

ORGANIZATION

The Universe League is a representative democracy, with each world or stellar nation choosing its own representatives (136 at last count). The President and Vice President are elected separately every 5 years, and neither can serve in the same position for more than 15. Basically, each world under the Universe League has two sets of laws — those of the Universe League as a whole, and its own (so long as they do not violate the rights and clauses set out in the Universe League's Constitution, such as freedom of speech, species equality, and so on). The Vice President presides over the meeting of representatives, as well as presenting initiatives and legislation by the President to such assemblies.

The Universe League's military is divided into ground forces, planetary navies, and the main space fleet. Ground forces handle all planetside infantry, armored and artillery units, planetary navies handle all aquatic forces, and the Space Fleet acts as both an air and space force. (It also employs a substantial contingent of Marine infantry.) The functions of these forces frequently overlap, and they are used to cooperation.

RANKS FOR GROUND FORCES

Non-Commissioned: Private, Corporal, Sergeant, Master Sergeant

Officers: Second Lieutenant, First Lieutenant, Captain, Major, Colonel, Major General, General

RANKS FOR PLANETARY NAVIES AND SPACE FLEET

Non-Commissioned: Seaman/Spacer Apprentice, Seaman/Spacer, Petty Officer First Class, Chief Petty Officer

Officers: Lieutenant Junior Grade, Lieutenant, Lieutenant Commander, Commander, Captain, Vice Admiral, Admiral

LOCATION

Satrenia is the capital of the Universe League, and the Council City is the seat of power. The planetary representatives meet in the Crystal Chambers, a large hall designed by the Mentons. The imperceptible vibrations of the structure generate calming psychic waves, designed to promote peaceful discussion and compromise. The President's offices and meeting halls are located on an upper floor, while both he and the Vice President live in adjacent buildings.

Officially, the military's base of operations is also on Satrenia, in an underground complex known as Alpha Base. However, with the war against Zarnon demanding as many of the military's resources as possible, most administration of the separate forces is done near the front lines, from mobile bases and battleships. Impromptu bases have been set up on nearly all the border worlds, while those permanent bases already existing before the war are now used as strategic rallying points, so an embattled force on Celonia may well fall back to Capricorn Base on Galenda to regroup.

ALLIES – THE SUPPORTING CAST

CHRISTOPHER SAGE

"President of the Universe League"

Oomph: 1

Stunt Points: 0

Hurt Points: 29

Size: Medium

STORY HOOKS

President — Major

TRAITS

Persuasion 4, Knowledge (Politics) 4, Performer (Oratory) 0/2, Wealth 4, Perception 1, Psychology 2

SPECIAL ABILITIES

Personal Shuttle (Vehicle, Power Level: Medium)

The President and entourage travel in a compact shuttlecraft.

Traits: Body 2, Speed 2, Auto-Pilot 1.

Travel Mode: Air Travel (Speed 2), Space Travel (Speed 2)

Size: Large

Capacity: 4 enclosed

Structure Points: 40

VDM: 4

Total cost: 18 (40 SCP)

Total CP Value: 50 CPs

BACKGROUND

A veteran diplomat, Christopher Sage's work was instrumental in carving out the treaty which ended the Mutant Wars, as well as preventing any of the outlying colonies from falling under mutant control. Sage was elected President in 2522, at the age of 61.

PERSONALITY

Sage is a calm, intellectual man with a gentle tone of voice. A diplomat by nature, he recognizes that this particular enemy is not willing to negotiate, though he holds out hope that destruction can be minimized. He trusts the Star Warriors implicitly, and only questions their actions if they seem to be clearly going against their stated mission. He knows how to keep his head in a crisis, which is good because his status as President makes him a giant target.

APPEARANCE

Christopher Sage is an elderly man with a thin build. His hair and beard are a dusty grey, and both are slightly long. He generally wears a white or light-colored jacket over a green shirt, with brown pants.

EBERONA

"Vice President and Visionary"

Oomph: 0

Stunt Points: 0

Hurt Points: 35

Size: Medium

STORY HOOKS

Vice President of the Universe League — Major

Prone to Visions — Moderate

TRAITS

Persuasion 4(2), Perception 3, Knowledge (Politics) 4, Willpower 4(2), Psychology 3, Knowledge (Galactic History) 2, Wealth 2

SPECIAL ABILITIES

Premonitions (Misc. SA, Power Level: Medium)

Eberona often receives strange, cryptic visions of the future.

No Components

Restriction: Cannot Control

Total cost: 4

Total CP Value: 50 CP

BACKGROUND

Originally one of the Great Seers at the Menton's Diamond Academy, Eberona has long possessed the gift of prophecy. One night, she received a vision of an ancient evil placing the entire universe in peril. She decided to leave the academy and enter the political arena in order to help the Universe League prepare for the arrival of this unknown menace. The Menton people trusted her powers as a seer, and their support carried her to the Vice Presidency in the general election. Throughout the first three years of her term, she has quietly worked to strengthen the frontier and keep the Space Fleet on the lookout for unusual occurrences. In 2525 her scrutiny paid off.

PERSONALITY

Like many Mentons, Eberona has a personality which seems rather cool and subdued to members of other species, but she is also friendly and compassionate. She is deeply dedicated to using her powers for the greater good, and will often tell the Star Warriors of her visions in hopes that they may benefit from her foresight.

APPEARANCE

Eberona has pale green skin, and is bald-headed — the mark of a high-ranking Menton elder. She has cool, regal features, appearing to be in her 30s or 40s, and dresses in an elder's robe decorated with the Universe League insignia.

GENERAL JOHN BROCK

"Gruff commander of the Universe League Army"

Oomph: 1

Stunt Points: 1

Hurt Points: 43

Size: Medium

STORY HOOKS

Leads the Universe League Army — Major

Tries to do everything himself — Moderate

TRAITS

Armed Combat 3, Unarmed Combat 3, Ranged Combat 4, Body 4, Perception (Strategy) 1/3, Medical (First Aid) 0/2, Persuasion (Command) 1/3, Willpower 2, Demolitions 1

SPECIAL ABILITIES

Blaster Pistol (OSA, Power Level: Low)

As a commanding officer, Brock carries a J37 Service Blaster for use in the field.

DR 4+2

Range: Medium

Restriction: Item

Restriction: Charges, Minor

Total cost: 4 CP

Total CP Value: 50 CP

BACKGROUND

John Brock first enlisted in the army near the tail-end of the Mutant Wars. Rising quickly through the ranks due to his determination and skill, Brock won many decorations and distinguished himself at the Battle of Derelus. In peacetime, he supervised patrols of the Mutant border, and was ultimately named a general. When Zarnon was revived and the Universe League prepared for war, Brock was made head of the Army's operations. He's been on the front lines ever since.

PERSONALITY

Brock behaves like a man out to prove himself, which is a bit odd since he's already one of the highest ranking members of the military. He is convinced that he and his forces are quite enough to handle the Cybertroops, and generally resents interference by the Star Warriors. Despite this he is a good leader, and will grudgingly accept help if it's in the best interest of the greater cause. He just likes to act tough about it.

APPEARANCE

Brock is a brown haired, sturdily-built man in his early forties. He is balding, and wrinkles have started to show. He is most often seen in plain green or camouflage fatigues, and is rarely out of combat long enough to put on a dress uniform.

UNIVERSE LEAGUE SOLDIERS

Though the heroes won't be fighting with the Universe League, under certain circumstances you may need to know the combat strength of the Universe League's forces. Assume, for ground battles, that a group of Universe League soldiers has a Goon Factor of 6 and Determined 1.

SPECIES DETAILS

HUMANS

PHYSIOLOGY

Your basic bipedal mammals of average strength and intelligence. The physiology of Humans is perhaps the most well-documented of all the sentient species, so you can easily look elsewhere for relevant details.

SOCIETY

Humans are the single most numerous member race in the Universe League, and serve in a variety of professions. Generally they are thought of as the explorers, colonists, and soldiers of the Universe League; they have a peculiar habit for taking initiative and rushing into danger. Human-dominated worlds tend to have democratic local governments and average technology levels, based on how close they are to the major spaceways.

HEMOWORLD

The planet Earth, occasionally called Terra, suffered from pollution and overpopulation during the 20th and 21st centuries. However, when Humans began to colonize other worlds in other star systems, they were able to ease the overcrowding of their home planet and were less dependent on its natural resources. Over time, Earth was allowed to heal as smaller populations began to live in harmony with the land. Now, Earth is a lush cultural center and a second capital for the Human half of the Universe League.

MODIFIERS

There are no modifiers to Human characters.

MENTONS

PHYSIOLOGY

Mentons are humanoid in stature and appearance, though they tend to be thin by human standards. Their skin is in varying shades of green, with both hair and eyes in bright colors (usually matching). All Mentons possess some degree of telepathic ability, though individual manifestations vary.

SOCIETY

The Mentons are focused on the cultivation and controlled use of their psychic powers. Nearly every Menton-

dominated world has an academy which not only trains Mentons to develop their power, but also provides first-rate education to all races in areas of science, galactic history, philosophy, mathematics, and other disciplines. The Mentons are the universe's scholars, educators, and scientists; their old Star Empire was founded primarily to explore surrounding worlds, rather than to exploit them. Mentons tend to value logic and discipline, and they are encouraged from birth to develop themselves and reach their full potential.

HOMEWORLD

Cerebros is a lush forest world. It is relatively underdeveloped, as the Mentons have learned to make homes for themselves without spoiling the surrounding environment. The gleaming, crystalline buildings of Menton cities sit comfortably among giant trees and green fields. The planet is also the home of the Diamond Academy, the single most prestigious psychic training facility in the universe.

MODIFIERS

Mentons get +1 to Willpower and Science, and a -1 to Psychology and Body.

DECEPTOIDS

PHYSIOLOGY

Descended from fish, the Deceptoids are lean, cold-blooded creatures with clammy skin in various pale shades of blue, brown, and purple. They are hairless, and have large eyes and webbed, pointed ears. Their hands and feet are also webbed, and their teeth are small and sharp. Deceptoids also possess varying degrees of telepathic ability, though their powers tend to focus on influencing the minds of others.

SOCIETY

Developing on a harsh, watery planet full of large predators, the Deceptoids were forced to find ways to preserve themselves. In addition to manifesting hypnotic powers as a natural defense, they evolved a paranoid mindset which encouraged them to continually grab for territory and influence over each other. To this day, their society is one of mutual distrust and suspicion, held together by a larger suspicion of the outside world. Deceptoids feel compelled to grab for power and security, though successful ones frequently extend this to outright greed.

HOMEWORLD

Mantennor is dominated by oceans, with only a scattering of small, rocky islands. In fact, it is somewhat remarkable that land-going life developed there at all. The Deceptoids live in a loose confederation of baronies and fiefdoms, frequently at odds with each other but never waging open war.

The Deceptoids are members of the Universe League, but Mantennor is close to the periphery of Universe League territory.

MODIFIERS

Deceptoids get a +1 to Athletics (Swim) and Wealth, and a -1 to Appearance (Humanoids) and Persuasion

FLAMITES

PHYSIOLOGY

Flamites are an odd race of humanoids who possess some kind of innate connection with fire. Outwardly, they look like orange-skinned humans with white hair and attractive features. Every Flamite has an elemental power which allows them to control fire. This power varies among individuals, and cannot be developed by formal training; it seems almost an intuitive connection, which each Flamite must develop on their own.

SOCIETY

Flamites are extremely social beings, naturally charismatic and artistic. At the same time, Flamite society is highly individualistic; Flamites tend to have very strong, dramatic personalities and exhibit a wide range of eccentricities and obsessions. Flamite-dominated worlds tend to have very loose aristocratic governments, concentrating power in wealthy dynasties while preserving the individual rights of all citizens. On the downside, they tend to be very lax in their persecution of crime, and Flamite criminals are notoriously ambitious, wreaking havoc on worlds all across the known universe. The best tend to enjoy a celebrity status among many of their people.

HOMEWORLD

Thermia is a rocky, volcanic world with temperatures so high that other species can hardly stand to visit for any long period of time. As such it is still populated almost exclusively by Flamites, who live happily in subterranean palaces and courts carved out of ancient lava tubes. Even when dormant volcanoes or ones thought extinct erupt without warning, it's more of an inconvenience than anything else. The Flamites are also members of the Universe League, though many criminals make homes for themselves outside of civilized space.

MODIFIERS

Flamites gain a +1 to Artist or Performer and well as to Appearance, but a -2 to Willpower.

FANGORS

PHYSIOLOGY

Fangors are large, woolly bipeds with exceptional strength. Their name comes from the large, sharp fangs reaching down from their upper jaw (these are rarely used as a weapon, however). They tend to have bright red eyes, which help them see in the dark.

SOCIETY

The Fangors have a primitive hunter-gatherer society. They are not inherently less intelligent than average, but the scarcity of metal deposits on their world prevented them from developing much in the way of advanced technology. The Fangors are grouped into tribes of a few hundred members each; the strongest and most well-trained of each tribe is made a sheriff, while other capable individuals are appointed protectors. The job of the sheriff and the protectors is to defend the tribe from external threats, such as wild animals. Other members of the tribe are hunters, miners, tool-makers, food-preparers, and so on. The Fangors are more peaceful than their brutish appearance would indicate; they generally leave outsiders alone unless provoked.

HOMEWORLD

Kashdor is primarily a jungle planet, with giant trees reaching some 100 feet into the air and almost totally blocking the sun from the surface. The Fangors live near the bases of these trees and at the foot of massive mountains, where they have set up mines in order to harvest the valuable Fire Diamonds. Since the Fangors' original contact with the Star Warriors, they have become members of the Universe League, though not many have left their home.

MODIFIERS

Fangors gain a +2 to Body and a -1 to Repair and Computers.

MUTANTS

PHYSIOLOGY

Created by Zarian bioengineering, the Mutants are one of the most diverse species in existence. Though generally humanoid, the Mutants vary widely in appearance and build. They tend to be stronger and more aggressive than most races, but each Mutant possesses some unique mutation, which may manifest itself as an exceptionally enhanced ability, some kind of meta-human power, or an external mutation such as an extra limb. Mutants tend to be unattractive in the eyes of most other species, and their propensity to violence does not help their popularity any.

SOCIETY

Left to their own devices when the Zarian race destroyed itself, the Mutants formed a violent, tribal society based on the principle of rule by the strongest. Each world in the Mutants' limited empire is dominated by large, well-armed gangs who take what they can from the others while trying to defend their own resources. As such, they are almost constantly fighting each other. A Mutant's identity is usually defined by his gang and his role within it; the strongest of the gang are the fighters, the smartest cobble together equipment and supplies, and so on. Mutants enjoy living in highly polluted areas, full of trash and radioactive ooze, which apparently acts as a nutrient. The less said about their personal habits, the better.

HOMEWORLD

Toxion, the site where the Mutants were first spawned out of chemical vats, has become their de-facto capitol. It is easily the most heavily populated, arguably the most polluted, and possibly the least pleasant of all the Mutant worlds. It is the home of the Horde, the single largest of all Mutant gangs. Mutant space lies beyond the Galactic Southern border of Universe League space, and the two have an uneasy peace treaty. Some Mutants already work for Lord Zarnon and his invasion force, and it is suspected that the Mutants may have an instinctive drive to obey a Zarian master, but the species' position in this new war is far from assured.

MODIFIERS

Mutants get a +2 to Body and a -2 to Appearance.

ZARIANS

Note to Players: In the standard setting, Lord Zarnon is the only surviving member of his race. The GM may decide to disallow any other Zarian characters, especially PCs, for this very reason. Get the GM's approval if you wish to play a character from this species.

PHYSIOLOGY

Zarians are green-skinned, bald-headed humanoids of average build. They have fangs and small pointed ears and pointed fingernails. Zarians seem to have possessed supernatural powers, such as Lord Zarnon's ability to fire laser blasts from his eyes. This may be the product of some as-yet-unknown technology.

SOCIETY

Zarnon being only one known Zarian still alive in this age, the idea of society is somewhat irrelevant. In their prime, the Zarians were a race of warlords with an indomitable thirst for power, living in a highly advanced Empire that covered most of known space. Their organization was feudal, with a single Emperor ruling over countless Lords and Dukes, but the loyalty of the lesser nobles was fleeting at best. The society and race eventually self-destructed in a giant civil war that left only ruins and the Mutants.

HOMEWORLD

Zaronia was the capital of the Zarian Empire, but its current location has been lost to memory. A vast world-city, covered by gigantic palaces and fortresses, it is now a ghost planet; all life on the world was wiped out by an unknown bioweapon in the last days of the Zarian civil war. All that remain are ruins, pieces of arcane, powerful Zarian technology, and strange "spirits" that can occasionally be seen drifting through the dead cities.

MODIFIERS

There are no modifiers to Zarian characters.

TECHNOLOGY

WEAPONS

The following are some of the common weapons used by Universe League soldiers.

BLASTER PISTOL (OSA, Power Level: Low)

A compact laser gun used by most officers and police forces.

DR 4+2

Range: Medium

Restriction: Item

Restriction: Charges, Minor

SA cost: 4 CP

BLASTER RIFLE (OSA, Power Level: Medium)

A more precise and slightly more powerful laser gun.

DR 5+2

Range: Long

Bonus: Advantage, Minor (laser scope, +1 to hit)

Restriction: Charges, Moderate

Restriction: Item

SA cost: 9 CP

AUTOBLASTER (OSA, Power Level: Medium)

A light automatic weapon which fires rapid salvos of laser bolts.

DR 6+2

Range: Medium

Bonus: Burst Fire

Restriction: Charges, Moderate

Restriction: Item

SA cost: 11 CP

BLASTER CANNON (OSA, Power Level: Medium)

The heaviest and most powerful personal laser weapon, often used against armored units and buildings.

DR 7+2

Range: Long

Bonus: Vehicle Class

Restriction: Charges, Major

Restriction: Item

SA cost: 18 CP

LASER KNIFE (OSA, Power Level: Low)

A small knife with a holographic blade.

DR 2+Body

Range: Point Blank

Bonus: Collapsible

Bonus: Ignore Force Field

Restriction: Item

SA cost: 10 CP

OTHER ITEMS

Here is a sampling of some personal gear employed by Universe League soldiers.

JETPACK (MSA, Power Level: Medium)

A back-mounted device which uses two fusion jets to propel the wearer into the air at high speed.

Flying

Speed 1

Restriction: Item

SA cost: 12 CP

SPACE SUIT (DSA, Power Level: Low)

Necessary for survival in a vacuum, this metallic suit also offers slight protection against weapons fire.

Protection 2

Bonus: Advantage, Major (sealed systems — allows survival in a vacuum or unsafe atmosphere)

Restriction: Item

SA cost: 5 CP

VEHICLES

Here are some of the major vehicles used both by the military and by citizens of the Universe League.

UNIVERSE LEAGUE FIGHTER (Vehicle, Power Level: Medium)

A swift and deadly starfighter employed by the Universe League Space Fleet.

Traits: Body 4, Maneuverability 1, Crew 1

Travel Mode: Space Travel (Speed 4), Air Travel (Speed 3)

Size: Large

Capacity: 1 enclosed

Structure Points: 80

VDM: 8

WEAPONS

Twin Blasters (DR 5+2; Range: Medium; Item; Charges, Minor)

SA cost: 18 (40 SCP)

UNIVERSE LEAGUE DROPSHIP (Vehicle, Power Level: Medium)

A large, egg-like craft which carries troops from battleships to the surface.

Traits: Body 4(2), Armor 4(2), Maneuverability -2, Crew 1, Computer 1, Perception 1

Travel Mode: Space Travel (Speed 0), Air Travel (Speed 0)

Size: Huge

Capacity: 11 enclosed

Structure Points: 480

VDM: 24

SA cost: 20 (60 SCP)

UNIVERSE LEAGUE FIGHTER

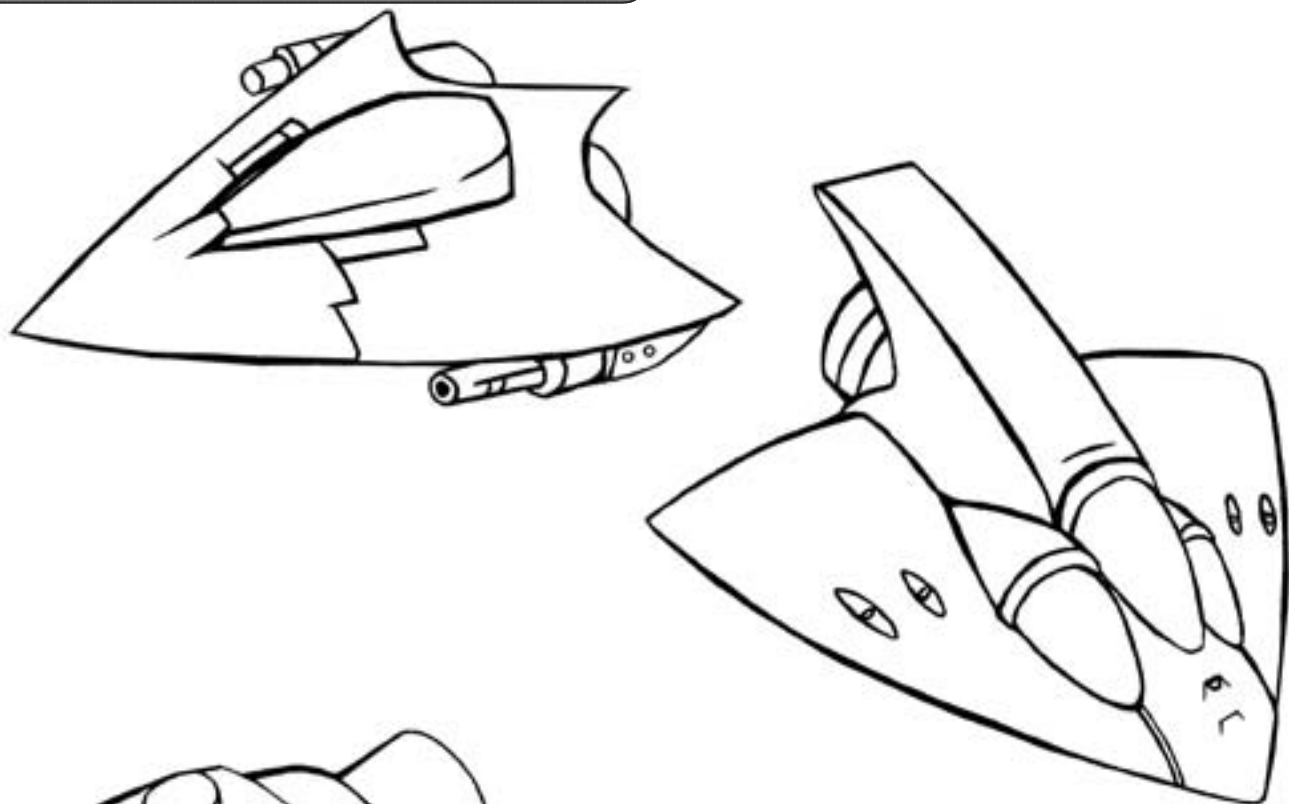

UNIVERSE LEAGUE SCOUTSHIP

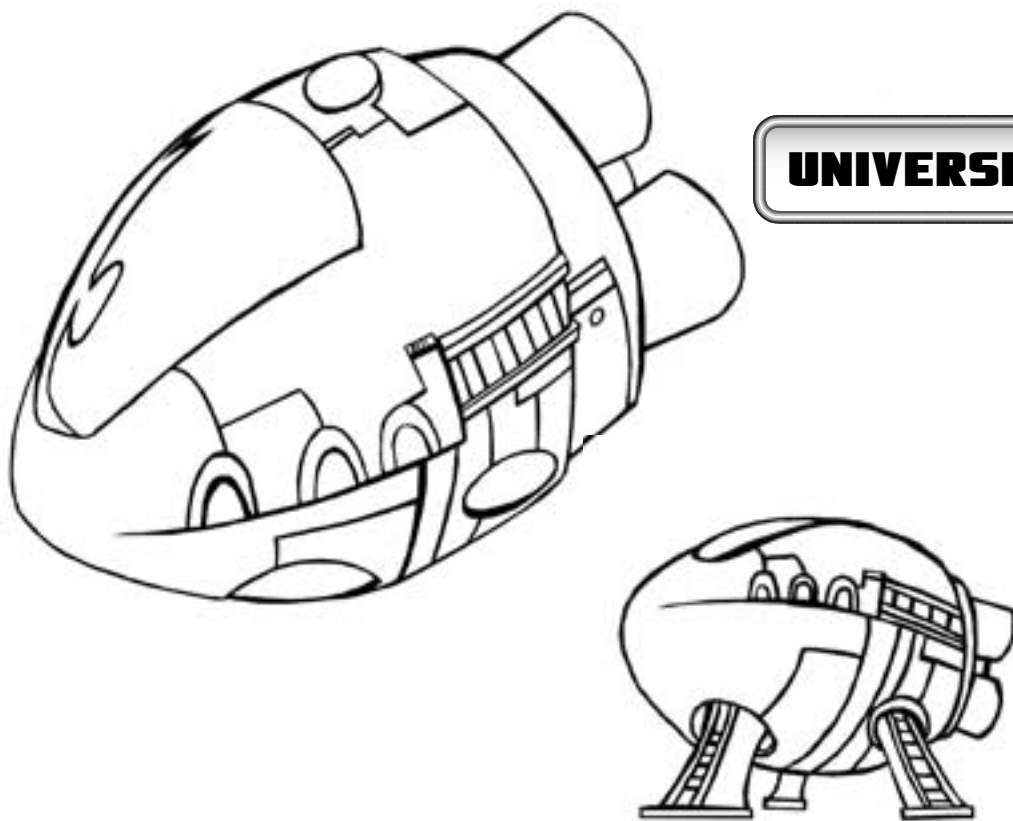

UNIVERSE LEAGUE DROPSHIP

UNIVERSE LEAGUE BATTLE CRUISER

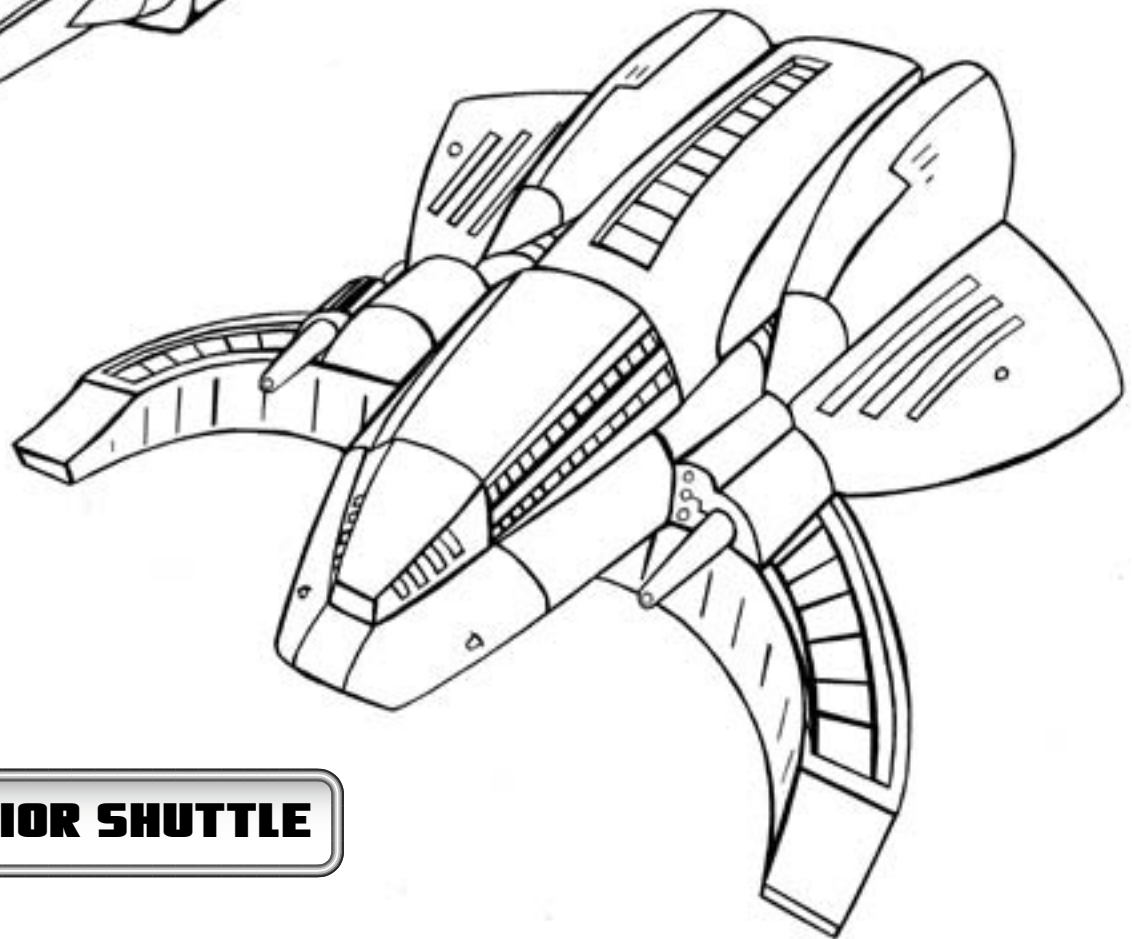
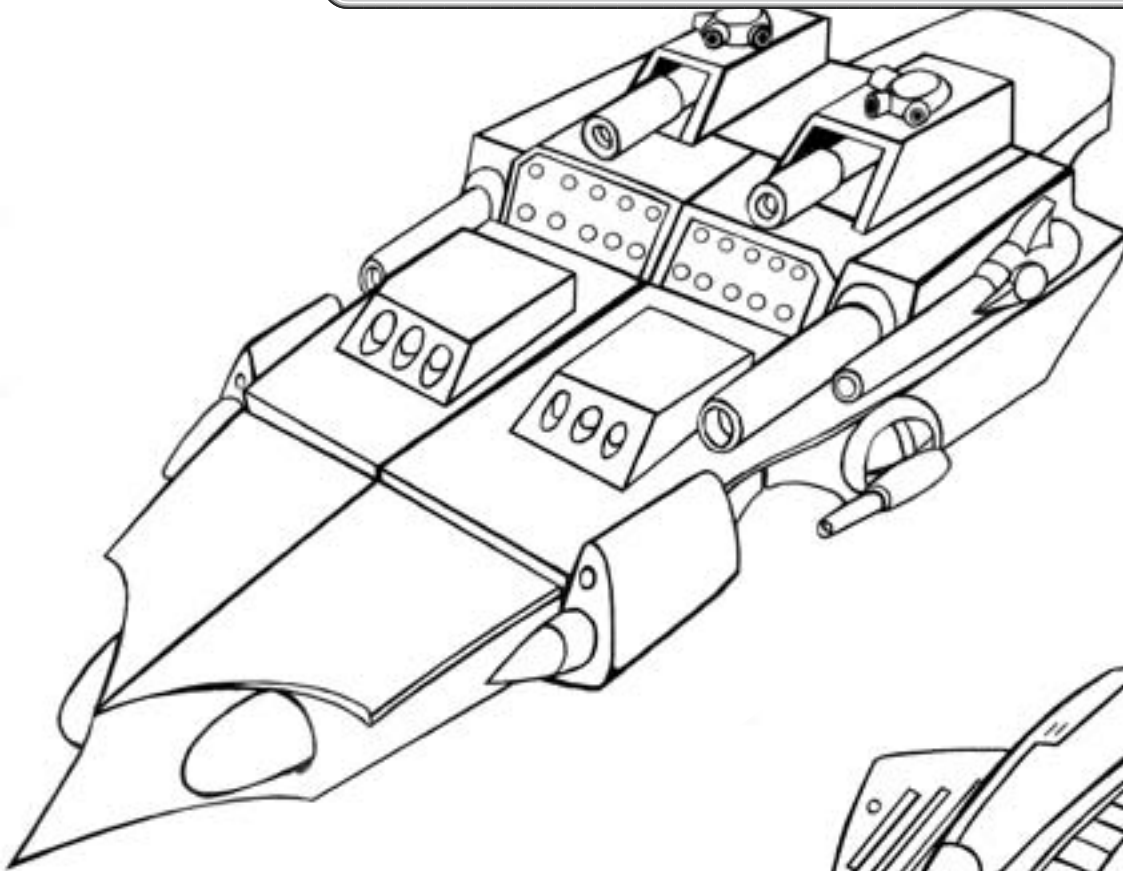

STAR WARRIOR SHUTTLE

UNIVERSE LEAGUE SCOUTSHIP (Vehicle, Power Level: Medium)

A long range craft designed for exploration and reconnaissance.

Traits: Body 3, Armor 1, Maneuverability 4, Stealth 3, Survival 2, Computer 4, Perception 3, Science 2

Travel Mode: Space Travel (Speed 4), Air Travel (Speed 4)

Size: Very Large

Capacity: 2 enclosed

Structure Points: 120

VDM: 8

WEAPONS

Mini Blasters (DR 3+2; Range: Medium)

SA cost: 22 (80 SCP)

UNIVERSE LEAGUE BATTLE CRUISER (Vehicle, Power Level: High)

A gargantuan flagship which dominates the battlefield. Only six are in service.

Traits: Crew 3, Body 4(4), Armor 4(2), Stealth -4, Computer 4, Perception (Strategy) 4/4(3), Knowledge 3, Medical 2, Repair 3, Science 1, Appearance 2

Travel Mode: Space Travel (Speed 1)

Size: Colossal

Capacity: 39 enclosed

Structure Points: 700

VDM: 28

WEAPONS

Turbo-Blasters (DR 7+2; Range: Medium; Autofire)

Neutron Torpedoes (DR 9+2; Range: Medium; Charges, Moderate)

SA cost: 66 (180 SCP)

SUPER TANK (Vehicle, Power Level: Medium)

A hulking armored vehicle employed by the Universe League's ground forces.

Traits: Body 4(4), Armor 4(4), Crew 2, Stealth -2, Computer 1, Perception 1, Maneuverability -1, Appearance 1

Travel Mode: Land Travel (Speed 1)

Size: Very Large

Capacity: 6 enclosed

Structure Points: 480

VDM: 32

WEAPONS

Blaster Cannon (DR 7+2; Range: Long; Charges, Moderate)

SA cost: 20 (60 SCP)

SHUTTLECRAFT (Vehicle, Power Level: Low)

A standard runabout used by most private space-goers.

Traits: Body 4, Armor 2

Travel Mode: Air Travel (Speed 2), Space Travel (Speed 2)

Size: Very Large

Capacity: 4 enclosed

Structure Points: 180

VDM: 12

SA cost: 16 (39 SCP)

JET CAR (Vehicle, Power Level: Low)

Just your average flying car, used by most citizens of the Universe League for daily travel.

Traits: Body 4, Maneuverability 1

Travel Mode: Air Travel (Speed 3)

Size: Very Large

Capacity: 4 enclosed

Structure Points: 120

VDM: 8

SA cost: 14 (29 SCP)

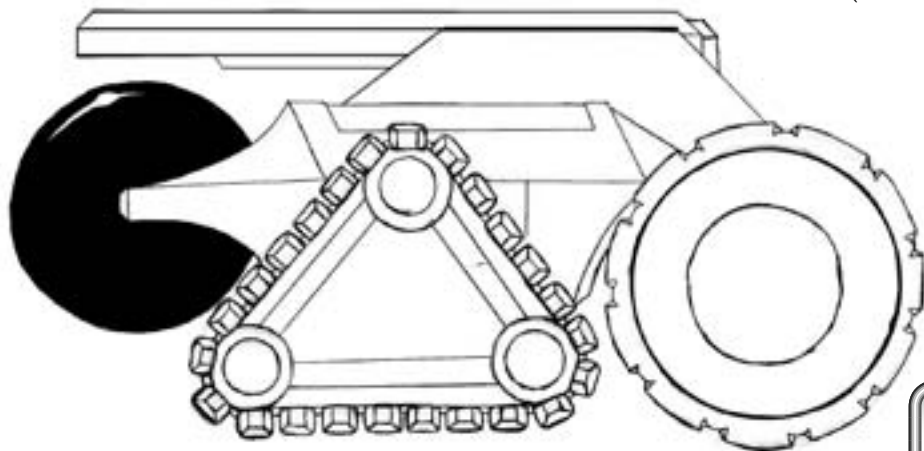

SUPER TANK

CHANNEL FOUR THE STAR WARRIORS

CAPTAIN LANCE

STARFIRE

"Fearless Team Leader"

Oomph: 5

Stunt Points: 2

Hurt Points: 42

Size: Medium

STORY HOOKS

Leader of the Star Warriors — Major

Archenemy (Lord Zarnon) — Major

Dedicated to teaching Maverick — Minor

TRAITS

Armed Combat 2, Athletics 3, Body 3, Piloting 1, Ranged Combat 3, Unarmed Combat 3, Perception 2, Survival 1, Willpower 4, Appearance 2, Persuasion 3

SPECIAL ABILITIES

Steel Bodysuit (DSA, Power Level: Medium)

Starfire wears a gleaming suit of light ultra-steel.

Protection: 5

Bonus: Weightless

Restriction: Item

Total cost: 11 CP

Super Rifle (OSA, Power Level: Medium)

Starfire's laser rifle is both deadly and accurate.

DR: 6+2

Range: Visual

Bonus: Advantage, Major (+2 Ranged Combat)

Restriction: Item

Total cost: 19 CP

Total CP value: 100 CP

BACKGROUND

Lance Starfire began his career as a Marine in the Universe League Space Fleet. He served with distinction during the Mutant Wars, and became both decorated and well known throughout the service. He was renowned for his natural leadership ability and his initiative on the battlefield, improvising ways to take advantage of changing situations.

When the wars ended, Starfire was assigned to the Fleet's scouting division. On a survey mission to a then-uncharted system, his scout craft was disabled by a meteor storm, and he was forced to crash-land on the barren world of Malitron. Starfire arrived on Malitron just in time to watch as the fugitive scientist Dr. Roboticus opened Lord

CAPTAIN LANCE STARFIRE, POST-MOVIE (150 CPS)

These stats represent Lance at the beginning of the series. The post-movie versions of the main characters are more powerful. To represent the post-movie Lance Starfire, make the following alterations:

IMPROVED TRAITS:

Armed Combat 4

Athletics 4

Body 4

Ranged Combat 4

Unarmed Combat 4

Hurt Points 45

MODIFY STEEL BODYSUIT:

Hardened +4

Advantage, Major (Sealed System- Space Suit)

w/ Jet Pack (Multi-SA)

Flying (Speed 4)

Super-Scale Movement

NEW SA:

Laser Sword (OSA, Power Level: Medium)

A shimmering energy blade that can cut through metal.

DR: 7+Body

Range: Point Blank

Bonus: Armor Piercing 5

Restriction: Item

Total cost: 15 CP

Zarnon's ancient coffin. The alien warlord was revived, and after Zarnon cowed Roboticus into submission, he turned his attention to Captain Starfire. Fortunately, Zarnon was in a weakened state after his slumber, and Starfire was able to evade capture, repair his ship, and fly back to civilization.

By listening in on Roboticus and his new master's conversation, Starfire worked out that Zarnon was planning to build an army. Upon reaching the scout base and showing his superiors secret holo-recordings of Zarnon's return, Starfire was told more about the legendary power of the Zarians, and he decided that special action was required. He presented to the Universe League plans for a new team of special defense operatives — the Star Warriors.

PERSONALITY

Starfire is a leader by nature, given to bold and decisive action. He knows and trusts his teammates, and despite being the de facto leader, he usually does not pull rank. He may take the initiative most of the time, but he regards his teammates as equal decision makers. The exception is Red Maverick, whom he regards as talented but not yet a disciplined soldier, and often offers him firm guidance.

Starfire is also the team member who has the most contact with the other forces of the Universe League. He tends to think of his battles with Zarnon in terms of the larger war, and will be quick to reject a course of action that puts anyone but his own team at risk.

DR. REX TOLKEN

"Brilliant Scientist & Inventor"

Oomph: 2

Stunt Points: 1

Hurt Points: 29

Size: Medium

STORY HOOKS

Archenemy: Dr. Roboticus — Major

Knows the secrets of the Star Warriors' technology — Moderate

TRAITS

Coordination 2, Piloting 2, Ranged Combat 2, Computers 3, Inventor 4, Medical 1, Repair 4, Science 4, Willpower 1

SPECIAL ABILITIES

Sonic Stunner (OSA, Power Level: Medium)

A gun that produces explosive bursts of low-frequency sound.



DR: 4+2

Range: Medium

Bonus: Area of Effect (6 yards)

Restriction: Item

Total cost: 12 CP

Oddily the Alien (Animal Companion, Power Level: Low)

A lovable one-eyed alien that Dr. Tolken rescued from Dr. Roboticus' lab.

Traits: Athletics 2, Coordination 2, Stealth 3, Perception 2, Repair -1

Oomph: 1

Stunt Points: 1

Hurt Points: 29

Primary Movement: Land

Size: Very Small

Story Hooks: Former captive of Dr. Roboticus — Moderate

Total cost: 14 CP (30 SCP)

Star Warrior Shuttle (Vehicle, Power Level: High)

Dr. Tolken built and pilots the shuttle that flies the Star Warriors from planet to planet.

Traits: Body 4(2), Maneuverability 2, Speed — Air 1, Speed — Space 1, Computer 2

Travel Mode: Air and Space

Size: Huge

Capacity: 6 enclosed

Structure Points: 240

VDM: 12

WEAPONS

Twin Laser Cannons (DR 4+2; Visual Range)

Total cost: 22 CP (60 SCP)

Total CP value: 100 CP

BACKGROUND

Dr. Tolken first distinguished himself as a research scientist at the Clark Institute on Antell. Interested primarily in mechanics and electronics, he gained enough attention from the Universe League military that they began to offer him lucrative defense contracts. This earned him the enmity of the Institute's other celebrity, Dr. Alexi Roboticus, who had been trying to convince the military for years to adopt his concepts for cybernetic weaponry. Dr. Tolken clashed with Dr. Roboticus over the issue of "pure mechanization", and their rivalry came to a head when Tolken found that Roboticus planned to use a helpless alien creature as a test subject in a particularly brutal experiment. Tolken rescued the alien (whom he named Oddily and adopted as a pet), and had Roboticus expelled from the Institute for unethical practices.

DR. REX TOLKEN, POST-MOVIE (150 CPS)

These stats represent Dr. Tolken at the beginning of the series. The post-movie versions of the main characters are more powerful. To represent the post-movie Dr. Rex Tolken, make the following alterations:

IMPROVED TRAITS:

Stunt Points 2

Oomph 3

Piloting 4

Ranged Combat 3

Computers 4

Medical 3

MODIFY SONIC CANNON:

DR 6+2

Ignores Force Fields (unless they block sound)

Vehicle Class

NEW SA:

Sonic Field Generator (DSA, Power Level: Medium)

A boxlike contraption that creates a protective wall of low-frequency soundwaves.

Protection 6

Duration: 1d12 minutes

Bonus: Area of effect (3 yards)

Restriction: Item

Total cost: 14 CP

Years later, while developing a new kind of space shuttle for the Universe League, Dr. Tolken overheard reports that Roboticus had resurfaced and was working with a mysterious alien overlord, planning an invasion of free space. He later found that the Universe League was developing a special task force to deal with the threat, and offered his services. He dusted off many unused design concepts and began building weapons, vehicles, and other devices for the team. As a result, he was given a quick promotion from scientific consultant to active member when war finally broke out.

PERSONALITY

Dr. Tolken is perhaps the most good-natured of the group, with a pleasant attitude and a sense of humor. At the same time, he is extremely committed to the cause, feeling a particular responsibility to stop Dr. Roboticus from gaining any more power. He sympathizes very much with Roboman's condition, understanding that he was the victim of his archenemy's twisted version of science, and is probably that team member's closest friend. Though by no means a coward, he does try to avoid being caught up in any heavy fighting, knowing that his strength is as an inventor and not a soldier. He also understands that if he

were ever captured, Zarnon would try to make him reveal information about the Star Warriors' base or any other piece of technology he has designed for them. Ultimately, he will not run from a fight when it erupts, but he is usually the team's voice of caution.

SHEILA SAPPHIRE

"The Future's Finest Detective"

Oomph: 2

Stunt Points: 1

Hurt Points: 33

Size: Medium

STORY HOOKS

Works too hard — Minor

Enemy: Baron Hypno — Moderate

Villains find her attractive — Major

TRAITS

Armed Combat 1, Piloting 2, Ranged Combat 1, Detective 4, Perception 4, Willpower 4, Appearance 4, Persuasion 4, Psychology 3

SPECIAL ABILITIES

Crime Lab (MiscSA, Power Level: Medium)

In Star Warrior Central's crime lab, Sheila uses the most advanced technology to solve mysteries.

Trait Modification A: +2 Detective

Restriction: Disadvantage, Major (can only be used in Star Warrior Central)

Restriction: Restriction (Details)

Total cost: 5 CP

Hand Blaster (OSA, Power Level: Medium)

Sheila carries a compact laser gun with a modified scope.

DR: 6+2

Range: Visual

Bonus: Advantage, Major (laser scope, +1 Ranged Combat)

Restriction: Item

Restriction: Charges, Major

Total cost: 13 CP

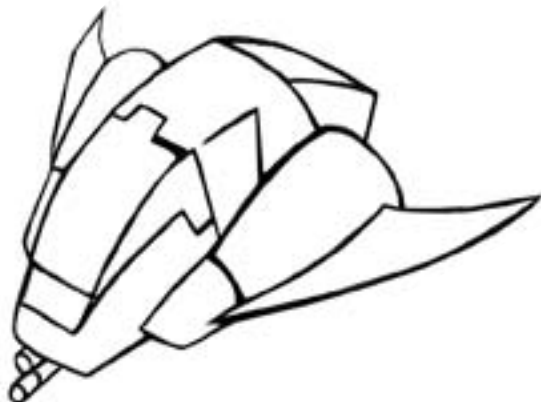

SHEILA SAPPHIRE, POST-MOVIE (150 CPS)

These stats represent Sheila at the beginning of the series. The post-movie versions of the main characters are more powerful. To represent the post-movie Sheila Sapphire, make the following alterations:

IMPROVED TRAITS:

Armed Combat 2

Piloting 3

Ranged Combat 3

MODIFY HAND BLASTER:

Vehicle Class

NEW SA:

Space Suit (DSA, Power Level: Medium)

Sheila dons this suit when she needs to do EVA work in the depths of outer space. It is equipped with jet thrusters for easy maneuvering.

Protection 3

Bonus: Advantage, Minor (sealed)

Bonus: Multi-SA (Jet Thrusters — Flying [Speed -1])

Restriction: Item

Total cost: 14 CP

Explorer Submarine (Vehicle, Power Level: Medium)

A miniature submarine the team uses to explore undersea environments.

Traits: Armor 2, Body 4, Maneuverability 1, Speed 1, Stealth 2, Survival 1, Computer 2, Perception 4

Travel Mode: Sea

Size: Huge

Capacity: 6 enclosed

Structure Points: 240

VDM: 12

WEAPONS

Energy Torpedo (DR 5+2; Visual Range; Restriction: Charges, Moderate)

Total cost: 20 (60 SCP)

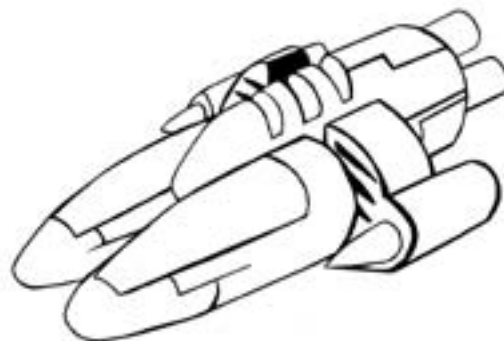

Hawkeye (Vehicle, Power Level: Medium)

Sheila uses this sleek air and space craft to scout for trouble.

Traits: Armor 1, Body 2, Maneuverability 2, Speed 2 —
Air, Speed 2 — Space, Stealth 4, Computer 3, Detective
3, Knowledge 3, Perception 3, Appearance 2

Travel Mode: Air and Space

Size: Large

Capacity: 1 enclosed

Structure Points: 60

VDM: 6

Weapons

Pinpoint Laser Scope (DR
2+2; Beyond Visual
Range)

Total cost: 22 (80 SCP)

Total CP value: 100 CP

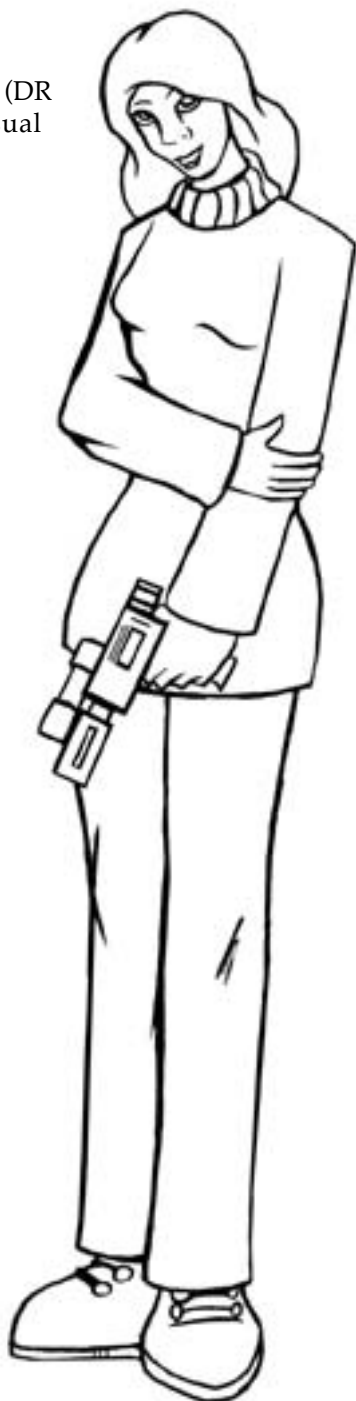

BACKGROUND

Sheila Sapphire was the daughter of Jack Sapphire, a Universe League Police detective that attained a measure of fame for catching Garkla, a notorious thief who stole some of the galaxy's most valuable art. Sheila admired her father greatly and soon followed in his footsteps. Starting as a lowly patrol officer on the Lunar beat, she worked countless hours, and eventually earned a place in the Special Case Department. There, over a period of three years, she assembled evidence against suspected slave trader Baron Hypno, destroying his operation and driving him into exile in unknown space. He has not forgotten this.

The government was already courting Sheila for a Galactic Bureau of Investigation position when news of Lord Zarnon's return reached them. Lance Starfire personally requested that a skilled detective join his team, and after being briefed Sheila quickly agreed to take the position.

PERSONALITY

Sheila is nearly as stern as Lance, having acquired a ruthless tenacity from her days with the police. She is something of a workaholic, pursuing leads as far as they go and rushing heedlessly into danger if it means uncovering the truth. She does not get much sleep. She does keep some sense of humor about her, and gets a particular thrill from outsmarting her enemies. She knows she'll figure out everything Zarnon is up to someday — it's merely a question of when.

RED MAVERICK

"Daring, fun-loving rookie"

Oomph: 2

Stunt Points: 2

Hurt Points: 38

Size: Medium

STORY HOOKS

Overconfident — Major

Thrillseeker — Moderate

Does not like being ordered around — Moderate

TRAITS

Armed Combat 2, Athletics 2, Body 2, Driving 3, Ranged
Combat 2, Unarmed Combat 3, Willpower 3, Appearance 3,
Streetwise 2

SPECIAL ABILITIES

Rocket Cannon (OSA, Power Level: Medium)

This hefty weapon fires explosive shells.

DR: 5+2

Range: Medium

Bonus: Vehicle Class

Restriction: Charges, Moderate

Restriction: Item

Total cost: 14 CP

Laser Knife (OSA, Power Level: Low)

A small knife with a holographic blade.

DR: 2+Body

Bonus: Collapsible

Bonus: Ignore Force Field

Restriction: Item

Total cost: 12 CP

Super Cycle (Vehicle, Power Level: Medium)

A jet-powered motorcycle that can attain incredible speed.

Traits: Armor 2, Body 1, Maneuverability 3, Speed 4,
Stealth 2, Computer 4, Perception 3, Appearance 4

Travel Mode: Land

Size: Large

Capacity: 1 exposed

Structure Points: 60

VDM: 6

WEAPONS

Gatling Guns (DR 6+2; Range: Medium;
Armor Piercing 1; Burst Fire)

Total cost: 20 CP (60 SCP)

Total CP value: 100 CP



RED MAVERICK, POST-MOVIE (150 CPS)

These stats represent Red at the beginning of the series. The post-movie versions of the main characters are more powerful. To represent the post-movie Red Maverick, make the following alterations:

IMPROVED TRAITS:

Stunt Points: 3

Oomph: 4

Hurt Points: 44

Armed Combat 4

Athletics 4

Body 4

Ranged Combat 4

Unarmed Combat 4

Demolitions 2

Repair 2

Persuasion (Intimidate) 0/2

MODIFY ROCKET CANNON:

Area of Effect 9 Yards

MODIFY SUPER CYCLE

Air Travel (Speed 2)

Auto-Pilot 2

Auto-Gunner 2

Repair 2

NEW STORY HOOK:

Equipped with a wisecracking onboard computer
— Moderate

BACKGROUND

From the start, Red Maverick had difficulty in the army. It was not that he couldn't handle heavy artillery or wrestle any given opponent to the ground; it was that he was no less likely to do this when ordered not to. Though stable enough to pass all psychological evaluations, he had trouble listening to orders and often interpreted them however he wished, but he was far too talented for the army to let go.

It was Maverick's commanding officer that heard about a new task force being assembled to deal with an imminent alien invasion. This force would not need a unit or platoon, but extremely competent individuals willing to take decisive action against the enemy. Seeing an answer to everyone's problems, he quickly transferred Maverick to the Star Warriors. Lance Starfire inherited a soldier who tended to ignore the group and take his own approach to problems, often causing disruption and confusion, but who also possessed the raw energy and determination that they would need to defeat Zarnon.

PSYCHLOS, POST-MOVIE (150 CPS)

These stats represent Psychlos at the beginning of the series. The post-movie versions of the main characters are more powerful. To represent the post-movie Psychlos, make the following alterations:

IMPROVED TRAITS:

Armed Combat 2
Perception 3
Willpower 4(5)

MODIFY CRYSTAL STAFF:

Long Range
Melee DR: 5+Body

NEW SAS:

Psychic Armor (DSA, Power Level: High)

A suit of crystalline armor that defends against mental attacks.

Protection 6
Levitating (Speed 2)
Bonus: Mental Defense
Restriction: Item

Total cost: 26 CP

Empathy (MiscSA, Power Level: Low)

Psychlos can sense strong emotions felt by people nearby.

No components

Total cost: 4 CP

PERSONALITY

Red's biggest problem is that he knows exactly how good he is. As a result, he feels little need to listen to other's opinions of how he should do his job. Under Lance Starfire's very active guidance, he is starting to learn some of the value of teamwork and modesty, but he has a very long road ahead of him. Red enjoys his work a little too much; he fights evil and puts himself in danger primarily for the thrill of it.

PSYCHLOS

"Powerful Alien Telepath"

Oomph: 2

Hurt Points: 36

Stunt Points: 2

Size: Medium

STORY HOOKS

Cold and aloof — Minor

Trains Continuously — Minor

TRAITS

Stealth 2, Detective 1, Perception 2, Willpower 4(3), Appearance 1, Persuasion 4, Psychology 3

SPECIAL ABILITIES

Crystal Staff (OSA, Power Level: High)

This Menton artifact allows Psychlos to channel blasts of Psychic Energy.

DR: 6+2
Range: Short
Bonus: Mental Attack
Restriction: Item
Restriction: Self-Damaging, Minor

Total cost: 16 CP

Mind over Matter (MiscSA, Power Level: Medium)

Psychlos can levitate objects with the power of his mind.

Levitation (Speed 0)
Range: Visual
Restriction: Only affects inanimate objects

Total cost: 15 CP

Psychic Shield (DSA, Power Level: Medium)

Psychlos can generate a protective barrier to defend against attacks.

Protection 5
Duration: 1d12 turns
Bonus: Area of Effect (3 yards)

Total cost: 15 CP

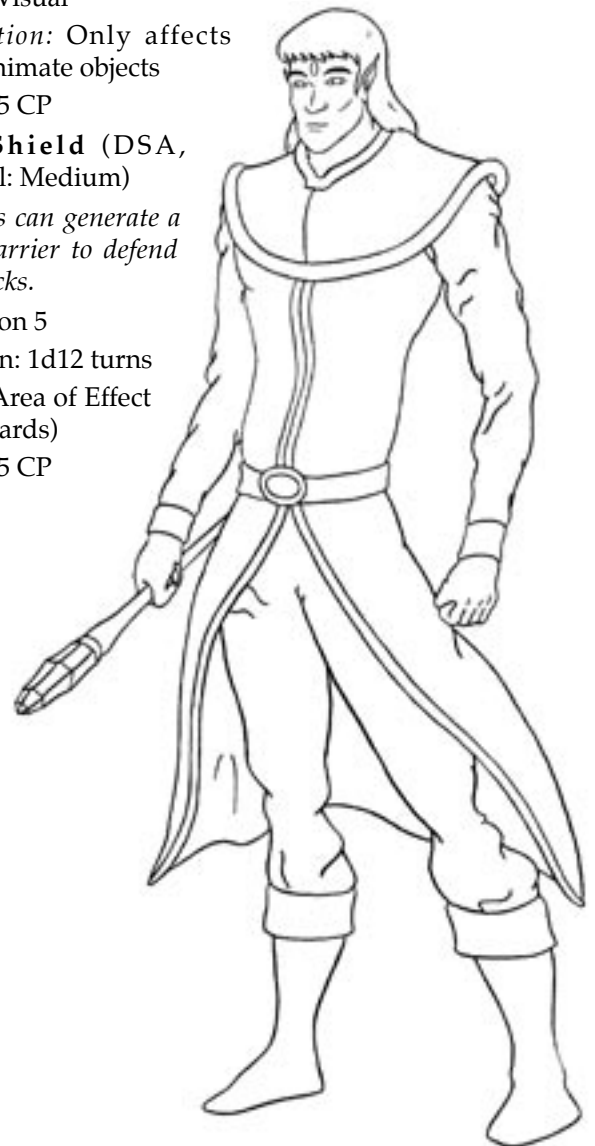

Hypnosis (MiscSA, Power Level: Medium)

Psychlos can command others by projecting his thoughts.

Trait Modification A: +4 Persuasion

Range: Point-Blank

Restriction: Only affects organic creatures

Total cost: 8 CP

Total CP value: 100 CP

BACKGROUND

Psychlos was raised on Cerebros, the Menton homeworld and capital of their empire before the formation of the Universe League. It was also the home of the Diamond Academy, the renowned center of learning where Mentons developed their psionic abilities. Psychlos was privileged enough to enter the Academy at an early age, and talented enough to pass many of its rigorous tests, honing his ability to exceptional levels.

While he was still in training, Menton seers had their direst predictions fulfilled with the return of Zarnon. Wanting to make a special contribution to the war effort, the Mentons decided to select a particularly talented psychic to add to the ranks of the Star Warriors. Psychlos, not fully trained but still far ahead of the rest of his kind, was selected and entrusted with the Academy's Crystal Staff — an ancient artifact that would give him the power of a true psionic warrior. Psychlos has yet to finish his training, but understands his duty comes first.

PERSONALITY

Psychlos is seemingly a stern, unemotional figure. In truth he does not lack feelings, but he has disciplined his mind enough to control them — and in light of what he sees as a serious assignment, he most often decides to remain cool and logical. He has not given up on his training, and uses every free moment to either meditate or practice his existing skills.

ROBOMAN

"Rogue Cyborg Allied Against Zarnon"

Oomph: 3

Stunt Points: 2

Hurt Points: 50

Size: Medium

STORY HOOKS

Resents his inhumanity — Moderate

Wants revenge on Roboticus — Major

Wants to remember his identity — Moderate

TRAITS

Armed Combat 2, Athletics 4, Body 4(3), Coordination 3, Ranged Combat 4, Unarmed Combat 4, Computers 2, Disguise -1, Repair 2, Willpower 3, Appearance -1

ROBOMAN, IF HE HAD SURVIVED (150 CPS)

At the end of the *Star Warriors* movie, Roboman was missing and presumed dead in a battle with Dr. Roboticus; however, throughout the show's last season there were hints that he had survived. If you wish to stage his return, or simply have a more powerful version of the character, here are some hypothetical improvements:

IMPROVED TRAITS:

Stunt Points: 3

Armed Combat 3

Driving 2

Piloting 2

Computers 4

Disguise 0

Perception 2

Repair 4

Survival 3

Willpower 4

Appearance 0

MODIFY STEEL FIST:

Vehicle Class

MODIFY HAND CANNON:

Vehicle Class

SPECIAL ABILITIES

Steel Fist (OSA, Power Level: Medium)

Roboman's left arm is cybernetic and can deliver a solid steel punch.

DR: 5+Body

Range: Point Blank

Total cost: 8 CP

Hand Cannon (OSA, Power Level: High)

The steel fist unscrews to reveal a large energy gun.

DR: 5+2

Range: Long

Restriction: Disturbance, Minor (Loud Booming)

Restriction: Charges, Moderate

Total cost: 11 CP

Cyber-Eye (MiscSA, Power Level: Low)

Roboman's left eye has been robotically enhanced, helping him see things in great detail.

Trait Modification A: +2 Perception (Spot the Hidden)

Total cost: 4 CP

Cyber-Jack (MiscSA, Power Level: Low)

Roboman can use his circuitry to hook into computer systems.

Trait Modification A: +4 Computers

Restriction: Disadvantage, Major (Can only use when in contact with a computer terminal)

Total cost: 7 CP

Total CP value: 100 CP

BACKGROUND

The first target in Zarnon's conquest of free space was a small outpost station near Malitron; a shock wave of Cybertroops quickly overran and destroyed it to show the Universe League what it was facing. One of the survivors was a marine soldier whom Roboticus insisted on studying. With dreams of creating a more advanced Cybertrooper, he began implanting the anonymous soldier with devices similar to his own cybernetic enhancements, as well as a crude control program that wiped out the subject's human identity.



When Zarnon's forces landed on Satrenia and encountered the Star Warriors leading the defense, Roboticus was ordered to give his new creation "Roboman" a test. The super-cyborg advanced on the heroes with orders to destroy, but Psychlos, sensing a human presence, broke his control programming. Roboman turned on Roboticus and Zarnon, forcing them into a hasty retreat. After the battle was over, Roboman, still lacking memories or any identity, offered to join the Star Warriors as repayment for gaining his freedom. He was accepted, and continues to fight against his former captors while seeking to recover his memories.

PERSONALITY

Roboman is perhaps the most discontented member of the group. He is devoted to the cause, but he must continually wrestle with not being fully human. His implants give him unique powers and skills, but he would gladly trade it all to be who he was, or even just to know who he was. He also nurses a personal grudge against Dr. Roboticus. He gets along best with Dr. Tolken, who sympathizes with what Roboticus has done to him and has promised to help find a solution. He is also deeply grateful to Psychlos for his help, and seeks to learn some peace of mind from the mysterious psychic.

BRUTAS

"Tough, Proud Alien Warrior"

Oomph: 5

Stunt Points: 3

Hurt Points: 54

Size: Medium

STORY HOOKS

Feels indebted to the other Star Warriors — Moderate
Impulsive — Moderate

TRAITS

Armed Combat 4, Athletics 4(3), Body 4(4), Coordination 2, Driving 1, Ranged Combat 4, Riding 3, Stealth 2, Unarmed Combat 4(3), Medical (First Aid) 0/2, Perception 3, Survival 4, Willpower 4, Appearance -1, Persuasion (Intimidate) 2/4

SPECIAL ABILITIES

Tough Hide (DSA, Power Level: Medium)

Brutas' furry hide acts as natural armor.

Protection 6

Total cost: 12 CP

Laser Bow (OSA, Power Level: Medium)

A weapon that fires brilliant bolts of energy.

DR: 4+2

Range: Long

Restriction: Item

Restriction: Charges, Moderate

Restriction: Rare Recharge (Fire Diamonds)

Total cost: 4 CP

Diamond Axe (OSA, Power Level: Medium)

Normally used to chop trees, Brutas' Diamond Axe is also effective against Cybertroops and other baddies.

DR: 7+Body

Range: Point Blank

Bonus: Armor Piercing 5

Restriction: Item

Total cost: 15 CP

Total CP value: 150 CP

BACKGROUND

The Fangors of Kashdor are a reasonably peaceful race of hunter-gatherers, but each tribe needs protectors to ward off the wild beasts living in the jungles and in the dark Fire Diamond mines. Brutas was the sheriff of the Kligor tribe, and served faithfully for many years. Like his people, he knew little of the outside universe, until a great ship from the stars crashed in a nearby swamp. Its occupants, calling themselves warriors of the stars, said they were fleeing an attack by a cruel man named Zarnon, who had conquered many worlds and enslaved their people. Zarnon soon arrived in pursuit, and his minions threatened the Kligors as he attempted to conquer the area and plunder the valuable Fire Diamonds for himself. The Star Warriors organized a counterattack, and Brutas helped them drive the invader from his world. For this, he pledged his eternal gratitude to the Star Warriors.

Years later, after the Universe League had set up a permanent embassy on the world, Brutas learned through them that the Star Warrior Roboman was presumed dead after a battle on Zaronia. Brutas, having retired as sheriff, arranged a meeting with the Star Warriors and offered to join their team as a replacement for their vanished comrade. He has decided that the best way to honor his debt is to fight with them until Zarnon's menace is truly ended.

PERSONALITY

Brutas is tough and sometimes reckless, but he is also extremely good-natured. He lives by a code of honor, which makes things very clear for him; Zarnon and his minions are a threat to be confronted head-on at every opportunity, regardless of the danger. He does not ask his teammates to endanger themselves needlessly, just that they allow him to do so. He is honored to fight alongside the Star Warriors and enjoys his work. He particularly likes spending time with Red Maverick, who has a similar love of danger and excitement. Captain Starfire is not sure who is a worse influence on whom

BRUTAS, THE EARLY YEARS (100 CPS)

Why is Brutas so tough? The character joined the series for its fourth and last season, and so had to be as powerful as the other characters had become. However, you may wish to play Brutas as a starting character in a series, so below are modifiers to make him less powerful:

MODIFIED TRAITS:

Armed Combat 2

Athletics 4

Coordination 0

Driving 0

Ranged Combat 2

Riding 1

Stealth -1

Unarmed Combat 4

Medical 0

Willpower 3

No Diamond Axe





CHANNEL FIVE GAMEMASTER'S SECTION

OVERVIEW

Star Warriors, as a series, was designed as a straightforward space opera. Most '80s sci-fi cartoons relied more heavily on some central gimmick; the characters might have special battlesuits, drive customizable vehicles, or have some other feature that would make their accompanying toy lines stand out on the shelves (particularly considering that the kids probably already had lots of toys based on a certain blockbuster sci-fi movie trilogy). However, the space opera was a common enough genre for action cartoons for some of its themes to be worth discussing here. In itself, "space opera" is difficult to define in exact words, but generally speaking it's the kind of science fiction that focuses less on technology or scientific rigour and more on broad, flashy adventures where larger-than-life characters jet across space, encountering danger and excitement everywhere they go. In fact, it's the kind of science fiction most people are familiar with — they may not know Asimov or LeGuin, but they know a rocketship or a bug-eyed monster when they see one.

Space operas tend to feature a large central conflict, much bigger than any of the individual characters. The conflict in *Star Warriors* is very much a battle of Good vs. Evil, where every character takes a side. This epic conflict overshadows everything that's happening in a given episode, and is usually the focus. The fact that this is a full-fledged war should be emphasized; while the *Star Warriors* are doing their job, numerous other battles are being fought on other worlds as Universe League soldiers try to hold back the advancing Cybertroops. Not every episode needs to be entirely about the war; the characters may fight other adversaries from time to time, to add variety and keep things from getting repetitive. However, they should always be *aware* that the war is taking place, and that Zarnon is an ongoing threat. Let them find out, through allies and reports, that there's heavy fighting on Thermia, or that Cyber-fighters have been making surgical raids on supply convoys. Throwing in details like these helps give the players a feel for the scope of what's happening, and how high the stakes are.

A second major theme of *Star Warriors* as a space opera is exploration and the wonder of the universe. Despite being "civilized" overall, the Universe League has countless worlds that haven't been fully explored; beyond those borders, nobody's quite sure what there is. In the course of their missions, the *Star Warriors* should frequently find themselves in strange, exotic and wild locales, planets brimming with the kind of weirdness that was a staple of '80s sci-fi and fantasy. Crystal mountains, lakes of slime,

twisted rock and metal formations — let your imagination go crazy. Good space opera never pays too much attention to realism anyway. Even well-explored, civilized planets should be fairly distinctive; Satrenia is a massive world-city, Cerebros is all lush forests and alien architecture, and so on. Building up a variety of alien races is also a good idea — the ones mentioned in Channel Three are just a sample. Space is infinitely vast, so there's always room for you to introduce new worlds, races, or even entire empires.

THE SPACE OPERA GENRE

Of course, *Star Warriors* is also an '80s Saturday morning cartoon (or at least it's presented as one), so those genre elements will play an important part as well. There are many options for emphasizing the Saturday morning feel, and you should pick and choose among them based on whatever you think will work for your group.

MORALITY

As mentioned, the basic conflict at the heart of *Star Warriors* is a fairly black and white one. Zarnon and his invading forces are Bad, while the *Star Warriors* and the enlightened, egalitarian Universe League they fight for are Good. There are people and races caught in between (the Mutants, though not really friends of civilization, have not fully thrown in with Zarnon either), but as the conflict continues most everyone is forced to pick a side. Faced with groups or characters who haven't decided, the *Star Warriors* may have to convince them of the rightness of their cause; this can provide a good opportunity for roleplaying and character interaction, as long as it's appropriately melodramatic.

OPTIMISM

The war overall is generally a stalemate; Zarnon's forces and those of the Universe League are evenly matched, and things might even tip in Zarnon's favor if the *Star Warriors* weren't around. The *Star Warriors*, however, are a powerful force that tips things back towards the good guys. They can foil Zarnon's plans, keep him on the run, and polish off a few Cybertroop platoons while they're at it. Their only problem is that they can't be everywhere at once, and so while they should come out on top most of the time, the rest of the war should progress slowly, and its outcome should be uncertain. The *Star Warriors* should feel that they definitely *can* win the war, but not that they necessarily *will*, or that it will be easy.

EXAGGERATED ACTION

Epic space battles. Hordes of human and robotic soldiers clashing violently on strange worlds. Mutant and cybernetic thugs, giant alien monsters, and villains who throw fire or blast lasers from their eyes. The setting has plenty of opportunities for action, and enough weirdness to make it believably exaggerated. When designing episodes, you should be able to inject at least one element into every action scene that makes it seem more epic or more fantastic—an unusual location, strange powers displayed by enemies or allies, or an even larger battle as the backdrop. The space combat rules provided in this chapter may also be useful when it comes to adding flavor. And stealing ideas from sci-fi movies and TV shows never hurts.

COINCIDENCE

In its way, fortune favors the Star Warriors. When they are not actively searching out and foiling Zarnon's latest plan to win the war, they are accidentally stumbling across said plan, or said plan happens to directly target them. Simply put, wherever the PCs are in an episode, that is the place where the fate of the universe will be decided. Of course, this can work against them; if they leave the Star Warrior Shuttle unguarded, Dr. Roboticus may just be in the area and decide to sabotage it. If they're visiting a Universe League garrison, they may well find that Baron Hypno has brainwashed the troops to make them think that the Star Warriors are wanted criminals. Give the heroes plenty of opportunities to foil the big plan, but make sure the villains occasionally take advantage of an opportunity to make things more difficult as well.

ROGUE'S GALLERY

Zarnon's immediate henchmen are already something of a motley crew. You've got a beautiful fire-woman, an old cyborg scientist, a burly mutant, a bug-eyed monster with hypnotic powers, and a robotic general. Just exploiting their various abilities can produce a number of stories. But there's no reason to stop there. New villains can be associated with Zarnon's invasion; they might be "one-shot" diversions, or they may be part of some entirely new force which both sides must contend with. All that really matters is that they be distinctive — that they fill some niche that the existing villains don't.

COMIC-RELIEF CHARACTERS

The level of comic relief in this show can vary widely. Oddily, Dr. Tolkien's alien companion, is the only blatant comic relief figure, but other characters on both sides have comedy potential. Red Maverick could be made more obstinate and childish, Brutus could be more of a clumsy

oaf, and the bickering between the villains could reach childish levels. Or your group could ignore all that, and stick to action and maybe a bit of banter. Neither approach will really change much about the setting.

THE AFTER-SHOW MESSAGE

There are two ways you could handle these. One would be to extract general "life lessons" from each episode and use that as the basis for the message; an installment where the characters encounter a friendly Mutant may have a message about not judging people by their appearance, and if a show revolves around Baron Hypno distributing Skul, that's a perfect opportunity for an anti-drug sermon. Or, you can take the concept of the after-show message in a different direction (albeit one used in at least one '80s cartoon), and have the characters deliver brief educational messages about science and technology, perhaps also drawing on the content of the episode; if the Star Warriors have faced off against a deadly supercomputer, Sheila or Dr. Tolken could take a minute to explain how real computers work and what they're capable of. This presumes your players know something about science or technology. Then again, maybe it doesn't — they're not being graded for accuracy.

THE MOVIE

The Episode Guide in this book contains a brief summary of *The Journey of the Star Warriors*, the "official" *Star Warriors* movie which marked a major turning point in the continuity. You may adapt this scenario to your campaign, but depending on how the series has gone, you may find it more beneficial to come up with your own scenario. Either way, the movie should involve a major change in the state-of-play in the universe. Big things should happen — the characters themselves should be changed somehow, a new set of villains is introduced, important characters on both sides die or leave, and so on. Basically, all of the advice in the *Cartoon Action Hour* core book about how to do a "movie" of your series applies here.

THE STAR OF THE SHOW

The Star Warriors do have a leader — if Lance Starfire is not being played in your series, whichever PC has the highest rank can easily fill that niche. The leader is in some ways the star, but the variety of niches the characters can fill — scientist, soldier, pilot, detective, and so on — means that you should be able to regularly shift the focus from one character to another, often in the course of the same episode. In addition, the power structure of the *Star Warriors* is not that strict; the leader shouldn't regularly be pulling rank on the other characters. Any PC may take charge in a given situation, depending on their abilities.

ADJUSTING THE TONE

The default tone of *Star Warriors* is fairly middle-of-the-road by *Cartoon Action Hour* standards. It is not particularly light, though there is some humor and an overall sense that Good can triumph over Evil; it is not particularly dark, though the villains are quite threatening and have diabolical plans for the universe. You may wish to modify the tone, and this can be done either in subtle or dramatic ways that alter certain aspects of the setting.

MAKING IT LIGHTER

- Play up the humor on both sides — the heroes should joke a lot, and the villains should be comically inept instead of threatening. Emphasize physical gags and groan-worthy puns.
- Present a less-balanced war, with things going very well for the Universe League. Zarnon's forces are basically contained outside the borders of the Universe League, and the Star Warriors' job is to see that he never breaks through or gains any significant advantage.
- Make the villains really, really incompetent. They have dangerous powers, but once per episode they make a blatant logical blunder that gives the Star Warriors an opportunity to defeat them. This can be hard to do without making it seem too easy to the players, but it's present in a lot of '80s cartoons.
- De-emphasize the destructive aspects of war. Don't refer to human casualties, or have Zarnon plotting to kill large numbers of innocents; have him stick to enslaving them or accomplishing some vaguer goal (maybe learning the secrets of Satrenia? Nah...)

MAKING IT DARKER

- Unbalance the war in the other direction, with Zarnon's forces overrunning those of the Universe League. Resources become scarcer, and the Star Warriors can't always count on the rest of the Universe League for assistance.
- Ratchet up the tension between the characters. Introduce stories and plot elements which may create inter-personal conflict, and present situations where characters will disagree over the most ethical course of action.
- Make the villains scarier. Zarnon is the last of an ancient and evil race, so it should be easy to make him seem almost demonic. You can similarly play up the more macabre aspects of the rest of the rogues' gallery, and make all of them utterly ruthless.
- Advance the timeline a bit, so that Lord Zarnon has already conquered the known universe and declared himself Emperor. His henchmen have power over individual sectors in a kind of feudal system. Cybertroops

regularly patrol the streets, looking for dissidents. The Star Warriors, fighting for a Universe League that is barely remembered, are a small band of rebels hoping to defeat the Emperor and restore freedom to the galaxy... wait a minute...

PLANETARY GENERATION

A number of planets have been described in various Channels throughout this book, but chances are you'll need more. Coming up with them can be quite easy, as you only need to cover the most obvious and distinctive features — players in a *Star Warriors* series don't need to know the local economy or population demographics of every place they visit, unless it's important to the storyline. However, you should render planets in very strong, distinctive terms. If you have trouble coming up ideas, the following table can be used for random generation, or you can pick and choose. Roll 1d12 in each column for the "Climate", "Population" and "Technology" results — some combinations may not entirely make sense at first, but thinking how they might work can produce interesting results. For example, if you have "Wildlife/Uninhabited" for the Population, but a "Universe League Normal" Technology level, the world could be the site of a dead colony. In addition, you may roll for a "Hook", a feature that makes the world particularly distinctive — some of these results may override those in the basic categories, so you can either roll for it first or adjust the basics afterward. Explanations of the results follow.

ROLL	CLIMATE	POPULATION	TECHNOLOGY	HOOK
1	Vacuum	Wildlife/Uninhabited	Primitive	Asteroid
2	Exotic	Wildlife/Uninhabited	Pre-Industrial	Rogue Planet
3	Rocky	Deceptoids	Industrial	Artificial World
4	Desert	Mutants	Industrial	Hollow World
5	Plains	Mentons	Spacefaring	Volcanic
6	Earth-Like	Humans	UL Low	Mining World
7	Forest	Humans	UL Low	Ruins
8	Swamp	Flamites	UL Normal	Polluted
9	Islands	Varied	UL Normal	Inhabited Moon
10	Jungle	New Race	UL Normal	Gas Giant
11	Water	New Race	UL Maximum	Military Base
12	Ice	Exotic	Super-Advanced	Colony

CLIMATE

Worlds in space opera tend to be all one thing or another (desert worlds, jungle worlds, and so on), even though it often contradicts what we know about climatology.

- *Vacuum*: No atmosphere — the planet is usually barren and without native life. Characters who need to breathe must wear space suits or similar protection.

- *Exotic*: The atmosphere is composed of strange gases. Most characters, including Humans, will need either space suits or gas masks to explore.
- *Rocky*: The planet is mountainous, and dominated by jagged rocks with little or no vegetation. Planets in this and later categories are assumed to have a breathable atmosphere.
- *Desert*: The planet is extremely arid, with little vegetation and mostly sandy terrain.
- *Plains*: The ground is mostly flat and host to vast fields of grasses and grains.
- *Earth-Like*: The planet has a variety of terrain types, varying depending on latitude, air currents, elevation, and so on.
- *Forest*: The planet has a temperate climate with abundant plant life, and usually a lot of animal life as well.
- *Swamp*: The planet is extremely humid, and much of the land is waterlogged. Plant life also thrives, and the ground is usually muddy and difficult to traverse.
- *Islands*: Water covers about ninety percent of the planet, leaving only scattered landmasses.
- *Jungle*: The planet is hot and humid, with generally wild and overgrown plants as well as abundant animal life.
- *Water*: The planet has no landmasses — it's essentially one giant ocean.
- *Ice*: The planet is dominated by water, but most of its surface has frozen. Land may be present.

POPULATION

This indicates the dominant inhabitants of the world — in other words, whom the players will encounter if they explore it.

- *Wildlife/Uninhabited*: There is no intelligent life on the planet. Creatures with animal intelligence may be present, depending on the climate and your whims.
- *Single Race (Deceptoids, Mentons, etc.)*: Beings from a single species described in Channel Three dominate the planet. Other races may be present, but they will be in the minority.
- *Varied*: A number of intelligent species call this world home. Specific demographics may vary depending on where the world is in the known universe.
- *New Race*: The planet is inhabited by an undescribed (possibly undiscovered) race of your own design.
- *Exotic*: As above, except there is something radically unusual about the race in question. They may be living gas clouds, energy beings, intelligent immobile trees, or anything else your imagination can come up with.

TECHNOLOGY

This indicates what kind of technology is readily available to this world and its inhabitants.

- *Primitive*: Indicates Stone-Age development at best. Wildlife/Uninhabited worlds may possess no technology whatsoever; planets inhabited by a "known" race may be long-lost colonies that have degenerated into primitivism.
- *Pre-Industrial*: Technology similar to that of Earth at any period between the birth of civilization and the Industrial Revolution — generally speaking, concepts like the wheel, metallurgy, and gunpowder may be present, but not electricity or mass production.
- *Industrial*: Earth up through "the present" (i.e. the '80s). Electricity, flight, the automobile, and the microchip may all be available, but nothing really "futuristic" (this includes information superhighways and cloning). Spaceflight is crude and dangerous, and rockets or shuttles cannot go very far.
- *Spacefaring*: Space travel has become safe and common, though it is limited to the planet's solar system. A number of other futuristic gadgets are available, though perhaps less well-made than normal.
- *Universe League Low*: Much like the above, except that FTL travel and communication are available. This represents the lowest level of development for planets who are acting members of the Universe League, and may also be used for colonies with limited resources, where not everything is available. It is also common for many Mutant worlds.
- *Universe League Normal*: Most planets in the League enjoy this level of development, and it represents the standard level of technology for your series. Generally speaking, all devices that are commonplace (aircars, laser guns, spaceships) should be available on these worlds.
- *Universe League Maximum*: Represents a particularly high level of development, possibly a research facility or a very heavily industrialized planet. Unusual, experimental, or particularly elaborate devices may be available, such as Red's supercycle or Dr. Tolken's Sonic Stunner.

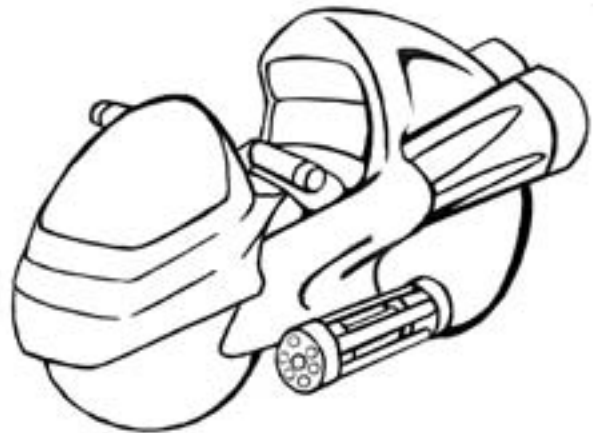

- *Super-Advanced*: Represents technology that is outright unknown to the Universe League. Real wonders exist here — planet-controlling supercomputers, time machines, and anything else that you don't normally want your players to have access to. May be a research facility run amok, the home of a superintelligent race, or a Zarian ruin.

HOOK

A hook is a feature that does not readily fall into any of the other categories; it is not necessary to describe a planet, but occasionally this category can spark ideas.

- *Asteroid*: The "planet" is basically a large, irregularly shaped rock. It might be part of a belt or wandering alone, but it is large enough to have significant local gravity. Asteroids usually have no atmosphere.
- *Rogue Planet*: The planet has no native solar system or single orbit, but travels its own path. It may even be guided by some intelligence like a giant world-ship. Rogue planets usually have very turbulent climates, if they have any atmosphere at all.
- *Artificial World*: The world was deliberately manufactured. It may pass for a normal world, with only some clues as to its true nature, or it may obviously be a giant biosphere.
- *Hollow World*: The planet, whatever its surface climate, has a thin crust, and another inhabited world lies beneath its surface. It may be a series of caves or an entire interior surface.
- *Volcanic*: The planet is tectonically unstable and suffers from frequent earthquakes and volcanic eruptions. It may have entire lakes or oceans of hot lava, or

simply have more volcanoes than is healthy for a world of its type. Flamites love these planets.

- *Mining World*: The planet contains abundant mineral resources, and some sort of installation has been set up to harvest them. It may possess a unique ore or metal (such as Kashdor's Fire Diamonds), or it may simply contain a number of valuable deposits.
- *Ruins*: The planet is dotted with the ruins of some unknown race different from those currently inhabiting the world. The ruins may also be Zarian in origin.
- *Polluted*: The planet's inhabitants have mistreated their environment, resulting in toxic seas, smog-filled skies, and possibly even radioactive waste. These planets are usually inhabited (or were at some point) and have a Technology level of "Industrial" or higher. Mutants gravitate towards these worlds.
- *Inhabited Moon*: The planet is a small satellite, orbiting a much larger world (usually a gas giant).
- *Gas Giant*: Ignore any "Climate" results — the planet has no solid landmass or liquid (except, perhaps, at depths where the pressure is too great for anything to live anyway). Any inhabitants must live in the atmosphere (natives may be able to fly, while other races may build floating cities).
- *Military Base*: The planet contains a major military installation for the local dominating power. These planets are usually inhabited by one of the known races, and have technology of "Universe League Low" or higher.
- *Colony*: The planet is inhabited by settlers from some other world who are trying to make a new home for themselves. Any of the known races would work as an inhabitant, though a new race that has space travel could also work.

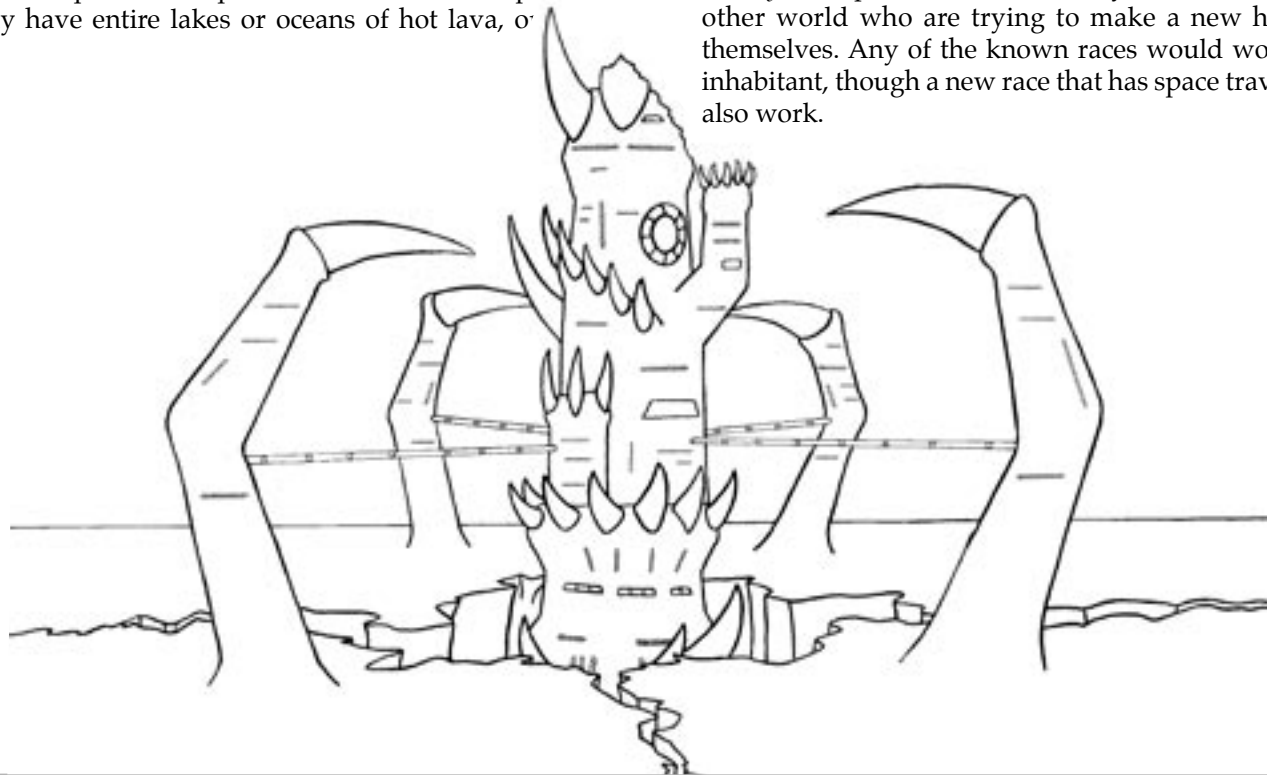

CHANNEL SIX

THE ENEMIES OF THE UNIVERSE

HISTORY

The Zarians were an ancient race, living long before any other of the known species in the Universe came into existence. Legends place their reign as "billions of years ago", but this belief contradicts most theories on the age of the universe, and comes to us primarily from the Mutants, who have difficulty with big numbers.

Nonetheless, long ago, the Zarians were the most intelligent and most aggressive species in the universe. They were a race of warlords, constantly struggling for control of land, resources, and each other. They were also extremely intelligent, and as they fought, they developed new and better weapons of destruction. It seemed, for a time, that they might destroy themselves altogether, but they discovered space travel. Zarian ideas of physics easily allowed for travel and communication at speeds faster than light, and shortly after their first space flights came their first interstellar missions. They discovered other, less advanced races, and the problem of self-destruction was solved. No longer would they slay each other on their home planet; instead, they would conquer everything and everyone else within reach. The Zarian Empire spread over space like an unstoppable tidal wave. Their civilization reached peaks of technological development and material wealth that no other has approached. Zaronia became the wonder of the universe.

Soon, the Zarians had conquered every world within their reach. They were the undisputed masters of space. With no enemies to defeat, their lust for power again turned inward. A thousand Lords and Dukes of the Zarian Empire began jockeying for the title of Emperor, while Az-Rol, the current ruler, sought to hold the position for as long as possible. The conflict was subtle at first, a game of intrigue and deception and politics played out in the courts and throne rooms of palaces across the galaxy. Alliances were made and broken, Lords died under mysterious circumstances, and planets shifted allegiance between a thousand different houses. Open warfare seemed out of the question; the Zarians understood how destructive their previous civil wars had been. But as the years passed they forgot their history, and began building stockpiles and developing new weapons.

On the remote world of Toxion, Zarian scientists under the employ of the cagey Lord Anzor began a project that would push the empire over the brink. Seeking to create a strong, loyal supersoldier for their employer's private army, they spawned the first of the Mutants: twisted, ugly creatures whose blind aggression and relative lack of intelligence made them ideal foot soldiers. Word of Anzor's armies spread, and soon every competing Lord wanted a platoon or

two. Four neighboring baronies launched a daring raid on Toxion, making off with several mutants and the knowledge necessary to breed more, and soon every house was breeding its own troops. The Toxion Raid itself became the first battle in the final war of the Zarian Empire.

Fighting quickly spread from a handful of outlying territories to encompass all of space. There was no longer any need for pretense or subtlety; every minor noble in the galaxy was out to become emperor, or die trying. There were no alliances, no treaties, not even spies; there were only the legions of mutant soldiers laying waste to entire star systems.

The smallest houses were destroyed first, and the mutants who served them joined with the victors, their armies growing larger as the number of sides shrank. Soon there were but five Great Houses, converging on Zaronia from all ends of the galaxy for a final confrontation. His forces outnumbered and outgunned, Emperor Az-Rol set a final ambush for his enemies. His scientists prepared a bio-weapon to be detonated in the atmosphere when the opposing forces arrived on Zaronia, while he and his loyalists cowered underground.

All that is known about this bio-weapon is that it worked far too well. As the entire Zarian race converged on the planet, leading their armies into battle, there was a bright flash. An unstoppable wave of energy coursed over the surface of the planet, and then reached underground into houses and bunkers, cleansing the entire planet of all organic life. The great and powerful Zarian race vanished in an instant, leaving their homeworld a desolate and shrouded world full of ruins and ghosts. Those mutants left to maintain garrisons offworld eventually figured out that their masters had gone, and formed their own ramshackle civilization. An era of galactic history had come to an end, to be remembered only in legends and myths.

But there was one who was wise enough to avoid destruction. Lord Zarnon had been the leader of the House of Ezred, a minor barony that quickly fell in the early decades of the war. Zarnon, unnaturally cautious and cunning among his kind, fled to Zaronia masquerading as an Imperial Loyalist. He saw how the unravelling Empire was headed for a catastrophe, and fled the planet in his Dragonship a few days before the destruction of his people. Retreating to a hidden fortress on Malitron, Zarnon stood alone and assessed his situation. With the other Zarians gone, he had no competition for power, but also no real way of attaining it. The fledgling universe, still healing from the scars of battle, would have to catch up with him. So he placed himself in cryogenic sleep, putting a lock

on his "coffin" that could only be solved by an advanced spacefaring intelligence.

When Dr. Alexi Roboticus opened the coffin and freed Zarnon, he was swiftly cowed into submission by the ancient tyrant. Zarnon swiftly set about learning all he could about the age he had awakened in. Studying the Universe League, he judged it to be a shaky union of weak races, covering too much space with too little force. It would be an easy conquest with the right army. He put Roboticus to work designing an army of robotic Cybertroops, while he himself secretly scoured the scummiest backwater worlds in the universe for the most powerful outlaws to aid him in his invasion. On Toxion (now the informal capital of Mutant space), he recruited a local gang leader named Mutaton as his personal bodyguard. Mutaton was sent to Derelus, where he "persuaded" the intergalactic femme fatale Infuriana to join the team. Finally, a wanted Deceptoid criminal named Baron Hypno offered his services, and Zarnon declared his "court" complete. Once the Cybertroop armies and the spaceships necessary to transport them were ready, Zarnon declared war.

MISSION

Lord Zarnon's ambition is simple enough; he wants to rule the universe. Right now, he has limited his sights to the worlds controlled by the Universe League; he has an informal alliance with the Mutants, who seem to fear him instinctively, while the outlying uncivilized worlds have little strategic value to him. His approach so far has been aggressive, frequently making daring strikes at the heart of Universe League territory; he has pushed the borders back far enough to keep the enemy on the defensive for the time being. Zarnon also has an interest in finding his homeworld of Zaronia, which seems to have drifted from its original position and become lost in a dark nebula. The planet holds the last remnants of Zarian technology outside of Malitron, and Zarnon feels that gaining possession of such technology would assure his victory. There is frequently dissent among Zarnon's "court", made up as it is of criminals and lowlifes, each with their own agenda. However, his will to command and his promise of power has kept a semblance of order.

ORGANIZATION

On one level, the power structure of Zarnon's forces is fairly simple; he is in charge, and none may challenge his authority. There may be arguments, insults, and dramatic threats, but in the end Lord Zarnon's word always carries the day. After him, the power structure becomes generally looser. His chief henchmen — Mutaton, Dr. Roboticus, Infuriana, Baron Hypno, and Cyberchief — have a generally equal level of authority over lesser servants and allies, such as the Cybertroops and (later) the Mutant Horde. Cyberchief has special authority over the Cybertroops, and the Horde has

officially pledged its loyalty to Mutaton, and these groups will recognize this authority over that of another henchman. (Dr. Roboticus has some sway over the Cybertroops, but not as much as Cyberchief.) The Cybertroops have no formal organization of their own; each is equally subservient to its commanders. Since the only commanding officers — Cyberchief, Zarnon, Dr. Roboticus, and so on — are likely to stay far from the front lines to control the forces remotely, the troops on the field can take heavy casualties without any disruption to the chain of command.

HEADQUARTERS

The Palace of Dread was built by Zarnon at the start of the Zarian civil war. He deliberately placed it on the fringes of Zarian space. The world of Malitron (as insignificant then as it is now) was a place to retreat to should the worst come to pass. When the House of Ezred fell, Zarnon, the only survivor, decided instead to flee to Zaronia, but when calamity engulfed that world, Malitron was one of the few worlds not being fought over by rogue Mutant armies. Before he entered his long sleep, Zarnon made sure his new home had everything he would need to put his plans of conquest into action. The arcane Zarian technology remained pristine and uncorroded over countless years as he slumbered.

The Palace of Dread is a harsh, imposing structure, featuring the sharp points and unnatural curves common to Zarian architecture. The Universe League has been unable to pinpoint the Palace's location, due to a fantastic energy shield which not only blocks attacks but renders the palace invisible and blocks it from radar. A Plasma Ray mounted on the top tower serves as an immediate defense, but Zarnon almost never uses it for fear of giving away his location. All Universe League assaults on the planet have been met with wave after wave of CyberShips, beating back the enemy force before they can look for the Palace. Inside, the Palace's central throne room overlooks a volcanic chasm, and serves as the court for Zarnon and his allies. The Palace also contains living quarters for them, each room replicating the home environment of its inhabitant. An ancient bio-computer gives Zarnon access to an extensive surveillance network, as well as the vast repository of Zarian knowledge (which is not as out-of-date as one might think, though it lacks information on the new coordinates of Zaronia.) Perhaps even more impressive, though, is an elaborate Auto-Mining and Metal Processing system, which takes raw materials from the metal-rich planet, refines them, and forms the resulting metal into shapes specified by the operating engineer. Using this system, Dr. Roboticus has been able to build and repair hundreds of Cybertroops, Cyber-vehicles, and various pieces of equipment without needing to hire or enslave any builders. The system is remarkably fast, and Roboticus is usually able to replace any casualties within weeks.

TECHNOLOGY

WEAPONS

Two major weapons are employed by most of Zarnon's forces, though they may also make use of weapons described in Channel Three.

CYBERTROOP LASER RIFLE (OSA, Power Level: Low)

A simple laser weapon employed by most of the Cybertroop infantry.

DR 5+2

Range: Long

Restriction: Item

Restriction: Charges, Moderate

SA cost: 6 CP

MUTANT BLASTER (OSA, Power Level: Low)

A crude energy gun, common on Mutant worlds.

DR 6+2

Range: Medium

Restriction: Item

Restriction: Charges, Major

SA cost: 4 CP

OTHER ITEMS

SKUL (1 SUPPLY) (MiscSA, Power Level: Medium)

A fiendish drug created by Baron Hypno to sap the will and concentration of Universe League forces.

Trait Modification B: Willpower -2

Trait Modification B: Perception -2

Bonus: Advantage, Major (addictive to the target)

Restriction: Disadvantage, Major (target must be persuaded to ingest if he has not before)

Restriction: Item

Restriction: Charges, Major

SA cost: 4 CP

VEHICLES

CYBER-FIGHTER (Vehicle, Power Level: Medium)

A fast and deadly space fighter flown by Cybertroop pilots.

Traits: Body 2, Crew 1, Maneuverability 2

Travel Mode: Space Travel (Speed 4(5)), Air Travel (Speed 4(5))

Size: Large

Capacity: 1 enclosed

Structure Points: 40

VDM: 4

WEAPONS

Twin Laser Cannons (DR 5+2; Range: Medium)

SA Cost: 20 (60 SCP)

THE PALACE OF DREAD: THE PLAYSET

As with Star Warrior Central, the features of Zarnon's base are modeled using *Cartoon Action Hour's* Vehicle construction rules, only without the purchase of any modes of movement. It is point-balanced with Star Warrior Central, and thus is at no cost to the NPCs (though the GM may use any experience given to the villains to improve the palace.)

The Palace of Dread (Vehicle/Playset, Power Level: High)

The secret lair of Zarnon and his partners in evil!

Traits: Body 4(5), Auto-Gunner -1, Computer 4(3), Perception 4(3), Knowledge 4(2), Repair 4(2), Appearance 4

Size: Colossal

Capacity: 16 enclosed

Structure Points: 450

VDM: 18

WEAPONS

Plasma Ray (DR 6+2, Range: Long)

Energy Shield (Power Level High, Protection 5, Trait Modification A: +5 to Stealth)

SA cost: 46 (140 SCP)

ENEMY GOONS

In addition to his henchmen, Zarnon has two major forces on the Battlefield. First are the Cybertroops; in whatever quantity they appear, they have a Goon Factor of 5, the Grab Bonus, and the Restrictions Natural Born Followers and Slow 1.

Some time after his invasion had begun, Zarnon had Mutaton enlist the aid of his gang, the Mutant Horde. They, and possibly other bands of Mutants the players may encounter, have a Goon Factor of 6, the Bonuses Rugged and Tough as Nails, and the Restriction Natural-Born Followers.

CYBER TRANSPORT (Vehicle, Power Level: Medium)

A large, slow, boxy craft used to carry Cybertroop infantry from space to planet surfaces.

Traits: Body 4(2), Armor 4, Crew 1, Maneuverability -1, Stealth -1, Computer 2, Perception 2, Repair 2

Travel Mode: Space Travel (Speed 2), Air Travel (Speed 2)

Size: Huge

Capacity: 10 enclosed

Structure Points: 400

VDM: 20

WEAPONS

Laser Cannons (DR 5+2; Range: Medium)

SA cost: 22 (80 SCP)

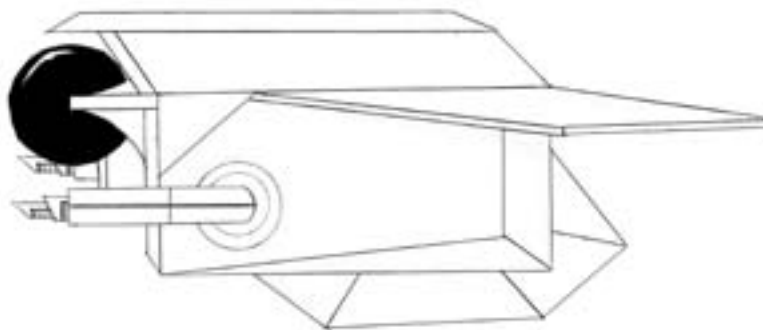

CYBER TRANSPORT

MUTANT WARSHIP (Vehicle, Power Level: Medium)

A bulky, ugly craft flown by most Mutant forces during their battles with the Universe League.

Traits: Body 4(2), Crew 1, Computer 1, Perception 1, Appearance -1, Maneuverability -1

Travel Mode: Space Travel (Speed 4(2)), Air Travel (Speed 4)

Size: Huge

Capacity: 3 enclosed

Structure Points: 240

VDM: 12

WEAPONS

Energy Cannon (DR 5+2; Range: Medium)

SA cost: 20 (60 SCP)

CYBERTANK (Vehicle, Power Level: Medium)

A rugged ground vehicle driven by a force of Cybertroops.

Traits: Body 4(3), Stealth -1, Crew 1, Armor 4(2), Computer 1, Repair 1, Perception 1

Travel Mode: Land Travel (Speed 1)

Size: Very Large

Capacity: 4 enclosed

Structure Points: 390

VDM: 16

WEAPONS

Plasma Cannon (DR 7+2; Range: Long; Area of Effect: 6 Yards)

SA cost: 20 (60 SCP)

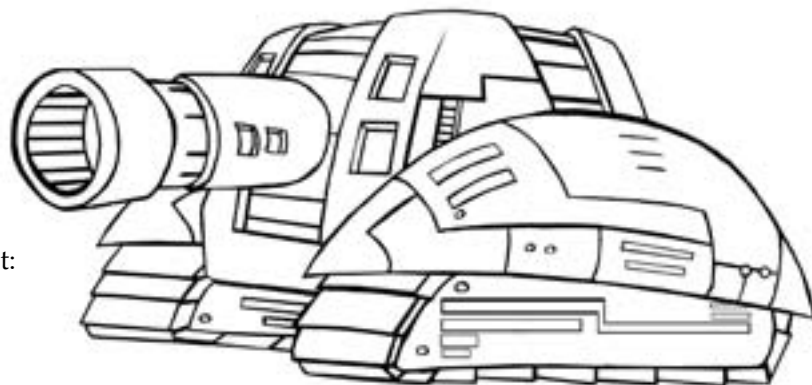

CYBERTANK

CHANNEL SEVEN ZARNON'S EMPIRE

LORD ZARNON

"Evil Galactic Conqueror"

Oomph: 5

Stunt Points: 1

Hurt Points: 38

Size: Medium

STORY HOOKS

Impatient — Moderate

Obsessed with Galactic Conquest — Major

Wants to locate his homeworld — Minor

TRAITS

Armed Combat 2, Body 1, Piloting 2, Ranged Combat 3, Perception (Strategy) 2/4, Knowledge — The Galaxy 4, Willpower 4(2), Persuasion 4, Streetwise 4

SPECIAL ABILITIES

Cosmic Scepter (OSA, Power Level: High)

Zarnon's ornate scepter can fire energy blasts or be used as a blade weapon.

DR: 5+Body (Melee)

DR: 7+2 (Ranged)

Range: Point Blank (Melee)

Range: Medium (Ranged)

Bonus: Multi-OSA (Melee Weapon)

Bonus: Vehicle Class

Restriction: Item

Total cost: 28 CP

Laser Eyes (OSA, Power Level: Medium)

Zarnon's eyes can fire deadly rays.

DR: 4+2

Range: Long

Total cost: 12 CP

Cybertroops (Goon SA, Power Level: Medium)

Zarnon has a small cadre of Cybertroops reserved for use as personal bodyguards.

Goon Factor 5

Mob Quantity 1

Bonus: Grab

Restriction: Natural Born Followers

Restriction: Slow 1

Total cost: 18 CP

Dragonship (Vehicle, Power Level: High)

A sleek, deadly vessel that prowls the spaceways.

Traits: Armor 3, Body 4(2), Speed 4(4) (both modes), Computer 1, Perception 2, Repair 1, Appearance 1

Travel Mode: Space and Air

Size: Huge

Capacity: 6 enclosed

Structure Points: 360

VDM: 18

Story Hooks: Unique — Moderate

WEAPONS

Plasma Beam (DR 6+2; Range: Medium)

Total cost: 24 (80 SCP)

Total CP value: 150 CP



EMPEROR ZARNON (200 CPS)

During the film *The Journey of the Star Warriors*, Zarnon and his henchmen (except Roboticus) underwent a revision. Bonding with ancient Zarian spirits on Zaronia, they were augmented and changed form. Zarnon had a largely cosmetic makeover to become Emperor Zarnon, and here are the stats for this new version of the character.

IMPROVED TRAITS:

- Stunt Points 3
- Hurt Points 43
- Body 2
- Armed Combat 4
- Ranged Combat 4
- Knowledge (Zarian Technology) 3
- Willpower 4(4)

MODIFY COSMIC SCEPTER:

- Trait Modification A: +5 Persuasion (Intimidate)
- Trait Modification A: +5 Persuasion (Command)

MODIFY EYE BEAMS:

- Range: Visual

MODIFY CYBERTROOPS:

- Mob Quantity 3

BACKGROUND

In his day, Zarnon was one of countless minor nobles vying for power within the Zarian's vast empire. He went almost unnoticed at the time, but he had unusual insight. He saw the empire tearing itself apart as the Zarians, having conquered all other races, turned on each other. He wanted the Emperor's throne as much as anyone else, but he sensed that the current struggle had grown too great for any one leader to end. Mere days after he fled the planet, all of its inhabitants were vaporized in a flash of some unknown energy, and Zarnon was the last of his kind.

Retreating to a small keep on the planet Malitron, the one fortress his rivals had not destroyed, Zarnon hatched a plan. Isolated and with few resources in a galaxy scarred by war, his dreams of power would have to wait. Over time, new civilizations would rise with new technology, and he would find a way to use that to his advantage. He constructed a large cryogenic coffin and placed himself in eternal sleep, waiting for a new civilization to unleash him.

Untold eons passed. Humans evolved, advanced, entered space, and broke the light barrier. Races met and formed the Universe League. In 2525, Dr. Roboticus, drawn by legends and myths of an ancient race with unimaginable power, came to Malitron and uncovered Zarnon's tomb. Tampering with the mysterious coffin, he activated the

revival process, and Zarnon awoke. The ancient being looked upon the advanced ape who proclaimed himself a genius for solving a great mystery of the universe, and saw that this was just what he needed. Through his imposing presence and explicit threats of physical violence, Zarnon bent the old scientist to his will. He learned more of Roboticus' skill in electronics, and ordered that he build him an army. As Roboticus toiled away perfecting the Cybertroops, Zarnon traveled the fringes of the galaxy, recruiting powerful criminals and evildoers to his cause. In less than a year his forces were assembled, and an invasion began.

PERSONALITY

Zarnon used to take a long-term view of things, but eons of slumber has put a decided end to that. Now, not only does Lord Zarnon wish to rule all the universe, he wants to do so by the end of the week. He is continually frustrated by the shortcomings of his underlings, and lets them know of his displeasure frequently and sardonically. When he takes action himself (as is frequently necessary), he is ruthless, cold, and often frightening. No level of defeat will ever convince him that he is not destined to rule; every setback is merely delaying the inevitable.

DR. ROBOTICUS

"Cyborg Scientist and Inventor of the Cybertroops"

Oomph: 2

Stunt Points: 1

Hurt Points: 31

Size: Medium

STORY HOOKS

Rival: Dr. Tolken — Major

Schemes for power within the group — Moderate

Invented the Cybertroops — Minor

TRAITS

Ranged Combat 2, Unarmed Combat 1, Computers 4, Inventor (Robots) 3/4(2), Medical 3, Repair 3, Science 4, Willpower 2

SPECIAL ABILITIES

Cybertroops (Goon SA, Power Level: Medium)

Roboticus always keeps a battalion of Cybertroops on hand to defend him.

Goon Factor 5

Mob Quantity 2

Bonus: Determined 1

Bonus: Grab

Restriction: Natural-Born Followers

Restriction: Slow 1

Total cost: 26 CP

Cyber-Claw (OSA, Power Level: Medium)

Dr. Roboticus' left arm is a strong metal claw with a powerful grip.

DR: 5+Body

Range: Point Blank

Total cost: 8 CP

Laser Pistol (OSA, Power Level: Medium)

A standard-issue laser gun that Roboticus uses to defend himself.

DR: 4+2

Range: Medium

Restriction: Item

Restriction: Charges, Minor

Total cost: 6 CP

Ultra-Goggles (MiscSA, Power Level: Low)

Roboticus' glasses are actually sophisticated microbinoculars.

Trait Modification A: +4 Perception

Restriction: Item

Total cost: 8 CP

Total CP value: 100 CP

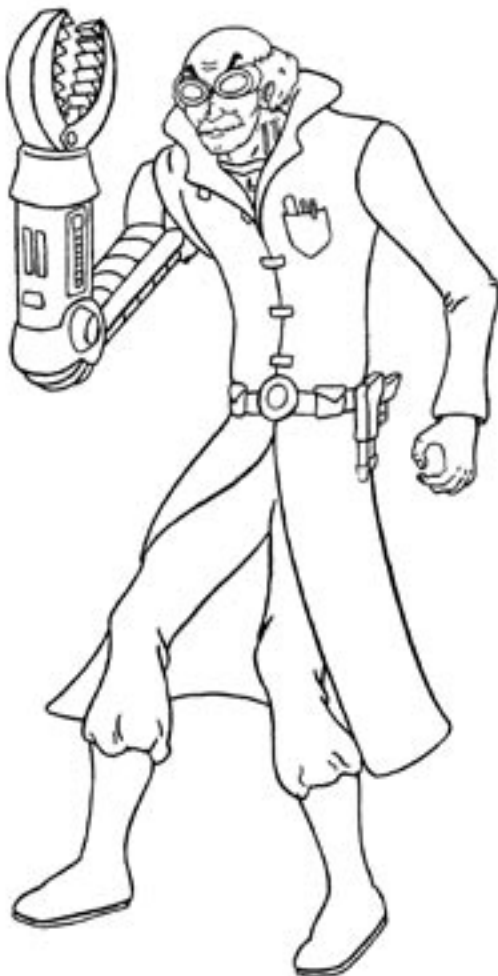

DR. ROBOTICUS, MOVIE VERSION (150 CPS)

Roboticus did not survive *The Journey of the Star Warriors*, as he was destroyed in a battle with Roboman. Thus there is no "post-movie" version; however, Roboticus had augmented himself over the years, and the following stats reflect his advancement.

IMPROVED TRAITS:

Stunt Points 3

Oomph 4

Hurt Points 37

Athletics 2

Body 2

Ranged Combat 3

Unarmed Combat 2

Persuasion 2

Willpower 4

Appearance -1

MODIFY LASER PISTOL:

DR 6+2

Range: Long

MODIFY CYBER-CLAW:

DR 7+Body

NEW SA:

Robotics Lab (MiscSA, Power Level: Medium)

Part of Zarnon's fortress, the lab allows Roboticus to easily repair the Cybertroops and perfect new diabolical inventions.

Trait Modification A: +2 Inventor

Trait Modification A: +1 Repair

Trait Modification A: +1 Science

Restriction: Disadvantage, Major (Can only use in fortress)

Total cost: 9 CP

BACKGROUND

For much of his career, Dr. Alexi Roboticus was a highly accomplished scientist in the field of cybernetics. He attained a post at the prestigious Clark Institute on Antell as a researcher, and soon became head of the cybernetics department. It was in this phase of his career that he augmented his aging body with newly-created cyberware, as much to make a point as to gain any benefits. Soon he came to believe that all organic life would inevitably fuse with and be absorbed by electronic life, and he advocated making this change as soon as possible. He proposed to the military that they adopt a wholly robotic army and worked up crude designs for cybernetic soldiers, but the Universe League rejected his plans as too grandiose and unfeasible. He debated the subject of mechanization with Dr. Rex Tolken, who had a more traditional view of man's

relationship to technology. As time passed, Roboticus concocted more radical experiments to prove his theories; for one, he planned to turn a small alien creature into a wholly mechanical being. Dr. Tolken discovered the twisted experiment and rescued the alien before any harm was done. When his plans were discovered, Roboticus was expelled from the Institute.

For a year, Roboticus simmered with resentment, unsuccessfully attempting to obtain private financing for his increasingly twisted concepts. In his research, he heard rumors and stories of a long-dead race that had advanced far beyond anything the universe now knew. The tomb of the last of these creatures was said to be somewhere beyond civilized space. Eventually Roboticus was able to pinpoint the tomb's precise location, on the desolate planet of Malitron. Chartering a small shuttle, he travelled to the world, where he found a massive coffin pulsing with energy. Hoping to find further secrets within, he was able to deactivate the electronics that kept the device sealed. The coffin opened, and released the living Lord Zarnon. Any hope of further discoveries was dashed when Zarnon, scepter in hand and eyes blazing with lightning, commanded Roboticus to grovel before him. The terrified scientist was quickly cowed. Zarnon led Roboticus to a hidden fortress, where his liberator gladly assented to help with any plans the warlord had in mind. Roboticus was commanded to use his genius to build an army, and with the fortress's vast resources, he was soon able to realize his dream of a robotic soldier.

Roboticus was not wholly satisfied with the Cybertroops, or even the advanced Cyberchief built to lead them. Believing that true perfection would come only when an organic lifeform was turned into a robot (but not wanting to risk operating on himself), Roboticus instructed that the troops capture a live human soldier in their first assault on a remote starbase. When the specimen was obtained, Roboticus began his sinister work. The completed creation, Roboman, was unveiled (and quickly turned on his creator) at the Battle of Satrenia. Zarnon has not let Roboticus live this down.

PERSONALITY

Roboticus is extremely singleminded. He does not care much for the success of Zarnon's campaign; indeed, he is only working for him because quitting is not much of an option. He is always searching for a way to gain power, and would not mind taking control of the invasion himself. So far, his desires have yet to manifest as open rebellion, but he is probably the most obstinate member of Zarnon's forces. He avoids combat whenever possible, though he often ends up dragged to the front lines.

MUTATON

"Ugly Mutant Henchman"

Oomph: 3

Stunt Points: 2

Hurt Points: 51

Size: Medium

STORY HOOKS

Mutant Leader — Major

Power Hungry — Moderate

Bad Temper — Moderate

TRAITS

Armed Combat 3, Athletics 2, Body 4(3), Piloting 1, Ranged Combat 2, Unarmed Combat 4, Perception -2, Survival 4, Willpower 4, Appearance -3, Persuasion (Intimidate) 2/4, Streetwise 4

SPECIAL ABILITIES

Mutant Hide (MiscSA, Power Level: Medium)

Mutaton, like all mutants, heals damage quickly.

Healing 5 (Type A)

Total cost: 9 CP



Fangs (OSA, Power Level: Low)

Mutaton has sharp teeth and sometimes uses them in a fight.

DR: 3+Body

Range: Point Blank

Total cost: 3 CP

Club (OSA, Power Level: Medium)

For most fights, Mutaton carries a heavy wooden club.

DR: 5+Body

Restriction: Item

Total cost: 8 CP

Power Jump (MSA, Power Level: Low)

Mutaton's great strength lets him make powerful leaps.

Bounding (Speed -2)

Total cost: 7 CP

Total CP value: 100 CP

BACKGROUND

Mutaton was born and raised (or rather, left to fend for himself) on the mutant world of Toxion. Like all mutants, Mutaton developed in his own unique manner — in his case, gaining exceptional strength and a wit as sharp as a bowling ball. Living in a polluted, crumbling landscape, Mutaton had to fight for every scrap of slimy food, every drop of diseased water, and every night's sleep in a bombed-out apartment complex. He fell in with the Horde, one of the worlds' countless gangs, and before long was in charge. Though never one for strategy, Mutaton's relentless aggression and ability to make the Horde do what he wanted by shouting at them caused the gang to become one of the largest on the planet.

When Lord Zarnon discovered that the mutant race created by his people had somehow survived to the present day, he decided that they might be useful to him. Upon arriving on Toxion, he discovered they were too disorganized to form an army, but observed Mutaton's prowess in battle. He offered Mutaton a position as chief bodyguard and enforcer, promising that he would gain power and rule worlds, and also get to bash things. Mutaton saw this as a good deal, and left the Horde to fend for themselves. He now serves as Zarnon's right hand man — considered the most trustworthy, for he is the easiest to fool.

PERSONALITY

Mutaton's approach to most problems is simple. If it can be smashed, smash it. If not, try to smash it anyway. He is not wholly stupid — he can, for example, speak in complete sentences — but he lacks the patience for much more than fighting and shouting. He desires power, but unlike most of Zarnon's henchmen he is fairly loyal. The way he sees it, he has a good job, and he believes his boss will win in the end.

MUTALORD (150 CPS)

The Zarian spirits awakened in *The Journey of the Star Warriors* bonded not only with Zarnon, but his henchmen (except for Roboticus, who refused to submit to the process). Mutaton was granted new powers of transformation to become Mutalord. He had also already accumulated his horde of mutant followers and his own ship.

IMPROVED TRAITS:

Oomph 4

NEW SAS:

Mutant Horde (Goon SA, Power Level: Medium)

Mutalord leads a gang of rugged mutant toughs from his homeworld of Toxion.

Goon Factor 6

Mob Quantity 1

Bonus:Rugged

Bonus:Tough as Nails

Restriction:Natural-Born Followers

Total cost: 24 CP

Space Raider (Vehicle, Power Level: Medium)

Mutalord and his gang travel in a bulky, ugly but heavily armed freighter.

Traits: Body 4, Maneuverability -1, Speed 4 (both modes), Stealth -1, Appearance -2

Travel Mode: Air and Space

Size: Huge

Capacity: 10 enclosed

Structure Points: 240

VDM: 12

Weapons

Blaster Cannons (DR 7+2; Range: Medium)

Missiles (DR 6+2; Range: Medium; Charges, Major)

Total cost: 20 CP (60 SCP)

Mutant Limbs (MiscSA, Power Level: Low)

Mutalord's further transformation allows him to sprout a second pair of limbs for improved agility.

Trait Modification A:+1 Athletics

Trait Modification A: -2 Body

Trait Modification A: -1 Coordination

Trait Modification A: +1 Unarmed Combat

Duration: 1d12 turns

Total cost: 4 CP

He is at least wise enough to perceive the Star Warriors as the greatest threat to his boss' plans — and so is particularly keen on showing them what he's capable of.

CYBERCHIEF

"Leader of the Marauding Cybertroops"

Oomph: 2 **Stunt Points:** 1
Hurt Points: 43 **Size:** Medium

STORY HOOKS

Rivalry with Roboticus — Moderate

TRAITS

Body 4, Ranged Combat 2, Unarmed Combat 1, Computers 3, Perception (Strategy) 2/4, Willpower 2, Persuasion (Command) 2/4

SPECIAL ABILITIES

Cybertroops (Goon SA, Power Level: Medium)

Cyberchief commands the Cybertroop army, and can always summon a large number of them.

Goon Factor 5

Mob Quantity 2

Bonus: Determined 1

Bonus: Grab 1

Restriction: Natural-Born Followers

Restriction: Slow 1

Total cost: 26 CP

Cybercommand Saucer (Vehicle, Power Level: Medium)

A gold and silver craft from which Cyberchief guides his troops into battle.

Traits: Armor 2, Body 4(2), Crew 1, Maneuver 3, Speed 4(3) (Air), Speed 4(5) (Space), Stealth 2, Computer 2, Perception 1

Travel Mode: Air and Space

Size: Very Large

Capacity: 4 enclosed

Structure Points: 240

VDM: 16

WEAPONS

Energy Blasts (DR 8+2; Range: Medium)

Total cost: 22 CP (80 SCP)

Command Rod (OSA/MiscSA, Power Level: Medium)

Cyberchief uses this crackling electronic rod to control soldiers and to fire laser blasts at opponents.

Range: Medium

Trait Modification A: +2 Persuasion (Cybertroops)

Trait Modification A: +1 Perception (guiding Cybertroops) Bonus: Multi-SA

Restriction: Item

Total cost: 10 CP

Total CP value: 100 CP

BACKGROUND

When Dr. Roboticus created the Cybertroops, he realized that they would need some ability to guide and govern themselves when Zarnon or himself could not give orders. Not wanting to create an entire army of free-willed, independent robots, he instead chose to build one commanding officer who would be just autonomous enough to make strategic decisions. The black-and-gold creation was dubbed Cyberchief, and upon being activated he instantly assumed his position as the master of the Cybertroops.

PERSONALITY

Cyberchief was created to look after the Cybertroops, and this remains his key motivation. He will not recklessly endanger the troops under his charge, and whenever Zarnon is making battle plans he will politely and obediently suggest the most conservative attack strategy (but he is often overruled). Cyberchief is loyal to Zarnon, but sees Roboticus as redundant and obsolete, and frequently contests his orders.

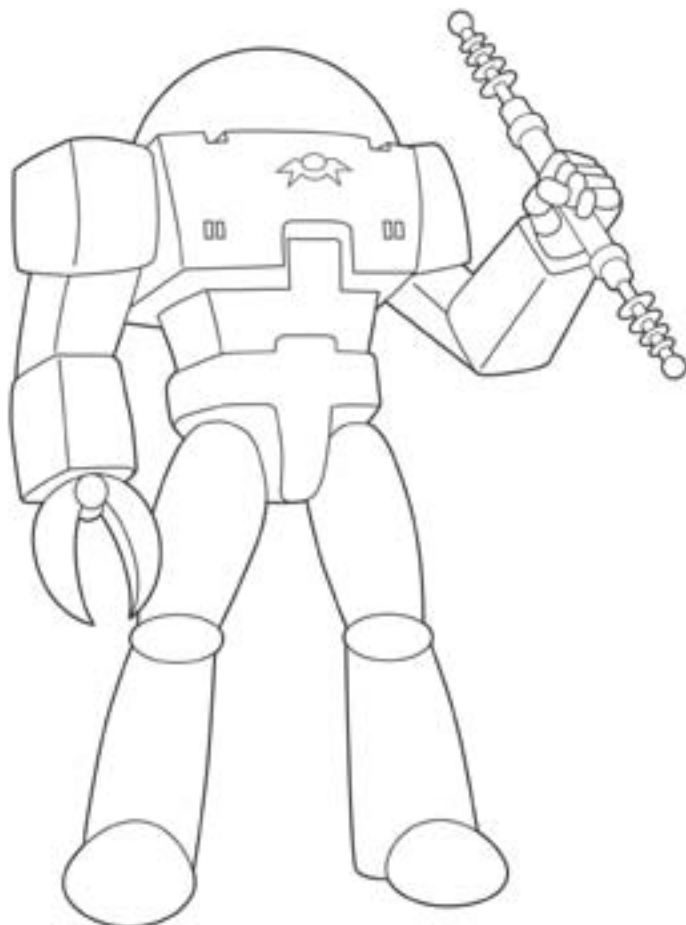

CYBERKING (150 CP)

Fusion with Zarian spirits — which could enhance machinery as much as organic life — turned Cyberchief into Cyberking, who now could control any electronic systems within the range of his voice.

IMPROVED TRAITS:

Oomph 4
Stunt Points 2
Hurt Points 45
Ranged Combat 4
Computers 4(3)
Willpower 4

MODIFY COMMAND ROD:

Trait Modification A: +4 Persuasion
Trait Modification A: +3 Perception
DR 6+2
Bonus: Vehicle Class
Restriction: Only affects computer systems (including Cybertroops)

NEW SA:

Enhanced Armor (DSA, Power Level: Low)

Cyberking's armor is stronger and more ornate, befitting his regal position.

Protection 4

Total Cost: 6 CP

INFURIANA

"Dark Mistress of Fire"

Oomph: 2

Stunt Points: 1

Hurt Points: 31

Size: Medium

STORY HOOKS

Easily Frustrated — Minor
Wanted by Her People — Major
Mischevious Streak — Minor

TRAITS

Appearance 4, Ranged Combat 3, Disguise 2, Perception 2, Willpower 2, Persuasion (Seduction) 2/4, Wealth 1

SPECIAL ABILITIES

Flame Jets (OSA, Power Level: Medium)

Infuriana can shoot deadly fire from her hands.

DR: 5+2

Range: Long

Total cost: 14 CP

Fire Shield (DSA, Power Level: Medium)

An impassable ring of fire that can block attacks.

Protection 4

Duration 1d12 Minutes

Bonus: Advantage, Major (characters cannot cross it)

Bonus: Area of Effect 6 Yards

Restriction: Disadvantage, Major (Infuriana cannot move out of the center while this is in effect)

Total cost: 14 CP

Fire Flight (MSA, Power Level: Low)

Infuriana can use her flame jets to levitate into the air.

Levitation

Speed 0

Total cost: 9 CP

Flame Immunity (DSA, Power Level: Medium)

Infuriana cannot be harmed by fire.

Protection 10

Restriction: Specific Defense (Fire)

Total cost: 23 CP

Total CP value: 100 CP

LADY MAGMA (150 CP)

The Zarian ritual enhanced Infuriana's natural command of flame, and extended it to lava and the natural force of the volcano. Recognizing her new power, Infuriana rechristened herself Lady Magma.

IMPROVED TRAITS:

Stunt Points 3
Oomph 4
Hurt Points 32
Ranged Combat 4
Willpower 3

NEW SAS:

Scalding Skin (OSA, Power Level: Medium)

Lady Magma's skin is red-hot, and can sear the flesh of any man.

DR 7+Body

Range: Point Blank

Restriction: Disadvantage, Minor (must touch with bare skin)

Total Cost: 11 CPs

Magma Wave (OSA, Power Level: High)

Lady Magma can summon a tide of burning lava from the ground.

DR 6+2

Range: Short

Bonus: Vehicle Class

Bonus: Area of Effect 6 Yards

Restriction: Disadvantage, Major (cannot use in space or if otherwise far from the ground)

Total Cost: 23 CPs

BACKGROUND

The Flamites of Thermia are known for their beauty and their ruthlessness, and it is Infuriana who is largely responsible for this reputation. She began her criminal career on Thermia as a con artist; however, after being chased off-planet by the authorities, she put her natural affinity with fire to use in melting through bank vaults, burning down buildings and taking a cut of the insurance, and so on. As she practiced she grew more adept in her control of flame, becoming one of the few of her kind who could produce it at will. Her beauty and charisma, meanwhile, were useful for beguiling gullible sentients and getting out of tight situations.

Eventually, Infuriana's luck ran out. She fleeced one too many aristocrats and set fire to one too many mansions, and found herself on the Universe League's Space-Wide Wanted List. Forced to flee beyond the boundaries of civilized space, she ended up on a bar on Derelus, where she was approached by a large mutant with an unusual offer to make. It seemed a long-thought-dead galactic warlord had reawakened and was planning to invade the galaxy, and was searching for some assistants for special missions to undermine the Universe League. Resentful of her persecution by the Universe League, promised great rewards when Zarnon was victorious, and with Mutaton's laser gun to her head, she quickly signed up.



PERSONALITY

Infuriana is the ultimate femme fatale (at least to the degree that '80s Saturday Morning television would accept). She is clearly dangerous and untrustworthy, but charming enough that you might forget about it, just long enough for her to kill you and take your stuff. She is quick-tempered, and becomes quite flustered when things do not go her way. Her loyalty to Zarnon is conditional — she won't put her life on the line for him, but his winning the war would have the Universe League off her back permanently, and at any rate, she's enjoying herself and making some money. If things go too obviously against Zarnon, she may re-evaluate her place in his hierarchy.

BARON HYPNO

"Fiendish Intergalactic Deceiver"

Oomph: 2

Stunt Points: 1

Hurt Points: 32

Size: Medium

STORY HOOKS

Greedy — Moderate

Infamous — Minor

Grudge against Sheila Sapphire — Moderate

TRAITS

Ranged Combat 2, Stealth 3, Disguise 4, Science (Chemistry) 1/3, Willpower 3, Appearance -2, Persuasion 4, Psychology 2, Streetwise 3, Wealth 2

SPECIAL ABILITIES

Hypnotic Gaze (MiscSA, Power Level: High)

Baron Hypno's eyes can hypnotize the boldest of men!

Trait Modification A: +3 Persuasion

Duration: 1d12 Minutes

Restriction: Only affects organic life

Total cost: 12 CP

Shape Change (MiscSA, Power Level: Medium)

Hypno can change his shape at will to hide his identity.

Trait Modification A: +2 Disguise

Trait Modification A: +2 Appearance

Trait Modification A: +5 Performer (Acting)

Duration: 1d12 hours

Restriction: Disadvantage, Major (reflection shows true self)

Restriction: Restriction (Details)

Total cost: 18 CP

Laser Rifle (OSA, Power Level: Medium)

Baron Hypno prefers to fight from a distance, and carries a standard-issue laser rifle.

DR: 6+2

Range: Long

Restriction: Item

Restriction: Charges, Minor

Total cost: 12 CP

HYPNOTRON (150 CPS)

Baron Hypno was drastically mutated by the Zarian "ghosts", his eyes fusing into one and his brain swelling, granting him psychic powers beyond that of his kind. No longer a true Deceptoid, Hypno granted himself a new name — Hypnotron.

IMPROVED TRAITS:

Stunt Points 3
Oomph 4
Hurt Points 33
Psychology 4
Willpower 4

MODIFY HYPNOTIC GAZE:

Hypnotron's single eye relentlessly projects his will.

Persuasion +5

Duration: Permanent

NEW SA:

Cloud of Fear (MiscSA, Power Level: Medium)

Hypnotron's diabolical mind can project his enemies' worst fears in front of them, causing their will to weaken.

Trait Modification B: -3 Willpower

Duration: 1d12 turns

Restriction: Disadvantage, Minor (cannot use at the same time as Hypnotic Gaze.)

Total Cost: 10 CPs



Laser Knife (OSA, Power Level: Medium)

The Baron also carries a small knife with a laser blade.

DR: 4+Body

Range: Point Blank

Restriction: Item

Total cost: 4 CP

Total CP value: 100 CP

BACKGROUND

On his home world of Mantennor, Baron Hypno was a skilled politician and leader by Deceptoid standards — which means he lied, cheated, and murdered his way towards controlling a sizable barony on the misty, windswept world. Not content with the power he had on his world, he began building a vast interstellar criminal empire, selling slaves, contraband weapons, and his own creation — an addictive muscle-wasting drug called Skrul. He enjoyed some success in his criminal enterprises, but found that the Universe League police — in particular a skilled young detective named Sheila Sapphire — were able to break up many of his operations and keep him from entering civilized space.

Then, through the interstellar underworld, came word that a Zarian warlord had been awakened and was planning to overthrow the Universe League. Baron Hypno reasoned that a single universal emperor would have his hands full quashing rebels and dissidents, and an unobtrusive criminal barony would go relatively unnoticed. Hypno arranged a meeting with Zarnon and offered his complete support in his invasion. Zarnon has officially deemed Hypno his master of spies, dedicated to undermining the Universe League, gathering information on their plans, and weakening their soldiers with Skrul.

PERSONALITY

Hypno is both cowardly and devoted; he tries to avoid combat and confrontation whenever possible, but he's firmly intent on seeing Zarnon realize his goal, because he is convinced that this would be the best for his operation. The Baron realizes his strengths — he will always favor a subtle, corrupting approach over a direct attack. Even in combat, he will attempt to sway the actions of his enemies, and turn the battle to his advantage.

It would take up far too much space to list all of the episodes in *Star Warriors'* four-year run. However, to help give you some ideas for your series, we're presenting some of the series' classic episodes as adventure seeds, as well as a summary of the movie and a complete, ready-to-run episode. Though these episodes were written with the original cast of characters in mind, it should be easy to alter them to your player's characters.



CHANNEL EIGHT THE BEST OF STAR WARRIORS

SEED #1:

Attack on Satrenia

(Broadcast Order: Season 1, Episode 1)

Lord Zarnon begins his first incursion into Universe League territory, launching a deadly surprise attack on the capital world of Satrenia. The planet's defense forces are rapidly overwhelmed by hordes of Cybertroops, while Zarnon and his henchmen personally appear in the town square of Council City to announce his ultimatum: surrender or die.

The Star Warriors — Lance Starfire, Dr. Rex Tolken, Sheila Sapphire, Red Maverick, and Psychlos — are barely ready when the attack begins. Hastily assembling at Star Warrior Central, they take Dr. Tolken's experimental shuttle to Satrenia. They must first run a veritable blockade of Cyber spaceships, only to face waves of Cybertroops on the ground. Finally, Dr. Roboticus has prepared a surprise for the team — a super-strong cyborg named Roboman. But Roboman's buried humanity may yet cause him to turn on his creator...

GM NOTES

The first issue you may want to decide on for this episode is whether or not to use Roboman. If you are using the original cast of characters, this can be a good opportunity to introduce him. Be sure to give him something to do before he meets the other heroes, though. Perhaps Dr. Roboticus uses him as an enforcer or troop leader in the ground battle, kicking off Roboman's struggle to regain control and building to his climactic defection to the side of good (hopefully). If the original characters are not being used, Roboman can either be omitted or used as an NPC — if the Star Warriors succeed in converting him, he may appear as an ally in future episodes.

Overall, this can be a fairly simple episode in terms of structure — a space battle as the PCs try to reach Satrenia, then plenty of conflict on the ground as they try to beat back Zarnon's initial assault. There should be ways to gain the upper hand other than straightforward combat; perhaps they can find the generator room for the city's automatic defense grid, or sneak on board Zarnon's Dragonship to sabotage it as he's shouting at the masses.

PRODUCTION NOTES

The pilot episode for *Star Warriors* was written by series co-creator Edward Bochmann, who originally planned it as a two-part episode. Though this was common practice for Saturday Morning cartoons, a production crunch forced him to abbreviate it to ensure it being completed on time for the

fall premiere. Some of the deleted material, in which the Star Warriors make their way through the sewers to get past the Cybertroops surrounding the town square, was incorporated into the series finale "Zarnon the Conqueror."

SEED #2:

The Crystal Palace of Cerebros

(Broadcast Order: Season 1, Episode 3)

The Star Warriors are summoned by a call from Cerebros; Eberona, the Universe League's Vice President, has had a premonition about "dark forces at work" at the Diamond Academy, the school of psionic arts where Psychlos was trained. Sure enough, Lord Zarnon has led a small force to the planet in secret. His goal is to siphon psionic energy from the Crystal Well to incorporate into his own Scepter. The Crystal Well, used to harness the surplus psychic energy that is often released during training, is located at the bottom of the structure; to prevent unauthorized access, it is located within a large maze, full of illusions and mind traps.

The Star Warriors arrive at the Academy just as Zarnon, having knocked out the guards, is breaking into the lower levels. They follow, but quickly lose him as the maze becomes more elaborate. Fortunately, Zarnon and his enforcer Mutaton are having just as much trouble figuring out where to go next. The Star Warriors must either overtake and drive off Zarnon and Mutaton before they reach their goal or get to the Crystal Well first and drive off the invaders.

GM NOTES

The Maze itself doesn't have to be very elaborate — the physical layout isn't what confuses people so much as the weird psychokinetic phenomena within. You can place a good variety of obstacles within the maze, so long as they stay within a "psionic" theme — illusionary monsters, mind puzzles, and so on. Obviously, the question of whether or not there's a character with psionic powers in your group will affect exactly what kind of challenges you put them up against.

PRODUCTION NOTES

Series writer Karla Hunter created this episode to focus on Psychlos and his background; many episodes from the first season similarly acted as a "showcase" for the main characters. Until this point, there was no clear picture of who the Mentons were or where they lived. The success of this episode led her and other writers to write other episodes focusing on the various races represented by the main heroes and villains, which helped to develop a strong continuity for the series.

SEED #3:

The Dangers of Skul

(Broadcast Order: Season 1, Episode 9)

The Star Warriors are at a military base on the planet Lucida, far from the front lines, to discuss strategy with General Brock. Brock is glad to show off the strength and discipline of the Universe League infantry, but during the visit, some of the soldiers exhibit disturbing behavior. A major fist fight breaks out in the mess hall, one cadet breaks into hysterical raving, and another — one of the strongest men in his unit — faints during afternoon drills. The Star Warriors sense something sinister is at work, and must investigate to discover the cause.

The culprit is Baron Hypno, who has been in disguise and selling the soldiers a drug of his own manufacture called Skul. A white, chalky substance, Skul is highly addictive, and creates in the user a loss of willpower and a blurring of the senses. Investigation by the Star Warriors reveals that use is widespread throughout the base, and they must track down the dealer before he decides to try out this trick on other bases...

GM NOTES

As the obligatory "anti-drug" episode of the series, this is a perfect opportunity to focus a session on roleplaying and heavy melodrama. Things can get very cheesy very quickly, and it might not be a bad idea to encourage that. Of course, you could also try to play it seriously. Either way, the episode is in some ways one giant after-show message; give roleplaying awards accordingly.

Setting up the mystery will be the big challenge preparation-wise. You could focus the investigation entirely on one troubled kid (as anti-drug episodes often did), or have the PCs pick up clues from each of the affected soldiers. Discovering the drug itself should be easy (it's the focus of the episode); finding the dealer and unmasking him as Baron Hypno should be the hard part.

PRODUCTION NOTES

This episode was commissioned early in the show's development to alleviate network Standards & Practices concerns about antagonizing parents' groups. By having at least one show per season devoted to a "relevant issue", along with the after-show messages

accompanying each episode, the producers were able to claim some educational value to the program. Jack Nathan, the episode's writer, was genuinely enthusiastic about tackling the issue, and produced what many consider a sincere, surprisingly tasteful episode.

SEED #4:

Battle in the Asteroids

(Broadcast Order: Season 1, Episode 12)

The Star Warrior Shuttle makes a rendezvous with the Universe League Battle Cruiser *Dynamo* in the Tyren system. Word has gone out that Zarnon's forces have suffered heavy losses since the Satrenia invasion, but he is attempting to break the Universe League lines somewhere in this sector. There was heavy fighting on the outskirts of the system, but the attack forces — led by Cyberchief's saucer — have apparently disappeared.

Scouting ahead in *Hawkeye*, - discovers that the Cyberships are hiding and regrouping inside of the vast Sargasso asteroid belt. She intercepts a transmission detailing their plan of attack, but is detected and set upon by Cyberships. Picking up her distress signal, the other Star Warriors lead the *Dynamo* and their own Shuttle, as well as a wing of fighters, into the perilous belt to confront the enemy.

GM NOTES

This episode focuses primarily on space combat and tactics, and you should decide whether or not to use this book's space combat rules to run the big battle. The exact composition of the Universe League's forces and the Cyberfleet is left vague; put in enough to make it seem like a big epic battle, but not so many that it's a pain to keep track of.

If you want this scenario to be more than just a big battle, emphasize the search (even if the title gives away the fact that they're in the asteroid belt, that doesn't really narrow things down). Searching and scouting through the treacherous asteroids, trying to trace enemy transmissions, plan the best attack, and so on can all make for a good buildup to the climactic fight.

PRODUCTION NOTES

Edward Bochmann wrote this episode as a bust-up "season finale", despite the inconsistent nature of cartoon broadcasting. It also gave the Juego corporation several designs for new vehicles for the line; by this point, the series and the initial run of figures were already quite successful, and the people in charge were looking for ways to expand the line quickly.

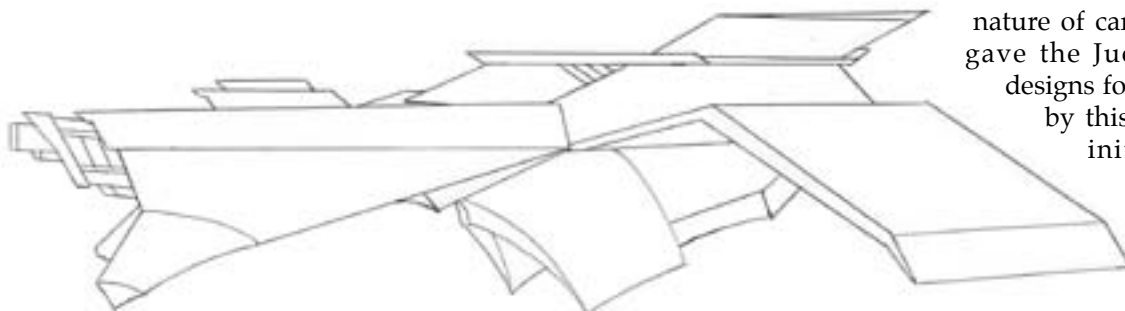

SEED #5:

The Lava City

(Broadcast Order: Season 2, Episode 3)

The Flamites of Thermia are considering joining the Universe League war effort, and the Star Warriors have been sent on a diplomatic mission, well aware that enemy forces may try to threaten them into inaction. Donning heat suits to enter the vast underground capital city, the heroes arrive in the midst of a battle between Thermian guards and a horde of Cybertroops led by Infuriana! She and her forces quickly depart upon seeing the Warriors, fleeing into unused lava tubes. Magmon, the current High Noble of the Flamites, explains that the notorious criminal, with her superb skill in controlling fire, has been threatening to destroy the city if they join the war. The Flamites are not sure if she can do it — even if the city were plunged into the lava below, it would not kill anyone — but they are concerned.

As the Warriors are talking with Magmon and his council, Infuriana broadcasts a threat over the city's radios: surrender to Zarnon and join his side, or she will detonate several bombs placed amongst the lava tubes, causing the volcano above the city to collapse. Flamites can survive lava, but not burial under tons of rock. The Star Warriors must act quickly to locate and disarm the bombs, and drive off Infuriana and her forces for good.

GM NOTES

This episode can contain about an equal mix of action and diplomacy; the characters must convince the Flamites, who are intimidated by the attacks on their planet, to join the fight. However, there are at least two opportunities for good fight scenes in the basic plot, and more attacks may be added if necessary.

It's important that the characters have several options for the climax. They can attempt to track down the bombs one at a time, or split up to find them, or go after Infuriana to stop her from setting them off, or divide the tasks of finding the bombs and stopping Infuriana into two groups, or any number of other options. Chances are your players will come up with some plan you haven't thought of, so be ready!

PRODUCTION NOTES

Before this episode was ever written, some background detail on Infuriana's people had appeared in the packaging for her action figure, explaining that she came from a race of "fire-people who live under volcanoes and control flames at will!" It fell to new writer Mark Cain to turn this into an entire episode, and his major contribution was to make the Flamites into a race of charismatic aristocrats. The Flamites became more of a common sight after this episode, appearing frequently in crowd scenes and the like.

SEED #6:

The Space Derelict

(Broadcast Order: Season 2, Episode 5)

Tracking Zarnon's Dragonship through a remote region of space, the Star Warriors pick up a garbled signal from an unknown vessel. Tracing its origin, they come across a massive ship of unknown alien design. It appears to be powerless, adrift in space, and abandoned. After some debate, the Star Warriors decide to investigate, docking with and boarding the vessel.

Shortly after the Star Warriors leave their Shuttle, Zarnon's ship also enters the area. At first planning to simply destroy the Shuttle, Zarnon decides that perhaps he should also see what secrets lie within the craft, the origin of which is unknown even to his ancient mind. The derelict is large enough that he can dock with it and not even be seen by the Shuttle, and so he leads his henchmen on an expedition to unlock whatever ancient powers lie within. Once both parties are aboard, the ship's systems automatically switch on, and the explorers find out how "dead" this ship really is...

GM NOTES

What is the derelict? That's up to you. Here are some suggestions: a ship guided only by a sentient (and, after many years, quite insane) computer, an experimental Zarian vessel, the vanguard of some new alien fleet with the crew in hibernation, or some combination of the above. You may wish to draw a crude map, or you may include turbo-elevators or teleportation pads to allow characters to get wherever they need to be (after a few tries). You'll still need to know what kinds of rooms are in the ship, however.

Your players may well be reluctant to send their characters onto an abandoned alien ship, knowing how such encounters often turn out. This is not terribly in-character, but it is a possibility. You could remind the PCs of "Universe League Directive 1.2.74: Potential opportunities for first contact with alien races must be investigated", or you could point out that this is an '80s cartoon and so the ship is not likely to contain parasitic face-hugging aliens that burst out of people's stomachs. Or you could ditch the idea and improvise a new situation for the rest of the episode. Whatever works.

PRODUCTION NOTES

As the episode turned out, the ship in question belonged to an alien race heretofore unknown by any of the characters, abandoned by its crew when the central computer turned hostile. The door was left open as to whether this race still existed or not and whether we might see them, but this was ultimately unexplored. This moody, atmospheric episode was written by Karla Hunter, who already was gaining an excellent reputation for her work on the show.

SEED #7:

The Gangs of Mutant City

(Broadcast Order: Season 2, Episode 12)

The Universe League has reported a number of Mutant raids taking place along the border worlds; President Sage is worried that the Mutant empire may be planning to attack the Universe League while it is still battling Zarnon. The Star Warriors head to Toxion to search for the cause of these attacks and put a stop to them.

The heroes arrive in the middle of an intense war between rival Mutant mobs. It seems that the planet's most powerful single gang, the Horde, split into rival factions when its leader Mutaton left to work for Zarnon. A particularly ambitious and cunning leader, Lurrig, has led his gang to take control of the planet's shipyards, and has been using the meager space forces to conduct the raids. The Star Warriors must put an end to Lurrig's plan, and perhaps bring peace to this war-torn world. (Good luck.)

GM NOTES

This episode can be run with various degrees of complexity. On a simple level, it might be a matter of tracing the ships to the shipyard, finding out a bit about the gang responsible, and beating them senseless. If you want it to be more intricate, bring in Mutant politics — get the characters involved in the intrigues of the gang wars, trying to decide between equally odious factions or perhaps finding one group of "good" Mutants who can help put a stop to the wars.

In addition to Lurrig (who is not as strong as Mutaton but a bit smarter), create a few other interesting Mutant characters, to emphasize the weird variety that exists within the race. Be sure to play their brutish, aggressive personalities to the hilt.

PRODUCTION NOTES

Plans to introduce a group of villains called "The Mutant Horde" were already being discussed by the producers and Juego Toys, and to test out this idea, the show decided to have a Mutant-centered episode as its second season finale. Jack Nathan wrote this episode, one of the few in the series not to feature Zarnon or any of his forces.

SEED #8:

Meet the Horde

(Broadcast Order: Season 3, Episode 1)

Now becoming personally frustrated by the Star Warriors' constant interference in his schemes, Zarnon commands his enforcer Mutaton to find some way to "take them out of the picture". Mutaton decides to make contact with his old underlings on the planet of Toxion, and travels there to round up the toughest bruisers in his old gang.

Some time later, the Star Warriors receive a distress signal from a cargo freighter which apparently crashed on the remote, swampy world of Aronath. Being the only ship in the sector, they investigate. Once they have landed on the planet and approached the freighter, they find themselves ambushed by the Mutant Horde, Mutaton's own "assassination force" composed of members of his old gang on Toxion. The Horde first sets a blockade around the Star Warrior Shuttle, blocking the heroes' escape, then pursues them into the treacherous wilds.

GM NOTES

Statistics for "The Horde" as a Goon SA can be found in Channel Six and Channel Seven (with the Mutalord write-up) of this book; however, not all members of the Horde should be Goons — if they were, this episode would be very short. Instead, you should set aside a few — from three to five sounds about right — to be built as NPCs, each with a CP total about half or 2/3 of the average for the PCs. Give each one a niche — one is even bigger than Mutaton, but incredibly dumb, one is very smart but weak, and so on. SA's can also be used to add variety.

The wild swamp setting is intended to add a bit of a hunting angle to the scenario, with the PCs being stalked in a hostile environment. Be sure to add a number of fitting obstacles/encounters: wild beasts, quicksand, and the like. These can add an additional challenge to the PCs, or they may be turned against the Horde — it depends on how the players use them.

PRODUCTION NOTES

After the success of "Gangs of Mutant City", Jack Nathan was commissioned to bring "The Mutant Horde" to life as a gang of second-string villains. This rather simple action episode was not the writer's favorite, but the colorful villains found favor with the audience (who had already made Mutaton one of the show's most popular characters).

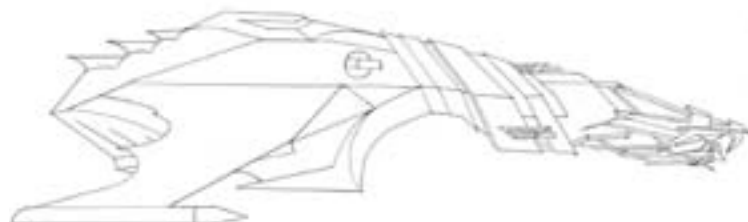
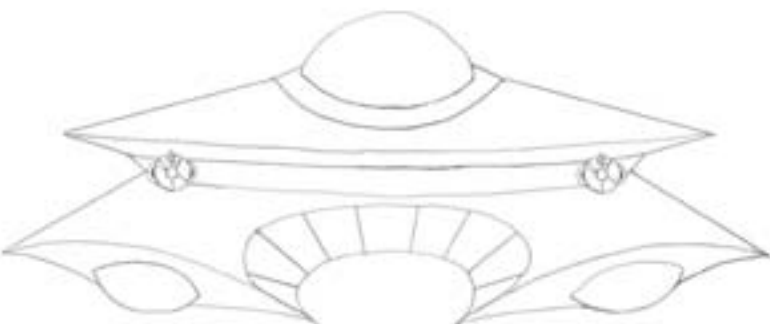

SEED #9:

Monster Machines

(Broadcast Order: Season 3, Episode 8)

The Star Warriors are visiting the world of Onyx, a technocratic city-planet with some of the most advanced machinery in the universe, to research potential new weapons that might be used in the fight against Zarnon. The Onyxians guide them through a large exhibition of automated weapons systems, which are shown impressively wiping out large numbers of dummy targets. Then, suddenly, the robotic weapon platforms turn on the Star Warriors themselves!

Escaping from the exhibition hall, the Star Warriors watch the battle-robots and other robotic devices turning on the Onyxians. Soon, their leader reveals himself — Dr. Roboticus! The mad scientist has decided to develop some new ideas for Zarnon, and has figured out how to control Onyxian technology. The Star Warriors must liberate Onyx and defeat Dr. Roboticus before he turns his new army on any other worlds...

GM NOTES

There are some alternatives to the basic plotline given here. Dr. Roboticus could work entirely in secret, forcing the PCs to do some investigating to uncover the cause of this machine revolt. Another option would be to have Cyberchief, or his more powerful incarnation Cyberking, be responsible.

The best way to design the robots would probably be as Vehicle SAs with Auto-Pilot and Auto-Gunner features. After running this episode, you may wish to have "friendly" versions of the robots show up, if only to make the PCs feel a bit paranoid.

PRODUCTION NOTES

Originally, this episode was to have been the introduction for a group of "battle-robot" figures, and Karla Hunter worked from prototype sketches to create a story and context for the idea. The toys themselves never made it to shelves, as Juego ultimately deemed them too costly to produce, but by this point the episode was already in production and Osborne Animation saw no need to stop work on it or rush in a replacement. The "Onyx robots" have since become fan favorites, and it is rumored that the new wave of *Star Warriors* figures may include them.

SEED #10:

The Library at Babel V

(Broadcast Order: Season 3, Episode 11)

Babel V houses the Omnibus Library, the largest repository of books and writings in the known universe. Their collection contains several rare and undeciphered documents of unknown origin, known collectively as the Enigma Volumes. Lord Zarnon believes that the Enigma Volumes contain the coordinates of his lost homeworld, Zaronia. The Volumes are well guarded, and so Zarnon asks his other henchmen to help create a diversion.

The Star Warriors happen to be at the Library, appearing as part of a publicity benefit for a new school being built in the city. Mutaton and Infuriana lead a surprise attack, the former threatening the Warriors while the latter starts burning books. The Star Warriors have to prevent damage to the library's valuable treasures while trying to work out what Zarnon is trying.

GM NOTES

This is another episode with heavy After-Show-Message potential. The characters are trying to save books — what could be nobler than that? Of course, you should remind them constantly that they need to take care not to damage the building — force them to find creative ways of handling the situation. This will probably depend more on description than rules, but a few die rolls might be called for anyway.

Note that Zarnon's search for Zaronia is mostly a MacGuffin — if, in your series, he's already found it or doesn't care yet, he may be looking for some other secret in the Enigma Volumes. Or, in classic cartoon tradition, he may just want to destroy all the Universe League's most valuable books because he's evil.

PRODUCTION NOTES

Edward Bochmann had two motives in writing this episode. For one, it was the season's obligatory "message" show, this time drawing on the writer's love of books. (In interviews, he admitted that the title was a Borges reference.) The episode also foreshadowed Zarnon's eventual discovery and return to Zaronia in the upcoming movie, *The Journey of the Star Warriors*.

SEED #11:

A Surplus of Sludge

(Broadcast Order: Season 4, Episode 2)

Mutalord (formerly Mutaton) and his Horde are sneak onto Satrenia as part of a new plan. They infiltrate the sewers and garbage disposal plants in Council City, which are not very well maintained — people don't pay much attention to what they throw away these days. The Mutants use the sewer pipes to start pumping toxic waste and dangerous radioactive sludge onto the streets of the city, driving citizens into their homes.

The Star Warriors are quickly summoned. Donning hazmat suits, they must find some way of cleaning up the city, and perhaps encourage the citizens to recycle their refuse in the future. Oh, and there's the large gang of Mutants determined to stop them from doing anything of the sort.

GM NOTES

It doesn't necessarily have to be Mutalord leading the gang — plain old Mutaton can work just as well. Indeed, if you want to set this very early in your series, you can have him working with Cybertroops instead of the Horde. It doesn't alter the basic premise much. The structure of this episode is fairly loose- the Star Warriors can battle the villains above-ground, or you can make them go through the sewers and disposal plants to reach their goal.

This is yet another good opportunity for lots of thoughtful lecturing and message-giving, this time on the environmental issue. A bonus experience point should be awarded to the first PC who mentions "recycling", and players should be encouraged to tackle the problem from an environmental angle, while at the same time beating up a horde of Mutants.

PRODUCTION NOTES

Following the revamp of the villain line-up in *The Journey of the Star Warriors*, the writers used many episodes to focus on the new characters, just as the first season had showcased the original line-up as individuals. Jack Nathan also used this episode as an opportunity to introduce environmentalism as an issue, having recently become interested in the topic.

SEED #12:

Arena of Doom

(Broadcast Order: Season 4, Episode 11)

The Star Warriors and Emperor Zarnon are engaged in a dogfight over the seemingly nondescript world of Aniren, when suddenly a beam of energy leaps from the planet and ensnares both ships. The inhabitants find themselves transported inside a vast, alien arena, where strange crystalline beings look down on them from the stands.

The alien leader, identifying himself as Aralox, explains that his people, the Anians, are an advanced race who wish to study the universe around them. They are fascinated by the savage, primitive war being fought across the galaxy, and have brought its chief combatants together to see "how they would act under different circumstances." With that, he unleashes a swarm of strange alien creatures gathered from across the universe, and sets them loose. The Star Warriors must somehow work together with their enemies to survive.

GM NOTES

Though this is obviously going to be a combat-heavy episode, you can find ways to break up the action so that it isn't just one fight after another. Have Aralox continually comment on the action and question the characters to encourage them to try and reason with him. Similarly, it may take quite a bit of diplomacy to encourage the villains to cooperate. The arena space should be large and filled with obstacles, so that the heroes can conceivably hide from the aliens while trying to plan, or set traps for them.

Aralox is motivated by curiosity, so the characters can "win" by demonstrating teamwork with their enemies, or explaining the nature of their original conflict in a way that he and the Anians can understand. This is a culture that has long since abandoned war, conflict, and even emotion (to some degree), so it should be interesting. It may seem quite a bit more cerebral than the average cartoon series (and a bit like an episode of a certain live-action sci-fi series), so the challenge is really balancing the action with the discussion. Go with whatever seems best for your group.

PRODUCTION NOTES

This was Karla Hunter's last script for the series. She, like everyone else on board, sensed that the show was winding down, and used the opportunity to experiment a little by writing a more "thoughtful" episode. Discussions regarding toys based on the alien monsters and the arena never went very far, as the series was canceled shortly after the episode finished production.

SPECIAL BONUS SEED: THE JOURNEY OF THE STAR WARRIORS – MOTION PICTURE

(Date of Release: June 3, 1988)

Introduction

The idea of a *Star Warriors* motion picture was considered from the start of the franchise, but it was not until 1987 that production officially began. The film, directed by veteran series helmers Andy Simon and Len Wallace from a script by Edward Bochmann and Karla Hunter, was used to radically remodel the show's villains, as well as write out two characters who had become problematic.

THE STORY

The film begins with a lengthy scroll, complete with voiceover, briefly explaining the history of the Zarian race, the return of Zarnon, and the formation of the Star Warriors. It then moves to the Omega Nebula, where Sheila is scouting out the location of a massive Cyberfleet. Escaping unnoticed, she pilots the *Hawkeye* to rendezvous with the Star Warrior Shuttle and a detachment of Universe League fighters. An epic battle quickly ensues, and the heroes decisively dispatch the Cyber ships. From his fortress in Malitron, Zarnon watches with displeasure. He angrily blames Dr. Roboticus for creating "substandard soldiers", and decides that more power will be needed to truly oppose the Star Warriors. Just then, Baron Hypno reports from a spy mission on Antares — he has successfully stolen an artifact which pinpoints the location of Zaronia, deep in the wild regions of space. As soon as Cyberchief returns to the fortress, he orders them all to embark on the Dragonship, and sets out for the lost world.

Meanwhile, the Star Warriors, regrouping on Freedonia, analyze the movements of Zarnon's forces to date — and determine that something is up. He's made a series of bold incursions into Universe League territory with relatively meager forces, spreading them out to get the Universe League's attention. Sheila thinks it's probably a gigantic diversion. The Star Warriors decide to head for Malitron, and find the planet relatively unguarded, though the Fortress is still concealed from their sight. Dr. Tolken picks up traces of hyper-drive plasma, and plots a course following the trail. As the Shuttle begins its long journey, the Warriors try to figure out what Zarnon may be up to.

Zarnon's ship reaches Zaronia, a dead world full of crumbling, fog-shrouded ruins. He guides his henchmen to a gigantic palace, the seat of the Emperor in older times. Inside, he is able to reactivate the ancient machinery, which seems to be possessed by "spirits" — traces of the dead Zarians, infused with energy from the bioweapon which caused their extinction. The spirits, glad that Zarnon is alive to dominate the universe as the Zarians rightfully

should, infuse their energy with him and his henchmen, turning them into powerful Dread Lords. Mutaton becomes Mutalord, Infuriana becomes Lady Magma, Baron Hypno becomes Hypnotron, and Cyberchief becomes Cyberking. Lord Zarnon's own natural abilities are augmented, and he is crowned Emperor Zarnon. Only Dr. Roboticus refuses, feeling that these "untrustworthy spirits" will cause trouble. He takes a batallion of Cybertroops and flees into the depths of the palace, promising that Zarnon will regret his decision.

Meanwhile, the Star Warriors have reached the orbit of Zaronia, only to be fired upon by the palace's planetary defense system, manned by the Mutant Horde. They manage to land the Shuttle and confront the Horde on the ground in front of the palace. After driving off their attackers, the Star Warriors decide that Zarnon must be doing something incredibly important inside, and it needs to be stopped. They enter through a side passage half-obsured by rubble. Dr. Roboticus finds a laboratory in the palace's lowest levels, and begins modifying the Cybertroops so that they will obey him, not Zarnon. Cyberking detects this, and quickly acts to dominate as many troops as he can. The result is two opposed factions of Cybertroops, and Roboticus officially declares mutiny. Meanwhile, Emperor Zarnon learns more about the strange bio-plague that once destroyed the planet, and finds that there is a sample of it still in the palace vaults. He sends Mutalord, Lady Magma, and Hypnotron to retrieve it.

The Star Warriors stumble across the palace's weapons vault just as Mutalord, Magma, and Hypnotron uncover the bio-plague warhead. A battle breaks out, and the Warriors seem to have the advantage, but a group of Roboticus' Cybertroops enter, attacking both sides. In the chaos Hypnotron slips away with the warhead, and Mutalord and Lady Magma follow. The Star Warriors defeat the Cybertroops, and Roboman volunteers to split from the group to find Dr. Roboticus and prevent any further "interference."

Just as Emperor Zarnon places the warhead inside a missile aimed at Satrenia, Roboticus' Cybertroops launch a full assault on the throne room. The Star Warriors break into the vast chamber, and have to fight their way past the super-powered Dread Lords *and* the warring Cybertroops to stop Zarnon before he can launch his deadly weapon. In the laboratory, Roboman fights Dr. Roboticus and a small guard force of Cybertroops to a standstill, promising vengeance on the man who ruined his life. The laboratory begins crumbling around them. The Star Warriors notice that the battle of the Cybertroops is causing the entire palace to collapse. Lance Starfire manages to hold off Emperor Zarnon while Red Maverick leaps to the missile controls, aborting the launch and ruining the firing mechanism. The Star Warriors then quickly move to escape the falling palace. Emperor Zarnon and his Dread Lords are apparently trapped inside, as are Roboman and Dr. Roboticus as they endlessly battle. The remaining Star Warriors make it to the

outside in time to watch the entire building fall in on itself. They observe a moment of silence to honor their fallen comrade and his sacrifice — a moment ended when Dr. Tolken, in the Shuttle, detects Zarnon's Dragon ship leaving the planet. The Star Warriors take off in hot pursuit, and the battle continues...

GM NOTES

Needless to say, this entire scenario can play out quite differently depending on the characters involved and what decisions the players make. The summary of the film is more complete than the episode seeds to explain some developments in the overall series, but it can be simplified further — the villains find Zaronia and the palace, use the machinery to "upgrade" themselves into the Dread Lords, Roboticus (if he is in your campaign) leads a mutiny and Zarnon aims a deadly weapon at Satrenia. Additional elements — the Mutant Horde, traps within the palace, even angry spirits — can be added as further obstacles for the PCs. Whatever you need to do to make the movie suitably epic.

No one character *has* to die in order to advance the story, and you may simply go by the rules here. (Indeed, even the movie rules make death a matter of GM discretion.) You may decide to keep Dr. Roboticus alive, to lead his own adversarial faction in subsequent episodes. Other dramatic developments besides death are possible — the heroes could even find some upgrades of their own.

PRODUCTION NOTES

Though work on this film was rushed compared to most animated features, several Japanese animation firms were able to work in concert to produce some decidedly impressive visuals. To boost publicity, several of the characters were recast with celebrity voices, though fans feel they didn't sound much different anyway.

The decision to kill off Roboman and Dr. Roboticus had been primarily motivated by sales — Roboticus was the least popular of the original line-up of villains, and Roboman suffered a similar status. The writers blamed themselves for Roboman's relatively low popularity — regulation from parenting groups made it difficult for them to explore the idea of an amnesiac hero with a sense of self-loathing and a desire for vengeance. To assuage his own guilt, Edward Bochmann dropped hints in later episodes that the character may have somehow survived.

The show's merchandising hit a peak with the release of this film, including a Zaronian Palace playset, new Dread Lord figures, "movie version" re-issues of all the other characters, a board game, and a soundtrack album (featuring songs by more than a few '80s pop stars). Though the film itself only managed to break even at the box office, merchandising revenue put it firmly into the black.

JEWELS OF THE JUNGLE PLANET – A COMPLETE EPISODE

"Jewels of the Jungle Planet" is a complete episode for *Star Warriors*. It is intended for four to six players and a GM, and assumes that the players are playing the 100 CP versions of the characters from Channel Four, with the exception of Brutus. Some alterations may be needed if they are playing their own characters, particularly one from the Fangor race. You also may need to alter things if there are fewer players.

THE STORY SO FAR...

Lord Zarnon is looking for new power sources for his armies' weapons, and has recently located a mineral-rich jungle world called Kashdor. A week before the beginning of this episode, he landed on the planet and discovered that its mountains were rich in fire diamonds, rare energy-emitting crystals that could boost the power of weapons and equipment. The native Fangors, unfamiliar with the universe, were easily intimidated by Zarnon and his Cybertroops, and he soon pressured a village into mining the Fire Diamonds for him. Gorlath, a greedy Fangor warrior, has agreed to be his enforcer in exchange for his own supply of the diamonds.

HUNT FOR THE DRAGONSHIP

Read or paraphrase the following to the players:

You are in the Delta Zone, a mostly unexplored region of space. Universe League scouts have reported sighting Zarnon's Dragonship in this area, and his forces have shown surprisingly little activity elsewhere. Currently you are searching the Ardon system, and nearing its one inhabitable planet, Kashdor.

Allow some time for in-character discussion or banter — the Star Warriors have a job to do, but it's been a long journey. A Knowledge (The Universe, or a similar field) or Science roll at difficulty 5, or a Computers roll at difficulty 6 will give any of the characters all the information the Universe League has on the planet of Kashdor — it's a jungle planet, with many forms of dangerous wildlife, and probably contains abundant mineral resources. No survey team has stayed on the planet long enough to ascertain whether or not it's inhabited by any sentient beings. Of course, any Fangor character can tell them a lot more, including information on the Fire Diamonds. This may take away some of the surprise, but you may be able to run the adventure well anyway. After enough time has passed, read the following:

You arrive in orbit around the planet. Under thick clouds, you can make out spots of dark green, probably vegetation. Suddenly the control panel starts beeping- the sensors have

picked up something. A starship has landed somewhere on that planet.

The players should easily put two and two together and work out that Zarnon has landed on Kashdor. (If not, they're still bound to investigate.) From space the shuttle's sensors can work out the general area where the craft has landed, but a Computer roll at difficulty 9 will let them zero in on its precise location. In any case, they'll have to land first, and there is, unfortunately, very little even, uncovered ground in the area. A Piloting roll of 10 is required to bring the ship in for a safe landing — a failed roll means that the ship crashes in the jungle and takes 2d12+4 damage. One way or another, the Star Warriors end up on Kashdor, and it doesn't take long for Zarnon to figure out that they're here.

THE TREK THROUGH THE JUNGLE

If the PCs were able to track down the Dragonship's exact location, they can practically land next to it. Otherwise, they may have to go looking for it. The Shuttle's sensors can give them the general direction that it lies in (unless that system was damaged), but it will take a Survival roll of difficulty 8 for the characters to make it through the jungle without getting lost. Describe the trek with something like the passage below:

Getting through the jungle is even harder than it seems. The

ground is extremely muddy, and the underbrush is very thick. The air is so humid you could probably swim through it, and the heat is just this side of uncomfortable. All around you can hear the cries of alien birds, insects, and... other things.

The Dragonship, if the PCs find it, is located in a small clearing surrounded by watery swampland. If the players want to try to break into it for any reason, the electronic lock requires a Computers roll at difficulty 16 to open. Otherwise, the door simply won't budge. If the PCs are lost, they should end up in a boggy, waterlogged area anyway, in time for the next encounter. Read:

All of a sudden there's a foaming rise in the water. A huge reptilian beast, with dark green scales and a long neck, rises up from the bog — it must have been hiding itself by lying flat. The monster turns towards you and bares its huge, slavering fangs...

If the PCs have successfully broken into the Dragonship somehow, the beast should arrive before they can enter. The Swamp Beast's stats are at the end of the section — before beginning the combat, you may want to roll its Stealth against the PC's Perception to see if they're taken by surprise. If so, it automatically gets initiative for the first round.

If the PCs win the battle easily, then Zarnon will show

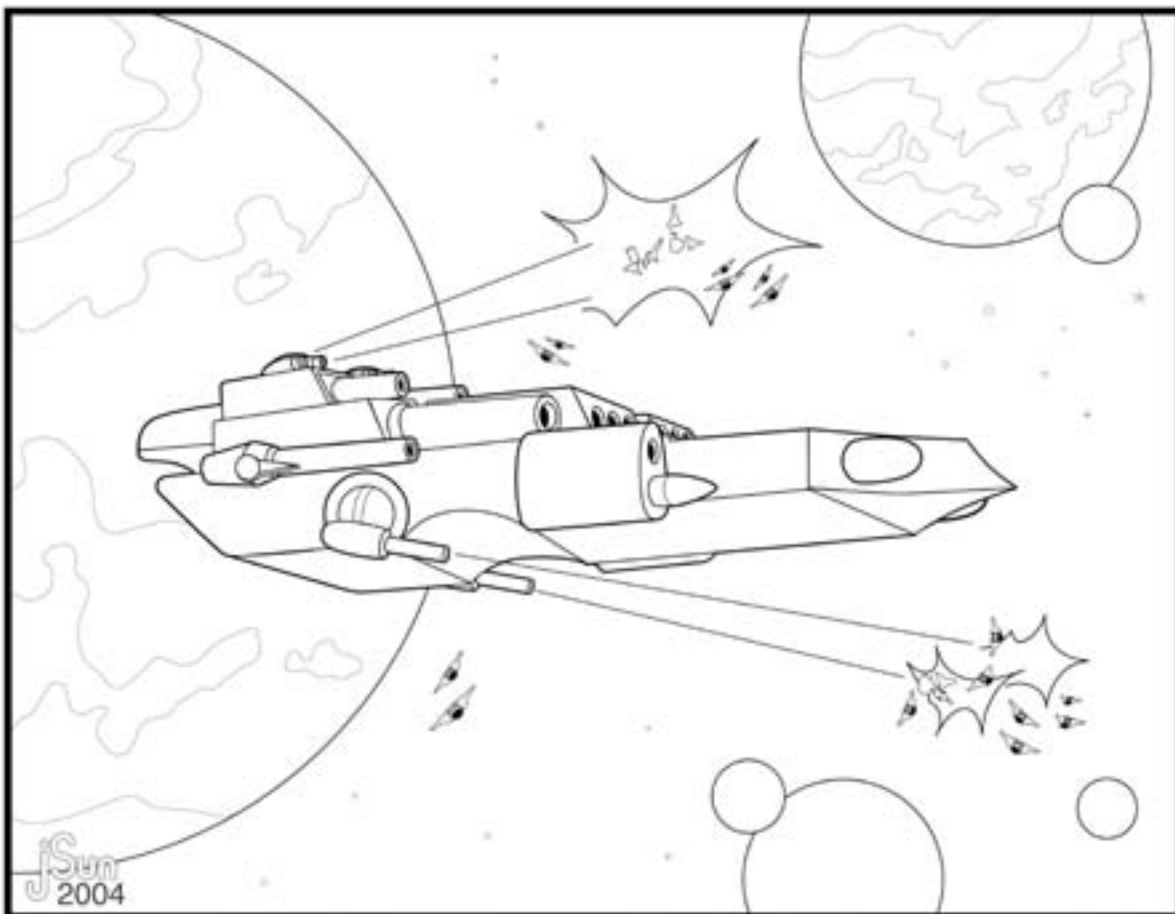

up with a gang of Fangors shortly after they've dispatched the beast. If they're losing, then the Fangors will appear and drive off the monster; when the Star Warriors are thanking their rescuers, Zarnon will appear to take the credit himself. The Fangors will level fierce-looking diamond spears at the PCs at Zarnon's direction, and he will call for the Star Warriors to lay down their weapons and "accompany" him to the village. The PCs' first instinct may well be to fight, but Zarnon will scold them — "Now, now, these are innocent beings we're talking about. You wouldn't want to hurt them simply because I've persuaded them to work for me — burning down half the village tends to have that effect." Needless to say, any attempt made by the PCs to attack Zarnon alone will prompt the Fangors to rally around their feared leader. The second instinct may be to escape, which will set off a merry chase through the underbrush. The Fangors will have an advantage because they know the area, but it's still quite possible for the Star Warriors to lose them. If they do, they'll probably still want to find out what's going on, and this should lead them back to the village. Thirdly, the PCs may well let themselves be captured. It's in-genre, at least.

THE VILLAGE OF KRISHAK

The village is a collection of wooden huts surrounding a raised stone platform, which acts as a central meeting area and campfire ground. Around 50 adult Fangors call Krishak home, and there are currently 20 children. There are also three waves of Cybertroops present. If the PCs come here as prisoners, they will be quickly led into a large wooden prison. The bars of the prison are stronger than they look — they're made from Steelwood, and it'll take a Body check at difficulty 13 to break them. Picking the lock will be a Coordination test with a difficulty of 11 (and of course, they'll need something to pick it with, since the Fangors will take their weapons and anything else that looks valuable.)

Zarnon's deputy Gorlath will personally toss the PCs in the prison. Also held in the large cell is either Brutus (use the "low-powered" version in Channel Four) or Tarlok, a somewhat grimmer, more solemn Fangor warrior with the same stats. Brutus/Tarlok will explain to them that he was the sheriff of this village when Zarnon arrived, and initially led a movement to oppose the invader. However, the Cybertroops intimidated the townsfolk into submission, and Brutus/Tarlok was imprisoned as an "instigator". Gorlath, who had always desired the position, agreed to become sheriff as a puppet for Zarnon and to drive the rest of the Fangors to mine the Fire Diamonds for him. He will then explain about the Fire Diamonds, and so on. The talk will inevitably drift towards plans of escape, and Brutus/Tarlok will admit that he smuggled a key with him into the cell — however, he's had no opportunity to use it, as the Cybertroops watch day and night. But now that he has some allies...

After some time, a group of Fangors will return from the

mines, carrying a large haul of glowing red Fire Diamonds. Zarnon will react with glee at the prize, and make a grand dramatic speech:

"At last! With these Fire Diamonds, I will not only be able to power my armies, I will make them stronger and more devastating than ever! And to think that such a primitive world would contain such a technological treasure! Yes, these beasts have served me well — I think I'll put a garrison here!"

If the PCs break out, Zarnon will send the Cybertroops after them. Since the Star Warriors aren't really afraid of the troops, they should have no trouble defeating them — and the sight of these intimidating figures being thoroughly trounced by these new arrivals will stir the emotions of any Fangors who happen to see it. After that, a noble speech or two should be enough to get them in the mood to turn on Zarnon and Gorlath — at which point the two will flee into the caves. (See next section.)

If the Star Warriors evaded capture in the last encounter, the scene will play out very differently. They may be able to sneak just outside the village and observe it from a distance. They'll see Zarnon greedily collect the diamonds and give his big expositional speech, and may be able to sneak into the prison (which of course is on the outskirts of the village) to talk to the benevolent Fangor imprisoned within.

THE FIRE DIAMOND MINES

Zarnon and Gorlath head to the mines, which are located in a cave at the foot of Mount Kalamanturo. You can call for Perception rolls and roll some dice behind a screen, but secretly, the two are making no effort to remain hidden. (You may wish to remark on how easy it is to follow them.) They mean to lure the Star Warriors into the mines and then ambush them. Brutus/Tarlok will likely accompany the heroes.

Read the following to the players when the PCs enter the mines:

There are no lights in the mine, but it doesn't need them. Glittering jewels and rocks illuminate the caves in a variety of brilliant colors. You can see several passageways twisting off into the distance, and a large main tunnel leading straight ahead. Just as you start to think it might be hard to find these two, you hear Zarnon's distinctive cackle echoing from far down the main tunnel.

If the heroes follow, they won't have to go very far before Gorlath attacks from a side tunnel. He will first unleash Prowler, his pet gamma wolf, and throw his spear at a random PC. If that doesn't do the trick (and it shouldn't), he will move in with his Steelwood club. He should be easy to dispose of.

The real surprise waits for them in the next cave. Zarnon has taken a contingent of his Cybertroops and given them Fire Diamond power packs, turning them into "super-charged" troops with exceptional strength and speed. These new Cybertroops have a Goon Factor of 10, and there is

one mob for each PC. Zarnon will contribute to the fight by firing energy blasts from his Cosmic Scepter, but also will do his best to stay out of harm's way. If it looks like he's going to lose, he will slip into a side passage — if the PCs follow, they will see that it leads to the swamp clearing, and arrive just as the Dragonship takes off.

AFTERMATH

Brutas/Tarlok will thank the Star Warriors for helping to free his people, and request that they be allowed to join the Universe League. He will also offer the heroes a cargo of Fire Diamonds as a reward, but the heroic thing to do will be to reject such an offer. (Give an extra Experience Point to anyone who decides this.)

SPECIAL GUEST VILLAINS

GORLATH

"Treacherous Fangor Despot"

Oomph: 1

Stunt Points: 2

Hurt Points: 46

Size: Medium

STORY HOOKS

Wants to rule his tribe — Major

Archenemy: Brutas/Tarlok — Major

TRAITS

Body 4(2), Armed Combat 3, Unarmed Combat 3, Survival 3, Perception 2, Willpower 2, Persuasion 1

SPECIAL ABILITIES

Prowler, Gamma Wolf (Animal Companion, Power Level: Medium)

This large, fierce beast is Gorlath's loyal guard dog.

Traits: Athletics 2, Body 4, Unarmed Combat 3, Stealth 2

Oomph: 1

Stunt Points: 0

Hurt Points: 41

Primary Movement: Land

Size: Medium

SPECIAL ABILITIES

Sharp Teeth (Power Level: Low; DR 3+Body; Range: Point Blank)

Total cost: 14 (25 SCP)

Steelwood Club (OSA, Power Level: Medium)

A crude club made from wood that's as strong as metal.

DR 3+Body

Range: Point Blank

Restriction: Item

Total cost: 3 CP

Fire Diamond Spear (OSA, Power Level: Medium)

A spear with a sharpened Fire Diamond as a head.

DR 4+Body

Range: Long

Bonus: Armor Piercing +4

Restriction: Item

Total cost: 14 CP

Total CP Value: 75 CP

SWAMP BEAST

"Large reptilian monster that preys in the swamps of Kashdor."

Oomph: 0

Stunt Points: 0

Hurt Points: 50

Size: Very Large

STORY HOOKS

None

TRAITS

Because the Swamp Beast is an animal, it has only the traits considered "Natural" for animal companions. See pages 21-22 of the Cartoon Action Hour book for details.

Body 4(4), Athletics 1, Stealth 1, Perception 2, Unarmed Combat 3

SPECIAL ABILITIES

Fangs (OSA, Power Level: Medium)

The Swamp Beast has teeth as long as a human arm.

DR 5+Body

Range: Point Blank

Total cost: 8 CP

Total CP value: 40 CP

TYPICAL FANGOR

"Hairy alien hunter-gatherer"

Oomph: 1

Stunt Points: 1

Hurt Points: 41

Size: Medium

STORY HOOKS

None

TRAITS

Body 4, Unarmed Combat 2, Armed Combat 2, Survival 2

SPECIAL ABILITIES

Diamond Knife (OSA, Power Level: Low)

Most Fangors carry a small knife to cut food, hack at underbrush or use as a weapon.

DR 3+Body

Range: Short

Restriction: Item

Total cost: 3 CP

Total CP Value: 25 CP

APPENDIX 1

RECOMMENDED SOURCES

CARTOONS

TRANSFORMERS

(Marvel/Sunbow, 1984-1987) — Much of this show was earthbound, but in later years it did take on more of a space-opera feel. Either way, it remains one of the neatest sci-fi shows in the genre. It's also very easy to find nowadays.

CENTURIONS

(Ruby-Spears/Worldvision, 1986) — Technically not a space opera, this show nonetheless has the kind of intense action and striking visuals that I like to think *Star Warriors* would've had. Also note the nifty "educational" messages at the end of each episode. Who'd'a thought you could learn about pattern recognition by watching cartoons?

JAYCE AND THE WHEELED WARRIORS

(DIC, 1985-1987) — A unique science fiction series with a neat accompanying toyline, featuring weird high-tech cars with interchangeable parts. The fact that one of the show's writers went on to create *Babylon 5* helps.

STAR BLAZERS

(Claster/Sunwagon, 1979) — Though a year shy of being '80s, this imported Japanese favorite features a truly nifty epic story, with the crew of a starship out to save the human race. Each episode ended with a clock showing just how much time Earth had left.

HE-MAN AND THE MASTERS OF THE UNIVERSE

(Filimation, 1983-85) — This show was mostly a fantasy, but managed to incorporate many sci-fi gadgets nonetheless. Its colorful rogues' gallery is a perfect model for Zarnon's group of bickering henchmen.

MOVIES

THE STAR WARS FILMS

(Fox/Lucasfilm, 1977 through 2005) — The originals brought space opera into the modern age, and despite the criticism the prequels have gotten, they've still got the right pulpy vibe in my opinion. You can't beat any of these for epic sci-fi action.

BATTLESTAR GALACTICA

(Universal, 1978) — Technically a kind of theatrical pilot for the gorgeous but short-lived TV series. A defining portrait of what space opera looked like in this era.

TRANSFORMERS: THE MOVIE

(Marvel/Sunbow, 1986) — A frequent point of reference when I was first designing the setting. Beautifully animated for the time, with a fun cast of celebrity voices and some infuriatingly catchy songs on the soundtrack. This is also the film that introduced me to the concept of a show killing off old characters and changing other ones so that new figures could be sold. Sometimes the needs of drama and merchandising coincide.

ROLEPLAYING GAMES

TRAVELLER

(Various editions) — One of the earliest sci-fi RPGs, this started as a semi-generic game but quickly developed a setting that skillfully combined numerous space opera elements. Numerous incarnations are out there, but I'm a fan of the reprints of the original "Classic Traveller".