



M.U.

Miskatonic University
LIBRARY ASSOCIATION

**MONOGRAPH
#0367**

*Miskatonic University
Library Association*

monographs are works in which the author has performed most editorial and layout functions. The trustees have deemed that this work offers significant value and entertainment to our patrons.

Other monographs are available at
www.chaosium.com



JOVIAN NIGHTMARES



**A SOURCEBOOK FOR CTHULHU RISING
CALL OF CTHULHU ROLEPLAYING
IN THE 23RD CENTURY**





**We hope you enjoy
this Chaosium publication,
and thank you for purchasing this
PDF from www.chaosium.com.**

JOVIAN NIGHTMARES

A SOURCEBOOK FOR CTHULHU RISING
CALL OF CTHULHU ROLEPLAYING
IN THE 23RD CENTURY



JOVIAN NIGHTMARES

By John Ossoway

JOVIAN NIGHTMARES is published by Chaosium, Inc. JOVIAN NIGHTMARES © 2008 Chaosium Inc. as a whole; all rights reserved. Text for JOVIAN NIGHTMARES is © 2008 by John Ossoway. "Chaosium Inc." and "Call of Cthulhu" are registered trademarks of Chaosium Inc. Similarities between characters in JOVIAN NIGHTMARES and persons living or dead are strictly coincidental.

Address questions and comments by mail to Chaosium Inc., 22568 Mission Blvd. #423, Hayward, CA 94541-5116 U.S.A.

Our web site www.chaosium.com always contains the latest release information and current prices.

Chaosium publication 0367. ISBN 1-56882-295-2. Published in March 2009. Printed in the United States.

TABLE OF CONTENTS

Introduction	4
About Jovian Nightmares	5
About Cthulhu Rising	6
Acknowledgements	6
Dying in a Winter Wonderland	7
Circum-Jove: History	9
Jupiter	17
Io	20
Europa	23
Ganymede	26
Callisto	29
Other Locations	32
Organisations	34
Jovian Investigations	42
Jovian Secrets	46
Cut Back Blues	52
Escape Velocity	54
Adventure Seeds	86
Glossary	90

INTRODUCTION



Welcome to Circum-Jove.

By the late 23rd century, the gas giant Jupiter and its sprawling system of rings and moons is home to a colonial population of millions.

Over the century and a half since the colonisation of the outer planets began in earnest, an aggregation of settlements and outposts have developed to mine the raw materials which drive the economy upon which the United Earth Federation depends. The types of settlements found in the region are varied, ranging from the subterranean conurbations at the top of Europa's oceans to the harsh mining towns of Io; from the Callisto orbitals to the countless corporate research outposts.

Despite its location in the most densely-populated and heavily-policed star system in the United Earth Federation, Circum-Jove remains a fertile breeding ground for a multitude of subcultures, outlaws and weird religious cults. It's also a hotbed of new technologies research and home to corporate infighting at its worst.

Humanity is not the first starfaring culture to have visited this region. There are beings far older than Man. Ancient, malign beings that would be

described in human terms as pure evil, but for whom such a label is meaningless. Here, they wait. Beneath aeons old ice and rock. In the dark spaces between the stars. Waiting for when the time is right.

Some nightmares are very real. Jovian Nightmares.

ABOUT JOVIAN NIGHTMARES

Jovian Nightmares was conceived and written as a campaign setting for *Cthulhu Rising – Call of Cthulhu Roleplaying in the 23rd Century*.

The book is deliberately designed to be an open setting. What this means is that the background information is deliberately presented in an overview format rather than describing every minute detail of life in the Circum-Jove system. The reason I chose this approach is that I personally tend to dislike source books where everything is already 'filled in' for you. It can often limit scope for individual GM creativity. Jovian Nightmares will hopefully provide enough of a framework for writing and running adventures in the Circum-Jove colonies, with enough freedom for Keepers to be as creative as they like.

Jovian Nightmares is also structured so that it can be easily translated into a non-mythos BRP resource if this is desired.

WHAT'S IN THE BOOK?

- **Fiction:**
Dying in a Winter Wonderland by John Ossoway
Cutback Blues by Gary Cooper
- **History:**
A brief history of the colonisation of the Circum-Jove system.
- **Circum-Jove – The Rough Guide:**
Jupiter and major locations of interest in the Circum-Jove system.
- **Jovian Organisations:**
Political, governmental, corporate and private organisations of interest.
- **Jovian Investigations:**
New professions for roleplaying in the Circum-Jove colonies.
- **Jovian Secrets:**
A Keepers-only chapter full of Mythos secrets associated with this region of space. What lies in the world-oceans beneath the ice of Europa? Who or what has been causing disappearances in the labyrinthine catacombs beneath Ganymede? What dwells within the eye of Jupiter?
- **Adventure:**
Escape Velocity is a short adventure designed to be played in one gaming session. The adventure also contains deck plans and details of an orbital gas mining platform.
- **Adventure Seeds:**
Ideas for more adventures set in the Jupiter system.
- **Glossary:**
A glossary of terms and abbreviations used in Jovian Nightmares.



ABOUT CTHULHU RISING

It is the year 2271.

The future is a dark and dangerous place. Outer space is the new frontier — humanity exploits the galaxy for its own ends. It is more than a hundred and fifty years since the United Earth Federation began to colonise the solar system and beyond.

Millions of colonists — employees of either the Federation or one of the many megacorporations — live out their lives on worlds light years from Earth. Corporate-funded exploration craft push ever deeper into space. It is only a matter of time before one of these craft stumbles upon some remote, alien edifice, a cosmic mausoleum of the Great Old Ones. But who is to say this has not already occurred?

Players take the roles of the investigators of the future. These enlightened and oft-unlucky individuals know something of the true nature of the universe. Be they fools or heroes, they take the fight against the Great Old Ones to the stars themselves.

Cthulhu Rising is published by Chaosium as part of their MULA Monograph series and is available in print and PDF format from the Chaosium website: www.chaosium.com

In addition, try a visit to the Cthulhu Rising website, where there is a wealth of free background information and scenarios for download: www.cthulhurising.co.uk

ACKNOWLEDGEMENTS

Apart from where otherwise indicated, Jovian Nightmares was conceived, researched and written by John Ossoway.

Cover art by John Ossoway.

Interior artwork/illustrations and maps by John Ossoway, except for corporate logos in the Organisations chapter by Ben Thornley and John Ossoway.

Cutback Blues by Gary Cooper.

Adventure Seeds chapter by John Ossoway and Chas Blackwell.

Proof-reading and additional ideas - Ste Barton, Chas Blackwell, Gary Cooper, Andy Edwards, Newt Newport, Andrew Shanahan, Graham Raynes.

Extra special thanks to Newt Newport for all the noodle-doodle brainstorming lunches.

Images and surface maps of the Galilean moons are courtesy of the USGS Astrogeology Research Program, <http://astrogeology.usgs.gov>, the NSSDC Photo Gallery and the open source program Celestia.

Extra big thanks to all the members of the Cthulhu Rising forums who continue to support the setting.

Last but by no means least, thanks to Nerissa, for putting up with all of this.

Note: The above list is far from complete. I haven't missed anyone off here intentionally.



DYING IN A WINTER WONDERLAND

By John Ossoway

Foster Smiled.

It was not a smile born out of happiness. This time though there was no one around to misinterpret his facial expression, an unfortunate subconscious reaction to stressful situations that had gotten him into trouble on more than one occasion.

Foster had been in worse situations than this before. He could think of at least half a dozen incidents that would turn many pilots the colour of the unforgiving icy landscape around him. There was no point in panicking. Besides, he was space pilot Aurelious Foster. There was no point in panicking.

Something always happens. That was what his uncle Silas had always taught him. Stuck in an apparently no-win situation? Don't worry – some timely event would occur, or piece of information present itself to move things forward. All well and good, Foster mused, but I bet uncle Silas never found himself trapped out on the frozen surface of a moon with a rapidly diminishing air supply. The thought made Foster's eyes flick involuntarily to the display projected on the interior of his suit visor. Air supply 38 minutes. Suit power at 71%. At least his corpse would be warm. Note to self – always make sure the air tanks in the emergency space suits are replenished after each EVA.

The visor widget representing the signal strength of his uplink winked red. Still no signal. By some particularly cruel twist of fate, his suits integral communications system wasn't getting any signal from the network of satellites orbiting overhead.

Despite his suit's thermal regulation systems, Foster could feel the deep, numbing cold slowly seeping into his bones. Precious little of the sun's warmth reached this far out. It was so cold that the icy crust of the moon was kept as hard as granite.

Trapped in a wilderness of fractured and refrozen ice, a world of twinkling, perpetual twilight. Dying in a winter wonderland.

Foster looked back towards the hole, then down at the inert spacesuited body lying next to him. Hendricks was still alive - barely. She needed medical attention and she wasn't going to get it out here. There was a cryopod on board the shuttle which would keep her



stable until he could fly her back to Sarpedon. If he could get her back up there. He had already squandered a lot of air and power getting Hendricks out of the hole, but then he had always had a soft spot for her.

Something had happened down there in the warren of tunnels and ice caves beneath the canyon floor. Something bad. Foster could never know for sure that Doctor Robinson and his team were all dead, but about fifteen minutes ago the strangled screams, crying and desperate pleading had finally stopped. Now the com-channel was deathly silent, an open channel broadcasting nothingness.

To preserve his sanity, he had to convince himself that Robinson and the rest were dead, or worse, and that what he was about to do was for the best.

Foster put his hand up to the inscrutable concave mirror of his spacesuit visor, wishing he could rub his eyes with thumb and forefinger. Come on Aurelious, he reassured himself, there was nothing more you could have done. You were lucky just to get back out of the hole with Hendricks.

Grasping Hendricks by her boots, he began unceremoniously dragging her across the icy canyon floor towards the winch cable. He doubted the unconscious technician would complain given the circumstances.

As soon as she was securely strapped into the harness, Foster thumbed the control box, and a distant vibration from above signalled the start-up of the winch motor. The rope went taught, and Hendricks limp form began to rise slowly into the air.

Watching her rise into the mist, Foster flipped open his compad and punched out a series of commands to the cluster of robot servitors sat patiently waiting above. The servitors would quickly disengage Hendricks from the harness and carry her on-board the shuttle. Delta AIs might not be too bright, but provided they had the right instructions they could be relied upon to get the job done.

He was halfway up the canyon wall himself and noting that his air supply monitor said he had 22 minutes of oxygen to enjoy, when he first heard it over his open com-link. A sinuous, heavy, ominous noise. Something was slithering its way up the pit. It was coming for him.

It had to be now. No more time to get clear.

Foster flipped open his compad again and punched the sequence that would ignite the demolition charges he had hastily armed down in the hole before that thing could engulf him in its foul embrace. From that first distress call, every survival instinct had screamed in his ear to run. Forget Hendricks. There will be other women. Just get in the shuttle, punch it and never look back.

The deep bass resonance of the subterranean explosion knocked him into the ice wall, dislodging a cloud of ice particles. Before audio pickups from the hole cut out he felt sure he heard an inhuman primal keening.

As the fireball silently billowed towards him from below and he watched it stretch and distort across his visor, a thought occurred to him.

Something always happens? Not always, Uncle Silas.

CIRCUM-JOVE: HISTORY

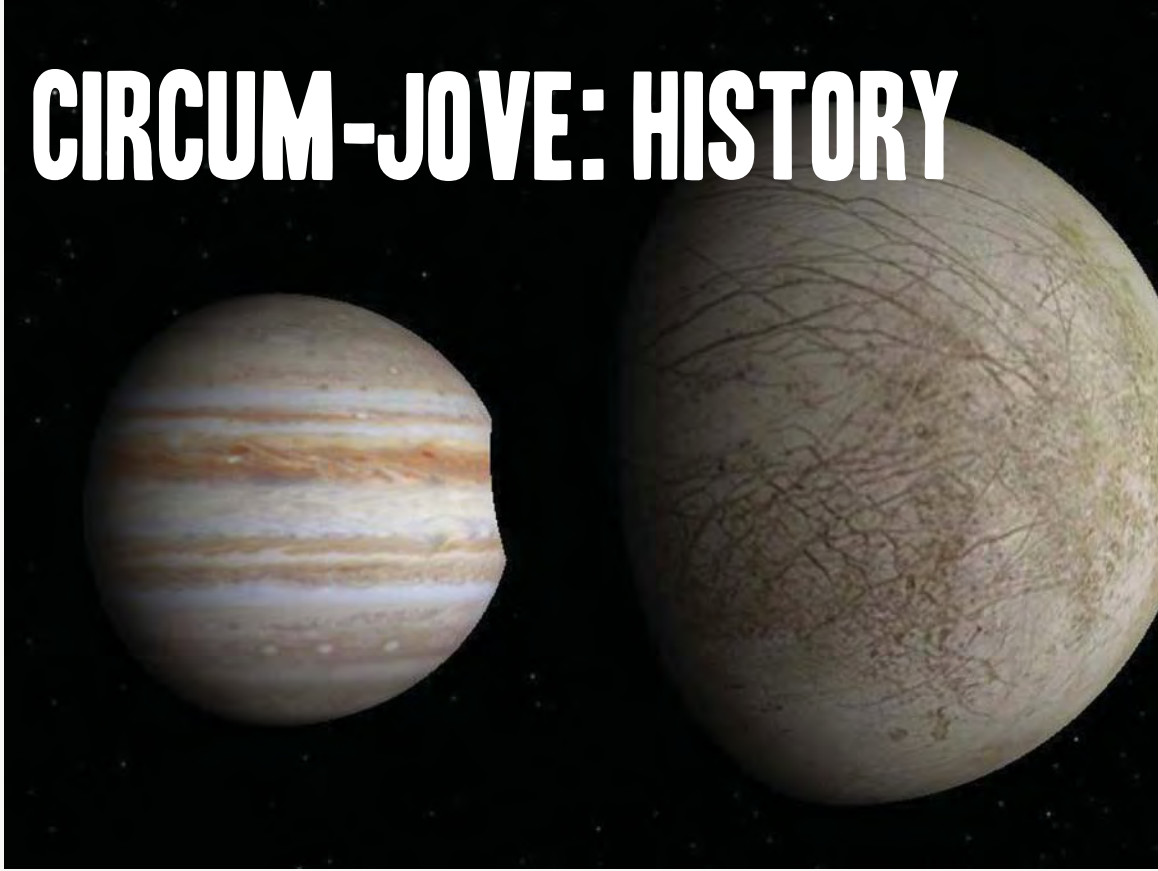

EARLY HISTORY

Up until the mid-21st century, the exploration of Jupiter consisted of only a few automated spacecraft, the first (Pioneer 10) visiting the planet in 1973. The majority of these missions were flybys – detailed observations carried out by the probe without it ever even entering orbit of the gas giant.

1973-74

During their passage by Jupiter, NASA probes Pioneer 10 and 11 obtain the first close-up images of the planet, as well as charting Jupiter's intense radiation belts and locating the planet's magnetic field.

1995-2003

Between 1995 and 2003, the Galileo probe makes observations from repeated elliptical orbits around Jupiter, passing low over the Galilean moons. These

close approaches result in images of unprecedented detail.

2018-2020

The Juno probe makes the most in-depth study of Jupiter yet.

2020-2024

The Jovian Explorer mission launched by the European Space Agency makes detailed observations of Europa, deploying a compact robotic microprobe onto the moon to perform on-the-spot measurement of the ice crust. The probe establishes the existence of liquid water beneath the surface.

PRE-COLONIAL EXPLORATION

By the late 21st century, the commercial colonisation of the Moon had moved up

several gears. Technology was moving fast to catch up with the aspirations of Humanity and noises were already being made about the colonisation of Mars and the asteroid belt. The economic climate on Earth was not yet ready for the colonisation of the Outer Planets, but it would now only be a matter of time. As it was, the late 21st century saw the first manned mission into the Deep Beyond.

The signing of the Solar System Treaty (SST) in 2074 would have long lasting repercussions for the exploration and exploitation of outer space, not all of them positive. Up until this point, all space exploration had been governed by two outdated pieces of Cold War legislation – the Outer Space Treaty and the Lunar Treaty. These two pieces of legislation effectively limited expansion and innovation in the realm of outer space. While neither forbade mineral exploitation in outer space, any such endeavour was only allowed under the oversight of a global body i.e. the beleaguered and ill-equipped United Nations. Furthermore, the Lunar Treaty required that the means to acquire extraterrestrial mineral wealth be given to countries that could not develop it on their own. It was no wonder that private enterprise was loath to invest in technologies to exploit space with these conditions hanging over their heads.

The SST meant that these restrictions were lifted, but nations and corporations were still forbidden from staking sovereign claims on extraterrestrial property.

2074

Signing of the Solar System Treaty (SST), giving greater freedoms to private enterprise in the commercial exploitation of the solar system.

2077

The Demetrius - a joint NASA/ESA mission with a crew of 8 – completes its trans-Jupiter injection. Using an advanced fusion drive capable of 0.25g acceleration for sustained periods, Demetrius arrives in

orbit around Callisto in less than one Earth month. Its mission is a year long study of Jupiter and the Galilean moons.

2082

Contact is lost with the exploration vessel Paracelsus as it begins orbital insertion around Ganymede. Later investigation reveals the craft had suffered a catastrophic systems failure and crashed into the surface of the moon. Of the 8 crew members there were no survivors. Safety concerns nearly halt further space missions to Jupiter but NASA/ESA lobbyists manage to keep the dream alive with private investment from megacorporations.

COLONIAL AMBITIONS

By the start of the 22nd century, the colonisation of Mars had begun in earnest and the UEF was looking to secure the resources necessary to sustain the ever growing power needs of Earth and its fledgling colonies. With the rapidly expanding fusion economy, the gas giants of the outer Solar System began to look like the new Persian Gulf.

In 2115, the maiden flight the Foscolo – a spaceship named after the famous physicist Hugo Foscolo – transformed Humanity into a fledgling interstellar civilisation. Using an experimental drive powered by the rare element Ununpentium (Element 115, later dubbed Foscolium), the Foscolo made the first interstellar flight to Alpha Centauri. This groundbreaking event was to spark the first wave of mass interstellar colonial expansion from Sol, now known as the First Exodus (2115 - 2135).

Unfortunately, Foscolium was rare and very expensive to manufacture artificially. It occurred in its natural, stable state in the heart of stars, thrown out into space as cosmic debris. The resultant scramble amongst corporations to develop a means to extract this element from the sun was to result in numerous false leads and millions wasted in futile research. A discovery in

Circum-Jove was to soon make those corporations already out there very rich indeed...

2110

Advancements in space engineering – especially in the field of radiation-shielding - begin to make mining the helium-rich atmosphere of Jupiter and Saturn a very attractive and financially viable proposition. After lengthy feasibility studies, the United Earth Federation announces the Jovian Project, a long-term plan to colonise the Galilean Moons orbiting Jupiter. The initial mission objective is to construct infrastructure that will form the basis of larger permanent colonial settlements to support the mining of the Jovian atmosphere for 3He .

As with the colonisation of Earth's moon and Mars, the Jovian Project will require substantial commercial investment. A package of tax breaks and other financial incentives are offered by the UEF to any corporation willing to sign on.

2111

After almost a year of legal wrangling and planning, the first of the colonial contracts for the Jovian Project are issued. Federated Boeing Interstellar wins the lucrative contract for the design and construction of the fleet of colonisation and mining ships required. It is a huge undertaking, and will be instrumental in establishing the company as the largest spacecraft manufacturer in the United Earth Federation of that period. The primary corporations involved in the mining and colonisation projects are Hallidor Corporation and a consortium of Chinese companies led by Cheung Industries.

It would be another 5 years before the first ships departed for Jupiter, but in that time events would take place which would change things forever...

2115

The flight of the Foscolo. Beginning of the

First Exodus.

2116

The first Jovian Project ships emerge from the vast Federated Boeing Interstellar construction scaffolds in lunar orbit. This first wave consists mainly of deep space mining craft and associated support vessels. Equipped with the latest reactionless drives and artificial gravity technologies, these ships are capable of sustaining their crews for extended periods without support.

Within a matter of months, the first of these vessels are in Jupiter orbit, actively mining the gas giant's atmosphere.

In the same year, a rival project, the Saturn Project, is announced by a consortium of corporations who were outbid for the Jovian Project contracts. A colonial mission lands on Titan, largest of Saturn's moons. It is deemed perfect for a long-term terraforming operation.

2118

The second wave of Jovian Project ships - consisting of cargo transports and colonial support ships in the main - begin arriving in the Jupiter system. Valhalla Base is established on the Galilean moon Callisto. It will serve as the main staging area for the colonisation part of the project. The largest cargo vessels, their primary mission completed, are stripped and their space frames used to construct the Callisto orbital fuel depot and Port Valhalla. The initial colonists are mostly made up of construction workers, scientific personnel and mining crews.

In the same year, survey teams establish outposts on the 3 other Galilean moons: Europa, Ganymede and Io.

2119

A Hallidor Corporation research lab orbiting the Galilean moon Io makes a remarkable discovery: the magnetosphere of Jupiter – specifically the Jupiter-Io magnetic flux - is a natural collector of Element 115,

Foscolium. The solar wind carries particles of Foscolium out of the solar system, but over the centuries, large quantities have become trapped in the Io regolith.

Io is soon to become the primary source for all Foscolium mined in the Sol system, and those companies involved in mining it become very rich during the First Exodus.

THE BALANCE OF POWER

In 2120 Maunder Minor struck. Maunder Minor was the name given to the period lasting from 2120 to 2146 during which time reduced sunspot activity caused Earth's sun to dim, repeating a behaviour first exhibited in the seventeenth century (then called the Maunder Minimum), though this time to a much lesser extent. During this 26 year period of reduced heat and light radiated by the Sun, the economies of those nations of Earth and fledgling inner colonies who relied heavily on solar power found it hard to adjust. Agriculture and power-generation were severely handicapped.

Maunder Minor was the reason for fusion power eventually winning out over solar power. Now more than ever, Circum-Jove was becoming the focus for a great deal of wealth.

2120

Maunder Minor causes major economic upheavals on Earth.

Colony bases are established on Europa and Ganymede.

Indigenous life is discovered in the subterranean seas of Europa. Mostly krill-like creatures and microbial life, it is nonetheless the first life discovered in the Sol system other than on Earth, and so Europa soon becomes centre of scientific study.

The first permanent mining base on Io is established. It is owned by Cheung Industries, the corporation that will

eventually become the Cheung Corporation. Named Marduk, the base will eventually become the administrative centre on the moon.

2127

A recruitment drive on Earth to find colonists for the fledgling Jovian colonies receives an unexpectedly overwhelming response. The resultant social upheaval from Maunder Minor has forced many people into such poverty that leaving Earth to start new lives as offworld colonist-workers is a very attractive proposition.

The sudden influx into Circum-Jove of migrant workers from the poorer countries on Earth causes simmering resentment amongst the earlier colonists. Historians have since recorded that many of these new colonists had already applied and been refused colonist status for Mars or Alpha Centauri. It seems with hindsight that the government felt that the dangerous environments of Circum-Jove were much better suited to colonists drawn from the poorer nation states of Earth.

Construction work is started on Sarpedon, the first of the Hanging Cities of Europa.

2128

The colonial transport vessel Moonchaser vanishes while enroute to Jupiter. All hands and 400 colonists are lost. The disappearance of the Moonchaser becomes one of the great mysteries of the Jupiter colonisation age. No trace of the vessel has ever been found.

2131

A series of leaked stories to the press force Remick Inc, a subsidiary of Hallidor Corp, to reveal details of genetic experiments carried out on some of its employees working in extreme environments in the Circum-Jove system. During the ensuing investigation two chairmen commit suicide and shares in Remick plummet, resulting in its bankruptcy and final collapse. Despite strongly denying any knowledge, Hallidor

Corp is dogged by rumours that they sanctioned the experiments.

2132

Cheung Corporation formed from the three-way merger of Cheung Industries, Ling Consumer Products, and Shenzhou Aerospace. Up until this point the American Hallidor Corporation was unchallenged as the dominant corporate power in Circum-Jove.

2134

Work started on Acallaris, a settlement which will eventually become the primary population centre on Ganymede.

2138

The Tau Ceti war sees an increase in the demand for Gravidium - used in munitions manufacturing. Gravidium, Element 126, exists in a stable state on Io.

2139

The Europa Incident. Much like the Roswell incident of the mid-20th century the Europa incident has been the source of much speculation and conspiracy theories. It has also generated a remarkable amount of media material in the form of documentaries, literature and movies.

Miners are rumoured to have witnessed a craft of strange organic design smashing its way out of the icy surface of the moon. Also heavy seismic activity tore through the surface of the moon, and destroyed the nearby mining colony of Gower 2, killing four citizens.

2140

Tragedy strikes on Ganymede when a cutter from the commercial ore transporter Black Star loses power and crashes into the Acallaris City surface dome, decompressing several sections of the colony. Emergency teams work fast in hazardous conditions, but despite heroic efforts, 93 colonists lose their lives.

2144

There is public outcry on Earth when an independent news story reveals that some enterprising colonists on Europa have begun to farm and eat the local marine life. What is worse is that the megacorporations and local authorities seem to be accepting the practice.

Despite political posturing by the government, and widespread condemnation from various environmental groups back on Earth and Mars, the fact remains that local food sources are cheaper and more reliable than shipping it in from the inner planets. Edible if rather flavourless, Teemers become a popular dish amongst the poorer colonists on Europa.

2162

Gas mining is big business, and with such vast resources, Jupiter-mined 3He is fast becoming competitively priced. Meanwhile, megacorporations vie for control of the biggest of the Foscolium deposits on Io, while around them a myriad of smaller mining start-ups fight over the scraps.

The battle for economic and financial dominance in the Circum-Jove colonies begins to heat up when a dispute between Cheung Corporation and new arrivals Motokatsu-Kyono Combine over allegations of claim-jumping escalates out of control. The result is a stand-off between rival corporate security personnel at the Masubi claim on Io. The situation quickly degenerates into a shooting war which the small Federal Police presence is unable to contain. The UEF reacts quickly and sends in a force of Colonial Marines. The marines rapidly take control of the Masubi region of Io, and disarm the corporate security personnel with minimal resistance.

A permanent marine garrison is established on Callisto to enforce the peace in the Galilean colonies. Camp Orestheus is home to a company-strength garrison of Colonial Marines, and a UEAF support base.

SUPPLY AND DEMAND

With the arrival of the Interplanetary Marines in the Circum-Jove colonies, the UEF had demonstratively stamped its authority on the colonies – this was not some collection of wild-west boom towns – this was the heart of power production for the rapidly expanding Federal Colonies.

With interstellar travel becoming safer and cheaper all the time, and vast numbers of people clamouring to escape the resource-drained Earth, the second half of the 22nd century was dominated by what is now referred to as the Second Exodus. This thirty-year period saw intensive colonial expansion on an unprecedented scale, and when it was over, the Federal Colonies had grown to encompass a sphere 40 light-years in diameter, with Sol at its centre. This massive migration from Sol pushes Foscolium mining in Circum-Jove to its limits.

2166

The Second Exodus begins. The demand for Foscolium and 3He to fuel the seemingly endless convoys of interstellar vessels heading out to the new frontier steadily drives up fuel prices.

2170

Flight crews and dock workers blockade the Callisto refinery to protest poor pay and rising fuel prices in the outer planets. Fuel bound for the inner planets remains heavily subsidised by the UEF government.

2171

The fuel shortages begin to get noticed back on Earth and by the steady stream of interstellar transports heading out of the solar system. When FedPol officers refuse to cross picket lines, the UEF General Assembly votes to send in the Colonial Marines to break the blockade.

The protests on Callisto turn violent as the Colonial Marines arrive. Accusations of agitators infiltrating the protestors to provoke the marines are levelled at the

<Sophie Sweet> [shouting over sound of dropship engines] that's right Mike. If you've been following my reports since I left Mars orbit with Taskforce 37, sent to defuse the growing crisis on Io, you'll know I am embedded with the 3rd Orbital Assault Battalion of the 1st Colonial Marine Division. We have just been mobilised with orders to disarm a group of corporate paramilitaries who either didn't get the UEF ultimatum, or have chosen to disregard it. Either way, they're continuing to fire on the government personnel attempting to shut down mining operations on the Masubi Claim.

With me is Lieutenant Watts. Lieutenant, what can we expect when we arrive at Masubi?

<Lieutenant Watts>We have been told to expect light resistance, but that-[there is a sudden sound like drumming in the background]

<Sophie Sweet>What-What was that?

<Lieutenant Watts>Sounds like medium-calibre kinetic weapons being directed against this vessel and the others in this drop group. If you come with me to the cockpit you can see for yourself.

<Sophie Sweet>Mike, can you see these sparks coming towards us from that-those-are those hills? Are you getting this from my headcam? The paramilitaries are firing on us. Lieutenant are we in any danger?

<Lieutenant Watts>There is always danger in a combat zone ma'am, but the threat will be neutralised shortly. Make sure you keep watching that low range of hills to the north.

<Unidentified voice in cockpit>Affirmative. Thor Echo-Six. Thor Echo Six. Do you have target acquisition? Roger that. Light it up Thor Echo Six.

<Lieutenant Watts>Here we go [a series of bright objects streak from the sky and explode in flashes light illuminating the hills indicated by Lieutenant Watts]. AS-90 Thor light gunships firing Air-to-ground smart missiles.

<Sophie Sweet>My god. Amazing. Did you see that? I think that the UEAF have sent a clear message to the paramilitaries. The marines are here, and are not afraid to use deadly force. This is Sophie Sweet for Channel 88 News. Back to you Mike.

Transcript of part of a report posted by Sophie Sweet, embedded reporter for Channel 88 News during the Io Crisis of 2162.

Security Council on Earth. The brutal military interdiction creates a deep-seated resentment at the time for UEF authority. Tensions already bubbling under the surface come to the fore as newly-formed terrorist organisations and myriad splinter cells began to operate.

2180

Hallidor Corp wins contract to begin construction of a Penal Mining Facility on Io. It will become the dumping ground for many of Sol's worse criminals, those deemed unfit for enrolment into the Penal Involuntary Servitude programme.

THE JOVIAN TREATISE

During the Second Exodus, many of the larger megacorporations relocated their R&D arms from the inner planets to Circum-Jove and Circum-Sat, spinning them off into new company start-ups to take advantage of the colonial tax-breaks. These companies perform research and development in dangerous edge technologies that is banned on the inner planets.

This dangerous trend would continue unabated until the Anubis Incident and Himalia Containment forced the UEF began to clamp down on these unregulated research companies. It resulted in a piece of legislation called the Jovian Treatise...

2194

The Anubis Incident. A nano-tech accident at a research base in the Anubis crater on Ganymede results in a large loss of life. Rumours circulate for years about how the military were forced to seal many inside the site using spray-rock, prior to deploying experimental nanocide weapons to contain the incident. To this day the Anubis Quarantine Zone is a no-go area, and is patrolled by a marine contingent.

2197

The Himalia Containment. To prevent a

malfunctioning swarm of self-replicating von-Neumann machines escaping an unregistered laboratory on the moon Himalia after a serious accident, a military taskforce from Callisto is forced to destroy the moon Himalia using foam-phase plasma weapons.

2198

The UEF General Assembly succeeds in pushing through the Jovian Treatise – a comprehensive piece of legislation which sees a tightening of restrictions on scientific research and development in the Circum-Jove and Circum-Sat colonies. Megacorporations manage to tack on a series of last-minute amendments that many view as a means of guaranteed legal loop-holes for the future, should they be required.

THE MODERN ERA

The 23rd century was marked by Circum-Jove getting its own administrative centre, rather than being controlled direct from Earth. This finally established the region as a political power on equal footing with the inner colony worlds like Mars, Luna and the Belt Habitats. Immigration problems continued, and the authorities fought a continual battle against corporate corruption and organised crime.

2200

The Circum-Jove Administration (CJA or Jovad) is established. Modelled after the Mars Administration, it provides the colonies with a political voice in the General Assembly on Earth. Midgard City on Callisto becomes the official administrative centre for Circum-Jove. Unlike the cosmopolitan nature of Callisto, cultural lines are beginning to appear elsewhere in the Circum-Jove colonies.

2215

Illegal immigration from Earth into the Jovian colonies reaches its highest peak. Media groups publish shocking evidence that a powerful organised crime syndicate

is using the region as a centre of operations for people-trafficking to the extra-solar colonies. Rumours begin to circulate that several senior UEF senators are implicated.

The subsequent media frenzy coincides with an incident that will become known as the Medea Tragedy. When the UEF corvette Blucher attempts to stop and board a suspect freighter named the Medea, the crew panic and jettison their cargo – 200 immigrants from Earth. The Blucher is forced to let the Medea escape as it desperately attempts to save the human cargo.

The resulting outcry forces the UEF to act. Several senators are quietly “retired” and a crackdown by the Federal Law Enforcement Authority quickly brings to justice those running the trafficking operations in the region. Sajela Sy, leader of the criminal organisation, is tried and sentenced to life in prison.

2219

Sajela Sy escapes when mercenaries attack the detention centre she is held in on Callisto. She is never heard from again.

2226

Callisto-born author Paul Mabrius writes the controversial work *The New Sol Empire*. The work criticise what Mabrius calls “the Sol-centric attitudes of the UEF that see the colonies as tax and material deposits to be plundered at will, often steam rolling local issues and showing little regard for the feelings of local colonial communities.” His work is seen as groundbreaking and prescient in its claims that as the UEF grows then humanity runs the risk of splintering into factions, increasing the risk of civil war.

2267

The first Chrislam temple is opened on Callisto. The temple is a large and beautifully constructed architectural phenomenon, spearheaded by Javed Khan, one of the leading lights in the religious life of the Jovian colonies, and a

senior figure in human rights. Tragedy strikes during the opening ceremony as loner George Mackay guns down Javed Khan. Mackay is later judged to be insane and placed in a secure facility. Public grief for Khan is overwhelming.

2270

Colden Mine Disaster. An explosion rips through a mine on Callisto, the resultant flash-fires killing 300 miners. Lobbyists in Geneva push for tighter safety regulations for mining, a move that is resented by locals, who interpreted the move as Earther politicians scoring points at the expense of local wishes.

2271

The Jovian Colonies are now well established and over a century old.

JUPITER



Jupiter is the fifth planet from the Sun, orbiting at an average distance of 5.2 AU, and also has the distinction of being the largest planet in the Solar System. To give this some perspective, Jupiter is two and a half times as massive as all the other planets in the solar system combined. It is massive enough to easily swallow a thousand Earths. Jupiter, together with Saturn, Uranus and Neptune, is classified as a gas giant. Jovian is the adjectival form of Jupiter, and while it is has to some extent used to describe any large gas giant, it is still used primarily to describe the Jupiter system.

COMPOSITION

Jupiter's upper atmosphere is primarily composed of about 90% hydrogen and 10% helium, with trace amounts of ammonia, methane, water vapour and silicon-based compounds, amongst others. The proportions of hydrogen and helium in the atmosphere are close to the theoretical composition of the primordial solar nebula. Jupiter's core consists of a dense core with a surrounding inner layer of liquid metallic hydrogen and helium, and an outer layer predominantly of molecular hydrogen. The entire atmosphere is approximately 1000km thick.

STATISTICS

Distance from Sol:	5.2 AU
Equatorial Radius:	71,492km
Mass:	317.8 Earths
Mean Density:	1.326g/cm ³
Gravity:	2.528g
Escape Velocity:	59.5km/s
Rotational Period:	9.925 hours
Orbital Period:	11.85 years
Atmospheric Composition:	89.8% Hydrogen; 10.2% Helium; 0.3% Methane; 0.026% Ammonia; 0.003% Hydrogen Deuteride; 0.0006% Ethane; 0.0004% Water.
Ices:	Ammonia; Water.
Temperature:	165K
Satellites:	63

The upper atmosphere is arranged into wide parallel bands of different latitudes called tropical regions. The light-coloured bands are referred to as zones and the dark ones as belts. Temperature variations and chemical reactions cause their shades of yellow, brown, orange, and red. Interactions between these different regions cause violent storms and atmospheric turbulence. Winds of up to 600 km/h and lightning discharges that is a thousand times as powerful as on the Earth are commonplace in the Jovian atmosphere.

Perhaps the most famous feature of Jupiter's atmosphere is the Great Red Spot, a persistent anticyclonic storm that is large enough to contain two or three planets the diameter of the Earth. The storm has been in existence since at least 1831, and mathematical models show it to be so stable that it is thought to be a permanent feature of the atmosphere.

MAGNETOSPHERE

Jupiter has a very large and powerful magnetosphere. Eddy currents in the planet's metallic hydrogen core generate the magnetic field, which is 14 times as powerful as the Earth's, and fatal to any unshielded human. The magnetosphere of Jupiter – specifically the Jupiter-Io magnetic flux - is a natural collector of Element 115, more commonly known as Foscolium. The solar wind carries particles of Foscolium out of the solar system, but over the centuries, large quantities have become trapped in the frozen Io regolith. Foscolium is the key to making interstellar travel possible.

MOONS

Jupiter has 63 orbiting satellites and a faint planetary ring system. The rings are primarily made of dust, rather than ice as is the case for Saturn's rings.

THE INNER SATELLITES

Also called the Amalthea Group, these four moons - Metis, Adrastea, Amalthea, and Thebe - orbit very close to Jupiter, and help to replenish and maintain Jupiter's faint ring system.

METIS

Metis is the innermost moon of Jupiter. This irregularly shaped chunk of rock has a mean radius of approximately 20km. Metis has a small automated base operated by the Jovian Administration

PROTECT AND SURVIVE

Defence against Jupiter's radiation belts

Perhaps the biggest challenge to the colonisation of the Circum-Jove system has been the planet's intense radiation belts. The harshest radiation is within about 300,000 kilometres of the gas giant. Without the proper protection, the high energy particles whipped up to relativistic speeds by Jupiter's intense magnetosphere are potentially fatal to Earth-life, and can often be enough to scramble even radiation-hardened electronics.

Advances in space engineering – especially in the field of radiation-shielding, mean that the men and women living and working in the Circum-Jove volume no longer live their lives with the constant threat of developing cancers from the radiation-drenched vacuum. Spacesuits in the late 23rd century have layers of nanoweave fibres which contain large proportions of hydrogen atoms, allowing for much greater protection against cosmic radiation. In addition, the majority of interplanetary and interstellar spacecraft have magnetic shield generators capable of creating a bubble to protect the crew and electronics.

ADRASTEIA

With a mean radius of less than 10km, Adrastea is the smallest of the four inner moons of Jupiter.

AMALTHEA

Within the outer edge of the Amalthea Gossamer Ring, which is formed from dust ejected from its surface, Amalthea is the largest of the Inner Satellites with a mean radius of 85km. Irregularly shaped and reddish in colour, the surface of Amalthea features large craters and high mountains. Motokatsu-Kyono subsidiary Red Dragon Mining has a small exploratory mining base on this moon.

THEBE

Orbiting within the outer edge of the Thebe Gossamer Ring, Thebe is the second largest of the inner satellites of Jupiter. Like Amalthea, Thebe is irregularly shaped and reddish in colour. It has a mean radius of 49km.

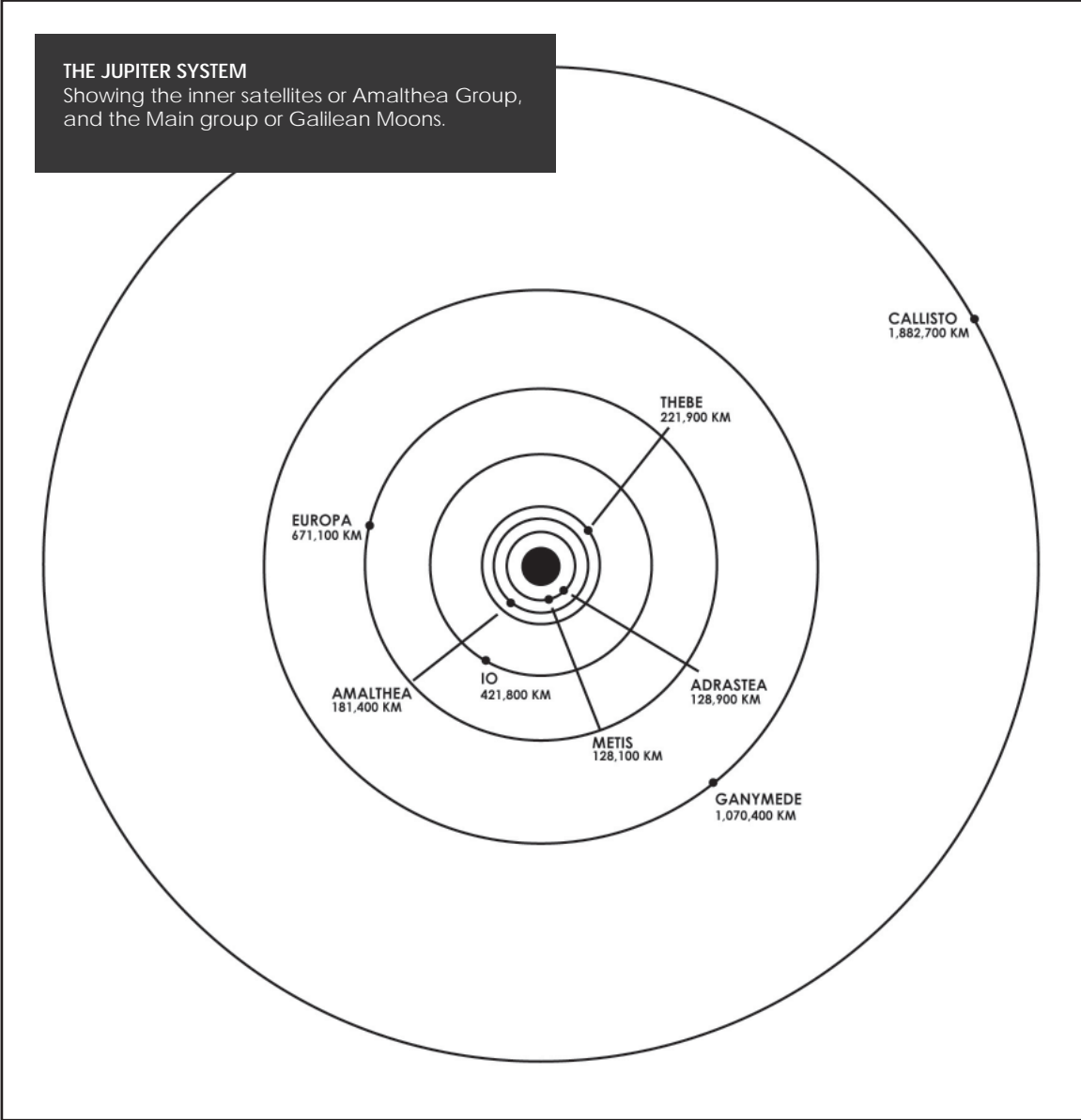

THE GALILEAN MOONS

Named after the astronomer Galileo Galilei, who discovered the moons by telescope between 1609 and 1610, the four largest moons of Jupiter are collectively called the Galilean Moons. They are the largest of the many moons of Jupiter and derive their names from the lovers of Zeus, the Greek equivalent of the Roman god Jupiter: Io, Europa, Ganymede and Callisto.

The Galilean moons are the location of the majority of the Circum-Jove colonial infrastructure and population. They are covered in detail in the following sections.

10

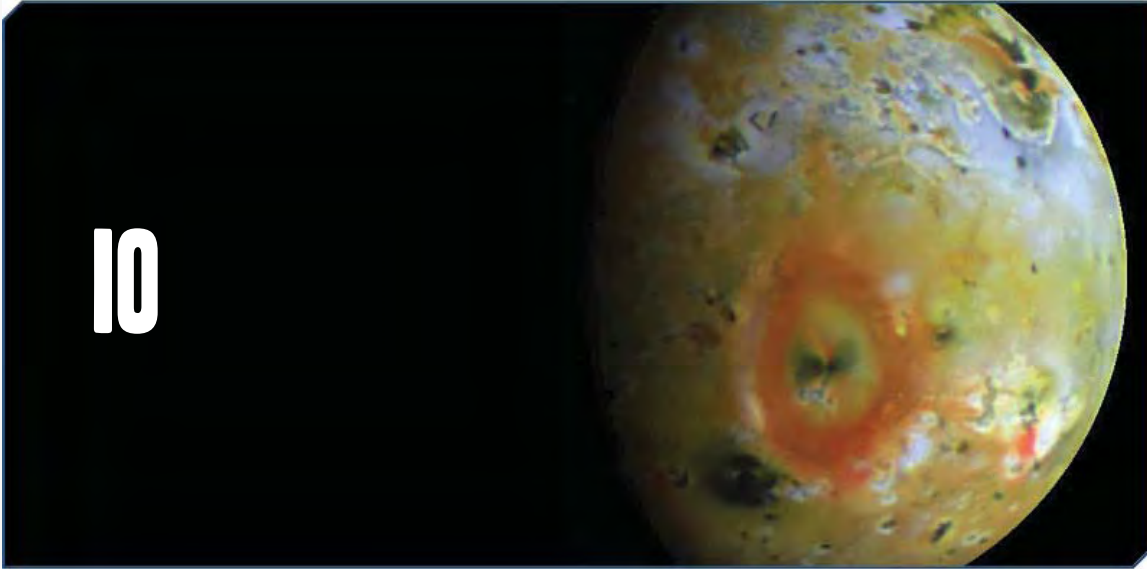

The innermost of the four Galilean moons of Jupiter, Io is the most volcanically active body in the solar system. Infernally hot lava flows across a bitterly cold landscape, while billowing volcanic geysers spew plumes of sulphur to heights of up to 500 kilometres. This coupled with almost constant seismic activity and the vast electrical storms lasting weeks at a time which rage across the moon's angry surface make Io a very unwelcome place to visit.

Io's volcanoes continually expel an enormous amount of particles into space. These are swept up by Jupiter's magnetic field, where they become ionized and form a doughnut-shaped track around Io's orbit called the *Io Plasma Torus*. For spacecraft attempting to enter/leave Io orbit, these ionized particles can create seriously hazardous conditions, and have been responsible for a score of accidents involving crew fatalities. Despite the advances in radiation shielding that has made the colonisation of the Circum-Jove system possible, when the ion and radiation storms caused by the Io Plasma Torus are at their worst, getting on or off Io is nigh on impossible.

Not all of Io is dominated by volcanoes. The most common terrain is open, flat frost-covered plains. It is in the Io regolith

STATISTICS

Distance from Sol:	5.2 AU
Equatorial Radius:	1821.3km
Mass:	0.015 Earths
Mean Density:	0.35
Gravity:	0.183g
Escape Velocity:	2.558 km/s
Rotational Period:	Synchronous
Orbital Period:	1.769 days EST
Atmospheric Composition:	90% sulphur dioxide
Temperature:	130K
Satellites:	0
Total Population:	10,000

that the first Foscolium deposits were discovered on the moon. Were it not for the sizeable deposits this most important of elements, it is doubtful anyone would ever come to this hellish place.

Io has a thin atmosphere composed of sulphur dioxide and other gases. Unlike the other Galilean satellites, Io has little or no water.

SETTLEMENT

There are numerous small mining outposts scattered across the surface of Io, mining Foscolium and the metal ores that are ejected from the moon's many volcanoes. Life is hard on Io, but the pay is generally good. The population is approximately 10,000.

IO SURFACE MAP

SCALE: CIRCUMFERENCE: 11443.56 KM

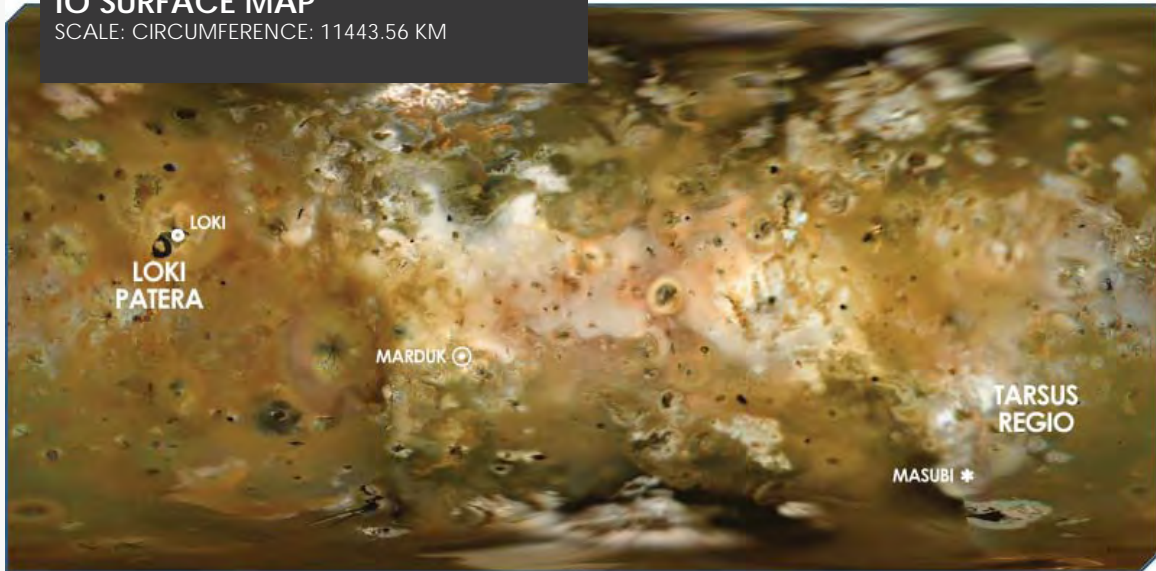

"Most people you ask think freelance prospecting on Io is a waste of time and money. I can sometimes see their point. The Corps have got all the best claims sewn up tight, and trust me – you really don't want to go messing with those boys. It can be real nasty out on the sulphur flats. Some people will shoot you as soon as look at you. Especially if they decide you're on their claim. If you got some crazy idealistic belief in the goodness of your fellow man, forget it. Believe me when I tell you I soon learnt my best friends are my rover, and my trusty Boyars Mk V Hunting Rifle."

Christian 'Foggy' Fogarty, independent prospector, Io.

LOCATIONS

MARDUK

The administrative centre for all Io mining operations, and the only spaceport, Marduk is the only officially-sanctioned permanent settlement on the surface of this hostile moon. Constructed in one of the few geologically stable regions on the moon, the majority of Marduk is underground, to provide added protection from the often violent Ionian weather. Most of the population of Marduk are either government staff or corporate employees.

Although Marduk is nominally governed by the Jovian Administration, the truth is

that the mining corporations have the real power here. Despite the best efforts of the United Earth Federation and the Federal Law Enforcement Authority, corruption amongst civil servants assigned to Marduk is rife.

LOKI PATERA

202 km in diameter, Loki Patera is the largest crater on Io. It contains an active lava lake, and is the scene of the biggest Foscolium find since Tarsus Regio. Until the major corporations mine Tarsus Regio dry, their operations around Loki Patera consist mainly of borehole sampling and subsequent staking of claims. As such there is still a chance for the smaller prospector to get in early and make some money.

LOKI

A boom town on the edge of the Loki Patera, this cluster of bubble-fab domes, converted cargo modules and pressurised cave systems can best be described as 'Deadwood in space'. What little law and order there is in Loki is provided by corporate cops. The token FedPol presence spends most of their time preventing simmering rivalries between various prospecting groups and the larger mining concerns from boiling over into a shooting war. FedPol are also confronted by the spectre of organised crime, notably



in the shape of the *Estrella Negra* crime syndicate.

TARSUS REGIO

The frozen regolith of the Tarsus Regio is rich in Foscolium, as well as a myriad of other minerals and ores, and as such it is currently the most contested region on Io. The major mining corporations have already muscled out most of the smaller independent prospectors, and reports of claim-jumping involving violence are increasing in number. It is only a matter of time before the Jovian Administration order in the peacekeepers.

MASUBI

Masubi is the site of a played out Foscolium deposit, and in 2162 saw fighting between Cheung Corporation and new arrivals Motokatsu-Kyono Combine. It was the catalyst for the establishment of a permanent military garrison in the Circum-

Jove system. The boom towns of Masubi are all but abandoned now.

ARGUS PANOPTES

Owned by Threshold Unlimited - a subsidiary company of Cenargo Corporation - and located in a geostationary orbit around the moon Io, Argus Panoptes is very much a special-purpose station, and its facilities and staff are rather minimal compared to most other stations of similar size. Approximately 200 people live and work on the station, most of them scientific personnel. FTL propulsion and communication, exotic matter synthesis, unified field theory, and a variety of other disciplines have extensive laboratories aboard the station, many of which use the magnetic field the station is immersed in as a testbed.

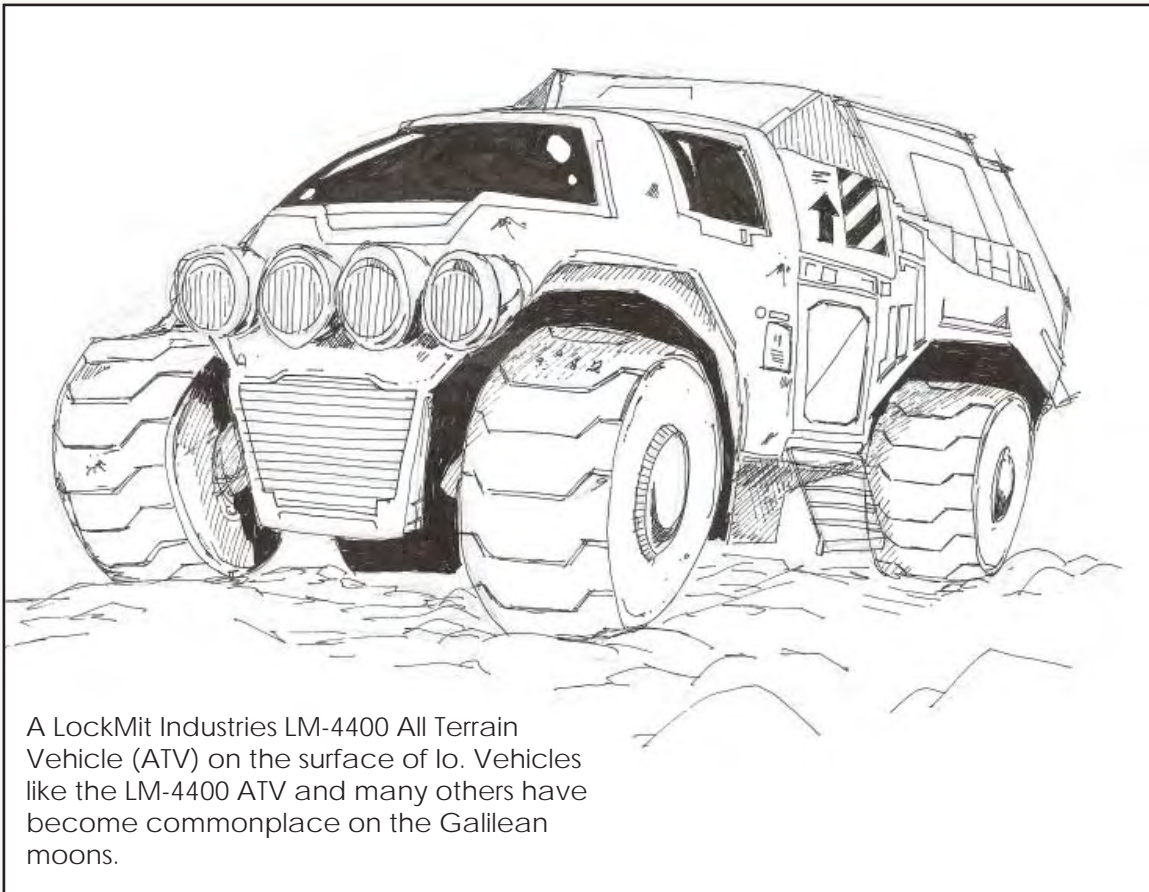

A LockMit Industries LM-4400 All Terrain Vehicle (ATV) on the surface of Io. Vehicles like the LM-4400 ATV and many others have become commonplace on the Galilean moons.

EUROPA

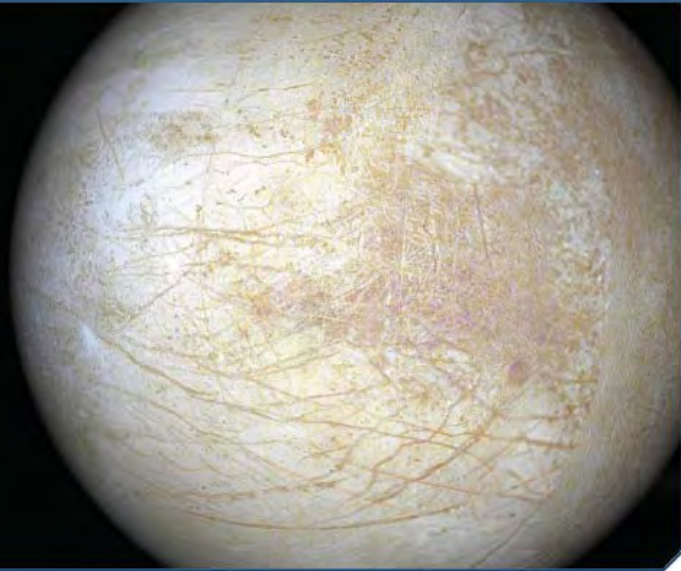

Like a giant vitrified eyeball in space, the eternally frozen moon Europa is the sixth of Jupiter's satellites and the fourth largest. It has a trace oxygen atmosphere, little more than vacuum. Unlike the oxygen in Earth's atmosphere, Europa's is not of biological origin. It is generated by sunlight and charged particles hitting Europa's icy surface producing water vapour which is subsequently split into hydrogen and oxygen.

Europa's surface is almost completely flat and covered in ice. Few topographical features are more than a few hundred metres high, and the majority of the surface consists of smooth, undulating ice plains. Europa's most striking surface features are the ice fractures – huge ice chasms some over 20 km (12 miles) across that are the result in large part by the tidal stresses exerted by Jupiter, which produce volcanic water eruptions and geysers from beneath the frozen surface. From orbit they resemble a series of dark rust-coloured streaks criss-crossing the entire globe.

Beneath Europa's surface ice there is a layer of liquid water, as much as 50 km deep in some places. Most of this European world-ocean is barely above freezing, and kept liquid by tidally generated heat created by the moon's orbit around Jupiter.

STATISTICS

Distance from Sol:	5.2 AU
Equatorial Radius:	1569km
Mass:	0.008 Earths
Mean Density:	0.35
Gravity:	0.134g
Escape Velocity:	2.025 km/s
Rotational Period:	Synchronous
Orbital Period:	3.551 days EST
Atmospheric Composition:	Trace atmosphere composed mostly of molecular oxygen
Temperature:	102K
Satellites:	0
Total Population:	1.4 million

The only man-made surface structures on Europa, apart from scientific outposts and mining survey bases, are the surface access points to the subterranean colony and the associated spacecraft landing zones.

SETTLEMENT

Europa has the largest population of all the Galilean moons, and is a centre for cutting edge biotech research and development – scientists from Europa have gained the nickname 'gene-genies' for their advances they have made in the field of genetic engineering. Today the moon supports a population of 1.4 million, most of who live in hanging cities at the top of the world-ocean, where oceanic hotspots have

EUROPA SURFACE MAP

SCALE: CIRCUMFERENCE: 9858.3 KM



eroded the crustal ice to a mere kilometre thick. Mynos and Sarpedon, the 'Hanging Cities of Europa' have become popular tourist destinations for visitors from the inner planets.

A large percentage of the population of Europa are descended from the families of the original migrant workers who came to the Jovian colonies looking for a new life. In the wake of 'Maunder Minor' in the mid-22nd Century.

LOCATIONS

SARPEDON

Built into a canyon cut into the underside of the European ice, sealed and filled with air, Sarpedon, like its sister city Mynos, is a miracle of 22nd century engineering. They are called the Hanging Cities of Europa for good reason – the buildings are all constructed from the top down, anchored in the ice mountains above, the 'tallest' almost touching the undulating black surface of the European world-ocean below. Since its construction, Sarpedon has grown quickly, and once all the real estate in the canyon ceiling was used up, many suburbs have since sprung up in the walls. In these haphazard assemblies of acentric conurbation live the poorest of the colonial population on Europa, unable to afford

INDIGENOUS EUROPEAN LIFE

Europa is the only place in the Solar System where indigenous extra-terrestrial life has been discovered. The majority of this life clusters around hydrothermal vents on the world-ocean floor. These vents are like super-heated geysers, and are covered in a form of anaerobic chemosynthetic bacteria and archaea adapted to life in very hot water temperatures. In the oasis of relative warmth surrounding these black-smoker vents dwells a krill-like life organism dubbed 'Teemers' by the colonists, and a species of tube-worm.

This singular discovery has attracted many to Europa, most with peaceful intent. Scientists come to study the European biosphere, tourists come to gawp, and pilgrims come to marvel at God's creations. A small minority of fanatics and extremists come to Europa with violence in mind. Even now, despite life being discovered on a score of extra-solar worlds, eco-terrorist organisations such as Covenant Europa continue to wage a war against the settlement of the moon. FLEA has a taskforce stationed on Europa dedicated to tracking down and eliminating such terrorist cells.

the living costs in the hanging cityblocks. Although most of the power used by Sarpedon city is fusion in origin, tidal power schemes and geothermal taps on the World Ocean floor have recently started to become economically viable alternatives. It is currently the largest colonial settlement in the Circum-Jove volume, with a

"How cold is the water?

Put it this way sparky - you don't want to go skinny dipping in that there ocean below Sarpedon City. First you got your cold shock. Typically kills in three-four minutes or less. The two main symptoms are sudden vasoconstriction - which can lead to unconsciousness and subsequent drowning - and tachycardia - your already stressed heart faces lower blood pressure, and bang! You're having a heart attack. You're lucky if you survive long enough to get hypothermia."

Captain Maria Corazon, talking to a tourist before departure of the European World-Ocean tour.

population of close to 0.8 million. Sarpedon is the home of the European Institute of Technology. Founded in the late 22nd century, EIT's goal is to advance knowledge and educate students in biotechnologies and genetics sciences.

MINOS

Located in a vast natural fissure at the top of the European World Ocean, construction on Minos started when Sarpedon was almost complete. Though the city is noticeably smaller than Sarpedon, with a population of approximately 0.4 million, it is no less impressive. Minos has become the cultural capital of the Circum-Jove colonies, and is home of the 200 Club - a loose-knit organisation of rich industrialists and scientists so named because their most popular haunt, the opulent and exclusive Lycian Ballroom, can reputedly only hold a maximum of 200 guests.

THE TWIN CITIES MAGLEV

The Twin Cities of Minos and Sarpedon are connected by an underground maglev system, which tunnels through the European ice at a depth of approximately 1km.

CONAMARA CHAOS

Conamara Chaos has become the setting for the Conamara Derby, during which daredevil pilots race souped up suborbital craft down its labyrinthine network of ice

fissures and canyons at breakneck speeds. The number of fatalities has increased in recent years, and it is only a matter of time before the Jovian Administration steps in and starts regulating the event; or worse, shuts it down.

TYRE RESEARCH INSTITUTE

In the ice cauldron of the Tyre Macula, subsurface geothermal heating has caused an upwelling plume of water from the world-ocean to melt the icy crust of Europa, creating regions where the ice is only hundreds of metres rather than kilometres thick. Floating in the icy blackness of the world-ocean below Tyre Macula, the Tyre Research Institute is the centre for official government-sanctioned research into life on Europa.

CALLANISH

Callanish Macula is the site of an exclusive holiday resort which is a popular destination for the rich and famous of Circum-Jove society, as well as tourists from down-system. The majority of this luxury resort is buried beneath the European ice, and boasts facilities which are best described as opulent.

GANYMEDE

"...Then there was Ganymede, the handsome son of King Tros, whom Jupiter, having taken the form of an eagle, transported to heaven on his back, as poets fabulously tell... the Third, on account of its majesty of light, Ganymede ..."



Ganymede is Jupiter's largest moon, and indeed the largest moon in the entire solar system; it is larger in diameter than Mercury but only about half its mass. Ganymede is much larger than Pluto. It was one of the first places that human explorers landed when visiting the outer planets.

The surface of Ganymede has a rich variety of terrain including mountains, valleys, craters and lava flows. The most striking features are the ridges and troughs. These features form complex patterns and have a vertical relief of a few hundred metres and run for thousands of kilometres across the moon.

Ganymede has a very thin oxygen atmosphere very similar to the one found on Europa. Ganymede is also the only moon in the Sol system with a magnetosphere. The moon is far enough away from Jupiter that it only receives around 8 rems per day of radiation from Jupiter's radiation belts, well within the range to be managed with shielding; while Ganymede is also close enough to Jupiter that it experiences significant tidal stresses from Jupiter, which makes geothermal energy and liquid water available underground. The moon also possesses water ice, carbonaceous material, metals

STATISTICS

Distance from Sol:	5.2 AU
Equatorial Radius:	2634.1km
Mass:	0.025 Earths
Mean Density:	0.35
Gravity:	0.146g
Escape Velocity:	2.741 km/s
Rotational Period:	Synchronous
Orbital Period:	7.154 days EST
Atmospheric Composition:	Trace atmosphere composed mostly of molecular oxygen
Temperature:	110K
Satellites:	0
Total Population:	50,000

and silicates. Ganymede is still fairly deep within Jupiter's gravity well, however, making travel to and from this moon relatively energy-intensive and therefore expensive until the advent of the reactionless displacement drive.

SETTLEMENT

The third largest of the Circum-Jove colonies, Ganymede has a population of approximately 50,000. Most of this number is located in the settlements on and below the vast Galileo Regio plains. Ganymede is often referred to as *Nanotech Valley*, the name a homage to Silicon Valley back on Earth. This is because the moon is a leading high tech hub with a large number

GANYMEDE SURFACE MAP

SCALE: CIRCUMFERENCE: 16549.91 KM



of nanotech-engineers and venture capital backed technology start-ups based here. The Nanoforges and Manufactories of Ganymede are the lead suppliers of nanotechnology to Sol industry.

LOCATIONS

ACALLARIS

Located in the Memphis Facula at the southern edge of the frozen Galileo Regio plains, the domed city of Acallaris is the largest city on Ganymede, with a population of approximately 30,000. The city extends deep below the surface structures into the warrens of lava tunnels and caverns which honeycomb this area. The lower levels of these caverns contain vast ice glaciers, which provide a valuable resource for the city. Acallaris is also known as Ganymede City, and is a popular destination for flight-crews from ships orbiting in the Ganymede Swarm.

APOPHIS

Apophis is a relatively young settlement built on top of the Apophis Aquifer, where water warmed by Ganymede's radioactive core reaches relatively close to the surface. The population of Apophis is close to 2500, and almost all are members of a religious movement who call themselves Redeemers

"It was Rosalind Van Owen, a planetary engineer working at the Acallaris Biome, who showed me the Ganymede Lights for the first time. We had taken a rover out on the Siwah Facula, when the blackness overhead was suddenly filled with majestic yellow-green fire.

Of course I thought I knew all about what the Ganymede Lights were – how the interaction between the magnetospheres of Ganymede and Jupiter produces dazzling variations in the auroral glows in Ganymede's tenuous atmosphere of oxygen.

I had to quickly concede that no amount of research could ever substitute for seeing those spellbinding celestial lights in person. It was only then that I finally understood the true extent of their beauty."

Harper Abraham, author of *Circum-Jove on E\$20 a day.*

– a bizarre amalgam of puritanical Christianity and eco-hippy commune. With its closed-loop recycling, vacuum-organism farms and forest biome, Apophis is a model self-reliant community.

THE GANYMEDE SWARM

Ganymede has no central orbital facility equipped to handle the larger of the corporate and independent cargo vessels which regularly visit this moon. Instead, visiting spacecraft are directed



into holding patterns over the moon's North Pole. The central point the dozens of spacecraft orbit is Ganymede Station. Ganymede Station is little more than a transfer and space traffic control station.

MARIUS BASE

Site of the original landings on the moon, Marius Base has since grown up into a large industrial centre and storage depot for the various mining firms who send mining teams down the well to either lo or deep Jupiter orbit.

NABUPLEX

The top-secret NabuPlex facility is owned by Artificial Life Incorporated, and is their main off-world laboratory for android and artificial intelligence research and development. It was within the walls of NabuPlex that the legendary 5th generation androids were conceived.

TIAMAT

Nicknamed Chaos Canyon, the official name of the Military Sciences Division (MiliSci) installation located here is the Tiamat Aerospace Flight Test Centre

(Department 8). The steep canyons and deep fissures of the Tiamat Sulcus are permanently off-limits both to civilian and normal military space traffic. Unauthorised personnel caught within the perimeter are quickly caught and expelled. Even non-MiliSci military pilots risk disciplinary action if they accidentally stray into the exclusionary "box" surrounding Tiamat's territory.

The base's primary purpose is to support development and testing of experimental spacecraft and weapons systems. What else this secret wing of the United Earth Armed Forces gets up to below the surface of Ganymede is unknown.

THE ANUBIS QUARANTINE ZONE

This restricted area is the site of a nanotech disaster in 2194. Almost a century later it is still a no-go area. An 250km radius exclusion zone around the site is patrolled by elements of the Colonial Marine force from Camp Orestheus, Callisto.



Callisto is one of the most heavily cratered satellites in the solar system. In fact, impact craters and associated concentric rings are about the only features to be found; there are no large Callistoan mountains. Callisto's battered surface lies on top of an icy layer that is about 150 kilometres thick. Beneath the crust lies a salty ocean in excess of 10 kilometres deep. Callisto has a trace atmosphere composed of carbon dioxide. Its source is the slow sublimation of carbon dioxide ice from the satellite's icy crust. Outside of Jupiter's radiation belt and also geologically very stable, Callisto was chosen as the location of the first landing by a manned mission to the moons of Jupiter.

SETTLEMENT

Even though the colony at Europa is far larger, Valhalla Station is still the only orbital facility capable of accommodating the giant Jovian refinery ships. The surface colony is built in and around the Asgard Crater, and between this, several outposts and the orbiting spaceport facilities; Callisto has a population of approximately 250,000.

STATISTICS

Distance from Sol:	5.2 AU
Equatorial Radius:	2410.3km
Mass:	0.018 Earths
Mean Density:	0.35
Gravity:	0.126g
Escape Velocity:	2.440 km/s
Rotational Period:	Synchronous
Orbital Period:	16.68 days EST
Atmospheric Composition:	Trace amounts of carbon dioxide and molecular oxygen
Temperature:	134K
Satellites:	0
Total Population:	250,000

LOCATIONS

VALHALLA STATION

In geo-stationary orbit over the Valhalla Crater and an integral part of the Circum-Jove space logistics infrastructure, the vast cats-cradle of superstructure that forms Valhalla Station makes possible the orbital assembly and maintenance of large platforms, and spacecraft in Circum-Jove space. Valhalla Dry-Dock 1 is large enough to accommodate one of the giant gas-mining ships, while its numerous other docks and enclosed hangar decks allow maintenance of smaller spacecraft and space planes, as well as the construction of non-atmospheric spacecraft and other space facilities. The station has grown

CALLISTO SURFACE MAP

SCALE: CIRCUMFERENCE: 15142.47 KM

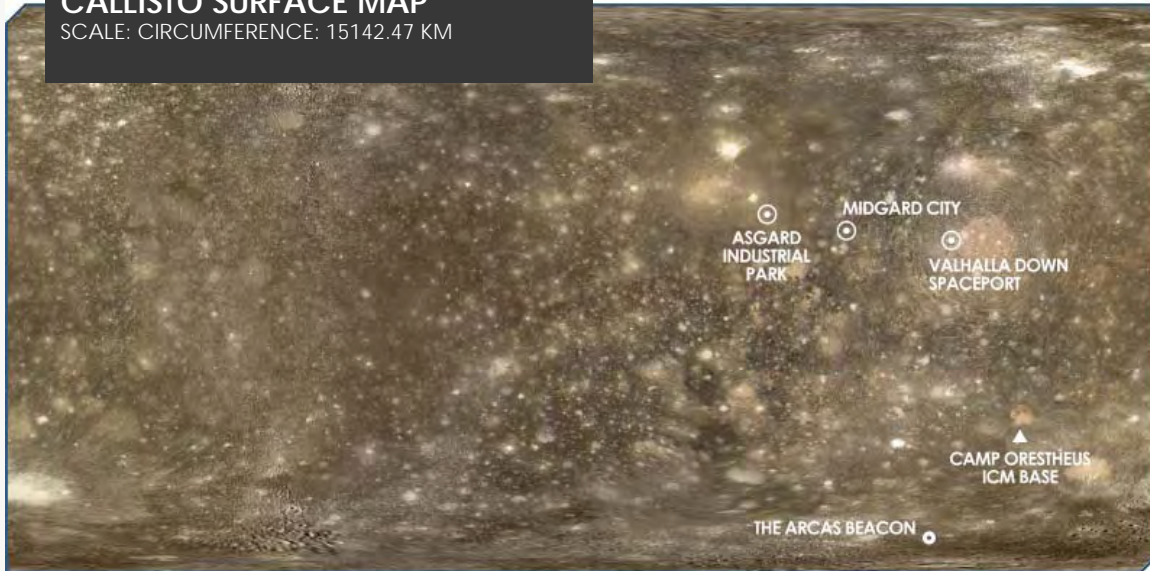

from its initial function into a sizable orbital facility and a hub of space traffic in the Circum-Jove volume.

The deep space contingent of the Camp Orestheus military garrison is stationed at Valhalla Station. *Taskforce 37* as they are called has dedicated docking facilities which are off-limits to non-military personnel.

CALLISTO ORBITAL REFINERY

The large agglomeration of factory modules and fuel storage containers that sprawls across the nearside surface of asteroid 11663ZA is the central repository for Helium-3 fuel mined from the atmosphere of Jupiter. Once refined, the majority of the fuel is shipped down-system.

VALHALLA DOWN

Valhalla Down is the largest surface-based spaceport in Circum-Jove space, and outside of Titan Sound is the largest spaceport in the outer Sol system. Because of the lack of gravity on Callisto, much larger ships can land at Valhalla Down than on larger worlds down-system, which makes loading and uploading of freighters and bulk container ships much easier. On the surface, Valhalla Down resembles not much more than an expanse of flattened and fused rock. The majority of the infrastructure is below ground.

"There is a reason the Camp Orestheus garrison are nicknamed the Crater Haters. I mean, have you seen Callisto? Man, that place is nothing but craters. Trust me - after you've spent a rotation on Zero-Gee and Microgravity combat training - jumping in and out of crater after crater after fucking crater, you'd hate them too!"
**Gunnery Sergeant Carlos Chavez, 2nd Battalion
5th Colonial Marine Regiment**

MIDGARD CITY

Located in a network of craters between Asgard and Valhalla craters, Midgard City is the primary colonial settlement on Callisto. The various districts are connected by the Midgard Maglev. Population 200,000. Districts of Midgard City are as follows:

- **Tapio District** – more commonly referred to as Dockside, Tapio District serves Valhalla Down spaceport and is where most flight-crews and dock workers on Callisto spend much of their time and money. Dockside houses a myriad of bars, clubs, brothels and casinos, and despite the best efforts of FedPol it can be a dangerous place for the inexperienced traveller. Dockside teems with illegal immigrants, transients and criminals, and has been described in one popular tourist guide as a 'place of vagabonds and thieves'.

- **Veraldan District** – most of the government infrastructure of the Circum-Jove Administration is located in Veraldan District.
- **Vutash District** – the largest district in Midgard City, Vutash is the also called the ‘burbs, as most of the working population on the moon have habitation blocks here.
- **Tontu District** – with large areas still under construction, Tontu is an overflow from Vutash District.
- **Maderatcha District** - playground of the corporate elite on Callisto.

ASGARD INDUSTRIAL PARK

Known as ‘the ape’ after phonetic pronunciation of acronym AIP, the Asgard Industrial Park contains many corporate facilities, automated manufactories and research laboratories.

CAMP ORESTHEOUS

Camp Orestheous is the base of operations for United Earth Armed Forces in Circum-Jove. A company strength ICM rapid reaction force is stationed here, ready to respond to any infringement of UEF law, or to support FedPol/FLEA operations in the Circum-Jove volume.

The marines of Camp Orestheous are nicknamed the Crater-Haters due to the amount of time they spend on the cratered surface of Callisto training in zero-g and microgravity combat operations.

THE ARCAS BEACON

The south polar astrogation beacon is primarily used by robot freighters to guide them safely into Callisto orbit.

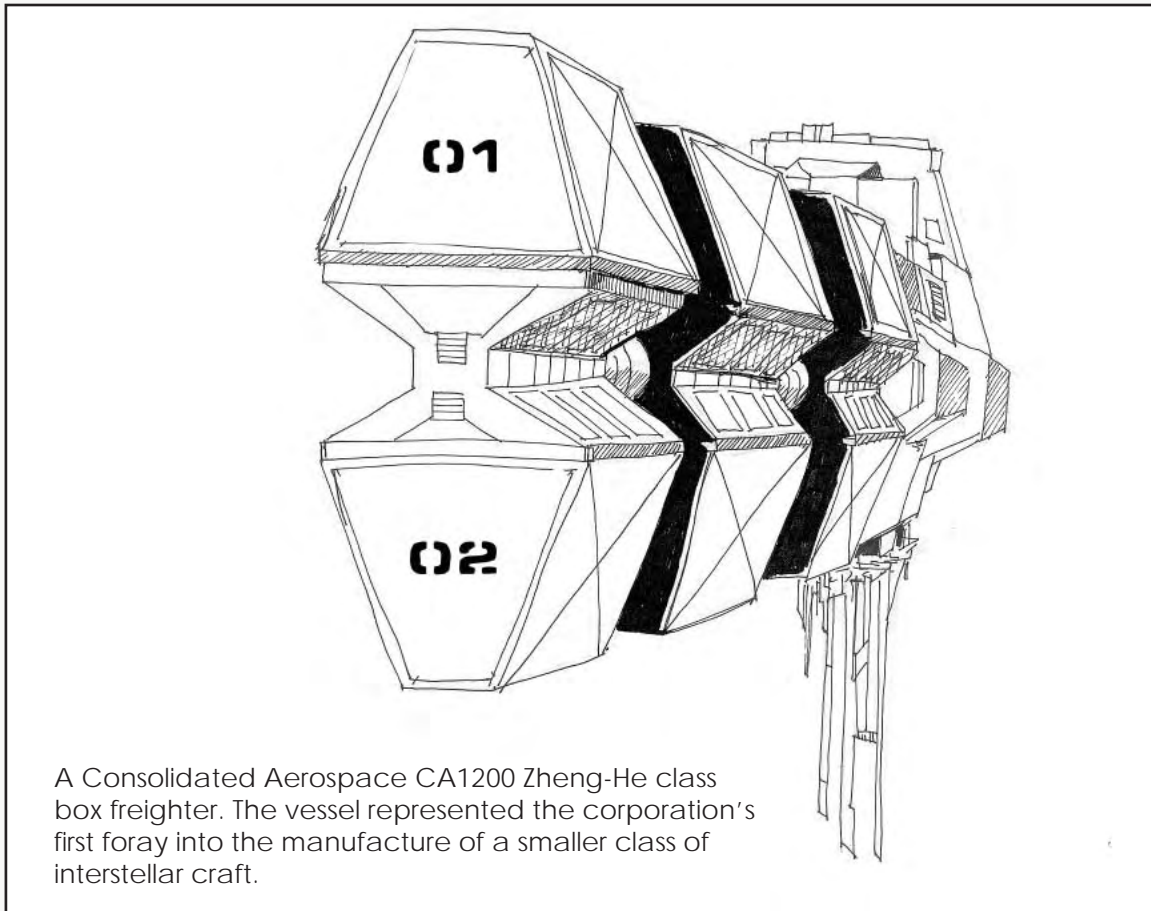

A Consolidated Aerospace CA1200 Zheng-He class box freighter. The vessel represented the corporation's first foray into the manufacture of a smaller class of interstellar craft.

OTHER LOCATIONS

THE JOVIAN ORBITAL GAS MINES

Jupiter's immense atmosphere consists of about 75% hydrogen and 25% helium by mass (90% hydrogen and 10% helium by number of atoms), with trace amounts of methane, ammonia, and other light substances. By way of comparison, there is more Helium-3 on Jupiter than there is water in all oceans of earth (roughly 100 times more). Helium-3 is the fuel of choice in fusion reactors, which makes Jupiter a vast fuel reserve in waiting. By the late 23rd Century the Jovian Gas Fields supply all the outer colonies of Sol with fuel for their fusion reactors.

The orbital mining platforms that work the Jovian Gas Fields scoop up the gas through their massive intakes, then refine the Helium-3 fuel before loading it onto robot transport tankers that continually fly the 'Jovian Loop' between Callisto and the upper atmosphere of Jupiter. At Callisto the robot tankers unload their payload into the giant orbital fuel depot, or onto ships bound for down-system destinations.

There are scores of mining platforms in the upper atmosphere of Jupiter, and almost all are owned by one of three companies: Jovian Holdings (a subsidiary of Hallidor Corp), the Circum-Jove Development Corporation (a subsidiary of Cheung Corporation) or MKC-Jupiter (a subsidiary of Motokatsu-Kyono Combine). The first generation of mining platforms were designed and constructed by Federated Boeing Interstellar, but they have since been superseded by an improved generation of Consolidated Aerospace craft.

THE JUPITER TROJANS

The Jupiter Trojans are a large group of asteroids that share the orbit of Jupiter around the Sun. The asteroids are divided into two distinct groups, each distributed throughout elongated, curved regions around one or other of Jupiter's two Lagrangian points of stability, L4 and L5. These respectively lie 60° ahead of and behind Jupiter in its orbit around the sun. All the Jupiter Trojans are named after mythological figures of the Trojan War.

THE GREEK CAMP

The Trojans orbiting ahead of Jupiter, around Lagrangian Point L4 are collectively referred to as the Greek Camp. There are 1179 objects recorded as orbiting Jupiter L4, the largest being *624 Hektor* at 370 × 200km.

The Greek Camp is the location of the Telephus Observatory. This swarm of 200 individual robot telescopes is controlled from the scientific base on the asteroid Telephus. The robot telescopes are each equipped with a Delta Level AI which allows them to reposition themselves based on orders from Telephus. Combined, the robot telescopes allow for high resolution imaging of distant stellar objects.

THE TROJAN CAMP

The Trojans orbiting behind Jupiter, around Lagrangian Point L5 are collectively referred to as the Trojan Camp. There are 1045 objects recorded as orbiting Jupiter L4. The Trojan Camp is the home of the *Trojan Pirates* (see the chapter on organisations for more details).

OUTER OBJECTS

This grouping includes a number of small irregular moons with elliptical and inclined orbits, which for the most part appear to be captured asteroids or fragments of captured asteroids. They are grouped according to shared similar orbital elements and thus may have a common origin, perhaps as a larger moon or captured body that broke up. They include:

THEMISTO

Themisto is a single moon belonging to a group of its own, orbiting halfway between the Galilean moons and the Himalia Group.

THE HIMALIA GROUP

This group of objects are a tightly clustered group of moons with orbits around 11,000,000–12,000,000 km from Jupiter. The group comprises of three objects: Leda, Lysithea and Elara. There was a fourth member of this group – Himalia after which the group is named - but was destroyed in 2197 by the military to prevent a malfunctioning swarm of self-replicating von-Neumann machines from escaping an unregistered laboratory on the moon.

CARPO

Like Themisto, Carpe is another isolated case; it is located at the inner-edge of the Ananke Group.

THE ANANKE GROUP

Averaging 21,276,000 km from Jupiter and with an average inclination of 149 degrees, this group has rather indistinct borders, and includes (from largest to smallest): Ananke, Praxidike, Iocaste, Harpalyke, Thyone, Euanthe and Euporie.

THE CARME GROUP

With an average inclination of 165 degrees, the Carme Group averages 23,404,000 km from Jupiter and includes (from largest to smallest): Carme (the largest, which gives its name to the group), Taygete, Eukelade, S/2003 J 5, Chaldene, Isonoe, Kalyke, Erinome, Aitne, Kale, Pasithee, S/2003 J 9 and S/2003 J 10.

THE PASIPHAË GROUP

The Pasiphae Group is a general catch-all group that covers all the outermost moons or Jupiter. It includes (from largest to smallest): Pasiphae, Sinope, Callirrhoe, Megaclite, Autonoe, Eurydome and Sponde.

ORGANISATIONS

BLACK SUN SECURITY



Type: Private Security Company.

Location: Regional office on Callisto. Assets deployed on Io, working for Hallidor Corp and several of the smaller mining companies such as Ceres Metals, Praxis Mining and Proxima Inc.

Description:

Founded in 2260 by ex-marine colonel Alexei Baretzki, Black Sun Security is a subsidiary of Black Sun Consulting, and is alternatively described as a security contractor or a mercenary organisation depending on whom you ask. The majority of personnel hired by Black Sun Security are either ex-police or ex-military.

In 2267, Black Sun Security was hired to provide a Personal Security Detachment to work with Hallidor Corp employees working on Io. Under this contract, Black Sun Security is authorised to have 480 staff on Io.

CHRISLAMIC CHURCH

Type: Religious Group

Location: The impressive Midgard Temple was officially opened in 2267, but make-shift centres of worship have existed for decades prior to this. The Midgard Temple is the only official Chrislamic temple existing in the Sol system.

Description:

One of the fastest growing religions in the 23rd century is Chrislam, a religious sect that unifies Christianity and Islam. Chrislam

first appeared on the planet Tamir in the 61 Cygni Star System during the Second Exodus (2166-96). Since then it has become a very popular religion in the colonies, though it has made little headway on Earth.

The primary language of Chrislam is Arabic in origin. All followers of Chrislam are encouraged to perform a pilgrimage (called a 'hajj') once in their lifetime to the city of New Mecca on Tamir. Chrislams do not drink alcohol.

CHEUNG CORPORATION



Type: Corporation

Location: Cheung Corp maintains a regional office in Midgard City on Callisto. From here it manages its assets in the Circum-Jove volume.

Description:

Cheung Corporation was formed in 2132 from a three-way merger of Cheung Industries, Ling Consumer Products, and Shenzhou Aerospace. These companies had formed a consortium three decades earlier to become one of the primary commercial concerns involved in the initial stages of the Jovian Project.

In the years since its inception, Cheung Corporation has bought out scores of

smaller companies and gained ownership of many privatised government assets. As a result the board membership includes private citizens and members of the Chinese Consortium government and military. The corporation is engaged in business in virtually every industry, including energy, metals, colony management, terraforming, machinery, chemicals, food and general merchandise. Cheung Corporation has sizable investments and assets in the Circum-Jove system.

CIRCUM-JOVE ADMINISTRATION, THE



Type: Government organisation
Location: Administrative centre in Midgard City, Callisto, with a regional office on each of the Galilean Moons.
Description:
 The Circum-Jove Administration was established in 2200. Modelled after the Mars Administration, it provides the colonies with a political voice in the General Assembly on Earth. The CJA (or Jovad as it is often called) manages the day-to-day running of government in the Circum-Jove colonies. The administration has devolved a lot of local government to locally-elected councils on the Galilean moons. The CJA and various corporate concerns are guaranteed non-voting seats on these councils.

Prior to the formation of the CJA, the Jovian Project was managed by a branch of the United Earth Federation government named the Circum-Jove Development Corporation. Historians now cite mismanagement of the Circum-Jove economy and the gross mishandling of

the Callisto Dockers Strikes of 2170-71 that brought an end to direct government of Circum-Jove from Earth via this body.

CIRCUM-JOVE WORKERS PARTY

Type: NGO (political)
Location: Regional
Description:
 The Circum-Jove Workers Party's origins lie in the early 22nd century when it became apparent that there was a need for a political party to represent the interests and needs of the Circum-Jove proletariat which was steadily increasing in numbers in the wake of Maunder Minor.

In 2128, Tobias Fletcher, a senior construction engineer working on Callisto proposed in his union branch that the Trans-Sol Trade Union Congress call a special conference to bring together all the organisations and form them into a single body which would sponsor candidates to represent workers in their dealings with the Circum-Jove Development Corporation. The CJWP was recognised as a force to be reckoned with when it instigated the Callisto Dockers Strikes of 2170-71.

COVENANT EUROPA

Type: Terrorist organisation
Location: Europa
Description:
 Covenant Europa is the latest in a long line of terrorist organisations claiming to be fighting for a human-free Europa. There have been organisations similar to Covenant Europa ever since colonists discovered indigenous life living in the oceans of Europa a century and a half ago. Covenant Europa has been engaged in a campaign of economic sabotage and guerrilla warfare for almost two decades.

Covenant Europa has no formal leadership, hierarchy, membership or official spokesperson and is entirely decentralised, consisting of cells operating

independently though occasionally coordinating their actions through mutual consent. Despite the leaderless nature of the movement, FLEA says that imprisoned activist Sabrina Peixoto is the leader of Covenant Europa. Peixoto describes herself as an “unofficial Covenant Europa spokesperson”, and despite the best efforts of the UEF, continues to publish her weblog, How Things Are, from her cell in the Agarum Correctional Facility on Luna.

The prime directive of the organisation’s manifesto is to “inflict maximum economic damage on those profiting from the destruction and exploitation of the European biosphere.”

Covenant Europa literature was banned by the Jovian Administration in 2270. FLEA has assigned a team of agents to Europa dedicated to taking Covenant Europa down.

ESTRELLA NEGRA

Type: Criminal organisation

Location: Operations throughout the Circum-Jove volume.

Description:

Throughout Circum-Jove, organised crime is a serious and growing problem. One of the most powerful crime syndicates operating in Circum-Jove is the Estrella Negra (the Black Star). A cartel of organised crime groups originating for the most part in South America on Earth, Estrella Negra has a lot of influence amongst immigrants to Circum-Jove from Latin America. Despite the best efforts of FLEA and the Colonial Marines, this organisation continues to run sizable drug smuggling and people trafficking operations to the Circum-Jove colonies. Estrella Negra is known to exert a great deal of influence amongst the poorer social classes, and have government officials and cops on the payroll. As yet, FLEA has been unable to locate La Catedral – the infamous headquarters of Pedro Ignacio Ramirez, head of the Estrella Negra Circum-Jove Cartel.

EUROPA BIOTECH

Type: Company

Location: Sarpedon, Europa, with field research laboratories across the moon.

Description:

Founded by Zen Medical Corp 2168 as a subsidiary specialising in cutting-edge biotech R&D, Europa Biotech quickly rose to become one of the leading lights in the Circum-Jove biotech industry. When the Jovian Treatise began to squeeze the biotech research economy in Circum-Jove, Zen Medical began making moves to divest themselves of their Circum-Jove portfolio. In 2214, a consortium of board members and senior researchers at Europa Biotech led by famed geneticist Herodotus ‘Hero’ Singh, took the opportunity to take control of the company during a management buy-out.

Since becoming an independent company, Europa Biotech has blazed a path few could keep pace with. It wasn’t long before the press started calling Singh and his staff the Gene-Genies. Amongst their achievements are the original templates for the closed hydroponic systems and biomass reactors which are used not only on the Galilean moons but on colony worlds far from Sol. Europa Biotech also developed the first generation of vacuum organism farms. On these farm fields, chemoautotrophic vacuum organisms derive energy by oxidation of elemental sulphur and ferrous iron, converting carbonaceous material into useful organic chemicals.

Now 110 years old, Hero Singh is a legend amongst the scientific community. He went into semi-retirement 25 years ago, living a hermit-like life in a remote habitat attached to the ice at the top of the European World-Ocean.

EUROPEAN PURITY PARTY, THE

Type: NGO (political)

Location: Headquarters in Sarpedon City,

Europa.

Description:

The European Purity Party (EPP) is the political wing of Covenant Europa. Led by Jason Knox-Wright, the EPP promote the abandonment of all colonies on Europa, ending humanity's pollution of the biosphere and leaving the planet to its indigenous lifeforms. The EPP has no seats in the European Council, but is a vocal presence at most public meetings.

FEDERAL LAW ENFORCEMENT AUTHORITY

Type: Government organisation

Location: Midgard City, Callisto

Description:

While there are FedPol stations in every major settlement in the Circum-Jove colonies, the Federal Law Enforcement Authority (FLEA) also maintains an Administrative Field Office in Midgard City on Callisto. The duties of this office include:

- Managing the deployment and movement of Special Agents;
- General logistical management of law enforcement assets throughout Circum-Jove;
- Management of law enforcement agencies, especially during joint operations;
- Field headquarters for Federal Marshals;
- Field liaison with other federal institutions e.g. the Interstellar Trade Commission;

GANYMEDE CLUB, THE

Type: Private Members Club

Location: Headquarters in Acallaris City, Ganymede

Description:

Often dismissed as a private members club made up of rich industrialists and trust-funders, since the early 23rd century the Ganymede Club has famously pioneered the pursuit of alternative, radical and dangerous sports in and around Circum-Jove. Its roster of activities includes: low-level suborbital racing, interplanetary

shuttle racing in the upper Jovian atmosphere, diving in the European World-Ocean, caving on Ganymede and many more. Membership is by invite only.

HALLIDOR CORPORATION



Type: Corporation

Location: Regional headquarters located in Midgard City, Callisto

Description:

Formed in the late 21st Century out of a dozen smaller companies in an effort to combine and protect their interests, Hallidor is now one of the largest megacorporations operating in the Federal Colonies and beyond. Hallidor has invested greatly in terraforming technology, and it has managed to secure a large number of Colonisation Development Contracts. There have recently been reports of infighting between some of the companies making up Hallidor Corp, but there is no real evidence. Hallidor's corporate headquarters were originally on Earth, in the United Americas. Recently they relocated to the planet Hallidon in the Epsilon Indi star system.

Hallidor has greatly diversified interests, and has spun off numerous subsidiaries to push into new and emerging markets.

Hallidor was one of the corporations to be involved in the Jovian Project from the start, and as such has established a strong influence amongst the colonies here. In 2118 Hallidor formed the subsidiary Jovian Holdings, through which it now manages all its assets in the Circum-Jove volume.

HERCULES SHIPPING

Type: Company

Location: Acallaris City, Ganymede

Description:

Hercules Shipping was formed in 2196 and is an interplanetary shipping company based on Ganymede. Hercules Shipping deals in both the intricate logistics and freight forwarding requirements of major companies as well as smaller companies and personal courier services. The company prides itself on providing the same high level of professional service - whether using express interplanetary freight services or cheaper freight-forwarding services.

IMMORTALS

Type: Youth movement

Location: Largest concentration in Minos City, Europa

Description:

Immortals are a growing subculture amongst the youth of the Circum-Jove colonies, especially on Europa. The main tenet held by the Immortal movement is that they believe that they are being guided by their immortal future selves from the year 3000.

The spiritual leader of the Immortals is one Ariel Sring. A one-time employee of Interstellar Explorations (ISX) until a psychotic episode landed her in a psychiatric hospital on Mars, Sring emigrated to Europa upon her discharge. Settling in Minos, disaffected youths soon began gravitating towards this enigmatic woman and her tales of how she had been contacted by her future self, and told to prepare for coming enlightenment.

Immortals eschew socialising with outsiders unless absolutely necessary. They often appear arrogant and aloof. They can easily be recognised by their appearance - their shaved heads and figure-hugging white clothing; their complex body tattoos; their love of cutting-edge technologies.

THE INDEPENDENT SPACERS UNION

Type: NGO

Location: Regional office on Callisto

Description:

The Independent Spacers Union (ISU) is the largest aerospace, interplanetary and interstellar pilot union in the Federal Colonies and represents nearly 53,000 pilots. Founded in 2171, the ISU provides three critical services: space safety and security, representation and advocacy.

JOVIAN HOLDINGS

Type: Company

Location: The company headquarters are located in the city of Sarpedon, on Europa, with regional offices at Acallaris on Ganymede and Midgard City on Callisto.

Description:

Jovian Holdings Incorporated is a subsidiary of the Hallidor Corporation and was incorporated in June 2118 to administer Hallidor's colonial and mining projects in the Circum-Jove colonies. Jovian Holdings has a fleet of eight mining platforms working the atmosphere of the gas giant. They also have 24 automated robot freighters for transportation of 3He (Helium-3) fuel back to Callisto, as well as numerous smaller transport, maintenance and cargo vessels. In addition, Jovian Holdings are also actively engaged in Foscolium mining from the Io regolith.

MOTOKATSU-KYONO COMBINE



Type: Corporation

Location: Regional office on Europa.

Description:

The Japanese owned Motokatsu-Kyono Combine (MKC) has roots that go back over two centuries, to the summer of 2033, when two of the largest Japanese corporations at that time merged in preparation for the commercial exploitation of the Moon. Motokatsu Electronics and the the Kyono Telecommunications Engineering Company had realised early on that off-world investment was a market that would soon be opening up to commercial interests, and would potentially become a much more lucrative revenue stream than Earthbound investment projects.

MKC initially displayed a ruthless streak in its dealings with rival corporations also trying to establish an off-world presence. In 2074 in what is now referred to as the Luna Crisis, a dispute over water mining rights at the Clavius Crater between MKC and the recently formed Lunar Development Corporation (LDC inc) rapidly escalated to the brink of the first armed conflict in space. Before events could escalate out of control, the UNSA managed to negotiate a peaceful settlement. The Luna Crisis gave MKC reason to rethink its policies regarding corporate competition, and over the coming decades would work hard to reposition itself as a firm but fair competitor.

The corporation was one of the first commercial organisations to invest heavily in the development of the Luna colony, and did not hesitate to become a member of the Martian Development Consortium. By 2106, Motokatsu-Kyono's fortunes were inextricably entwined with the colonisation and terraforming of Mars. The corporation became one of the biggest employers on the red planet, behind Cheung and Cenargo, and was one of the major investors in the Phobos Project (2168-2178) which saw the construction of the Martian Space Tether.

Unlike the majority of the other megacorporations on Mars, MKC has opted to locate its headquarters in Anchorpoint City rather than Viking City, citing the proximity to the Martian Space

Tether as being the driving factor behind this decision.

MKC is a heavily diversified corporation, with interests in advanced technologies research, electronics, terraforming, colonisation and aerospace manufacturing. Although much of its assets are now located on Earth's moon and on Mars, a strong tie with tradition has kept the corporate headquarters located in Tokyo, on Earth.

MKC did not invest in the Circum-Jove colonies until the mid-22nd century, when the corporation expanded into Foscolium mining. Their confrontation on Io with Cheung Corporation was the catalyst for the UEF establishing a permanent marine garrison in the region.

Most of the corporation's dealings in the Circum-Jove volume are via their subsidiary MKC-Jupiter. Their influence in the region is growing, though they are still a minor player when compared to Hallidor and Cheung.

ORESTHEUS SUPPORT GROUP, THE

Type: Military

Location: Camp Orestheus, Callisto

Description:

Based at Camp Orestheus on Callisto, the mission of the Orestheus Support Group is to provide the 2nd Battalion 5th Colonial Marine Regiment with organic and deployable combat support and combat service support which is centralised for economy of personnel and equipment. This support includes complete aerospace operation services (less space traffic control), engineer and transportation support, medical assistance, food services, security support, and other direct combat and combat service support to the marine combat elements.

PRAETORIAN SECURITY CONSULTING

Type: Private Security Consultancy

Location: Regional office on Callisto

Description:

Praetorian Security Consulting is a subsidiary of the Praetorian Group, an umbrella corporation whose roster also includes Praetorian Hardware (weapons tech), Praetorian Logistics (specialised interstellar shipping) and Praetorian Solutions (software security).

Praetorian Security Consulting works mainly in the corporate and private sectors, developing comprehensive security programs for high-profile individuals, private corporations and non-governmental organisations working in high-risk environments across the Federal Colonies and beyond.

QIN MIAN TECHNOLOGIES

Type: Company

Location: Acallaris City, Ganymede

Description:

Qin Mian Technologies is an advanced biotechnology firm engaged in industrial and medical biotechnology research and development. Their CEO, Aaron Kwok, is an outspoken critic of the Jovian Treatise of 2198, believing biotechnology research will lift humanity to the next level of its evolution, but only if allowed a free reign to explore the possibilities.

SEABORNE FOUNDATION, THE

Type: NGO

Location: The Foundation has a regional office on Europa, in the city of Sarpedon.

Description:

The Seaborne Foundation is a consortium of rich businessmen from Earth with sizeable investments on Earth and in the Circum-Jove colonies, as well as a portfolio of extra-solar colonial interests and holdings in

a number of marine research and genetic research companies.

The Foundation prides the privacy of its members, and as such very little is known about them. Founding member Daniel Seaborne lives out his life in a private arcology in orbit around Earth. He is 133 years old, kept alive by the medical technologies affordable by being a multi-billionaire.

The Seaborne Foundation have invested an undisclosed sum in the exploration of the European World-Ocean, and are actively working on the moon with one of its associated companies, Triton Marine Research, to catalogue the entire ecosystem below the European ice.

TASKFORCE 37



Type: Military

Location: Taskforce 37 is based at Valhalla Station in Callisto orbit

Description:

Taskforce 37 was originally an expeditionary force of the United Earth Space Command formed during the deployment of marines to Io in 2162. With the subsequent construction of Camp Orestheus on Callisto, Taskforce 37 was restructured and repurposed as a patrol group and permanently assigned to the Circum-Jove system. Taskforce 37 is based at Valhalla Station in Callisto orbit, and comprises 2,900 men under the command of Captain François Cook. It consists of the following vessels:

- The Ares class destroyer *Hannibal*
- The Artemis class frigates *Romulus* and

- *Remus*
- The Combat Support Ship *Sacramento*
- Two squadrons of *Vulture* class aerospace fighters
- A mixed squadron of ground support aerospace craft

THRESHOLD UNLIMITED

Type: Company

Location: Argus Panoptes, a space station in Io orbit

Description:

Threshold Unlimited is a subsidiary company of Cenargo Corporation, focused on high energy and particle physics research. Their only presence in the Circum-Jove volume is the space station Argus Panoptes.

Located in a geostationary orbit around the moon Io, Argus Panoptes is very much a special-purpose station, and its facilities and staff are rather minimal compared to most other stations of similar size. Approximately 200 people live and work on the station, most of them scientific personnel. FTL propulsion and communication, exotic matter synthesis, unified field theory, and a variety of other fields have extensive laboratories aboard the station, many of which use the magnetic field the station is immersed in as a testbed.

Cenargo is very guarded about the work being conducted onboard Argus Panoptes. The station keeps to itself, and does not get involved in anything that happens on Io.

TRITON MARINE RESEARCH

Type: Company

Location: Minos City, Europa

Description:

Triton Marine Research (TMR) is a biological consulting firm that has provided marine biological services to both public and private sector clients since 2258. The company specialises in performing near-shore habitat inventory, assessment and

environmental impact analysis, prior to deployment of large scale sea farming on colony worlds. It was set up with funding from the Seaborne Foundation.

TROJAN PIRATES, THE

Type: Criminal organisation

Location: The Jupiter Trojans (Trojan Camp)

Description:

The Trojan Pirates, so called because their base of operations reputedly lies somewhere in the Jupiter Trojans, are a loose-knit coalition who engage in smuggling, and small-scale acts of piracy against commercial and private shipping in and around the Circum-Jove system.

Due to the concentration of law enforcement assets in the Sol system, the pirates favour using small interplanetary ships and take advantage of the small number of crew members on modern cargo vessels. They also use large vessels to supply the smaller attack/boarding vessels.

Spaceborne piracy is estimated to cost the UEF between E\$13-18 billion per year. FLEA, with the aid of the ITC and ICM are actively attempting to shut the Trojan Pirates down.

JOVIAN INVESTIGATIONS

This chapter presents a selection of optional new professions for your Cthulhu Rising Investigators, all of which are inspired by the Circum-Jove setting. The list is by no means complete, and Keepers are encouraged to expand upon what is here as they see fit...

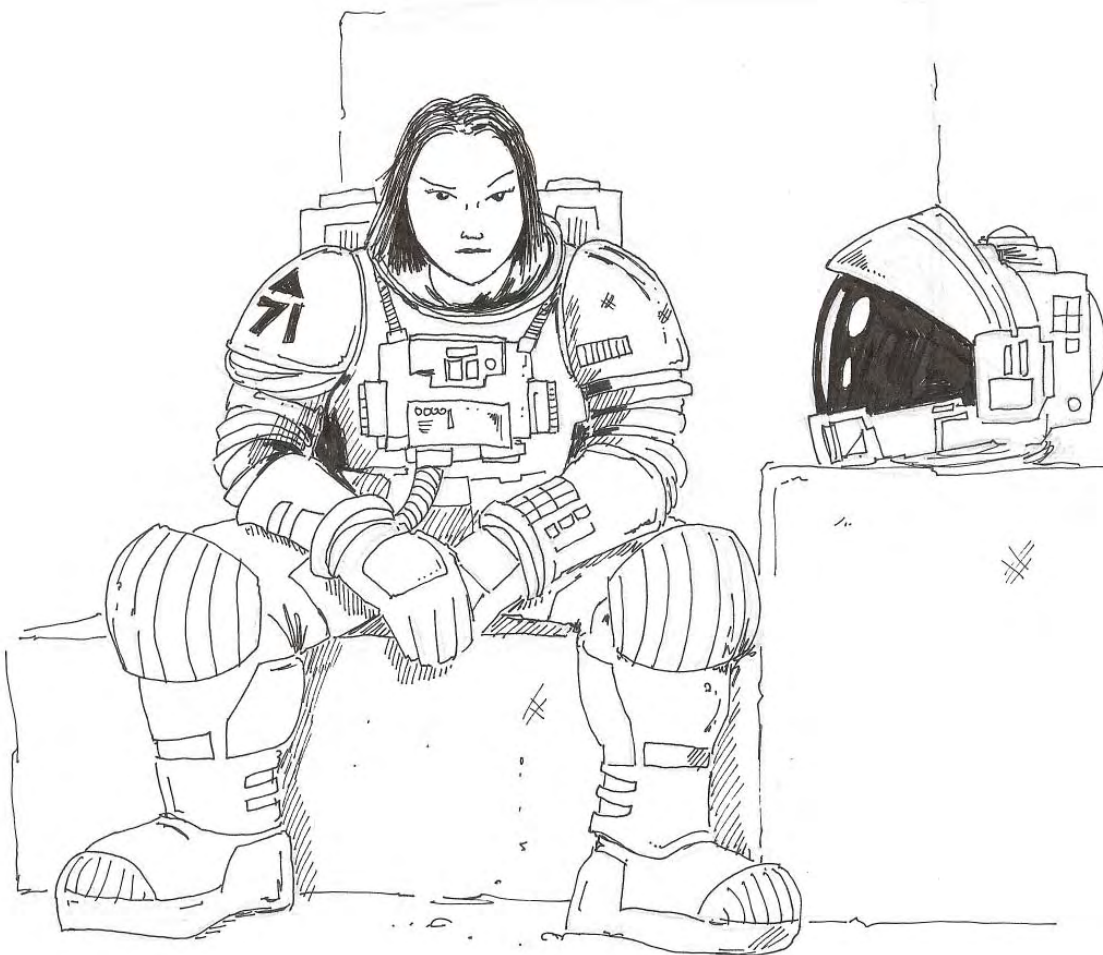

BLACK MARKETEEER

Despite the best efforts of FedPol and FLEA, there is a healthy black market in the Circum-Jove system. Someone has to move the stolen goods from the smuggler to the seller. The Black Marketeer works to move stolen property for later resale in a legitimate market.

Occupation Skills:

Computer (Operation), Credit Rating, Conceal, Data Analysis, EVA, Hide, Sneak, Bargain, Fast Talk, Streetwise, Gun Combat (Pistol), Law (Criminal), Evaluate, Psychology, Vacc Suit, Unarmed Combat plus 2x other skills to reflect personal field of expertise.

Background:

E\$10,000pa income from illegal activities; E\$5,000 in personal equipment; Rented accommodation in one of the Galilean colonies; 2x underworld contacts (Keepers' discretion).

DOCKER

The Dockers, or Dock Labourers, are an integral part of the operation of the Circum-Jove space ports. Though much of the work has been automated with the use of robots, loading and unloading ships still requires knowledge of the operation of this robotic loading equipment, the proper techniques for lifting and stowing cargo, and correct handling of hazardous materials.

Occupation Skills:

Climb, EVA, Computer Operation, Mechanical (Vehicle, Robotics), Powered Armour (to use powered exoskeleton suits), Vacc Suit, Vehicle.

Background:

E\$15,000pa salary, vacc suit, personal equipment related to profession.

FLEA FIELD AGENT

FLEA Field Agents spend a large part of their time in the field on investigative work, usually working in pairs though also work alone or in a larger group. They are usually armed, but the weapon is always concealed in order to blend in and avoid

being conspicuous. Some assignments require that Field Agents go undercover, travelling using fake identity documents that may be under the name of a front organisation or shell corporation.

Requisites:

STR/DEX10+

INT/EDU12+

Must have minimum 30% in Administration, Law, Gun Combat (Pistol) when character fully generated.

Occupation Skills:

Administration, Computer (Operation), Data Analysis, Dodge, Gun Combat (Hand Gun), Law, Listen, Search, Spot Hidden, Streetwise, Unarmed Combat, Vacc Suit, Vehicle plus three other skills as personal specialties from: Electronics, Fast Talk, First Aid, Psychology, Sciences, Gun Combat (Player choice), Languages.

Background:

E\$25,000pa salary; 2x police contacts (Keeper's discretion); E\$1000x1d10 savings; personal items related to profession; rented accommodation.

FREEHAULER

Freehauler is the catch-all term for the ever-growing numbers of self-employed flight-crews who make a living hauling cargo from colony to colony. There are scores of small haulage firms plying the shipping lanes in and around the Circum-Jove system.

Occupation Skills:

EVA, Streetwise, Speak Other Language, Astrogration, Computer Operation, Engineering, Evaluate, Mechanical (Aerospace), Pilot (Aerospace, Spacecraft), Vacc Suit.

Background:

Freehaulers are either salaried (E\$10+2d6x1000pa salary plus profit sharing) or have part-ownership in a spacecraft along with the rest of the crew; personal items related to profession; 2x contacts.

GANGSTER

A career-criminal who is a member of a crime organisation such as the Estrella Negra. This profession represents the

mid-level members of a criminal gang. They generally have easy access to money and equipment from their employers (at Keepers' discretion).

Occupation Skills:

Computer (Operation), EVA, Bargain, Fast Talk, Interrogation, Leader, Streetwise, Gun Combat (Pistol), Law (Criminal), Evaluate, Psychology, Vacc Suit, Unarmed Combat plus 2x other skills to reflect personal field of expertise.

Background:

E\$20,000pa income from illegal activities; E\$10,000 in personal equipment; Rented accommodation in one of the Galilean colonies; 2x underworld contacts (Keepers' discretion).

GENE-GENIE

Though the term is now used more broadly, Gene-Genie is the name which was originally given to the scientists working in the Circum-Jove colonies specialising in genetics, the science of heredity and variation of organisms. Gene-Genies are usually employed by one of a small niche group of cutting edge R&D companies based in the Circum-Jove system.

Occupation Skills:

Instruction, Speak Other Language, Administration, Computer (Operation), Credit Rating, Data Analysis, History, Medical (First Aid, Medicine), Pharmacy, Read/Write Other Language, Sciences (Biology, Chemistry, plus one from: Medical Genetics, Biotechnology, Forensics), Vacc Suit, Spot Hidden.

Background:

E\$50,000pa salary from biotech company, rented accommodation at one of the Galilean colonies, E\$4d6x1000 in company share options, personal equipment related to profession.

MARINE

The Interstellar Colonial Marines are soldiers specially trained for combat in space. In many ways Colonial Marines are 'special forces', undertaking short to medium duration missions including ship-to-ship and fleet-boarding actions, or the establishing

of the initial planethead during a planetary assault. They are also tasked with shipboard security of UEAf spacecraft. The marines based in the Circum-Jove system are part of Taskforce 37, established to keep the peace between rival corporations, and to provide support to FLEA and FedPol in ongoing operations against criminal and terrorist organisations. There are many specialities in the Colonial Marine Corps. The skillset given is for the basic marine infantryman. For more information on the Colonial Marine Corps, download the free supplement in PDF format from the Cthulhu Rising website.

Occupation Skills:

Armoury, Dodge, EVA, Throw, Unarmed Combat, Zero G Combat, Computer Operation, Medical First Aid, Navigation, Survival, Vacc Suit, Sneak, Blade, Gun Combat (Rifle), Gun Combat (Handgun), Gun Combat (user defined), Vehicle.

Background:

E\$17000pa salary. E\$1000x1d20 savings; personal items related to profession.

PIRATE

The pirates operating in the Circum-Jove system are mainly smugglers and scavengers, as FedPol and FLEA come down hard on those individuals involved in kidnapping for ransom and murder.

Occupation Skills:

Dodge, EVA, Zero-G Combat, Bargain, Streetwise, Astrogation, Computer Operation, Demolitions, Evaluate, Mechanical (Aerospace), Medical (First Aid), Pilot (Aerospace), Vacc Suit, Conceal, Devise, Spot Hidden, Search, Hide, Sneak.

Background:

E\$1000x1d6 savings from profit sharing; personal items related to profession; 2x contacts.

PROSPECTOR

Independent miners who search the moons of Jupiter for precious ores and minerals, including the Foscolium hunters on Io are commonly referred to as Prospectors. Unlike the image of the Wild West gold

prospector, 23rd century prospectors rely on training, the study of geology, and prospecting technology. Despite all of this, intuition still plays a significant role. With the larger mining corporations as competition, the life of the Prospector in the Circum-Jove system is becoming increasingly difficult.

Occupation Skills:

Climb, Dodge, EVA, Streetwise, Speak Other Language, Computer Operation, Data Analysis, Demolitions, Electronics (Systems), Evaluate, Mechanical (Vehicle), Medical (First Aid), Navigation, Sciences (Geology, Planetology), Survival, Vacc Suit, Vehicle, Spot Hidden, Search.

Background:

E\$1000x1d10 savings; All Terrain Vehicle; suitable prospecting equipment (Keepers' discretion), Vacc Suit.

ROUGHNECK

In the Circum-Jove system, the term roughneck is associated with the crews who work on the Jovian orbital gas mining platforms, mining the atmosphere of the gas giant for Helium 3, the primary fuel used in fusion reactors. These workers range from the unskilled labourer to highly skilled professionals, depending subjectively on the individual worker's aptitude and experience.

Because of the dangerous nature of the work, it has become common practice for mining companies to buy roughneck crews from Prison Auctions down-system.

Occupation Skills:

Climb, EVA, Computer Operation, Electronics (Systems), Engineering, Vacc Suit, Devise.

Background:

E\$20,000pa salary (unless prison-worker), company shares (unless prison-worker), suitable equipment relating to profession.

SPACE GANGER

The Space Ganger is a catch-all term for the street level thugs in the Circum-Jove colonies. Space Gangers are comparable to the street-gangs of Earth, except with

additional skills to reflect the fact that these thugs' streets sometimes are the cold hard void of space.

Occupation Skills:

Dodge, EVA, Unarmed Combat, Zero-G Combat, Bargain, Streetwise, Computer (Operation), Evaluate, Psychology, Vacc Suit, Conceal, Devise, Gun Combat (Hand Gun), Club.

Background:

Personal items relating to profession; Vacc Suit.

TERRORIST

Terrorists are typically extremist members of political or religious groups who employ violence against civilians for the advancement of their political views or religious beliefs. The most high-profile terrorist group operating in the Circum-Jove system is Covenant Europa.

Occupation Skills:

Dodge, EVA, Streetwise, Computer (Operation), Demolitions, Evaluate, Psychology, Religion, Vacc Suit, Conceal, Devise, Gun Combat (Hand Gun).

Background:

Personal items relating to profession.

JOVIAN SECRETS

This chapter is for the Keeper's eyes only. If you are not a Keeper, you may want to turn away now...

In this chapter lie the secrets concerning how the Cthulhu Mythos is related to this region of space. The chapter contains a list of conspiracies, events, locations, individuals and organisations which all have one thing in common – all have a link, no matter how tenuous, to the Cthulhu Mythos...

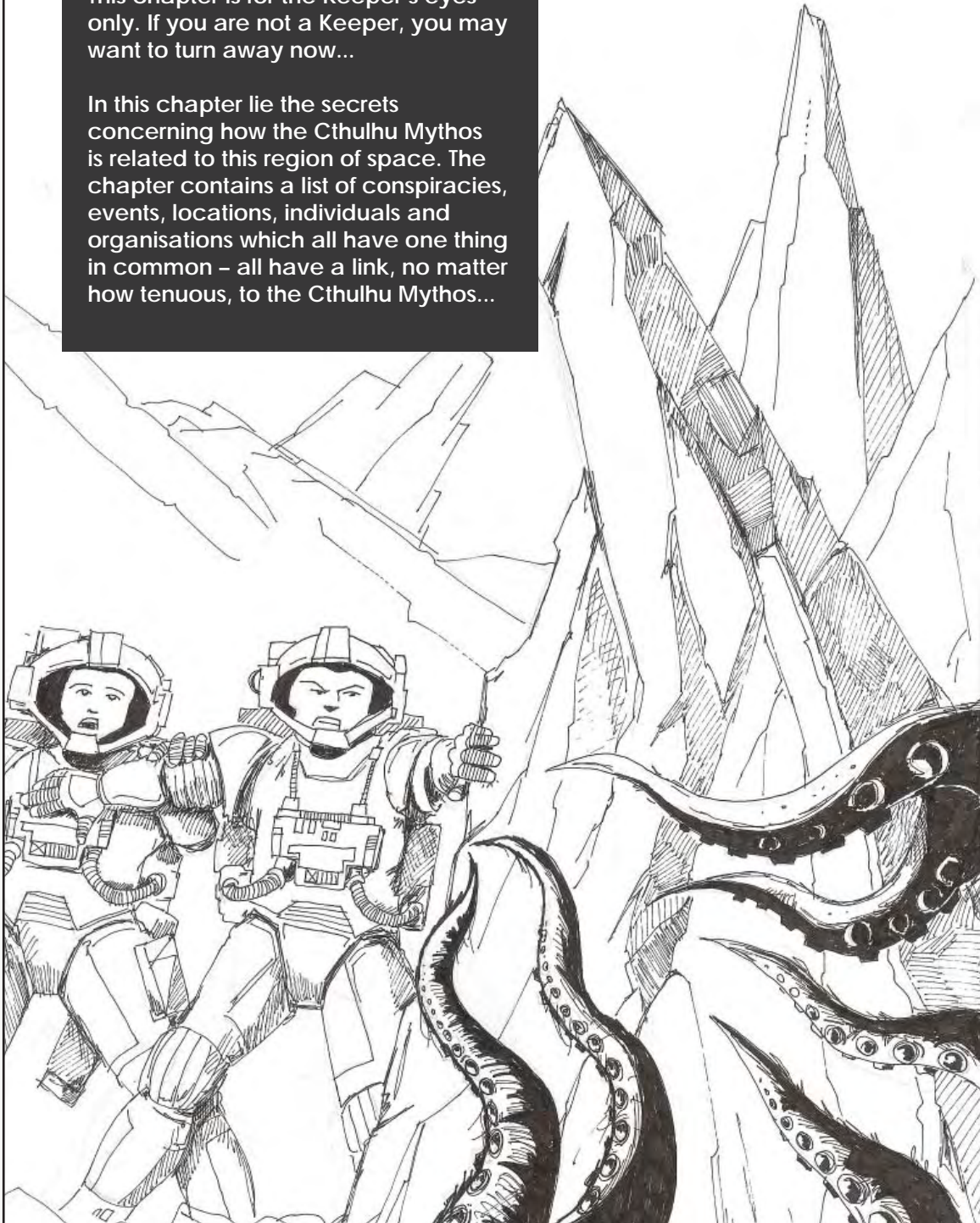

JUPITER

Even after over a century and a half of exploration and colonisation by humanity, there are secrets the Circum-Jove system steadfastly refuses to give up. One of the greatest of these secrets is what exactly lies at the core of Jupiter. It is a mystery that has been open to much speculation over the years – as even with the technologies available in the late 23rd century, there is still no way of going down to find out.

In many ways, it is perhaps better that Humanity remains ignorant. Deep below the turbulent Jovian storms, below the global ocean of tremendously compressed hot hydrogen and helium, atmospheric pressures reach a staggering 100 millions times that found on Earth. In these extreme conditions the hydrogen changes to a liquid metallic state. The heat generated by all this pressure is immense – approximately 30,000C/30,273K – substantially hotter than the surface of the sun. Within the metallic hydrogen lies a core of heavy metals, roughly 10 times as massive as the Earth, but only twice its physical size. This core is hollow, and contains... something. Something ancient. Something evil. ..

Jupiter is in fact a prison for an unnamed dying alien entity. A being of star-fire, imprisoned aeons ago when the only life on Earth was in the form of simple prokaryotes. Possibly related to Cthugha, it lies within its extra-terrene prison, blindly ignorant of the passage of time, clinging to the knowledge that one day, when the stars are right, its time will come. At that time, it will emerge in a blaze of nuclear fire – a cosmic spark which will ignite the core of Jupiter, turning the planet into a proto-Brown Dwarf, an angry coal glowing in the cold night of space...

THE GREAT RED SPOT

Jupiter's Great Red Spot is colder (and thus, higher in altitude) than most of the other clouds on the planet, with cloud tops about 8 km above the surrounding clouds.

Winds around the edge of the clouds peak at about 430 km/h (120 m/s). The storm rotates counter-clockwise, with a period of about six Earth days or 14 Jovian days. Its dimensions are 24–40,000 km west-to-east and 12–14,000 km south-to-north.

Robot probes have been launched into the Great Red Spot on numerous occasions, but none has survived long enough to send back any concrete evidence concerning the interior of the storm, and why the storm has persisted for at least the 400 years that humans have observed it through telescopes.

The Red Spot is actually the fallout from a failed Mi-Go experiment conducted centuries ago. The Mi-Go had detected strange signals from deep within Jupiter, and the experiment was designed to burrow deep into the atmosphere of the gas giant in an attempt to glimpse the origin of these signals. The experiment failed and was quickly abandoned, but the technologies employed by the Mi-Go left an extra-terrene atmospheric anomaly – deep within the storm lies an extra-dimensional portal, a ball of blackness around which the storm rotates. Abandoned by its creators, this portal has recently been discovered by the Lesser Independent Race known as the Space Eaters, who are now using it as a portal to enter our universe. Information about these creatures can be found on page 84 of the Malleus Monstrorum.

The portal is gradually closing, and in a few centuries will be gone, at which point the storm will begin to dissipate.

IO

Io's volcanoes continually expel an enormous amount of particles into space, and these are swept up by Jupiter's magnetic field, becoming ionized in the magnetic field and forming a doughnut-shaped track around Io's orbit called the Io Plasma Torus.

The Io Plasma Torus is a natural attractor

of Fire Vampires. They flock to the orbital path of Io in their hundreds, sometimes in their thousands, but their activity is usually catalogued as unusual natural phenomena. What it is that attracts them, and what they gain from their interaction with the torus is unclear.

EUROPA

Of all the Galilean moons, frozen Europa, with its subterranean world-ocean has the most connections to the Cthulhu Mythos.

In the black world-ocean which lies below Europa's icy crust lie the ruins of a cyclopean city of alien architecture. The architecture is similar to ruins found below the oceans of Earth, and only the Deep Ones themselves know if this is a different city, or if this actually part of sunken R'lyeh extending into the oceans of Europa through some unfathomable extra-dimensional anomaly. What is known is that in ancient mausoleums, a number of Cthulhu's kin lie sleeping here.

Two factions from Earth know of the existence of this city. They are the Seaborne Foundation and the super-black branch of Military Sciences Division (MiliSci) known as the Black Chamber. The Black Chamber has made some kind of deal with the Seaborne Foundation, for access to these ruins. Neither organisation trusts the other, and both are secretly working towards the downfall of the other.

ARGIOPE LINEA

Argiope Linea is the name of a yawning ice chasm which cuts deep into the surface of Europa. It is below the Argiope Linea where the ancient alien city lies.

ARGIOPE RESEARCH STATION

At the bottom of Argiope Linea is a small research station run by Triton Marine Research (TMR). What most people do not know about TMR is that the company was set up by its parent company, the Seaborne Foundation, to provide cover for a number of top secret projects, the

primary one being codenamed Altior. Project Altior concerns cloning a race of Super-Deep Ones from a combination of Deep One and Star Spawn DNA.

THE BLACK CHAMBER

There are many sub-divisions in the Military Sciences Division (MiliSci) arm of the United Earth Armed Forces (UEAF), ranging from lower echelon black projects to the super-black branch known as the Black Chamber. The Black Chamber does not officially exist, and most members of the UEF government can exercise plausible deniability in this matter, because most of them believe this also.

The Black Chamber is in charge of all research and development involving the occult and/or alien technology. They have a base in the Circum-Jove system, on the Galilean Moon Europa, where they are engaged in what can only be described as The European Conspiracy.

CILIX

A top-secret Black Chamber base is located within the Cilix Crater on Europa. From here several exploratory missions have been sent into the alien ruins codenamed Telephassa. While the Black Chamber hopes to find technology in Telephassa that they can exploit, they are also accumulating data with the intention of finding a way to destroy the site if the event becomes necessary. Cilix has a serious amount of black project funding, and has a dedicated team from the MiliSci Commando Force assigned to it.

DEEP ONES

The Deep Ones in the Circum-Jove colonies have mostly arrived as employees of the Seaborne Foundation or one of its subsidiaries, and can be found on the moon Europa. They are as careful as on Earth to conceal their identities from the humans around them.

PROJECT ARONNAX

Aronnax is the name given to the project concerning the exploration of the site codenamed Telephassa.

PROJECT NEMESIS

The sister-project of Project Arronax, the goal of Project Nemesis is to develop a means to destroy Telephassa and its sleeping inhabitants, should the need arise. Currently Project Nemesis has developed experimental Contra-Terrene (antimatter) weapons. They probably have the explosive yield to wipe Telephassa from Europa, but the resultant shockwave in the European World-Ocean could potentially cause the deaths of many colonists.

THE SEABORNE FOUNDATION

The Seaborne Foundation is a consortium of rich businessmen from across the globe, with sizeable investments in several extra-solar colonial interests - notably Proxima II in the Proxima Centauri star system, and Horizon in the Groombridge 1618 star system - as well as holdings in a number of marine research and genetic research companies.

The Foundation prides the privacy of its members, and as such very little is known about them. Founding member Daniel Seaborne lives out his life in a private arcology in orbit around Earth. He is 133 years old, kept alive by the medical technologies affordable by being a multi-billionaire. What is not common knowledge is the fact that the senior members of the Seaborne Foundation are also Deep Ones and high ranking members of the Second Church of Ashago. The Seaborne Foundation's extra-solar colonial interests are the main facilitator for Deep One migration from Earth...

Telamon Seaborne, cousin of Daniel Seaborne is in charge of operations on Europa.

TELEPHASSA

Telephassa is the Black Chamber codename for the alien ruins located in the oceans below the Argiope Linea.

GANYMEDE

Deep within Jupiter's gravity well, Ganymede hides many secrets beneath its scarred surface, and of the Galilean moons is second only to Europa for connections to the Cthulhu Mythos.

DIMENSIONAL SHAMBLERS

For reasons known only to themselves, Dimensional Shamblers are attracted to the hidden Elder Thing ruins deep within the labyrinthine catacombs beneath Ganymede. Those disappearances in the lava caves which are not the doing of the Mi-Go are usually caused by these creatures.

THE GANYMEDE LIGHTS

The Galilean moon Ganymede has an aurora similar to the one found in the polar regions of Earth. Interaction between the magnetospheres of Ganymede and Jupiter produces dazzling variations in the auroral glows in Ganymede's tenuous atmosphere of oxygen.

The aurora is harmless, but sometimes attracts Colours out of Space.

THE LABYRINTHS OF GANYMEDE

Beneath the surface of the Galilean Moon Ganymede lie thousands of kilometres of lava tubes, caves and caverns. The top levels are popular tourist attractions, but even hardened caving experts eschew journeying into the lower levels. There have been reports of explorers going missing in these seemingly endless black warrens. Deep below Ganymede there lie the ancient ruins of a long-abandoned Elder Thing city...

MI-GO

The Mi-Go began abandoning their operations in the Jupiter system when humans began arriving in the early 22nd century. Though the Mi-Go abandoned the last of their sites on Europa in 2139 (see The Europa Incident in the history chapter), they continue their mining operations beneath the surface of Ganymede, albeit in reduced numbers. There are obviously minerals and ores of great importance on this moon. To avoid any possibility of detection, the Mi-Go travel to and from Ganymede using Gate technology, thus removing the need to appear above ground.

On several occasions, human explorers have stumbled unwittingly upon the Mi-Go activities, and have been abducted to prevent news of their discovery reaching the surface. These abductees are usually experimented upon. Some end up as brains in jars; others have been surgically conditioned to become Mi-Go agents and released back into the colonial population.

THE FORGOTTEN CITY

Deep beneath the region of Ganymede we know as Galileo Regio lies a forgotten and ancient city of the Elder Things. It was built almost a billion years ago, when this race of star-faring creatures first arrived in our solar system, but was slowly abandoned in favour of the colony on Earth. No living Elder Things has inhabited or visited this city in tens of millions of years. That is not to say that they will not return here in the future. There is also the likelihood that the site could still contain remnants of their passing, including evidence of Elder Thing technology, plus perhaps one or two of their slave race, the Shoggoths...

NIDUS LABS

Nidus Labs is where the research and development arm of biotech firm Qin Mian Technologies conducts its most sensitive work. Nidus is a small laboratory complex located at the Arbela, a deep fissure in the

icy surface of the frozen moon. In the lower levels of Nidus Labs, scientists have foolishly been experimenting with Shoggoth matter. They were attempting to create some kind of bio-weapon by splicing Shoggoth DNA with a sample of the virus that caused the Ngano Plague of 2250. What they have ended up with is a highly infectious contagion which mutates its victims into proto-shoggoth matter.

CALLISTO

There is little in the way of activity from mythos-related alien races on Callisto, but it is a veritable hotbed of cultist activity. The large transient population of the colony on Callisto has made it the perfect base of operations for the nefarious activities of several less than savory organisations...

DR SAMUEL BACHMANN

Dr Bachmann is an enigma. Welcome at the tables and parties of the movers and shakers of the UEF he manages to remain circumspect and unknown to the general population. He is, however, much more than the urbane, fiercely well-educated and witty man he appears to be. He is a mythos sorcerer of some considerable power and knowledge. He is willing to pass on this knowledge but at a hefty price. But not just anybody can hire him. He carefully vets his clients before he even meets them. Sometimes his clients never complete their studies, they just disappear...

THE ORDER OF THE GOLDEN ROSE

A secretive group with a small but dedicated following, the Order of the Golden Rose migrated their activities from Mars to Callisto about 10 years ago after their leader, the charming and charismatic libertine Lincoln Jones, was named as being involved in a scandal involving a prostitution ring and a wealthy UEF senator's daughter.

The group practice a form of free love that involves some pretty debauched

behaviour, and has prospered in the Circum-Jove colonies. Lincoln Jones has even published a book, *The Philosophy of the Golden Rose*, which has earned him a certain amount of notoriety in some circles.

Unbeknownst to many of his followers is the fact that Jones is a priest of Y'gonolac and the sect is a way to insure hosts for this monster. Those in Jones' trusted inner circle like to prey on the transient and the dispossessed, upon whom they commit the usual depravities and brutalities associated with Y'gonolac.

THE REID BUILDING

Even in the 23rd century there are many that still believe in haunted homes and the Reid building is just on place. Sighted in the Dockside quarter of Midgard City, this building has developed a gruesome reputation with the locals. A reputation built on several suicides, odd deaths and sinister rumours. The building is home to several families that are shunned by the locals. Strange lights, and stranger people have been seen entering the building.

THE SERVITORS

A street gang that peddles drugs, prostitutes and guns, the Servitors are known for their brutal nature and belief in the occult. They have a close-knit society, which originates from a variety of Central and South American cultures. They hold bizarre rituals and are known to regard their mysterious and enigmatic leader as something of a messiah figure. In recent months several brutal ritualised killings have been attributed to them.

THE TEMPLE OF THE EYE

The Temple of the Eye is a quasi-religious group that has sprung up in the Circum-Jove colonies. Fusing new age mysticism with prophetic old-testament style doom-saying, the members of this cult are recognised by their red Jupiter pendants. Their leader, Julius Sark, is an ex-employee of Hallidor Corporation. What is not common knowledge is that Sark and his

inner circle are actually cultists worshipping the Space Eaters, who enter our universe via a portal deep within the Great Red Spot of Jupiter. The Temple of the Eye make regular sacrifices to the Space Eaters in the form of abducted illegal immigrants and other unregistered travellers passing through Midgard City.

TRANSIT STATION 13

A suborbital transit station between Midgard City and the Asgard Industrial Park, Transit Station 13 was closed down over a year ago after a flash fire destroyed it and a docked personnel transport, killing 126 people. Conspiracy theories and dark rumours have dogged this disaster. Some claim that the passengers' bodies were not burnt but badly mutilated, and that no traces of fire were found by the initial rescue team. Rumours also claim that MiliSci arrived on the scene and closed off the station. All of which is denied by the authorities. Though it is an odd fact that all of the ten man fire team that first arrived on the scene that day have either left the colony, vanished or died.



CUT BACK BLUES

By Gary Cooper.

Welder was starting to irritate Joel. For days now he had heard nothing but the booming thump and crash of the robot digger's turbines. The grinding of its giant gears screeching and groaning as it worked amongst the grit and debris of its own excavations. The vibrations of the machines obsessive work pulsed through the mineshafts dislodging dust and stone. Joel felt saturated by the noise of the machinery; its oppressive presence seemed to flood into every one of his pores. Time was, he would often think to himself, this rock in space once had loads of good old-fashioned humans sweating over it. That was good, you needed people to talk to, to back you up if things go bad and sometimes get drunk with. But out on this little asteroid there was only him and Welder. And Welder was trying to kill him.

Cut backs. That's what's to blame, thought Joel. Crazy! This was the goddamn 23rd century and "cutbacks" was still screwing the average working stiff. Got a problem in ore production? say the bosses, no problem! Just cut back! Get rid of four highly skilled humans, and replace them with an old banged up, evil looking, yellow monstrosity named "Welder." Sure, why not? Coz everyone knows that cheaper make better! For all our tech, mused Joel; humans were still as dumb as ever.

He had hated Welder on sight. It looked like some huge crane crossed with a blast furnace and some beast from an ancient steaming jungle. A metal predator that was all industrial yellow with warning chevrons, heavy tracks, cold steel and smoke. The company reasoned it was better to use this goliath than a bunch of working stiffs that they'd have to pay an honest wage to. After all; it doesn't need a pressure suit, piss breaks; hell, it doesn't even need to eat. It just works. Doing nothing but chewing up ore and poring out slaggy crap from its fiery belly like some dragon. The only reason he still had a job, thought Joel glumly, was the simple economic truth that it was cheaper to have a human mechanic than an android repairing "Welder." Androids had to be insured fully, programming checked and its "body" regularly overhauled in this bitter environment. The mines on the asteroids of the rings of Jupiter could be tough on an android. But a human...well he was just too dumb and too expendable down here. Who cared if you lost one? Yeah, that damn Welder got more respect than poor old Joel. He even had to keep making reports on its production and repair routines. Yet, no one seemed to ask about him. No reports or inspections for him. He was just another human out on some suck ball. Who cared? It was enough to send a guy crazy.

Something else about Welder was worrying him. The day Welder went weird there had been some kind of energy surge from the asteroid core. All the comms went out, the sensors went crazy, and Welder just...stopped. It sat there like it was listening to something. The sudden alert stillness was somehow more unnerving than watching the thing move. In a way he would have preferred if the beast at just gone crazy like some old movie. He could have understood that, but the stillness had an expectancy and a menacing promise. Then suddenly it started up again, but this time with a purpose alien to its programming. It ignored his previous work orders, discarded its load, and started digging downwards into the solid rock core. At first he thought it was just a malfunction, but every time he tried to stop it, he failed. Remote console access no longer worked, trying to hack into its CPU resulted in nothing but a scream of static. It even ignored his increasingly desperate verbal commands and when he tried to stop it physically it tried to hurt him. He had risked his neck by running up to the thrashing machine and tried to get to the instrument panel on its side. That was when the grabber tried to take his head off. Later, realised Joel that was the first time Welder tried to kill him. The second time he had got himself onto the back of the machine and tried to access the controls via the ore grinders. As he scrambled on the large metal teeth of the grinders they started to roll and only by sheer desperate luck did he jump clear. The third time was when the huge robot started to reverse as Joel stood behind it, the massive steel tracks nearly crushing him. The thing's sensors would have told him he was there. It knew what it was doing.

He had taken a look at its current programming data from a remote console. But the code it was using to think with had changed. Unrecognisably so. Streaming patterns of data he had never seen before. The language almost seemed to twist and undulate as he looked at on the screen. It was like its basic programming had been completely re-written by a madman.

Joel had tried radioing for help, but for some reason he couldn't get a signal out. Too much interference. He was truly alone on this rock, and all he could do now was watch the great beast work. Joel was isolated, cut off as the massive machine tore on with terrible purpose. The thing had become a terrific engine of deep concentrated focus as it ripped into the fabric of the asteroid. It wanted something, or something wanted it to get to them. It was prepared to kill anyone that tried to stop it, and Joel felt insignificant to its cold will.

One night as he slept fitfully in his pressured cabin; he was jolted awake by a deep systolic thump, like some huge rotten heart given life. It felt like a punch to his stomach. Something deep in Joel's soul went dead with fear as he realised the vibrations of the machine had stopped. Silence pervaded throughout the mine. In the quiet that followed he knew that something else was now moving through the mineshaft, rising and rushing through the empty tunnels. Welder had found what it was looking for, and Joel knew that whatever it was Welder had found now searched for him...

ESCAPE VELOCITY

Escape Velocity is a short Cthulhu Rising adventure for a group of up to six players, designed to be played in one gaming session. Set in its entirety onboard the *Jovian Discoverer IV*, an orbital gas-mining platform (or 'rig') in Jupiter orbit, the adventure assumes that the Investigators are all convict-workers whose prison contracts have been purchased by the corporate owners of the mining platform as part of the Penal Involuntary Servitude program (see *Keeper's Information 4* for more details).

The adventure is designed to play out like a horror-action movie, and from the start the investigators are against the clock. The mining platform is falling into Jupiter's gravity well, and they have a finite amount of time to overcome a series of obstacles and formulate an escape plan before the platform is destroyed by the crushing atmospheric pressure.

Will they reach escape velocity in time..?

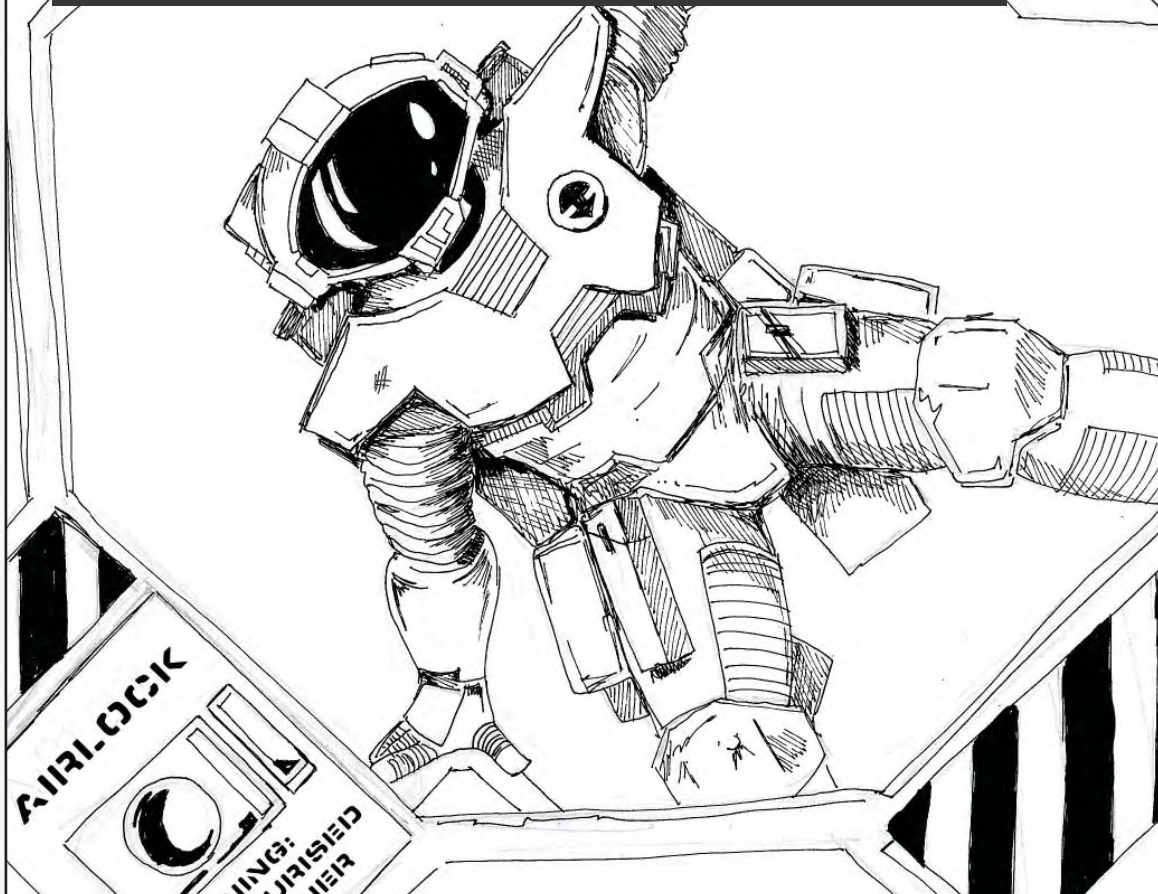

KEEPER'S INFORMATION 1

Adventure Background/Timeline

A particularly virulent virus of unknown, possibly alien origin has got loose on board the Jovian Discoverer IV. It has already infected most of the crew, and was the impetus for a chain of events set to culminate in the orbital mining platform plunging to its doom in the crushing depths of Jupiter's atmosphere.

Because of the fast-paced nature of this adventure, the players will be unlikely to ever find out the complete story behind the chain of events that have led to their current situation. For Keepers, these events are broken down into a timeline. This timeline includes all important events up until the start of the adventure, as well as developments after the adventure starts, to simulate the gradual breakdown of systems onboard the Jovian Discoverer IV. Keepers are encouraged not to give the players much time to think, and if the pace starts to flag, move the timeline forward one section.

At the start of the adventure timeline, the Jovian Discoverer IV is 7 weeks into a 12 week shift, on the opposite side of Jupiter from Callisto.

Keeper's note: deckplans, handouts and rig personnel are all detailed fully in Appendices A-D at the end of this adventure.

18 Hours Ago

A distress signal is picked up by the orbital gas mining platform Jovian Discoverer IV. The signal is from an unregistered freighter by the name Telemachus – it requests immediate aid as it has suffered a critical systems failure and is falling into Jupiter's gravity well.

16 Hours Ago

After a discussion amongst the senior crew members, the Jovian Discoverer IV dispatches a team onboard its shuttle in an attempt to lend aid to the stricken vessel. In the team are:

- Helmsman Jacob Hollingshead
- Assistant Medical Officer Alex Lee
- Extra-vehicular activity (EVA) Specialist Darren Vogel
- Rig-Tech Hollis Sutter

13 Hours Ago

The away team arrives at the stricken freighter.

12 Hours Ago

The Investigators get into a fight during a routine EVA work detail, and are sent to the brig.

9 Hours Ago

The Jovian Discoverer IV receives a message from the away team: They are enroute back to the rig from the Telemachus. One survivor was rescued before the freighter fell too low into the Jovian atmosphere. She initially seemed shaken and distressed, but physically in good condition. During the return flight, she suffered some kind of fit, attacking and injuring Hollis Sutter before she could be restrained and sedated.

Unknown to the team, the survivor is infected with a particularly lethal bio-weapon, and now so is Sutter...

5 Hours Ago

The shuttle arrives back at Jovian Discoverer IV. The survivor is kept sedated and restrained in the infirmary. Doctor Shaheen Malik the senior medic onboard the rig gives Sutter a tetanus shot for his bite and dresses the wound, then sends him back to work. Warden-Administrator O'Halloran sends a message back to Callisto Control, informing them of the situation.

4 Hours Ago

Sutter begins to show signs of illness. By the time he goes to the infirmary, he has already infected Deputy Warden Anderson, Assistant Rig-Chief Lambert, Rig-Tech Ivanov, Roughneck Suarez and Roughneck Kovac.

3 Hours Ago

More crew members start to call in sick. Doctor Malik misdiagnoses the symptoms as Martian Flu, which has been doing the rounds in the Galilean colonies of late.

2 Hours Ago

Sutter hits Stage II of the virus. He becomes psychotic and attacks Vogel, biting him. Vogel and Durand manage to restrain Sutter and take him to the infirmary.

1 hour 40 Minutes Ago

Doctor Malik now identifies the illness as resembling late-stage Ngano Plague. Sutter is sedated and placed in the infirmary cryovault. Malik now commits to her personal notes her concerns that she does not have the equipment necessary to test for Ngano Virus, and has no idea how many people onboard could already be infected.

1 hour 30 Minutes Ago

Warden-Administrator O'Halloran holds an emergency meeting with section heads: Senior medic Malik, rig chief McKenzie and chief engineer Johannson. They decide that they have to inform their bosses back at Callisto of a possible outbreak of Ngano Plague, despite the claim seeming ludicrous, and impose a quarantine order on the rig. Johannson, who is an ex-soldier, knows how the authorities 'deal' with quarantine situations – they have been known to destroy ships rather than risk infection spreading. He secretly begins working on an escape plan.

1 hour ago

Darren Vogel reaches Stage II and attacks Doctor Malik in the infirmary, throttling her with a length of cable. Alex Lee the assistant medic arrives in time to find the corpse of Malik with the blood covered Vogel crouched over her. Lee sounds the alarm and avoids the same fate as the poor doctor by locking himself in a washroom. Deputy Wardens Petrov and Anderson arrive and take down Vogel with shock rifles. Vogel is restrained and sedated in the infirmary.

40 Minutes Ago

O'Halloran authorises Petrov to go to the security room and open up the lethal weapons box in the weapons locker. Petrov and Anderson arm themselves.

30 Minutes Ago

Anderson begins to show signs of infection. Petrov tricks her into entering the brig airlock, knocks her out and leaves her there.

20 Minutes Ago

Various crew-members are not responding to their comlinks. O'Halloran, Petrov, Miyazaki and Lee regroup in operations.

Assistant medic Alex Lee receives new orders on an encrypted channel, and quietly heads off to start the process of scuttling the Jovian Discoverer IV. He uses the excuse of recovering medical supplies from the infirmary. Petrov accompanies him at O'Halloran's insistence, but Lee manages to give him the slip. Once alone, Lee patches into the avionics systems and introduces a computer worm to permanently disable several critical pieces of software, including the automatic pilot program.

15 Minutes Ago

Hollingshead, Johannson and one of the convict-workers (Kovacs) attempt to flee the rig in the shuttle before the corporation arrives to 'contain' the outbreak. O'Halloran orders them to stop. They ignore him and begin the takeoff cycle. O'Halloran orders Miyazaki to override and close the hanger door controls to prevent the takeoff.

13 Minutes Ago

Unfortunately Hollingshead is gripped by mania and attempts to pilot the shuttle through the rapidly closing doors. He is not as skilled a pilot as he thinks he is, and crashes the shuttle inside the hangar, causing a large explosion. The hangar doors are jammed open, and a flash fire rages as the atmosphere is vented.

12 Minutes Ago

Automatic emergency bulkheads attempt to seal the hangar, but debris from the wrecked shuttle has damaged one of the airlocks to A-Deck. The bulkhead is stuck partially open, and air continues to vent. The flash fire causes multiple electrical fires to knock out primary networking on the ship. Communications, light and power begin to fail.

11 Minutes Ago

Petrov arrives back at Operations, and begins hammering on the door, which is locked. O'Halloran refuses to open the door, scared that Petrov is now infected too. Ignoring Petrov's shouts, O'Halloran orders Miyazaki to lock down Hab-B, imprisoning all the convict roughnecks.

Engineer Amy Cooke manages to repair the circuits for the emergency bulkhead to A-Deck, but while trying to do so she is caught in the closing bulkhead doors. Her left foot is crushed.

8 Minutes Ago

Prospero, the Jovian Discoverer IV AI, calmly informs Operations that the orbit of the rig has begun to decay beyond established safety margins and requires human intervention. When interrogated further by Miyazaki, it is revealed at a computer program has irretrievably corrupted the firmware of several primary network routers, meaning that the AI can no longer control the attitude jets on the station. At present rate of decay, the rig will reach the 'hard deck' (point of no return) within 58 minutes. Any lifeboats will be unable to climb out of Jupiter's gravity well unless launched within the next 8 minutes. In addition the loss of the network routers has disabled the laser and quantum communications, leaving radio only.

7 Minutes Ago

Miyazaki tells O'Halloran that they have to get to the lifeboats. O'Halloran pulls a gun and tells her to sit down and stay put.

6 Minutes Ago

Miyazaki pings all crew member ID tags,

and notices the six still trapped in the brig. Before O'Halloran can stop her, she sends the security code to release them, however he smashes her PDA, preventing her opening the brig airlock.

NOW – The Adventure Begins!

External Atmospheric Pressure: 1.0
The players awaken.

2.5 Minutes Later

External Atmospheric Pressure: 1.5
Systems failure: Jovian Discoverer IV's non-critical computer network fails, knocking out primary lighting, vid-comms, wireless/remote computer access and AR overlays. Red emergency lighting comes online, and wired audio comms still work. Onboard data network still accessible via static hardwired terminals.

5 Minutes Later

External Atmospheric Pressure: 2.0
Structural failure: One of the thruster pylons buckles and breaks away under the increasing atmospheric pressure. The rig lurches – DEX check to stay on feet.

10 Minutes Later

External Atmospheric Pressure: 2.5
Systems failure: Critical computer network failure. Data access compromised. Only data stored in local buffers is now accessible. Life support system fails - this includes heat, and atmospheric recycling. Nothing that will affect PCs short-term – the rig will be gone long before the air runs out...

20 Minutes Later

External Atmospheric Pressure: 3.0
Systems failure: The magnetic containment field around the fusion reactor powering the rig begins to fluctuate. The vessel AI, Prospero, immediately begins emergency shutdown protocols.

30 Minutes Later

External Atmospheric Pressure: 3.5
Systems failure: Artificial gravity fails.
Systems failure: The rig loses power as the reactor shuts down. Battery backups come online.

40 Minutes Later

External Atmospheric Pressure: 4.0

Structural failure: A section of the gas storage ring buckles and breaks away from the rig. Rapid depressurisation of the entire ring access corridor.

50 Minutes Later – the hard deck

External Atmospheric Pressure: 5.0+

Structural failure: The rig begins to implode. If the PCs are still onboard, they die.

KEEPER'S INFORMATION 2

The Telemachus

The freighter Telemachus was carrying the only remaining samples of a very dangerous bio-weapon – couriating them covertly to a top secret lab complex on one of Jupiter's smaller moons.

The vessel was flying under false registration papers, and was in fact carrying a corporate mercenary unit. They were responsible for stealing the bio-weapon from the labs of a rival corporation on Ganymede. The intel surrounding the package to be stolen was fragmentary and vague. As such they did not take proper precautions. The virus got out.

By the time the away team from the Jovian Discover IV arrived, there was only one person left alive onboard the Telemachus. The lone survivor had flushed the corpses of her colleagues out the airlock, after witnessing the final stages of the virus. She then sent out the distress call, but did not know she was already infected too...

KEEPER'S INFORMATION 3

The Contagion

The research and development arm of an unidentified corporation has foolishly been experimenting with Shoggoth matter. They were attempting to create some kind of bio-weapon by splicing Shoggoth DNA with a sample of the virus that caused the Ngano Plague of 2250. What they ended up with was a highly infectious contagion with a 99.6% communicability rate, and

which mutated its victims into proto-shoggoth matter.

Ngano Virus

The Ngano Virus is a highly contagious viral disease that causes vivid hallucinations and acute paranoid delusions in those exposed. Infected victims are dubbed 'Crazies' due to the insane psychopathic state induced during the plague's later stages.

The virus originated on 58 Eridani II (Ngano), a jungle world in the 58 Eridani star system. The plague quickly wiped out the colony on the planet, and due to its 4 week incubation period claimed almost half a million lives on other worlds before its spread could be checked.

58 Eridani II is still quarantined by military blockade. It is a no-go area to all except android science teams. The men and women enforcing the blockade have a shoot-to-kill policy on any spaceships attempting to leave the system that do not first submit to rigorous quarantine checks. The danger pay for working the military blockade is high. An individual accidentally exposed to the atmosphere of 58 Eridani II is immediately banned from ever entering the Sol system, under pain of death, whether infected or not.

Scientists have since identified the source of the Ngano Virus: a species of hyper-evolving virus analogue indigenous to 58 Eridani II. The virus has an uncanny survival trait that allows it to mutate and evolve at a rate that is in the order of millions of times faster than its Earth-bound cousins. This trait has allowed the virus to adapt to be able to infect and thrive in life forms not native to its home planet – i.e. in human hosts.

The Ngano-Shoggoth Virus

The new improved Ngano-Shoggoth pathogen initially starts out like a classic case of Ngano Virus, but incubation and onset of the later stages is much, much more rapid. Also, in the later stages the host body begins to decay into a pool of protomatter which eventually reassembles

itself as a Proto-Shoggoth.

The virus-path is as follows:

Infection The virus is spread through contact with an infected victim's bodily fluids (blood, sweat, saliva etc) which is swimming with Ngano Virus II containing Shoggoth DNA.

Incubation Incubation period is terrifyingly short – 30-60 minutes

Stage I Temperature rise. Coughing. Eventually coughing leads to bleeding from eyes, nose, mouth. Time until onset of next stage – 1-4 hours

Stage II Victim becomes psychopathically violent. +5 STR. This stage usually lasts a further 1-4 hours at which point the infected individual collapses with multiple organ failure as Shoggoth matter invades system.

Stage III 10-15 minutes after death the body begins to reanimate as Proto-Shoggoth matter.

The genetic engineers who created the Ngano-Shoggoth Virus were still working on an encoded self-termination code when the crew of the Telemachus stole the samples.

Infection Vectors

The main infection vector of the Ngano-Shoggoth Virus is via bodily fluids e.g. sweat, saliva, mucus, blood. Contact with an infected individual requires the player to make a CON check vs a variable POT rating dependant on the type of contact:

POT 10 Skin on skin contact with an infected individual.

POT 15 Skin on skin contact with infected fluids other than sweat e.g. saliva, blood, mucus etc.

POT 20 Infected fluids entering body, via a bite, scratch, kiss etc.

KEEPER'S INFORMATION 4

Penal Involuntary Servitude

Prisoners in United Earth Federation (UEF) territory who have been sentenced to a minimum 5 year prison term can be sold at auction into Penal Involuntary Servitude.

Penal Involuntary Servitude has existed since the Colonial Act of 2140 amended the Geneva Statute of 2084, allowing the Federal government the authority to sell the contracts of individual prisoners to private corporations. The prisoner then becomes the property of the corporation, who has the right to set the prisoner to work, usually at those tasks deemed unpopular and dangerous by the corporation.

Penal Involuntary Servitude makes financial and economic sense for both the UEF government and those megacorporations involved in colony management: the UEF cannot afford to maintain and supply large numbers of prisons on every major colony world, and the megacorporations gain access to a large supply of cheap labour.

Penal Involuntary Servitude does sometimes have advantages. Criminals who manage to work off their sentence through this system usually receive help starting a new life in the colonies by their former keepers.

The prison slang for Penal Involuntary Servitude is 'doing a piss', which comes from the initials PIS. In the Sol System, the Mars Prison Contract Auctions have become infamous as the go-to place for corporations wishing to recruit disposable personnel for dangerous work assignments.

KEEPER'S INFORMATION 5

The Jovian Discoverer IV: Overview

The Jovian Discoverer IV is one of 8 orbital gas-mining platforms in the Jovian Holdings fleet, and left Mars Orbital Shipyards in 2254, from where it was towed by Colonial Heavy Mover to Callisto orbit. It has been in service in the Circum-Jove colonies ever since.

An orbital gas mining platform or 'rig' is a large structure designed for orbital operations to house the workers and machinery needed to harvest valuable atmospheric gases from gas giants, primarily 3He , which is the main fuel used in fusion reactors of the late 23rd century. Generally, mining platforms ply their trade in the upper atmosphere of gas giants, where the pressure, radiation and gravity are at their weakest. As technology improves, mining deeper in the gravity well is gradually becoming both feasible and profitable.

Jovian Discoverer IV uses a Richter Dynamics RD2300 Fuel Scoop to mine 3He gas. This device combines a powerful magnetic field generator, an atomic sensor and a vacuum lock collector to actively suck gases from the atmosphere of a gas giant. The ionised gas particles are separated by mass and charge in a centrifuge, and the 3He is then processed and injected into the rig's ring of storage tanks, ready for loading onto robot transports that continually fly the Jovian Loop between the rigs and Callisto. At Callisto the transports unload their payload into the giant Jovian Holdings orbital fuel depot located there.

All non- 3He materials are processed according to value and either stored for use or ejected back into the atmosphere.

The Jovian Discoverer IV is powered by a SunCore VII fusion power plant, which provides all the power the rig needs for 36 months of normal operations before requiring refuelling. In addition, a closed-loop recycling system means that water

and air supplies for a standard crew compliment should last up to 12 months before resupply.

KEEPER'S INFORMATION 6

Jovian Discoverer IV: Working Practices

Crew-members currently serving on the rig under a Penal Involuntary Servitude order are always first assigned as Roughnecks. Only through working the rig can they hope for any promotion to more responsible position.

Crew-members currently serving on the rig under a Penal Involuntary Servitude order wear different coloured clothing and spacesuits to identify them from the normal-contract crew.

Crew-members currently serving on the rig under a Penal Involuntary Servitude order have a separate habitation block from other crew members. They are forbidden from socialising and/or fraternising with crew members unless the Warden-Administrator says otherwise.

KEEPER'S INFORMATION 7

Jovian Discoverer IV: Systems

The Jovian Discoverer IV has a number of platform-wide systems. Each description below also contains the status of the system as the adventure begins.

Augmented Reality Overlays/Tags

Jovian Discoverer IV has functionality to allow positional augmented reality ('AR') overlays on decks A through D. These overlays and tags are visible to anyone with an AR interface and the correct access codes. This allows crew members the ability to call up informational displays without needing a computer terminal, or leave virtual sticky notes for one another, etc.

Within minutes of the adventure starting, all wireless AR functionality will be lost. Oh well...

Communications

For routine communications, Jovian Discoverer IV is equipped with a long range laser communicator keyed to the Circum-Jove satellite network. For more sensitive data, there is a quantum communicator. For emergencies there is also a long range radio transmitter backup.

8 minutes before the start of the adventure, an act of sabotage disables the laser and quantum communications, leaving radio only. Within minutes of the adventure starting, a critical failure of the computer network will result in all onboard wireless communications functionality being lost. Static communication devices hard-wired into the network will still function as normal.

Computers

All Jovian Holdings mining platforms are equipped with a carbon-60 based core mainframe running Prospero, a robust Gamma level AI designed specifically for deep-space mining craft. Prospero is programmed to monitor and maintain all autonomic systems such as life support, power and gravity, as well as having the capability of operating communications and security if necessary.

Prospero can be contacted via any terminal on the rig, or via any wireless device with access rights. However the AI can only be reprogrammed via the main CPU terminal in the operations centre.

10 minutes into the adventure, the computer network will suffer a critical failure. This will knock out main lighting, wireless connectivity, life support and AR.

Gravity

The Jovian Discoverer IV maintains a standard gravity field of 0.9g.

30 minutes into the adventure, the artificial gravity will fail. The station will immediately be in a state of zero-g.

Life Support

Prospero, the onboard AI, constantly monitors the autonomic life support

systems, making minute adjustments to air pressure and temperature to keep the rig at an acceptable equilibrium. Water and coolant for these environmental systems is stored on C-Deck.

Although life support systems will fail 10 minutes into the adventure, the effects will not be felt before the station breaks up in the Jovian atmospheric pressure.

Lighting

The Jovian Discoverer IV has ambient lighting programmed to maintain a 24-hour circadian rhythm in the crew members.

2.5 minutes into the adventure, the main lighting will fail. For a few seconds, the station will be plunged into blackness, then red emergency lighting will flicker on.

Power

A SunCore VII fusion plant provides power for the Jovian Discoverer IV. The plant runs on a deuterium-3He reaction. The plant is located on D-Deck where there is a small control room. There are multiple fail-safes and battery backups, and it can be shut down by Prospero, the station AI if certain scenarios arise.

30 minutes into the adventure the power plant will be shut down to avoid a containment breach. Battery backups will come online instantly.

Security

Because the Jovian Discoverer has part of its crew compliment made up of convicted criminals, security is paramount. Security procedures for important locations will be described in more detail in the descriptions of those locations.

Crewmembers are required to wear Personal Data Transmitters (PDTs) at all times. This enables Prospero, the station AI, to track their location while onboard. PDTs resemble small plastic dog-tags. In addition, the rig has security systems to prevent events such as hostile boarding actions and unauthorised access to restricted areas. Crew members all carry ID

cards which grant access to areas of the ship they have permission to enter.

There is a security operations centre and secure brig on A-Deck. The security operations centre has a weapons locker, which is digitally locked and can only be unlocked by consent of two senior crewmembers. The Jovian Discoverer IV has scant few lethal weapons. Wardens usually carry stun batons. There are two Deputy Wardens onboard who report directly to the Warden Administrator.

Convict-workers identified as trouble-makers are usually restrained and forced to wear a Control Collar (think of it as a shock-collar, paired with a control device carried by the wardens) until they can be shipped off the rig, usually to a worse job like the mines on Io.

Doors

There are 3 main categories of door onboard the Jovian Discoverer IV as follows:

1. Partition

Partition doors are not airtight, and are for privacy purposes only. They slide open and shut and have simple bolt-locks. Partition doors have 1AP and 8HP

2. Bulkhead

Bulkhead doors are internal pressure doors, designed to give access from one airtight section of a space vessel to another. Bulkhead doors are kept closed by default, and can be locked. In the event of a pressure loss, bulkhead doors are programmed to automatically seal off the compartment. This can only be overridden by the most senior crew member, as to do so will risk compromising another airtight compartment. Bulkhead doors have 15AP and 12HP

3. Airlock

Each airlock onboard the Jovian Discoverer IV is laid out in a typical fashion: a chamber with a reinforced pressure door at either end. Only authorised crew members can activate the airlocks on

the rig. There are safeguards in place to prevent both doors being opened at the same time. Airlock doors have 20AP and 30HP.

Airlocks usually contain emergency equipment such as medical kits, rescue balls etc. Cycling an airlock usually takes between 30-60 seconds. There are usually spacesuits either in or adjacent to all airlocks.

THE ADVENTURE 1

Investigators Introduction

The Jovian Discoverer IV is 7 weeks into a 12-week shift, on the opposite side of Jupiter from Callisto. All of the Investigators came onboard approximately 3 months ago after having their prison contracts bought by Jovian Holdings at a prison-contract auction on Mars.

Give them the following information:

- Keeper's Information 4: Penal Involuntary Servitude
- Keeper's Information 5: Jovian Discoverer IV Overview
- Keeper's Information 6: Jovian Discoverer IV Working Practices
- Keeper's Information 7: Jovian Discoverer IV Systems

THE ADVENTURE 2

The Fight

Prisoners are often bored, isolated and frustrated. Confinement exaggerates human behaviour and fights can start over very petty things. The fight that got the players thrown in the brig is a perfect example. The spark that started the fight isn't really relevant. Keepers should pick two players as they see fit. Once the fight broke out, everyone in the work team was rounded up whether involved or not.

Before the players went out on their ill-fated EVA repair duty, they would have been vaguely aware of an announcement by O'Halloran that in accordance with the tenets of Space Law (amended by the



Colonial Act 2140) he was dispatching a team in the rig shuttle to lend assistance to a ship in Circum-Jove space broadcasting a distress signal. Then cut to the chase (the intro boxed text below).

THE ADVENTURE 3

Awakenings

Once the players have their characters, and you have given them the relevant background information, Keepers should read the following boxed text to start the adventure:

"You awake with a dull throbbing pain in your head. The kind of headache a bout of mild oxygen starvation brings. You wince as you try to sit up. You're in the brig of the orbital gas mining platform Jovian Discoverer IV for the third time in a month. It looks like Warden-Administrator O'Halloran has decided to lock you and the other trouble-makers up until you cool off, or until he can devise a worse punishment..."

Some people are stupid. You could sense there was going to be trouble. What kind of spacenoob jamhead starts a fight during an EVA work detail? With suit systems slaved to Prospero, the station AI, it was no biggie for O'Halloran to change the trimix of your air supply. Knock out the trouble-makers and reel 'em back in on their safety lines. Standard procedure.

Penal Involuntary Servitude - it is what it is. 'Recruited' by Jovian Holdings from a prison-contract auction on Mars 3 months ago. You and about a dozen others.

And now you wake up to this. Your cell door is unlocked. Good start. No sign of a warden. Even better. But as you get to unsteady feet you feel the rig making dark groaning noises. Then you hear an alarm klaxon somewhere in the distance. As you peer out into the open entrance to the brig you see someone

lying on the floor. This is less good."

THE ADVENTURE 4

A Simple Plan

From this point on it is up to the players what they do. The adventure starts in the brig - encounter location (1) on the maps. Provided the players can defeat deputy warden Anderson and get her keycard to open the brig airlock, then they have a chance of escaping the Jovian Discoverer IV before it is destroyed. They will need to formulate their own escape plan, however the following two important pieces of information should be noted:

1. By the time the adventure starts, it will be too late to escape using the lifeboats - the station is now so deep into the atmosphere of Jupiter, they no longer have enough thrust to escape the gravity well.
2. The shuttle was completely destroyed during Hollinghead's failed escape attempt 13 minutes ago.

During their flight through the rig, the players will find some sections of the space station inaccessible and some filled with infected crew members. They may also encounter crew members who do not intend helping lowly convicts to escape, or whom may actively try to prevent their escape.

KEEPER'S INFORMATION 8

Jovian Discoverer IV: Deckplans

The Jovian Discoverer IV has 4x main decks, housing areas such as rig operations, crew facilities and habitation, mine production and storage. Below these decks is the fuel scoop assembly itself, which is surrounded by the rig's main source of propulsion: 4x General Republic Starfire IX thrusters each mounted on a reinforced diffusion-bonded steel-titanium pylon. These thrusters are generally used for manoeuvring, docking and orbital insertion.

The maps can be found on pages 73-76

at the end of this adventure, and have arbitrary north assigned as the top of the map to aid description of exit locations etc. Unless stated otherwise, it should be assumed an encounter location is empty of inhabitants.

A Deck

A-Deck is the main habitation deck for the non-convict crewmembers. All formed plastics and brushed metal, it is usually well lit and clean. Unless otherwise stated, all plastics are a shade of grey or white; all corridors are 2.5m across and have an octagonal cross-section.

1. The Brig

The brig is a self-contained modular design, bolted on to the rig with an airlock attaching it to the rest of the vessel. This airlock can only be operated by a keycard carried by one of the rig warden team.

The interior of the brig is split over 2x levels, with the airlock entrance on the upper level. There is a ladder-well in the centre of the floor leading down to the lower level. Each level has 4x cells. Each cell is deliberately designed to cause physical and psychological discomfort in the occupant. They are cramped, being 2m3 in size, with no furniture other than a toilet and a water dispenser. The door to each cell is transparent, constructed of reinforced carbon-nanotube impregnated plastics (10AP and 10HP). Electronically locked, the cell doors can only be unlocked by Prospero, or by the keycards carried by the Deputy-Wardens.

The player characters occupy 6 of the 8 cells in the brig. The other 2 cells are empty.

Listen:

As described in The Adventure 2, the rig is making dark groaning noises. There is also an alarm klaxon somewhere in the distance. It is a hull breach alert.

Spot Hidden:

The airlock doors that lead out of the brig stand open...

2. The Airlock

The inner airlock doors to the brig are open. The doors leading into the rig are locked shut. Lying face down on the floor is a body. It looks like deputy-warden Anderson. She will have a keycard around her neck.

If approached, Anderson moans and rolls onto her back. Something is definitely wrong. She looks very pale, and there is dried, congealed blood around her mouth, nose and eyes. And her eyes – they don't look natural – they are red. Anderson springs into a crouch position and hisses at the PCs...

SAN: 1/1d3

Occupants: Deputy-Warden Anderson. Anderson is at Stage II of the infection. She will attack the nearest Investigator in a crazed frenzy. See her NPC capsule for more details.

If PCs are struggling with Anderson, let them have an Idea roll to spot possible improvised weapons - these could include:

- Makeshift club - a toilet seat or maybe an emergency air canister in wall brackets in the airlock
- Medical supplies - Items from the wall mounted medical kit (tranquillizer, scalpel etc.)

3. Storage Area

Crates stacked against one wall. Example of items in crates: Clothing; O2 cylinders and masks; food.

4. The Duty Office

When the brig is occupied, one of the Deputy-Wardens is usually required to be on duty here. There is a desk and chair, a notice board covered in pinned documents, a wall-mounted vid-phone and a wall-mounted first-aid station.

Desk:

On the desk is a computer workstation with 3x flat panel displays, all displaying a rotating Jovian Holdings screensaver. The workstation is locked, but a Computer

Security check will allow a guest login account to be used. The guest account allows a limited amount of data to be accessed – items unrelated to rig-systems such as information about the company, some ShipNet access (basic info about the rig and its systems) etc. No deckplans, no crew manifest, no tracking of PDTs – all this much be done from Operations (17).

Behind the screensavers, one screen displays a montage of the brig cells, the second displays a duty roster, and the third a schematic of A-Deck, with Ladder-well A (5) flashing red. The duty roster details the PCs incarceration in the brig, and who is supposed to be on duty (Anderson). The duty office is unoccupied.

Notice board:

Covered in old duty rosters, e-postcards from various locations across Sol, humorous cartoon printouts, company memos etc.

First-aid station:

Contains basic medical supplies.

5. Access: Ladder-well A

There are 2 primary ladder-wells on the rig, each running from A through to D deck. Each ladder-well runs up through the centre of an octagonal chamber on each deck. Where the ladder-well enters and exits each deck, there are emergency bulkheads which will automatically close in the event of a serious fire or depressurisation. This can only be overridden by the rig A.I. or a member of the command crew. All ladder-well chambers have a 'you are here' deck plan and emergency escape routes from the rig.

There are four exits out of this room. 3x closed bulkhead doors lead to other areas of A-Deck, and can be opened with Anderson's keycard. The ladder-well would normally lead down to B-Deck, but a bulkhead door has sealed the exit. There is a control panel on the wall, which displays a warning message: the compartment below is in a state of vacuum, so the bulkhead cannot be opened.

The bulkhead door is covered in blood and bloody hand-prints, and a trail of blood leads to the N door.

6. The Infirmary

The infirmary can handle most medical emergencies. If a situation arises that cannot be taken care of, the patient can be stabilised and placed in one of the on-board cryopods in the cryo-vault (9), and a message can be sent to Jovian Holdings HQ for a medical team to be sent. There are 3x diagnostic beds with equipment racks overhead that hold various medical gadgets. Two are unoccupied, but the third has a sheet apparently covering a corpse. There are also lots of storage cupboards built into the walls. All the items found in an Advanced Medical Kit can be found in the infirmary.

Spot Hidden checks are not needed to spot the trail of blood leading to the door of the Holo Room. Nor to spot the two corpses – one on an infirmary bed, the other at the entrance to Dr Malik's office. Each is covered in a bloodied white sheet.

Corpse 1:

Beneath the sheet is the corpse of the survivor from the Telemachus. She has black, congealed blood around her eyes, nose and mouth. If examined too closely it will look like something is moving underneath her skin (SAN check 1/1d4). If the PCs stay here too long, they will hear cracking of bones as the corpse begins its evolution into a Proto-Shoggoth...

Corpse 2:

The corpse is that of Dr Shaheen Malik. She has been strangled with a length of electrical cord and her face is a horrible colour. A First Aid check will establish she has been dead about an hour at most. She still wears her id-card, and here black rimmed spectacles lie broken beside her. SAN: 0/1 or 1/1d3 for the PC running Nate Stollmeir.

Occupants:

While the PCs are looking about, Darren

Vogel will crash out of the cryo-vault and stagger towards them hissing in a most disturbing manner, bleeding from his eyes and nose, wielding a fire-axe.

SAN: 1/1d3

7. Dr Malik's Office

A small office where Dr Malik worked. There is a desk and chair, computer terminal, smart-poster of a tropical beach on one wall, which has a looped animation of swaying palm trees and lapping waves.

Search:

Common diagnostic medical equipment can be found in the desk drawers, as well as the Doctor's PDA (see handout The Good Doctor's Journal). There is also a coffee maker and a half-eaten bowl of pasta on the desk.

8. The Holo Room

The Holo-Room is becoming a common sight onboard long-haul spacecraft. It is designed to allow crew members respite from long shifts and cramped conditions, and also help alleviate the psychological effects of deep-space travel. Dr Malik has a library of holographic scenes from Earth – forests, beaches, mountain vistas, city scenes etc. The scenes are just holograms and cannot be interacted with. This isn't Star Trek!

The Holo Room is currently inactive, and all the active projection walls are blank.

Occupants:

Amy Cooke is sat in here, bleeding profusely. See her NPC capsule for more details.

9. The Cryo-Vault

The cryo-vault is only used for medical emergencies. There are 3 cryopods in here. Hollis Sutter occupies one, the other two are empty.

Occupants: Hollis Sutter, in cryo-sleep.

10. W.C.

Washroom. Nothing of interest here, unless the PCs need the toilet.

11. Equipment Stowage

This area contains equipment commonly used by EVA teams using the main A-Deck airlock (12). There is a rack of spacesuits (1d4+2). The spacesuits are Standard Vacuum Suits, and each is kept prepped with 24 hours of life support.

12. Airlock

Just that. See Keeper's Information 10 for more details about airlocks on the rig.

13. Access: Ladderwell B

Same as (5) but the floor exit is open.

14. Security Centre

The door into the Security Centre is a bulkhead door, which has been manually locked from the inside. A Special Electronics Systems check is required to bypass the lockouts and open the door.

Inside is a 5m x 10m room with a low ceiling. One wall is a huge high-definition screen. This can display information from the rig databases as well as from multiple camera feeds, both interior and exterior. There are 3x work stations and a ladder well up into Operations (17). There are also 3x doors labelled as a washroom, weapons locker, and the private quarters of Warden-Administrator O'Halloran.

Occupants:

Petrov is outside the door. He is armed, and he certainly isn't planning on letting the PCs escape. He will try to force the PCs back up the corridor at gunpoint. Then he will head for the escape pod in Hab-A.

Example of Petrov's dialogue:

"Where do you think you're going? I don't think so. That fucker has locked himself in Operations. Well fuck him, and fuck you. I am getting out of here, but you're not..."

The Weapons Locker:

The weapons locker is open, and the secure lock-box that used to contain the only lethal firearms on the vessel is empty. It has spaces for 3x automatic pistols, plus

6x magazines. These weapons are currently in the possession of Petrov, O'Halloran and Lee. All that is left are several batons.

15. Captain's Quarters

Personal quarters of Warden-Administrator O'Halloran. In addition to the bunk, clothes locker and washbasin, there is a small workstation, upon which are a computer terminal, bible and a family portrait. A pair of old duelling pistols are mounted on the wall (useless as weapons).

16. W.C.

Washroom.

17. Operations

This is the nerve-centre of the Jovian Discoverer IV. There are control stations for the rig commander, helmsman, systems-tech, rig-chief and chief engineer.

Occupants:

Warden-Administrator O'Halloran and Aki Miyazaki are here. O'Halloran is holding Miyazaki at gunpoint. He thinks his career is over, and has decided he and Miyazaki are going down with the rig. He will blame everyone but himself for gross incompetence.

"Incompetents. Surrounded by fucking incompetents. Look at my rig. It's your fault. Fucking incompetent criminals. You should still be locked up, but this little bitch decided to let you out. Rats leaving a sinking ship eh? 22 years. 22 fucking years for this company. How can I go on from this? "

O'Halloran will shoot Miyazaki if the PCs try anything rash, and then shoot himself. As far as he is concerned, he has lost everything. See their NPC capsules for more details.

18. Prospero

The CPU of Prospero the rig AI lies behind a locked bulkhead door, and only O'Halloran has the key.

19. Observation Blister

There are lovely views of Jupiter visible from

here. The gas giant fills the sky. In fact it looks a little too close...

20. Hab-A: Dining Area and Galley

The dining area is laid out like a mess hall, with 2x rectangular tables each capable of seating 10. The galley contains an autochef with a touch screen interface allowing crewmembers to order from a menu of pre-prepared meal-packs. There are also facilities for crewmembers to do the cooking. Refrigerated cabinets contain ingredients etc.

There is access to an emergency escape vehicle here (see 32/33 for more details) though the readout appears to indicate it has already been launched. It was launched by assistant medic Alex Lee to form part of the cover story for the scuttling of the rig (see his NPC capsule for more details).

Occupants:

Dominique Durand lurks in here, and will emerge from beneath a table and attack the PCs relentlessly.

21. Hab-A: Crew Quarters

14x small 3m x 2m cabins for the crew. Each cabin contains a single bunk, footlocker, washbasin and work-area (desk and chair). All the cabins are in use, and contain clothing and personal effects of the non-convict crewmembers. Keepers should allow the PCs to find anything within reason that could conceivably be stored here. This does not include weapons, armour or space suits.

22. Hab-A: Lounge and Micro-Gym

Common area where crewmembers can relax and/or exercise when off-duty. The common area has a large vid-screen on one wall, with comfy chairs arranged in a semi-circle in front of it. There is also a micro-gym with a W.C. and shower room attached.

B Deck

B-Deck houses both the rig shuttle bay, and the habitation block for the convict-workers. Unlike A-Deck, the formed plastics

are stained and dirty, and the brushed metal corroded. Corridors all corridors are 2.5m across and have an octagonal cross-section, and have exposed cabling on the walls.

23. The Shuttle Bay

By the time the adventure starts, the shuttle bay is a write-off. The shuttle is a pile of twisted and blackened wreckage, and the shuttle bay is in vacuum, debris preventing the airlock doors from closing.

24. The Damaged Airlock

Debris from the exploding shuttle damaged this airlock. Both the inner and outer doors are breached, leaving Ladderwell A (25) open to vacuum.

25. Access: Ladderwell A

Ladderwell A is inaccessible on B-Deck – the emergency bulkheads have sealed access due to the airlock breach in (24).

26. Hab-B: Galley

The Hab-B galley is laid out in a similar fashion to the Hab-A galley, except the convict crewmembers only have access to autochef meals, and all cutlery is plastic.

27. Hab-B: Showers

Shower block.

28. Hab-B: Lounge and Micro-Gym

A lower-rent version of the Hab-A facilities.

29. Hab-B: Convict Worker Quarters

The quarters in Hab-B are double occupancy, and as such much more cramped than Hab-A.

Occupants:

Marcus Jones is hiding in his quarters. He is freaking out because Hab-B has been locked.

30. Airlock

Just that. See Keeper's Information 10 for more details about airlocks on the rig. This airlock provides access from Ladderwell B into Hab-B. It has been locked electronically on the orders of O'Halloran.

A Warden ID-Card will not open this airlock – an Electronics Security check is required.

31. Access: Ladderwell B

Ladderwell B is open to both A and C decks. None of the doors are locked.

32/33. Emergency Escape Vehicle

The Jovian Discoverer IV carries a number of Type 44 Emergency Escape Vehicles (EEVs). Each is capable of carrying 10 crewmembers in relative comfort, but is not designed for long-term occupancy. There are emergency respirators onboard, as well as survival kits (which could be ransacked for food/water). If the PCs choose to try to escape the rig in an EEV, it won't have the power to climb out of Jupiter's gravity well. They will meet their fate being crushed by terrible pressures. Perhaps allow them a Know check to realise this.

34. EVA Operations

The majority of EVA work missions are carried out from here. There is an airlock out into space, plus equipment racks and a control booth from where the EVA operations chief can monitor the camera feeds and vitals from EVA work teams. This is where the PCs had exited the rig on their last work-detail, to conduct repairs on micrometeorite shielding.

The equipment present includes:

- 3x Vacuum Worksuits (each prepped with 18 hours life support)
- 3x Thruster packs
- 3x Worklines (connect to suit from outside the airlock).
- 3x grapple guns
- 1x Advanced Medical Kit
- 1x Rescue Ball
- 1x Fire Axe
- 1x Rivet-gun
- 1x Spot welder

35. Freight Lift

Cargo from the hangar-bay is loaded onto this freight lift, which then takes it down into the storage bays on C-Deck.

Occupants:

If not already encountered, Gustav Suarez will be in here, leering and looking decidedly infected...

C Deck

The main purpose of C-Deck is a storage area for coolant (used in the atmospheric recyclers) and water. It is dark and dirty...

36. Access: Ladderwell B

The floor here is 50cm deep in cold water, and the lower bulkhead door to D Deck is sealed.

Listen:

The sound of rushing water can be heard from somewhere down the corridor.

37. The Flooded Corridor

Water is flooding this section of the rig from the onboard storage tanks. At present it is 50cm deep, but every minute spent in here sees the depth increase by 30cm. It is also very cold.

Occupants:

None, though if the PCs stay here too long, the corridor will eventually be completely underwater.

38. Water tanks

These 3 storage tanks hold water for use by the crew and the rig systems. The emergency access doors have been opened on all 3x tanks for some reason, and water is pouring out into the corridor (37).

39. EVA Room

Equipment stowage area for teams performing an EVA. The equipment present includes:

- 2x Standard Vacuum Suits (each prepped with 24 hour life support)
- 2x Thruster packs
- 2x Worklines (connect to suit from outside the airlock).
- 2x grapple guns
- 1x Advanced Medical Kit
- 1x Rescue Ball
- 1x Fire Axe

This room is rapidly flooding like the corridor (37).

40. Airlock

External airlock. See Keeper Information 10.

41. Airlock

This is an internal airlock which provides access to the freight lift. There is a small window in the airlock.

Occupants:

Nikoli Ivanov, or what is left of him, is in here. He is currently turning into a Proto-Shoggoth. Looking through the window into this room, a PC who succeeds a Spot Hidden check will see something moving on the floor – something that doesn't look good – tendrils and the like (SAN check 1/1d10). The Proto-Shoggoth can be avoided by going back up to B-Deck and using the Freight Lift (35).

42. Freight Lift

See (35) for more details).

43. Coolant Storage

Long chamber, walls covered in racks of coolant tanks. Coolant is needed for the rig atmospheric scrubbers. It is dark, and some Listen checks might hear creaking and groaning sounds – but that's just the sound of the rig beginning to suffer in the increased atmospheric pressure. There are two types of coolant used onboard the rig – one is liquid nitrogen, the other is very pure deionised water.

44. Access: Ladderwell A

The ceiling hatch here is sealed to vacuum (remember above is the ladder well and airlock damaged by the hangar bay explosion). The ladderwell to D-Deck is open.

D Deck

D-Deck houses the rig powerplant and the fuel scoop operations centre. It also provides access to the fuel storage ring. Jean-Jacques Lambert is stalking D Deck. Keepers can fit him into the adventure where they like.

45. Access: Ladderwell A

Bottom of the ladderwell. Access to C-Deck.

46. Fuel Scoop Operations Centre

Looks like a power station control room. A jumble of industrial-gothic pipes and dials, with a central ring of control consoles. There are 4 exits. 2 lead out to the ladderwells, one is an external airlock, and one is an internal airlock into the power plant (48). The control consoles are displaying lots of warning messages concerning such things as gas intakes, scoop alignment and atmospheric pressure.

47. Airlock

External airlock. See Keepers Info 10.

48. Power Plant

The power plant pretty much runs itself, monitored by Prospero and several slaved Delta Level AI. An emergency shut down of the reactor will commence 30 minutes into the adventure. There's not much to be gained from visiting this chamber.

49. Access: Ladderwell B

Bottom of the ladderwell. Access to C-Deck above is denied – the readout says the above chamber is flooded.

50. Maintenance Access A

A jumble of industrial-gothic pipes and dials, steam venting from machinery. An airlock leads into a narrow access tunnel, which leads to Freighter Dock 2.

Occupants:

Catalina Yung, one of the other convict workers, is here. She is armed with an industrial riveter, and is wearing a space suit. Kessler has left her here, while he tries to find another route to reach the robot tanker. She is on edge and very trigger-happy – before she knows what she's done, she will have fired a rivet at the first PC into the room. Yung may be persuaded to join the PCs, but will defect to join Kessler if he appears.

51. Maintenance Access B

This chamber is identical to (50), except that this chamber is occupied by assistant medic Alex Lee. Lee has been attaching explosive devices to several power conduits in here, and will hear the PCs approach. He is armed. If the PCs try to reason with him, Lee will appear unmoved. As far as he is concerned, he has his orders (which he is not at liberty to discuss), and the PCs are expendable, and not part of 'the plan'.

52. Freighter Dock 2 Access Tunnel

The airlock to the Freighter Dock 2 access tunnel is closed, and red warning symbols indicate that the tunnel beyond is depressurised. In actual fact the tunnel no longer exists – it was struck by debris and has broken away from the rig. There is now a 20m gap between the two airlocks at either end which is in vacuum. A successful EVA check is required to cross the gap safely. Inside the airlock on the other side, warning messages will state that the storage ring has zero gravity.

The Storage Ring

The storage ring is where the 3He fuel is stored before being collected by robot freighter and shipped back to the Callisto orbital refineries. The ring can dock two freighters at a time. The ring is reached from the main rig structure via two 1.5m wide access tunnels.

There is a tunnel that leads around the storage ring. It can be accessed via the ladderwells at both Freighter Docks. This tunnel provides maintenance access to individual 3He storage tanks if need be. The storage ring has 16x storage tanks attached, with piping from the fuel scoop and to the 2x freighter docks. Each tank is capable of holding 250 tons of pressurised 3He gas. The gas is non-toxic and non-flammable, but there are several pipes carrying more dangerous gases (liquid oxygen, liquid nitrogen). There are lots of warning signs. A fire-fight in here is very inadvisable.

If the storage ring buckles and breaks

away from the rig while the PCs are here (see timeline), it will result in the rapid depressurisation of the entire ring access corridor, including the freighter dock. The airlock into (54) will slam shut to prevent the rig depressurising.

Occupants:

Valentin Kessler is prowling here. He has had the same idea as the PCs, and is trying to get to the tanker dock via the storage ring.

53. Emergency Equipment Stowage

Beyond the airlock from the ruined access tunnel (52) there is an equipment storage area. Plastic crates are stacked against the walls. The crates mostly contain machine parts and tools, though a successful Search check will find some air tanks (1d3). Anything unsecured in here is floating in zero G.

54. Ladderwell

This ladderwell leads up to the maintenance access tunnel which runs around the entire storage ring.

55. Dock Control Room

Control room containing a control console and a wall-mounted lock-box with a keypad, as well as stacks of crates. In large signage above the control console are instructions detailing how, in the event of an emergency, the robot freighter can be uncoupled from the docking clamps manually here. The procedure is quite straight-forward:

1. Patch into the freighter's onboard AI using the computer terminal on the console, and instruct it to begin its pre-launch cycle. Once the freighter is ready for launch it will signal via the terminal.
2. Manually release the docking clamps. This is achieved by retrieving the key from the lock-box, inserting it into each of the four clamp-locks on the console, and turning the key so that each lock moves from the red position to the green position (clearly labelled).
3. As soon as the last docking clamp

is released, the freighter will begin manoeuvring away from the rig on its pre-programmed flight-plan back to Callisto.

Idea:

The PCs will need to be onboard the freighter before the clamps are released. This means someone is going to have to stay behind, as there is no way to automate the procedure.

56. EVA Prep Room

This room has 1x vacuum worksuit with a thruster pack and other assorted equipment (grapple gun, repair kit etc).

Occupants:

In amongst the debris floating in here there is a spacesuited figure. It is Rig Chief Mackenzie. He is dead. If examined closely, tendrils and tentacles will burst forth from his spacesuit and a Proto-Shoggoth will emerge to attack. If the corpse is ignored, this will happen anyway...

If the PCs have trouble getting past the Shoggoth, then perhaps have the ring above the ladderwell (54) depressurise and fall away from the rig, providing access to space.

57. Freighter Dock

This is one of two docking ports for the robot freighters that transport 3He fuel from the rig storage tanks back to the Callisto orbitals. There is currently a freighter docked here. There is no airlock or docking umbilical to gain access to the freighter. There is an external maintenance airlock, but it will mean an EVA in the Jovian atmosphere...

THE ADVENTURE 5

Extra-Vehicular Activity

The EVA to the airlock of the robot freighter will only take a couple of minutes, and the spacesuits should protect the PCs from the high radiation and increased atmospheric pressures of Jupiter.

Exposure

The radiation in the Jupiter magnetosphere is fatal to anyone exposed without protective clothing. Any PC exposed to the Jovian atmosphere must make a CONx1% check or suffer 1d8 cold damage per round exposed. The PC must also make a CON check vs. POT 20 radiation, and failure means the radiation will kill them in CON/2 hours unless adequate medical assistance is received.

KEEPER'S INFORMATION 9

Consolidated Aerospace CA 275 Autonomous Robot Cargo Freighters

Jovian Holdings operates a fleet of autonomous robot freighters. The CA275 has capacity to haul up to 1000 tons of pressurised 3He gas, and is equipped with a fusion drive capable of a sustained 0.1g acceleration with a maximum output of 0.25g.

Though the CA275 is fully automated with an onboard Gamma Level AI, there is a small maintenance area accessible via a ventral airlock which can be pressurised. A ladderwell leads down from the airlock into a 3m² square room. One door leads into a 5m² chamber with equipment stacked against one wall (emergency space-suit, air supply, medical kit, thruster pack, tools etc), and a computer terminal against the other, giving access to the freighter AI and flight computer. The maintenance area is not designed for extended occupancy, though if pressurised is capable of supporting a two-man technical team for up to 24 hours under optimum conditions.

The freighter technical schematics are available on the rig computer network to anyone with the *Computer Operation* skill. They will also be stored locally in the buffers of the computer terminal in the Dock Control Room. Anyone with Computer Operation can query the freighter AI either directly while onboard, or via a computer terminal (before the network failure). A Computer Programming check is required to alter the flight plan.

THE ADVENTURE 6

Escape Velocity

As the freighter detaches from the rig, for a few heart-pounding seconds it falls into the Jovian gravity well. Then the main drive fires. The PCs will feel the 0.25g push against them as the freighter quickly accelerates beyond the escape velocity of Jupiter (59.5 km/s). Once out of the gravity well, the rumbling of the main drive will settle into a background hum, and the freighter will throttle back to its cruising velocity of 0.1g.

Callisto is currently on the opposite side of Jupiter, a distance of approximately 2.9 million km. At 0.1g, the freighter will arrive in Callisto orbit in just under 31 hours. If the PCs have the necessary skills, they could attempt to hack into the flight computer, and reprogram the freighter to head to another location. The freighter AI has flight plans and astrogation data for the following destinations:

Destination	Flight Time*
Callisto - the orbital refineries	31 hours
Io - Reynolds Space Station	11 hr 37 min
Europa - Griffin Orbital	15 hr 51 min
Ganymede - The Ganymede Swarm	19 hr 25 min
Thebe - automated navigation beacon	8 hr 21 min

*Flight time calculated at a constant 0.1g with a deceleration phase during second half of journey.

At least the PCs have escaped certain death onboard the Jovian Discoverer IV. Now all they have to do is make sure the authorities don't pick them up when they reach their destination. Give anyone still alive a 2d6 SAN reward.



JOVIAN DISCOVERER IV

DECKPLANS
REPRODUCED BY KIND PERMISSION
OF CONSOLIDATED AEROSPACE

WELCOME TO THE JOVIAN DISCOVERER IV

The Jovian Discoverer IV is one of 8 orbital gas-mining platforms in the Jovian Holdings fleet, and left Mars Orbital Shipyards in 2254, from where it was towed by Colonial Heavy Mover to Callisto orbit. It has been in service in the Circum-Jove colonies ever since.

Jovian Discoverer IV uses a Richter Dynamics RD2300 Fuel Scoop to mine 3He gas. This device combines a powerful magnetic field generator, an atomic sensor and a vacuum lock collector to actively suck gases from the atmosphere of a gas giant. The ionised gas particles are separated by mass and charge in a centrifuge, and the 3He is then processed and injected into the rig's ring of storage tanks, ready for loading onto robot transports that continually fly the Jovian Loop between the rigs and Callisto.

At Callisto the transports unload their payload into the Jovian Holdings orbital fuel depot.

All non- 3He materials are processed according to value and either stored for use or ejected back into the atmosphere.

The Jovian Discoverer IV is powered by a SunCore VII fusion power plant, which provides all the power the rig needs for 36 months of normal operations before requiring refuelling. In

addition, a closed-loop recycling system means that water and air supplies for a standard crew compliment should last up to 12 months before resupply.

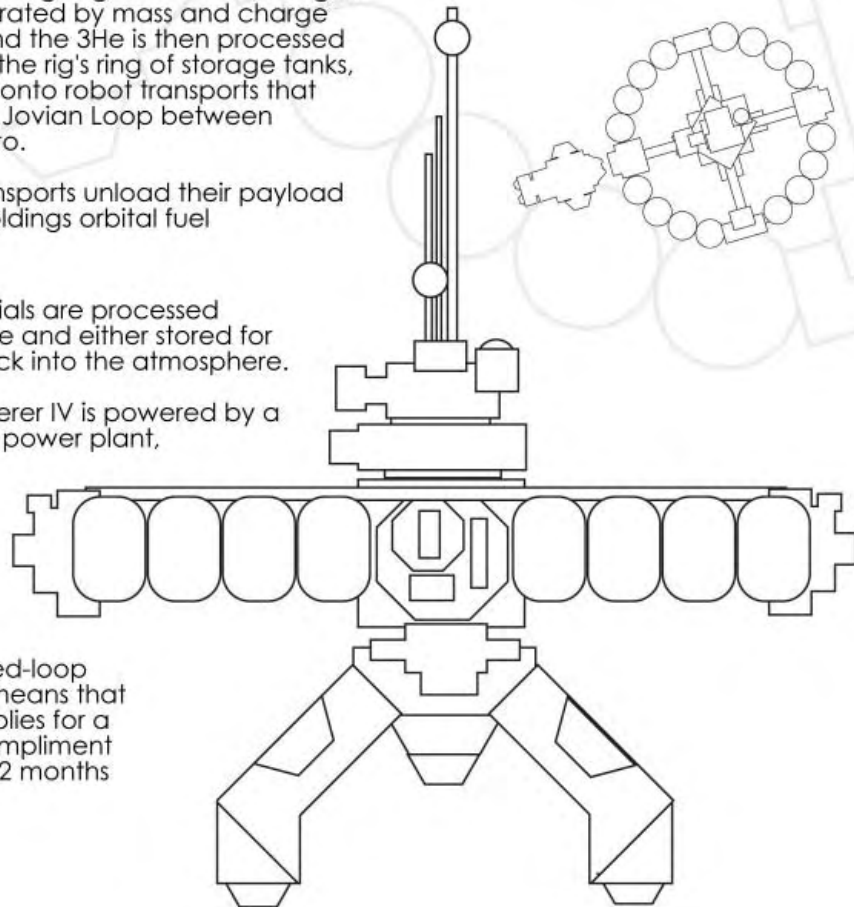



JOVIAN DISCOVERER IV

DECKPLANS
REPRODUCED BY KIND PERMISSION
OF CONSOLIDATED AEROSPACE

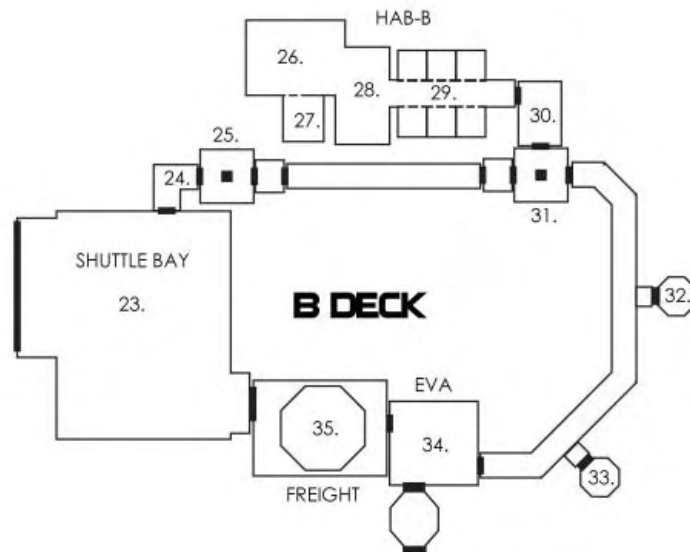
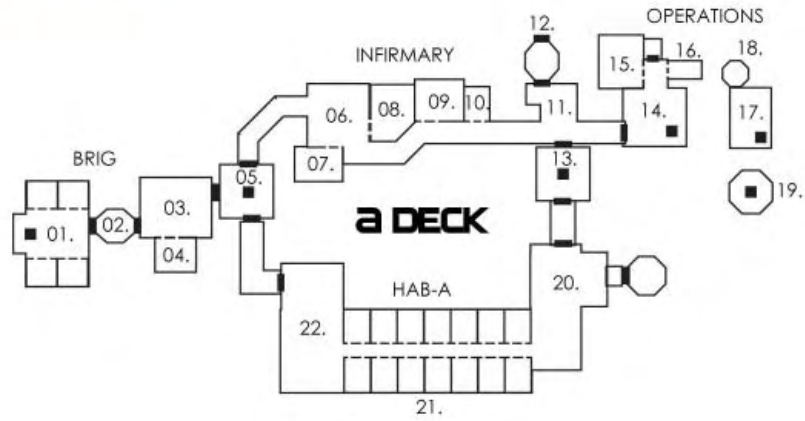



JOVIAN DISCOVERER IV

DECKPLANS
REPRODUCED BY KIND PERMISSION
OF CONSOLIDATED AEROSPACE

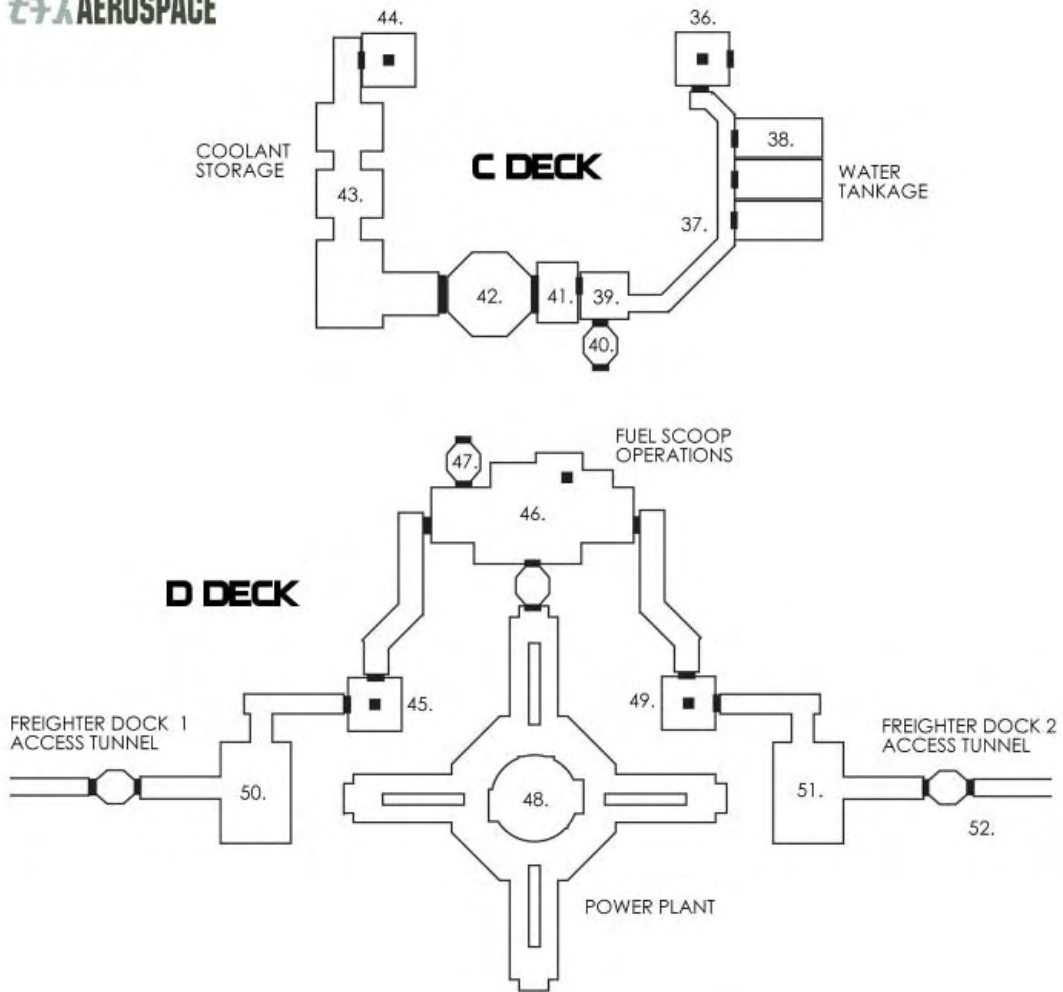



JOVIAN DISCOVERER IV

DECKPLANS
REPRODUCED BY KIND PERMISSION
OF CONSOLIDATED AEROSPACE

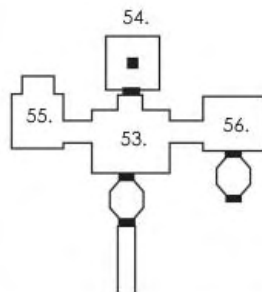
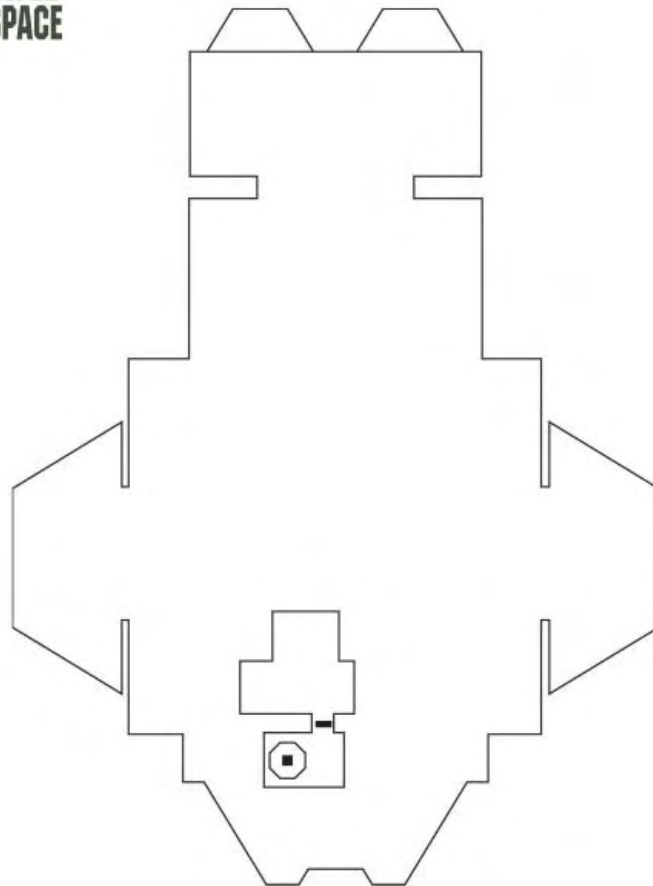

FREIGHTER DOCK I

APPENDIX A: CREW MANIFEST

Full statistics and selected skills are only given for those NPCs who are still alive, and who have chance of heavy involvement in the adventure. Keepers should have no trouble expanding those NPC capsules without selected skills where necessary. Hit locations are not listed, but are very easy to extrapolate from total hit points.

The Jovian Discoverer IV has a crew of 26. Of these 15 are civilian workers contracted to Jovian Holdings, a subsidiary of Hallidor Corp. The remaining 11 are convict-workers whose prison contracts were bought by Hallidor as part of the Penal Involuntary Servitude program as established by the Colonial Act of 2140 (an amendment to the Geneva Statute of 2084).

CIVILIAN CREW MEMBERS

Christoff O'Halloran – Warden-Administrator

Dutch-European male aged 55.

O'Halloran is the administrative head of the rig. He has the joint role of being the 'captain' of the rig and the warden for the convicts working off their prison contracts. He defers to rig section heads for the day to day running of the Jovian Discoverer IV, as he respects their knowledge. O'Halloran is a strict disciplinarian and wants his ship run smooth, and by the numbers. He sees himself as firm but fair. He doesn't like chaos.

STR: 10 **CON:** 10 **SIZ:** 14 **INT:** 14
POW: 14 **DEX:** 12 **APP:** 13 **EDU:** 16

SAN: 62

Hit Points: 12

Damage Bonus: 0

Armour: 4AP spacesuit (not wearing helmet).

Weapons: Fist 50% 1d3; Pistol: 45% 1d10.

Selected Skills:

Administration 70; Data Analysis 50; Fast Talk 65; Computer Operation 25; First Aid 20; Vacc Suit 30; Streetwise 40; Spot Hidden 50; Listen: 40; Vehicle 35; Science (Biology) 60; Law (Criminal) 50.

Current Status: Uninfected.

Initial location: Operations.

Notes: Is armed. He is holding the systems tech Aki Miyazaki prisoner. Trigger-happy and close to breaking point, he may shoot Miyazaki and take a shot or two at the PCs too.

Douglas 'Mac' McKenzie - Rig Chief

Scottish-European male aged 58.

Mac is the rig chief, in charge of all mining operations carried out by the Jovian Discoverer IV. He has ultimate responsibility for the operation of the fuel scoop and processing plant, which is the reason the rig is out there in the first place. Doug has worked on deep space mining rigs all his life and knows the ins and outs of mining 3He intimately. He has previously worked for the Titan Corporate Collective in the Saturn colonies, and also spent his youth working at Alpha Centauri.

Current Status: Dead/infected. Almost ready to turn into a Proto-Shoggoth when encountered.

Initial location: The EVA prep room at Freighter Dock 2.

Notes: Mac will be floating in a spacesuit.

Shaheen Malik – Chief Medical Officer

Indian female aged 26.

Malik was the rig medical officer, on hand to deal with any medical emergencies during the long shifts orbiting Jupiter. She was fresh out of medical school on Mars, working on the Jovian Discoverer IV to pay off her student debts. Generally considered a nice person by the crew.

Current Status: Died before she could be infected

Initial location: Her bloodied corpse is still on the floor of the rig infirmary, under a sheet.

Notes: Was secretly having a relationship with prisoner Nate Stollmeir.

Argus Johansson – Chief Engineer

Norwegian-European aged 44.

A humourless Scandinavian in his mid-40s, Johansson is in charge of the smooth running of the rig's orbital and deep space engines, fusion power plant and other essential non-mining systems – life support etc. He is ex-United Earth Space Command, and served as an engineer on board fleet vessels during the Colonial Wars.

Current Status: Died before he could be infected

Initial location: His corpse is in the twisted wreckage of the shuttle.

Notes: Died in shuttle crash in hanger bay.

Andrei Petrov - Deputy Warden

Russian male aged 38.

Petrov is responsible for the onboard security of the rig and the day to day management of those crew-members currently serving on the rig under Penal Involuntary Servitude orders. Petrov is ex-army, and doesn't much like his charges. He is known for delivering what he sees as 'administrative punishment' to convict crew members who step out of line.

STR: 13 **CON:** 15 **SIZ:** 12 **INT:** 11
POW: 10 **DEX:** 11 **APP:** 09 **EDU:** 11

SAN: 44

Hit Points: 14

Damage Bonus: +1d4

Armour: 6AP space worksuit.

Weapons: Fist 50% 1d3; M29 Tactical Assault Rifle: 50% 2d6 (PV0); Pistol 55% 1d10; Club 45% 1d6; Knife: 60% 1d4+2.

Selected Skills:

Dodge 30; Unarmed Combat 40 Computer Operation 25; First Aid 25; Vacc Suit 30; Streetwise 40; Spot Hidden 50; Listen: 40; Law (Criminal) 40; Psychology: 40; EVA 50.

Current Status: Uninfected.

Initial location: Petrov will initially be trying to get into Operations.

Notes: Petrov is wearing a vacuum worksuit, and is armed with a pistol (1d6+2 rounds left), iron bar (improvised club) and a knife. Petrov doesn't intend letting the PCs escape. He has locked Anderson in with them.

Ruth Anderson – Deputy Warden

American female aged 32.

Anderson is responsible for the onboard security of the rig and the day-to-day management of those crew-members currently serving on the rig under Penal Involuntary Servitude orders. Anderson is ex-FedPol. She is generally seen as being a soft touch when compared to Petrov.

STR: 18 (13+5) **CON:** 14 **SIZ:** 11 **INT:** 12
POW: 14 **DEX:** 14 **APP:** 14 **EDU:** 12

Hit Points: 13

Damage Bonus: +1d4

Armour: 4AP personal body armour on chest/abdomen.

Weapons: Claw 50% 1d3; Bite: 50% 1d4; Grapple 60%.

Current Status: Infected. Stage II

Initial location: In the brig airlock.

Notes: Anderson is wearing personal body armour over a company issue jumpsuit, and has the following equipment on her:

- id-card on lanyard around neck – this will open any bulkhead/airlock that has not been locked down by Petrov/O'Halloran
- Polycarbon knife tucked in boot
- Sick-Stick in belt-holster. This is a stun baton used to prod the target. POT 15 vs CON or victim overcome with dizziness and nausea (incapacitated for 1d6+1 rounds) – it has 1d10+1 charges left
- Empty holster for handgun of some kind
- Flashlight
- PDA
- Pen+Pad
- Sweets

Jacob Hollingshead - Helmsman

English-European male aged 32.

Hollingshead was the rig helmsman. As such he was in charge of manoeuvring and positioning the rig into the correct geostationary orbit over Jupiter, maintaining orbiting integrity, and overseeing the autopilot AI systems. Also the shuttle pilot. Hollingshead was a nervous, scrawny individual, who smoked constantly.

Current Status: Died before he could be

infected.

Initial location: Died when the shuttle he was piloting crashed into the hangar bay doors. The resulting explosion caused serious damage to the rig.

Notes: Died in shuttle crash in hanger bay.

Alex Lee – Assistant Medic

Chinese male aged 35.

A trained paramedic who previously worked for Cheung Corporation, Lee's career history is fabricated as he is actually a company android. He has recently received orders from Hallidor Corp to scuttle the rig, so that the company can collect on the insurance rather than get bogged down in any ITC investigation into how a Class One Biohazard got loose on one of their vessels.

STR: 16 **CON:** 12 **SIZ:** 10 **INT:** 16
POW: n/a **DEX:** 16 **APP:** 11 **EDU:** 14

Hit Points: 11

Damage Bonus: +1d4

Armour: None.

Weapons: Grapple 50%.

Selected Skills:

Medicine: 75; Computer Programming: 75; Computer Security 75; Data Analysis 50; Dodge 50; Vacc Suit 50; Spot Hidden 50; Listen: 50; EVA 50.

Current Status: Uninfected.

Initial location: Lee will be encountered in the the robot tanker dock control room, setting explosives.

Notes: Lee has had some of his behavioural inhibitors removed. He is programmed to defend himself and the company interests. He cannot kill the PCs, but he can restrain them and knock them out if necessary. Lee is carrying:

- An id-card which grants him access to anywhere on the rig
- PDA with a suite of intrusion software
- Electronics tool kit
- A canister of stun gas POT 12

Amy 'Cookie' Cooke – Engineer's Mate

American female aged 26.

Amy Cooke is the assistant to Chief

Engineer Johannson. Pretty with a slight figure, she is a chirpy, likeable sort who generally gets on well with everyone, convicts included.

STR: 10 **CON:** 10 **SIZ:** 09 **INT:** 14
POW: 12 **DEX:** 13 **APP:** 15 **EDU:** 11

SAN: 48

Hit Points: 5 (10) – all HP lost from left leg.

Damage Bonus: 0

Armour: 4AP spacesuit – it is not airtight due to injury to foot.

Weapons: Fist 50% 1d3.

Selected Skills:

Climb 50; Computer Operation 35; First Aid 15; Vacc Suit 30; Streetwise 40; Spot Hidden 50; Listen: 40; EVA 50; Engineering 50; Electronics Systems 60; Mechanical Aerospace 35.

Current Status: Uninfected.

Initial location: The Holo Room (8).

Notes: Cooke managed to seal the faulty airlock to the hangar to save the lives of everyone on A Deck. She lost her left foot in the process. She has lost a lot of blood, and unless the PCs help her, she will probably die and go down with the rig. If the PCs are struggling to come up with an escape plan, Cooke may suggest the robot freighters.

Aki Miyazaki – Systems Technician

Japanese female aged 29.

Petite and never seen without her AR SmartSpecs and PDA, Miyazaki is in charge of the onboard computer systems, including Prospero, the Gamma Level AI.

STR: 10 **CON:** 09 **SIZ:** 09 **INT:** 14
POW: 08 **DEX:** 13 **APP:** 15 **EDU:** 11

SAN: 34

Hit Points: 9

Damage Bonus: 0

Armour: None.

Weapons: Fist 30% 1d3.

Selected Skills:

Computer: Operation 65 / Programming 60 / Security 55; Data Analysis: 60; Vacc Suit 10; First Aid 15; Spot Hidden 40; Listen: 40; Electronics Systems 40.

Current Status: Uninfected.

Initial location: Operations.

Notes: Aki is being held hostage by O'Halloran. Unless the PCs help her, she will either be killed by him or go down with the rig. She is responsible for releasing the PCs from the brig.

Darren Vogel – EVA Specialist

German-European male aged 30.

Vogel is the crew member in charge of supervising all EVA activities – spacewalks, exterior repair teams etc. Vogel was in charge of the PCs repair team when the fight broke out.

STR: 20 (15+5) **CON:** 16 **SIZ:** 14 **INT:** 13
POW: 11 **DEX:** 14 **APP:** 12 **EDU:** 13

Hit Points: 15

Damage Bonus: +1d6

Armour: None.

Weapons: Claw 50% 1d3; Bite: 50% 1d4; Grapple 60%.

Current Status: Infected. Stage II

Initial location: Locked in the cryo-vault but will escape shortly after PCs emerge from the brig.

Notes: Vogel is wearing a heavily bloodstained company issue jumpsuit.

Jean-Jaques Lambert - Assistant Rig Chief

French-European male aged 34.

Lambert is the assistant to Mac, the rig chief. He is the direct supervisor of the Rig Techs and Roughnecks on the Jovian Discoverer IV. Lambert is addicted to three things: coffee, playing cards and trying to get into Miyazaki's pants.

STR: 13+5 **CON:** 15 **SIZ:** 13 **INT:** 12
POW: 10 **DEX:** 11 **APP:** 15 **EDU:** 13

Hit Points: 14

Damage Bonus: +1d6

Armour: None.

Weapons: Claw 50% 1d3; Bite: 50% 1d4; Grapple 60%.

Current Status: Infected. Late stage II

Initial location: Stalking D-Deck

Notes: Lambert is wearing a heavily bloodstained company issue jumpsuit.

Dominique Durand – Rig-Tech

French-European female aged 34.

Durand is responsible for the maintenance and smooth operation of the fuel scoop and processing machinery as well as other mining machinery on the rig. Also assists the Roughnecks if needed.

STR: 16 (11+5) **CON:** 13 **SIZ:** 12 **INT:** 14
POW: 10 **DEX:** 15 **APP:** 13 **EDU:** 14

Hit Points: 13

Damage Bonus: +1d6

Armour: None.

Weapons: Claw 50% 1d3; Bite: 50% 1d4; Grapple 60%.

Current Status: Infected. Stage II

Initial location: Lurking in Hab-A.

Notes: Durand is wearing a heavily bloodstained company issue jumpsuit.

Hollis Sutter – Rig-Tech

American male aged 41.

Sutter is responsible for the maintenance and smooth operation of the fuel scoop and processing machinery as well as other mining machinery on the rig. Also assists the Roughnecks if needed. Sutter was the Rig Tech infected on the return journey from the ill-fated mission to rescue the Telemachus.

STR: 18 (13+5) **CON:** 13 **SIZ:** 14 **INT:** 10
POW: 10 **DEX:** 12 **APP:** 13 **EDU:** 11

Hit Points: 14

Damage Bonus: +1d4

Armour: None.

Weapons: Claw 50% 1d3; Bite: 50% 1d4; Grapple 60%.

Current Status: Has reached Stage III and is currently turning into a Proto-Shoggoth...

Initial location: Cryovault.

Nikoli Ivanov – Rig-Tech

Eastern European male, aged 26.

Ivanov is responsible for the maintenance and smooth operation of the fuel scoop and processing machinery as well as other mining machinery on the rig. Also assists the Roughnecks if needed.

STR: 18 (13+5) **CON:** 13 **SIZ:** 14 **INT:** 10

POW: 10 **DEX:** 12 **APP:** 13 **EDU:** 11

Hit Points: 14

Damage Bonus: +1d4

Armour: None.

Weapons: Claw 50% 1d3; Bite: 50% 1d4; Grapple 60%.

Current Status: Has reached Stage III and is currently turning into a Proto-Shoggoth...

Initial location: D-Deck.

The Proto-Shoggoths

Intelligent Shape-Shifters from the stars.

A large mass of quivering and pulsating flesh mottled many hues of pink, brown, orange and yellow. Tendrils, tentacles and grasping claws extend from this coagulation of foul matter at seemingly random locations. A myriad of eyes, black as the deep gulfs of space themselves regard you with an expression at once indiscernible and inscrutable.

STR: 35 **CON:** 25 **SIZ:** 28 **INT:** 13
POW: 17 **DEX:** 11

Move: 8

Hit Points: 26

Damage Bonus: +3d6

Armour: None, but suffers only minimum damage from any attack against it. They also regenerate 2HP/round.

Weapons: Crush 100% 6d6; Limb (x3 per round) 50% 3d6; Bite 25% 2d6.
SAN: 1/1d10.

CONVICT WORKERS - NPCS

Lowest job on the rig is the position Roughneck. Manual labour. They work on the rig floor (i.e. down at the business end of the rig) in a team of three and are responsible for the operation of equipment and machines as required by the RigTechs. All the Roughnecks on the Jovian Discoverer IV are convicts serving Penal Involuntary Servitude orders, their contracts purchased by Jupiter Holdings. Six are described under the PC archetypes. The remaining five are as follows:

Kovacs, Boris. M23832

Russian male, aged 34.

Before he was arrested, Kovacs was a heavy working for the drug gangs currently plaguing the Circum-Jove colonies.

Crime: Murder, Second Degree.

Sentence: 20-Year sentence.

Current Status: Died before he could be infected

Initial location: Died when the shuttle he was piloting crashed into the hangar bay doors. The resulting explosion caused serious damage to the rig.

Notes: Died in shuttle crash in hanger bay.

Jones, Marcus. M23833.

American male aged 22.

Marcus Jones is a computer hacker, and was caught trying to steal the identities of Hallidor employees from a European Data-Vault.

Crime: Net Crime, fraud, identity theft.

Sentence: 5 years

STR: 10 **CON:** 09 **SIZ:** 12 **INT:** 14
POW: 10 **DEX:** 13 **APP:** 12 **EDU:** 16

SAN: 34

Hit Points: 11

Damage Bonus: 0

Armour: None.

Weapons: Fist 30% 1d3.

Selected Skills:

Computer: Operation 75 / Programming 60 / Security 75; Data Analysis: 40; Spot Hidden 40; Listen: 40; Electronics Systems 30.

Current Status: Uninfected.

Initial location: Hiding in Hab-B.

Suarez, Gustaves. M23834

South American, aged 25.

Suarez underwent Behavioural Alteration as per Clause 404 of the Geneva Statute. He looks vacant and spaced-out most of the time.

Crime: 1st Degree Rape, 4 counts.

Sentence: 18 years

STR: 18 (13+5) **CON:** 13 **SIZ:** 14 **INT:** 10
POW: 10 **DEX:** 12 **APP:** 13 **EDU:** 11

Hit Points: 14

Damage Bonus: +1d4

Armour: None.

Weapons: Claw 50% 1d3; Bite: 50% 1d4; Grapple 60%.

Current Status: Stage II

Initial location: Stalking B-Deck.

Yung, Catalina. F23835.

Chinese-American aged 24.

Yung was caught attempting to smuggle illegal contraband into the Sol system.

She's not particularly bright, and prone to hysteria.

Crime: Drug-Smuggling. 2 counts

Sentence: 10 years

STR: 10 **CON:** 11 **SIZ:** 10 **INT:** 11

POW: 16 **DEX:** 13 **APP:** 12 **EDU:** 09

SAN: 34

Hit Points: 10

Damage Bonus: 0

Armour: None.

Weapons: Fist 30% 1d3.

Current Status: Uninfected.

Initial location: Waiting for Kessler on D-Deck.

Kessler, Valentin. M23836.

Serbian-European aged 37

Ex mercenary. Not a nice chap. Kessler has managed to find a spacesuit and arm himself with an M25 Combat Rifle (taken from body of Ivanov before he began changing). He intends getting off the rig and doesn't care who he kills to do it.

Crime: GBH, ABH, Assault, various firearms charges

Sentence: 18 years

STR: 14 **CON:** 14 **SIZ:** 13 **INT:** 13

POW: 10 **DEX:** 16 **APP:** 13 **EDU:** 11

SAN: 48

Hit Points: 14

Damage Bonus: +1d4

Armour: None.

Weapons: Fist 50% 1d3; Combat Rifle 45% 2d6; Knife: 50% 1d4+2; Club: 50% 1d6+1

Selected Skills:

Dodge: 35; Computer: Operation 35;

First Aid 30; Spot Hidden 40; Listen: 40;

Electronics Systems 30; Vacc Suit: 25; EVA:

40; Psychology: 40; Devise: 30.

Current Status: Uninfected.

Initial location: D-Deck

Notes: Kessler has thought of the robotic freighter escape route, and will already be there when the PCs arrive. He will hide in the shadows, revealing himself once he ascertains if the PCs know how to get onboard.

APPENDIX B: SAMPLE INVESTIGATORS

The following sample investigators are given as examples, but Keepers should feel free to create their own if they see fit.

If you do choose to use one or all of the six listed here, you can download fully pregenerated character sheets by following the link below:

http://www.cthulhuring.co.uk/downloads/jn/jn_pregens.zip

Monika Jacowski. F23837.

Martian-American female aged 29.
Jacowski was involved in an armed robbery on Ganymede that went wrong. A hijacked shuttle crashed, killing 13 colonists and 1 FedPol officer. Jacowski managed to get into a space suit and EVA before the crash, and was picked up by a law enforcement cutter before her air ran out. As far as she is aware, only one other member of the gang survived - Marcus Van Owen, the rat who squealed to the cops...

Crime: Murder, Second Degree. Sentence: 20-Year sentence.

Carl Henriks. M23838.

Scandinavian-European male, aged 48.
Henriks was a helmsman at the Callisto orbital docks. His main job was making fuelling runs between the M-class tankers and smaller ships. Or it was, until a docking went bad. He crashed and took out the better part of two ships. 49 dead. He was so drunk at the time, he doesn't remember much about how it happened...

Crime: Manslaughter, 49 counts. Sentence: 49-year sentence.

Cherie 'Cherry Bomb' Bond. F23839.

Anglo-Japanese female aged 25. Known alias: 'Cherry Bomb.'

Cherie is a member of the Peoples Revolutionary Army, caught with a fake ID trying to enter Mars space. She is young and reactionary, and often contrary and generally disagreeable for the sake of it. The UEF deals with terrorists harshly. Too

harshly some would say. Bond got a 10 year stretch.

Crime: Possession of Firebomb, Incitement to Riot, Corporate Terrorism. Sentence: 10 year sentence.

Howard Grimes. M23840.

European-English aged 38.

A horrible excuse for a human being, Grimes is a nasty piece of work. He is a career criminal involved in everything from armed robbery to extortion. He doesn't care who he kills to get off the rig alive.

Crime: Armed Robbery, Assault, Attempted Murder. Sentence: Aggregate 32-year sentence.

Jesus Ignacio Dominguez. M23841.

Latin-American/Martian Native male aged 21.

Dominguez is a career gang member from Mars (the Red-Lats). He was arrested for involvement in a fly-by killing of 4 rival gang members in Anchorpoint City.

Crime: Murder, First Degree, four counts. Sentence: Life sentence on each count.

Nathaniel 'Nate' Stollmeir. M23842.

American male aged 36.

Stollmeir is a conman, and has been all his life. He was arrested for his part in an attempt to shake down the Daylight Casino on Unity Space Station. He is also known for being a bit of an escape artist, having previously escaped Terre Haute Earth, and Promontorium Agarum Correctional Facility, Luna. For the past 4 weeks he had been conducting an illicit relationship with the rig medical officer, Shaheen Malik.

Crime: Fraud. Sentence: Fraud, 10-year sentence. Additional five years for escape, Promontorium Agarum Correctional Facility, Luna.

APPENDIX C: DR MALIK'S PERSONAL JOURNAL

ENTRY: TIME STAMP 5 HOURS AGO

The shuttle has returned from its rescue mission. They managed to recover one survivor before the freighter fell too deep into the well. According to Darren (Vogel), she initially seemed physically in good shape, if a little shaken and distressed. During the return flight, she suffered some kind of fit, and attacked Hollis.

I've recommended that the woman be restrained and kept under sedation until we can figure out what is wrong with her. Shortly after arriving in the infirmary, she started bleeding from the left nostril. It appears that we have no information as to who she is. The away team were unable to recover any of the ship's log or a cargo/crew manifest.

I have given Hollis a tetanus shot for his bite injury, and dressed his wound. I doubt it will become infected, but you can never be too careful. O'Halloran has sent a message back to Callisto Control, informing them of the situation. I have piggybacked a DNA sample, in the hope CC can run it through their databases to see if they have a match.

ENTRY: TIME STAMP 4 HOURS AGO

As soon as Sutter arrived in the infirmary I could tell this wasn't going to be my day. He has developed a cough and a fever. Examined his bite wound – it doesn't look infected. Have run a blood test through Prospero to see what it comes up with.

ENTRY: TIME STAMP 3 HOURS AGO

Panic over. Sutter shows all the signs of a bad case of Martian Flu, which has been doing the rounds in the Gallilean colonies of late. More of the crew have started to call in with the same symptoms. I have recommended the standard treatment: analgesics when needed, plenty of fluids, bed rest if symptoms become worse. O'Halloran is not happy: We have one robot freighter docked and in the middle of its loading cycle, with another on the way. If this cuts into our schedules, it will affect everyone's share-options and quarterly bonus.

ENTRY: TIME STAMP 2 HOURS AGO

This isn't good at all. I will have to write more later, because things are a bit of a mess at present. Sutter had a fit – apparently the same kind of fit that the survivor suffered en-route back to the JD4. He had some sort of psychotic episode in the Hab-A galley and attacked Vogel, biting him. Vogel and Durand manage to restrain Sutter and bring him to the infirmary.

ENTRY: TIME STAMP 1 HOUR 40 MINUTES AGO

I don't see how it can be, but Sutter shows all the signs of being infected with late-stage Ngano Virus, except that it is progressing at a much more rapid pace. I have had Sutter put into one of the cryopods in the cryovault. I do not know what to do. I do not have the equipment necessary to test positively for Ngano Virus. The crew are worried. I don't blame them. We don't know how many people onboard could already be infected. O'Halloran has called an emergency meeting in Operations for all senior crewmembers. He wants my medical opinion. What am I going to tell him? I hope you're ok Nate. If O'Halloran decides to impose a quarantine order on the rig, and it is some strain of Ngano Virus, then you're safer than the rest of us. You've been locked up since before the shuttle returned. There is no way of knowing how many of us have already been exposed. God help us all.

APPENDIX D: CREW MANIFEST

Crewmember	Position
Anderson, Ruth	Deputy Warden
Cooke, Amy	Engineer's Mate
Durand, Dominique	Rig-Tech
Ivanov, Nikolai	Rig-Tech
Jacob Hollingshead	Helmsman
Johannson, Argus	Chief Engineer
Lambert, Jean-Jacques	Assistant Rig Chief
Lee, Alex	Assistant Medic
Malik, Shaheen	Senior Medical Officer
McKenzie, Douglas 'Mac'	Rig Chief
Miyazaki, Aki	Systems Technician
O'Halloran, Christoff	Warden-Administrator
Petrov, Andrei	Deputy Warden
Sutter, Hollis	Rig-Tech
Vogel, Darren	EVA Specialist

Convict Crewmember	Position
Bond, Cherie	Rig-Tech
Dominguez, Jesus Ignacio	Rig-Tech
Grimes, Howard	Rig-Tech
Henriks, Carl	Rig-Tech
Jacowski, Monika	Senior Rig-Tech
Jones, Marcus	Rig-Tech
Kessler, Valentin	Senior Rig-Tech
Kovacs, Boris	Rig-Tech
Stollmeir, Nathaniel	Senior Rig-Tech
Suarez, Gustaves	Rig-Tech
Yung, Catalina	Rig-Tech

ADVENTURE SEEDS

1. IN TOO DEEP

Location: The European World-Ocean
Optimum Number of players: 4-6
Required Skills/Professions: Scientist with skills in biology or chemistry, Pilot.

Investigators' Background

The Investigators are employees or associates of a megacorp with colonial assets on Europa. It doesn't matter which one - Keepers should pick one to fit in with their campaign. Contact has been lost with a deep sea exploration rig. The Investigators are part of a corporate search and rescue mission, a last ditch effort to contain the situation before news gets out and the ICA step in.

Keepers' Information

The rig was sent by the corporation to investigate a discovery in one of the trenches at the bottom of the European world-ocean. Robot probes sent into the trench have found some kind of structures resembling sunken city ruins. The structure an outpost, and is related to the sunken alien city located in the Argiope Linea (see *Jovian Secrets* chapter for more details).

What has happened?

1. Deep Ones have attacked the drilling rig, killing or capturing the crew. They are still on board;
2. As above, but they have taken survivors hostage into the structure;
3. The Black Chamber (MillSci) have taken control of the rig, to prevent knowledge of the alien ruins reaching the wider public;
4. As above, but while the Investigators are confronting the Black Chamber, the Deep Ones arrive...

2. BREAKING POINT

Location: Loki Patera, Io
Optimum Number of Players: 4-6
Required Skills/Professions: Corporate security personnel

Investigators' Background

The Investigators are corporate security personnel just arrived from Marduk to secure a new mining facility on the Loki Patera. Unfortunately, their first day starts off with a bang; the twelve workers on the skeleton crew have taken the manager, his secretary, and two other guards hostage, and are demanding that the corporation give in to a long list of demands, or they will use mining explosives to destroy the facility. The players have been ordered to deal with the problem without letting anything happen to the mining station.

Keepers' Information

The workers have been planning this for a while, and the momentary confusion as the security team switched over gave them the chance to put it into action. They don't have much in the way of weapons -- mostly construction and mining gear -- but they are very determined, and aren't likely to give in without having their demands met.

What's really going on here?

1. The crew are illegal immigrants who have been pushed to breaking point by poor conditions and even poorer wages. The company can't allow their story to get out.
2. As above, but the leader of the crew is suicidal due to a messy divorce; he has no intention of getting out alive.
3. The mining crew unearthed some sort of alien artifact, which has driven them insane; their demands make no sense and they ramble on endlessly, sometimes in unintelligible tongues.

- The leader of the revolt is actually an industrial saboteur working for a rival, who has been fomenting a revolt and plans to detonate the explosives no matter what happens, once he can make his escape.

3. DOUBLE CROSS

Location: Midgard City, Callisto
Optimum Number of Players: 4-6
Required Skills/Professions: Law enforcement or corporate security personnel

Investigators' Background

The Investigators are law enforcement or corporate security personnel who have caught wind of a meeting being held between Jovian separatists and a number of offworld visitors. The Investigators are told to make sure that everyone is in attendance at the meeting and then bust everyone there. Unfortunately, when they carry out the raid, everyone there is dead or dying.

Keepers' Information

Jovian separatists have become increasingly emboldened by a series of corporate abuses, and have been trying to stage an event which will make it impossible for the authorities to simply keep a lid on the whole movement. The Investigators were sent in to cut this off before it can even get out of the gate.

What's really going on?

- The offworlders were representatives of Proxima Mining, which is sympathetic to the separatists (but also wants lucrative Jovian resource rights for themselves). The attendees were all killed by a rival corporate hit squad.
- The offworlders were members of *Free Mars*, who were bringing a biological weapon to Callisto for the Jovian revolutionaries. The canister was damaged in shipping, and the contagion killed the attendees -- and now threatens to do the same to the Investigators and everyone else in

- Midgard City.
- The offworlders were members of a Mythos cult; the meeting was a summoning ceremony for a horrific servant to carry out a political assassination, but went horribly wrong. Now all the cultists and separatists are dead, and the thing has escaped.
- There were no offworlders; the entire meeting was a ruse to frame the Investigators for the murders by the Jovian separatists. The media arrives at the location of the meeting only minutes after the bust.

4. JUPITER FIFTY-SIX

Location: Jupiter 56 (S/2003 J 9), a minor satellite of Jupiter in the Carme Group
Optimum Number of Investigators: 4-6
Required Skills/Professions: Pilot, scientists, salvagers

Investigators' Background

The Investigators are sent by corporate or independent sponsors to conduct a series of surveys on Jupiter 56, a minor satellite of Jupiter. After several days of intense work, it becomes clear that something is very odd about the planetoid; it isn't a natural satellite at all, but some sort of derelict spacecraft of unknown origin.

Keepers' Information

The backers of the Investigators' expedition have suspected that something was not quite right about the moon for some time (but few people take claims about spaceships of little green men seriously, especially these days). They sent an expedition before, but it never returned; this only piqued their curiosity, and now they hope to confirm that they've made the find of the century.

What's going on inside the derelict?

- The derelict isn't quite as derelict as it seems. Alien creatures (such as Shoggoths or Mi-Go) still inhabit the spacecraft, and cause problems for any explorers.
- A rival crew of salvagers/explorers

- arrives, creating a showdown over who will get salvage rights on the derelict.
3. As above, but MiliSci commandos arrive a short while after the rivals, with orders to “sterilize” the scene and take possession for themselves.
 4. The derelict is actually a massive temple to one of the Great Old Ones; a group of cultists, drawn here through divination rituals, arrives to seize the derelict and use it to summon their master.

Note: Credit to Arthur C. Clarke for the idea for *Jupiter Fifty-Six*, in his story “Jupiter Five”.

5. GLACIAL

Location: Cadmus Linea, Europa

Optimum Number of Investigators: 4-6

Required Skills/Professions: Pilot, Security Officer, Medic.

Investigators' Background

Contact has been lost with a geological survey team working at the bottom of the Cadmus Linea on Europa. Cadmus Linea is one of many vast ice fractures crisscrossing the surface of the moon, and is over 1km deep. The Investigators are members of a team dispatched by the corporation funding the survey to ascertain what has happened.

Keepers' Information

The geological survey team have woken something up which has been frozen in the ice for countless millennia. It isn't in a friendly mood. Add unaccountable communications interference and cryovolcanic activity, and you have what can only be described as a 'situation'.

What do the Investigators find upon their arrival?

1. The survey team base camp is in ruins, but there is no sign of any of the team. Clues point to a warren of ice caves which the team was investigating. Within are a clutch of Star Vampires, who have eaten the survey team.
2. As above, but the Investigators find

- one member of the team still alive, but completely insane and covered in blood.
3. As above, but instead of Star Vampires, the insane survivor has actually been possessed by an alien entity, which was trapped inside an alien artifact unearthed in the ice caves. It can only transfer to other minds when in physical contact with the intended host body. The possessed team member has killed the rest of the survey team, and buried their bodies in the ice caves.
 4. As above, but the alien entity has the ability to jump into the mind of anyone within 10m.

6. THE GANYMEDE JOB

Location: Ganymede

Optimum Number of Investigators: 4-6

Required Skills/Professions: Computer Specialist, Weapons Specialist, Covert Insertion Specialist. Useful general skills include EVA, Vacc Suit, Devise.

Investigators' Background

A rival corporation has somehow learnt that Qin Mian Technologies are working on a very valuable and very dangerous project out at their Nidus Laboratory on Ganymede. Somebody in the special projects division of this rival has decided to engage in a little industrial espionage – they have put plans into motion to recruit a team to get a sample of whatever it is that Qin Mian Technologies are working on. This is where the Investigators come in...

Keepers' Information

The Investigators are all specialists in their fields, hired to plan and execute a heist at Nidus Laboratory Complex on Ganymede. The Investigators will be equipped by their patron (a fixer for the unnamed rival corporation), and given information and potential insertion points into the Nidus Laboratory Complex, which lies in the remote Nidus Crater on Ganymede. Once the job is done, they are to rendezvous on board a freighter in Ganymede orbit.

How does the heist go down?

1. The item that their patron wishes stolen is plans for a prototype antimatter engine. It is a straightforward heist.
2. As above, but the item stolen is actually a bio-weapon being illegally developed by Nidus Laboratories. The weapon is the same contagion that gets loose on board the Jovian Discoverer IV in the adventure *Escape Velocity*.
3. As above, but to complicate matters, one of the Investigators is actually undercover and working for a third faction who also wants the item.
4. As above, but once the Investigators escape to their rendezvous on board the freighter, the contagion gets loose...

7. SALVAGE RITES

Location: Circum-Jove Volume

Optimum Number of Investigators: 4-6

Required Skills/Professions: Pilot, Computer specialist, Weapons Specialist, Medical Officer, EVA specialist.

Investigators' Background

The Investigators are the crew of the *Nausicaa*, a deep-space salvage vessel owned by Deep Salvage, a subsidiary of Hallidor Corp. They are headed for some well earned R&R on Callisto, when HQ re-routes them to intercept a space-wreck falling through Circum-Jove space.

Keepers' Information

As the *Nausicaa* closes on the wreck, the onboard AI will detect a very weak transponder signal being broadcast. The vessel is the Orion, a colonial transport that went missing almost 23 years ago after making an F-Space jump from the Tau Ceti star system, headed for Earth. No attempt at communication will elicit any response. Its current trajectory and speed will make docking difficult, but there may be rich pickings on board, and the Investigators will get a sizeable bonus if they manage to bring it back to Callisto.

Where has the Orion been for the past 23 years?

1. The Orion suffered a critical systems failure while in F-Space, and it emerged in the Oort cloud surrounding the Sol system. It has been drifting ever since, slowly falling inwards towards Sol. The crew are all dead, but the cargo is still intact, and could be valuable. To complicate matters, a rival corporation has dispatched their own salvage mission to the Orion. It is up to the Keeper whether they arrive prior to or after the Investigators, and how hostile they are.
2. As above, but the cargo manifest includes several containers marked as the property of Cenargo Corporation Special Projects Division. In one of these containers is a *Servitor of the Outer Gods*, imprisoned inside a vat of viscous fluid which has kept the creature in a dormant state these past years. Where Cenargo discovered this monstrosity is unknown. By the time the Investigators arrive, the other salvage team has inadvertently let the creature free.
3. As above, except that not all the crew are dead. One cryopod still has power. Who is within and what do they know about the Cenargo Corporation cargo?
4. As above, but in the middle of everything else, the Trojan Pirates turn up too.

GLOSSARY

Explanations of terms and abbreviations used in Jovian Nightmares.

3He: Acronym for Helium-3, the primary fuel used in fusion reactors of the late 23rd century.

Aquifer: an underground layer of water-bearing permeable rock from which groundwater can be usefully extracted using a water well.

Chaos: Planetary geology - a distinctive area of broken terrain.

Circum-Jove: Term used to describe the region and objects around Jupiter.

Circum-Jove System: Term used to describe the region and objects around Jupiter.

Circum-Jove Volume: Term used to describe the region and objects around Jupiter.

Circum-Sat: Term used to describe the region and objects around Saturn.

CJA: Circum-Jove Administration.

Claim-Jacking: The act of taking over a mining claim by force.

Crater-Haters: Slang for the ICM garrison stationed on Callisto.

Cryovolanic: literally cold volcanic activity. Cryovolcanoes form on icy moons.

Rather than molten rock, these volcanoes erupt volatiles such as water, ammonia or methane. Collectively referred to as cryomagma or ice-volcanic melt, these substances are usually liquids and form plumes, but can also be in vapour form.

After eruption, cryomagma condenses to a solid form when exposed to the very low surrounding temperature.

EVA: Acronym for *Extra-Vehicular Activities*. Any physical action performed in a zero or micro-gravity environment. The term most commonly applies to an EVA made outside a spacecraft or space station (a spacewalk), but also applies to activity in microgravity environments such as on the Galilean moons.

Facula: Planetary geology - a bright area on the surface of a planet or moon.

FLEA: The Federal Law Enforcement

Authority. Primary law enforcement arm of the United Earth Federation.

ICA: Interstellar Colonial Authority.

ICM: Interstellar Colonial Marines.

ITC: Interstellar Trade Commission.

Jamhead: Slang for idiot.

Jovad: Jovian Administration. The government of the Circum-Jove colonies.

Kinetic Weapon: Projectiles which do not contain an explosive charge are termed kinetic weapons. Designed to impact a target at high velocity, on impact, the momentum of the projectile is transferred to a small target area, often penetrating building materials and vehicle armor.

Linea: Planetary geology - a dark or bright elongate marking, may be curved or straight.

Macula: Planetary geology - a dark area on the surface of a planet or moon.

MKC: Acronym for Motokatsu-Kyono Combine, the Japanese megacorporation.

Regio: Planetary geology - a large area marked by reflectivity or color distinctions from adjacent areas, or a broad geographic region

Regolith: Planetary geology - a layer of loose, heterogeneous material covering solid rock. It includes dust, soil, broken rock, and other related materials and is present on Earth, the Moon, some asteroids, and other planets and moons.

Spacenoob: Slang for someone new to living and working in microgravity environments.

UEAF: United Earth Armed Forces.

UEF: The United Earth Federation.

ONLINE RESOURCES

Cthulhu Rising website

<http://www.cthulhuring.co.uk>

Chaosium website

<http://www.chaosium.com>



CHAOSIUM
INC.

JOVIAN NIGHTMARES

...

**By the late 23rd century,
the gas giant Jupiter and its sprawling system
of rings and moons is home to a colonial population
of millions. Humanity is not the first star-faring
culture to have visited this region.
There are beings here
far older than Man.**

ISBN-10: 1-56882-295-2

ISBN-13: 978-1-56882-295-2

51695



9 781568 822952

**Find other treasures at
www.chaosium.com**

