

1920s

2371

CALL of HORROR SOURCEBOOK CTHULHU

ESCAPE FROM INNSMOUTH

SECOND EDITION, EXPANDED & REVISED



THE CLASSIC SOURCEBOOK, REVISED AND EXPANDED,
WITH TWO NEW ADVENTURES SET IN DEBACENT, INNSMOUTH

BY KEVIN ROSS

WITH ANIDLOWSKI, BEHRENDT, HERBER,
KINGREA, MORRISON, AND SZYMANSKI

ART BY ECKHARDT, KALIDHACK, AND SNYDER



ESCAPE FROM INNSMOUTH





H.P. Lovecraft
1890-1937

ESCAPE FROM INNSMOUTH

Second Edition, Expanded & Revised

by Kevin Ross

with Scott Aniolowski, Fred Behrendt, Keith Herber,
J. Todd Kingrea, Mark Morrison & Mike Szymanski

and Penelope Love, John Tynes & Richard Watts

Cover Art by John T. Snyder

Interior Art by Jason Eckhardt & John T. Snyder

Original Maps by Tom Kalichak

New Maps by J. Todd Kingrea

Project and Editorial by Shannon Appel

Prevision Edition Editorial by Keith Herber & Les Brooks

Interior & Cover Layout by Shannon Appel



Chaosium Inc.

1997

The Clear Credit Box

The heart of first edition *Escape from Innsmouth* was the work of Kevin Ross. Both introductions and the entire guide-book are his work. Mysterious Innsmouth, Welcome to Innsmouth, and Shadow Over Innsmouth are all Kevin's work as well, with the help of Heith Herber.

Kevin Ross was the primary hand in revising the first edition, and putting together the new scenarios for this expanded edition of *Escape from Innsmouth*.

The Crawford Inheritance scenario is also the work of Kevin Ross, while the *Escape from Innsmouth* scenario was written by Fred Behrendt.

The format of the Raid on Innsmouth scenario was devised by Keith Herber. Through a "summit meeting" of raid writers held at GenCon 1991, the scenario came to be. The individual authors of the scenario are: Kevin Ross (Introduction and Devil Reef), Fred Behrendt (Esoteric Order of Dagon), Scott Aniolowski (Marsh Mansion), Mike Szymanski (Smugglers' Tunnels), Mark Morrison (Y'ha-nthlei), and J. Todd Kingrea (Marsh Refinery).

The Sinister Seeds section was also written by a variety of people: Fred Behrendt, Keith Herber, Penelope Love, Mark Morrison, John Tynes, Kevin Ross, and Richard Watts.

The Appendix on Lovecraft Country originally appeared in *Tales of the Miskatonic Valley*, which was edited by Keith Herber. It has been revised for this new appearance.

The cover for *Escape from Innsmouth* is by John T. Snyder. He also did the interior illustrations, along with Jason Eckhardt. Almost all maps in this book, including the fold-out, are the work of Tom Kalichak. His Lovecraft Country map originally appeared in *Adventures in Arkham Country*. The new maps for The Crawford Inheritance and The Marsh Refinery section of the Raid on Innsmouth Scenario were drawn by J. Todd Kingrea.

Finally it should be noted that much of what you see here is the work of Keith Herber. He was the editor of the original edition of this book, and also the mastermind behind the original *Lovecraft Country* series of books for *Call of Cthulhu*

Escape from Innsmouth Second Edition
is published by Chaosium Inc.

Portions of *Escape from Innsmouth* written by Kevin Ross are copyright ©1997 by Kevin Ross. All rights reserved.

All other sections of *Escape from Innsmouth* and the book as a whole are copyright ©1992, 1997 by Chaosium Inc. All rights reserved.

Call of Cthulhu® is the registered trademark of Chaosium Inc.

Similarities between characters in *Escape from Innsmouth* and persons living or dead are strictly coincidental.

H.P. Lovecraft's works are copyright ©1963, 1964, 1965 by August Derleth and are quoted for purposes of illustration.

Except in this publication and in related advertising, art work original to *Escape from Innsmouth* remains the property of the artists, and is copyright by them under their individual copyrights.

Reproduction of material within this book for the purposes of personal or corporate profit, by photographic, electronic, or other methods of retrieval, is prohibited.

Address questions and comments concerning this book as well as requests for free catalogues of Chaosium books, games, and supplements to:

Chaosium Inc., 950 56th Street, Oakland, CA U.S.A.,

or by email to:

chaosium@chaosium.com

Visit our web site at:

<http://www.sirius.com/~chaosium/chaosium.html>

ISBN 1-56882-115-8

Chaosium Publication 2371. Published September 1997.

10 9 8 7 6 5 4 3 2 1

Printed in the United States.

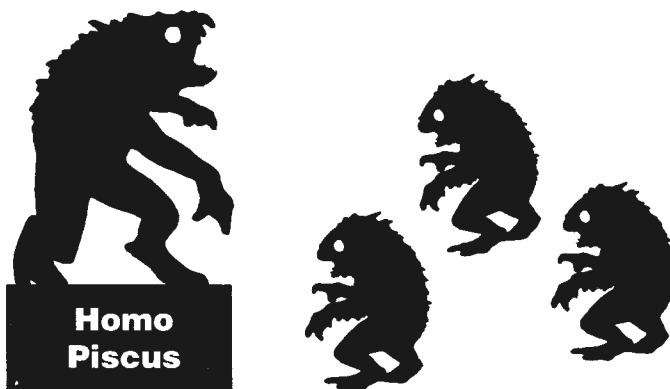

Table of Contents

Introduction	7	Objective Two: The Marsh Mansion	112
Mysterious Innsmouth	8	The Marsh Mansion Raiders	112
Welcome to Innsmouth.	13	Part One: Belly of the Whale	114
Shadow Over Innsmouth	15	The Marsh Estate & Environs [Map]	114
A Guidebook to Innsmouth and Environs. ..	21	Part Two: This Old House	116
Index to Guidebook Entries [Box]	22	The Marsh Mansion [Map]	117
Innsmouth [Map]	24	Part Three: The Wailing Writher	121
The Neighborhoods [Map]	27	Objective Three: Smugglers' Tunnels ...	122
100: The Northern Shoreward Slums	21	The Tunnel Raiders	122
200: New Church Green	27	Part One: Breaching the Tunnels	125
New Church Green [Map]	30	The Smugglers' Tunnels [Map]	124
300: Fine Old Residential Section	34	Part Two: Canals of Hell	126
400: Northern Residential Area	39	Slum House #1 [Map]	127
500: Riverfront Factory and Commercial ...	42	Slum House #2 [Map]	128
600: Southern Residential Area	46	Part Three: Hearts of Darkness	128
700: The New Merchant District	50	Typical Northern Shoreward Slums [Map] ..	129
New Town Square [Map]	50	Objective Four: Devil Reef	132
800: Southern Shoreward Slums	55	The Harbor Raiders	132
900: The Harbor Area	56	<i>Vigilant & Spectre</i> [Maps]	133
1000: Outskirts	59	<i>Urania</i> [Map]	134
Innsmouth Outskirts [Map]	60	Part One: First Contact	134
Devil Reef [Map]	63	Part Two: From Deep Waters	135
Air-Filled Chambers of Y'ha-nthlei [Map] ..	65	Part Three: Final Confrontations	138
The Crawford Inheritance	68	Objective Five: Y'ha-nthlei	139
Welcome to Innsmouth	69	Submarine Raiders	139
The Crawford Place [Map]	71	S-19 Submarine [Map]	141
The Crawford House [Map]	72	Part One: First Blood	141
Genealogical Research	76	Part Two: Deep Trouble	142
Things Get Ugly	77	Part Three: The Sunless Depths	143
Escape from Innsmouth	80	Objective Six: Marsh Refinery	146
Involving the Investigators	81	The Refinery Raiders	146
Innsmouth	85	Part One: Shootout!	148
Thomas Waite's House	87	Part Two: Into the Refinery	149
Innsmouth Jail	90	The Marsh Refinery [Map]	151
The Ceremony and the Sacrifice	90	Part Three: Destruction	152
Escape from Innsmouth	92	The Raid On Innsmouth: Conclusion ...	154
Statistics	97	Raid Records	156
The Raid on Innsmouth	98	Innsmouth Hybrids & Deep Ones	158
Project Covenant	98	Sinister Seeds	159
Objective One: Esoteric Order of Dagon ..	104	Appendix: Lovecraft Country	165
The Esoteric Order Raiders	104	Lovecraft Country [Map]	166
Part One: The Frozen River	105	Index	168
Part Two: Inside the Order	108	Support Character Sheets	170
The Esoteric Order of Dagon [Map]	109	Investigator Sheets (Front)	171
Part Three: Disruption	110	Investigator Sheets (Back)	172

*This second edition is dedicated to
Doc Herber, the true architect of
the Lovecraft Country series,
and the heart and soul of Call of Cthulhu
—Kevin Ross, May 1997*





MYSTERIOUS INNSMOUTH



*The history of Innsmouth,
accepted and secret.
Also, a chronology.*

What goes on in Innsmouth is unknown to most outsiders. Rumors, legends, and gossip abound in the towns and cities located safely miles away from the isolated region, but as one gets closer to Innsmouth, the locals become less willing to talk. It is known to most that the town is dying, victim of a choked harbor and a failing fishing industry. Older folks remember tales of a strange plague brought home by sea-traders, and of the riots sparked by the plague. A few whisper stories of pagan religions, but none know the whole truth.

The Accepted History

(Excerpted from Fall's Historical Atlas of Massachusetts, by David Gyer Fall, published 1898)

INNSMOUTH—Founded 1643. Current population estimated at 556. Region first settled by the Hogg, Eliot, Marsh, and Martin families of nearby Newbury. In 1678 a shipyard was opened by Thomas Martin, an industry supported by the increasingly prosperous trade in codfish. Additional shipyards were opened and prosperity early embraced the town.

The first Innsmouth voyage to the West Indies was made in 1662, followed over the years by an ever-expanding trade with the East Indies, the South Pacific, and China. To avoid running afoul of the increasingly restrictive provisions of Britain's Trade Acts, early traders found smuggling their only available recourse. Illegal cargoes were unloaded far offshore, then secreted into town by way of a complex of sea caves and man-made tunnels running under parts of the town. Some of these tunnels, long unused, are supposed to still exist.

By the time of the American Revolution, Innsmouth had grown to a community of nearly 2000 people, most of them engaged in the shipping and fishing industries. The town had by then spread to both sides of the Manuxet river, now crossed by a bridge built over the gorge near the location of the present day Main Street. At Bunker Hill, Innsmouth was represented by a small band of stalwart men, but for most of the war the town's contributions were in the form of ships, and the privateers who took them to sea. The privateers were authorized by the newly formed American government to attack and raid ships flying under the flag of England. Privateers signed agreements that allowed them to keep one third to one half of any English booty, the rest to be turned over to the government and the cause of the Revolution.

The success of the American Revolution allowed the New England traders free access to the seas and Innsmouth,

like similar ports, prospered. But the War of 1812, bitterly opposed by many of the Federalist New England traders, brought an end to prosperity. The loss of ships and men was atrocious and the end of the conflict found an Innsmouth crippled by a lack of ships as well as manpower. Some of the town's most prosperous families were ruined by the losses they suffered in the course of the war. An unfortunate series of maritime disasters over the next few decades further crippled the town's growth. The last of Innsmouth's trade ships made their final port of call by the middle of the 1800s.

By then the town's interests had turned to industry, spurred in part by the Marsh gold refinery operated on the banks of the Manuxet River. But the Industrial Revolution never caught fire in Innsmouth, and the failing fishing industry added to the town's woes. In 1846 the town was struck by a plague, believed to have been carried into town by a ship returned from the South Pacific. Although little is known of the incident, riots eventually broke out resulting in the deaths of dozens of individuals. By the time of the Civil War, Innsmouth had fallen into a steep decline, and already the number of empty houses was a cause for remark.

Today Innsmouth is a shadow of its former self, a half-deserted seacoast town forgotten by time. Most of its residents are of old stock, rooted to the land by time and tradition.

The Secret History

The true story of Innsmouth is known only to its residents, and a very few outsiders. Vague rumors circulate in neighboring communities, and terrible secrets are whispered at firesides, but no one guesses the whole truth. The secret history of Innsmouth begins in the 1820s, when an uncharted island east of Otahenté (Tahiti) was discovered by a young Captain Obed Marsh, then engaged on a voyage to China. Marsh here found a tribe of Islanders and managed to trade with them for the remarkable pieces of gold alloy jewelry they wore. Curious as to the source of the jewelry—it seemed obviously beyond the abilities of the natives to manufacture—he was told by the chief, Walakea, that it was given to them by the "sea-gods," and that his people could get more of it, as much as they wanted.

Marsh never saw the islanders' dreaded sea-gods, but he was taken to a nearby island—a tiny portion of land the natives claimed had been thrown up from the ocean floor. The carved stone ruins Marsh found on the island were unlike anything he had ever seen or heard of, and he did not argue with Walakea's claim that they were parts of the sea-gods' city. It was here that the islanders practiced their degenerate rites, offering human sacrifices to their sea-gods

in return for good fishing harvests, safe weather, and the pieces of gold jewelry the sea-gods made.

Promising to return with more of the glass beads favored by Walakea, Marsh left the islands, the gold in his private chest worth more than all the cargo on the rest of the ship. In his pocket he carried several small metal discs given to him by Walakea. The “deep ones,” as the islanders sometimes referred to their gods, lived all over the world. If Marsh dropped the discs near one of their underwater cities, and recited the chant the chief had taught him, the deep ones would rise to the surface in answer.

For years Captain Marsh dealt secretly with the islanders, going to great lengths to disguise the location of their home to keep it safe from other traders. The power and wealth of the Marsh family grew, even as that of other families decreased.

At first the jewelry was sold as it was, but when too many questions were asked about its source Marsh purchased the old Waite fulling mill and outfitted it as the Marsh Refining Company. Here the jewelry was smelted down, the impurities removed, and the pure gold sold on the market. In order to mask his operation Marsh also purchased loads of low-grade ore, doctoring his records as necessary to cover the profits. The Marsh family continued to prosper.

In 1838 Captain Marsh voyaged to his secret trading place only to discover the village destroyed. Walakea and his tribe were dead. They had been wiped out by some of the neighboring tribes who Marsh knew feared and loathed Walakea’s people. The nearby island of the sea-gods was deserted, the natives’ altars overturned, the ground littered with strangely-marked stones bearing five-pointed stars. Despairing, he returned home, without the gold on which he relied.

Despite the late successes of the Marsh family, the town was showing signs of failing. The trade industry was almost dead, and the fishing was no longer as good as it used to be. Even some of the factories along the Manuxet had closed their doors.

It was then that Obed hatched a desperate plan to rejuvenate Innsmouth. Using the metal discs given to him years before by Walakea, he would attempt to contact the deep ones. Out beyond Devil Reef Obed cast the discs, muttering softly the chant taught to him by the native chieftain. Before long, forms rose up from beneath the sea.

At first the deep ones were satisfied to trade for glass and rubber trinkets, but before long they demanded more. As had the deep ones in the South Seas, these wanted their sacrifices—men and women from the town of Innsmouth.





A NEW RELIGION

Attempting to meet the deep one's demands, Marsh began subtly undermining the religious faith of the townsfolk, preaching against a god who would do nothing to help his people, and hinting that he knew of other gods that were more willing to listen to the needs of their worshipers. Marsh showed them the hands-on power of his religion in the form of increased schools of fish in the area.

Having suffered through decades of recession, many of the Innsmouth folk began to listen to what Captain Obed had to say. Many turned their backs on the old churches, and more and more began to join the new church founded by Marsh and some of his loyal followers. This new church was named The Esoteric Order of Dagon. Most of their rites were attended by the full congregation, but some were conducted in secret, attended only by Marsh and his most loyal followers.

Occasional disappearances of townsfolk were noted, but little was thought of it. The fishing harvest was increasing, particularly for those affiliated with the Esoteric Order. Others. Eager to share in the wealth, many townsfolk joined their friends in worship at the new church run by Obed.

The Congregational church, its flock nearly depleted, was the first to close its doors. A short time later it was followed by the Methodist church. The Baptist church held

out longer, but after the parson mysteriously disappeared, the congregation disintegrated and it too was left abandoned. Within a few short years the Esoteric Order completely controlled the spiritual aspect of the town. Numerous disappearances throughout this period went unsolved, although unsavory rumors about Marsh and his followers—and what it was they did out beyond Devil Reef in the dead of night—began to be whispered about. Although a few spoke out about the disappearances, the majority were willing to ignore them. Actual evidence of wrongdoing was scarce or lacking, and most were unwilling to risk the prosperity they now enjoyed.

But there were those who actively opposed Marsh. Matt Eliot, formerly the first mate aboard Marsh's *Sumatra Queen*, had a good idea of the true nature of the horror overtaking the town. It was he who first secretly warned the local religious leaders about Marsh's blasphemous doings. After the churches had closed Eliot became more vocal, attempting to enlist the aid of John Lawrence, editor of the *Innsmouth Courier* newspaper, along with other influential members of Innsmouth's Freemason lodge. But then Eliot mysteriously disappeared. Lawrence continued to publish against Marsh but, in an ironic twist, the by-now depleted Freemasons defaulted on their loan and the Masonic Hall



AN INNSMOUTH PANORAMA

was bought out from under them by Captain Obed Marsh. The Esoteric Order of Dagon moved in.

In 1846 those who feared Obed Marsh still outnumbered his followers. Rumors of countless kidnappings, human sacrifices, and other blasphemies too terrible to recount were rampant. One night a band of men followed Obed and his men out to Devil Reef. A brief gun battle ensued, resulting in the arrest of Captain Marsh and 32 of his followers, all jailed on suspicion of murder and kidnapping.

Two weeks passed before the people of Innsmouth suffered the retribution of the deep ones. Pouring out of the harbor and swimming up the Manuxet, the horrible fish-headed, frog-headed deep ones, the sea-gods of Walakea, took their revenge on the town.

Assaulting the jail, they freed Obed and his followers. Street riots and bloodshed ensued, violence that was to end only when over half the townspeople were either dead or missing. The offices of the *Innsmouth Courier* were destroyed and editor Lawrence never seen again. Selectmen and constables not allied with Obed likewise were found dead, or not found at all.

Innsmouth was now in the grip of Obed. Replacing the murdered officials with men of his own choosing, he moved quickly to make sure that the surviving townsfolk

spread no tales of what had taken place in Innsmouth. Stories of a strange plague and a riot leaked out, but they contained no details. Threatened by the near presence of the horrible things from the sea, the few remaining survivors feared to cross Obed. Over the next few years most joined, or were forced to join, the Esoteric Order.

A BLASPHEMOUS PACT

Even Captain Marsh did not expect the next demand that the deep ones made of Innsmouth. He was shocked when told that they now wanted to mate with the humans of the town, the same way their cousins had mated with Walakea's people in the South Pacific.

There was no point in trying to deny them; they now held the town in their scaly grip. Marsh himself was forced to take a second wife, a spouse rarely, if ever, seen in public. Other townspeople were also forced to assume new partnerships, prompting a wave of suicides, particularly among the female population of the town. Innsmouth became a place where the wise asked no questions, and kept themselves locked behind doors at night.

Thereafter many children born in town exhibited what became known as the "Innsmouth look," the bulging, watery eyes, broad mouth, scaling skin, and shuffling gait that betray

An Innsmouth Chronology

1616: Captain John Smith's journal records the sighting of "the Devil's reef" while he is exploring the east coast of the New World.

1643: Innsmouth is founded. Initial settlers are from the Hogg, Eliot, Marsh, and Martin families of the nearby city of Newbury.

1662: First Innsmouth voyage to the West Indies.

1678: Martin's shipyard begins building ships to supply Innsmouth's rapidly expanding fishing and trade industries.

1775: Innsmouth militiamen present at Bunker Hill. Innsmouth later provides ships and men to aid the cause of the Revolution.

Post-Revolution: Innsmouth's sea captains navigate their vessels to new ports in the Orient and the South Pacific.

Early 19th century: The Pierce, Waite, and Southwick families, among others, diversify their interests, and several textile mills are built along the Manuxet River.

1812: Innsmouth's sea trade suffers a series of setbacks beginning with the loss of many privateer ships in the War of 1812. Following the war, storms and hostile natives bring ruin to the Gilman family shipping lines.

1820: Captain Gardner Averill of Innsmouth learns a dangerous demon-summoning ritual from a Burmese sage, and records it in his log. Captain Obed Marsh's ships, the *Columbia*, the *Hetty*, and the *Sumatra Queen*, begin a series of successful voyages that brings prosperity to the entire Marsh family.

1823: Obed Marsh discovers an island in the Tuamotu Archipelago where natives wear fabulous gold jewelry and worship perverse sea-gods. Marsh begins a regular trade in the alien jewelry, eventually purchasing Waite's abandoned fulling mill in Innsmouth and converting it into a sham gold refinery in an effort to justify his source of wealth.

1831: Captain William Henry Parker meets with a Chinese sage named Lang-Fu. Learning of Obed Marsh's alleged contacts with a race of sea-gods, Lang-Fu kindly entrusts Parker with a sacred manuscript to be delivered to Marsh. Parker reads the manuscript (an English translation of the *R'lyeh Text*) and, horrified, hides it in his own library.

1833: The *Innsmouth Courier* newspaper is founded, edited by the fiery John Lawrence.

1834: Jedediah Gilman, almost ruined by a series of shipping failures, invests the last of his fortune in building the huge Gilman House Hotel.

1838: On a voyage to the South Pacific Marsh discovers that the native tribe who traded him jewelry has been completely wiped out by neighboring islanders. His source of gold is lost.

1840: Obed Marsh, having previously learned the true nature of the islanders' gods, now contacts a colony of them living off Devil Reef. The deep ones of Y'ha-nthlei begin supplying Marsh with the gold he desires.

1840s: Innsmouth's legitimate churches are run out of town by Marsh and his followers. Others are subverted to their cause with offers of gold and promises of eternal life. By this time Innsmouth's industries are showing signs of failure, many of them relocating to other towns. Although opposed by many, Marsh's Esoteric Order of Dagon flourishes, all the while secretly conducting human sacrifices off Devil Reef.

1841: The branch rail line from Rowley is built.

1842: Douglas Averill, son of retired sea captain Gardner Averill, is murdered by one of Marsh's followers. Due to Marsh's influence the suspect is soon released and all charges dropped. But soon after Gardner Averill and his surviving son conduct the strange ritual the old man learned in Burma. Summoning a Servitor of the Outer Gods, the fiendish creature is sent to slay the offender in a manner most terrible. The Averills are not bothered again for many years.

1846: Obed Marsh and several of his followers are arrested and thrown in jail on suspicion of kidnaping and murder. Two weeks later the deep ones invade the town, free Marsh, and kill anyone who resists—including *Courier* editor Lawrence and Selectman Leonard Mowry. Later referred to as "a riot," the unrest is blamed on a plague that swept the town.

Innsmouth is now completely in the hands of the deep ones and their human minions. Hereafter, the people of Innsmouth are forced to cohabit with deep ones and for the next eighty years, a large proportion of Innsmouth's children bear the tainted blood of the deep ones. Semi-batrachian horrors are sealed away in attics and cellars.

1863-64: Government conscription agents are sent to Innsmouth to see why draft quotas are not being filled. These men find inbreeding and degradation, and leave the hateful place to its own squalor.

1866: A near curtailment of sea trade, combined with the clogging of Innsmouth's harbor, prompts the federal government to close down the Custom House and rescind its status as a port-of-entry.

1878: Obed Marsh dies leaving the Esoteric Order of Dagon in the hands of his tainted descendants.

1889: The branch rail line to Rowley is abandoned, and left to rust.

1921: Innsmouth wizard Ephraim Waite dies, leaving his daughter, Asenath, a ward of the principal of the Hall School in Kingsport.

July, 1927: Robert Martin Olmstead visits the town and is forced to flee for his very life after learning too much about Innsmouth's secrets. He reports his ordeal to government officials and in the ensuing months the Treasury Department conducts a secret investigation.

February, 1928: The U.S. government stages a devastating raid on Innsmouth, freeing it from the dire forces of the deep ones. ■

the tainted blood of deep one heritage. Those afflicted eventually became so bad that they were forced to stay indoors, out of the sight of other, normal people. Although their deaths would eventually be announced, it was rarely the case. These individuals, now fully transformed deep ones, would instead return to the sea to dwell with their cousins in the depths.

Throughout the rest of the 19th century Innsmouth's people continued in their blasphemous ways, some by choice, some without. More hybrid horrors were born, and occasionally individuals married into unsuspecting families in neighboring towns—forever damning the children and grandchildren of such unions. Obed Marsh ruled Innsmouth as though a dictator, using the Esoteric Order of Dagon as his tool, but always obeying the directives of his deep one masters. Residents were required to take the First Oath of Dagon. Selected others were forced to swear the horrid Second and Third Oaths. Its people inbred and decayed, their spirit destroyed by oppression and horror, their sorrow drowned in alcohol and forgetfulness, the town's economy faltered. Innsmouth began to slowly die.

Obed Marsh passed away in 1878, leaving behind a legacy of horror and degeneration which poisoned generation after generation of townspeople. As the number of hybrids increased, the few human residents lost all will to resist, and the Esoteric Order over the years relaxed its grip. There was no longer a need for strict enforcement.

The Present

Little has changed in Innsmouth over the last few decades. Its economy continues its decline, its impoverished residents still isolated by harsh terrain and whispered rumor. Schools of fish teem in the waters around Devil Reef, but competition from the mass-production packers in Gloucester and elsewhere have eroded their value. Marsh's gold refinery still operates, but at only a fraction of its former capacity. Few outsiders visit the place, and most maps and guidebooks omit any mention of the town. Innsmouth's only connection to the outside world is the bus route driven by Joe Sargent, one of those bearing the Innsmouth look.

Many of Innsmouth's residents enjoy gas and electrical service, but many still rely on candle light and wood-burning stoves and fireplaces. There is telephone service in town, but less than half the townsfolk have their own phones. To save money the streetlights are used sparingly, and usually turned off during nights of bright moonlight. Automobiles and trucks are fairly common, but almost uniformly old and in poor condition. With very few exceptions, the local fishermen use boats powered by sail and oar.

Visitors to Innsmouth are relatively rare. Sightseers, tourists, antiquarians, and other curious types occasionally stop in to see the shunned town, but they rarely stay long—almost never overnight. ■



WELCOME TO INNSMOUTH

*An overview of Innsmouth.
Location, climate, and government.
Also, rumors and lore.*



Innsmouth lies on the coast of the Atlantic Ocean, straddling the small, but swiftly flowing, Manuxet River. Nestled in a bowl-shaped depression, Innsmouth is surrounded by marshlands, and further hemmed-in by steep hills to the north and west. South of Innsmouth the ground is level, and occasionally dotted by stands of hardwood. The greatest of the marshes surrounding Innsmouth lies just north of town. Known as the Great Innsmouth Salt Marsh, it is a vast expanse of reeds and sandbanks inhabited by terns and gulls.

Arable farmland around Innsmouth was scarce and any likely spot was cleared and planted many centuries ago. These farms are now nearly all abandoned. Their fields are sandy wastelands which have been ravaged by wind and erosion, the end result of unchecked deforestation. The town's harbor, which was once the home port of globe-spanning ships of trade, is now clogged by the eroded soil and sand that has been washed downstream by the Manuxet. The clogged harbor can only be entered safely by the smallest of craft.

North of the harbor is a rocky spit of land, pierced by sea caves, that extends out into the ocean. Due east of town, more than a mile out to sea, lies the long dark line of Devil Reef, a low rise of black stone jutting irregularly above the waves. It is also the site of numerous sea caves.

Finding Innsmouth

Taking Highway 1A north out of Arkham, an unmarked junction is found that leads into Innsmouth from the south. From Newburyport in the north a similar unmarked road follows the coast before rising steeply to crest Carson's Hill, overlooking the town. The small towns of Rowley and Ipswich lie west of Innsmouth, connected to the shunned town by unimproved and rarely traveled roads that wind through marshes and over decrepit stone and wooden bridges. A branch rail line leads to Rowley, but was abandoned years ago. The rusting tracks can still be seen stretching across the marshes west and north of town, raised upon an embankment.

Innsmouth Lore & Rumors

The Innsmouth Lore skill is a measure of how much a person knows about the town, his ability to recognize the signs of tainted blood, his knowledge of a given family's tainted ancestry, and his hypotheses about what it is that is wrong with Innsmouth. The following breakdown offers some guidelines as to exactly what type of knowledge might be known to an individual.

01-30%: Innsmouth Lore skill of this level provides general bits of knowledge about specific inhabitants of Innsmouth (e.g., the Jed Gilman family has three young children, their daughter has not been seen since she began developing an odd skin condition on her hands). At this level there is recognition that an unknown disease has achieved widespread infection throughout the community.

31-65%: This level of knowledge provides more in-depth, historical information about the depraved town. At this level the possessor knows when the infection first appeared among the inhabitants of Innsmouth, and to which families the conditions first spread. The possessor also has reason to believe the disease has been spread intentionally.

66-99%: Provides knowledge about the social activities of the Marsh family and other highly placed members of the Esoteric Order of Dagon. The possessor may also know when the order was first established and other important facts regarding the social and religious history of Innsmouth.

81-00%: Allows the possessor to correlate the information learned at earlier levels into a terrifying overall awareness of the situation in Innsmouth. Upon achieving this knowledge, the possessor is charged a Sanity loss of 1D6 points.

An investigator can increase his own Innsmouth Lore skill by speaking with knowledgeable people. Any informative conversation with a resident that can be followed with a D100 roll less than that resident's Lore skill allows the listener to add 1D6 to his own skill. Innsmouth Lore also increases a character's Cthulhu Mythos score. For every ten percentiles gained in Innsmouth Lore, a character should increase his Cthulhu Mythos score by one point, simultaneously subtracting a point of Sanity.

Note that certain artifacts and written sources of information add to Innsmouth Lore: most of these are discussed in "Other Sources of Information," p. 18.

If unsure of a non-player character's particular Innsmouth knowledge, the keeper may use the list of rumors below. A person will know approximately one rumor for every 5% of Innsmouth Lore he possesses. Note that not all rumors are true.

- 1 In the 1830s Captain Obed Marsh discovered a pirate hoard somewhere out on Devil Reef. The gold jewelry sometimes worn by Innsmouthers is part of that hoard.
- 2 There is a vicious gang of moonshiners working out of the ruined houses north of the river. Stay clear of that area.
- 3 Obed Marsh's second wife was a South Sea islander who introduced some sort of awful disfiguring disease into the Marsh blood line. Several of Marsh's sailors also had Kanaka wives, and their families were similarly afflicted.

4 A plague brought back from the East Indies swept through Innsmouth in the 1840s or 1850s, killing many residents.

5 A few years back a factory inspector got a terrible scare in Innsmouth. He's in the Danvers State Mental Hospital now.

6 Animals hate the Innsmouth folk.

7 A lot of the houses in Innsmouth are abandoned, but many are actually inhabited by hoboes and squatters.

8 Some of the worst-looking of Innsmouth's deformed folk are kept locked up in attics and cellars.

9 The churches in Innsmouth all preach strange South Sea islander mumbo-jumbo, in addition to their regular sermons. All the congregations are tainted with this pagan worship.

10 The fishing off Innsmouth is supposed to be excellent—but only the Innsmouth fishermen know the waters well enough to avoid ripping their nets or losing their boats on the reefs and submerged rocks. Outsiders who have tried their luck in these waters have had little success, and sometimes were run off by the Innsmouthers.

11 About the time Obed Marsh started his new religion, the Esoteric Order of Dagon, the land around Innsmouth became infertile. Some say it was God punishing the people of Innsmouth for their blasphemies.

12 The Marsh Refinery seems to produce a lot of gold, at least compared with the amount of raw ore they buy.

13 There are supposed to be terrible monsters lurking in the salt marshes north of Innsmouth.

14 Folks in these parts won't marry into an Innsmouth family. They fear infection by whatever disfiguring disease it is that causes the "Innsmouth look."

15 Some people staying in the Gilman Hotel have reported hearing strange, foreign voices at odd hours of the night.

16 The only industries left in Innsmouth are the fishpacking houses and the old Marsh Refining Company. There can't be more than a dozen businesses still operating in that town.

17 The Marsh family has run Innsmouth since the 1830s.

18 Nobody's seen Old Man Barnabas Marsh, the grandson of Obed, for over ten years. His sons are now running the refinery.

19 Some of the old warehouses in Innsmouth still have forgotten cargoes stored in them. Some of them have been stored away for over a hundred years.

20 Rumors say that people have disappeared while visiting Innsmouth. It could have been the work of bootleggers, robbers, or maybe somebody ran afoul of the still-powerful Marsh family.

21 There can't be more than 300-400 people left in Innsmouth. Over half the town is abandoned in ruin.

22 Back in the early 1800s the Gilman family's shipping trade ran into a series of disasters. Ships were variously lost to hostile natives, storms, and other misfortunes.

23 Stories say that old Obed Marsh sold his soul to the Devil for gold, and it was this that destroyed the town. ■

Two small communities lying southeast of the town fall within the jurisdiction of Innsmouth Township. Falcon Point, home to forty or fifty people, is the larger of these two villages and is found on a rocky peninsula a short distance from town. Lying nearer to Innsmouth is Boynton Beach, a fishing village next to a long line of cliffs with a population of about a half-dozen families.

Climate

In the fall, high temperatures along the north coast range from the low 50s to the mid-60s F. First snowfalls often arrive in late October, but sometimes as late as the end of November. Normal winter highs range from the mid-20s to upper 30s—though cold air masses rolling in from the north often drive temperatures down into the teens and lower. Spring thaws come to Innsmouth in late March or early April, with balmy temperatures averaging in the 50s, and 60s. In the summer, cooled by sea breezes, temperatures rarely go above the mid-80s.

Township Government

Innsmouth and the neighboring villages of Falcon Point and Boynton Beach share a township government. Annual town meetings are held every March 15 at the Assembly Hall in Innsmouth. Elections are held every three years. Voters choose three selectmen, a school committee, a clerk,

a treasurer, a tax assessor, and a Justice of the Peace. All residents of the township are eligible for office, but those who live outside the town rarely even vote. The government has long been controlled by the Esoteric Order. Current town selectmen include Sebastian Marsh, F. Murray Gilman, and Jonas Waite. All three are descended from old Innsmouth families—and all three are tainted by the blood of the deep ones. All other elected town offices are held by either the hybrids, or by humans closely affiliated with the Order. The Town Constables are appointed by the selectmen and are responsible for tax collection and law enforcement within the township.

CRIME AND PUNISHMENT

Normal crime in Innsmouth is rare. Kidnapings and murders committed by the Esoteric Order are ignored and covered up, and few complaints are made. Similarly, crimes committed by certain powerful hybrids also go unchecked. Town citizens who fall afoul of the Esoteric Order are dealt with in a summary manner. There is little resembling normal justice in Innsmouth.

Outsiders committing a crime in Innsmouth are subject to arrest and jail. Although by law felony crimes are the jurisdiction of the Essex County courts, in practice Innsmouth deals with its problems in its own manner, pragmatically and in secret. Outsiders arousing the suspicion of the Order can be arrested on any trumped-up charge and legally held for up to 72 hours. Few live that long. ■



SHADOW OVER INNSMOUTH

*The Esoteric Order of Dagon and its members.
The blasphemous magic of Innsmouth.
Also, a listing of other sources of information.*



FOR NEARLY AS LONG as any Innsmouth resident can remember, the town has been in the grip of the deep ones living off shore. The few pure-blooded human residents are completely under the control of their hybrid counterparts. Those who draw the hybrids' wrath find their fishing boats holed and sunk, their jobs taken away, or fall victim to accidents arranged by the hybrids. The worst offenders are kidnaped and sacrificed to the deep ones, or fed to the shoggoth that dwells in the tunnels and caves beneath the warehouse district. Large gatherings of humans are actively discouraged. Outnumbered two to one by the hybrids, the humans are cowed and defeated, few left with the strength to retain even the last shreds of dignity. Many people have chosen to side with the hybrids—or at least pay them lip service—attempting to better their situation. By aiding the hybrids, humans can assure themselves of secure employment in the fishpacking houses or other low-paying jobs. Locals seen spending much time

with outside investigators are sure to draw the attention of The Order, and to be suspected of collusion.

Beyond its general air of decay and decrepitude, visitors to Innsmouth are struck by two things: the furtive, fearful attitude of the normal townspeople, and the openly suspicious, almost sinister behavior of those that bear the “Innsmouth look.”

The Innsmouth Look

The Innsmouth look is a local term describing the odd condition suffered by many of the residents of this town. Variousy blamed on inbreeding, the introduction of foreign blood, or the long-term result of the plague that swept through in the 19th century, it is characterized by large, distended eyes, a general broadening of the mouth, and a stooping posture. Skin diseases resulting in a scaling, flaking condition often accompany it. Later stages of the mala-

dy result in an enlargement of the hands and feet, and a change in hip structure that results in a hopping, shuffling gait. It is, of course, a result of the cross-breeding between deep ones and the inhabitants of the accursed town. Although most offspring of such unions are born as normal humans, changes begin taking place usually in the victim's early teens. By middle age, most hybrids show some form of gross deformity, many retiring to the privacy of their closely-shuttered homes. Most make the final transformation to deep one, and return to the sea.

The hybrids do not take to the water unprepared. Their physical changes are accompanied by an awakening of new senses, and they are visited in their dreams by other deep ones, sometimes introducing themselves as the hybrid's forebears. They are shown vast aquatic cities swarming with strange creatures, and they are taught about life under the sea.

In the final stages the dreams and mutations intensify until the hybrid is either driven mad or undergoes the final physical change into a deep one. Other deep ones may try to lure the hybrid to their lairs where they can supervise the final stages of metamorphosis. Approximately 10% of all hybrids do not complete the metamorphosis and spend a normal human life span as a half-human, half-deep one.

Typical Hybrids

The typical statistics and skills shown below can be used by the keeper to create hybrids. Although the chance of a hybrid owning a specific weapon is indicated as a percentage in parentheses, most are not normally armed. Only in the time of a town emergency will most hybrids be carrying their weapons.

Additionally, a selection of pre-generated hybrids is found in the back of this book, p. 158.

	<i>Range</i>	<i>Average</i>
STR	3D6	10-11
CON	3D6	10-11
SIZ	2D6+6	13
INT	2D6+6	13
POW	3D6	10-11
DEX	3D6	10-11
APP	2D6-1	6
EDU	2D6	7
HP	—	12

Weapons: Fist 55%, 1D3

Grapple 35%, special

Knife (20%) 35%, 1D4 +db

.38 Revolver (5%) 30%, 1D10

.20 Gauge Double-Barrelled Shotgun (20%) 40%,
2D6/1D6/1D3

.22 Rifle (15%) 35%, 1D6+2

Skills: Bargain 25%, Cthulhu Mythos 15%, Dodge 35%, Drive Automobile 35%, Electrical Repair 10%, First Aid 35%, Hide 30%, History 25%, Innsmouth Lore 50%, Jump 45%, Law 10%, Listen 30%, Mechanical Repair 30%, Occult 20%, Psychology 20%, Sneak 35%, Spot Hidden 35%, Swim 85%.

Sanity Loss: Variable.

Occasionally hybrid monstrosities are born, creatures with tentacled faces or arms, sometimes with long, sinuous fin-tailed bodies, or even flaccid, undeveloped bat-wings. Such offspring are believed to have been touched by the dreams of Great Cthulhu and are sacred to the deep ones. Often suffering from impaired mental development, these mutant offspring are kept hidden from sight in the rotting buildings along the harbor north of the river. Sanity loss for seeing one of "the beloved of Cthulhu" ranges between 1/1D8 and 1/1D10.

The Esoteric Order of Dagon

Dagon, mentioned in the Books of Judges and I Samuel, was the chief deity of the Philistines, worshipped in the form of a fish-god, merman, or triton. The name was derived from the Hebrew word "dag," meaning small fish. Dagon's largest temple was in the city of Gaza, destroyed by Samson, who pulled the building down upon the heads of the mocking Philistines. The Bible also tells us of a "house of Dagon" at Ashdod. Here the Ark of the Covenant toppled a statue of the god and then cut off its head and hands. Later ages found Dagon in the role of an agricultural deity, providing a second possible derivation of the name as Dagan, the Semitic word for corn. He was worshipped also by the Babylonians under yet another name. Further derivations of the name link it to clouds and rain, implying a fertility function to the god.

Innsmouth's Esoteric Order of Dagon was founded around 1840 by Captain Obed Marsh and a few of his closest followers. Touted by Marsh as "a new religion" more effective than the one preached in Christian churches, those who joined soon found themselves rewarded by larger catches of fish and more opportunities within the town. It was obvious to many that Marsh's god provided its followers with a prosperity and security that the traditional churches could not match. More worshipers soon joined Obed's church, and in their new-found prosperity most were willing to ignore the ugly rumors connecting Obed and the Order with the odd rash of disappearances lately plaguing the town.

The Order has a pyramidal hierarchy. Those in the lowest ranks are told only as much as they need to know. Only those who have achieved a higher status are privileged to learn the deeper secrets of the Order.

The Order conducts weekly mass services, as well as other smaller and more private ceremonies. In the early days of the Order these meetings were conducted in one of the Marsh warehouses along the waterfront. When the Congregational Church on New Church Green became vacant, the Order moved their ceremonies there. A few years later it moved into its present quarters in the old Masonic Hall.

The Order's meetings consist of sermons glorifying Dagon as a sea-god who bestows his benefits directly upon his worshippers. Along with healthy harvests of fish, followers are promised the gift of eternal life for their children, if they will ally themselves with Dagon. All is steeped

Innsmouth Magic

Most of the spells listed here are variations on deep one magicks, as adapted by Polynesians to suit their own purposes. Deep one versions, often cast underwater, usually lack verbal components.

ALTER WEATHER: moderates or exacerbates any weather condition. Large groups may cast the spell to achieve great meteorological effects. Every ten magic points sacrificed effects one level of change (see below). The caster may expend as many magic points as he is able, as can anyone else knowing the spell. Those ignorant of the spell can contribute 1 magic point only.

Casting the spell costs each participant 1 Sanity point, and requires a song-like chant to be uttered for three minutes per degree of weather change. The effective radius is two miles; this can be widened for 10 magic points for each additional mile. The change in the weather lasts thirty minutes for every ten magic points contributed, but violent weather such as a tornado lasts a much shorter time.

Five different weather elements can be affected by this spell. The only limit to elements affected, and how much each is affected, is the number of magic points invested. Each of the five elements are rated by degrees. Altering any single element by one degree costs ten magic points.

Cloud Cover: (1) clear, (2) foggy, (3) partly cloudy, (4) cloudy, (5) heavy clouds.

Wind Direction: The sixteen compass points, (1) north, (2) north-northeast, (3) northeast, (4) east northeast, etc.

Wind Speed: (1) calm, (2) breezy, (3) gusty, (4) strong steady wind, (5) gale, (6) hurricane, (7) tornado.

Temperature: raise or lower the temperature in the area of effect by five degrees Fahrenheit.

Precipitation: (1) dry, (2) drizzle, (3) rain [snow], (4) hail, (5) heavy rain [snow], (6) thunderstorm [blizzard].

BREATH OF THE DEEP: the target's lungs fill with sea water, drowning him or her. The caster must be able to see the target. After mentally intoning the spell for a round, the caster sacrifices 8 magic points and 1D6 Sanity. Match POWs on the Resistance Table. If the caster wins, examine the rules for drowning in the *Call of Cthulhu* rules. The rolls begin at CON x5, then CON x4, etc., and the target must make them for 1D6 rounds. Each missed CON roll costs the target 1D8 hit points.

CALL FISH: a fisherman's aid to be cast over either salt or fresh water. The cost is 2 magic points and no Sanity. Bait must be placed in the water and a simple sing-song chant uttered for two minutes. In 1D6 minutes, 1D100 x 1D10 fish arrive in the area, called from a radius of one mile. Fish must be native to the area around the casting or the spell has no effect.

CAUSE DISEASE: afflicts the target victim with a feverish illness resembling cholera, malaria, pneumonia, etc. The caster may invest as many magic points as he or she can; match them against the target's POW on the Resistance Table. Casting time is five rounds. If the target wins, there is no effect.

If the caster wins, symptoms such as high fever, nausea, vomiting, dehydration, and loss of concentration follow. The victim loses 2D6 STR, CON, and DEX (roll separately for each), at the rate of one point daily. If the victim survives, he or she regains these points. If any of the characteristics reach zero, the victim dies.

To cast the spell, the attacker obtains some personal item of the target, especially something that has touched the mouth. The object is buried in a deep hole with shreds of poisonous plants or bamboo. The hole is filled and a specially carved stone placed on top. A short chant follows, and the spell is cast.

First Aid and Medicine skills are ineffective, other than to slightly reduce the suffering. Bed rest is the only treatment that seems to keep the victim's mind active. Only curative magic truly helps. Retrieving the buried object breaks the spell. Otherwise the spell must run its course.

COMMAND SHARK / PORPOISE: for committing human sacrifices to the gods of the sea. The spells originated in the South Pacific. Each casting costs 1 magic point; for each additional point, the chance of success rises by ten percentiles. It must be cast upon salt water. To bring sharks, blood is splashed into the sea; for porpoises, small live fish are dropped in. If the caster fails a Luck roll, a second shark or porpoise accompanies the one called for. The second one is not subject to magical control.

LOBSTER CHARM: This spell is used to attract lobsters or other shellfish to a specific harvesting ground. Small, rounded pebbles, white in color, must first be collected, then enchanted. A chant is sung over the stones, accompanied by the expenditure of one magic point for every ten pebbles enchanted. The pebbles are scattered over the water where the shellfish are desired. Within a week the lobsters will appear, approximately one for every pebble.

SIREN'S SONG: the caster sings the spell, which if successful binds the target for 2D6+20 hours, believing the caster to be all that his or her heart desires. Casting the spell costs 1 magic point and 5 Sanity points. The target may resist POW vs. POW on the Resistance Table, and if the target succeeds, the spell has no effect. Siren's Song can affect as many as can hear it.

WAVE OF OBLIVION (variant): in this version, one sorcerer must know the spell and expend all but one of his or her magic points, but others can also contribute magic points to allow the creation of vast waves capable of sinking ocean liners or battleships. Other casters knowing the spell can contribute as many magic points as desired. Those who do not know the spell can contribute 1 magic point each. Casting time is three rounds, plus one round per ten additional magic points invested. A large quantity of salt water is, of course, required.

The variant requires a minimum of 30 magic points, creating a wave ten feet long, ten feet wide, and thirty feet high. Each additional magic point adds a foot to length and width of the wave. Ships, boats, and people swallowed by a Wave of Oblivion usually vanish forever below the surface. ■

Other Sources of Information

There are numerous places outside of Innsmouth where investigators can learn about the shunned town. The following list includes those places most likely to be investigated.

ESSEX COUNTY HISTORIES

Information about Innsmouth can be gleaned from the many and various histories publications about Essex County, Massachusetts. With minimal study time and a successful Library Use roll, any investigator can discover the information found in *The Accepted History* essay found on p. 8. References to the strange gold jewelry associated with Innsmouth are also found, mentioning the specimens on display at the Miskatonic Exhibit Museum and at the Newburyport Historical Society.

Add 2D8 to Innsmouth Lore.

THE INNSMOUTH COURIER NEWSPAPER

This small newspaper was founded in 1833 and published until 1846, folding immediately after Innsmouth was swept by plague and riots. Few, if any, complete collections of the paper exist, the publishing office being destroyed in the course of the riot. The nearly complete collection kept in the basement of the Miskatonic Library has over the years suffered at the hands of unknown vandals. Some issues are missing, others mutilated. Investigators searching libraries in other cities in northeastern Massachusetts must roll their POW x2 or less to find even a partial collection. A nearly complete collection can be located only with a roll of POW x1 or less. One such set is found in Harvard's Widener Library. There are no known copies of the newspaper's final edition, printed just prior to the riots. All copies were believed to have been destroyed during the unrest.

Later editions of the *Courier* are notable for their inflammatory editorials, written by John Lawrence, attacking the character of Obed Marsh, patriarch of the powerful Marsh family. In these editorials Marsh, his followers, and their church are implicated in kidnappings, murders, and other crimes.

Add 2D8 to Innsmouth Lore for incomplete collections, 3D8 for reading a complete collection.

ARKHAM—ASBURY M.E. CHURCH

The pastor of this church, Dr. Ezekiel Wallace, has considerable knowledge about the shadow hovering over Innsmouth. Wallace's knowledge and artifacts are fully detailed in the *Escape from Innsmouth* scenario, p. 83.

ARKHAM—M. U. EXHIBITION MUSEUM

In a dusty display case in a dark corner are specimens of Innsmouth jewelry. Still mistakenly residing among the American Folk Arts collection, these obviously Polynesian-influenced golden armlets were sold to the museum in 1844 by a seaman from the Marsh vessel, the *Sumatra Queen*. Made of a whitish-gold alloy, and carved with odd geometric designs and bizarre ichthyic or batrachian figures, the jewelry seems too large for most human arms.

Add 1D2 to Innsmouth Lore.

DANVERS—MASSACHUSETTS STATE HOSPITAL

Confined to this institution is the state factory inspector driven mad by what he experienced in Innsmouth six years ago. Anytime an investigator interviews a knowledgeable person there is a POW x1% chance that they learn the story of the state factory inspector confined to the State Hospital.

An investigator with proper psychiatric credentials (Psychoanalysis 60%+ or Psychology 75%+) might be allowed to interview this patient, George Cole. Failing this, a successful Fast Talk roll might gain an investigator unauthorized entrance to the ward. According to his file, the 54-year-old Cole was admitted to the hospital six years ago, hysterical and incoherent, screaming about "scaly water devils." He has lapsed in and out of coherence ever since.

Interviewing Cole, a successful Psychoanalysis roll induces him to talk about what happened to him in Innsmouth. While returning to the Marsh refinery after dark to retrieve some forgotten papers, he noted movement near the row of darkened houses along the northern shore of the harbor. Investigating, Cole claims to have seen several fish-like, frog-like humanoids huddling with some men down near the wharves. At this point Cole begins raving, becomes delirious and, without a second successful Psychoanalysis to calm him, soon brings the orderlies who ask the investigators to leave. If the second roll succeeds, Cole calms down, explaining that what really frightened him was the huge black shapeless thing he thought he saw slipping into the waters below the wharf—the heaving, pulsing thing that was all eyes and mouths!

Add 2D4 to Innsmouth Lore and 1D2 to Cthulhu Mythos. Sanity loss is 0/1D2 points.

NEWBURYPORT—HISTORICAL SOCIETY

Among the items on display in the Society's small exhibit room is a beautiful tiara made of a white-gold alloy. The tiara is oddly proportioned, elliptical and too large for a human head. Of truly unique workmanship and style, it is chased throughout with both geometric designs and marine motifs. The latter depict creatures half-fish, half-frog, and somehow disturbingly human. The piece is tentatively described as East-Indian or Indo-Chinese in origin.

If the investigators talk to the Society's curator, the pious Miss Anna Tilton, they learn more. The tiara was obtained in 1873 from a pawnbroker who had gotten it from a drunken Innsmouth native who was soon afterward killed in a brawl. Miss Tilton believes it to be part of a pirate hoard discovered by Obed Marsh, citing as proof the fact that to this day the Marshes still occasionally offer ridiculous sums of money trying to purchase it back from the Society.

The elderly Miss Tilton attributes Innsmouth's decay to the rise of the Esoteric Order of Dagon, a heathenistic religion imported from the Far East nearly a century ago. This pagan faith eventually supplanted all other religions and organizations in Innsmouth, even the Masons, whose Hall the Esoteric Order now occupies. She claims that Innsmouth has degenerated into a dying, backward, inbred town.

Examining the jewelry adds 1D3 to Innsmouth Lore. Speaking with Miss Tilton can add another 2D4 points. ■

in vague Biblical allegory, with dashes of Middle Eastern and Oriental occultism thrown in for good measure.

The Order's priests wear voluminous robes of deep blue-green, decorated with embroidered fishes, octopi, dolphins, and mermen. About their heads are strange, golden tiaras and on their wrists bracelets of the same workmanship and material. This is the jewelry given to the people of Innsmouth by the deep ones in exchange for the human sacrifices they demand.

Membership in the Order has never been compulsory, but cooperation is expected of all townsfolk.

The Deep Ones

The deep ones living off the coast of Innsmouth are part of an ancient race believed to dwell in secret underwater cities in numerous places around the globe. Although sources disagree about the origins of the deep ones, they are universally recognized as followers and worshipers of Great Cthulhu. Although subject to accidental death, the deep ones are immortal. Like some reptiles, they continue to grow throughout their lifetimes, ancient individuals eventually attaining great size. Those two known as Dagon and Hydra are believed to be the largest, and consequently oldest, of the species.

Deep ones practice only temporary monogamy, and form no true family units. Ancestor worship and a deep, abiding respect for elders is the heart of their society. All deep ones can trace their ancestry back to Dagon and Hydra, also known as the Great Father and the Great Mother. This pair, revered by the deep ones as gods, may not, in fact, be individuals at all. These names may be no more than titles bestowed upon the largest and eldest male and female alive. Whenever a present Dagon or Hydra dies, its spiritual role is taken by next oldest individual.

Deep ones are solitary types, rarely forming any lasting relationships. Cold-blooded, they are ponderous thinkers, slow to resolve issues despite their intelligence. With eternal life before one, what could be the rush? The pace of their society is a reflection of the slow-motion movement of a life spent underwater.

Communication is infrequent, most often a form of ESP perhaps more empathic than telepathic. This natural understanding and agreement is augmented by hand gestures and subtle facial expressions, along with a few barks and cries audible underwater. A written language exists, based on the mysterious R'lyeh glyphs, but it is rarely used.

At one with their surroundings and their world, there is little conflict or difference of opinion among deep ones. All perceptions are one, a deep one's view of the world identical to that of his neighbor. Necessary tasks are performed naturally and instinctively, all in agreement as to what needs be done.

Discussion and debate are nearly unheard of—and a cause for community concern when they occur. There are no laws or courts, nor any form of government. All worship Dagon and their individual ancestral lines, along with Cthulhu. Although some perform the functions of priests or

The Three Oaths of Dagon

All members of the Esoteric Order of Dagon are required to swear at least the First Oath of Dagon. Those deemed worthy are allowed to take the far more terrible Second and Third Oaths. Failure to obey a sworn Oath results in a trial conducted by other members of the Order, punishment ranging anywhere from fines, to imprisonment, to death.

THE FIRST OATH

Iä! Dagon! I, [speaker's name], do solemnly swear that I will neither interfere with, nor inform upon, the activities of the deep ones. Iä! Dagon!

THE SECOND OATH

Iä! Dagon! I, [speaker's name] do solemnly swear that, if requested to do so, I will render aid to the deep ones to the best of my ability, and in whatever form or manner is required of me. Iä! Dagon!

THE THIRD OATH

Iä! Dagon! Iä! Hydra! I, [speaker's name] do solemnly swear that I take this entity [a deep one] as my wife or husband, that I shall take her or him into my home, and that with her or him I will endeavor to have and raise children, so that the race, and the faith, can continue to prosper. Iä! Dagon! Iä! Hydra!

PROVISO TO ALL THREE OATHS

(spoken after each)

I understand and accept that by breaking this Oath in any way, I am subject to trial and punishment by the members of the Order, and that such punishment shall be commensurate with the severity of the offense.

sorcerers, there is no true religious hierarchy. They live and co-exist in a form of naturally-governed anarchy.

The taciturn disposition of the deep ones results in little or no communication between the various communities scattered around the globe. The most direct contact the deep ones of Y'ha-nthlei off the coast of Massachusetts have ever had with the deep ones of Ponape is what was told to them by Obed Marsh during the mid-19th century. Being of like minds, deep one communities have no reason to communicate. All "important" knowledge is common, and casual conversation considered undesirable.

Although artful design is highly prized, actual manufacture is limited. Individual possessions are few, often limited to no more than an ornate, carefully carved fishing spear. A tradition of soft metal-working results in the intricately carved jewelry the deep ones trade with humans. Made of a naturally occurring alloy found in fair quantity in numerous places beneath the sea, the metal is hand formed and hammered, carved and chased, without the aid of heat or flame.

20 – Escape from Innsmouth

The size of deep one communities is regulated in natural ways. As the population nears the maximum comfortable size for its environment, the sex drive of both males and females decreases, resulting in fewer births. If the population continues to grow, pressure on the local environment increases, resulting in a crowded community and anxiety among the deep ones. Births are infrequent and most of those born falling victim to neglect and abandonment, or dying at the hands of their own mothers who often murder their newborns in response to the environmental pressure. Thus is the growth of this nearly deathless species held in balance.

The deep ones have always been aware of the existence of mankind, but only rarely have they been moved to make contact. More often first contact is accidental, or at the instigation of a human who has learned how to contact the deep ones. At first fascinated by the human creatures, the deep ones establish amenable relationships, trading their hand-worked gold for trinkets of rubber and glass, materials foreign to their underwater experience. But continued contact with humans awakens within the males deeply-suppressed desires. Dreams of expanding their race begin to invade the sleep of the deep ones, lurid visions of conquest and domination. A world united as one, all worshipping Cthulhu.

Sacrifices are first demanded of the humans, victims to be tossed to the waiting claws and teeth of the sea creatures. Then is made the demand to interbreed with the humans. By breeding on the surface, new deep ones will be raised as humans, safe from the infanticidal females, expanding the race in preparation for the far-off day when the lands will be conquered by those from the sea.

THE POWER OF THE ELDER SIGN

Of all the creatures that the Elder Sign may be used against, the deep ones are probably most affected by this arcane

device. Somehow awakening deeply-buried psychological fears, the Elder Sign—believed by some to be the invention of the Elder Things—can effectively bar the path of these beings. Carved over a door, or placed on a stoop, affected creatures are unable to knowingly pass by the symbol. So powerful is the device that an Elder Sign placed over the doorway of a small house is enough to keep the entire structure safe. Deep ones or hybrids find themselves incapable of entering by any means, even by way of a window or other door. It should be noted that the Elder Sign causes no physical damage; the pain is strictly psychological.

The Elder Sign must be either seen or touched by the deep one to be effective. An Elder Sign whose presence is unknown is ineffective. Most often the sign is used to bar entrance to a room or building, or to guard a specific item such as a book or other small object. Seeing the symbol over the doorway, or touching the book that contains one, a deep one will be driven off, unable to overcome the fear and discomfort the sign evokes. An Elder Sign amulet worn under the shirt does little or nothing to protect an investigator. Even should it be pulled out, a deep one distracted by battle is unlikely to notice it. The sign must be openly displayed and easy to read if it is to have any effect.

The Elder Sign is near equally effective against hybrids—those humans with deep one blood running through their veins. Those hybrids with less deep one blood may be discomforted less, but are still aware of the power of the sign, and unable to violate it. Their discomfort will be obvious. Young hybrids who have not yet reached puberty sometimes seem unaffected, the symbol only gaining power over them as they grow and mature. But others are sensitive even at the youngest ages, some as infants crying and bawling at the sight of an Elder Sign dangled over their crib. ■

WELCOME TO INNSMOUTH

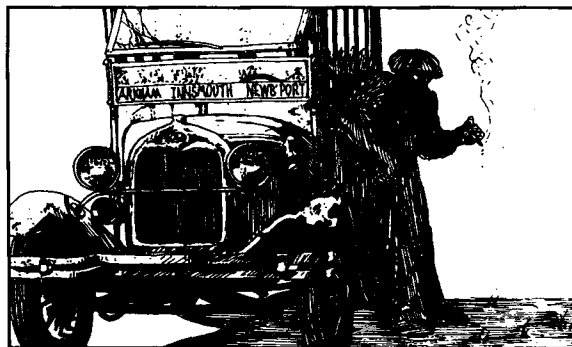



A GUIDEBOOK TO INNSMOUTH & ENVIRONS

The people and places of Innsmouth, by neighborhood.



The Northern Shoreward Slums

This area lies north of the river, extending two or three blocks inland from the harbor. Here, the fishy stench of the harbor is strongest. The neighborhood is mostly of tumble-down homes of varying sizes—modest early 19th century structures of brick or wood—set close together, and sharing bedraggled yards and ill-kept courtyards. A full two-thirds of these homes are deserted, windows shuttered and doors boarded over, yards choked with weeds. Several have collapsed completely, leaving only shattered timbers, crumbling chimneys, and water-filled stone cellars. Those few that are still inhabited look little better; broken window panes are stuffed with rags and yards are littered by trash. Traveling away from the waterfront, west and north, the number of occupied homes increases. These houses are newer and are a little better cared for.

In reality, a number of these apparently deserted buildings are home to some of the worst of Innsmouth's hybrids, and several deep ones as well. Entries number 101 and 102 are typical. Many similar locales exist in the area and are left to the keeper to design and describe. Roughly one of every four abandoned houses hides an advanced hybrid or deep one. Note also that some of these homes, especially those adjacent to the harbor, are connected by the ancient tunnels that riddle this part of the waterfront. Used long ago by smugglers to avoid customs agents, contraband was loaded offshore onto small boats which entered the water-filled tunnels via the inlet north of town (see 1013 for a full description of the Smugglers Tunnels).

The streets are of packed earth and badly weathered brick; they are unlit. Dock and Water Streets are in slightly better shape. A handful of local residents may be met during each hour spent here (although any disturbances will draw more), most exhibiting the disturbing Innsmouth look. Visitors would do well not to tarry long in the area, and should definitely ignore any untoward sounds they might hear coming from some of the empty houses; investigating might prove deadly.

Additional information, including typical house and block plans, can be found in "The Smugglers' Tunnels" portion of the *Raid On Innsmouth* scenario, pp. 122-131.

101 THE GREENE HOME

105 Martin St. This sagging two-story clapboard abode, one of the few conspicuously inhabited houses in the neighborhood, is home to a typical hybrid family, the Greenes. The sulking fish packer Ken Greene, 37, lives here with his wife Wilma, 33, daughter Carrie, 19, and sons Wesley and Charley, 14 and 13. The house is terribly rundown, with broken and tattered furniture, poor lighting, and trash littering the hallways and corners.

Male investigators nosing around this part of town may attract the unwanted attention of Carrie Greene (APP 8), who attempts to seduce one of them. A Luck roll is required to escape her advances—or the anger of her inebriated, surly father.



CARRIE GREENE

102 THE DWELLER IN THE HOUSE ON FISH STREET

Fish St. between Pierce and Southwick. This small, tightly boarded early 19th century house appears unoccupied. Passing by, an investigator making a successful Listen roll detects the sound of movement within. It takes 1D4 minutes to pry away enough boards or shutters to allow entry through a door or window. During this time the house's occupant has ample time to flee to the tunnels in the cellar if necessary.

The house contains old, dusty, rotted furniture dating back to the 18th century, and reeks to high heaven of rotting fish and excrement. Spot Hidden rolls note webbed footprints—both recent and old—in the dust coating the floors, along with numerous fish, rat, mouse, and bird bones. A wooden-barred door in the damp, empty cellar opens on a watery tunnel which connects with the inlet northeast of town (see 1013).

This house is home to a terrible hybrid monstrosity, mostly deep one, but partly something else. The creature tries to ambush groups of three or less who invade its lair, or who wander the nearby streets after dark. Larger groups it leaves alone, fleeing if necessary. The thing is a seven-foot tall batrachian humanoid with webbed claws and feet, prominently protruding gill-slits at the sides of its neck, a five-foot long finny tail, huge flat fish-eyes, and several foot-long tentacles surrounding its small beaked mouth.

When attacking, the creature attempts to hit and hold on with its claws. If it hits with both claws, it holds on, tearing

Index to Innsmouth Guidebook Entries

NORTHERN SHOREWARD SLUMS

- 101 **The Greene Home**; typical hybrid family: Ken, Wilma, Carrie, Wesley, and Charley
- 102 **The Dweller in the House on Fish Street**; mutant deep one in abandoned house, with statistics
- 103 **The Old Asbury M.E. Church**; ruined and abandoned
- 104 **Church Street Green, Revolutionary War Memorial**
- 105 **Ruins, with Tunnel**; typical entry into Smugglers' Tunnels (see 1013)
- 106 **Miscellaneous Ruins**; ruined homes

OLD TOWN SQUARE AND NEW CHURCH GREEN

- 201 **Old Town Square**
- 202 **Innsmouth Jail**; hybrid constables Andrew Martin, Nathan Birch, and Elliot Ropes, with statistics; see also Escape from Innsmouth scenario
- 203 **Dr. Rowley Marsh (& Son)**; hybrid doctor and libidinous law consultant, son Ralsa, with statistics
- 204 **St. John's Church**; ruined and abandoned
- 205 **The Offices of the Innsmouth Courier Newspaper**; abandoned, with clues leading to a rare complete run of the newspaper
- 206 **New Church Green**
- 207 **Esoteric Order of Dagon**; deep one church; gate to Y'ha-nthlei; *Ponape Scripture*; hybrid deep one priests Robert Marsh and Jeremiah Brewster, with statistics; see also Raid on Innsmouth scenario
- 208 **Innsmouth Congregational Church**; subverted to hybrid teachings
- 209 **Rawes and Hogg—Nautical Insurers**; an abandoned storefront
- 210 **East India Marine Merchants Bank of Innsmouth**; maritime museum, includes Nyarlathotep fetish
- 211 **Christchurch Cemetery**; graves of Obed Marsh and Ephraim Waite; many hybrid graves
- 212 **Church Street Burying Ground**; oldest Innsmouth graveyard; no hybrid graves
- 213 **Innsmouth Assembly Hall**; town meeting hall and hall of records; Eustis Eliot, crotchety Township Clerk; list of elected Innsmouth Township officials
- 214 **The Faith Baptist Church**; subverted to hybrid theological teachings

FINE OLD RESIDENTIAL

- 301 **Charles Throckmorton**; old fellow married to a full deep one living in attic, with statistics for Mrs. Throckmorton

- 302 **Barnabas "Old Man" Marsh**; current hybrid patriarch of Marsh family; normal wife Abigail, hybrid daughter Esther, servant Norvell Hastings, with statistics; Marsh family history, Obed Marsh's ships' logs, handwritten *Ponape Scripture*; see also Raid on Innsmouth scenario
- 303 **The Old Ephraim Waite House**; abandoned; Warding magic; grimoires, *Pnakotic Manuscripts*, *The Lore of the Abyss*
- 304 **Sebastian Marsh**; hybrid refinery manager, oldest son of Barnabas, with statistics
- 305 **Thomas Waite**; untainted owner of Waite's Variety Store; see also Escape from Innsmouth scenario
- 306 **Warren Billingham**; hybrid owner of fishpacking plant with office down town; see also Escape from Innsmouth scenario

NORTHERN RESIDENTIAL

- 401 **Cynthia Jenckes Gilman**; untainted woman married to deep one; hybrid children, with statistics
- 402 **The Quentin Averill Clan**; carpenter Quentin, truck driver son Joseph and his family; seek magical revenge on Ralsa Marsh, who ravished Quentin's daughter, with statistics; Summon/Bind Servitor of the Outer Gods spell and enchanted flute
- 403 **Lester Davis**; Marsh's gardener; has an uncanny plant empathy
- 404 **Water Tower**
- 405 **William Henry Parker III**; hybrid fish packer and wife; unknowingly possesses a copy of the *R'lyeh Text*
- 406 **The Gortons**; degenerate untainted family who aid hybrids; father Rich, sons Mike and Scott, dog Rip, with statistics
- 407 **The Old Warnes House (poorhouse)**; Zadok Allen's former home; Walter Bielacki, talkative ex-fisherman

RIVERFRONT FACTORY AND COMMERCIAL AREAS

- 501 **Marsh Refinery**; gold refinery; hybrid night watchman Robert Ballant, with statistics; see also the Raid on Innsmouth scenario
- 502 **Abandoned Railway Station**; tracks to Rowley, river bridge filled with bats
- 503 **Fire Station**; reticent untainted firemen
- 504 **Ruined and Abandoned Factories**; empty, some rotted and dangerous
- 505 **Ruined and Abandoned Warehouses**; empty
- 506 **Dangerous Bridge**; crosses Washington Street; decrepit and rusted
- 507 **Fish Packing Houses**; major Innsmouth employers; hire hybrids when possible

SOUTHERN RESIDENTIAL

- 601 **The Lodger**; Ervin and Millie Padgett, normal couple; hybrid bibliophile lodger Kermit Allen Rawes; *Thaumaturgical Prodigies in the New-English Canaan, Monstres and Their Kynde, Eltdown Shards*
- 602 **The Bernard Slocum Family**; untainted man and family, with statistics; may aid outsiders; daughter is pregnant, raped by deep ones or hybrids
- 603 **Schoolhouse**; helpful non-native schoolteacher Ellen Werman; two native school teachers
- 604 **Eliot Street Green**
- 605 **The Garden (Bar & Grill)**; tavern; hybrid hang-out; Victor Obrecht, untainted, but criminal proprietor
- 606 **The Garrison Family**; paranoid family fears their children are hybrids, with statistics
- 607 **Daniel Mowry**; untainted fish packer; wife works at First National Grocery
- 608 **Doctor Bloom**; untainted eccentric, physician, occultist, with statistics
- 609 **Obed Marsh Memorial**; statue
- 610 **Otis Fuller**; Grave digger, knows of suspicious local burials; dynamite
- 611 **Transformer**
- 612 **The Deans**; normal couple spying for hybrids

PRESENT DAY MERCHANT DISTRICT

- 701 **New Town Square**
- 702 **First National Grocery**; manager Brian Burnham; owned by Arthur Anderson; see also Escape from Innsmouth scenario
- 703 **Gilman House Hotel**; run by hybrids; visiting salesman Jerry Holland; factory inspector Lucas Mackey (undercover Treasury agent), with statistics
- 704 **Innsmouth Cafe**; hybrid-run
- 705 **Eliot's Drugstore**; hybrid-run
- 706 **Billingham's Seafood Distribution Company**; owned by hybrid Warren Billingham
- 707 **Marsh Refining Company Office**; Jacob Marsh, manager, son of Sebastian Marsh, with statistics
- 708 **Waite's Variety Store**; run by Thomas Waite; sells alcohol; see also Escape from Innsmouth scenario
- 709 **The First Unitarian Church of Innsmouth**; Decapitated and Abandoned; church records remain
- 710 **Marsh Street Green**
- 711 **Redemption Cemetery**; some hybrid graves; many 1846 graves
- 712 **Innsmouth Fuel Stop**; gas, wood, coal; Ken Martin, hybrid owner and employer of Bernard Slocum
- 713 **Moira Pierce**; Switchboard Operator; hybrid woman who monitors calls
- 714 **Innsmouth Electric**; office

SOUTHERN SHOREWARD SLUMS

- 801 **Abraham Southwick**; untainted man married to hybrid woman who is an evil stepmother; six children, three of which are hybrids
- 802 **Brick and Stone Warehouses**; abandoned, may contain strange cargoes
- 803 **Joe Sargent's Bus Service**; home of Joe Sargent, bus driver, with statistics; bus schedule

HARBOR

- 901 **The Old Wharves**; rotting, abandoned except for small boats owned by hybrids
- 902 **The Stone Breakwater**
- 903 **Fishermen's Shacks**; sinister hybrids Harris Jakes and Sandy Lanier; Dewey Smith, an unsuspecting human
- 904 **The Old Lighthouse Ruins**; nameless bones
- 905 **Custom House**; closed and abandoned
- 906 **The Old Martin Shipyard**; abandoned; weird, voracious arthropods, with statistics
- 907 **The Babsons**; old wharf-top warehouse with hybrid clan and deep one paramours
- 908 **The Lair**; wharf-top warehouse littered with gooey human remains; shoggoth lair, with statistics

OUTSKIRTS

- 1001 **South Woods Memorial Cemetery**; many hybrid graves
- 1002 **Outlying Farmhouses**; abandoned
- 1003 **Farmhouses**; inhabited by timid folk
- 1004 **Annie Pernel**; near-sighted shotgun-wielder; several *Innsmouth Couriers*
- 1005 **The Stunted Hybrid**; pathetic landlocked hybrid, with statistics; gone feral and hiding in an abandoned farm; haunts nearby creek and cemetery
- 1006 **Nick Casper**; outdoorsman, with statistics
- 1007 **The Abandoned Railway**; to Rowley
- 1008 **Town Dump**
- 1009 **Boynton Beach**; scattered untainted fishermen; Fish Head Rock, deep one contacting point
- 1010 **Falcon Point**; small village of untainted fishermen; story of Enoch Conger; reticent ex-fisherman Jedediah Harper
- 1011 **Devil Reef**; map; sea-caves with carvings, tunnel to Y'ha-nthlei, holding caves, etc.; weird arthropods
- 1012 **Y'ha-nthlei**; deep ones' city; air-filled chambers with map; carvings, flora and fauna, tunnel to reef caves, gate to Esoteric Order of Dagon, etc.
- 1013 **The Smugglers' Tunnels**; tunnels from inlet lead to houses on north shore; for details see the Raid on Innsmouth scenario. ■

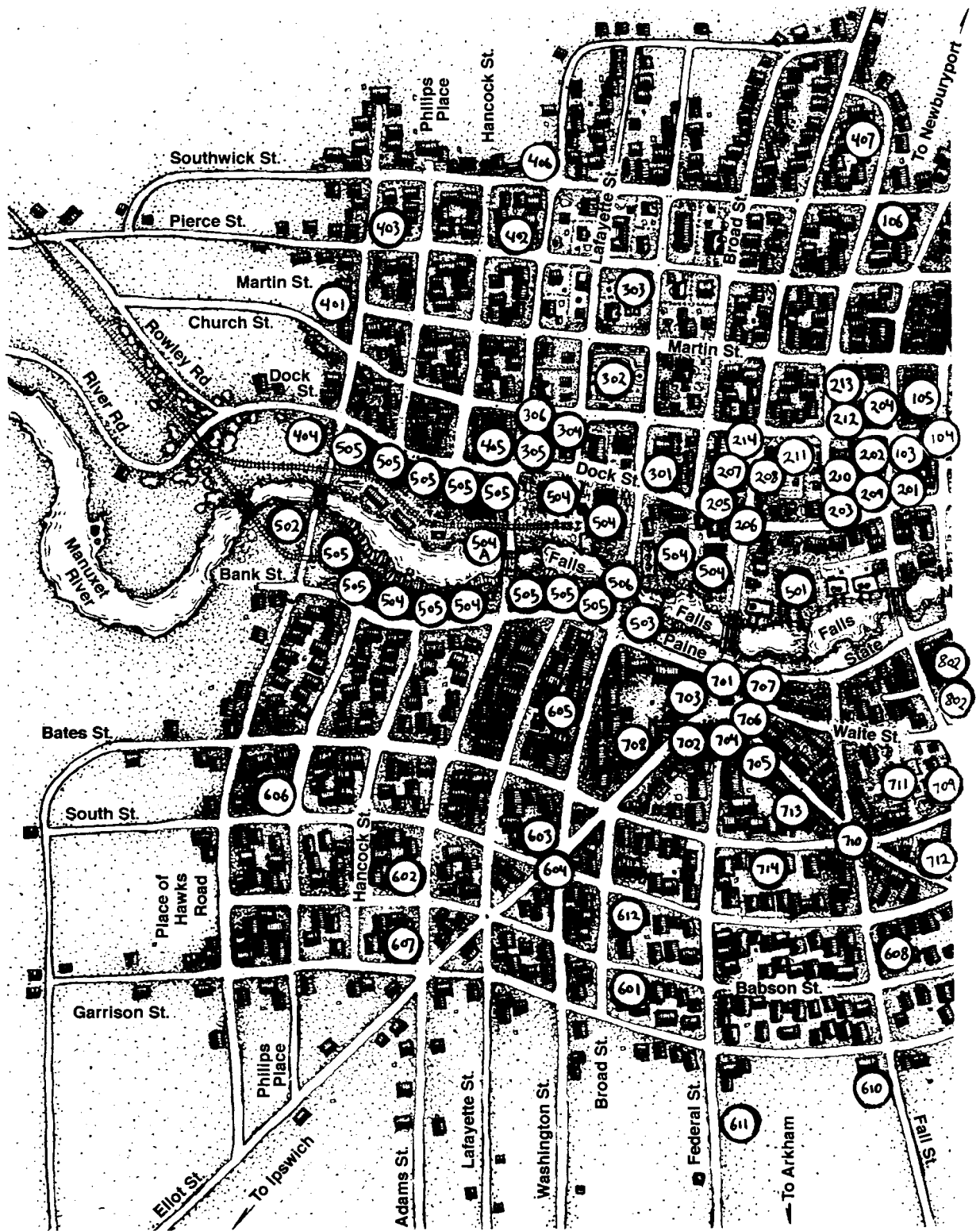

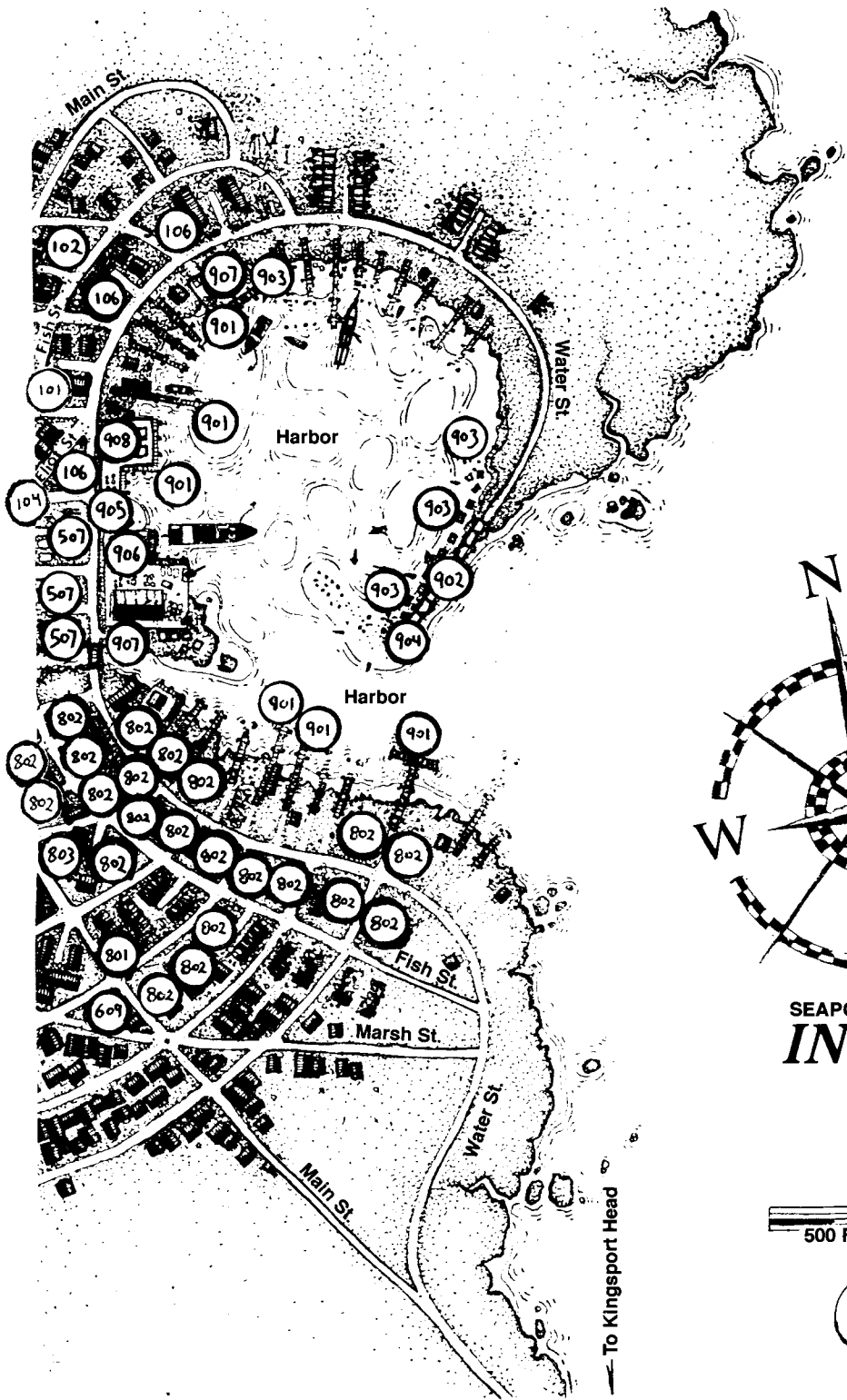

— To Plum Island —

ATLANTIC OCEAN

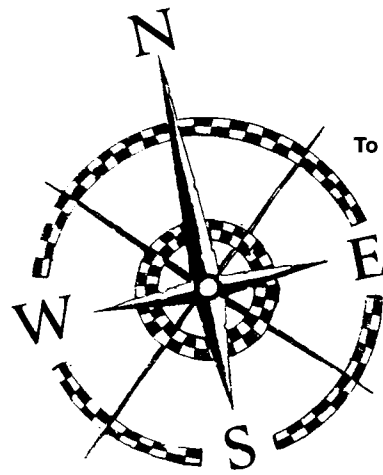

— To Devil Reef —

SEAPORT OF ...
INNsmouth
MASSACHUSETTS

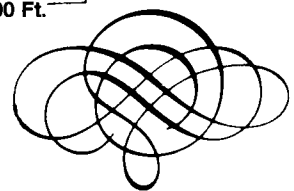

K/12

— To Kingsport Head —

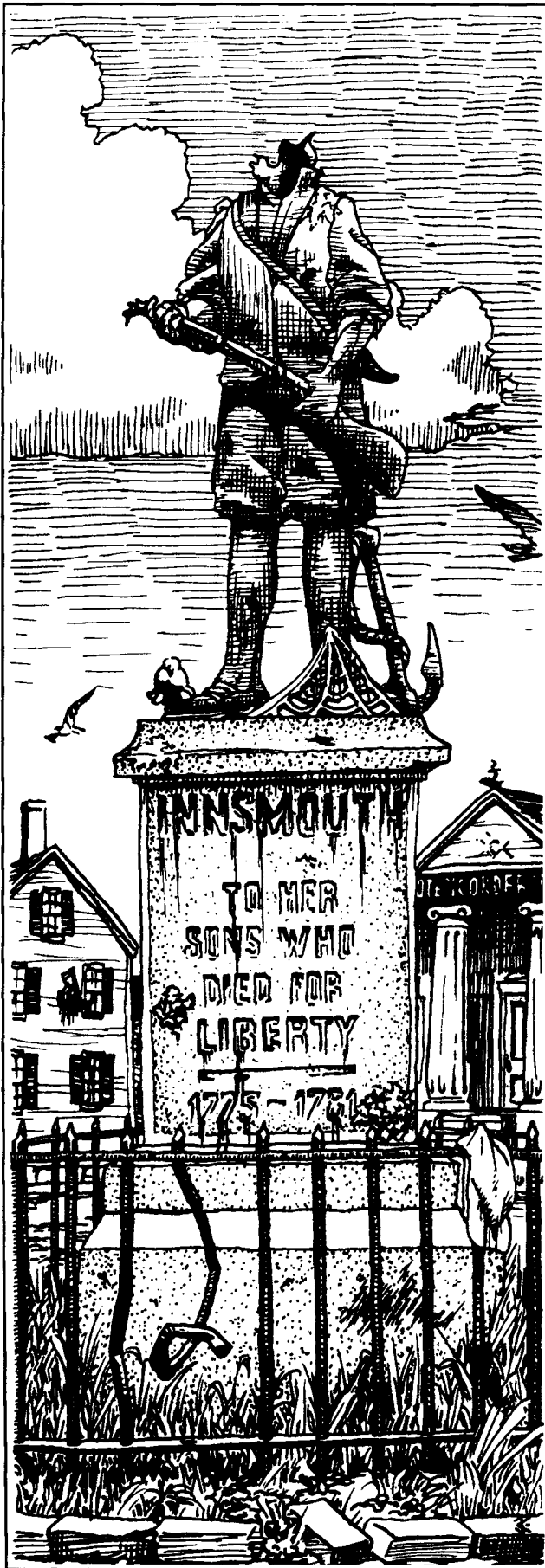

REVOLUTIONARY WAR MEMORIAL (104)

at the victim with its beak and facial tentacles. A STR vs. STR roll is needed to break free. The thing can attack multiple opponents, using its powerful tail to defend its back.

THE DEEP ONE THING

STR 19 CON 16 SIZ 21 INT 8 POW 10
DEX 9 APP NA EDU NA SAN NA HP 19

Damage Bonus: +1D6

Weapons: Claws x2 55%, 1D6+db each

Tentacles (only if both claws hit) automatic, 1D4

Bite/Beak (only if both claws and tentacles hit) automatic, 1D6

Tail lash (to rearward foes only) 25%, 1D6

Armor: 2 points of scaly hide.

Skills: Dodge 30%, Hide 25%, Listen 40%, Spot Hidden 30%, Swim 85%.

Sanity Loss: 1/1D8.

103 THE OLD ASBURY M.E. CHURCH

216 Church St. The old barn-like Asbury M.E. Church was founded in 1794. Abandoned less than a half-century later, its pastor wisely fled during the rise of Obed Marsh's Esoteric Order of Dagon in the 1840s. The gambrel roof of the old Georgian-style church is starting to sag, the featureless interior littered with dust, bat droppings, and a few fallen timbers. A small chamber in the cellar contains the church's moldering records, dating from 1794-1841. Later documents, those implicating Obed Marsh and his followers in plots of kidnapping, murder, and worse, were carried off by the pastor, Darius Cooke, when he fled the town.

104 CHURCH STREET GREEN, REVOLUTIONARY WAR MEMORIAL

The intersection of Church and Fish Streets. This is a small, square patch of high, weedy grass enclosed by an iron fence. In the center of the green stands a headless, broken-rifled stone statue of a minuteman, erected in honor of those Innsmouth men who fought in America's Revolutionary War.

105 RUINS & TUNNEL

Fish Street between Church and Martin. One of the most ruined houses in this district of slums, this place consists of only a tall, crumbling brick chimney standing amidst a tangle of fallen timbers. A halved Spot Hidden roll detects a cavity in the rubble near the chimney. Eight man-hours spent moving the debris clears enough space to allow entry into the collapsed building's cellar. The cramped cellar is dark, very muddy, and strewn with debris. Another Spot Hidden roll makes out a warped door opening onto a small dock beside a watery tunnel (see 1013 for details of the tunnels).

106 MISCELLANEOUS RUINS

Various locations. More ruined and collapsed homes similar to those described above. Crumbling chimneys, sagging or open roofs, exposed and debris-filled cellars, and skeletal frames are all that remain of these homes. Those closest to the waterfront are the most likely to have entrances to the tunnels.

New Church Green & Old Town Square

This neighborhood centers on the two semi-circular street intersections known as Old Town Square and New Church Green (see map on p. 30). The square is an open confluence of streets lined with old shops, now mostly abandoned. Bedraggled New Church Green is flanked by several churches, some still operating, and a couple of closed shops nearer the river. This was Innsmouth's civic center and business district prior to the Revolution, before the rapid expansion of the town on the south side of the river. During the riots of 1846 many of these buildings were damaged, or closed down following the unexplained disappearances of their owners. Since that time this neighborhood has slowly fallen into decay. Only the churches, the town meeting hall, the jail, and a couple of businesses are still in active use.

Most of the architecture here dates back to the early 19th century and include many buildings of weathered, sooty brick. An exception is the squat Gothic-styled Congre-

gational Church, constructed in the early 1840s, and a short time later taken over by the Esoteric Order of Dagon.

The only cobbled streets in this area are Federal and Dock Streets. The others are of packed earth; those nearest the river are reinforced with buried wooden planks. The streets in this neighborhood are better maintained, and well-used. Narrow brick sidewalks line the streets, and streetlights illuminate Dock and Church in the area of Main. Nearer the eastern slums streetlights and sidewalks are not to be found.

Residents encountered in this part of town, with few exceptions, strongly show the Innsmouth look. Staring and scowling suspiciously at strangers who linger too long, they alert the constables if anyone should spend too much time poking around the area of the churches. Intruders are often hauled in for questioning, or arrested outright. Some visitors have disappeared altogether.

201 OLD TOWN SQUARE

The intersection of Main and Dock Sts. This open semi-circular intersection was, prior to the Revolutionary War, Innsmouth's Town Square. The cobblestones are cracked or missing, and most of the shops to the west, northeast, and east are closed, displaying boarded up, dusty, or white-washed windows. The jail, Dr. Rowley Marsh's office, and the East India Marine Merchants Bank appear to be open.

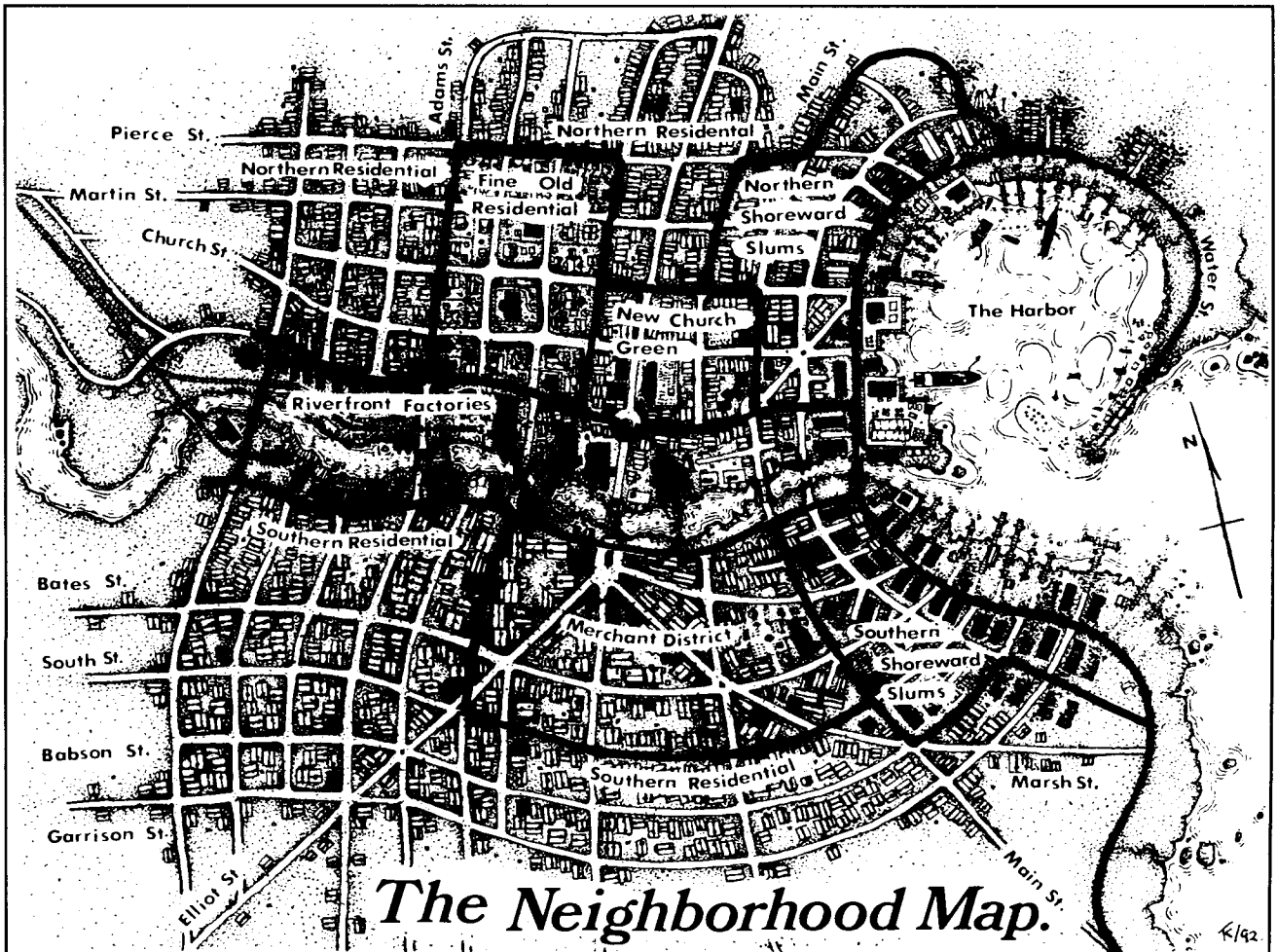

202 INNSMOUTH JAIL

504 Main St. Innsmouth's jail is a crumbling brick structure with a second story built of wood. Signs of charring and smoke damage around the door and windows mark the scars left by the freeing of Obed Marsh by the deep ones in 1846. Following the riot, the jail was haphazardly repaired.



ANDREW MARTIN

The jail consists of a large office in front, with a locked sturdy door between it and the cells in the rear. The four stone-walled cells are cramped and filthy, horribly stinking things that measure no more than five by eight feet, ventilated by tiny barred windows. The cells lack toilets and prisoners are provided only a thin mat to sleep on. The doors are made of sturdy iron bars. The second story

of the building holds several unused offices and a set of slightly nicer cells, rarely used.

The office contains a battered desk and several chairs, a phone, some file cabinets, and a locked wooden gun cabinet holding two 12-gauge pump shotguns, two .38 revolvers, and ammunition. A cot in one corner is used by the constables whenever it is necessary for one of them to stay and watch a prisoner.

A battered old sedan parked in the driveway just north of the jail serves as the town's police car. A map of the jail is included in the Escape from Innsmouth scenario on p. 90.

Prisoners are held in this facility until their fates are decided by the Esoteric Order. If the detainees pose any sort of risk for the community, the Order usually has them taken down to a warehouse on the harbor and fed to the shoggoth.

See also p. 75 for a quick reference on the law in Innsmouth.

CHIEF CONSTABLE ANDREW MARTIN

A silent, serious-looking hybrid, Andrew Martin is a dangerous adversary. Powerfully-built, he has thin, scraggly blonde hair, jowly cheeks, bulging eyes, and a flat nose. Tall and foreboding despite his stooping gait, Martin is a loyal follower of the Marshes, and particularly close to Robert Marsh of the Esoteric Order of Dagon (207). Martin is a cold, cruel man who uses torture to force prisoners to reveal what they may have learned. He always carries his knife, nightstick and gun. He lives very near the jail, in a run-down house on north Hancock Street.

ANDREW MARTIN, 31, chief constable

STR 16 CON 14 SIZ 16 INT 13 POW 14
DEX 10 APP 8 EDU 8 SAN 0 HP 15

Damage Bonus: +1D4

Weapons: Fist/Punch 75%, 1D3+db
Grapple 50%, special
Nightstick 55%, 1D6+db
Bowie Knife 55%, 1D4+2+db
.45 Revolver 55%, 1D10+2

Skills: Climb 50%, Cthulhu Mythos 35%, Dodge 30%, Drive Automobile 35%, Hide 40%, Jump 45%, Law 40%, Listen 55%, Psychology 35%, Sneak 30%, Spot Hidden 60%, Throw 35%, Track 25%.

CONSTABLE NATHAN BIRCH

Birch is a pudgy, stooped hybrid with narrow eyes and a wide, malicious grin. Although intensely jealous of the younger Martin's position as Chief Constable, Birch says little; Martin's connections with the Esoteric Order are strong.

Birch always dresses in a heavy coat, concealing the sawed-off shotgun he habitually carries. The trigger-guard of this gun is sawed off in order to allow Birch's thickly-webbed fingers to reach the trigger. When expecting trouble Birch also carries a baseball bat. He and his hybrid family live a couple of blocks north of the jail.



NATHAN BIRCH

NATHAN BIRCH, 37, wily old constable

STR 15 CON 14 SIZ 15 INT 12 POW 12
DEX 15 APP 10 EDU 9 SAN 0 HP 15

Damage Bonus: +1D4

Weapons: Fist/Punch 65%, 1D3+db
Grapple 60%, special
Head Butt 45%, 1D6+db
Baseball Bat 65%, 1D8+db
Sawed-Off Double-Barrelled 12-Gauge Shotgun 65%, 4D6/1D6
(0-5 yards/5-10 yards)

Skills: Dodge 35%, Drive Automobile 55%, Hide 45%, Jump 55%, Law 45%, Listen 40%, Psychology 25%, Sneak 50%, Spot Hidden 50%, Track 40%.

CONSTABLE ELLIOT ROPES

Ropes is a huge and thickly-muscled hybrid, an incredibly ugly specimen with bulging eyes, scaling skin, and a protruding jaw. More beast than man, he prefers to fight hand-to-hand rather than with weapons. He lives in a filthy hovel south of the river on Main Street.

ELLIOT ROPES, 26, brutish constable

STR 17 CON 16 SIZ 16 INT 10 POW 9
DEX 12 APP 6 EDU 7 SAN 0 HP 16

Damage Bonus: +1D6

Weapons: Fist/Punch 85%, 1D3+db
Grapple 75%, special
Head Butt 50%, 1D4+db
Two-by-Four 70%, 1D8+db
.38 Revolver 35%, 1D10

Skills: Climb 55%, Dodge 35%, Law 10%, Listen 30%, Spot Hidden 35%, Track 45%.



ELLIOT ROPES

203 DR. ROWLEY MARSH (& SON)

510 Main St. This small brick storefront with dusty windows has a sign hanging overhead reading “Dr. Rowley Marsh—General Practitioner.” Below that, in smaller letters, is written “Ralsa Marsh—Law Consultant.” Inside, sitting at the receptionist’s desk is a homely younger woman, Dr. Marsh’s widowed daughter, Ruth Gilman. She refers clients to her father’s or brother’s offices located on either side of the hall.

Neither of the two Marshes operate within the law; it’s been at least a decade since Dr. Marsh renewed his medical license, and the younger Marsh has yet to take the Massachusetts bar examination. Despite this, Innsmouth’s hybrid population still calls on them for their needs.

The widower Rowley, son Ralsa, and widowed daughter Ruth live in a modest brick house just around the block, across from the Church Street Burying Ground.

DR. ROWLEY MARSH

Dr. Marsh is one of the grandsons of Captain Obed Marsh. He serves as Innsmouth’s Medical Examiner, signing all birth and death certificates. Short and stocky, with a jutting jaw, piercing eyes, and deep creases at the sides of his neck, Rowley’s skin is scaly and flaky. What little remains of his hair is brushed forward into a widow’s peak. Stooped, and with a lurching gate, he walks only with the aid of a cane. He spends little time in his office, and has gotten a bit forgetful and sloppy in his practice. Rowley Marsh is trapped halfway between human and deep one, and will never take to the sea as most hybrids do. He considers his state shameful, especially considering the Marsh family heritage. Rowley is slow-moving, quite rueful, and feels that he has very little left to live for.



DR. ROWLEY MARSH

DR. ROWLEY MARSH, 68, physician

STR 8 CON 9 SIZ 13 INT 14 POW 16
DEX 8 APP 8 EDU 18 SAN 0 HP 11

Weapons: Scalpel 35%, 1D4 (can impale)

Skills: Biology 25%, Chemistry 40%, Credit Rating 65%, Cthulhu Mythos 50%, First Aid 60%, Law 20%, Medicine 50%, Persuade 55%, Pharmacy 45%, Psychoanalysis 30%, Psychology 50%.

RALSA MARSH

Ralsa, the oldest of Rowley’s sons, attended Harvard Law School but, despite his father’s influence, was expelled during his second year. The younger Marsh’s poor attendance and even poorer grades, and his interest in less scholarly subjects (notably his instructors’ daughters) were his eventual undoing at the school. The shiftless Ralsa Marsh returned to Innsmouth to putter away his time, and to await his father’s inevitable death, at which time he stands to inherit the bulk of the family estate.

Ralsa is a notorious ladies’ man, responsible for fathering several illegitimate children upon both willing and unwilling female residents of Innsmouth. He is hated by many, but being one of the Marshes, few dare to raise a word against him.

One of Ralsa’s many conquests was distant cousin Sarah Whateley, a resident of Dunwich. On a visit to Innsmouth, Sarah met Ralsa and trusted with him, later bearing a hybrid child back in Dunwich Country (see the story “The Shattered Room”, by H.P. Lovecraft, for complete details).



RALSA MARSH

But Ralsa recently overstepped his bounds when he attacked Patricia Averill, a non-hybrid woman of proud local family. Miss Averill committed suicide shortly after the attack and her father has sworn vengeance on the dastardly Ralsa Marsh. The Marshes, fed up with Ralsa’s libidinous behavior, have sworn not to help him. (See 402, The Quentin Averill Clan, for more details.)

Ralsa is tall and powerful-looking, appearing almost human. His eyes and mouth are only a little too big, and his fingers but slightly webbed. Arrogant and self-centered, he presents himself as a dandy, always on the look-out for a handsome female. Ralsa likes to impress his dates with lots of money, and an assumed air of class which he feels part of his aristocratic Marsh family heritage. Ralsa’s limited education and short attention span prevent him from carrying on a sustained intellectual discussion. A hedonist, he spends most of his time indulging in food, alcohol, and sex.

Ralsa fears the Averills and their rumored magical guardian, and has started carrying a gun to protect himself. Regardless of this, he will die horribly for his crime.

RALSA MARSH, 39, law consultant

STR 14 CON 15 SIZ 14 INT 13 POW 10
DEX 11 APP 11 EDU 12 SAN 0 HP 15

Damage Bonus: +1D4

Weapons: Fist/Punch 60%, 1D3+db
9mm Automatic Pistol 35%, 1D10

Skills: Credit Rating 35%, Cthulhu Mythos 35%, Dodge 35%, Drive Automobile 30%, Fast Talk 50%, Law 25%, Listen 35%, Occult 20%, Persuade 50%, Psychology 30%, Spot Hidden 50%, Swim 80%.

204 ST. JOHN S CHURCH

408 Main St. Like the old Methodist Church down the street, this is another fine example of late Georgian architecture. This old Catholic church, with its tall, tapering steeple and arched, stained glass windows (mostly broken, unfortunately) is still an impressive, foreboding structure. Built sometime around the early 1800s, it was abandoned during the 1840s when Obed Marsh and his fellows ran the other parishes out of town. All its records are lost or destroyed, its interior empty of all but bats, rats, and their evil-smelling excrement.

205 THE OFFICE OF THE INNSMOUTH COURIER

501 Dock St. A single story building with a roomy cellar, there are doors on the north and south, with windows all around, some leading to the cellar. This office has been closed since 1846 when it was looted by the rioters who destroyed the files and murdered the editor, John Lawrence. The place now stands empty, most of its windows and both doorways boarded up. Traces of a long-ago fire are still evident.

Although significant finds may be discovered here, anyone entering the building risks notice by the locals and the attention of the authorities. Inside, all the presses, papers, files, rows of type, and equipment have been burned, smashed, and strewn throughout the building. Interior walls show further signs of smoke and fire damage. In the cellar, a small vault stands open; the charred fragments within are all that remain of the archive collection of the *Courier*.

Anyone making a Spot Hidden roll while searching through the mess finds papers revealing that John Lawrence was the *Courier's* editor, and apparently an enemy of Obed Marsh. A second Spot Hidden roll unearths Lawrence's address from among these papers: 1003 Martin Street.

Visiting the address, the investigators find a modest two-story Georgian home, long abandoned. Windows are broken out, doorways stoutly boarded. Those who enter can, with successful Luck and Spot Hidden rolls, discover a secret panel in the ground floor landing of the main stairway, held down by screws. Inside are several large, bound volumes comprising a complete run of *Innsmouth Courier* from its inception in 1833 to its demise in 1846. The collection includes a loose copy of the uncirculated, inflammatory final issue announcing the arrest of Obed Marsh and his followers on charges of murder, kidnapping, and other crimes. Reading the entire run adds 3D10% to Innsmouth Lore, but requires nearly two weeks of study time. Needless to say, Miskatonic Library would be enormously interested in acquiring this lost treasure, willing to pay as much as several hundred dollars.

206 NEW CHURCH GREEN

The intersection of Federal and Dock Streets. Here the cobblestone streets wind round an overgrown, circular green containing a streetlight, uneven brick sidewalks, and two rotted benches on the verge of collapse. Churches flank the green to the northeast and northwest, and the old Masonic Hall stands nearby. The rest of the structures, shops and stores, are generally abandoned. From the green a narrow, iron-railed highway bridge crosses the Manuxet.

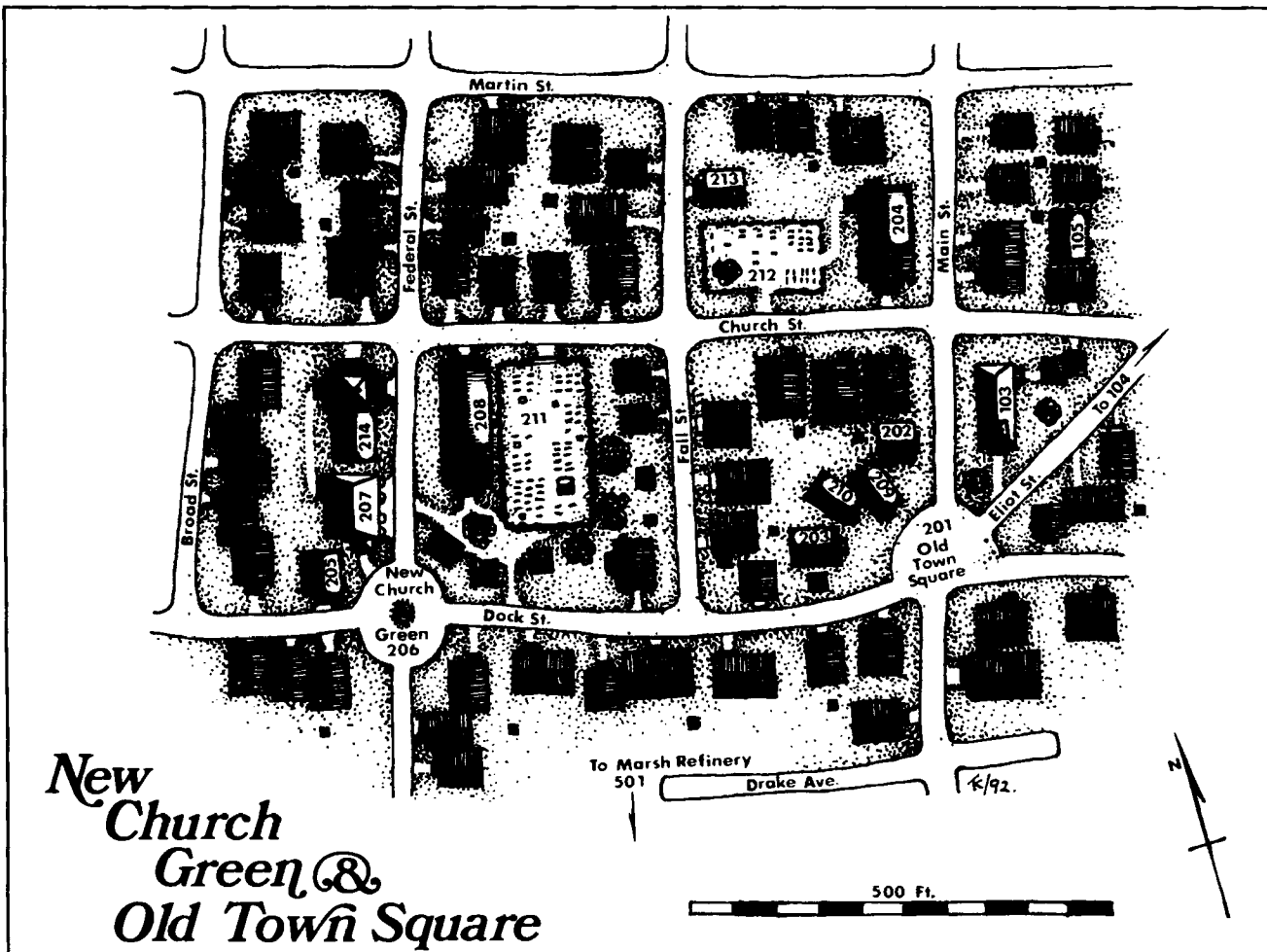

207 ESOTERIC ORDER OF DAGON

506 Federal St. Formerly the Masonic Temple, this large hall of Classic Revival design boasts four massive pillars framing the main doorway. The white paint has long faded to gray and is peeling badly. A black sign with cracked gold lettering over the pediment reads: “Esoteric Order of Dagon.”

Originally built in the 1830s, this building was eventually purchased by Obed Marsh and his followers and converted to the meeting place of the Esoteric Order. Here the hybrids and their followers—and frequently the deep ones themselves—hold rites in honor of Father Dagon, Mother Hydra, and Great Cthulhu. Services are regularly held on Saturday and Sunday nights when as many as 80 or 90 worshippers attend. Particularly huge and blasphemous ceremonies are held on May-Eve (April 30th) and Hallowmass (October 31st), and are attended by many deep ones.

At any given time there are at least 1D6+1 hybrids in the hall, a group usually including at least one church elder, either Robert Marsh or Jeremiah Brewster. Strangers lingering too long in this vicinity are subject to attention from the authorities. Anyone caught inside is probably doomed.

INSIDE THE HALL

Inside, numerous tapestries, paintings, sculptures, and other works of primitive and exotic art decorate the hall. History, Archaeology, and/or Anthropology rolls identify examples of art from the China Sea, the Mediterranean, the west coast of South America, and the South Pacific. All feature aquatic motifs of one type or another, and many depict fish-like, frog-like humanoids.

The hall’s upper floor consists of unused offices and rooms containing resplendent robes of green and blue, decorated with cabalistic symbols and aquatic motifs featuring dolphins, octopoid creatures, and the familiar fish-like humanoids. One of these rooms also contains a gate to dread Y’ha-nthlei, the legendary underwater city of the deep ones (1012).

Beneath the ground floor of the central hall is the huge main worship chamber. Made of flagstone, and lit by several torch-sconces, the walls are carved with leering, octopoidal forms, and cavorting frog-like men. Three massive statues, one of them over ten feet tall, stand in the shadows on the far side of the room. The largest of these depicts Great Cthulhu. The other two, slightly smaller statues, represent Dagon and Hydra. All may be identified with successful Cthulhu Mythos rolls. Sanity loss for making this discovery is 0/1D3.

An Anthropology roll identifies the statues’ place of origin as most likely the South Pacific, probably French Polynesia. Behind the idols are passageways leading to the smugglers’ tunnels (1013). Nearby, atop a battered wooden lectern, rests a manuscript copy of the Ponape Scripture, the Esoteric Order’s “bible.”

Additional information on the hall, including a map, is found in The Esoteric Order of Dagon section of the Raid on Innsmouth scenario, pp. 104-112.

ROBERT MARSH

Robert is the son of Barnabas Marsh (302), and a great-grandson of Captain Marsh. Due to his “spiritual” nature, he has succeeded to the head of the Esoteric Order of Dagon. By tradition, the Order has always been led by a member of the Marsh family, dating back to the time of its founder, Obed Marsh.



ROBERT MARSH

Robert runs the Order, and to a great extent the town itself, with an iron fist, disposing of trespassers and meddlers as quickly and quietly as possible. Robert deals even more harshly with those residents who talk too much with outsiders. The late Zadok Allen was the most recent to feel the wrath of Robert Marsh.

Marsh usually has the offending party arrested, or murdered by the degenerate Gorton family (406). Those taken into custody are usually fed to the shoggoth. In an emergency Marsh can call upon the deep ones of Y’ha-nthlei off the coast.

Marsh is an advanced hybrid, short and stockily built, and will be ready to take to the sea in a few more years. He has already made pilgrimages to underwater Y’ha-nthlei. Habitually dressing in the flowing blue-green robes of the Order, he makes use of their voluminous folds to disguise his deformities. His feet are too wide for any shoes; he covers them with several pairs of worn and ragged socks. His scaly hands are similarly oversized and webbed. He still retains much of his dark hair, but his ears have nearly disappeared, and his large glassy eyes stare unblinkingly.

Marsh usually carries with him a silvery, metal baton with a pointed tip, primarily used to keep the cult’s shoggoths in line. By pointing the tip at a shoggoth, expending one magic point, and mentally voicing the activator word, “Veket-nihili,” the rod gives one the power to control a chosen shoggoth—provided that the shoggoth’s POW can be overcome in a POW vs. POW resistance struggle. If the shoggoth loses, it must follow commands for a number of hours equal to the wielder’s POW. Failure means the shoggoth is unaffected. The rod sparks blue-white fire whenever it is used.

ROBERT MARSH, 46, high priest

STR 13 CON 15 SIZ 14 INT 16 POW 22
DEX 13 APP 6 EDU 14 SAN 0 HP 15

Damage Bonus: +1D4

Weapons: Grapple 50%, special
Sacrificial Dagger 70%, 1D4+2+db
.38 revolver 35%, 1D10

Spells: Breath of the Deeps, Contact Cthulhu, Contact Deep Ones, Contact Father Dagon, Contact Mother Hydra, Contact Cthulhu.

Skills: Anthropology 40%, Archaeology 35%, Astronomy 55%, Biology 35%, Cthulhu Mythos 75%, Dodge 40%, Hide 45%, History 55%, Jump 50%, Listen 40%, Occult 65%, Sneak 30%, Spot Hidden 50%, Swim 85%.

ESOTERIC ORDER OF DAGON (207)

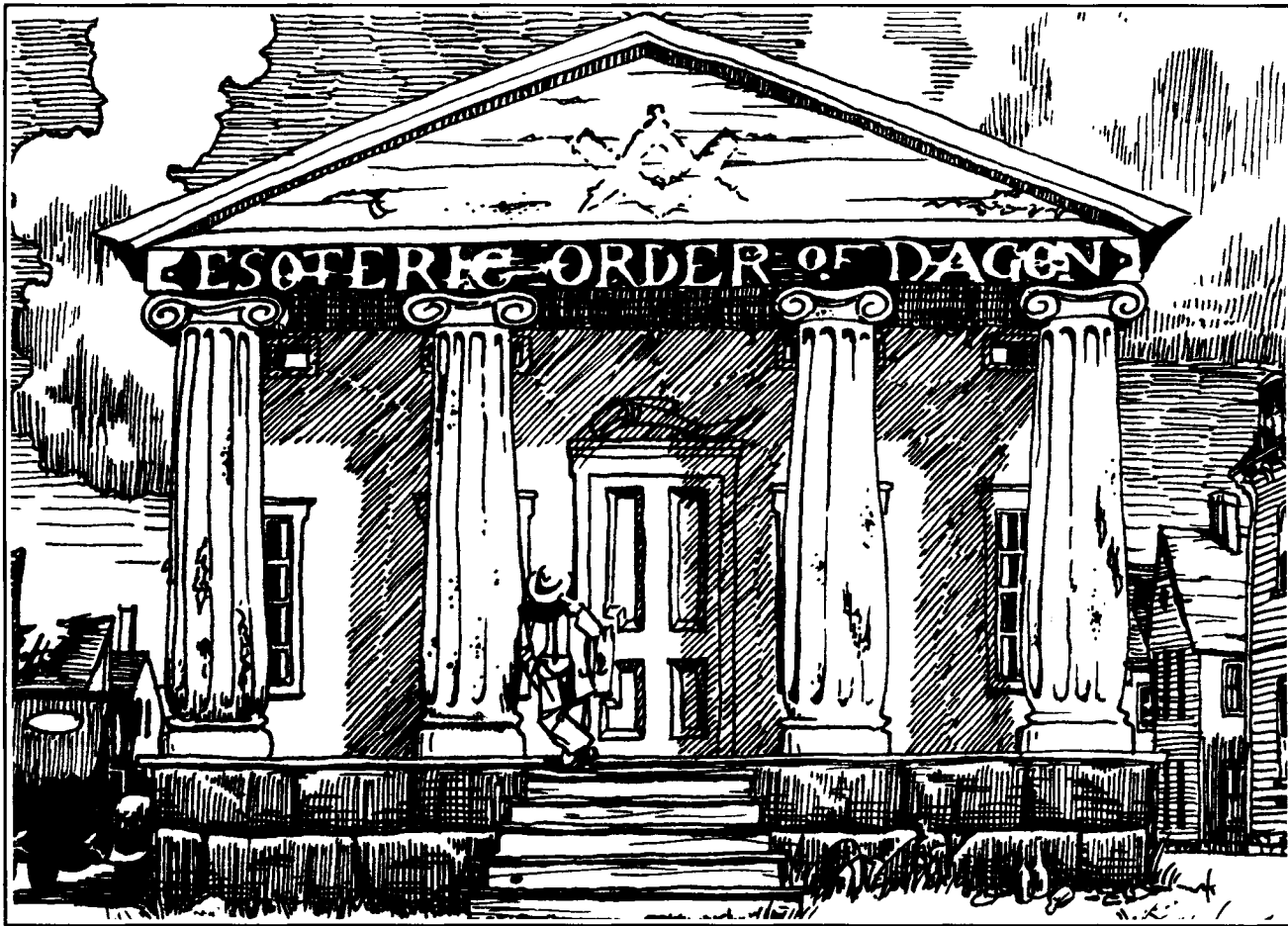

JEREMIAH BREWSTER

Jeremiah Brewster is the second-highest ranking priest in the Order and a sorcerer since childhood. A long-time member of the cult, his magical abilities, combined with strong faith and a strict adherence to the Order’s code, have aided him in his rise to the top. Like Robert Marsh, he has often visited the undersea deep one city of Y’ha-nthlei. Within a few months he is destined to become a permanent resident of the sea.

Brewster is nearly a full deep one. He is never seen outside the hall during daylight hours, preferring to stay hidden until after dark. He always dresses in church robes—the better to hide his scaly, web-footed body. His voice is little more than a slobbering, croaking bark.



JEREMIAH BREWSTER

JEREMIAH BREWSTER, 47, priest

STR 16 CON 18 SIZ 16 INT 15 POW 20
 DEX 12 APP 4 EDU 10 SAN 0 HP 17

Damage Bonus: +1D4

Weapons: Claws x2 75%, 1D6+db
 Grapple 60%, special
 Sacrificial Dagger 60%, 1D4+2+db

Spells: Breath of the Deep, Contact Deep Ones, Contact Cthulhu, Contact Father Dagon, Contact Mother Hydra, Curse of the Stone, Enchant Stone Tablet, Grasp of Cthulhu, Power Drain, Shrivelling.

Skills: Astronomy 35%, Biology 45%, Cthulhu Mythos 60%, Dodge 45%, Hide 35%, Jump 65%, Listen 30%, Occult 55%, Sneak 25%, Spot Hidden 55%, Swim 95%.

Sanity Loss: Since Brewster is nearly a full deep one, it costs 0/1D6 Sanity points to see him.

OTHER PRIESTS

In addition to either or both of the elders described above, there are always a number of lesser priests in attendance. Numbering 1D6, each has a POW equal to 10+2D4 and each knows 1D4 spells. Make likely choices from the lists of spells given for Robert Marsh and Jeremiah Brewster.

208 INNSMOUTH CONGREGATIONAL CHURCH

505 Federal St. This massive stone building is of later construction than most of the structures in town. Although the sign still identifies it as the Congregational Church, it is a wing of the Esoteric Order. Like other local churches, the Congregationalists’ sermons reek of blasphemous notions about bodily immortality through the worship of decidedly un-Christian deities. Churches in neighboring towns disavow it, accusing it of heathenistic, paganistic leanings.

Originally constructed in the early 1840s, the congregation was several years later disbanded and the structure purchased by Obed Marsh. Obed soon after moved the Esoteric Order of Dagon in, abandoning the old warehouse on the harbor formerly used by the cult.

The church itself is of clumsy Gothic Revival design, with basement and two-story tower with broken clocks. The church's many basement windows are kept shuttered, but the cracked bell is rung every hour between sunrise and sunset. This ugly, crumbling gray edifice is referred to by some as "St. Toad's"—but only in whispers.

The Congregational parson is Amos Hetfield, a shambling hybrid in his early 40s. Hetfield dresses himself in the greenish robes and jewelry common to all the clergy of Innsmouth's churches. More often than not he also wears one of the gold tiaras of the deep ones. Hetfield is rarely seen by outsiders. Most of the church's public duties are handled by a silent, black-clad hybrid youth who discourages any outside visitors. Persistent strangers will be reported to the authorities.

209 RAWES & HOGG, NAUTICAL INSURANCE

506 Main St. A small, abandoned, late 18th century brick office building with boarded windows and doors. A sign hanging over the door displays the faded picture of an old sailing ship, along with the name of the business. Rawes and Hogg insured local shipping ventures for years but were ruined in the early and mid-19th century by the numerous maritime losses suffered by Innsmouth, especially those ships lost by the Gilman family.

210 EAST INDIA MARINE MERCHANTS BANK

508 Main St. This dirty brick building is one of the oldest in Innsmouth, built during the late 18th century. Financed by the combined capital of the Marsh, Gilman, Waite, and Martin families, it thrived until the mid-1800s when Innsmouth's maritime industry suffered a devastating series of losses. It still survives, though loans are only infrequently made. Interest paid is low or non-existent.

Outsiders find it impossible to cash a personal check here. Even registered checks or money orders are difficult to convert, requiring several days of waiting time. Strangers who can get a reputable local to vouch for them have an easier time. New accounts are rarely accepted unless the depositor is a resident. The place has very little working capital, and is usually deserted except for one or two listless hybrid tellers.

A brass sign plate near the bank entrance announces "The Innsmouth Marine Merchants Museum" in the north wing. Down this hall a pair of doorways lead to the small museum. Beyond the doors are two crowded, ill-lit rooms packed with rows of dusty shelves, and tables displaying such objects as hand-painted China plates; sketches of islands, flora and fauna, and native peoples; ship models of

famous Innsmouth vessels such as Obed Marsh's *Sumatra Queen* and Esdras Martin's *Malay Bride*; maps and nautical charts showing trade routes and island topographies; exotic animals inexpertly stuffed and mounted; native jewelry and clothing (mostly Oriental silks and jade—nothing resembling the Esoteric Order's garb); weird musical instruments such as tasseled drums and ornately carved nose-flutes; a shrunken human head with its hair falling out; numerous native fetishes and Oriental miniatures; and hundreds of other items. A few are identified with faded, handwritten cards listing the object's origin, and the name of the donor.

Although the Order long ago removed from the collection any artifacts of deep one origin, a Spot Hidden roll picks out one item of odd interest. Supposedly of Malaysian origin, it is a small native fetish made of sticks, animal fur and pieces of horn. It depicts a black man blowing some sort of musical instrument. A Cthulhu Mythos roll identifies this fetish as a representation of an obscure creature sometimes associated with Nyarlathotep—an avatar of the Outer God.

211 CHRISTCHURCH CEMETERY

404 Church St. This crowded graveyard, consecrated in the 1730s, is the second oldest in Innsmouth, predated only by the old Church Street Burying Ground (212). Still occasionally used by some of Innsmouth's more prominent families, it is dotted by many opulent tombs and grave markers, broken-winged angels standing watch over the marble-columned crypts, and tall stelae.

Among the graves found here are those of the elder Marshes, including Obed, as well as the grave of the wizard, Ephraim Waite. Plots are found containing the remains of several generations of Gilmans, Eliots, and Martins. There are few graves dated later than the mid-19th century, about the time when the cemeteries became crowded and the new South Woods Memorial Cemetery (1001) was created southeast of town.



INNSMOUTH MARINE MERCHANTS MUSEUM (210)

Anyone crazy enough to break into a random crypt (and lucky enough to avoid the locals' notice) has a 35% chance of discovering a coffin that contains nothing more than a log or large rocks, one of the many false graves used to cover the disappearances of hybrids who have since gone to sea. (Note that the moldering bodies of Obed Marsh and Ephraim Waite are in their respective graves.)

Due to its proximity to the Congregational Church, and the hybrid nature of many of its residents, this place is called by the local humans, "St. Toad's Cemetery."

212 CHURCH ST. BURYING GROUND

307 Church St. Consecrated alongside the ancient Assembly Hall, this is Innsmouth's oldest graveyard, dating back to the 1640s. Few of the old stone markers are legible now, and many have fallen over or are nearly worn away. The place is overgrown, crowded with markers of different shapes and designs, all canted at crazy angles. The earliest legible date is 1649, the latest 1765. Among the family names found here are Hogg, Pierce, Martin, Gilman, and Southwick. Only a few Marsh graves are found in this churchyard.

213 INNSMOUTH ASSEMBLY HALL

403 Fall St. This building is an amazing amalgamation of different architectural styles. The central building consists of the old, wooden meeting hall built in the late 1600s. Numerous additions have since been made, including two-storied wooden wings on the north and east, circa 1750 and 1800. These wings contain offices for town officials and file rooms for public records.

Among the offices found here are: those of the three town selectmen, hybrids Sebastian Marsh, F. Murray Gilman, and Jonah Waite; the current Township Clerk, fully-human Eustis Eliot; Tax Assessor Noah Eliot, the hybrid husband of Eustis; Treasurer Ethan Hale; and Justice of the Peace, the honorable Arthur Pierce. The township government is controlled entirely by the hybrids of Innsmouth, a fact not lost on the untainted fishermen of nearby Boynton Beach and Falcon Point.



EUSTIS ELIOT

The Assembly Hall is most often nearly vacant, with only a 10% chance that any given official will actually be found in his office. Normal hours are 9 AM to 5 PM, Monday through Friday, but unscheduled closings are frustratingly frequent. Although there is almost always a minor clerk around, a few successful Hide and/or Sneak rolls allows intruders access to files, at least for short periods of time. Due to the distressing disorganization of the files, all Library Use rolls are made at half-normal.

Investigators requesting information find the people at the hall reluctant to help them. Eustis Eliot, the fully human Township Clerk, is a wrinkled old harridan who loathes

snoopers. A Fast Talk or Persuade is needed to get her to look up even simple deeds or other public records. Even then, it takes her 1D3 days to locate the requested materials. A successful Law roll may force her to turn over additional papers, but she will then inform the authorities about the "pushy intruders."

214 THE FAITH BAPTIST CHURCH

502 Federal St. Despite its empty clock steeple, the old wooden Baptist church is a fine example of early Georgian architecture. Like the other churches in Innsmouth, this place was long ago subverted to the worship of Dagon. The last regular services were held in 1846, just prior to the disappearance of Parson Resolved Babcock, a cantankerous opponent of Obed Marsh's blasphemous policies. It was widely believed at the time that Babcock fell victim to some of Obed's murderous followers, but nothing could be proved. Since then the old Faith Baptist Church has combined a minimum of traditional Christian ceremony with a shocking amount of quasi-Biblical prophecy of wondrous transmogrification and eternal life.

The dozen or so Innsmouth Baptists are led by a squat, web-fingered hybrid in his 60s, the Reverend Ezra Hartley. Scowling old Hartley, with his woefully thin mutton-chop whiskers and stringy hair, is a sinister figure, eyeing strangers suspiciously as he hops about town in his greenish robes and odd gold rings.

The deep ones and their followers sometimes meet here in times of emergency. The dark, bat-infested steeple makes an excellent watchtower, and can be used to signal others in town or on Devil Reef.

Fine Old Residential Section

This is the most modernized section of Innsmouth. The streets are all of brick and cobblestone, intermittently lined with low-power incandescent streetlights. Sidewalks are common, though usually buckled by tree roots or other, less discernible causes. Once shaded by stately elms, these trees now show advanced stages of Dutch elm disease, their foliage twisted and brown.

Bordered by Southwick and Dock Sts. on the north and south, and Broad and Adams Sts. on the east and west, this area is home to some of the finest residences found in Innsmouth. Formerly the homes of sea captains and traders, mill owners and bankers, these great gambrel-roofed mansions have housed generations of the town's gently-bred sons and daughters. Many of these estates sprawl the entire width of a block, their high roofs, cupolas, and railed widow's walks providing clear views of the once all-important harbor.

The mansions are now in decay, many abandoned, their finely terraced lawns and gardens running wild from years of neglect. The few remaining fine families are hopelessly inbred with the deep ones, their fortunes declining or lost, their futures—at least in this world—bleak and uncertain. Many of these mansions are uninhabited, or at least appear that way. In fact, more than a few of these abandoned hulks are home to hybrid horrors and full deep ones descended from the houses' original owners. Along Washington Street are several better tended homes, including the residence of Barnabas "Old Man" Marsh, grandson of the infamous Obed and current patriarch of the town. Most of the houses feature tightly shuttered attic and upper-story windows. The houses along Dock Street, though finer than most Innsmouth dwellings, are modest when compared to the full-fledged mansions and estates north of Church Street.

301 CHARLES THROCKMORTON HOME

507 Washington St. This fairly well-kept, two-story hip-roofed structure of late Federal design is home to Charles Throckmorton. "Charlie," a spry and friendly 67-year-old, is an untainted human often found tending his yard or rocking quietly on the front porch. He welcomes visitors, talks about mundane subjects (claiming to know nothing of Innsmouth's secrets), and offers hot coffee. He and his wife have lived here all their lives, raising five children all now married and moved on. He declines to discuss his wife, a Psychology roll revealing that he is keeping a secret.

If it is near meal-time, Charlie invites friendly visitors to stay for dinner—if he's found their company enjoyable. His fare is simple, and the conversation innocent. But with a Listen roll visitors hear something shuffling about on the second floor. Charlie says it's nothing, but becomes visibly agitated if anyone tries to investigate. Those who manage to sneak upstairs find that the sounds are coming from behind an unlocked door. Knocking, entering, or calling through the door arouses the female deep one on the other side of the door, a deep one that serves as Charlie's wife. There is a 50% chance that the enraged female deep one attacks strangers; otherwise she just eyes them quizzically. Stirring her up, or worse yet killing her, upsets poor Charlie terribly. He sobs over her dead body, then throws the killers out of his house before reporting their heinous act to the Order

MRS. THROCKMORTON, deep one

STR 13 CON 10 SIZ 15 INT 12 POW 11
DEX 12 APP NA EDU NA SAN NA HP 13

Damage Bonus: +1D4

Weapons: Claws x2 30%, 1D6+db.

Armor: 1 point of scales.

Sanity Loss: 0/1D6.

302 THE MARSH MANSION

404 Washington St. The home of hybrid town leader Barnabas "Old Man" Marsh, his insane, fully human wife, Abigail, their hybrid daughter Esther, and their servant Norvell Hastings.

Easily the finest home in Innsmouth, the palatial late Federalist Marsh estate covers nearly half a block, extending all the way from Washington Street in the front to Lafayette in the rear. The beautifully-maintained grounds consist of wide landscaped terraces that surround the house. A driveway circles a small fountain in front, connecting with Washington Street in the front and a two-bay carriage house in the rear. Two cars are kept parked in this building—large, fairly new sedans, both fitted with curtains to veil occupants of the back seat.

The mansion faces Washington Street. Its central portion is three stories high while its two great wings, which spread north and south, are each two stories high. Numerous chimneys and a railed widow's walk break up the vast expanses of hipped roofs, all topped by a large, shuttered cupola.

Inside are countless antiques, many of Oriental origin. Decorating the walls are oil portraits of various Marsh family members stretching back to the days of Obed and earlier. Most of the portraits after Obed depict Marshes exhibiting one or more characteristics of the Innsmouth look. Viewing this gallery of portraits, and tracing the decline of an old New England family, costs 0/1D2 Sanity points.

Among the books found in the library are Obed Marsh's ships' logs and journals, a Marsh family history written in 1862, and a handwritten manuscript copy of the *Ponape Scripture*. The last is signed by its transcriber, Captain Abner Ezekiel Hoag of Kingsport.

Obed's logs and journals tell of his discovery of the deep ones on a small island east of Otaheité in the year 1823, and how he eventually brought this new-found religion back to Innsmouth. Reading these journals takes three weeks, adds 4% to an investigator's Cthulhu Mythos skill, 4% to his Innsmouth Lore, and subtracts 1D6 points from the investigator's Sanity.

The Marsh family history begins normally enough, but in the years following Obed's "conversion" the family begins breeding with the deep ones. Several passages hint at the nature of the unseen Marsh husbands and wives. Also listed are family trees, many of which inexplicably trail off after a generation or two. Reading the family history takes less than a week, adds 1% to Cthulhu Mythos, 3% to Innsmouth Lore, and costs 1D2 Sanity points.

The handwritten copy of the *Ponape Scripture* requires several weeks of close study, adds 7% to Cthulhu Mythos and costs 1D8 Sanity points. The book has a x2 spell multiplier and contains the following spells: Contact Deep Ones, Contact Father Dagon, and Contact Mother Hydra. Other magical books or artifacts may be discovered here, as the keeper desires.

Upstairs, from behind a locked and shuttered attic door, comes a nauseating stong fishy stench, worse than that found in other parts of the house. The cellars are similarly odoriferous.

Additional details of the Marsh mansion, including complete maps of the mansion and environs and additional statistics, are found in the Marsh Mansion section of the *Raid on Innsmouth* scenario, pp. 112-122.



BARNABAS MARSH

The eldest son of Onesiphorus Marsh and an unknown mother, Barnabas is well along in his transformation into deep one. He still wears human clothing—custom-tailored—but for all practical purposes he is a deep one masquerading as a man. He often makes the long swim out to Devil Reef.

Barnabas hasn't been seen in public for nearly ten years, the management of the Marsh refinery left to his son, Sebastian. As patriarch of the Marsh family, Barnabas is feared and respected by most Innsmouthers, hybrids and humans alike. Those who meddle in Innsmouth's affairs discover that Barnabas is a ruthless adversary, holding the normal townspeople in thrall with unspoken threats to their loved ones. He uses the Dread Curse of Azathoth to control both hybrids and normal followers, or has them killed outright when he deems it necessary. Outsiders are rarely treated so drastically, unless they stumble upon something serious. Most are scared off, threatened, or driven insane.



BARNABUS MARSH

Old Man Marsh is six feet tall, with old, wrinkled, scaly grayish skin. His mouth is wide, thick-lipped, and slack-jawed. There are deep, rough, scabby creases at the sides of his neck, and his eyes are large and unblinking. He is completely bald, his head elliptical and unnaturally shaped. His jaw juts forward, his forehead has receded, and his nose is nearly flat. He walks with a bizarre hopping, shuffling gait, habitually dressed in the Edwardian clothes of an earlier era.

BARNABAS MARSH, 73, hybrid and town patriarch

STR 10	CON 12	SIZ 15	INT 13	POW 18
DEX 8	APP 2	EDU 16	SAN 0	HP 14

Damage Bonus: +1D4

Weapons: Fist/Punch 50%, 1D3+db

Claws x2 60%, 1D4+db

Grapple 45%, special

.38 revolver 35%, 1D10

12-Gauge Double-Barrel Shotgun 55%, 4D6/2D6/1D6

Spells: Contact Deep Ones, Contact Father Dagon, Dread Curse of Azathoth, Voorish Sign.

Skills: Accounting 70%, Credit Rating 95%/55%

(Innsmouth/elsewhere), Cthulhu Mythos 60%, Dodge 40%, Hide 35%, History 60%, Jump 40%, Latin 45%, Listen 35%, Occult 25%, Sneak 25%, Spot Hidden 50%, Swim 90%.

Sanity Loss: 0/1D6

ABIGAIL WINTHROP MARSH

Abigail, formerly of Ipswich, is Barnabas' wife of more than fifty years. Although there was some opposition to the courtship of an Ipswich girl by one of the Innsmouth Marshes, the Winthrop family was poor and the Marshes then quite well-to-do. Eventually, the family reluctantly gave their blessing to the union.

In the more than fifty years since then, Abigail has seen a great many terrible things. Her young husband was, at first, fairly normal looking, but over the years he began to slowly transform. Abigail lived with the gradual changes in Barnabas, and tried to ignore the howlings and bleatings that came from behind the closed doors and shuttered windows of Innsmouth, but when her children began to grow older, and also began transforming horribly, Abigail was driven over the edge of sanity.



ABIGAIL MARSH

Abigail now spends her days sitting in a wheelchair, blank-faced, drooling, nearly catatonic. She must be fed, either by Barnabas or their repellent

daughter, Esther, or by their servant Norvell Hastings. She occasionally mutters something about her children going to live with the fish, but it is obvious that she is quite mad.

Nevertheless, in times of stress she may break out of her near-catatonic state. Her maternal instincts are still strong and if she feels her family is threatened there is a 40% chance every minute or so that she suddenly jumps up and attacks her family's enemies. She fights until restrained, killed, or until her attackers are dead or have fled.

ABIGAIL MARSH, 67, madwoman

STR 9 CON 8 SIZ 10 INT 12 POW 8
DEX 8 APP 11 EDU 15 SAN 0 HP 9

Weapons: Fingernails 50%, 1D4
Club 25%, 1D6

Skills: Erupt in Frenzy 40%, Mumble Ominously 60%

ESTHER MARSH

The repellent Esther Marsh is a reptilian woman, 36 years old. Her most distinctive feature is the many peeling patches of scaly skin covering her body. To compliment her inhuman looks, Esther frequently dresses herself in pieces of deep one gold—rings, torcs, necklaces, and arm bands. Though her family disapproves of her open displays of alien wealth, Esther will not refrain from being seen around town.

Esther is intelligent and strong-willed. She has spent many years studying the results of human/deep one interbreeding and seeks a suitable mate with whom to produce a superior offspring. Most prospective fathers have failed to survive the mating process, winding up dead in Esther's hands.



ESTHER MARSH

ESTHER MARSH, 36, hybrid daughter

STR 14 CON 15 SIZ 14 INT 13 POW 12
DEX 12 APP 6 EDU 13 SAN 0 HP 15

Damage Bonus: +1D4

Weapons: Fist/Punch 65%, 1D3+db
Claw x2 65%, 1D4+db

Spells: Contact Deep Ones.

Skills: Anthropology 25%, Biology 75%, Archaeology 15%, Credit Rating 40%, Cthulhu Mythos 45%, Dodge 40%, Hide 35%, Jump 50%, Latin 15%, Listen 35%, Sneak 40%, Spot Hidden 40%, Swim 80%.



NORVELL HASTINGS

NORVELL HASTINGS

Tall, lugubriously thin, and silently sinister, Norvell Hastings serves the Marshes as driver, cook, and butler. Taciturn, vigilant, and relentlessly faithful to the Marshes, he will, if necessary, die protecting his masters.

NORVELL HASTINGS, 56, faithful retainer

STR 11 CON 13 SIZ 15 INT 13 POW 11
DEX 9 APP 12 EDU 14 SAN 0 HP 14

Damage Bonus: +1D4

Weapons: Fist/Punch 55%, 1D3+db
Grapple 45%, special
Butcher Knife 50%, 1D6+db
9mm Automatic Pistol 35%, 1D10

Skills: Bargain 55%, Cook 70%, Cthulhu Mythos 15%, Drive Automobile 40%, First Aid 40%, Law 35%, Listen 30%, Persuade 50%, Psychology 45%, Sinister Stare 75%, Spot Hidden 35%.

303 THE EPHRAIM WAITE HOUSE

302 Washington St. The old Waite house is a sprawling three-story Federalist mansion set on a corner lot well back from the street. The front yard is overgrown with tall weeds and untrimmed trees dying from the effects of Dutch Elm disease.

The late Ephraim Waite was a normal human, and reputed to be a wizard. His wife, a deep one, was never seen in public. Their union gave birth to a single child, a daughter named Asenath, now residing in Arkham.

Waite's magical powers supposedly included the ability to raise or quell powerful storms, control schools of fish, and to divine the future. He was often called upon to solve minor crimes in and around the town, and his hypnotic powers were known to many. He died raving mad in 1921, leaving his daughter a ward of the principal of the Hall School in Kingsport. No one knows what became of Waite's wife.

Unknown to anyone, Ephraim is still alive today, his mind and personality inhabiting the body of his ill-fated daughter, Asenath. Asenath's consciousness was forced into her father's aging body before she was locked away in the attic and poisoned to death by Ephraim. She was buried in her father's body, in her father's grave.

Asenath/Ephraim, now a student at Arkham's Mis-katonic University, is presently married to poet Edward

Derby, a native of Arkham. Derby has been marked by the wizard to become his next “vessel.” Already Derby’s mind has been forced into Asenath’s body while Ephraim inhabits Derby’s, using it to attend blasphemous conventicles in the wilds of Maine. Soon, Waite will attempt a permanent transfer, afterwards murdering Derby while he is trapped in Asenath’s body.

Although Ephraim long ago removed his most important equipment to the old Crowninshield manor outside Arkham, from time to time either he or one of his Innsmouth-bred servants return to retrieve a needed item or notes. The hybrids rarely interfere with these visits; old Ephraim was feared by most Innsmouthers, including even the Marshes.

Inside the house, most of the remaining furnishings are found covered with ghostly white sheets, coated with a thick layer of dust. Upstairs, in a locked, shuttered, and padded attic room, the lingering traces of an old, fishy stench can be detected. Claw marks scar the floor and walls while a Spot Hidden roll discovers scrawled writing in a shadowy corner. Written in blood are the words:

“HELP—SHE’S NOT ME—IT’S FATHER.”

In a locked second-floor library investigators find numerous books on history, geography, and occult topics. Gaps among the rows of books testify to the volumes that have been removed by the wizard. At the keeper’s option, investigators might discover one or two minor grimoires. Each contains only one or two spells, with multipliers of $\times 1D3$. Each adds $1D4+1$ percentiles to an investigator’s Cthulhu Mythos skill, with a subsequent loss of $1D6$ Sanity points.

Two Cthulhu Mythos tomes can be discovered here, with a couple hours’ search, and successful Spot Hidden rolls. One is a copy of the *Pnakotic Manuscripts*, the other a moldy handwritten tome titled *The Lore of the Abyss*. This second book is much like a journal, and hints at the activities of a strange subterranean cult, their formless guardians, and other attendant horrors. It describes journeys into other dimensions, hooded, clandestine meetings, and human sacrifice. If, after reading the book, an investigator makes either a successful Cthulhu Mythos or INT $\times 1$ roll, he can identify this cult’s location as being somewhere in central Maine. Reading this book adds 11% to Cthulhu Mythos at a cost of $2D6$ Sanity points. The tome has a $\times 2$ multiplier and includes the following spells: Create Gate, Summon/Bind Byakhee, and one to four others of the keeper’s choosing.

THE WARDING

Waite long ago placed a special ward on his house, intended to deter trespassers. Upon entering, anyone not intoning the cryptic phrase, “null-thoth, tyaa, n’garg,” is subject to feelings of increasing unease. A Sanity roll is made upon entering the house, and approximately every quarter-hour afterward. Failed Sanity rolls indicate increasing discomfort and fear.

The first failed roll results in a general unease—the investigator feels that someone is watching him. With a second failed roll an investigator begins to hear natural, but odd, sounds such as wind, wood creaking, or others. These mysterious sounds are unsettling enough to cost the investigator $0/1$ Sanity points. A third failed roll and the affected

character starts hearing more ominous noisescurrying sounds, heavy breathing, and soft footsteps. Affected characters lose $0/1D2$ Sanity points. A fourth failed Sanity roll leaves a character convinced that there is someone—or something—in the house with him, resulting in a loss of a further $0/1D3$ Sanity points. A fifth failed roll costs $1/1D6$ points of Sanity, and leaves those affected convinced that they are unable to get out of the house. Try as they might, they find all windows securely latched, and all doors locked.

This effect is indefinite, and unless rescued, it is possible that a character so affected will remain in the house until he or she dies of thirst or fear. Once away from the Waite mansion, the effects fade after $2D3$ hours.

304 SEBASTIAN MARSH HOME

502 Lafayette St. Sebastian Marsh, 49, is the eldest son of Barnabas Marsh. He lives in this ancient house with his wife, Elizabeth Gilman Marsh, 47, their youngest son, Bernard, 18, and daughter Barbara, 20. Four other children, two sons and two daughters, are all married and live away from home—some in Innsmouth and others in neighboring communities. All family members are hybrids, and are among some of the most hideous in town. The house—a very early Georgian design of three stories with gambrel roof—is the original Marsh family home, prior to the construction of the palatial Washington Street house in the early 19th century.



SEBASTIAN MARSH

Sebastian rarely leaves the house. His appearance is such that he prefers not to be seen about the streets. He is stooped, bulge-eyed, thick-mouthed, and covered with scaly patches of yellowing skin. Deep creases in his neck and prominent webs between fingers and toes indicate that Sebastian is near to complete transformation. His wife, Elizabeth, is a cousin to the owner of the Gilman House Hotel. Just as reclusive as Sebastian, she is only slightly better looking. The children, Bernard and Barbara, are further along in their transformations than most hybrids their age, but are still able to move about in public.

Sebastian is ostensibly the manager of the Marsh Refining Company, but the actual day-to-day operation is handled by his son, Jacob. There is a minor rivalry between Sebastian and his younger brother Robert, head of the Esoteric Order of Dagon. Although Sebastian controls the economic reins of Marsh power in Innsmouth, it is his younger brother that controls the Order, and the real power in town.

Sebastian is ostensibly the manager of the Marsh Refining Company, but the actual day-to-day operation is handled by his son, Jacob. There is a minor rivalry between Sebastian and his younger brother Robert, head of the Esoteric Order of Dagon. Although Sebastian controls the economic reins of Marsh power in Innsmouth, it is his younger brother that controls the Order, and the real power in town.

SEBASTIAN MARSH, 49, semi-retired

STR 13 CON 14 SIZ 15 INT 14 POW 13
DEX 9 APP 5 EDU 15 SAN 0 HP 15

Damage Bonus: +1D4

Weapons: Fist/Punch 60%, $1D3+db$

Skills: Accounting 40%, Bargain 50%, Credit Rating 70%, Cthulhu Mythos 40%, Dodge 30%, Factory Management 65%, Geology 45%, History 45%, Spot Hidden 40%, Swim 80%.

305 THOMAS WAITE HOME

803 Dock St. Details of this house are found in the Escape from Innsmouth scenario, pp. 86-88, and under entry 708.

306 WARREN BILLINGHAM HOME

503 Adams St. Details of this house are found in the Escape from Innsmouth scenario, pp. 89-90, and under entry 706.

Northern Residential Area

The northern residential area contains various neighborhoods found north of the Manuxet River. Here are found many rundown, dilapidated homes along the northern and western fringes of town, as well as some slightly better kept homes near the New Residential section as well as along Dock Street. The houses east of Broad Street, north of Southwick Street, and west of Place of Hawks constitute those slums populated in the main by normal, untainted humans. Here dwell the poor and very poor, eking out meager livings as fishermen and fish packers.

Architectural styles range from collapsing 17th century houses to decaying gambrel-roofed Georgian homes. A few solid brick homes just north of the Old Town Square are inhabited by hybrids. As in the shoreward slums, here and there a crumbling chimney, or yawning cellar is the last remaining trace of a once-proud house. Yards are small and overgrown, houses built close together, and residents sullen and suspicious of strangers. Streets are generally unpaved, with no streetlights or sidewalks. North of Southwick the streets either dead-end or wind off toward abandoned, crumbling homes standing on the edge of the salt marshes.

The nicer areas just west of the New Residential neighborhood are populated with an even mix of hybrids and untainted. Many of these homes are middle-class hip-roofed Federals dating to the late 18th and early 19th centuries. They were built by Innsmouth's early industrialists along Dock and Adams Streets. Many of these homes have shuttered attic windows, permanently sealed against the outside world. There are fewer uninhabited homes in this area and, unlike other parts of town, few deep ones or awful hybrids lurk within the abandoned ones. Sidewalks are common here, but there are no streetlights.

This neighborhood includes a wide variety of Innsmouth residents, ranging from dignified old hybrid families to untainted individuals and families with dangerous secrets of their own.

401 CYNTHIA J. GILMAN HOME

402 Place of Hawks Road. This small, shabby house is owned by Cynthia Jenckes, an untainted woman forcibly

married to a hybrid. Cynthia, middle-aged, resides here with her second husband and five children. Plain-looking Cynthia is quite insane, wandering about the house performing cooking and cleaning chores in a robot-like manner.

Cynthia's first husband died nearly fifteen years ago, just shortly after their marriage. A second marriage was then arranged for the grieving Cynthia, her new husband to be the reclusive hybrid George Gilman, the eldest son of the Orel Gilman family. The ceremony was privately held, the couple soon after moving into this small, secluded home.

Cynthia has since borne the repulsive George Gilman five healthy, but cruelly mischievous children, now aged three to thirteen years. Investigators wandering in this part of town may be targeted by the Gilman kids armed with slingshots (15% to hit, 1 point of damage). If an investigator chases after the perpetrators, and makes a DEX x1 roll, he can catch one of the fishy-smelling little whelps and force them to tell the investigator where his or her parents live. At the house a bedraggled Cynthia dully states that their father will punish them when he comes back—which seems to frighten the child immensely. Cynthia does not discuss the matter further, closing the door in the investigator's face.

George Gilman—now a full deep one—dwells under the sea in nearby Y'ha-nthlei, but visits Cynthia frequently, spending the night with her before returning beneath the waves.

GEORGE GILMAN, deep one husband

STR 16 CON 11 SIZ 19 INT 12 POW 13
DEX 7 APP NA EDU 10 SAN NA HP 15

Move: 8/10 swimming

Damage Bonus: +1D6

Weapons: Claws x2 40%, 1D6+db

Armor: 1 point scales.

Sanity Loss: 0/1D6



CYNTHIA JENCKES

402 QUENTIN AVERILL HOME

903 Pierce St. A much nicer home than most found in Innsmouth, this proud Federalist house has been lately painted and boasts a well-tended yard and gardens. Owner Quentin Averill resides here with his son and daughter-in-law, and their 4-year-old daughter, June. Until recently Quentin's spinster daughter also lived here, but a few weeks ago, after being raped by bestial Ralsa Marsh, she committed suicide.

Quentin Averill, a proud, stern individual in his late 60s, has sworn vengeance. Although fearful of the Marshes and their deep one benefactors, he has a few secrets of his own. His grandfather, Captain Gardner Averill, was himself a successful trader familiar with the secrets of the Far East. From a wizened Burmese sage Gardner Averill learned a dangerous ritual supposed to summon a powerful servant spirit.

It was during the 1840s, long after his retirement from the sea, that Gardner Averill first attempted the ritual. His son

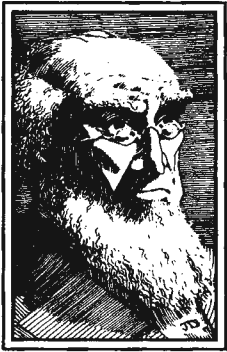

QUENTIN AVERILL

had been slain by one of Obed's followers, a man later released from jail following Obed's intervention. Enraged, Gardner and his remaining son—the current Quentin's father—took up the carved wooden flute given them by the Burmese wizard and, on Midsummer's Eve, summoned and bound a Servitor of the Outer Gods. This creature was ordered to find and kill the murderer of Averill's son, a task it accomplished with some relish. Since then, respectful of the Averill power, the Marshes have gone out of their way to avoid antagonizing the hostile family.

But that was before the swaggering Ralsa Marsh forced himself on Quentin's daughter, Patricia, precipitating her suicide. Quentin has since warned Barnabas Marsh that he intends to send "the demonic protector of the Averills" after Ralsa, and that the Marshes had best stay the hell out of the way. Barnabas, surprisingly, has acquiesced, though he has warned both Ralsa and Ralsa's father, Dr. Rowley Marsh, of Averill's vengeful intent.



JOSEPH AVERILL

Meanwhile, Quentin's son, Joseph Averill, 39, and Joseph's wife Laura, 35, fear the worst. They have tried to convince the old man of the possible danger to their 4-year-old daughter, June, but he is too proud and too stubborn to listen. He intends to perform the ritual soon, and has been studying the old family journal in preparation. Using the ornately carved wooden flute (enchanted to add 20% to the chances of successfully casting the spell) Quentin will summon and bind a Servitor of the Outer Gods and send it to kill Ralsa Marsh. If an investigator should get his hands on the Averill family journal, and reads it, he adds 2% to his Cthulhu Mythos while losing 1D3 Sanity points. The journal contains the spell Summon/Bind Servitor of the Outer Gods, with a x3 spell multiplier.

For the most part, the Averills stay out of Innsmouth's affairs. Joseph drives a truck for the Billingham fishpacking house while Quentin works as a carpenter. The Averills are usually hesitant to speak of the dark shadow that hangs over Innsmouth.

QUENTIN AVERILL

Quentin Averill, the patriarch of the Averill family, is a short, tanned, spry-looking old man who perpetually wears a serious, severe expression. Balding, he sports a straggly gray beard, and no moustache. He wears small, gold-rimmed spectacles, and always dresses in a black coat and white shirt. His old musket is kept well-polished and properly oiled.

QUENTIN AVERILL, 67, sea captain and carpenter

STR 11 CON 12 SIZ 12 INT 14 POW 16
DEX 17 APP 10 EDU 11 SAN 53 HP 12

Damage Bonus: +0

Weapons: Hammer (or Club) 85%, 1D6+1 (or as Club)

Fist 70%, 1D3

Musket 55%, 1D10

Spells: Summon/Bind Servitor of the Outer Gods

Skills: Anthropology 10%, Astronomy 20%, Carpentry 90%,

Credit Rating 60%, Cthulhu Mythos 10%, Dodge 40%, History

35%, Listen 35%, Mechanical Repair 75%, Occult 20%,

Persuade 55%, Spot Hidden 45%.

JOSEPH AVERILL

Joseph Averill is a quiet, unassuming man. A friend of hybrid Warren Billingham's since childhood, Joseph was able to get a job driving a truck for Billingham's fishpacking house. Averill and Billingham have, over the years, grown apart as the latter becomes progressively less and less human. Averill likes driving the truck, however; it gets him out of Innsmouth. He would like to move his family out of town, but his father is too proud to leave and Joseph fears to leave the old man alone in this town.

JOSEPH AVERILL, 39, truck driver

STR 13 CON 11 SIZ 14 INT 13 POW 11
DEX 14 APP 13 EDU 12 SAN 46 HP 13

Damage Bonus: +1D4

Weapons: Fist/Punch 55%, 1D3+db

Club 35%, 1D6+db or 1D8+db.

Skills: Accounting 20%, Bargain 40%, Carpentry 55%, Dodge

30%, Drive Automobile 70%, Electrical Repair 45%,

Mechanical Repair 65%.

403 LESTER DAVIS HOME

205 Place of Hawks Rd. Lester Davis lives in this small, ivy-clad, one-story house surrounded by an immaculate yard filled with rose bushes and flower beds. In back, a small garden provides Lester with fresh vegetables throughout the summer months. Trellises and fences crawl with ivy and other creeping plants. Lester's are always the first plants to bloom, and the most beautiful to see and smell. His harvests are frequent and fruitful.

Lester is large and overweight, quiet and shy, with big, liquid eyes. He speaks only rarely to people, more often to his plants. He is the Marshes' gardener and groundskeeper, spending at least three days a week working on the grounds of the Marsh mansion on Washington St. Lester knows that the Marshes are part of the sickness that afflicts the town. Despite this, Lester fears talking to strangers.

Lester enjoys an eerie empathy with his plants. These living things may come to his aid if he is attacked, threatened, or even frightened. In the yard, those attacked by plants must make successful Dodge rolls each round to avoid shrubbery, trees, and creepers lashing out and inflicting 1D3 points of damage. Inside Lester's house the many potted plants each do 1D2-1 damage. If the attackers kill Lester in his house, the ivy and other outdoor plants band together to collapse the house,

crushing any attackers trapped inside. There is a cumulative 10% chance per round that the plants succeed at collapsing the house, inflicting 1D20 points of damage on anyone inside.

Special Skills: Botany 95%, Cthulhu Mythos 10%, Innsmouth Lore 50%.

404 WATER TOWER

512 Place of Hawks Rd. This wooden, circular tank, forty feet in diameter, stands fifty feet above the ground. A creaky wooden ladder climbs one leg of the tower to a rickety, wooden-railed walkway that circles the top of the tank. From this vantage point one can get a view of the entire town. The ancient tank often springs leaks and is patched all over with tar and pieces of sheet metal. Water is pumped to the tank by a small pump house standing nearby.

405 WILLIAM H. PARKER III HOME

508 Adams St. Standing near the grand patrician neighborhood of Innsmouth's upper crust, this more modest two-story Federalist home was built by sea captain William Henry Parker and is presently occupied by one of his descendants, William Henry Parker III. William, 32, is currently employed at the Martin fishpacking house—his tiresome, repetitive job a far cry from his grandfather's adventurous career. His wife Doris, 35, cares for their three young children. All members of this family have tainted blood, although they are among the least abnormal-looking hybrids in town.

Parker's family is not well off. Doris in particular wishes they could better their lives. For the right price, they might reveal some of Innsmouth's secrets. William, an extremely nervous little man, insists on the utmost secrecy, going as far as suggesting a secret, nocturnal meeting in a nearby town such as Ipswich, Rowley, or Newburyport.

The Parkers have other information possibly of interest to investigators. Among their late grandfather's papers are several ships' logs detailing his travels around the Orient during the early 19th century. One logbook in particular relates Captain Parker's dealings with a Chinese priest named Lang-Fu, described as a wizard said to be in contact with gods living under the sea. Captain Parker shows particular interest in this man, mentioning to him his contemporary, Captain Obed Marsh, and the rumors of discoveries Marsh made in the South Pacific. Lang-Fu, learning of Marsh, gives Captain Parker a sacred manuscript and asks him to deliver it to Obed. But, after reading part of the manuscript, Captain Parker is so horrified by what it portends that he hides it away in his house and never contacts Lang-Fu again. A successful Spot Hidden roll finds the sacred manuscript—an English translation of the *R'lyeh Text*, on a back shelf of the Parkers' library. They are willing to sell it for \$50.

Special Skill: Innsmouth Lore 55%.

406 THE GORTON HOME

106 Adams St. This rundown place is home to the degenerate Gorton family: husband Richard, 56, wife Sandra, 34, and sons Mike and Scott, 20 and 15, all human, but all

loathsome. The yard is large, overgrown, and cluttered with scrap wood and metal, lengths of pipe, piles of bricks, car parts, and just plain junk. Two battered trucks, still in running condition, are kept parked in the back of the yard. The house itself is small, with damaged shutters and rags stuffed into broken windows. A large dog named Rip is kept chained in back where he barks almost non-stop.



RICH GORTON

The Gortons are a dirty lot who subsist by doing odd jobs around town, usually for the hybrid families. Occasionally they work for a human family, but they must be watched

closely. Inveterate petty thieves, they habitually steal from grocers, hardwares, and variety stores whatever they need

or want. They are known throughout town as a particularly violent and dangerous bunch and rarely does anyone try and stop them. Robert Marsh, head priest of the Esoteric Order of Dagon, often makes use of them, hiring them to take care of troublemakers hanging around town. The Gortons can be counted on to threaten, intimidate, vandalize, or assault snooping investigators as Marsh deems necessary. In exchange for their services the Gorton men are



MIKE GORTON

sometimes allowed to entertain deep one females in their home. Occasionally they are allowed a kidnapped human woman. Sandra Gorton is a doting wife and mother—and as insane as the rest of them.

RICH GORTON, 56, degenerate father

STR 13 CON 13 SIZ 14 INT 11 POW 12
DEX 14 APP 8 EDU 4 SAN 0 HP 14

Damage Bonus: +1D4

Weapons: Fist/Punch 65%, 1D3+db

Kick 45%, 1D6+db

Grapple 45%, special

Axe-handle (club) 60%, 1D8+db

12-Gauge Double-Barrelled Shotgun 70%, 4D6/2D6/1D6

Skills: Camouflage 40%, Dodge 40%, Drive Automobile 70%, Electrical Repair 25%, Hide 45%, Listen 55%, Mechanical Repair 70%, Sneak 55%, Spot Hidden 60%, Throw 65%, Track 55%.

MIKE GORTON, 20, degenerate older son

STR 16 CON 12 SIZ 16 INT 12 POW 11
DEX 10 APP 10 EDU 4 SAN 0 HP 14

Damage Bonus: +1D4

Weapons: Fist/Punch 60%, 1D3+db

Grapple 65%, special

Bowie Knife 45%, 1D4+2+db

12-Gauge Double-Barrelled Shotgun 55%, 4D6/2D6/1D6

Skills: Climb 55%, Dodge 45%, Drive Automobile 40%, Hide 30%, Listen 30%, Sneak 35%, Spot Hidden 40%, Throw 55%, Track 40%.

42 – Escape from Innsmouth

SCOTT GORTON, 15, degenerate younger son

STR 13 CON 13 SIZ 12 INT 9 POW 8
DEX 15 APP 9 EDU 3 SAN 0 HP 13

Damage Bonus: +1D4

Weapons: Fist/Punch 55%, 1D3+db

Kick 55%, 1D6+db

Pocketknife 30%, 1D3+db

.22 Bolt-Action Rifle 50%, 1D6+2

Skills: Climb 70%, Dodge 60%, Hide 60%, Jump 55%, Listen 55%, Sneak 60%, Spot Hidden 35%, Swim 55%, Throw 65%, Track 60%.

RIP, the Gortons' mutt-dog

STR 10 CON 12 SIZ 6
POW 6 DEX 14 HP 9

Damage Bonus: -1D4

Weapons: Bite 30%, 1D6.

Skills: Track by Scent 50%.



SCOTT GORTON

Rip doesn't like deep ones or hybrids, barking furiously whenever they come near, but failing the courage to actually attack them. However, if ordered to attack, Rip fearlessly goes after untainted humans. Rip is gun-shy, and flees if a round is fired off.

407 THE TOWN POORHOUSE

Northwest Fall St. This crumbling, two-story farmhouse stands near the end of Fall Street. Currently owned by the Gilman family, it was purchased by them several years ago when the former owner, Old Lady Warnes, died of old age. Now, as then, it functions as an almshouse, home to a handful of Innsmouth pensioners who can't afford to live any-

where else. All the current residents are untainted. Rooms are a few cents a night, meals a few cents more. The rooms are drafty, crowded, and tenanted by bugs and rats. Meals are most often cold and insect-adorned. Tenants take turns cooking and doing laundry, usually haphazardly. The place smells of sweat, urine, alcohol, and cheap tobacco.

Many of the current tenants remember old Zadok Allen, a 96-year-old drunkard who lived here until this

past summer, when he mysteriously disappeared. If asked about him, the retirees pretend to know nothing. Most fear the deep ones and their hybrid allies, especially after what happened to poor old Zadok. If offered a bottle, one resident might state that "they" finally did away with Zadok because he talked too much, but the old man won't elaborate. None of old Zadok's belongings are found here, and his old room is now occupied by a handful of pathetic old men.

There is perhaps one resident who dares to speak with the investigators—a bitter Polish fisherman named Walter Bielacki. Gruff and smelling of whiskey, the 58-year-old Bielacki relates the story of how he and several other Polish

families came here forty years ago looking for a place to start a new life in America. They tried to make a living fishing out of Innsmouth but found their nets and boats frequently, and mysteriously, damaged. Unable to make a living, most of the Poles left town, settling farther down the coast. Only a handful of the original immigrants remained, content to scrape by for a living. Most of them have since then either died or left town. Walter is the last of them. He rarely, if ever, puts his boat to sea anymore.

Bielacki remembers Zadok Allen, and Zadok's stories about the Marshes and how they were supposed to have brought fish-devils up out of the sea to help the Marshes control the town. Considering what happened to the immigrant fishermen—and to old Zadok—Walter thinks those stories are probably true. If he gets riled enough, Bielacki begins ranting, cursing the Marshes for all they've done to him and the town. Other residents of the poorhouse shy fearfully away from him, afraid of the wrath Bielacki might bring down on all their heads. At the keeper's option, Walter may later turn up missing, or be found floating face down in the harbor.



ZADOK ALLEN (MISSING)

Riverfront Factory and Commercial Areas

This area extends from the Water Street bridge west to the railway bridge on the fringes of town. It is bordered by Dock Street on the north and Bank, Paine, and State Streets on the south. Formerly an area of bustling activity, the riverfront is now mostly deserted, the once-active mills, factories, and warehouses empty and crumbling. The only operating locations within this neighborhood are the Marsh gold refinery, the fire station, and a few fish packing houses.

The Manuxet courses through a deep, rocky gorge that bisects the town. Waterfalls are found at the foot of Lafayette, Broad, and Fall Streets. The gorge is deepest near Federal Street where old mills and deserted factories perch barnacle-like on the sides of the rocky ravine.

501 MARSH REFINING COMPANY

North shore of the river. The Marsh gold refinery stands on a steep river bluff overlooking the lower falls of the Manuxet River. A small brick structure surmounted by a



WALTER BIELACKI

white belfry and numerous chimney stacks, it was originally the Waite fulling mill, built in the mid-18th century. Purchased by Obed Marsh in the 1820s, it was converted to a gold refinery. Although supposedly still in operation, the place seems oddly free of activity.

The refinery purportedly uses a process called cyanidation to extract gold from rough ore. Using this method, ground ore is placed in a tank with a weak cyanide solution. The gold then is separated out by bringing it into contact with metallic zinc. The gold is then smelted down and cast into ingots. Machinery found in the refinery includes a large tank for the cyanide solution, a grinding machine for powdering rough ore, and smelting and casting facilities. A close look at the operation, combined with a successful Mechanical Repair, Chemistry, or Geology roll indicates that the refinery is, at best, only half-operative. The leaking cyanide tank contains only old, contaminated solution, and the ore grinder has apparently been inoperative for years. Only the smelting and casting operations are functional, both showing signs of recent use.

Additional information on the refinery, including a map, is found in the Marsh Refinery section of the Raid on Innsmouth scenario, pp. 146-154.

Only a half-dozen people work in the refinery, all of them surly hybrids. Owned by Barnabas Marsh, the busi-

ness is ostensibly managed by his son Sebastian, who in turn leaves the day-to-day operation to his son Jacob. Barnabas Marsh never visits the refinery or its offices; Sebastian does so only rarely. Jacob can usually be found either here, or in the refining company office (707) south of the river.

The workers turn away curious outsiders, refusing to speak to anyone about the business. Important or official-looking visitors are referred to the company office. Even state factory inspectors must be cleared by management before they are allowed inside. At night an armed hybrid watchman, Robert Ballant, patrols the factory. He shoots to kill, phoning for help if necessary. If someone were to explore the place, they would find little of note.

ROBERT BALLANT, 28, night watchman
STR 14 CON 13 SIZ 16 INT 12 POW 11
DEX 9 APP 6 EDU 5 SAN 0 HP 15

Damage Bonus: +1D4

Weapons: Fist/Punch 70%, 1D3+db

Grapple 65%, special

Bowie Knife 60%, 1D4+2+db

12-gauge Double-Barreled Shotgun 75%, 4D6/2D6/1D6

.45 Revolver 65%, 1D10+2

Skills: Dodge 30%, Hide 50%, Listen 50%, Sneak 45%, Spot Hidden 65%.

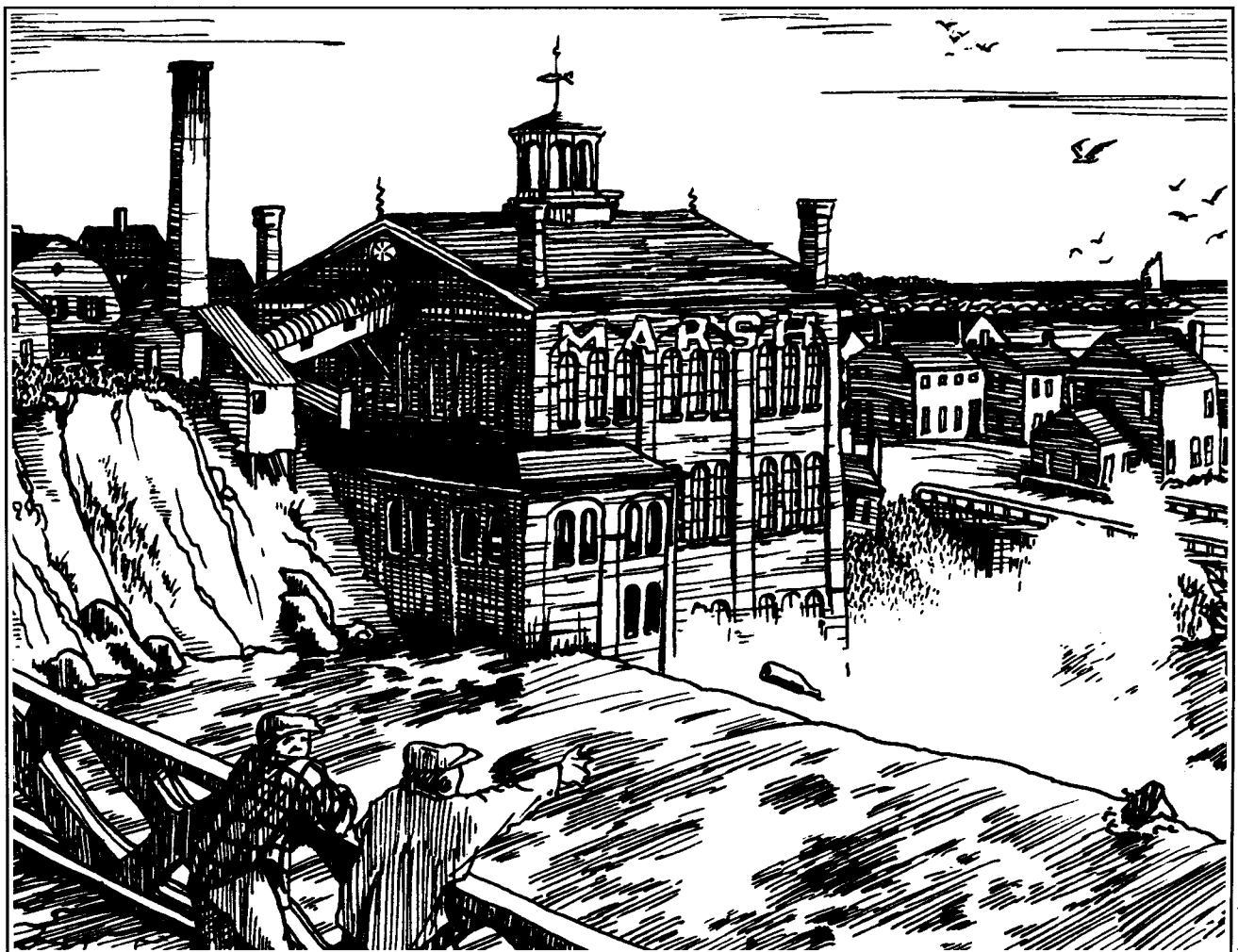

MARSH REFINING COMPANY (501)

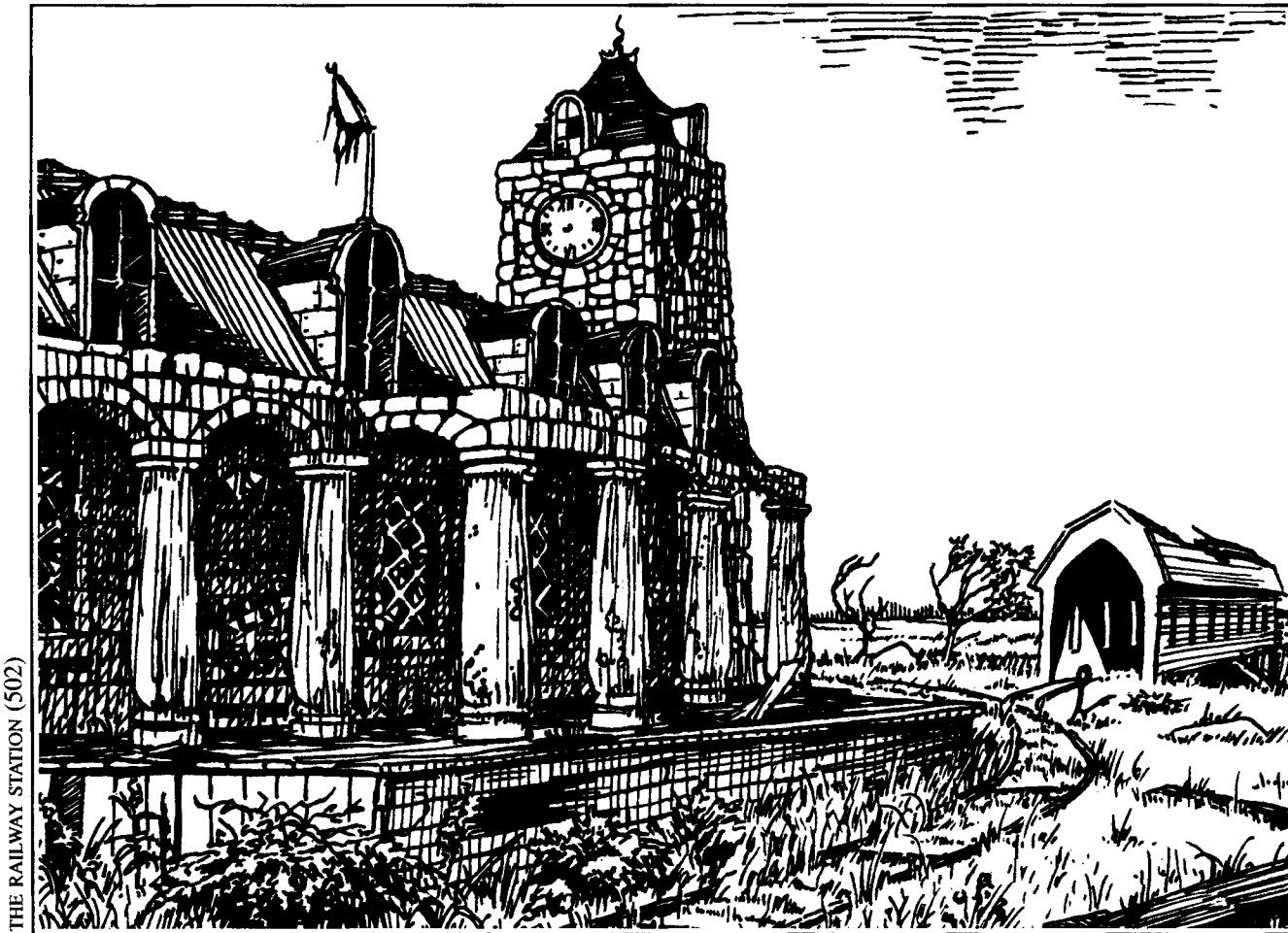

THE RAILWAY STATION (502)

502 THE RAILWAY STATION

The western end of Bank St. Formerly linking Innsmouth to Rowley, this branch line was abandoned by the railroad in 1889. The stone Gothic Revival station south of the river now stands empty, a haven for raccoons and owls. The rotting barn-like covered railway bridge spans the nearby Manuxet, rusted rails and broken ties can be seen heading off across the salt marsh toward the northwest and Rowley. It is possible that the deserted station could serve as a hiding place for someone fleeing the wrath of the townspeople.

The bridge is home to hundreds of bats. Anyone turning a light on while inside is swarmed by the disturbed creatures. Although they cause no damage, a Sanity loss of 1/1D2 points might be called for. A particularly frightening episode might instill a phobia of bats. Inside the dark tunnel a perilous gap in the ties requires a Jump roll to cross. Failure indicates a fall into the Manuxet River, a loss of 1D6 hit points, and a chance of being swept all the way out to the harbor. An investigator falling into the river is allowed the opportunity to make a Swim roll prior to each of the three waterfalls between here and the harbor. With a successful roll, the swimmer manages to safely reach shore before going over the falls. Failure inflicts 1D8 drowning damage plus 1D2 points of bruising and laceration as the hapless investigator is tumbled over the rocks. Additional Swim rolls are allowed before the investigator reaches each

of the remaining two waterfalls. A character swept all the way to the harbor—and still alive—is allowed further Swim rolls to attempt to make it back to shore.

503 THE FIRE STATION

100 Paine St. Innsmouth’s small tumble-down fire station houses two ancient fire engines. Manned by a full-time crew of four firemen, a large volunteer force can also be called upon when necessary. At the moment, only one of the fire engines is operable.

Innsmouth’s fire chief is 53-year-old Arthur Stowes, a slovenly, taciturn human. All the firemen, including most of the volunteers, are normal humans. The hybrids take little interest in such civic responsibilities.

The firemen are fearful of outsiders, refusing to answer any snooping questions. Talk of the missing Zadok Allen, a frequent visitor to the station, evokes a visible twinge of fear.

504 ABANDONED FACTORIES

Located along the banks of the Manuxet. When Innsmouth’s industrialists moved their operations to other towns in the mid-19th century, they salvaged the machinery from these mills leaving only empty buildings. Most of the rotted, broken-windowed structures were built in the late 18th or early 19th century and are generally one or two stories high. Some

still bear badly faded signs proclaiming “Southwick Wools,” “Jackson Pierce Fulling,” “Phillips,” and others. Only one or two retain their broken, rotting waterwheels. Inside there is only dirt and debris, and vacant fittings where various types of machinery once stood. Explorers of these ruins find only clouds of dust and packs of rats.

At 504A, just west of the Adams Street bridge on the north bank of the river, there is a tottering old gristmill hanging precariously over the gorge. If entered, the combined SIZ points of the entire party represents the percentage chance of the whole ruin toppling over into the river. Those inside take 2D6 damage from the fall, then must make successful DEX x5 and Swim rolls to extricate themselves from the sinking ruins and swim to shore. Failing the DEX roll indicates the character is trapped and the drowning procedure is initiated. Further DEX rolls may be allowed, one per round. Failing the Swim roll results in being swept down the river as described under The Railway Station (502).

505 ABANDONED WAREHOUSES

Located along Dock and Bank Streets. These crumbling late 18th and early 19th century brick and stone structures were built to store the produce of Innsmouth’s textile mills, as well

as the overseas goods brought here by the last of Innsmouth’s China trade. Most are rectangular, two stories high, with a wooden upper floor (usually rotted) equipped with hoists for lifting bundles to the upper story. Windows are usually found only on the second floor, and these are shuttered with wood. Most of the warehouses are long empty (see 802). Investigators exploring them find only crumbling brick and rotting wood, scurrying rats, and occasional bundles of decaying cloth. Most of the warehouses bear signs corresponding to the names of the nearby factories.

506 DANGEROUS BRIDGE

Washington Street over the Manuxet. This decrepit bridge is made of wood, with rusted iron railings and supports. Signs posted at each end warn traffic: “Dangerous Bridge: Use At Own Risk.”

For investigators on foot every 10 SIZ points on the bridge represents a 3% cumulative chance that the structure suddenly collapses into the river; double the chances of collapse if the investigators are running. A typical light auto, such as a Ford Model T, has a flat 60% chance of collapsing the bridge. Larger vehicles increase this chance. See The Railway Station (502) for falling into the river.

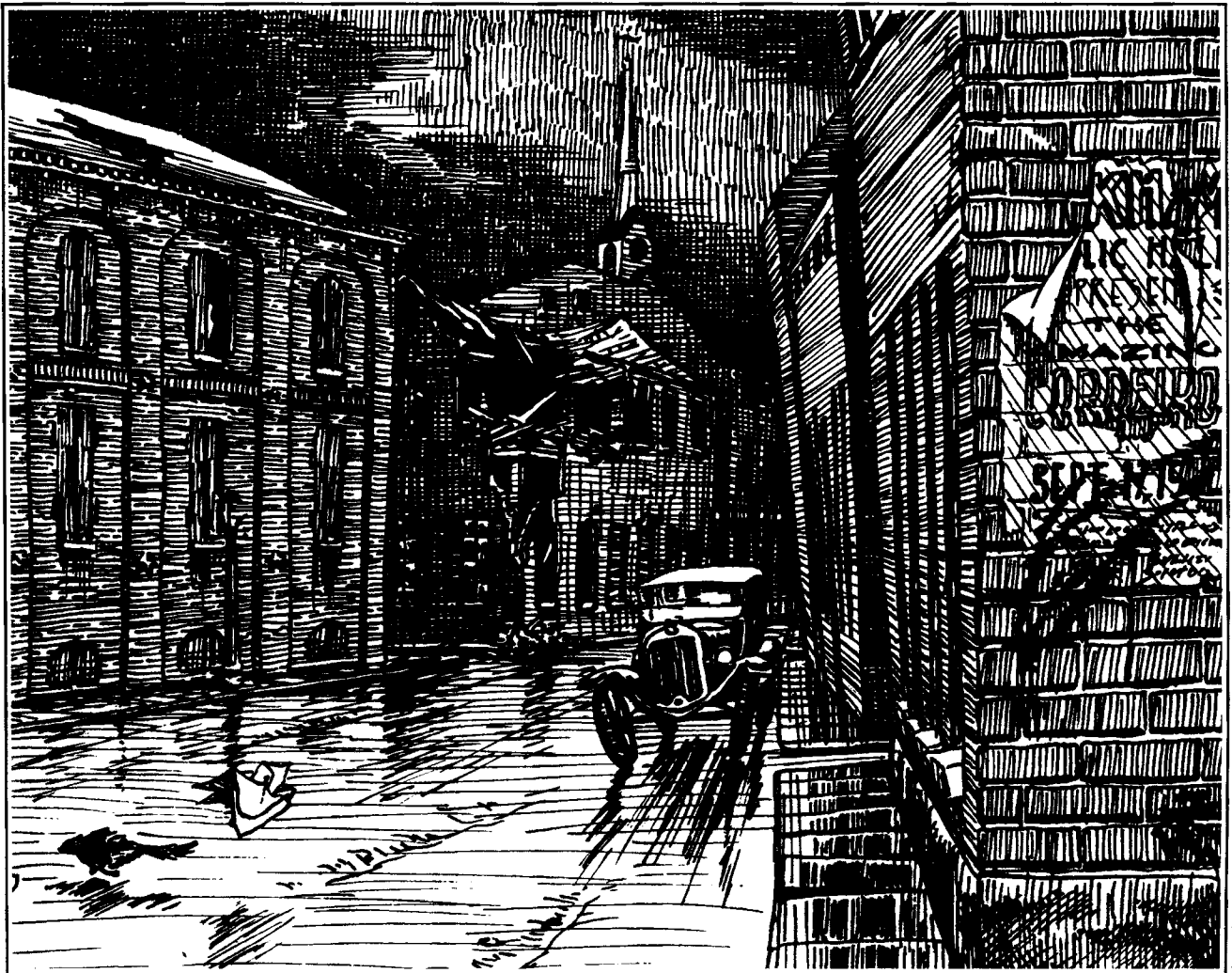

ABANDONED WAREHOUSES (505)

507 FISH PACKING HOUSES

Located along Water Street. These three squat buildings constitute one of the few Innsmouth industries still active. An area reeking of fish, it is here that fish and lobster caught by the local fishermen are weighed and paid for, processed, wrapped, then shipped throughout eastern Massachusetts. Drivers make daily deliveries to Arkham, Newburyport, Lowell, Lawrence, Haverhill, and elsewhere. Jointly owned by Warren Billingham, Jonah Waite, and Douglas Martin—all well-to-do hybrids—the plant is the largest employer in town. The owners hire hybrids whenever possible—they prefer workers they can trust.

Southern Residential Area

Similar to its northern counterpart, the Southern Residential area describes those parts of town that fall outside the border of the New Merchant District and the Southern Shoreward Slums. Most buildings here are private homes dating back to the late 18th or early 19th centuries. A few newer homes may be found scattered about, but no construction has been undertaken since before the Civil War.

Nicer brick homes stand along the south side of Bank Street, but only half of these seem inhabited. South of Garrison and west of Place of Hawks the houses become less and less well-preserved, some are no more than hovels, and most are deserted. The remainder of the houses in this area are average homes, about half of which are actually occupied.

The residents of this neighborhood are primarily untainted humans with only a few scattered hybrids living amongst them. The majority of the untainted folk in Innsmouth live in this area, their numbers providing them with a sense of security. Nevertheless, these folk fear strangers and the kind of trouble they could bring. People here prefer to mind their own business, and expect others to do the same. Investigators will see more people moving about the streets in this area than in any other part of town but their conversation is limited to small talk and offering directions.

Most of this neighborhood has sidewalks, though many are in sad disrepair. The streets are in better shape than some other parts of town, though the farther one travels away from the Merchant District the rougher they become. Marsh, Federal, Eliot, Bank, Bates, and South Streets are perhaps the best preserved, portions of them actually made of closely-laid brick. Garrison and Place of Hawks are made of packed earth, unpaved, and often turning impassably muddy after a heavy rain. Only Federal, Eliot, and Bank Streets have street lights. Even these are widely spaced and often inoperative.

601 THE LODGER

510 Babson St. Here, in a simple two-story early 19th century house, live Ervin and Millie Padgett, an untainted couple in their late 40s. The spectacled Ervin is a skilled carpenter who does odd jobs around town. Millie spends most of her time tending the large vegetable garden behind the house. To supplement their meager income this peaceful and unsuspecting couple rent out their basement to another local man, a sly hybrid named Kermit Allen Rawes. Little do they guess that that which dwells in their basement is assuredly less than human.

KERMIT ALLEN RAWES

Rawes, 30, a collector of arcane books, functions as a hybrid informer, keeping an eye on the local untainted population, and reporting any suspicious activities to the authorities. A private dealer in rare books, he often leaves town for weeks on end, enjoying lengthy buying-selling trips all over New England. By mail, he has established bibliophilic connections all over the world. His carefully chosen library takes up more than half his lodging space, the remainder of which is filled by a small bed.

Rawes' private collection contains many rare and not-so-rare volumes, mostly on occult topics such as demonology and alchemy. His more noteworthy volumes include an uncommon first printing of Ward's *Thaumaturgical Prodigies in the New-English Canaan*, a unique handwritten copy of *Monstres and Their Kynde*, and the long *Elddown Shards* brochure. Rawes is familiar with the collection of Mythos tomes at the Miskatonic University Library. Before prohibitive restrictions were placed on these volumes by Dr. Armitage, Rawes had several times visited Arkham to consult these books.

Special Skills: (Rawes) Book Lore 91%, Cthulhu Mythos 41%, Occult 65%. (Ervin) Carpentry 90%, Fishing 90%. (Millie) Botany 90%, Cooking 90%.

602 THE BERNARD SLOCUM FAMILY

903 Babson St. This forlorn two-story house is home to the Slocums: Bernard, 40, his wife Louise, 35, and their daughters, Andrea, 17, and Jane, 8. Bernard is a stout, pot-bellied, unshaven man, his wife a very thin, sad-looking woman. Bernard works for Ken Martin's Innsmouth Fuel Stop (712), where he occasionally pumps gas, but more often delivers coal and firewood to homes around town. Louise tends their struggling garden, canning and preserving what she can.



BERNARD SLOCUM

Several months ago the Slocums suffered a terrible tragedy. Their daughter Andrea was attacked by a gang of men one night while returning home from a friend's house. So vicious was the attack that the girl soon after lapsed into a catatonic state. Since then it has become apparent that the girl was raped. Her belly swells as she enters the

third trimester of her unwanted pregnancy. The Slocums hold no illusions, and are sure the hybrids were responsible.

Directly confronting the hybrids is out of the question, but the Slocums will offer to aid those who do. It is quite possible that Bernard shows up just about the time the investigators are in need of help, offering to show them a temporary hiding place, providing them with gas for their automobiles, loaning them his battered Model T truck, or telling them where they can get their hands on a secret cache of dynamite (610). If the investigators come to rely on Slocum's help too much, he may be discovered and eliminated by the foul hybrids.

After an initial meeting with the Slocums, the keeper may wish to have the investigators present when Andrea's child is born. Exactly what transpires that day is left to the keeper, but witnesses should lose at least 0/1 Sanity points, even if the if the new-born child appears normal. If the infant is monstrous, the Sanity point loss should be increased to as much as 1/1D6, depending upon the imagination and descriptive abilities of the keeper. The Slocums will insist on destroying any monstrosity, quickly drowning the child in large bucket of water. Whether or not Andrea survives her arduous labor is up to the keeper.

Special Skills: (Louise) Botany 70%, Cooking 75%, First Aid 75%.

BERNARD SLOCUM, 40, fuel supply worker
STR 13 CON 13 SIZ 14 INT 12 POW 12
DEX 12 APP 10 EDU 8 SAN 38 HP 14

Damage Bonus: +1D4

Weapons: Fist/Punch 55%, 1D3+db
Grapple 50%, special
Club 45%, 1D6+db

Skills: Dodge 40%, Drive Automobile 40%, Electrical Repair 35%, First Aid 45%, Hide 35%, Innsmouth Lore 45%, Listen 35%, Mechanical Repair 75%, Sneak 45%, Spot Hidden 45%, Throw 45%.

603 SCHOOLHOUSE

808 Washington St. Innsmouth's schoolhouse is a simple one-story wooden structure with steeple and school bell. It contains three small classrooms, one for students five to nine years old, one for those ten to thirteen years old, and another for those over thirteen. Classes are quite small—none larger than fifteen students—and made up almost entirely of untainted humans. The hybrids' children rarely attend, and those few who do are among the rowdiest and most uncontrollable students in the school. They delight in crude behavior and nasty practical jokes, mentally and physically abusing other students and sometimes even teachers.

All three teachers are untainted humans and include Helen Davis, 65, instructing the oldest class; Mary Miller, 45, teaching the middle students; and Ellen Werman, 27, caring for the



ELLEN WERMAN

youngest. Both Mrs. Davis and Mrs. Miller are Innsmouth natives, while young Ellen Werman was born and bred in Lowell, Massachusetts. All three live in the Southern Residential district—Mrs. Davis and Mrs. Miller with their respective husbands, and Miss Werman at a boarding house.

Of the three teachers, only the young outsider, plain-looking Ellen Werman, is willing to talk with strangers about Innsmouth. But never on school time. Away from school Ellen opens up—at least a little. Although she suspects much, her facts are few. She talks about the hideously ugly people she's seen, about the noises sometimes heard coming from the supposedly abandoned houses north of the river, and about the mysterious Marshes. Other hints and rumors can be taken from facts related in the History sections.

Ellen came to Innsmouth four years ago, talked into taking this position by Mrs. Miller, an old friend of Ellen's family. She now regrets having ever taken the job. If the keeper desires, Miss Werman may turn up drowned in Innsmouth harbor not long after speaking with the investigators. The Innsmouth constabulary will claim she fell into the harbor while out walking alone at night, but investigators may suspect otherwise.

Special Skills: (Miss Werman) Innsmouth Lore 40%. (Mrs. Davis and Mrs. Miller) Scowl Disappointingly 65%.

604 ELIOT STREET GREEN

The intersection of Washington and South Sts. A large park-like green, surrounded by an iron railing. It contains a rotting wooden bench, a burned-out street light, and a weed-choked lawn.

605 THE GARDEN BAR & GRILL

710 Washington St. A sign hanging over the door reads "The Garden," and includes a faded picture of a plate of meat and potatoes set next to a foam-topped mug. The Garden, a seedy-looking building, was once a low-class eatery, but now it's simply a saloon. Although illegal in Prohibition days, the place operates openly, unbothered by local authorities, some of whom number among the Garden's best customers. The place is dimly lit and smells of fish, stale beer, and smoke. Hours are from 10 AM or so until midnight or later, seven days a week. Shots of whiskey and mugs of warm beer each cost 50 cents apiece.

The Garden is owned and operated by an overweight, rough-looking German immigrant named Victor Obrecht. The unshaven, cigar-chomping Obrecht, 45, is a sullen man not normally prone to talking about the town. If someone slips him a bribe of \$5 or more Victor may open up, whispering conspiratorially in his thick German accent. He claims that the Innsmouthers suffer from some sort of strange disease or hereditary problem, and that many of them die young. He has never seen any of the fabled "fish-devils" said to swim near Innsmouth, but he has heard wild, croaking voices echoing out of the churches on certain nights of the year. He cautions the investigators against asking too many questions around town, mentioning that strangers have been known to disappear while visiting Innsmouth.

48 – Escape from Innsmouth

If any hybrids enter the Garden, Victor immediately clams up, refusing to answer any more investigator questions, attempting to shush them if they persist. The hybrids are some of Obrecht's best customers and it is a rare evening when there are not at least a few hanging around his establishment. Obrecht receives shipments of liquor at least twice a week, delivered by Lucky Clover Cartage trucks from Arkham, a front for an Arkham-based bootlegging operation. Obrecht in turn supplies liquor to Thomas Waite (708) and other merchants who sell it out of their stores.



VICTOR OBRECHT

Obrecht is a man on the run. Wanted in Florida for the murder of a prostitute, he has been hiding out in this backwater for nearly three years. He is just barely able to make a living.

Special Skill: Innsmouth Lore 40%.

606 THE GARRISON HOME

804 Phillips Place. Anyone passing this area and making a successful Listen roll hears a small child crying out for help. A second successful Listen roll pinpoints the source of the cries—the boarded-up cellar window of a nearby run-down house. Peering through the cracks, a Spot Hidden roll reveals three small children huddled in the darkness. They beg the investigator to let them out.

If the investigators linger any length of time they are confronted by a gaunt, grim-faced man who levels a rusty-looking musket at them. He tells the investigators to get the hell away or he'll shoot. After firing his single shot he uses the musket as a club, flailing away until he is either killed or subdued.

The man is Neil Garrison, 35, employed as a laborer on a small farm south of town. He and his untainted wife, Dora, live here with their three small children: Billy, age 8, Della, age 5, and Nora, age 3. The Garrisons keep their children locked in the cellar in order to keep them from being "infected" by the disease afflicting so many of the townsfolk. The children are fed and bathed regularly, but rarely allowed out of the damp cellar—and never out of doors. The parents suffer from a deep-seated paranoia, as well as a misunderstanding of what has happened to Innsmouth.

If Garrison is subdued, investigators may attempt to reason with the man and his wife. If investigators spend time with the Garrisons a series of successful Psychoanalysis rolls over several days may convince the couple that their children are untainted and safe from any imagined infection. Other investigators may choose to remove the children by force, or alert local or state authorities about the situation. The locals either ignore the matter entirely or hand the kids over to a hybrid foster home. The state may eventually investigate, but only after a delay of several months.

NEIL GARRISON, 35, farm laborer

STR 12 CON 11 SIZ 14 INT 12 POW 7
DEX 17 APP 11 EDU 6 SAN 21 HP 13

Damage Bonus: +1D4

Weapons: Club 35%, 1D8+db

Musket 10%, 1D10

Skills: Dodge 45%.

607 DANIEL MOWRY

901 Garrison St. This modest Georgian home belongs to Daniel Mowry and his wife Sandra, both in their late 40s. Daniel works at the Waite fish packing house, weighing and hauling the daily catches. A smelly, disgusting job, it is all that Daniel can get in Innsmouth. He would look for work elsewhere but he never seems to have the money needed to move. Mowry has adjusted to working side-by-side with the hybrids who make up the bulk of the company's employees; the stink of fish helps mask the repulsive stench of the hybrids. Sandra works part-time at the First National Grocery downtown (702). If this childless couple is befriended, they might discuss some of Innsmouth's secrets.

Special Skill: Innsmouth Lore 35%.

608 DOCTOR BLOOM

1006 Fall St. This tiny, one-story house is nearly covered by dark ivy, its yard unkempt and rampant with waist-high weeds. The house is set well back from the streets, its windows curtained with heavy black drapes. It is the home of the man Innsmouthers call Doctor Bloom, a half-crazed old human who variously claims himself to be a wizard, a doctor, an alchemist, and a philosopher. In truth, he is a little of each.

Luther Bloom, 71, is a spindly old man with longish gray hair and a gray beard. He dresses habitually in black, and wears tiny gold-framed spectacles. Conversation with Bloom is difficult. He frequently goes off on tangents unrelated to anything being discussed, one moment talking of spiritual and mental purity, the next of plant hybridization and Dr. Dee's obsidian mirror. His manner is at best distracted; he often blithely tosses off the most incredible comments as though they were common, accepted knowledge. Speaking with Bloom can be frustrating.

Most untainted Innsmouthers mistrust old Dr. Marsh (203) and when in need of medical attention avail themselves of Doctor Bloom. Bloom has been treating wounds and diseases, setting limbs, and prescribing home remedies for almost forty years. His success rate is good and people often come from as far away as Boynton Beach and Falcon Point. When necessary, Bloom is willing to make house calls.

The old man's house is crowded with beakers and flasks, glass and rubber tubing, burners, stoves, and other laboratory equipment. Fluids and powders of all colors and consis-



DR. LUTHER BLOOM

tencies are stored in unlabelled bottles, their contents known only to Bloom. Scattered about are numerous old books on chemistry, the occult, and alchemy—most opened to seemingly random pages. There are 2D6 such books here, each capable of raising an investigator's Occult skill 1D4 points.

If the investigators come to Bloom for medical attention he willingly treats them. If asked about Innsmouth he casually mentions that there is a vast city of deep ones just the other side of Devil Reef, that Obed Marsh introduced the deep ones to interbreeding with the people of Innsmouth, and that the whole town is under the sway of the hybrids. He knows most of Innsmouth's secrets and is absent-minded enough to discuss them with anyone who asks.

If a befriended investigator dies in Innsmouth, Bloom retrieves the body, reduces it to its essential salts, then Resurrects them—just to see if the process works. In combat, Bloom prefers to Dominate his foes, then flee. Somewhere among the clutter of the house is a blessed dagger.

DOCTOR LUTHER BLOOM, 71, physician, alchemist,

STR 9 CON 13 SIZ 12 INT 17 POW 17
DEX 14 APP 9 EDU 20 SAN 45 HP 13

Weapons: All at base chances.

Spells: Bless Blade, Dominate, Elder Sign, Resurrection.

Skills: Alchemy 70%, Astronomy 85%, Biology 55%, Botany 40%, Chemistry 85%, Cthulhu Mythos 15%, First Aid 75%, Geology 65%, History 75%, Innsmouth Lore 65%, Mechanical Repair 55%, Medicine 65%, Occult 70%, Persuade 55%, Pharmacy 55%, Physics 25%, Psychoanalysis 40%, Psychology 60%, Spot Hidden 55%.

609 OBED MARSH MEMORIAL

The intersection of Fall, Marsh, and South Streets. A bronze statue of a 19th century sea captain dominates this triangular patch of green situated in the middle of the intersection. Surrounded by an iron-railed fence, the statue is of Obed Marsh, 1790-1878, identified by a plaque on the base. The statue was erected in 1885, seven years after the Captain's death, at the expense of the Marsh family. Both the statue and the green are in surprisingly good repair.

610 OTIS FULLER, GRAVE DIGGER

Southwest Fall St. Little more than a shack, this small, two-room dwelling has the name "FULLER" painted crudely over the ramshackle doorway. Inside is a living room/kitchen area and a cramped, filthy bedroom. It is home to Innsmouth's 47-year-old grave digger, Otis Fuller. Short, bent, and unshaven, Fuller digs graves, hauls coffins, removes stumps, and performs other odd jobs around town. He is rarely seen without a sliver of wood or a toothpick in his mouth.

Otis knows a good deal about Innsmouth burial practices and will be glad to share the information—if someone offers him a few dollars or a bottle of cheap liquor. Otis has buried more than one coffin that seemed too light to be holding a corpse. Others rattled and bumped as though filled with logs or stones. Otis believes that a lot of these

people aren't really dead, but are living in the houses north of the river. But he admits that he doesn't want to know for sure. He won't reveal any further secrets, and he certainly won't help out in any illegal activities.

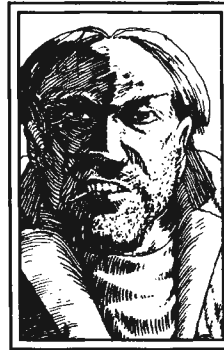

OTIS FULLER

In back of Otis' shack are a pair of smaller outbuildings, one a stinking outhouse, the other a toolshed. Inside the toolshed investigators find a collection of shovels, picks, axes, chains, ropes, and crowbars. A thorough search turns up a tarp-covered box containing 4D6 sticks of dynamite. This dynamite is obviously quite old. Extreme care must be taken

when handling it to avoid accidental explosion. Due to its age, the damage of Fuller's explosives is only half that of normal dynamite.

Special Skills: Bargain 80%, Craft (Graves) 35%, Demolition 65%, Innsmouth Lore 35%.

611 TRANSFORMER

Southeast Federal St. Guarded by a decrepit wooden fence, these tall metal towers stand humming on a small rise overlooking the decaying town. Entry is easy and once inside a saboteur could shut down all power to Innsmouth's homes and businesses with but a single successful Electrical Repair roll. However, on a roll of 96-00 the ancient circuits fry the tamperer, inflicting 8D6 points of damage on him. A separate circuit powers the town street lights which must be shut down separately. The station is unmanned.

612 THE DEAN HOME

510 South St. A well-kept brick home inhabited by Stephen Dean, 36, and his wife Beverly, 33, an untainted couple. Stephen is employed at the Billingham fish packing house while Beverly brings in extra money by taking in sewing. They are a quiet and friendly couple without children.

The Deans are secret allies of the hybrids, keeping an eye on suspicious strangers and reporting on the activities of their neighbors. If their suspicions are aroused, they immediately notify the Order. They never openly consort with the hybrids, and would never take any physical action to help them. The Deans have an informal understanding with the hybrids: in return for information, the hybrids slip the Deans a few extra dollars now and then. The Deans aren't very outgoing, and have few friends. Few Innsmouthers, if any, have any reason to suspect that the Deans are helping the hybrids.

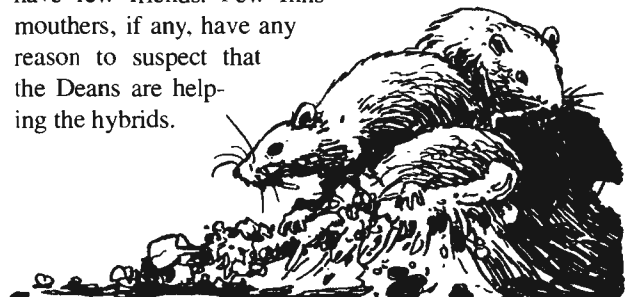

The New Merchant District

This is the current commercial center of Innsmouth, home to most of its still-functioning merchants. The area's main feature is the Town Square, an open cobblestone area surrounded by slant-roofed brick buildings dating to the early and mid-19th century. Most of these structures are occupied and in fair condition, though outside the immediate area many are dilapidated and abandoned. South of the Square most of the buildings are small 19th century residences.

The most imposing structure is the towering five-story Gilman House Hotel, a peeling, yellow-painted edifice of aged wood. The block on which the Gilman House stands is occupied by several buildings in varying states of decay. In the center of the block is a small courtyard, access to which can only be gained by going through one of the buildings.

Though many of the residents south of the river are normal, the majority of those found lingering about the Square are hybrids. Most of the businesses found here are owned either by hybrids, or humans who have made deals with the tainted ones. Perhaps a dozen or so people are found here at any given time during the day. A few autos, most decrepit and badly maintained, are found parked around the Square.

Similar to the Southern Residential area, the New Merchant District enjoys better streets than most parts of town. Paine, State, Eliot, and Federal are cobblestone, and in good repair. Bates and South Sts., along with other, north-south streets, are also cobblestone, though not so well maintained. East of the Square, most streets are in poor shape, with broken cobblestones and plagued by mud holes. The Square is lit by low-powered incandescent street lamps which extend down Paine, State, Federal, and Eliot Streets. This neighborhood contains a good number of sidewalks, though those along South, Fall, and Main Streets are in disrepair.

701 NEW TOWN SQUARE

The junction of Paine, Eliot, Federal, Marsh, Waite, and State Sts. This public square was created shortly after the Revolutionary War, when Innsmouth south of the river began to expand. It has since that time served as the commercial hub of the town.

702 FIRST NATIONAL GROCERY

708 Federal St. An older building remodeled by the First National Grocery chain to house one of their modern markets. The business is managed by 18-year-old Brian Burnham of Arkham, a cheerful lad more than happy to spend time talking with someone from outside of town. The young manger has only an inkling of what goes on in Innsmouth, but he suspects much more. He offers strangers

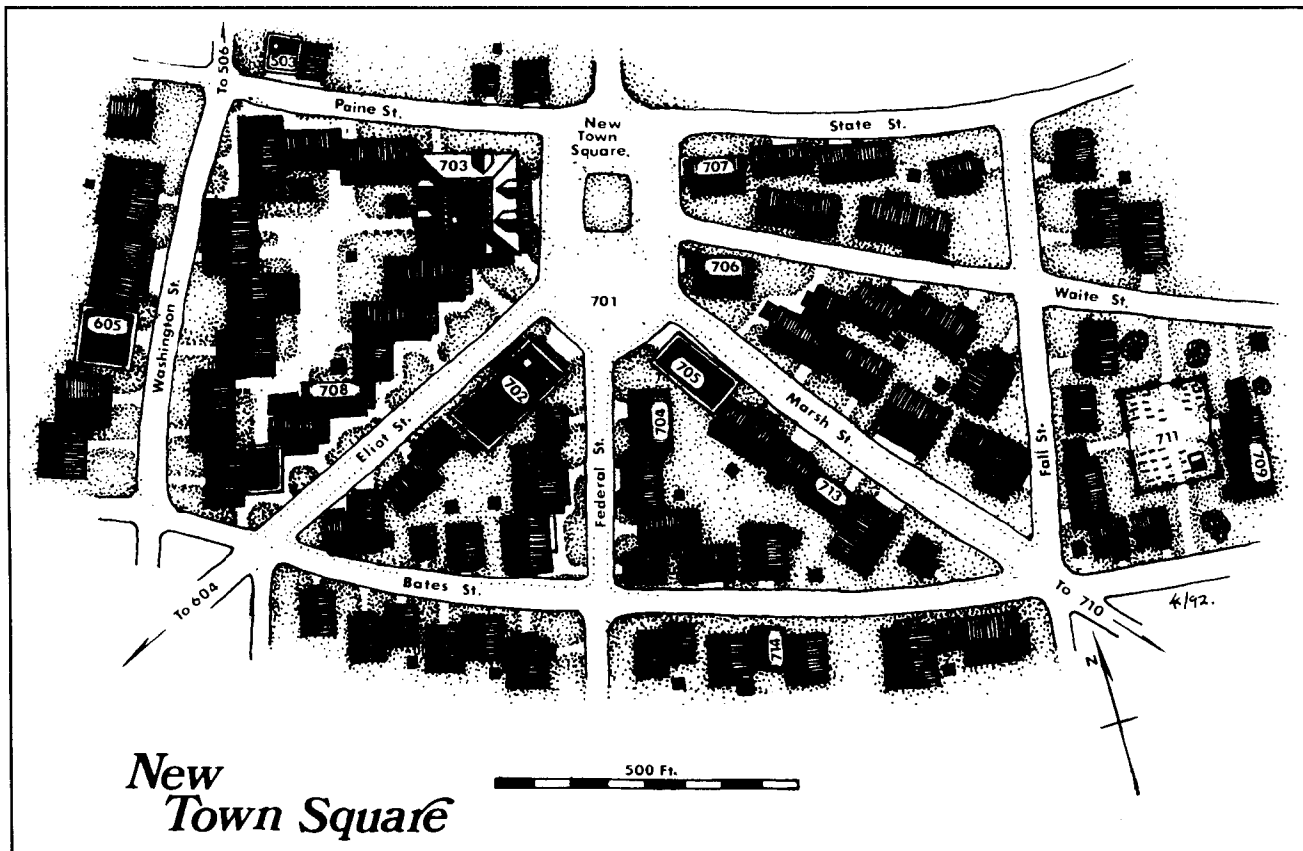

helpful directions, perhaps even sketching a map for them, should they ask. He warns visitors to stay away from New Church Green, and to not bother the Marshes or other powerful families in town. He has heard rumors that those too curious have in the past disappeared. Brian warns strangers about prying too much.

Brian boards with a family in nearby Ipswich, visiting his family in Arkham whenever possible. Before coming to work in Innsmouth the boy was warned by his pastor, Dr. Ezekiel Wallace of the Asbury M.E. Church, to stay away from the Innsmouth churches, advice that Burnham passes along to investigators. The Innsmouth store is visited once a week by district manager Arthur Anderson, a resident of Arkham. Although he knows no facts, Anderson finds Innsmouth a disturbing and depressing place. He has heard some of the stories told about the town.

The store is open Monday through Saturday from 8 AM to 5 P.M.. Aside from Burnham, the store occasionally employs one or two part-time workers including Sandra Mowry (607).

More information on Brian Burnham, including his statistics, is found in the Escape from Innsmouth scenario.

703 THE GILMAN HOUSE HOTEL

702 Federal St. Innsmouth's only operating hotel is the five-story Gilman House, which dates back to the 1830s. It was built by Jedediah Gilman who pooled the last of his family's seafaring assets to construct this once-regal hotel. The Gilman family's fortunes had floundered after a series of shipping losses. The hotel was an attempt to change their fortunes. After a period of prosperity, the hotel's clientele fell off as Innsmouth's economy spiraled down during the latter half of the 19th century. Although still operating, it has stood mostly vacant throughout the present century. An Idea roll notes that the building lacks fire escapes, a clear violation of state safety regulations. Twice a day Joe Sargent visits, picking up and delivering mail and local newspapers.



GEORGE HABBITT

The daytime desk manager is an elderly, untainted man named George Habbitt, 62 years old. He is faithful to the hybrids, particularly the hotel's owner, 45-year-old F. Murray Gilman. Habbitt usually houses visitors on the upper floors, isolating them and making their escape difficult. He

is very quiet, and won't answer questions asked about Innsmouth. There is no bell hop and visitors are required to haul their own bags to their rooms.

The night clerk is sullen Charles Gilman, 26-year-old son of the hotel's owner. An obvious hybrid, he also checks guests into upper floor rooms, far away from any easy exits. If a tip looks in the offing, Charles helps visitors with their luggage.

Rooms are \$2 a night, with no meals provided. The rooms are dusty and plain. Most provide only a single win-

dow, a simple bed, a bare electric light, and a battered wardrobe. Rooms given to investigators usually lack proper bolts on the doors. Most of the rooms are connected to rooms on either side, again often lacking proper dead bolts. There are no private baths, each floor sharing a single facility located at the end of the hallway. These are equipped with ancient marble bowls, tin tubs, and decorated with musty paneling.



CHARLES GILMAN

The Gilman House is often the last place overly-inquisitive visitors see in Innsmouth. Once lodged here, the hybrids either murder them, or kidnap them for sacrifice to the deep ones or shoggoths.

Escapes from the upper floor rooms are possible. Northwest and southwest are slant-roofed brick buildings built flush to the Gilman House. From a high window an escapee can use a rope or other means to reach one of these roofs. A failed roll probably results in a fall to the stone courtyard below. Apply normal falling damage. Once on the roof of a neighboring building, the ground level can be obtained by way of broken skylights and flights of dusty stairways.

Although visitors to the hotel are infrequent, it is possible that investigators might cross paths with either of the following guests.

JERRY HOLLAND

Holland is a traveling salesman dealing in lightning rods and odd hardware items. Slight of build, in his late 40s, with graying mustache and hair, he is always colorfully well-dressed. He talks rapidly and incessantly, most listeners finding it hard to get a word in edgewise. He visits Innsmouth semi-regularly, once or twice a year, and rarely makes more than two or three sales. Consequently, Holland seldom spends more than a day here, and has little useful information to offer about the town.

LUCAS MACKEY

Investigators visiting Innsmouth at any time have a 20% chance of crossing paths with Lucas Mackey, a factory inspector for the state of Massachusetts. Mackey might be met at the hotel, at the Marsh refinery or its office, in a restaurant, or any place else of the keeper's choosing. Proving friendly, he discusses Innsmouth matters bemusedly, all the while subtly attempting to learn why the investigators are in town.

Mackey is actually a U.S. treasury agent operating undercover, attempting to find out the secret of Innsmouth. Only under drastic circumstances will he blow his cover. Mackey is in Innsmouth investigating allegations made by a previous visitor to the



LUCAS MACKEY

The Innsmouth Bus

The bus is an old, gray motor coach owned and operated by the repulsive hybrid, Joe Sargent. A hand-written sign mounted in the windshield reads “Arkham-Innsmouth-Newb’port.” Most trips carry no more than two or three of Innsmouth’s hybrids, traveling to Arkham or Newburyport to conduct business or run errands. Sargent picks up mail and newspapers (the *Arkham Advertiser*, *Arkham Gazette*, and the *Newburyport Correspondent*) on his route, delivering them to the Gilman House.

Sargent’s bus leaves Innsmouth for Newburyport at 9 AM and 6 PM daily; return trips leave the front of Hammond’s Drug Store on Old Market Square in Newburyport at 10 AM and 7 PM. The trip takes about 35 minutes, the fare is 60 cents.

Trips to Arkham leave Innsmouth at 7 AM and 8 PM; return trips leave Arkham at 8 AM and 9 PM. The trip takes about 30 minutes and costs 40 cents. The bus stop in Arkham is at 705 Dyer Street, near the Fleetwood Diner.

seaside town who claimed to have only barely escaped with his life. Thus far Mackey’s investigations into Innsmouth have been quite disturbing.

If the investigators start stirring up too much trouble, Mackey uses his government clout to back them off. If the investigators don’t force his hand, he may reappear during subsequent adventures in Innsmouth, never letting on about his true mission. Mackey brings the investigators to the attention of the government when it comes time for the Raid on Innsmouth scenario.

Mackey is of average height, but a little plump, clean-shaven, with slightly thinning hair. He dresses plainly. A heavy smoker, he comes off as a little loud, always laughing and joking. It is all part of his act, an attempt to quell the suspicions of the hybrids. He attempts to pass himself off as a “regular guy” who spends most of his life traveling and living out of a suitcase. Psychology rolls cannot penetrate this facade but watchful investigators might find some of his actions suspicious. Mackey travels with a .45 revolver but keeps it packed in his suitcase unless expecting trouble.

LUCAS MACKEY, 44, factory inspector

STR 13 CON 12 SIZ 14 INT 15 POW 14
DEX 12 APP 12 EDU 15 SAN 70 HP 13

Damage Bonus: +1D4

Weapons: Fist/Punch 65%, 1D3+db

Grapple 50%, special; Kick 45%, 1D6+db
.45 revolver 75%, 1D10+2

Skills: Accounting 25%, Dodge 35%, Drive Automobile 45%, Fast Talk 45%, First Aid 40%, Hide 40%, Law 55%, Listen 55%, Occult 15%, Persuade 40%, Psychology 35%, Sneak 45%, Spot Hidden 55%, Throw 35%, Track 20%.

704 INNSMOUTH CAFE

707 Federal St. This dismal greasy-spoon offers counter service and take-out food prepared on a grill not cleaned in decades. The fare is simple, featuring sandwiches, stews, and pre-packaged soups, all served with weak coffee or bluish milk. Meals range in price from 25 to 50 cents. The cook is a stooped, narrow-skulled hybrid in his early 40s named Darold Eliot. His hybrid daughter, Brittany, 22, waits on the counter. She is an unattractive, flat-nosed woman, huge-handed and clumsy.

The cafe is open every day, from about 7 AM until 8 P.M. or so.

705 ELIOT S DRUGSTORE

706 Federal St. This drugstore is owned by another of the Eliots, 36-year-old Morgan, brother of Darold. Tall and thin, Morgan is a balding hybrid with straggly salt-and-pepper beard and mustache. He wears small spectacles, and speaks in an eerie bass monotone. He grimly watches strangers from the window of his store—sending shivers down the spines of innocent passers-by. The store is sparsely stocked with a selection of toiletries, patent medicines, candy, and other common items. The store is open from 9 AM to 5 PM, Monday through Saturday.

706 BILLINGHAM S SEAFOOD DISTRIBUTION COMPANY

705 Federal St. Unlike the Waite and Martin fishpacking houses, who sell their seafood products directly out of their plants, Warren Billingham conducts the bulk of his business from this office in the heart of town. Billingham, a proud, shrewd hybrid in his 40s, frequently deals with out-of-town buyers, who no doubt cringe at the man’s numerous symptoms of the Innsmouth look.

707 OFFICE OF THE MARSH REFINING COMPANY

701 Federal St. The company’s offices are open to suppliers wishing to sell raw ore, and those customers wishing to buy purchase refined gold. Lucy James, an unattractive human woman, serves as both office receptionist and mistress to the manager, Jacob Marsh, son of Sebastian.



JACOB MARSH

Young Jacob Marsh is a slimy, but friendly character, oozing charm whenever it is necessary to cover up the factory’s poor, nearly non-existent bookkeeping. He is short, with slicked back hair, a too-wide smile, and slightly bulging eyes. If questioned, Marsh explains that the refinery’s high manufacturing efficiency accounts for any apparent discrepancies

in the amounts of ore purchased and the amount of pure gold produced. Anyone breaking in and checking the

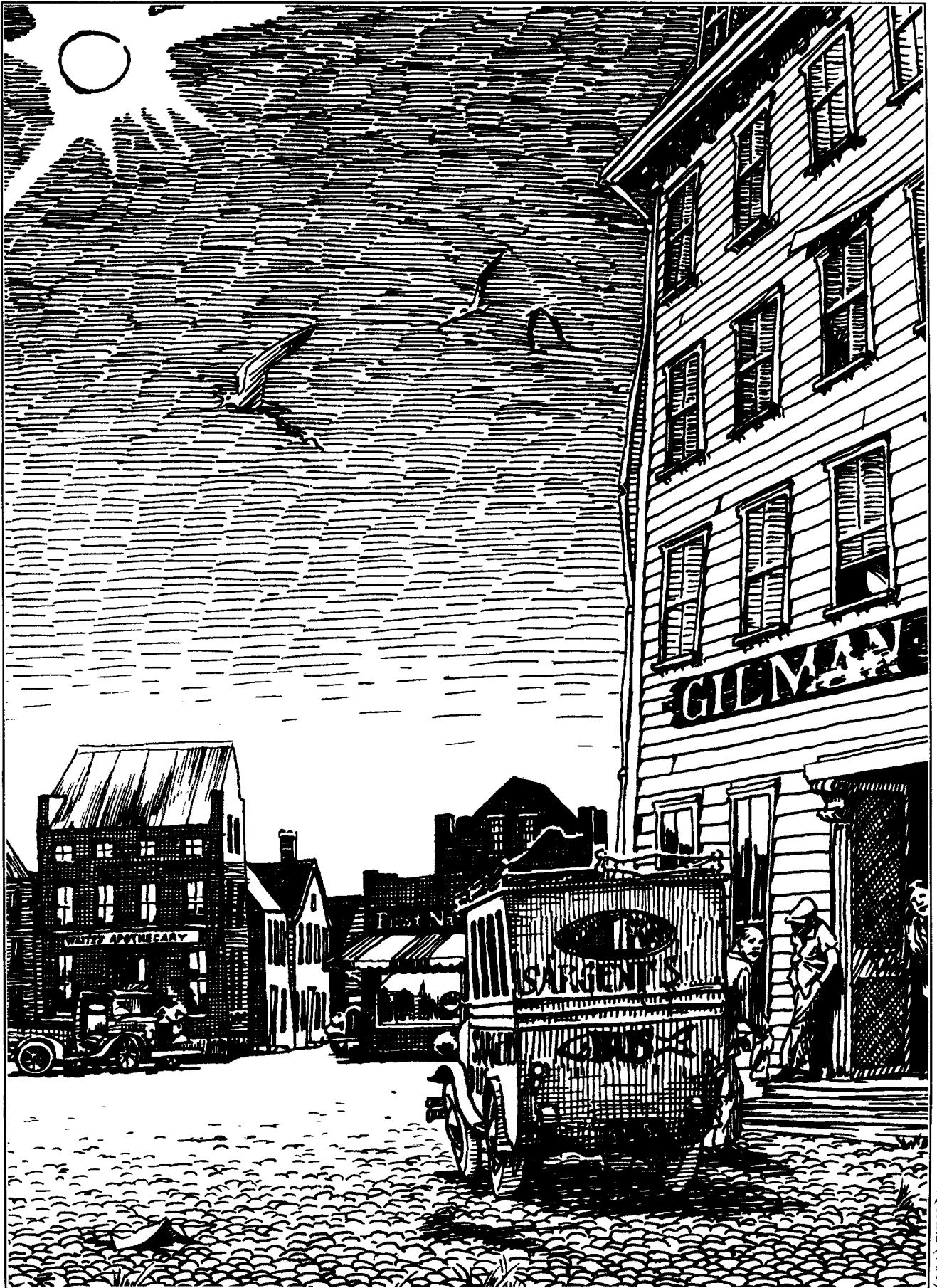

NEW TOWN SQUARE (701)

54 – Escape from Innsmouth

misaligned files discovers, with a halved Accounting roll, that the Marsh refinery does indeed market far too much gold when compared to the amount of ore purchased. Anyone bothering Jacob Marsh without good reason is likely to be visited by the local constabulary.

The office is open Monday through Friday, from 9 AM to 5 PM, but unexplained closings are frequent.

JACOB MARSH, 27, refinery manager

STR 10 CON 13 SIZ 11 INT 13 POW 13

DEX 13 APP 9 EDU 12 SAN 0 HP 12

Weapons: None carried; all at base percentages only.

Skills: Accounting 65%, Bargain 65%, Chemistry 20%, Credit Rating 55%, Cthulhu Mythos 30%, Factory Management 55%, Fast Talk 80%, Geology 45%, Mechanical Repair 30%, Psychology 55%, Spot Hidden 45%.

708 WAITE S VARIETY STORE

404 *Eliot St.* A dingy brick storefront with its name painted in faded lettering on the dirty glass of the front window. Inside a maze of crowded aisles holds items of every description: tools, nails, screws, curios, small fireworks, inexpensive toys, stationery supplies, and households. Bootleg liquor is sold from the back room, to townsfolk and visitors alike.

The store is owned and operated by Thomas Waite, 56, an untainted human with a deep one wife and a hybrid daughter. Waite looks much older than he is—he has had a long and suffering life. Under most circumstances he doesn't talk much with strangers; he fears the wrath of the hybrids. Withdrawn, he barely acknowledges customers, and is often found staring at a small tarnished locket containing an old picture of a pretty, young woman—a long-lost love. Thomas is the younger brother of Ephraim Waite, a reputed wizard who died in 1921.

The variety store is open from 9 AM to 5 PM, Monday through Saturday, and occasionally on Sundays as well.

It has long been rumored that Old Waite keeps a great treasure in a safe in the back of this store. Most suspect it to be old pirate gold and jewelry, but the elders of Innsmouth know that it is an even greater treasure, a handwritten translation of the ancient stone tablets kept in the basement of the Esoteric Order of Dagon. Translated by Obed Marsh from the R'lyeh glyphs found on the tablets he brought back, it is titled the *Book of Dagon*.

Using knowledge learned from the book, Waite has carved an Elder Sign on the inside of the safe's door, protecting it from deep ones and hybrids alike. Details of this book are found in the scenario *Escape from Innsmouth*.

709 THE FIRST UNITARIAN CHURCH OF INNSMOUTH

804 *Main St.* Abandoned, and with its tall steeple decapitated by storms, this early 19th century church stands crumbling amidst a tangle of scraggly grass, the remains of its once-noble steeple lying in the grounds of next door Redemption Cemetery. Inside the church investigators find fallen timbers, roosting pigeons, and scabbling rats. Floors

are rotted and ceilings collapsed, the pews and pulpit broken and disintegrating. Sunlight pours through a gaping hole in the roof.

The church's congregation disbanded in the late 1830s, in the years before Obed Marsh began actively running the local ecclesiastics out of town. The liberal-thinking Unitarians were among some of the first to join Marsh's newly-formed Esoteric Order of Dagon. Abandoned long before the riots of 1846, the basement of this building still shelters some of the church's long-forgotten records. Of these, some hint at increasingly shocking stories and items brought back to Innsmouth by her sea captains. Among these are fragmentary stories of Obed Marsh's dealings with certain South Sea islanders and the heathen sea-gods they worshiped, as well as tales of other mysterious finds and cargoes brought back to the town from abroad.

710 MARSH STREET GREEN

Intersection of Marsh, Fall, and Bates Sts. The streets surrounding this large iron-railed green are in poor shape. Weeds growing up inside the fenced green have taken firm root well out into the pavement, filling the cracks in the street with dandelions and thistles. The waist-high weeds of the green hide the remains of a toppled Indian statue and a rotting park bench.

711 REDEMPTION CEMETERY

Bordered by Fall, Waite, Main, and Bates Streets. This lonely, crowded graveyard stands in the middle of a block of run-down, mostly vacant homes. A leaning fence of corroded iron bars surrounds the grounds, while rusty, unlocked gates give access at each of the four cardinal compass points. Towards the southeast lie the ruins of the Unitarian Church steeple among tombstones shattered and crushed by its fall. This cemetery was opened in the early 1800s and was used mainly by middle-class families like the Martins, the Eliots, some of the Waites, and others. Although some space remains, the cemetery is little used these days and the grounds are dotted with saplings that have been allowed to take root. Most of the markers are very simple, and no statues decorate the place. The earliest tombstone is dated 1828, the latest 1904.

A little prowling and an Idea roll notes that a large number of the graves are dated 1846—the year of the Innsmouth plague and riots. These graves hold the victims of Obed's revolution. Graves dated later than 1865 have a 30% chance of holding empty coffins. These burials were conducted to cover the disappearance of Innsmouth hybrids that returned to the sea.

712 INNSMOUTH FUEL STOP

303 *South St.* A gas island with two hand-operated pumps stands just off the street, next to a small, run-down wooden shanty. A battered flatbed truck parked outside is used to deliver firewood and coal to local customers. Inside the shabby office are a pair of rickety wooden chairs and a clut-

tered desk. Behind the station are stacked cords of wood, great piles of coal, and a few rusty tools.

The Innsmouth Fuel Stop is owned by Ken Martin, an ill-tempered hybrid in his late 30s. Martin sells gasoline, firewood, and coal to the locals. His assistant, Bernard Slocum (602), is an untainted human. Most of the time either Martin or Slocum are on the job, ready to pump gas or take orders for fuel. Slocum is usually stuck with the heavy work of making the deliveries.

If Martin suspects investigators of meddling in Innsmouth's affairs, Martin refuses to sell them gas, claiming that he is sold out. Or, while pumping the fuel, he takes the opportunity to tamper with their vehicle. Martin will do whatever he can to make it difficult for investigators to leave town. The human Slocum, on the other hand, bears a grudge against the hybrids and may well come to the aid of the investigators. The Fuel Stop is open seven days a week, from 8 AM to 8 PM.

713 MOIRA PIERCE, SWITCHBOARD OPERATOR

104 Marsh St. This small house is home to Innsmouth's telephone switchboard operator, a 58-year-old hybrid spinner named Moira Pierce. Moira works the switchboard in her home from about 7 AM until 6 PM every day. There are very few telephones in town, and almost no one calls into Innsmouth, so her workload is light. Moira listens in on strangers' calls and reports anything she hears to members of the Order.

All phone calls going in or out of town must be connected by Moira. If she suspects callers of wrongdoing, she cuts off their calls in mid-sentence, then claims that she cannot re-connect them. Moira sometimes coordinates movements taken against troublemakers, calling the constables, alerting the Gilman House Hotel, and in serious cases even calling the Marshes. She is at the center of all hybrid communications.

714 INNSMOUTH ELECTRIC

408 Bates St. A tiny, sporadically attended office where Innsmouth folk pay their bills or arrange to set up service. The desk is staffed by locals.

Southern Shoreward Slums

The most desolate, uninhabited section of Innsmouth, this slum area is made up of dozens of crumbling gambrel-roofed homes dating back to the 18th century. Many lean at bizarre angles, and some have collapsed upon their sunken foundations. Most are tightly boarded up,

but a few open or broken windows gape menacingly at passersby. The sturdiest structures are the numerous brick and stone warehouses lining Fish Street. Warehouses along Water Street are of older vintage and less sound. Unlike their northern counterparts, the southern slums are largely uninhabited—visitors scarcely encounter a soul within this area.

Streets are for the most part unpaved. State and Water Streets are cobblestone and brick. There are no street lights in this area, and the few sidewalks narrow, cracked, and uneven.

801 ABRAHAM SOUTHWICK HOME

905 Main St. This is one of the few visibly inhabited homes on Main Street. Nearly as run-down as the abandoned ruins around it, it is actually home to a family of eight. Abraham



ABRAHAM SOUTHWICK

Southwick, 41, lives here along with his second wife, Vera, 31, a homely, bulgy-eyed hybrid harridan, and six children. Three of the children (Joseph, 7, Absalom, 6, and Anna, 4) are fully human, the product of Abraham's first marriage. The others (Roy, 13, Jack, 11, and Mark, 5) are Vera's, all of them illegitimate. The couple have not produced any children of their own. Vera's children are a dirty, mischievous lot of hybrids who tease, beat, and otherwise mistreat

Abraham's untainted children.

Abraham is a fisherman, one of the few untainted humans left in the profession. His first wife, an untainted woman whom he had known since childhood, was killed three years ago by an unidentified hit-and-run driver. Desperate to find a mother for his children, he last year married Vera Chapman, a poor Innsmouth woman, unaware that his new wife carried the tainted Innsmouth blood. She has turned out to be a wicked stepmother of classic proportions, treating Abraham's three children as little better than servants, while her own are free to do as they please. Abraham, defeated by life, does little or nothing about it. He spends his days fishing, and his nights drinking till he passes out.

Investigators wandering through this part of town might find themselves accosted by one of Abraham's small sons. Rushing into the street and throwing his arms around a random stranger's knees, he begs to be saved from his awful mother and tries to explain his plight as best he can. Should the investigators actually take the child away, the local constables and the State Police charge them with kidnapping. If the boy is instead returned to his home, the investigator finds conditions there as bad as described. Vera curtly thanks the investigators for their trouble, then slams the door and proceeds to give the runaway a sound thrashing.



VERA SOUTHWICK

802 BRICK & STONE WAREHOUSES

Fish and Water Sts. These structures are left over from Innsmouth's days as a port-of-entry. These great, square buildings stored cargoes brought back to Innsmouth from exotic ports all over the world. Most are still intact, their hipped roofs and wooden-shuttered windows still standing firm against the elements. Most are locked with chains and padlocks. In some cases a nameplate identifies the warehouse's former owner. Most belonged to the Marshes, but a few belonged to the Martins, Gilmans, and Hoggs.

Most of the warehouses are empty, but a few contain moldering bales of silk, casks of spices, bags of tea or coffee, and stacks of rotting sandalwood, all long forgotten. At the keeper's option, there may be other, more interesting cargoes stored in some buildings—strange artifacts or trinkets brought back from abroad, left forgotten in the dark.

803 JOE SARGENT

801 Main St. This is the seedy home of Joe Sargent, driver of the Innsmouth bus. The house is a tall, narrow two-story gable-roofed affair with broken windows and dangling shutters. Its paint is gray and flaking. The battered mailbox reads "SARgeNT." Sargent keeps his bus parked on the street in front of the house.

Sargent is just under six feet tall, thin, stoop-shouldered, and smelling of fish. He dresses shabbily in oversized shoes and wears a golf cap half-cocked on his misshapen head. His watery blue eyes are wide and bulging, and deep creases mark the sides of his neck. His nose is flattened, his forehead receding, and his ears so small as to be almost negligible. He smiles a wide, thick-lipped smile that shows many small, sharp teeth. His skin is a grayish color, peeling in many places. His hands are abnormally large, with the suggestion of webbing between the fingers. Sargent walks with a queer shambling gait.

Sargent carefully observes any strangers who board his bus for Innsmouth. Any who seem particularly suspicious are reported to the clerk at the Gilman House who passes the information along to the members of the Order. Sargent is a loyal hybrid ready to assist in any way he can. He keeps a .38 revolver in his home, and a tire iron tucked under the dashboard of his bus.

JOE SARGENT, 33, bus driver

STR 11 CON 11 SIZ 14 INT 13 POW 12

DEX 9 APP 8 EDU 8 SAN 0 HP 13

Damage Bonus: +1D4

Weapons: Fist/Punch 65%, 1D3+db

Tire Iron 45%, 1D8+db

.38 Revolver 30%, 1D10

Skills: Dodge 20%, Drive Automobile 80%, Electrical Repair 25%, Listen 40%, Mechanical Repair 60%, Psychology 20%, Spot Hidden 50%, Throw 40%.



JOE SARGENT

The Harbor Area

The Harbor area is defined as that area lying between Water Street on the west, and the stone breakwater offshore. Included in this area are the several rotting wharves jutting into the harbor north and south of the mouth of the Manuxet, and the abandoned warehouses that stand upon them. Water Street south of the river is home to several old brick and stone warehouses dating back to the late 18th century, most of them now falling into ruin. In some places along the grassy shore one finds the jagged remains of walls and piles of loose stone, the last remains of fallen buildings.

Out in the harbor, the crumbling stone breakwater still protects the harbor from the fierce Atlantic, the remains of a shattered stone lighthouse standing on the breakwater's far tip. The harbor itself is choked with sand from the Manuxet, leaving the water no deeper than seven or eight feet in most places and creating a sandy tongue dotted with the shanties of fishermen. It is impossible for any but the smallest craft to navigate Innsmouth's harbor. When tides are right, the river creates a dangerous current in the harbor capable of carrying even the strongest human swimmer out past the breakwater and into the open sea.

Few humans, if any, are encountered in this area. It is inhabited nearly exclusively by shuffling hybrid fishermen, all of them sullen and horribly deformed by the Innsmouth look.

901 THE OLD WHARVES

Those ancient wharves depicted on the map are those few that are still usable. Others, particularly those found south of the Manuxet, have long-ago collapsed into the water. Where once proud ships berthed, there are now only small fishing boats owned by hybrids. These wharves once wore the names of their proud owners, but now are forgotten by all but a few.

902 THE STONE BREAKWATER

This is a long stone wall, fifteen feet wide, extending from the sandy spit of land just northeast of town out into the harbor. Sandy deposits have built up on the inside of the breakwater, forming a small beach now lined with the rude shacks of hybrid fishermen.

903 FISHERMEN'S SHACKS

Along the sandy beaches of Innsmouth harbor live fishermen of the poorest sort. Their nets, lobster-pots, dories, and dilapidated shanties mark the shores, piles of fish bones and spent campfires attesting to their lifestyles. They fish by day, either off the breakwater, or setting out to sea in their small boats. There are perhaps a dozen fishermen living here, only one of them fully human.

The hybrid fishermen are unfriendly and not prone to talking, especially while engaged in fishing. Most carry a knife of some kind. Listed below are three fishermen likely to be met by investigators.

HARRIS JAKES

Jakes, 40, is a sinister looking hybrid of prodigious size and strength. Thick-lipped, web-fingered, and short-tempered, Jakes warns strangers against hanging around the harbor. “Accidents been knowed to happen aroun’ here,” he says. Jakes carries a huge Bowie knife with which he gestures menacingly. And he’s not afraid to use it. He watches closely any strangers hanging around the harbor, sometimes following those that seem particularly suspicious.



HARRIS JAKE

SANDY LANIER

Sandy is a horribly deformed hybrid in his late 50s, appearing very much as a deep one, though lacking the scales. Sandy’s appearance is frightening, and if an investigator is surprised by Lanier in a dark alley or otherwise, he suffer a Sanity loss of 1/1D3 points. Like Jakes, Lanier watches strangers closely.



SANDY LANIER

DEWEY SMITH

Dewey is an untainted human, the only one dwelling in the harbor area. A victim of delusion, he views the hybrids as nothing more than unfortunate victims of a strange disease. Dewey suffers from a Panza-like inability to see the fantastic for what it is. In his late 30s, he has been living along the harbor for nearly twenty years, and claims to have never seen anything unusual. He’s heard of some funny stories about Innsmouth—but believes them nothing more than mean-spirited rumors. Dewey is of no help or hindrance to the investigators whatsoever. The hybrids view him as harmless.



DEWEY SMITH

904 THE OLD LIGHTHOUSE

At the southern tip of the breakwater stands the remains of the old lighthouse, now little more than a jumbled pile of stones. The original structure was nearly sixty feet tall, and very broad, nearly twenty feet in diameter. The lighthouse was destroyed in the 1888 by a freak storm, killing its keeper, Paul Garrison, whose body was never found. Anyone picking through the fallen stones has a POW x1 chance of discovering a piece of human skull or thigh bone. A little

more digging produces further bone fragments, but never enough to positively identify the victim.

905 CUSTOM HOUSE

100 Dock St. This once-handsome late 18th century building with its proud eagle perched atop its pediment has, like all of Innsmouth, fallen into neglect and decay. The gold-painted plaque reading “Custom House” is faded almost beyond legibility and the building’s windows are all boarded up. Innsmouth lost its port of entry status shortly after the Civil War, the town’s shipping industry by then fallen off to nearly nothing. Ship registries, cargo manifests, tax records, and other customs documents were all taken by the federal government, leaving the building vacant and empty. Inside are two floors of dusty offices and file rooms containing nothing of value or interest.

906 THE OLD MARTIN SHIPYARD

Located just north of the mouth of the Manuxet, this shallow depression was once a thriving shipyard. Now all that’s left are a few stagnant pools of water, some scattered pieces of rotting lumber, and the remains of docks along the eastern shore.

Anyone lingering here more than a few minutes attracts the attention of some of the small but voracious crustaceans native to Innsmouth waters. One or more of these bizarre creatures may quietly crawl up out of the weeds to attack an unsuspecting visitor.

CARNIVOROUS CRUSTACEANS

These strange animals, some up to a foot long, are of numerous types resembling crabs, lobsters, and prehistoric trilobites. They are commonly found in areas harboring deep one cities.

These creatures attack by silently creeping up on a potential victim (Spot Hidden to notice their approach), then hooking their claws or mouth parts into the victim’s leg. The things hang on tenaciously with a STR of 9 until either forcibly pulled off or killed. They inflict one point of damage per round; the Sanity loss for suffering a surprise attack from these creatures is 1/1D3. The creatures have only one hit point but are protected by two points of chitinous armor.



CRUSTACEANS

A successful Biology or Natural History roll verifies that these things resembles no known Earthly species.

907 THE BABSON HOME

East of Pierce St. Here, upon a rotting wharf jutting out into the harbor, stands a large, single-story warehouse occupied by the hybrid Babson family. Smoke can sometimes be seen curling from the crude pipe protruding from one wall.

A closer approach and a Listen roll detect guttural, croaking voices coming from within. A peek through any of the windows verifies the building is inhabited. If alerted to the presence of eavesdroppers, the Babsons charge outside to confront them, possibly alerting the authorities.

The hybrid Babson family consists of Margaret Babson, 42, her two teenage daughters, a teenage son, and four small hybrid children. At any given time there may be 1D6-1 deep ones making a conjugal visit to the family. The horrible Babsons fight with fists and clubs. Use standard hybrid stats.

Fish bones and garbage litter the ground around the building and a horrible fishy stench surrounds the area. Inside, garbage is strewn through the hallways and rooms. If present, the deep ones and their partners are lounging in dark back rooms hidden behind whitewashed windows. A couple of trap doors allow quick and easy access to the waters below the warehouse.

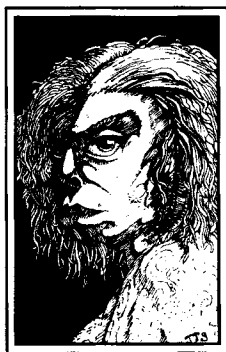

MA BABSON

908 THE LAIR

This is one of the larger wharves, supporting a huge two-story warehouse. Both wharf and warehouse are in disrepair, but the warehouse is sealed with a stout padlock and its windows covered with whitewash. Anyone entering the building is immediately assaulted by the stench of death and decay. The upper floor has collapsed while a hole in the floor looks down into the water ten feet below.

But what really catches the eye are the trails of tarry slime that mark the floor. Great gouts of this stuff are also found stuck to walls and even the ceiling. Close examination reveals that this material contains bits of flesh, bone, cloth, and metal—the regurgitated remains of a human being. Here and there a human finger may be found, or a half-digested hand or foot. Sanity loss is 1/1D6 points.

A character rolling his POW x1 or less on a D100 discovers a sticky clump containing shreds of cloth, a partially-dissolved human hand, and a broken, chainless pocket watch inscribed with the name “Zadok Allen.” If the discoverers are familiar with this man’s name, and his disappearance, this discovery costs an additional 1/1D2 Sanity points.

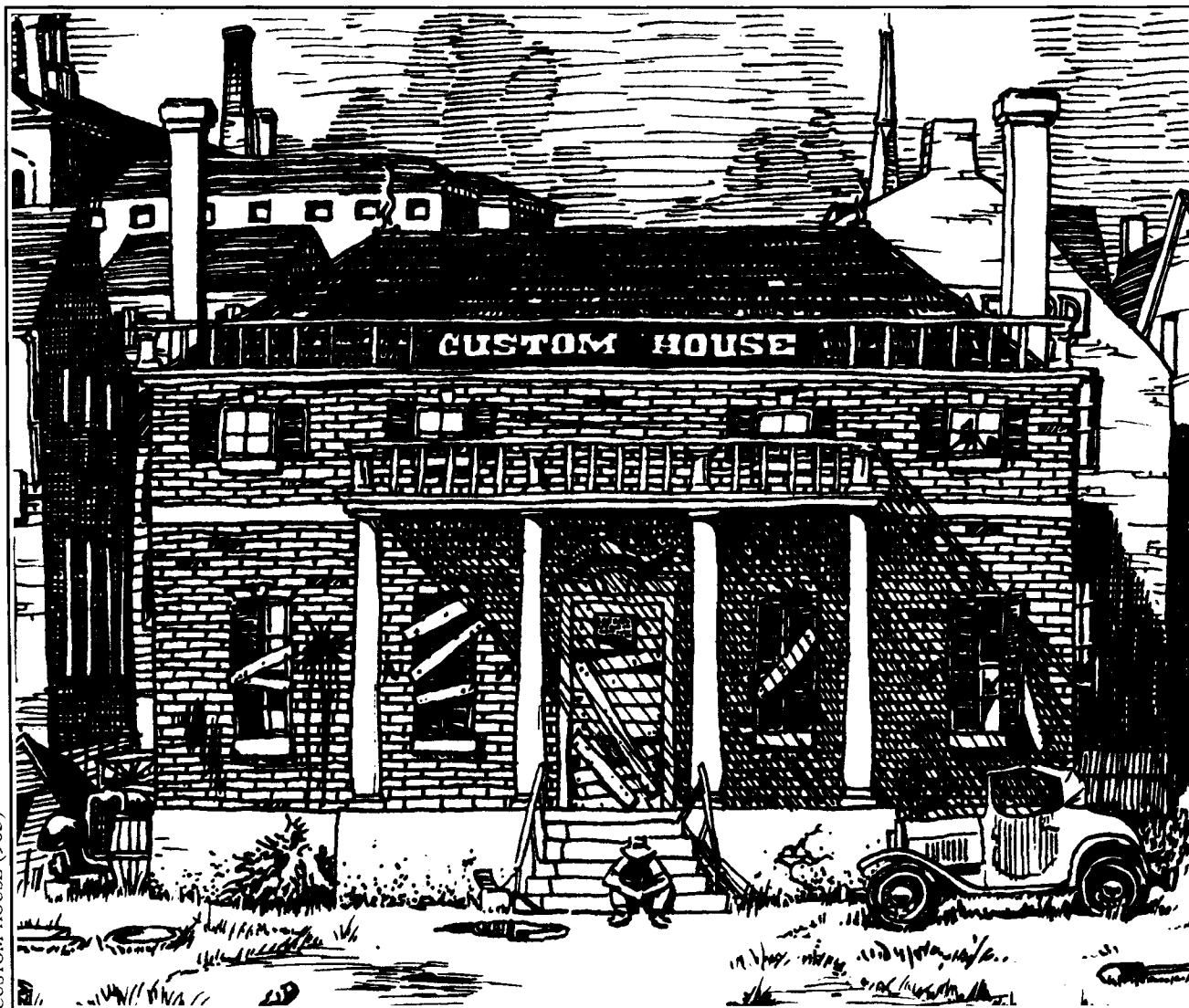

CUSTOM HOUSE (905)

This warehouse is the occasional lair of a huge shoggoth. The gooey remains are all that is left of various victims consumed by the gelatinous horror.

A successful Cthulhu Mythos roll may warn visitors of the nature of this place's inhabitant. The monster shows up only if the character with the highest POW fails a Luck roll. It slays any non-deep ones it meets and, out of ancient habit, always consumes the heads of its victims first.

THE SHOGGOTH

STR 63 CON 34 SIZ 91 INT 5 POW 9
DEX 3 HP 63 Move 10

Weapons: Crush 90%, 9D6 (see below)

Armor: Physical weapons do only one point of damage and cannot impale; fire and electricity do half normal damage. Shoggoths regenerate two hit points per round until slain.

Sanity Loss: 1D6/1D20.

All those caught within a five by five yard area are affected separately by the shoggoth's attack. Captured victims must successfully match their STR vs. the shoggoth's to escape its grasp and resultant crushing damage. If more than one character is successfully attacked, divide the shoggoth's STR evenly among all intended victims. Engulfed victims can only take action if they roll their STR or less on D100.

Outskirts

1001 SOUTH WOODS MEMORIAL CEMETERY

Just beyond the southeastern rim of town is a small forested area set back from the shore. Stunted, twisted trees bristling with thorns shade tilted tombstones. This is the newest of Innsmouth's cemeteries, first opened for use in the 1830s. Rough and frequently unusable, South Woods Road runs through the heart of the cemetery, connecting Water Street with Federal, the main road to Arkham.

The graveyard itself is wildly overgrown, but is still used for most Innsmouth burials. Many of the stone markers have fallen over and graves are unkempt, thick with weeds. Other headstones are lost among thick tangles of brambles. Everywhere an unpleasant smell of fishy decay lingers in the air. After dark, a faintly greenish, barely discernible mist rolls over the grounds while the night air is filled with the croakings of frogs that inhabit the nearby brook.

Almost no one ever visits the grounds, though Otis Fuller, the grave digger (610), is supposed to check the cemetery at least once per day.

Many of these graves belong to hybrid folk and there is a 40% chance that any random grave contains a coffin filled with stones or logs. Although the practice has since fallen into neglect, Innsmouth residents used to take great pains accounting for the hybrids who had returned to the sea, filing fake death certificates and digging graves for empty coffins.



A close inspection of the grave markers show a remarkable number of them date to the year 1846. Presumably, these are victims of the plague and riots which swept the town in that year.

1002-3 OUTLYING FARMHOUSES

Scattered along the back roads around Innsmouth are many ancient farmhouses, a few dating as far back as the late 17th century. Most of these habitations are vacant, the sandy, infertile soil of Innsmouth long ago defeating most would-

be farmers. Some houses have collapsed into ruins barely discernible among the high weeds; others still stand, but with broken windows and sagging roofs. Abandoned farms are identified by the number 1002.

Those few farms still occupied are marked 1003 and are inhabited primarily by very poor human families who scrape out a living by farming, fishing, and hunting. These timid folk rarely, if ever, visit the town, warning any outsiders to stay away. Few know much specific about the town, but all fear and loathe the place.

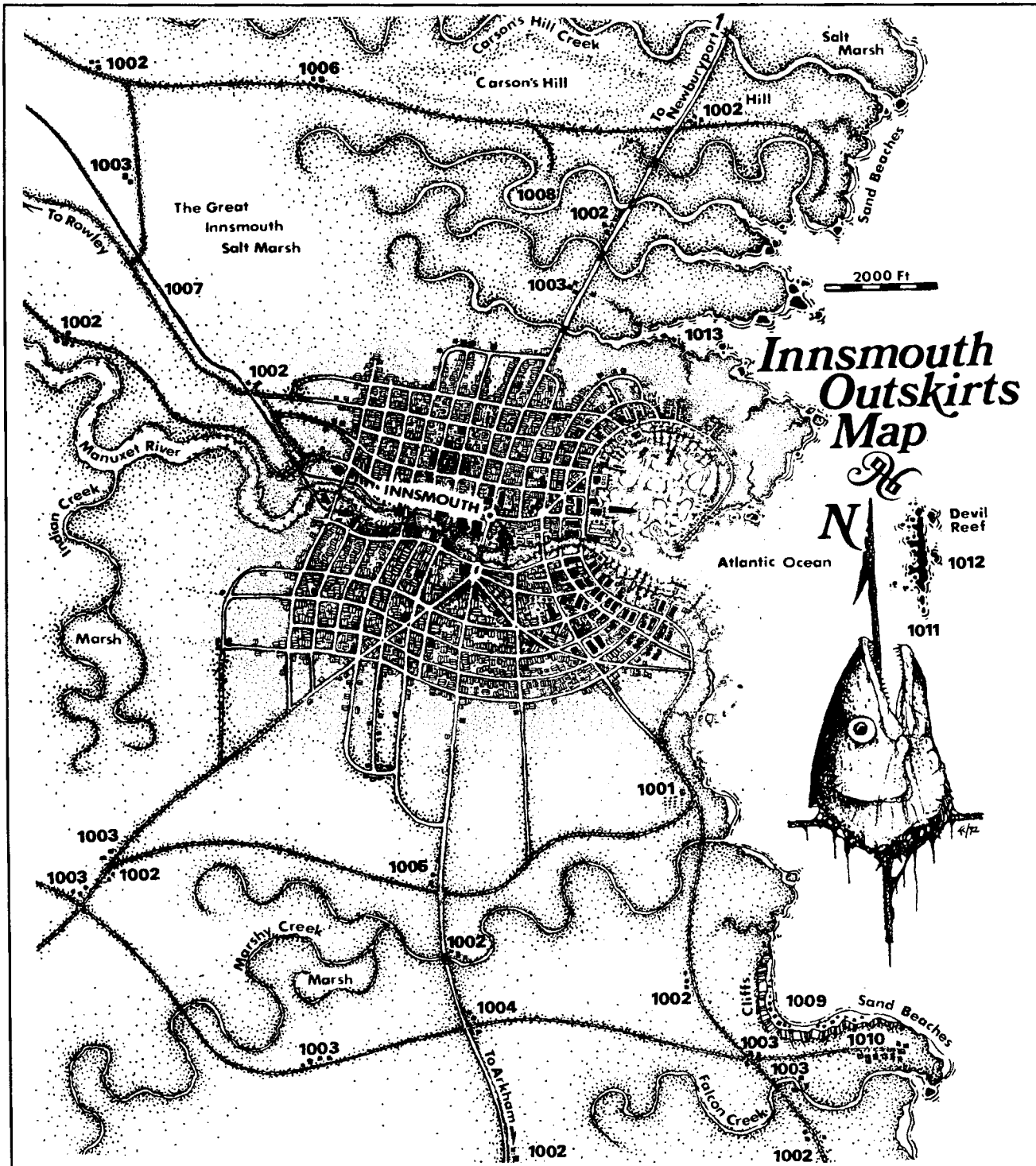

1004 ANNIE PERNELL

This farmhouse, though run-down, is obviously inhabited, as testified to by the well-tended vegetable garden out back. Anyone who gets too close to the house is warned off:



ANNIE PERNELL

“Yew git aoutta here! Git aout naow or I’ll shoot! I see yew, yew ugly birds! Git!,” croaks the voice of an old woman.

Any hesitation on the part of the investigators and the inhabitant lets loose with the double-barreled 20-gauge shotgun left to her by her late husband. She has a 5% chance to hit, the rock salt-charged weapon causing only 1D3 points of damage.

This near-sighted old woman is Annie Pernell, a widow living alone out here since the death of her husband, Lester, ten years ago. Annie knows plenty about the hybrids of Innsmouth, but her vision is so bad that she can’t tell hybrid from human. Consequently, she occasionally opens fire on innocent travelers, mistaking them for the half-human monsters. If the investigators can convince her of their untainted blood, she relents slightly and warily agrees to answer some questions. She talks about the “ugly birds” of Innsmouth, and how “they’s been ugly since afore the Civil War,” and how all this “has sumpin’ to do with Devil Reef and thet ol’ limb of Satan, Obed Marsh, cuss him.”

Annie’s house is a repository for junk, including a nearly complete run of the *Innsmouth Courier* newspaper stored in the attic. Discovering and reading this nearly complete collection adds 3D8 percentiles to an investigator’s Innsmouth Lore. If an investigator makes a POW x1 roll, Annie may, in passing, make mention of the collection. She will part with it for a mere \$10.

Special Skills: Cooking 80%, Innsmouth Lore 25%, Shotgun 5%.

1005 A FERAL DEEP ONE

Near the spot where South Woods Road crosses the road to Arkham is an apparently deserted farmhouse set far back from the road. The outbuildings are little more than collapsed piles of wood and jutting timbers.

This is home to a half-human thing, a stunted hybrid that never completed its transformation to deep one. This feral creature dresses itself in scraps of clothing, emerging only at night to prowls Marshy Creek and South Woods Cemetery in search of the small animals it feeds upon.

Although it may be tempted to attack a lone traveler, it flees from groups, cowering pitifully if cornered.

The thing attacks with a bite and both its claws each round. If both claws hit in the same round, it automatically



STUNTED HYBRID

does 1D3 bite damage every round thereafter until slain or pulled off with a successful STR vs. STR roll.

THE STUNTED HYBRID

STR 9 CON 9 SIZ 8 INT 10 POW 10
DEX 16 APP 1 EDU NA SAN NA HP 9

Weapons: Claws x2 45%, 1D4 each
Bite 30%, 1D3

Armor: 1 point scaly hide.

Skills: Dodge 70%, Hide 80%, Listen 55%, Sneak 95%, Spot Hidden 50%, Swim 75%, Track 60%.

Sanity Loss: It costs 1/1D4 to see this pitiful, ichthyic creature.

1006 NICK CASPER

This long, narrow cabin is decorated with animal traps of every description, hung from the eaves. Sun-bleached animal skulls—mostly raccoon and deer—top the fenceposts. This is the home of Nick Casper, hunter, fisherman, trapper, and expert outdoorsman.



NICK CASPER

Bearded, and over six feet tall, Casper is an impressive figure who tips the scales at 220 pounds. A quiet, reclusive man, Nick lives, like his father before him, entirely off the land, selling furs in Rowley or Newburyport. Nick knows some of the stories about Innsmouth, and never visits the place. He’s seen some

of the ugly folk that live there but figures if he doesn’t bother them, they won’t bother him.

Inside Nick’s spacious cabin are plentiful stores of dried meat, vegetables, and other supplies. All his furnishings are hand made.

If, by Persuade or Fast Talk, Nick is convinced that the Innsmouthers actually pose a threat or danger, he may aid the investigators in some small way, either cooking for them, loaning them firearms, helping them set traps, or offering them a place to hide. He only agrees to fight against the townspeople if they attack him, or if he learns the monstrous truth.

NICK CASPER, 46, outdoorsman

STR 15 CON 17 SIZ 15 INT 13 POW 13
DEX 15 APP 9 EDU 9 SAN 61 HP 16

Damage Bonus: +1D4

Weapons: Fist/Punch 65%, 1D3+db

Grapple 60%, special

Kick 50%, 1D6+db

Bowie Knife 55%, 1D4+2+db

Small Club 35%, 1D6+db

Wood-Ax or Hatchet 45%, 1D8+2+db or 1D6+1+db

.30-06 Rifle 85%, 2D6+3

Skills: Camouflage 70%, Climb 55%, Dodge 45%, First Aid 40%, Fishing 55%, Hide 50%, Innsmouth Lore 20%, Jump 45%, Listen 65%, Mechanical Repair 45%, Natural History 45%, Navigate 30%, Sneak 55%, Spot Hidden 80%, Throw 65%, Track 65%, Trapping 70%.



1007 THE ABANDONED RAILWAY

The branch rail line to Rowley was abandoned in 1889. All that remains of the railway is the crumbling barn-like bridge over the Manuxet River (502), and the rusty rails leading off across the salt marsh toward Rowley. Forlorn telegraph poles, tilted and stripped of wires, march down the track in a drunken line.

1008 TOWN DUMP

Located on the edge of the salt marsh, the stinking town dump is reached by way of a bumpy, rutted road. Here in this area of dunes, marshes, and streamlets, the town of Innsmouth dumps its raw garbage. By day scavenged by crows and gulls, at night the place crawls with raccoons, possums, and rats.

1009 BOYNTON BEACH

A little over a mile southeast of Innsmouth is a wide sandy deposit bordered by stone cliffs fifty feet high. This is Boynton Beach, home to a half-dozen human fishermen and their families. A narrow road running along the top of these cliffs links the community with the main road to the city of Arkham.

These simple folk stay away from town and when at sea give a wide berth to Devil Reef. They are extremely poor, but prefer to sell their catches to the packing houses in Gloucester rather than take them to nearer, more convenient Innsmouth. They initially mistrust outsiders but once assured that strangers are not from Innsmouth, they carefully warn travelers about the place.

The unofficial leader of the fishermen is Cory Weston, a grizzled fisherman 37 years old. Like the others, Weston warns travelers of the dangers of Innsmouth, but refuses to actively aid them.

Special Skill: Innsmouth Lore 30%.

FISH-HEAD ROCK

Near the northern end of the Beach a rocky crag extending out into the surf is roughly carved into a huge bust resembling a gigantic fish or frog. The head is narrow with gill slits in the neck, possessed of huge eyes and a wide mouth. Legend says that it was carved long ago by the Indians, an Anthropology or Archaeology roll verifying the story. Exact dating is impossible but erosion of the stone makes it obvious that the carving is at least several centuries old. A successful Geology narrows the time the carving was made to somewhere between 1500 and 2000 years ago. The superstitious fishermen avoid Fish-Head Rock at all costs, claiming that the spot is haunted. Some make the sign of the cross when passing by it.

This place was once used by a long-forgotten Indian tribe that worshiped “devils that came up from the sea.” Traces of legends about this tribe still exist, claiming that they used to practice human sacrifice. According to one legend, the tribe eventually disappeared, supposed to have joined their gods in a great city below the waters. They would not die because their gods had taught them how to live forever.

The rock was used as a way to summon the deep ones of Y’ha-nthlei. Touching the stone while standing in the surf triggers the spell, automatically draining three magic points from the user. Within 2D6 minutes, 2D3 deep ones arise from the deeps. They are likely to attack anyone who does not make the proper obeisances to them.

1010 FALCON POINT

Just down the coast from Innsmouth lies the tiny fishing village of Falcon Point, named after the great numbers of peregrines, gyrfalcons, and merlins which wheel through the air above the rocks and cliffs. The village consists of about a dozen small houses, and no commercial outlets. The forty or fifty souls residing here do their meager shopping in Ipswich or elsewhere along the coast, seldom visiting decrepit Innsmouth.

The sea-salts of Falcon Point, both young and old, know something of the shadow over Innsmouth. They are willing to talk with strangers over a cup of steaming coffee—particularly if it has been laced with some of the investigators’ whiskey. They can relate the story of Enoch Conger, a fisherman who claimed to have once caught a mermaid off Devil Reef. Years later, after he had retired, he one night disappeared from his shack.

If the investigators have supplied the drinks, one of the old salts tells them that when Conger was discovered missing there were found a set of fresh footprints leading away from the house toward the sea—footprints that were webbed. Another adds that not long ago one of the locals swore he saw old Enoch swimming with a bunch of strange-looking folk off Devil Reef—but most of the fishermen laugh this tale off. Another old salt pipes up, stating that only old Jedediah Harper knows the real truth. At the mention of this man’s name, the other fishermen fall silent.

Special Skill: Innsmouth Lore 25%.

JEDEDIAH HARPER

Jedediah Harper is the former leader of the Falcon Point fishermen, and a past friend of Enoch Conger. In poor health, he



JEDEDIAH HARPER

is now retired and lives in a well-kept house some distance from the center of the village. Old Jedediah proves short with strangers, refusing to discuss Innsmouth, Enoch Conger, or any related topic. He says the investigators are fools for believing the tall tales spun by the locals and denies that any such things ever happened. A Psychology roll reveals that he is lying. Further conversation is short and uninformative. Afterward the investigators may learn that Harper, once quite a

tale-spinner himself, was approached by the Innsmouth Marshes shortly after he announced that he has seen Conger swimming off Devil Reef. Since then Harper hasn't returned to the sea, nor spoken of Conger or Innsmouth. Rumor has it that the Marshes pay to keep him silent.

Special Skill: Innsmouth Lore 50%.

1011 DEVIL REEF

The name of this reef is attributed to Captain John Smith, who, in his *Description of New England* (1616), told of landing on a certain stretch of black reef off the coast of the New World, and here finding dark sea-caves filled with strange carvings. "This must surely be the Devil's reef," he wrote.

Outsiders approaching the reef by day are watched by several Innsmouthers standing along the breakwater and the shore, staring after the party as long as they remain in the vicinity of the reef. A visit to Devil Reef guarantees that any strangers will be closely watched by the townsfolk from now on. By night, Hide rolls may allow the party to avoid scrutiny by the hybrids, but a failure could result in immediate death at the hands of the deep ones or their shoggoth.

The reef is a low, nearly-continuous outcropping of slippery black rock visible even at the highest tides. Anyone exploring the reef on foot must make DEX x5 roll (DEX x2 at night) to avoid slipping on the slimy rocks. A fall results in a minimum of 1D2 points of damage, perhaps higher with a fumble. Carried items might be broken.

Each time the reef is visited, the character with the highest POW must make a Luck roll. Failure means that deep ones near the reef are watching their every move. These creatures eventually notify Robert Marsh at the Esoteric Order of Dagon, who then deals with the intruders as necessary.

Anyone failing a Luck roll while exploring the reef may be attacked at some point by some of the voracious crustaceans described earlier (906). One or more of these arthropods may creep out to attack unwary intruders.

A: A series of caves. Within, a Spot Hidden roll finds strangely carved symbols identified with Archaeology, Anthropology, or History as Norse runes. If the investigators find some way to translate the portions still legible, they read the following:

"Thorvald and ... wintered here ... off by the evil spawn of Ran's daughters ... defeated them here 1004 A.D. but sailed on ..."

B: These caves contain very different carved figures which a Cthulhu Mythos roll recognizes as R'lyeh glyphs, the written language of the deep ones. Though it is unlikely, if these carvings are deciphered they are found to be deep one myth-cycles. Successfully deciphering the markings results in a +4% Cthulhu Mythos and a loss of 1D4 Sanity points.

A Spot Hidden roll detects a very narrow cleft winding downward out of sight. This slimy passage soon widens to reveal a set of well-worn steps descending into the darkness. Traversing this downward-spiraling tunnel, each investigator must make a DEX x5 roll to avoid slipping and falling. After two hours of traveling, the investigators find themselves in the grotto in the air-filled chambers of Y'ha-nthlei.

C: Each of these two caves contains bas-relief carvings depicting batrachian humanoids engaged in swimming, battle, intercourse, and other activities both natural and

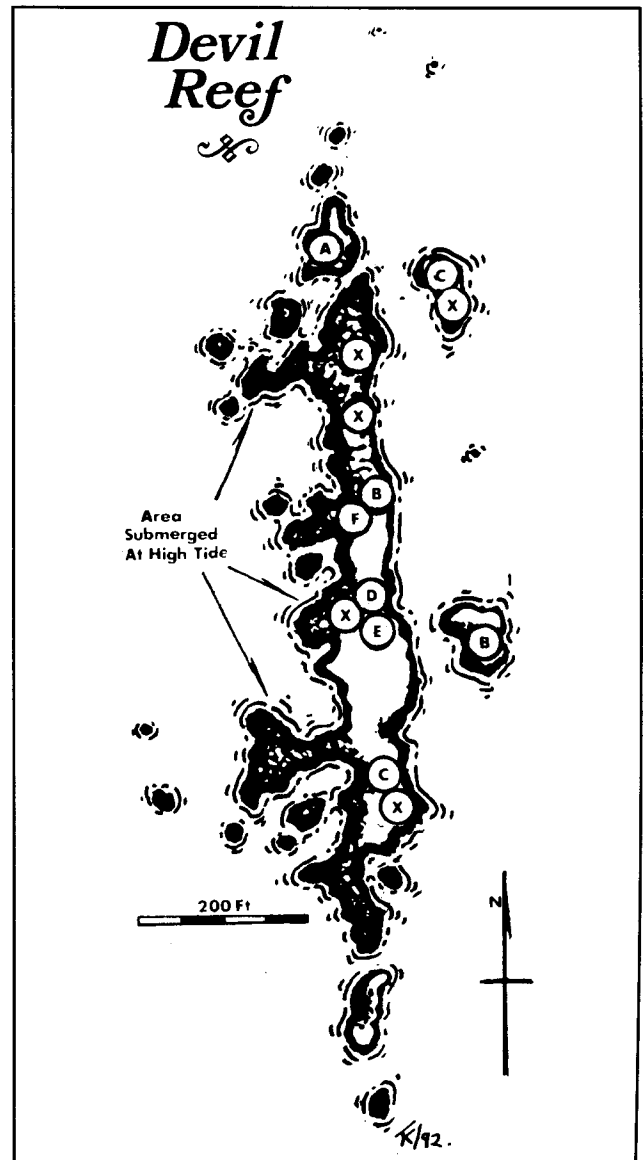

64 – Escape from Innsmouth

blasphemous. At both of these locations, an investigator examining the carvings adds 2% to his Cthulhu Mythos score while losing 1D3 Sanity points.

Anyone making a Spot Hidden roll finds a webbed footprint or two, calling for a Sanity point loss of 0/1. A Cthulhu Mythos roll identifies it as the spoor of deep ones.

D: Within this portion of the reef are a series of tunnels frequently used by the deep ones. One is a small cave used for holding sacrifices. Captives are tied to iron rings driven into the walls, left to languish for a few hours in the cold wet darkness, and then thrown to the deep ones during ceremonies.

E: This cavern is used to store the ceremonial robes, daggers, torches, and other paraphernalia used in the rites of the Esoteric Order. The cave continues on past these chambers, finally ending at a water-filled pool leading down to Y'ha-nthlei. Other caves in the reef have similar watery tunnels or pools which descend far down into the sea. These tunnels and pools can be used by the deep ones to surprise intruders. There is also a dry tunnel winding down deep into the heart of the reef.

1012 Y HA-NTHLEI

In the nighted depths below Devil Reef lies dark Y'ha-nthlei, the massive city of the deep ones, hundreds of feet below the surface. Inhabited by thousands of deep ones, this eons-old city is several miles across, a vast undersea metropolis of weedy spires and coral temples. Deep ones swim among naturally carved palaces aglow with microscopic, phosphorescent life while titanic vaults house unknown occupants and gardens of leprous corals surround black stone buildings with windows but no doors. Towering plants line the city like trees. Even the fish themselves are alien: deep-sea, fierce-toothed monsters rarely seen by surface dwellers. Equally alien crustaceans of all sizes and descriptions scuttle about the sea floor while vast jellyfish-horrors drift through the panorama, beautiful and elegant, but no less deadly for it. The mind-numbing spectacle of Y'ha-nthlei, if one were somehow to behold it, would cost the viewer 1D3/2D6+1 Sanity points.

Chances are that few untainted humans will ever see Y'ha-nthlei. Typical deep-sea diving equipment available to investigators is incapable of withstanding the pressure of these depths, though especially brave or foolish investigators might use the tunnel hidden on Devil Reef or the gate in the headquarters of the Esoteric Order of Dagon. Either of these entrances leads into a typical section of the air-filled chambers of Y'ha-nthlei.

THE AIR-FILLED CHAMBERS

These are pressurized, oxygen-filled chambers used to hold captives or by visiting hybrids not yet ready for the descent to Y'ha-nthlei.

The mapped portion of Y'ha-nthlei shows a typical group of air-filled buildings in the city. This section includes two spires (A-C, K-N), a dome-like building (H, J), and a few attached smaller buildings. These are all made of strange stone: slimy green, black, and gray.

Combat in the air-filled chambers is likely. Here stray bullets can be deadly. For each bullet that misses, a Luck roll must be made to avoid striking a window. If a bullet strikes a window, roll normal damage. For every ten points of damage taken by a window there is a 1% chance that it begins to crack. The pressures of the water outside will eventually push in the weakened window, flooding these chambers and killing everything inside. The window breaks and flooding begins 10D10 rounds after it has cracked.

A: This spire is three stories high, needle-thin, and pyramidal in shape. The room marked A is the chamber accessed by a two-way gate found in the Esoteric Order of Dagon. Passage requires the expenditure of one magic point and the loss of one Sanity point. A glance around the chamber reveals similar gates marked on the other walls. The destinations of these other gates are left to the imagination of the keeper, but at least one of them is a one-way gate that deposits users on a lonely stretch of shoreline a few miles north of Innsmouth. At least one or two are inoperative, as their destinations are in ruins. Note that some of the gates are one-way in, and others are one-way out. The walls are of worked stone, with balcony-like projections at each corner. These balconies are shaped like upward-turned thorns, and are made of some translucent, slightly phosphorescent blue-green material. The nightmarish view of the city seen through these windows calls for a Sanity point loss is 1D3/2D6+1. The one normal-looking window is actually a sea-gate, which the deep ones use to enter and leave the air-filled chambers; water cannot pass through this magical device. If touched it feels rubbery, and can be passed through from either side at a cost of one magic point and one Sanity point. Unfortunately, human beings passing out into the ocean are unequipped to deal with the incredible pressures; each round spent outside requires a CON x1 to avoid taking 1D20 damage. A Swim roll is needed to get back through the gate, a passage that again costs one magic point and one Sanity point. Elsewhere in the room is a stone stairway leading down.

If desired, the keeper might have each person who uses the Esoteric Order's Gate roll their POW x5 or less. Failure indicates that the gate has somehow activate the dormant genes in the user, infecting him with the taint of the deep ones. This should take time to develop and longer to notice.

B: This room is overgrown with a bizarre tangle of coral, seaweed, and unfamiliar plant life. A successful Biology or Natural History roll recognizes none of these alien growths, some of which seem more animal than plant. Observers lose 0/1D3 Sanity points. The plants are harmless, but strange.

The thorn-like translucent balconies jut from the corners of this garden. A stairway leads further down into the pyramid-spire, and a translucent tube-like passage snakes through the ocean to the upper story of a squat building resembling a dome-like pyramid. The translucent tube is rubbery to the step, and swings and bobs slightly as the party travels through it. This weird effect costs 0/1 Sanity points. More of the city can be seen from the tube, including the sea floor far beneath the travelers' feet.

C: The base of this pyramid is featureless save for the staircase to the upper levels, two open stone passages on opposite sides of the room, and a door in another wall. There is always one deep one here, and a 25% chance of encountering 2D3 more. Unless outnumbered, the deep ones attack, fleeing to the temple or the nearest sea-gate should they lose half their number.

D: This is a long, narrow grotto filled with strange rock formations and alien plant and animal life. A Biology roll picks out numerous previously unknown species of arthropods, coral, and sea-worms. The grotto is reached by the

stone passage from the pyramid-spire as well as from Devil Reef by way of the slimy tunnel found therein. Here the entrances are hidden by a purple coral formations, and require a Spot Hidden to find. Climbing the passage up to the reef takes over three hours.

The grotto is lit by phosphorescent algae clinging to the walls, as well as stalactites and stalagmites. Several windows allow views of the surrounding sea floor. Near a large columnar formation lurks a large polypous creature camouflaged to appear as part of the surrounding stone (Spot Hidden to see and avoid). This creature has a three-foot high barrel-like torso topped by dozens of six-foot long ten-

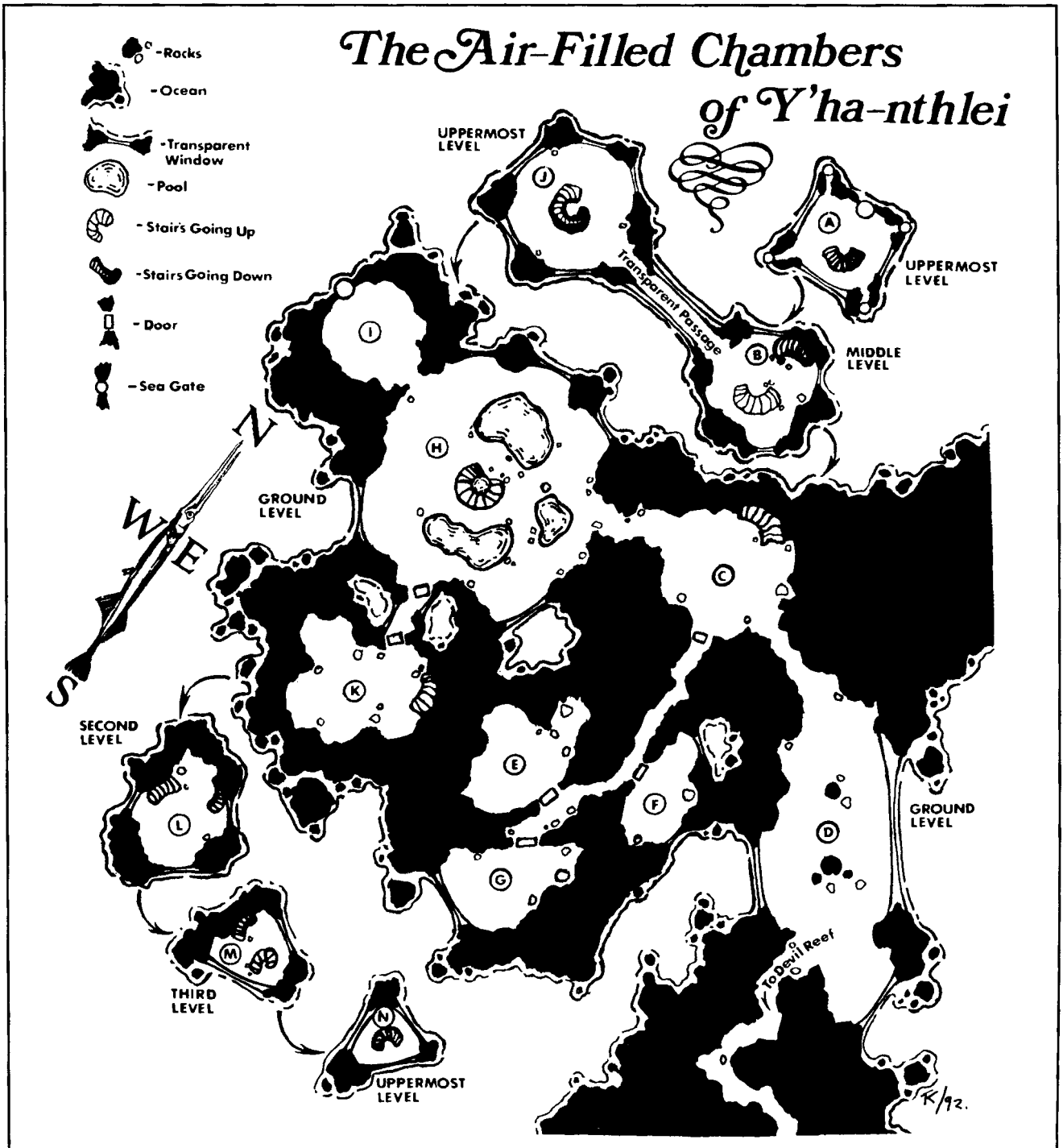



tacles surrounding a gaping toothless maw. The thing attacks anyone who strays too near.

THE POLYP

STR 12 CON 17 SIZ 10

DEX 6 HP 14 Move 0

Weapons: Tentacles (1D6 per round) 35%, each does 1D6 damage per round; STR vs. STR required to break free. Also, each tentacle exudes a mild poison, POT 6, which causes total paralysis if it overcomes a victim. Potency accumulates each round of contact, and paralysis lasts 25-CON minutes.

Sanity Loss: 1/1D4.

The door leading from the spire's base opens on another stone passage with three driftwood-barred doors marked E, F, and G. Each door is equipped with a small, sliding panel that allows a viewer to look inside these arched ceiling rooms. These chambers house hybrids who resist the change. Some are suicidal, others raving mad, and most in great pain due to physiological stresses.

E: This chamber contains those hybrids most human. 1D6-1 are found here at any given time, their suffering and deformities costing viewers 0/1D2 Sanity points.

F: This chamber holds 1D4-1 hybrids slightly further along in the change. Sanity points loss for seeing these wretches is 0/1D3.

G: This room contains the worst of the lot—1D3-1 savage, feral former humans now very near to becoming full deep ones. Seeing them costs 0/1D6 Sanity points. Note that any humans taken captive by the deep ones might be placed in these cells to amuse the hybrids. An investigator imprisoned here must roll against his Sanity twice: once for seeing the hybrids, and once for being imprisoned with them. The hybrids are fed once or twice a day by a deep one tender.

H: This is the sea floor level of the squat, dome-like pyramidal temple. More of the thorn-like windows jut up the curving inner walls of this seventy-foot high chamber, and a foul condensation drips from the slimy walls. Encircling the walls are carved R'lyeh glyphs and titanic bas-reliefs depicting anthropomorphic, octopoidal entities at war with barrel-bodied plant-like creatures. A Cthulhu Mythos roll identifies these creatures as Cthulhu-spawn and elder things respectively. Deciphering the glyphs adds 1D4 to Cthulhu Mythos at a cost of 1D6 Sanity points. In the center of the room is a vast dripping pillar of black, ridged stone, within it a circular staircase that climbs to the temple's upper level.

In the floor of the temple are meditation pools, used by the deep ones to bring themselves in closer contact with the dreams of Great Cthulhu. When the party first enters the temple a deep one is found floating face down in one of these pools. If it is molested in any way it stumbles out of the water and attacks, its hit points doubled due to its lingering religious ecstasy. It attempts to grab intruders and hurl them into the nearest pool. Anyone thrown into a pool must roll his POW x2 or less on D100 each round to avoid a glimpse of the baleful dreams of Cthulhu. Failing this

they lose 1/1D6 Sanity points. A Swim roll is required to get out of the pool, each round that it fails the swimmer suffers receives additional Sanity losses.

Elsewhere, a heavy door opens on a stone passage leading to the guest tower (K-N). If the keeper wishes to expand the air-filled section of Y'ha-nthlei detailed here, other passages could be created from either level of this temple, leading to keeper-created sections.

I: This small, bubble-like building is inhabited by deep ones who, if they spot investigators in the nearby domed pyramid, attack unmercifully. There are always 2D3 deep ones here, one of which knows 1D3 spells. The room's only feature is one of the rubbery-feeling sea-gates, described earlier.

J: This is the uppermost level of the temple pyramid, and it holds another of the bizarre grotto-gardens. Here the leprous coral tendrils stretch to the domed ceiling thirty feet overhead. Ominous scuttling should alert visitors to the presence of more of the obnoxious alien crustaceans which plague Innsmouth and its waters. A Spot Hidden detects their presence before they can attack. If they attack they do so en masse. Dodge rolls are required to safely exit the room. Failure indicates that the investigator is attacked by 1D6 of the scabbling horrors. Sanity points loss is 1/1D6, with no additional losses for successful attacks. The trilobite-things don't pursue anyone fleeing the garden. Using fire or explosives clears the room of them for 2D6 minutes.

K-N: This air-filled spire is reached by an arched, windowed passage. Shaped like a conglomeration of spheres or bubbles, this structure houses guests at Y'ha-nthlei: honored cultists, prominent hybrids, or very important captives. The rooms are spare, equipped only with beds, chairs, chamber pots, and tables. Guests, like prisoners, dine on seafood. If the keeper wishes, and can think of a suitable motive for such a visit, an old enemy of the investigators could conceivably be found here.

1013 THE SMUGGLER'S TUNNELS

Along the sandy and rocky shores of the inlets northeast of town are found several sea-caves. Found throughout the inlets, only those caves in the southernmost inlet, nearest the town, are discussed here.

The sea-caves were discovered by early Innsmouth sailors, who widened and extended them so that they reached underneath the northern part of town and were used to smuggle cargoes into town. Several of the homes in this area have cellars with wooden docks or landings which were used to load and store the smuggled goods. Depending on the tide, the water depth in the tunnels is anywhere from two to five feet, with clearance between water and ceiling ranging from three to eight feet. Most of the tunnels are between four and eight feet wide.

These tunnels are now used by the deep ones to enter town unseen. A map of these tunnels is included in The Smugglers' Tunnels section of the Raid scenario, pp. 122-131, along with maps of typical homes with access to the tunnels. ■



THE CRAWFORD INHERITANCE



*After inheriting a family estate,
an investigator uncovers a legacy of degeneracy,
which might include himself.*

This scenario is intended to introduce investigators of any degree of experience to the brooding secrets of shadowy Innsmouth. It is most useful when used as a party's first foray into this legend-haunted town. Any number of investigators may participate, even as few as one. Though physical perils are few here, the mysterious workings of the town should serve to enhance the psychological stresses around which the adventure revolves.

Keeper's Information

In 1846 Jeremy Crawford was a simple Innsmouth townsman, running a small shop and living out the last of the money he had inherited from his father's tiny, long-abandoned sawmill. He had a lovely young wife, Elizabeth Garrison Crawford. Before the Crawfords could start a family, the terrible shadow which had begun to creep over Innsmouth overwhelmed the town in a single night.

Obed Marsh and his followers had been jailed for almost two weeks prior to that fateful night, when hordes of deep ones and several hidden members of their cult rioted through Innsmouth. The prisoners were freed from jail in the melee, and many enemies of Marsh's Esoteric Order of Dagon were slain or chased out of town. By the next morning only the faithful or the helpless remained in Innsmouth. Elizabeth Crawford was one of those slain that night, leaving Jeremy a ruined man.

But, Jeremy was to suffer further indignity, for in 1847 Obed Marsh demanded that he take a new wife, just as many others had in town had taken new spouses. These new spouses were deep ones, and the newly-married couples were expected to reproduce so that the cult might spread. Jeremy Crawford was no exception, and he was too far gone to protest. With his unseen inhuman wife "Mary", he fathered three sons. Gregory, the oldest, was born in 1849; his development into a deep one over the years was not sufficient to allow him to take to the sea. Geoffrey Crawford was born in 1851; fearing his monstrous older brother and mother and the strange curse which afflicted the family, Geoffrey fled Innsmouth in 1870. The Crawfords' last child, George, was born in 1854; he eventually became a full deep one and went to the sea. The deep one Mary Crawford stayed hidden in the house until her sons were sufficiently grown before returning to Y'ha-nthlei in 1862.

Jeremy raised the boys as best he could, watching their deformities worsen until they became monsters. George took to the sea, but Geoffrey fled his destiny, and Gregory, idiotic and monstrous, remained behind for Jeremy to care for. In the late 1880s, Jeremy's mental and physical health

began to fail, and he hired a young Innsmouth man to be his servant. Richard Manning served Jeremy faithfully for over 40 years, yet he never saw the Crawford house's other resident: the monstrous Gregory Crawford, who was kept locked in an attic room. Manning suspected this creature's presence, but Jeremy insisted on caring for his son personally. Jeremy finally died in 1925, and Richard Manning retired to a small house in town to live out his final days.

Since that time the Crawford house has stood unoccupied—as far as anyone in town knows. At the urging of the town elders, Innsmouth's "law consultant", Ralsa Marsh sought out the missing Geoffrey Crawford, so that he or his tainted heirs might return to Innsmouth.

Geoffrey Crawford is the pivotal character in this scenario, for he did indeed have the Innsmouth taint — and at one time he was married to the grandmother of one of the investigators! He fathered at least two children by this woman, and possibly a third (the investigator's mother), before he was overcome by his awful heritage and forced to take to the sea. This was also the fate of his two children (see the "Family Tree" on p. 70 for more details). The investigator's grandmother, however, disturbed by her husband's deteriorating behavior, began taking up with another man, who would eventually become her second husband after Geoffrey's disappearance. The grandmother's third child, the investigator's mother, is of uncertain parentage: was her father the deep one-tainted Geoffrey Crawford or the normal grandfather remembered by the investigator? This is one of the key problems to be solved during this scenario.

The investigator's mother has been contacted by a Boston law firm who was in turn hired by Ralsa Marsh to find Geoffrey Crawford's heirs. She contacts her son or daughter (the investigator) to check into the property (perhaps because she lives too distant to inspect it personally). She wants the investigator to determine the property's value and make arrangements for its sale.

Unfortunately, the investigator and his companions soon find that the house isn't as vacant as was believed — the hybrid Gregory Crawford still lurks in his locked attic room. He has shrunken down to the size of a rat, gradually metastasizing his own flesh and bone to feed himself since he has no other source of nourishment (see "The Lurker Among the Dunes", below). Gregory is but one of the many oddities the investigator and his friends come across during their stay in Innsmouth.

As for the investigator's possible tainted heritage, the truth is left for the individual keeper to decide. The investigator's mother is either the legitimate, tainted child of Geoffrey Crawford, or the illegitimate child of a normal

man. The consequences of an investigator's having the Innsmouth taint are discussed in "The Problem of Birth" section, near the end of this adventure. The keeper's decision also has considerable bearing on the section entitled "Genealogical Research" and the box on "The Dreams".

Investigators' Information

The scenario begins when one of the investigators receives a phone call or telegram from his mother (or, if she is dead, her brother or sister). She wants the investigator to check out a piece of property which the family has just inherited. "Mother" is unable to do so herself because of distance from the area, scheduling conflicts, work, etc.

Contacting the Boston law firm of Brock, Bainbridge, and Langton, the investigator is told he should go to near-by Innsmouth to view the property in question, called the Crawford house after its owner Jeremy Crawford. The property consists of a large house and several acres of land on northwest Hancock Street, just outside of town. If the investigator has any further questions he is told to contact an Innsmouth law consultant named Ralsa Marsh.

Current maps of the state (circa 1928) do not show Innsmouth, but a successful Library Use roll finds it marked on a pre-Civil War-era map. Sketchy information on the town can be gained through additional research (see "Other Sources of Information" on p. 18).

Welcome to Innsmouth

The investigators' journey to Innsmouth should be an ominous one: signposts are missing, painted over, or toppled into the brush, and farmers give directions hesitantly — if at all. Eventually, after countless dead ends and wrong turns, the party comes upon Innsmouth.

Innsmouth is hideously squalid, a rotting half-deserted town of perhaps 300-400 people. Many buildings are collapsing or boarded up, and a terrible fishy stench hangs

Adventuring in Innsmouth

This book provides the keeper with three complete scenarios set in decaying Innsmouth. The keeper should take care to introduce the investigators to Innsmouth gradually. If they learn too much too fast, the town elders may react harshly, even murderously, taking steps to eliminate the investigators the next time they dare set foot in town. Death or incarceration await the unwary or the too nosy. The keeper should introduce the investigators to Innsmouth slowly, involving them first in peripheral adventures, and only later allowing them to uncover some of Innsmouth's deeper secrets.

With this in mind, players should be encouraged to roll up an extra investigator or two, in case their primary investigator finds the town no longer safe to visit or, possibly, is jailed as a result of his actions in town. It should be kept in mind that Innsmouth is a real town, its inhabitants American citizens with a right to police protection and recourse to the courts. Investigator excuses about "monsters in the town" will do little to aid their case if accused of murder or other crimes—unless, of course, a defense of insanity is the goal. It should be kept in mind that any number of Innsmouth citizens may be willing to testify against the investigator, framing him as necessary. The U.S. Government may at some point intervene in the case, but not until it is ready to mount the raid on the town. In the meantime, the investigator might find himself cooling his heels in jail for several months.

"The Crawford Inheritance" is suggested as a party's first foray into Innsmouth. It is subtle enough that it is

unlikely the investigators will create undue friction with the populace of Innsmouth. Keepers are urged to run additional adventures between "The Crawford Inheritance" and "Escape from Innsmouth" scenarios, using either the Sinister Seeds found in the back of this book or creating adventures of their own. The successful completion of the "Escape from Innsmouth" adventure may result in the investigators being unable to safely visit the town again.

The Sinister Seeds come in three basic types: those suitable for introductory adventures; those which can be used after the investigators become known to the inhabitants; and a few that can be staged after the climactic "Raid on Innsmouth."

"The Raid" recreates the police action taken against the town of Innsmouth by the U.S. Government in February of 1928. It is assumed that the raid is, for the most part, a successful action resulting in the arrest and incarceration of most of the town's hybrids, finally ending the deep ones' reign of terror. The raid should only be staged when the keeper is sure that he has exploited all the best possibilities the town has to offer. After the raid, the character of Innsmouth changes drastically.

According to the Lovecraft's story, "The Shadow Over Innsmouth," the government raid on Innsmouth took place in February of 1928. For the purposes of this book we have chosen to ignore this date. It is presumed that the keeper will run it at a date that suits his own campaign.

over the town regardless of the wind direction. The streets are narrow and ill-paved, with most street signs missing. The main highway passes through the town’s apparent merchant district, south of the Manuxet River. In short, Innsmouth appears ancient, decayed, and foreboding.

Fewer than 20 people are glimpsed as the investigators come into town. Of these, half are slightly sinister-looking folk with unblinking eyes and stooped shuffling gaits. The remainder of the townsfolk seem to be more or less normal working class folk. Both types stare as the investigators pass, suggesting that perhaps strangers are rare here.

If the investigators ask one of the locals for directions to the Crawford house, a Luck roll is required to find someone who knows where it lies: north on Hancock Street, the last house on the left, just before the road ends out by the marsh. A Psychology roll infers that the normal folk questioned seem fearful of outsiders. If the investigators ask the whereabouts of Ralsa Marsh’s office, nearly anyone can give them the address, but another Psychology roll reveals that the “normals” seem fearful of this question as well. In any case, the normal folk answer only a few questions before hurriedly moving on, frequently glancing around as if afraid of being watched. The more sinister folk behave much more calmly when speaking with outsiders, though a Psychology roll hints that they are just a little suspicious of these strangers to Innsmouth.

In addition to Ralsa Marsh’s office, which is discussed below, the keeper may want to familiarize himself with

these other Innsmouth locations likely to be used by the investigators: the Gilman House Hotel (703), the First National Grocer’s (702), the Innsmouth Cafe (704), and Waite’s Variety (708).

Ralsa Marsh

Ralsa Marsh’s rundown “law office” (203) on Main Street, north of the river, is shared with his father Rowley’s medical practice. Entering the office, the investigators are met by the Marshes’ homely receptionist, Ruth (Marsh) Gilman, who answers their questions flatly. The heir-investigator should attempt a Luck roll, and if successful Ralsa Marsh is available to see them; if the roll fails Ruth Gilman states that Ralsa isn’t coming in to the office today, and that the gentlemen should come back the next day. Mrs. Gilman won’t give out Marsh’s home address, nor disturb her brother/employer.

If Ralsa Marsh is “in”, he meets with the heir-investigator. The late-thirtyish Marsh seems haughty, fashionably dressed, and fairly normal in appearance. During the interview he openly ogles any female investigators present, and may ask a particularly pretty one to join him for dinner. A Psychology roll guesses that his intentions aren’t totally honorable, but that he is driven by nothing more sinister than lust. He may press the matter if spurned, and continues to proposition these women every time he sees them.

He questions the investigator about his plans for the Crawford property, who his friends (the other investigators)

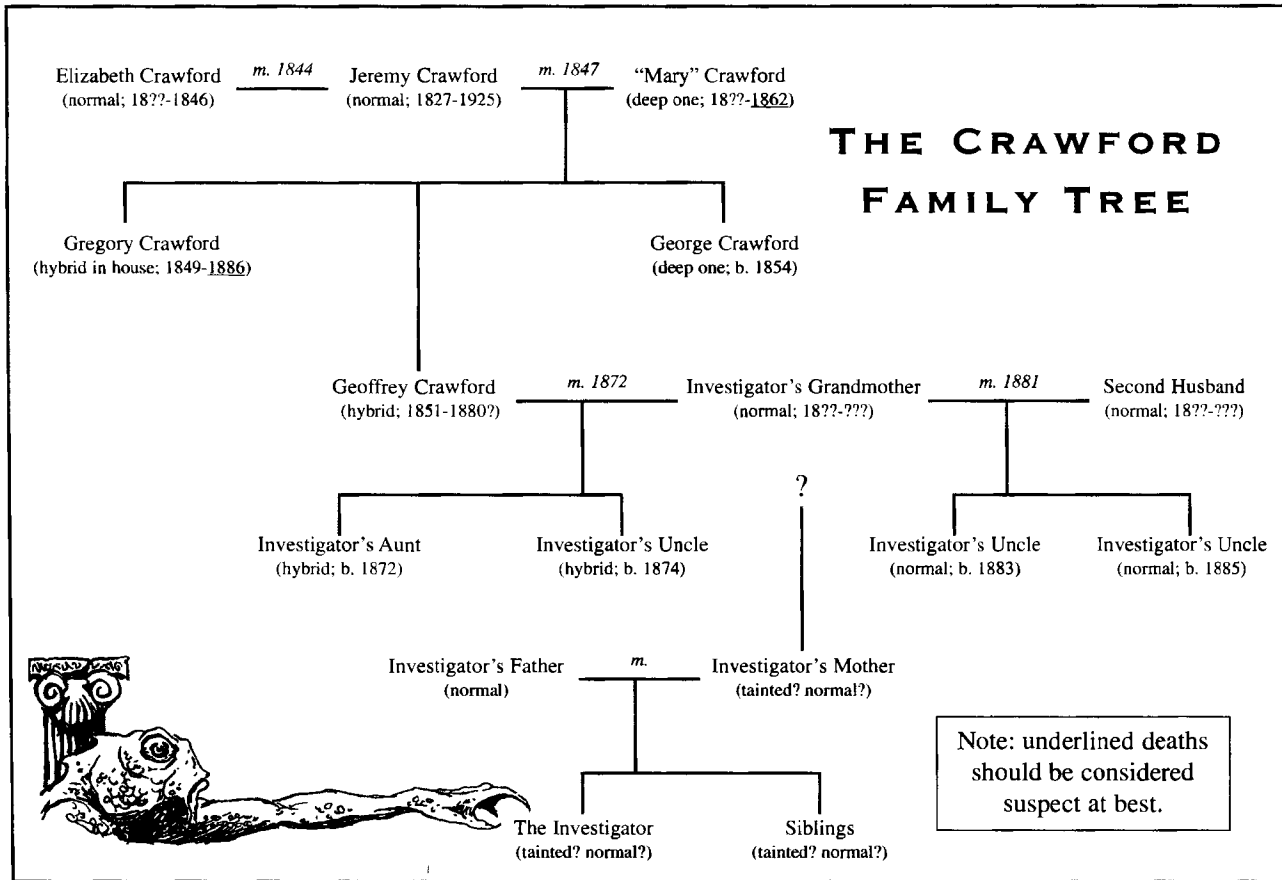

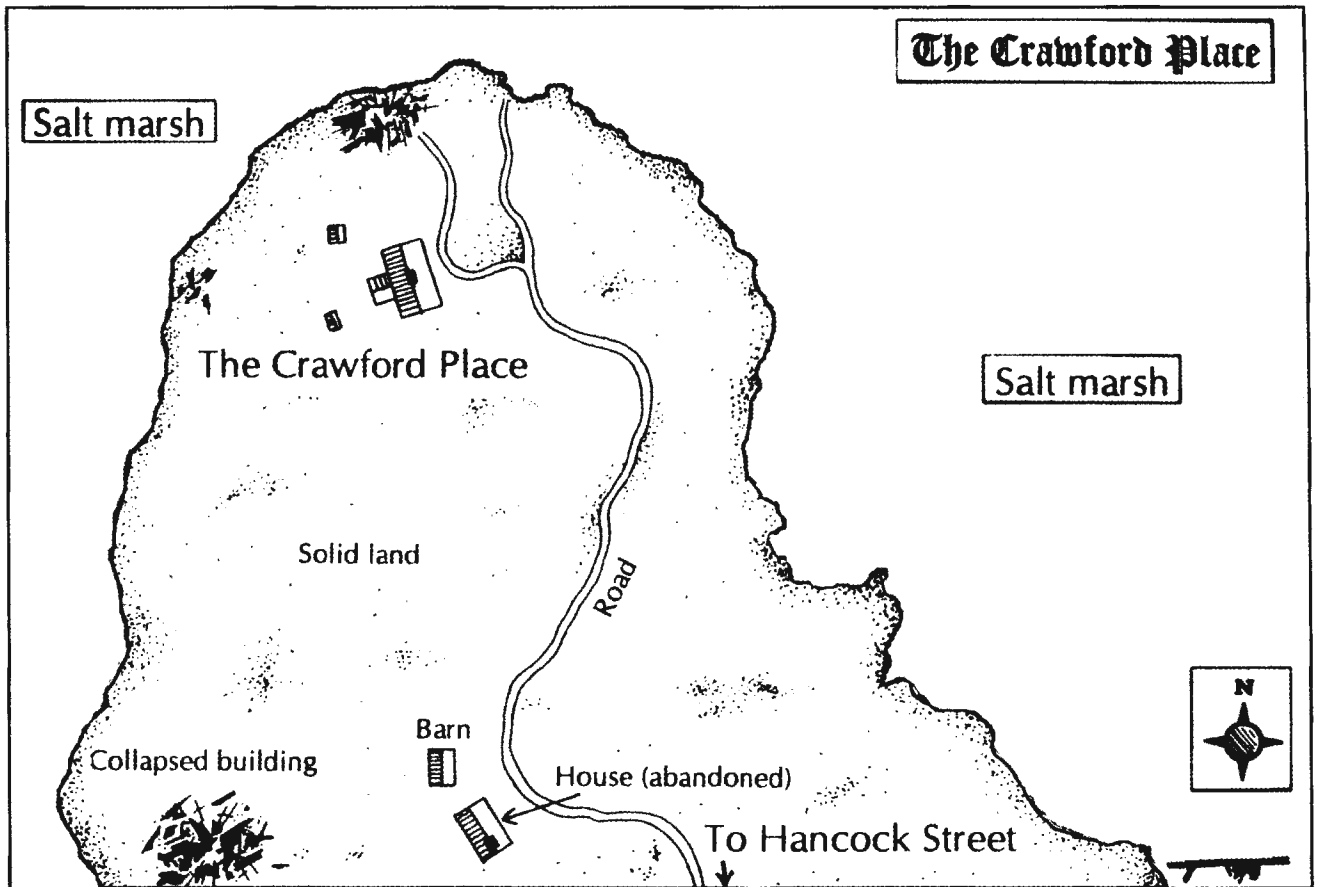

are, how long they are staying in town and where, and so forth. Of the Crawfords, Marsh knows only that Jeremy Crawford died in 1925 at the age of 98, and that his only remaining heir would have been Geoffrey Crawford — the investigator's grandfather. Since no other heirs remained, the estate went to Geoffrey's wife's family (the investigator's mother, uncle, or aunt, as applicable). Marsh eventually becomes disinterested with the investigators, and finally has the heir sign a few papers before giving him or her a set of keys for the Crawford Jouse and directions explaining how to get there.

The Crawford House and Grounds

The house is located on northwest Hancock Street, a half mile or so outside of town. Along the rutted road are a couple of abandoned farmhouses falling to ruin.

The Crawford place is perched on a low rise at the edge of the huge salt marsh that surrounds Innsmouth. A large carriage house or barn has in fact collapsed and partially sunk into the encroaching marsh. Behind the house are a crumbling woodshed (containing a rusty axe and rotted wood), a small toolshed (with dozens of rusty tools and other rotted items), and an outhouse which has also been claimed by the sandy, marshy earth. An overgrown carriage path leads past the front of the house and back to the collapsed carriage house.

The house itself appears to be in good condition: it is an older Georgian clapboard house, with two stories and an

attic, a hipped roof, a central chimney, and a small overhanging gable in the rear. The windows are all intact, and the doors are locked; Mechanical Repair rolls will open either, or they can be forced or broken open—the door's STR is 11.

GROUND FLOOR: Inside the front door is a dusty entryway with a large fireplace and a staircase leading upstairs. To the right of the entry is the living room, with several chairs spilling their stuffing and a dust-caked but well-preserved Queen Anne lowboy; an oil lamp rests on a table here as well. The other door leading out of the living room opens on a simple study, with a battered desk and chair, and a few moldy ancient books—most concern America's industrial history—on a sagging bookshelf; the desk-drawers contain nothing but useless pens, bottles of dried ink, and several yellowed and stained sheets of paper. To the left of the main entryway is a dining room with six high-backed chairs and a long narrow table. A door leads into the pantry, where the smells of damp and rot are strong; the many boxes, jars, tins, and barrels here hold spoiled foodstuffs: flour, preserved vegetables and fruits, etc. Off the pantry is the kitchen, with a large fireplace, a wood-burning stove, a pair of waterbasins, and some old tablewares. The back door opens into the kitchen.

SECOND FLOOR: Upstairs are two nearly identical bedrooms in the northeast and southeast corners, each with its own small closet. The northern one is dusty, the bed and

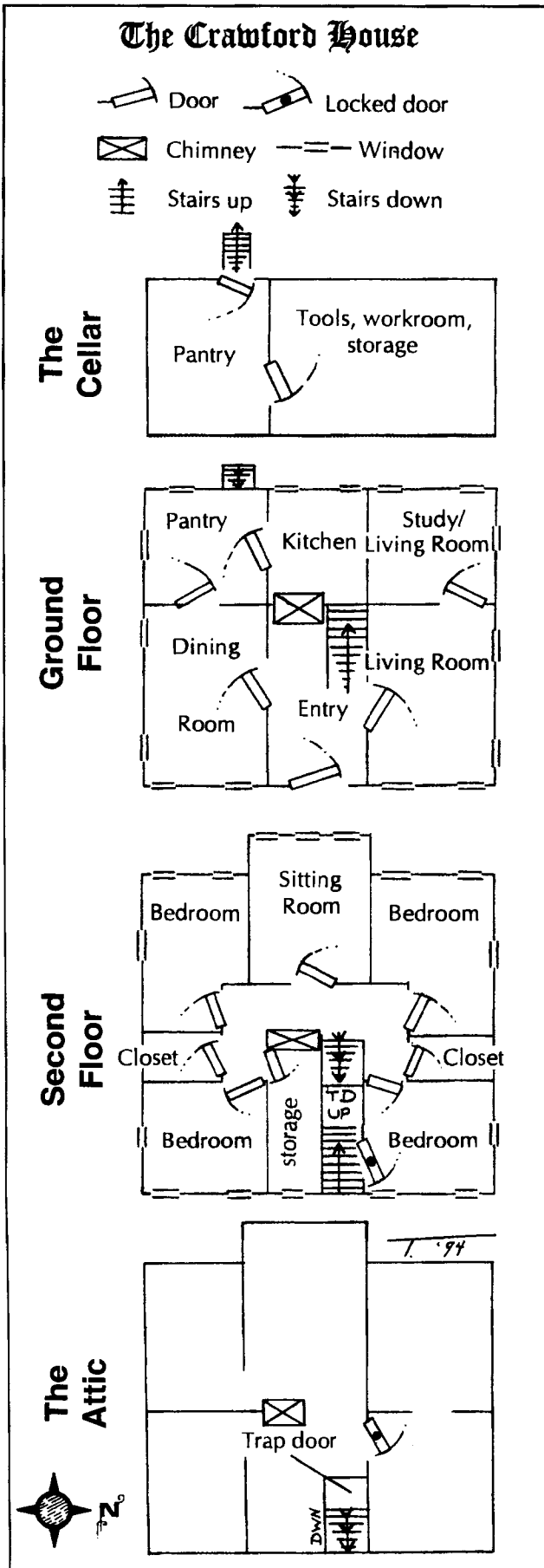

dresser apparently unused for decades; a locked door leads off this bedroom to a narrow staircase up to a trapdoor opening into the attic. The southern bedroom appears to have been used within the last few years, at least (it was Jeremy Crawford's). The bed is heaped with comforters and the closet and dressers contain old articles of men's clothing. Beneath the lumpy mattress is a thin book, handwritten in a barely legible scrawl—the diary of Jeremy Crawford (see "The Diaries" below).

In the northwestern and southwestern corners of the house are additional bedrooms, both much smaller and more austere than the others, with beds and dressers but no closets. Again, while the southern one seems to have been in use within the last decade (this was used by Jeremy Crawford's servant, Richard Manning), the northern one has been unused for decades.

Elsewhere on the upper floor is a cramped storage room, with old lanterns, sagging furniture, fading ancient paintings and family portraits, and countless boxes of old clothes and other personal items; other than a possibly valuable antique or two, there is nothing of note here.

The final upstairs room is a sitting room in the gabled extension at the rear of the house. Several cushion-seated chairs offer an excellent view out of this room's many windows. A successful Spot Hidden roll or a glance underneath one of the chairs discovers another handwritten diary held there by cloth strips. Fairly slim, and written in a careful, precise feminine hand, this is Elizabeth Crawford's diary; it too is discussed in "The Diaries", below.

ATTIC: The uppermost floor of the Crawford house holds the attic, most of which is a dust-caked and cobwebby open space. The crumbling chimney juts through the center of the roof, with a few loose bricks scattered here and there. The locked door here refuses to budge even if unlocked—it is stuck in the jamb and must be forced (its STR is 13). Forcing the door open splinters the jamb so that the door now won't stay shut. Inside the investigators find a large room smelling horribly of fish and excrement and rot. Much of the place is cobwebby, and looks to have been long-vacant. There are a few rat-sized holes in the baseboards, but these also seem long-unused. A small alcove to the west contains several torn pillows, more cobwebs, and some broken plates stained with long-dried food. The fishy smell is much worse here, but these attic rooms are empty. Spot Hidden rolls note a few small claw marks raked across the inside of the door and on the walls of the alcove.

CELLAR: Outside the back door is a leaf-strewn stone staircase leading to the cellar door. The unlocked door opens on another pantry full of spoiled, rotting, stinking foodstuffs—burst jars are everywhere. The smell of damp rot is rampant here. A door leading off the pantry opens into a workroom and storeroom: more badly rusted tools, warped lumber, and broken furniture are strewn inside. The damp smell is even stronger here, and puddles of salty water dot the floor.



THE CRAWFORD HOUSE

THE DIARIES

The two diaries found in the house offer some tantalizing hints of the shadow over Innsmouth, and the fate of the Crawfords. Each diary requires 25-EDU hours of study and an English roll to read.

JEREMY CRAWFORD'S JOURNAL: The initial portions of Jeremy's journal deal with his early teens, and are very sporadically kept; there is nothing out of the ordinary in these sections. In 1844, young Jeremy courts and marries Elizabeth Garrison, a beautiful Innsmouth girl. In the ensuing years Jeremy hints of trouble in the town, centered on "the Esoteric Order of Dagon", a paganistic church founded by Obed Marsh, once a successful sea captain and now secretly in control of Innsmouth. In 1846, Jeremy's handwriting breaks down as he reports Elizabeth's disappearance during a series of riots brought on by the arrest of Obed Marsh. Dozens are left dead or missing, and Marsh is now firmly in control of the town. His followers are rewarded, and those who oppose him are punished.

From this point on the entries are scrawled and barely coherent. Living alone in despair for over a year, Jeremy is finally forced—by Obed Marsh and the Order—to remarry in 1847; he doesn't discuss his wife in any detail, nor even name her—she is merely "that one" whom he took according to the demands of "that terrible third oath". Jeremy and his second wife have their first child, Gregory, in 1849; little mention is made of Gregory thereafter. A second child, Geoffrey, is born in 1851, and a third, George, in 1854. In 1862, Jeremy writes that "she" returns "home". In 1870, Jeremy and the middle son, Geoffrey, argue, and the boy runs away from home. In 1879 George leaves "to join his

mother". In 1886, "they" decide that it is time for Gregory to die: "Dr. Marsh signed the death certificate and they gave him a funeral, and made me go along."

Again, the handwriting deteriorates in the years after Jeremy is left alone. In 1887 Jeremy hires Richard Manning, a young Innsmouth man, to help take care of the house. Entries become rarer and rarer in the next 30 years. Jeremy at one point writes cryptically that Manning "surely must hear it's pityous cries and fits of peek—yet he has never asked about it, bless him." In the journal's last entry, dated January of 1925, Jeremy complains of a fierce chill he has suffered.

Reading Jeremy's journal adds 1D4 points to a investigator's Innsmouth Lore skill.

ELIZABETH CRAWFORD'S DIARY: This diary is much shorter than Jeremy's, dating back to Elizabeth's early teens. Most of the entries deal with everyday life: playing with friends, talking about boys, feminine mischief, and her mother's teaching her to be "a lady". Scattered among these entries are references to the shipping successes of "Captain Obed". Elizabeth's mother warns her to stay away from the Marsh warehouses, where she and her friends sometimes play; Mrs. Garrison warns that Captain Marsh has brought back strange and terrible animals from his travels. Still later, after Elizabeth and Jeremy are married, Mrs. Garrison warns her daughter to stay away from Marsh's Esoteric Order of Dagon, where "That man and his heathen horde pray to some filthy South Seas fish-god". The final entry in the diary chronicles the arrest and jailing of Obed Marsh and his followers: shots were reportedly fired between Marsh and the authorities in a battle near Devil Reef;

Marsh's gang were captured and charged with numerous kidnappings and murders dating back the last few years. Elizabeth's diary ends "Now that that man has been captured maybe Innsmouth can return to normal."

Elizabeth Crawford's diary adds 1D3 points to its reader's Innsmouth Lore skill.

Arrested in Innsmouth

This event occurs only if the investigators travel to the Crawford house without visiting Ralsa Marsh first. Without keys, the investigators must force or pick a lock, actions which count against them when the local constables arrive.

The locals, always suspicious of outsiders, alert the authorities they see an unknown car (or cars) tooling through town. All three of Innsmouth's hybrid constables arm themselves and pile into their car; if more than one strange car was reported, the Gortons, a depraved local family, are "deputized", and they also come along, armed, in their truck.

When they arrive at the Crawford place, Constable Martin and his cohorts gruffly ask the investigators who they are, what they're doing here, why they're armed (if applicable), and how they got in the house (if applicable). If the investigators didn't visit Ralsa Marsh, they have no way to prove their innocence: Marsh would have given them papers and keys to corroborate their story. The constables leave the party alone if such proof is brought forth. If the investigators have no such proof, Martin and company arrest them on charges of breaking and entering; a Law roll reduces this to a detainment until the matter can be straightened out. Martin and his men pile the investigators into their vehicles and drive them back to town, confiscating any weapons first; illegal weapons bring more charges with less of a chance of getting out of trouble. The "law" meets any resistance with fists and/or clubs—a good beating, but not murder.

Back at the jail (202), as few investigators as possible are put in each cell, and one of them is allowed a phone call (presumably to Ralsa Marsh's office); other investigators making Law rolls also receive their phone calls. Calls outside of town are frowned upon, but out of town lawyers can get the investigators out of jail within 1D2 days, barring any serious charges. If Ralsa Marsh is in his office, he can clear things up in 1D4 hours, again barring any serious charges.

Until the matter is cleared up, the investigators must languish in the filthy, cramped Innsmouth jail. The conditions are terrible: a chamberpot for a toilet, stinking mats on stone floors for beds, and runny stew or soup twice a day. Escape is possible, but unlikely, and not recommended: considering their innocence, and in the interest of preserving their reputations, the investigators should want to get out of this legally.

The Lurker Among the Dunes

When the investigators break into the locked attic room they unwittingly unleash this adventure's "monster": the deep one Gregory Crawford. Jeremy Crawford kept his unmetamorphosed offspring in the attic, and cared for him

for a time. Over the last several decades Jeremy gradually stopped feeding him. Starving, but trapped in the attic room, Gregory had to metabolize his own cellular structure to stay alive, eventually shrinking to the size of a rat. He hides in a rathole while the investigators search the attic.

The night after the investigators splinter the attic door Gregory slips out, pulls some loose bricks out of the chimney in the attic, and then either jumps up and out, or down if there is no fire in the fireplace, breaking out a kitchen window to complete his escape.

Over the next several days Gregory haunts the nearby salt marshes, gorging on anything he can get his paws on (birds, frogs, squirrels, snakes, insects, etc.) and growing rapidly. The investigators hear strange inhuman/amphibious cries out in the marshes by night, catch glimpses of *something* moving out in the weedy dunes, and perhaps find webbed footprints in the dunes (tiny at first, but growing in size each time they are found). Over the next several days they also find bloody half-gnawed animal remains—perhaps piles of them. The keeper is urged to keep Gregory out of sight as long as possible: he is much more frightening when not clearly seen. Eventually he turns to larger animals for food, necessitating his capture or death (see "The Lurker Brought to Bear", below).

The table below shows Gregory's statistics each day as he grows: Day 1 shows how he appears until released from the attic; Day 2 reflects his statistics after spending one full day feeding outside the house. Gregory Crawford is a naked, hunched, human-like figure, very filthy and feral, with hairless scaly skin, protruberant eyes, a wide, thick-lipped mouth, deep creases at the sides of his neck, and some webbing between his fingers and toes. He dislikes light, and until he gets huge he prefers to fight single targets.

In combat, Gregory may attack with both claws and a bite each round. If both claws hit in the same round, the hybrid automatically does bite damage that round and each round thereafter until slain or removed via STR vs. STR roll.

GREGORY CRAWFORD, hybrid deep one

Day	1	2	3	4	5	6+
STR	1	2	5	8	14	19
CON	6	7	10	13	17	19
SIZ	1	2	5	9	15	22
INT	4	5	5	6	6	7
POW	6	6	7	7	7	8
DEX	18	17	15	14	13	12
APP	4	3	2	2	1	NA
HP	4	5	8	11	16	21
DB	-D6	-D6	-D6	—	+D4	+2D6
Armor	0	0	1	2	2	3

Weapons: Claws (x2) 45%, damage 1D4+db

Bite 30%, damage 1D3

Skills: Dodge 60%, English 10%, Hide 70%, Listen 60%, Sneak 55%, Spot Hidden 50%, Swim 55%, Track 25%.

Sanity Loss: It costs 1/1D6 Sanity to see Gregory Crawford, regardless of his level of development. Footprints or animal remains he leaves behind might call for a loss of 0/1 to 0/1D3 Sanity, if the keeper desires.

The Law in Innsmouth

Innsmouth's law enforcement consists of three hybrid constables, all of whom are loyal to the deep ones and the Esoteric Order of Dagon. Those who glimpse too much of Innsmouth's darker secrets and are caught are often held in the Innsmouth jail until they can be dealt with — usually by feeding them to deep ones or a shoggoth. When in need of additional “deputies”, the constables turn to the men-folk of the Gorton family (406): a degenerate human family in thrall to the Innsmouth hybrids.

ANDREW MARTIN, chief constable, age 31
STR 16 CON 14 SIZ 16 INT 13 POW 14
DEX 10 APP 8 EDU 8 SAN 0 HP 15

Damage Bonus: +1D4

Weapons: Fist 75%, damage 1D3+db
Nightstick 55%, damage 1D6+db
Bowie Knife 55%, damage 1D4+2+db
.45 Revolver 55%, damage 1D10+2

Skills: Climb 50%, Cthulhu Mythos 35%, Dodge 30%, Drive Automobile 35%, Hide 40%, Jump 45%, Law 40%, Listen 55%, Psychology 35%, Sneak 30%, Spot Hidden 60%, Track 25%.

Chief constable Martin is a silent, serious-looking hybrid in his thirties. He is powerfully-built, and has thin scraggly blondish hair, jowly cheeks, bulging eyes and a flat nose. Martin is cold and cruel, and often terrorizes prisoners into revealing what they've seen. He always carries his knife, nightstick and gun, and frequently sleeps at the jail.

NATHAN BIRCH, wily old constable, age 37
STR 15 CON 14 SIZ 15 INT 12 POW 12
DEX 15 APP 10 EDU 9 SAN 0 HP 15

Damage Bonus: +1D4

Weapons: Fist 65%, damage 1D3+db
Grapple 60%, damage special
(Sawed-off) double-barrelled 12-gauge shotgun 65%,
damage 4D6/1D6 (0-5 yards/5-10 yards)

Skills: Dodge 35%, Drive Automobile 55%, Hide 45%, Jump 55%, Law 45%, Listen 40%, Psychology 25%, Sneak 50%, Spot Hidden 50%, Track 40%.

Birch is a pudgy, stooped hybrid with surprisingly narrow eyes, and a wide, thick-lipped malicious grin. Birch always wears a heavy coat, barely concealing his sawed-off shotgun; the shotgun's trigger-guard is sawed off to allow Birch's thickly-webbed fingers to reach the trigger. When expecting trouble he also carries a baseball bat.

ELLIOT ROPES, brutish constable, age 26
STR 17 CON 16 SIZ 16 INT 10 POW 9
DEX 12 APP 6 EDU 7 SAN 0 HP 16

Damage Bonus: +1D6

Weapons: Fist 85%, damage 1D3+db
Grapple 75%, damage special
Head Butt 50%, damage 1D4+db
.38 revolver 35%, damage 1D10

Skills: Climb 55%, Dodge 35%, Law 10%, Listen 30%, Spot Hidden 35%, Track 45%.

Ropes is a huge thickly-muscled hybrid. He is incredibly ugly, with bulging eyes, deep creases in his neck, scaly skin, a bestial protruding jaw and receding forehead, a flabby-lipped downturned mouth, and thinning hair. He is more beast than man, and prefers to fight hand-to-hand rather than with weapons.

RICH GORTON, degenerate father, age 56
STR 13 CON 13 SIZ 14 INT 11 POW 12
DEX 14 APP 8 EDU 4 SAN 0 HP 14

Damage Bonus: +1D4

Weapons: Fist 65%, damage 1D3+db
Kick 45%, damage 1D6+db
Grapple 45%, damage special
12-gauge double-barrelled shotgun 70%, damage
4D6/2D6/1D6

Skills: Camouflage 40%, Dodge 40%, Drive Automobile 70%, Electrical Repair 25%, Hide 45%, Listen 55%, Mechanical Repair 70%, Sneak 55%, Spot Hidden 60%, Throw 65%, Track 55%.

Rich Gorton is a crafty man. He does handy-man-type jobs around town and hunts for game to feed his family.

MIKE GORTON, degenerate son, 20
STR 16 CON 12 SIZ 16 INT 12 POW 11
DEX 10 APP 10 EDU 4 SAN 0 HP 14

Damage Bonus: +1D4

Weapons: Fist 60%, damage 1D3+db
Grapple 65%, damage special
Bowie knife 45%, damage 1D4+2+db
12-gauge double-barrelled shotgun 55%, damage
4D6/2D6/1D6

Skills: Climb 55%, Dodge 45%, Drive Automobile 40%, Hide 30%, Listen 30%, Sneak 35%, Spot Hidden 40%, Throw 55%, Track 40%.

Mike, the oldest son, is a bit of a clumsy oaf, but in other respects is much like his dad.

SCOTT GORTON, degenerate son, 15
STR 13 CON 13 SIZ 12 INT 9 POW 8
DEX 15 APP 9 EDU 3 SAN 0 HP 13

Damage Bonus: +1D4

Weapons: Fist 55%, damage 1D3+db
Pocketknife 30%, damage 1D3+db
.22 bolt-action rifle 50%, damage 1D6+2

Skills: Climb 70%, Dodge 60%, Hide 60%, Jump 55%, Listen 55%, Sneak 60%, Spot Hidden 35%, Swim 55%, Throw 65%, Track 60%.

Scott is a strange, quiet kid who spends a lot of time in the salt marshes north of town. He behaves almost like an animal at times, and frequently tells his family he wants to be “one o’ them fish-folk like we plays with sometimes.”

Genealogical Research

This is an obvious avenue of research for the investigators once they learn more of the house's former occupants and the heir-investigator's relationship to the Crawford family. Below are brief listings of what may be learned from various sources in Innsmouth and elsewhere.

Innsmouth Records

Scowling, sinister, Eustis Eliot is the untainted human township clerk at the Innsmouth Assembly Hall (213). She is loathe to surrender information, but successful Law or Perusade rolls force her to produce what marriage, birth, and death certificates exist for the Crawford family. Failed rolls cause her to delay the search until the next day—when another Law or Persuade roll is required.

Marriage certificates exist for Jeremy Crawford and Elizabeth Garrison (1844), and for Jeremy Crawford and Mary Smith (1847). Birth certificates are present for Jeremy Crawford (1827), and his sons Gregory (1849), Geoffrey (1851), and George (1854). There are death certificates for Elizabeth Garrison Crawford (1846, cause of death: unspecified fever), Mary Crawford (1862: drowning), Gregory Crawford (1886: natural causes), and Jeremy Crawford (1925: pneumonia); the death certificates for Gregory and Jeremy are signed by Dr. Rowley Marsh.

If questioned, Dr. Marsh gives no further details on any of these findings. The hybrid locals watch the investigators more closely once they begin delving into genealogical matters.

Investigator Family Papers

Much of the information discovered here depends on whether or not the heir-investigator actually has the Innsmouth taint. Some items are the same regardless. First, the investigator's family firmly believes that the investigator's mother was fathered by the grandmother's first husband, Geoffrey Crawford. Secondly, older family members or old letters or journals reflect that Geoffrey was very strange, secretive, and irritable at times, particularly just prior to abandoning his family. Their first two children, a boy and a girl, were just as strange and secretive, and thankfully passed out of communication with the investigator's family when they came of marrying age. Grandma's second husband had been a long-time friend and supporter of her and her family, even during her first marriage.

If the heir is not tainted, then hidden in some long-lost stack of Grandma's letters is her confession to her closest confidant in the family: during one of Geoffrey's fits of

pique, Grandma sought comfort with her friend—soon to be her second husband. She and this loving man were intimate, though no one—not even Geoffrey—knew. Shortly afterward Geoffrey disappeared, and it soon became apparent that Grandma was pregnant. Considering her first husband's coldness, the child (the investigator's mother) could only be the illegitimate child of her soon-to-be second husband. The investigator's mother and the investigator thus are found to harbor none of the tainted Crawford blood.

If, on the other hand, the keeper decides that the heir is to be tainted, similar hidden letters from Grandma to a confidant reveal that, much to her revulsion, Geoffrey Crawford forced himself on her shortly before his disappearance. The investigator's mother is undoubtedly Geoffrey's child, so the investigator and his mother are both tainted.

These fragments could take weeks or months to unearth, perhaps requiring several Spot Hidden, Library Use, English, or Luck rolls to reflect time rummaging through trunks, attics, and garages for old family letters, journals, and so forth. Nevertheless, the heir will almost certainly be obsessed with finding the truth about his heritage. This could haunt a character—and a campaign—for some time.

Richard Manning

Richard Manning, Jeremy Crawford's old servant, is another likely source of information regarding the Crawford family and (especially) the old house. The investigators may learn of Manning through Jeremy's journal, and the locals might then grudgingly give the old man's address.

Manning lives in a tiny rundown house on Phillips Place, between Church and Martin Streets. Though only 56, Manning looks much older. He seems old and tired and speaks fairly freely once he learns the investigator is an heir of Jeremy's. Jeremy was also old and tired, relates Manning, and was basically ruined when his first wife died. That second marriage was more *their* idea than his (Manning doesn't elaborate as to who *they* are). The children were also a result of *their* urging. Gregory was supposedly real sickly, Geoffrey a hothead who ran away from home, and George a pretty level-headed fellow. No one knows much about the second wife, Mary. All of this was long before Manning came along, however. If the investigators inquire about the mysterious death certificates and journal references, Manning says that it's best not to ask questions. If they press further, a Persuade roll elicits the following from the old man, and then he ushers the party out: "Yer askin' the right questions an' the wrong ones et once. A fella could find some answers an' more'n a few new questions if he uz ta dig in the right plot, if ye know whut I mean. They's a lotta dead folk in this taown thet ain't whar they oughta be—an' some of 'em's Crawfords. Yew git goin' naow, 'fore ya git us all in it. Git!"

A LITTLE DIGGING

Richard Manning's cryptic hints urged the investigators to do a little digging, and the South Woods Memorial Cemetery (1001), south of town, is the place he had in mind. The investigators might wander around Innsmouth's other graveyards

seeking the Crawford plots, or they might ask Eustis Eliot or Otis Fuller (610), the town gravedigger, for help.

The cemetery is sheltered by a small forest of lowering, stunted trees, and is bisected by an old track that connects with narrow roads to Arkham and nearby Falcon Point.

The Crawford plot is in a badly overgrown section of the cemetery. Crumbled gravemarkers trip the unwary, and waist-high grass and weeds hold sway here. Dates and names, though faded, correspond to the dates listed above.

The investigators presumably carry out any graverobbing activities under cover of night. The chirps and calls of birds, frogs, and less identifiable creatures fill the darkness, and an inexplicable greenish, fishy-smelling miasma hangs over the ground in the dim moonlight. Intrusions by Otis Fuller, the constables, or other Innsmouthers are left to the keeper's discretion. Graverobbing investigators lose 0/1 point of Sanity during their nocturnal quest for morbid information. Each grave takes an hour to exhume and half that to refill.

Jeremy Crawford and his first wife Elizabeth are found moldering within their coffins, the former bloated with rot

and the latter mostly bones and parchment flesh: Sanity loss is 0/1D3 for Jeremy, 0/1 for Elizabeth. A successful Spot Hidden, First Aid, Medicine, or Forensics roll discovers a bull-hole in Elizabeth's skull. Elsewhere, the rotted coffins in wife Mary's and second son Gregory's graves contain no bodies or bones: instead, there are merely logs wrapped in rotted cloth. This unsettling discovery costs 0/1D2 Sanity per instance. For if the bodies aren't here, where are they?

Things Get Ugly

While the investigators explore the Crawford house, look into the Crawford family history, and tour Innsmouth, Gregory Crawford continues to feed and grow out in the desolate salt marshes. Soon he makes forays along the edge of town. Farmers along the

Deep One Dreams

Over the course of this adventure, and perhaps during subsequent ones, the heir-investigator has at least one dream related to his questionable heritage. The character suffers dream one ("The Look") regardless of whether he or she actually has deep one blood. This dream occurs after this person finds out about the Innsmouth curse; even if he doesn't have the taint, his anxiety is likely to play tricks with his unconscious mind.

The other nightmares are only suffered if the heir actually does have the taint. The keeper should space these out over other adventures so that the character's gradual metamorphosis into a deep one is hinted at throughout the campaign. If using this adventure in conjunction with the other Innsmouth adventures, "The Bells" could be used during the title scenario; "Going Home" could then be used as a prelude or follow-up to "The Raid on Innsmouth". Hybrid dreams such as these are discussed under the heading "The Innsmouth Look", pp. 15-16.

DREAM ONE: THE LOOK

The afflicted investigator is walking the streets of Innsmouth, passing hybrids and normal citizens. The hybrids pay no attention to him now, whereas before they stared suspiciously. The normal residents, who were merely skittish before, are now almost openly fearful. Passing by a store window, the dreamer catches his reflection in the glass: his own features are distorted by prominent symptoms of the dreaded "Innsmouth look"! This calls for a Sanity loss of 0/1D3 points, and with a failed roll the investigator awakens with a scream.

DREAM TWO: THE BELLS

For the truly afflicted investigator only. The investigator "awakens" to the distant tolling of a bell, which compels him out of the house and into the town, toward the harbor. The bell seems to be tolling from out on—or in—the ocean. Still compelled by the ominous pealing, the dreamer borrows a nearby rowboat and rows out to the black line of the reef. Once there, he or she realizes that the bell is ringing from the ocean depths beyond Devil Reef; this calls for a loss of 0/1 Sanity points, or 1/1D3 points if the dreamer knows of Y'ha-nthlei, the legendary deep one city which lies there. Soon after having this dream the investigator should develop the first symptoms of the Innsmouth look.

DREAM THREE: GOING HOME

For the truly afflicted investigator only. As in the previous dream, the sleeping investigator is awakened by the tolling bell and compelled to the harbor, and on to the reef. On reaching the reef, however, the compulsion becomes too strong for him, and he dives into the ocean, swimming deeper and deeper. His lungs swelling to burst, his consciousness fading, the investigator suddenly finds himself grabbed and dragged down into the depths by several deep ones. By all rights he should be dead—drowned or crushed by the water pressure—but the deep ones take him deeper, down, down, down. Down to Y'ha-nthlei (1012), where the dreamer briefly beholds some of the wondrous spires and alien flora and fauna of the sunken city before waking with a scream. The dreamer loses 1D4/2D8 points of Sanity, and his Innsmouth look symptoms now become much more obvious.



northern fringes of Innsmouth lose chickens. A dog. And finally, inevitably, a child.

The Jordans, a dirt-poor untainted family living on northern Phillips Place—less than half a mile from the Crawford house—discover their 9-year old daughter Rowena missing the fourth day after Gregory’s release. Along with several neighbors, they search vainly for the girl—perhaps even asking the investigators if they’ve seen her. While no trace of Rowena is initially found, some small animal remains turn up, and whispered rumors circulate among the searchers: something has been raiding local farms, and a few have even heard or glimpsed it out in the marshes. Could it be one of *them*? No, they usually stay out of sight. A wild animal? No, they hate this place. But what then?

Portions of the Jordan girl’s tiny gnawed and mangled body may be discovered eventually. Viewing these remains and those of any of Gregory’s subsequent victims costs the investigators 1/1D6 points of Sanity.

The searchers briefly question the investigators (with barely suppressed anger and suspicion) before the old paranoia sets in and they depart. Shortly afterward, another child disappears from the northern fringe, and the murmurs grow louder: maybe they in the Crawford house did something to anger *them*, and this is *their* revenge. The investigators are henceforth scorned by the locals, hybrid and normal alike. They may even be asked to leave—for everyone’s good. Stones might be thrown through investigator windows, with messages such as: “Leave us”, “Send it back”, “Get out and

take it with you”, etc. Increasingly violent threats follow any subsequent disappearances or killings.

The Lurker Brought to Bear

In the end Gregory’s feasts finally bring out a torch, rifle, and club-wielding mob. They spread out into the marsh to search for the killer of their children (and perhaps their adult neighbors, once Gregory has reached full size). The investigators may want to join the search to assuage the locals’ anger. A tense hunt then ensues beneath Innsmouth’s leaden skies, in a desolate, weedy, salt-stinking landscape of damp dunes; by night, fog and mist, shadowy forms, flickering lanterns, and eerie insect- and animal-cries accentuate the hunt. Whether the mob or the investigators find Gregory first is left for the keeper to decide.

Gregory proves to be a large, semi-idiotic, almost child-like creature—but a murderous monster nonetheless. He may recognize (smell?) a kinship with the tainted investigator, perhaps even approaching him peacefully. Others he distrusts, fears, and attacks only if provoked or if they are alone. Alternately, the piteous Gregory may return to his home—the Crawford house—for protection. Are the investigators there? And do they attack or take pity on him?

In the end—the “civilized” hybrids be damned—the mob calls for Gregory’s blood. The pitiful thing almost certainly dies, either at the hands of the mob or the investigators. If the heir-investigator is tainted, a Spot Hidden roll notices a very faint resemblance between the features of the

dead thing and the tainted character; such recognition costs 0/1D3 Sanity points for what it portends. Meanwhile, if the townspeople have their way they burn Gregory’s corpse in silence and return home.

SAMPLE TOWNSPEOPLE

	#1	#2	#3	#4	#5	#6	#7	#8
STR	12	16	12	12	6	9	11	13
CON	10	11	10	11	8	11	11	11
SIZ	15	16	17	13	12	13	15	15
INT	13	13	12	14	14	14	12	14
POW	7	14	16	7	14	6	12	14
DEX	10	10	11	12	11	10	7	13
APP	13	9	9	15	8	10	11	11
EDU	8	10	7	9	6	9	10	10
SAN	30	55	70	30	55	25	40	60
HP	13	14	14	12	10	12	13	13
DB	+D4	+D4	+D4	+D4	—	—	+D4	+D4
Fist	60	65	60	60	70	55	55	60
Grp	35	55	35	40	25	40	40	25
Kick	30	40	30	30	25	35	30	35
SClub	30	—	—	25	—	—	40	50
LClub	—	25	—	—	30	—	—	—
Knife	—	—	40	—	—	35	—	45
Rifle	—	45	55	—	50	45	—	65

Notes: Grp is Grapple skill; SClub does 1D6 damage; LClub does 1D8 damage; Knife (butcher’s) does 1D6 damage; odd # Rifles are .22 bolt-actions (damage 1D6+2), while even #s are .30 lever-action carbines (damage 2D6).

The Problem of Birth

Once the investigators have unearthed the terrible truth about Innsmouth, their friend’s questionable heritage should become obvious to them as well. The realization that one of their number may in fact carry the taint of the deep ones costs each investigator (including the afflicted one) 0/1D4

points of Sanity. If they later determine that he does not carry the tainted Crawford blood, each gains back 1 Sanity point (1D3 in the case of the afflicted investigator).

If the heir does prove to be tainted, his fate is sealed: he will eventually become a deep one. Discovering for certain that their friend is a deep one in the making calls for a loss of 1/1D4 points of Sanity from his fellow investigators; additional losses of at least 0/1D3 may be called for later, as they helplessly watch the transformation into a deep one take place over time.

The tainted investigator loses 1D6 points of Sanity upon learning for certain that he has the blood of the deep ones. The dreams he has will drain more of his Sanity, and when the actual physical transformation begins (exactly when is left for the keeper to determine) there is another 1/1D6 loss. These physical changes mirror the deformities of Gregory Crawford and the other hybrids in town (as outlined in “The Innsmouth Look”, pp. 15-16. From then on, monthly losses of 1/1D6 Sanity aren’t uncalled for. Eventually, the metamorphosing investigator falls into madness and is left with two terrible choices: immortality as a monster of the deep or merciful death as a man.

In Conclusion

Each investigator earns 1 point of Sanity and 1D3 points of Cthulhu Mythos for learning of the Crawford taint. Another 1D4 Sanity points are gained with the death or capture and incarceration of Gregory Crawford. Any other hybrids killed by the investigators net them no rewards, and leave the culprits wanted for murder. The accused murderers’ Credit Ratings drop by 2D6 per murder, and they are hunted by the State Police. Other infractions might also make the investigators wanted criminals.

In short, there is little to gain from this scenario: a crumbling house full of dilapidated antiques and secrets, and—more importantly—a glimpse of the sinister shadow which hangs over Innsmouth. ■

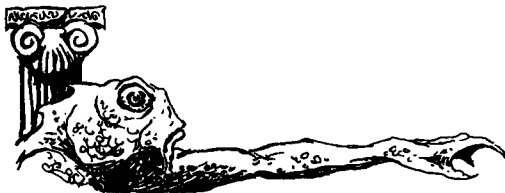

**INNSMOUTH
BECKONS**





ESCAPE FROM INNSMOUTH

A kidnapping leads to an uncovering of blasphemous secrets, and, in the end, a wild flight from the town of Innsmouth.



This scenario assumes the investigators either live or work in nearby Arkham, Massachusetts, and are familiar with the Miskatonic Valley and surrounds. If otherwise, the keeper should adjust the initial clues to suit the situation.

The investigators are faced with the task of tracking down the missing Brian Burnham, the 18-year-old manager of the First National Grocery store in Innsmouth. Burnham disappeared under mysterious circumstances and has not been heard from in days. The investigators will have to travel to the town, explore and learn a few of its secrets, try to free Brian, and then escape alive.

Although a number of Innsmouth personalities appear in this adventure, the keeper is encouraged to introduce other characters drawn from the source section. These characters can be either persons met previously by the investigators, or total strangers. They may offer aid to the investigators, or try to hinder their efforts, depending upon their own wants and needs.

A character appearing briefly in this scenario is Treasury Department agent Lucas Mackey, presently working undercover in the guise of a state factory inspector. One incident involving Mackey is described, but the keeper should take pains to make sure that the investigators' path crosses Mackey's at least once. It is as a result of a report filed by Mackey that the U.S. Government contacts the investigators and asks them for their assistance with the Innsmouth raid.

The scenario is written as though it takes place in late October, though the keeper may alter this as he sees fit. As written, the scenario describes the sacrifice as part of an annual Hallowmass rite, but the keeper is free to conduct the ceremony on any other night of the year, as suits his campaign. Dagon is willing to receive sacrifices whenever they are offered.

What Has Gone Before

Brian Burnham is the manager of the small First National Grocery in Innsmouth, part of a rapidly growing East Coast chain of markets. His supervisor is district manager Arthur Anderson of Arkham, responsible for stores in Arkham, Kingsport, Innsmouth, and one soon to be opened in Ipswich.

Brian, born and raised in Arkham, was as a youth involved with the Irish youth gang, the "Finns." At the age of fifteen Brian spent a night in jail after an evening of mischief ended in the shake down of a Miskatonic U. student—a robbery that netted Brian and his pals barely more than five dollars. That marked Brian's last run-in with authori-

ties and since that time he seems to have buckled down and become a hard-working, honest kid. First beginning work at the Arkham National store as a sweeper and stock boy, he was chosen to manage the new National store opening in nearby Innsmouth.

The facts of the matter are that no one else really wanted the job. The town has long been the source of veiled and disquieting rumors and few outsiders can abide the place for long. Brian's pastor, Dr. Ezekiel Wallace of the Asbury M.E. Church in Arkham, learning of Brian's new job, went so far as to warn the young man about the place. Wallace, advising the boy against living in Innsmouth, arranged for him to board with an Ipswich family known to the pastor.



BRIAN BURNHAM

Burnham has done a good job at the store, working hard, despite the fact that sales have so far been disappointing. But given the economic conditions of Innsmouth, the chain can expect little better. The sole commercial outlet in town not owned or controlled by hybrids, both the store and Brian have proven popular with the humans in town.

It was only a few weeks after arriving in Innsmouth that Brian met young Ruth Billingham, sultry daughter of Warren Billingham, the well-to-do owner of a local fish-packing house. Ruth, 17, fed up with small town life, has long been looking for a way to get out of town. Unaware of the tainted blood that runs through her veins, she knows little or nothing of the secrets that Innsmouth hides. It did not take the young woman long to convince young, virile Brian to aid her endeavor. Together the two made plans to run off to New York, intending on stealing an automobile in order to make a fast getaway. But they had little money, and Brian was unsure how long it would take either of them to find work once they made it to the big city.

Ruth's father had for years talked of a "treasure" kept by Thomas Waite in a safe in the back of his store. Assuming this to be gold or money, Ruth never realized that the treasure she heard her father speak of was no more than an old book. Brian claimed he knew something about cracking safes, and together the two made plans to burglarize Waite's store on their way out of town.



RUTH BILLINGHAM

Brian had unfortunately overestimated his skills. After several fruitless hours prying, chiseling, hammering, and cursing, the two youngsters were caught in the act by townspeople curious about the noise coming from Waite's closed and darkened store. Arrested, the couple was separated—Ruth sent home with her father, and Brian incarcerated in the dank, near-subterranean Innsmouth jail.

When Brian was eventually reported missing by Arthur Anderson, the Innsmouth authorities told State Police that Brian had been caught in the act of attempting to rob Waites Variety Store. Claiming that the young man broke away from the constables, police were told that Brian escaped town in a stolen vehicle and has not been seen since. Checking Brian's police record in Arkham, the State Police were inclined to believe the story, despite protests to the contrary by both Anderson and the boy's parents.

As Hallowmass approaches, the people of Innsmouth make preparations for the upcoming sacrifice to Father Dagon. Meanwhile Brian, unaware of what fate has in store for him, bides his time in jail, smoking cigarettes, waiting for an opportunity to call home.



WARREN BILLINGHAM

Involving the Investigators

The investigators may be introduced to this scenario in a number of ways: by chance encounter with Arthur Anderson; being sought out by either Brian's worried parents or by Dr. Armitage of Miskatonic University; through the tried and true method of ominous newspaper articles about the case; or by any combination of the above. The entries immediately following can be used as means of introduction, or as early research sources.

A chance meeting with Arthur Anderson is described as occurring immediately after Anderson's discovery of the missing Burnham. If the investigators are directly contacted by concerned parents or others, it will be on the day following Anderson's discovery, after he has made his report to the police.

Arthur Anderson

Probably the most unique way to introduce this adventure is through an auto accident with a harried Anderson, regional manager of the First National Grocery chain, just returning from Innsmouth after discovering that his employee is missing. If walking down the street, the investigators are witnesses to Anderson's auto accident; if

behind the wheel of their own car they become involved, possibly suffering minor injuries.

A DISTRESSED ARTHUR ANDERSON

Anderson's car comes careening down the street, flying along well over the 20 mph speed limit. Swinging a hard right turn, Anderson momentarily loses control of the car, crossing the centerline in front of oncoming traffic. Investigators are allowed a Drive roll, a success indicating that they were able to stop fast enough to reduce the crash to little more than dents and scrapes. A failed roll indicates a harder collision, each passenger suffering 1D2-1 points of damage. In either case, a busted radiator now gushes steam.

Anderson emerges shakily from his car, looking frightened, but apparently unconcerned about the damage he has caused. Speaking so fast that he is nearly incoherent, he babbles on about some boy missing from a store in Innsmouth.

"All the lights were on so I figured he must be in there, even though it was way past closing time. I went inside, thinking he was working late in the back. Right away I noticed a kind of funny, fishy odor, terribly strong, almost overpowering, but there didn't seem to be anyone about. I don't mind telling you that it scared the hell out of me, what with some of the things people have said about that town."

"Anyway, the cash register was smashed open and empty. I took a peek in the back, and called Brian's name a couple times, but no one was around. That was enough for me. I ran out, got into my car and drove all the way back here without stopping. Something funny's going on and the police should be notified."

Anderson takes off on foot, heading for the nearby Arkham Police station, his traffic accident forgotten.

Investigators looking through Anderson's vehicle find invoices from the First National Grocery stores. The registration in the glove compartment lists Arthur Anderson as the owner of the vehicle.

A moment later an Arkham police officer appears on the scene, investigating the commotion. He questions the investigators for as much as they know before driving Anderson's crippled car back to the police station.

A MORE COMPOSED ARTHUR ANDERSON

If Anderson deliberately seeks out the investigators' help it is not until the next day—and he is now far more rational. The Arkham police contacted the Massachusetts State Police who drove out to Innsmouth to investigate the matter. The Innsmouth constables told the police that Brian was caught in the act of burglary and fled town in a stolen car. Having learned a little about Brian's criminal past, and having had the night to think it over, Anderson seems less sure of foul play.

"Maybe he did do as they said. But then why he did smash open the cash register—he had the key. That's the one thing I still don't understand."

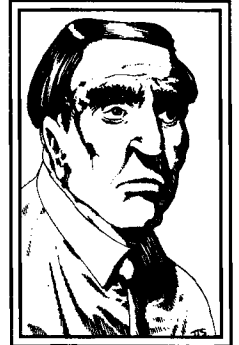

ARTHUR ANDERSON

Despite this, Anderson still seems quite concerned that something may have happened to one of his employees. If the investigators agree to look into the case, he offers to do whatever he can to help.

Use of Psychology reveals that Anderson feels guilty about something; perhaps he feels responsible for sending Brian to Innsmouth. He apparently knows little about the town other than the usual unpleasant whispers about the degenerate folk that live there. During the interview Anderson repeatedly asserts that the boy had an exemplary work record, never giving Anderson any reason to doubt him, and claims that Brian's willingness to work were the reason he was given the promotion to Innsmouth.

As far as Anderson can tell from inventory and receipts, nothing was missing from the store except the money that was taken from the cash register—something less than \$50.

A NEWSPAPER STORY

The day after the possible accidental meeting with Anderson, a newspaper article appears. See *Escape Papers #1*, an article from the *Arkham Advertiser*. The story relates the disappearance of Brian Burnham, teenage manager of the Innsmouth First National Grocery.

The Arkham Police

Successful Law or Persuade rolls (or previously established connections) allow the investigators a look at the Brian's police record. It notes numerous incidents with the police between the ages of thirteen and fifteen and although most

Escape Papers #1

**STORE EMPLOYEE
GOES MISSING**

Innsmouth Grocery Manager Vanishes

INNSMOUTH—Brian Burnham, manager of the First National Grocery Store in Innsmouth, was reported missing yesterday by his employer, regional manager Arthur Anderson of Arkham. Burnham, 18, was scheduled to meet with Anderson at the Innsmouth store at 7:30 PM last evening, around closing time. Upon entering the store, Mr. Anderson found the premises unlocked, unoccupied, and the till emptied. After assuring himself that the youth was not inside the store, Anderson returned to Arkham and reported the incident to Arkham police who in turn notified the Massachusetts State Police. The State Police have not yet released a statement.

The
Ald
are
kin
wit
the
Tez
of r
Hel
mi-
twc
bya
blu
dee
red



are minor, the list is quite long, the boy averaging nearly an incident a month over a two-year span. The last incident, involving the strong arm robbery of a Miskatonic University student, landed Brian in jail for a night. Although released by the judge, the incident seemed to serve as a warning to the troublesome Burnham and he never ran afoul of the Arkham police again.

Detective Mickey Harrigan handled Brian's last arrest; the investigators may wish to talk with him (a Law or Persuade roll might be necessary). Harrigan tells them that Burnham's offenses were mostly minor, and that he seemed to stay out of trouble after he spent the one night in jail.

"We had no more trouble with the boy after that. In fact, I'd heard he got himself a job with the First National store and that up until now, was doing pretty good. I guess you just can't change a bad apple."

If asked, Harrigan provides the address of Brian's parents.

William and Margorie Burnham

The investigators may find Brian's parents' address in the phone book, or they may be referred to the Burnhams by the police, by Arthur Anderson, or possibly others. The couple live at 325 S. Powdermill Street in a modest residential neighborhood on French Hill. Both have been employed at Miskatonic for years: Brian's father as part of building maintenance, his mother as a domestic in the girl's dormitory.

Brian's parents know little about Innsmouth, but visiting their son they found the town inhospitable, filthy, and decrepit. Margorie may mention that she thinks her son had a girlfriend in town, but she admits that this is just a mother's hunch. His parents also mention that Dr. Wallace, pastor at the Burnhams' Asbury M.E. Church, showed deep concern after learning of Brian's transfer to Innsmouth. He took time to caution Brian about certain people in the town, explicitly warning him against joining any of the town's churches. Dr. Wallace procured lodging for Brian with an Ipswich family named Gregg. The Burnhams can provide the name and address of Garth and Evelyn Gregg, the Ipswich family with which Brian has been boarding.

A Psychology roll made while talking with Mrs. Burnham reveals the fear lurking behind her eyes. With a successful Persuade roll, Mrs. Burnham opens up.

"Several years ago," she says, "before Brian started working for the First National stores, he had a couple brushes with the law." According to Mrs. Burnham, he has not been in any real trouble since, but she has always worried that someday Mr. Anderson might learn of her son's past indiscretions and fire him. She refuses to believe her son capable of committing the crimes he is accused of.

The couple have voiced their fears to Dr. Henry Armitage, who has known the couple for years through their employment at Miskatonic. If the investigators are known to Dr. Armitage, it may be that he is the one who first contacts the investigators about the missing Brian.

Dr. Ezekiel Wallace

Dr. Wallace is pastor of the Asbury M.E. Church in Arkham. Both Brian and his parents are members of the church. Learning of Brian's plans, Wallace took pains to warn Brian about Innsmouth's churches, and it was he that arranged for Brian to board with the Gregg family of Ipswich. Wallace probably knows more about Innsmouth than anyone outside that accursed town, and he guesses even more. Wallace is a graduate of the Miskatonic Medical School, and spent time in the South Seas as a missionary.

Wallace does not readily reveal what he suspects about Innsmouth. Only if the investigators reveal a knowledge of the Mythos does he even hint at what he believes has taken place in that town. Suspicious, he does not at first trust the investigators. It may take extra effort on their part to gain his trust and get him to reveal what he knows.

WALLACE'S STORY

Prior to the World War, Wallace spent several years as a missionary, caring to the natives' spiritual needs in the Tuamotu Archipelago of French Polynesia. With an amateur's interest in cultural anthropology, Wallace made a study of the local inhabitants' beliefs, myth patterns, and legends. One legend of recent origin regarded a supposedly degenerate tribe that once lived on a nearby island. This tribe allegedly had traffic with a race of "fish-devils" that came up out of the sea. Doleful tales were told of this tribe, of their loathsome habit of human sacrifice, and of how they themselves slowly turned into fish, eventually taking to the sea. The neighboring tribes, disgusted by these habits, eventually banded together to wipe out the degenerate fish-worshippers. As near as Wallace could calculate, this had occurred within the last century.

Wallace was fascinated by this story, speculating that the vanished tribe suffered from some degenerative disease and were wiped out by superstitious neighbors. He even went so far as to visit the two deserted islands of the vanished Kanakas. Here, on the smaller island, he found strange carvings on oddly fashioned stone monoliths, but little else.

Returning to the States Wallace soon realized the similarities between the tales of the vanished Kanakas and certain rumors whispered about Innsmouth, a small seacoast town a few miles from Arkham. A visit to the Miskatonic Exhibit Museum convinced him. The same jewelry described to him by the natives of Polynesia was on display here—attributed to the people of Innsmouth! Further research pointed to an unholy pact between the Marsh family and something else—something perhaps not human. He has made a few visits to the town over the years, eventually learning enough to substantiate his fears.

WALLACE'S EVIDENCE

Wallace has accumulated considerable information about Innsmouth, kept under lock and key in a storeroom next to the parish library in the basement of the church.

Among his holdings are several fragile, faded issues of the *Innsmouth Courier*, dated 1840-46, containing numerous

articles and editorials by the *Courier's* editor, John Lawrence. The editorials deal with mysterious disappearances taking place in and around the town, and some of the later editorials name Obed Marsh and members of The Esoteric Order of Dagon as the perpetrators. Reading these articles adds 2D6% to an investigator's Innsmouth Lore skill.

Dr. Wallace also possesses the diary of Eugene Hart, a former Innsmouth man who left home to fight in the Civil War. The diary explicitly describes Marsh and his followers' roles in several midnight journeys to Devil Reef, and of the alleged human sacrifices that were made there. The diary adds 2D4% to Innsmouth Lore and 3% to Cthulhu Mythos, at a cost of 1D4 Sanity points.

Stacked against the wall are two oil portraits dating from the late 19th century. Executed in a primitive, somewhat naive style by an unknown artist, they were collected by Wallace on one of his trips to Innsmouth. One depicts a family posed in formal style, most of them sharing an odd, bulge-eyed aspect. A woman seated in a chair wears a floor-length white gown, her face is hidden behind a thick veil. Wallace believes this to be a portrait of the Marsh family including Onesiphorous and other descendants of Obed Marsh. The second portrait is the most frightening. Standing before the doors of what must be a church is a hideous travesty of a man—a vaguely fish-like, frog-like anthropoid dressed in voluminous robes of sea-green and blue. On his misshapen head he wears a gold crown, or tiara, of alien design and workmanship. Most terribly, he holds in his scaly arms a small human child. Both the child's and the frog-man's head are illuminated by glowing halos, in the manner of the Renaissance artists. Viewing the second portrait adds 1D4% to Innsmouth Lore, and costs 0/1 Sanity points.

In a drawer, kept wrapped in a piece of burgundy velvet, is a rectangular, whitish-gold tablet measuring two inches by four inches, and nearly a quarter-inch thick. On one side is a primitive styled carving depicting a monstrous half-man thing with webbed hands and feet, bulging eyes, and gills; the figure is very obviously male. A few indecipherable runes are carved below the fish-man (R'lyeh glyphs). On the reverse side someone has crudely scratched the word *tagon* in English.

Wallace's diaries and notes from his sojourn in the South Seas are also kept here. It takes about six hours to read the pertinent entries. Doing so adds 5% to an investigator's Cthulhu Mythos skill, reducing Sanity by 1D6 points.

A SECOND NEWSPAPER STORY

This story—see *Escape Papers #2*—appears in the *Arkham Advertiser* the day after the investigators first meet and talk with Dr. Wallace, a day or two into the investigation.

Dr. Henry Armitage

If Armitage and the investigators are familiar with each other, it may be that the librarian can provide the easiest path into this adventure. Acquainted with Brian's parents from their years of employment at the University, Armitage takes concern for their plight and volunteers to contact his

friends, the investigators. Otherwise his appearance in this scenario is strictly optional.

Armitage knows only a little about shunned Innsmouth; he is familiar with the rumors about the town. He knows its public history, and has heard of the degenerative disease that afflicts so many of the townspeople. He even knows of the rumored paganistic religious practices the town is supposed to indulge in-but little else.

Garth and Evelyn Gregg

The investigators can get the name and Ipswich address of the Greggs from Brian's parents, Dr. Wallace, or from the Arkham Police. They are members of the Asbury M.E. church in Ipswich, and known to Wallace. Brian lived with the Greggs, walking or bicycling to Innsmouth.

The middle-aged Greggs have told all they know to the State Police, who have already searched Brian's room. The Greggs liked and trusted the youth; he had been given his own key to the house.

With a successful Persuade roll, or if the investigators can prove they have the approval of the police or Brian's parents, the Greggs allow them to search Brian's room. The room is reasonably neat, though it shows signs of the police search. Mrs. Gregg says that all Brian's clothes are still in the wardrobe and that none of his other possessions are missing.

On top of a small desk the investigators find a recent bill from the store. Marked "Paid," it bears the name and address: "W. Billingham, 503 Adams." Written on the back are the words: "Tonight is the night. Love, R." The writer has used little hearts to dot the i's. The police made a note of this bill, but did not bother to take it with them.

Waite and Derby

Asenath Waite and Edward Derby's appearance in this scenario is strictly up to the keeper, providing extra interest, but

possibly muddying already murky waters. Make a decision after gauging the interests of your players.

Asenath Waite, a hybrid deep one, is presently married to the young poet Edward Derby of Arkham. Asenath's body is actually home to the spirit of Ephraim Waite, Asenath's own father, and the elder brother of Thomas Waite of Innsmouth. Ephraim, during his lifetime, was reputed to be an Innsmouth wizard.

Years ago Ephraim swapped minds with his daughter, Asenath, trapping the young girl in his own aged body. After he poisoned her, she was buried in her father's body. Ephraim then assumed Asenath's identity and moved to the city of Kingsport. Ephraim's spirit is presently planning to execute a similar mind swap with Edward Derby, eventually eliminating the Asenath body altogether, along with Edward's spirit.

This process takes considerable time, involving any number of mind swaps of short duration before a final and permanent transfer can be made. Current rumors about Derby point out personality changes.

Ephraim Waite desires a certain manuscript kept by Thomas Waite in the safe behind his store. Appearing as Edward Derby, Ephraim comes to the investigators feigning an interest in the plight of the missing store manager. It is obvious that he knows, or guesses, some of Innsmouth's secrets. Ephraim/Derby will try to extract a promise from the investigators: in exchange for the information he provides them, they will try to locate this manuscript and bring it to him at the old Crowninshield manor outside Arkham. He avoids accompanying them for extended periods of time, or involving himself in active "adventuring." Either can lead to a loss of control on Ephraim's part, leaving the investigators in the company of a bewildered, frightened, and semi-amnesiac Edward Derby. Ephraim, using his three hybrid servants as contacts, can learn the fate of Brian, offering this information in exchange for the book.

Escape Papers #2

STORE MANAGER CHARGED WITH BURGLARY

Young Crime Suspect Flees in Stolen Car

INNSMOUTH—Brian Burnham, manager of the First National Grocery Store in Innsmouth, and first reported missing two days ago, is now the prime suspect in the robbery of his own store, as well as a second Innsmouth establishment. Burnham, 18, after robbing the store he managed, reportedly broke into a safe in the back of a variety store and stole an undisclosed amount of cash.

Burnham is currently being sought by Innsmouth authorities and the Massachusetts State Police.

It is thought the youth may have fled to Boston, according to Chief Constable Andrew Martin of Innsmouth. Sources at the State Police were unable to offer further details, saying only that a warrant has been issued for the boy's arrest. Stories reaching our reporters indicate that Burnham, formerly a res-

ident of Arkham, has had trouble with the law prior to this incident, although this has yet to be substantiated. Stories have also reached us that Burnham may have had a female accomplice, but officials in Innsmouth have denied this.

State Police were told by Innsmouth officials that Burnham escaped town in a stolen car and was last seen headed south out of Innsmouth. Persons with knowledge of the whereabouts of Brian Burnham are urged to contact the Massachusetts State Police.

Innsmouth

The First National Grocery Store

This old brick building stands on the southwest side of the current town square. It is the most modernized and best-maintained structure in town. Exterior electric lights have been mounted above the storefront bathing the surrounding area in light from 6 PM to 9 PM every night, including weekends. The lights are turned on and off automatically by a large mechanical timer.

When the investigators arrive, the front door is locked. They may or may not have a key provided to them by Arthur Anderson. If the investigators spend any time in front of the store they are approached by shuffling Ezra Blank, a fairly uncorrupted hybrid who worked here part-time, sweeping up, putting up stock, etc. He expresses concern over the missing Burnham but if asked his opinion, he is non-committal. A Psychology roll indicates he is hiding something. Blank knows where Burnham is, and what lies in store for him. Although he feels sorry for his former employer he does not breathe a word of it to anybody. The other hybrids would kill him if he did.

Ezra has a key to the front door, a copy he had made without Brian's knowledge. If the investigators are without means of entry, he may offer to let them in. He will do this surreptitiously, nervously, then shuffle off around a corner. He wishes the investigators good luck.

INSIDE THE STORE

The place appears normal, although a closer inspection reveals that the cash register is smashed open. A Spot Hidden, or close inspection also notes that one of the double-hung windows has been broken out of its tracks—pushed inward from outside by someone of great strength, and hastily repaired. A Mechanical Repair roll indicates that the stout window frames have an approximate resistance STR of 20. A second Spot Hidden roll notices raking gouges made in the wood, as if by large claws.

Two doors in the rear of the building, both slightly ajar, lead from the main store area. The one on the right opens on a storeroom filled with canned goods.

The other door opens onto a small room that served as the store office. Innsmouth's town elders have been through here, but found nothing that incriminates either them or the town. Arthur Anderson, in turn, took away any important papers pertaining to store business.

STAYING TOO LONG

While the investigators are inside there is a cumulative 25% chance per half-hour that a town constable walks in on them. This is probably Birch or Ropes, but could be Martin if the encounter occurs around noon (see 202 for details of specific constables). If Martin shows up, he is business-like and brusque, escorting the investigators from the store,



THOMAS WAITE

telling them to leave town immediately or “next time they’ll be spending a night in jail.” He is more obsequious if the investigators prove they have Arthur Anderson’s approval. Constable Birch, on the other hand, may try to use the investigators to somehow discredit or inconvenience his superior, Chief Constable Martin. Ropes is barely intelligent, and any attempt at communication is wasted. He starts a fight at the slightest provocation—something the investigators should try to avoid. Killing or injuring a town official, particularly in broad daylight, almost certainly spells doom for their mission.

Note that the constables will avoid arresting and taking the investigators to jail. Brian is there and they don’t want his whereabouts known. This condition lasts throughout this scenario—unless the hybrids are angered to the point of killing the investigators. In that case it won’t matter if they know that Brian is being held prisoner.

Waite’s Variety Store

This dilapidated building is located on Eliot Street, near the town square. In need of a new coat of paint, its large front windows are streaked with dirt and dried soapy water. The store is open Monday through Saturday, and Thomas Waite, the owner, will be found inside, usually behind the counter (see also 708).

Waite is an untainted human, 56 years old, with grizzled features and a overly-long, wispy white hair. Customarily attired in a long-sleeved white shirt gray with age, he doesn’t greet his customers, ignoring them until spoken to.

Thomas Waite is forcibly mated to a female deep one who shares his home at 803 Dock Street. They are the parents of a hybrid daughter named Ramona. Life has driven poor Waite half-mad.

WAITE’S SAFE

Kept in the back of the store is Thomas Waite’s safe, a small but sturdy item, with a weight equivalent to SIZ 35.

Investigators may notice some signs of damage around the door, the result of Brian and Ruth's futile attempts to pry the safe open. A halved Idea roll notes that the damage to the safe was apparently not enough to force the safe open, despite the Innsmouth constable report that Thomas Waite had been robbed.

Opening the safe without the proper combination, or an appropriate Safecracking skill, is a lengthy, noisy process, requiring pounding and bending tools, drills, torches, and even explosives. Stealing the entire safe and opening it elsewhere is the best course of action. Inside are jumbled stacks of papers and a soiled envelope containing the week's receipts—\$26. Carved on the inside of the door is an intricate Elder Sign, identified as such with a Cthulhu Mythos roll. In a flimsy locked drawer at the bottom of the safe is an untitled hand-written manuscript bound in cloth covers. A Read English roll reveals it be something called *The Book of Dagon*, supposedly translated from a "purer source." It is unique, and if lost, irreplaceable. The unspoken threat of its destruction has given the Waite family a certain amount of protection over the years. Thomas has read some of the manuscript—enough to be horrified by what he learned, but also enough to create the Elder Sign that guards the safe from tampering by either the deep ones or the hybrids.

The hybrid's interest in the book has waned over the years. They are immortal, and they know that someday the book will come into their hands. In the meantime they are content in the knowledge that when the time of transformation comes all will be revealed anyway.

The Book of Dagon

Only a single complete copy of this hand-written book is known to exist. Translated from R'lyeh glyphs by the hand of Obed Marsh, it consists of a saga-like history of the deep ones and their relationship to Cthulhu. Obed learned how to translate the glyphs from Walakea, chief of the Kanak tribe that worshiped the deep ones. It is unknown if he left notes regarding their translation.

The manuscript came into the hands of Ephraim Waite at the time of Obed's death in 1878. Stolen from the Marsh home by servants bribed by young Ephraim. The stolen book was later discovered by Ephraim's father, a devout Methodist, who confiscated the volume over his son's protests. Upon the elder Waite's death a few years later, it was given over to Thomas for safekeeping.

Reading the book requires a successful English roll and sixteen weeks study time. It adds 12% to an investigator's Cthulhu Mythos, costing him 2D8 Sanity points. It has a x4 spell multiplier and contains the following spells: Contact Deep Ones, Contact Cthulhu, Breath of the Deeps, Command Shark, Command Porpoise.

The Home of Thomas Waite

Located at 803 Dock Street, this house exudes an atmosphere of general decrepitude. Here and there can be seen attempts at upkeep, but all are half-hearted and half-finished at best. This slovenly place is occupied by storekeeper Thomas Waite, his deep one wife, and his hybrid daughter, Ramona, 17. The wife is a half-insane creature kept locked away in the attic.

As a young boy Thomas was partially shielded from Innsmouth's horrors by his father, who sent the young lad to Crown Boy's Academy in Boston. Upon graduation he returned to Innsmouth to take over the store from his ailing father, and soon came to learn firsthand of the fear that holds Innsmouth in its grip. Devastated when he learned what was expected of him, he broke off his engagement to Miss Jessica Hodgkins of Newburyport and began adjusting to life as a minority human in a town full of monsters.

Like his older brother Ephraim, Thomas was forced to take a deep one female as a wife. The disgusting unions producing Ephraim's daughter Asenath, and Thomas's daughter, Ramona. Ramona's ichthyic mother, driven permanently half-mad with the lust to kill the girl, has remained locked in the attic ever since, tended to by the faithful Thomas.

On the front porch the investigators find the hybrid Ramona seated on a glider, slowly swinging back and forth, eyeing their approach. She says nothing until spoken to.

During the week Thomas is usually home any time after 7 PM, and on Sunday all day. If the investigators ask for him, Ramona replies languidly that he is either inside, or that he is at the store, depending on the day and time. If asked about her mother, Ramona replies that she is ill, and resting upstairs. She makes no effort to move from her seat on the glider.

THE ENTRYWAY

A dirty room occupied by an overloaded coat rack.

KITCHEN

The kitchen is likewise far from clean. Grime and filth are crusted on the counter tops, and the wood-burning stove is layered with food scraps and years of blackened grease.

LIVING ROOM

Here are found a few old tintypes-portraits of a family, showing a young Thomas with his father, mother, and nearly-adult brother Ephraim. None show signs of the Innsmouth taint. There are no photos of Thomas's wife or daughter.

Waite's big easy chair occupies a corner of the room. Standing next to it is a round table holding a kerosene lamp and a pile of almanacs, newspapers, and dime novels. Among these papers is a hardbound composition book containing Thomas' sporadic journal. It contains little about the history and horror of Innsmouth, instead lamenting of a life of forced marriage to a "horrid thing of the sea." One grisly passage describes the birth of his daughter, Waite acting as midwife to pull the infant girl issued from his wife's monstrous, scaled loins. Several passages in the journal express his sadness over giving up the woman he loved so many years ago.

Waite never shows his journal to anyone, keeping it well buried in the stack of newspapers and almanacs. It can be found with a Spot Hidden roll. Reading it costs 1D4 Sanity points and adds 1% to Cthulhu Mythos and 2D4% to Innsmouth Lore skill.

THE BEDROOMS

Both Ramona's and Thomas's rooms are bare and uninteresting. Neither of the two are prone to accumulating personal items, although Ramona's is decorated in distinctly feminine fashion.

THE ATTIC CELL

Thomas keeps his deep one wife locked upstairs, away from his daughter. The door has been replaced by a stouter one of oaken planks reinforced by rusting steel bands. The door frame is strengthened by rough-hewn four-by-fours spiked to the surrounding walls.

As often happens with female deep ones mated to humans, the birth unsettled the creature, resulting in a deadly hostility toward her half-human offspring. Soon after giving birth to Ramona, the female was locked away by Thomas, who feared she would murder and eat their infant daughter. Unlike most, the deep one mother never recovered and has become increasingly unstable over the years, developing an obsessive desire for the flesh of her child—along with an insatiable sexual attraction to her human husband.

There is a small opening in the reinforced door, sealed by a sliding panel. Opening this panel reveals the hideous, slobbering face of Waite's wife, pressed into the narrow aperture. Being surprised by her scaled, batrachian features costs 1/1D6+1 Sanity points. Her hearing is sharp and she scurries to the opening whenever someone mounts the stairs leading to her room.

Startled by strange faces, the deep one begins smashing herself against the door, attempting to break free. She has a 60% chance per round of bursting the door. She then pushes past the investigators, seeking Ramona. If she finds her, the voracious female deep one pounces on the screaming half-breed girl, seizing her and instantly tearing her to bloody fragments, devouring the gory remains with obvious relish. This grisly display of animal ferocity costs 1/1D8 Sanity points to view.

The deep one is only deterred by the presence of Waite himself; if she sees him, she calms suddenly, then sidles toward him, purring with affectionate lust. Waite, however, is horrified by his freed wife and hurls the nearest object at her before fleeing. The deep one follows after her husband, leaving the investigators unmolested.

THE THING IN THE ATTIC

STR 17 CON 9 SIZ 19 INT 13 POW 6
DEX 12 APP NA EDU NA SAN NA HP 14

Damage Bonus: +1D6

Weapons: Claws x2 30%, 1D6+db

Armor: 1 point scales.

Skills: Brush by Investigator Without Stopping to Fight 75%, Rend and Devour Offspring 80%.

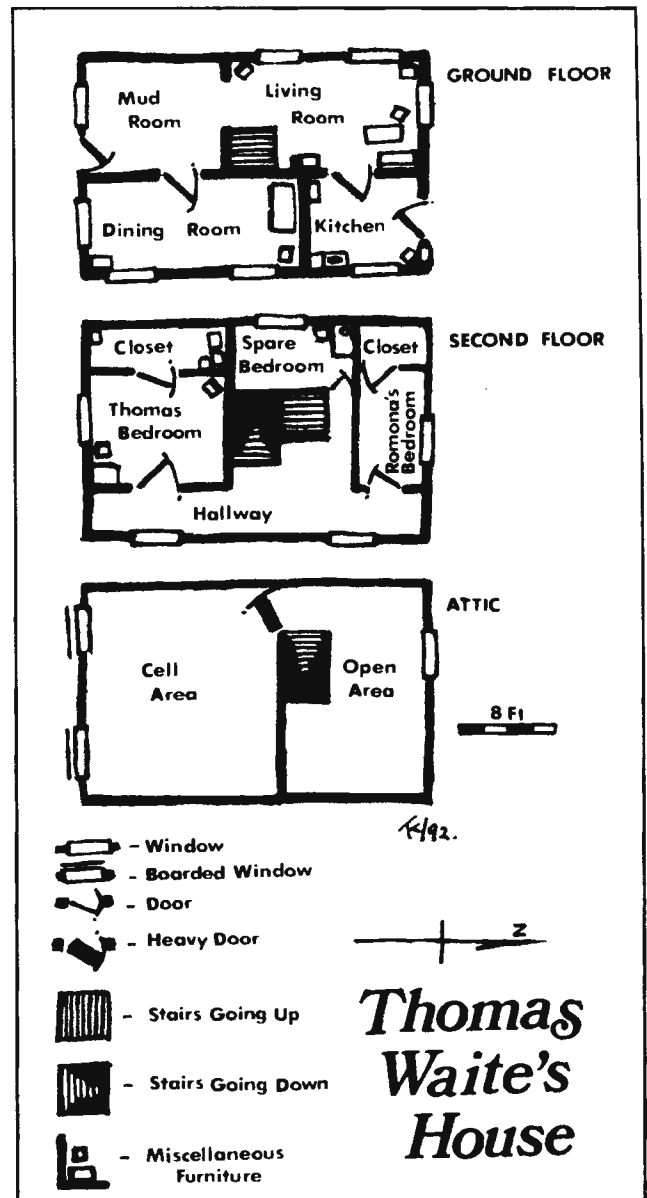

If the deep one is driven off or killed, Thomas falls to his knees beside the partially consumed corpse of his daughter. He grieves quietly for a moment before looking up. "That's why they need us, you know. The females kill their young." Investigators lose 1/1D2 Sanity points.

"The deep ones are seeking those on the surface who are willing to breed with them. Their females rarely allow the young to live. They are immortal and would otherwise overpopulate. But they have greater designs, and some of the males seek to expand their race. They make use of their similarity to us."

If the investigators don't seem to understand, Waite explains further. "Sometime longer ago than anyone can imagine, we and those ones from the sea were divided from the same stock. We're related—almost the same. That's why they can mate with us."

If the investigators haven't already figured this out, they lose 1/1D6 Sanity points, but add 2% to their Cthulhu Mythos skill and 2D4% to their Innsmouth Lore.



WAITE'S WIFE

With Ramona dead, Thomas loses his sense of caution. Depending on how the investigators have treated him previously—and how they react to the possible death of his daughter—Waite probably helps them find Brian.

“They’ve got the boy in the jail. They’re waiting for the time when Dagon comes up from the bottom looking for his sacrifice. That’s what’s in store for the boy if somebody doesn’t help him. Soon they’ll take him out to Devil Reef and he’ll never be seen again.”

The Firehouse

On nice days as many as a half-dozen men are found lounging around in front of the old rundown firehouse. Some of them are firemen, others just visitors—but none show signs of the Innsmouth taint. A Spot Hidden roll notes a whiskey bottle tucked inside the shirt or jacket of a couple of the men.

Investigators find the men reluctant to talk with strangers. Conversation about the weather or other mundane subjects is easy, but questions about Innsmouth and its secrets result in blank looks and mumbled denials. Without a bribe of money or liquor it is next to impossible to gain any information.

Jake, a stubbly-bearded fireman in his 50s, waits until the investigators have walked away from the firehouse, then moves to catch up with them. Nervous, and looking over his shoulder, he promises to tell them what they want to know.

“Meet me at the inlet north of town—Kelly’s Cove—just after dusk. Don’t let no one see ya come up there. Bring me a bottle of whiskey and some of that foldin’ money you’re sportin’. Jake’ll take care of you.”

KELLY’S COVE

If Jake shows up, he relates the following:

“Ya know, that kid started aout all wrong here, takin’ up with that Billingham gal arter bein’ here less’n a month. Her daddy owns the fishpackin’ plant, ye know? Jes’ about the only place a fellah can git a job araoun’ here these days, eh? If that kid was a-fixin’ ta make sure that newfangled business didn’t make no money, then messin’ around with ol’ man Billingham’s fav’rite darter’s a darn good way ta do it.

“Now this girl of his, Ruth, she’s been tryin’ ta get herself outta this town ever since she’s old enough ta think fer herself. She took up with ‘bout any salesman ever set foot in this town—an’ her only fifteen when that started. Anyways, when that kid come inta town she set her sights on him real quick. Me an’ the boys could see that easy enough. Seems like the kid musta fell fer her pretty hard too. She is a danged pretty thing, even if she has got the ‘look,’ if ya know what I mean.

“Lissen, that’s all I can tell ya, they’ll miss me back in taown. Don’t folla me. You can’t have them seein’ us together too much. And ya might want to see what that girl can tell ya ‘bout the kid.” With this, Jake hurries off into the darkness, back toward town. With a halved Listen roll,

an investigator hears a strange sloshing nearby in the waters of the inlet—but there is seemingly nothing there.

There is a 75% chance that the old fireman never makes it back to town. Found out by the hybrids, he is kidnaped on the way back and never seen or heard from again. Further down the beach a successful Spot Hidden roll provides the only clue: a set of man's footprints partially obliterated by what could only have been some sort of struggle. Seen talking with strangers, Jake became food for the cult's shoggoth. If Jake disappears, the rest of the firehouse gang refuses to have anything to do with the investigators, falling silent at their approach, and finding other things to do if spoken to.

If the investigators fail to visit the firehouse, this information can be gained from either Thomas Waite or Walter Bielacki (407).

The Billingham House

This fine, two-story Georgian home on Adams Street belongs to the hybrid Warren Billingham, owner of one of the town's fish packing houses. Billingham lives here with his human wife, Judith, and their teenage daughter, Ruth. Ruth is one-quarter deep one but unaware of her heritage, or of Innsmouth's dark secrets. Not knowing what she is destined to become, Ruth longs only to leave this backwater, isolated town.

The investigators may learn of Ruth's relationship with Brian and decide to look her up. No one in Innsmouth is likely to give out her address, but the investigators may find it on the receipt found at the Greggs' house in Ipswich, or it may be supplied to them by a desperate Thomas Waite. When the investigators arrive Ruth is at home, kept confined here by her angry father. She answers the door but before long is interrupted by one of her parents. Which parent interrupts, and at what point in the conversation, is left to the discretion of the keeper.

RUTH BILLINGHAM

Dark-haired Ruth Billingham is a beautiful 17-year-old, despite her slightly protuberant eyes and wider than normal mouth. Seeing the investigators, she narrows her eyes at the strangers. She is cautious; if the investigators ask about Brian Burnham, she responds by asking them who they are, who hired them, and so on, not answering any questions until the investigators' win her trust.

She doesn't know where Brian is, only that the constables took him away. Ruth at first denies having had anything to do with the failed robbery but if told that Brian is in danger of losing his life, she becomes visibly upset. She insists that they find and rescue him, then get both her and him out of town. If the investigators produce proof that Ruth was involved in the robbery she admits to her role in the crime.

JUDITH BILLINGHAM

Ruth's mother is a plain-looking, middle-aged woman, fully human, her spirit crushed by a life spent married to one of Innsmouth's hybrids. She silently appears in the doorway behind Ruth, glaring at the inquisitive strangers.

"Ruth," she tells the girl, "go to your room. Now!" The girl protests briefly, then stalks off upstairs.

Judith Billingham is abrupt with investigators. She denies any knowledge of the missing Burnham boy, bids them "good day," then shuts the door. She notifies her husband of the investigators' visit at the first opportunity.

WARREN BILLINGHAM

Warren Billingham, 41, is a proud and shrewd businessman. Thinning hair, large watery eyes, and a flattened nose identify his hybrid heritage. He ends the investigators' interview with Ruth abruptly, scowling suspiciously at the strangers. He denies his daughter had any relationship with Brian Burnham, but a Psychology roll will note that he is lying to the investigators.

Conversation Overheard in the Town Square

This incident requires engineering by the keeper. As written, it occurs just as the investigators near New Town Square, but the keeper may wish to stage it in another location. Investigators stumbling onto this encounter may be required to jump back out of sight, making Sneak and/or Hide rolls as the keeper deems reasonable. Listen rolls are necessary to clearly hear what is said. The conversation may need to be tailored in order to reflect the actual activities of different investigators.

As Joe Sargent steps down from his bus following the Arkham to Innsmouth leg of his route, Constable Elliot Ropes shambles up. A Spot Hidden or Psychology roll reveals the constable's agitation. He mentions something the investigators have done today, then goes on: "Them outsiders is trouble," he spits,

spraying Sargent with saliva. Andy says they ain't s'posed to get on the bus, no matter whut. They's askin' too many questions 'bout the kid and we can't have that hap"

Sargent clamps a hand down on the back of Ropes thick neck. "Shut the hell up, ya damn fool!" he hisses. "Do you think everyone who hears us is a friend?"

If the investigators make a Spot Hidden roll, they notice Lucas Mackey, the "factory inspector," lurking in the shadows nearby. Spotted, the undercover Treasury agent ducks back out of sight and disappears. Meanwhile, Sargent hustles the beastly Ropes onto the bus then drives off toward the jail.

At the keeper's discretion, this entire encounter can be redesigned to occur at any place, any time, and to

He refuses to allow the interviewers to speak further with his daughter and sends them off. If they persist, he becomes angry and threatens to call for a constable. Billingham immediately reports suspicious strangers to the Esoteric Order.

Innsmouth Jail

The Innsmouth jail is located at 504 Main Street. At any given time one of the constables will be present, acting as jailor. 65% of the time it is Andrew Martin. If not him, then either Nathan Birch or Elliot Ropes will be there, a 50-50 chance (see also 202).

The constables will not discuss the Burnham case with civilians, pointing out that the matter is now in the hands of the State Police. A licensed private investigator legally employed can demand information, but receives only minimal cooperation and gains little information. The constable will say no more, other than to state that the boy was caught in the act of robbery and subsequently escaped

south out of town in a stolen vehicle. A Psychology roll easily spots this as an out-and-out lie. The constables vehemently deny that Burnham was caught or is being held prisoner. They flatly deny access to the rear of the jail.

Meanwhile, Brian waits miserably in his dingy cell, smoking the last of his Pall Malls and wondering why he has not yet been allowed even a phone call.

OUTSIDE THE JAIL

In the alley behind the jail, a row of narrow, barred windows near ground-level provide fresh air for the cells inside. One of them looks down into Brian’s cell. It should be noted that both ends of this alley open on major streets. Anyone passing by has a chance of spotting activity behind the jail. After dark would clearly be a better time to attempt conversation with Burnham.

The boy is easily convinced that the investigators are friendly. Although unaware of his intended fate, he is gravely worried of what the townspeople have in store for him. This has by no means been a normal arrest. But Burnham never admits to having committed a crime; he instead claims that the Billingham family stopped him and Ruth from leaving town. For whatever reason, her father wants Ruth to stay here. He (untruthfully) claims no wrongdoing on his or her part and (truthfully) claims no knowledge of the theft committed in the National Grocery store. Desperate, he pleads with the investigators to get him out of jail.

It is possible that during any extended conversation with Brian that the jailor will overhear and come to investigate. A halved Listen roll on the part of the jailor draws his attention. If either Brian or the investigator speaking with him make a normal Listen roll, they hear the approach of the constable and can avoid being caught. Exposure at this point will force the investigators to make a quick exit or face arrest.

If the investigators propose any sort of plan, Brian quickly agrees, but then requests that they also rescue Ruth. He insists her family has something bad in store for her and does his best to convince the investigators she must be rescued. If the investigators absolutely refuse, he grudgingly agrees to their plan, but once free, he will do everything possible to go after Ruth.

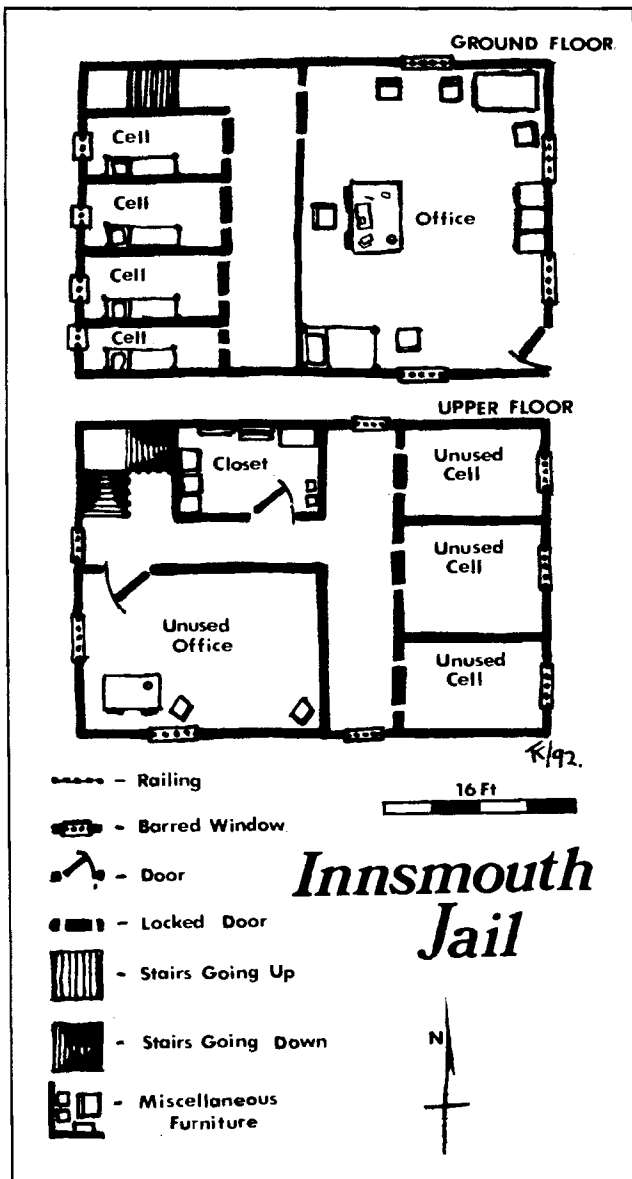

The Ceremony and the Sacrifice

If the investigators don't rescue Brian in time, he is doomed. As dusk approaches, groups of hybrids begin leaving their homes, shambling and shuffling down the deserted streets toward the hall of the Esoteric Order of Dagon. Those members of the community who choose not to celebrate the rites know to stay inside, behind closed and barred doors and shuttered windows. Watching this unholy gathering of hybrids costs 1/1D3 Sanity points.

Among those the investigators might see are members of the Marsh family, including "Old Man" Barnabas dressed in his Edwardian frock coat. Others known to the investigators, such as bus driver Joe Sargent, might also be seen.

In the meantime, a group of hybrids meet at the jail and prepare to escort Brian to the hall. Hands cuffed behind his back, a coat tossed over his head to shield his identity, Brian is led from the jail by an escort of 2D3 hybrids led by either Robert Marsh (30%), or Jeremiah Brewster (70%).

HYBRID ESCORT

	#1	#2	#3	#4	#5	#6
STR	9	7	15	15	9	14
CON	7	10	9	11	10	6
SIZ	11	13	12	11	12	11
INT	10	15	13	8	10	12
POW	6	5	13	8	10	12
DEX	10	9	8	5	11	6
APP	11	3	7	8	4	7
HP	9	12	11	11	11	9
DB	—	—	+1D4	+1D4	—	+1D4

Weapons: Fist/Punch 50%, 1D3+db
 Small club 25%, 1D6+db (escorts 1-4)
 20-Gauge Double-Barrelled Shotgun 40%, 2D6/1D6/1D3 (escorts 5-6).

Skills: Dodge 35%, Hide 25%, Listen 30%, Sneak 35%, Spot Hidden 35%, Swim 85%.

Sanity Loss: It costs 0/1D4 to see this brutish group.

The Esoteric Order of Dagon

The foul hybrids lead Brian through town to the Order's hall, entering through the front door and filing down into the basement. Here, they meet up with 2D6+3 deep ones who have arrived by way of the smugglers' tunnels found behind the hideous statues. Brian is dragged forward and chained by his wrists to base of the statue of Cthulhu.

For the next two hours the hall resonates with a series of bizarre croaking cries, guttural chants, and eldritch songs. Anyone hearing the inhuman voices loses 1/1D4 Sanity points. With a successful Listen roll investigators can make out the frequently repeated words "Dagon," "Hydra," "Cthulhu," and "Y'ha-nthlei."

Properly disguised (wearing the Order's robes, for instance), the ceremony might be infiltrated. The infiltrator must make a Luck roll to avoid discovery; immediate death is the result of failure. An infiltrator attending the ceremony loses 1D2/1D8+1 points of Sanity over the course of the evening, meanwhile adding 4% to Cthulhu Mythos knowledge and 2D4% to Innsmouth Lore. If insanity results, the spy's cover is blown, resulting in a quick but painful death.

Just before midnight, the congregation leaves the hall and heads toward the harbor. Here, some climb into boats while others strip themselves of clothing and plunge into the water. A Spot Hidden roll reveals other shadowy forms bobbing and splashing about in the waves.

The securely bound Brian is loaded into one of the boats, accompanied by several oarsmen and two of the

robed priests. As the small flotilla rows out toward the reef, the nearly-full moon rises high above sea. With the aid of binoculars investigators can watch as the futilely struggling Brian is roughly unloaded from the boat and, forced to stand, is secured by long chains stretching between his wrists and iron rings set in the reef. The priests then back away, beginning a long, ululating chant accompanied by hand gestures, and the croakings and barkings of the assembled multitude of hybrids and deep ones.

After several minutes the sea beyond the reef starts to boil—then explodes upward as a great dark form rises up to blot out the stars. The air fills with the excited barkings and bleatings of the deep ones paying homage to the Great Father. It is Dagon, come to claim his sacrifice. Witnesses lose 1/1D10 Sanity points.

Dagon moves toward the reef and takes hold of the shrieking Brian, attempting to pull his sacrifice free. Brian screams in pain as the chains go taut and the iron bracelets cut into his wrists. One of the iron rings pops free of the rock, the chain swinging wildly, but the other holds fast. Brian's left arm is torn from its socket as Dagon claims his sacrifice. The monstrous deep one submerges back beneath the surface, Brian's last scream choked off by the swirling waters. Witnesses lose 1/1D6 Sanity points.

The sacrifice complete, the congregation returns to shore, either by boat or swimming.

Rescuing Brian

Numerous ways of rescuing Brian present themselves but from the moment his hybrid escort shows up to take him to the Esoteric Order's hall, the investigators' chances are radically diminished.

Rescuing Brian from the jail can be accomplished in any number of ways. Simply overpowering the jailor is the most direct; keys hanging on the wall quickly open Brian's cell. Creating a major diversion in another part of town will draw the constable on duty away from the jail, allowing investigators easy entrance and rescue. A third possibility is breaking Brian out through the alley window. The ancient masonry of the jail is soft and rotten and a heavy chain attached to an automobile could easily pull the iron bars from the surrounding cement. Brian can then quickly scramble out and the party make a quick getaway. The keeper must judge if this procedure damages the vehicle, and to what degree.

Rescuing Brian after he has been taken from jail is far more difficult. A well-planned ambush might allow the investigators to overcome Brian's hybrid escort. Rescue from the temple is far more difficult. From this time on Brian is continually surrounded by dozens of hybrids and deep ones.

Players planning violent rescues relying on lots of gunplay should be reminded that in the eyes of the law they will be committing murder, despite the inhuman nature of Innsmouth's hybrids. Aside from this, investigators prompting the use of firearms may find themselves seriously outgunned. The keeper should take pains to make sure the investigators clearly realize the possible consequences of any planned actions.



A GANG OF HYBRIDS

Saving Ruth

Once Brian is free, he insists on rescuing Ruth from her father's house. He will not take "no" for an answer. If Brian is driving, he heads straight for the Billingham house. If not, he gets out at the first opportunity and begins to make his way on foot. Only by using force can the investigators make him leave town without his Ruth. Investigators may be willing to let him go off on his own, taking this opportunity to effect their own escape, but it is obvious that alone, Brian's chances are almost nil. He will almost certainly be captured and put to death. All the investigators' efforts will have gone for nothing.

For the keeper's part, efforts should be made to keep the rescue and escape fast and exciting, but with an eye toward some level of investigator success. Results of random dice rolls should be modified as suits the situation. If necessary, nonplayer characters may be employed to provide helpful aid, among them Bernard Slocum, Dr. Bloom, or Nick Casper. The helpful character shows up in a fast car, or plugs a menacing deep one in the back, or offers a place for investigators to hide out, all at the keeper's option. If the investigators have not made contact with Lucas Mackey yet, this would be an appropriate time.

The Billingham House

Brian's escape will quickly be discovered. By the time the party reaches the Billingham house 1D3 deep ones have already arrived on the scene and wait hiding in the shadows. As soon as the investigators pull up, the deep ones rush forward, clambering over the roof, pressing their flaccid, batrachian features against the windshield, and beating on the glass with their clawed fists until the car's windows shatter. Sounds of the disturbance alert Warren Billingham, who appears on the front porch armed with a bolt-action .30-06 rifle. He immediately fires on the investigators'

vehicle, regardless of the squirming deep ones crawling over it. Billingham's second shot is knocked away by Ruth who suddenly emerges from the house and runs for the investigators' car. Billingham chases after her, tackling Ruth and sending her sprawling across the front lawn before she gets halfway there. If at all possible, Brian bursts out of the car, sidestepping any deep ones, and races to rescue his girl. Billingham releases his daughter and faces his attacker, ready to kill the boy with his bare hands.

The investigators must decide how to deal with this conflict—and quickly. In 1D6+4 minutes Constable Elliot Ropes and 3D6 armed hybrids arrive on the scene.

Escape from Innsmouth

No matter how successful the rescue, Brian's escape is soon noted and the alert goes up even before the investigators reach the Billingham house. Church bells ring wildly and hoarse shouts echo across the town. Within minutes gangs of hybrids are on the streets searching for the investigators, some on foot, others in vehicles.

The investigators may attempt escape on foot or in a vehicle, or a combination of the two. Provisions for both are given below, first escaping from town, followed by flight across the countryside.

Escaping Town

Assuming that the investigators have their own vehicle, they have probably used it to make the rescue. But unless they

have taken special precautions, they soon discover that their auto has been sabotaged. The sabotage can be almost anything: sugar in the gas tank, a transmission drained of oil, a loosened wheel, or even tampered brakes. The specific type of sabotage, and its eventual results, are details left to the keeper. In any case, the vehicle should prove inoperable soon after the investigators leave the Billingham house.

BY VEHICLE

Once they are in need of a vehicle, Brian Burnham is allowed to show off a special skill: Hot-Wire Auto. Brian quickly offers to hot-wire and steal the nearest parked car. This is quickly achieved and, if the party has so far declined to rescue Ruth, he quickly jumps behind the wheel and refuses to budge. With Brian driving, the party has but little choice to accompany him to the Billingham house. With events at the Billingham house concluded, he allows one of the investigators to drive.

Brian's car thieving skill may come in handy later during the escape, should the investigators' present vehicle become disabled.

The investigators will want to leave town as quickly as possible, but may be unsure of the way. If they lack a map, Ruth or Brian can shout directions from the back seat. Investigators will have to decide which of the four major routes leading out of town offers them the best chance of escape. Each of the four routes leads to a different nearby town: Newburyport, Rowley, Ipswich, or Arkham.

Town encounters occur randomly, a 25% chance of an encounter occurring every block. If an encounter is indicated, roll a D10 on the Town Encounter Table. The keeper will need to decide particular details of the encounter such as from which direction it comes, its distance from the investigators, etc. Ideally, an experienced keeper will simply use the table as inspiration, employing the encounters at opportune moments in an effort to create a dramatic and exciting escape.

Drive rolls are unnecessary if the investigators are driving normally. Being pursued by hybrids indicates a high-speed chase requiring skillful handling of the car. The investigator at the wheel must make a Drive roll for every corner turned. A failed roll indicates loss of control. Roll a D6 on the Town Accident Table and apply the results. Note that two results are listed. In the case of a fumbled Drive roll (any roll of 91-00) the second, more drastic result is indicated.

TOWN ACCIDENT TABLE (1D6)

- 1 Hit Light Post: vehicle damaged but driveable, minus 2D20% to Drive skill; a fumble indicates double damage plus 1D3 points of injury to each occupant.
- 2 Break Off Fire Hydrant: see above.
- 3 Plow Through Storefront: similar to above except a fumble indicates that car is now stuck and unsalvageable.
- 4 Sideswipe Parked Car: -2D10% to Drive; fumble means a rear-end collision with double damage to car, causing 1D6 points of injury to each passenger.

Town Encounter Table

- 1 Potshots from hybrid sniper on the second floor of a nearby deserted building.
 - 2 1D3 hybrids armed with clubs and/or guns rush out from a dark alley.
 - 3 Joe Sargent's bus pulls up and blocks the street in front of the investigators. Meanwhile 1D6+1 hybrids charge from behind.
 - 4 A sweep of headlights behind the investigators indicates a jalopy full of armed hybrids has pulled out behind them and is giving chase. 1D3 hybrids open fire on the fleeing investigators.
 - 5 A single hybrid charges out from a doorway or alley, trying to Jump aboard the investigators' moving vehicle.
 - 6 2D4 hybrids on foot, including a robed priest of Dagon, try to block the road. The investigators may run one or two down causing damage of -2D10 to handling, or attempt to swerve around them. A Drive roll is required for the swerve to succeed.
 - 7 A car comes from other direction attempting to run the investigators off the road. Play "chicken" with the hybrid vehicle by winning two out of three POW vs. POW struggles. The loser must swerve to avoid a head-on collision and must make a Drive roll to avoid suffering an accident. A fumble indicates a head-on collision.
 - 8 2D6 Hybrids stationed on a roof hurl down rocks and bricks upon the investigators. Little damage is done unless the car is an open model without a roof, or the investigators are on foot.
 - 9 2D6 deep ones shamle out into the street in front of the investigators. Sanity loss is 1/6 points. Run them down, or swerve. See 6.
 - 10 A stake truck full of hybrids barrels down the street toward the investigators, its occupants wave pitch forks and clubs and fire random shotgun blasts from the bed. A side street opens to the left or right, allowing an opportunity to escape but requiring a Drive roll at -10% to
- 5 Run Up and Over Curb: -1D10% to handling plus a Drive roll is required to retain control of vehicle. If failed, roll again on the Town Accident Table.
 - 6 Spin-Out: no damage; fumble indicates car rolls over, rendering it useless and causing 1D8 points of injury to each occupant.

94 – Escape from Innsmouth

TAKING FIRE: Any number of encounters include armed hybrids who open fire on the fleeing investigators and their vehicle. Hybrids firing from stationary positions use their normal percentage. Anyone shooting from a moving vehicle—including investigators—fires at half their normal skill. Successful hits on a vehicle normally do little damage, harmlessly imbedding themselves in body panels, dashboards, etc. An impaling hit, however, has done real damage, either to the vehicle itself, or its occupants. Roll a D20 and consult the table below.

VEHICLE IMPALE TABLE (1D20)

- | | |
|-------|---|
| 1-5 | Windshield hit and shattered. Make an immediate Drive roll at -30% (plus any applicable modifiers) or suffer accident. Windshield is now starred and semi-opaque, and must be smashed out or subsequent Drive rolls are made at -20%. |
| 6-10 | Tire hit. An immediate Drive roll must be made to avoid an accident. With a flat tire, all subsequent Drive rolls are made at -50%. |
| 11-12 | Passenger hit! Determine target randomly. Damage is half normal due to the bullet passing through the vehicle's body. |
| 13-14 | Driver hit! Apply damage as above, and driver must make a Drive roll at -40% to maintain control. |
| 15-16 | Steering mechanism hit. Make immediate Drive roll at -20% plus any other modifiers. Handling is permanently reduced by 25%. |
| 17-19 | Engine/drive train hit. Make immediate Drive roll at -10%. Vehicle is permanently damaged and coasts to a stop within one block. |
| 20 | Gas tank or fuel line hit. Driver must make a Luck roll or vehicle explodes immediately, inflicting 2D6 damage on all occupants. Successful DEX x5 rolls are required by each occupant to clear the vehicle before it explodes. |

DAMAGED VEHICLES: Aside from specifics such as broken windows or shattered headlights, damage to vehicles is often expressed as a reduction in handling ability. These effects are cumulative, and should be subtracted from the driver's skill whenever a Drive roll is deemed necessary. Cumulative damage that reduces the driver's skill to 0 or below means the vehicle is inoperable and will have to be abandoned. Of course, an investigator with a higher Drive skill could get behind the wheel and possibly get a little more mileage out of the wreck.

REPLACING VEHICLES: While still in town, investigators may replace a disabled vehicle by stealing a parked car. Brian may hot-wire it, or an investigator can try to accomplish the same thing with an Electrical Repair roll. Anytime the investigators lose their vehicle, there is a 50% chance that a parked car is in sight. If not, there is 60% chance of finding one on the next block, a 70% chance on the following block, etc. Roll for the type of vehicle, and its condition. Once out of town the chances of finding a parked vehicle are nil.

TYPE (1D6)

- 1 Ford Model T
- 2 Ford Model T with truck bed
- 3 Coupe
- 4 Small Delivery Truck
- 5 Packard or Chrysler
- 6 Pickup Truck

CONDITION (1D8)

- 1 Fair condition
- 2 Fair condition
- 3 Old, but operable
- 4 Back seat full of fish guts
- 5 Bad suspension; -25% to Drive
- 6 Brakes fail on the third hard stop
- 7 Steering sloppy; -20% to Drive rolls
- 8 Car will not start

ON FOOT

Traveling on foot is of course slower, but in some ways safer. Roll for encounters twice for every block traveled but allow investigators to slink through the shadows and hide in doorsteps. Hybrids passing in vehicles are unlikely to spot alert investigators quick to jump out of sight. Allow passing hybrids a Spot Hidden roll of 25% for such encounters. Failure to make the Spot Hidden indicates that the hybrids did not see the investigators. If spotted, investigators may try to imitate the shambling walk of the hybrids. A POW x5 roll is necessary to pull off the masquerade.

Progress on foot is slow and investigators will probably want to obtain a replacement vehicle at the first opportunity.

Escaping Cross Country

Once out of town, the investigators must still cross several miles of countryside before reaching the safety of the township line. As in town, this may be accomplished in a vehicle or on foot, or by any combination of the two. Vehicles are limited to travel along the roads, but investigators on foot may cut across open terrain.

BY VEHICLE

Although the investigators may relax when they finally get out of town, the respite is brief. A car filled with six hybrids swings out from nowhere in hot pursuit. They are armed and three of them open fire. It is likely that the investigators can outrun their pursuers, but only if they drive hard.

There are four routes out of town, each leading to a different nearby town: Newburyport, Rowley, Ipswich, or Arkham. Driving hazards are located along each route. At normal speeds these are easy to negotiate or avoid, but if pursued at high speeds Drive rolls are necessary. The results of failed Drive rolls are noted in the hazard description. Keepers are free to apply extra penalties for fumbled Drive rolls, as they see fit. Once the investigators have successfully negotiated all the marked hazards, their escape is considered successful. The hybrids give up the chase and return to town.



NEWBURYPORT ROAD

EXTREMELY NARROW BRIDGE: this bridge crosses the second of the four small streams along this route. It is particularly difficult to see due to a twist in the road and overhanging growth. A Drive roll is required, failure indicating the car has run off the bridge and plunged nose-first into the stream. Occupants suffer 1D4 points of damage and the vehicle is permanently disabled.

CURVE: occurs right after crossing the second bridge. Failure to make a Drive roll results in a vehicle permanently stuck in the marsh.

THICK FOG: found between the third and fourth bridges. The Driver must make a Luck roll or run off the road into the marsh.

RISE: the crest of Carson's Hill. At high speed a vehicle becomes airborne. A failed Drive roll results in running off the road and into a tree. Occupants suffer 1D6 points of damage each.

ROWLEY ROAD

CURVE: a sweeping left-hander encountered right after leaving town. Failure to make a Drive roll results in a vehicle permanently stuck in the marsh.

RISE: the railroad crossing. At high speed a vehicle becomes airborne. A failed Drive roll results in running off the road and getting stuck.

THICK FOG: occurs right after the railroad tracks. The driver must make a Luck roll or run off the road.

MUD HOLE: at the intersection. If Drive roll is failed, vehicle spins out and becomes stuck. It will take two rounds to push it free.

IPSWICH ROAD

CURVE: a sharp left-hander that occurs just shortly after leaving Innsmouth. Failure to make a Drive roll results in a collision with a large, gnarled tree, reducing further Drive rolls by 2D20% and causing 1D6 points of injury to each occupant.

ROCK: just past the curve, right before the T-intersection. A failed Drive roll while attempting to avoid the rock results in the vehicle running off the road and getting stuck. Straddling the rock is easy, but results in a broken drive train and a useless vehicle.

FALLEN TREE: encountered just before the four-way intersection. A Drive roll is necessary in order to stop in time. Failure indicates a ruined vehicle and 1D4 points of damage to each occupant. If the stop is successful, the tree may be cleared by a team of investigators by successfully combining their STR against the tree's SIZ of 35 on the resistance table.

SANDY WASH: just past the four-way intersection. A Drive roll is required to avoid a spin-out.

ARKHAM ROAD

EXTREMELY NARROW BRIDGE: found at the small brook. A Drive roll is required, failure indicating the car has run off the bridge and plunged nose-first into the stream. Occupants suffer 1D4 points of damage and the vehicle is permanently disabled.

THICK FOG: occurs right after crossing the brook. Driver must make a Luck roll or run off the road.

SEVERE DIP: occurs at the four-way intersection. The vehicle slams through the dip, requiring a Drive roll to avoid going off the road. The vehicle is now stuck, but can be freed with two rounds of pushing.

MUD HOLE: encountered just past the intersection. If a Drive roll is failed, the vehicle spins out and becomes stuck. It will take two rounds to push it free.

Escape on Foot

On foot, the investigators may travel either by road, or across the marshes and fields. If their escape has been slow they may be forced to abandon the roads when vehicles filled with hybrids start pouring out of town to scour the highways.

The following encounters occur randomly, and are keyed to various areas around Innsmouth. Keepers may roll one to four times on the random encounter charts, depending on how far the investigators have to travel to reach the edge of the map and eventual safety. Traveling the railroad tracks is considered to be the same as the marshes.

MARSH: A roll of 50% or less indicates an encounter. Roll a D6 on the Marsh Encounter Table.

MARSH ENCOUNTER TABLE (1D6)

- 1 Prowling Shoggoth: the deep ones' hungry shoggoth rears up out of the darkness and attacks a random character. If the character is slain, the shoggoth settles down to consume him, allowing others to escape.
- 2 1D6 Deep Ones: these are spotted at a distance of 1D6 x20 feet. They pursue, but if one or more are slain they retreat. Lose 1/1D6 points of Sanity.
- 3 Quicksand: a randomly chosen character stumbles into a pool of quick sand. Unless rescued he is sucked down in six rounds. Investigators must roll Luck once per round until an object is found to pull the character free. A fumble (96-00) indicates that character has also run afoul of the quicksand and must be rescued. Once a proper object is found, a quicksand STR of 25 must be overcome by the combined STR of those trying to pull the character free.
- 4 Startled Heron: Investigators almost step on this sleeping marsh bird who flies up with a great whooping noise, possibly attracting attention.
- 5 A Single Deep One: this creature suddenly pops up in front of a randomly chosen character at a distance of ten feet, and attacks.

- 6 Rotting Corpse: A randomly chosen character trips over a dead body lying in the marsh and loses 1/1D4 points of Sanity. This is the corpse of treasury agent Bill Forbes who a short time back disappeared while on undercover assignment in Innsmouth. Forbes was posing as a historical writer and was staying at the Gilman house when last heard from.

WOODS AND FIELDS: A roll of 30% or less indicates an encounter. Roll D3 on the Woods and Fields Encounter Table.

WOODS AND FIELDS ENCOUNTER TABLE (1D3)

- 1 Friendly Character: this non-player character is an Innsmouth human who has come to the aid of the investigators. He may be armed and on foot, ready to lead them out, or waiting behind the wheel of a car.
- 2 Hybrid Patrol: 1D6+2 hybrids with flashlights turn up at a distance of 2D6 x20 feet. They may or may not spot the investigators.
- 3 Single Hybrid Sniper: A single hybrid with a .30-06 rifle opens fire from behind a tree 1D6 x20 feet away. Investigators may flee, taking four more shots from behind (25% chance to hit), or open fire. Darkness and partial cover reduce the chances of investigators hitting the sniper to one-quarter normal.

A Guardian Angel

This event may be engineered by the keeper either to save a desperate party, or simply to end the scenario with a dramatic flourish. In either case, a dark sedan suddenly pulls up on a nearby road. The occupant hops out and signals the fleeing investigators with a flashlight, calling their names. It is Lucas Mackey, the U.S. Treasury Agent. Without revealing his real identity, he tries to convince the investigators he is their ally. Accepting a ride with Mackey, the investigators are dropped off at the nearby town of their choice before the agent heads south to his office in Boston.

Conclusion

If the investigators rescue Brian from Innsmouth they each receive 2D6 Sanity points. If they fail, or Brian is killed during the escape, each loses 1D6 Sanity points. Rescuing Ruth is worth another 1D6 Sanity points; failure to rescue her costs each investigator one Sanity point. There is no reward if Waite's copy of the *Book of Dagon* is retrieved from his safe, unless the investigators have knowingly kept it out of Asenath Waite's hands. In this case award each investigator 1D3 Sanity points. One point of Sanity is gained for each dead one killed, up to a maximum of six points.

WRAPPING UP

The investigators must decide how to explain Brian's disappearance and his alleged role in the Innsmouth robbery. They may also have to explain any criminal actions they may have engaged in during the course of the rescue. It is left for the keeper to deal with these matters, but it is pos-

sible that charges may be brought against them by the angered Innsmouthers. If arrested on felony charges investigator Credit Ratings drop by 2D10, or more. The keeper may deal with this eventuality as he wishes, but before the raid is staged, the Treasury Department may intervene in these investigators' cases, working deals behind the scenes in order to secure their release, possibly even arranging to have the charges dropped.

Finally, if the investigators were able to take away any conclusive evidence concerning the situation in Innsmouth and turn this information over to government authorities they may add 1D6 to their Credit Ratings. This also ensures that the investigators will be given a role in the upcoming Raid on Innsmouth.

Statistics

BRIAN BURNHAM, 18, Innsmouth First National Grocery manager

STR 11 CON 10 SIZ 9 INT 13 POW 8
DEX 9 APP 15 EDU 12 SAN 35 HP 10

Weapons: Fist/Punch 75%, 1D3
Pocket Knife 35%, 1D3

Skills: Accounting 45%, Bargain 55%, Credit Rating 30%, Drive Automobile 45%, Fast Talk 65%. Hide 60%, Hot Wire Auto 75%, Innsmouth Lore 15%, Locksmith 45%, Mechanical Repair 35%, Pick Pocket 25%, Sneak 65%, Spot Hidden 55%.

RUTH BILLINGHAM, 17, attractive hybrid girl

STR 7 CON 9 SIZ 8 INT 13 POW 9
DEX 11 APP 17 EDU 11 SAN 20 HP 9

Damage Bonus: -1D4

Weapons: all at base percentages

Skills: Climb 55%, Fast Talk 65%. Hide 50%, Innsmouth Lore 25%, Listen 40%, Occult 15%, Seduce 55%, Swim 70%.

THOMAS WAITE, 56, tired old shopkeeper

STR 8 CON 11 SIZ 10 INT 14 POW 14
DEX 10 APP 12 EDU 12 SAN 25 HP 11

Damage Bonus: 0

Weapons: Fist/Punch 45%, 1D3

Lead Pipe (under store counter) 55%, 1D6

Skills: Accounting 55%, Bargain 65%, First Aid 50%, Innsmouth Lore 70%, Listen 55%, Pharmacy 25%, Psychology 30%.

WARREN BILLINGHAM, 41, hybrid businessman

STR 16 CON 18 SIZ 14 INT 15 POW 14
DEX 10 APP 8 EDU 14 SAN 10 HP 16

Damage Bonus: +1D4

Weapons: Fist/Punch 60%, 1D3+db

.30-06 Bolt-Action Rifle 40%, 2D6+3

Strangle 45%, 1D4+1 per round*

Skills: Accounting 70%, Bargain 65%, Drive Automobile 55%, Fast Talk 60%, Innsmouth Lore 70%, Listen 45%, Persuade 70%, Spot Hidden 45%, Swim 85%.

*Attack percentage is for initial hold. Must overcome STR of target each round thereafter to maintain strangle hold. ■



THE RAID ON INNSMOUTH

When the blasphemies of Innsmouth are finally uncovered, the government prepares a raid of epic proportions, and player investigators are given the opportunity to join.



This climatic adventure recreates the U.S. government's raid on the town of Innsmouth. Because of their activities, the investigators have come to the attention of the Treasury Department. Agent Lucas Mackey, whom they probably met during the Escape from Innsmouth scenario, is most likely the reason they are contacted.

The government investigation began last summer after the department was contacted by Robert Olmstead of Ohio. While visiting the town of Innsmouth the previous summer the man had innocently stumbled upon a nest of illegal, perhaps even unnatural, activity. A preliminary investigation proved some of the man's allegations accurate. A secret investigation was launched and is probably underway at the same time the investigators are conducting their own inquiries. Treasury agents, visiting the town in the guise of salesmen, tourists, and factory inspectors, have amassed enough evidence about Innsmouth to spur the government into action.

One of these agents, posing as a travel writer, disappeared while in Innsmouth. His rotting remains lie in the marsh northwest of town. His corpse may or may not have been discovered by investigators during the Escape from Innsmouth adventure.

Contacted by the Treasury Department, the investigators are first questioned about what they know, then later asked to take part in the raid. The influence of Lucas Mackey and

his superiors at the Treasury Department can even extend to procuring the release of investigators currently held in jail, perhaps even arranging a favorable plea bargain or a dropping of charges altogether.

Supporting Characters

Because a player's investigator will be active in only one of six missions, during the course of the other five scenarios, players will be called upon to take the parts of other characters. These are members of the military (marines, coast guardsmen, or sailors) or treasury agents. These roles are referred to as Supporting Characters. Although the intent of this adventure is to provide each investigator with a "starring role," supporting characters also play active and important parts.

If an investigator or supporting character is lost or killed during the raid, the keeper may assign that person another supporting character to play.

Project Covenant

At Agent Mackey's urging the government has begun running background checks on the investigators. This involves examining employment and police records, checking memberships in private and public organizations, and, oddly enough, a tracing of family histories—looking for evidence of Innsmouth ancestry. The investigators are initially unaware of these investigations, but from December through mid-January they may have disturbing hints that something is amiss.

Each investigator making a successful Luck roll gets 1D3 reports from fellow workers, family members, employers, friends, or landlords to the effect that: "some friend of yours was asking about you the other day." The unnamed friend was interested in details of the investigator's personal life, work habits, and strangely enough, if they have ever shown any interest in the occult. Halved Listen rolls note odd disturbances and static on investigator telephone lines; Idea rolls spot strangers on the streets that investigators are sure they've seen before.

Contact

Once assured of the investigators' backgrounds and loyalties, the government contacts them at their homes. Each

Running this Adventure

The raid on Innsmouth is a unique scenario. Presented as six separate raid actions called objectives, or missions, each of these is divided into three parts. Part one of each mission is run in a specific order, followed by part two of each mission, again in a specific order. When part three of each Objective has been played through the raid has been completed. The proper sequence of play is found in a box on p. 100.

The investigators are invited to take part in the raid, acting as advisors and participants. They will be asked to split up, each investigator taking part in a different objective, either of their choosing, or as chosen for them by the keeper. Ideally, there will be one investigator for each mission. If there are less than six investigators, a player may wish to have one of his back-up investigators accompany a raiding party. If there are more than six players with investigators, it is perfectly acceptable to have more than one investigator on a given mission.

investigator is visited on a cold Sunday afternoon in January by a group of men who arrive in a large, black sedan. Dressed in dark topcoats, suits, and hats, they are led by Agent Albert Ryan, who identifies himself at the investigator's door.



ALBERT RYAN

The agents ask if the investigator is alone; they would like to speak to him or her privately. If the investigator agrees, they are asked a series of questions about Innsmouth, and any activities they may have taken part in over the last few months. The agents are polite, but it is obvious that they are trying to discern how much the character knows or suspects about the town. Notes are taken, the interviewers'

placid expressions changing only when an investigator's story of "fish-men" or "horrifying monstrosities" results in a lifted eyebrow, or the momentary hesitation of the otherwise busy, scribbling pen.

The interview lasts about twenty minutes after which the investigator is politely thanked for their cooperation. Ryan asks the investigator to "please refrain from speaking of this matter. It is of utmost important to our nation's security." Ryan indicates that some of the investigator's associates have also been contacted, or soon will be. "You'll be hearing from us again," he assures them.

The Call to Duty

As promised, the investigators are contacted again, just a few days later. A phone call, or telegram, requests their presence at the Federal Building, Room 402, in Boston on the following evening, at 8 PM. They are to ask for Agent Drew. If necessary, a car and driver will be provided. A phone number is given and the investigators asked to confirm that they have received the message.

By eight o'clock the streets of Boston are dark, the office district that the Federal Building stands in nearly deserted, and swept by a cold winter wind. A light snow falls on the investigators' shoulders.

Most of the six-story Federal Building is dark, but a row of fourth floor office windows shine brightly. Entering, the investigators find a front desk, a young man seated behind it. He inquires of their business and, after a call to the fourth floor, confirms them and points the way to the elevators. If any of the investigators attempt to sign the visitor's register, the young man quickly stops them. "That's not necessary," he smiles.

Once on the fourth floor, room 402 found at the end of the hall. The door stands open and voices are heard coming from within. The investigators may attempt knocking at the open door, or stepping straight inside. In either event they find themselves in small ante room, a smiling woman receptionist in her mid-thirties ready to meet them. She introduces herself as "Miss Jameson" and seems to know all the investigators by name. "Mr. Drew is waiting for you in his office."

She leads the way into the small office complex, toward a closed door. On the way the investigators pass a meeting room, a long table surrounded by a number of men, some in uniform, seated in chairs. Cigar smoke hangs thick in the air.

The investigators are shown into the further office and Miss Jameson retreats, closing the door behind her. Lucas Mackey, smiling, steps up and warmly welcomes the investigators, shaking hands, perhaps even slapping a back. Mackey's exact manner depends wholly upon the investigators' past dealings with the agent.

Agent Ryan stands a bit farther off, next to the tall, thin, gray-haired agent seated behind the large desk. The seated man takes off his glasses then stands up and walks out from behind the desk; he extends his hand to the investigators. The agent's eyes are cold and blue, his smile thin-lipped and unconvincing. Mackey makes introductions all the way around and the investigators are asked to seat themselves. Drew takes center stage in front of his desk, Mackey meanwhile perching casually on its corner while Ryan stands out of the way, in the back. Drew speaks:

"Gentlemen, [ladies,] I know you're curious as to why you've been called here tonight. The government needs your aid in a matter of utmost importance. Because you are all already familiar with the town of Innsmouth, I feel there is



"MR. DREW"

no need for me to explain why your government has become involved. A lengthy investigation conducted by this department has revealed the need for swift and sure measures to be taken against the widespread criminal activities occurring in that town. Numerous federal and interstate laws have been violated, including conspiracy to transport illegal alcohol, kidnaping, murder, and possibly even white slavery. There is no need for me to elaborate to you the vile and disgusting practices some of these cutthroats and criminals are rumored to indulge in. Although the figures are sketchy, we now assume that at least half the people in that town are involved in a criminal conspiracy—one that reaches all the way up to the most powerful families in town.

Although the figures are sketchy, we now assume that at least half the people in that town are involved in a criminal conspiracy—one that reaches all the way up to the most powerful families in town.

THE OATH OF SECRECY

"Needless to say, a police action of this type must be handled with delicacy, not only to avoid alerting the criminal element in Innsmouth, but also because the action might be viewed by some as a violation of Constitutional rights. Never before has federal martial law been declared over an entire township—but the government feels there is no alternative."

"Before I can speak any further I must ask you to sign these documents, Oaths of Secrecy, binding you to keep secret any events that you should witness or take part in over the next few days. If you wish, you may choose not to sign. In this case, you will be escorted to accommodations in the basement of this building. By law, we can hold any of you for up to 72 hours without charges or arrest. We have no desire to inconvenience you, but due to the secrecy nec-

essary to this operation it is essential that we maintain security. Your needs will be provided for, and all will be done to see to it that you are made comfortable.”

Those who sign are congratulated warmly by Mackey, stiffly and formally by Drew. Those who refuse to swear the oath are escorted to holding cells in the basement of the building, clean, but small and confining. All efforts are made to make the investigators’ forced stay as comfortable as reasonably possible. Any investigator making a Law roll while reading the document realizes that violating the oath could result in massive fines and/or imprisonment.

Left with those investigators who have agreed to sign, Drew explains his request:

“The government has need of your aid, your expertise in these matters. Apparently you know as much or more about this town than we’ve yet been able to learn. You should understand that participation will involve a certain amount of personal risk. We would like each of you to accompany different bodies of troops taking part in the raid, acting primarily as advisors and experts. that will be entering the town and engaging in other operations. You will, of course,

be under the command of military officers, and subject to their orders. Make no mistake—we have every reason to expect armed resistance. Are you interested? Are you willing to aid your government?”

Assuming that the investigators agree, Drew rises and leads them to the large meeting room seen earlier.

THE BRIEFING

In the meeting room the investigators are introduced to the eight men sitting around the table: Marine officers Major Maines, Captain Corso, and Lieutenant Doud; Coast Guard Commander Hearst; a government agent, John Edgar Hoover, the 34-year old director of America’s Bureau of Investigation (Know roll); and a civilian, East Indian Dr. Najar, who identifies himself as “a parapsychologist.” Finally they are introduced to marine Colonel James Rothler of Naval Intelligence. In charge of the military contribution to this action, he is the source of the thick cigar smoke that hangs in the room. The investigators are introduced as “special civilian advisors who, like Dr. Najar whom you’ve already met, have generously offered to lend

Raid Order of Play

Certain events in the scenarios suggest a logical sequence of play. A recommended order of presentation follows. In some cases communications or meetings between two groups of raiders is possible. This may require a simultaneous playing of two different raid actions for a brief time. For the most part, however, each is self-contained.

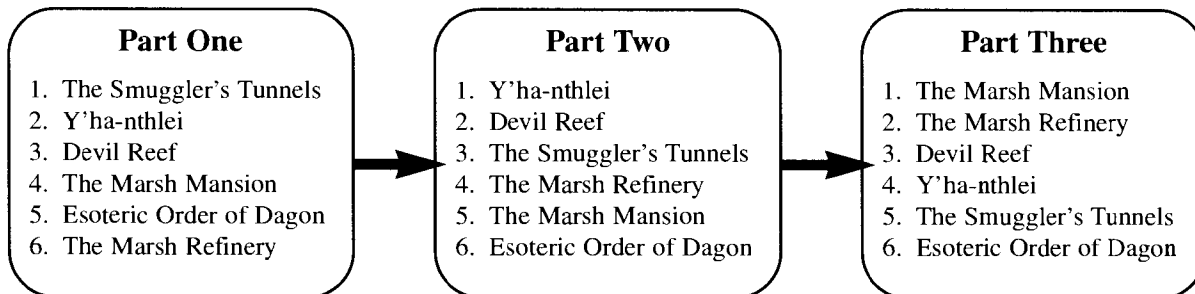

THE RAID OBJECTIVES

Objective 1, The Esoteric Order of Dagon: a direct assault by two squads of marines against the headquarters of the despicable cult. Led by Captain Corso and Sergeant Grabatowski. Investigators should be healthy. Skill with firearms is desirable.

Objective 2, The Marsh Mansion: a sneak attack by a single squad of marines against the home of the most powerful family in town; the taking of prisoners is the prime objective. Led by Major Maines. Stealth skills and some firearms abilities are desirable.

Objective 3, The Smugglers’ Tunnels: two squads of marines in four boats will row up the tunnels that run under Innsmouth. Lieutenant Doud will lead the marines. Combat skills are important, as well as a healthy Sanity.

Objective 4, Devil Reef: a Coast Guard contingent will be stationed offshore to patrol the reef and harbor under the command of Commander Hearst. It is possible to avoid combat, but for safety’s sake a good Swim skill would be handy.

Objective 5, Y’ha-Nthlei: the U.S. Navy has assigned a submarine to torpedo the site of the alleged undersea city. Commander Robert Harrow is skipper of the S-19. Physical skills are not important. Psychology and a strong Sanity are recommended.

Objective 6, The Marsh Refinery: agents of the U.S. Treasury Department are to enter the Marsh Refinery and seize important documents, gold, and Refinery officials prior to destroying the building. The agents are led by FBI Director J. Edgar Hoover. Good physical and combat skills are recommended.

the government their aid." All take seats except Drew and Rothler, who remain standing at the head of the long table. Agent Mackey closes the door before sitting down next to fellow-agent Ryan. Major Maines pulls a metal flask from



MAJOR JOE MAINES

a pocket inside his coat and pours drinks for himself and the Colonel. He lifts the flask toward the investigators at the far end of the table, inviting them to join them. Dr. Najjar declines, quickly, almost embarrassed. The investigators may or may not choose to indulge. Drew, surprisingly, offers: "I have a first-rate bottle of Irish whiskey in my desk, if anyone would care for some."

Miss Jameson is sent for the bottle, and to brew the cup of tea requested by Dr. Najjar. The discussion begins, Drew quickly outlining the situation in Innsmouth as best the government investigation has learned. Investigators note that the government case centers on suspected kidnappings and murders, and the degenerate religious cult that seems to underlie these activities. Tales of monstrosities hidden away in houses are thought to be the unfortunate results of inbreeding, or possibly captives held by the cult; rumors of monsters from the sea are dismissed with skepticism. It is evident that the more supernatural elements surrounding Innsmouth are either ignored or misunderstood, or both. He then turns the briefing session over to Colonel Rothler.

"Most of you have been briefed individually," he begins. "And you know what your missions are. But for the benefit of all of us, particularly those that have just joined us, we will quickly go over the operation." The colonel turns to a nearby easel displaying a map of the area around Innsmouth. Brandishing his cigar like a pointer, he outlines the mission.

"There are numerous objectives we wish to achieve, but the capture and questioning of all citizens of the town is



CPT. ANTHONY CORSO

paramount. To accomplish this, penetrating actions by small groups of marines will either capture inhabitants, or drive them inland where they will be intercepted by roadblocks and patrols of marines sweeping into the town from the west. Hopefully, there will be a minimum number of civilian casualties. It is also the intention of the government that this operation be handled in a way that avoids arousing the fears or anxieties of neighboring communities. To this end we have purposely chosen to approach the problem with a minimum of manpower. We don't wish to attract attention. News of the action will be released to the public once the govern-

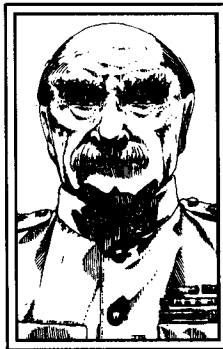

COL. JAMES ROTHLER

ment has had time to properly access the situation."

"The assault will be the coordinated efforts of several different groups, each operating separately. Central to the plan is the capture of the headquarters of the religious cult, The Esoteric Order of Dagon. Two squads of marines, led by Captain Corso, have been assigned this task."

Corso stands up halfway in his chair and nods to the investigators. In his late twenties, he is handsome and intelligent looking.

"Corso's squads, in white camouflage will enter town from the west, traveling down the frozen river, using the gorge for cover. They will exit the gorge at the Federal Street bridge and move north to the green, entering the hall through the front entrance if possible. All found within are to be taken prisoner. Certain cult leaders may be encountered here, and can be identified by the robes and golden jewelry they are reputed to wear. These individuals must not be allowed to escape. The marines have orders to shoot if necessary."

Colonel Rothler gestures towards Major Maines, presently in the act of pouring himself another drink.

"Major Maines here will lead a squad of hand-picked men to effect the arrests of certain town leaders."

Maines raises his glass to the investigators and winks. At least forty, his face is strong, tanned and lined by years spent in the Corps—a true leatherneck.

"His group is to enter the Marsh Mansion on Washington Street and there effect the arrests of certain town elders and their families. His squad will accompany Corso's squads down the river until they reach the Washington Street bridge. Here Major Maines' squad will detach, heading north to their objective.

"Meanwhile, two carloads of agents of the United States treasury will enter Innsmouth from the south, cross the river, and effect an entry into the Marsh gold refinery. FBI Director Hoover and agent Mackey will be leading this mission. They're to seize any officials or documents that they may find, as well as any gold stores, before demolishing the entire building."

Rothler looks at the young lieutenant seated at the table.

"In the meantime Lieutenant Doud will head up two squads of marines in boats who will enter the network of underground caves and tunnels north of town."

The cocky young lieutenant glances down toward the investigators and nods.

"These caves were once used by smugglers. We have reason to believe that they may be being used today as part of a white slavery operation. Lt. Doud is to look for evidence of this as well as demolishing the empty warehouses



J. EDGAR HOOVER



DR. NAJAR

these tunnels lead to.”

Colonel Rothler next indicates the naval officer seated at the table.

“The Coast Guard has provided us with the services of Commander Hearst.”

Hearst, his gold-trimmed dress blues resplendent compared to the olive drab of the marine officers, looks every inch an officer. Strong-jawed, intelligent, he raises a hand to the civilians.

“Commander Hearst will command three vessels charged with patrolling the coast line. Some of the culprits may attempt to escape by boat. It is the responsibility of Commander Hearst to see that they do not get away.”

“As some of you know, this meeting was also to be attended by Commander Harrow of the United States Navy. Commander Harrow was unavoidably delayed by a submarine rescue operation off the north coast. His vessel, the S-19 is due to arrive in port in the next hour. Sealed orders regarding his mission await his arrival.”

The Colonel begins to wrap up the briefing. “I suggest that we spend the next twenty minutes or so getting to know each other. The civilian advisors will be participating in these actions and I think it would behoove some of the officers here to see what they can learn from them.”

Over the next few minutes most of the officers—with the exception of Lt. Doud—show little reluctance to mix with the civilians. Questions are asked, and advice listened to. Only Doud seems to effect a haughty, superior attitude. The investigators first impressions are confirmed. Although

hints are made—and rumors abound—the government does not officially recognize the existence Innsmouth’s monstrousness. Investigators find that if they talk too freely of “deep ones” and “Great Old Ones,” they are met with skeptical looks.



LT. ERIC DOUD

Only Dr. Najar seems to share some of the investigators’ views. Posing behind the facade of a scholarly academic, it is soon apparent that he and the investigators share an interest in the Cthulhu Mythos. He secretly believes that they may be going up against much more than the government realizes.

During this time, the investigators should come to a decision about which portion of the raid they will accompany. The keeper, after looking over the six different raids, may wish to consider the individual investigators’ particular skills and encourage choices that best suit his players’ characters. Dr. Najar has already volunteered to join the group entering the Marsh mansion, but encourages another of the advisors to join him.

THE TIME IS NOW

At some point one of the investigators will probably inquire as to when the raid is scheduled to take place. The officer he asks will look at his wristwatch, back at the investigator, smile, then say: “in about two hours, I think.” Intelligence reports have revealed that the government investigation may have been discovered. The decision has been made to conduct the raid immediately.

Before long the meeting breaks up. Those investigators who have chosen to accompany the raiding parties assaulting the Esoteric Order and those who are aiding in the attack on the Marsh mansion are escorted downstairs and shown into the back of one of three large trucks, each filled with marines and their gear. Two of the trucks pull away, heading north for their staging point just east of Rowley. Mackey and Hoover take the Refinery-raiding investigator to where a handful of Treasury agents are waiting with a pair of black sedans and a truck with a snowplow blade affixed to the front.

Investigators accompanying the tunnel raiders, the Coast Guard patrol, or the submarine are driven in Navy staff cars to the nearby Boston docks where the Coast Guard vessels and the newly-arrived sub await them. The remaining truckload of marines follows the staff cars. The tunnel raiders will sail to Innsmouth aboard the Coast Guard cutter, and then be dropped off near shore. The three Coast Guard vessels will be accompanied on their voyage by the S-19 submarine cruising the surface.

In all cases the investigator advisors will have time to meet and get to know some of the non-player characters they will be working with. During this time other players will go about choosing their supporting characters from among those supplied.

Project Covenant

Project Covenant is the name the government has assigned to this top-secret undertaking. A halved Know roll reveals that the name is derived from the biblical story found in I Samuel describing how the Ark of the Covenant dismembered a statue of Dagon at Ashdod. Otherwise, Drew can explain the relevancy of the name.

THE PASSWORD

In order to identify each other, those taking part in the raid will use the password “Samson.” Roadblocks will be placed on all roads leading in and out of Innsmouth and squads of marines will patrol the open ground searching for civilians attempting to flee town. Raiders may accidentally encounter one of these mop-up squads and will use the password to identify themselves.

Unfortunately, an insane investigator must make a halved Idea roll to recall the password. Failing, they will be arrested and shoved into a truck full of frightened, fishy-smelling Innsmouth refugees. Sanity point loss is 1/1D4. See The Fate of the Prisoners in the Conclusion of this scenario for further indignities suffered by such hapless investigators.

Last Minute Notes

COLD WEATHER EFFECTS

Mid-February is the coldest time of the year in Massachusetts. On the morning of the raid, the temperature is a chilly 23 degrees F, with just a hint of spitting snow. The ground is thinly covered by a previous snowfall, now iced and crusted over.

The streets of Innsmouth are slick in places, and snow drifts have accumulated. Characters hurrying over icy pavement might need to make DEX rolls to keep from falling, while those plodding through knee-deep drifts should have their movement rates reduced accordingly. The Manuxet river is frozen over, but the ice is thin in some places. The waters of both the river and the harbor are extremely cold; exposure for more than a few minutes may result in hypothermia or even death.

Finally, the cold weather might render the deep ones slightly sluggish. Keepers may reduce their DEX by 1-2 points to reflect this.

Other possible effects of winter weather may present themselves to the ingenious keeper.

INVESTIGATOR WEAPONS AND EQUIPMENT

Investigators may be without arms and are probably lacking any equipment. They will be supplied as needed, as described in each raid scenario. The raid takes place in mid-winter and warm clothing is a must. The raid forces will loan the investigators military issue coats and boots. The bulky clothes provide 1D3-1 armor protection, but can reduce DEX by 1D2 points.

SPECIAL SANITY RULES

Because of the special conditions, investigator sanity is handled in a slightly different manner. Charged with adrenalin, and bolstered by the support of fellow raiders, bouts of temporary insanity will be of the shortest duration, usually no more than 1D4 rounds. Indefinite insanity does not occur during the raid, although after-effects may manifest themselves following the raid, as outlined in the conclusion.

Major non-player characters should be treated in a similar manner, although the keeper is encouraged to ultimately decide their fates, lives, or deaths, as suits his sense of drama. Some of these characters may have specific reactions, as outlined in their descriptions.

SPECIAL INSANITIES

The following insanities are intended for use with non-player and supporting characters. A keeper should carefully consider the consequences before inflicting these on an investigator. They may be rolled randomly, on a D6.

1-3 The character is immobilized with fear, obeying no further orders and taking no further actions—perhaps lying down and curling up into a ball, but probably just freezing, staring with horror. Roll Sanity on subsequent rounds (or at appropriate intervals) and if the roll succeeds the subject snaps out of it and rejoins the main action.

4-5 The crazed character surrenders to battle-lust. No longer interested in the reasoned orders of his commanding officer, the character attacks all enemies in sight, emptying his gun frantically. He then attacks with combat knife or fists, not stopping until he or all visible enemies are dead. When all enemies have been eliminated the character shakes off his berserk rage.

6 The character breaks, totally demoralized by the horrors crowding his tortured mind. The character flees the scene in a blind panic and doesn't return to the scenario, save as a corpse or a madman.

STREAMLINED DICE ROLLING

To speed combat it is suggested that attack and other skill percentages be divided by 10 (dropping all fractions) and rolled on D10s. For example, a Rifle skill of 45% converts to a skill level of 4 (45 divided by 10 equals 4.5, which is rounded down to 4) on a D10. Using this method, handfuls of D10s can be rolled for attacks. Rolling a 10 is always a miss; while rolling a 1 is always a hit. Using colored dice, keepers can even assign specific dice to represent certain characters in the scenario.

KEEPER AIDS

A number of helpful references are included at the back of this book. A listing of some of the more common weapons found in this scenario describe everything from fighting knives to .50 caliber machine guns. Also included are selections of pre-generated deep ones and hybrids—both lightly and heavily armed—which can be photocopied and used during the raid. Blank supporting character sheets are provided to help players keep track of the different roles they are expected to play. Finally, a Raid Record is supplied to aid the keeper in keeping track of the hit points and sanity of the primaries of the different scenarios. See pp. 156-158 for these references.

Staging the Raid

Before actually playing any of the raid scenarios, the keeper should conduct a series of brief staging scenes during which investigators will be able to meet their commanding officers and other non-player characters, and requisition any necessary equipment; other players also may choose the supporting characters they will be playing in this adventure at this time.

Investigators involved in the Smugglers' Tunnels, Devil Reef, and Y'ha-nthlei missions meet at the Boston docks, where the Coast Guard vessels and the S-19 submarine await. Those accompanying the Esoteric Order of Dagon and Marsh Mansion raiders meet on the western outskirts of Innsmouth. The Marsh Refinery raiders rendezvous near Falcon Point, on the coast road south of Innsmouth.

Once the staging operations are completed the raid may then begin.

*Go to Part One of Objective Three
The Smugglers' Tunnels*



OBJECTIVE ONE: THE ESOTERIC ORDER OF DAGON



The main goal of this objective is the seizing of the headquarters of the Esoteric Order of Dagon and the capture of its leaders. The marines are expected to identify and confiscate any evidence of illegal activities. Under orders to restrain their fire when possible, the marines have nonetheless been equipped with rifles and grenades, and have been instructed to shoot cult leaders before allowing them to escape. Explosive satchel charges are provided in case the sudden destruction of the headquarters is deemed necessary.

The Esoteric Order Raiders

Two squads of marines, totalling sixteen men in all, have been assigned to this mission. Under the command of young Captain Anthony Corso, the unit consists almost entirely of newly-trained recruits from Fort Hoskins in nearby Wareham, Massachusetts. The only experienced combat veteran is hard-face Sergeant Emile Grabatowski, a veteran of the World War, and presently nearing retirement.

Captain Corso and Sergeant Grabatowski, along with any number of enlisted marines, are keeper-characters. Players without investigators take the parts of enlisted marines, choosing from the five recruits detailed under Supporting Characters.

CAPTAIN ANTHONY CORSO

Corso is a product of West Point, a specialist in military history who graduated near the eleventh in his class. Although he has a clear idea of the tactics required of this situation, he has never held a field command. Under fire he may hesitate, trying to order his thoughts, bringing only the best book-learned tactics to bear on desperate and rapidly-unfolding situations. Once Corso's sanity begins to slip he becomes increasingly adamant about following the patterns of history's great generals.

Corso is subject to short bouts of temporary insanity in the form of a collapse of nerve. Corso may fold up during the raid, leaving Grabatowski and the investigator to lead the green recruits.

CAPT. ANTHONY CORSO, 26, squad leader

STR 16 CON 9 SIZ 14 INT 13 POW 9
DEX 10 APP 8 EDU 16 SAN 45 HP 12

Damage Bonus: +1D4

Weapons: .45 Automatic 45%, 1D10+2
Commando Knife 40%, 1D4+2+db
Throw Grenade 40%, 4D6/4y

Skills: Textbook Tactics 65%.

SERGEANT EMILE GRABATOWSKI

"Sarge," a World War veteran, is a survivor of the battlefield of St. Michel. After the war he was assigned to Fort Hoskins as a drill instructor where he has since trained thousands of young recruits. He volunteered for the Innsmouth raid, hoping to recapture his slipping sense of purpose. He sees this as his last chance to experience a few fleeting moments of glory before retiring from the Corps.

Grabatowski is tough, but cool and level-headed. More than likely he respects the investigator's knowledge of the situation, particularly if the investigator is closer to his own age than is young Corso. If driven temporarily insane, Grabatowski is likely to charge right down the enemy's throat, ending his life in a last blaze of glory.

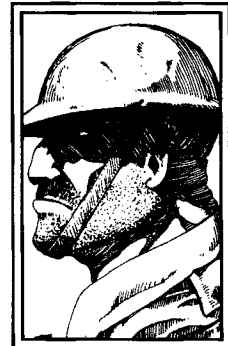

SGT. E. GRABATOWSKI

SGT. EMILE GRABATOWSKI, 48, battle-hardened veteran

STR 15 CON 8 SIZ 13 INT 12 POW 18
DEX 15 APP 14 EDU 9 SAN 95 HP 11

Damage Bonus: +1D4

Weapons: Thompson Submachine Gun 65%, 1D10+2
Commando Knife 60%, 1D4+2+db
Throw Grenade 75%, 4D6/4y
Head Butt 60%, 1D6+db

Skills: Ambush 65%, Shout Orders 85%.

OTHER MARINES

The rest of the unit consists of young enlisted men recently graduated from boot camp. Typical statistics are listed below. Each marine is equipped with at least a .30-06 rifle and three pineapple-style hand grenades. Warned not to use the grenades unless absolutely necessary, there is a 50% chance that once the shooting at the temple starts, the green recruits begin lobbing them at the enemy.

TYPICAL MARINE RECRUIT

STR 12 CON 16 SIZ 15 INT 9 POW 11
 DEX 12 APP 11 EDU 13 SAN 55 HP 16

Damage Bonus: +1D4

Weapons: .30-06 Bolt-Action Rifle 40%, 2D6+4
 Bayonet 35%, 1D4+2+db
 Throw Grenade 35%, 4D6/4y

Skills: Hide 35%, Listen 35%, Sneak 35%, Spot Hidden 35%.

Supporting characters are described in the next section. Those recruits that are played by the keeper include Privates LaPaca, Hammer, Whitney, Carron, Tully, Fulci, Moore, Prochowski, and Tolben. LaPaca carries two satchel charges.

Supporting Characters

Players without investigators take the parts of individual marines. Players may use the typical characteristics listed above, or roll up their own. Skills should be no higher than those listed under Typical Marine, with the occasional exceptions noted below. The keeper should take the part of any characters not chosen by players.

LANCE CORPORAL CHARLES DRAKE

The brightest recruit in his boot camp class, he was promoted to Lance upon graduation. The product of a well-to-do Boston family, Drake is next in command after Corso and Grabatowski.

Skill: Browning Automatic Rifle 50%, 2D6+4.

PRIVATE PETER RONDALE

Rondale is a tall, lanky, shy man. Back home in Indiana he was the star pitcher on his local baseball team. He's never seen without a mouthful of chewing tobacco.

Skill: Throw Grenade 85%, 4D6/y.

PRIVATE DENNIS PARKER

Parker is one of the unit's two demolition experts. The strong and silent type, he is nervous about the explosives he has just barely learned to handle. On any demolitions roll of 91-00, Parker accidentally sets the charge off early, killing himself and possibly injuring others. He is equipped with two satchel charges.

Skill: Demolitions 55%.

PRIVATE FIRST CLASS DALTON TRIMBLE

Trimble, a Kentucky farm boy, won his company's marksmanship competition in boot camp. Upon graduation he was promoted to PFC.

Skill: .30-06 Bolt-Action Rifle 85%, 2D6+4.

PRIVATE GORDON PRUITT

Pruitt was a high school football star. Ferociously competitive, he looks forward to close, hand-to-hand combat, one man against another.

Skill: Bayonet 75%, 1D4+2+db.

Part One: The Frozen River

The raiders, accompanied by the squad attacking the Marsh mansion, enter the town from the west, following the course of the frozen Manuxet River. Moving in the cover of the deep gorge, camouflaged by their white suits, they move in a silent group until the Marsh Mansion squad diverges from the rest of the marines near the Washington Street bridge. The main unit continues on alone to the Federal Street bridge. Here they climb the gorge, emerging on the streets just south of New Church Green, and head for the temple.

At least this is the plan. Anything can go wrong, and the marines realize it. Investigators attached to the squad are

Personal Equipment

Investigators will be issued their choice of either a .45 automatic pistol or a .30-06 rifle, complete with extra ammunition. They are not issued grenades, although they may be able to salvage some from casualties. Other equipment includes a white camouflage suit, a fighting knife, and a flashlight.

NEW WEAPONS

Some of the supporting characters carry new weapons: a Browning Automatic Rifle and satchel charges.

BROWNING AUTOMATIC RIFLE (BAR): A light machine gun weighing over twenty pounds, the air-cooled BAR was used as an infantry weapon. It is chambered for a .30-06 round, and at this date had a short barrel and no bipod. It employs a 20-round magazine, unlike the later and heavier belt-fed versions.

Rate of Fire: 1/2 or burst (burst fires 10 rounds)

Damage: 2D6+4

Base Range in Yards: 90

Magazine: 20 rounds

Malfunction: 00, 91-00 if burst.

SATCHEL CHARGES: The unit is equipped with four charges—Privates Parker and LaPaca each carrying two. The mechanical timers can be set for as long as 60 minutes, or as short as a few seconds. Each charge has a blast radius of 6 yards, and does 10D6 damage to living targets caught within the radius. The amount of structural damage they are capable of depends on numerous factors, but it is safe to assume that two well-placed charges could demolish the Esoteric Order's headquarters.

urged to stay to the rear; point men proceed in close order with bayonets fixed, under the command of Sergeant Grabatowski.

Frozen Falls

Poor light makes scrambling down the rocky falls hazardous. A failed Climb roll means a slip and fall, possibly plunging the character into the freezing open water below the falls. This could result in something as minor as a soaking wet leg to full submersion in the icy river, depending on Luck rolls. A fully equipped marine or investigator can only make one Swim roll before the effects of Drowning begin. Failing this roll results in the victim being pulled under the ice and carried downriver by the swift current, eventually wedging up against a bank somewhere. Breaking through the ice from underneath requires the victim to make a successful STR roll against the frozen surface, its STR equal to 3D6+2. If the victim's companions can locate him, it will take only 1D4+1 rounds to chop him free.

Anyone experiencing complete immersion suffers up to 1D6+2 points of hypothermia damage—although this can be adjusted downward if the character is rescued quickly enough. Failing a CON x5 roll results in a case of pneumonia, its first symptoms showing up the following morning.

A Chance Encounter

This first event occurs after the Marsh Mansion raiders have left the group, and right after the Esoteric Order team has climbed down the second waterfall, in the area between Broad and Federal Streets. There is a large patch of open water at the foot of these falls.

Make Listen rolls for the investigator and any supporting characters, as well as the squad's leaders, Corso and Grabatowski. If successful, someone hears a scabbling among the rocks high above the river bank, just a little farther down the river. Corso hesitates a moment, indecisive, then sends his men for cover. If no one hears the noise and the raiders move forward, they are surprised by a sudden encounter with a group of Innsmouthers who have climbed down the gorge onto the ice of the river.

A lone, sluggish deep one leads a group of 2D3 hybrids. The hybrids carry between them a naked man who seems to be weakly struggling against them. Climbing down the gorge in the pale moonlight requires all the hybrid's attention and it is unlikely that they notice the stealthy approach of the camouflaged raiders.

The man they carry is about thirty years of age, a hybrid in the last stages of transformation. His fully-developed gills are sealed over by an abnormally thick layer of skin, resulting in the man's slow suffocation. His unblinking eyes bulge painfully from their sockets and his skin is a cyanotic shade of blue. If the man doesn't get to water soon he will suffocate inside his own flesh. All witnesses lose 0/1D6 Sanity points.

If the raiding party is surprised, the two groups spot each other right after the hybrids have reached the surface

of the river. If the raiders have had time to hide, the hybrid party starts heading for the open water below the falls. There is a 50% chance that they spot a poorly hidden marine. If the raiders attack, the deep one makes a dash for the open water below the falls while the hybrids break and run, trying to get back to town (to possibly raise an alarm). The transforming hybrid is left abandoned on the surface of the ice, twisting and kicking as suffocation slowly tightens its merciless grip.

The marines are ordered to fight man-to-man, keeping silent. No gunfire or grenades. Corso orders a handful of marines after the fleeing hybrids, Grabatowski reminding them: "Bayonets only. No fire!" Most of the hybrids may be killed or captured, but at least one will escape to warn the town of the raiders' approach.

The naked, partially transformed hybrid is left twitching on the ice, warmth draining from his muscles as he struggles for oxygen. His glassy eyes fall upon the investigator, and he reaches forth a trembling hand, imploring aid. The investigator loses 1/1D3 Sanity points.

The investigator may either push the deep one into the icy water where the sudden immersion completes his transformation, execute the monster, or simply wait for the hybrid to die.

A few moments are wasted as startled young marines whisper excitedly about the "fish-headed thing" they saw leading the group of men.

New Church Green

The plan is to ascend the bank near the Federal Street bridge and emerge at street level near the green. A small fire team consisting of three riflemen and the investigator are sent up first to reconnoiter the situation. One Climb roll is required by the investigator to reach the top, a failure indicating a slip. A failed DEX x5 roll then results in 1D2 points of damage and a painfully twisted ankle that will plague the investigator throughout the remainder of the raid.

Once sure the coast is clear, the rest of the marines are ordered up the bank.

APPROACHING THE TEMPLE

Alerted by the hybrid that escaped the marines, the Esoteric Order has set armed guards at the front of the building. 3D4 hybrids equipped with rifles and shotguns lurk near the entrance, hiding in the shadows of the huge, Doric columns gracing the front of the old Masonic Hall.

As the marines advance toward the Green at a trot, the hybrids emerge from hiding and open fire. Once they have emptied their weapons they do not reload but instead charge across the Green, attacking the raiders with rifle butts, knives, and scaly hybrid fists. The marines are free to gun them down as they hop and shamble across the green, shouting, barking, and grunting.

The guards are probably quickly defeated, and the night falls silent again. Nothing seems to stand between the raiders and the temple. But as they get halfway across the green they are suddenly bathed in headlights as a truck roars



A STARTLING PLEA FOR AID

down a nearby street, racing directly toward them. Jumping curbs, the vehicle bears down upon the main body of marines. In the open back of the truck are 1D4+4 hybrids, some of Innsmouth’s best marksmen, and they open fire on the raiders. Their normal skill is 60%, but shooting from the bed of the bouncing truck reduces their skill by half; their badly maintained rifles jam on rolls of 91-00.

The truck bounces over the icy, frozen green, bearing down on the marines, but is unable to attain a speed much above 25 mph. Anyone caught in its path can easily get away unless they fail a DEX x5 roll and slip on the ice. Unless quickly snatched away by a companion, the character is run over, suffering 2D10 points of damage. The driver of the truck intends to make one pass through the marines before circling around and taking up a defensive position in front of the hall. For purposes of this encounter the hybrids’ truck has 20 hit points, but is only damaged by impaling shots. Damage in excess of this amount renders it inoperable.

Once parked in front of the hall, half the armed hybrids scramble out and take up covered positions behind the hall’s columns. The rest remain in the bed of the truck, firing at anything that moves.

Sgt. Grabatowski volunteers to lead a few men close enough to take out the truck with grenades, although it seems a nearly suicidal action. He first seeks out the investigator.

“Is there anything we should know before me an’ my men risk our necks on that truck? Is there another way to get into that place other than blasting our way past that bunch of fish-heads?”

An investigator who knows the area might remember other entrances located on the south and west sides of the building. The back entrance is the least likely to be guarded and the best bet, although its small size won’t admit more than one or two men at a time.

Corso respects the investigator’s knowledge, and is willing to order a rear assault if that is what the investigator suggests. Grabatowski suggests that he and a handful of men remain out front to occupy the hybrids while Corso circles around with six marines and the investigator, and try to find the rear entrance.

A REAR ASSAULT

At the back door there is no sign of fortification or guard, only a very stout wooden door covered with peeling white paint. The locked door has a STR of 25. It is possible to open the door with a Locksmith skill, but this requires the proper tools and several minutes’ time. A satchel charge is quick and effective, although it negates any chance of surprise. Corso, now without Grabatowski, looks to the investigator for advice.

If it is decided to use stealth, make Sneak rolls for those testing or listening at the door. Any failure indicates that the horror waiting on the other side of the door is aware of the intruders. Alerted, it bursts out and attacks immediately. At the keeper’s option it may be accompanied and aided by 1D3 deep ones.

HORROR FROM BEYOND THE DOOR (Josiah Bentley)

STR 17 CON 15 SIZ 14 INT 1 POW 9
DEX 12 APP NA EDU NA SAN NA HP 15

Damage Bonus: +1D4

Weapons: Claws x2 25%, 1D6+db each
Horn-Tipped tentacles 40%, 1D6+db

Armor: 1 point of scales.

Sanity Loss: 1/1D6+1

This creature was born Josiah Bentley, but is one of those sometimes referred to as a “beloved of Cthulhu”. Sired by a human, the fetus, while in the womb of its deep one mother,

was affected by dreams thought to have been sent to it by Great Cthulhu himself. The strange dreams altered the creature's DNA and although born appearing generally human, it was equipped with horn-tipped tentacles sprouting from its face and shoulders. Over time its appearance changed until it now resembles one of Cthulhu's servitor star-spawn.

It does not possess anything resembling human intelligence and is normally kept locked in the depths of the Order's basement. It has been released tonight to help protect the Order from the raiders. It enjoys plunging its dagger-sharp tentacles into its target then lapping the blood that wells from the multiple wounds.

Once Josiah and the hybrids guarding the front of the temple are dealt with, the night falls silent. The quiet building beckons the raiders to enter.



THE HORROR

*Go to Part One of Objective Six
The Marsh Refinery*

Part Two: Inside the Order

Once the raiding forces have dealt with the hybrids guarding the front entrance, and possibly Josiah Bentley at the rear, they may enter the temple. At first, all seems quiet.

The keeper should use his imagination to keep luring the raiders along, exploring the upper portions of the temple as long as possible. Once they move to explore the basement, Part Two of this scenario ends.

The Ground Floor

FRONT ENTRANCE

This is a dingy place, decorated with ragged Masonic pennants hanging from the high ceiling. All seems quiet, but waiting in ambush, on the balcony above, are 2D3 armed hybrids. Successful Listen or Spot Hidden rolls can foil their plan to surprise the raiders. Otherwise their first shots +20%.

MAIN HALL

This is a large meeting hall filled with rows of benches. A podium stands at the far end of the room; above it hangs a limp and dusty banner with the seal of the Esoteric Order of Dagon. A stairway in the corner leads up to the second floor.

The long benches are not secured to the floor and can be tipped over and used for cover. The thick hardwood provides twelve points of armor.

SMALLER ROOMS

These are offices and storage rooms. Brewster's office is unremarkable, but a search of Marsh's turns up a handwritten manuscript called *The Book of Dagon*. A translation of the carvings found on certain stones hidden in the basement of the hall, it is a flawed and far less complete version than the one Thomas Waite keeps in his safe. Reading Marsh's scrawled handwriting requires an English roll.

A page chosen at random describes the nature of something called a "dealstone." A second randomly chosen page contains information about the "beloved of Cthulhu," mutant hybrid offspring thought to have been touched and transformed by dreams sent by Great Cthulhu himself. Reading the entire translation takes four weeks, adding 7% to Cthulhu Mythos and costing 2D4 Sanity points. The translation contains the spells Contact Deep Ones and Breath of the Deeps, with a x2 multiplier.

The Second Floor

Most of the rooms on the second floor are small meeting chambers or offices, all rarely used. Waiting silently on the balcony are 2D3 deep ones. They wait for the marines to gain the second floor before attacking.

These creatures fight to the death, wielding strange javelins of rough, green coral that glow faintly in the shadowy light. The deep ones use their weapons like fighting spears, each with a 35% chance to hit. The spears cause 1D8+1 points of damage and are capable of impaling. The coral spears are fairly fragile and can only be used as thrusting weapons. Any successful hit indicates the target has been skewered by the javelin. The victim may attempt to remove the javelin on the following round, but only if he is not under attack, and successfully only with a roll of DEX x5 or less. Usually, once a deep one's spear has been driven home, the creature then attacks with claws and teeth. Unless someone intervenes to draw off the deep one, the speared character will have no chance to pull the spear out. The coral is delicate and a failed roll means the tip has broken off to remain embedded in the flesh.

On the second round after being hit, the power of the spear begins to sap the life from its victim. The stricken character must use his POW to resist the spear's enchantment STR of 12, or take an additional 1D6 points of damage as the spear sucks out the victim's body heat. On the second round after the character fails the struggle, green, salty seawater begins to surge through the victim's body, spurting from the wound, and causing another 1D6 points of damage. On following rounds seawater begins to pour from the victim's ears, mouth, nose, and anus, and from under finger and toe nails. Eyeballs bulge from the internal pressure, and the victim suffers 1D6 points of damage every round until dead or the spear is somehow removed.

THE ROBING CHAMBER

Hanging inside metal lockers are the blue-green, strangely decorated robes worn by the priests of the Order. The arched ceiling in this room is hand-painted, depicting a

The Esoteric Order of Dagon

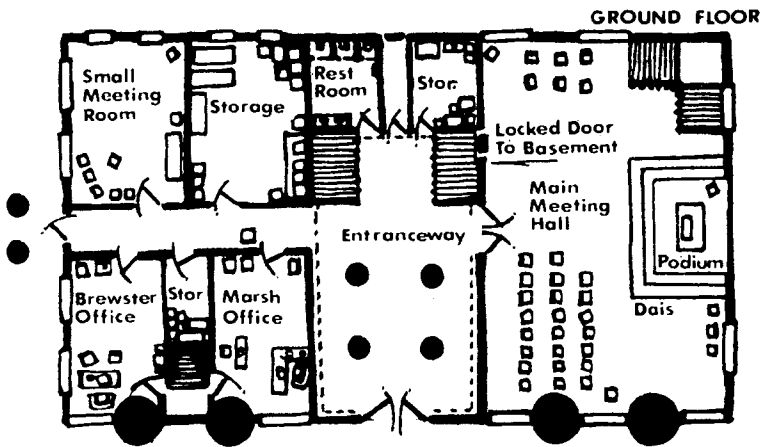
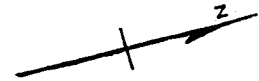
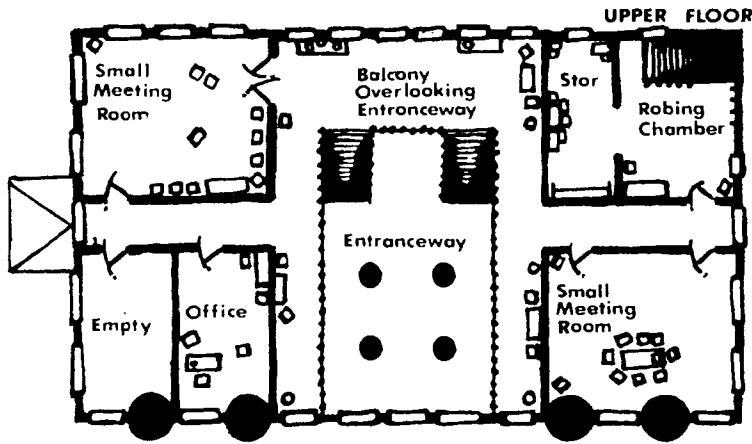

- Pillars
- Railing
- Window
- Door
- Locked Door
- Stairs Going Up
- Stairs Going Down
- Miscellaneous Furniture

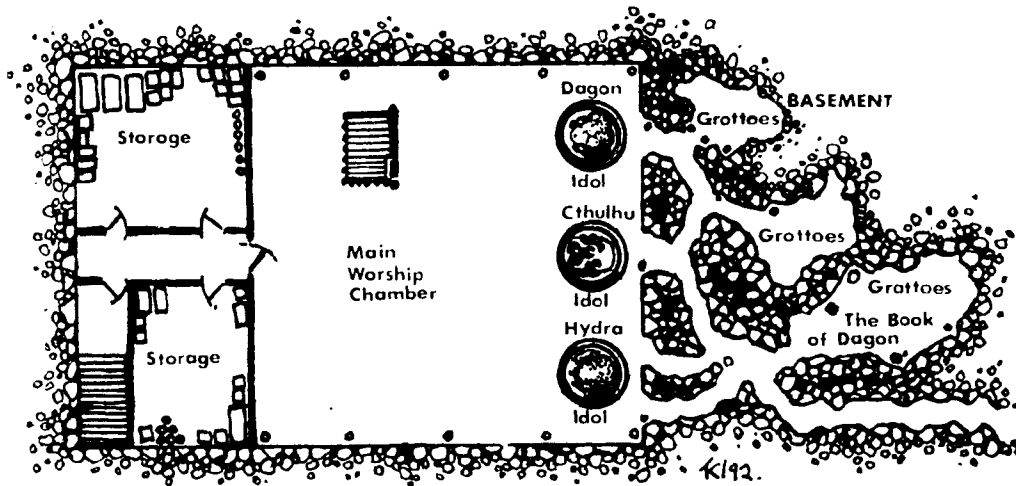

view of the dread underwater city of Y’ha-nthlei. A vast community of coral and rock formed into homes and buildings, the landscape is graced by waving fan corals, sea vegetation, and other life forms. In the background a hulking shape of disturbing proportions can be seen. A successful Cthulhu Mythos roll allows the viewer to identify it as Dagon, the Great Father.

In the opposite corner a stairway leads back down to the main meeting hall on the first floor. On the far wall a dark green curtain conceals an open doorway leading into another room.

Beyond the green curtain, the ceiling painting is found to continue on into the next room, here spreading down to decorate the walls as well. The effect is as though one were actually under the sea, an eerie feeling that costs 0/1 Sanity points. A black doorway depicted on one of the foreground buildings is actually a gate leading to the Gate Room in the air-filled chambers of Y’ha-nthlei.

BEYOND THE GATE: Anyone passing through the gate loses one magic point and one Sanity point. Consult The Air-Filled Chambers in description of Y’ha-nthlei (1012) for details. The descriptions there hold true even during the raid. Keepers might wish to have Barnabas Marsh hiding in the Guest Spire with 2D3 former Marshes now turned deep ones.

Visiting the underwater city for any length of time is dangerous. Later in the adventure, during Part Three, the submarine fires on the city. Characters in the city at this time can hear, with successful Listen rolls, the dull thudding of torpedoes tearing into the city. If they don’t guess the cause of the sounds, an Idea roll might allow them to recall the submarine’s mysterious mission. Quick escape is essential to avoid being caught in the attack. Rushing back to the Gate Room they feel the ground rumble with explosions. Crystal windows, their seals damaged, begin to leak seawater into the air-filled chambers. This harrowing situation calls for a Sanity loss of 1/1D3 points.

If the keeper wishes to throw the players a further curve, the gate back to the Esoteric Order might be cracked and inoperable, forcing the characters to use a different gate, or possibly the long flight of steps leading up to Devil Reef.

*Go to Part Three of Objective Two
The Marsh Mansion*

Part Three: Disruption

The Basement

The Order, perhaps only moments before echoing with screams and gunfire, is now as quiet as a church. The stairway to the basement is unprotected. Listening from the

main meeting hall, the squad hears the quiet murmur of many voices coming from below.

The door opens easily, revealing a flight of stairs that look as though they were hewn directly from the rock. Moisture and mud adheres to the surface of walls and ceilings. Men descending two abreast pick up a layer of black filth scraped from the dank walls. Once on the stairs, a successful Listen roll picks out the word “Dagon” from among the otherwise incomprehensible mutterings. Two sputtering torches on the walls provide a dim, shadowy light.

At the foot of the stairs the characters find a large, barren room filled with row after row of kneeling worshipers. From the far wall statues of Father Dagon, Mother Hydra, and Great Cthulhu, carved from gray stone veined with black striations, glare down on their followers. Witnesses lose 1/1D3 Sanity points.

Disturbed by the appearance of the raiders, 3D6 worshipers stand and turn, their robes dropping away to reveal them as full deep ones, each of them armed with one of the glowing, coral spears. Robert Marsh and Jeremiah Brewster, high priests of the Order garbed in robes and gold tiaras, also turn to face the invaders.

Marsh, Brewster, and the deep ones continue to intone the ritual phrases in a language unknown to humans. A Cthulhu Mythos roll identifies the ritual as a summoning sent to Dagon. At least one young marine panics and opens fire as the rest of the congregation rises to face the shocked party of raiders. Although most of the worshipers appear human, they are all hybrids with the taint of the deep ones in their faces. The congregation include men, women, and small children.

ROBERT MARSH, 46, hybrid and high priest

STR 13 CON 15 SIZ 14 INT 16 POW 22
DEX 13 APP 6 EDU 14 SAN 0 HP 15

Damage Bonus: +1D4

Weapons: Grapple 50%, special
Sacrificial Dagger 70%, 1D4+2+db
.38 Revolver 35%, 1D10

Skills: Anthropology 40%, Archaeology 35%, Astronomy 55%, Biology 35%, Cthulhu Mythos 75%, Dodge 40%, Hide 45%, History 55%, Jump 50%, Listen 40%, Occult 65%, Sneak 30%, Spot Hidden 50%, Swim 85%.

Spells: Breath of the Depths, Contact Cthulhu, Contact Deep Ones, Contact Father Dagon, Contact Mother Hydra, Curse of the Stone, Enchant Stone Tablet, Grasp of Cthulhu, Power Drain.

JEREMIAH BREWSTER, 47, deep one hybrid and priest

STR 16 CON 18 SIZ 16 INT 15 POW 20
DEX 12 APP 4 EDU 10 SAN 0 HP 17

Damage Bonus: +1D4

Weapons: Claws (x2) 75%, 1D6+db
Grapple 60%, special
Sacrificial Dagger 60%, 1D4+2+db

Skills: Astronomy 35%, Biology 45%, Cthulhu Mythos 60%, Dodge 45%, Hide 35%, Jump 65%, Listen 30%, Occult 55%, Sneak 25%, Spot Hidden 55%, Swim 95%.

Spells: Breath of the Depths, Contact Deep Ones, Contact Father Dagon, Contact Mother Hydra, Shrivelling.



THE SUMMONING IS DISRUPTED

The Climax

If Dagon has survived the attacks of the submarine and the Coast Guard vessels, he now reaches the temple. Bending down, the huge deep one thrusts his head and shoulders through the east windows of the main meeting hall. Realizing Innsmouth is lost, Dagon seeks the ancient tablets of The Book of Dagon, hidden in the tunnels behind the statues of Cthulhu, Dagon, and Hydra. Dagon smashes his fists through the wooden floor and reaches down into the basement. Timbers, plaster, and stone rain down on marines and worshipers alike, a Luck roll is required to avoid falling debris and 1D6+1 points of damage. Mighty Dagon looms above, costing 1/1D10 Sanity points.

The gigantic deep one croaks orders to his children below, telling them to seize the tablets then flee with them through the tunnels and out to the sea. Dagon may take a swing or two at any marines within reach, but due to his great size and cramped quarters, his claw attack is made at only 40%. After two or three rounds, Dagon leaves to return to the sea. He will avoid engaging in combat that seems likely to result in his death.

If Dagon was stopped before reaching town, the congregation's summoning is in vain. As the first marine fires without orders, the shouting hybrids flee for the exits while the deep ones move toward the tunnels. Marsh selects an appropriate target (an investigator or commanding officer) and casts *Breath of the Depths*. As the target suffers the effects of the spell, Marsh, Brewster, and the deep ones flee into the grottoes and tunnels beneath the temple.

As the marines move to pursue, the panicked hybrids inadvertently block their way. If the raiders open fire, they must make Luck rolls to avoid accidentally hitting hybrid women and children. At close range heavy caliber rifle rounds blow gaping wounds in whomever they hit. Blowing away a comparatively innocent woman or child could result in a loss of 1/1D4 Sanity points.

If Josiah Bentley, "The Horror from Beyond the Door," has not been encountered, he now surges forth from a dark cranny and attacks Corso, Grabatowski, or the investigator.

Marsh and the deep ones do not fight with the soldiers, instead fleeing through the grottoes hoping to make it to the smugglers' tunnels and the sea beyond.

The walls of the narrow tunnels are covered with a slippery, salty-smelling slime. While the deep ones quickly disappear into the winding passages, humans must make DEX x5 rolls to avoid falling and injury.

The Book of Dagon

Only one of the underground grottoes holds anything other than residual slime. Here Robert Marsh has set up a crude desk made of old planking. A battered hurricane lantern hangs from a cord slung over an outcropping.

Five cone-shaped stones, each over a foot high, are covered with strange glyphs. Crumpled wads of paper found lying about contain notes and scribbles that identify the stones as the original text of the Book of Dagon. The characters covering the tablets are R'lyeh glyphs, difficult, if not impossible for investigators to translate. Even Marsh

has long been stymied by some of the weird characters. Dr. Armitage, with opportunity and much time, might effect a fair translation—if his problematic nervous condition allows it.

Unfortunately, Dagon’s servants may also be after these tablets. Even if Dagon didn’t directly order the tablets’ retrieval, there is a 65% chance that Marsh or the other deep ones try to take them. Each is bulky, weighing over fifty pounds. A deep one could carry, at most, two at a time.

Translating and reading the entire text (which should take months, even with Armitage’s help) imparts +12% to Cthulhu Mythos and costs 2D8 Sanity points. The tablets contain the spells Contact Deep Ones, Contact Cthulhu, Breath of the Deep, Command Shark, and Command Porpoise, with a x4 multiplier.

After the Mission

After completing their mission, the raiders are supposed to hold and thoroughly search the building. Any strange items

are to be seized and additional captives taken if possible. Only if absolutely necessary is the building to be destroyed.

THE CONSEQUENCES

Each deep one or hostile hybrid slain during the adventure gains the investigator one Sanity point, with a limit of ten points. If the squad managed to capture Marsh or Brewster, award the investigator 1D6 Sanity points for each prisoner. Killing these two priests results in an award of only 1D3 points for each. If the priests escape, the investigator loses 1D6 Sanity points. If Barnabas is found in his Y’ha-nthlei hideout and captured, award the investigator 1D8 Sanity points; 1D3 for simply killing Barnabas. If Dagon is met and slain, another 1D10 Sanity points are awarded. Taking possession of the stone tablets brings an additional 1D4 Sanity points. Final rewards will be given in the conclusion section of the Raid.

*The Raid is Completed.
Go to the Conclusion.*



OBJECTIVE TWO: THE MARSH MANSION



This part of the raid calls for the capture of Barnabas Marsh along with other members of his family. The Marsh family is believed to be the power behind the Esoteric Order and a special commando unit has been assigned the task of sneaking into the Marsh mansion and capturing as many of the degenerate Marshes as possible.

Unknown to the raiders, Barnabas Marsh has heard rumors of the upcoming raid and by the time the marines have arrived he has already fled to the undersea city of Y’ha-nthlei. Other members of the Marsh family have rallied at the mansion, however, and will still be there. These may be taken prisoner.

Unknown to anyone, a force far mightier than the U.S. government is also at work in Innsmouth tonight. Monstrous Nyarlathotep has descended upon the town intending to capture Esther Marsh and spirit her off to fulfill his own vile

plans. The Crawling Chaos has infiltrated the raiders in the guise of the East Indian Dr. Ravana Najar, a supposed parapsychologist who has generously donated his services to the U.S. government. His credentials are impeccable.

The Marsh Mansion Raiders

THIS UNIT consists of seven men plus investigators accompanying the group. Captain Maines, Treasury agent Albert Ryan, and Dr. Najar are keeper-characters. Players may choose supporting characters from among the remaining four enlisted men.

MAJOR JOSEPH “FIGHTING MAD” MAINES

Major Maines is a seasoned military man who served in Europe during the Great War. A charismatic leader, his squad consists of hand-picked men trained in the arts of stealth and guerilla-style warfare. A military hero to the end, if mortally wounded he uses his last dying breaths to urge his men on. “Go get ‘em boys... get the job done fer yer Captain—and fer

Personal Equipment

Each investigator accompanying the raid is issued a white camouflage suit, two pairs of handcuffs, a commando knife, a small can of black face paint, a flashlight, and their choice of a .45 automatic or a .30-06 rifle, with ammunition.

Uncle Sam...” Maines has carried the nickname “Fighting Mad” for so long that he claims he can’t recall its origins.

MAJ. JOSEPH MAINES, 43, marine officer

STR 15 CON 16 SIZ 14 INT 12 POW 13
DEX 14 APP 10 EDU 12 SAN 65 HP 15

Damage Bonus: +1D4

Weapons: Commando Knife 55%, 1D4+2+db

Sabre 60%, 1D8+1+db

.45 Automatic 60%, 1D10+2

Skills: Camouflage 70%, Climb 80%, Dodge 60%, First Aid 65%, Hide 80%, Listen 75%, Mechanical Repair 35%, Persuade 75%, Spot Hidden 70%, Sneak 80%.

TREASURY AGENT ALBERT RYAN

Balding Albert Ryan is a government agent known for doing things by the book. Ryan disbelieves the unsubstantiated rumors of monstrosities, believing instead that some sort of smuggling ring is operating out of Innsmouth—perhaps even white slavers. Ryan falls to pieces at the first sign of supernatural events, or anything that denies the mundane world he chooses to believe in. Once he loses nine Sanity points he goes indefinitely insane, turns traitor, and attempts to make contact with the Marshes, offering his aid. When his usefulness is expended, the Marshes brutally murder him.

ALBERT RYAN, 45, treasury agent

STR 12 CON 15 SIZ 9 INT 14 POW 12
DEX 12 APP 10 EDU 13 SAN 45 HP 12

Weapons: .32 Automatic 40%, 1D8

Skills: Fast Talk 35%, Hide 30%, Law 65%, Listen 35%, Spot Hidden 35%, Sneak 40%.

DR. RAVANA NAJAR

Najar is a diminutive East Indian parapsychologist apparently in his mid-50s. He wears thick, round spectacles and speaks with a melodious eastern accent. He keeps mostly to himself but takes pains to warn the raiders that the situation they face may be extremely dangerous.

Ravana Najar is a human avatar of the Outer God Nyarlathotep. He has come here with the express purpose of capturing Esther Marsh, intending to use her for his own inexplicable purposes. Nyarlathotep true identity is revealed only after he has captured Esther Marsh—or if his Dr. Najar form is somehow “killed.” Slain, Najar crumples to the ground where, after a moment, the corpse begins to bubble and smoke. Then, with a great tearing sound, Najar’s body splits wide open and up rises a quivering, gaseous, shrieking form known as the Wailing Writher. The body of Dr. Najar is left a smoking husk that quickly deteriorates and disappears.

Watching this ghastly transformation costs 1D4/1D20 Sanity; hearing the shriek of the Writher costs 1/1D4 Sanity.

DR. RAVANA NAJAR, human avatar of Nyarlathotep

STR 12 CON 19 SIZ 9 INT 86 POW 100
DEX 19 APP 18 Move 12 HP 14

Weapons: Sword Cane 100%, 1D6

Skills: Any 100%.

Spells: All

Supporting Characters

Each of the following marines have unique characteristics and skills. Any characters not chosen by players should be played by the keeper. If there are more than four players needing characters then the keeper may create additional marines.

CORPORAL TONY “KID” DITULLIO

Ditullio is a tough kid from the Bronx, with slicked-back dark hair and ever-present five o’clock shadow. A tough, foul-mouthed smoker and drinker, he is nonetheless never seen without his crucifix hung round his neck. Tony was christened “Kid” during his Golden Gloves days back in the Bronx.

CPL. ANTHONY DITULLIO, 22, marine

STR 18 CON 16 SIZ 16 INT 10 POW 13
DEX 10 APP 17 EDU 11 SAN 65 HP 16

Damage Bonus: +1D6

Weapons: Fist/Punch 80%, 1D3+db

Commando Knife 75%, 1D4+2+db

.45 Automatic 35%, 1D10+2

Skills: Camouflage 35%, Climb 65%, Dodge 70%, First Aid 35%, Hide 50%, Listen 35%, Marital Arts 65%; Mechanical Repair 25%, Spot Hidden 45%, Sneak 65%.

LANCE CORPORAL WILLIAM LOGAN

Billy Logan is a bookish college boy adept in the sciences of chemistry and electricity. A thin, pale young man with long features and sandy hair, Billy is a favorite of the rest of the squad, who tend to treat him like their mascot.

LCPL. WILLIAM LOGAN, 25, chemical expert

STR 11 CON 10 SIZ 13 INT 18 POW 12
DEX 17 APP 9 EDU 14 SAN 60 HP 12

Weapons: Fist/Punch 50%, 1D3

Commando Knife 30%, 1D4+2

.45 Automatic 45%, 1D10+2

Skills: Camouflage 35%, Chemistry 80%, Climb 50%, Dodge 35%, Electrical Repair 85%, First Aid 40%, Hide 35%, Listen 40%, Spot Hidden 40%, Sneak 45%.

PFC PATRICK “LEPRECHAUN” O’BRIEN

Pat O’Brien is a red-headed lad with a wife and son waiting for him back home. A former street punk, Pat is tough and mischievous, with a strong back and a devilish grin. O’Brien’s nick-name is due partly to his ethnic background, partly to his abilities as a pickpocket. His sleight-of-hand reputedly “worked like magic.”

PFC PATRICK O’BRIEN, 23, light-fingered marine

STR 15 CON 16 SIZ 14 INT 12 POW 11
DEX 14 APP 12 EDU 12 SAN 55 HP 15

Damage Bonus: +1D4

Weapons: Fist/Punch 60%, 1D3+db

Commando Knife 50%, 1D4+2+db

.45 Automatic 55%, 1D10+2

Skills: Camouflage 65%, Climb 70%, Dodge 70%, First Aid 55%, Hide 70%, Listen 55%, Mechanical Repair 40%, Pickpocket 75%, Spot Hidden 70%, Sneak 70%, Track 40%.

PFC GEORGE “BULLSEYE” WILLIAMS

Williams is a down-to-earth Iowa farm boy with broad shoulders, boyish good looks, and the eye of a sharp-shooter. George is friendly, and everyone’s buddy. Williams’ nickname comes from his amazing shooting ability.

PFC GEORGE WILLIAMS, 19, marksman

STR 12 CON 14 SIZ 13 INT 12 POW 15
DEX 14 APP 16 EDU 12 SAN 75 HP 14

Damage Bonus: +1D4

Weapons: Fist/Punch 70%, 1D3+db
30.06 Bolt-Action Rifle 85%, 2D6+4
Bayonet 45%, 1D6+db
Commando Knife 60%, 1D4+2+db

Skills: Camouflage 40%, Climb 45%, Dodge 40%, First Aid 30%, Hide 50%, Listen 30%, Mechanical Repair 50%, Spot Hidden 75%, Sneak 35%.

Part One: Belly of the Whale

This unit’s mission begins west of town. Accompanied by the two squads assigned to take the Esoteric Order of Dagon hall, the white camouflage-suited marines follow the frozen Manuxet River into the heart of town, moving under cover of darkness and the towering walls of the river’s deep gorge.

At the Washington Street bridge the Marsh Mansion raiders leave the Esoteric Order raiders and climb the steep, rocky gorge to street level. An investigator has to make a Climb roll to get out of the gorge without slipping on the icy rocks. Failure results in 1D2 points of damage and, failing a DEX x5 roll, a sprained shoulder that may affect his ability to fire a weapon.

Once at street level the marines head north towards the mansion, using hedges and trees for cover. Near the mansion they darken their faces with grease before attempting to enter.

The Marsh Estate

Located at 404 Washington Street, the Marsh estate is the most splendid home in Innsmouth. The late Federal mansion stands on a vast expanse of property that fronts on Washington Street and extends all the way back to Lafayette. The grounds are neatly-kept, with wide flower-bedded terraces in the front and rear. A small fountain stands in front of the house, surrounded by a circular drive that connects with Washington Street and a two-car garage behind the house.

The central part of the manse is three stories high, while its two expansive wings are each of two stories. The vast hipped roofs are surrounded by iron widow’s walks and a shuttered cupola crowns the structure.

THE LOOKOUTS

At first sight, the ominous Marsh mansion appears silent and still, but a Spot Hidden roll by an investigator, supporting character, or Major Maines, reveals two shadowy figures moving about the iron-railed third story roof. The

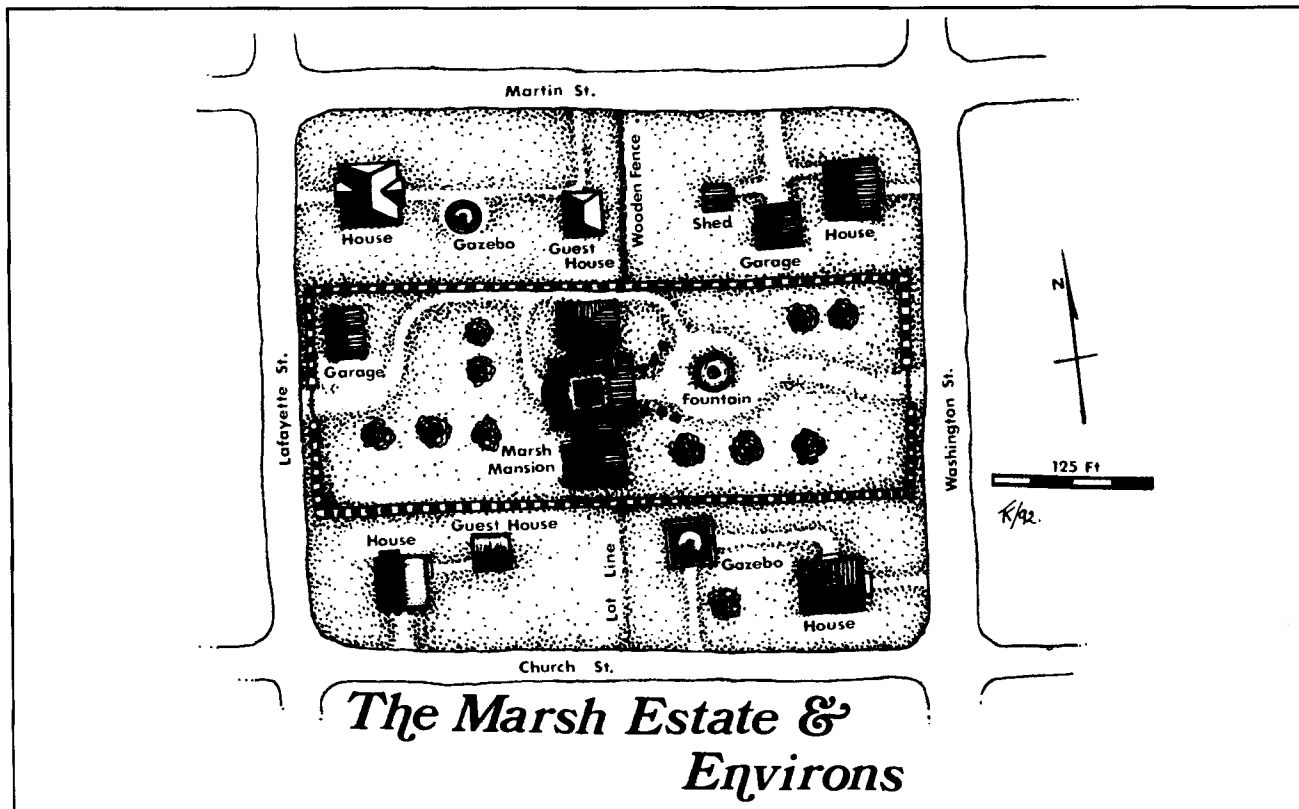

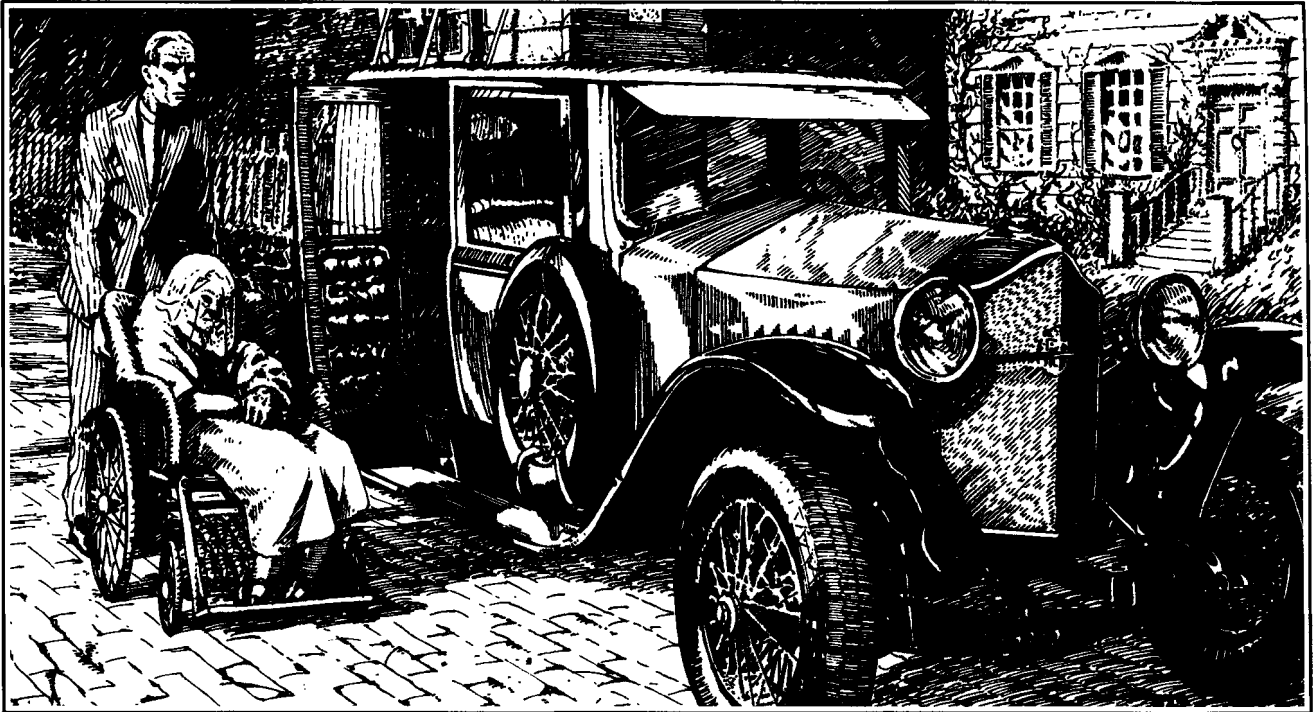

NORVELL HASTINGS AND ABIGAIL MARSH

pair seems to be acting as lookouts. Hide rolls may be required to avoid the lookouts' attention, but healthy bonuses should be applied for the white camouflage suits and the marines' training. A raider is perhaps spotted only on a fumbled roll of 91-00.

The two lookouts are the adult hybrid children of Sebastian Marsh—Bernard and Barbara. Posted atop the mansion by their family, they watch for intruders, ready to call out a warning to their vile, degenerate relatives inside. If warned of the raiders' approach, the Marshes inside either hurry their efforts to escape, or arm themselves and prepare for a fight. Bernard and Barbara duck inside and hide somewhere in the third floor rooms, waiting to ambush the intruders.

If the raiders spot the lookouts, they may attempt to Sneak past, again with healthy bonuses for darkness, camouflage, and the silencing effect of the snow.

BERNARD MARSH, 18, hybrid son of Sebastian Marsh

STR 17 CON 14 SIZ 16 INT 10 POW 12
DEX 14 APP 5 EDU 8 SAN 0 HP 15

Damage Bonus: +1D6

Weapons: Fist/Punch 55%, 1D3+db

Switchblade 35%, 1D4+db

Baseball Bat 30%, 1D8+db

Skills: Cthulhu Mythos 15%, Drive Automobile 35%, Fast Talk 65%, Hide 50%, Listen 40%, Sneak 65%, Spot Hidden 35%.

BARBARA MARSH, 20, hybrid daughter of Sebastian Marsh

STR 7 CON 11 SIZ 10 INT 12 POW 11
DEX 11 APP 7 EDU 8 SAN 0 HP 11

Weapons: Fingernails 40%, 1D4

Kick 35%, 1D6

Hatchet 25%, 1D6+1

Skills: Cthulhu Mythos 15%, First Aid 35%, Listen 30%, Sneak 35%, Spot Hidden 40%.

THE GETAWAY VEHICLES

Parked in the driveway near the front door are two fairly new sedans. Engines running, exhaust pipes pour clouds of steam into the cold night air. The cars' trunks stand open.

Both cars are fitted with black curtains covering the rear windows but, from a distance at least, there does not appear to be anyone in either of them. A look in the open trunks finds them loaded with bulging, tightly packed suitcases.

Before the raiders can draw too close the front door opens revealing a tall, sinister-looking man in a chauffeur's uniform pushing a drooling, glassy-eyed old woman in a wheelchair. Following on their heels comes a second, younger woman struggling with a large suitcase.

The trio heads for one of the waiting sedans where the crippled old woman is unceremoniously bundled into the back seat. The younger woman climbs in behind her while the chauffeur stashes the suitcase in the car's trunk. He then waits outside the car, alternately scanning the street and impatiently checking his watch.

The wheelchair-bound old woman is Abigail Marsh, the human wife of Barnabas Marsh. The younger woman is Ruth Gilman, the hybrid daughter of Dr. Rowley Marsh. Their chauffeur, Norvell Hastings, a human, is the relentlessly loyal servant of Barnabas and Abigail Marsh. Hastings and Gilman have hurriedly packed the two sedans, which now stand ready to speed the Marsh family to safety. Crippled Abigail is mostly oblivious to what's going on around her.

If attacked, the ever-loyal Norvell Hastings fights ruthlessly to protect his masters, ready to die for them if necessary. Ruth Gilman attempts to flee. There is a 40% chance every few rounds that blank-faced Abigail suddenly comes out of her catatonia to throw herself, spitting and clawing, at anyone who threatens her family. She does not cease her attack until her foe is vanquished, or she is somehow

116 – Escape from Innsmouth

restrained or killed. Remember that the team's goal is to capture alive as many of the Marshes as possible. If the team captures any of these three, Maines orders them gagged, taken to the ballroom, and then handcuffed to the grand piano.

NORVELL HASTINGS, 56, loyal servant

STR 11 CON 13 SIZ 15 INT 13 POW 11
DEX 9 APP 12 EDU 14 SAN 0 HP 14

Damage Bonus: +1D4

Weapons: Fist 55%, 1D3+db; Grapple 45%, special
Butcher Knife 50%, 1D6+db
9mm Automatic Pistol 35%, 1D10

Skills: Bargain 55%, Cook 70%, Cthulhu Mythos 15%, Drive Automobile 40%, First Aid 40%, Law 35%, Listen 30%, Persuade 50%, Psychology 45%, Sinister Stare 75%, Spot Hidden 35%.

RUTH MARSH GILMAN, 37, widowed daughter of Rowley Marsh

STR 9 CON 15 SIZ 8 INT 13 POW 9
DEX 12 APP 9 EDU 10 SAN 0 HP 12

Weapons: Fingernails 35%, 1D4
Kick 60%, 1D6

Skills: Accounting 15%, Credit Rating 20%, Cthulhu Mythos 35%, Fast Talk 55%, Listen 45%, Psychology 40%.

ABIGAIL WINTHROP MARSH, 67, insane wife of Barnabas Marsh

STR 9 CON 8 SIZ 10 INT 12 POW 8
DEX 8 APP 11 EDU 15 SAN 0 HP 9

Weapons: Fingernails 50%, 1D4
Club 25%, 1D6

Skills: Stare Glassy-Eyed 80%, Mumble Ominously 60%, Erupt in Frenzy 40%.

*Go to Part One of Objective One
The Esoteric Order of Dagon*

Part Two: This Old House

Ground Floor

Once inside, the raiders find the Marsh mansion an eerie place filled with many marvelous antiques. The floors creak underfoot and walls groan and shudder in the winter wind. A stale, fishy odor hangs heavy in the air, stronger when approaching the attic or basement.

LAUNDRY

This large, cold room is where the linen and clothes are washed, hung to dry, and ironed. Large iron kettles hang in an enormous fireplace. They are hung from swinging metal bars.

KITCHEN

The stairs in the large kitchen lead down to the cellar, down below.

PANTRY

The pantry is stocked with canned and dried goods: nothing unusual here.

DINING ROOM

The centerpiece of the regal dining room is a heavy antique table with twelve chairs; a beautiful Oriental rug covers the floor. The table is set with curious dishes, flatware, and goblets, all of gold and carved with intricate aquatic designs. Cold, drying food still sits on the plates, as though a meal was suddenly interrupted.

A successful Anthropology or Archaeology roll identifies the style of the strange aquatic designs on the tableware as Polynesian.

LIBRARY

Hundreds of volumes fill the built-in shelves of the library. Topics range from literature, to sea lore, to philosophy and religion. Special items include Obed Marsh's ship's logs, an amateur history of the Marsh family, and a handwritten copy of the *Ponape Scripture* signed by its transcriber, Captain Abner Ezekiel Hoag of Kingsport. The latter three volumes are detailed under entry 302.

Above the fireplace, staring menacingly down upon the room, is an enormous figure of a woman carved in wood. Splintered and weathered, paint chipped and faded, this wooden figurehead once adorned Obed Marsh's sailing ship, the *Sumatra Queen*. Another beautiful Oriental rug covers most of this floor.

When the squad nears this room they hear the sounds of two men arguing. Within the library Rowley Marsh and Sebastian Marsh quarrel over the disposition of some of Barnabas's old books and records—in particular the ship's logs, the family history, and the copy of the *Ponape Scripture*. Rowley wishes to take the tomes with them, as an aid to carrying on the Marsh legacy; Sebastian wants to destroy them in the fireplace, fearing they might fall into the wrong hands.

Preoccupied with their heated debate, the degenerate-looking men do not hear the raiders' approach. Each member of the squad gets an automatic action before the two men even realize they are there.

When Sebastian spots the intruders he tries to grab Obed's ships' logs, the Marsh family history, and the copy of the *Ponape Scripture* and hurl each of them into the fire. Unless he is stopped there is an 80% chance of each of these books landing in the flames. The old paper ignites quickly and immediate action is needed to save them. Either the investigator or one of his party must successfully make a DEX x3 roll to reach the fireplace and pull the smoking volumes from the fire in time. Even so, portions of the books may be destroyed. The two men grudgingly surrender if it appears they have little or no chance to survive a fight. If captured, the pair are gagged and handcuffed to two decorative pillars at either side of the fireplace.

It is possible that the raiders mistake the aged Dr. Rowley Marsh for Old Man Barnabas Marsh. Rowley and Sebastian encourage this error, doing what they can to keep the raiders confused.

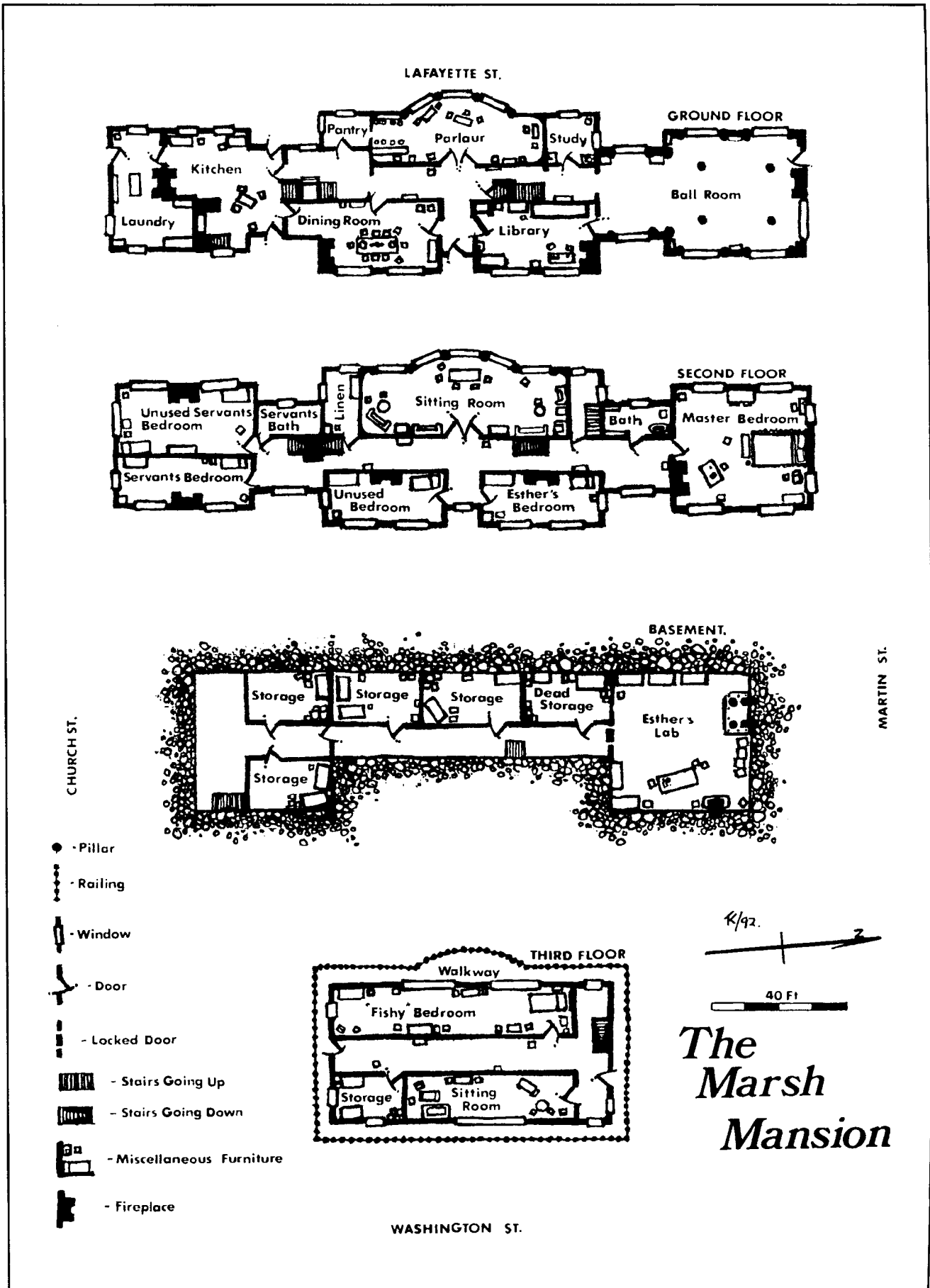

Dr. Najar Disappears

Sometime during the exploration of the house, Dr. Najar mysteriously disappears. Perhaps he lingers to search a room while the others move on to the next, or goes to use the servant's bathroom. If a single raider is left to guard him, Najar kills him with a knife to cover his escape.

Once he is alone, Nyarlathotep/Najar begins searching the house on his own, looking for Esther Marsh. Whether he finds her before the raiders do is left to the keeper. As a delicious side-note, while Nyarlathotep searches the house, he slays any captives he comes across.

When the team begins searching for Dr. Najar they probably search some of the rooms containing captives. In each room with captives there is a 30% chance that Najar has been here first, slaying all that he found. The discovery of the first of these bodies ends Part Two of this scenario. Descriptions of what raiders find in each room follow.

BALLROOM: Norvell Hastings is Shrivelled, his corpse burnt in half at the abdomen by the spell. Sanity point loss is 1/1D4.

Ruth Marsh Gilman sits against the piano. Her eyes have been gouged out leaving bloody, empty sockets. Her eyeballs rest in her lap, staring up at the investigator. Sanity point loss is 1/1D6.

Abigail Winthrop Marsh's head has been severed from her body with piano wire. When the team finds her she appears to be dozing, her head nodding on her chest. If touched, the head rolls onto the floor. Sanity point loss is 1/1D6.

LIBRARY: Rowley Marsh seems untouched, he sits next to the fireplace, his eyes wide, his mouth open. He is dead, but there is no sign of what killed him. Sanity point loss is 0/1.

Sebastian Marsh's corpse shows evidence of rapid aging. Barely recognizable, his thin hair is now snow-white, his face and hands horribly wrinkled with age, and his skin flaking to the touch. Anyone moving him in any way hears brittle bones snapping and crumbling. Sanity loss is 1/1D4.

MASTER BEDROOM: Elizabeth Gilman Marsh is found turned to stone. Sanity point loss is 0/1.

THIRD FLOOR: Bernard and Barbara Marsh are found Shrivelled. The indistinguishable heap of their charred corpses costs 1/1D6 Sanity points to view.

These murders—some of them using bizarre Dreamlands magicks—were committed by Nyarlathotep to confuse, frighten, and tease the raiders.

DR. ROWLEY MARSH, 68, hybrid physician

STR 8 CON 9 SIZ 13 INT 14 POW 16
DEX 8 APP 8 EDU 18 SAN 0 HP 11

Weapons: Scalpel 35%, 1D4

Skills: Biology 25%, Chemistry 40%, Credit Rating 65%, Cthulhu Mythos 50%, First Aid 60%, Law 20%, Medicine 50%, Persuade 55%, Pharmacy 45%, Psychoanalysis 30%, Psychology 50%.

SEBASTIAN MARSH, 49, hybrid deep one

STR 13 CON 14 SIZ 15 INT 14 POW 13
DEX 9 APP 5 EDU 15 SAN 0 HP 15

Damage Bonus: +1D4

Weapons: Fist 60%, 1D3+db

Skills: Accounting 40%, Bargain 50%, Credit Rating 70%, Cthulhu Mythos 40%, Dodge 30%, Geology 45%, History 45%, Spot Hidden 40%, Swim 80%.

PARLOUR

Within this large, elliptical room hang the portraits of several generations of Marshes. The gallery of faces range from John Marsh, one of Innsmouth's earliest settlers, down through Captain Obed Marsh and Barnabas Marsh. Most of the Marshes after Obed show signs of the Innsmouth taint. Viewing them costs 0/1 Sanity points, but those who study them closely may add 1D10% to their Innsmouth Lore.

Also found here are several small gold figurines cut with queer aquatic designs: dolphins, sharks, octopoidal swirls, etc. These pieces have an Oriental look to them, verified with an Archaeology or Anthropology roll.

STUDY

In a locked cabinet are six figurines carved from various types of stone including volcanic rock and a soapy-feeling jade. The statues represent Mother Hydra, Father Dagon, Great Cthulhu, Byatis, Gloom, and Zoth-Ommog, each identified with separate successful Cthulhu Mythos rolls. These creepy icons cost 1/1D3 Sanity points to view. Those who actually handle them are left feeling uneasy, resulting in another Sanity loss of 0/1 points. In addition, anyone handling the statue of Byatis must match their POW against a 32 on the resistance table. If overcome, that person permanently loses 1D4 POW to Byatis.

BALLROOM

There is nothing unusual in this stately, cavernous chamber, although if the raiders listen closely they may hear the faint, echoing sounds of voices and haunting music—and catch for just a split second the image of a room full of people in turn-of-the-century garb. This hazy vision costs viewers 0/1 Sanity points, but might be passed off as nothing more than the result of frayed nerves.

If they have already been captured, Norvell Hastings, Ruth Marsh Gilman, and Abigail Marsh are gagged and handcuffed to the legs of a dust-caked concert piano in one corner of this room. A door in this room leads out to the driveway, and the waiting sedans.



DR. ROWLEY MARSH AND SEBASTIAN MARSH

The Cellar

Those descending into the dark, unlit basement hear weird skittering noises. A successful Spot Hidden notices an odd crustacean creature the size of a large rat scuttling away into the dark. Lose 0/1D3 Sanity points.

Successful Natural History or Geology rolls note that the thing resembles a trilobite—a Paleozoic marine arthropod thought extinct for millions of years. Light frightens off the crab-like creatures, but only for a short period of time. Soon they clamber back out of their barrels and corners, fearlessly attacking any lingering raiders. Anyone entering the basement without a light is immediately attacked by these hungry, living fossils.

The bizarre crustaceans use their claws to cling to victims, then gnaw away at exposed flesh, tearing through clothing or even leather boots. There are dozens of these voracious scavengers in the cellar and a motionless victim may be attacked by as many as 1D6 creatures at a time. Anyone unfortunate enough to fall to the damp floor is swarmed upon by twice that number. See p. 57 for combat statistics for these creatures.

STORAGE ROOMS

Most of the junk-crowded cellar is taken up by dank, musty storage rooms filled with old furniture, clothing, etc.

DEAD STORAGE

This room holds water-filled tubs containing the partially eaten, decayed portions of human, or semi-human, corpses.

These are the remains of Esther Marsh's experiments: limbs, heads, and hunks of torso left to be picked clean by the scavenging trilobite-things. Seeing the results of Esther's experiments costs 1/1D6 Sanity points. Several of the vicious arthropods are hiding in the water-filled tubs.

ESTHER'S LAB

This dank, spacious chamber stinks of rotten fish. Within are several deep tubs holding the motionless, dissected corpses of 2D3 male humans and deep ones, preserved in cloudy formaldehyde. Sanity loss is 1/1D6 points. These are some of Esther's unfortunate lovers. None were able to withstand the fury of her frenzied lust.

Glass jars line the wooden shelves of this room, many containing what appear to be human fetuses. Lose 1/1D2 Sanity points. Close examination of these jars, combined with a successful Biology or Medicine roll, allows the investigator to realize that not all of the fetuses are completely human. Some show distinct amphibian characteristics including feathery gills and webbed appendages. This discovery costs another 1/1D2 Sanity points, and adds one point to a character's Cthulhu Mythos skill.

Other jars and jugs contain further specimens of aquatic and amphibious creatures. All are normal except for a single specimen of one of the trilobite creatures.

Esther's notebooks contain theories about the evolutionary paths of humans and deep ones, postulating a remote ancestor common to both races. There are also sketches and notes about various monstrous deep one hybrids, including some with tails, tentacles, and other



abnormalities. Reading Esther's notes adds 5% to the reader's Cthulhu Mythos score at a cost of 1D6 Sanity points.

There are also several shallow barrels full of fishy-smelling water, rippling and bubbling ominously. Looking into the barrels, the investigator and his team may spot shadowy movements. These tubs hold more of the strange trilobite-like arthropods. These specimens were captured by Esther Marsh in the cold coastal waters of Innsmouth. The degenerate Marsh daughter is studying the living fossils to help comprehend the tenuous evolutionary links shared by all life. Anyone getting too close to these tubs is attacked by the ancient arthropods.

Second Floor

SERVANT'S BEDROOM

This is Norvell Hastings' room. Nothing unusual is found here, although the squad may notice that the wardrobe looks hastily emptied. Hastings has packed most of his things for the flight from town.

UNUSED SERVANT'S BEDROOM

This dusty vacant room contains nothing of interest.

UNUSED BEDROOM

This room functions as a guest room on those very rare occasions when the Marsh family entertains company. There is nothing unusual here.

ESTHER'S BEDROOM

Esther's room is a mess, and stinks of stale fish. Dresser drawers and the wardrobe hang open while clothing lies scattered everywhere. A successful Spot Hidden roll finds a few pieces of curious gold jewelry, all etched with fine

aquatic designs. Another Spot Hidden roll reveals a strange patch of scaly skin on the floor, a few inches across. This was shed by Esther.

MASTER BEDROOM

The master bedroom is in a similar state of disarray. The doors of the wardrobe are closed, however, concealing the presence of Elizabeth Gilman Marsh, the reclusive wife of Sebastian Marsh. She hides if a group of raiders enter the room, but if a single individual enters she attacks with her claw-like nails. If discovered in the wardrobe she attempts to use her gun, a .22 revolver. If captured, she is gagged and handcuffed to a stout bedpost.

ELIZABETH GILMAN MARSH, 47, wife of Sebastian Marsh

STR 10 CON 12 SIZ 8 INT 13 POW 10

DEX 10 APP 8 EDU 12 SAN 0 HP 10

Weapons: Fingernails 40%, 1D4

.22 Revolver 35%, 1D6

Skills: Credit Rating 50%, Cthulhu Mythos 25%, Spot Hidden 40%, Swim 80%.

The Third Floor

The narrow, loudly-creaking hallway connecting these rooms has doors leading out onto the roof, giving access to the third floor widow's walk. Bernard and Barbara Marsh lurk within these rooms (see stats p. 115).

STORAGE ROOM

A crowded but unspectacular room full of junk.

SITTING ROOM

A large, amply-windowed room with chairs and couches. Several Massachusetts road maps are spread out on a table.

THE FISHY BEDROOM

A huge, dark room with boarded-up windows and an old, sagging bed. The stench of fish is absolutely overwhelming here. Anyone entering must make a CON x5 roll or suffer nausea for 1D6 minutes. Spot Hidden rolls note numerous claw marks on the floor. A Cthulhu Mythos roll suggests they were made by deep ones.

THE CUPOLA

Gained by a narrow, steep stairway, the cupola gives a view of the city all the way out to the harbor and Devil Reef.

*Go to Part Two of Objective One
The Esoteric Order of Dagon*

Part Three: The Wailing Writher

Esther Marsh

Esther Marsh stays elusive throughout the scenario, and should only be encountered after the squad has had ample opportunity to explore the Marsh estate. She may even be suspected of the brutal and bizarre murders described above. If seriously outnumbered Esther doesn't put up a fight, but if encountered by a lone raider or two, she attacks quite savagely.

The keeper may allow the team to meet Esther wherever desired, but care should be taken that Dr. Ravana Najar, the human avatar of Nyarlathotep, is also present. If he is not, it is important that Esther stay alive until Najar rejoins the group. It may be that the raiders find her in the clutches of Dr. Najar, who has himself just stumbled upon her.

ESTHER MARSH, 36, hybrid breeder

STR 14 CON 15 SIZ 14 INT 13 POW 12
DEX 12 APP 6 EDU 13 SAN 0 HP 15

Damage Bonus: +1D4

Weapons: Fist/Punch 65%, 1D3+db

Fingernails 65%, 1D4+db

Kick 60%, 1D6+db

Spells: Contact Deep Ones.

Skills: Anthropology 25%, Archaeology 15%, Biology 75%, Credit Rating 40%, Cthulhu Mythos 45%, Dodge 40%, Hide 35%, Jump 50%, Latin 15%, Listen 35%, Sneak 40%, Spot Hidden 40%, Swim 80%.

Najar's Return

As Esther is being taken away by her captors, the diminutive Dr. Najar reappears, his face and clothes spattered with blood. Severe knife or claw wounds (self-inflicted) mark his chest, his glasses are broken, and he gasps for breath. He claims he was attacked by some sort of scaly thing

which he barely saw. He suggests that the party leave as soon as possible, before the thing returns.

Back among the raiders, Najar takes pains to linger close to Esther Marsh. Soon, while the others are distracted, he lays his hands on her head and stares fiercely into her bulging eyes. Esther struggles, her eyes widening as she opens her mouth to scream. Her shriek is drowned out by Dr. Najar who lets out an unearthly wail. All who hear this laugh must roll Sanity against a loss of 1/1D6 points. Before anyone can act, Esther's skin begins to char and melt, and Dr. Najar's body smokes and splits.

Najar's smoking carcass falls and out of it pours the twitching, whirling blackness that is the Wailing Writher, its numerous mouths snapping and screaming. Viewing this horrible transformation costs 2D4/4D10 Sanity points.

The raiders have 1D3+1 rounds before Esther Marsh melts into a steaming pool of primal fluids and is horribly absorbed by the towering column of wriggling worms and shrieking mouths that is the Writher. If the keeper desires a bloody climax, the Writher may lash out at the raiders, engulfing any remaining non-player characters. Unless he actually attacks Nyarlathotep, the investigator is probably spared. The obscene, mind-numbing god then lets out a final horrible shriek before smashing through a wall and disappearing into the night, leaving the investigator surrounded by destruction and madness.

THE WAILING WRITHER

The Wailing Writher manifests itself as a towering, swirling black mass of dripping, squirming tendrils and drooling, shrieking mouths. Millions of rope-like tendrils constantly wriggle and squirm, giving the avatar the appearance of a great column of black worms. The Wailing Writher is mentioned in some very obscure Hindu myths, although it has no known cult among humans.

This creature attacks by engulfing a victim with its writhing body where they are quickly and savagely torn apart by the wriggling tentacles before being swallowed by the screaming mouths. Seeing this manifestation of the Outer God costs 1/1D6 Sanity points. The Wailing Writher may also attack by biting a victim with 1D6 mouths; roll separately for each mouth.

THE WAILING WRITHER, avatar of Nyarlathotep

STR 50 CON 65 SIZ 45 INT 18
POW 55 DEX 25 Move 18 HP 60

Weapons: Bite 75%, 3D6 per mouth

Engulf 100%*, death on following round.

*Allow the target a Dodge roll to avoid this attack.

Armor: None, but normal weapons cannot harm the Wailing Writher. Fire, magic, and similar forces harm this manifestation of the Outer God normally.

Spells: All.

Sanity Loss: 2D4/4D10, plus 1/1D6 for hearing the wailing..

The Rest of the Marsh Family

It is assumed that Ralsa Marsh has already met his demise at the hands of the vengeful Averill family, and that Robert

Marsh is busy trying to stave off the forces that are attacking the Esoteric Order of Dagon. Jacob Marsh is currently at the Marsh refinery, and Old Man Barnabas Marsh is safely hidden away far below the ocean, in the deep one city of Y'ha-nthlei.

After the Mission

Once their mission is completed at the Marsh Mansion, Maines' squad is supposed to take its living captives north of town to the roadblock on Federal Street.

REWARDS

The investigator gains one point of Sanity for every Marsh (Gilman and Hastings, as well) that the raiders capture and hand over to the government. If the team somehow managed to thwart the Wailing Writter, either by killing Esther before she could be absorbed or somehow rescuing her from the clutches of the god, award an additional 4D10 points. One point of Sanity is also allowed for each of the books saved from destruction in the library.

*Go to Part Three of Objective Six
The Marsh Refinery*



OBJECTIVE THREE: SMUGGLERS' TUNNELS



This mission calls for the raiders in boats to enter the old smugglers' tunnels running under Innsmouth. Once inside they are to make their way to the houses lining the north side of the harbor and destroy them, along with the unclean, ichthyic monstrosities they are thought to contain.

The force of twenty-four men is divided into two squads of twelve men apiece, each under separate command. Identified as Abel and Baker squads, each is equipped with two rowboats and has been assigned to explore a different part of the tunnel system. Baker squad is controlled by the keeper and is fated for disaster early in the adventure. The investigator advisor and any supporting characters should be assigned to the Abel squad, Boat 2.

The raiders will be dropped offshore a mile north of town by the Coast Guard cutter *Urania*. Rowing to shore, the squads are to seek out the overgrown, half-drowned entrances to the old smugglers' tunnels and penetrate them as deeply as prudently possible. On the way out they are to set demolition charges along the way. Though they cannot hope to get all the infested houses in this first strike, it is believed that the blast concussions and resulting fires will finish the job.

The Tunnel Raiders

Most of the characters in this scenario are keeper controlled, including Boat 1 of Abel squad and the entirety of Baker squad. The investigator should be assigned to Boat 2 of the Abel squad and supporting characters should be chosen from among the marines assigned to this boat. Also in Boat 2 is Sergeant Smeltz, a keeper character that should not be played as a

supporting character. Typical veteran marine characteristics are provided, although players may wish to roll up their own. As before, skills should be no higher than those listed under Typical Veteran Marine.

Abel Squad, Boat 1

Boat 1 of Abel squad is captained by squad leader Lt. Doud. Its crew is made up entirely of keeper characters.

LIEUTENANT ERIC DOUD

The Abel squad leader is a pompous prig who doesn't believe stories about monsters hiding out in Innsmouth. He is a classroom officer with no field experience, relying heavily on Sergeant Smeltz for advice—though he behaves as if all decisions were actually his own. When faced with the horrifying reality of what has infested Innsmouth, he eventually breaks down completely, becoming totally useless to the squad.

LT. ERIC DOUD, 30, marine officer

STR 15	CON 17	SIZ 15	INT 16	POW 12
DEX 17	APP 15	EDU 17	SAN 60	HP 16

Damage Bonus: +1D4

Weapons: .45 Automatic 55%, 1D10+2

Skills: Camouflage 20%, Climb 45%, Demolitions 35%, First Aid 40%, Hide 35%, History 30%, Jump 35%, Listen 35%, Military Law 25%, Persuade 25%, Sneak 30%, Spot Hidden 30%, Swim 30%, Throw 35%.

CORPORAL NORMAN WOLD

Lt. Doud's boot-kisser and Abel squad's radio operator. He always backs up Lt. Doud, no matter what the situation. A thwarted bully, he takes great pleasure in using his rank to push around those under his command.

CORPORAL NORMAN WOLD, 21, non-com brown-noser
 STR 16 CON 15 SIZ 15 INT 14 POW 13
 DEX 14 APP 14 EDU 15 SAN 65 HP 15

Damage Bonus: +1D4

Weapons: .45 Automatic 40%, 1D10+2

Skills: Camouflage 15%, Climb 50%, Demolitions 25%, Dodge 45%, First Aid 40%, Hide 45%, Jump 45%, Listen 60%, Sneak 35%, Spot Hidden 30%, Swim 10%, Throw 30%.

PRIVATE CHARLES ANZACK

A crafty, fast-talking schemer always on the lookout for an easy dollar. If he sees any loot to be had in these tunnels, or in the houses above them, he deserts his duties and goes after it. Care should be taken so that Anzack survives into the second part of this scenario. He has a specific role to fulfill.

PVT. CHARLES ANZACK, 23, scheming marine
 STR 16 CON 17 SIZ 16 INT 14 POW 15
 DEX 16 APP 12 EDU 14 SAN 75 HP 17

Damage Bonus: +1D4

Weapons: .30-06 Bolt-Action Rifle 55%, 2D6+4
 Bayonet 45%, 1D4+2+db

Skills: Camouflage 30%, Climb 40%, Dodge 50%, Fast Talk 65%, First Aid 30%, Hide 55%, Jump 45%, Listen 45%, Sneak 55%, Spot Hidden 40%, Swim 30%, Throw 40%.

Other Marines

In addition to Doud, Wold, and Anzack, Boat 1 contains the following marines: Private Cooley, Lance Corporal Leven (Demolitions 50%), and PFC Witzneki (Thompson submachine gun 50%). Their characteristics and skills are those of a typical veteran marine.

TYPICAL VETERAN MARINE
 STR 16 CON 17 SIZ 16 INT 14 POW 15
 DEX 16 APP 12 EDU 14 SAN 75 HP 17

Damage Bonus: +1D4

Weapons: .30-06 Bolt-Action Rifle 60%, 2D6+4
 Bayonet 40%, 1D4+2+db
 Commando Knife 50%, 1D4+2

All marines come equipped with .30-06 rifle, commando knife, and flashlight.

Skills: Camouflage 40%, Climb 50%, Demolitions 15%, Dodge 45%, First Aid 25%, Hide 30%, Jump 35%, Listen 30%, Sneak 30%, Spot Hidden 40%, Swim 30%, Throw 40%.

Abel Squad Boat 2

This boat is under the command of Sergeant Rudy Smeltz. All other characters in this vessel can be used as supporting characters. Any not chosen should be played by the keeper.

GUNNERY SERGEANT RUDY SMELTZ

A towering, bald-headed veteran whose best friend is "Tommy," his Thompson submachine gun, he is unlikely to be rattled by anything that occurs tonight. He is a man who shoots first, then asks questions later—one of the main reasons he was selected for this particular mission.

GUNNERY SERGEANT RUDY SMELTZ, 38, marine lifer
 STR 18 CON 17 SIZ 18 INT 15 POW 16
 DEX 14 APP 13 EDU 14 SAN 80 HP 18

Damage Bonus: +1D6

Weapons: Thompson Submachine Gun 60%, 1D10+2
 .45 Automatic 50%, 1D10+2
 Commando Knife 45%, 1D4+2+db

Skills: Camouflage 60%, Climb 65%, Demolitions 45%, First Aid 50%, Hide 55%, Jump 45%, Listen 55%, Navigate 45%, Mechanical Repair 40%, Sneak 55%, Spot Hidden 50%, Swim 40%, Throw 45%, Track 20%.

CORPORAL ARCHIE POLLARD

The demolition expert, he never goes anywhere without a lit cigar. Pollard knows his stuff, and enjoys giving his buddies an occasional scare with his "explosive" humor.

Skill: Demolitions 70%.

PRIVATE PELKIE

Pelkie is the youngest and most inexperienced of the squad; the others tend to look after him. Anxious to prove himself worthy, his greatest fear is that he will chicken out under pressure. This tends to make him a little reckless, and a potential danger to those around him.

Skills: Listen 85%, Spot Hidden 80%.

Personal Equipment

Investigator advisors are supplied with their choice of a .45 automatic or .30-06 rifle, and a commando knife. They will also be given a dark, waterproof poncho, a knit watch cap, and a flashlight. Faces will be blackened before departing from the *Urania*.

NEW WEAPONS

A supporting characters carries a flamethrower.

FLAMETHROWER: The Germans made use of the first modern-day flamethrower during WWI. Other countries soon developed their own versions. The contraption is heavy (60-70 pounds), and worn as a backpack, reducing the wearer's DEX by 4 points. If hit by weapons fire, a failed Luck roll indicates the tank has been struck. A second Luck roll determines whether it was merely punctured, or if it has ignited. In the latter case, the device explodes, doing its remaining damage capacity (see below) to all within a 10 yard radius. Removing the flamethrower takes two rounds; refilling the tank requires at least five rounds.

Base chance 05%; damage 2D6 for short bursts, 4D6 and higher for extended fire. The weapon has a cone-shaped area of effect and causes normal damage up to 15 yards, half damage at 15-25 yards, no damage beyond that range. The back pack contains enough fuel to create a total damage of 8D6 (four short bursts) before needing a refill.

LANCE CORPORAL DAVID KAYE

A quiet, sullen man in his 30s, with bad burn scars on his hands and cheek. He wields the squad's flamethrower, as he had some experience with it in the Great War—on the receiving end. Kaye is often moody and foul-tempered.

Skill: Flamethrower 45%, damage varies.

PRIVATE FIRST CLASS EDWARD DEVORE

Just an average Joe trying to survive until his enlistment is up. The others tell Devore all their problems, and ask his advice on matters they feel uncomfortable discussing with others. Through Devore, the investigator can learn more about the men he has been teamed with.

Skill: Persuade 75%, Psychology 75%.

LANCE CORPORAL ELWIN MAYHEW

A big, beefy midwestern boy with a south Indiana drawl. He's not sure if he believes in monsters or not, although he claims to have once seen "Shaggy Harry," a large, furry anthropoid that is rumored to live in the woods near his

own home town. The other members of the squad occasionally joke with him about this.

Skill: .30-06 Bolt-Action Rifle 80%, 2D6+4.

Baker Squad Boats 1 & 2

The doomed Baker squad is led by Lt. David Carter (Tommy-gun 55%). Boat 3 contains Pvt. Rist, PFC Purdon, Pvt. Muzzarelli, Lance Corp. Deems, and PFC Chumeski.

They are all—sadly enough—destined to become monster fodder. Boat 4 carries the rest of Baker squad, consisting of Private Bloom, Private Bouchard, PFC Pearlman (Baker's radio operator), Sergeant Roeser (Tommy-gun 50%), Lance Corporal Downey, and PFC Lanier.

The Boats

Each of the four wooden boats is capable of carrying six or seven persons and is powered by oars. In a pinch each can carry as many as twelve in reasonable safety. Each is equipped with the following:

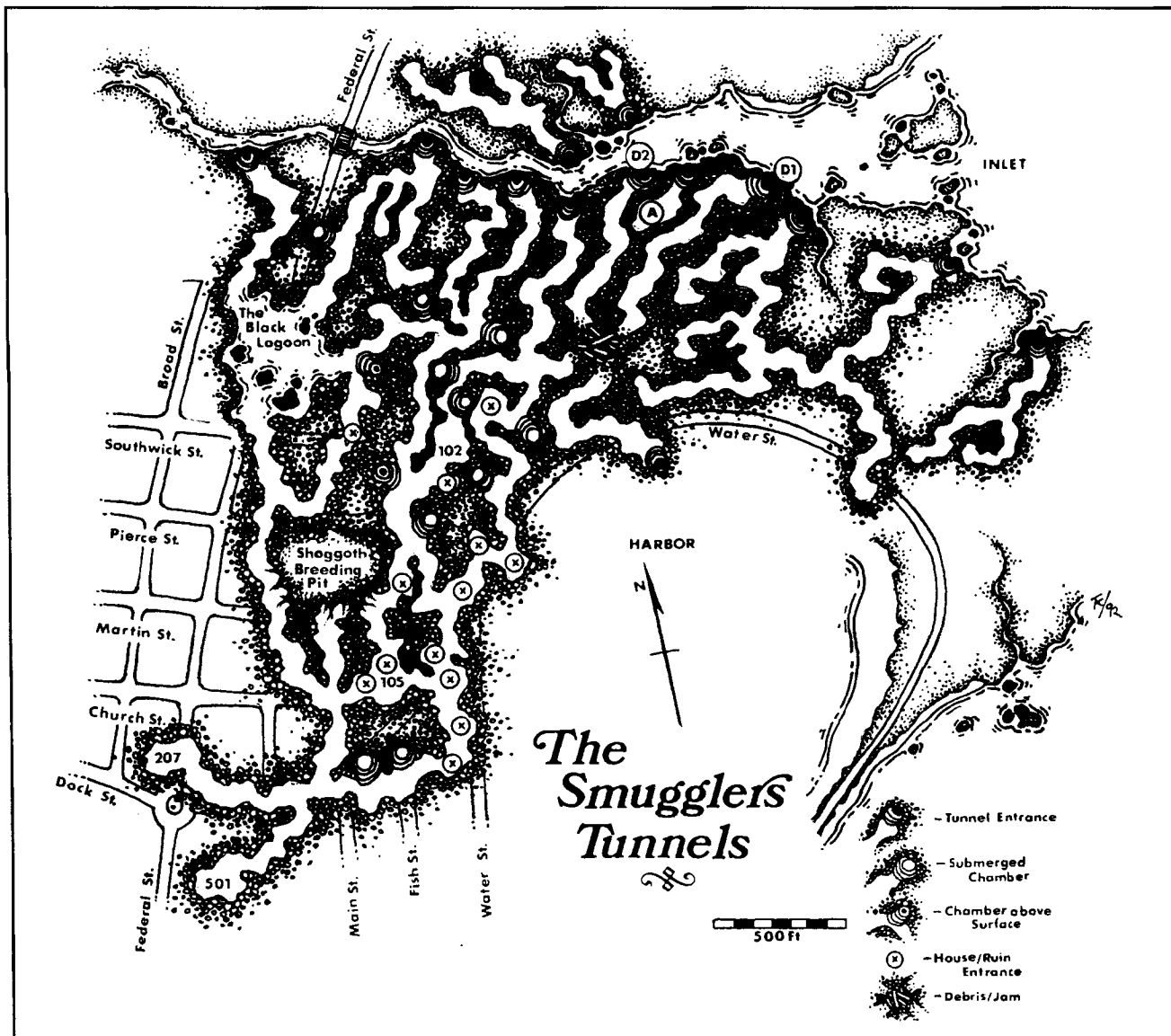



THE DEEP ONES ATTACK

- 1 watertight case containing 50 sticks of dynamite
- 10 blasting caps with combustion fuses
- 5 mechanical timers with settings from 1-60 minutes
- 4 five-gallon cans of gasoline
- 6 emergency flares
- 3 battery lamps
- 2 cases of spare ammunition

Boat 2, the investigator's, also carries two cans of fuel, each containing one refill for the flamethrower. Abel squad's radio is aboard Boat 1.

Part One: Breaching the Tunnels

After being dropped offshore by the Coast Guard, an uneventful trip brings the squads to the designated inlet. The briny water of the marsh is thick with a slightly phosphorescent algae which casts a ghostly illumination across a macabre winter landscape. This algae is also present inside the tunnels, creating an unsettling, spectral glow that, unfortunately, does not provide enough light to clearly see by.

The two squads silently prowl the shore together, the investigator attempting a halved Luck roll at each of the openings depicted on the Smuggler's Tunnels map. A successful roll indicates someone has spotted an opening large enough to enter.

The two boats of Baker squad enter the first tunnel found, keeping in radio contact with Abel squad for as long as possible. Abel squad enters the second tunnel located. Barring catastrophe, the two squads operate separately for almost the rest of the scenario, Abel squad occasionally receiving scratchy reports over the radio, and sending some of their own.

AN ENTRY

Abel's tunnel is blocked by driftwood and debris which has to be cleared before the boats can enter. Two marines leap to the task while the rest of the squad keeps watch. During this time any player character watching the entrance and making a Spot Hidden roll sees a vast and fast-moving underwater shadow silently exit the tunnel to disappear into the deeper water of the inlet. This is the team's first intimation of the forces at work beneath the town. Lieutenant Doud, of course, discounts the sighting, but a Sanity loss of 0/1D2 points should be charged to whomever spotted it.

Note that not all the tunnels lead under Innsmouth. The squads may have to spend some time exploring dead-end sea-caves before finding the main complex.

Inside the Tunnels

In general, the smugglers' tunnels are natural caves, slimy and half-choked with rotting debris drawn in by the currents. In some places they are almost completely blocked by masses of decaying wood and less identifiable organic matter, all shrouded in the corpse-glow of the omnipresent algae. The squad is assailed by the reeking stench of decaying fish and the primal sludge of the ocean floor.

AN AMBUSH

The worst tunnel blockage is found in tunnels D1 and D2, where the currents are the strongest. At the confluence of these tunnels a clotted jam of debris requires 3D20 minutes to clear. Things that travel underwater can easily bypass this obstacle.

It is possible to walk on this tightly-packed debris, but there is a 35% chance of falling through a weak spot. This hapless person remains submerged for an inordinately long time, then suddenly bursts to the surface, the poor wretch's face shredded into bloody tatters by the deep ones lurking below. Witnesses lose 1/1D4 Sanity points. The deep ones meanwhile retreat up the tunnel to prepare another ambush. Although the squad is now understandably spooked, Doud orders them ahead.



SGT. RUDY SMELTZ

Further progress is unhindered; Lesser debris can be easily pushed aside. Under normal circumstances, the squad need only worry about an occasional gobbet of sea slime dropping on them from the ceiling. But this place is a warren of the deep ones, and the humans' presence in these nighted canals will not be tolerated very long.

Sneak Attacks

These occur at the keeper's discretion. They should be employed in a manner that creates a sense of claustrophobic urgency and sudden fatal danger. Keepers may ask for Sanity rolls against small losses, as they see fit.

Numerous underwater fissures are used by the deep ones to negotiate the tunnels. Making use of these hidden passages, they attempt to pick off the party in ones and twos as the boats pass their hiding places. They begin with the rearmost boat, singling out the soldier in the stern for their first attack.

The first attack is always successful, but after the first marine disappears, successful halved Spot Hidden or

halved Listen rolls can detect the stealthy approach of the deep ones. If the deep ones go undetected, further victims simply vanish into the darkness with little more than a strangled cry and a splash. This type of attack may occur whenever the boats pass one of the above-surface chambers marked on the tunnel map.

With each successive attack the investigator may add 5% to his Spot Hidden or Listen roll, since he is ever more alert to the lurking threat. Although they continue throughout the course of this scenario, the first of these ambushes brings an ominous end to Part One.

*Go to Part One of Objective Five
Y'ha-nthlei*

Part Two: Canals of Hell

Open Assaults

As the raiders penetrate deeper into the smuggler's cave system, the deep ones become increasingly aggressive. At each tunnel intersection and at the mouth of each submerged or above-surface chamber, the investigator should make a halved Luck roll to determine if the deep ones stage an ambush.

If an attack is indicated, the investigator is allowed a halved Spot Hidden roll. If successful, the raiders are alerted to a group of 1D4+1 deep ones quietly paddling their way toward the boats. They can usually be driven off with a few rounds.

Smugglers' Cache Houses

The main map (p. 122) indicates the smugglers' tunnels and where they open onto the rotting houses above ('X'). Two maps of slum dwellings are shown pp. 127-128, typical of the types the raiders encounter. Once the safe houses of smugglers, they are now the home to some of the town's most revolting hybrids, the secret tunnels affording them quick and easy access to the sea.

The houses all appear uninhabited, with sagging roofs, broken windows, garbage strewn in the yards, etc. Inside are crumbling furnishings, more garbage, dust and dirt. Ancient and rotting, the structures are inherently dangerous; a false step or a failed Luck roll results in a collapsing floor and a fall into the clutches of whatever waits below. The ancient wood is bone-dry, and very little flame is needed to set them ablaze.

25% of these houses are inhabited by 1D6 of the town's worst hybrids and deep ones. These creatures

move to attack the raiders if their lairs are invaded. Note that The Guardians of the Nest, described in Part Two, may also be lurking somewhere in these buildings.

DEMOLITIONS

The raiders' mission is to destroy the riverfront slums. Each time they discover a house with a cellar opening on the tunnels, members of the squad set a charge of up to three sticks of dynamite near the hovel's ground floor. The charges may be set with simple combustion fuses or with mechanical timers. Some of the raiders guard their fellows while others pour gasoline on flammable materials in the cellars. When all is set, the charges are rigged to blow. If successful, the blast destroys most of the house and sets surrounding structures ablaze. The team always allows itself several minutes to clear the area.

If undetected, the deep ones attack Boat 1, attempting to overturn it, pitting their total STR against a resistance STR of 60 for the boat. If overturning the boat fails, or seems too unlikely, they instead attempt to drag raiders out of the boat and under the water. Treat this as a normal claw attack, but pit the deep one's STR against the target's STR. Anyone dragged under is lost, a thick red stain of blood boiling up to pollute the water. This gruesome sight calls for a loss of 1/1D3 Sanity points, and is followed by an utter chilling silence which is broken only by the lapping of the dark waters against the cavern walls.

The Radio Call

There is but one communication from Lt. Carter's Baker squad. The radio call breaks the still, damp silence. Radio operator Pearlman's panicked voice can barely be heard above the sounds of gunfire and screaming.

"Squad Baker under attack... unable to retreat... need reinforcements... Lieutenant Carter is gone, dragged under by... oh my god, Sarge! They're right underneath us! Right underneath! Chumeski! God! They're comin' outta the walls, right outta the goddamn walls!?"

Pearlman begins a scream that is suddenly, gruesomely reduced to a thick gurgle just before the radio emits a solid stream of static. The horrified Abel squad members lose 1/1D3 for hearing this. They are now alone.

REUNION

If Abel squad has deteriorated to dangerously low levels, reinforcements can be introduced by having some of the routed Baker squad members show up. They are cold, wet, frightened, and low on ammunition, but otherwise able to carry on: keeper's choice as to the number of such reinforcements and their condition.

The Shoggoth-Spawn

Five shoggoth-spawn inhabit the tunnel system. They mostly lurk near the shoggoth breeding pit but occasionally one of these vile creatures ventures out farther into the tunnels. These foul, amorphous creatures spread themselves over the walls and ceilings of the tunnels, adhering to the slimy surface and appearing as nothing more than slimy rock.

One of these creatures lies in Abel squad's path. As a boat passes by, the alien atrocity drops down, engulfing a random occupant on whom it attempts to feed. Sanity loss for seeing the thing and its surprise attack is 1/1D8+1 points. The creature is relatively small and should prove easy to kill.

THE SHOGGOTH-SPAWN

STR 18 CON 17 SIZ 10 INT 3
 POW 10 DEX 4 HP 14 Move 6

Weapons: Crush 50%, 2D4

Armor: All weapons do only one point of damage with no impales; explosives do half damage. The creature regenerates one point of damage per round.

Sanity Loss: 1/1D8

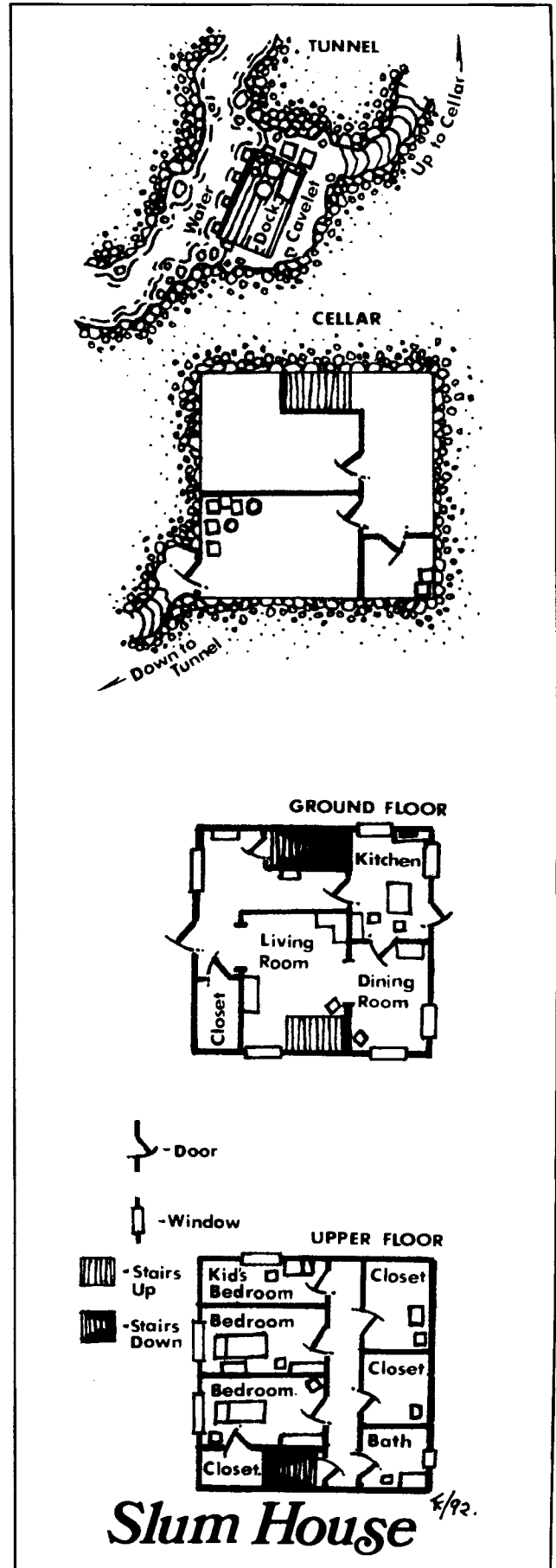

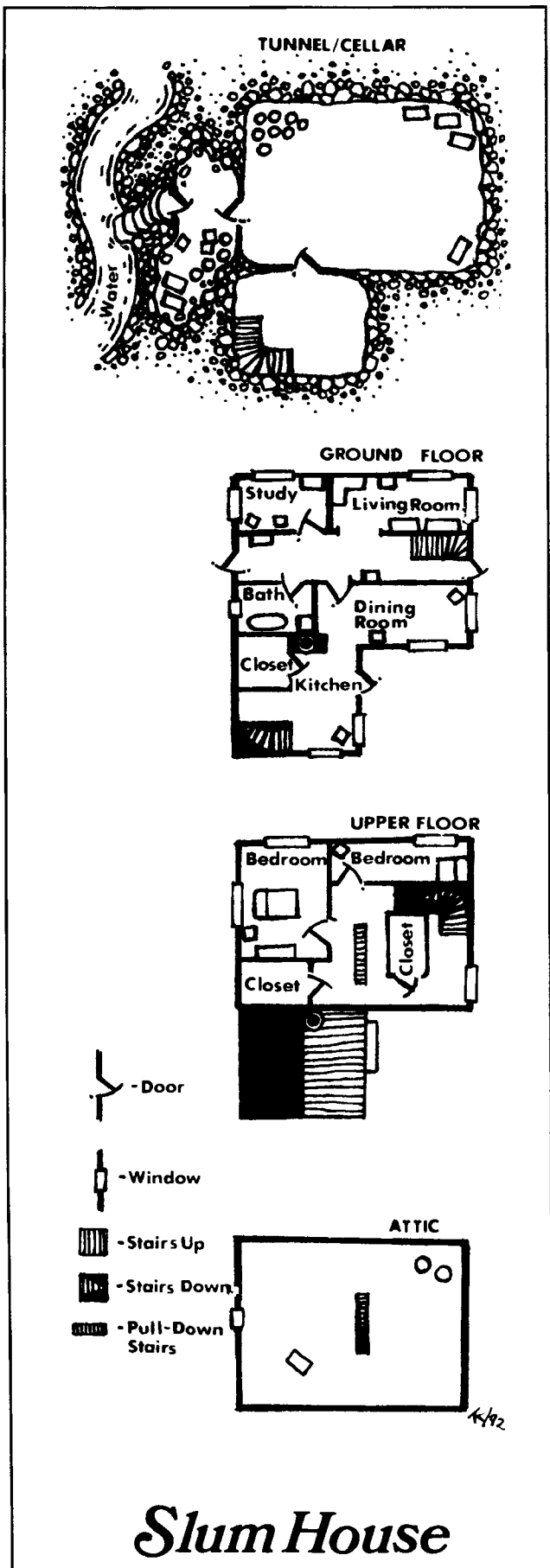

Going for the Gold

This event assumes Private Anzack has so far survived. It takes place while part of the squad is setting charges in one of the houses above.

Rumors of Innsmouth gold have circulated amongst the marines and the greedy Anzack has fallen under the spell of quick and easy riches. Enlisting the aid of Voltz and Witzneki, he waits until the others are setting charges, then steals one of the boats to go off and search for riches. If caught in the act, Anzack and the others claim to have heard something, and attempt to row off in order “to reconnoiter.” If everyone is busy at the time, the marines departure might be noted with a successful Spot Hidden or Listen roll. The greedy private plans to fill the boat with as much gold as possible, then exit the tunnels and head for parts unknown. He stops at nothing, sacrificing the rest of the squad—even his partners—if need be.

Whether or not Anzack succeeds, or is met again, is left to the keeper, but it is suggested that the investigator’s squad catch up with him and his partners in the Shoggoth Breeding Pit (see below).

Friendly Fire

The Coast Guard, though ordered not to shell the town, does so in an attempt to kill several deep ones that have gotten past the patrols—heedless of the possibility that friendly forces might be inside the houses along the northern shoreline.

If any of the raiders are inside a slum building during the middle to late stages of Part Two, a failed Luck roll indicates that the houses above have taken hits. Luck rolls allow raiders to escape unhurt, otherwise they suffer 1D6 damage from flying splinters and falling debris. A fumbled roll means the character suffers 2D6+1 points of damage from a falling beam or collapsing cellar wall.

*Go to Part Two of Objective Six
 The Marsh Refinery*

Part Three: Hearts of Darkness

In the final act of this scenario, the remnants of the investigator’s squad come upon numerous terrible places and even more terrifying creatures. The hunters may become the hunted.

The Shoggoth Breeding Pit

The water in this high-ceilinged chamber is relatively clear, the omnipresent algae illuminating the three-foot depths all the way to the bottom. Beneath the surface the raiders see

a trove of golden jewelry, stored here by the deep ones. Within the pale emerald depths can be seen amulets, necklaces, statuettes, and all manner of alien artifacts mounted in the disturbingly lustrous gold of the deep ones. The raiders should not assume that all this gold is unprotected. This is the breeding pit of the shoggoths.

When the raiders arrive they find Anzack, Voltz, and Witzneki near the center of the room in their stolen craft. Witzneki is leaning over, reaching into the water. The other two whirl to face their fellow marines, the men they abandoned. Harsh words are perhaps exchanged while Witzneki continues to try and reach the object he has his eye on.

The argument is ended abruptly by Witzneki's scream. Unknowingly extending his hand into the formless, semi-liquid body of a shoggoth, the creature has flowed up his arm with fluid swiftness, burning and devouring the man's flesh as it travels. The rest of the creature rises to the surface revealing through its semi-transparent protoplasm the half-digested remains of its previous victims—mangled, gape-mouthed corpses with horribly gnawed heads, bloated torsos, and partially dissolved limbs, all churned into a human stew. Sanity point loss for this sight is 1D3/1D20.

The shoggoth completely engulfs Witzneki, lifting him clear of the boat, simultaneously forming itself into a fluid pillar of semi-flesh that reaches nearly to the ceiling. Inside the shoggoth the doomed Pole can be seen making his final futile struggles against the abomination that devours him alive. Witnesses lose another 1/1D4 Sanity points.

The thing takes 1D3 rounds to consume Witzneki, during which time the others can attack or flee. After that it

A Second Shelling

This only occurs if the surface forces have failed to stop Dagon from approaching the town. In this case, the Coast Guard fires on the shore a second time with consequences similar to the previous occasion. See *Friendly Fire* (p. 126) for details.

pursues either Anzack's party or the investigator's, determined randomly (or not, if the keeper feels the investigator needs a break). Use the average shoggoth statistics in the *Call of Cthulhu* rulebook.

If the shoggoth is slain its smaller brood-mates arise to retaliate—but not individually. Instead these formless horrors surface, joining in a writhing, twisting dance around one another, melding to form a communal entity.

This patchwork horror rises nearly twenty feet above the surface of the water, a glutinous, protoplasmic tornado of ravaging flesh that bears down on the raiders with unimaginable alien appetite. Sanity point loss is 1D6/1D20. Add together the STR, CON, and SIZ of the surviving shoggoth-spawn (described on p. 124), to determine this creature's hit points and other statistics.

If reduced to less than 20% of its hit points, the creature flees by smashing its way through the roof of the chamber and into the house above. Tearing its way out of the decrepit structure, it froths and bubbles through the streets of Innsmouth in a headlong flight to the sea.

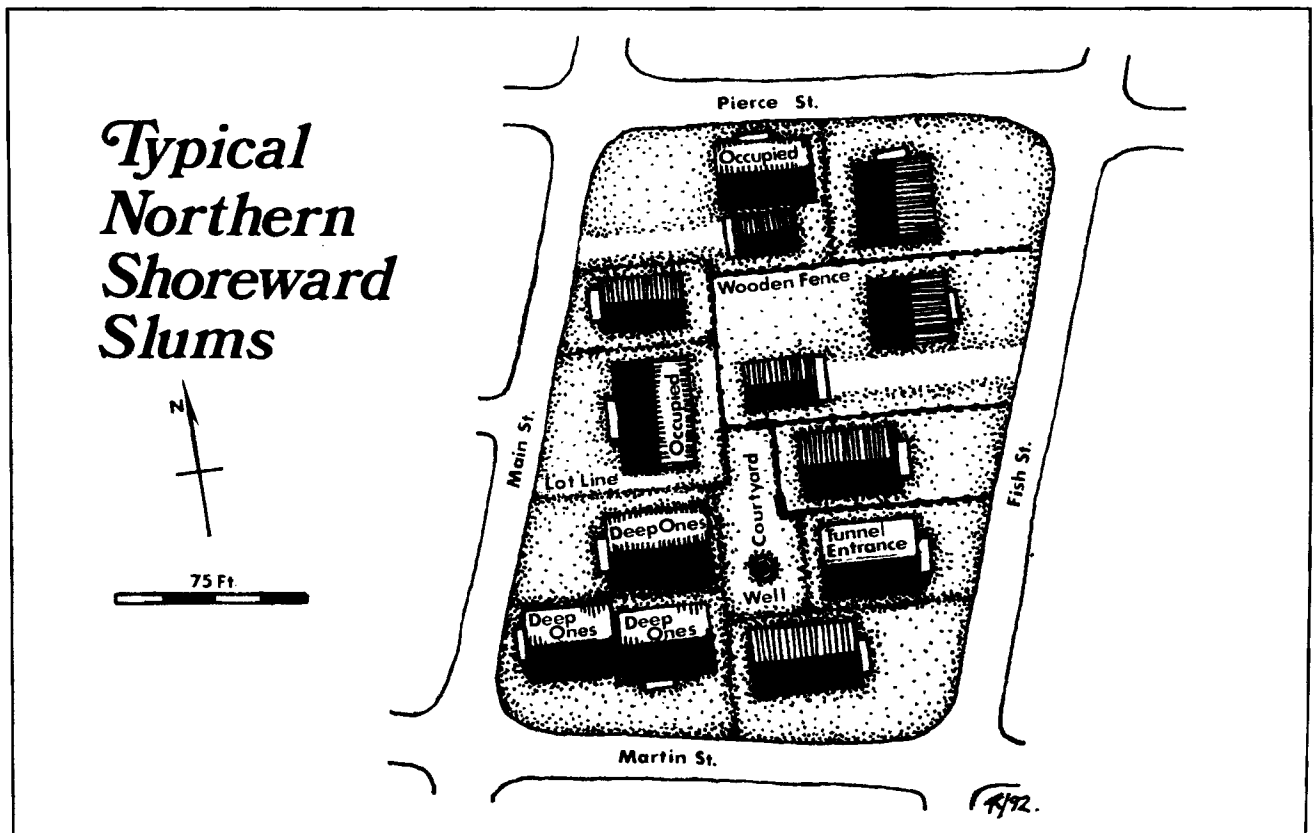

The Black Lagoon

This is a huge cavern roughly three blocks long and two blocks wide with a high ceiling supported by four thick, naturally-formed columns. The water is deep ebony-black, a light penetrating only to a depth of two feet.

A failed halved Luck roll in this chamber indicates an attack. The surface of the lagoon begins boiling and frothing as 5D10 hostile deep ones rise and converge on the raiders' boats, a sight calling for a loss of 1/6 Sanity points. The deep ones attack until half their number are killed, or until the raiders manage to escape.

To The Esoteric Order of Dagon

A narrow, unflooded but slimy tunnel snakes deeper beneath the town, eventually entering the basement of the Esoteric Order of Dagon (207 on the Smuggler's Tunnels map), emerging from behind the legs of the horrible idols there. Near the end of the raid there may be many deep ones fleeing down from the temple above, possibly including the priests Robert Marsh and Jeremiah Brewster, driven out by the raiders' assault. The keeper may need to coordinate this flight with the tunnel raiders' actions, or he may simply rule that the priests either escape or automatically encounter the raiders in the tunnels.

To The Marsh Refinery

A watery tunnel also leads toward the shore of the Manuxet and beneath the Marsh Refinery (501 on the Smuggler's Tunnels map). There a band of federal agents is confiscating records and gold supplies and taking prisoners prior to destroying the factory.

The keeper may need to coordinate parts of this segment of the raid with the Refinery mission, as there may be hybrids or even raiders fleeing the refinery through the smugglers' tunnels. If Private Anzack hasn't gone for the gold yet, he takes off for the refinery, shooting any escaping hybrids en route and looting their gold. Other raiders might meet him later, his boat loaded with the weird whitish gold of the deep ones.

The Vengeful Sorcerer

Prowling the tunnels is a deep one sorcerer in the company of his three adepts. While the priest remains at a central location in the warren, his underlings maintain a constant search for unwanted visitors.

Each time the squad enters a house, there is a 30% chance of encountering one of the underlings accompanied by 1D4 normal deep ones. The adept deals with the intruders from concealment while the others take word to the Elder, who arrives on the scene 1D6 minutes later. The sorcerer is the most intelligent and crafty of the creatures in the warrens, and can organize its fellow deep ones into an effective fighting force long enough to ward off the invasion or secure an escape route.



JOINED SHOGGOTH-SPAWN HORROR

The sorcerer carries a golden gong it uses to summon the shoggoth-spawn (see p. 131). One or more of these creatures responds to the sounding of the gong, at which time the sorcerer sends the amorphous things after the invading forces. Only the sorcerer can safely summon and order the spawn in this manner.

If the sorcerer is slain, the adepts are thrown into confusion, capable of little more than overseeing the evacuation of the crumbling dwellings. If the adepts are also slain, pandemonium results and there is a panicked rush for the tunnels and the safety of the sea.

THE SORCERER

STR 15 CON 12 SIZ 20 INT 15 POW 16
DEX 14 APP NA EDU NA SAN NA HP 16

Damage Bonus: +1D6

Weapons: Claws x2 40%, 1D6+db each
Sea Stars* (Thrown) 35%, see below

Armor: 1 point of skin and scales.

Sanity Loss: 0/1D6

Spells: Breath of the Deeps, Contact Cthulhu, Contact Deep One, Contact Father Dagon/Mother Hydra, Grasp of Cthulhu, Shrivelling, Wave of Oblivion.

**The deep ones have mutated common sea stars, transforming them into a deadly weapon which they unleash on the invaders. It is thrown at the target like a throwing star. On a successful hit, the arms of the starfish burrow into the target's flesh, causing one point of agonizing damage per round. After three rounds, the creature is sufficiently anchored to extend its razor-sharp tube-like mouth and commence gnawing its way into the victim's body, now causing 1D4 damage per round.*

The starfish grips with a STR of 16. This must be overcome to pull the creature loose. Forced removal causes 1D3 points of damage to the hapless victim. The creature can be burned off with flame or acid, causing only a single point of damage to its victim.

THE ADEPTS

STR 13 CON 12 SIZ 15 INT 14 POW 14
DEX 15 APP NA EDU NA SAN NA HP 14

Damage Bonus: +1D4

Weapons: Claws x2 30%, 1D6+db

Spells: Contact Deep One, Grasp of Cthulhu, Shrivelling.

Sanity Loss: 0/1D6.

The Exodus

With the first explosion or firing of shots, the deep ones prepare to leave the tunnels. The investigator and his compatriots meet these bloated humanoid things and their grotesque semi-human kin when they swarm into the tunnel system, streaming out of tunnel walls and ceilings, causing the waters to boil with their swimming and thrashing forms.

The sight of this ichthyic exodus calls for a Sanity loss of 1/1D6 points. The raiders might come under attack if the deep ones' route takes them past the invaders, but most of the creatures concentrate solely on flight. The raiders might decide to use this flight to their advantage, attacking from

ambush or setting off charges in the midst of the routed deep one hordes.

On the Surface

If the raiders are forced to the surface, they may have to make their escape through Innsmouth's ravaged streets, possibly continuing their demolitions from above. An accompanying map (p. 127) shows a typical block of houses in this bedraggled neighborhood.

The majority of the houses have narrow alleyways between them, each giving access to dark and brooding courtyards near the center of each block. Many of the snow-drifted alleys are at least partially blocked by debris, but most are still negotiable.

The courtyards are cluttered with crates, garbage, and rubble fallen from the crowded hovels, and are wildly overgrown with lichen and tangled weeds. In the center of some, partially concealed by snow, debris, and wild growth, are crumbling communal wells. Many of these have been excavated by the deep ones and now provide access to the smuggler's tunnel system. From within the tunnels, these wells are discovered only with halved Spot Hidden rolls.

These areas are possible sites for deep one attacks. Anyone entering a courtyard alone must make a Luck roll or be swarmed over by 2D3 waiting deep ones who try to drag their victim down the well into the tunnel system. Such a victim disappears before any rescuers can arrive, his screams echoing into the depths. Parties of deep ones may also Sneak (50%) out of the courtyard and attack small groups of raiders.

Squad members entering the courtyards are also potential targets for rocks and rubble thrown or dropped from the surrounding houses. Although the deep ones try to make it look as if these attacks are the result of accidentally falling debris, a Spot Hidden reveals the fishy attackers. These attacks have a 30% chance to hit and do 1D6 damage.

End of Mission

After leaving the tunnels, either victoriously or in full retreat, the raiders are to continue dynamiting the waterfront houses from above, eventually joining up with the forces destroying the Marsh refinery.

REWARDS

As long as the mission was at least partially successful, reward survivors with 1D10 Sanity points. In addition, they gain one point of Sanity for every deep one slain, to a maximum of ten points. Four additional points are awarded for slaying the sorcerer. Each shoggoth-spawn destroyed is worth 1D8 Sanity points, and each full shoggoth (including the communal horror) is worth 1D20.

Whatever the result of their endeavors, the raiders are free to rendezvous with other raiding parties.

*Go to Part Three of Objective One
The Esoteric Order of Dagon*



OBJECTIVE FOUR: DEVIL REEF



This portion of the raid involves the U.S. Coast Guard, which has been assigned to patrol the harbor entrance and the sea beyond Devil Reef. Using three vessels, their mission is to prevent the escape of refugees from Innsmouth in boats, and also to keep any deep ones from reaching shore and lending aid to their human counterparts in town. The Coast Guard commander is under orders to not shell the town.

Personal Equipment

Investigators are supplied with a life jacket, commando knife, binoculars, and their choice of a .45 automatic or a .30-06 rifle.

Several of the supporting characters have new skills and new weapons.

NEW SKILLS

GUNNERY SKILL (BASE 00): This skill is added to the base chance to hit with any of the ship-mounted weapons listed below to determine the final attack percentage.

SHIPHANDLING SKILL (BASE 00): In this scenario this skill is used to maneuver a ship into position to fire its guns, perform a rescue, ram a foe, etc..

NEW WEAPONS

.30 CALIBER MACHINE GUN: Base chance 15%, damage 2D6+4; fires up to 20 rounds per burst, range 150 yards; requires a crew of two, gunner and belt-feeder; 500-round belts; jams on roll of 99-00 (96-00 with only one crewman).

.50 CALIBER MACHINE GUN: Base chance 15%, damage 2D6+10; fires up to 20 rounds per burst, range 200 yards; requires a crew of two, gunner and belt-feeder; 500-round belts; jams on roll of 99-00 (96-00 with only one crewman).

3-INCH GUN: Base chance 00%, damage 10D6 (2-yard radius); 1 shot/3 rounds, range 1-2 miles; requires a minimum crew of two, gunner and at least one loader or firing rate 1 shot/6 rounds; high-explosive shells; jams on roll of 99-00.

The Harbor Raiders

The three Coast Guard vessels include a 165-foot cutter and two smaller, 75-foot patrol boats. The investigator advisor will be assigned to the cutter.

Supporting characters may be sailors aboard the cutter or, if desired, two players may take the parts of the commanding officers of the two patrol boats.



WO CURTIS HENLEY

CPT. STEPHEN HEARST, 50

Hearst is a spotless, clear-eyed officer judged by his superiors as efficient, but lacking in imagination. A religious man, Hearst keeps a bible in his breast pocket. He is rigid and unbending. The investigator advisor must successfully Persuade when suggesting tactics to Captain Hearst; he is loathe to listen to advisors "and damn the higher-ups if they don't like it." Hearst always wears his sidearm.

CAPTAIN STEPHEN HEARST, age 58, commanding officer

STR 13 CON 15 SIZ 15 INT 14 POW 12
DEX 11 APP 10 EDU 14 SAN 60 HP 15

Damage Bonus: +1D4

Weapons: Fist/Punch 65%, 1D3+db

Grapple 60%, special

.45 Automatic 45%, 1D10+2

.30-06 Bolt-Action Rifle 35%, 2D6+4

Gunnery 45%, as per weapon

Armor: 1D3-1 for heavy wool clothing.

Skills: Persuade 50%, Listen 35%, Shiphandling 70%, Spot Hidden 65%, Swim 50%, Tactics 55%.

THE PATROL BOAT COMMANDERS

Warrant Officer Henley of the *Vigilant* and Chief Petty Officer Wallis of the *Spectre*, in communication with the *Urania* are more easy going than their commanding officer, and more likely to listen to investigator-but neither disobeys orders. Both carry sidearms and wear woolen overcoats. Wallis is a heavy smoker.

WARRANT OFFICER CURTIS HENLEY, 35, of the Vigilant

STR 14 CON 15 SIZ 14 INT 14 POW 14
DEX 15 APP 13 EDU 12 SAN 60 HP 15

Damage Bonus: +1D4

Weapons: Fist/Punch 55%, 1D3+db

Grapple 45%, special

.45 Automatic 45%, 1D10+2

.30-06 Bolt-Action Rifle 60%, 2D6+4

Gunnery 55%, as per weapon

Armor: 1D3-1 for heavy wool clothing.

Skills: Listen 55%, Shiphandling 55%, Spot Hidden 50%, Swim 65%, Tactics 55%.

CPO JOHN WALLIS, 44, of the Spectre

STR 13 CON 14 SIZ 12 INT 15 POW 13
DEX 14 APP 14 EDU 12 SAN 65 HP 13

Damage Bonus: +1D4

Weapons: Fist/Punch 60%, 1D3+db

Grapple 55%, special

.45 Automatic 65%, 1D10+2

.30-06 Bolt-Action Rifle 55%, 2D6+4

Gunnery 45%, as per weapon

Armor: 1D3-1 for heavy wool clothing.

Skills: Listen 60%, Shiphandling 65%, Spot Hidden 55%, Swim 60%, Tactics 45%.

TYPICAL COAST GUARDSMEN

All three vessels are manned by full crews. Use the following typical characteristics for all enlisted men.

TYPICAL SAILOR, age 20-40

STR 12 CON 13 SIZ 13 INT 13 POW 10
DEX 13 APP 11 EDU 12 SAN 55 HP 13

Damage Bonus: +1D4

Weapons: Fist/Punch 65%, 1D3+db

Grapple 65%, special

.30-06 Bolt-Action Rifle 35%/45% (Troops), damage 2D6+4

Gunnery 55%/25% (Troops), as per weapon

Armor: 1D3-1 from heavy woolen clothing.

Skills: Dodge 40%, First Aid 40%, Listen 30%, Spot Hidden 40%, Swim 50%.

Supporting Characters

Each of the vessels has a number of men stationed on deck to act as combat troops. Armed with rifles, they are to repel boarders and otherwise deal with the enemy in the harbor. In close combat the seamen use their rifle-butts as clubs (35%, damage 1D8+db), and some may have knives (30%, 1D4+2+db damage). A few personalities are described below. Supporting characters may use the Typical Sailor characteristics, or players may roll up their own. Skill levels should not exceed those of a Typical Sailor (Combat Troops) except as described below.

PETTY OFFICER THIRD CLASS DEREK CHIMES

Although assigned to one of the heavy guns, Chimes, a veteran of the World War, keeps a rifle at his side. He is quiet and cool-headed under fire—a dedicated warrior.

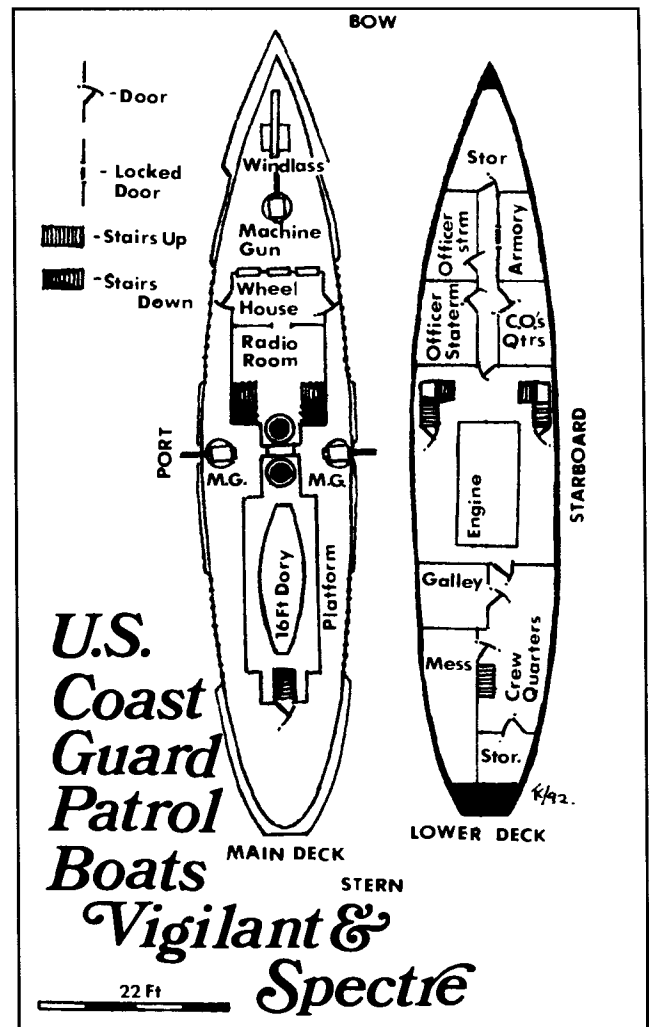

Skills: Gunnery 60%; .30-06 Bolt-Action Rifle 40%, 2D6+4; Swim 65%.

SEAMAN FIRST CLASS PAUL FULTON

Fulton is a good-natured Tennessee boy with a backwoods drawl. A laid-back individual, Fulton nevertheless is a good fighter, armed with a rifle and a flare gun with three flares.

Skills: .45 Automatic 45%, 1D10+2; .30-06 Bolt-Action Rifle 60%, 2D6+4; Swim 30%.

SEAMAN RECRUIT BARRY TAFT

Taft, a young and relatively new recruit, is extremely nervous about this mysterious mission. Boarding parties? Attacking one of our own towns? What has he gotten himself into?! His Sanity is currently 45.

Skills: .30-06 Bolt-Action Rifle 45%, 2D6+4; Swim 55%.

SEAMAN GENE HENSON

Henson is a sullen, unpleasant machine-gunner, prone to violence. If driven mad, he is likely to continue firing even when there are no available targets. He carries a .45 automatic pistol. His current Sanity is 40.

Skills: Gunnery 45%; .45 Automatic 40%, 1D10+2; Swim 25%.

Ships, Armaments, and Crews

The command vessel is the 165-foot cruising cutter *Urania*, displacing 337 tons, with a top speed of 14 knots and a crew of 44 including five officers. The *Urania* carries a 3-inch gun forward and two .50 caliber belt-fed Browning machine guns mounted port and starboard. Mission commander Captain Stephen Hearst is in direct command of the vessel.



CHIEF JOHN WALLIS

Each of the two patrol boats is 75 feet long, displacing about 150 tons, with a top speed of thirteen knots, and manned by a crew of fifteen men.

These boats are much more maneuverable than the cutter, and each is armed with a .50 caliber Browning machine gun forward and two .30 caliber

fed Lewis machine guns mounted amidships port and starboard. The commanding officers are Warrant Officer Curtis Henley aboard the *Vigilant* and Chief Petty Officer John Wallis aboard the *Spectre*.

Part One: First Contact

The three Coast Guard vessels travel north from Boston in formation, accompanied by the S-19 submarine. Nearing Innsmouth, the sub pulls away and the two patrol boats anchor out at sea while the *Urania* travels nearer to shore. A mile and a half off, and well north of the town, the *Urania* casts off the four rowboats manned by the tunnel raiders. The cutter then sails south.

When the land-based forces begin their attacks, the patrol boats move into the waters between Devil Reef and the harbor, the *Spectre* sailing in from the north while the *Vigilant* enters from the south. The *Urania*, meanwhile, positions itself out beyond the reef in the open sea.

Throughout the scenario, Captain Hearst moves between the wheel house, the top of the deck house, and the main deck. Similarly, the commanders of the patrol boats divide their time evenly between the wheel house and the main deck.

First Sighting

Almost immediately upon arriving at their positions, the first sounds of assault are heard echoing from the distant shore. Faint shouts are heard, and occasional flashes of gunfire can be seen. Meanwhile, Spot Hidden rolls detect movement in the waters between the harbor and the reef. Using binoculars, spotters see dozens of man-like shapes swimming towards the harbor and shoreline. Deep ones! Due to the extreme distance, Sanity loss is only 0/1D2 points.

The patrol boats, closer to the swimmers, move in and open fire. If the investigator can Persuade him, Captain Hearst sails the *Urania* inside the reef to assist in repelling the shore bound horrors.

There are 4D10 deep ones in this first wave. During the first round of combat they are caught unawares. Each ship making a successful Shiphandling roll is assumed to be able to pull into position to open fire with at least one deck weapon. Successful Shiphandling rolls 20 points or more under the necessary minimum can bring a bonus of two weapons bearing on the enemy. Note that due to its array of weapons, the *Urania* always has at least two guns in position to fire, more if Shiphandling rolls qualify for the bonus.

The gunners fire bursts of 2D6 shots each, and for every twelve points of damage they inflict, one shore bound deep one is killed or incapacitated. After the first round of fire the surviving deep ones submerge, giving up their attempt to reach the shore and returning to the reef for reinforcements.

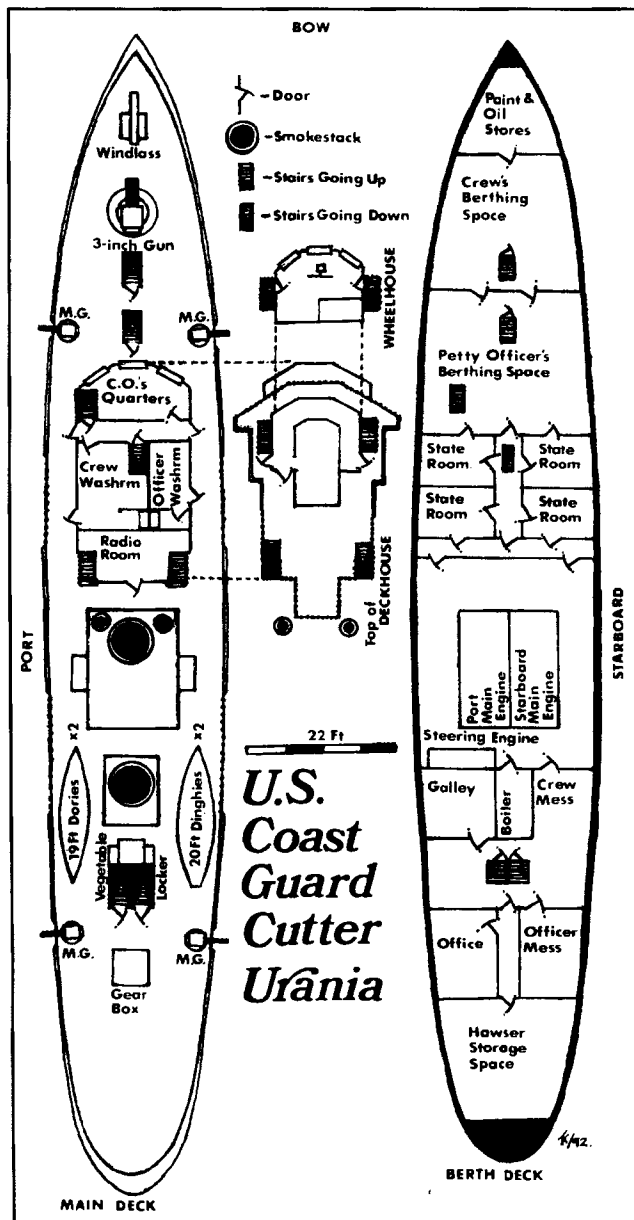



THE BOARDING PARTY

Note that the number of shore bound deep ones killed in no way affects the number of deep ones encountered by the land forces and that no detailed bookkeeping is required. Those deep ones encountered in town are assumed to be those who somehow slipped by the Coast Guard's gun batteries and made it to shore.

Regardless of the number of deep ones killed, the Coast Guard's attack seems to drive the first wave underwater and back toward Y'ha-nthlei.

The Boarding Party

The waters again are quiet and the vessels resume their initial patrolling formation: the patrol boats between harbor and reef, the cutter beyond the reef. Investigator recommendations that the cutter remain inside the reef are subject to Persuade rolls against the still-unfazed Captain Hearst. He and the crews of all three ships seem cautiously overjoyed by their victorious first engagement.

The victory is short-lived, however. Roll a Spot Hidden for the commander of each vessel, as well as the investigator and any supporting characters. If any roll is successful, the crew of that vessel is not surprised by the deep one boarding party that now clambers up the sides and over the rails. Sanity loss is 1/1D6 points.

Inside the reef, boarders number 2D6 per vessel, outside it, 2D4. Unsurprised seamen get one round of fire at point-blank range before the fishy-smelling deep ones close and engage in melee combat. During the melee rifle attacks are allowed only once every three rounds, and at half the normal chance to hit, due to the milling crowds on deck. Fumbles indicate the character has accidentally shot one of his own sailors.

The chaos of battle reigns as deep one blood and brains splatter across the decks and crewmen fall screaming to

raking ichthyic claws. The investigator may stand aside or join in battle, as he chooses. Alternately, the keeper can ask for a Luck roll; if it fails a deep one comes after the investigator wherever he may be.

For every eleven points of damage scored by the deep ones a Coast Guardsman is killed or incapacitated. For every twelve points of damage inflicted by the humans, a deep one is killed or incapacitated. Use the sample deep ones given at the back of the book for the boarding party's statistics.

SOMETHING SURFACES NEARBY

After any boarding actions are beaten back, cries from some of the sailors aboard the *Urania* attract the attention of the investigator.

"My God! What is that thing!" exclaims one of the men. Another shrieks aloud. A retching odor carried by the wind rolls over the ship.

*Go to Part One of Objective Two
The Marsh Mansion*

Part Two: From Deep Waters

The Dead Thing

Near the end of the skirmish with the deep one boarders the corpse of the slain star-spawn surfaces near the *Urania*. Observers see it burst to the surface in a huge rush of water and spray, one tattered wing upthrust like the sail of a some

hellish, spectral ship. Sanity loss for seeing this awesome development is 1/1D6 points.

Those who rush to the side of the ship see a great wound in the thing's side from which an oily slick of foul smelling green-black blood spreads out over the surface of the water.

The winged mass of tentacles, limbs, and claws can be identified with a successful Cthulhu Mythos roll as one of Cthulhu's star-spawn. A closer look calls for a further Sanity loss of 1/1D3. The corpse still bubbles and oozes disgustingly. If the *Urania* stays in the area any length of time the stench becomes nearly unbearable and CON x5 rolls may be required to overcome nausea.

Moments later the S-19 surfaces a few hundred yards away. Officers and men can be seen emerging onto the deck. Then dark forms can be seen swarming over the hull of the sub and the S-19's machine gun begins to chatter. As the deep ones converge on the conning tower, the sub descends, perhaps even while sailors on deck man the machine gun. Sanity loss is 0/1D4. Is the sub's descent intentional, or was it the result of something else?

Meanwhile, an investigator making a Spot Hidden roll and a Cthulhu Mythos roll realizes that the "dead" thing in the water is in the process of regenerating its destroyed flesh. Potential Sanity loss is 1/1D6, but negated if the investigator can Persuade the ships' commander to fire enough rounds into the corpse to destroy it. Otherwise the spawn will continue to regenerate until strong enough to make its escape.

AN OPTION

It is possible that the star-spawn was not severely wounded by the sub. In this case it surfaces alive and makes for shore, physically attacking any vessels it encounters along the way. Use the lower average statistics found in the Call of Cthulhu rulebook. Sanity loss for seeing an active, living star-spawn is 1D6/1D20. If the wounded spawn is hit by any additional weapons fire, it flees the area, winging its way east out to sea.

The Calm Before the Storm

With the first boarding party dealt with, the patrol boats concern themselves with picking off a few deep ones that managed to sneak close to shore. The cutter may be still inspecting the dead thing on the surface if the investigator (or the keeper) desires. In any case, there is a lull in the action in which First Aid can be rendered, replacements ordered for the gunnery crews and seamen on deck, and so on. Again, distant explosions and gunfire in Innsmouth remind those at sea that similar struggles are taking place on shore.

The Wave

By this time the two patrol boats have returned to patrolling the waters between Devil Reef and the harbor while the *Urania* remains at sea. No deep ones have been seen since the attack on the submarine. The crews are edgy and apprehensive. It seems too quiet.

An investigator making a Spot Hidden roll from on deck notices a glowing point of light in the waters near the reef.

Below the surface, deep one sorcerers have joined together to create a Wave of Oblivion. A total of forty magic points have been expended, creating a wave thirteen feet long, thirteen feet wide, and forty feet high. The wave forms on the surface between the reef and the harbor and, moving toward shore, grows so fast any patrol boat failing a Shiphandling roll is struck broadside and capsized, crushed beneath the wave and sunk like a stone. If both vessels make their roll, one is sunk anyway, determined randomly. Those witnessing the demise of a patrol boat lose 1/1D4 Sanity points; Captain Hearst automatically fails his Sanity roll and begins to lose control.

Any player characters aboard a capsized patrol boat are allowed Jump rolls to escape, then must make Swim rolls each round until rescued. If the other patrol boat has survived, rescue arrives in 1D4+2 rounds. The *Urania* requires 2D4+2 rounds to reach the scene. In addition to the possibility of drowning, characters in the water must make CON x5 rolls each round or suffer one point of damage from exposure to the freezing waters.

The Battle Rejoined

As the remaining Coast Guard vessels search for survivors another school of deep ones starts heading toward shore. There are only 3D10 in this group, widely dispersed between reef and harbor, apparently headed for sites along the breakwater and in the inlet north of town. Shiphandling rolls again allow vessels to position themselves in range. These deep ones do not submerge when fired upon, instead redoubling their efforts to make it to shore. Hearst, enraged at the loss of a vessel under his command, orders both craft to close in and paint the sea red.

ANOTHER BOARDING PARTY

In the chaos of gunfire few notice the scaly claws grabbing gunwales and pulling themselves aboard both craft, on the sides opposite the firing. Allow a single, halved Spot Hidden roll per ship, plus an additional roll for the investigator, to alert the crews to this latest boarding party. If the rolls fail, the rifle-armed seamen react too late to fire before the fighting breaks out. As before, later rifle attacks are attempted once every three rounds of combat at half the normal chance to hit, and with the possibility of hitting friendly forces.

There are 2D6 deep ones in each boarding party. The tenth deep one rolled up is an ancient sorcerer; his statistics are found below. The sorcerer uses his spells against those it assumes to be in positions of command, casting them in a deep croaking voice.

Sanity loss is 1/1D6 for this new group.

DEEP ONE SORCERER

STR 12 CON 10 SIZ 15 INT 15 POW 18
DEX 16 APP NA EDU NA SAN NA HP 13

Damage Bonus: +1D4

Weapons: Claws x2 25%, 1D6+db

Armor: 1 point scales.

Spells: Curse of the Stone, Implant Fear.



THE SLAIN STAR-SPAWN

Several other events occur during the chaos of this battle. First the meager shoreward feint and the boarding action are meant to distract the Coast Guard long enough so that a large school of deep one reinforcements can reach the shore. 6D10 deep ones now swarm in the direction of the town, counting on the boarding parties to keep them from suffering concentrated gunfire. A Spot Hidden roll made by Captain Hearst, or the investigator, spies the huge school of reinforcements just as they are about to reach shore. As the last of the boarding deep ones are being despatched, Hearst rashly gives the order to open up on the deep ones on shore. The concentrated fire destroys deep ones, fishermen's shacks, and homes alike, in an eruption of explosions and screams. This may have repercussions on the raiders currently in the smugglers' tunnels.

A SABOTEUR

During the battle a deep one tries to get belowdecks on one of the vessels (randomly determined) in an attempt to sabotage it. Again, allow one halved Spot Hidden roll for the ship's beleaguered crew and one for each investigator or supporting character aboard to notice the sneaking creature. If not stopped, the deep one has a 20% chance of somehow crippling that vessel. Possibilities include: damaging the ship's engines or navigation equipment, and reducing speed and/or Shiphandling rolls by half; causing an explosion that kills 1D6 crewmen; damaging communications equipment, preventing the vessel from communicating with other forces; flooding the bilges; or anything else the keeper can think of. The creature continues to attempt sabotage until discovered or the vessel is completely disabled.

A TERRIFYING RESURRECTION

This last development occurs only if the wounded star-spawn was left unmolested and allowed to regenerate. In the heat of

the battle there is a sudden awestruck pause among both men and deep ones as a vast shadow lifts itself up from the sea. Torrents of water pour off its vast hulk as the ragged-winged horror flaps heavily up into the sky, circling Innsmouth once or twice before heading out over the Atlantic and disappearing from sight. Sanity loss is 1/1D8 points.

Another Calm

Again, when the deep one boarding parties have lost half their number the survivors flee, leaving the decks awash with the blood and bodies of man and monster alike. The surviving sailors are shaken, unsure of what may happen next. Captain Hearst still has his men raking the shore with machine-gun fire, cutting down the few deep ones that straggle up out of the sea. The wounded moan, haggard gunnery crews reload their weapons, and the two vessels resume their patrols.

Even if the crews have taken massive casualties, Captain Hearst stubbornly insists on staying to support the land forces. Anyone questioning his authority too strongly ends up locked in irons, confined belowdecks. A Psychology roll reveals that Hearst is dangerously, perhaps recklessly vengeful.

As the investigator ponders the belligerent captain's disposition, allow Spot Hidden rolls for each ship to detect movement in the surrounding waters. The ocean's surface is alive with another 6D10 deep ones stroking for shore. Hearst, sputtering, orders the *Urania* and any remaining patrol boat to cut right over them and open fire.

Allow each investigator and supporting character a halved Spot Hidden roll. If successful, someone notices the water on ocean side of the reef boiling up again, as if something large were rising to the surface.

*Go to Part Two of Objective Three
The Smugglers' Tunnels*

Part Three: Final Confrontations

The Enemy God

If the submarine failed to stop Dagon, the Coast Guard crews see him surfacing near the reef. If Dagon was slain by the sub, it is his corpse that rises to the surface. In this case, if the keeper feels that the Coast Guard has had too easy a time of it, he may elect to have the surfacing creature be another of Cthulhu's star-spawn. This creature behaves in a manner similar to that described for Dagon, below.

DAGON RISING

The dripping head and shoulders of gigantic Dagon rises from the waters beyond Devil Reef while 1D10+10 normal deep ones crawl and scramble over the black crags before him. A Cthulhu Mythos roll identifies him as the all-father of the deep ones. Sanity loss is 1D3/2D8. Before the ships can bring their guns to bear, the reef is bathed in thick white fog, the result of the deep ones casting the Mists of R'lyeh spell. The fog reduces any attack rolls to half-normal for the next 1D6+4 rounds.

Captain Hearst turns his ship so that the 3-inch gun can be brought to bear while he orders the patrol boat to concentrate on any shore bound deep ones. "That big son of a bitch is mine," he growls.

FATHER DAGON

STR 52 CON 50 SIZ 60 INT 21 POW 30
DEX 20 APP NA EDU NA SAN NA HP 55

Damage Bonus: +6D6

Weapons: Claws x2 80%, damage 1D6+db each

Armor: 6 point scaly hide.

Spells: Wave of Oblivion, Contact Deep Ones, many others.

The Last Wave

As the ships maneuver into position, Listen rolls make out croaking, bleating voices coming from the fogbound reef. Dagon and his disciples are creating another Wave of Oblivion, to be directed at a randomly determined ship. The wave is fifty magic points strong, requiring five rounds to cast, and creating a wave sixteen feet long, sixteen feet wide, and fifty feet high. If an investigator makes a Cthulhu Mythos roll, he recognizes the spell and can warn his captain. With such a warning, a vessel can evade the wave with a normal Shiphandling roll; without a warning, the roll is halved.

If the patrol boat is struck by the wave, it is lost; Sanity loss is 1/1D4. The cutter, if struck, might survive, a successful Shiphandling roll righting the vessel after being nearly capsized. Even so, 1D10 men are swept from the decks. The investigator must roll DEX x5 to stay aboard, suffering 1D6 points of damage even if successful. Those

swept overboard need to make Swim rolls until rescued. If the *Urania* goes down, the Sanity loss is 1/1D4+1.

Desperate Pursuit

After the Wave attack Dagon sends boarding parties of 2D6 deep ones to worry any remaining vessels, then submerges and swims toward shore accompanied by another 4D10 deep ones. Luck rolls might be required of the investigator to avoid being sought out by deep one boarders.

If Captain Hearst and/or the cutter *Urania* are lost, the captain of a remaining patrol boat falls back beyond the reef. Protecting the harbor is given up and from now on the patrol boat merely fires at any deep ones within range, retreating if and when boarding attempts are made.

If the *Urania* is still afloat, Captain Hearst becomes suicidally vengeful, particularly if the other patrol boat was taken by the second wave. When Dagon slips beneath the waves and heads toward shore Hearst—oblivious to any boarding party activity—turns the vessel and follows the monster. Halved Spot Hidden rolls by those on deck can make out the huge shadowy form moving rapidly underwater towards the shore. Hearst, grim-faced, has his guns strafe the waters for swimming deep ones, all the while waiting for Dagon to surface.

In his lust for revenge, Captain Hearst is blind to all hazards, so much so that he brings the cutter in too close to the clogged harbor and must make a Shiphandling roll to avoid disaster. Failure means that the *Urania* rakes the bottom, staving in her side, and sinking in 1D100+20 minutes. In the meantime, her speed is halved, as well as all Shiphandling rolls.

The cutter has one clear shot at the huge deep one as he climbs over the breakwater and into the harbor—and a second as he climbs up the shore and heads into the northern part of town. Failure to bring down Dagon by this time means he reaches the Esoteric Order of Dagon. If Hearst fails to stop Dagon, he collapses on deck, stupefied by what he has seen and his inability to stop it.

If at any point Captain Hearst is killed or incapacitated, his executive officer Lieutenant Marvin Winter, is left in command of the *Urania*. Winter, a young and inexperienced officer, can be persuaded to break off the attack fairly easily. With all he's seen today, Persuade attempts are at +25%.

If Dagon is brought down at any time, the remaining deep ones stop what they are doing, and stand stunned and motionless for one round. When what has happened finally sinks in, they quickly submerge and swim back to Y'ha-nthlei. With the deep ones in retreat, the Coast Guard operation has succeeded.

If the submarine sent to Y'ha-nthlei survives its journey to the dark depths, one of the ships receives a radio call from the sub. They have surfaced nearby but they need one of the vessels to help machine-gun the horde of deep ones clinging to their hull. This is easily accomplished, as the deep ones flee as soon as they are fired upon. Just the thought of the submarine back safe on the surface is good for a 1D3 Sanity point award. Together the submarine and

remaining ships can watch the last of the fiery, smoky battle for Innsmouth.

After the Mission

The Coast Guard vessels patrol the reef throughout the remainder of the raid, perhaps rescuing crewmen and dispatching wounded deep ones, but suffering no more attacks.

REWARDS

Success of the Coast Guard operation depends largely on whether Dagon was allowed to reach town, and whether the ships were driven off by the deep ones. If either of these events occurred, the operation was a failure and surviving investigators aboard the Coast Guard vessels lose 1D10 Sanity points.

If Dagon was stopped, the operation was a success; the deep ones retreat after their father's death. This brings a 1D10 Sanity point award for helping to protect the land-based forces. If Dagon was slain by the sub and a star-spawn was substituted in the final encounter, the Sanity point award is 1D20.

Another 1D10 Sanity points are awarded if the investigator recognized the regenerating star-spawn and had it blasted before it revived.

If the *Urania* survived, another 1D6 Sanity points are awarded, and another 1D4 points for each patrol boat that survived the mission.

Finally, for those who kept close count, an additional point of Sanity might be awarded for every ten deep ones slain.

*Go to Part Three of Objective Five
Y'ha-nthlei*



OBJECTIVE FIVE: Y'HA-NTHLEI



The U.S. Navy submarine S-19 has been assigned the task of torpedoing the undersea city of Y'ha-nthlei. The crew has little idea of what they are up against and even the commanding officer operates under sealed orders not to be opened until the operation is underway. The men only know that the sub has been loaded with deep water, high-explosive torpedoes.

Submarine Raiders

The crew of the S-19 is comprised of nine officers and twenty-four crewmen. Most are keeper characters. The two most important are described below. For others, use the Typical Officer and Sailor descriptions offered below. Supporting characters are described separately.

COMMANDER ROBERT HARROW

Harrow served during the Great War and is one of the few men aboard with combat experience. Harrow is quick thinking, and held in high regard by officers and men alike. He keeps cool in any crisis.



ROBERT HARROW

COMMANDER ROBERT HARROW, 34, commanding officer
STR 14 CON 15 SIZ 14 INT 18 POW 17
DEX 9 APP 13 EDU 17 SAN 85 HP 15

Damage Bonus: +1D4

Weapons: Fist/Punch 65%, 1D3+db
.32 revolver 60%, 1D8

Skills: Fast Talk 45%, Navigate 65%, Persuade 70%, Physics 40%, Pilot Submarine 95%, Spot Hidden 80%.

PETTY OFFICER 2ND CLASS BENJAMIN PETERS

Peters is an ordained Episcopalian minister, especially assigned to this mission in an effort to provide the crew with spiritual reinforcement in the face of unknown dangers. Chaplain Peters is marked by his large eyes, and a nervousness that he attributes to never having been in a submarine before. He speaks much of God, but falters if asked about specific scriptures.

This imposter is actually Zachary Waite, a hybrid deep one sailor who, learning of the mission of his ship's chaplain, killed and replaced the man assigned to this post. No one aboard the submarine has ever met Peters and the hybrid's masquerade is safe. The imposter plans to sabotage the sub whenever the opportunity presents itself, then swim to safety. His white collar hides his partially-open gill slits.



ZACHARY WAITE

140 – Escape from Innsmouth

ZACHARY WAITE aka Benjamin Peters, 30, hybrid chaplain

STR 22 CON 17 SIZ 14 INT 13 POW 11

DEX 14 APP 6 EDU 9 SAN 0 HP 16

Damage Bonus: +1D6

Weapons: Fist/Punch 75%, 1D3+db

Grapple 85%, special

Skills: Dodge 56%, Swim 93%.

OTHER SUBMARINERS

The following typical characteristics can be used for other keeper controlled officers and sailors.

TYPICAL OFFICER

STR 11 CON 13 SIZ 12 INT 14 POW 11

DEX 11 APP 12 EDU 15 SAN 55 HP 13

Weapons: Fist/Punch 55%, 1D3

.45 Automatic 35%, 1D10+2

Skills: Persuade 50%, Pilot Submarine 30%.

TYPICAL SAILOR

STR 13 CON 13 SIZ 12 INT 11 POW 10

DEX 12 APP 10 EDU 13 SAN 50 HP 13

Damage Bonus: +1D4

Weapons: Fist 65%, 1D3+db

.30-06 Rifle 40%, 2D6+4

Skills: Electrical Repair 20%, Gunnery 20%, Mechanical Repair 20%, Navigate 10%, Pilot Submarine 5%.

Supporting Characters

Note that each of these characters is of low sanity and, should any of them go insane, they are capable of creating havoc aboard the sub. The keeper should determine if and when any individual character goes mad, and the results of this madness.

LIEUTENANT COMMANDER FRANKLIN BAIRD

College trained Baird is second-in-command. He is mystified by the purpose of this mission, but follows orders without question. He spends most of his time in the control room.

Baird was raised by a strict fundamentalist father. If driven insane he reverts to his father's character. Viewing the deep one chaplain, Waite, as a pure man of god, he conspires with the false chaplain to kill Commander Harrow and take over command of the ship. Waite easily convinces him that the attack of the submarine is against the will of God.

LT. COM. FRANKLIN BAIRD, 31, executive officer

STR 17 CON 11 SIZ 13 INT 16 POW 11

DEX 10 APP 10 EDU 16 SAN 25 HP 12

Damage Bonus: +1D4

Personal Equipment

Little is needed in the way of equipment aboard the sub. An investigator will be issued a .45 automatic if he requests ones.

Weapons: Fist/Punch 65%, 1D3+db

.45 Automatic 40%, 1D10+2

Skills: Navigation 70%, Persuade 50%, Physics 35%, Pilot Submarine 45%.

PETTY OFFICER 1ST CLASS WILLIAM MURPHY

Red-haired, with arms covered by tattoos, Bill Murphy is a veteran trained in the use of the .50 caliber machine gun mounted on the deck of the sub.

If driven insane, Murphy turns paranoid and becomes convinced that at least one of the crew is a traitor working in league with the deep ones to betray the entire crew. Unfortunately, he decides it is the investigator and begins making plans to expose him.

PO1 WILLIAM MURPHY, 29, gunner

STR 14 CON 11 SIZ 11 INT 10 POW 8

DEX 16 APP 9 EDU 13 SAN 25 HP 11

Damage Bonus: +1D4

Weapons: Fist/Punch 75%, 1D3+db

.30-06 Bolt-Action Rifle, 75%, 2D6+4

.50 Caliber Machine Gun 65%, 2D6+10

Skills: Mechanical Repair 35%, Spot Hidden 50%.

PETTY OFFICER 2ND CLASS DANIEL BURNES

Burnes is a stout man with short black hair. Machines please him, and he enjoys the exercise of making things work. He has few interpersonal skills, often communicating in mutters and grunts. Burnes remains in the engine and motor rooms of the vessel, a "snipe" amidst the pounding pistons.

Although a simple man, Burnes depends heavily on a rational, mechanical world. If driven mad by events, he responds by sabotaging engines, generators, and other equipment, convinced that all reason has failed.

PO2 DANIEL BURNES, 37, chief engineer

STR 16 CON 12 SIZ 10 INT 17 POW 10

DEX 13 APP 8 EDU 16 SAN 50 HP 11

Damage Bonus: +1D4

Weapons: Fist/Punch 60%, 1D3+db

Wrench 25%, 1D8+db

Skills: Electrical Repair 95%, Mechanical Repair 90%, Operate Heavy Machinery 90%.

LIEUTENANT CRAIG HYDE

Hyde is in command of the torpedo room. He is in a foul mood. His leave was cancelled for this foolish mission, and he was to be married this weekend. He is eager to blow things up. He is stationed in the forward torpedo room.

If driven insane, he may respond by either sabotaging torpedoes, or the tubes that fire them.

LT. CRAIG HYDE, 26, gunnery officer

STR 13 CON 16 SIZ 13 INT 15 POW 11

DEX 15 APP 12 EDU 15 SAN 55 HP 15

Damage Bonus: +1D4

Weapons: Fist/Punch 60%, 1D3+db

.45 Automatic 65%, 1D10+2

Skills: Electrical Repair 50%, Mechanical Repair 32%.

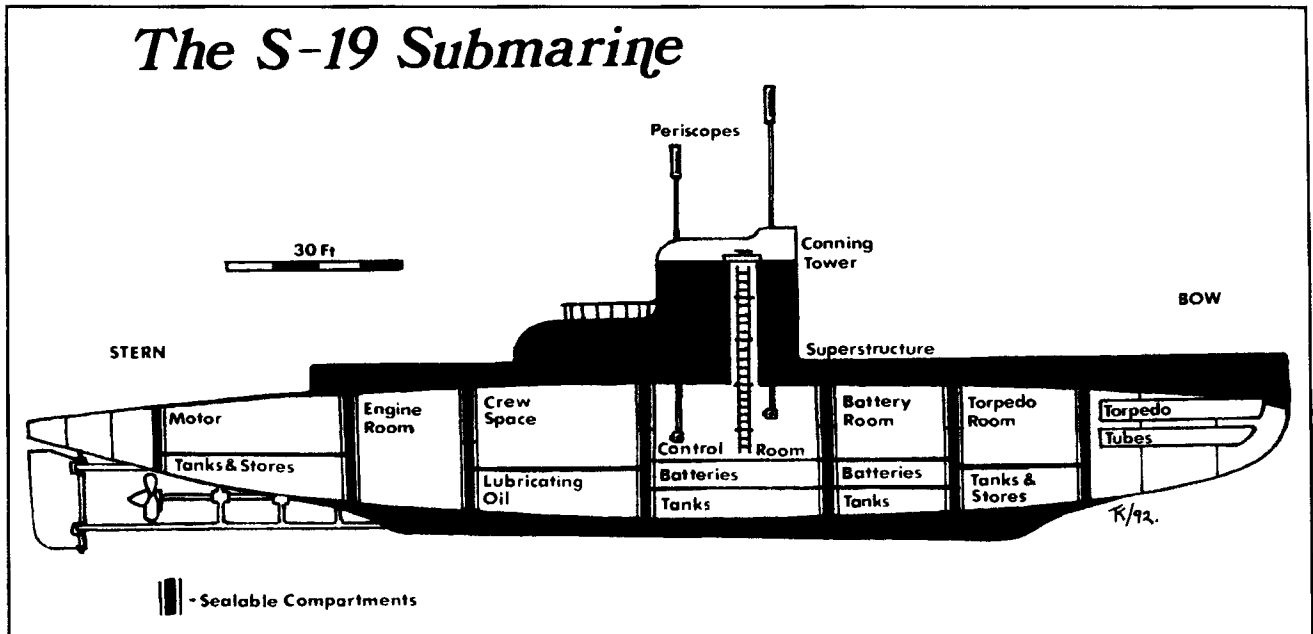

PETTY OFFICER 3RD CLASS ROY ACKER

Acker operates the radio and sonar from his post in the control room. Acker is nervous; his best friend died in a submarine accident a year ago last December when the S-4 sank off Rhode Island. The just-completed sub rescue mission has left him afraid for his own life aboard these uncertain vessels.

If Acker goes insane, he panics and tries to escape, attempting to open hatches or whatever in his desperate attempt to escape the confines of the sub.

ROY ACKER, 26, radio operator
 STR 11 CON 12 SIZ 11 INT 14 POW 10
 DEX 12 APP 15 EDU 15 SAN 25 HP 12

Weapons: Fist/Punch 50%, 1D3
Skills: Electrical Repair 55%, Listen 75%.

The S-19 Submarine

The sub is an S-boat, built during the 1920s, designed for the navy by the Holland-Electric Boat Company. 219 feet long and over 20 feet wide, the vessel contains six compartments: forward torpedo room, battery room, control room and conning tower, crew quarters, engine room, and motor room. Each can be sealed watertight.

The S-19 is equipped with diesel engines for surface cruising (14 knots maximum speed) and electric motors for underwater operation (11 knots max.). The ship can safely submerge to a depth of 200 feet. Armament includes a .50 caliber machine gun mounted on the conning tower plus twelve torpedoes fired from four 21-inch tubes in the bow.

The vessel makes use of a hydrophone, a form of sonar which converts underwater sounds into electrical output and transmits them into the operator's earphones. There is also a radio, effective only when the vessel is on or near the surface. There are two periscopes: a "search periscope" with a wide angle horizon view, and an "attack periscope" with a tighter focus. Ballast tanks are flooded when submerging, or

blown empty when the sub surfaces. A locked armory in the crew quarters holds twelve .30-06 rifles, six .45 automatic pistols, and ammunition for both. Keys for the cabinet are held by the commanding, executive, and gunnery officers.

There are no portholes, no natural light, no room, and no escape. Sealing a damaged compartment can save the ship from flooding, but if the submarine cannot be raised this merely postpones death. Six S-boats sank during the 1920s after various mishaps. Claustrophobia is paramount in submarines; you can't see out, and you can't get out. You're always pushing your way past fellow crewmen in the cramped corridors.

**Part One:
 First Blood**

The submarine pilots out of the harbor and into the open sea, cruising on the surface, accompanied by the three Coast Guard vessels. The convoy turns and heads north along the coast. The men are curious about the mission, and a little edgy. It is not a drill, but what threat could possibly exist in American waters?

At the captain's order, the commissary officer winds up the gramophone in the officer's quarters in an effort to boost morale and distract the crew. Soon the strains of "It's a Long Way to Tipperary" echo tinnily through the ship. Some of the men sing along. An investigator making a Psychology, Psychoanalysis, or even Idea roll notices how the music uplifts the men's spirits.

Officers and enlisted men move about without regard to rank or station, all formalities dropped in the interest of efficiency, comfort, and practicality. Obviously, maintain-

ing morale aboard a submarine is a primary concern. Meanwhile, the chaplain moves among the crew, bestowing muttered blessings.

As the vessels round Cape Ann, the captain orders the gramophone turned off, and directs the men to battle stations. The convoy bears northwest, toward Innsmouth. As they near the coast the sub parts company with the Coast Guard vessels. The sub lying motionless in the water, the captain ascends the conning tower to survey the coastline, making a point of inviting the investigator along. The stars shine coldly in the brisk twilight. Distant Devil Reef lies low and black. A Spot Hidden gives the impression of undulating movement amidst its rocky crags.

Harrow asks the investigator what it is they expect to face. Harrow, who had missed the earlier briefings due to the rescue mission, seems skeptical of the undersea cities and fish-men mentioned in his orders.

After hearing the investigator out, Harrow descends to the control room and makes an announcement over the loud speaker. "Now hear this. Shortly we will submerge to a depth of 200 feet and move into position. Prepare for dive."

Dive! Dive!

The conning tower is evacuated and sealed. Harrow gives the order, and the submarine slides beneath the surface. The crew mans their stations, exchanging bemused glances. Fifty feet below the surface the ship angles steeply downward.

With a successful Listen, the hydrophone operator picks up the echo of a moving object outside, drawing closer to the ship. At seventy feet the vessel slams into something, coming to a halt, a boom echoing through the vessel. Anyone failing a DEX x5 roll is thrown to the deck, suffering 1D2 points of injury, 1D4 if the roll is fumbled (96-00). The sub groans and creaks, then suddenly rolls to port, calling for additional DEX x5 rolls as above. Lights flicker and somewhere a Klaxon horn goes off. "Collision!", cries Harrow. "Stop the engines!" A seal in the hull opens near the investigator, spraying him with water. A second boom shakes the ship. "Reverse engines," Harrow shouts.

But it does no good; the ship is being dragged inexorably down. The sub rolls back to starboard. In the forward compartment a torpedo snaps its restraints and rolls out, crushing a man. (Keeper's note: the torpedoes are manually armed as they are loaded into the firing tubes—there is no danger of them exploding if they roll out of their cradles.) The sub continues to be dragged down. From the bow comes the screeching of metal—the sound of something trying to claw its way in! All aboard lose 1/1D3 Sanity points.

Outside in the deeps, one of the star-spawn of Cthulhu holds the metal invader in its tentacles and claws, dragging it down, trying to pry it open, wanting the meat within.

The investigator may attempt to Persuade Harrow that they are in the clutches of some creature. Whether successful or not, Harrow finally realizes their plight and orders a torpedo loaded into the tubes. "Set detonator for minimum range!" he barks. With the torpedo in the tube, he gives the order to fire.

The torpedo discharges, and a split-second later, detonates. A huge explosion rocks the sub and from somewhere outside comes a shrieking, unearthly sub-bass howl unlike anything anyone aboard has ever heard before. Sanity loss is 1/1D2.

But the sub is now free and begins to back away, motors still reversed. Harrow decides to surface in order to make a damage survey. "Prepare to surface!" he shouts, but before the order can be actually given, he is grabbed from behind and a .45 automatic pressed to his head.

It is one of the crewmen (perhaps even a supporting character). Driven insane by the star-spawn's attack, his nerve has snapped.

"We're taking this ship out of here," he hisses to the rest of the ship. "Or the Commander gets it!"

*Go to Part One of Objective Five
Devil Reef*

Part Two: Deep Trouble

After narrowly escaping the clutches of the star-spawn, Harrow has prepared to surface. But before giving the order he was jumped by a sailor who, driven mad, now holds a gun to the Commander's head and demands the sub leave the area.

Showdown

The insane sailor's eyes are starting from his head. Sweat runs down his face in rivulets. Psychology reveals him to be totally mad.

"You're taking us out of here, or the Commander dies," he says.

Officers attempt giving the man direct orders, but it only angers him and he presses the .45 tighter against Harrow's head, repeating his demand.

The investigator may attempt Persuade, but it does no good. Psychoanalysis may be of use, but it requires more time than they really have. Fast Talk accomplishes nothing, and if failed results in disaster. The sailor pulls the trigger, scattering Harrow's brains across the bulkhead before he sticks the gun in his own mouth and commits a messy end. Sanity loss is 1/1D4+1 for this grisly and unsettling event.

However, if negotiations last for any length of time one of the non-player officers whispers to a nearby supporting character to try to get the gun away. The character is to make his move while the officer distracts the madman with conversation.

Grabbing the gun away from the madman in these cramped quarters is difficult. A roll of DEX x5 or less is required to pull the gun away from Harrow's head quickly

enough to save the officer's life. A failure results in the scene described above. Even if successful the madman manages to squeeze off a shot, grazing Harrow's head and rendering him unconscious for the rest of this adventure. A successful Grapple is then required to restrain the man long enough for others to get the gun away. Every round the Grapple fails, the madman squeezes off another shot. 75% of the time these shots go ricocheting through the sub. All player characters must make Luck rolls. Any roll of 96-00 indicates they've been hit and suffer 1D6 points of damage. 25% of the time the shot goes into either the madman or the player character who is attempting to disarm him: 1-50 the madman, 51-00 the player character. It does normal, impaling damage.

Regardless of the outcome of the above, Executive Officer Baird is now in command of the sub. Relying heavily upon the investigator's advice, he may be simultaneously conspiring with the hybrid chaplain.

Above the Waves

Once the hostage situation is ended, the submarine heads for the surface. Baird asks for damage reports, then scales the conning tower. He orders the gunner, his loader, and the investigator to follow. Outside the night is cold and clear, and the lights of the town can be seen on shore. The occasional chatter of the Coast Guards' guns punctuates the dull pounding of distant explosions on shore. In the distance a huge mass floats on the surface, near it the Coast Guard cutter *Urania*.

With binoculars the investigator can see a stinking mass of tentacles, wings, and claws floating in a spreading slick of greasy ichor—the monstrous corpse of a dead star-spawn torn and blasted by the submarine's torpedo. Whether or not it can be identified by a successful Cthulhu Mythos roll, a Sanity loss of 1/1D3 points is charged for seeing this bubbling, oozing monstrosity.

Without warning, the water around the sub begins to boil. Dozens of deep ones clamber up out of the water on all sides and begin hopping towards the conning tower, barking and growling at the sight of humans. Sanity loss is 1/6 points.

The conning tower must be quickly evacuated and the hatch sealed or the submarine is invaded by hordes of scaly deep ones. Any characters driven insane by the sight of the deep ones must be physically dragged below. If gunner Murphy goes mad, he stays at his post, pumping .50 caliber rounds into the flopping forms until he sees the whites of their bulging eyes and feels the sweep of their barbed claws.

Below the Waves

Once inside with the hatch sealed, the sounds of the deep ones flopping and scurrying over the hull can be heard, even while others pound fiercely at the closed hatch.

The damage report is favorable, and the engines are unharmed; the small leaks suffered by the sub have been closed. Baird gives the command to dive and the sub descends back below the waves—but the hammering on the hull continues unabated. The crew is uneasy and any who did not see what went on above now lose 1/1D2 Sanity points.

SOMETHING RISING

The sonar operator picks up a pair of large blips deep underwater, near the reef. One blip seems to be ascending, rising several hundred yards away; the other is soon lost somewhere along the reef. A single torpedo shot at the rising blip is possible, but probably in vain: only on a roll of 5% or less is Dagon struck and wounded. As the sub descends to 180 feet the other blip, Hydra, the Great Mother, begins her work.

THE CALL OF THE SIREN

A new sound pervades the sub, rising over the hum of electric motors and the poundings on the hull. A wavering litany of paradise and splendor, it drifts through the ship, calling to the sailors, lulling them with its dark caress.

Few can resist it. The steel hull muffles some of its effect, but even so it is more hypnotic than most can stand. All aboard must match their POW vs. POW 15, or be hypnotized by the sound. The investigator and supporting characters who fail their resistance struggles can “shake off” the effects, but at a cost of 1/1D4 Sanity points. Rather than roll resistance struggles for all non-player characters, the keeper can safely assume that 2D8+15 crewmen will be affected by the spell.

Those sailors that have fallen under the spell abandon their posts, even as the sub reaches its theoretical depth limit of 200 feet. Eerily humming along with the alien melody of the Siren Song, the sailors leave the controls unmanned, and the ship continues its plunge. At 210 feet the hull starts to groan from the pressure. The player characters are inexorably pressed back around the conning tower by the blank-faced sailors stumbling toward them. At a depth of 220 feet the hull begins to shake and shriek. A rivet, driven by the pressure, pops free of the hull, ricocheting across the sub's interior like a bullet.

Outside in the deeps Mother Hydra sings her Siren Song. As the sub sinks lower her children wait for the feast to begin.

Normally the spell's effect lasts 2D6+20 hours and is unchangeable by Persuade, Fast Talk, violence, etc. Due to the stress of the situation, however, if the song can be seriously disrupted in some manner it can be counteracted.

*Go to Part Two of Objective Four
Devil Reef*

Part Three: The Sunless Depths

A total of 2D8+15 crewmen have succumbed to the Siren Song. Scuffles begin to break out as those who have not been affected try to hold back those who are. The uncontrolled vessel continues to sink, now nearing 230 feet. Investigators and supporting characters

may come under assault as riots flare. One of the non-player officers shoots a sailor, who falls to the deck mortally wounded. But the rest keep on coming, stumbling over the corpse, moaning insanely, while the offending officer is borne down under their weight. Screaming, he is torn to shreds. Sanity loss is 1/1D4.

Other seduced crewmen along the ship fight to reach the player characters, swinging fists and available tools. There are too many of them to fight, but sealing bulkheads against their advance contains them in single sections. One side or another undoubtedly thinks to break into the armory.

The solution to the situation is to start up the gramophone. If the player characters do not think of this themselves, a Psychology, Psychoanalysis, or Idea roll might suggest it. To reach it, the person must fight their way through to the officer's quarters, find a record, and crank the machine up. The raucous strains of "It's a Long Way to Tipperary" jar discordantly with the seductive melody of the depths, but soon the infectious tune overcomes the Siren Song and those who were affected begin to sing along. The Siren Song dispelled, the crew come to their senses. One of them finds the torn-off head of the murdered officer in his bloody hands, and begins to scream. Sanity loss for others who see this is 1/1D6.

The sub is now at a depth of 250 feet. The hull warps and creaks hideously, and more rivets pop and ricochet; leaks spring up and down the length of the ship. The groggy crew scramble to their posts to stop the unchecked descent. The sub levels out and then, slowly, begins its ascent toward safer water. Sailors report that the controls are responding sluggishly, some not at all.

The Enemy Within

The deep one chaplain has taken this opportunity to sabotage the sub, damaging the controls and the fresh air recirculators. He is now in the process of finishing his work and getting ready to make his escape. In the forward compartment he struggles desperately, working away at one of the torpedo tubes. With a near superhuman effort he manages to jam it open, allowing a roaring stream of water to pour into the forward compartment. It knocks away his white collar, revealing the gill slits in his greenish neck. Sanity loss for seeing this is 1/1D2. The chaplain laughs fiendishly.

The false chaplain fights to defend the open tube, using his great strength to fling assailants out of the way. In the face of a wave of attackers, he rolls a torpedo off its cradle and into the aisle. Those in the way of the toppling missile must roll Dodge or take 2D6 damage. The water continues to pour in.

The chaplain must be defeated within ten rounds, or the compartment is sealed off, in order to save the sub from flooding and sinking to the bottom. It takes raw strength to close the tube. Only one person may try, and they must defeat STR 20 on the resistance table. Each round a character stands in the high-pressure stream of water he suffers 1D3-1 hit points.

If the flooding cannot be stopped, the forward compartment can be sealed off and allowed to fill. This denies access to the torpedoes, and the submarine must return to the surface

to pump the water out before its offensive capabilities can be restored. By then the deep one chaplain has escaped through the torpedo tube. Due to the damage the sub has suffered, a return descent is ruled out. The sub has failed its mission.

The City in the Deep

The submarine has barely been trimmed and ascent procedures begun when the lights go out. The interior of the submarine is pitch black and noticeably silent. A quick report from the engineer indicates damage to the electrical systems, including the air recirculators. Already, as the sub drifts without power at depths greater than those ruled safe, the shortage of oxygen can be felt. Soon, the sounds of deep ones scrambling over the hull is heard as they once again begin pounding on the hatches.

The engineers, working by flashlight beams, feverishly attempt to repair the damaged equipment. Sparks and small fires sputter in the dark confines of the sub.

Y'HA-NTHLEI

Soon, however, there are flickers of color in the darkness—impossible hues of alien radiance. They appear in patches where the hull is wet from the many leaks that have sprung; those who were affected by the Siren Song are the first to witness this phenomena. In brief snatches and weird phosphorescent patterns, the landscape outside the sub slowly becomes visible through the solid walls of the hull. The electrical malfunctions, the enormous external pressures, and the unearthly phosphorescent flora on the seabed have combined to create this bizarre, impossible effect.

The cold-light comes from the awful city of Y'ha-nthlei, the many-columned home of the deep ones. A perverse Atlantis, it lies below the submarine, a glowing blasphemy in stone and coral. Its light shines through the scrambling bodies of the deep ones on the outside of the hull, showing brief x-ray-like glimpses of their alien forms. The water clouds with scores of the amphibious warriors, rising from below toward the iron-skinned intruder. Sanity loss for seeing Y'ha-nthlei, which perhaps no living human has ever seen, is 1D3/2D10+1.

Inside the sub men wail in terror at these glimpses of the horror they were sent to destroy. At least 1D6 crewmen go mad (keeper's choice as to their maladies and actions). One of these, a previous victim of the Siren Song, now acts under the delusion that the city below is Heaven. He attempts to send the sub down to its heavenly reward or, failing this, to flood the torpedo room as Waite did earlier. Unless stopped, he succeeds at one of the other.

If the madman is stopped, 1D3 Electrical Repair rolls are needed to restore the air and lights, and incidentally shut out the visions of Y'ha-nthlei. The badly shaken crew cheers with enormous relief once the lights come on, and the engineers are congratulated. But the mental damage has already been done, and several crewmen roll and gibber in the shallow water washing to and fro across the floor of the submarine. Some lie face-down, and may drown if they are not turned over.



Y'HA-NTHLEI, THE CITY IN THE DEEPS

The sub is now ready to either surface or continue on its mission, depending on whether or not the torpedo room is functional. If it is, the crew grimly nod their assent: the nightmare below must be destroyed.

Completing the Mission

There are probably still ten serviceable torpedoes. If the forward compartment has been saved, the three undamaged tubes may be used to bombard the underwater city.

The first torpedo speeds out of the tubes, carrying 497 pounds of dynamite down towards the sunken city, its path tracked by the hydrophone operator. It plunges deep and distant, finally striking the city with a dull explosion that can be heard within the sub. The crew throws up a victorious cheer.

Torpedo after torpedo is unleashed on the city, each firing rewarded with a jarring detonation. All aboard gain 1D6 Sanity points as they wreak their vengeance. When all the torpedoes are expended, the submarine rises to the surface. The hammering outside continues with incessant fury, a totem of doom and revenge struck repeatedly on the hull of the vessel.

Surfacing

The submarine breaks the surface, and the surviving crew lets out a weak cheer, then hushes to listen to the terrible sounds of trespass above. A glimpse through the periscope reveals a multitude of black amphibious forms squirming across the decks, still seeking entrance. The radio comes alive with the chaotic dispatches of the land forces and of the Coast Guard vessels. The radio operator can raise the ships, and explain the submarine's predicament. The reassuring voice of an equally exhausted ship's radio-man crackles over the speaker. "Sit tight. We'll come and blast the devils off you."

The search periscope can be used to sight the rescuing vessel as it swings around the far end of the reef. It moves in closer, and soon bullets are ricocheting and whanging off the hull as its guns clear the submarine's deck of unwelcome passengers. Any periscopes still up are hit and shattered, but the S-19 sustains no other lasting damage save dents and scars.

The commander of the Coast Guard ship gives the all-clear over the radio, and the submarine crew can throw open the conning tower hatches and breathe sweet fresh air. But they had best keep the machine gun ready, in case of deep one survivors. The Coast Guard vessel circles the submarine once before steaming away to resume patrol on the landward side of the reef.

Innsmouth is ablaze. The sky is filled with smoke, flame, and the sound of weapons' fire. Explosions echo dully.

After the Mission

The submarine can stand guard, cruise to the other side of the reef, or return to Boston. Its orders have been carried out, its ammunition spent, and its mission completed.

REWARDS

Survivors of the sub expedition gain 1D3 Sanity points when they step off the boat onto dry land. They gain another 1D10 points if they managed to hit Dagon with a torpedo at long range. Additional points may be awarded for valorous actions, as the keeper sees fit.

If the sub failed to torpedo the city, the investigator loses 1D8 Sanity points.

*Go to Part Three of Objective Three
Smugglers' Tunnels*



OBJECTIVE SIX: THE MARSH REFINERY



This segment of the raid involves members of the United States Treasury Department under the supervision of J. Edgar Hoover. Their objectives are to enter the Marsh refinery, remove as much gold as possible, confiscate any pertinent documents, and capture refinery official Jacob Marsh (if possible). The refinery is then to be destroyed with dynamite. The agents are under orders to take Jacob Marsh alive, although this does not apply to any other hybrids in the refinery.

J. Edgar Hoover and Lucas Mackey are the leaders of this portion of the raid. They have six subordinate agents under them.

The Refinery Raiders

There are a total of eight agents on this mission. J. Edgar Hoover and Lucas Mackey are keeper-controlled. Players may choose characters from the remaining six agents as desired.

J. EDGAR HOOVER

Hoover has been the head of the Federal Bureau of Investigation for nearly four years now. He is an unbendingly strict officer of the law, and expects the same from his men.

Hoover currently doesn't believe the stories of fish-men and pagan worship surrounding Innsmouth. Nevertheless, he does regard the mysterious happenings in the town with suspicion. His theory is that the whole town is criminally corrupt, hiding illegal smuggling, bootlegging, and distilling operations, among other offenses. He believes the outlandish legends concerning Innsmouth are a ruse manufactured to keep people away, and that the disappearances were outsiders who had seen too much of the town's criminal activities. He is businesslike and humorless throughout the scenario, and won't take kindly to risk-taking or insubordinate actions on the part of the civilian investigator.

Surprisingly, Hoover's experiences in Innsmouth do little to change his theories. In years hence he becomes even more devoted to ridding the country of criminals—and increasingly paranoid to boot.

J. EDGAR HOOVER, age 33, Bureau of Investigation Director

STR 13 CON 15 SIZ 12 INT 16 POW 13
DEX 13 APP 14 EDU 16 SAN 50 HP 14

Damage Bonus: +1D4

Weapons: Fist/Punch 60%, damage 1D3+db
Grapple 50%, damage special
.45 automatic pistol 70%, damage 1D10+2
Tommy-gun 40%, damage 1D10+2

Skills: Accounting 40%, Dodge 30%, Drive Automobile 65%, Fast Talk 60%, First Aid 45%, Hide 35%, Law 75%, Listen 50%, Occult 10%, Persuade 70%, Psychology 50%, Sneak 40%, Spot Hidden 55%, Throw 25%, Track 15%.

LUCAS MACKEY

Lucas Mackey has been investigating activities in Innsmouth in the guise of a factory inspector for several months, during which time the investigators may have encountered him. The plump, good-natured Mackey is a perfect foil for the dour Hoover.

LUCAS MACKEY, age 44, Treasury agent

STR 13 CON 12 SIZ 14 INT 15 POW 14
DEX 12 APP 12 EDU 15 SAN 60 HP 13

Damage Bonus: +1D4

Weapons: Fist/Punch 65%, damage 1D3+db
Grapple 50%, damage special
.45 automatic pistol 75%, damage 1D10+2
12-gauge pump shotgun 45%, damage 4D6/2D6/1D6

Skills: Accounting 25%, Dodge 35%, Drive Automobile 45%, Fast Talk 45%, First Aid 40%, Hide 40%, Law 55%, Listen 55%, Occult 15%, Persuade 40%, Psychology 35%, Sneak 45%, Spot Hidden 55%, Throw 35%, Track 20%.

Supporting Characters

MARK “EDDIE” DROTOS

Drotos is new to the Treasury Department, and this is his first assignment. As a result, he is eager to please but prone to

mistakes. Agent Ashbrook keeps a protective eye on him, but nevertheless there is a cumulative 30% chance per Part of this scenario (ie. 30% in Part One, 60% in Part Two, etc.) that Drotos makes some crucial blunder: he may run out of ammunition at an inopportune moment, run into an unexpected enemy, or fail to spot an enemy while on watch. Drotos is thin, anxious, and likely to cry out in terror if things get hairy. If driven insane he becomes spastic and indecisive.

MARK “EDDIE” DROTOS, age 28, Treasury agent

STR 12 CON 14 SIZ 13 INT 14 POW 11
DEX 14 APP 13 EDU 15 SAN 55 HP 14

Damage Bonus: +1D4

Weapons: Fist/Punch 50%, damage 1D3+db
Grapple 45%, damage special
.45 automatic pistol 40%, damage 1D10+2
12-gauge pump shotgun 40%, damage 4D6/2D6/1D6

Skills: Accounting 15%, Dodge 30%, Drive Automobile 40%, Fast Talk 35%, First Aid 30%, Hide 30%, Law 50%, Listen 40%, Persuade 35%, Psychology 10%, Sneak 25%, Spot Hidden 30%, Throw 25%, Track 10%.

SCOTT CONNER

Conner is a large, burly man with an eye for the humorous side of life. However, he knows the time and place for levity. He is methodical, unbending, and precise. Conner believes in cold, hard facts, not in occult mish-mash and rumors of “fish people.”

SCOTT CONNER, age 42, Treasury agent

STR 14 CON 14 SIZ 15 INT 14 POW 12
DEX 11 APP 12 EDU 15 SAN 60 HP: 15

Damage Bonus: +1D4

Weapons: Fist/Punch 60%, damage 1D3+db
Grapple 55%, damage special
Kick 45%, damage 1D6+db
.45 automatic pistol 55%, damage 1D10+2
Tommy-gun 45%, damage 1D10+2

Skills: Accounting 20%, Demolitions 60%, Dodge 35%, Drive Automobile 55%, Fast Talk 45%, First Aid 45%, Hide 50%, Law 55%, Listen 45%, Operate Heavy Machinery 65%, Persuade 50%, Psychology 30%, Sneak 35%, Spot Hidden 50%, Throw 45%, Track 25%.

JONATHAN ASHBROOK

Lanky and pale, Ashbrook habitually wears a grungy, open trenchcoat and a tilted fedora, and smokes with fevered intensity. He is a quick-tempered man, aggressive and tough despite his thin frame. Ashbrook has been known to consciously break the rules on several occasions, gaining him the reputation of a maverick. It is a label he enjoys.

JONATHAN ASHBROOK, age 35, Treasury agent

STR 14 CON 13 SIZ 13 INT 14 POW 12
DEX 13 APP 11 EDU 15 SAN 60 HP 13

Damage Bonus: +1D4

Weapons: Fist/Punch 70%, damage 1D3+db
Grapple 65%, damage special
.45 automatic pistol 45%, damage 1D10+2
12-gauge pump shotgun 55%, damage 4D6/2D6/1D6

148 – Escape from Innsmouth

Skills: Accounting 15%, Demolitions 55%, Dodge 35%, Drive Automobile 40%, Fast Talk 35%, First Aid 40%, Hide 50%, Law 50%, Listen 60%, Occult 3%, Persuade 55%, Psychology 25%, Sneak 45%, Spot Hidden 60%, Throw 45%, Track 15%.

PETER HILL

Hill is a sandy-haired young man with a stoic expression and a quiet, reserved personality. He wears an immaculate double-breasted suit beneath his trenchcoat. Hill observes everything quickly but carefully and does not leap into rash or abrupt decisions. He prefers to stay silent and let his performance speak for him. He is a talented agent, deeply dedicated to the cause for which he fights.

PETER HILL, age 33, Treasury agent

STR 12 CON 14 SIZ 12 INT 15 POW 12
DEX 13 APP 13 EDU 15 SAN 60 HP 13

Damage Bonus: +0

Weapons: Fist/Punch 55%, damage 1D3

Grapple 40%, damage special

Kick 35%, damage 1D6

.45 automatic pistol 55%, damage 1D10+2

12-gauge pump shotgun 35%, damage 4D6/2D6/1D6

Skills: Accounting 20%, Demolitions 45%, Dodge 40%, Drive Automobile 45%, Fast Talk 40%, First Aid 60%, Hide 55%, Law 60%, Listen 30%, Persuade 45%, Psychology 30%, Sneak 45%, Spot Hidden 45%, Throw 40%, Track 30%.

DAVID FRUSHOUR

Frushour is a rail-thin, black-haired fellow with rumpled clothes and an appearance of general lassitude. He suffers from a knee injury acquired during his last assignment—an assignment that somehow unnerved him and changed him from a practical joker into a dour nihilist.

DAVID FRUSHOUR, age 30, Treasury agent

STR 11 CON 12 SIZ 13 INT 16 POW 12
DEX 9 APP 11 EDU 15 SAN 60 HP 13

Damage Bonus: +1D4

Weapons: Fist/Punch 50%, damage 1D3+db

Grapple 40%, damage special

Personal Equipment

Investigators will be issued a .45 automatic and extra ammunition. Each Treasury agent has a .45 automatic, a shotgun or tommy gun, two pair of handcuffs, and one hand grenade. Agents Conner, Ashbrook, Hill, and Williams each carry a satchel charge for use in destroying the refinery. These satchel charges feature mechanical timers which can be set for as long as 60 minutes, or as short as a few seconds; each charge has a blast radius of 6 yards and does 10D6 damage to targets caught within the radius. Two or three properly-placed charges should be sufficient to destroy the refinery. The trunk of the sedan holds an extra shotgun, various types of ammunition, and four fire axes.

Kick 25%, damage 1D6+db

.45 automatic pistol 45%, damage 1D10+2

Tommy-gun 50%, damage 1D10+2

Skills: Accounting 15%, Cthulhu Mythos 3%, Dodge 25%, Drive Automobile 45%, Fast Talk 50%, First Aid 35%, Hide 35%, Law 50%, Listen 45%, Occult 8% Persuade 35%, Psychology 10%, Sneak 25%, Spot Hidden 40%, Throw 25%, Track 10%.

ROBERT WILLIAMS

Agent Williams is a small stocky man with orangish-red hair, powerful arms, and finely-chiseled features. His good looks and *joi de vivre* often cause his opponents to underestimate him. Williams spends a great deal of time working out in gymnasiums, honing his body to perfection. His headstrong attitude sometimes results in reckless (but so far harmless) decisions.

ROBERT WILLIAMS, age 33, Treasury agent

STR 15 CON 14 SIZ 12 INT 15 POW 14
DEX 13 APP 14 EDU 15 SAN 70 HP 13

Damage Bonus: +1D4

Weapons: Fist/Punch 75%, damage 1D3+db

Grapple 60%, damage special

Kick 40%, damage 1D6+db

.45 automatic pistol 45%, damage 1D10+2

Tommy-gun 40%, damage 1D10+2

Skills: Accounting 20%, Demolitions 40%, Dodge 35%, Drive Automobile 40%, Fast Talk 45%, First Aid 40%, Hide 45%, Law 55%, Listen 45%, Persuade 45%, Psychology 20%, Sneak 35%, Spot Hidden 50%, Throw 35%, Track 20%.

Part One: Shootout!

The mission begins with a sedan carrying Hoover, Drotos, and any investigators approaching Innsmouth from the south. A second car carrying Hill, Frushour and Williams follows behind. As they reach the outskirts of town, the sedans turn down Main Street. At the Main Street bridge, just below the refinery, they are met by agents Mackey, Ashbrook, and Conner in a truck with a battered snowplow blade on the front. The truck then leads the way across the Manuxet and turns onto Drake Avenue. Conner then accelerates toward the refinery gate, followed closely by the two sedans.

At the refinery loading dock are two panel trucks. Hybrids scurry back and forth from the refinery to the trucks, loading gold ingots aboard. Two hybrids are in the back of each truck stacking the gold and covering it with tarps. As the truck reaches the gate, one hybrid on lookout raises the alarm.

The government vehicles crash through the gate and the hybrids take up defensive positions around the trucks and on the docks. Conner angles the plow to prevent the trucks from leaving; the sedans skid sideways to a halt, and all the agents leap out and assume defensive positions.



THE SHOOTOUT!

There are a total of nine hybrids, including night watchman Robert Ballant; a listing of sample hybrids is included at the end of this adventure, on p. 158. The hybrids all use .38 revolvers (doing 1D10 damage) while Ballant relies on his shotgun to provide covering fire. Because of the amount of cover available for both characters and hybrids, all firearm attacks suffer a -15% penalty. If any attacker rolls a critical failure, a Luck roll should be made. If unsuccessful, the attacker has hit the gas tank of one of the vehicles. It explodes in a blistering inferno, doing 3D6 points of damage to anyone within 10 yards, unless a Jump roll is made (in which case the damage is only 1D8).

ROBERT BALLANT, 28, nightwatchman

STR 14 CON 13 SIZ 16 INT 12 POW 11
DEX 9 APP 6 EDU 5 SAN 0 HP

Damage Bonus: +1D4

Weapons: Bowie knife 60%, damage 1D4+2+db
12-gauge double-barreled shotgun 75%, damage 4D6/2D6/1D6
.45 revolver 65%, damage 1D10+2

Skills: Dodge 30%, Hide 50%, Listen 50%, Sneak 45%, Spot Hidden 65%.

Once the hybrids have been dealt with, the agents may enter the shipping and receiving areas of the refinery. These areas—currently empty—are described at the beginning of Part Two. For now, Part One ends as those agents who succeed in Spot Hidden rolls see young Jacob Marsh—his arms laden down with files and paper—disappear down a stairwell beside the freight elevator.

*Go to Part Two of Objective Five
Y'ha-nthlei*

Part Two: Into the Refinery

As the investigator and the agents move through the refinery, they notice that very little of the equipment is functioning. Most of the machinery is in fact derelict, covered in grit and rust. The refinery is smoky, hot, and smells of sweat, sea-water, and, strangely, fish.

The Refinery's Operation

Raw ore is either loaded onto the conveyor belt or dumped into the cyanide vat. The conveyor carries the materials through the grinder and the crushed ore is then sent into a separator (which removes the waste product from the ore). The ore is then smelted down and moved in its molten state to the foundry, where it is shaped and cast into ingots. If the cyanidation process has been used, the ore is separated from the waste product in the vat, flooded through pipes, and then smelted down. After forging, the finished product is then returned to shipping for removal.

Ground Floor

RECEIVING

This area contains the conveyor belt to the grinder, and the cyanide vat and its related equipment. None of these mechanisms appear to have been used in years. The cyanide vat

holds a few feet of weak, pungent solution which a reflective film has settled over.

If the grinder is explored, the creaky building which houses it is discovered to be festooned with cobwebs and soot. The grinder is useless due to rusted or broken gears and rotted belts.

SHIPPING

This area holds only a few large crates (containing old machine parts) and three stacks of gold ingots on the cold floor. There are 27 ingots in all, which the hybrids were trying to salvage. Hoover orders one agent and possibly the investigator to begin loading the gold into the back of their truck. A set of metal stairs (down which Marsh fled) and the massive freight elevator stand against one wall, opposite the sliding metal door to receiving.

Sub-Level 1

SMELTING

The refinery's smelting facilities occupy this level. Several huge pieces of machinery squat on the floor, connected by conveyor belts, troughs, and pipes. All show signs of recent use. The smelted ore is routed to the northern section of the plant where it is lowered via huge black buckets to the foundry below. Several metal catwalks criss-cross overhead, allowing access to the buckets, pipes, and machinery.

Here Hoover assigns Mackey to lead Drotos, Hill, and Williams onto the catwalks to deal with potential snipers and provide a secondary front in the event of a coordinated attack. The remaining agents, keeping within sighting distance, sweep across the floor. Among the clanging and shuddering of the equipment, Listen rolls detect the sound of footsteps on the concrete floor. A Spot Hidden reveals Jacob Marsh descending a ladder on the south wall and disappearing down a stairwell.

Marsh has purposefully chosen this route in order to draw his pursuers out into the smelting facilities. Four

About the Catwalks

The catwalks located on each of the three sub-levels of the refinery are 25 feet off the ground and only wide enough for one person. The eastern stairs allow access to the catwalks on the first two sub-levels along a short landing; the stairs then continue down to the floor. The southern stairs bypass the catwalks. There is at least one ladder on each wall that also allows access to the catwalks. The catwalks on the third sublevel are reached by the sole stairway leading to the level. The only access to the floor of that level is via a ladder.

The catwalks have a waist-high handrail. Actions such as running and fighting require a DEXx5 roll each round to avoid falling. This roll does not apply to the hybrids, who use these catwalks all the time. A fall from one of the catwalks does 2D8 damage.

hybrids armed with .38 revolvers lie in wait to ambush the group. A halved Spot Hidden roll from any investigator or agent discovers at least one hybrid prior to the attack. If two of the hybrids are killed, the other two quickly surrender and are taken into custody by the agents.

Sub-Level 2

FOUNDRY

This level contains all the machinery used to cast the gold. Two great furnaces are located in the center, where the gold is delivered and cast. The heat in the foundry is oppressive, like a solid wall.

With a Spot Hidden roll, Jacob Marsh is now glimpsed darting between pieces of machinery, heading toward a door on the west wall. He drops his papers while fumbling with the door handle, wrenches the door open, and tries to retrieve his documents. When the investigators draw closer, he forsakes most of the files and disappears through the door.

Marsh has seven hybrids in the foundry. Three are on catwalks, the rest scattered about on the floor. Halved Spot Hidden rolls detect the hybrids before they can surprise the agents. The hybrids may engage with .38 revolvers, or hand-to-hand (using pipes, clubs, and knives), with the intent of knocking their opponent into one of the raging furnaces or into the molten gold. If this should happen, death is instantaneous. The hybrids fight until three are dead, then the rest surrender. Frushour pauses to retrieve the fallen documents.

Conner notices a door to the west labeled "Warehouse." Beyond the door is a large room filled with crates, boxes, and shelves of gold. The gold is in the form of countless unsettling statues of bloated cephalopods, wondrous tiaras and combs, and fanciful alien jewelry items. On closer examination, the gold proves to be an odd whitish color, only vaguely resembling yellow gold. The room is crammed with literally tons of it, all fashioned in an exquisite but disturbing technique. A Cthulhu Mythos roll identifies it as the gold of the deep ones. There is a 0/1D2 Sanity loss for examining this bizarre alien treasure trove. Before leaving, Hoover orders each agent to confiscate a few lighter pieces as evidence.

Following Marsh, the group descends a narrow, slimy set of stairs that ends at another door. It is unlocked, and another downward set of stairs lies behind it. This set ends on a catwalk above the refinery's power plant.

Sub-Level 3

POWER PLANT

Some 30 or 40 feet below the catwalk are three huge vats filled with water. Hundreds of pipes, cables, tubes, and lines sprout from the walls and ceiling; all are covered in a mossy, organic-looking substance resembling a greyish-green, bacterial metal. The vats are studded with dials and gauges, also overtaken with the bio-mechanical growth.

A Mechanical Repair or Electrical Repair roll notes that the proliferation of cables and wires coming out of the water indicates that it is the source of power for the entire plant. But the water is unmoving—it has no kinetic energy whatsoever.

THE MARSH REFINERY

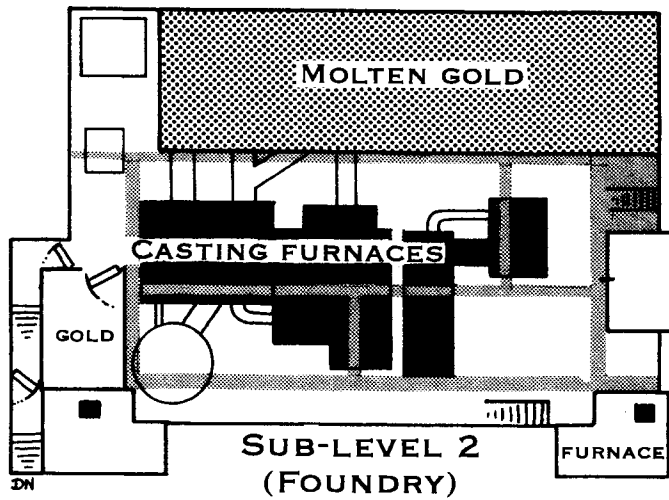
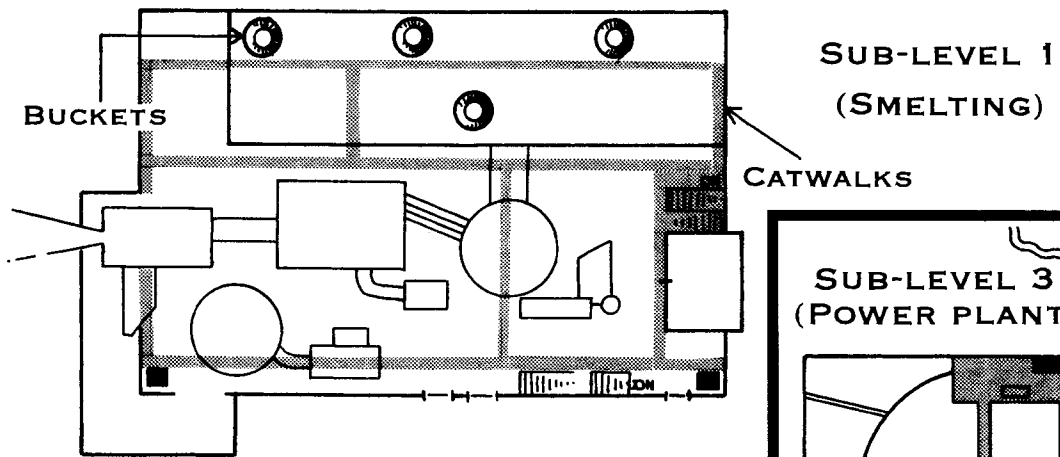
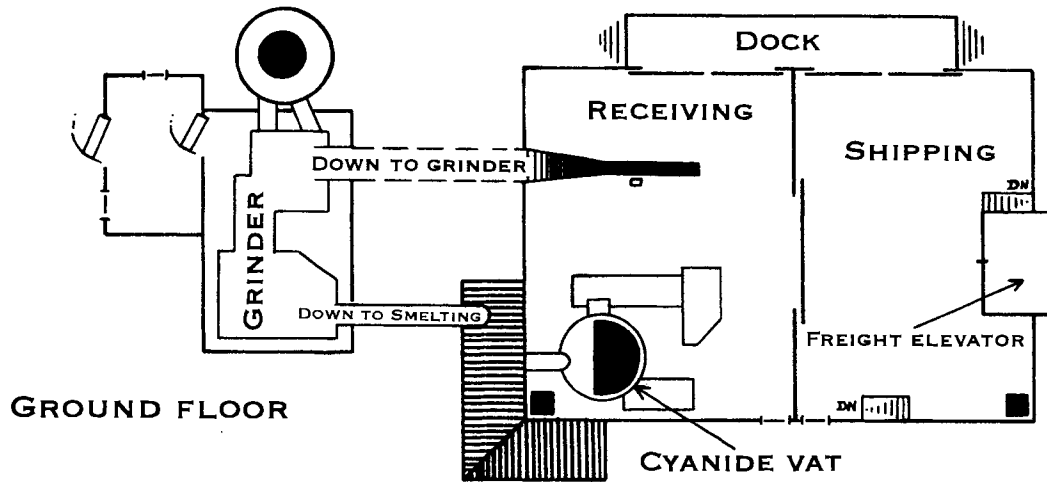

SUB-LEVEL 3 (POWER PLANT)

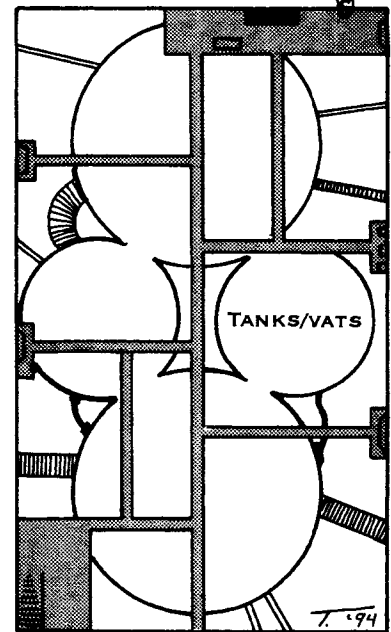

As the group ponders this oddity, Jacob Marsh is spotted at the other end of the catwalk. He is standing before a huge control panel, his back to the party. Marsh waits until the group has moved to the middle of the catwalk before he rapidly begins flicking switches and turning dials. As he does so a low hum begins to build and the semi-organic conduits quiver. The catwalk vibrates. The water in the tanks begins to ripple. Then a huge yellow eye forms in the liquid and stares idiotically at the investigators; several more veined, bulbous eyes appear, unblinking and searching. There is a loss of 2D3/4D6 points of Sanity, as the bubbling liquid—the source of power for the entire refinery—reveals itself to be a mammoth shoggoth!

Marsh sprints across the catwalk to a hidden doorway that leads into the smuggler's tunnels beneath Innsmouth. It takes him one round to open the door. Each investigator may attempt two shots at Marsh before he escapes completely. All shots suffer a -10% penalty due to the shuddering catwalk. Sane characters may specifically target Marsh's legs, but they only receive one shot (regardless of the actual number allowed), and that at an additional -15% penalty. A successful hit on Marsh's leg drops him instantly, preventing his escape.

JACOB MARSH, 27, refinery manager

STR 10 CON 13 SIZ 11 INT 13 POW 13
DEX 13 APP 9 EDU 12 SAN 0 HP 12

Damage Bonus: +0

Weapons: None carried; all at base percentages only

Skills: Accounting 65%, Bargain 65%, Chemistry 20%, Credit Rating 55%, Cthulhu Mythos 30%, Factory Management 55%, Fast Talk 80%, geology 45%, Mechanical Repair 30%, Psychology 55%, Spot Hidden 45%.

As the vibrations increase, blue arcs of electricity begin to leap up and down the conduits, singeing the air. The shoggoth bubbles as the electricity crackles into it, dozens of eyes and fanged mouths spastically forming and gaping along its fluid bulk. Investigators making a DEXx5 roll to dodge the arcing electricity can get to Marsh (if he has been wounded) and take him into custody; those failing the roll suffer 2D8 points of electrocution damage. As the group begins their retreat, a great sloshing, sucking sound fills the chamber and the shoggoth heaves itself up toward the catwalk.

*Go to Part Two of Objective Five
The Marsh Mansion*

Part Three: Destruction

The shoggoth responds to the electricity being poured into it by jerking spasmodically upward. Forming dozens of pseudopods, tentacles, and members, it flails and grasps at the air, emitting a horrible piercing

shriek. The investigator with the lowest POW should attempt a Luck roll. If unsuccessful, one of the shoggoth's pseudopods rams into the catwalk, snapping it in half. Everyone on the catwalk must then make a DEXx4 roll to avoid falling into the shoggoth. Both sections of the catwalk rest at angles, the break in the middle tilted down toward the vats. Those on the catwalk must make a Climb roll to get to a level catwalk or pull themselves off the broken one.

The size of the creature, coupled with the energy it is releasing through the conduits, causes the refinery to crumble as if in the throes of an earthquake. Idea rolls show that the shoggoth's writhings could substantially compromise the refinery's foundation and structure. As if to punctuate this, a section of nearby catwalk is torn from the wall by a falling chunk of cement.

THE SHOGGOTH

STR 100 CON 80 SIZ 180 INT 2 POW 7
DEX 2 Move 8 HP 130

Damage Bonus: +16D6

Weapons: Crush 90%, damage 16D6

Armor: None, but fire and electrical attacks do only half, all physical attacks do only 1 point (no impales possible), and it regenerates 3 HP per round.

Sanity Loss: 2D3/4D6 for this exceptionally large specimen.

The shoggoth is not interested in the investigators. It is merely reacting to a stimulus. The true challenge is escaping before the refinery collapses. The group may attempt to escape into the smuggler's tunnels through the hidden door. If so, Marsh tries to direct them into the shoggoth breeding pit or areas heavily populated by deep ones. As the raid on the tunnels is underway, it is likely that the group will meet with large numbers of fleeing deep ones. However, with two Navigate rolls and two Luck rolls, the party can find a slimy set of stairs or a ladder that leads back to the surface, via a cellar or well.

If the party decides to flee back the way they came, they are in for a rough time. It seems as if the refinery is alive, throwing things at the group to keep them from escaping. Several events designed for specific levels are presented below. Others can be found in the boxed text nearby.

CROSSING THE FOUNDRY LEVEL

The stairs on the south wall are blocked by fallen debris. As the group races past the shuddering equipment, a sudden shock rips through the floor. DEXx4 rolls are needed to retain footing. The shock buckles the gold vat, pitching a tidal wave of molten gold across the floor. Anyone failing a Luck roll is washed over, suffering 2D8+4 points of damage in the process.

CROSSING THE SMELTING LEVEL

The force of the shoggoth's power is felt here as the massive buckets break free from the ceiling. Investigators and agents in this area must make Dodge rolls to avoid being hit by a falling or rolling bucket. Anyone failing the roll suffers 2D6+2 points of damage.



Running the Gauntlet

Each refinery raider should make two DEXx4 rolls while transversing each level or flight of stairs as a result of the shaking floor and falling debris. Failed rolls result in 1D2 points of damage from a minor scrape. At least one of the following obstacles should also be encountered on each level.

- **Falling catwalks:** If the victim is beneath it, a Dodge roll avoids 1D8 points of damage. If the victim is on the catwalk when it falls, a Jump roll avoids falling damage of 1D10 points.
- **Falling equipment:** With successful DEXx4 or Luck rolls investigators may avoid having small pieces of machinery or equipment fall on them. Damage is 1D4 points for failed rolls.
- **Debris pile:** This obstacle could be from the ceiling or walls, twisted catwalks, or shattered machinery. Climb rolls are needed to navigate safe passage over the pile. Failed rolls result in 1D3-1 points of damage and a tumble back to where the climb started.
- **Chemical bath:** A pipe containing noxious chemicals bursts, resulting in 1D4 points of damage unless a Dodge roll is made.
- **Floor caves in:** A section of the floor ruptures and caves in beneath the investigators' feet. Jump rolls are needed

to leap to safer flooring. If failed, the damage is 1D6, and a failed Luck roll then causes the individual to drop all the way through to the level below (damage 2D6+3).

- **Stairway blocked:** An alternate route must be chosen.
- **Live wires:** Several live electrical wires coil and crackle across the investigator's path. A successful Jump roll is required to vault over wires. Failure results in a shock of 2D8 points. If the roll is a critical failure, the investigator stumbles and falls on the wires, taking double damage.

After the Mission

Since the refinery is largely destroyed by the shoggoth's frenzy, the mission's success is almost guaranteed. Give each survivor a 1D4 Sanity reward for this. If, by some chance, the investigators destroy the refinery with explosives before the shoggoth can, reward each with 1D8 points of Sanity instead.

If more than four agents/investigators escaped with confiscated gold and/or Marsh's papers as evidence, each survivor gets another 1D6 points of Sanity.

If Jacob Marsh was taken into custody, there is a reward of another 1D6 Sanity points. Finally, the keeper might want to add another reward of 1 point of Sanity for each hybrid killed, to a maximum of 6 points.

*Go to Part Three of Objective Four
Devil Reef*



THE RAID ON INNSMOUTH: CONCLUSION



Regardless of the experiences of individual investigators it is assumed that overall the raid was at least a partial success. But success and failure are relative terms, and both sides have probably suffered numerous casualties. Innsmouth is never the same afterward—it suffered the worst of the battle. But how many lost their lives in the effort to destroy Dagon and his minions?

Debriefing

With clean-up operations and house-to-house searches still continuing, the investigators are eventually taken to the outskirts west of town. Waiting here is the enigmatic Agent Drew. After requesting the return of any government supplied equipment, he asks for any physical evidence the investigators may have acquired during the course of the scenario. This done, the party is bundled into a waiting truck and taken to Boston for debriefing.

In Boston the investigators are grilled about their raid experiences. Information about traitors and infiltrators is of particular interest. Investigators may argue for the return of any particular Mythos items found during the raid, but probably to no avail.

After debriefing, the investigators are offered a ride home, if needed. A long rest is probably in order.

The Fate of the Prisoners

Nearly two hundred prisoners are taken during the Innsmouth raid, including dozens of fleeing hybrids captured at the roadblocks. Panel trucks filled with captive men, women, and children trundle off to secret government installations in the area where tests will be conducted in an attempt to sort out the untainted humans from the rest. Those found to be human will be allowed to return to town—after pledges of secrecy are extracted. Most of

Innsmouth's humans, now released from the bondage of the hybrids, prove cooperative.

The tainted individuals are soon after packed into train cars and shipped to various clandestine camps and military prisons across the country. Eventually a secret desert detainment camp is set up and all prisoners are confined here. Many, distanced from the ocean, die here. The rest brood, pondering dreams of vengeance.

The press soon learns of the raid and the government responds with fabricated tales of a huge smuggling and bootlegging operation centered in Innsmouth, and hints of white slavery activities. The investigators may be questioned by the press. Do they back the government's claims? Eventually, some particularly tenacious journalists are taken to the detainment camps to view the most monstrous hybrids. With the exception of a few tabloids, the stories are soon dropped and matter forgotten.

Innsmouth does not survive long. Its population reduced to less than two hundred, and lacking industry, the town withers. Still shunned by neighbors, many inhabitants move away and the population dwindles further. A fire in the early 1940s led to an exodus of the remaining population and after World War II only a handful of squatters could be found here. By the latter part of this century Innsmouth is abandoned and in ruins.

Rewards and Penalties

In addition to the rewards and penalties listed at the end of each raid, investigators may benefit from overall success. For each objective that was completed successfully, the investigators are awarded an additional 1D4 points of Sanity. Conversely, each mission deemed a failure results in a loss of 1D4 Sanity points. The death of an investigator in the course of a mission constitutes a failure—at least as far as the rest of the investigators are concerned.

A grateful government rewards the investigators, each receiving a check for \$2000. In addition, newly-formed government contacts result in an increase of 2D6 points to each investigator's Credit Rating.

On the other hand, investigators who break their Oaths suffer accordingly. Investigators who fail a Luck roll lose their jobs. Even when employment can be gained, it is usually at a wage at least \$1000 a year less than what they earned previously. Credit Ratings mysteriously drop as much as 4D6 points. Persistent indiscretions may result in imprisonment on trumped-up charges, or even worse.

The Cost to Sanity

Although during the course of the raid the effects on the investigators' sanity seem minor, the after-effects may be far worse. Anyone who lost 20% or more of his pre-raid Sanity is subject to long-term effects—different forms of indefinite insanity that can only be cured with exhaustive psychotherapy. These effects manifest themselves within 1D4 days after the raid. The keeper should roll a D6, or simply choose an insanity from the following list.

1 INSOMNIA: This investigator is plagued by dreams of underwater cities and of a great horror that sleeps somewhere beneath the surface of the Pacific Ocean. The resultant chronic insomnia results in a loss of four CON points (with resultant loss of hit points) and four APP points until cured.

2 PARANOID DELUSIONS: This investigator, terrified by the prospect of the deep ones' cross breeding, begins to see evidence of deep one blood in everyone he meets. Large eyes or a wide mouth are enough to set suspicions raging. People who like to swim are immediately suspect; conversely, those who profess not to swim are suspected of trying to cover-up their true nature. Even the investigator's closest friends may be suspect. The furtive, suspicious nature of the investigator results in halved Communication and Credit Rating skills.

3 PHOBIAS: Numerous phobias beset the investigator including fears of the sea, sea creatures, and even sea food. It is impossible to get this investigator to go near a large body of water and a common pet turtle or goldfish in the room creates so much discomfort the individual will eventually be forced to leave. In its final stages the investigator even refuses to bathe, resulting in lowered APP, communication skills, and Credit Rating.

4 SOMNAMBULISM: Plagued by half-remembered dreams of the deep, this investigator becomes a chronic sleep walker. Unless restrained in bed there is a 10% chance every night that he will rise and begin walking toward the nearest ocean, even if it is thousands of miles away. Being suddenly awakened from sleep-walking results in disorientation and a loss of 1D3 Sanity points. Sleep walking is hazardous, and the keeper may wish to create additional dangers.

5 DELUSIONS: The investigator comes to believe that his own blood is tainted with that of the deep ones. Revealing his "secret" to no one, the investigator slowly undergoes a psychosomatically induced "transformation." These changes manifest themselves as a sudden thinning of hair and a dry, scaling of the skin. In later stages the victim's eyelids undergo paralysis, resulting in a staring, unblinking expression and watery eyes. Communication and Credit Rating skills suffer from progressively worsening penalties, along with the investigator's APP.

6 SPLIT PERSONALITY: While the experience of the raid may have convinced the investigator more than ever that he must stand strong against the blasphemous forces of the Cthulhu Mythos, a second—and secret—personality quietly emerges. While to all his friends and acquaintances the investigator seems normal, he secretly seeks out information about Cthulhu and deep ones, trying to make contact. He becomes a secret follower of Great Cthulhu, constructing a temple in his basement or some other private location, and sacrificing small animals in obnoxious and unholy rites. If left untreated, this investigator may lead his companions into a trap. ■

Raid Records

OBJECTIVE 1: ESOTERIC ORDER OF DAGON

<i>Keeper</i>	<i>HP</i>	<i>HP</i>	<i>SAN</i>	<i>SAN</i>
<i>Characters</i>	<i>total</i>	<i>current</i>	<i>total</i>	<i>current</i>
Capt. Anthony Corso	12	_____	45	_____
Sgt. Emile Grabatowski	11	_____	95	_____
<i>Supporting</i>	<i>HP</i>	<i>HP</i>	<i>SAN</i>	<i>SAN</i>
<i>Characters</i>	<i>total</i>	<i>current</i>	<i>total</i>	<i>current</i>
Lcpl. Charles Drake	16	_____	45	_____
Pvt. Peter Rondale	16	_____	45	_____
Pvt. Dennis Parker	16	_____	45	_____
PFC Dalton Trimble	16	_____	45	_____
Pvt. Gordon Pruitt	16	_____	45	_____
<i>Marine Extras</i>	<i>HP</i>	<i>SAN</i>		
9 Enlisted Privates	16	45		

OBJECTIVE 2: THE MARSH MANSION

<i>Keeper</i>	<i>HP</i>	<i>HP</i>	<i>SAN</i>	<i>SAN</i>
<i>Characters</i>	<i>total</i>	<i>current</i>	<i>total</i>	<i>current</i>
Maj. Joseph Maines	15	_____	65	_____
TA Albert Ryan	11	_____	45	_____
Dr. Ravana Najar	15	_____	NA	NA
<i>Supporting</i>	<i>HP</i>	<i>HP</i>	<i>SAN</i>	<i>SAN</i>
<i>Characters</i>	<i>total</i>	<i>current</i>	<i>total</i>	<i>current</i>
Cpl. Tony Ditullio	16	_____	65	_____
Lcpl. William Logan	12	_____	60	_____
PFC Patrick O'Brien	15	_____	55	_____
PFC George Williams	14	_____	75	_____
<i>No extras in this unit.</i>				

OBJECTIVE 3: THE SMUGGLERS' TUNNELS

Abel Squad, Boat 1

<i>Keeper</i>	<i>HP</i>	<i>HP</i>	<i>SAN</i>	<i>SAN</i>
<i>Characters</i>	<i>total</i>	<i>current</i>	<i>total</i>	<i>current</i>
Lt. Eric Doud	16	_____	60	_____
Cpl. Norman Wold	15	_____	65	_____
Pvt. Charles Anzack	17	_____	75	_____
Pvt. Cooly	17	_____	75	_____
Lcpl. Leven	17	_____	75	_____
PFC Witzneki	17	_____	75	_____

Abel Squad, Boat 2 continued

<i>Supporting</i>	<i>HP</i>	<i>HP</i>	<i>SAN</i>	<i>SAN</i>
<i>Characters</i>	<i>total</i>	<i>current</i>	<i>total</i>	<i>current</i>
Cpl. Archie Pollard	16	_____	60	_____
Pvt. Pelkie	16	_____	60	_____
Lcpl. David Kay	16	_____	60	_____
PFC Edward Devore	16	_____	60	_____
Lcpl. Elwin Mayhew	16	_____	60	_____

Abel Squad, Boat 2

<i>Keeper</i>	<i>HP</i>	<i>HP</i>	<i>SAN</i>	<i>SAN</i>
<i>Character</i>	<i>total</i>	<i>current</i>	<i>total</i>	<i>current</i>
Sgt. Rudy Smeltz	18	_____	80	_____

Baker Squad, Boats 3 & 4

<i>Squad Extras</i>	<i>Current Condition</i>
12 Doomed Marines	_____

OBJECTIVE 4: DEVIL REEF

<i>Keeper</i>	<i>HP</i>	<i>HP</i>	<i>SAN</i>	<i>SAN</i>
<i>Characters</i>	<i>total</i>	<i>current</i>	<i>total</i>	<i>current</i>
Capt. Hearst (Urania)	15	_____	60	_____
WO Henley (Vigilant)	15	_____	60	_____
CPO Wallis (Spectre)	13	_____	65	_____
<i>Supporting</i>	<i>HP</i>	<i>HP</i>	<i>SAN</i>	<i>SAN</i>
<i>Characters</i>	<i>total</i>	<i>current</i>	<i>total</i>	<i>current</i>
PO3 Derek Chimes	13	_____	55	_____
SFC Paul Fulton	13	_____	55	_____
Smn. Barry Taft	13	_____	45	_____
Smn. Gene Henson	13	_____	40	_____
<i>Ship Extras</i>	<i>HP</i>	<i>SAN</i>	<i>Withdraw</i>	
Urania — 44 Sailors	13	55	14	
Vigilant — 15 Sailors	13	55	4	
Spectre — 15 Sailors	13	55	4	

OBJECTIVE 5: Y'HA-NTHLEI

<i>Keeper</i>	<i>HP</i>	<i>HP</i>	<i>SAN</i>	<i>SAN</i>
<i>Characters</i>	<i>total</i>	<i>current</i>	<i>total</i>	<i>current</i>
Com. Robert Harrow	15	_____	85	_____
PO2 Peters (Z. Waite)	16	_____	0	NA
<i>Supporting</i>	<i>HP</i>	<i>HP</i>	<i>SAN</i>	<i>SAN</i>
<i>Characters</i>	<i>total</i>	<i>current</i>	<i>total</i>	<i>current</i>
Lt. Com. Franklin Baird	12	_____	25	_____
PO1 William Murphy	11	_____	25	_____
PO2 Daniel Burnes	11	_____	50	_____
Lt. Craig Hyde	15	_____	55	_____
PO3 Roy Acker	12	_____	25	_____
<i>Submarine Extras</i>	<i>HP</i>	<i>SAN</i>	<i>Withdraw</i>	
2 Officers	13	55	14	
24 Crewmen	13	50	14	

Raid Records & Other Aids

OBJECTIVE 6: THE MARSH REFINERY

<i>Keeper</i>	<i>HP</i>	<i>HP</i>	<i>SAN</i>	<i>SAN</i>	<i>Supporting</i>	<i>HP</i>	<i>HP</i>	<i>SAN</i>	<i>SAN</i>
<i>Characters</i>	<i>total</i>	<i>current</i>	<i>total</i>	<i>current</i>	<i>Characters (cont.)</i>	<i>total</i>	<i>current</i>	<i>total</i>	<i>current</i>
J. Edgar Hoover	14	—	50	—	Scott Conner	15	—	60	—
Lucas Mackey	13	—	60	—	Jonathan Ashbrook	13	—	60	—
					Peter Hill	13	—	60	—
<i>Supporting</i>	<i>HP</i>	<i>HP</i>	<i>SAN</i>	<i>SAN</i>	David Frushour	13	—	60	—
<i>Characters</i>	<i>total</i>	<i>current</i>	<i>total</i>	<i>current</i>	Robert Williams	13	—	70	—
Mark Drotos	14	—	55	—					

Part One

1. The Smuggler's Tunnels
2. Y'ha-nthlei
3. Devil Reef
4. The Marsh Mansion
5. Esoteric Order of Dagon
6. The Marsh Refinery

Part Two

1. Y'ha-nthlei
2. Devil Reef
3. The Smuggler's Tunnels
4. The Marsh Refinery
5. The Marsh Mansion
6. Esoteric Order of Dagon

Part Three

1. The Marsh Mansion
2. The Marsh Refinery
3. Devil Reef
4. Y'ha-nthlei
5. The Smuggler's Tunnels
6. Esoteric Order of Dagon

RAID WEAPONS LIST

Format: type; base chance; damage; range; shots/round; shots in gun; malfunction.

COMMON WEAPONS

.45 Automatic pistol, 20%, 1D10+2, 15 yards, 1, 7, 00.

.30-06 Springfield bolt-action rifle, 25%, 2D6+4, 100 yards, 1/2, 5, 00.

Bayonet or fighting knife, 25%, 1D4+2+db, touch, 1, NA, NA.

EXPLOSIVES*

Grenade, Throw skill, 4D6/4 yards, thrown, 1/2, 1, 99.

Satchel charge, Demolitions skill, 10D6/6 yards, placed, 1/3, 1, 97.

Dynamite (per stick), Demolitions or Throw skill, 5D6/2 yards, placed or thrown, 1/4 or 1/2, 1+, 99.

LIGHT & PERSONAL MACHINE GUNS**

Thompson submachine gun, 15%, 1D10+2, 20 yards, 1 or burst, 30, 96.

Browning automatic rifle, 15%, 2D6+3, 90 yards, 1/2 or burst of 10, 20, 00.

INCENDIARY WEAPONS***

Flamethrower†, 05%, 4D6 (long burst) or 2D6 (short burst), 15 yards (1/2 damage at 15-25 yards), 1, 8D6 damage worth of bursts, 91.

Flare pistol, 20% (as Handgun skill), 4D6+2/1D8, 5 feet/10 feet, 1/2, 1, 00.

HEAVY WEAPONS

.30 caliber machine gun††, 15%, 2D6+3, 150 yards, burst, 500, 96.

.50 caliber machine gun††, 15%, 2D6+10, 200 yards, burst, 500, 96.

3-inch gun†††, 00%, 10D6/2 yards, 1-2 miles, 1/3, 1, 99.

NOTES

* Explosive damage reduces by 1D6 per yard outside listed radius.

** Chance to hit increases by 5% per shot in burst, up to twice gunner's skill only.

*** May set flammable materials ablaze.

† Cone-shaped area of effect. See p. 123.

†† Fires up to 20-round bursts. Requires crew of two or malfunction becomes 91.

††† Explosive damage as *. Requires crew of two.

Innsmouth Hybrids & Deep Ones

LIGHTLY ARMED & UNARMED HYBRIDS

	#1	#2	#3	#4	#5	#6	#7	#8	#9	#10
STR	13	8	14	9	13	10	13	17	11	12
CON	12	10	11	9	11	12	13	17	12	14
SIZ	14	14	16	11	16	12	14	17	13	12
INT	12	13	11	10	14	13	14	11	15	13
POW	11	10	9	7	11	14	14	10	13	7
DEX	12	9	10	17	11	7	8	13	10	11
APP	5	7	10	6	8	6	10	5	9	9
HP	13	12	14	10	14	12	14	17	13	13
DB	+D4	—	+D4	—	+D4	—	+D4	+D6	—	—
Fist	60	65	60	60	70	55	55	60	65	60
Grp	35	55	35	40	25	40	40	25	25	25
Kick	30	40	30	30	25	35	30	35	25	40
Sm Club	25	—	—	30	—	—	25	—	—	40
Lg Club	—	35	25	—	30	—	—	—	—	—
Knife	—	—	40	—	—	—	—	35	—	25

HEAVILY ARMED HYBRIDS

	#11	#12	#13	#14	#15	#16	#17	#18	#19	#20
STR	11	11	14	9	11	11	15	8	9	12
CON	13	12	11	10	10	12	17	10	7	13
SIZ	12	13	13	14	12	14	14	13	13	13
INT	11	11	12	13	10	13	13	8	14	11
POW	11	9	8	8	10	9	11	11	15	7
DEX	15	14	9	14	13	12	15	8	9	9
APP	7	9	12	7	5	7	13	9	12	10
HP	13	13	12	12	11	13	16	12	10	13
DB	—	—	+D4	—	—	+D4	+D4	—	—	+D4
Fist	65	65	60	55	60	65	70	75	50	55
Grp	30	35	25	35	35	50	35	35	30	35
Kick	30	35	35	25	35	25	40	35	30	30
Pistol	—	—	—	35	—	—	—	—	35	—
Lt Rifl	—	—	—	—	—	—	—	35	—	30
Hy Rifl	—	35	—	—	—	—	—	—	—	—
Lt Shot	35	—	—	—	—	—	35	—	—	—
Hy Shot	—	—	—	—	—	30	—	—	—	—
Musket	—	—	30	—	40	—	—	—	—	—

NOTES

db is damage bonus
Grp is Grapple skill
Sm Club does 1D6 damage
Lg Club does 1D8 damage
Knife (butcher's) does 1D6 damage
Pistol is usually a .38 revolver
Lt Rifl is a .22 bolt-action rifle (1D6+2 damage)
Hy Rifl is a .30-06 bolt-action rifle (2D6+3 damage)
Lt Shot is a 20 gauge double-barrel (2D6/1D6/1D3 variable damage)
Hy Shot is a 12 gauge double-barrel (4D6/2D6/1D6 variable damage)
Musket fires 1 shot/6 rounds and does 1D10 damage.

SAMPLE DEEP ONES

	#1	#2	#3	#4	#5	#6	#7	#8	#9	#10
STR	14	22	19	16	20	12	15	12	12	13
CON	13	10	16	10	12	11	12	10	9	11
SIZ	18	18	16	23	18	16	10	16	19	15
INT	18	10	11	13	11	14	12	9	9	14
POW	15	4	14	13	11	15	9	12	13	7
DEX	12	11	6	9	10	7	11	15	10	8
HP	16	14	16	17	15	14	11	13	14	13
DB	+D4	+D6	+D6	+D6	+D6	+D4	+D4	+D4	+D4	+D4
Claw	30	50	35	30	30	30	30	50	35	30
Spells	2	—	2	—	—	—	—	—	—	—
Weapon	—	30	—	50	—	—	—	—	35	—

	#11	#12	#13	#14	#15	#16	#17	#18	#19	#20
STR	10	12	13	12	18	8	17	17	19	14
CON	11	15	14	11	10	11	11	17	16	7
SIZ	14	13	20	16	14	16	20	19	19	20
INT	18	13	10	17	12	13	10	8	9	15
POW	8	8	13	12	9	8	14	10	12	11
DEX	10	10	11	14	10	12	9	12	12	15
HP	13	14	17	14	12	14	16	18	18	14
DB	—	+D4	+D6	+D4	+D4	—	+D6	+D6	+D6	+D6
Claw	30	35	30	40	25	30	35	35	40	40
Spells	—	—	—	—	—	—	2	—	—	—
Weapon	30	—	40	—	—	—	—	—	—	35

	#21	#22	#23	#24	#25	#26	#27	#28	#29	#30
STR	13	12	11	15	15	14	21	15	16	16
CON	12	12	10	11	12	13	12	10	9	12
SIZ	12	13	16	20	18	17	21	22	17	24
INT	16	12	11	13	15	15	10	13	9	16
POW	6	10	10	13	17	9	10	9	10	13
DEX	10	14	9	14	12	11	17	12	11	18
HP	12	13	13	16	15	15	17	16	13	18
DB	+D4	+D4	+D4	+D6	+D6	+D4	+2D6	+D6	+D6	+2D6
Claw	40	40	40	30	40	25	30	30	25	40
Spells	—	—	—	—	—	—	—	—	—	—
Weapon	—	—	30	—	35	—	—	—	—	—

NOTES

All sample deep ones have 1 point armor, move at 8/10 swimming, and cost 0/1D6 Sanity points to view.

Spells are left to the keeper to choose if desired.

db is damage bonus.

Where **weapons** are indicated, the creature can wield a hunting spear or can introduce one of the bizarre weapons found in either The Esoteric Order of Dagon or The Smugglers' Tunnels portions of the Raid on Innsmouth scenario.





SINISTER SEEDS

A collection of short adventure ideas for Innsmouth, set both before and after the fall.



People Change

This scenario unfolds like a hard-boiled detective story. A young woman named Jennifer Longstreet approaches one of the investigators—preferably a private eye—to find her missing fiancée, Adam Wilkes. Wilkes, whose father is a prominent Boston banker, disappeared a few weeks ago. Jennifer thinks Adam’s family knows more about his vanishing than they let on.

Visiting the spacious suburban estate of the fabulously wealthy Wilkes family, the investigators find that Adam’s father, Ethan Wilkes, is resentful of their intrusion into his family’s affairs. He honestly doesn’t know where Adam is, and suspects his disappearance is merely one way of getting himself out of an unwanted love affair. “People change. Adam obviously doesn’t love her any more.”

Adam’s mother, Margaret, is a cold-hearted socialite; she is even more resentful of Miss Longstreet’s meddling and suspects the girl has gold-digging motives. (A little research discovers that Margaret herself was once a common saloon-singer, brought to wealth by her husband.) She feigns ignorance of her son’s whereabouts, but she actually knows the truth.

Adam is Margaret’s illegitimate child by Vic Martin, an old flame whom she met just prior to marrying Wilkes. Their relationship continued even after her marriage. Just before he left her, Vic gave Margaret a handful of strange stones to be given to their child “when the time comes. He’ll know what to do with ‘em,” he told her. Martin was a hoodlum from Innsmouth, as well as a half-human hybrid (Margaret doesn’t know this). Adam is presently undergoing the change into a deep one.

Adam is suffering physically and mentally from the onset of his transformation; he has immersed himself in alcohol and drugs to ease his pain, hiding himself away in Innsmouth’s seedy Gilman House Hotel. Adam was drawn here via dreams of the deep ones, and knows what to do with the (deep one-summoning) stones his mother has. Rudy Merritt, the Wilkes’ chauffeur, delivers food, money, liquor, drugs, and whatever else Adam needs. Investigators can tail him to Adam’s hideout. Maggie also visits, though rarely. The locals, meanwhile, hover menacingly and protectively around the “new blood.”

Ethan Wilkes may call the police to keep the investigators out of his business. Margaret, on the other hand, makes use of some of her old shady contacts. She hires thugs to beat up or threaten investigators in an attempt to hide her past indis-

cretion. She may alternate these threats and beatings with bribery or seduction. Margaret eventually goes to her son with the stones, hoping that with them she can see Vic Martin again. Adam won’t go back to Jennifer, or even willingly leave the hotel. Ethan Wilkes may learn of his wife’s treachery. If Adam uses the stones, several deep ones show up to take him to Y’ha-nthlei. Vic Martin is among them, and he may have a bizarre reunion with the horrified Margaret (who isn’t expecting this). Ethan may find “his” son, and perhaps shoot him to put him out of his misery. Jennifer may also have a horrific reunion with her deformed lover. Any of these characters may run afoul of the Innsmouth hybrids or constables. Adam is either slain by one of his parents or Jennifer, or takes to the sea as a deep one.

Brotherly Love

Jubal Pierce is an eight-year-old with a secret. An orphan whose parents were killed in an auto accident, he has recently registered in the Arkham school system after moving from Innsmouth. At the time of the accident the papers reported that his parents’ auto skidded off the end of an Innsmouth wharf, but whispered rumor suggests that it was no accident—that Shep Pierce and his wife Ruth were driven mad by the accidental drowning of their eldest son two years before and, out of remorse, they deliberately drove themselves and their Model T into the sea. Their bodies were never found. Jubal now resides in Arkham with his second-cousins.

One day Jubal fights with another boy, Rupert Whipplethorp, in an attempt to make him release a captured frog Rupert brought to school in a jar. After Jubal loses the fight, several children hear him swear that his big brother will “get” Rupert. Everyone laughs: they all know Owen Pierce is dead.

The next day, young Whipplethorp is dead, his body found floating in the Miskatonic River, drowned, strangled, and torn. Tangled about the body are the knotted green stalks of lilies from the banks of Hangman’s Brook. The police call it murder.

Once they hear of the case (perhaps by witnessing the fight or finding the corpse) the investigators can begin to unravel the mystery. If they travel to Innsmouth, the Pierce’s old family home isn’t hard to find, assuming that they obtained an address from somewhere. Located in the Northern Shoreward Slums, the Pierce house is a damp decaying ruin, its flooded basement swarming with frogs and other amphibians.

Although the newspaper stories show that the elder Pierce boy drowned two years ago, investigators can find no evidence of a second, older child living in the house. There is but one child's bedroom, that obviously previously occupied by the much younger Jubal. Neighbors are very few—sullen, degenerate-looking folk loathe to speak with strangers.

Owen Pierce, Jubal's elder brother, is now a deep one. When the youngster calls to him from the marshy shore of Hangman's Brook, where Jubal likes to play, the Owen-Thing comes. When Jubal orders it, the Owen-Thing kills. Young Rupert Whipplethorpe was its most recent victim; investigators who pry into Jubal's life might be its next.

The Fairly Terrible Old Man

A Gloucester fishing boat is lost at sea with all hands and without a trace. Then another boat and its crew go missing. A telegram boy and his bicycle disappear next, followed by a carload of fraternity boys from Miskatonic University. All these disappearances occur within a few miles of Innsmouth, leading to an investigator delegation to the shadowy New England town.

Innsmouth's inhabitants aren't renowned for their conversational skills, but with persistence the investigators might learn of Kirkpatrick Deuteronomy Crane, an ancient man who lives in a flotsam-built shanty near Boynton Beach. Even the people of Innsmouth seem apprehensive when they speak of him. Although he lives alone, strange lights and voices are often seen and heard behind his shuttered windows.

Like his compatriot in Kingsport, this Fairly Terrible Old Man collects souls in bottles, crooning to them late at night in strange and sorcerous tongues. Not just souls does he keep, but boats, automobiles, and bicycles, too, magically reduced to miniatures and placed in bottles of thick green glass. If the bottle is broken, whatever is inside explodes back to its normal size. In one bottle is a large deep one, angry at its imprisonment, and hungry. It waits only to be released—by chance, accident, or a curious stranger.

“Bring Me the Innsmouth Courier...”

After an adventure or two in Innsmouth, the investigators are approached by someone offering a very respectable sum for a full set of the long-defunct *Innsmouth Courier* newspaper. If the investigators have made the acquaintance of Dr. Armitage, perhaps it is he seeks out their particular skills and expertise in this delicate matter. If the investigators have met Dr. Wallace of

Arkham's Asbury M.E. Church, perhaps it is he who hires them to complete his collection of *Couriers*.

Regardless of who does the hiring, the task is a difficult one. Obviously the best place to start looking for the *Couriers* is Innsmouth itself, but the townspeople are of little help. The hybrids actually seek to thwart such attempts, to prevent outsiders from learning any more of Innsmouth's secrets. As in most cases involving nosy strangers, the authorities and townspeople make increasingly threatening moves to keep the investigators from collecting the newspapers.

As for the papers themselves, there is a complete set in the abandoned home of the *Courier's* former editor, John Lawrence (205). This set includes the only known surviving copy of the final issue, which details the arrest of Obed Marsh and his followers. Other sets, in varying degrees of completeness, may be found elsewhere at the keeper's discretion. Putting together a complete set from a large number of sources should be fairly difficult and time-consuming. And the hybrids become increasingly intolerant of the nosy investigators as they poke around Innsmouth.

Hunting for Uncle Moses

Innsmouth residents Solomon and Saphronia Fiske contact the investigators. They are distraught; their Uncle Moses went out to walk the dogs along the beach two nights ago, and did not return. The dogs came back alone. Solomon went out looking for him, and found blood on the sand and a spent rifle cartridge. The local constables refuse to treat it as a disappearance, so the Fiskes are asking the investigators for help. Saphronia especially pleads with any male investigators. The Fiskes have no photograph of Uncle Moses, but they give the investigators the rifle cartridge. It is a hunting caliber. An Idea roll suggests that there is no evidence of dogs around the Fiske place.

Gathering evidence in Innsmouth, they might question the inhabitants of the houses nearest to where the bloodstains were found. One person recalls hearing a bang, like a gunshot, while another recalls seeing a man load something into a green truck and drive away. With a Track roll, the investigators find tire marks. If they ask around town, they find people who recall the truck and claim it was parked at the Gilman Hotel.

The desk clerk at the Gilman recalls the driver staying there overnight and the hotel register reveals his name is Fred Allen. An Arkham address is given, but turns out to be false. The clerk recalls that the man was upset because someone stole his wallet overnight. A gleam in the clerk's eye implies that he knows who might have done it. A bribe rewards the investigators with the information that a man named Bunker Daniels has been spending big at Waite's Variety and the First National Grocery the last few days.

Bunker did steal the wallet, and if any pressure is applied he hands it over. There is no money in it. The address of the man is found inside, along with his proper name: William Fletcher. His address is just outside Springfield, Mass.

Evidence in the wallet suggests the man is quite a traveler; he has cards from hotels in England, Australia, Egypt, and other places.

Fletcher's address leads the investigators to a large house several miles outside of Springfield. It has a high fence, a closed gate, and a sign that warns that trespassers will be shot. Several large and savage dogs bark at their approach, and these are unleashed against the intruders. A volley of gunfire from the house greets any investigator who approaches. Fletcher has plenty of guns, and no qualms about using them. Either the investigators negotiate a shouted truce, or they must shoot Fletcher dead. He is a little unhelpful, and hard to deal with.

The house is dark and musty inside, and full of trophies: lions and tigers and bears, buffalo and rhino and cougars, and even a moth-eaten Tasmanian Tiger. In a place of pride is a new specimen, freshly mounted, and still smelling of the sea: a man-like fish head. Its pop-eyed gilled features bear an uncanny family resemblance to Saphronia Fiske. It is Uncle Moses, and he was a deep one.

In all his travels in strange and foreign places, Fletcher hadn't bagged one of those yet.

Deep One Marmalade

A dear old granny lives in a ramshackle, cluttered cottage overlooking the sea, somewhere a little out of Innsmouth. She has a reputation as a witch and nearby farming communities, as well as those who haven't "gone over" to the deep ones, visit her when they have a small problem: an impotent spouse, an unwanted pregnancy, or a lingering pain.

She barter for her services, accepting farm produce or some service performed in return. Both she and the locals are ferociously strict about this barter; she gains a magical hold over any who fail to keep their half of the bargain—a "fearsome accounting" she is bound to keep else the devil will drag her under.

She keeps a pig and a scaly legged black cockerel for company, and she uses this diseased pair to blight the livestock of those who disagree with her. If really angry she can bewitch cows into drowning themselves.

Biddy spends most of her time puttering around her cottage and the beach. She collects the kelp for the gold specks it carries, picking off the sea lice to make a crunchy topping for her mackerel-pecan pie.

There is always something nauseous bubbling on her stove and her cottage stinks of the rank sea. Her specialty—on the rare occasions that fresh scale and gill is available—is deep one marmalade: a green, pickled and spicy treat that enamors the eater of the ocean. Biddy might be met when she attempts to collect the body of a freshly investigator-slain deep one.

This sweet if peculiar old lady feuds with some of the Innsmouth people. Perhaps they have broken a bargain, or perhaps she simply feels it ain't right for townspeople to

turn into sea-things, especially when they might end up in her marmalade. She's smart enough not to offend anyone more powerful than herself and her feuds are purely local.

Perhaps one of these enemies, too afraid to attack Biddy directly, enlists the investigators by painting her as vindictive and themselves as entirely innocent. Both the feud and the feudee should be designed prior to play. The investigators may wind up either in deep trouble or with a formidable ally, depending on how they play their cards.

Curiously enough, Biddy is occasionally seen accompanied by a placid, flabby, pale young man, or sometimes an eager and over-sexed dark one. Both men wear clothing of strange and antique cut, and it is rumored that they are lovers of her long distant youth, kept by her as familiars. These young men occasionally appear in town on her business, or to deliver her threats, summons, or bargains. People fall silent when they draw near.

BIDDY THE WITCH

STR 13 CON 18 SIZ 11 INT 19 POW 19
DEX 17 APP 6 EDU 10 SAN 0 HP 15

Skills: Bake Cake 80%, Bargain 90%, Brew Coffee 15%, Brew Kelp 60%, Brew Sea Mead 85%, Confuse Brewing Skills 50%, Make Marmalade 76%.

Spells: Brew Sea Mead*, Contact Nodens, Create Familiar. Biddy also knows many traditional witch spells including love and lust potions, and invisibility and invulnerability ointments. She has additional magic points stored in various otherwise harmless and homely looking household artifacts.

**Sea Mead allows the drinker to breathe sea water instead of air, protects the drinker from any form of pressure damage, and adds 25% to their Swim skill. Once the investigator breathes air again, the Sea Mead loses its effects.*

Both of Biddy's pets are fairly nauseating on close acquaintance.

PIMPLE THE PIG

STR 15 CON 13 SIZ 15 INT 15
POW 12 DEX 10 HP 15 Move 9

Skills: Adore Stranger 65%, Consume Food 100%, Radiate Content 100%, Sleep 95%.

Pimple is a friendly and obese white pig, with disgusting weeping blisters about his trotters and snout. A Medicine roll recognizes the ailment as hoof-and-mouth, a debilitating and highly contagious disease. Local health authorities, if informed, are strangely reluctant to act. The disease only spreads from the pig if Biddy wills it.

THE SCALED COCKEREL

STR 5 CON 19 SIZ 3 INT 12
POW 13 DEX 18 HP 12 Move 7

Skills: Radiate Malice 100%, Spot Ideal Place for Sun Bathing 45%, Track 75%.

This cockerel could just be a black chicken with peculiar legs, or it could be a cockatrice. Its legs are scaled like a lizard's and its eyes bright and reptilian. It loves to bask in the sun—a jumbled, flattened mass of inky feathers. If the investigators try to do its mistress any harm this sinister

bird takes to following them, even haunting their nights with a glare that turns them, in their dreams, to stone.

The cockerel has scales, a disease of fowl normally as debilitating and infectious as hoof-and-mouth. However, like the pig, the cockerel seems unaffected by the disease, and is non-infectious unless Bidy wills it.

The Scientist

In the midst of research, the investigators discover an old family journal belonging to the Martin family of Innsmouth. In its pages is the story of how in the 1830s Captain John Frederick Martin discovered an ancient stone ruin thrown up from the ocean's depths near Cape Horn, and how Martin brought the disassembled ruin back to Innsmouth with him. Before he could reassemble his bizarre archaeological treasure, Captain Martin died of a raging fever, and the ruin was left to gather dust buried in the family warehouse. Family fortunes turned ill soon afterward, and the jumble of stones was forgotten.

Curious investigators travelling to Innsmouth find that the Martin family warehouse still stands near the harbor. Breaking in, they find the jumble of stones exactly as described in the journal. A successful Cthulhu Mythos roll identifies the hieroglyphs on some of the stones as the language of the Elder Things. Further Cthulhu Mythos or Idea rolls allow the investigators to put the ruin back together, forming a pentagonal archway; at some point another Cthulhu Mythos roll, or knowledge of the Gate spell, recognizes the ruin as being some sort of Gate. Once it's together the Gate automatically activates, draining ID10 magic points from each person present.

The Gate is a temporal experiment initiated millions of years ago by an Elder Thing scientist, who hoped that the Gate would be found and activated far in the future. The Elder Thing then intended to come through the Gate to study whatever time and place the Time Gate opened on.

Which of course is what happens. The elder thing comes out in Innsmouth (or wherever the investigators reassembled it), waddles past the investigators (it is somewhat grateful to them for triggering its experiment, so it leaves them alone), and goes out to study its surroundings. If attacked, it uses whatever fantastic technological items it brought with it. Otherwise its agenda includes studies of anatomy (ie. dissection of any available life forms), history, technology, and the general differences between the distant past and the present. When and if it decides to return to its own time is up to the keeper.

Meanwhile the Time Gate is still activated, and charged with enough magic points to allow the investigators to use it safely. Unfortunately, it leads to a city of the elder things in the prehistoric past! Details of the world and time of the elder things are left for the keeper to create—dinosaurs? Elder Things? Worse? And what if the Elder Thing scientist comes back through the Gate while the investigators are still exploring the distant past? In any case Sanity loss for

using the Gate should be 1D3/1D10, in addition to that for seeing any fantastic creatures.

A Subject for Further Study

This episode assumes the investigators have befriended Luther Bloom (608). After they have had the chance to exchange some notes on the occult, Bloom makes a proposal: if the investigators help him obtain a deep one specimen, he'll study it to see if he can come up with anything they might find useful or helpful in defeating those ichthyic horrors.

Bloom knows of a place where deep ones can be summoned fairly easily: Fish-Head Rock, on Boynton Beach. He suggests they wade out and touch the rock, then wait in ambush and try to take out the deep ones as quietly as possible when they arrive. Bloom has touched the rock in the past and hidden to watch the results, so he knows they'll come. Bloom accompanies the investigators, but stays out of the fighting.

2D3 deep ones answer the summons, but as soon as the fighting starts they try to flee, unless they outnumber their attackers and can engage in close combat. The investigators could be in dire peril if any of the fishy horrors escapes—the Esoteric Order is bound to tear down the town looking for them. And they'll do away with Bloom for his role in the affair as well. Even if the investigators manage to massacre all the summoned deep ones, the Y'ha-nthleians and the hybrids are still suspicious enough to look into the incident at Fish-Head Rock. How quick and effective their efforts are is left to the keeper. Meanwhile, Dr. Bloom calmly dissects his specimen, provided the party smuggled the thing into town safely.

It is a grisly sight, watching Bloom hacking through scaly skin, snipping at muscles, mopping blood away from severed arteries, calmly removing dripping, stinking, bloody organs. Anyone watching loses 1/1D6 Sanity points; coming upon the finished product later costs 0/1D4. Bloom has various anatomical and zoological texts open next to his grisly work. Anyone making a successful Biology roll loses 0/1D2 Sanity points, as they realize how similar the insides are to the internal organs of a human being, as if they had descended from a common ancestor! This also adds a point of Cthulhu Mythos knowledge.

Bloom's studies are bound to take quite a long time, and meanwhile the hybrids are looking into what happened at Fish-Head Rock. Bloom finds that man and the deep ones are very closely related and extremely similar in many ways, but learns nothing that can be used as a "miracle weapon" against them. He jots down his findings and notes, and anyone reading them loses 1D3 Sanity points and gains 2 points of Cthulhu Mythos knowledge as they realize how terribly true Bloom's findings are. If they weren't already sure that deep ones could reproduce with mankind, they know now.

Do the hybrids find out about Bloom's studies? What does Bloom do with his findings? More studies? Maybe some sort of experiment?

Dreams of the Deep

After the investigators have made themselves a nuisance in Innsmouth (for instance, after experiencing the "Escape from Innsmouth" scenario), the deep ones decide to strike back. Gathering personal items left behind by the investigators in their earlier visits (hair, blood, shell casings, clothing, etc.), the Esoteric Order of Dagon devises a plan to Send Dreams over a great distance.

The investigators are then drawn into a series of dreams wherein they travel to Innsmouth, then to Devil Reef, and finally into the depths to visit Y'ha-nthlei itself. In these dreams the investigators themselves gradually take on the Innsmouth look and develop the ability to survive underwater (swim, see, hear, etc.), and get a chance to explore the weedy city of the deep ones within these dreams. Other strangers who have offended the deep ones might also be encountered in these dreams: federal agent Lucas Mackey, for example.

As these dreams are a variation of the Send Dreams spell, Sanity losses incurred in the dreams are only 10% of the actual figures. When running the dreams keep track of the Sanity lost and incur insanities normally, but when the dream ends divide the total Sanity loss by ten—dropping all fractions—the result being the actual Sanity loss. Investigators who die in a dream lose 1D6 Sanity points but continue their experiences in the next dream.

While the investigators are trapped in the dreams, the deep ones (using the personal items as their "homing devices") send out hybrid and human agents to track down their sleeping bodies and kill them. The investigators must find a way to stave off the dreams of Y'ha-nthlei as well as their would-be assassins.

There are perhaps three or four dreams. The first consists of a dream-journey to Innsmouth and Devil Reef. Meanwhile, in the real world, the questing assassins are still far from finding the sleeping investigators.

A second dream picks up with the investigators' descent through the depths to Y'ha-nthlei, and their first explorations there. The assassins may reach the investigators' home town during this dream, closing in and perhaps causing some notable mayhem which tips the investigators off that they are being sought.

The third and fourth dreams are further and more dangerous Y'ha-nthleian explorations, as by this time the deep one inhabitants of the dream-city are slowly mobilizing against them. The assassins may find the investigators' homes during the third dream, and are perhaps noticed by neighbors. They possibly make an attempt on a sleeping investigator or two. During the fourth dream, attempts are made on the lives of any remaining investigators. Failing to kill the investigators, the Esoteric Order gives up further

attempts to plague their dreams, hoping they've warned the meddlers off.

This adventure gives the investigators an opportunity to get a glimpse of the deep ones' city, and possibly allows them to meet and form an alliance with Lucas Mackey. This may lead to their roles in the "Raid on Innsmouth" scenario.

Escape from Y'ha-nthlei

Arevenge tactic the deep ones might use against meddlers is to capture the investigators and their loved ones, relatives, employers, or contacts. The prisoners are taken to Y'ha-nthlei, the deep ones' horrible city on the ocean floor. There they are thrown in with groups of maddened hybrids which are undergoing the change into deep ones.

Stripped of all but their clothes, the captives are fed only fish, tended by a deep one "jailor", and beaten and tormented by the crazed hybrids. Through their windows they see only the horror and madness of the darkest depths.

This scenario can either be run with the investigators trying to rescue someone from Y'ha-nthlei, or with the investigators themselves trying to escape. Use entry 1012 as a guideline in creating the air-filled chambers in which the prisoners are held, but feel free to expand on them. This might be run in conjunction with the "Raid on Innsmouth" scenario, with the investigators having to escape from the city or free its prisoners before the city falls under the attack of the submarine.

Innsmouth after the Fall: "This is an Outrage!"

Such were the words of Lawrence Dappledown, Democratic congressman from Massachusetts, in the days immediately following the Treasury Department's raid on Innsmouth. The youthful representative, serving his first term in office, has taken exception to the federal government's stunning intrusion into his district. Headstrong and hoping to make a name for himself, Dappledown is just beginning to raise a storm of fury about the incident. While several social and welfare organizations have kept quiet following visits from government agents, Dappledown refuses to be silent. Within a week of the raid he makes a personal inspection of the town, complete with representatives of the more sensationalist press (perhaps including an investigator or two). In short order he produces two round-eyed orphaned (hybrid) waifs, overlooked in the confusion of the raid. "Where are their parents?" the angry congressman demands.

Agents of the Treasury Department are trying desperately to silence Dappledown, but he is having none of it. Senior Democratic Party leaders have strongly urged him to drop the issue, but to no avail. Shortly, information begins to trickle into Dappledown's office about the locations of some of the prisoners and he begins a series of headline-making demands for the whole Innsmouth story and any alleged "crimes" to be made public. The investigators' government contacts express anxiety about the situation, and wonder what can be done to quiet Dappledown.

Lawrence Dappledown is not a deep one hybrid and has no direct connection with Innsmouth—he is perhaps something worse, an ambitious politician with a cause. However, one member of his staff can trace his lineage back to the ill-fated town, and this hybrid is working with the surviving deep ones to feed information into Dappledown's efforts. They hope to embarrass the government to prevent them from taking such drastic action ever again. In addition, it is hoped that with Dappledown's rallying, financial and political rebuilding will occur in Innsmouth and eventually get it back on its feet again.

In the weeks to come, Dappledown's crusade continues and others join in. Eventually the government quietly "restructures" the Treasury Department, breaking up the task force which instigated the raid and destroying any remaining evidence of the government's involvement—unless the investigators can convince Dappledown that he is being manipulated. Dappledown's hybrid aide has a hidden past, and if sufficient evidence can be garnered to prove this, Dappledown announces that all is well and the government did the right thing after all—provided of course that he can get private assurances of future good publicity from the Treasury Department and other government agencies.

If Dappledown is allowed to continue, aid pours into Innsmouth. Contractors start to rebuild her, and when the depression hits a small army of WPA workers help put the town back together. By the mid-1930s, Innsmouth may be a thriving little community once more.

Innsmouth after the Fall: The Underground Railroad and "The New Order."

After the "Raid on Innsmouth" scenario, the town of Innsmouth is in ruins and nearly abandoned. Only a few scattered fishermen remain, as most of the businesses are closed. The hybrids appear to have been wiped out entirely, and with them whatever prosperity remained in the town.

But some of the fishy hybrids escaped, and secretly, either alone or in small groups, they now are returning to Innsmouth. There is an "underground railroad" in operation—a clandestine smuggling of hybrids back into Innsmouth. An unsuspected hybrid hides the scattered remains of the Esoteric Order and the tainted when they return to Innsmouth. He gives them food, clothes, weapons—and information.

For the Esoteric Order of Dagon is not dead. It has started anew. "It would be a city greater than Innsmouth next time." It is Boston, where a very secretive new Order is reforming, with old members from Innsmouth and new ones from the poor and decadent of Boston. Soon the first of Boston's hybrid children will be born.

The Innsmouth contact helps the refugees get to Boston, and the cult grows. Can the investigators track the hybrid cultists to their new home? Can they prevent the slow infiltration and corruption of a major American city at the hands of the deep ones and their cult? And exactly what do they do with the women already pregnant with the children of the deep ones? ■

NOW LEAVING INNSMOUTH





APPENDIX: LOVECRAFT COUNTRY



*A brief overview
of the other places
surrounding Innsmouth.*

Lovecraft Country is a land located in the northeast of Massachusetts. The most important portion stretches along the Miskatonic river valley, from Dunwich in the far west to where it enters the Atlantic Ocean, between Arkham, Kingsport, and Martin's Beach. Page 166 includes a small map of the easternmost portion of *Lovecraft Country*. The depicted cities are detailed in the accompanying text, along with a few cities located beyond the main map, but important nonetheless. References to other books in the *Lovecraft Country* series are noted when they contain central information. Many of them are currently out of print.

Annisquam—A summer resort community that is located within Gloucester (see below).

Arkham—pop. 22,562, settled in 1692, incorporated in 1699. Textiles form the bulk of the present industry. Home of Miskatonic University. Mysterious sightings have occurred in the nearby Billington's Woods and at Nahum Gardner's farm, both located west of town. Detailed in *The Compact Arkham Unveiled*, *Miskatonic University*, *Adventures in Arkham Country*, and *Tales of the Miskatonic Valley*.

Aylesbury—pop. 16,539, founded in 1802 on the site of the former village of Broton. A planned industrial city financed by Arkham and Boston industrialists. Textiles are the main industry.

Beverly—pop. 27,478, settled in 1626 as part of Salem, incorporated in 1688. Home of the first cotton mill in the U.S. (1788). Shoes and shoe manufacturing machinery are its main industries.

Bolton—pop. 15,539, founded in 1650. An industrial town specializing in shoes, leather goods, and textiles.

Boston—pop. 782,623, first settled in 1630. The capital of Massachusetts. Site of Bunker Hill, Faneuil Hall, the Boston Massacre, and the Boston Tea Party. Important libraries include the Boston Public Library with over a million volumes, The Boston Athenaeum, the Massachusetts Historical Society, the New England Historical Genealogical library, and the the Boston Society of Natural History. Major industries include printing and publishing, men's and women's clothing, and shipping. Boston is an international port.

Cambridge—pop 124,451, first settled in 1630. Home of Harvard University, Radcliffe college, and the Massachusetts Institute of Technology (MIT). Cambridge is the site of the first printing press in America. Industries include printing

and publishing, and the manufacture of soap, candy, and electrical apparatus.

Concord—pop. 7056, founded 1635. Site of "the shot heard round the world." Home of Ralph Waldo Emerson, Henry D. Thoreau, and Louisa May Alcott.

Danvers—pop. 11,893, located approximately three miles west of Beverly. Settled in 1626 and until 1757 known as Salem Village. The center of witchcraft activity in 1692 and the birthplace of Israel Putnam. Nearby is the Massachusetts State Hospital for the Insane.

Dean's Corners—pop. 83, settled in 1821. A small town on the Aylesbury Pike, last stop before Aylesbury. Originally a stop on the stage line, now Dean's Corners occasionally trades with motorists on their way to Aylesbury. A combined Boston Society for American Indian Research and Miskatonic University archeological Dig is being conducted just a few miles southeast. Detailed in *Tales of the Miskatonic Valley*.

Dunwich—pop. 373, settled in 1692. A small farming community. Formerly the site of several large lumber mills. Dark forces seem ascendent among the decadent inhabitants of Dunwich. Detailed in *Return to Dunwich*, and *Adventures in Arkham Country*.

Essex—pop. 1654, first settled in 1634, incorporated in 1819. Famous for its small shipyards and its clam beds.

Falcon Point—pop. 56, settled in 1696. A small fishing village just south of Innsmouth. Detailed in *Escape from Innsmouth* and *Adventures in Arkham Country*.

Fitchburg—pop. 45,448, located ten miles southeast of Dunwich, past the Aylesbury Pike. Incorporated in 1764. It is a large paper manufacturing industry and a Worcester county seat.

Framingham—pop. 25,118, located fifteen miles west of Boston. first settled in 1640, incorporated 1700. Industries include straw hats, boots and shoes, rubber goods, boilers, and patent medicines. It is the seat of the state arsenal and the location of the state reformatory for women.

Gloucester—pop. 25,101, first settled by English fishermen in 1623, incorporated 1642. A popular summer resort and the greatest salt-water fishing port in the U.S. Within the city limits is the summer resort community of Annisquam.

Innsmouth—pop. 367, founded in 1643. Originally active in the China trade. Launched many privateers during the

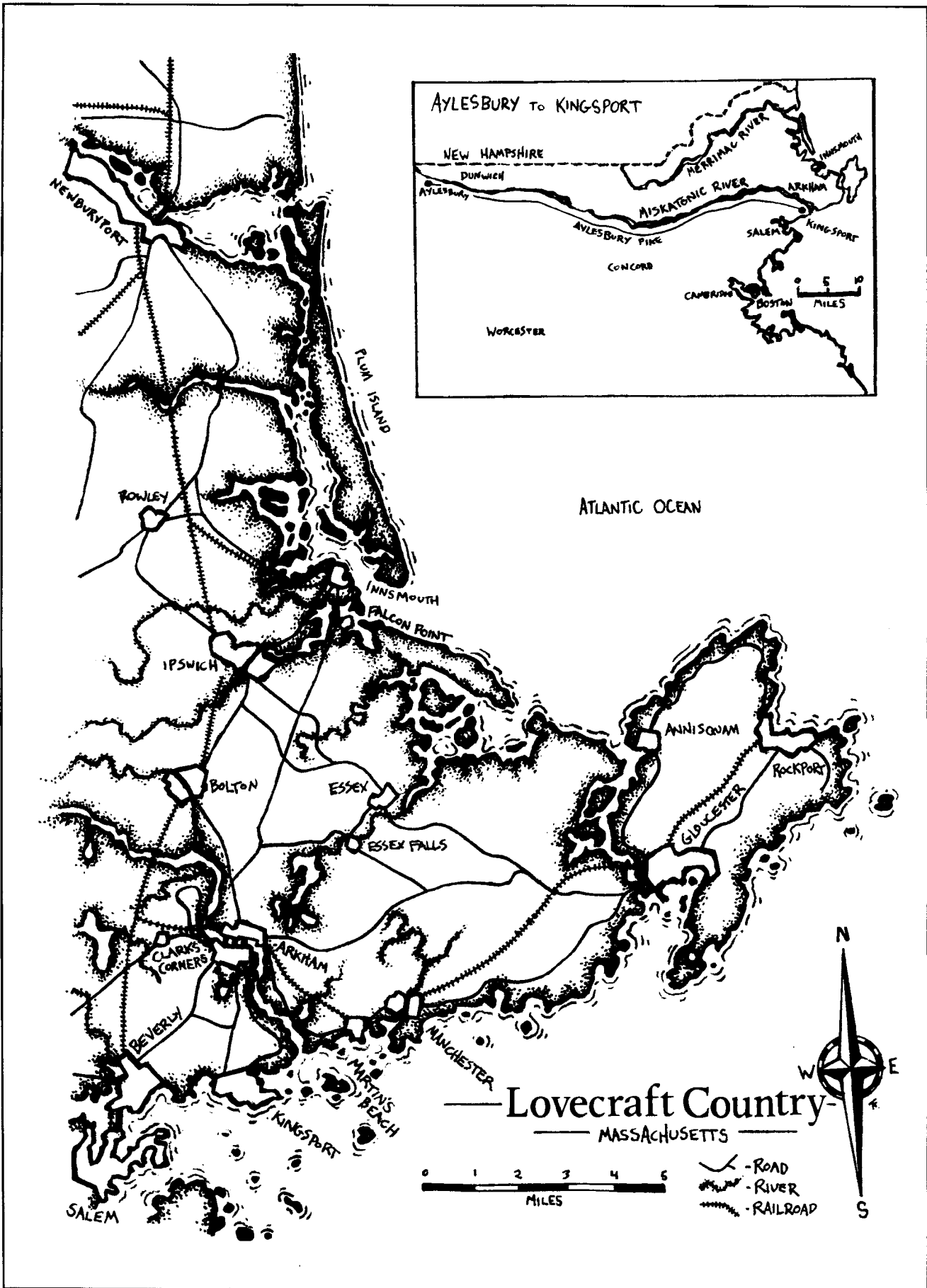

Revolutionary War and War of 1812. Fishing is the main industry. A small gold refinery is still in operation. Innsmouth is being controlled by the decadent Marsh family, and for years there have been hints of a malevolent force living beneath the sea, at nearby Devil's Reef. Detailed in *Escape from Innsmouth*.

Ipswich—pop. 6098, first settled in 1633 as Aggawam, incorporated in 1634. A popular summer resort and site of the oldest arched bridge in America. The home to the Rev. Nathaniel Ward.

Kingsport—pop. 7834, founded in 1639, incorporated in 1651. Home port of numerous privateers during the Revolutionary War. A summer resort and artist colony, fishing is the main industry. Rumors abound of a strange fire cult worshipping beneath the streets of Kingsport. Detailed in *Kingsport: The City in the Mists* and *Tales of the Miskatonic Valley*.

Lexington—pop. 7785, located five miles northwest of Cambridge along the 3. Founded 1642. Site of the first armed conflict of the American Revolution and the destination of Paul Revere's ride. Truck gardening and dairying are the principal industries.

Lowell—pop. 114,759, located ten miles north of Concord on the Merrimac River. Incorporated in 1826. Home to many textile mills and the birthplace of James McNeil Whistler. A Middlesex county seat.

Lynn—pop. 106,081, located five miles southwest of Salem. Founded 1629. An industrial city famous for its shoes and boots, an industry it began in 1636. The first smelting works in New England were established here in 1643.

Manchester—pop. 2599, settled 1630. A resort area thought by some to be the most beautiful on the Atlantic coast and a favorite summer residence with many foreign diplomats.

Marblehead—pop. 8414, located just southeast of Salem. Settled in 1629, separated from Salem in 1649. Launched many privateers during the Revolutionary War and the War of 1812. A popular summer resort and a yachting center. Principal industries include the manufacture of children's shoes, fishing, and yacht and launch building. Claimed by some to be "the birthplace of the American Navy."

Martin's Beach—pop. 867, first settled in 1644. A small fishing village and vacation spot. On occasion, a strange creature has been seen in the ocean. Detailed in *Dead Reckonings*.

Mayotteville—pop. 1,997, founded in 1667 by settlers from Bolton, located just a few miles down the road. Recently the source of a strange winged apparition. Detailed in *Adventures in Arkham Country*.

Newburyport—pop. 16,618, settled in 1635, separated from Newbury in 1764. A manufacturing town and shipping port. Newburyport was active in privateering during the Revolutionary War and War of 1812. The town was also famous for its smugglers and before the Civil War an active fishing, whaling, and trading port. An Essex county seat.

Peabody—pop. 21,677, located just west of Salem, which it was originally part of. It was incorporated in 1855. The town specializes in the manufacture of leather, leather-working machinery, and cotton goods.

Quincy—pop. 67,655, originally settled in 1625 as Merry Mount, a community reputed to have danced around maypoles and worshipped Dagon. The original settlers were finally driven off by members of the nearby Puritan communities. Now the home of modern naval shipyards. The birthplace of John Adams, John Quincy Adams, and John Hancock.

Rockport—pop 2345, originally settled in 1690, separated from Gloucester in 1840. A summer resort famous for its large artist colony.

Salem—pop. 44,688, founded in 1626 by Roger Conant. Site of the Salem witch trials of 1692 and birthplace of Nathaniel Hawthorne. Salem was once very active in the China trade and was home of America's first millionaire, Elias Haskett Derby. The town launched many privateers during the Seven Years War, the Revolutionary War, and the War of 1812. Home of the Essex Institute, the Peabody Maritime Museum, and the Salem Athenaeum.

Waltham—pop. 38,144, located ten miles west of Cambridge along the 117. Incorporated 1738. Home of the world's largest watch factory and the site of the first cotton power mill in America (1814).

Worcester—pop. 197,788, first settled in 1657 but twice abandoned due to Indian attacks, first in 1675 then in 1702. Incorporated in 1722. Industries include wire and wire products. The home of Clark University, Worcester Polytechnic, the Jesuit College of the Holy Cross, and Assumption college. Site of the American Antiquarian Society, the Worcester Natural History Society, and the Worcester Historical Society, all with museums and libraries. Home at one time or another to Elias Howe, Eli Whitney, Dorothea Lynde Dix, and Clara Barton. ■





INDEX

*Being a listing of
the most important references
for the items included.*



Characters, Misc.

- A -

Allen, Zadok 42
 Arncliffe, Henry 83
 Anderson, Arthur 81-82
 Averill, Gardner 39-40
 Averill, Joseph 40
 Averill, Jane 40
 Averill, Laura 40
 Averill, Patricia 40
 Averill, Quentin 39-40

- B -

Babson, Margaret 58
 Ballant, Robert 43, 148-149
 Bendley, Josiah 107
 Bidly the Witch 161-162
 Bickel, Walter 42
 Billingham, Judith 89
 Billingham, Ruth 80-81, 89, 97
 Billingham, Warren 46, 52, 80-81, 89, 90, 97
 Birch, Nathan 28, 75
 Bloom, Luther 48-49, 162-163
 Brewster, Jeremiah 32, 110
 Burnham, Brian 50-51, 80-81, 97
 Burnham, Margorie 82
 Burnham, William 82

- C -

Claus, Kirkpatrick 160
 Crawford, Elizabeth 68, 73-74
 Crawford, Geoffrey 68, 70
 Crawford, George 68, 70
 Crawford, Gregory 68, 70, 74
 Crawford, Jeremy 68, 70, 73
 Casper, Nick 61

- D -

Davis, Helen 47
 Davis, Lester 40-41
 Dean, Beverly 49
 Dean, Stephen 49
 Deep One, Feral 61
 Deep One Thing 21, 26
 Derby, Edward 84

- EF -

Eliot, Brittany 52
 Eliot, Darold 52
 Eliot, Bustis 34
 Eliot, Morgan 52
 Eliot, Noah 34
 Fiske, Moses 160-161
 Fuller, Otis 49

- G -

Garrison, Billy 48
 Garrison, Della 48
 Garrison, Dora 48

Garrison, Neil 48
 Garrison, Nora 48
 Gilman, Charles 51
 Gilman, Cynthia 39
 Gilman, P. 34
 Gilman, George 39
 Gilman, Ruth 70, 116
 Gorton, Mike 41, 75
 Gorton, Richard 41, 75
 Gorton, Sandra 41
 Gorton, Scott 41-42, 75
 Greene, Carrie 21
 Greene, Charley 21
 Greene, Ken 21
 Greene, Wesley 21
 Greene, Wilma 21
 Gregg, Evelyn 84
 Gregg, Garth 84

- H I J -

Habbit, George 51
 Harper, Jedediah 63
 Hartley, Ezra 34
 Hastings, Norvell 37, 116
 Hatfield, Amos 33
 Holland, Jerry 51
 Jakes, Harris 57
 James, Lucy 52
 Jordan, Rowena 78

- LM -

Lanier, Sandy 57
 Lawrence, John 40-41, 30
 Mackey, Lucas 51-52, 147
 Manning, Richard 68, 76
 Marsh, Abigail 37, 115-116
 Marsh, Barbara 38, 115
 Marsh, Barnabus 35-36, 43
 Marsh, Bernard 38, 115
 Marsh, Elizabeth 38, 120
 Marsh, Esther 37, 119-121
 Marsh, Jacob 43, 52, 54, 152
 Marsh, Obed 8-13
 Marsh, Ralsu 29, 70-71
 Marsh, Robert 31, 110
 Marsh, Rowley 29, 116-119
 Marsh, Sebastian 34, 38, 43, 116-119

Martin, Andrew 28, 75
 Martin, Douglas 46
 Martin, Ken 55
 Martin, Vic 159
 Miller, Mary 47
 Mowry, Daniel 48
 Mowry, Sandra 48

- OP -

Obrecht, Victor 47-48
 Padgett, Ervin 46
 Padgett, Millie 46
 Parker, Doris 41

Parker, William 41
 Fernell, Anne 61
 Pierce, Arthur 34
 Pierce, Jubal 159-160
 Pierce, Maira 55
 Pierce, Owen 159-160

- RS -

Rawcs, Kermit 46
 Repes, Elliot 28, 75
 Sargent, Joe 51-52, 56
 Slocum, Andrea 46-47
 Slocum, Bernard 46-47, 55
 Slocum, Jane 46
 Slocum, Louise 46
 Smith, Dewey 57
 Stoves, Arthur 44
 Sorcerer, Deep One 136
 Sorcerer, Vengful 130-131
 Southwick, Abraham 55
 Southwick, Absalato 55
 Southwick, Anna 55
 Southwick, Jack 55
 Southwick, Joseph 55
 Southwick, Mark 55
 Southwick, Roy 55
 Southwick, Vera 55

- TW -

Throckmorton, Charles 35
 Throckmorton, Mrs. 35
 Waite, Aemath 37-38, 84
 Waite, Ephraim 37-38, 84
 Waite, Jonah 34, 46
 Waite, Mrs. 86-88
 Waite, Ramona 86-88
 Waite, Thomas 54, 86-88, 97
 Walle, Zachary 139-140
 Walakea 8-9
 Wallace, Ezekiel 18, 83
 Werneth, Ellen 47
 Weston, Cory 62
 Wilkes, Adam 159

Characters, Raiders

Anzack, Pvt. Charles 123
 Carter, Lt. David 124
 Corso, Cpt. Anthony 101, 104
 Daud, Lt. Eric 101, 122
 Drew, Mr. 99
 Grabatowski, Sgt. Emilio 104
 Harrow, Cmdr. Robert 130
 Hearst, Cpt. Stephen 132
 Henley, WO Curtis 132-133
 Hoover, J. Edgar 101, 147
 Mackey, Lucas 51-52, 147
 Maines, Major Joe 101, 112-113
 Najjar, Dr. Ravana 101, 113, 118, 121
 Peters, PO2 Benjamin 139-140

Rottler, Col. James 101
 Ryan, Albert 99, 113
 Snelza, Sgt. Rudy 123, 126
 Wallis, CPO John 132-133
 Wald, Cpl. Norman 122-123

Creatures

Carnivorous Crustaceans 57
 Deep Ones 19-20
 Sample 158
 Hybrids, Sample 158
 Hybrids, Typical 16
 Polyp 65, 67
 Shoggoth-Spawn 127
 Walling Wither 121

Locations, Cities & Towns

Arkham 18, 165
 Asbury M.E. Church 18
 M.U. Exhibition Museum 18
 Boynton Beach 62
 Fish-Head Rock 62
 Danvers 18, 165
 Massachusetts State Hospital 18

ESSEX

Histories 18
 Falcon Point 62-63, 165
 Innesmouth 8-167
 Chronology 12
 Climate 15
 Government 15, 34
 Guidebook 21-67
 Guidebook Index 22-23
 History 8-13
 Law 15, 75
 Location 13, 15
 Maps, 200s 30
 Map, 700s 50
 Map, Neighborhoods 27
 Map, Outskirts 60
 Map, Overview 24-25
 Outskirts 59-67
 Religion 10-11, 16, 19
 Rumors 14
 Lovcraft Country 165-167
 Newburyport 18, 167
 Historical Society 18
 Otisville 8-9
 Y'ha-Nthlei 64-67, 139-146, 163
 Air Filled Chambers 64-67

Locations, Innesmouth

- AB -

Asbury M.E. Church 26
 Assembly Hall 34
 Averill Home 39-40
 Babson Home 57-58
 Billingham Home 39, 89-90

Billingham's Seafood 52	Fishermen's Shacks 56-57	New Town Square 50	Transformer 49
Black Lagoon 130	Fuller Home 49	Obed Marsh Memorial 49	Waite (Ephraim) House 37-38
Bloom Home 48	- G -	Old Lighthouse 57	Waite (Thomas) Home 39, 86-88
Bonyton Beach 62	Garden Bar & Grill 47-48	Old Martin Shipyard 57	Map 87
- C -	Garrison Home 48	Old Town Square 27	Waite's Variety Store 54, 85-86
Casper Home 61	Gilman Home 39	Old Wharves 56	Water Tower 41
Christchurch Cemetary 33	Gilman House Hotel 50-52	- PQR -	Y'ha-Nthlei 64-67, 139-146, 163
Church Street Burying Ground 34	Gorton Home 41-42	Padgett Home 46	
Church Street Green 26	Greene Home 21	Parker Home 41	Skills
Congregational Church 32-33	- IJKL -	Pernell Home 61	Gunnery 132
Crawford Place 71-74	Innsmouth Cafe 52	Pierce Home 55	Innsmouth Lore 14
Map, Grounds 71	Innsmouth Courier 30	Poorhouse 42	Shiphandling 132
Map, House 72	Innsmouth Electric 55	Railway 44, 62	
Custom House 57	Innsmouth Fuel Stop 54-55	Station 44	Spells
- D -	Jail 28, 90	Redemption Cemetary 54	Alter Weather 17
Davis Home 40	Map 90	Revolutionary War Memorial 26	Breath of the Deep 17
Dean Home 49	Kelly's Cove 88-89	Rawes & Hogg Nautical Insurance 33	Call Fish 17
Devil Reef 9, 63-64, 132-139	House on Fish Street 21, 26	- S -	Cause Disease 17
Dr. Roley Marsh & Son 29, 70-71	Lair of the Shoggoth 58-59	Sargent Home 56	Command Porpoise 17
- E -	- M -	Schoolhouse 47	Command Shark 17
East India Marine Merchants Bank 33	Marine Merchants Museum 33	Shoggoth Breeding Pit 128-129	Lobster Charm 17
Eliot Street Green 47	Marsh (Sebastion) Home 38	Slocum Home 46-47	Siren's Song 17
Eliot's Drugstore 52	Marsh Mansion 35-37, 112-122	Slums, North 21, 26	Wave of Oblivion 17
Esoteric Order of Dagon 16, 19, 31-32, 104-112, 130	Layout 116-121	Map, Slum House #1 127	
Layout 108-110	Map, Environs 114	Map, Slum House #2 128	Tomes
Map 19	Map, Mansion 117	Map, Typical Slums 129	Book of Dagon 54, 86, 111-112
Three Oaths of Dagon 19	Marsh Refinery 9, 42-43, 130, 146-154	Smuggler's Tunnels 67, 122-131	Essex County Histories 18
- F -	Layout 149-152	Cache Houses 126	Innsmouth Courier Newspaper 18
Faith Baptist Church 34	Map 151	Map, Tunnels 124	
Falcon Point 62-63, 165	Office 52	Southwick Home 55	Weapons
Fire Station 44, 88	Marsh Street Green 54	South Woods Memorial Cemetary 59-60	.30 Caliber Machine Gun 132
First National Grocery 50-51, 85	Martin Warehouse 162	Stone Breakwater 56	.50 Caliber Machine Gun 132
First Unitarian Church 54	Mowry Home 48	- TWY -	3-inch Gun 132
Fish Packing Houses 46	- NO -	Throckmorton Home 35	Browning Automatic Rifle 105
	New Church Green 30	Town Dump 62	Flamethrower 123
			Satchel Charges 105

COME BACK SOON

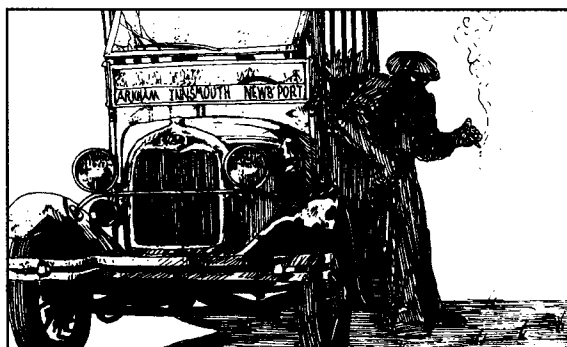

Supporting Character Sheets

Name _____				Skills					Hit Points				
STR _____	DEX _____	INT _____	HP _____	_____	_____	_____	_____	_____	Dead -2 -1 0 1	_____	_____	_____	_____
CON _____	APP _____	POW _____	Luck _____	_____	_____	_____	_____	_____	2 3 4 5 6 7	_____	_____	_____	_____
SIZ _____	SAN _____	EDU _____	DB _____	_____	_____	_____	_____	_____	8 9 10 11 12 13	_____	_____	_____	_____
Sanity Points				Weapons					Magic Points				
Insane 0 1 2 3 4 5 6 7 8 9 10 11 12 13 14				Weapon _____					Unconscious 0 1				
15 16 17 18 19 20 21 22 23 24 25 26 27 28 29 30 31				Skill% _____					2 3 4 5 6 7				
32 33 34 35 36 37 38 39 40 41 42 43 44 45 46 47 48				Damage _____					8 9 10 11 12 13				
49 50 51 52 53 54 55 56 57 58 59 60 61 62 63 64 65				Range _____					14 15 16 17 18 19				
66 67 68 69 70 71 72 73 74 75 76 77 78 79 80 81 82				Shots/Rd _____					_____				
83 84 85 86 87 88 89 90 91 92 93 94 95 96 97 98 99				_____					_____				

Name _____				Skills					Hit Points				
STR _____	DEX _____	INT _____	HP _____	_____	_____	_____	_____	_____	Dead -2 -1 0 1	_____	_____	_____	_____
CON _____	APP _____	POW _____	Luck _____	_____	_____	_____	_____	_____	2 3 4 5 6 7	_____	_____	_____	_____
SIZ _____	SAN _____	EDU _____	DB _____	_____	_____	_____	_____	_____	8 9 10 11 12 13	_____	_____	_____	_____
Sanity Points				Weapons					Magic Points				
Insane 0 1 2 3 4 5 6 7 8 9 10 11 12 13 14				Weapon _____					Unconscious 0 1				
15 16 17 18 19 20 21 22 23 24 25 26 27 28 29 30 31				Skill% _____					2 3 4 5 6 7				
32 33 34 35 36 37 38 39 40 41 42 43 44 45 46 47 48				Damage _____					8 9 10 11 12 13				
49 50 51 52 53 54 55 56 57 58 59 60 61 62 63 64 65				Range _____					14 15 16 17 18 19				
66 67 68 69 70 71 72 73 74 75 76 77 78 79 80 81 82				Shots/Rd _____					_____				
83 84 85 86 87 88 89 90 91 92 93 94 95 96 97 98 99				_____					_____				

Name _____				Skills					Hit Points				
STR _____	DEX _____	INT _____	HP _____	_____	_____	_____	_____	_____	Dead -2 -1 0 1	_____	_____	_____	_____
CON _____	APP _____	POW _____	Luck _____	_____	_____	_____	_____	_____	2 3 4 5 6 7	_____	_____	_____	_____
SIZ _____	SAN _____	EDU _____	DB _____	_____	_____	_____	_____	_____	8 9 10 11 12 13	_____	_____	_____	_____
Sanity Points				Weapons					Magic Points				
Insane 0 1 2 3 4 5 6 7 8 9 10 11 12 13 14				Weapon _____					Unconscious 0 1				
15 16 17 18 19 20 21 22 23 24 25 26 27 28 29 30 31				Skill% _____					2 3 4 5 6 7				
32 33 34 35 36 37 38 39 40 41 42 43 44 45 46 47 48				Damage _____					8 9 10 11 12 13				
49 50 51 52 53 54 55 56 57 58 59 60 61 62 63 64 65				Range _____					14 15 16 17 18 19				
66 67 68 69 70 71 72 73 74 75 76 77 78 79 80 81 82				Shots/Rd _____					_____				
83 84 85 86 87 88 89 90 91 92 93 94 95 96 97 98 99				_____					_____				

Name _____				Skills					Hit Points				
STR _____	DEX _____	INT _____	HP _____	_____	_____	_____	_____	_____	Dead -2 -1 0 1	_____	_____	_____	_____
CON _____	APP _____	POW _____	Luck _____	_____	_____	_____	_____	_____	2 3 4 5 6 7	_____	_____	_____	_____
SIZ _____	SAN _____	EDU _____	DB _____	_____	_____	_____	_____	_____	8 9 10 11 12 13	_____	_____	_____	_____
Sanity Points				Weapons					Magic Points				
Insane 0 1 2 3 4 5 6 7 8 9 10 11 12 13 14				Weapon _____					Unconscious 0 1				
15 16 17 18 19 20 21 22 23 24 25 26 27 28 29 30 31				Skill% _____					2 3 4 5 6 7				
32 33 34 35 36 37 38 39 40 41 42 43 44 45 46 47 48				Damage _____					8 9 10 11 12 13				
49 50 51 52 53 54 55 56 57 58 59 60 61 62 63 64 65				Range _____					14 15 16 17 18 19				
66 67 68 69 70 71 72 73 74 75 76 77 78 79 80 81 82				Shots/Rd _____					_____				
83 84 85 86 87 88 89 90 91 92 93 94 95 96 97 98 99				_____					_____				

Personal Data

Investigator Name _____	Episodes of Insanity _____
Residence _____	_____
Personal Description _____	Wounds & Injuries _____
_____	_____
Family & Friends _____	Marks & Scars _____
_____	_____
_____	_____



Investigator History

_____	_____
_____	_____
_____	_____
_____	_____
_____	_____
_____	_____
_____	_____
_____	_____

Income & Savings

Income _____
Cash on Hand _____
Savings _____
Personal Property _____

Real Estate _____

Adventuring Gear & Possessions

_____	_____	_____
_____	_____	_____
_____	_____	_____
_____	_____	_____
_____	_____	_____
_____	_____	_____
_____	_____	_____
_____	_____	_____
_____	_____	_____

Mythos Tomes Read

_____	_____
_____	_____
_____	_____
_____	_____

Entities Encountered



_____	_____
_____	_____
_____	_____
_____	_____
_____	_____
_____	_____
_____	_____
_____	_____

Magical Artifacts / Spells Known

Artifacts _____	Spells _____
_____	_____
_____	_____
_____	_____

ESCAPE FROM INNSMOUTH

A century ago Innsmouth was a thriving community on the Massachusetts coast. Then a shadow fell over Innsmouth. There were whispered rumors of heathen religions and blasphemous pacts. Now Innsmouth lies rotting, its harbor choked with sand, the town itself nearly engulfed by salt marshes. Outsiders shun Innsmouth and its sullen, deformed inhabitants. But the secret is still there. Hiding. Festering. Growing. Waiting.

This book recreates H. P. Lovecraft's most haunted locale for the *Call of Cthulhu* roleplaying game. Herein are described all of the terrible places, brooding characters, evil tomes, and monstrous inhabitants of shadowed Innsmouth. This is a revised, second edition, containing all of the original source material and maps, with corrections. Included for the first time in this edition are an introductory Innsmouth scenario and an entirely new section for the acclaimed "Raid on Innsmouth" adventure.

Exploring
Lovecraft Country

CALL OF CTHULHU

Over sixty supplements have been created for this award winning game. The newest are *The New Orleans Guidebook*, *Secrets*, and *The Dreaming Stone*. Our line of classic reprints currently includes *The Compact Arkham Unveiled*, another Lovecraft Country sourcebook, as well as *The Compact Trail of Tsathoggua* and *The Complete Dreamlands*. Write to the address below for a catalog.

The popular *Call of Cthulhu* fiction line continues to expand. The next release is *The Innsmouth Cycle*.

MYTHOS STANDARD GAME SET

The *Mythos Standard Game Set* contains over 100 all new cards that are completely compatible with both the *Mythos Limited Edition* and *Dreamlands* sets. Explore New York of the 1920s. Learn of the strange festival held deep below Kingsport, the city in the mists. Discover the mi-go that dwell in the wilds of rural Vermont. *Mythos Standard Game Set* contains two already constructed decks, and is the perfect way to get started with *Mythos*.

Mythos: The Dreamlands is also still available. The 200 cards in this set may be used to expand your *Mythos* games into a whole new dimension.

ISBN 1-56882-115-8



9 781568 821155

0897-2371CH22.95

Chaosium Inc.

950 56th Street, Oakland CA 94608

<http://www.sirius.com/~chaosium/chaosium.html>



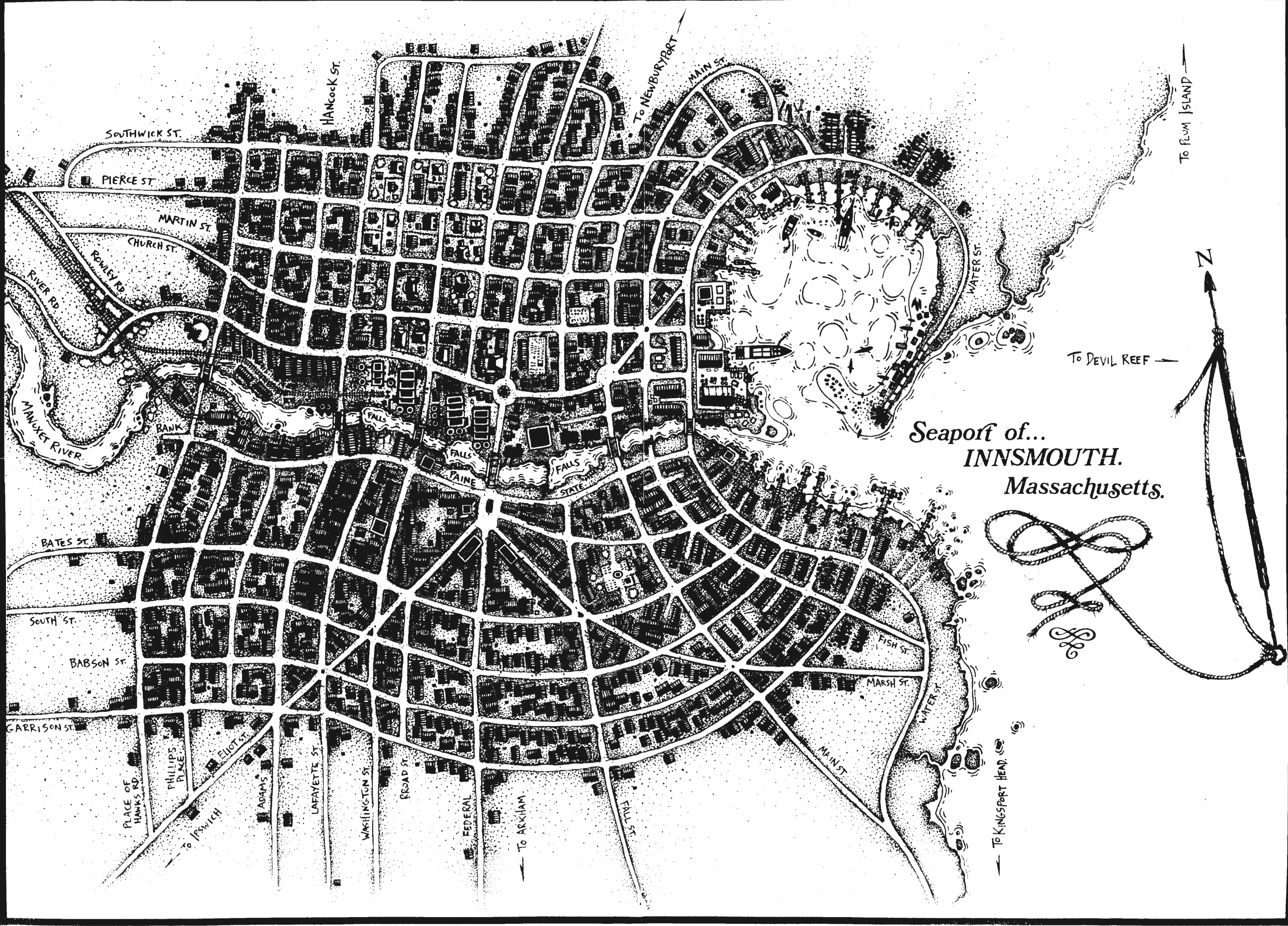

Seaport of...
INNSMOUTH.
Massachusetts.

To Plum Island

To Devil Reef

N

To Kingsport Head

To Arkham

To Ipswich

To Newburyport