

TRIGUN



TRIGUN



TRIGUN © 1998 YASUHIRO NIGHTOW / SHONEN GAHO-SHA, TOKUMA SHOTEN, JVC GUARDIANS OF ORDER and BESM are trademarks of GUARDIANS OF ORDER, INC.

d20 System game material requires the use of the Dungeons & Dragons®,
Third Edition Core Books, published by Wizards of the Coast®

besm d20

 geneon



TRIGUN

2-3	Introduction
4-99	Episode Summaries
100-130	Characters
100	Vash the Stampede
102	Meryl Stryfe
104	Milly Thompson
106	Nicholas D. Wolfwood
108	Millions Knives
110	Legato Bluesummers
112-130	Other Characters
131-144	The World of Trigun
145-174	d20 System Game Material
189	Index

Written by **Michelle Lyons**, Edited by **Lucien Soulban**, Designed by **Jeff Mackintosh**,
Editing Assistance by **Mark C. MacKinnon** and **Meredith Katz**, Production Assistance by **Karen A. McLarney**

TRIGUN © 1998 YASUHIRO NIGHTOW / SHONEN GAHO-SHA, TOKUMA SHOTEN, JVC
GUARDIANS OF ORDER and TRI-STAT SYSTEM are trademarks of GUARDIANS OF ORDER, INC.

Copyright © 2003 GUARDIANS OF ORDER, INC. / Pioneer Entertainment USA, Inc.

'D20 SYSTEM' and the 'D20 SYSTEM' logo are Trademarks owned by WIZARDS OF THE COAST and are used according to the terms of the D20 System License version 5.0. A copy of this License can be found at www.wizards.com/d20.

DUNGEONS & DRAGONS® and WIZARDS OF THE COAST® are Registered Trademarks of WIZARDS OF THE COAST, and are used with Permission.

All rights reserved under international law. No part of this book may be reproduced in part or in whole, in any form or by any means, without permission from the publisher, except for brief quotes for use in reviews.

Version 1.0 — September 2004

GUARDIANS OF ORDER, INC.
P.O. Box 25016
370 Stone Road
Guelph, Ontario
CANADA N1G 4T4
Phone: 519-821-7174
Fax: 519-821-7635
info@guardiansorder.com
<http://www.guardiansorder.com>



Print Edition — ISBN 1-894938-44-5
Product Number 02-671



Introduction

Trigun is a 26-episode television series first released by Victor Company of Japan. Dubbed and subtitled versions were produced for North America in 1998 by Pioneer Entertainment (USA) L.P. *Trigun* is based on the *manga* (comic book) series *Trigun* and *Trigun Maximum*, the latter published by the Shonen Gaho Publishing. The opening theme is an instrumental electric guitar rock piece, called "H.T.," composed and performed by Tsuneo Imahori (who also provided the remaining music for the series).

Trigun follows the misadventures of Vash the Stampede, also known as "The Humanoid Typhoon." Vash is considered a fugitive and a criminal, wanted by the Feds for the destruction of over 300 towns. The series recounts him through the eyes of Meryl Stryfe and Milly Thompson, disaster investigators for the Bernadelli Insurance Society, who are assigned to find and follow Vash the Stampede, and prevent further claims against their employer if possible.

Trigun derives its name from the three guns the main character carries: a revolver, a cybernetic gun, and the Angel Arm artifact. The animation production company, Mad House, produced the series while Yasuhiro Nightow developed the initial concept for *Trigun* through the *manga* series *Trigun* (published originally in *Shonen Captain Comics* by the Tokuma Publishing Company). During that period, Victor Company of Japan secured the rights for the Japanese anime.

Originally, *Trigun* was virtually unknown. It aired in a late-night slot on Japanese television. It eventually caught on, however, developing a cult popularity that overcame its programming difficulties. The *Trigun* series has inspired countless fan sites and even a line of toys by a prominent U.S. manufacturer.

The first four episodes devote themselves to light-hearted character development and slapstick humour, introducing the characters of Vash, Milly, and

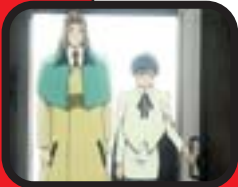

Meryl, and building their relationship through a series of largely unrelated stories. Beginning at the fifth episode, a story arc slowly takes shape, introducing more serious themes. This continues throughout the first half of the series until episode 12. There, *Trigun* introduces the first of the major antagonists in a lead-in for the second half of the series.



The second 13 episodes are much darker thematically than the first 13. The first episode (#14), "Little Arcadia," is a transitional story. It deals primarily with Meryl and Milly, and does not really touch on the larger issues of the series' story arc. It is far more like the stories from the show's first half. The remaining episodes, however, deal with the over-arching story line involving Vash, his brother Knives, and the Gung-Ho Guns.

The themes for the series as a whole are brought to the surface in the latter half, dealing with such topics as the horror of genocide, exploitation, violence and its prevalence in society, the sanctity of life, and self-love, among others. It pits the rights of the individual against society's rights, as embodied by Knives and his struggle against humanity, as well as by Wolfwood's internal struggle with Vash's belief system.

Space Cowboy Shonen

Trigun is a relatively new derivative of *shonen* (young boy) anime. Set on a sparsely populated desert planet with two suns, it evokes the Wild West of the United States in the late 1800's, with its drifters, unruly towns, and reliance on rural law enforcement. At the same time, the series is obviously futuristic, with space travel, nuclear energy, and other mysterious technologies often no longer understood by the people who rely on them for survival.

This style of anime differs from traditional *shonen* stories in that it draws heavily from historical Western sources. It is a cross between typical *shonen* sword-and-sorcery fare and the *samurai* or *ninja* action genre, substituting the Old West for the fantasy element. This approach makes a refreshing change from more traditional forms, and is slowly gaining popularity.

Currently there are only a few examples of this type to choose from, making too small a sampling to be called a genre of its own. Other popular examples include the *Cowboy Bebop* and *Outlaw Star* series. With the growing interest in this genre, however, and the popularity that Western influences are enjoying in Japan, it is likely that more anime will develop in this vein.



Planned byShigeki Komatsu
Masao Maruyama**Based on**the comic by Yasuhiro Nightow
serialized in "Young King Hours" (Shonen Gaho Publishing)
Shonen Captain Comics (Takuma Publishing Company)**Produced by**

Shigeru Kitayama

Series Story Editor

Yosuke Uroda

Character Design by

Takahiro Yoshimatsu

Mechanical Design by

Noriyuki Jinnguji

Art Director

Hidetoshi Kaneko

Director of Photography

Hisao Shirai

Audio Supervisor

Yasunori Honda

Music

Tsuneo Imahori

Music Produced by

Yukako Inoue (Victor Entertainment)

Opening Theme**"H.T"-Composed and Performed by**

Tsuneo Imahori

Opening Animation**Storyboard**

Satoshi Nishimura

Unit Director

Shigetoshi Takayanagi

Animation Director

Takahiro Yoshimatsu

Animation Produced by

Mad House

Animation Producer

Masao Marosawa

Directed by

Satoshi Nishimura

Presented by

Victor Company of Japan, LTD.

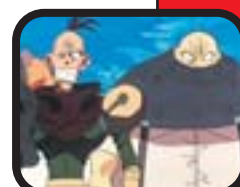

TRIGUN

The \$\$60,000,000,000 Man

EPISODE SUMMARIES



Trigun takes place sometime in the far future, though exactly when is never specified. The stories are set on a desert planet that looks remarkably like the southwestern United States in the 1880s. The planet has twin suns and is possibly named Stantal (though Stantal might also be a geographic, and not planetary, indicator). While there is a significant amount of advanced technology, most of the people on the planet have forgotten how to



use it or how it worked (if, in fact, they knew to begin with). Areas off the beaten paths are dangerous, with abandoned ruins or outlaws waiting to snare unwary travellers.

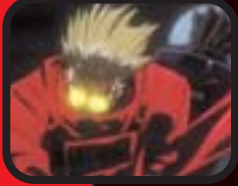
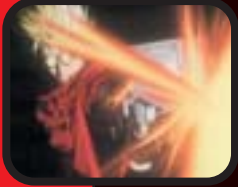
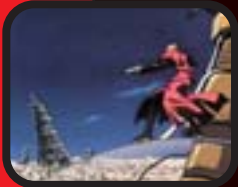
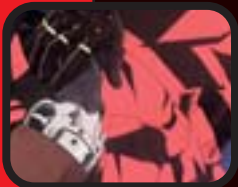

TRIGUN

The \$\$60,000,000,000 Man

EPISODE SUMMARY EPISODE: 01



Episode One: The \$\$60,000,000,000 Man

In an unnamed saloon in the middle of the desert, a tall man with spiky blond hair and a long red duster-style coat drinks alone at the bar. Known as Vash, or Vash the Stampede, he has a sixty billion double-dollar bounty on his head for the destruction of over 300 cities.



Without warning, a group of men lead by Descartes, a giant cyborg, attack the bar. Descartes (dressed in red with enormous pierced ears, a metal arm, and a green mohawk) decapitates the building with his giant bladed boomerang while his men open fire, destroying the saloon and sending the other patrons running for their lives.



Vash stays put, however, untouched by the hail of bullets. He draws his silver customized long-barrel Colt-45...

Meanwhile, in the ruins of Dankin Town, the sheriff stands in what is left of his office, talking to a tall blond man with a large rifle, grey coat and hat. The sheriff claims Vash the Stampede caused the destruction, and describes him as a short-legged, earringed giant dressed in red. The man in grey nods and sets out to find the person responsible for the destruction of Dankin Town.

Meanwhile, two women walk into a seedy diner outside a city called Felnarl, just as the radio broadcasts news of Dankin's destruction. The first, Milly Thompson, is as tall as most men, with

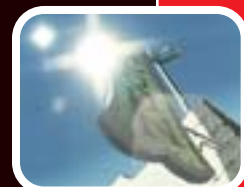

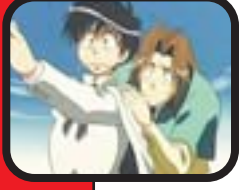
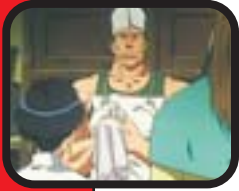

long, light brown hair and blue eyes. The other woman, Meryl Stryfe, is short with boyish black hair and grey eyes. Some rougher patrons try harassing the two young women, but Milly accidentally drops a gun half her size from under her coat. She smiles sweetly and hefts the gun easily, turning to shrug at the men. The intimidated patrons immediately retreat to the back of the salon.



Milly defers to Meryl, who turns and asks the bartender about Vash. The bartender is surprised, but describes Vash as 12 feet tall, with a huge weapon, lots of henchmen, a mohawk, and an unsavoury attitude, especially with women. Milly and Meryl are unfazed by this description.

On rocky cliffs overlooking Felnarl, the giant Descartes stands with his men, looking for Vash. Vash is hiding, after discovering in the earlier fight that his gun was out of bullets. Forced to flee, Vash is now trying to sneak past Descartes and his men without being captured. Descartes' henchmen are unhappy, refusing to believe Vash the Stampede could have been caught without ammo in such a stupid way.



They are convinced they had the wrong man and want to leave, but Descartes' strength, size, and bad temper convince them otherwise.



As Vash tries to escape, he manages to beat three henchmen before Descartes corners him. After Descartes' boomerang cuts the boulder Vash hid behind in half, the henchmen tie Vash up, leaving Descartes in a very good mood.

While Descartes' prepares to deliver Vash to the Feds, Meryl and Milly show up. They tracked the man they believe is Vash to this spot, and are determined to speak with him, regardless of how frightened they are. They approach Descartes, having mistaken him for Vash from the barkeep's description, but Descartes thinks they intend to rescue Vash or take the bounty for themselves.



Just before Milly can introduce herself, a gunshot rings through the air, silencing everyone. On the cliff above the group stands the man from Dankin. He introduces himself as Ruth Loose (read "Ruthless"), a bounty hunter also known as "Constance Rifle." He trains his rifle on Descartes, and addresses him as "Vash." This confuses everyone except for Meryl and Milly, who also believe Descartes is Vash. Meanwhile a henchmen attracts Descartes' attention ... Ruth's coat is lined with red, which matches the description of a blond man with a red coat and a big gun. Descartes had used that description to track Vash down, but after Vash's earlier incompetence, Descartes decides Ruth is actually Vash.



dodges, however, jumping over the blade and landing on Descartes. Using the cyborg's implants against him, Vash pins Descartes' arms painfully behind his back. Vash then tries to warn Ruth, but the returning boomerang hits and badly wounds Ruth while he was preparing another explosive device.



As Vash stands triumphant on the field, waving at the astonished girls, the forgotten explosives detonate, sending the cliffside crashing down on the town of Felnarl. Vash and the girls are horrified; luckily the town was evacuated.

Later, a discouraged Meryl prepares her disaster report in nearby Lewiston Town. She was sure they had found Vash, only to be proven wrong. When Milly suggests the real Vash was the person they were looking for, Meryl cannot believe that a man reputed to be so deadly could win simply by dumb luck. She is resolved to continue their assigned search, however, while Vash walks away from the ruins of Felnarl on his way to the next town.

Ruth and Descartes each accuse the other of being Vash, before exchanging gunfire. When Ruth drops a small bomb, the girls jump on their steeds and gallop away. Vash, dodging rocks and debris from the explosion, manages to escape as well, running alongside the girls on their way back to town.

Ruth shoots at Vash, knocking him from the animal, but Vash merely catches the bullets, throwing them back and cutting the ropes that held the girls. Meryl and Milly run, as does Vash, dodging bullets as he goes.



Unfortunately, Vash finds himself at the cliff's edge overlooking Felnarl while Descartes catches up with him. When Vash refuses to jump to his death, the giant throws the boomerang. Vash

Vash and the girls talk while escaping, with Milly revealing that Meryl and she are disaster investigators for Bernadelli Insurance Society, assigned to 24-hour surveillance of Vash the Stampede to prevent further property damage. Vash, alarmed by this news, avoids revealing his identity. Halfway back, Meryl and Milly stop, asking Vash to warn the town while they return and try to speak with the giant. Vash, touched by their concern for the city, watches them ride away.

Back on the cliffs, Ruth and Descartes have realized their mistakes, so they capture the returning girls, believing they helped the real Vash escape. Meryl and Milly are bound with rope and left hanging from a rock archway. Vash soon rides to the rescue on one of the girls' steeds, bouncing absurdly in the saddle.

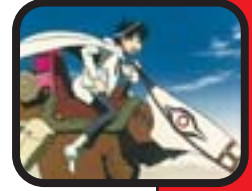

TRIGUN

The \$60,000,000,000 Man

EPISODE SUMMARY EPISODE: 02



Episode Two: Truth of Mistake

A tall blond figure wearing a red coat approaches a large house under cover of darkness. A short, moustached man in a dark suit emerges from the front of the house and fires his gun. The figure staggers and runs away.

A few days later, Milly and Meryl ride into an unnamed town. It is abandoned, and the only well they find is completely

dry. While they investigate the well, two people walk by. The passers-by mention that Vash the Stampede is working as a

bodyguard for Mr. Cliff Schezar. Meryl sits up, her thirst temporarily forgotten. She and Milly resolve to find Mr. Schezar as soon as possible.

When Milly and Meryl arrive at the house, Vash opens the door. Mr. Schezar, the small man from the first scene, is also there and invites them in. Schezar introduces himself, explaining that someone is after him. He advertised for a bodyguard and Vash took the job. Schezar also introduces his guest, Marianne, who steps out from behind a large curtain in the living room. Vash is smitten with Marianne, annoying Meryl with his attempts to be charming.

Finally, Meryl takes Mr. Schezar aside. She explains that the man he calls Vash is an impostor. Mr. Schezar says he does not care who his bodyguard really is, so long as everyone believes the man he hired is Vash. The name is sufficient to keep would-be criminals at bay.

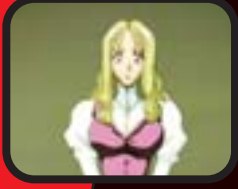
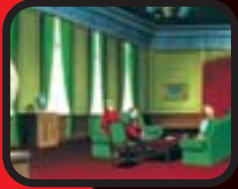
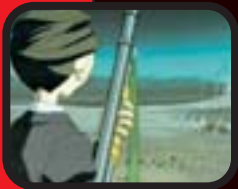

does not notice, taking it to be a measure of her feelings for him.

Marianne interrupts Vash's romantic overtures by pointing out the window, claiming to have seen something move. Vash excuses himself, leaping out the window. He spots someone and jumps on them, discovering that it is Meryl and Milly. He rushes back to tell Marianne everything is fine, only to find she is no longer there.



Concerned for Marianne, Vash and the girls search the house, but discover that both Mr. Schezar and Marianne are missing. Meryl puts the facts together as she understands them, and decides Marianne is hiding something. Vash denies it, leading into an argument between Meryl and he. Meryl discovers



Schezar tells Meryl that the person stalking him is a blond man with a silver gun. Meryl perks up at that description, suspecting that the real Vash is the one after Schezar. She offers herself and Milly to Mr. Schezar as bodyguards for free, hoping to catch the real Vash. Mr. Schezar accepts, but assigns the girls to fix dinner.

That evening, Vash realizes Marianne is in the room next to his. He sneaks up to the roof and lowers himself down in front of her window, hoping to catch her bathing alone. He calls out to her, but she is not in the room. Meanwhile, Meryl sees Marianne slip out from Mr. Schezar's study. Meryl is troubled by Marianne's behaviour, but says nothing.



After dinner is served, Vash, Marianne, and Mr. Schezar talk at the table. Mr. Schezar explains that his father purchased land containing the water source for the surrounding area. His fortune comes from maintaining that source and ensuring others do not squander it, like the local "rabble." Marianne becomes agitated during the discussion and leaves the table, feigning



illness. Mr. Schezar is not fooled, however, and apologizes to Vash.

After she leaves the table, Marianne goes up to her room and begins undressing, revealing bloodstained bandages. Vash knocks on her door, however, so she re-zips her gown. Vash comes in, wanting to talk with her. During the conversation, he is overcome by his feelings and takes her by the shoulders. Her eyes widen in pain but he

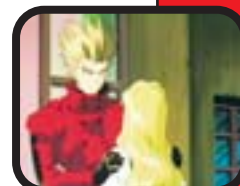
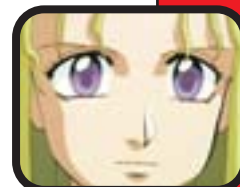
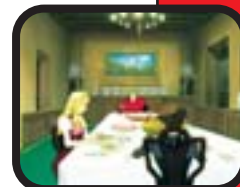

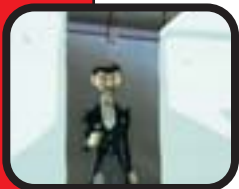
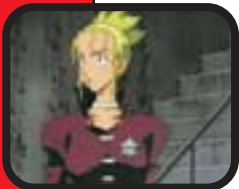
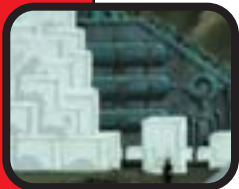

Vash had tried to peek in Marianne's window and backs Vash into a couch. He reaches for the curtain pull to keep from falling. When he puts his weight on it, the curtain opens and a secret door slides back, leading to a dark passageway.

Below the house, Marianne — now wearing a red jump-suit, a marshal's badge and carrying a silver gun — is exploring. She finds a facility where water is being frozen into blocks and stored, preventing the town from using it. Mr. Schezar comes out from a side room with gun in hand, confirming her suspicions.



Mr. Schezar is amused to discover that Marianne is a marshal, although he claims to have suspected her secret for some time. She accuses him of killing the surrounding land and town by stealing



the water. She tries to raise her gun, but her shoulder is injured where Schezar shot her during the first scene. Schezar hits her on her wounded shoulder and she falls to the ground in pain. He points his gun at her, ready to shoot while congratulating himself on getting rid of all the witnesses by hiring a false Vash.

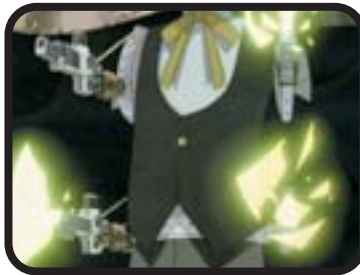

Before Schezar can fire, Vash slides down a water chute and splashes into the pool at the bottom. Schezar aims at Vash;

Marianne tries to warn him to run. Vash is touched by Marianne's effort to save him. He stands and faces Schezar down.

Schezar fires, but Vash manages to dodge each bullet. He closes in, taking away Schezar's gun. Schezar pulls open his coat, revealing four miniguns strapped to his body. They fire as Vash leaps into the air. The bullets miss Vash and hit the ice blocks, breaking pieces off. Vash grabs one and throws it at Schezar, who accidentally shoots the freezing tanks. Electricity arcs out and the tanks explode. Schezar's house is flattened, and a huge geyser of water shoots into the sky.

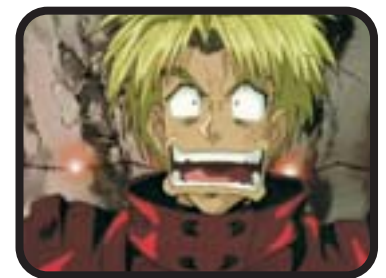

The next morning, Vash, Marianne, Meryl, and Milly stare down at the lake where the city used to be. Marianne reassures everyone that things will be fine. She thanks Vash first, then Meryl and Milly. He slips away while the girls talk so that Marianne does not realize who he is and arrest him. Before they notice, Vash is gone into the desert again.



WANTED

DEAD OR ALIVE



Money the Gale

TRIGUN

FIREARMS

Just as in the Old West of the United States, guns are common in *Trigun*. Standard, non-customized guns are readily available to anyone who needs one, and most people own at least one for personal defense. As currently seen in the series, this is true across the planet, from the smallest town to the largest city.

It should be noted that although many people in *Trigun* use guns, most do not carry obvious weaponry. Wearing a gun openly is a statement, indicating that you are able and willing to use it. Only criminals, law enforcement, and bounty hunters bear weapons openly. Civilians will politely attempt to distance themselves from anyone who is obviously armed and not a member of local law enforcement. Criminals seeking to establish their reputation will likely treat a revolver displayed on the hip as a challenge, while authority figures will perceive it as a threat. Players in this setting should be aware of the risks such choices entail.

The world of *Trigun* relies primarily on modern-day ballistic weapons. Despite the series' futuristic setting, weapons are no more advanced than their current counterparts technology wise. As examples, Vash's gun is a six-shot revolver, while Wolfwood favours pistols with clips.

Customized weapons are available, but costly. There is no shortage of gunsmiths, but ones known for quality work are few and far between. Most people who earn their living with a gun have customized weapons, whether unusual versions of standard sidearms or items that are non-existent in the real world. Milly's stungun is a good example of a fantasy customization, as are Monev the Gale's arm guns.



TRIGUN

The \$60,000,000,000 Man

EPISODE SUMMARY EPISODE: 03

Milly again suggests that he could be the right person, but Meryl refuses to believe it.



After Vash walks away from the girls, the drunk from the first scene knocks him over. He hounds Vash for booze. When Vash tries to leave, the man climbs on top of him and wrestles him to the ground. Vash has no choice but to buy the man something to drink.

Vash and the drunk go back into the bar, where Vash purchases a drink for the man and himself. Vash turns over his gun to the bartender upon request, and asks the drunk if he knows Frank Marlon. The drunk denies it, but the bartender says she knows of Marlon. She describes him as a hero. Years ago,

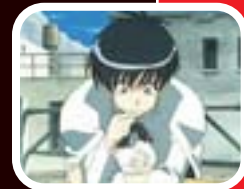

Episode Three: Peace Maker

A drunk man with dark hair accosts the other patrons of a saloon, asking for money or booze. Two customers who are tired of the boozier throw him out. They threaten him, and one kicks the fallen drunkard. The drunk laughs while they walk away, blushing and cursing from embarrassment and inebriation.



Meryl and Milly are sitting in Warrens City, discussing their lack of success in finding Vash the Stampede. Meryl decides that the rumours they have been following are no good, and decides to talk to local law enforcement for a real description. Milly interrupts her to greet Vash, who was just walking by.



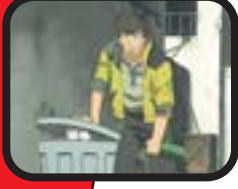
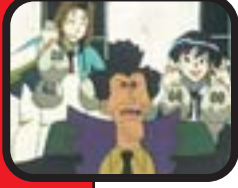
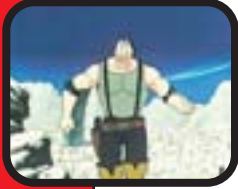
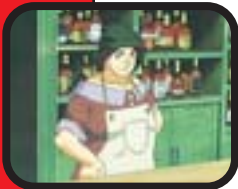

bandits attacked Warrens City regularly. Marlon, a genius gunsmith, made guns for everyone in the town and gave them to anyone who needed one.

When Vash asks about having Marlon fix his gun, however, the bartender lowers her gaze, saying that Marlon would only pawn it for alcohol. The drunk throws his glass at the bar, smashing it. He then grabs another, calling Vash a fool for wanting to give his gun to a complete stranger. Vash studies him for a moment, then pours the man another drink.



Meanwhile, Meryl and Milly go to the mayor of Warrens City. They discover there is no sheriff in town, because nothing ever happens there to require one. Meryl tries to tell the mayor that the town is in danger from Vash the Stampede, but he does not believe her.



At the same time, a large bald man is walking out of the city toward a small group of men. He tells the leader, Joshua, that the town has no sheriff, and an armoured car is due at the bank the next day. He also says that Vash the Stampede was reputedly seen in the area. Joshua decides to convince the town he is Vash the Stampede when he robs the armoured car, so that everyone will be too afraid to stop him.

A few hours later, Vash and his companion are thrown out of the bar. They go back to the drunk's house to keep drinking. After a few more bottles, both are completely intoxicated. The drunk says that he used to do charity work, but that helping one person only hurts another. All he does now is drink, to keep things equal. The drunkard passes out soon after this.

Vash stands and covers him up, suddenly much less intoxicated. He remembers asking someone else about Marlon. The man told him that the famous gunsmith is nothing but a drunk now, giving up everything after gunmen killed his wife and child in a bank heist. When Marlon discovered the guns that killed his family were ones he had made and given away, he became the drunk Vash met.



When Marlon wakes up in the morning, Vash is not there though his gun is on the table. He hears a shout that Vash the Stampede is robbing the armoured car. Outside, the thugs are shooting guns into the air. Meryl and Milly attempt to introduce themselves to the false Vash, only to be put to work loading the money into his getaway car.

The real Vash is hiding in a trashcan looking out of an alley. He is planning his strategy when Marlon arrives, trying to keep Vash from involving himself. Vash steps past him, carrying the trash-can lid and saying that the situation is unequal. In silence, Marlon watches him leave.



Vash walks out to the robbers. When he reaches the getaway car, they shoot at the ground to stop him. He uses a hidden blade in his boot to puncture a car tire. One shoots at him, but Vash uses the trash can lid to block the bullets. Knocked off balance, Vash falls at the feet of a henchman behind him. Vash takes the man's gun away, then breaks the henchman's arm and drops him to the ground.



Vash, pointing a gun at the robbers from inside his coat pocket, faces off against them in the street. No one moves until the bartender comes out with a gun pointed at Joshua. The gang leader tries to maintain eye contact with Vash the Stampede, but one by one the townspeople all bring out their guns.

Meanwhile, Marlon tries to come to grips with what he sees. He realizes his



choices have been wrong. In a last-ditch effort to intimidate the townspeople, Joshua transforms his gun into an even larger, more impressive, one. Marlon, acting at last, sneaks up behind Joshua and puts a gun to the back of his head, whispering "Check mate."



Joshua drops his gun, and he and the robbers take off, running for their lives. Marlon and Vash both reveal that their "guns" were just pointed index



fingers. Meryl is caught between admiration and dismay at Vash's antics, convinced that he is crazy.

In the wake of the victory over the robbers, the town throws a party. Vash gets drunk again while Meryl and Milly discuss him. During the party, Marlon returns Vash's gun, completely fixed. Marlon reveals that he does not drink anymore and invites Vash to come back any time he needs his gun fixed.



The next day, Vash leaves town on foot, walking into the desert. Meryl and Milly follow behind on their mounts, though Meryl still will not admit that he is Vash the Stampede. Vash smiles, points a finger at the twin suns overhead, and whispers "bang bang."

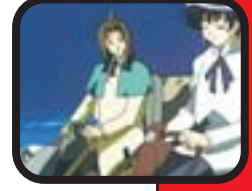
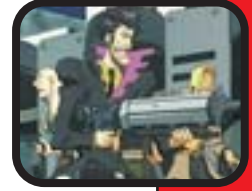

TRIGUN

The \$60,000,000,000 Man

EPISODE SUMMARY EPISODE: 04



Episode Four: Love & Peace

In the middle of a sandstorm, a taxi comes to a stop. Vash gets out, giving the reluctant man some money to cover his trouble. Vash walks through the sandstorm into the town of Orleans, through a huge graveyard that almost stretches to the horizon.

In town, the sandstorm has stranded the insurance girls. Depressed

by their luck, Meryl looks around the bar. A girl in an evening gown sits at a

table close by, playing cards and winning. With brown hair and blue eyes, she is pretty and charming.

The girl, Stefany, is disappointed when her current playmate quits the game. A dark man wearing a hat pulled low over his face comes over, offering to play. Before they begin, the man pulls out a gun and tells her the stake of the game is her life.

On the street, the annoyed sheriff, Stan, talks to his deputies. The Earl of Orleans pulls up in a large expensive car, looking very concerned. At the sheriff's direction, the deputy tells the Earl the kidnapper's demands. He also says that Stefany — the Earl's daughter — is among the four hostages being held. The Earl is furious and frightened. The sheriff intimates that the Earl, formerly known as "Grim Reaper" Bostalk, used to do similar things, which angers Bostalk. The Earl tells Stan to save Stefany

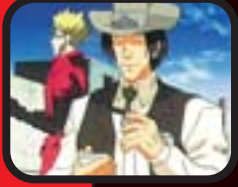
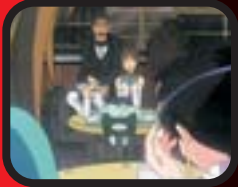



regardless of the cost of human life, but Stan reacts badly to Bostalk's order.

Meanwhile, Vash suddenly appears, wearing headphones and dancing. Oblivious, he dances past the sheriff and his men. They call out to him, but he does not notice. The four gunmen fire at him, but he dances between the bullets and finally reaches the bar door. When he opens it, the kidnapers put three guns to his head.



The gunmen tie Vash up while he screams for help, and toss him on Meryl and Milly, who were also taken captive along with Stefany's bodyguard. Meryl jerks away from Vash, letting his head hit the floor with an audible thud. Stefany, who is tied and hanging from the ceiling, asks if Vash is okay. When Vash sees her, a glazed look clouds his eyes and he tries crawling over to her. One of the gunmen, Gene, suspects that Vash is going to do something odd and kicks him away.

Stefany offers to convince her father into giving the kidnapers her pocket money if they let her go. Jean loses his temper and threatens to kill her,

drawing his gun and putting it in her mouth. Before he can press the trigger, the bandit leader, Ingway, comes up behind Jean and takes his gun. Pulling Jean away from Stefany, Ingway notices that Vash's bubble gum is stuck in Gene's gun, preventing it from firing.



Outside, a group of freakish homicidal mercenaries show up. Stan wants to send them in to retrieve Stefany. Bostalk does not trust them, but Stan



guarantees that if they are paid enough, they will not harm her. Bostalk reluctantly agrees, knowing that they will likely kill everyone else.



Just as the kidnapers are growing nervous, the getaway wagon arrives. A deputy jumps out and shows the group the money, before setting it down and running away. Marvin, one of the gunmen, goes out to check the wagon. He sees a mercenary inside the vehicle through the rear-view mirror. He alerts his partners, but is shot before he can make it back to the bar.



Jean runs out to avenge Marvin before Ingway can stop him. The mercenaries start up the wagon and head straight for Gene, running him over before crashing into the front of the saloon. Meryl and Milly manage to

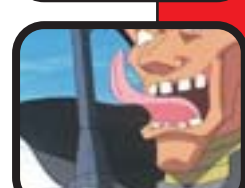
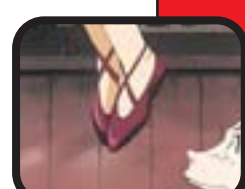
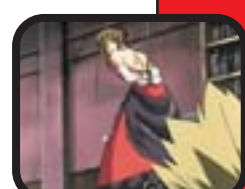
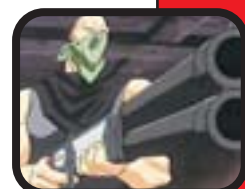

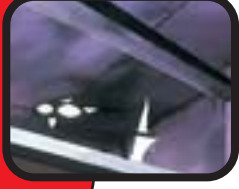
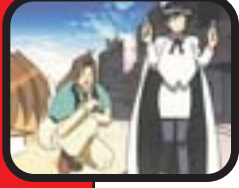
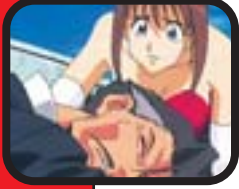
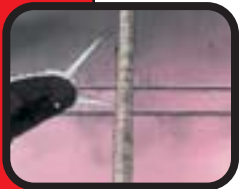

throw themselves behind the bar and untie themselves. Vash, no longer tied up, flips through the air and grabs a screaming Stefany, cutting the rope with his boot knife and landing with her behind the bar. Ingway is there as well.



The mercenaries shoot at the tied up bodyguard. Vash retrieves his gun from a nearby table, catching it roughly two inches from the mercenary leader's face. Pausing, he lowers his gun instead of shooting. Milly pulls out her stungun and incapacitates two mercenaries, while Vash pops the bullets from his gun into the face of another mercenary. The startled man fires wildly, hitting a fourth. Before the startled merc can recover, a lamp falls on his head and knocks him out. With only the leader still standing, Ingway renders the last one unconscious from behind.



In the wake of the battle, Stefany tries to convince Ingway to release her. He refuses, explaining that Bostalk and his men murdered his parents fifteen years ago. They were buried in the huge graveyard outside of town, and Bostalk stole the rights to all the land. Stefany is horrified, but Ingway is unmoved, determined to have his revenge.



In the street, the sheriff is surprised when the mercenaries run away. Vash

comes out, relaying Ingway's demands for a duel with Bostalk. When the two men are in position, Ingway releases Stefany. Both men shoot, and Bostalk falls to the ground. Stefany screams and rushes to him, but he is only wounded.

Ingway tries to turn himself in, but Stan refuses his surrender. Surrounding everyone with his deputies, he explains that he plans to kill them all. Stan reveals his hatred for Bostalk; everyone realizes Stan was one of Bostalk's men. He orders everyone to throw down their weapons. They comply unwillingly.



While Stan is explaining, Vash winks at Meryl before leaping on Stan. Meryl, the only one still armed, unfurls her cloak to reveal fifty one-shot Derringer pistols strapped to the cloak's lining. She takes down all Stan's deputies single-handedly.

Vash walks up to Stan, who is standing with his gun drawn, and points his own gun at the sheriff. Stan fires at Vash, point-blank, but misses. Vash strips Stan of his badge, tossing it away. Finally, Vash forces Stan to learn a universal truth by making him repeat the phrase: "This land is made of Love and Peace!"

TRIGUN

The \$60,000,000,000 Man

EPISODE SUMMARY EPISODE: 05

Vash puts his finger in the end of the barrel and stands up. The leader tries to put a gun to Vash's head and shoot him. Vash fires the toy gun before they can react, hitting each of gunmen in at least one vital spot. Unnerved, the leader of the gunmen tries to fire again, but is out of ammunition. Vash sends them off into the desert wearing only their underwear.



Vash returns the toy to the child. The restaurant's owner talks to Vash about his methods while he eats. When he finishes, the waitress and owner both apologize and pull guns on him. Vash glances out the window and sees armed people coming to help capture him.

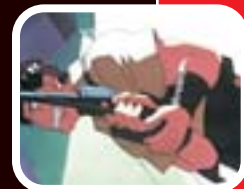

Episode Five: Hard Puncher

In a diner in Inepril City, Vash is having breakfast. The other patrons take no notice of him, especially over the noise of a small boy with a toy gun. Without warning, four men burst in, readying their guns. The other patrons dive for cover while Vash finishes his food. The men open fire at Vash, acrid smoke filling the air.

When the smoke clears, Vash is face down on the floor. The boy is crying while the other patrons hide; the gunmen are congratulating themselves on killing Vash the Stampede and



collecting the reward. One of the gunmen goes to check Vash, trying to poke him with the barrel of the gun.



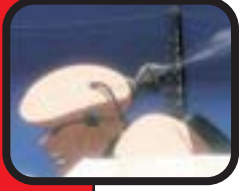
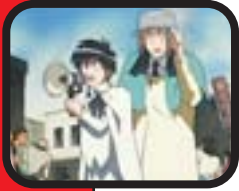

Outside of town, Meryl and Milly survey the landscape from their thomases. Meryl notes that their plant must have broken down because half the town is covered in sand. While they watch, a siren goes off in the town. The girls are there because Vash was rumoured to be coming through, and they are excited to finally catch up with him.



Meanwhile, Vash is running for his life across rooftops and through homes. The town's entire population is chasing him down with guns and explosives. Meryl and Milly arrive just as the townspeople blow up a tower trying to catch Vash. The girls try to stop the damage the townspeople are causing, but no one pays any attention to Meryl.

Suddenly a voice over a loudspeaker temporarily calls off the manhunt for



Vash. Meryl and Milly trace the announcement to a tent in the middle of the city. The city chairman is there, full of remorse after seeing the damages heaped upon Inepiril City. Meryl tries to dissuade him from chasing Vash, but he tells them that the bounty on Vash is their last hope for fixing the plant. While the chairman explains that it is too late to stop, the bounty hunters he hired arrive in town.

A giant cyborg named Gofsef Nebraska walks through the city, crushing cars and buildings in his wake. He carries his father in a pocket on his suspenders. They introduce themselves as the Nebraska Family. Meryl recognizes them as a pair of bloodthirsty killers who recently broke free from jail and yells at the chairman for hiring them. The Nebraska family are about to begin their

search for Vash when a little girl named Sandie runs up, announcing that they caught Vash the Stampede.



While Milly and Meryl were finding the chairman, Vash was running for his life. He found an empty saloon and snuck in for a drink. Suddenly the waitress from the diner, along with several other women, stands up and asks him to surrender. The waitress tells the girl to run and find help. Hoping to convince Vash to surrender peacefully, the women tell Vash how desperate they are to fix the plant, and that capturing him is their only hope.



Vash is touched by their situation, but he refuses to capitulate. With insanity in his eyes, Vash pulls out his gun and stands up, refusing to surrender until he finds "him." An explosion



Vash runs toward the weapon, leaping into the air and firing his gun. Using five precise shots, he deflects the arm and throws it off course. The Nebraska Family is stunned with disbelief. Vash uses his last bullet to shoot Gofsef in his arm socket, ensuring that he will never be able to use that projectile again. When she sees him do this, Meryl finally believes he is Vash.

Professor Nebraska is still in a fighting mood, however, and pulls a gun on Vash. In an instant, Vash has grabbed the boy's toy gun again and plastered darts all over Professor Nebraska's face. The Professor tries again, but Vash puts an end to the battle by repeating his favourite phrase: "Love and Peace!"



nearby causes everyone in the room to jump. Vash warns all the women to get down. The building collapses; shortly thereafter, Meryl and Milly arrive.

The Nebraska family demolished the saloon. The father had instructed Gofsef to launch his cybernetic arm at the saloon and reduce it to rubble. When Gofsef retracts his arm, however, he discovers graffiti drawn all over his fist. There is a stirring in the rubble, and slabs of concrete fall away to reveal a figure silhouetted behind a cloud of dust.



in his arms are still unharmed. Professor Nebraska sets out to force Vash into choosing between himself and the innocents he claims to protect. After moments of verbal abuse by the Professor, Vash puts the woman down. He moves into duelling position, still never speaking. At the last moment, Gofsef turns at his aim toward the injured women, forcing Vash to save them.

Meryl is excited and amazed to see the figure of the real Vash the Stampede after chasing him for so long. She waits anxiously for the cloud to clear, which only reveals ... the Vash she already knows. He is standing, holding the unconscious body of the waitress in his arms. He removes the women from the wreckage, laying them down a short distance away. Professor Nebraska taunts Vash for his compassion and has Gofsef shoot his arm again at Vash and the woman he carries.

The impact kicks up a huge cloud of dirt. When it clears, Vash and the woman

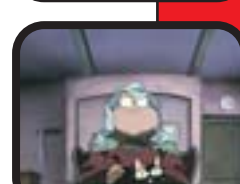
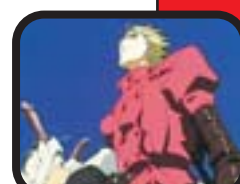
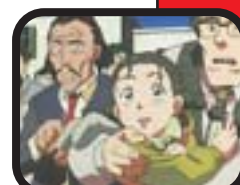



WANTED DEAD OR ALIVE



Vash the Stampede

TRIGUN

The \$60,000,000,000 Man

EPISODE SUMMARY EPISODE: 06



Episode Six: Lost July

In a diner in Inepril City, Vash is eating while the city officials talk to him. Meryl and Milly stand guard while the three men discuss Vash's decision to give the city the bounty for capturing the Nebraska Family.

When the conversation concludes, Meryl shoos the men away, reminding them of Vash's reputation. Vash leaves the

cafe soon after, but Meryl continues walking ahead, announcing Vash and warning people away with an annoyed

tone. The people of Inepril City react to Vash with cheers instead of fear, however, a reaction that grates on Meryl even more. Vash is annoyed by Meryl's constant surveillance, and the two of them are about to argue when a sand steamer arrives. The docking steamer is one of the largest of its kind, and by the time the girls finish staring at it, Vash has already disappeared.

In the meantime, an impromptu market has opened on the docks. People wander the stalls, looking for work or fun. In the middle of the commotion, a beautiful woman disembarks with her entourage from the steamer. She walks toward the city officials, who are holding up a sign for the Technical Industrial Union.

Meanwhile, Vash is standing on a balcony in the building next to the plant. The woman from the steamer walks up and greets Vash by name, telling him a number of his vital statistics. Vash is suspicious until he sees her, at which

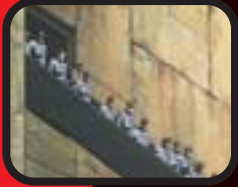
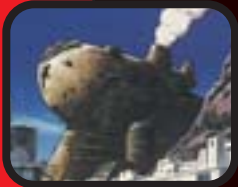



In the middle of the argument, someone interrupts with news about a malfunction in the plant. Meryl is overcome with fear, believing Vash involved. When more problems arise, Elizabeth becomes concerned as well. Vash and she leave Meryl and Milly in the control room and head for the main plant in hopes of containing the malfunction before everything explodes.

point he acts like a love-struck fool. The woman introduces herself as Elizabeth, the chief engineer of the Marius-Breskem-Kantacle Technical Industrial Union work dispatch team. She tells him that she came to repair the plant, but she also has a job she would like him to do.

Back at the market, Meryl and Milly are looking for Vash when Elizabeth and he find them. Elizabeth explains Vash is now working for her as a personal bodyguard while she repairs the plant. He responds, barking like a dog and grinning; she leads him away to the hotel. Meryl loses her patience at Vash's behaviour and storms off.

The next day, Vash and Elizabeth are at the plant. Elizabeth explains that the assassin must have been meant for her, because of her knowledge concerning plants and their repairs. In the middle of her explanation, Meryl storms in with Milly at her heels. Meryl accuses Vash of causing the explosion in the hotel. She attempts to remove him from the plant before he can damage anything, but Elizabeth stops her.



Vash and Elizabeth enter a secured room deep inside the plant itself when the bladed assassin attacks again. Vash steps between the attacker and Elizabeth, protecting her. When she does not run, Vash does his best to keep her from the flashing blades before pushing her out the door. Finally Vash pulls his gun and disables the man, pinning him to the floor with the man's own blades.



Vash hopes to stay in Elizabeth's room, but she has arranged for him to sleep down the hall. Upon entering his room, he senses an impending intrusion. An assassin crashes through the window and attacks with blades attached to his arms and legs. Vash manages to evade the attacker until he can draw his gun to fire, at which time the intruder leaves, dropping a bomb on the way out. The bomb explodes, blowing out the entire corner of the building and throwing him and his bed into the street.

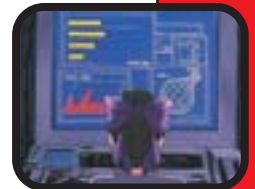

Upon disabling the assassin, Vash tries to identify him. Elizabeth leaves and locks the door, refusing to open it. She tells him she wants him dead. Vash is quiet while she continues explaining. Elizabeth says she used to live in the city of July, before he destroyed it. She was three at the time, and her parents died in the ensuing chaos. She wants to avenge the death of her parents, and the suffering she endured, by killing him. She walks away, waiting for the plant to self-destruct and take him with it.



Back in the main control room, Elizabeth evacuates the facility. She tells Meryl and Milly that Vash decided to stay behind. Meryl starts to go after him, but Elizabeth points out that if she stays, she will die too.



Back in the room, the ceiling opens. The assassin rants about how Elizabeth left him there to die, but Vash ignores him. Vash stands at the podium in the centre of the room and looks to the ceiling with his arms open wide. A multi-coloured shifting light descends.



The people of Inepiril City are outside the plant while the energy field around it glows and shimmers. Suddenly the plant normalizes, and the

door opens to reveal Vash standing there. Everyone cheers except Meryl and Elizabeth, who both seem uncomfortable. Meryl turns towards Vash and finds Elizabeth walking towards him. Meryl turns and leaves with Milly, not waiting to talk with Vash.

Elizabeth is astonished and upset that he survived. Vash apologizes for not dying, but explains that he could not allow the city to be destroyed because of him. Elizabeth is upset and reminds him what he did to her home, calling him a hypocrite. Vash then reveals that he remembers nothing of the events in July.



Elizabeth breaks down and cries while Vash stands quietly in front of her. As he comforts her, she remembers a man who sheltered her from the wind as a small child in her ruined hometown. She looks at Vash, and realizes that not only is he that man, but that he has not aged at all. She collapses on the ground crying while he holds her, her rage spent at last.

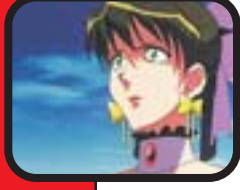
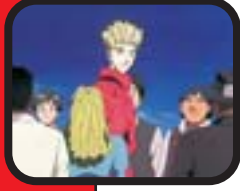
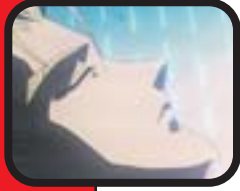

TRIGUN

The \$60,000,000,000 Man

EPISODE SUMMARY EPISODE: 07



Episode Seven: B.D.N.

Nighttime in Inepiril City, and the town is throwing a party in Vash's honour at a bar. Meryl and Milly are in attendance, though Milly has passed out. Meryl watches Vash enjoying himself and tries reconciling the man she thought she knew with the person she has seen over the last few days.



After the party, two disappointed prostitutes leave Vash's hotel room, telling the men who hired them that he is unconscious. Vash waits until they are gone, then flips over in bed, fully awake. He looks at the ceiling, and asks himself if he regrets his decision.

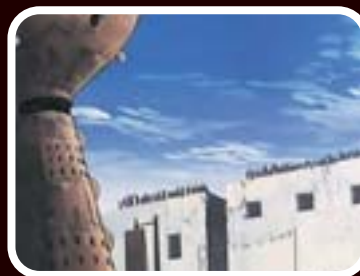
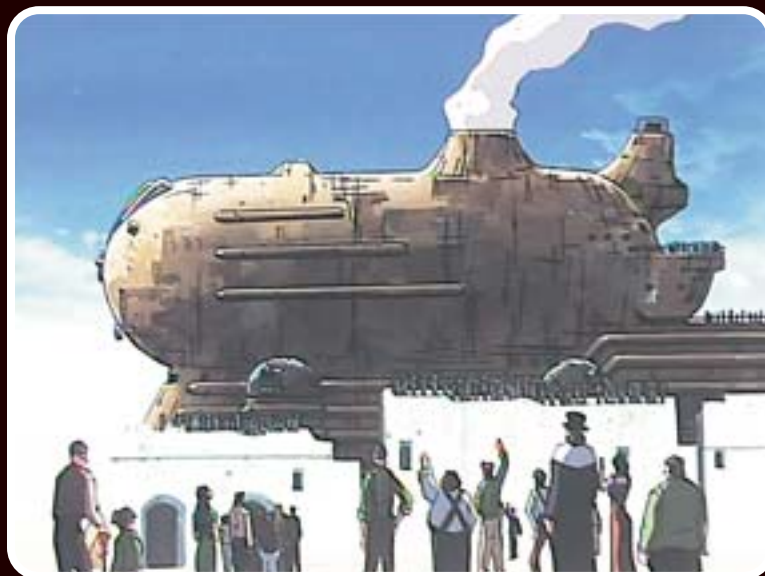

The next day, the sand steamer *Flourish* blows its horns, signalling its departure. News spreads through town that Vash has left on the steamer without telling anyone, leaving the local folk saddened and dismayed. Meryl and Milly frantically pack to try and catch up with him, while Meryl puzzles through boarding the ship when they do not have

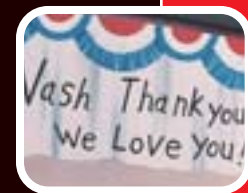

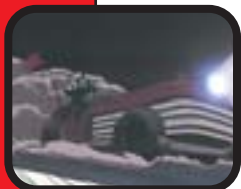

enough money to buy tickets. As the steamer leaves, Vash is standing on deck, smiling. Pleased to be on his own again, he waves to the crowd of the town's children who gathered to wish him farewell.

Once the *Flourish* is underway, a crewman approaches Vash. The man wants to hire him as extra security for the ship. Vash refuses, not wanting to involve himself, and goes to the restroom.



While Vash washes his hands, a boy falls out of the air vent above him and hits him in the face. When the boy tries escaping, Vash grabs him and demands an apology. Struggling, the boy admits he is a stowaway, and relates a false tale about an abusive family. The boy, Kaito, is concerned that Vash will not believe him, but Vash, moved by the boy's woeful story, offers his protection tearfully.



A little while later, Vash goes to a kiosk to buy food for the boy. Much to his surprise, Meryl and Milly are working behind the counter. Milly remarks on the amount of food Vash is buying, to which he smiles nervously. When Vash returns to his new room, Kaito is sitting on the bed. Vash offers Kaito food and the boy jumps at it, tearing the packages open and eating ravenously. A short time later, Kaito slips a drug into Vash's drink without his knowledge. When Vash falls unconscious, Kaito slips out and signals the Bad Lads Gang.

Outside, the Bad Lads Gang waits on a hill a short distance away. They charge at the steamer in their own vehicles and attack upon seeing Kaito's signal. Inside the ship, Kaito's gas bomb

knocks out the gunners. The shots from the gang awaken Meryl and Milly, who are in the storeroom that doubles as their quarters. They hear shouts that the *Flourish* is under attack and become concerned.



At the hatch, the fighting finally finishes. Through a haze of smoke, the leader of the Bad Lads Gang appears. His name is Brilliant Dynamites Neon (B.D.N.). Kaito is there to meet him. Neon praises the boy and directs him to gather the passengers.

During the attack, Vash is lying on his bed, dreaming of a woman named Rem. Rem sings her favourite song and explains to Vash that the future is always blank, an endless realm of possibilities. The dream fades; Vash calls to her and falls between the bed and the wall, waking him up. While orienting himself, a thug bursts into the room, looks around and leaves. Vash sets out to discover what is going on.

B.D.N. is in the ship's main hall where the passengers are gathered. He is disappointed with the loot accumulated thus far until one of his men discovers



B.D.N. and the thugs at bay until Neon shoots him, knocking him out of the window with Kaite in tow. Neon is amused at the challenge and sends his men after them. At the same time, two thugs try breaking into the storeroom where Meryl and Milly are hiding. They force the door open and enter. The thugs see only an empty room. They turn to leave and the girls attack from behind.

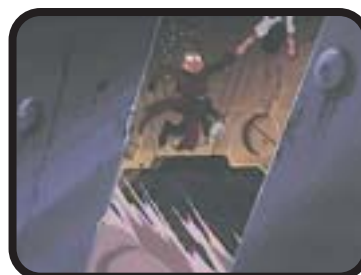

Back on the bridge, Neon is tired of the captain's refusal to co-operate. He has a hostage chosen from among the passengers and holds her at gunpoint in front of the captain. The captain relents and pilots the ship, speeding the steamer up even more. Vash and Kaite are hanging on to the outside of the ship, trying to find a way back in.

the giant safe. After determining that it cannot be opened, Neon decides to break the steamer open by crashing it off the Endoro Precipice.

Meryl and Milly are still in the storeroom. They want to help, but cannot think of what to do. Meryl admits that Vash is the only person who could stop Neon, as much as it galls her to admit it. They comfort each other and try to think up a plan. Meanwhile, Vash is crawling through air ducts while trying to maintain his bearing.

not left yet. When Neon gives his reasons and states his plan to crash the *Flourish*, Kaite tries to dissuade him. His objections annoy Neon, who knocks him across the room repeatedly. When Kaite finally starts yelling at Neon, saying that the ship belongs to his father, Neon puts a gun in Kaite's mouth to silence him.

Just as Neon is about to shoot, Vash shoots out the window from the outside and rescues Kaite. Vash manages to hold



Under Neon's orders, the steamer picks up speed. A crewman tries to slow it, but B.D.N. kicks him away. When the man tries to stand up to him, Neon kills the crewman while the captain looks on helplessly. A moment later, Kaite arrives on the bridge. Neon asks Kaite how to run the steamer, but the boy does not know. Instead, he tells him what he does know about keeping the steamer running in good repair, the sum of which makes Neon regret killing the only experienced pilot aboard.

Kaite, unaware of Neon's plan to wreck the steamer, asks why the gang has

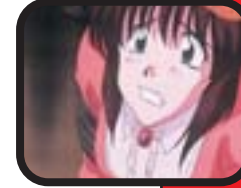
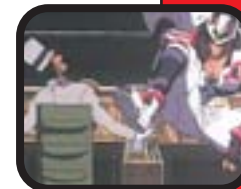

TRIGUN

The \$60,000,000,000 Man

EPISODE SUMMARY EPISODE: 08



Episode Eight: And Between The Wasteland and Sky ...

The sand steamer *Flourish* is speeding toward the precipice, much to the horror of the captain. Vash and Kaite are back inside the ship, hiding inside a ventilation shaft. They overhear the thugs passing around Vash's description. Kaite tells Vash about Neon's plans, and Vash tries to think of a solution. Kaite begins thinking about his father, but Vash interrupts his reverie and forces him to concentrate on the situation. Kaite produces a copy of the blueprint of the steamship.



Three of the Bad Lads thugs are searching the staterooms when Vash ambushes them and knocks them all out. He locks them away in a room before moving on with Kaite. Kaite uses his ship blueprint to find the communications room, where they overhear Neon giving orders to his men through voice tubes.

To confuse the Bad Lads gang, Vash pretends to be one of the thugs and sends Neon word that he has Vash trapped. When Neon gives orders to hold him there, Vash acts out a death scene that Neon hears. B.D.N. gives orders that Kaite can track. Vash gives Kaite a pen-shaped communicator that allows him to talk with Vash across distances. Kaite is amazed at the lost technology, but Vash will not tell him how he came by it.



Once Vash steps out of the room, two thugs coming down the hall ambush him. Kaite runs out to see what happened. He sees Vash kneeling over

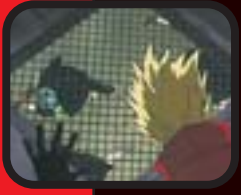
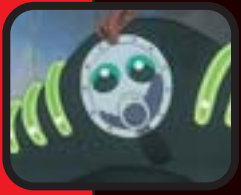

The steamer hits rocks just then, throwing everyone but B.D.N. and Vash to the floor. The two men stand facing each other, guns drawn; Neon challenges Vash to a duel. Vash agrees, on the condition that Neon must stop the steamer if he loses.



Vash and Neon move outside to the deck while the others watch from doorways and windows. Neon starts the duel by throwing a coin into the air. While the coin arcs up, the steamer bounces off the cliff face, showering the deck with rocks and boulders. The coin finally hits the deck and the duel begins.



Neon shoots first, but misses. Vash appears from behind a group of falling rocks and fires, hitting Neon. They both fall. Neon gets up first with his gun drawn while Vash lays on the deck.

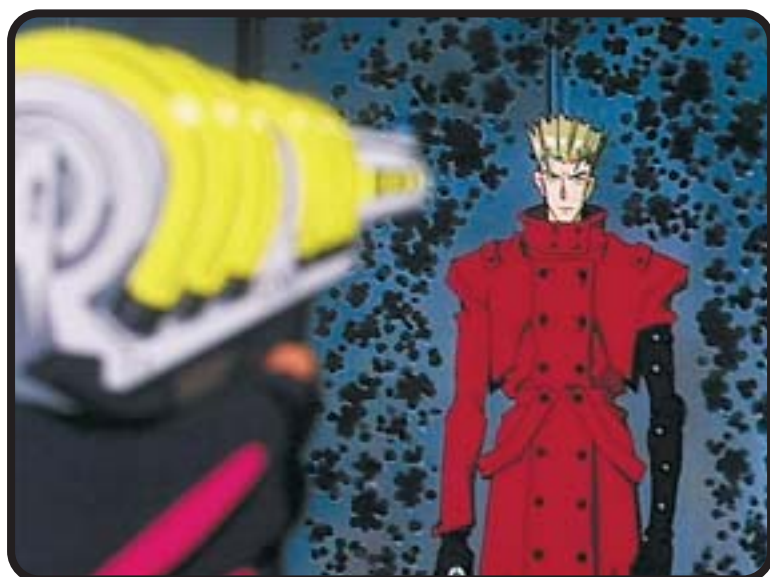
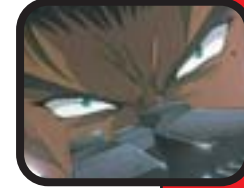
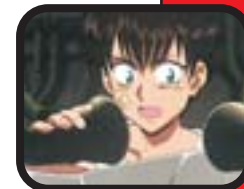
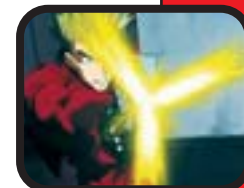

two gang members. Kaite realizes that Vash has been deliberately trying not to hurt or kill, and yells at Vash for taking chances. Vash ignores him; Kaite notices that Vash is bleeding as well. Vash quietly admits that Kaite is right, but he made a promise he must keep.

Soon, Vash works his way through the ship, taking out gang members. Neon listens to the reports and tries figuring out Vash's location, while Kaite tracks the movements of the gang and reports them to Vash over the transmitter. All the while, Kaite remembers how his parents died and how he joined forces with B.D.N. He yelled at Vash about this in the hallway earlier, claiming that once you harm or take advantage of others, there is no going back. Vash in turn suggested that Kaite should start over.

Vash tries warning Kaite to run, but hears no response.



At B.D.N.'s orders, the thugs shoot around Vash. Neon pulls a gun on Vash when they finish and prepares to fire when one of his own thugs ambushes him. The thug in question turns out to be Meryl. A couple more thugs try to take her down, but Milly disables them with her stun gun. Meryl asks Vash to shoot Neon and end this.



Back in the present, the thugs report that Vash has incredible luck. Neon figures out what is happening and issues false orders through the communication tubes. Kaite continues reporting to Vash, leading him to what should be the only safe place in his area. Vash arrives there to discover a whole group of thugs with B.D.N. leading them.





B.D.N. fires at Vash, destroying a large rock that was about to hit Vash in the head. Neon calls Vash a fool for ripping his wounds open again and acknowledges that Vash won.

When the jubilant crew tries to stop the ship, they discover that the braking system has been damaged and that the engine is ready to explode. Meryl and Milly are sitting with Vash back inside the ship when they hear the news. Vash calls to Kaite, waiting for a response. Kaite sees a chance for a fresh start and says he will help.



Trying to make up for his mistakes, Kaite approaches the crew and shows them his blueprint, telling them the location of manual switch for the emergency braking system. The crew realizes he was the one who helped the Bad Lads Gang take the



ship. They refuse his help and leave. Vash calls to Kaite again, who says he will try to pay for what he has done.

The crew, meanwhile, has reached the boiler room. While the steamer rapidly approaches the precipice, they manage to open the door. They discover the switch is on the far side of the room in a maze of pipes and beams that no adult can reach.



While the crew tries hacking through the pipes, Kaite shows up. He



dives for the lever and suffers burns by contacting the surfaces around him. He manages to wrap his hands around the lever and, ignoring the pain, activates the steamer's brakes. Kaite's sacrifice is too late, however; there is not enough room to stop the steamer. At the last minute, Neon rams the steamer with his own vehicle, forcing it to a stop.

Later, a bandaged and shirtless Kaite wakes up in a hospital bed. Vash is sitting nearby, and explains how Neon saved them all to keep his word. The two leave the infirmary and climb out onto the hull, looking out over the canyon. Kaite starts singing Rem's favourite song, surprising Vash. Kaite explains that it is a good song. While Kaite sings, Vash cries. Kaite thinks Vash is teasing him and hits Vash; the two start bickering.

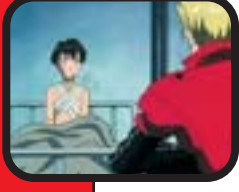
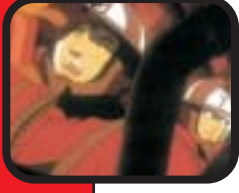
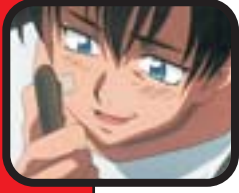
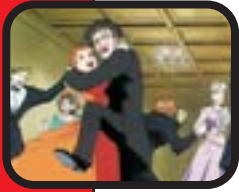





TRIGUN

The \$60,000,000,000 Man

EPISODE SUMMARY EPISODE: 09

upon moving closer to investigate, the man's head pops up with a grateful expression and he exclaims his gratitude.



Once everyone one is back onboard, Milly gives the man Vash's water canteen. The man guzzles it down and tells her he had been forced to walk after his bike broke down, carrying the cross with him. He thanks Milly first, then Vash, for saving his life, and introduces himself as Nicholas D. Wolfwood, a wandering priest.

A short while later, the bus stops for a break. The driver asks Wolfwood to pay the fare money, but he does not have enough. Wolfwood talks the driver into giving him a break, and then offers the man a free confession in his portable

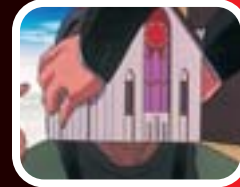
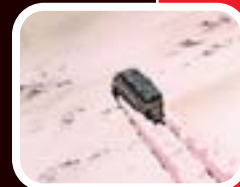

Episode Nine: Murder Machine

Vash is on a bus, riding across the desert. Milly and Meryl are there as well; Milly thanks Vash for buying their tickets. He remembers the scene she caused when boarding the bus. Milly cried and threatened to haunt him if he did not help them. Vash is looking around when he sees something out the window. He sits up and points at something glinting on the horizon.



The bus leaves the road and heads across the sandy dunes. It pulls up to the man who is sitting half-collapsed next to a large wrapped cross. The bus driver believes the man is already dead, but



confessional. The driver refuses and walks away. Wolfwood explains to Vash, who has been watching, that he travels to raise money for the orphanage his church supports.



Meanwhile, a passenger walks by with two children, who are begging her for food. Wolfwood walks over and offers to split his meagre rations with them. The family is grateful for his generosity. Vash smiles at Wolfwood, leaving Wolfwood to comment on how empty Vash's smiles usually seem. Vash is taken aback by this, until Wolfwood ruins the moment by recommending the portable confessional at a very reasonable price. Vash smirks at this, offering praise for Wolfwood's marketing skills.

Just then, an upset passenger runs up to the group. One of the passengers is



lying on the sand with a wounded shoulder, saying he was attacked. Milly jumps at Vash, stungun readied, demanding he should confess if he did it. Vash brushes away her accusation and says nothing mortal did this.



Immediately after, a giant four-legged robot pops out of the sand and heads toward the passengers. The crowd runs for the bus while Vash shoots at it, but the machine is unharmed. Milly fires

with her stungun, knocking it back over the hill. Others appear just behind it, however, and chase the bus and the people on it. The driver takes off for the road with the machines still following. Vash seems familiar with the machines and wonders why they are still operational after so long.



Luckily, the machines cannot keep up with the bus and are soon left behind. The mother of the two children stands and calls for her missing daughter. Vash and Wolfwood both immediately leap out of the bus to go after the girl. Once on the road, Wolfwood realizes too late that his cross is still on the bus. Vash tosses him a knife to work with since neither of them will turn back.

After a short venture, the two men see scores of machines ahead. Before Vash can explain how the machines work, Wolfwood jumps out from behind cover and attacks with his knife, failing completely. The robots shoot at Wolfwood, who dodges while Vash slides down the hill to the rescue, destroying most of the machines. Wolfwood takes out the last one of that cluster sneaking up on Vash with what remains of his





of roof gives way and falls on them. Meryl and Milly look in from the hole in the ceiling, asking if they are all right.



Back on the bus, Wolfwood thinks about what he saw Vash do, and admits to himself that he is impressed. He moves over to Milly and goes to sleep with his head on her shoulder, which surprises Milly. Meryl disapproves a little, but sits next to Vash and does not disturb them. At May City the next day, Wolfwood bids farewell to Vash, Meryl and Milly, saying he has to return to work. After he leaves, Vash decides he needs food. Milly agrees with the idea, for which he takes the opportunity to ask for his money back. The girls relent and admit they will pay him back.



knife, and the two men congratulate each other on working well together.

Vash finally sees the girl ahead and runs, taking out machines as he goes. Wolfwood is impressed, and acts as a sentry for Vash while they run. They see a robot carrying the girl away, and chase it, only to be sucked into a sand trap and forced underground. The girl is left on the surface where Milly and Meryl presumably rescue her.

They immediately fall into the tunnel under the sinkhole. Vash explains that they are in the remains of an ancient ship, the home of the machines. More monster robots appear and the men try to escape. When they reach an area of relative safety, they share the last of Wolfwood's food before resting.

Upon recovering, Vash and Wolfwood work their way through the complex, knocking out robots while running. The centre of the ship is a plant, which is still producing machines and shows no signs of stopping. Vash hands his gun to Wolfwood and jumps down among them, leaving Wolfwood to cover him. The robots close in on Vash as

soon as he lands, but Wolfwood shoots them all down while they both run. Wolfwood runs out of bullets while Vash and he face one machine apiece. Wolfwood closes his eyes and cringes. When he opens them, however, both machines are completely destroyed and Vash is standing in front of his unharmed. His left, exposed arm is also smoking.

Vash then goes into the control room and works at the computer console, shutting down the plant. When he comes out, Wolfwood is there, wondering what happened. Vash indicates that God must have saved them, but before Wolfwood can comment, the ship begins shaking. Expecting more machines, Vash and Wolfwood pause briefly before a section

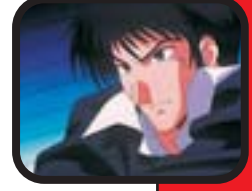

TRIGUN

The \$60,000,000,000 Man

EPISODE SUMMARY EPISODE: 10



Episode Ten: Quick Draw

It is morning in May City. Vash wakes up in a hotel room, dressed in pyjamas. He meditates on life and love for a few moments, then practices his reflexes by catching an egg on the barrel of his gun. After breakfast, he dresses himself and goes outside to play with the local kids. A boy named Neil walks by, and they ask him to join. Neil ignores them,

however, and walks away. Milly and Meryl come along and ask Vash how long he is going to stay here playing with children, but he ignores them and concentrates on Neil.



Down the street, Neil comes out of a store carrying a bag; Vash calls to him. Vash walks with Neil to his mother's restaurant, ostensibly in search of food. Once inside, Vash sees Wolfwood at the stove, cooking. Vash is surprised, but Wolfwood explains that the family needed help.

The next day, gunmen arrive for the contest on buses. Meryl and Milly watch the new arrivals and wait for Vash. Vash and Wolfwood finally show up, with Vash leaning on Wolfwood for support. Vash is deeply hung-over, while Wolfwood is fine.



The competition begins, and the other gunmen take the field. The first challenge is to shoot whisky bottles off a low wall. The other gunmen miss most or all of the bottles. At Vash's turn, he wobbles up to the mark and almost throws up. He still manages to hit all five easily. Everyone is amazed, but Vash is disappointed. He had intended to miss at least one. Wolfwood offers encouragement while Vash returns to the sidelines, only to discover that Vash entered him in the contest behind his back.



Wolfwood takes a break and explains that a group of men were trying to extort money from Neil's mom, Claire, after her husband vanished while in debt. Wolfwood made them leave, and has been helping Claire run the place since. He shows Vash a flyer for a quick-draw tournament with a first prize of \$\$50,000, and coerces Vash to enter to help Neil and his mother. Later, when Vash tells Milly and Meryl about the tournament, Meryl is convinced that it will end badly once people discover his identity. He insists it will all work out well, but Meryl is not convinced.

Later that evening at the office of the man organizing the event, a henchman brings in Vash's entry form. The henchman asks if he should dispose of the form, but the official does not believe the real Vash the Stampede would bother entering for such a trivial prize. He allows the entry to stand.



Wolfwood shows up at Vash's room that evening with a bottle of whisky. He blithely apologizes to Vash for putting him in the tournament, and both men drink together. While talking, Wolfwood calls out and invites the girls into the



room. The girls were standing outside the door eavesdropping. They come in and wish Vash luck in the contest. Wolfwood offers them drinks, which Milly enthusiastically accepts. It is not long before the alcohol goes to her head, however, and she does something over which Meryl expresses horror and the men greet enthusiastically (the camera never shows what happens but Milly is probably taking her clothes off).

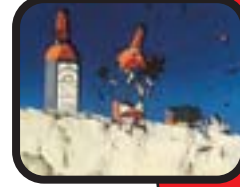
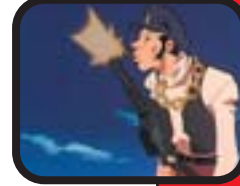
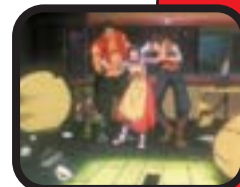

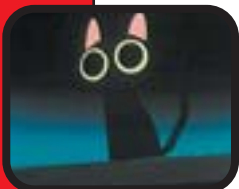
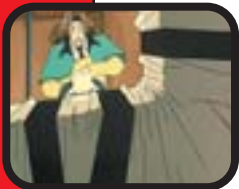
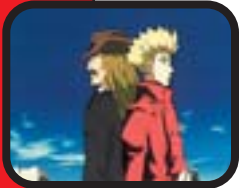

Wolfwood is angry at first, but sees Neil cheering and cannot bring himself to quit. He goes out and shoots all the bottles as well. When he returns to his seat, Milly is cheering enthusiastically. Another gunfighter comes up and sneers at them, explaining that they are up against the other gunfighters from this point out. Vash becomes upset about this, but to no avail.



While Vash waits his turn, he tosses rocks at the duelling pairs of gunmen, throwing the bullets off course and preventing any fatalities. When his turn comes, he beats and injures his opponent who tries cheating. Vash and Wolfwood continue defeating all their opponents without killing anyone until they are the only ones left. Wolfwood tries withdrawing from the tournament at that point, but the official refuses. When



Wolfwood asks why, the official points to a window where Neil and his mother are being held at gunpoint. Wolfwood must kill Vash to save the family.

In the final round, Vash and Wolfwood face off while the girls look on, horrified. Vash asks why he did not withdraw, and Wolfwood points out the window where Neil and Claire stand. The duel begins, and Vash runs and dodges while Wolfwood fires. The two shout at one another while exchanging shots and insults from behind cover. Finally they both run out and shoot at each other. They smirk, then fall; blood spreads on the ground.

Milly and Meryl are stunned, but the official is happy. He orders his thugs to finish the two men. When the goons approach, however, Vash and Wolfwood

get up and attack. Both hold a bottle of tomato sauce to fake their wounds. The official panics and orders his remaining men to kill Vash and Wolfwood; men with guns pop up on top of rooftops all along the street. Milly launches Wolfwood's cross to him, allowing him to pull out guns from it. Vash asks him not to kill people, so Wolfwood shoots to wound and takes out all the official's thugs.



Later, dozens of men lie on stretchers. Vash is vaguely horrified at the carnage, but no one was killed. Wolfwood goes to collect the money from the official, who now has no choice but to pay them. While Wolfwood collects the money, an unknown figure on a rooftop walks away.

A few days later, Wolfwood is outside wrestling with children while Meryl and Milly watch. Vash is in the restaurant, cooking for Claire. Neil suddenly runs in, stuttering "dad" with shock. A man, Claire's husband, stands in the doorway; Vash walks outside. Wolfwood and he note that they seem to be out of work again, then the gang of kids jump them and start a new wrestling match.



WANTED DEAD OR ALIVE



The Nebraska Family

TRIGUN

CYBERNETICS

In the world of Vash the Stampede, cybernetic body modification and limb replacement is available, if rare. Most inhabitants of the planet lost access to such advanced technology, though there are a few strongholds left capable of making and implementing such devices. Unlike cybernetics available in the cyberpunk genre, the cybernetics available in *Trigun* owe more to robotics than to medicine.

Available cybernetic options are typically mechanical in appearance. While most implants look completely robotic, they possess enough articulation to mimic their natural counterparts (for example, artificial limbs). Weaponry is a common addition to cybernetic components, such as guns in cyber limbs or heavy ordinance for specially fitted cybernetics. Limb replacement is one of the more common types of modification. Structural reinforcement is also common, as is strength augmentation. Advanced or delicate cybertechnology is rare and nearly impossible to obtain, such as optic replacement or enhancement, organ replacement, and nervous system improvement. Medical need alone is not enough to warrant cybernetic treatment. By appearances, people see technology as a tool, not a form of medical treatment.

Obtaining cybernetic technology can be difficult. Large corporations or organizations, such as the Marius-Breskem-Kantacle Technical Industrial Union could conceivably arrange for cybernetic enhancement of special agents to help them accomplish their duties better. They might also arrange replacement limbs for employees injured in the line of duty. Without that patronage, a character will find cybernetic technology difficult, if not impossible, to obtain. For the average individual, cyber enhancements are not an option.



TRIGUN

The \$60,000,000,000 Man

EPISODE SUMMARY EPISODE: 11

the men run up to them. When they ask where the girl went, Wolfwood tries to talk to them, but the men refuse to answer. When a henchman accidentally tramples one of Milly's pudding cups, she shoots them with her stungun. After the fight is over, the girl tries to leave again. It is clear from the shouts echoing through the streets, however, that they are still looking for her.



A few moments later, Milly and Wolfwood are walking down the street with the girl hidden under Milly's coat. The end effect is that Milly looks eight months pregnant, with Wolfwood at her side. They pretend to be a couple while walking past the searchers. Meanwhile, Meryl and Vash are waiting back at a



Episode Eleven: Escape From Pain

A caravan is stuck in a town called Demislad. There is a bar set up in a tent, with a girl dancing on the stage. Wolfwood is there, playing chess against one of the caravan members for passage. Nearby, Milly is asking the bartender for pudding without success. Wolfwood calls to her, and she comes over, explaining that she is here with Vash. Before Wolfwood can actually move his next piece, Milly moves for him. Wolfwood is frantic until the man suddenly gives up, his king in checkmate.

Later, Wolfwood and Milly are walking home. The dancing girl runs down the street and collides with Milly. The girl is frightened, and begs them to hide her from the people chasing her. Milly has the girl stand behind her before



shelter for Milly to return with groceries. A group of men run into the tent and ask for Vash, saying that someone wants to speak with him.



Milly and Wolfwood reach the edge of town with the girl. When Wolfwood tries finding out what is happening, a figure appears over the rise, shooting at Milly and Wolfwood and telling them to step back from the girl. The girl intercedes, however, and runs over to hug the stranger. She introduces him as Julius and herself as Moore, and explains that Milly and Wolfwood helped her escape.



Moore explains that Julius is the son (possibly adopted but definitely not legitimate) of the owner of the transport company that passes through Demislad, and that they are in love. When Wolfwood asks why the men were after



her, she says it has to do with the city of Fondrique.

Back in town, Vash meets with the caravan owner while Meryl waits outside. The owner explains that he has exclusive contracts to supply Fondrique with its transportation needs, but that Fondrique's production plant security is so tight that even he cannot enter without a pass. When Vash asks what the owner wants, the man says he wants Vash to find his son. In the desert, Julius and Moore explain that Julius is the pass the caravan is looking for. He shows his arm, which is tattooed, possibly because his real father is the mayor of Fondrique. Julius discovered that his father has been running a slavery operation and that Moore was to be sold next ... so they ran away.

The caravan owner begs Vash to take the job. He says he must have Julius back, or the caravan will go under. Vash demands \$\$20,000,000. The owner is shocked, but agrees. He amends the agreement, however, to include one more condition.



The pair thank Milly and Wolfwood for their help. They set out to cross the desert on foot, through the Demislad geyser field. Milly objects, but Julius intends to use the field to lose their pursuers. Wolfwood tries to point out the ramifications of the pair's actions, how the caravan will dissolve and people will die if he runs. Julius is too angry to listen, however, and ignores Wolfwood.

Wolfwood goes over to his cross and pulls out a gun, pointing it at Julius. He wants to see how determined they are, and what value they place on their freedom. He then points the gun at himself, threatening to shoot himself if they leave. Julius straightens himself and walks forward anyway; when they pass Wolfwood he pulls the trigger, which clicks but does not fire. Julius and Moore thank Wolfwood, then walk on. Milly starts to follow the pair when

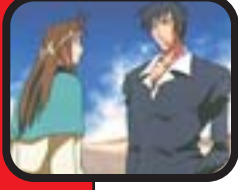
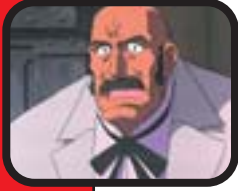
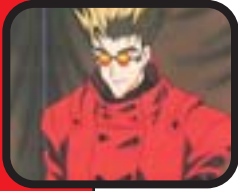
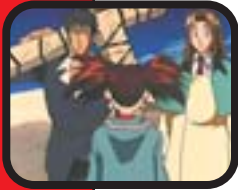



Julius and Moore standing next to a jeep parked at the bottom. Meryl passes on an apology to Julius from his father, and the young couple leaves on foot. Milly, who cries the whole time, waves at them while the couple walks away.



Later, as the caravan moves on, Milly and Meryl discuss Wolfwood's departure. Vash remembers their last talk before parting, and repeats Wolfwood's name. Meanwhile, across the desert Wolfwood drives away on his bike.

Wolfwood stops her. Milly insists she has to go because they need help, and leaves him there.

Milly catches up with Julius and Moore. She introduces herself to the two refugees and insists on accompanying them. Meanwhile, Vash and Meryl enter a car and head out of town. She tries to find out what happened, but he will not speak. Finally, he tells her that the owner wanted him to kill. Meryl is appalled, and pulls a gun on Vash to make him stop. After a moment, however, she relents and puts down the gun, asking him to explain what is happening.

Before they can escape, a line of caravan men appears on the horizon. Vash walks up from among them and shoots both Julius and Moore. Milly screams, and the caravan men complain. Vash says it was what he was hired to do, and the men leave. Milly runs up to Vash and hits him before collapsing on Meryl's shoulder. Wolfwood grabs Vash's gun and opens it, seeing that the bullets were rubber and non-lethal. When Milly runs over the hill, she sees



Julius, Moore and Milly walk through the geyser field, with Milly trying to protect them from the eruptions. Julius understands what it means to have others suffer on your behalf, and questions his actions. Before he can change his mind, however, the caravan men arrive. The men chase the trio across the sand, knocking down the women and grabbing Julius. They threaten to shoot the women to stop Julius from struggling, and finally he gives himself up. Wolfwood appears, however, and rescues Julius and the girls.

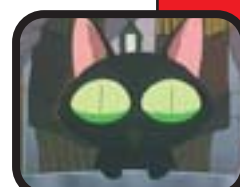
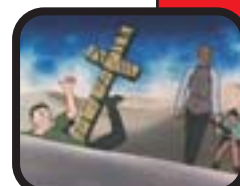
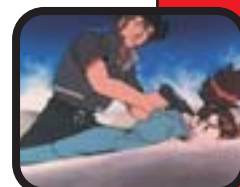
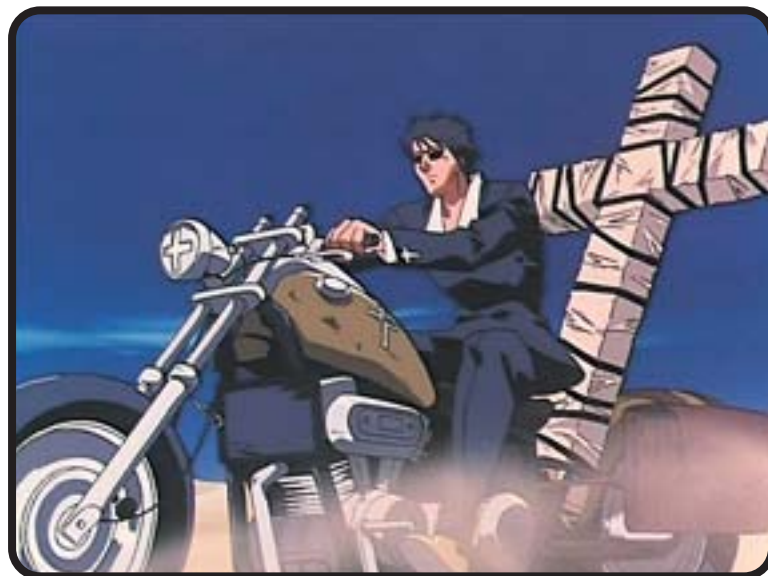

TRIGUN

The \$60,000,000,000 Man

EPISODE SUMMARY EPISODE: 12



Episode Twelve: Diablo

It is late at night, and a man in a dark cellar exercises amid a litter of explosives, blades and bullets. A flash of lightning reveals another man in a white coat standing in front of the window. The man in the white coat gives the first man instructions, telling him that it is time for him to hunt. Thunder drowns out the name of the person to die, but the first man laughs when he hears it.

Meanwhile, in an unnamed city, Vash is in a shoe store talking to the owner. He asks the man to uncover some information for him. Later that day, people have gathered in the centre of town to enjoy the beautiful weather. Vash sits on a bench on the other side of a large monument, contemplating the sky's colour and thinking of Rem. He snaps out of his reverie when a ball hits him in the face. He shakes off the blow and stands up to join in the play.

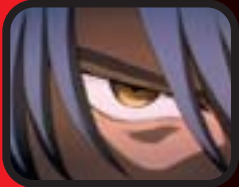
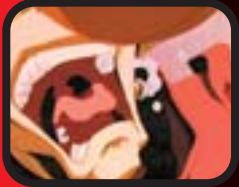

Vash treats the children to ice cream. Meryl offers a cone to a young, destitute-looking girl, who almost accepts but runs away instead. Vash and the others, including Meryl and Milly, all play ball together. As Vash plays, the man in the white coat from the first scene walks past, and Vash receives disturbing mental visions. The man sits at the bench on the other side of the monument and eats a snack. He has a



telepathic conversation with Vash and introduces himself as Legato Bluesummers.

Milly comes over to check on Vash and is startled by the look on his face. He gives her the ball he was holding, smiles at her, and sends her back in the game before donning his sunglasses. Mentally, he continues his conversation with Legato. Legato tells him that his life ends today and offers the young, destitute-looking girl a hotdog from his bag. Suddenly, he sends Vash a false image of him about to hurt the girl, eliciting a reaction from Vash. Legato threatens him with the lives of everyone present. He offers Vash the chance to fight him, but Vash does not react. At last Legato mentions a surprise hidden in his bag on the bench. A screaming woman runs into the town square, however, saying that her husband was murdered, distracting Vash. By the time he looks back, Legato is gone.



Although the episode never reveals the contents of the bag, it is possible it contained the tongue of the woman's dead husband, the shoemaker. The woman claimed her husband could not speak.

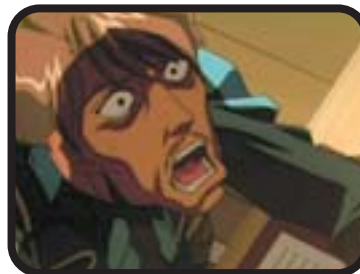

he were expecting it, and asks to be alone for a while.

While the girls are talking to Vash, a man walks into the sheriff's office. Vash is suddenly tense, saying someone is coming. The man points huge guns at the sheriff and fires. Vash shouts at the girls to get down; bullets tear through the walls. The office is destroyed while the guns keep firing. When they finally stop, the man throws off his hat and cloak, and says that his name is Monev the Gale. He towers above the quaking sheriff who survived the onslaught. Vash tries to tell the girls to run, but he is not fast enough. Monev punches through the wall next to Vash, picking him up and pinning him against the other end of his cell.

Trying to help, Meryl pulls a gun on Monev. Vash yells at her to stop, but



Later that evening, Meryl and Milly are in the sheriff's office arguing with him over Vash's arrest. He refuses to release Vash since he is the only suspect they

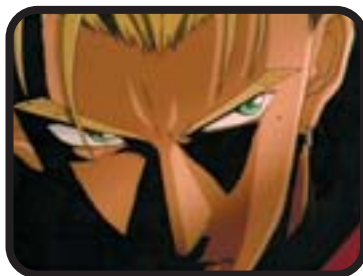

have in the shoemaker's murder. In his cell, Vash sits in chains thinking about Legato when Meryl and Milly come in. Milly sees his face (an eye glowing fiercely in the dark) and jumps back, frightened. Meryl, who did not notice, runs over to tell Vash the bad news. He acts as though

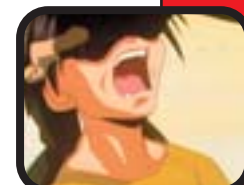
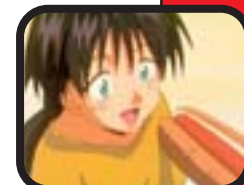

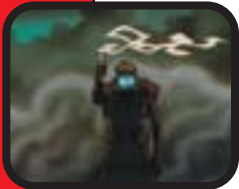
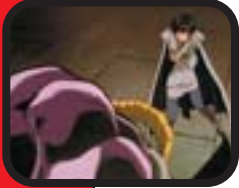

Money backhands her and knocks her across the room. Milly steps up right afterward, however, and shoots Money with her stungun. He blocks the attack, but it breaks Vash's chains, causing Money to lose his grip. Vash jumps over Money and runs for the door, grabbing his gun on the way out.



Money follows after him, leaving the girls behind. He slowly pursues Vash through the city while Milly helps Meryl to her feet. While word spreads through the town of the attack on the sheriff's office, Vash runs through the streets trying to escape the city. He tries to warn bystanders to move out of the way, shooting warning shots at them when they do not move fast enough. This angers Money, who feels Vash is mocking him.



Finally, Money shouts at Vash, telling him he needs to use civilians as a shield if he wants to live. Money switches to his explosive shells and shoots up the streets, reducing walls to rubble and killing all the civilians in the area. After the attack, Vash stands up from where the blast knocked him to the ground. He is shocked and horrified by the carnage around him. Money thinks Vash is defeated, but then three bullets hit him on the faceplate. Vash walks toward him with his eyes glowing like a demon's. Money runs away. Milly and Meryl catch up to Vash, but he yells at them to stay away. The girls are deeply concerned, but they cannot think of a way to help him.

Money retreats to a nearby rooftop to regroup. He was led to believe Vash

was harmless, and is shaken by what he saw. He is disheartened, but knows he must continue.



Vash walks into a bank and demands to use the safe. Money watches Vash, and assumes Vash intends to hide inside the bank. He goes into the bank but is hit by the explosion that Vash rigged. Vash uses the distraction to his advantage and fires at Money's gun, disassembling it.

Money shoots what is left of his gun at Vash, releasing a missile. Vash's left glove shreds to reveal his cyberarm and hidden gun. Vash's shot detonates the warhead, which explodes almost on top of Money, shredding his armour and knocking him down. Money begins to pick himself up, but Vash is on top of him before he can do anything, yelling about the people Money murdered. Vash is on the brink of killing Money when the assassin begs for his life. Suddenly, Vash remembers Rem. Her memory brings to mind the promise he made her, which prevents him from killing Money. He stands above the grovelling man, cradling his arm and trying to convince himself that shooting Money would be wrong.







THAT DARN CAT

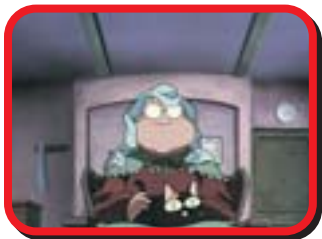
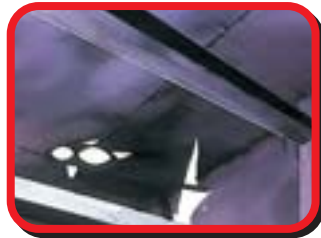
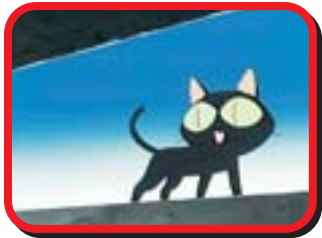

One of the first questions *Trigun* viewers often ask is: “Who is that darn cat, and why is it there?” The cat’s name is Kuroneko-sama, or “Lord/Lady Black Cat.” It appears both during the end credits and at least once in each episode. It is a black cat with large green eyes, though it sometimes appears with tan markings as well.

In anime, one standard convention is for a cute pet belonging to a main character to function as comic relief or to play the role of a “mystic guide.” Kuroneko-sama is a variation on this theme, a cat with no set role in the series. Instead, Kuroneko appears wherever a cat might and many places one should not. None of the main characters seemingly notice Kuroneko, except for the briefest moment, even when they pull it out of their luggage or see it in their room.



While there are no set rules to Kuroneko-sama’s appearances, they are often timed to relieve tension in a scene or to point out already present humour. One example is when townsfolk are chasing Vash through Inepiril City, and Kuroneko pops up in the lap of an old woman whose house Vash runs through. In another example, Kuroneko yowls from the rooftop on the night when Milly drinks too much.

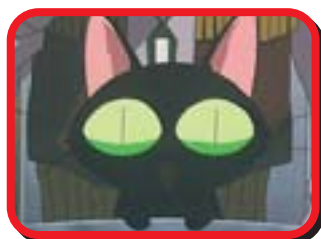
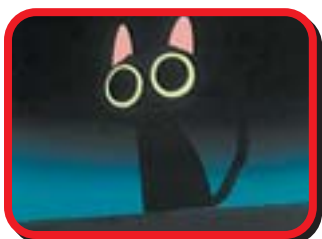

TRIGUN

The \$60,000,000,000 Man

EPISODE SUMMARY EPISODE: 13

Two days later, Meryl writes her report. She comments she does not understand why trouble follows Vash when he goes through so much trouble avoiding it. She recalls when Milly and she received the assignment to find Vash, followed by her first conversations with Vash when she still did not know who he was. While remembering, she writes her report noting that his inept behaviour had fooled her utterly at first; she ignores Milly's comments about the content of her report thus far.

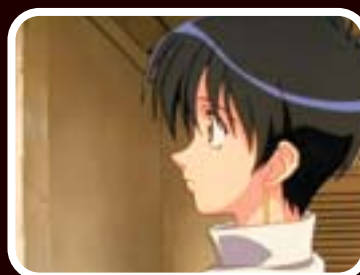
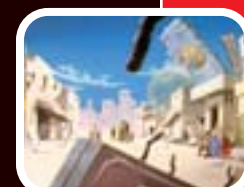
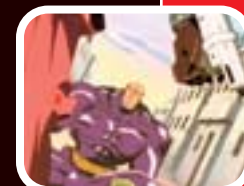
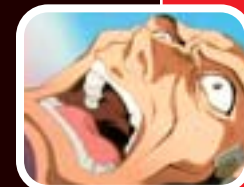

For a moment, Meryl ponders Vash's behaviour at the beginning of their acquaintance, the silly flirtations and awkward situations he seemed to land in continuously. Milly remembers



Episode Thirteen: Vash the Stampede

In the middle of the street, Vash stands over Money the Gale, who is lying in the street. Vash tries to get information from him, but Money does not know who hired him. Vash nods, turns his back on the man and walks away, to Money's astonishment. Money tries to point out how dangerous he is to Vash, but Vash simply indicates that he never let go of the trigger and keeps walking. After being so soundly defeated by the man he had trained to kill his whole life, Money falls apart and weeps openly. Vash walks away without looking back.

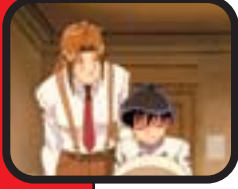
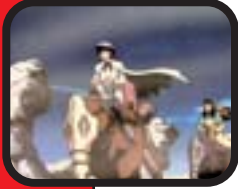
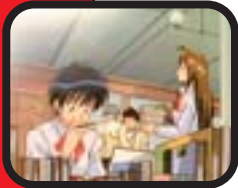

them as well, though perhaps more fondly. Meryl is frustrated at herself for not recognizing Vash despite his absurd actions, and Milly's reminders to this effect do nothing to ease Meryl's irritable mood.



Setting herself to her work again, Meryl continues writing the report, making it appear as though she knew it was him all along. She recounts the ways he resolved dangerous situations swiftly and safely. While dwelling on his methods, however, her frustration grows. Finally, she pulls the report from her typewriter, wads it up, and throws it away.

Taking a coffee break to calm her thoughts, she sips from her cup in silence. Mentally, she reviews the situations she witnessed, realizing for the first time that he solved most of these



incidents without using his gun, and that his refusal to harm others is so deeply ingrained that he would deliberately suffer injuries if it saved someone else. The question of why he acts as he does still puzzles her, though.



Returning to her report again, Meryl writes that part of Vash's reasons undoubtedly lay in his past, and his quest to find a mysterious man. When she stops to think who "he" might be, she

remembers Vash in the jail cell with his eyes glowing blue. The thought galvanizes her into action, and she writes her report with a vengeance.

Trying to portray Vash the Stampede to her superiors, Meryl describes the fight in which he saved the women of Inepiril City and defeated the Nebraska Family. She writes about discovering his real identity, seeing through the facade for the first time when she realized the annoying man she knew and Vash the Stampede were really one and the same; a legendary gunman who believes in Love and Peace.



Night falls and Milly is asleep at the table, on top of her pile of papers. Meryl is still working, standing by the window while drinking another cup of coffee. Trying to understand Vash well enough to convey his special qualities to someone who has never met him, she feels once again that there is something hidden inside him that he will not reveal. At the same time, she realizes the lives he touches are mostly better for the encounter, usually in the way those people had hoped.



suffered these from trying to deal with his opponents without killing them. Vash admits that he does not want girls to see his scars because he thinks it would scare them away, but Meryl disagrees. She tries talking Vash into giving up his convictions, but he refuses to do so until he has buried his past.



The next day, Vash is leaving town under the watchful eyes of the sheriff. He tries to thank the man for not turning him in, but the sheriff wants nothing to do with him. Meryl and Milly follow, with Milly hinting that Meryl is attracted to Vash. On his way out, he sees a young woman, and tries to offer his services as a free bodyguard. She spurns him, but Meryl is exasperated and possibly pleased to see Vash return to some of his old behaviours again.



The real issue Meryl faces, however, is determining if the dark changes she saw in Vash are indicative of the real man, hidden behind the bravado and flowing red duster. Before she realizes it, it is morning again and she is still standing there by the window, contemplating the bottom of her coffee cup. She recalls the gentle clown she knew versus the angry vigilante fighting Monev. Unable to decide which is the real Vash, she finds herself at a loss.



deciding what to do about this, a loud noise and shouts of pain awaken Milly. The two women hurry to check on Vash, only to discover him half-naked in his room looking sheepish for hurting himself accidentally.



When the girls see Vash, the number and severity of the scars and wounds that cover his torso shock them. Vash is embarrassed, but invites them in. Meryl confirms her suspicions that Vash

While Meryl tries to determine which, if either, is the true Vash, she hears voices through the window. The innkeeper and another man are talking about Vash, about how they want him to leave. The innkeeper understands the townspeople's fears, but he does not wish to anger the #1 Most Wanted man on the desert planet. While Meryl tries

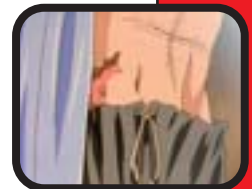
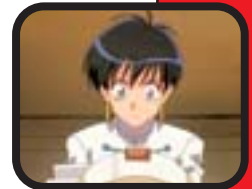
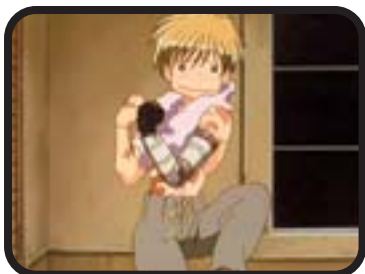



TRIGUN

The \$60,000,000,000 Man

EPISODE SUMMARY EPISODE: 14



Episode Fourteen: Little Arcadia

The episode opens in a town named Promontory. It is morning, and Milly has been up writing letters to everyone in her family all night. Meryl reveals that she never writes home, much to Milly's surprise. When asked why, Meryl seems uneasy, and says she is unsure what her family would think of her accompanying Vash the Stampede. The sound of gunfire interrupts the conversation.

Outside the duo's hotel, a dark-haired man with a rectangular face is sitting on a large armoured vehicle across



the street, holding a smoking gun. An elderly couple kneels in front of the building, both of them hiding behind Vash. The gunman, named Badwick, tries unsuccessfully to intimidate them. The woman yells that they will not surrender their land, while the man yells insults and tells Badwick to go back to his boss, Morgan.

Badwick loses his temper at the last insult and points his pistol at the group. Vash reaches for his weapon, but the girls knock him over when they run into the street. Milly shoots her stungun and overturns the vehicle into the building behind it. The gunman stands up in shock, only to have the building collapse on top of him.

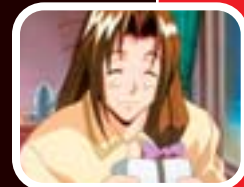

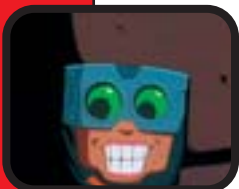
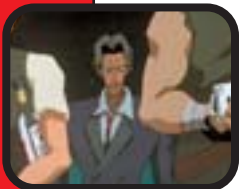
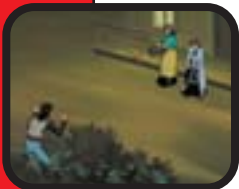

The couple expresses their gratitude to the girls and attempts to hire them as bodyguards. They refuse, but reconsider when the old man tries to hire Vash instead. The five of them walk out of town, with Meryl extracting a promise from Vash to stay out of whatever troubles may arise.



A short distance from town, the group arrives at the old couple's land. It is a small forest in the middle of the desert, complete with grass and wildlife. The girls are in shock since plants do not grow like that except around ships, and there are none nearby. Vash says that it is a geo plant. The old man explains the land is very valuable and Morgan, the local landowner, wants to buy it from them. They refuse to sell, however, since tending for this grove has been their life's work. They must keep him at bay with their band of vigilantes for one more day until they can bring the deed to City Hall.

That evening, Meryl and Milly are outside keeping watch when they hear a rustling in the underbrush. The girls draw their weapons, and the gunman from town steps out. He reveals he is the son of the couple inside; he wants to



speak with his parents. Milly is instantly angry with him, and attacks him for being disrespectful to his family. The elderly man hears the commotion and starts an argument with his son. Meryl puts a stop to the fight.



In the desert, Morgan reprimands his men for sitting around. When the men reveal they were waiting for Badwick, who was trying to talk to his parents one more time, Morgan decides to kill

everyone. A giant woman (who looks remarkably like Gofsef Nebraska) walks up and stubs her toe on the car, making her cry. A beautiful blond woman who rides on her shoulder comforts her. The blonde threatens to squish Morgan if he tries to take the car's cost out of their pay, which he nervously denies.



Back at the ranch, Badwick and his parents are talking. The father refuses to hand over the deed regardless of Morgan's actions, an attitude that frustrates and angers Badwick. They argue ever more heatedly, until they hear a whistling sound outside. It grows louder until an explosion happens outside the house, forming a large crater in the ground. The other bodyguards arrive, only to see a large brown ball. It uncurls itself, revealing an odd man (Kanta) who climbs out of the hole and runs away.

The blonde cheers, then gives the giantess a new target to hit, closer to the trees. When Morgan tries intervening, she mocks him and introduces herself and the "family" — the giantess Patricia ("Mom"), Tonkichi, Chinpei, and Kanta — as Marilyn Nebraska and Friends. The giantess and her petite daughter,





Marilyn, continue shelling the ranch while cars full of Morgan's henchmen attack. The rest of the vigilantes try to rout the attack, but are overrun. Badwick realizes he's been betrayed.



Badwick's father tells the girls to leave. They hide in the bushes while Morgan and his henchmen surround the house. Morgan tells the old man to hand over the deed, but he refuses. Morgan offers a blank cheque to the old man who shoots it. This angers Morgan, who in turn threatens to kill the father and all witnesses.

As Meryl stands there, trying to decide their course of action, Milly charges forward with her gun drawn. She stands between Badwick's father and Morgan, angrily telling Morgan that he should not try to take what is not his. Morgan tells his men to fire anyway, but Meryl comes forward first, derringers pointed at Morgan. There is a brief standoff before he laughs at her and raises his hand to signal his men. Before he can, however, Badwick comes racing out of the garage on a motorcycle, deed in hand. He calls to Morgan, who is surprised and pleased — until Badwick races past him and away toward town.

Morgan orders the Nebraskas to kill Badwick. Marilyn and her mother launch Chinpei. As the huge ball-man hurtles closer to Badwick, Meryl resolves to shoot Chinpei out of the sky. Chinpei is hit and falls to the ground, missing Badwick, who rides away. No one sees Vash hiding in a trash can a short distance away, blowing smoke from the barrel of his gun; he whispers that Meryl and he are now even, referring to the sand steamer incident.

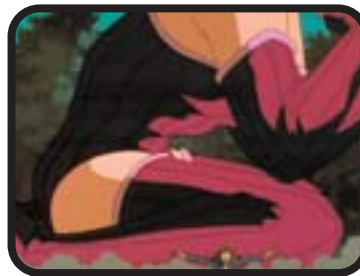

Marilyn Nebraska and her mother are in tears. They give up, disconsolate, and Patricia falls to her knees — accidentally pinning Morgan under her leg. His henchmen leave, and the elderly couple thank the girls while the father tells Meryl that, so long as she walks her own path, a child's success and happiness is all a parent truly cares about.



Badwick sits in the desert while the sun rises, staring at the deed. He nearly tears it in half, but relents and takes it to City Hall. There he discovers that he is the beneficiary of the land. Meanwhile, Milly and Meryl run for Vash's bus; they're late because Meryl spent all night writing to her family. At the last minute she sees a mailbox and stops to send the letter, then runs back to catch up with Milly, smiling.

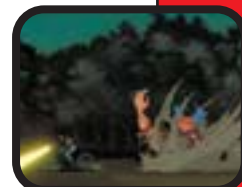
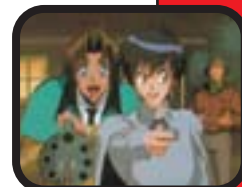
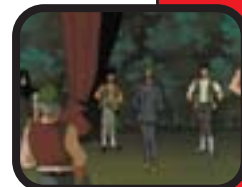
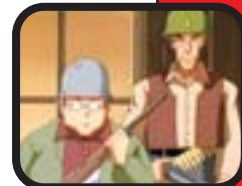

TRIGUN

The \$60,000,000,000 Man

EPISODE SUMMARY EPISODE: 15



Episode Fifteen: Demons Eye

Vash and the girls slowly make their way through the desert, with the girls riding on Vash's back because he wrecked their car.

Meanwhile, groups of men known as the Roderick Thieves drive armoured vehicles up to the medium-sized settlement of Jeneora Rock. The men, all wearing grey shirts and carrying guns, walk down the town's main street

escorting three barefoot and unresponsive young women. They enter the saloon, and the band continues to play while the bandits terrorize the patrons and staff. One of the women notices Legato sitting at the bar.

A bandit named Nagi becomes upset with the woman for noticing Legato and knocks her to the floor. When he's done beating her, he tries to start a fight with Legato over the incident. Legato ignores them and continues eating his food. Outraged, Nagi shoots the fork out of Legato's hand. Other bandits join in and fire on Legato, but they all miss.

Legato gives the bandits a chance to back down, saying he plans to kill everyone and they're rushing things, but the bandits turn the chance down. In response, Legato takes mental control of Nagi's arm and forces the thief to rip his own heart out. The other bandits are shocked and horrified. The leader pulls a gun on Legato and the rest of the bandits follow suit.

In response, Legato takes control of all the bandits' bodies. He forces the bandits to move their guns until they're

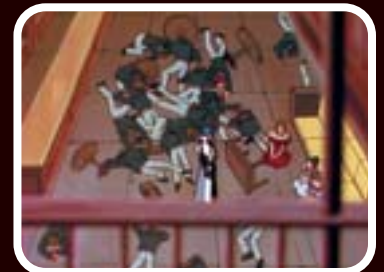
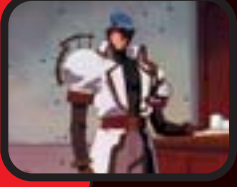
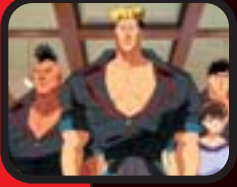
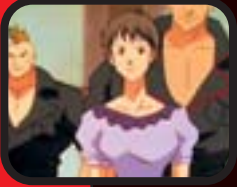
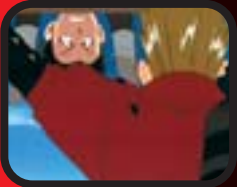



Leonof the Puppetmaster, Hoppered the Gauntlet, Rai Dei the Blade, E.G. Mine, Caine the Longshot, and Midvalley the Hornfreak. Mention is made of someone named Chapel as well, though that individual is not present. Legato tells the group that their target is near and assigns Dominique to deal with Vash.



Down in town, Vash runs frantically from door to door, trying to find someone who can tell him what happened in the saloon. When he finally finds someone, she screams and slams the door on his finger as soon as he describes Legato. After bandaging his finger, Meryl chides Vash for frightening the townswoman while he ponders Legato's whereabouts. He glances up and sees Legato at the top of the windmill, then runs past the girls and bounds up the side of the rock.



all aiming at each other. When the guns fire simultaneously, all the outlaws are killed while the band plays. Legato finishes his meal and leaves, stopping to tell the women to enjoy the short time they have left. As Legato leaves the saloon, doors slam up and down the street from frightened people trying to hide.

Vash and the girls arrive in town at last. He is exhausted, but after drinking a little water he feels refreshed. He goes in search of a drink and walks up to the saloon, his clownish demeanour in full swing again. He opens the door and turns utterly serious, however, upon seeing the bodies lining the floor. Meryl and Milly walk up, asking him what is wrong. He quickly shuts the door before the girls can see, and pretends nothing is wrong. All the while, however, he wonders who could have done such a thing.

talks to himself while apparently communicating with someone else. Immediately upon finishing the conversation, half the remaining thieves die while the other half are put to work burying them.



Once the Roderick Thieves are killed, Legato's gang goes through roll call. The Gung-Ho Guns (as they are called) consist of Grey the Ninelives, Dominique the Cyclops, Zazie the Beast,



Meanwhile, Legato confronts the remaining bandits up at the large windmill outside of town. The leader tries to kill Legato to avenge his brethren's deaths, but Legato takes control of another bandit's body and forces him to grab the leader's arm. He

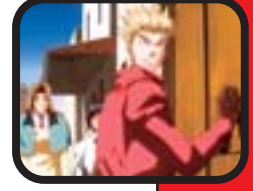
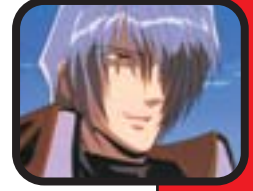
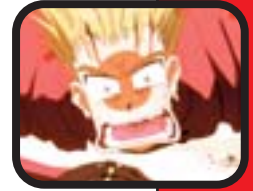

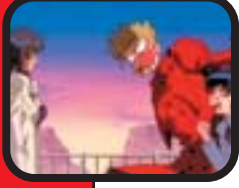
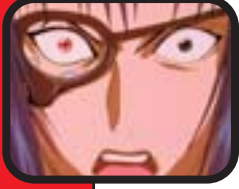
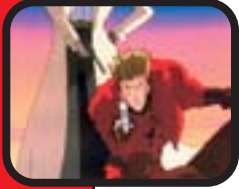

At the top, Vash sees nothing but a huge pile of corpses. Legato is nowhere to be found. Instead, Dominique, a woman with long dark hair and an eyepatch, magically appears beside him. Vash is surprised not to have noticed her. She brags how she might have killed him three times already; three buttons fall from his coat as a demonstration.



The woman introduces herself as Dominique the Cyclops, a member of the Gung-Ho Guns. She tells him that she killed the bandits. Vash grows angry with her, and causes five buttons to pop off her shirt to demonstrate that she is no faster than he is. He tells her that he does not wish to fight, but she chides him and refuses an alternative. As he prepares himself, she disappears, reappearing beside him. He manages to dodge and



roll away, only to have her reappear with a gun to his head as he comes out of the roll. While he manages to escape again, he is at a complete loss to explain how she moves so quickly. He tries studying her, but again narrowly escapes death after she teleports.

Desperate, Vash has an idea. He closes his eyes, concentrating hard and clenching his injured finger until it bleeds. Dominique becomes worried and tries to attack before he can finish. He anticipates her movements this time, however, seeing past her trick. He shoots her in the face with his arm-gun, destroying her eyepatch and revealing her oddly coloured right eye. She stands up, otherwise unharmed, and listens as Vash explains how she tricked him with sensory paralysis induced by hypnotic effects. She is

shocked because no mortal should be capable of evading the hypnosis. She tries attacking him again, and again fails. Beaten, she slumps to the ground.



Milly and Meryl appear, finally catching up. Meryl slaps Vash for attacking the woman while Milly checks to see if Dominique is all right. Dominique uses the opportunity to escape, exchanging telepathic remarks with Vash while running away. The girls have no idea what happened, though Vash considers himself lucky to have lived. Dominique escapes, stunned that Vash defeated her. She runs through the city streets until she runs into Midvalley the Hornfreak unexpectedly, gasping as though startled.

Back in town, Vash sits while Meryl demands an explanation. Midvalley and Legato appear on a nearby mesa. Legato smiles at Vash, who is visibly upset, then the two vanish in a cloud of dust. Vash tells Meryl and Milly that he can no longer stay with them, and will not argue or explain. Meryl tries objecting, but Vash will not let her. He walks away, determined to hunt down Legato at all costs.



The Planet

The planet where *Trigun* unfolds is definitely a hostile environment. The planet itself has a sub-stratum of quartz. It has no oceans and very little visible water, with sand covering its entire surface. There are underground rivers and reservoirs, however, which provide the much-needed water for humanity's continued existence. Weather is usually clear, though winds can blow at typhoon-strength levels. Precipitation is rare if it exists at all, although there are clouds in the sky.

The planet orbits twin stars, giving it two suns that are always seen in close proximity to one another. The planet also has five moons, indicating it may be larger than Earth. The moons' surfaces are different colours, with the fifth (the one Vash made a hole in) being red. The series does not give the order of the other moons.

There are seven main cities and many smaller ones for the planet's human population. The three mentioned are July City, Augusta City, and December City. There seems to be a pattern of naming them after months, but there is no conclusive evidence since the series does not mention the other cities. Vash's Angel Arm destroyed two of the named cities, July and Augusta. No information exists as to whether they were ever rebuilt.





TRIGUN

The \$60,000,000,000 Man

EPISODE SUMMARY EPISODE: 16



Episode Sixteen: Fifth Moon

The episode opens in a fancy ballroom, where members of the Gung-Ho Guns are relaxing and socializing. E.G. Mine complains to Legato about the inactivity and asks to be the next to attack Vash.



Legato agrees and Mine leaves, very pleased. Midvalley asks Legato if he plans to let Mine go alone, to which the leader replies that Mine will not be alone; there is a twist to the next encounter.

Two weeks later in Jeneora Rock, Meryl and Milly are sitting on park benches and wondering what to do next. A group of men standing nearby talk about Vash, saying that Legato works for him. Meryl chastises the men before realizing what she is doing. She walks away sheepishly with Milly trailing in her wake. After thinking about it, she

resolves to follow Vash. She calls Milly into action, and the two of them depart.

Meanwhile, Vash is in a bar, moping. He is afraid to face Legato and does not know where to find his enemy.



He has just decided to give up when a large pale man approaches him. The strange man tells Vash to find Legato in Augusta City. He threatens Vash not to ignore the message, or dire consequences will follow. The man puts a gun to his head and fires, falling to the floor. Vash realizes Legato sent the message and decides to travel to Augusta.

Soon afterward, a panicked man runs into another bar and tells the bartender that Vash is here. Wolfwood sets down his drink upon hearing the news. At the same time, Meryl and Milly are on their way to Augusta. They pass trucks of refugees headed out of town. The fleeing people will only say that Vash is in town, shooting his gun into the air and acting like a madman.



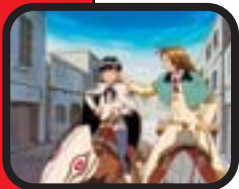
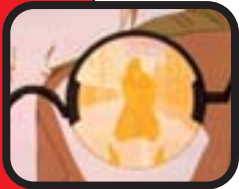
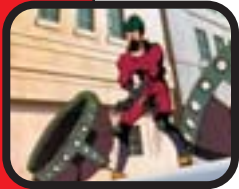

In Augusta, Vash tries to frighten people into evacuating the city. Once Augusta is deserted, he walks the abandoned streets in search of Legato. Something drips on the back of his neck, and he looks up to see the bodies of Money the Gale and Dominique the Cyclops pinned to the wall with spikes.

E.G. Mine steps forward. He admits to killing the two and gives Vash two choices: to die or allow the others to die. He follows up by shooting spikes at Vash, who dodges out of the way with his gun drawn. A cloud of smoke and dust appear and Vash turns to face a new threat. Mine is confused and annoyed when the cloud clears and reveals a tall man dressed in traditional Japanese costume. The man introduces himself as Rai Dei the Blade and politely asks Vash to fight him in a death match, for the sake of *Bushido*, the path of the sword.

Mine is annoyed by Rai Dei's sudden appearance and shoots spikes at him. Rai Dei calmly deflects the spikes with his sword blade, and explains that Mine's fight with Vash was already over. Mine does not understand until the straps holding his spike shooters give



way, cut by Vash's bullets during their initial encounter, which is only now revealed. Rai Dei praises Vash's performance and skill while he impales Mine on his sword, killing the would-be assassin. Vash is instantly angry and agrees to the duel.



Rai Dei sends shockwaves at Vash, kicking up dirt and debris while buildings are demolished. Rai Dei quickly understands that Vash is not trying to kill



him. He accuses Vash of blocking his path to spiritual awareness and redoubles his efforts. Buildings fall and clouds of dust rise from Rai Dei's shockwaves while Legato and Midvalley the Hornfreak look on from atop a mesa outside of town.

Milly and Meryl arrive in town while a large building falls. Meryl is intent on reaching Vash, regardless of the danger. She rides headlong into the destruction despite Milly's attempts to stop her. Rai Dei and Vash are still locked in combat and unaware of the girls' presence in the city. When Vash manages to gain the upper hand on Rai Dei but refuses to take the fatal shot, the samurai realizes that Vash will never try to kill him. He launches his blade from the hilt and uses his scabbard-gun to shoot Vash. He hits Vash several times, all the while ranting about his disappointment.





During Rai Dei's rant, Legato taunts Vash telepathically. He takes control of Vash's body and activates Vash's gun, revealing a power source. Vash's arm changes while he looks on, powerless to stop it. He remembers the destruction of July and realizes that the same thing is about to happen again.

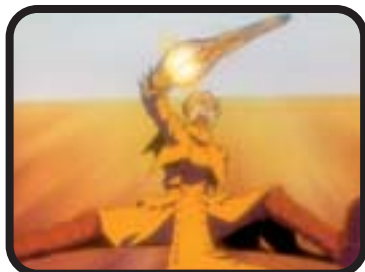

Meanwhile, Meryl and Milly reach the site of the first destroyed building. Meryl tries to approach closer, but Milly catches her arm. The two struggle briefly until a blinding light pours through the building next to them. They stand awe-



struck for a moment before Milly grabs Meryl and runs away. Milly mounts her thomas and rides off at top speed with Meryl under her arm, who is pleading to return for Vash.



While Rai Dei looks on in confusion, Vash's arm metamorphoses into a large gun called the Angel Arm. In a desperate attempt to stop the process, Vash tries to shoot the arm off with his cybergun to no effect. Outside the city, Wolfwood pulls up on his motorcycle and ponders the light.

The gun fires, spreading a glowing dome of light across the city. It destroys buildings in its wake and reduces everything inside the perimeter to rubble. The witnesses have varied reactions:



Legato is pleased, telling Midvalley that this was how July City was destroyed; Meryl begs Milly to let her go but Milly refuses. The girls watch as the light spikes up from the dome and burns a hole in the moon before the effect fades away.

Afterward, Rai Dei rises from the rubble, still terrified. He sees Wolfwood and asks him to help kill Vash; it seems the two know one another. Wolfwood refuses and shoots Rai Dei, killing him.

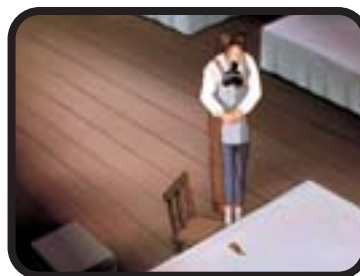

Days after Augusta is destroyed, Meryl stands in a hotel room sobbing quietly. Milly comes in with a letter from Bernadelli ordering the girls back to December City and declaring Vash mankind's first human Act of God, thus relieving themselves of any responsibility for his damages. Meryl bursts into tears at the decision and cries in Milly's arms.

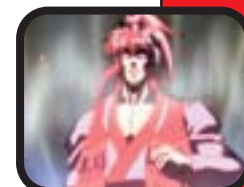

TRIGUN

The \$60,000,000,000 Man

EPISODE SUMMARY EPISODE: 17

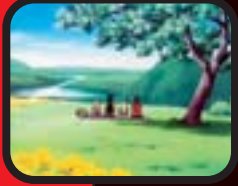
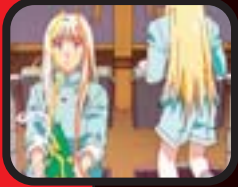
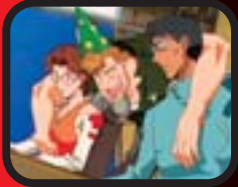

Episode Seventeen: Rem Saverem

A fleet of spaceships floats in space. The command ship has the word “SEEDS” emblazoned on its side. Five adult humans and two children are on the bridge of that ship, celebrating.

A dark-haired woman named Rem declares that it will be their new home, while another crewman named Steve (a lecherous individual) wants to land immediately. A third crewman, named

Rowan, doubts this planet is a good choice for landing. The captain, Joey, decides to wait; he will make the decision after receiving all the data. The two children, identical twins with long

golden hair, sit over to one side. One is quiet and serious, while the other is playful. Later, in the cold sleep room, Rem reveals to Vash that humans were frozen so that they can ensure their survival during the search for a new planet for habitation.

Rem, another woman named Mary, and the twins have lunch in the Recreation Room, which holds trees, plants, and insects. It was designed to look and feel like a rolling grassy hillside on Earth. Vash asks if he will ever see Earth, and Rem answers that they will make their own. Afterward, in the briefing room, the boys study their lessons with Rem and Joey. The children learn that Project Seeds was created because mankind damaged the Earth heavily enough that it could no longer support human life, and that humans did not realize the extent of the damage until the planet was beyond repair.



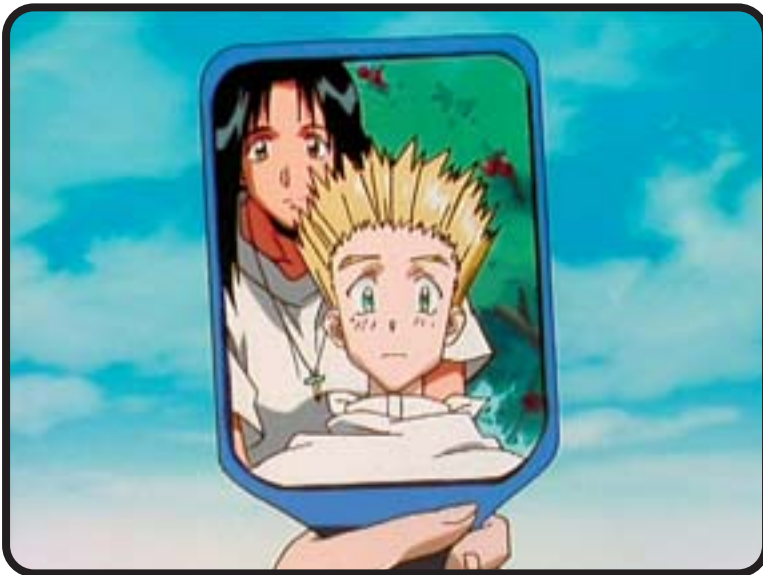

A while later, Joey, Mary, and Rowan are working on the bridge. Steve comes in after a nap and sits down to do his work, only to be told that Vash and Knives completed it for him while he slept, a job that would have taken him two days. He is scared and incredulous at learning this news, calling the boys monsters. The crew is taken aback, but Steve remains insistent, pointing out that the twins grew from babies to boys in one year.



Vash and Knives discuss the concept of living despite being hated and Knives, looking at an apple tree, wonders if he will be eaten when he grows up. Later, Rem gives Vash a haircut while Knives watches. Vash swears to stay with Rem. A furious Knives sneaks off to cut his own hair, claiming individuality.

The next morning, Vash and Knives are both sitting with Rem, Rowan, and Mary, who are complimenting the boys on the haircuts they received the previous day. The mood is jovial until Steve stands up from his seat at another table and calls the boys monsters again. He is drunk, and gropes Mary before Knives rebukes him for his behaviour. Steve laughs maniacally and leaves, but Knives tells the others that Steve is afraid.

Rowan is in his chamber alone later that day, complaining of Steve's treatment of Mary. The door opens suddenly and Knives is standing there. The same thing happens with Mary soon after, in the midst of her private complaints.



Knives, Vash, and Rem are walking in the Rec Room when they encounter a butterfly trapped in a spider's web. While Vash tries freeing the butterfly without harming the web, Knives grabs

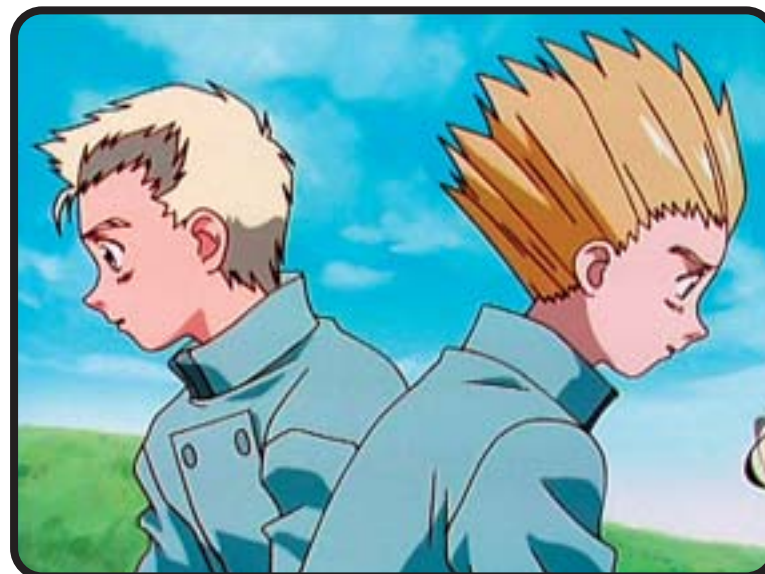

the spider and squashes it in his hand. Knives tries to explain that saving both is not possible, but Vash and Rem are still horrified. He tries justifying his behaviour to Rem, dismissing her assertions that one must carefully weigh each such decision. Vash tackles him, shocking Knives and saddening Rem while asking why he cannot save them both. Knives and Vash accuse each other of not making sense, then Knives leaves.

The next day, Steve is condemned to suspended animation for the remainder of the voyage on the charge of raping Mary. Both Rowan and Mary support the accusation, and no one listens to Rem when she asks that Steve's side be heard. Knives smiles when he hears Steve's sentence.

Following the trial, Mary and Rowan have a conversation in the cargo bay. He asks her to marry him, believing that she is in love with him as well. He tells her that he tampered with Steve's sleep chamber so that he will never wake up. When she refuses him, he becomes violent and kills her.

Rem and the boys hear the shots and run to the scene. Joey gives them

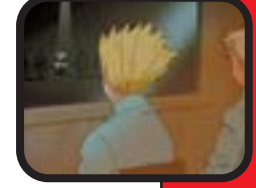
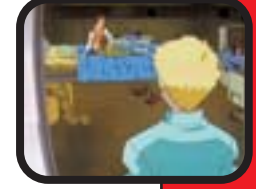
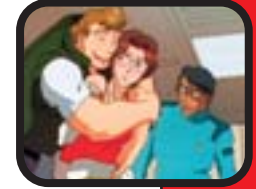

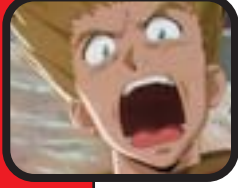
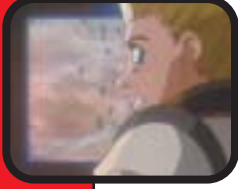
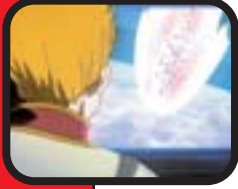
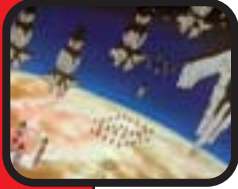
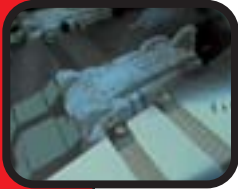

the location as he struggles to bring the monitors back online in that area. Rem and the boys arrive to find Rowan standing over Mary's body with a gun in his hand. He rambles for a while, then aims the gun at Knives, saying it is his fault. Rem interposes herself between Rowan and Knives and tries to talk him down. She nearly convinces him to drop the gun when Joey fixes the monitors. He sees Rowan about to shoot Rem and opens the airlock, blowing Rowan into space.

Rem is devastated, repeating that Rowan was not going to shoot her. Joey apologizes, but insists it was all he could do. When Knives tells Joey that his actions were right, Joey admits that if he had misjudged the situation, sentencing Rowan to death was wrong as well. Knives becomes angry and shoots Joey, claiming that Joey is just like all the other humans.

Knives, determined to kill them all, reprograms the fleet to crash into the planet. Rem quickly becomes aware of the problem and tries to fix it, but their course is locked. Knives returns to find Rem and Vash, and blames the problem



on Rowan. He convinces Rem to flee the ship with Vash and he, saving their own lives at least.



Rem and the boys reach the pods, but Rem is torn. She decides that she cannot leave without at least trying to help the sleeping people trapped on the ships. She seals the pod, telling a hysterical Vash to take care of Knives before running back into the ship to try and save it.

While Vash watches from the window of the small ship, Rem's ship hits the atmosphere and explodes. Vash screams her name with tears streaming down his face. He turns to find Knives laughing. Pleased with himself, Knives reveals he was responsible for everything that happened; he refuses to let the humans destroy another planet. Vash blindly attacks Knives, but his brother just kicks him away, laughing all the while.

Knives is rejoicing in his success, when the ships' computer announces an orbital correction. Knives had overlooked the reverse thrusters on the fleet, which slowed their descent. Rem managed to trigger them before she died, thwarting Knives' plan. Vash is heartbroken, unable to think of anything but Rem, her flowers, and her song.



Finally, 107 years later at July City, Vash is standing in the wind with two guns, one silver and one black. He tells himself, "I know, Rem. I'll take care of him."

TRIGUN

The \$60,000,000,000 Man

EPISODE SUMMARY EPISODE: 18

Later that day, a bus pulls into a town named Karsted City. Wolfwood steps off and is instantly mobbed by people trying to board the bus. He makes his way through the crowd and down the street while hordes of desperate people try to buy tickets.



A little way down the street, Wolfwood enters a saloon. Every patron in the place pulls a gun on him immediately, and he responds by putting his hands in the air. Once they see that he means no harm, they put away their guns and ignore him. Wolfwood sits at the bar and talks to the bartender, who explains that bandits are holding the town under siege, refusing to let anyone leave. An explosion outside of town

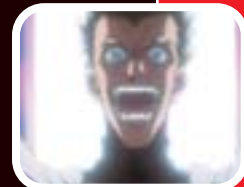

Episode Eighteen: Goodbye For Now

Vash enters a room and finds Knives standing over a man's body, claiming to have cut Vash's last tie to Rem. The brothers argue, with Knives determination to kill humans clashing with Vash's belief that no one has a right to take a life.



Eriks even though he looks like Vash with long hair. He does not respond and stays huddled in his bed.

The argument ends when Knives insults Vash and draws a gun. Vash draws two in return, but Knives shoots Vash first and blows his left arm completely off. Knives snaps his fingers and the casing flies off Vash's silver pistol, beginning the metamorphosis into the Angel Arm. The gun fires, and July city is blown away.

A girl enters a room where a blond-haired man is sleeping. She calls to him from the doorway, identifying him as



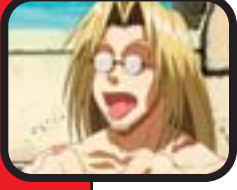
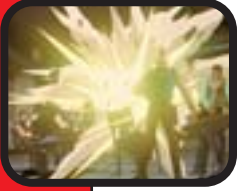

rumbles in the background; the bandits have blown up the bus, emphasizing the truth in the bartender's story. The bartender says that Vash the Stampede is rumoured as the leader of the bandits, though he has no proof to the allegations.



A tall man with long blond hair and glasses runs into the saloon, holding a girl in a headlock. The patrons draw guns on the now frozen pair, then put them down after recognizing the girl. Lina struggles out of "Vash's" arms, calling him Eriks and telling him to let go. She asks the bartender to hide her from the bandits, explaining that the bandit leader is looking for her after she kicked him.

The bartender becomes openly upset upon realizing the bandits might



come to his bar. Lina and Eriks try to calm his fears, but are interrupted by an explosion after the bandit leader blows a hole through the building. The head bandit, named Mohican, demands Lina surrender to him or he will kill the hostage in his care.



Eriks comes out of the bar, hands above his head. He apologizes to Mohican for their little joke and tries to dissuade him from revenge, but is shot for his trouble. Mohican demands Lina again, but Eriks refuses. Instead he kneels on the ground before the short, heavyset man and asks if this is enough to placate him. The bandit leader demands Vash strip naked and run around on all fours, barking like a dog. Lina screams at Eriks not to submit, but he does it so that Mohican leaves.

Lina and the bar patrons are shocked and appalled, but Eriks does not seem ashamed. Mohican laughs and is about to shoot Eriks, but when he spots Wolfwood, he gathers his men together and departs. On the way out of town, however, they shoot Eriks in the back while he stands in the street. Lina, Wolfwood, and the patrons rush Eriks to the hospital, where they remove the bullet and patch him up. Lina's grandmother comes in and causes a scene, trying to grab a gun so that she can go after the bandits herself.



After the doctor settles everyone down, Wolfwood asks to stay. He punches Eriks and asks if he plans to sleep all day. The doctor is immediately furious, but Eriks wakes up and reassures him, asking the doctor and nurse to leave the room.



They walk up to the house where the bandits are staying. Vash reminds Wolfwood before the battle not to kill anyone, and they fall back into their familiar banter. They defeat all two hundred of the bandits, rescuing Lina and returning home.

Back at Grandma Sheryl's house, Lina cuts Vash's hair short again. Lina's grandmother recalls the conversation Vash and she had regarding his departure, and she asks Wolfwood to take care of him. Lina remembers finding him in an alley after Augusta was destroyed, and cries while trying to tell him goodbye. As Vash and Wolfwood walk away from the house, waving farewell to Lina and her grandmother, he silently thanks Lina for saving him and tells her goodbye, for now.



Once the two are alone, Wolfwood greets Eriks as Vash. Vash surrenders the pretence and talks quietly with Wolfwood, admitting his part in the destruction of Augusta and the hole in the fifth moon. He says that he is unsure of exactly what happened in some places, but the fragments of memory he retains indicate he was responsible. He wants to live a quiet life under a different name, and has no wish to return to his old life. Wolfwood nods, and tells Vash that he needs help. He gives Vash back his gun, recovered from the rubble of Augusta. Vash does not pick it up, saying that he wants to stay.

inhabitants vanished without a trace. The only clue to their disappearance is the word "Knives," painted on the monument in the centre of town. Vash stares at the gun for a time, trying to make up his mind. He decides to pick up the gun again after he overhears Grandma Sheryl asking for help to rescue Lina, who has been taken by the bandits.

After Vash dresses, he and Wolfwood leave together to rescue Lina.



Wolfwood accepts Vash's decision and turns to go. Before he leaves, however, he tells Vash the story of the town of Carcases, where all the

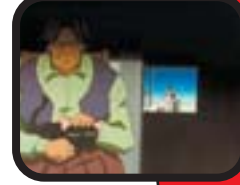

TRIGUN

The \$60,000,000,000 Man

EPISODE SUMMARY EPISODE: 19



Episode Nineteen: Hang Fire

Meryl is back at Bernadelli Headquarters in December City. She is asleep at her desk, dreaming about the destruction of Augusta City. A co-worker wakes her and a small crowd gathers, arguing among themselves whether to ask her for details of her experience. Her boss settles the question by calling her into his office for a chat.

After the meeting, Meryl rushes to the locker room looking for Milly. She finds her friend cleaning windows as a punishment for continued tardiness. Meryl reveals that she and Milly are head out to Little Jersey, Vash's last known location, and try to keep him out of trouble. Meryl bustles about in her locker, preparing to leave immediately. She complains bitterly about Vash, but her smile during the tirade suggests her true fondness for Vash.

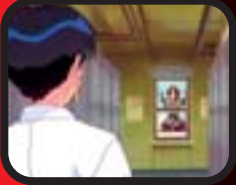

In the middle of the desert, a man in a truck stops by the side of the road. Vash and Wolfwood are lying there, prostrated from thirst and heat exhaustion. He offers them a ride, which they happily accept. The two drink water and argue during the ride, with the chief disagreement centred on their destination.

Back in Little Jersey, the girls begin their investigation. They talk to the



sheriff about Vash's actions and discover the town was damaged when Vash fought the local ruffraff. As Meryl finishes her conversation, Milly runs up to her. She tells Meryl that she heard on the satellite that Vash was headed for New Oregon.



Elsewhere, an older man named Mr. Lurald is talking to a group of men sitting at a table. He tells them that the Polo family has left town, leaving one son behind. He talks about a shuttle to New Oregon passing through, then asks for volunteers. After a moment, a nervous man named Benson stands. Everyone else agrees, and they make their plans.

In New Oregon, the satellite DJ broadcasts that Typhoon Jacqueline is coming in a day or two. Wolfwood and Vash are having lunch together when Wolfwood tells Vash about the ongoing town feud between the Polo and Fris families over the rights to the satellite. He explains that a girl distantly related to the Fris family was killed recently, and he does not want Vash involving himself. Wolfwood is distracted during the conversation and Vash sneaks away, headed down to the satellite offices. Vash inquires at the office with the boss, Slader, for a friend of his named Max Simon.



Meryl and Milly are on a sand steamer bound for New Oregon. The girls are in the public restroom readying for bed when bandits burst in. The desperados tie the girls up with other passengers in a common area, and stand over them with guns. The one guarding Meryl and Milly is Benson, the man who volunteered earlier. He is unusually polite for a bandit, but very determined. Meryl's attempt to dissuade him from his present course of action only reminds



Benson of "her," a girl who would apparently be close to Meryl's age.

Max Simon and Vash, apparently old friends who have not seen each other in some time, are reunited. As they talk, a giant crash shakes the room. The hijacked steamer has crashed into the satellite, and bandits are streaming out. The bandits quash any resistance they encounter, and search for Slader, the fourth son of the Polo family. Benson is particularly intent on finding him and ignores anyone else. The satellite DJ reports the attack on the satellite over the airwaves when Slader runs in, frightened. A couple of seconds later, the door is shot down and Mr. Lurald comes in, gun in hand.



The Fris family announces over the airwaves that they have seized the



satellite. They want the head of the Polo family delivered to them in three days, or Slader dies. Max and Vash hear the announcement deep in the halls of the building. Max says that Polo is away, and that there's no way he can return in time.



Back on the wrecked steamer, Meryl and Milly take advantage of a gullible guard and free themselves. At the same time, Vash is dealing with two guards in another hall. He and Max scare a second pair of guards away with Vash's reputation alone.

In the control room, Benson is standing over Slader. His finger is tightening on the trigger when Mr. Lurald spots him and walks over, telling him to relax. Benson releases the trigger just before the frightened guards come in, announcing that Vash the Stampede



is coming. The bandits begin to panic, but Mr. Lurald calms them down. They ready themselves, with one of the guards accidentally turning on the mike as he stands next to the board so everyone outside can hear what is happening.

Vash asks Mr. Lurald to surrender. He refuses, and the guards open fire down the hall. Vash dodges everything. He makes his way into the room, knocking the henchmen out with his gun. Mr. Lurald jumps out the window in the confusion, leaving only Benson standing.

When Vash turns, he sees Benson still holding a gun on Slader. Vash tells him to release the hostage, but he refuses and puts the gun barrel to Slader's head. Vash tries to talk the man into leaving, believing him a bandit for the Fris family. Benson refuses, however, revealing that Slader killed his daughter, Aileen.

Benson recounts how they found his daughter's body, and asks Vash to hand him over to the authorities when he is done. Slader pleads for mercy, which only enrages Benson more. While Slader begs, Benson's finger tightens on the trigger. Vash pulls him away at the last moment, trying to prevent the murder.



Benson is furious and lashes out at Vash, hitting him repeatedly in the face while he vents his anger. Benson stands up and puts his shotgun to Slader's head once more. Vash begs Benson not to kill Slader. After a tense moment, Benson realizes that he cannot shoot Slader, even to avenge his daughter's death. Meryl and Milly finally arrive, with Meryl being openly relieved to see Vash alive. Milly and she help Vash and Benson escape before the cavalry arrives.

Outside town, Mr. Lurald walks up to an odd little man standing in the desert. The man opens his briefcase, and Lurald falls into pieces. The parts fly into the briefcase, which closes on its own. The man telepathically reports to Legato, telling him that Vash is on the move.



TRIGUN

The \$60,000,000,000 Man

EPISODE SUMMARY EPISODE: 20



Episode Twenty: Flying Ship

Typhoon Jacqueline has hit New Oregon, and Meryl and Milly are in their hotel room. When the storm throws some thomases into their room, they go to check on Vash, but discover he left in the tempest. Milly reveals that she placed a transmitter in his food so she can track him, but Vash dumped the food out for the cat, allowing him to escape.



success. Vash accuses Knives of being inhuman, whereupon Knives beats Vash for daring to compare him to beings he finds so inferior. He vows to kill every human on the planet until only he and Vash remain.



Back in the present day, Vash stands on the edge of a cliff in the middle of the storm, remembering Rem's last words.



The scene flashes back to the landing of the escape pod holding Vash and Knives. Knives is concerned for Vash, who is lying on the ground unconscious. As Vash recovers, he confronts Knives, rebuffing his brother's attempt to help. Knives gloats about his



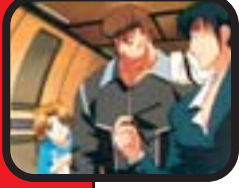

He jumps off the cliff, counting on the winds to catch him as Max predicted in the previous episode. He falls for a bit, but then the winds lift him high up into the sky. Speeding through the air, he hits a flying transport headfirst and climbs aboard. He has almost recovered when he hears Wolfwood yelling. Wolfwood followed Vash and is clinging to the side of the transport.



Once they are both aboard, Vash tells Wolfwood that he is "visiting the folks." Wolfwood is incredulous until they break through the clouds and see a floating spaceship in the sky. Vash explains the ship failed to crash 130 years ago, and people still live there.

While the transport ascends, a group of odd, mechanical birds watch from the ship's exposed structure. They



transmit the video back to Leonof the Puppetmaster, down on the planet's surface. He, in turn, telepathically notifies Legato that Vash has made his move. He reveals Wolfwood's presence to Legato as well, but Legato dismisses it.

On board the ship, a man named Brad runs into a chamber full of computers. He tells a man called "doctor" that there is a visitor. The Doctor already knew and was pleased, expecting it to be Vash. Brad reveals that he met Vash when he was six and is surprised that Vash has returned.

The Doctor is happy while he opens the door to the outside, but Brad is not. The Doctor lets Vash and Wolfwood in, and they all ride together on an elevator down into the ship. Brad is almost civil to Vash, but openly hostile to Wolfwood.

Wolfwood does not understand why until they arrive at the bottom and he sees families running to hide from him.



From down the hallway, a young woman runs up to Vash and hugs him. He recognizes her as one of the children he remembers from his last visit, Jessica. Brad grows angrier from the attention she heaps on Vash, until he finally extricates himself by promising to see her after he talks with the Doctor. After Vash leaves, Jessica is openly frightened of Wolfwood, despite his attempts to be friendly. Brad accuses him of being a warlike outsider and he and Jessica walk away, with Brad leaving instructions for him to remain there.

Back in New Oregon, Meryl is annoyed. She is determined to find Vash, despite Milly's warnings about the storm. She opens the door, only to have it ripped from her hands and carried away by the wind.

Up on the ship, the strange birds gather near the air ducts. They collapse into pieces and fall down the air vents, crashing into the bottom of the shafts and reforming into people-shaped puppets before entering the ship.



Wolfwood stands in the hall surrounded by angry people who are frightened of outsiders. He argues with the people, telling them eventually they will have to be in contact with the rest of the world. The mob becomes angry, but he insists that change is inevitable.

Vash and the Doctor are talking about the fifth moon incident while Brad looks on. Brad erupts and wants to fight Vash, but Vash will not fight back. After a reprimand from the Doctor, Brad struggles with himself, then leaves. The Doctor apologizes, explaining that Brad is jealous because he is in love with Jessica. He told her as much, but she said she was marrying Vash instead. While Vash thinks about Brad and Jessica, the Doctor brings out a new and improved cyberarm for Vash. Back in her chamber, Jessica is fixing dinner for Vash. She is starry-eyed over his return, and does not notice the segmented fingers appearing at the grate above her.



Wolfwood is walking down the hall when he hears screaming inside a room. He beats down the door, only to discover all the people inside are dead. He walks in and checks on them. When other

people arrive, they assume he killed everyone. Brad arrives and believes the same despite Wolfwood's remonstrance. The jealous man insists it must have been Wolfwood and is unwilling to look at another option.

Vash and the Doctor walk down the hall to Jessica's room. Vash has his new arm and is very pleased with it. They enter her chamber and discover she is not there. Vash picks up the present she left for him, finding the word "Kill" written on it in red letters.

Brad and Wolfwood stand off until a bystander falls against Brad's back, dead. Wolfwood and Brad run into the hall to find out what happened, only to see dead people littering the floor and Mr. Lurald at the other end. Wolfwood addresses Lurald as Leonof. Lurald/Leonof calls



Wolfwood "Chapel the...." but is silenced by Wolfwood's gunfire that blows the Lurald puppet to pieces.

More puppets fly in, and Wolfwood kills them all. Finally, one of them brings out Jessica as a hostage in an attempt to force Brad to kill Wolfwood. Brad nearly does it, but Wolfwood manages to stall him long enough for Vash to arrive and destroy the puppet holding Jessica. Vash steps out of the darkness to the astonishment of Brad and Jessica, wearing a new red coat that Jessica made for him.



A talking puppet-head interrupts, telling Vash that other threats still abound, including other Gung-Ho Guns aboard the ship. Vash determines there are three others on board. Meanwhile, down on the planet, Meryl and Milly cling to a board for dear life, trying to keep from being swept away by the storm.

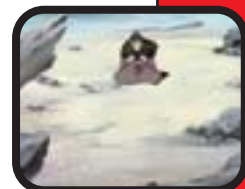

TRIGUN

The \$60,000,000,000 Man

EPISODE SUMMARY EPISODE: 21



Episode Twenty-One: Out of Time

In a strange room, Midvalley the Hornfreak is playing his saxophone. Legato is talking to Knives, who is hanging upside down in what appears to be a miniature light bulb, or plant. Legato asks Knives to allow him to make Vash suffer for hurting Knives.

The last few scenes from the previous episode are recapped, where Vash discovers there are other Gung-Ho Guns on board the ship. Grey the Ninelives is shown walking towards a group of people telling him to leave, then gunning them all down. Another scene shows Hoppered the Gauntlet lying in a hall. A group of people demands he depart as well. He kills them all with his guns.

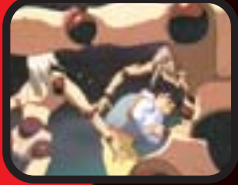

Vash talks to the Doctor via commlink. Doctor says that intruders are approaching from both sides of the ship, indicating that the groups who went to investigate have stopped reporting in. Vash and Wolfwood both wander the ship separately, blowing up whatever puppets they find. He finds one lone man surrounded by puppets and tries to save him. He runs out of ammo for his revolver and resorts to his new cybergun, only to discover it has far more recoil than



his old model. He is knocked to his feet, having taken out all but one puppet. As he tries to steady himself and aim, Brad shoots it from the doorway. Elsewhere, the Doctor realizes the intruders are heading to the two power plants.

Wolfwood stands alone in a hall, surrounded by broken puppets. The floor shakes and booming sounds erupt. A huge person comes up through the floor, his torso almost completely blocking the hall. Wolfwood tries to talk to him, but he does not respond. Wolfwood fires his machine gun at the huge man but the bullets bounce off. Dodging return fire, he flips his cross and fires an artillery shell at the opponent from the short end of his weapon.



Vash and Brad destroy the last puppets. The Doctor contacts them, saying that Plant Room 2 is in danger. Vash uses his cybergun to cut a hole underneath him. He continues to shoot until he has fallen all six floors to Plant Room 2.

Once Vash reaches the bottom, he sees scores of dead humans. While crying because of the massacre, a large spinning top lances out at him from the darkness. The top comes apart and a

figure reveals itself, laughing at Vash. It introduces itself as Hoppered the Gauntlet. Hoppered launches himself at Vash. Vash dodges and fires, but is dismayed to find that his bullets just bounce off Hoppered's shield.

Back in the hall with Wolfwood, the smoke clears. The giant man is still for a moment, then stirs, unaffected by Wolfwood's shots. Wolfwood realizes his opponent is Grey the Ninelives. Grey fires missiles at Wolfwood, which miss him but crack open the floor beneath them. They both fall into a huge chamber. Wolfwood catches himself on a catwalk railing with his cross. He wonders why Grey blew up the floor until he realizes that he is in Plant Room One.

Hoppered fires while he flies through the air, bullets coming out of his



shield's nosecone. Vash dodges and fires, but the bullets bounce off. The fight continues; Hoppered launches himself past Vash, firing something that knocks Vash over.

Grey fires on Wolfwood and hits him in the leg. Wolfwood returns fire futilely at Grey while the giant walks up to him. Some weakened pipes behind Grey burst, however, dousing Grey with a noxious chemical while Wolfwood leaps for safety. Grey's body and armour dissolve on contact, leaving only the framework of a giant mecha. Wolfwood is surprised, but wastes no time. He uses his artillery and destroys Grey.

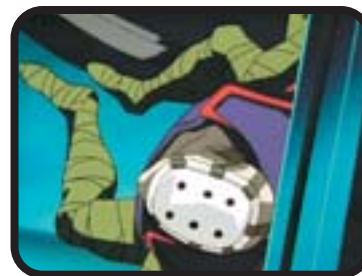

Brad arrives at Plant Room Two to discover Vash down and injured while Hoppered fires at the plant. Vash yells, and Hoppered turns his attention to Vash instead. He launches himself through the air at Vash, spinning madly and firing on his descent. Vash leaps out of the way and uses his pistol remotely to shoot the fasteners off Hoppered's spinning shield. Hoppered spins out of control and hits the wall headlong, smashing into a power source and electrocuting himself.

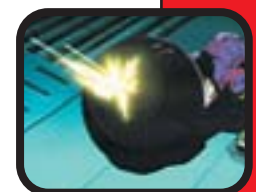
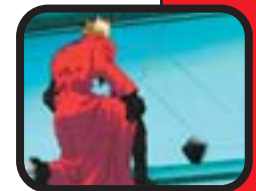

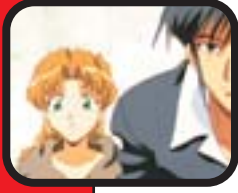
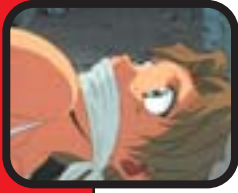

Brad runs over to Vash and tries to bring him around. Vash shows Brad the damage Hoppered did to the plant. Meanwhile, Wolfwood is recovering from his fight. Just as he thinks he has won, Grey's lower half — all that is left of him — walks toward the plant again. Wolfwood tries to shoot, but realizes he is out of machine gun ammo. He switches to his artillery, but Grey is too close to the plant for Wolfwood to fire. Grey kneels, pops a gun out of his thigh, and shoots the plant while Wolfwood looks on, helpless to stop it.

Back on the planet, Meryl and Milly are all right. The storm has passed. When they look up to the skies, though, they see the ship slowly descending toward the planet's surface.

On the ship, Plant #1 is down and #2 is failing. Brad and Vash try to save Plant #2. Vash walks up to the generator and addresses it as "little sister," then leans against it. Inside the plant, a nude woman with solid yellow eyes appears, floating above Vash with a portal behind her. The plant works again, and the woman reaches out to Vash.



Hoppered appears, launching himself at the plant while screaming Vash's name. Vash tries to stop Hoppered, but cannot. The force of the resulting explosion blows out the side of the ship. The ship descends quickly, yet lands with very little damage. Inside the ship, Wolfwood finds Jessica bound and gagged in a storeroom.



Outside the ship, the inhabitants are angry and in shock while Brad



supports Vash. The crowd is angry and blames Vash, but Brad stops them, insisting that they are to blame for not preparing for the inevitable.

Jessica runs up and hugs Vash. She seems completely normal, a fact that amuses both Vash and Brad. Wolfwood shouts from above, showing them that he has the real Jessica with him. The puppet Jessica pulls a gun and fires, killing Brad as he throws himself between her and Vash.

Leonof sees that he failed and reports back to Legato. He looks up to see Wolfwood on the flying transport, just before Wolfwood kills him. The Jessica puppet falls to the ground in pieces. Meryl and Milly ride up to the ship in time to see Vash kneeling over Brad who is dying. Vash is crying while calling Brad's name.



Lost Technology

While advanced technology is rare throughout the desert planet, it does exist in the major settlements. These major cities, as well as the floating ship where Vash replaces his arm, are seemingly the only available sources of such advanced technology.

Artifacts like the Demons Eye, Vash's earring/commlink, and Milly's transmitter exist, but usually in the possession of powerful organizations. There are still technology caches throughout the wilderness, however, that resourceful and knowledgeable individuals can find and utilize. The most obvious example of this is in the floating ship, and the satellite centre in New Oregon. The series does show other abandoned caches, however, in both the first and second halves.

These caches are, without exception, leftovers from the Project SEEDS fleet that crashed into the planet 130 years ago. There are still many dangerous areas, with both natural predators and futuristic security, likely extant across the planet. The objects recoverable from the wrecked vessels are advanced, ranging from items of daily use, to futuristic weapons, to possibly even mecha.





TRIGUN

The \$60,000,000,000 Man

EPISODE SUMMARY EPISODE: 22



Episode Twenty-Two: Alternative

Vash, Wolfwood, Milly, and Meryl are camping outside. The girls are asleep. Vash is trying to drink himself into a stupor, but Wolfwood stops him.

He tries consoling Vash, but to no avail. He remembers Brad's death and Jessica standing at Brad's grave, trying first to talk to Vash then running from him. Wolfwood and Vash agree, however, that he still needs to face "him." Meryl, still awake, overhears all this with a concerned expression.



The next day, the four of them are in a car, driving toward a town called Keybos. Wolfwood and Milly laugh and flirt in the front seat, while Vash and Meryl sit in the back. Meryl starts to talk to him, but cannot bring herself to say anything.

At the town, the group discovers that it is walled and the gates are closed. They call for the guard, but he will not let them in. When they continue asking, the guard fires warning shots until Vash suggests they just leave. When Vash reaches the car, he finds a small boy named Bete



rummaging in it. After being stopped by Vash and Milly, the boy runs away across the desert. Wolfwood suggests a side trip, and they all follow the boy.



They arrive at a house carved out of stone cliffs. When Wolfwood knocks on the door, children pelt him with trash and refuse him entry. He finally convinces them he means no harm by offering food in exchange for a place to stay. Later, a boy named Richie tells Vash and Wolfwood how the orphans all came to be at that house. It seems the adults living in the neighbouring cities, except for Keybos, had all left one day, walking into the desert without a word — as if something was controlling them. Vash asks if Richie saw anyone else, and the



boy says there was a voice. The voice said, "This is what you get for taking so long," a message Vash knows Legato meant for him.



Meryl and Milly work with the kids, soon overcoming the childrens' shyness. That night they all have dinner together with everyone enjoying themselves. The girls tuck the kids in and all seems well, except that Bete, the boy from the car, is crying in his sleep. Vash feels he must find Legato soon, but he cannot leave the kids on their own.

In town, a guard opens the gate. Another guard tries to stop him, but the first guard is under Legato's control and kills his partner. The townspeople are frightened, but they investigate only to find Midvalley the Hornfreak leaning against the huge door.



The next morning, the orphans' house comes under attack. Men from the town fire on it, insisting that Vash, Wolfwood, and the girls surrender. They blame the deaths of the townsfolk on the quartet. Vash and Wolfwood go out to

straight for the leader. Vash saves his life, and they all run into the house. Other worms soon follow.

Vash and Wolfwood charge Meryl and Milly with bringing the kids into town, while Wolfwood and Vash act as decoys. The men agree and help take the kids inside the walls. Vash and Wolfwood, meanwhile, manage to attract the two closest worms. They take off running with the worms right behind them. Wolfwood wants to shoot them, but Vash will not let him. Instead, they narrowly avoid being eaten a few times before finding a place to rest. They realize the worms are far too well organized; someone must be controlling them, at which point Vash looks over to the city and sees smoke rising from it.



talk to the men, but they will not listen. The pair refuses to fight and are beaten up; the men prepare to shoot Vash when the ground shakes. A giant worm launches itself up into the sky, coming



Worms have invaded the settlement and are destroying buildings while Meryl and Milly try desperately to find a safe place for the children. They narrowly avoid being eaten when Vash and Wolfwood show up, dropping whole sections of buildings on the beast to slow it down. Vash tells Meryl and Milly to reach the rooftops, so they take off. One little boy, however, wets himself from fear.





his humanity. Zazie claims to be a demon, but Vash does not believe him. Vash continues approaching Zazie despite his threats. It looks as though Vash might succeed, when Zazie suddenly falls to the ground, dead from a shot from Wolfwood's Punisher Cross.



Vash and Meryl are horrified, while Milly is simply sad. Vash and Wolfwood argue and Wolfwood punches him, asking what alternative he had to killing the boy. Vash relates his dream of a peaceful world to Wolfwood, but Nicholas rejects it as hypocrisy when they live on such a horrible world. He walks away; the girls silently watch him go.



He runs away, afraid and ashamed, forcing Milly and Wolfwood to chase after him. Vash catches up with Meryl and the children on a rooftop a few seconds later.

While Vash ensures Meryl and the kids are all right, he cannot shake the feeling that something is wrong. He turns to see a worm erupting through the building to attack them. At the same time, Milly and Wolfwood catch the boy. They turn around to bring him home, but a worm lunges through the air at Milly and the child.

freeze in mid-air. A second shot shatters the adornment, and the worms leave. Vash confronts Bete, who reveals himself to be a Gung-Ho Gun named Zazie the Beast. He draws a pair of revolvers and points one at Vash.

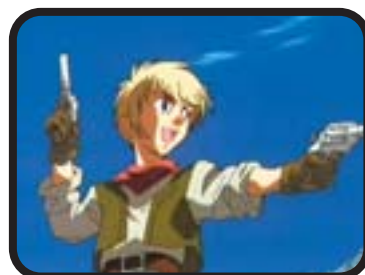

Zazie threatens a child and shoots the gun out of Vash's hands. He puts a gun to Meryl's head. Vash tries to convince him to put the gun down, calling him Bete and reminding him of

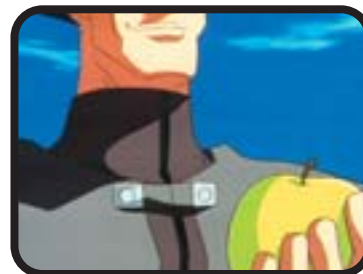

On a hill outside of town, a man in grey stands with a cross, holding a green apple in his hand. He watches the town with a small smile on his face.



As the worm closes in on Meryl and the children, Vash discovers he is out of ammo for his cybergun. He draws his revolver to fight it off, but notices something while running past the children. He turns and shoots one green decoration out of Bete's hair; the worms

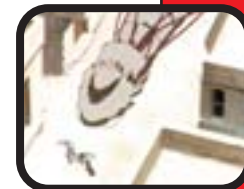

TRIGUN

The \$60,000,000,000 Man

EPISODE SUMMARY EPISODE: 23



Episode Twenty-Three: Paradise

The episode opens with a flashback to Wolfwood's past. A gunshot cracks the air and a man lies dead. Wolfwood was seven when he first picked up a gun and killed the man claiming to be his guardian. He did it to free himself, only to discover that things always became worse. He was apprenticed to a tall thin man eating an apple, the same man from the end of the previous episode.

The memory shows Wolfwood progressing through his lessons, first with shooting practice, then trying to take an apple from his teacher's hand. His master teaches him to be practical, to think, but most of all, that the ends justify the means. Wolfwood grows into a man under his tutelage. He starts an orphanage so that other children will not have to grow up as he did. It gave him a purpose, a way to do good for others even though his daily life was filled with death and destruction. He still regrets being trapped into this life, though, on this terrible planet.



Back in the present, the group is in Tonim Town; it is one of the places where the entire population disappeared. Vash and Meryl are standing near the monument in the town's centre. Vash stares at it and shoots it dead centre in the middle of Knives' name.

Meryl stands at a window, wondering about Milly's whereabouts. Vash lies in bed, wondering what he should do next. Wolfwood stands in the moonlight in his room, half-dressed while watching Milly sleeping in his bed. He wonders what he should do.



The next morning, Vash exits the building packed and ready to leave. Wolfwood is waiting, however, and apologizes for hitting him. Vash starts talking about what happened with Zazie, but Wolfwood cuts him off, unwrapping the cross and pointing it at Vash. He challenges Vash to fight, claiming that it would have happened eventually. The two talk, trying to sort out what is happening. Wolfwood asks Vash what he will do when he finds Knives, to which Vash admits he does not know.

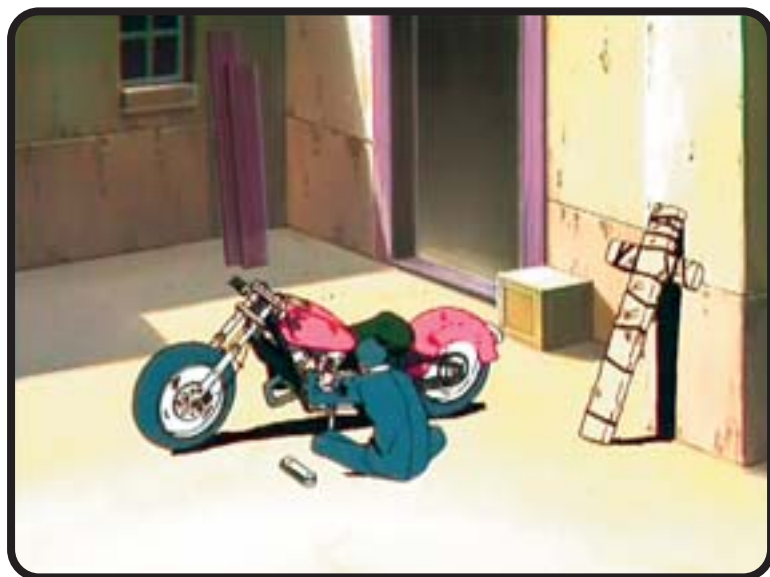

Wolfwood is working on his motorcycle, wishing Vash and Milly understood why he shot Zazie. A figure appears in the street behind Wolfwood, and he instantly senses it. He turns to face the man, his teacher, Chapel the Evergreen. Wolfwood again tries to take the apple from his hands, but without luck. He listens while Chapel chides him for his actions, then reveals he is to kill Vash.

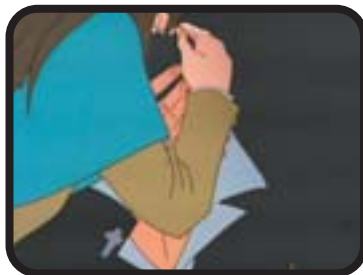

Wolfwood objects, saying that Knives' orders were to bring Vash alive. Chapel tells Wolfwood the order has been changed, and that he is now a Gung-Ho Gun too.

Meanwhile, Caine the Longshot is carrying a huge gun through the desert. When he reaches his chosen spot, he extends the gun and lays it out on the sand. He lies down, his coat changing colours to camouflage him, and waits.



Wolfwood walks towards Vash with Chapel's words echoing in his ears. They look at each other, and Wolfwood walks past without speaking. Later in his room, he realizes Vash is blaming himself for the boy's death. Angry, Wolfwood wishes someone would confront himself, just to put an end to it all.

Milly interrupts, bringing in sandwiches. Wolfwood begins by inquiring why she does not ask him about the boy, then ends up revealing all his pain, guilt, and anger about the dead boy and the choice he has to make in killing Vash. Milly holds him as he cries, comforting him. When he recovers, he says she smells nice and asks her to eat with him. Milly does not return home that night.

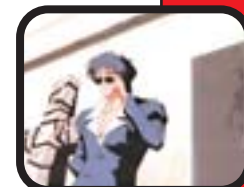

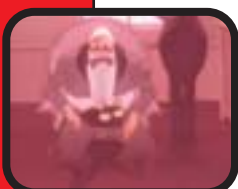
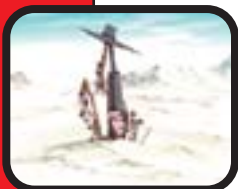
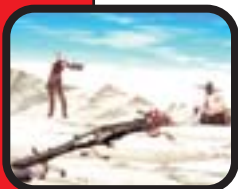
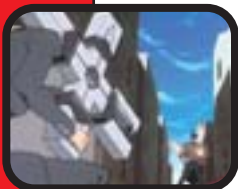

Wolfwood decides then to switch sides, disobeying orders and abandoning the Gung-Ho Guns.

A shot rings out, sending the two men scampering for cover. Wolfwood tells Vash about Caine outside of town, and that there is another Gung-Ho Gun in town as well. He tells Vash to take Caine while he finds the other one. Vash is afraid that Wolfwood means to die, but Wolfwood convinces him otherwise. The two split up and Vash jumps into a car to find Caine.



Wolfwood steps out and finds Chapel; the two open fire on each other. Meryl hears gunfire and searches for Wolfwood, only to find Milly in her pyjamas on Wolfwood's bed. Milly covers her ears and explains that Wolfwood told her to stay there, so she is staying until he returns.

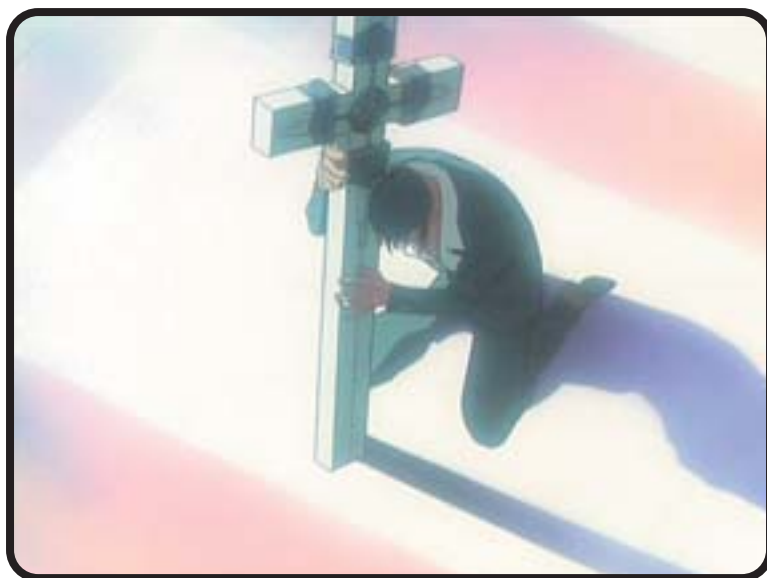

The fighting continues. Vash dodges bullets in the car while Caine tries to hit him. Wolfwood plays cat-and-mouse with Chapel until he realizes Chapel has led him into a bar with alcohol all over the floor — a firetrap just waiting for a spark. Caine finally hits the car, but realizes too late that Vash left his coat in the vehicle as a decoy. His gun blows up in his face when Vash destroys it. Vash tells him to leave, and Caine stands, looking defeated. Before Vash can stop him, however, he puts a pistol to his head and kills himself.

Wolfwood evades the trap and then Chapel and he square off. They both open fire, but Wolfwood hits Chapel, forcing him to his knees. Wolfwood struggles with the decision for a moment, but decides to follow Vash's

example and not kill Chapel. He takes the apple from his teacher and walks away with it. Chapel slumps, defeated. A second later, however, his arm lifts a single gun from the ground and points it at Wolfwood, against his will, possibly through Legato's mind control. Chapel makes a strangled cry, and Wolfwood turns, alerted. Gunfire ensues.



Vash buries Caine and heads back to town. After he returns, Wolfwood walks up to him and tells Vash that Knives is in Demitrihi. Vash is shocked, but before he can ask how Wolfwood knows that, Nicholas is gone, leaving a trail of blood behind.

Wolfwood goes into the church and drops to his knees in front of the altar. He gives a confession before God, though he cannot bring himself to ask forgiveness. He tries to accept death, but ends up fighting it. It is too late, however, and he dies there in the chapel, his cross on his shoulder. Milly's cries rip through the air, echoing through the empty streets as Meryl silently grieves. Vash stands outside, his face impassive except for a furrowed brow.

WANTED DEAD OR ALIVE



Millions Knives

WANTED DEAD OR ALIVE



Legato Bluesummers

TRIGUN

The \$60,000,000,000 Man

EPISODE SUMMARY EPISODE: 24

pass by and listens to them. Overwhelmed by grief, he drops the doughnuts and breaks down in tears.



Back in Tonim Town, Milly sits alone in Wolfwood's room with his cross. Meryl remembers Vash's departure, where she asked him why these things happen to him. He tries to leave, but she will not let him. She forces him to tell her before she will let him leave, so he tells her everything, recounting prior events. He tells her to stay for Milly, and then he walks out the door.

Meryl goes in to see Milly, who insists they follow Vash. Meryl tries to blow it off, but Milly will not let her. Tears run down Milly's face, but she

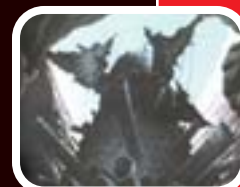

Episode Twenty-Four: Sin

A strange hivelike structure stands in the centre of a deep crevice. A carriage drives across a long bridge toward it, pulled by two thomases. Chapel waits in front of the building.

The carriage stops and Legato steps out, followed by Midvalley. Legato notes that Chapel is unhappy over Legato forcing him to kill Wolfwood. Chapel breaks out his guns and tries shooting Legato, only to have Legato take control of his body and contort it.

Legato passes judgement on Chapel. As Midvalley raises his sax to his lips, the building's doors open and Knives steps out. Knives asks Chapel why he came who explains that he is in Wolfwood's debt because he spared his life — a debt that Chapel must repay. Knives dismisses his answer as illogical. He denigrates the human race, comparing it unfavourably with every other form of life. When Knives finishes, he summons a black sphere of energy that consumes Chapel. Legato promises to inflict eternal pain on Vash.

In LR Town, Vash walks along the sand steamer docks. He purchases some doughnuts and sits down to eat them on the edge of the plaza. He watches people



packs her belongings, pointing out that if they do not work, Bernadelli will not pay them. Meryl is concerned, but unable to object. They pack up and leave.



Vash's grief attracts the attention of two small boys. They ask why he is crying, and he explains that a friend went away. The little boy answers in a different tone of voice, however, telling Vash that Wolfwood was killed because of him. Vash is astonished while the boys tell him that he was the cause; they pass out and fall to the ground. Vash looks around and discovers that everyone in the plaza is unconscious. He turns once more and sees Legato standing there.



Legato taunts Vash, asking if he plans to draw his gun. Legato continues to revile Vash for believing that he has never killed.



To add insult to injury, Legato tells Vash that he now wears Vash's old arm, the one blown off in Vash's fight with Knives in July City. He says he will be waiting on a nearby hill, then turns his back and walks away, confident in Vash's inability to shoot him. As Legato leaves, everyone in the plaza wakes up.

Midvalley the Hornfreak steps out from the porch of a nearby cafe and comments that Vash has also toyed with people's lives. He calls Vash a monster and introduces himself before asking Vash to "play a number" with him. When Midvalley calls Vash by name, the people in the square panic and empty the plaza.

Vash fires and Midvalley plays his saxophone, stopping the bullets in mid-air and causing them to fall to the ground. At the same time, sonic waves

from Midvalley's instrument blow Vash back and damage buildings around him. The two play cat-and-mouse for some time, Vash staying one-step ahead of Midvalley's blasts but unable to affect him in return.

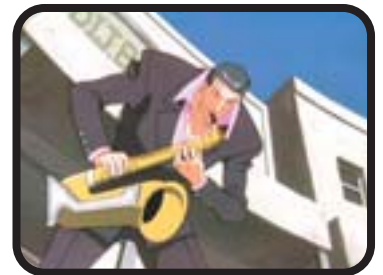

During a pause, Midvalley and Vash talk and Midvalley explains that he has no choice but to work for Knives. A bystander appears in the plaza, interrupting the conversation. He walks stiffly and begs for help, saying he cannot control himself. Midvalley prepares a sonic blast for the man, forcing Vash to take the blow to save him. The same scenario happens twice more, leaving Vash hurt and exhausted.



Outside town, Meryl and Milly have arrived. A man collapses on the sand in front of them. Meryl rushes to

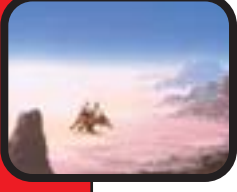
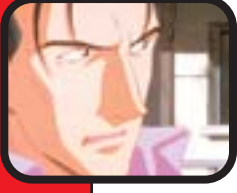
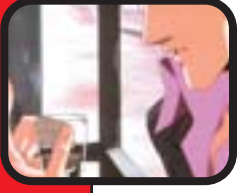
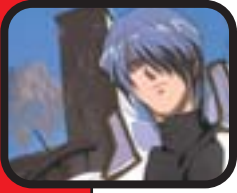



Legato tells Vash he will have to fight or die. When Vash refuses to kill him, the mob throws the bound and helpless Meryl and Milly to the ground. Someone in the mob fires at the girls, narrowly missing them. Legato forces Vash to lift the gun to Legato's head, but leaves control of the trigger to Vash. When that does not work, the mob crowds around the two screaming girls and Legato insults Rem and her values.

give him water, but he grabs her arm instead. When he looks up, he does not appear to be in control of himself.

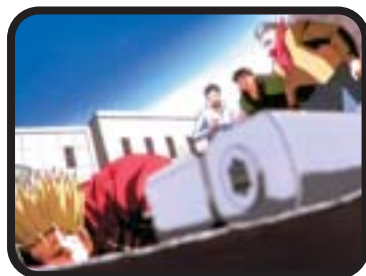

Vash is lying on the ground, battered and bruised, with the three victims frozen helplessly behind him. Midvalley is impressed, but has no intention of stopping now. Vash pops his arm gun, but Midvalley steps on it, holding it in place. Midvalley prepares to kill the three victims when Vash fires his gun, hitting the step nearby. He struggles a little more and raises his gun, hitting a pole and ricocheting the bullets at Midvalley. When the Gung-Ho Gun ducks, Vash jerks his gun free and fires at the saxophone, scoring it with holes.

effect. He remains calm, even when Vash puts a gun to his head, and promises Vash more pain to come.

Legato snaps the fingers of his left hand, activating Vash's gun. The Angel Arm begins to form, but this time Vash fights it back and controls it. Legato is annoyed, so he forces the crowd of townsfolk (who are down the path and under his control) to shoot Vash in the shoulder.

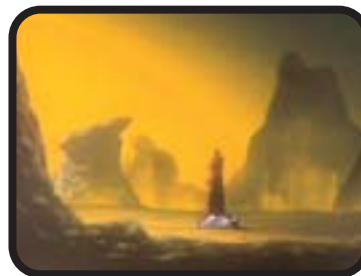

Vash stands, angry. Within himself is a fight between Wolfwood's and Rem's words while the crowd shoots him yet again. The girls scream with the mob closing in, and in his mind he sees Rem walk away. Vash shoots Legato and kills him. Legato's promise to make Vash suffer lingers in the air, and Knives laughs.

Midvalley is not done yet, however, and converts the sax to a gun. One of the gun barrels does not expand properly, though. Vash tries to warn Midvalley, but he fires anyway. The sax blows up and kills him.

Legato stands at the top of the hill, recounting his version of humanity's accidental survival. Vash walks up the path and interrupts him, shooting Legato in each limb with no apparent

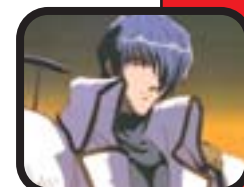
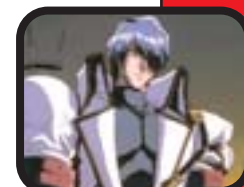

TRIGUN

The \$60,000,000,000 Man

EPISODE SUMMARY EPISODE: 25



Episode Twenty-Five: Live Through

Vash is asleep, dreaming of Rem. He opens his eyes and looks around, unsure of his surroundings. He sits up and realizes he is heavily bandaged. Only then does he remember what brought him there, beginning with Wolfwood's death.

After he killed Legato, everyone fell to the ground unconscious, including Meryl and Milly. Legato died with a

smile on his face, and Vash is in shock over what he did.

Vash is still overwrought with guilt and horror. He hears Meryl, who enters the room and sees him awake. She stares at him for a moment, her expression equal parts of worry and uncertainty, then is suddenly cheerful. She fixes him some food and tells him where they are ... a small town 200 miles from LR. They borrowed the house from the town to care for Vash, and he has been asleep for 10 days.

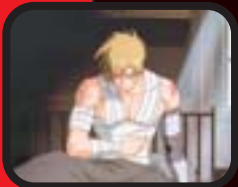

Vash begins to tell her what he remembers, but she suddenly remembers an errand and leaves the room. She stops on the other side of the door, however, to give him time alone. She covers her ears with her hands after he goes into hysterics.

A short while later, Meryl is walking on the street. An elderly man stops to inquire about her friend's health. While they talk, a huge boulder shoots out of the well in the centre of



town and nearly hits Meryl. Milly climbs out of the well wearing workman's clothes, apologizing cheerfully.



During Milly's break, the girls talk. Milly gives Meryl her paycheck and they go together to the store, buying some special food for a celebratory dinner now that Vash is awake. On the way home, Meryl sees Vash sitting on a mesa outside of town.

Vash is thinking about Knives, feeling uncertain about what he should do now. Morally, he feels he no longer has the right to condemn Knives's actions, being guilty of essentially the same thing. Meryl and Milly walk up from behind and ask him why he is up there. He stands and walks a few steps, then falls to his knees. He rambles about going to see Rem and killing someone, before he calls out to Rem and passes out.



At the house, Vash is back in bed, asleep. Meryl expresses guilt for having followed Vash in the first place and blames herself for what happened. Milly talks to her, however, and helps her to see past her regrets and fears. The two girls dedicate themselves to healing Vash and set about working hard to support themselves.



Later, after Vash is feeling better, the two girls leave him at the house while they go to work. A delivery driver pulls



up across the street and sees Vash on the porch. He recognizes him as Vash the Stampede, and speeds away quickly. That night, Vash and Meryl sit under the stars outside of town. Meryl suggests he could stay here permanently, and he surprises her by saying that sounds pretty good.



The next morning, Meryl is late to work after staying up the night before. She arrives at her workplace to find Milly surrounded by angry men. The townspeople turn against Meryl and Milly, accusing them of bringing Vash into their town. They promise the pair's wellbeing, though they will not say the same for Vash. Meryl runs to the window and sees a truck race by, dragging Vash behind it.

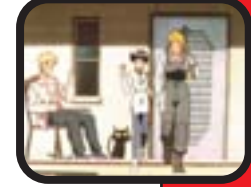
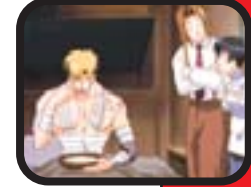

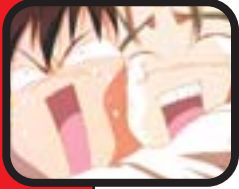

The truck stops and the driver disembarks. He yells at and abuses Vash, who endures the punishment silently. The gathered throng almost believe they have the wrong man because Vash does nothing to save himself. Vash tells them, however, that he is Vash the Stampede, a killer.



A man kicks Vash back to the ground and pulls out a gun. He shoots around Vash's head and demands that Vash smile and die like a man. Vash does not react. Meryl and Milly break through the crowd and run to Vash, lifting him to a sitting position. Meryl tells the driver that Vash tries to protect those around him, but the man refuses to listen and knocks her away.

Meryl insists the man is wrong. The driver pauses, then asks why Stefan had to die so horribly. He demands an



answer from Vash, who does not respond. The delivery man cries. Meryl stands and tells the man what Vash is really like. The driver fires past her, however, barely missing; he insists he and the other townspeople have a right to shoot Vash after what they have suffered. Meryl replies that no one has the right to take the life of another.

As Meryl speaks to the man, Vash looks up for the first time. He sees Rem in Meryl while Meryl walks towards the man, hands outstretched, trying to convince him to put down the gun. The man tries to back away from her, but she continues walking. She says the violence must stop, and takes the gun from the man's hand while he weeps.

After the other people leave, Vash speaks with the girls. They tell him they

just did what Vash would have done, an answer that gives him an inspiration. He hugs Meryl and cries for joy. Vash realizes a mistake is just that, and that it is possible to start again if you accept what you did was wrong. Mistakes can be corrected. He forgives himself for his failing and moves on, determined to try and rectify his errors.



The next morning, Vash dresses and readies himself. He walks outside where Meryl is waiting, and they say goodbye. He thanks her, and she is about to speak when Milly runs up with Wolfwood's cross. She gives it to Vash, saying Wolfwood would have wanted him to have it. Vash puts it on his back and walks into the desert, looking back to wave. Meryl cries as she watches him leave, telling Milly that she could not say anything. Milly tells her to say everything when he returns.

Vash walks away, remembering Rem's last words. He believes he finally understands. He will save Knives.



TRIGUN

The \$60,000,000,000 Man

EPISODE SUMMARY EPISODE: 26

this is why Knives wants to kill people, he says yes. Knives says he kills spiders to save butterflies. Wash, however, still does not accept that answer.

That night, Wash walks up to his sleeping brother with a large rock. He wants to kill Knives, but he cannot bring himself to do it. He throws the rock away and cries himself to sleep in the moonlight. A few months later, the twins are near a crashed ship. They watch a riot break out over water supplies. Knives activates a plant next to the people, possibly intending to detonate it. Wash distracts him, however, asking what he was doing. Knives does not explain.



Episode Twenty-Six: Under the Sky So Blue

Wash walks through the desert, with Wolfwood's cross on his back. He comes to an oasis of trees and grass in the middle of nowhere, with Knives sitting at a table drinking wine. Knives waves to him, but Wash simply pauses at the edge to set the cross down. They remember the history of their relationship. Neither one speaks.

The scene flashes back 130 years ago. Wash and Knives are children, and the scene recounts the two after the pod crash on the planet. Following the fight between the two boys, Knives tries convincing Wash to join him, pointing out there really is no alternative. The next day, Knives and Wash are walking through the desert. Knives is happy about the planet's harsh conditions, believing humans have little chance for survival. Wash indicates they can survive if they use the power plants, and Knives concurs, calling it "leeching off the living blood of our siblings." When Wash asks if





Ten years later, the twins arrive at the ruins of a ship. Knives says he is going in to retrieve something he left behind and tells Vash to wait there. One year later, Vash is still waiting. Knives exits the ship and walks to the edge of a mesa with barely a word to his brother. As Vash catches up, a huge explosion happens some distance away. Knives evidently caused it, but Vash did not see how.

Knives tosses Vash a gun, the silver twin to the black one in his hand. He calls them their "brethren," and explains that Vash and he are going to use them to wipe mankind off the planet. Vash refuses.



Determined to stop Knives, Vash tackles his brother. They roll down the slope, dropping both guns while grappling. They each grab for one, but Knives comes up with one first. Trying to



bully his brother, Knives mocks both Vash and Rem. He lowers his gun to his side while Vash stands, gun in hand.



Vash points the gun at Knives and tries to reason with him, to make him see that humans are alive and thus worthy of protecting. Knives refuses to agree, however, and before Vash realizes what he has done, he shoots Knives in the leg. Vash freaks out, grabs Knives's gun and runs away, leaving Knives there on the hill, wounded.



Two years later, Vash collapses in the desert. He wakes up on board the floating ship, where he stays for some time. 80 years later, he locates a relative of Rem's on the planet. The man lives in July City, and Vash goes find him and tell him about Rem.

When Vash arrives, Knives is standing over the body of the scientist. Vash is stunned, while Knives boasts of cutting the last of Vash's ties to Rem. Vash grows angry, but Knives is unconcerned. He tries to convince Vash that the last hundred years of pain and scarring Vash suffered is proof that humans are worthless.



Vash tries again to convince Knives of the value of all life, to no avail. They both draw and Knives shoots, blowing Vash's arm off. Knives activates Vash's Angel Arm, trying to force Vash into killing the humans. Vash points it at Knives instead, who practically dares Vash to shoot him again. Vash fires, catching Knives full force in the blow. July City is destroyed in the aftermath.

Sometime later, Knives is upside down in a tank, regenerating. Legato is

Finally, the two stand exhausted, Angel Arms gone. Knives shoots Vash in each limb until he falls. Knives kicks him over and retrieves the revolver from Vash. He activates both Angel Arms and points them at Vash.



Vash closes his eyes, having nothing left. In his head, he hears Wolfwood's voice calling him an idiot and telling him to use the cross. He finds the cross lying next to him under the dust. Vash shoots Knives with the cross while the two guns are charging, breaking the Angel Arm containing Vash's gun. It flies into the air and Vash catches it. He shoots Knives repeatedly. Knives, screaming, drops the black gun and falls.

In town, the well strikes water. Everyone is happy while water shoots into the sky and rains down on the heads of the townspeople. Milly asks if Vash will return, and Meryl says that he will; he promised not to keep her waiting.

In the desert, Vash stands over his bandaged brother and looks up into the sky. He drops his gun, sheds his coat and picks Knives up gently. He walks back to town with his brother over his shoulder.



there with Vash's arm, promising Vash will suffer. The Gung-Ho Guns are formed, and they all fight Vash and lose. Augusta City is destroyed. The floating ship crashes. Brad dies. Zazie dies. Caine dies. Wolfwood dies. Midvalley and Legato die. Knives laughs.

The flashbacks end, and the twins are back in the present day. Knives asks if Vash enjoyed living as a human. Vash smiles and says it was wonderful, then draws his gun.



Knives and Vash fight each other, guns blazing. They are equally matched, though their specific tactics differ slightly. Knives draws first blood by shooting Vash in the shoulder. Knives activates his Angel Arm, pointing it at Vash and firing. A blinding globe covers the area. When it clears, the trees are

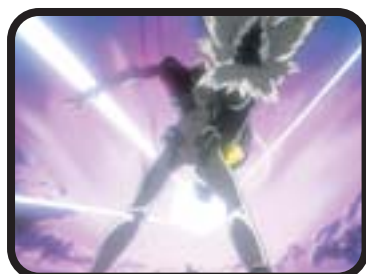

gone but Vash and Knives are both standing, each with fully expressed Angel Arms. Knives is shocked; the guns cancel each other out.



The two brothers speak telepathically. Knives realizes Vash will never agree to help him, regardless of what he does. They each confirm their opinions on the matter then fire their guns, making a globe between the two that swirls black and white.

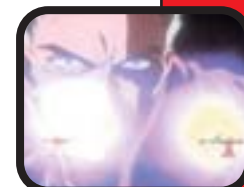
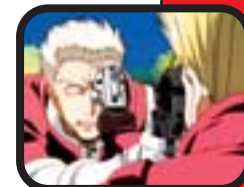

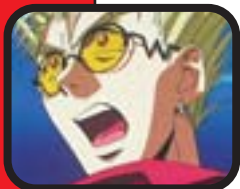

Vash the Stampede

Vash the Stampede, also known as “The Humanoid Typhoon,” is a drifter who roams from town to town on the planet of two suns, a desert planet. The Feds want him for the murder of Count Vasquez and suspicion of Class-G weapon damage. To ensure his capture, the Feds have placed a \$\$60,000,000,000 bounty on his head, dead or alive. He tops the federal Most Wanted List, and is one of the best gunmen on the planet. His twin brother is Millions Knives, and both are members of a species known as “the beings who exist outside of time.”

Vash looks like a normal human, with spiky blond hair and blue-green eyes. He is tall and slender, standing between 1.8 and 1.9 metres tall. He always wears a long red trenchcoat with the left arm missing. He also wears brown full-length gloves and boots, fastened along their length with straps and silver buckles. He carries a customized silver long-barrel Colt-45 on his right hip, and his left arm is a concealed cybernetic limb with an integral hidden gun. He possesses a number of small items of lost technology, including a pen-shaped transmitter, which allows communication over long distances.

Vash uses three weapons: his revolver, his fully automatic cyberarm gun (which is upgraded in Episode Twenty to a significantly more powerful model), and the Angel Arm, a weapon he creates by metamorphosing his arm and revolver into a single weapon. The Angel Arm is an incredibly cataclysmic weapon, and was the force that destroyed July City and Augusta City, as well as punching a hole in the fifth moon.

Vash’s past is shrouded in mystery. He has some memories of his childhood, but nothing else until the city of July’s destruction. He appears to be in his early- to mid-twenties, but his actual age is unknown. He has no known family, though he has an unexplained connection to a possibly deceased woman named Rem, who appears in his dreams.

Vash possesses a number of unusual powers. The first is longevity since there are indications that he has not visibly aged in twenty years. The second is mild precognition, an ability that alerts him when he is in imminent danger and allows him to avoid the worst of the incoming damage. The third is telepathy, used to communicate with Legato Bluesummers and possibly with the plant in Inepiril City. He can drink to excess with little to no ill effect, except that drinking too much almost always causes him to throw up.

Vash is highly skilled in combat, elevating it to an art. He has an unusual understanding of lost technology, including archaic computer systems, robotics, gadgets, and locations. He can dodge and catch bullets, and can even throw rocks to deflect speeding bullets from their course.

Vash is a friendly person who enjoys socializing and playing with children. He is sensitive, with a philosophical bent he keeps hidden most of the time. Only in his serious moments — when he is either alone or trying to help someone —



does he allow that side of himself to surface. The rest of the time he affects a comedic, inept demeanour, possibly to keep his identity hidden. This deception encourages others to underestimate him, as evidenced by Meryl’s reluctance to recognize him as Vash the Stampede.



Vash feels very deeply about the sanctity of life, a belief that is connected with his relationship with Rem. He goes out of his way to avoid killing, regardless of the cost to himself, and weeps openly when confronted with the suffering or death of others. He will not attack someone else unless circumstances force him to do so, and even then he chooses to inflict the least harm possible. While this jars with his reputation, he still manages to connect with a surprising number of people on his travels. Despite his caring nature, the authorities all too eagerly blame him for damage caused by others in his vicinity. He assumes responsibility for protecting those who cannot protect themselves.



Vash is also haunted by an unexplained sadness and driven to find an unidentified man, his nemesis. Presumably this is the man Legato Bluesummers calls Master, and the man who hired Monev the Gale. It is worth noting, however, that in the dubbed version of the episode “Hard Puncher,” Vash says “... until I find this man you’re



looking for ...,” while the subtitled version says “... until I find *him*” The subtitled version is the correct one, indicating someone unrelated to the events in Inepril City.

Vash tries not to get close to anyone, for fear that someone he cares for might come to harm by virtue of being around him. His favourite tactics are unexpected departures and an extraordinary effort to annoy people. Despite these measures, however, some people have stayed close to him. Whether by skill, determination, or fate, these people have broken through Vash’s attempts to keep others at bay. His allies are Meryl Stryfe, Milly Thompson, and Nicholas D. Wolfwood.



Vash wanted no part of Meryl and Milly when he discovered they had been assigned to observe him. He did not like the idea of someone watching him and did not want responsibility for their continued safety. He tried to leave them behind several times, but they always manage to catch up through a combination of dumb luck and keen strategy.



Vash is grudgingly fond of the “insurance girls,” as he calls them. While Meryl often bears the brunt of his irritation and odd sense of humour, he willingly goes out of his way to ensure



both Milly and she are safe. When they first met, he persistently made comments designed to send her into a rage. As the series continued, though, he irritates her less often. He slowly treats her with respect, if not open affection, and does his best to protect the innocence he sees in both Milly and she. He also entrusts Meryl with some of his secrets. While his actual feelings for her remain unsaid, his acceptance of her presence — especially in the face of trouble — is a significant change.

Vash is more openly fond of Milly, in an “elder brother” sort of way. Milly’s intuitive leaps have caught him off guard more than once and he has quickly learned to respect them. While his standard tricks would fool Meryl easily — at least in the beginning — he is rarely able to sneak anything past Milly. Her choice of weapon (a stungun) meets with his approval, as does her child-like way of dealing with the world. Milly can easily manipulate Vash because of this. All it takes is the threat of her tears to convince Vash to do something, even if he would ordinarily be reluctant.

Wolfwood is another matter entirely. Although he claims to be a wandering priest, Vash realizes there is much more to him than that. He was wary of Wolfwood at first, being uncertain of his motivations, and knowing only that the man has a secret. He eventually trusts the priest, however, after seeing his kindness to others on a number of occasions. The two still irritate one another periodically, but Vash seems to sense a kindred spirit in the wandering priest.

Vash’s internal struggle between his vow never to kill and the violent nature of his world is the focus of the second 13 episodes. Put to the test by the ruthless Gung-Ho Guns, Vash edges ever closer to violating his moral code until finally, he must choose between killing Legato or watching Meryl and Milly die. Unable to see another way, he kills Legato to save his friends.

Legato’s death, the destruction of Augusta City, and Wolfwood’s demise all push Vash over the edge. He feels he deserves to die for his actions, and loses all joy in life. He is lost until Meryl risks her own life to save him, using love and reason to convince his would-be killer to surrender. He then finds his way through the spiritual darkness entrapping him, and understands what Rem meant when she said that you can always start again; you can always fix your mistakes. From the depths of despair, he finds the courage to confront Knives and correct his blunders.

The biggest change in Vash’s relationships is with Meryl. Whereas he had seen her as a friend previously (and thus a liability against the Gung-Ho Guns), she is the one who helps him find his way again. She nurses him, cares for him, allows him to grieve, and gives him the inspiration to find his own answers. He sees Rem in Meryl’s conviction and respect for life, but he also sees Meryl from that point on as herself. He presumably returns to her after defeating Knives, fulfilling his promise to her and possibly starting a new phase of their relationship.

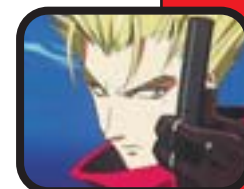
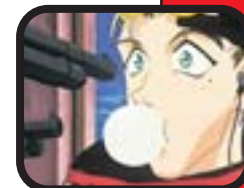
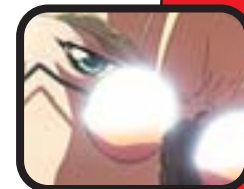

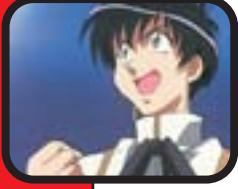
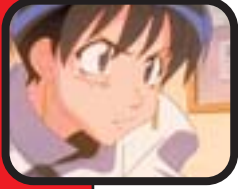
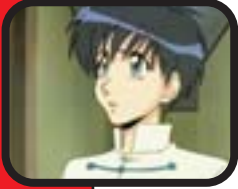
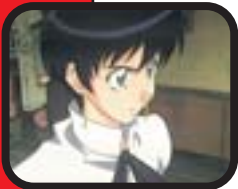

Meryl Stryfe

Meryl Stryfe, also known as Derringer Meryl, is an employee of the Bernadelli Insurance Society. She is a disaster investigator for the Society, assigned to keep Vash the Stampede under 24-hour surveillance and prevent him from causing any further property damages. Meryl's companion and subordinate is Milly Thompson, who functions as her secretary.

Meryl is an attractive, petite woman, standing approximately 1.5 metres tall. She has short black hair and dark grey eyes. She dresses in professional attire, primarily a white jacket with a mandarin collar, short white skirt and navy blue leggings. She also wears a white cloak with a navy-blue lining. Concealed in the lining of the cloak are fifty one-shot Derringer pistols, from whence she earns her nickname. She is in her early- to mid-twenties.

The series does not discuss Meryl's past, aside from her time with Bernadelli. Since she does not seem to have any specific issues about her past, it is reasonable to assume that her upbringing was traditional and that it has very little impact on her current situation. Her initial focus was on her career and job performance, but through the series' progress, situations force her to come to terms with people around her on a personal, rather than a strictly professional, level.

Meryl excels at middle-level management. She knows the ins and outs of insurance and law, and does not hesitate to use them to influence others. Her personal nemesis is paperwork, and Bernadelli requires she fill out lengthy reports immediately following every major event. She is conscientious about accomplishing this promptly and competently, however, no matter how unpleasant she finds the task. She also stays in excellent physical shape and is capable of climbing, jumping, and tumbling through obstacles as necessary in the line of duty.

As a field operative on the sometimes-violent planet she lives on, Meryl has been combat trained. She is at her best with her guns but is competent even without them. She is extremely fast, able to draw and shoot at lightning speeds, and is equally proficient with either one or two guns at a time. Meryl seems to prefer a supporting role in combat, and does not resort to her weapons unless other, more diplomatic tactics fail.

Meryl begins the story as a stereotypical career woman. She is quiet and capable, a person who prefers logic and reason to emotion. Accustomed to being in control of herself and her surroundings, her calm facade slowly cracks when Vash comes into her life. Throughout the beginning of the series, Meryl is constantly under stress when the world ceases to work the way she thinks it should.



After Meryl finally accepts the man she sees as a skinny goofball is actually Vash the Stampede, she undergoes a change. She looks past the surface to see what lies underneath, a skill she had not used previously. While she does not develop it fully by the end of the first 13 episodes, she is much more in tune with her surroundings in the end. She maintains her devotion to her job, but her world now extends further than her paperwork.

Meryl is still an innocent in many ways. Although she is working on her empathy and people skills, she remains ignorant of the real evil existing in the world. She still believes that good and the Bernadelli Insurance Agency will always triumph, but she does not seem to understand that sometimes victory has a cost. From the beginning she stumbled into situations that should have killed her, unaware of the surrounding danger. With a mixture of beginner's luck and skill, however, she escapes unharmed — though for how long is anyone's guess.



Through her business training, Meryl learned that courtesy is necessary in dealing with others. She has to lose her temper completely before yelling at a stranger, though polite bullying is well within her capability. She takes her role as official observer seriously, and does not hinder Vash publicly unless it comes into conflict with her duty to prevent damages. She is discreet and kind, if a bit introverted. Though she can be abrasive with people who refuse to behave responsibly or listen to reason, she does her best to learn from her mistakes.



Meryl has very few personal friends in the series. Milly and she are close, but they are primarily together because of their assignment. Vash is very different from anyone to whom she is accustomed, but she is required to stay near him and that means enduring his company. Wolfwood alone stands completely outside her duties, but his ties to Vash and Milly bring the two of them together in their common concerns. Her relationships with them and her efforts to move beyond the restrictions of duty are what bring her out of her shell over the series' duration.

Milly is Meryl's subordinate and friend. Where Meryl is focused, Milly is carefree. Where she is uptight, Milly is a calming influence. Meryl and Milly are not simply co-workers; they are also genuinely fond of one another. Meryl treats Milly like an occasionally irresponsible younger sister. She is protective of Milly, but relies on her at the same time. Milly has always saved her from the worst in herself, and gives Meryl much needed stability in chaotic situations. In Meryl's thankless position as straight man for the group, Milly gives her a break just when she needs it most.



Vash is another question entirely. He started off as a mystery, quickly became an irritant, switched to being a responsibility, and then miraculously changed into someone Meryl respects and possibly even likes. Meryl's feelings toward Vash soften considerably toward the end of the first half of the series. In understanding him and the reasoning behind his actions better, her opinion of Vash seems to improve. By the end of the first 13 episodes, she willingly goes out of her way for his sake in ways she would not have considered previously.



Meryl has the least interaction with Wolfwood, though there seems to be no conflicts between them. The only force binding them together is their common attachment to Vash and Milly. In many ways, Wolfwood and Meryl are like mirror images, on opposite ends of the spectrum in more than just their appearance. While they are both professionals, Wolfwood is unstructured and carefree. He uses his gun where Meryl tries diplomacy, and joins Vash in his romantic notions of love and peace. In addition, Wolfwood keeps secrets where Meryl is an open book. Her innocence, however, keeps her from suspecting he is more than he seems. Whether Meryl will come to know him better as time passes remains to be seen.

Meryl begins the series as a control-oriented, repressed businesswoman. By the second 13 episodes, however, her demeanor changes completely. Beginning in Episode Fourteen, Meryl realizes that following your heart is as important as following orders. She takes risks when necessary and goes out of her way to help people, even when it is technically outside the bounds of her assignment. Her relationships with Milly and Vash also grow, evidencing some of the most significant changes inside herself.

Milly is Meryl's best friend, if only from the months spent travelling together. In the first half of the series Meryl regards Milly as warm and caring, but hopelessly unable to assume responsibility or care for herself. This opinion changes by Episode 14, when Milly acts to protect an elderly couple without regard for her own safety. Meryl grows to appreciate Milly's steadfast belief in doing what is right, regardless the situation.

Meryl also develops a deep respect for Milly's wisdom and grace. She always sets her on the right path when Meryl is torn by her feelings and afraid to act. When pain and prejudice blind Meryl, Milly sees through to the simple truth behind Meryl's confusion. She is awed by Milly's strength and humbled by Milly's insight, turning their relationship into a true friendship between equals.

Meryl's relationship with Vash, however, is her greatest change. At the end of the first 13 episodes, Meryl comes to understand there is much more to Vash than she originally understood. In Episode Sixteen, "Fifth Moon," she realizes she has deeper feelings for Vash, enough to defend him in front of strangers. She realizes she cares for him enough to follow her heart and follow him to Augusta.

Once in Augusta, Milly must drag Meryl away from the city's destruction while Meryl insists she must be with him. Frightened for Vash, without concern for her own safety, her true feelings for Vash unfold. She cries when she believes him dead, is happy when she discovers he is alive, and grieves silently with him over his forced actions. Meryl lives from her heart in Episode Sixteen, and spends the remaining series trying to care for Vash and tell him how she feels.

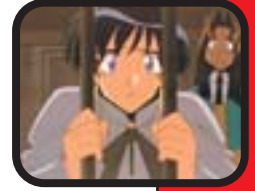

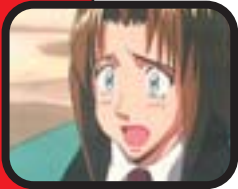
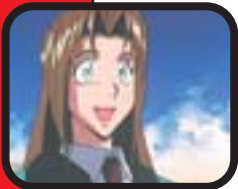
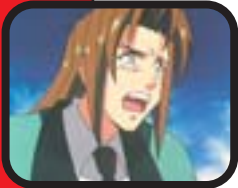
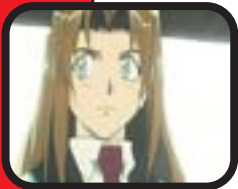

Milly Thompson

Milly Thompson, also known as Stungun Milly, is an employee of the Bernadelli Insurance Society. She is a disaster investigator assigned to assist Meryl Stryfe in keeping Vash the Stampede under surveillance and prevent him from causing further property damage. She acts as secretary and erstwhile companion to Meryl, who is her supervisor.

Roughly, Milly stands a tall 1.7 meters, with long light-brown hair and blue-green eyes. She is a big girl, only a few centimetres shorter than Vash and Wolfwood — meaning she towers over Meryl. She typically dresses in men's clothing, including a button-down shirt, brown necktie, tan slacks with suspenders, and men's shoes. Over it all she wears a tan and teal duster, the teal being the only reflection of femininity in her clothing. Her favoured weapon is a Gatling-type stungun, which she theoretically wears beneath her coat.

Milly is the youngest of ten children. They were apparently a close family, and Milly remains deeply attached to her siblings. Apparently, one of her older sisters was a very big influence in her life, and Milly often quotes her when explaining her decisions. Technically her position at Bernadelli appears equivalent to Meryl's, but she shows Meryl the respect due someone of higher rank.

Milly's principal duties seem to be a cross between companion, bodyguard, and secretary to Meryl. Her skills lie primarily in keeping Meryl from having a stroke, as well as being congenial and amiable with folks. She is a surprisingly good cook, probably stemming from her childhood duties, and she shows a unique talent for chess. She has no tolerance for alcohol, however, becoming intoxicated after only a few drinks.

Milly's greatest talent, however, is making frighteningly accurate leaps of logic. While she is very intelligent, her reasoning is more intuitive than logical. She is sensitive to the thoughts and feelings of those around her, and can often discern what others try to hide. At the same time, she rarely realizes her own actions. She seems unaware that what is obvious to her is not apparent to other people. As a result, she rarely backs her statements with any proof. This means others will sometimes brush her comments aside, but she is almost always proven correct later.

In combat, Milly's weapon of choice is a stungun (a contraption about a metre in length) that she hefts around like an oversized purse. While it looks like a rifle-mounted Gatling gun, it actually fires steel rods that open into large heavy X-shaped projectiles roughly 30 centimetres across. The gun typically unleashes two shots at a time, and she never misses with it. It never takes more than one volley to take down an opponent, a fact that has impressed Wolfwood more than once.

Milly is Meryl's opposite in personality. Whereas Meryl is an exacting professional, Milly is the casual one. She is happy, warm, and easygoing ... at

least until someone she cares for is in danger. Loyal to a fault, she will protect those to whom she feels attached until the bitter end, regardless the cost to herself. Milly is a very giving soul, ready to help anyone in need. She lives according to the principle of "Do the Right Thing."



Unlike Meryl, Milly's job seems to be something that pays the bills. She does not approach Meryl's devotion to work. At the end of the first 13 episodes when things have suddenly become more dangerous, she jokingly notes that she cannot let Meryl follow Vash without a chaperone. This seems to indicate Milly is either aware of Meryl's growing attraction to Vash, or it may be an innocent comment concerning Meryl's conservative tendencies.

Milly's motivations are few. She is content to do her job, following Vash around and taking orders from Meryl. Sometimes, though, she finds someone who needs her help more. On those occasions, she helps whomever she feels needs her most, regardless her duties to the Bernadelli Insurance Society. She relies on the principles she learned growing up and uses them to guide her through her travels.



Part of Milly's charm is her bubbly naiveté. Her innocent nature, however, is different from Meryl's. Meryl is innocent because she is largely unaware of the dangers, whereas Milly sees the intent behind people's actions. She may not be consciously aware of its significance, but she knows it is there. She simply relies on the goodness within herself and others to triumph, and she does so with such fervour that she is right more often than not.



Milly's child-like behaviour is not restricted to the principles that guide her. She is quite capable of using tears and pouts to force people into changing their minds, if she believes it will work and if other methods fail. Cruelty may anger her, but a single kind word or gesture will restore her to happiness. While she has a longer attention span than that of children, she is easily distracted by things she enjoys. She also has relatively few inhibitions, a trait that becomes even more marked if she is intoxicated.

Milly is bound to Meryl, Vash, and Wolfwood by more than just duty. She stays not only because of her job, but because of her affection for them all. There is a hierarchy of loyalties in her mind, though. Meryl is Milly's supervisor, companion, and friend. While she obviously respects Meryl, she also likes her. Milly has seen the best and worst of her partner during their months together. She happily puts up with Meryl's tempers and fits, doing paperwork and generally making herself useful. While Meryl would like to be completely self-sufficient, she needs Milly to provide balance. That need is one of the things drawing Milly to Meryl, and makes it safe to assume that Meryl is Milly's first loyalty.



Vash, or Mr. Vash the Stampede as Milly sometimes calls him, has two claims on her. The first is that Bernadelli assigned her to watch him. She is not irresponsible, however child-like she might seem. She knows her duties to her employer, and she will fulfill them until such time as she chooses to quit. The second is Meryl, who is determined to follow Vash whatever may come. Milly



likes Vash and enjoys his company. She appreciates his humour and boyish impulses, much as one child knows another. She sees his darker side, however, and recognizes his abilities. For all that the reasons she seems fond of him, she knows that he does not need her.

Wolfwood, on the other hand, has no claim on her. Despite that, Milly seems drawn to him. He notices her, flirts with her, and praises her abilities. She naturally responds to this, especially since she normally stays in Meryl's shadow. Milly notices Wolfwood's kindness to others, and seems to suspect a depth to him that he would like to ignore. While she does not know about his past, whoever he might have been is unimportant to her. She judges people on face value, not on past actions. At the same time, however, she seemingly acts as proof that people can go out of their way for others — something that he perhaps needs as well.

By the end of the first 13 episodes, Wolfwood has left the group, possibly for good. Milly is saddened by this but not overly distressed; this may indicate she was not as attached to Wolfwood as previously indicated, or perhaps she knows she will see him again.

When the series begins, Milly is little more than an overgrown child. She is fun loving and open, but Meryl considers her incapable of handling responsibility. Milly defers to Meryl in almost everything, and is highly impulsive.

Milly's pattern of behaviour changes in the second half of the series. It begins in Episode Fourteen, when she risks death to stave off attackers accosting an elderly couple. Although she has followed her heart before, she has not risked overwhelming odds to do what she feels to be right. The following positive reinforcement from Meryl strengthens Milly's resolve. With that in mind, she disobeys Meryl in Episode Sixteen, thus saving Meryl's life.

Wolfwood's attentions also play a big part in her transition from a child to a woman. She falls in love with Wolfwood, seeing the nobler aspects of his personality. He treats her with respect and shows a frank attraction towards her, culminating with them apparently sleeping together in Episode Twenty-Three, "Paradise." After Milly spends the night with Wolfwood, it becomes clear her priorities have changed. She informs Milly she intends to follow Wolfwood's directions regardless of what Meryl says, a profound change from the Milly of the first 13 episodes.

After Wolfwood's death, she is no longer impulsive or childish, behaving instead in a straightforward and responsible manner. Instead of allowing her loss to wound her, however, she finds a way to heal. She still finds joy in life, but that joy is tempered with a realization that life is sometimes far too short. Milly encourages everyone to live from his or her heart, and to experience each day to the fullest. She is Meryl's most adamant supporter and her ever-present source of strength.

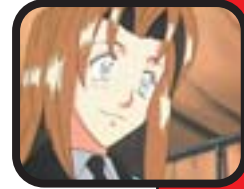
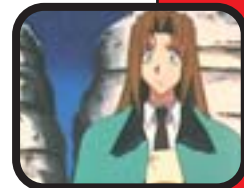



Nicholas D. Wolfwood

Nicholas D. Wolfwood, often called Mr. Priest by Milly, is an itinerant preacher who drifts from town to town. In addition to ministering to lost souls, he raises money for the orphanage his church supports. He acts as a friend and companion to Vash, but has secrets of his own as well.

Wolfwood is roughly the same height as Vash, 1.8 to 1.9 metres tall with a lean, lanky frame. He has black eyes and black hair, which looks in perpetual need of a haircut. He typically has some stubble on his chin, as though he has not shaved recently. He wears a white button-down shirt habitually opened halfway down his chest, black pants, and a simple black suit jacket with cross-shaped cufflinks. He carries a cross that is larger than he is, wrapped in canvas and tied up with black straps. He is in his mid- to late-twenties, and chain-smokes cigarettes.

Wolfwood claims to have had an uneventful life as a preacher, collecting money for an orphanage located a short distance away from December City. His abilities and attitudes, however, leave that in question. He seemingly belongs to a Protestant denomination of Christianity, but the series never outlines his specific religious beliefs. Milly suggests he is an ex-gunman, but he denies the possibility.

Aside from Wolfwood's charitable works, there is very little that is "priest-like" about him. He smokes, drinks, flirts with attractive women, and kills people when he must, all of which seem decidedly non-religious. He toes a fine line between councillor and shyster, offering confessions in exchange for a small donation to his cause. He carries a miniature church-shaped box called the "portable confessional," which he places on the heads of anyone who wants to confess their sins (after they place a coin in the steeple of course). While this tactic never actually works in the beginning of the series, it cannot be assumed that it never has. In addition to raising money for the orphanage, another of Wolfwood's tasks is to bring the abandoned and orphaned children he finds to the orphanage.

Wolfwood's more obvious talents lie in his combat abilities. He is nearly as good with a pistol as Vash, and possibly even better at fighting with two guns. The cross he carries is nicknamed the "Punisher Cross," and holds at least eight pistols within its arms. It is heavy enough that it takes three normal men to carry it, though Wolfwood tosses it around like it weighs nothing.

Wolfwood is outgoing and friendly, a practical person with a dry, sardonic sense of humour. He spends most of his time scraping for money and plying his trade as a pastor, which apparently does not pay well. He is sensitive and insightful, traits he uses to connect with those in trouble or in need. He cares very little of what others think of him, so long as they do not meddle in his personal affairs. He enjoys playing with children, a trait Vash and he share.



In his beliefs, Wolfwood is a practical version of Vash. He believes in protecting the innocent, though his definition of innocent seems tailored to attractive women and children. He agrees with Vash's philosophy of "Love and Peace," but does not extend that consideration to those who prey upon others. If someone uses violence against him, he will kill without hesitation to protect himself or those in need.

This outlook conflicts with Vash's abhorrence of death and suffering, something they have clashed over more than once. Wolfwood dislikes leaving enemies alive who might catch up with him later, though he does not kill lightly or with pleasure. Still, out of respect for Vash's beliefs, Wolfwood modifies his actions even though he does not completely agree.



Children and their safety are among Wolfwood's primary concerns. He reacts violently when someone threatens or harms a child, ostensibly due to some experience in his mysterious past. Another of Wolfwood's motivating forces is his need to help others. When Wolfwood encounters a bad situation, he feels compelled to fix it however he can. His resolution methods usually involve either money or violence, making poverty and fear his main targets.

To that end, Wolfwood is constantly trying to raise money, either for his latest cause or for the orphanage he supports. He is a determined man, and there is very little he will balk at that makes money short of stealing. Although he does not pay much attention to morals, he tries to follow his ethics. It is in that respect that Vash and

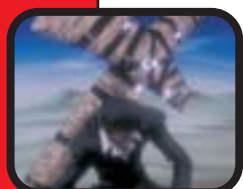

Milly make him uncomfortable; they adhere to their beliefs of right and wrong more strongly than he does, regardless what he tells himself.



Wolfwood's friendship with Vash is surprisingly strong, given the differences in their beliefs. Each recognizes the other's predatory prowess, as well as their shared determination to protect those who might otherwise be "prey." Wolfwood sees the emotional scars Vash carries inside, and seems to want to help him with them. At the same time, he is willing to wait until Vash asks for help, whenever that might be. Vash and Wolfwood work well together, though there is a competitive undercurrent between them. There also seems to be hints of anger toward Vash that surfaces from time to time when they fight. Whether Wolfwood is simply swept up in the heat of battle or feels something more serious, however, is impossible to say. Wolfwood does state that Vash reminds him of everything he hates about himself. That statement leaves open the possibility that something deeper is transpiring.



Wolfwood's feelings for Meryl are simple and straightforward. There are no problems between them, and they seem to mutually respect one another. He feels she is a little too strait-laced, but that only emerges when he gives Milly alcohol and Meryl becomes concerned. They do not have much in common aside from Vash and Milly, but they do not seem to clash in any meaningful way.

Milly is another problem for Wolfwood. He admires her for her conviction and compassion, things he feels he lacks from time to time. He



seems attracted to her, and flirts with her on the bus when they first meet. Wolfwood admits she does something to him, and when she is around he does things he never would otherwise. At the same time, he is not looking for a steady relationship. He believes that Vash and Milly share much in common, qualities that make him feel uncomfortable with his own actions and beliefs. When he leaves in Episode Eleven, he does not tell Milly goodbye, although he apparently talks to Meryl and Vash. While this could indicate something special about their relationship, the first half of the series does not confirm anything.

Nicholas D. Wolfwood masquerades as a wandering itinerant preacher. In reality, he is the protégé of a member of the Gung-Ho Guns, Chapel the Evergreen. Chapel assigned him to protect Vash the Stampede and guide him to a meeting with Knives. He acts as friend and companion to Vash the Stampede.

Wolfwood was orphaned at a young age. He found himself the ward of a man who apparently mistreated the boy. He picked up a gun for the first time at the age of seven and killed his tormentor with a single shot. After shooting the man, Wolfwood came under the care of Chapel the Evergreen, a Gung-Ho Gun who trained him ceaselessly to become a gunfighter. He grew up under Chapel's tutelage and continued carrying out Chapel's requests until the day before his death.

Wolfwood founded an orphanage soon after reaching the age of majority so other children would not endure the hardships he did. He travelled, before meeting Vash, looking for children who needed a home and raising money to support his cause, ostensibly by collecting rewards or killing corrupt individuals.

Wolfwood changes vehicles regularly, naming them various incarnations of "Angelina." His heavy cross, the "Punisher Cross," holds at least eight pistols in the cross bar, a heavy machine gun in the lower half and a missile launcher in the top.

Wolfwood's relationships with the group evolve over the second half of the series, especially where Milly and Vash are concerned. Wolfwood travels with Vash regularly after Episode Eighteen, "Goodbye for Now." He convinces Vash to continue seeking Knives, and the two head off together to uncover the fate of a small town's inhabitants. On their travels together, Wolfwood spends more time with Milly, flirting and laughing with her. He finds himself naturally drawn to her; at the end of "Alternative," however, after killing Zazie, Milly's expression is as hard for him to bear as Vash's. After he receives the order to kill Vash, he finds himself venting all his pain and confusion to Milly. She comforts him, and they end up spending the night together. Milly helps Wolfwood find the strength to reject the Gung-Ho Guns, even though he knows it will be dangerous.

Wolfwood came into contact with Vash because of the assignment. As he understands Vash better, however, he finds himself genuinely fond of the Humanoid Typhoon and deeply affected by his pacifist beliefs. After rejecting Chapel's orders, he fights his mentor and wins. He spares Chapel because he now accepts Vash's belief concerning the sanctity of life. Legato forces Chapel to shoot Wolfwood, however, and he dies in a church a short time later.

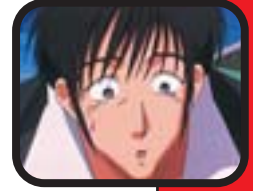
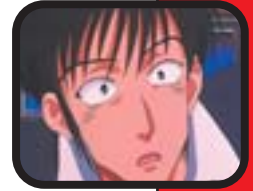



Millions Knives

Millions Knives, or Knives as he is more commonly called, is Vash's twin brother. Vash and he are both members of a species known as "the beings who exist outside of time," or "plants." Knives is also the employer of the Gung-Ho Guns. Very few people know of his existence, since he works behind the scenes to achieve his goals.

Knives looks like a normal human, with short white-blond hair and blue-grey eyes. He is tall and slender, standing between 1.8 and 1.9 metres tall. He is Vash's physical twin, except for slight differences in colouration. Knives has no visible scars or physical imperfections. He wears a futuristic jump suit, identical to the one he wore as a child when they escaped the Project SEEDS vessel. He carries a customized black long-barrel Colt-45 revolver of his own creation. He does not carry any other weapons.

Vash's and Knives's births are a mystery. They both appear to have been gestated in a lab, possibly on a spaceship, though it is uncertain whether humanity had a hand in their creation. One scene shows Rem interposing herself between the twin infants and armed crewmembers seemingly intent on shooting them. No other details are available, however. Vash and he lived the first year of their lives on the Project SEEDS command ship, with Rem and the other crewmembers. Rem Saverem was their primary caretaker and mother figure, though she was not related to them. During their first year of life, the twins grew from infants to the equivalent of 8-year-old children. Knives is over 130 years old, but still appears to be in his early to mid-twenties.

As a plant, Knives possesses many powers that humans rarely manifest. The first is longevity; Knives's rate of ageing is not on a human scale. In less than ten years he went from infant to mature adult, and has not visibly aged in the 120 years since. The second is telepathy, used to communicate with Legato and other plants. The third is an ability to manipulate energy. This can be done with or without his gun, which includes a power source of its own that may act as an amplifier. When the effect is coupled with the gun, Knives's arm metamorphoses into the Angel Arm, an awesome weapon that can destroy entire cities with its collateral effects alone.



Knives is highly skilled in combat, an equal to his brother, Vash. He has a seemingly unparalleled understanding of lost technology, including computers, medicine, robotics, space travel, and plant technology. He also possesses a high degree of leadership ability, commanding the utter loyalty of the Gung-Ho Guns Legato, Midvalley, and Chapel (the other members do not appear to know that they are employed by Knives).



Knives is intelligent and charismatic. Steve, a crewman on the Project SEEDS command vessel, abused him as a child, and that experience may have moulded his entire outlook on humanity. He grew up preferring logic over emotion, rarely playing or laughing. The kindness he expressed was reserved mostly for Vash, with Rem and Joey as exceptions. By some indications, Joey was to Knives what Rem was to Vash: a role model. He admired Joey's logical, pragmatic outlook, but when he saw that doubt and guilt could move Joey, he murdered him.

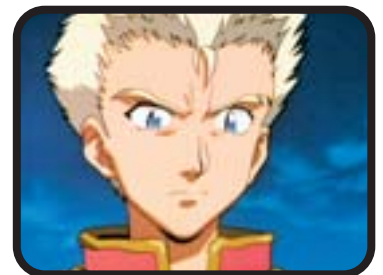



Knives does not deal with emotions; instead he considers them illogical, irrational, and — in the end — despicably human. He reviles the human race as parasitic ghouls, feeding off the lifeblood of his species to survive. He believes his species to be far superior, and thus sees the eradication of mankind as a noble and just pursuit.

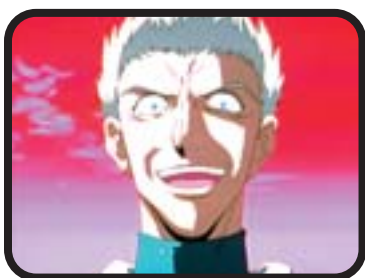

Knives once cared deeply for his brother, but he never forgives an injury. He looked upon Vash as his equal, the only one worthy to stand beside him in the paradise they would create. From the beginning, his hatred of humanity was not only for his sake, but for the injustices Vash suffered as well. He wanted to rid the world of humans for his brother's sake as well as his own, and was disgusted to discover his brother had been so deeply affected by Rem's teachings as to turn Vash against him.



Knives's goal is twofold: to teach his brother humanity's worthlessness (thus returning Vash to his side) and to punish Vash for turning against him. He wants to make Vash suffer, to regret ever shooting Knives or standing up to him. He wants Vash to suffer eternal pain for



choosing humanity over him, and so is set upon a path that will kill everyone who touches Vash's life in any significant way, whether friend or foe.

When Knives met Vash in July City, he activated Vash's Angel Arm. Vash shot the artifact directly at Knives, catching him fully in the path of the blast. It apparently took Knives decades to regenerate from the injury; he is only seen hanging upside down inside a miniature globe in Episode Twenty-Four, "Sin." At one point Legato talks about revenging himself upon Vash for the pain Knives suffered, indicating Knives was badly hurt in July City.

When Knives was trapped inside his sanctuary until he could recover sufficiently to hunt Vash down himself, he recruited Legato and the Gung-Ho Guns to do his bidding. Knives allied with them out of necessity, not choice. He makes it clear he views them as expendable foot soldiers, worth only slightly more than the dirt under his feet because they serve him. He recruits from among those humans who can be bought either by money or power, and from among those who accept his view of the world and become true believers.

This is also true for Legato, the only Gung-Ho Gun with whom Knives spends any considerable time. Knives is pleased with Legato's devotion, but it does not ameliorate the sin of Legato's birth. In Legato, Knives has another true believer in both the cause of humanity's destruction and the cult of his own divinity. While Knives never calls himself a god, he considers himself far superior and worthy of deciding who should live and die, both attributes generally considered the province of deities.

Legato's single-minded reverence of Knives as the only worthwhile being on the planet reinforces this identity, but it does not, in Knives's mind, raise Legato above the level of a valued tool. This is made clear in Episode Twenty-Four, "Sin," in the look he gives Legato after killing Chapel. The expression on his face made it clear he despises all humans, even Legato.

Knives feels no remorse for his actions. While it is questionable whether Knives would be willing to kill Vash, he is certainly more than willing to make every attempt to cut Vash's ties to humanity in order to bring his brother back to him, even if it meant killing people like Rem. His capture by Vash at the end of the series begs the question of whether Vash can contain Knives's hatred long enough to successfully rehabilitate him.

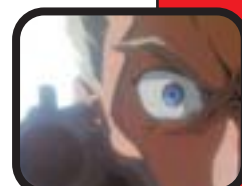

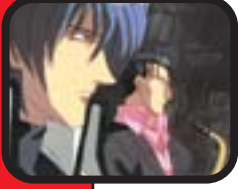
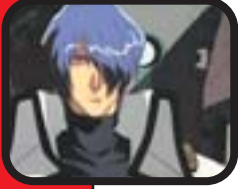
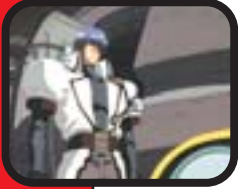
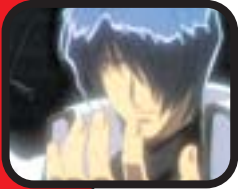
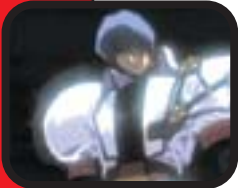

Legato Bluesummers

Legato Bluesummers is the leader of the Gung-Ho Guns, working for Millions Knives. His goals are the eventual destruction of all humanity, including himself, and the eternal suffering of Vash the Stampede. The authorities do not want him because they are unaware of him. He functions as an extension of Knives's will, and is Vash the Stampede's nemesis.

Legato is considered a strikingly beautiful man. He has light blue hair and amber eyes, both colourations that are typically not found among humans. He stands roughly 1.9 metres tall, making him slightly taller than Vash or Knives. Legato always wears a long white short-sleeved trenchcoat with a high collar. The trench coat's right shoulder is armoured and sports a row of banded spikes, while the left shoulder bears a skull. Underneath he wears a black long-sleeved shirt, brown pants, and boots. He wears a fingerless glove on his left hand and a full glove on his right. He does not carry a gun.

Legato is human, but shares Knives's dislike for humanity. The series never alludes to his past, though he appears to be in his mid-twenties. He is the first of the Gung-Ho Guns, and the only one to have regular direct contact with Knives. He is often shown eating sweets like ice cream or cake.

Knives replaced Legato's left arm with Vash's after the incident in July City, though no mention is made of how much time actually transpired between the events. Legato gained a number of powers from the arm, including the ability to activate the revolvers that trigger the Angel Arm. He claims to sense Vash through the arm, as though the arm retained some link to Vash after its severing, possibly evidenced by Legato's constant knowledge of Vash's location.

Legato possesses amazing mental powers at a level apparently unmatched among humans. He possesses telepathy that can send false sensory impressions and visual images as well as messages. He can mentally manipulate large groups of people at any one time, including assuming control over their fine motor skills. He even boasts he can kill someone in the blink of an eye, though the series does not indicate whether he could do so through direct mental assault. He can compel someone to kill others or themselves, even while leaving their conscious mind fully aware of the situation.



Trigun portrays Legato as a man whose only purpose in life is to serve his Master, Knives. He desires the end of human civilization, so he worships the superior being who works to make that happen. He despises himself and everyone around him, though some endure his contempt more than others do.



The series suggests Legato believes life is pain, and living is the greatest pain of all. Legato despises himself and everyone else around him, with the exception of Knives. To him, there is no virtue, no love, and no positive emotion in life. Everything that isn't pain is an illusion sent to cause greater torment, thus engendering his deep and abiding wish that humanity cease to exist.



Legato tries to teach his world view to as many people as possible, using a combination of mental attacks and murder. His preferred method of operation is to terrorize someone, taking away their security and peace of mind through mental attacks and murdering those they care for; he reduces them to a state where they wish they were dead. Once his victim achieves that level of



suffering, he denies them death and leaves them in misery, considering it a job well done.

Legato has no friends. Knives is an unforgiving master, Midvalley is a minion and Vash is a deep-seated irritant. They are the only relationships Legato has, however, and they each affect him profoundly.



Legato's relationship to Knives is largely that of a high priest or prophet to his deity. Legato treats Knives with reverence, calling him "Master" and attending him in his sanctuary. The series shows him regularly standing by Knives's chamber and offering a mixture of adulation and promises to accomplish his bidding. He considers Knives to be far superior to himself, or indeed to anyone. In return, he asks nothing of Knives, only that he serve despite his unworthiness and die when the time is right.



Midvalley the Hornfreak seems to be Legato's chosen second-in-command. While Midvalley does not give orders or assignments to anyone else, Legato and he are nearly always together. He



accomplishes Legato's bidding and carries out his commands. It is certain that Legato sees Midvalley as a subordinate, not an equal.

Vash is another problem altogether. He is the one person who violates Legato's understanding of the world and his place in it. As Knives's brother, Vash should be afforded the respect and adoration that Knives commands. By rejecting that role and refusing to destroy the cancer called humanity, he turns against the framework of Legato's reality. By living as a human, hiding his divine presence among mortals, and helping the weak and oppressed, Vash turns the entire order of Legato's universe on its head. For that reason, aside from Knives's anger towards Vash, Legato has his own hatred of Vash to fuel his actions.

Legato suppresses that emotion, as he does with all his emotions, and approaches his position with cold logic. He seemingly believes Vash is misguided, as shown in their last confrontation when he offers to teach Vash that he is not human, as a last courtesy. He never attempts to kill Vash, only push Vash into violating Rem's teaching. It is likely he does not understand Vash's beliefs; they are so far removed from what he believes true. Vash irritates him, annoys him, outrages him, and otherwise disturbs him so thoroughly that it is no surprise he seemingly enjoys pushing Vash over the edge.

Legato seems obsessed not only with Vash and Knives, but also with that part of himself that originated from them. He often stares at his left hand and arm, rubbing them or caressing them in some manner. It is possible his telepathic abilities come as an extension of Vash's transplanted limb, or that it amplifies abilities he already possessed. A portion of divinity is now part of him, and although he does not imagine himself as divine because of the arm, he remains awed by Knives's gift.

Legato meets his death in Episode Twenty-Four, "Sin," when he forces Vash to kill him. He welcomes death, especially at the hands of Knives's brother, and asks for it repeatedly. His plan was always that he should die at Vash's hand, thereby forcing Vash to violate Rem's teaching that no one should take the life of another. A single shot to the head killed him, and he died with a smile on his face.

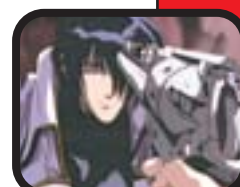
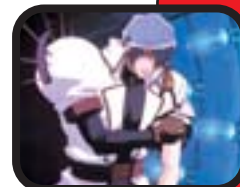

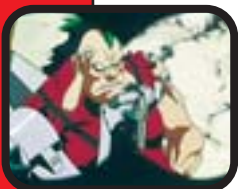
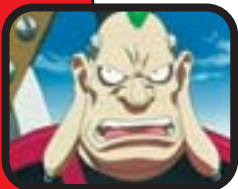
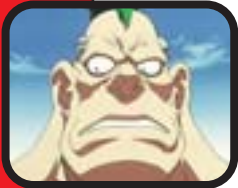

Descartes

Descartes is a bounty hunter from Episode One, "The \$60,000,000,000 Man." Due to confusing reports, both Ruth Loose and the insurance girls mistake him for Vash the Stampede. Descartes is typically found with at least four henchmen in his employ.

Descartes is an ominous figure, roughly 3.5 metres tall. He is overweight, with an enormous stomach and short legs for his size. He is bald except for a bright green mohawk, and his ears are pierced and hang down to his shoulders. Descartes usually wears a red sleeveless shirt, black pants, and a metal belt/codpiece combination. His left arm is obviously cybernetic and holds a huge metal boomerang, while screw-heads stick out of his shoulders and skull, possibly indicating other, less obvious cybernetic modifications or, at the very least, poor fashion sense. He is not terribly fast owing to his great bulk, and depends on his strength, endurance, and expendable underlings to carry him through.

The series portrays Descartes as a competent, if repulsive, bounty hunter with perverse personal habits. He did track Vash from city to city, regardless of the time it took. He uses his strength and appearance to intimidate others into following his lead and he does not use firearms; instead Descartes hires henchmen to provide support and up-front combat capability while he forces his target into the open.

The giant's weapon of choice is a gigantic metal-bladed boomerang. The boomerang is heavy enough that only he can presumably use it with his cyberarm, and he must also carry it on that side constantly. To wield the boomerang effectively, Descartes must add torque to the weapon by means of a strap connected to a screw-box on his belt. To throw it, he pulls the strap out of the box, attaches it to his arm, assumes throwing position, and hits the release switch on the box. The box then retracts the strap with enough force that the spinning blade penetrates any armour it comes in contact with, decapitating everything from rocks to buildings.

In Episode One, Descartes captures Vash outside Felnarl Town. A case of mistaken identity allows Vash to escape and finally defeat Descartes by using strategy. Vash incapacitates Descartes by dodging the boomerang Descartes threw, using the retractable strap to trap the cyborg's arms behind his back and throwing him off balance until he falls, helpless.

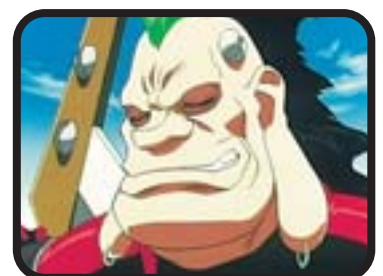

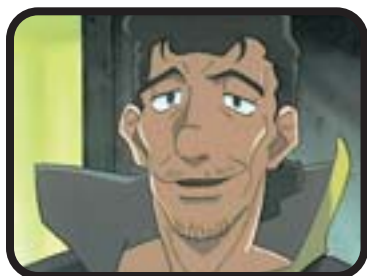

Frank Marlon

Frank Marlon is an expert gunsmith who appears in Episode Three, "Peace Maker." Vash wants Marlon to repair his gun, which is wearing out. Marlon must struggle with his own past, however, before he can help Vash in any way.

Frank Marlon is an ordinary-looking man, probably in his late thirties or early forties. He has dark, tanned skin and brown hair and eyes. He stands nearly a head shorter than Vash, with a medium build. He typically wears a yellow and grey jacket with dark jeans. He prefers whiskey over beer or wine, and is famous in Warrens City and surrounding towns.

Folks widely acknowledge Frank Marlon to be a genius in the manufacture and repair of guns. He is knowledgeable about all types of firearms, whether pistol, rifle, or machinegun. Blessed with an encyclopaedic knowledge of weapons, Frank can identify problems with a specific sidearm simply by looking at it.

Frank was known for his kindness and willingness to help others, until tragedy struck. When Warrens City was besieged by wave after wave of bandits, Frank made hundreds of guns and handed them out free of charge to anyone who did not own one. The bandit raids subsided after people proved able to defend themselves, but they did not stop entirely. While Frank's wife and child were at the bank one day, robbers came in and killed everyone, including his family. Frank discovered that the guns that killed his family were ones he had made and given away. Unable to cope with the guilt and rage he felt, he drank to dull the pain.

When Vash finds Marlon, the famous gunsmith is being thrown from another bar for drinking beyond his means. When robbers attack the armoured car the next day, Vash does his best to help, but it is the townspeople who face down the robbers with little more than determination. By caring for and helping others, Frank redeems himself, thus earning the strength to confront his own fears and pain. At the end of the episode, Frank no longer drinks, has fixed Vash's gun, and is ready to help those around him once more. Grateful to Vash for his help, he invites Vash to return if his gun ever needs work again.

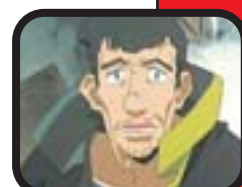
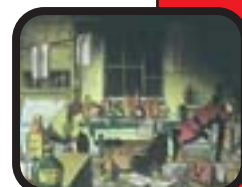
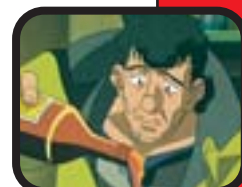
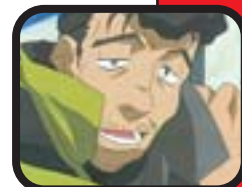
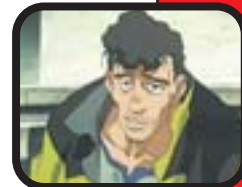



The Nebraska Family

The Nebraska Family are a pair of criminals wanted by the Feds who appear in Episode Five, "Hard Puncher." They are homicidal maniacs who enjoy causing pain and suffering, especially for profit. The group's two members are Gofsef Nebraska and Professor Nebraska, Gofsef's "father." The chairman of Inepril City hired them to capture Vash the Stampede, only to discover the destructive duo were far worse than the man they wanted to catch.

Gofsef Nebraska is a gigantic cyborg who is as tall as a three-storey building. He has a huge cranium with a smokestack poking out from the back of his head and screws sticking out of his body at various places. He does not talk and serves as little more than a walking weapons platform for his father, the brains of the outfit. He has the mental capacity of a small child, crying like a baby when he tripped on a parked car and stubbed his toe. He is incredibly strong, very hard to hurt, and cares only for his father, whom he would protect at any cost.

Professor Nebraska, however, is a tiny man who rides in his son's pocket when they travel. He is balding on top, with a shock of white hair sticking out all around the sides of his head. He stands less than 1.2 metres tall, and always wears a white lab coat and a green monocle. He is missing most of his teeth and is very unattractive. He is a physical weakling, with only his intellect and his son to protect him.

Gofsef is almost completely unskilled, except for some combat ability. His weapon of choice is a cybernetic implant that allows him to launch his fist as a retractable ballistic missile. This weapon, while not extremely accurate, can spin at high velocity like a drill, damaging everything across its wide path. It can even topple buildings, though it is slow to use since the fist must be retracted and loaded before Gofsef can fire it again.

Gofsef's father, Professor Nebraska, is a medical genius whose insanity makes him a hazard everyone around him. While he relies almost entirely on his son for protection, it is his brain that guides the pair. The Professor is probably an expert in the fields of Genetic Engineering, Robotics, Biochemistry and Surgery, and his son is almost certainly the result of his skills. He enjoys exerting power through his creation, Gofsef, and enjoys taunting others until they are mad enough to fight.

Following their last prison escape, Gofsef and the Professor were captured by the town of Inepril City. The town received the \$\$700,000 bounty, and returned the pair to prison.

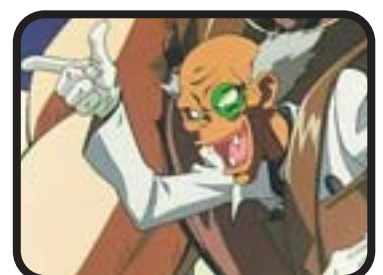
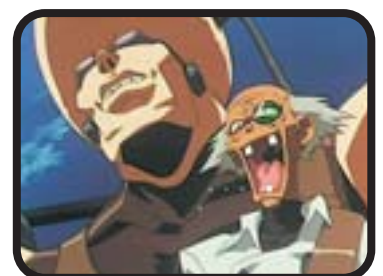
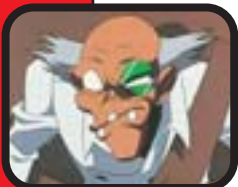
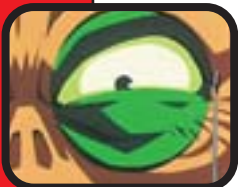
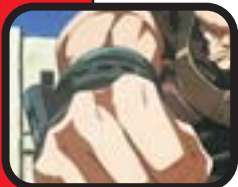
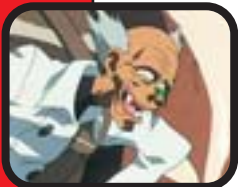
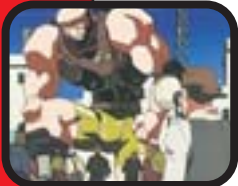

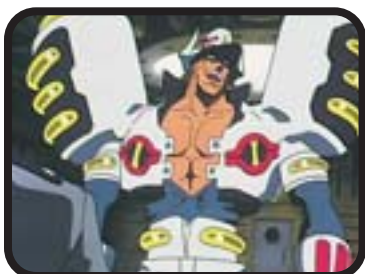

Brilliant Dynamites Neon

Brilliant Dynamites Neon, or B.D.N., appears in Episodes Seven and Eight ("B.D.N." and "And Between the Wasteland and the Sky" respectively) He is the leader of the Bad Lads Gang, a group of bandits preying on travellers near Luttonberg Canyon. He attempts to take over the sand steamer *Flourish* when it passes through the canyon in the hope of stealing the goods it carries. When he discovers the safe cannot be opened normally, he tries to dash the steamer off a cliff to break the safe open.

Brilliant Dynamites Neon is a tall, strongly built man. He stands 1.9 metres high, with tanned skin, dark hair, and angular features. He wears a white jumpsuit, which is open to show a broad expanse of muscled chest, and matching hat. Decorative red and yellow bands that light up with glowing neon colours in the dark cover the suit and hat. His gun matches his outfit as well, with a series of yellow lights down the barrel. The twin dynamos on his shoulders (each standing roughly twenty centimetres above his head) likely power his light show.

B.D.N. is a born leader. He has assembled an entire group of men who are incredibly loyal, turning the Bad Lads gang into a feared local legend. He is a great believer in the philosophy that the best lives are those that end in a blaze of glory. In light of this, he makes an effort to ensure everything he does is flashy and noticeable. He never sneaks up on someone, unless it allows him to make an even-more spectacular entrance. His oft-repeated mantra is "Make it sparkle," indicating that everything his gang or he does should fit that image. He frequently refers to good or successful things as "shining" or "sparkling," while anything or anyone who pleases him is "beautiful."

Neon is highly intelligent and fearless, a combination that has earned him renown across the planet. He also maintains a personal sense of honour, keeping his word regardless the cost. At the same time, he rarely gives his word unless he is certain it will not cost him anything. He will kill with very little provocation, and does not threaten unless he plans to make good on it.

Neon makes a good general in combat, with a grasp of tactics that he uses to deploy his men with ruthless efficiency. He is also good at personal skirmishes, using an impressive list of equipment to back up his considerable skills. He is very tough to hurt, a combination of his training and the suit he wears, which acts as light armour. In addition to his pistol, he also uses the dynamos on his shoulders as weapons. They can discharge a damaging and painful lightening attack at his enemies for times when his pistol or his men cannot achieve the effect he wants.

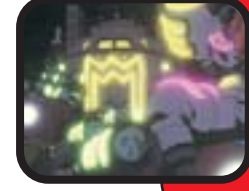
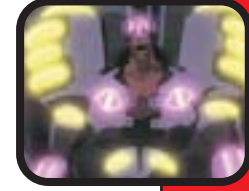
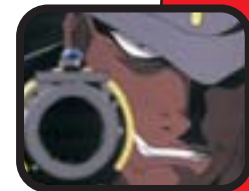

CLOSING SONG “KAZE WA MIRAI NI FUKU”

Written, Composed, and Arranged by: Akima & Neos

Underneath the blue sky,
the wind blows toward the future ...
as if to draw the rays of the sun
into an embrace.

I just let it push me along ...
leaving only my footprints behind.

If I have the air to stroke my cheek
and soft grass to fall down on ...
I don't need anything else,
sleeping with a contented smile ...

I stare into tomorrow
that stretches on endlessly

Na, na na na, na na na, na na na na na na ...



WANTED DEAD OR ALIVE



Brilliant Dynamites Neon



Kaite

Kaite is the boy from Episodes Six, Seven, and Eight, “Lost July,” “B.D.N.,” and “And Between the Wasteland and the Sky” He helps B.D.N. gain control of the sand steamer *Flourish*, which his father designed. When B.D.N. decides to wreck the steamer, however, Kaite rebels and helps Vash free the ship from the clutches of the Bad Lads Gang.

Kaite is roughly 12 years old. He stands about 1.3 metres tall, and has a slight build. Fair-skinned Kaite has dark hair and eyes, and he typically wears a ragged T-shirt and a pair of torn overalls attached at one shoulder.

Kaite was the son of the engineer who designed the *Flourish*. His father put his heart and soul into the sand steamer, teaching Kaite about it as he went. A few years following the completion of the steamer, Kaite’s parents died in an unexplained accident. Kaite found himself homeless, desolate, and starving, after their deaths. The only item he saved from his father was a copied blueprint of the sand steamer *Flourish*, his most treasured possession.

Bereft of the comfort and security he had known, homeless Kaite presumably had to beg and steal to survive. Finally he met Brilliant Dynamites Neon. Neon hired him to spy and infiltrate the sand steamer his father designed. While Kaite disliked what B.D.N. asked him to do, he saw no alternative. It was only after meeting Vash, when he discovered Neon planned to wreck the steamer, that he took the opportunity to turn his life around and help others rather than use them.

Kaite is an intelligent, sensitive child. He shows signs of possessing the same mechanical aptitude his father did, and may even surpass him if he receives the education to develop it. He has great skill in deception and stealth, both presumably learned from years of street survival in various towns across the desert. He has no combat ability, but he makes a fine amateur burglar.

Desperate to make up for his actions on behalf of the Bad Lads Gang, Kaite is determined to make a fresh start. He saved the *Flourish* from destruction, suffering bad burns in the process. He does not like be reminded of his time with the Bad Lads Gang, partially out of fear folks will probably hold it against him. He is resolved not to live in fear of what has been, however, taking to heart Vash’s comment that “your ticket to the future is always blank.”

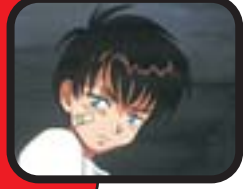
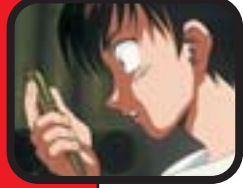
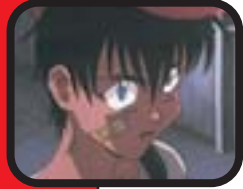
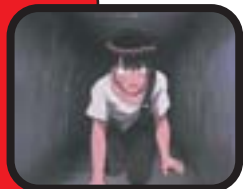



Money the Gale

Money the Gale is a hired assassin who appears in Episodes Twelve and Thirteen, “Diablo” and “Vash the Stampede.” He was “purchased” by an unknown person referred to as Master some time ago, and has been training for twenty years to kill Vash the Stampede (although he was unaware of his target’s identity for the majority of that time).

Money is approximately 1.9 metres tall. He is heavily muscled, but his bulk makes him seem larger than he really is. He is bald and wears a purple armoured suit, complete with a transparent orange helmet. At his disposal are two sets of guns; the first fits on both arms, and is connected to the ammo chambers on his back through cables. The second gun is taller than he is — roughly two metres in length and just short of one metre in width.

Money seemingly defers to Legato Bluesummers, a man who appears in Episode Twelve. Legato assigns Money to kill Vash on behalf of their “Master,” a person to whom no further reference is made. When Money is told his target, he is excited by the opportunity to finally act. He has spent years in a cellar, apparently training for this assignment, but not knowing when it would come or the nature of his target.

Money has devoted his entire life to this goal and is appropriately skilled in combat. He is fast and accurate with his guns, and proficient at determining the best approach for each situation. He can use his weapons to great effect, inflicting heavy punishment with either weapon, and his employer insures this juggernaut of destruction is well supplied with his armoured suit and impressive weapons. Money only flaw is that he is not as fast as his size and strength might imply.

When Vash and Money meet, he nearly succeeds in killing Vash. Money’s skill and killer instinct is only equalled by his desire to terminate his target and finally end this chapter of his harsh life. This makes Money exceedingly dangerous, for whether or not he was cold-blooded to begin with, his fixation on Vash precludes any concern for his surroundings. In all probability, however, with an epithet like “the Gale,” Money is probably a great fan of cutting loose and inflicting high collateral damage. He pursues destruction with an almost homicidal glee, but whether it is because he is buoyed up on the rush of his own invulnerability, or because he has simply lost control remains unknown. By the end of the first half of the series, however, Vash leaves Money terrified and begging for his life. Money knows he has been beaten and is last seen kneeling in the street, crying.

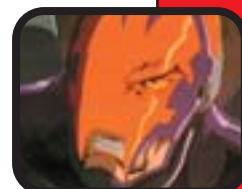

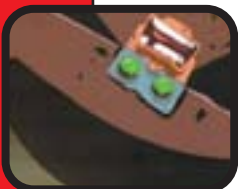
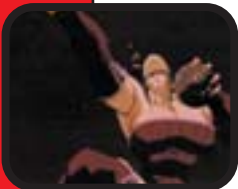
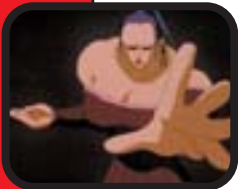
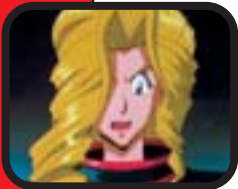
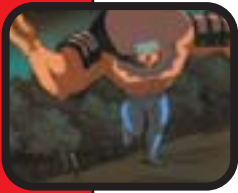

Marilyn Nebraska and Friends

Marilyn Nebraska is the daughter of Professor and Patricia Nebraska — a highly unlikely couple. Marilyn’s friends consist of her mother, Patricia, and three brothers Tonkichi, Chinpei, and Kanta. Morgan, a corrupt landowner outside the town of Promontory, hired the five to terrorize an elderly couple into surrendering the deed to their land. According to Marilyn, they were attempting to raise bail money for their father and brother — the outlaws known as the Nebraska Family who Vash defeated earlier in the series. Marilyn Nebraska and Friends appear in Episode Fourteen, “Little Arcadia.”

Marilyn is a beautiful young woman with long blond hair and dark eyes. She wears a short black dress with red trim and matching gloves. She does not carry any weapons, and her primary contribution is to negotiate with employers and direct her mother. She typically rides on her mother’s shoulder.

Patricia is a giantess, who stands as tall as a three-story building. She has an oversize cranium, even in proportion with the rest of her, and only moans. Marilyn claims to understand her, but there is no way to be certain. Patricia has dark hair and wears sunglasses. She is proficient with martial arts and thrown weapons, but weeps over the slightest pain or setback.

Marilyn’s brothers — Tonkichi, Chinpei, and Kanta — are all cyborgs, modified heavily to carry explosive charges. They can roll up into large balls, which their mother throws at targets assigned by Marilyn. Upon impact, they cause considerable damage to their target and remain unharmed, unrolling and returning to their mother for the next volley. They never speak.

Marilyn is petty, cruel, and short-sighted. She lives out a fantasy where she is the centre of the universe, as evidenced by the title she gives her family and her “magical girl” poses. She is of average intelligence, but lacks enough emotional stability to persevere through setbacks.

Vash defeats the Nebraskas by shooting Chinpei out of the air, throwing off Chinpei’s rotation and knocking him to the ground. Marilyn and her mother immediately burst into tears because someone defeated their strategy, and refuse to budge an inch. They show some concern for Chinpei’s well being, but are too overcome to check on him. When Patricia falls to her knees, she pins their employer, Morgan, underneath her leg, thus ending his schemes.

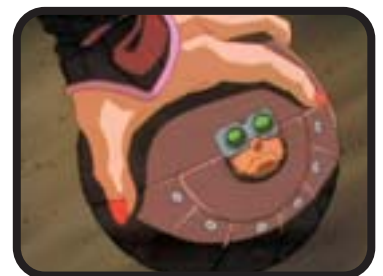

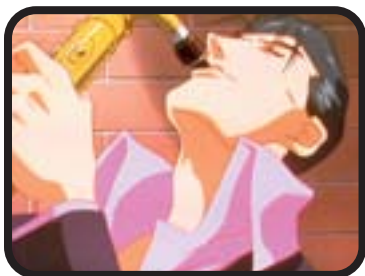

Midvalley the Hornfreak

Midvalley the Hornfreak is the eleventh Gung-Ho Gun. He serves as Legato's lieutenant, and executes other members of the Gung-Ho Guns who fail in their appointed tasks. He appears in Episodes Fifteen, Sixteen, Twenty-One, and Twenty-Four ("Demons Eye," "Fifth Moon," "Out of Time," and "Sin").

Midvalley stands 1.8 metres tall, with dark slicked-back hair and dark eyes. He wears a black suit with a hot pink shirt and brown shoes. He always carries a golden saxophone he calls "Sylvia." He loves music and women, and can be found sitting in with a band or entertaining ladies in his leisure time. He prefers playing jazz. Midvalley appears with Legato as early as "Demons Eye," where he plays with the band in the bar while Legato kills the Roderick Thieves. He remains at Legato's side throughout his appearances until his death in Episode Twenty-Four.

Midvalley's saxophone is both his instrument and his weapon. By playing it, he can create a sonic buffer around himself that slows and even stops bullets in mid-air before they reach him. He can also generate sonic blasts that inflict lethal levels of damage, as well as destroy buildings. As a backup attack, the bell of the saxophone converts into a gun with eight autofire mini-barrels.

Midvalley is unusual for a Gung-Ho Guns member. He seems to actively enjoy the good things in life. He has no apparent hatred for mankind, and his conversations with Vash during their fight border on jovial. Until the end, he did not seem to know who Vash was or why Knives wanted to torment him. He was shocked by the destruction Vash caused at Augusta City, and did not know anything about the Angel Arm or its effects.

As Midvalley told Vash during their match, he has no choice but to serve Knives — which meant he had no rights, no free will. Vash tried convincing him otherwise, but Midvalley would not listen. The episode hints that perhaps Midvalley believed, through his time with Legato, that Knives was indeed a superior being, and following him was the only option. He certainly seems resigned to his fate in the fight with Vash, and speaks at one point of the "fate of the dying." If Midvalley was unaware of the implications of joining the Gung-Ho Guns, he seems to have accepted it by the time he faced Vash.

During the fight, Midvalley fires the gun portion of the saxophone after Vash damages it. One of the saxophone's retractable barrels jams, causing the resulting explosion that kills Midvalley. Vash tries warning Midvalley before he fires, but the musician outlaw ignores the warning. Whether this is because Midvalley did not understand, or because he wanted to die, is unknown.

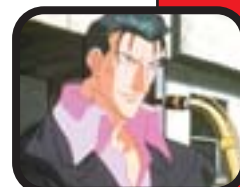
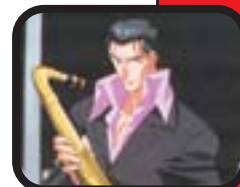

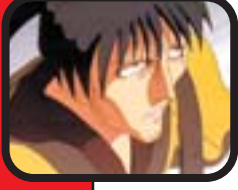
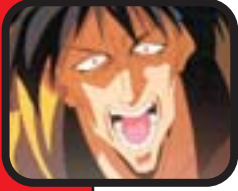
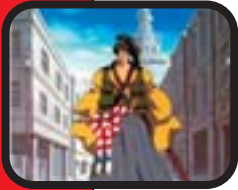

Rai Dei the Blade

Rai Dei the Blade is the ninth Gung-Ho Gun. He appears in Episodes Fifteen and Sixteen, "Demons Eye" and "Fifth Moon," respectively. He is one of two Gung-Ho guns to fight Vash in those episodes. The series never mentions his past, though he has a strong philosophical bent. He claims to be a member of the *Jigenzan Itto* School. He has no personal issue with Vash, but fights him because he was told to and because he seeks spiritual awareness.

Rai Dei is approximately 1.7 metres tall. He wears traditional Japanese clothing combined with a western-fringed vest. He has long black hair pulled up in a topknot and black eyes. There is stubble on his chin, and he often chews on a piece of straw. He carries what appears to be a traditional Japanese blade, a *katana*, with a filigree guard and wrapped hilt. The sword can launch its blade through the air, and the scabbard also functions as a gun.

Rai Dei is sent to follow and execute E.G. Mine. He appears from a dust storm after Mine's first exchange with Vash, claiming the fight is over. When Mine protests, Rai Dei explains that Vash had already sundered the straps holding Mine's weapon. Rai Dei then kills Mine, impaling him upon his sword blade.

Rai Dei claims no personal quarrel with Vash, but challenges him to *shi-Ai*, or death match, as a method of mastering *bushido* (the way of the *samurai*). He seeks spiritual awareness, to walk the edge between life and death and learn what secrets may reside there. He becomes angry, then, when he realizes Vash has no intention of trying to kill him.

While Rai Dei is a member of the Gung-Ho guns, it becomes quickly evident he has no idea of his target's capabilities. He knows nothing of Vash's beliefs or tactics, nothing of his weapons and proficiencies. He is shocked to see the Angel Arm, and even more distressed by its destructive effects. He tries fleeing the battle when he realizes something unforeseen is occurring, but his escape is blocked. At the point when he thought his life was ending, he did not find spiritual awareness in the situation, only terror.

After the destruction of Augusta City, Wolfwood killed Rai Dei after the cowboy samurai recognized Wolfwood and asked for help in killing Vash.

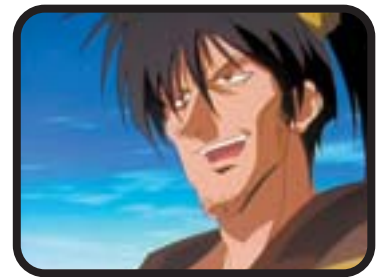



Leonof the Puppetmaster

Leonof the Puppetmaster is a member of the Gung-Ho Guns, though his rank remains undetermined. He appears in Episodes Fifteen, Nineteen, Twenty, and Twenty-One ("Demons Eye," "Hang Fire," "Flying Ship," and "Out of Time," respectively). He is responsible for the escalation in violence between the Polo and Fris families, as well as the deaths of many people in the floating ship, including Brad.

Leonof is an older man, standing roughly 1.6 metres tall. He wears a bowler hat, a brown overcoat with a green collar and yellow ascot, brown pants, white gloves and odd sunglasses with conical lenses. He never deals with anyone face to face if possible. Even in his telepathic conversations with Legato he appears as a puppet. He carries a briefcase in which he keeps puppets and their controller, and a small red ball through which he can see everything his puppets observe.

Leonof carries no visible armaments since he is never face-to-face with anyone, though his puppets use weapons from time to time. The series does not specify the method through which Leonof controls the puppets, though he is shown with a wire. He also possesses telepathy, which he uses to contact and report to Legato. Because his puppets and he can blend into a crowd seamlessly, the Gung-Ho Guns use him extensively for espionage and other covert operations. His favourite puppet forms are an older human male with long grey hair (Mr. Lurald) and a bird. The pieces for his puppets move seamlessly from one shape to another, giving him the base requirements for any necessary form. He can also generate specialized models, as the Jessica puppet proves.

Leonof knows something of Vash and his attachment to the people in the floating ship, though the degree of his knowledge is never ascertained. He knew of the ship and of Vash's reason for coming to New Oregon. He also acts as if he knows of Wolfwood's background but he mistakenly refers to Wolfwood by the name Chapel the Evergreen.

Leonof is a good strategist, setting up his forces to penetrate the ship undetected and wear Vash down before he faces the other two Gung-Ho Guns. He did not expect anyone to find him on the planet, however, and had no personal defenses against Wolfwood's attack. Leonof died in Episode Twenty-One, after Wolfwood launched an artillery shell at him from the ship's flying transport.

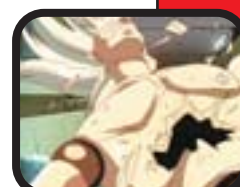
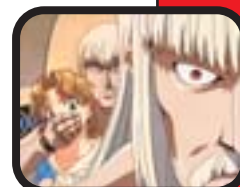
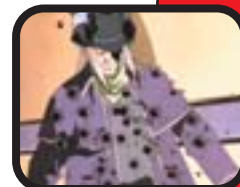

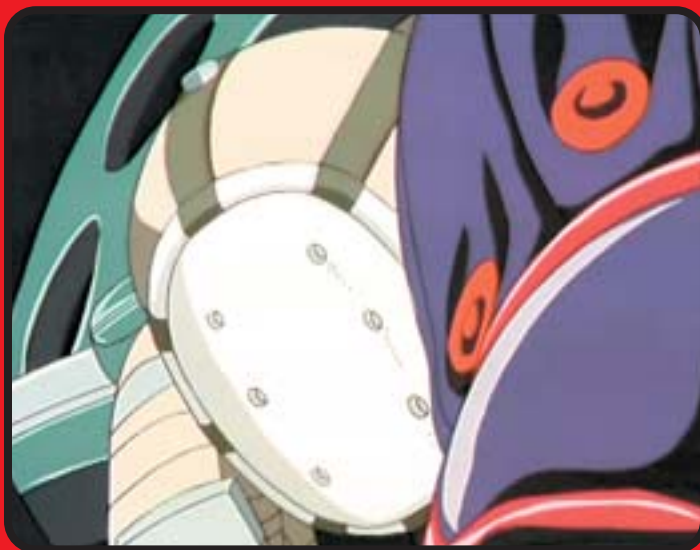

Hoppered the Gauntlet

Hoppered the Gauntlet is the third Gung-Ho Gun. He appears in Episodes Fifteen, Twenty, and Twenty-One (“Demons Eye,” “Flying Ship,” and “Out of Time,” respectively). Hoppered is a human who apparently underwent extensive modification, turning himself into an invulnerable giant spinning top, capable of wreaking destruction on a massive scale.

Hoppered never stands, so it is nearly impossible to determine his height. A white mask with six small holes covers his face and is strapped onto his head. Green strips of material wrap his entire body, while ribbed blue and red garment (distended upwards along his spine) cover his torso.

Hoppered is an arrogant individual who derives entertainment from destruction and murder. His past remains a mystery, but it seems reasonable to assume his body modifications occurred while with the Gung-Ho Guns. He knows enough about Vash’s motivations to ridicule him and drive him to anger. He also knows Vash destroyed both July and Augusta, and taunts him with the deaths of the innocents aboard the floating ship.

Hoppered’s only weapon is his suit, which he calls a Götterer. It consists of a wide blunt-nosed silver cone atop a larger black cone with rounded sides. His feet and legs fit into the smaller cone, while his torso fits inside the larger one. He can hide his entire body inside the two cones but must come out to communicate. An automatic weapon is fitted into the black nosecone, allowing him to fire in the direction he faces. Hoppered can also unleash a bolt of lightning when he emerges from the Götterer, which he does at close range in the battle with Vash.

Hoppered the Gauntlet appears on the floating SEEDS vessel with the mission of destroying at least one of the power plants. Vash arrives in the Plant Room in time to fight him, tricking Hoppered and breaking the hinges of the black shell. This throws Götterer off-balance, while the shell’s rotation sends Hoppered crashing into a wall, where his own weapon electrocutes him. Hoppered does not die, however, and later crashes into the plant while Vash and Brad try repairing it. The resulting explosion kills Hoppered.

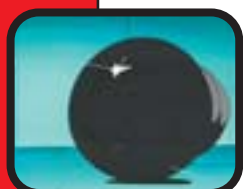
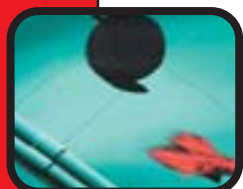
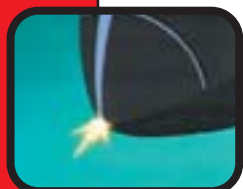
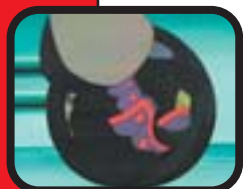
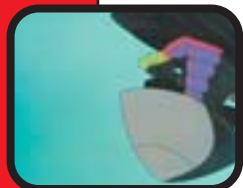



Chapel the Evergreen

Chapel the Evergreen is a Gung-Ho Guns member and Nicholas D. Wolfwood's mentor. His rank remains unknown. He appears in Episodes Twenty-Two, Twenty-Three, and Twenty-Four ("Alternative," "Paradise," and "Sin," respectively). He is assigned to kill Vash and to pass on the order to Wolfwood. While under Legato's control, he kills Wolfwood in a stand-off.

Chapel the Evergreen is a tall, thin man standing between 1.9 and 2.0 metres tall. He wears a tailored dark grey suit, a tall black cowboy hat and odd silver sunglasses with round red lenses, giving him the appearance of a cyborg. He appears mostly, if not completely, bald. He carries a green apple with him at all times, as well as a large cross that breaks in half to form two heavy machineguns.

Chapel took Wolfwood under his wing when the boy was no older than eight, though there is no information how he did so or why. Chapel's quote sums up the outlook he taught Wolfwood: "Life is an unending series of problems, all difficult, with brutally limited choices and a time limit. The worst thing is to make no decision, waiting for the ideal conclusion to present itself. Make the best choice possible in a split-second. We are not like God. Not only are our powers limited, but we sometimes have to play the Devil."

Chapel was evidently planning to retire prior to the fight with Wolfwood. The day before, he said that upon killing Vash, Nicholas would receive the name of Chapel the Evergreen and full membership into the Gung-Ho Guns. He tried talking to Wolfwood when it became clear his student had decided to disobey orders, but he gave up when he saw the determined look on Wolfwood's face.

Chapel is an honourable man who supports Wolfwood's responsibility to the orphanage. He is proud of Wolfwood despite disagreeing with his choices, and felt he incurred a debt to his protégé when Nicholas spared his life. He tried resisting Legato's control when Wolfwood walked away, and managed to make a strangled sound to alert Nicholas to danger.

Chapel would not have killed Wolfwood of his own volition after his former student spared him, and he was ready to avenge Wolfwood's death by killing Legato in return. Chapel died at Knives's sanctuary, however, when Knives summoned a portal of destructive energy and enveloped him in it.

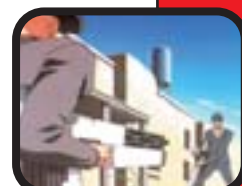
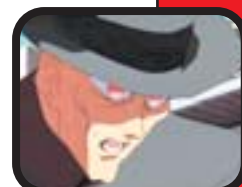
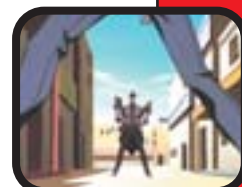
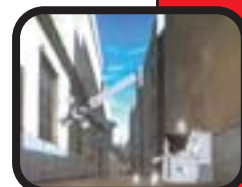
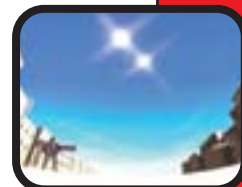

Ruth Loose

Ruth Loose is a bounty hunter, also known as “Constance Rifle.” He is tall and slender, with blond hair and a moustache. He wears a grey hat and coat and carries a revolving double-barrel rifle along with explosives. He appears in the first episode, “The \$\$60,000,000,000 Man.”

Ruth was tracking Vash the Stampede through an erroneous description obtained from the sheriff of Dankin Town. The man he thought was Vash was actually Descartes, another bounty hunter. After a case of mistaken identity, the two joined forces to capture Vash and split the reward. He was injured by Descartes’ bladed boomerang when it returned after Descartes had fallen.

Cliff Schezar

Mr. Cliff Schezar is a wealthy land baron in an unidentified town who appears in Episode Two: “Truth of Mistake.” He is short, with brown hair and a large moustache. He typically wears a suit and carries a Derringer pistol.

Schezar hires Vash to impersonate the famous outlaw Vash the Stampede and act as his bodyguard (not realizing Vash’s true identity). Schezar controls the local water supply, and is restricting its flow to the town to establish a monopoly for himself. He disappeared in an explosion under his house, when the generators to his underground water facility exploded.

Marianne

Marianne is a marshal posing as Mr. Schezar’s houseguest so she can find proof of his criminal acts. She is medium height, with wavy blond hair and violet eyes. She wears a frilly pink and white dress in her undercover role, switching to a red jump-suit when in uniform. She appears in Episode Two: “Truth of Mistake” as well.

Marianne’s full name is Marianne Aura Cayzen. She is ostensibly the granddaughter of the desert planet’s Federal Bureau’s director, though this may simply be part of her cover. Vash is very attracted to her, and fights Schezar when he tries to kill Marianne. She is attracted to Vash as well, but does not know his true identity.

Stefany

Stefany is the fun-loving daughter of the Earl of Orleans. She is slender and attractive, with large blue eyes and fashionable brown hair. She typically (and flamboyantly) wears expensive clothing and has at least one servant in attendance. She appears in Episode Four: “Love & Peace.”

Stefany’s father is the Earl of Orleans, known in his youth as “Grim Reaper” Bostalk. A man wronged by Stefany’s father many years before captures and holds Stefany for ransom as revenge for the death of his parents. She is released when her father consents to fight a duel with the man. Despite learning who her father was, she continues to support and love him.

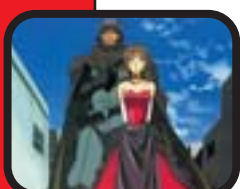
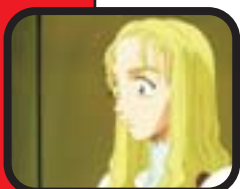
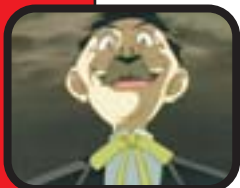



Ingway

Ingway is the leader of a group of men determined to revenge themselves upon "Grim Reaper" Bostalk. He is tall, with tanned skin, dark eyes and hair, and a long thin moustache. He wears a large brown hat, a brown duster, and a bandanna. He appears in Episode Four: "Love & Peace."

Ingway's parents were among the original settlers of Orleans. When they finally made the land arable after years of hard work, Ingway's parents died at the hands of "Grim Reaper" Bostalk and his gang. Ingway and his men captured Bostalk's daughter and held her for ransom. When that attempt failed, however, he challenged Bostalk to a duel and won.

"Grim Reaper" Bostalk

"Grim Reaper" Bostalk is now the self-styled Earl of Orleans, a rich land owner with a chequered past in Episode Four: "Love & Peace." He is tall and looks distinguished, with tanned skin and dark hair going grey around his temples. He dresses well, wearing expensive clothing.

Bostalk was an outlaw in his youth. His gang and he came to Orleans and killed the original settlers, stealing the land rights. Bostalk became a wealthy man and father to his daughter, Stefany. He consents to a duel to save her, and is shot in the shoulder by Ingway in an attempt to avenge the original settlers of Orleans.

Stan

Stan is Orleans' sheriff, a powerful man frustrated with his station in life. He is moderately tall, bald with dark eyes, and wears a light-coloured duster with a pistol at his side. He appears in Episode Four, "Love & Peace."

Stan was originally a member of Bostalk's outlaw gang. He helped Bostalk murder the residents of Orleans, only to see Bostalk keep all the land rights. Bostalk gave him the position of sheriff, a gift that did nothing to appease him. Stan waited until Ingway's duel to set his plan to murder Bostalk into action. Vash defeated him after Meryl disabled Stan's deputies.

Elizabeth

Appearing in Episode Six, "Lost July," Elizabeth is the chief engineer of the Marius-Breskem-Kantacle Technical Industrial Union work dispatch team. She is very attractive, with brown hair and green eyes, and wears an expensive and stylish full-length purple gown.

Elizabeth hires Vash as her bodyguard in hopes of killing him. She blames him for the death of her parents following the destruction of July, the first destroyed city attributed to Vash the Stampede. When he escapes her trap, however, she realizes he was the man who comforted her amid the rubble of July when she was a child.

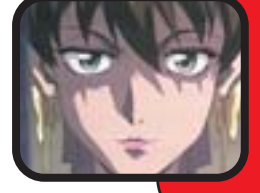
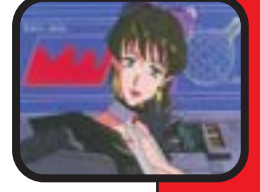
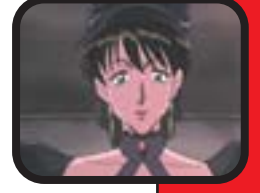
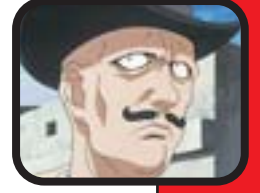
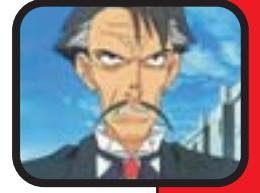

Dominique the Cyclops

Dominique the Cyclops is the second of the Gung-Ho Guns. She is a tall woman with long black hair who wears a tan duster, a wide brimmed hat, and an eyepatch. She appears in Episode Fifteen, "Demons Eye."

Dominique's special attack is called the Demons Eye. Her right eye has a red iris that is abnormally small. It is an artifact that causes hypnotically induced sensory paralysis, enabling her to "teleport" while her victim is under the Eye's influence. It affects all five senses.

Dominique was the second Gung-Ho Gun to face Vash. She fought him outside a small town called Jeneora Rock, where Vash defeated her. She escaped, only to be captured by Midvalley and killed for her failure.

E.G. Mine

E.G. Mine is the fifth Gung-Ho Gun. He appears in Episodes Fifteen and Sixteen ("Demons Eye" and "Fifth Moon," respectively). He is of medium height with abnormally long arms. He has spiky green hair with a white stripe down the centre, and a diamond-shaped mask over his nose and mouth. His weapon consists of two hemispheres strapped together with a brace over his head and covering the right and left sides of his body. They fire 10-centimetre-long conical spikes that automatically reload.

E.G. Mine survived his duel with Vash only to die at the hands of Rai Dei the Blade moments later.

Grey the Ninelives

Grey the Ninelives is a member of the Gung-Ho Guns whose rank remains a mystery. It appears in Episodes Fifteen, Twenty, and Twenty-One ("Demons Eye," "Flying Ship," and "Out of Time," respectively).

Grey is a giant mecha operating independently, possibly under the control of an A.I. Most people believe it to be a living person. It stands three times as tall as Wolfwood and has weapons throughout its structure. Its body is armoured and impervious to normal armaments. Wolfwood destroyed most of it in battle, though the surviving lower half blew up the power plant, demolishing itself in the process.

Zazie the Beast

Zazie is the fourth Gung-Ho Gun. He is a small boy who controls desert worms through the use of high-frequency devices. He appears in Episodes Fifteen and Twenty-Two ("Demons Eye" and "Alternative"). He is medium height for his age, with unruly sandy blond hair and large brown eyes. He goes by the name "Bete."

Zazie controls the worms through small green tubes that he wears in his hair. They allow him to manipulate large numbers of desert worms, including driving them into unusual terrain and forcing them to attack cities. Zazie tries to kill Vash, but is unsuccessful. Vash attempts to convince him into surrendering, but before he can decide, Wolfwood kills Zazie.

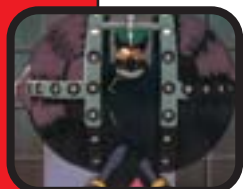

Caine the Longshot

Left-handed sniper extraordinaire and the most mysterious member of the Gung-Ho Guns, Caine was charged to shoot Vash and possibly Wolfwood, if the preacher failed to remain loyal to Knives. Based on the mask that he wears, it is reasonable to assume that Caine was somehow horribly disfigured and this may be the reason why he never speaks — simply, he cannot. Caine wears a chameleon-like cloak that takes on the pattern and colour of whatever background he is against. He uses this after he sets up his gun and positions himself to wait for his target. His gun and his hat remain visible, however. Caine can wait patiently for his mark for hours, never moving, foregoing food and water.

Caine was unable to kill Vash and when confronted by his target and offered mercy, Caine chose death — much to the horror of Vash, Caine shot himself in the head with his spare revolver.

Rem Saverem

One of the original team members from Project SEEDS, Rem Saverem became mentor, mother figure, and saviour to Vash. She truly believed that all life was sacred and she proved this to Vash on two separate occasions: she prevented her Captain from destroying Vash and Knives when they first found them as babies, and she saved the humans onboard the Project SEEDS ships after Knives sabotaged their directional controls. She was killed indirectly by Knives when she was unable to alter the course of her own ship and it burned up in the atmosphere of the planet. Her words had a profound effect on Vash — he based his entire way of life on her teachings, to the point where defying her words crippled him with sorrow. The memory of Rem and her favourite flower, the red geranium, remain a part of Vash forever — “I will keep the word of the red geranium, which I was taught so long ago. I keep the courage and determination deep in my heart.”

Lina

Lina is a twelve-year-old girl who finds Vash sitting in an alleyway in her hometown of Karsted City, following the destruction of Augusta City. She appears in Episode Eighteen, “Goodbye for Now.” She has short red hair and blue eyes, typically wearing western-style clothes.

Lina and her grandmother adopt Vash and nurse him back to health. He stays with them under the name Eriks and plans to live the rest of his life there. After bandits kidnap Lina, Vash and Wolfwood rescue her. Lina and her grandmother live quietly, hoping Vash will return one day.

Grandma Sheryl

Grandma Sheryl is Lina’s grandmother. She appears in Episode Eighteen, “Goodbye for Now.” Grandma Sheryl is a portly older woman with light brown hair, spectacles, and tanned skin. She cares for Lina and considers Vash her adopted family.

Grandma Sheryl is a feisty woman who would willingly fight a horde of bandits single-handedly to save the people she loves. She nurses Vash back to health and believes him a loveable but foolish do-gooder. She charges Wolfwood to take care of him.

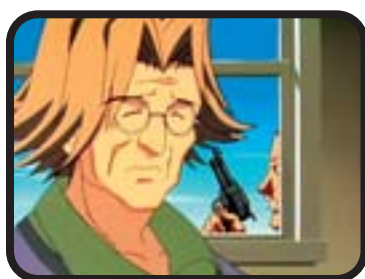
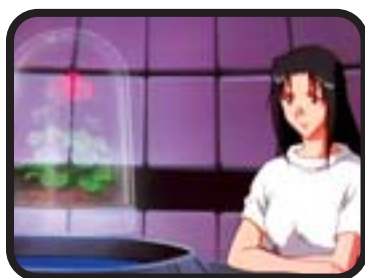
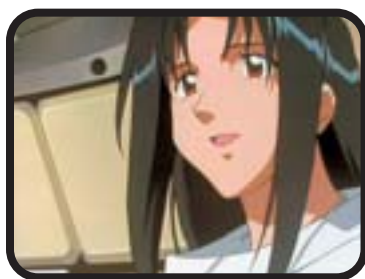

Max Simon

Max Simon is a heavy older man with grey hair, moustache, and a goatee who appears in Episode Nineteen, "Hang Fire." He works for the satellite-company in New Oregon as a weather forecaster. He is an old friend of Vash's and has known him for years.

The Doctor on the floating ship knows Max, so it is not unreasonable to assume a connection there. Max is an expert at predicting the weather of the desert planet, and has made that his profession. He is good enough that his boss, Mr. Polo, gives Max whatever allowances he wants to keep him happy. Max helped Vash free Slader Polo, the son of his employer.

Doctor

The Doctor is a specialist in cybernetic and medical technologies. He appears in Episodes Twenty and Twenty-One ("Flying Ship" and "Out of Time," respectively). He is a very short bald man with Asian features. He typically wears a brown hat and coat.

The Doctor is the source of Vash's cybernetic enhancements and is very skilled. He lives on the floating ship and acts as an authority figure for the vessel's inhabitants. He understands the ship inside and out, and can easily track the movements of individuals. He is cheerful even in the face of adversity and places great trust in Vash.

Brad

Brad is a young man living on the floating ship. He appears in Episodes Twenty and Twenty-One ("Flying Ship" and "Out of Time," respectively), and acts as a cross between policeman, assistant, and bodyguard for the Doctor. Brad is tall and muscular, with curly brown hair and dark eyes. He wears a brown jacket and carries a pistol with a laser sight.

Brad is jealous of Vash in the beginning, but comes to respect Vash's abilities and determination. He helps Vash destroy the puppets infesting the ship and tries saving the plant. The Jessica puppet kills him when he saves Vash's life.

Jessica

Jessica is a young woman on the floating ship. She last saw Vash when she was a small child and developed a crush on him that lasted for twenty years. She has light brown hair and large green eyes with a sweet, impulsive personality.

Leonof's puppets kidnap Jessica and put a decoy in her place. The switch is not discovered until the puppet tries to shoot Vash, accidentally killing Brad instead when he leaps in the way. Jessica mourns for Brad because she did not realize she loved him until he was gone. The people from the planet frighten her.

Julius and Moore

Julius and Moore are a pair of lovers trying to escape the caravan owned by Julius' adopted father. Julius is of moderate height, with short sandy-blond hair and blue eyes. Moore is petite, with spiky brown hair in ponytails. They appear in Episode Eleven, "Escape From Pain."

Julius is the son of the mayor of Fondrique, but was adopted by the leader of the caravan for unknown reasons. Whether he was kidnapped or ran away remains a mystery. It is unlikely either happened, however, since the caravan relies on its trade with Fondrique, and would hardly risk kidnapping or harbouring the boy if they continued dealing with the city. More likely, Julius' adoption was arranged as part of a treaty or exchange. Regardless, Julius bears an arm tattoo, allowing his caravan to enter the well-guarded city. The caravan needs him to enter Fondrique, but when Moore and he run away to keep her from being sold into slavery, the caravan hunts after the two fugitives. Vash shoots the pair with rubber bullets, convincing the caravan he killed them so the lovers can escape.

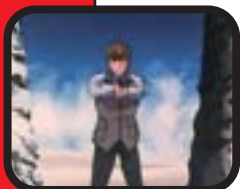
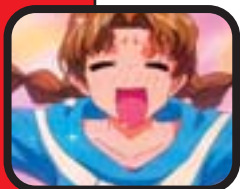
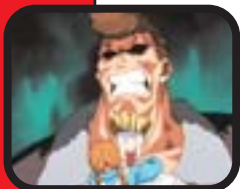
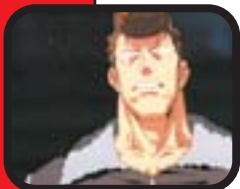
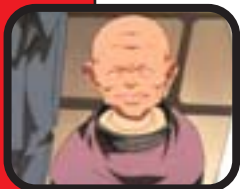

The World of Trigon

The world of *Trigon* is a hostile one, as much because of its people as the environment itself. A harsh and unforgiving place, the desert encompassing the planet is full of natural hazards. Its two suns and three moons overlook a smattering of human settlements, each dependent on century-old technology for its existence. Natural hazards dot the landscape, from geyser fields to canyons, and the constant threat of dehydration is one of the worst dangers for anyone brave enough to travel.

The greatest hazards, however, are those people who set themselves outside of society. Unbound by the codes of hospitality hostile regions usually engender, the outlaws and robber barons prey without mercy on those who pass beneath their shadow. Scrambling for survival and power over their surroundings, anyone who is within reach is a valid target.

Stantal (possibly the desert planet of *Trigon*, though it might well be the area where the series unfolds) seems to have one far-reaching federal government. Its presence is sparse, however, and autonomous city-states and feudal areas effectively exist with impunity. No standing armed forces or militias earn any mention in the first half of the series, making local law enforcement, marshals, and bounty hunters the only organized defensive presence throughout most of the land.



History

The history of the world rightfully begins somewhere in Earth's future, when humanity discovered that it had either overpopulated or overworked the planet, leaving little hope for survival. The damage was too extensive to repair once humans realized what they had done, and so there was no choice but to go looking for a new home.

Project SEEDS was a means of ensuring humanity's survival. They built a convoy of spaceships, many with the capacity to hold thousands of humans in suspended animation or the plants, until they could find a new planet. Whether Project SEEDS was meant to hold all humans or only a portion is not certain, but both Rem and Joey clearly state there was no other choice.

After searching for an unspecified length of time, the Project SEEDS crew happened upon a harsh, yet habitable, planet. Knives' machinations almost sent the ships crashing onto the planet's surface. The command ship was utterly destroyed, but Rem managed to save the fleet at the last minute.

The surviving humans from the crash went on to create the desert world as presented in *Trigon*. The crash seemingly destroyed much of humanity's technological and scientific knowledge, leaving the settlers to learn to function under harsh conditions and archaic technology in the hopes of rebuilding what they had once achieved.

Trigon timeline begins with stardate 0001, the year the ships landed. On stardate 0104, Knives and Vash destroyed the city of July. On stardate 0131, Vash devastated the city of Augusta, and on stardate 0132, Vash defeated Knives.





Technology

There are two levels of technology in *Trigun*: common technology and lost technology. The former is a combination of technology from the past, present, and future (in relation to the real world), though it can be described as low overall.

Cars and tracked vehicles are common, but folks use thomases — beasts of burden resembling a cross between a huge anteater and an ostrich — for travelling short distances or for cheap transportation. Air travel is unknown. Steam-power is common, especially in larger vehicles or those requiring more power. Personal computers are unknown. Photographic technology is still the province of the wealthy, and not commonly used.

Letters are the only apparent method of long-distance communication, and there is radio, but television is seemingly unavailable. Clothing is sturdy, with long coats and cloaks commonplace to help guard against sand and sun. Fashion is a mix of late-1800's styles with modern-day clothing. As a rule, the more urban and professional an area is, the more modern the clothing will be. Medical care is a mix of new and old. Reconstructive surgery is equivalent to modern-day practices, but there is a lack of organized health-care. Hospitals seem rare, and there is usually only one doctor to a town.

Available weaponry possesses a higher level of technology than anything in the real world. Ballistic technology serves as the basic weapon type while explosives are uncommon, but available.

Lost technology ranges from modern-day to futuristic. Robots and mechas are common, as are energy weapons and computer technology (like those found on large vehicles like the *Flourish*). Fusion and nuclear power once existed on the desert planet, as did space travel and microtransmitters. There is very little lost technology in the world, however, and nearly any item of that calibre is rare and wonderful.

Production Plants

Some of the planet's most important features of life are the production plants found in every city and town. The plants are lost technology, capable of output beyond anything provided in the real world. The plants are large curving shells that rise high above the city, supporting two concentric transparent spheres that look something like light bulbs.

The first season never specifies exactly what the plants produce or how, but it is clear they enable cities to exist, as shown in "Hard Puncher." It is probable the plants are responsible for some form of energy production, but there is nothing in the first 13 episodes to confirm or deny this. Towns and smaller villages do not require plants to exist. Cities or larger urban areas must have at least one.

The plants are the lifeblood of cities across the desert, and as such they are well protected. Some cities even isolate themselves for fear of sabotage, allowing only those with the correct identification or visa to enter. Wash is the only person in the first half of the series who seems to understand the plants, including the engineers responsible for their maintenance.

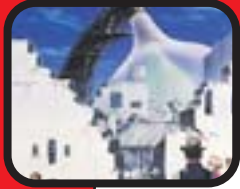
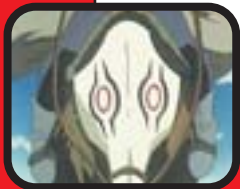

Cities

Dankin Town

Dankin Town is a small community shown in Episode One, "The \$\$60,000,000,000 Man." It was destroyed by a man fitting the description of Descartes, but was attributed to Vash the Stampede. While half the town was reduced to rubble, there were no casualties. Dankin does not have a plant.

December

December is not actually shown in the first half of the series, but it seems to be among planet's larger cities. It is the headquarters of the Bernadelli Insurance Society and home to both Meryl and Milly, when they are not following Vash around. It is also the closest city to Wolfwood's orphanage, which is 300 iles away. The series never mentions the number of production plants in December.



Demislad

Demislad is a small town adjacent to the Demislad Geyser Field. It is a popular way stop for caravans, and specializes in serving the needs of travellers. Demislad itself is small, though it doubles in size when a caravan arrives and pitches a blossom of tents around the town's edge like ruffles on a skirt. Demislad does not have a plant.

Felnar! Town

Felnar! Town was destroyed in Episode One, when Ruth Loose, a bounty hunter chasing Vash, caused a landslide and buried most of the community. Luckily, the town had been evacuated a short while before and there were no casualties. Felnar! Town has an incomplete or burned out plant that is (presumably) completely non-functional. The curving shell is present, but the spheres (the working portion of the plant) is not.

Fondrique

Fondrique is not shown in the early episodes. It is the destination of the caravan in Episode Ten, "Escape From Pain." The city jealously guards its handful of highly efficient production plants, though their numbers are never specified in the first 13 episodes. Fondrique does not allow outsiders into the city, for fear of terrorists. Julius, the adopted son of the caravan owner, is actually the son of the mayor of Fondrique, and the tattoo on his arm serves as a pass into the city.



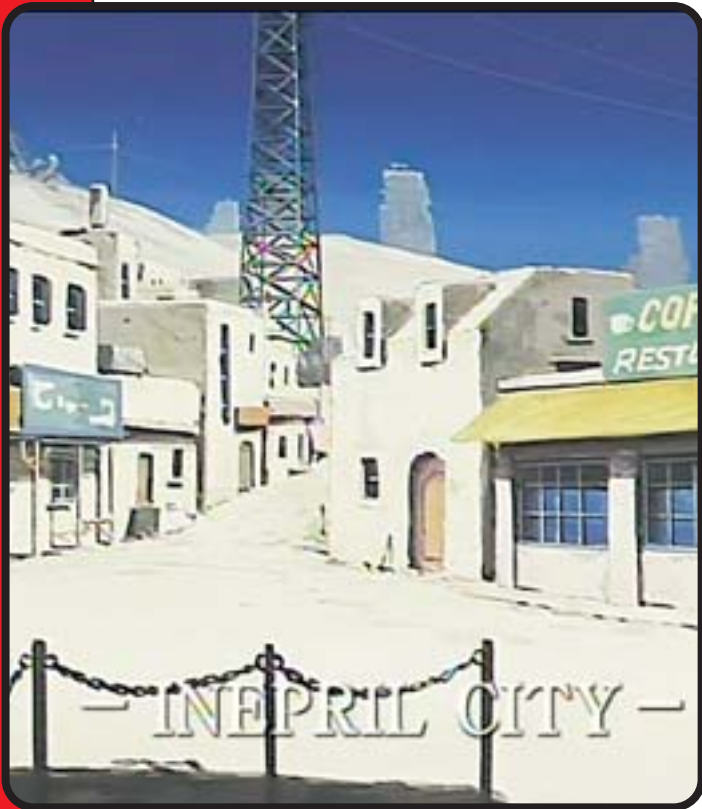

Inepril City

Inepril City is featured in Episodes Five, Six, and Seven, and lays half-buried in sand. The citizens of Inepril attempt to capture and kill Vash, to collect the reward and repair their malfunctioning plant, which is presumably why sand covers a large portion of the city. When Vash captures the Nebraska Family, he gives the city the reward so they can have the plant repaired. Presumably, the town will slowly grow and develop now that their plant is back in operating order. The city is also a stop for the sand steamer *Flourish*, and thus probably closest to Luttonberg Canyon. The citizens of Inepril hold Vash in high esteem, and will protect him against anyone whom they suspect might wish to harm him. Inepril City has one inoperative plant that is now presumably repaired, and at least three or four light-bulb spheres.

July City

July City was destroyed 27 years ago, supposedly by Vash the Stampede. It was the third city named July built in that location, though the fates of its predecessors are not mentioned. It was also the hometown of Elizabeth, from Episode Six, "Lost July." The number and status of July's production plants is not specified.

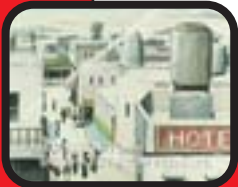

Lewiston Town

Lewiston Town is a small community near Felnarl that appears in Episode One. Milly and Meryl stay there for a time after parting ways with Vash. They fill out their reports regarding the disaster at Felnarl, and decide how best to continue trying to find Vash the Stampede. Lewiston does not have a plant.



May City

May City, or Mei City as it sometimes appears, is the setting for episodes Eight and Nine, "Murder Machine" and "Quick Draw." The Quick Draw tournament is held here annually, run by the local organized crime boss. May City has two working plants.



Orleans

Orleans is under the control of outlaw turned mayor, "Grim Reaper" Bostalk. As self-proclaimed Earl of Orleans for the past twelve years, he lives with his daughter, Stefany, though there is no indication of his wife's fate. Orleans does not have a production plant, though the fact settlers probably arrived after the fall of July (and presumably technology as well), it is unlikely they could have built one.



Warrens City

Warrens City appears in Episode Three, "Peace Maker." It is home to Frank Marlon, the genius gunsmith. Warrens City is probably the worst place to rob considering virtually everyone is armed thanks to Marlon supplying folks with weapons to protect themselves. Marlon fixes and designs firearms, and is one of the best on the planet. Warrens City also seemingly has two destroyed plants and two active ones.

Unnamed Town #1

There are three unnamed towns featured in the *Trigun*. The first appeared in Episode Two, "Truth of Mistake." It was the town Mr. Schezar forced people to abandon, which was later flooded when Schezar's water tanks exploded. This unnamed town was situated in a crater-like depression, and below the desert floor. After the flood, the town barely breaks the surface of the lake, although Marianne, the Marshal, indicates the water will eventually seep into the underwater caverns, allowing folks to return to their homes. Regardless, the town can anticipate years of rebuilding from the obvious extensive neglect present before the flood.

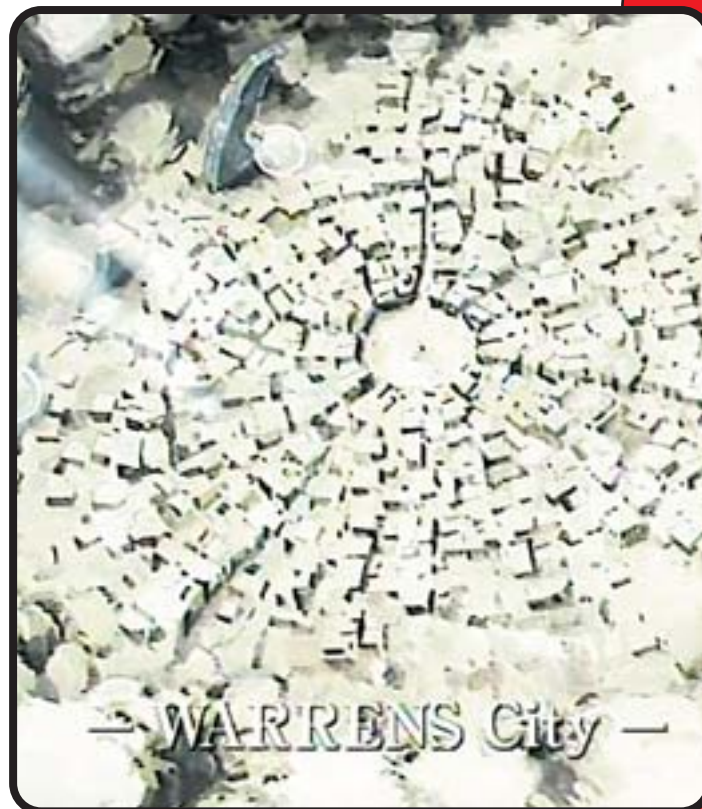

Unnamed Town #2

The second unnamed town is where Vash battles with Money the Gale in Episodes Twelve and Thirteen. The town appears vibrant and well populated early on, but that is before Money unleashes his fury while trying to kill Vash. From the cliff-side view where Legato Bluesummers stands, overlooking the region, it is obvious this city is larger than most. Dominating the horizon is a large plant seemingly larger than most seen thus far.

After Vash's confrontation with Money, however, the entire city seems wrecked from what little portions the episodes reveal. The plant remains unscathed by all appearances, but there is significant property damage almost everywhere, and many people are dead. Given recent events, this town understandably despises Vash.

Unnamed Town #3

This is a small town 200 miles from LR Town. It could be Demitrihi, the town in which Knives was found. It is the setting for Episode Twenty-Five, "Live Through." Meryl and Milly bring Vash here to recuperate from his fights with Legato and Midvalley, as well heal his spirit. Vash finds Knives within a short walk from town, and it is where Vash brings Knives after their fight. There is no plant in this town.

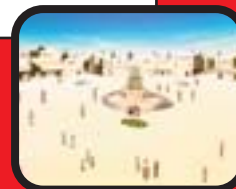



Promontory

Promontory is a large town shown in Episode Fourteen, “Little Arcadia.” It has a high population and appears to be a centre for business as well. The small forest owned by Badwick and his parents lies only a few minutes outside of the town. There is no plant shown.

Jeneora Rock

Jeneora Rock is a small town shown in Episodes Fifteen and Sixteen (“Demons Eye” and “Fifth Moon”). It lies at the base of a natural column of rock, which the town has converted into a windmill power generator. Legato Bluesummers and the Gung-Ho Guns kill the Roderick Thieves while Vash defeats Dominique the Cyclops at the top of the windmill. Jeneora Rock does not have a plant.

Augusta City

Augusta City is one of the seven largest settlements on the planet. It appears in Episode Sixteen, “Fifth Moon.” Vash’s Angel Arm devastated Augusta during the fight with Rai Dei the Blade. Legato triggered the arm through mind control against Vash’s will. Luckily, Vash evacuated the city before the blast. There is at least one plant in Augusta, along with a huge communications tower. The fate of the tower and plant are unknown.

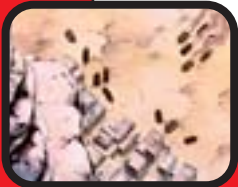

July City

July City is one of the seven largest settlements on the planet, and appears in flashbacks throughout the second half of the series. It was destroyed approximately twenty-five years earlier by Vash in his fight with Knives. Knives triggered the Angel Arm transformation that levelled the July. Vash caught Knives in the blast as well, forcing him to spend the next twenty years regenerating. July had at least three plants and an impressive tower with advanced communications equipment. The fate of the plants and tower are unknown.



Karsted City

Karsted City is a small community, despite its name. It is the setting for Episode Eighteen, “Goodbye for Now.” Lina and her grandmother, Sheryl, live in Karsted City, and Vash resided there for a time under the name Eriks. Karsted City does not have a plant.



Carcases

Carcases is a small rural town. It is not actually shown in the series, but Wolfwood mentions it in Episode Eighteen, “Goodbye for Now.” It is the first recorded instance where the entire population disappeared without a trace. The only clue is the word “Knives” written in red on the monument in the centre of town. There is no information to indicate that they have a plant.



December City

December City is one of the seven major settlements on the planet. It is shown in Episode Nineteen, "Hang Fire." The Bernadelli Insurance Society is based here, and it is home to both Milly and Meryl when they are not travelling. The series offers no information regarding plants or special structures for December.

Little Jersey

Little Jersey is a small town shown in Episode Nineteen, "Hang Fire." It was badly damaged in a fight between Vash and local bandits. It does not have a plant.

New Oregon

New Oregon is a medium-sized town and home to the satellite, one of very few radio broadcasting centres on the planet. It is the primary setting for Episode Nineteen, "Hang Fire." The Polo and Fris families have an ongoing dispute regarding ownership of the satellite. It is also the closest town to the landing site of the last SEEDS vessel. There may be one plant in New Oregon, but that remains unclear.



Keybos

Keybos is a medium-sized town shown in Episode Twenty-Two, "Alternative." It is unusual because of the walls surrounding the city, and the tall gates guarding the only entrance. Much of the city falls to desert worms during an attack by the Gung-Ho Gun, Zazie the Beast. It has one plant, but the plant's fate is unknown.

Tonim Town

Tonim Town is a medium-sized settlement, shown in Episodes Twenty-Three and Twenty-Four ("Paradise" and "Sin"). The population mysteriously abandoned town just as in Carcasses, and vanished without a trace. The word Knives is painted on the monument in this town as well. Both Wolfwood and Caine the Longshot are buried here. Tonim Town has no plants.

LR Town

LR Town is a large community and the setting for Episode Twenty-Four, "Sin." LR Town is prosperous with sand steamer docks and a stable economic base. It is the scene for Vash's fight with Midvalley and Legato. It does not have a plant, but is situated near an even larger town, from which it receives its power.





Production Plants

One of the world's most crucial technologies are the production plants scattered across the face of the planet. The plants are considered lost technology, capable of power output beyond anything provided in the real world. A plant is a pair of concentric transparent spheres resembling light bulbs. They usually hang from large curving shells that rise high above the cities, the remaining walls of crashed ships that landed over 130 years ago.

The plants are powered by a race called "the beings that exist outside of time." Exactly how the entities provide or regulate power is unknown, as is how the entities survive inside the plants.

The plants are a city's lifblood across the desert, and as such are well protected. Some cities even isolate themselves for fear of sabotage, allowing only those with the correct identification to enter. There are engineers who maintain the plants, but even they are not aware of the beings who actually provide the power. Vash and Knives are the only individuals who can communicate with the beings inside the plants, possibly through some form of telepathy.

The plants were the energy sources that allowed mankind to travel though space. Each ship had at least four, but many of these were damaged in the crashes. This would indicate there are probably a limited number of plants, and that it would be extremely difficult to move them to a new location given the low post-crash technology level. This also implies there are a limited number of possible cities and a maximum population ceiling these cities can support.



The Floating City

The Floating City is one of the last strongholds of lost technology left to humanity. Though it crash-landed on the planet by the end of the series, it maintained itself long enough to preserve much of the knowledge lost by the other survivors of the shipwrecks.

Project SEEDS was made up of a flotilla of dozens of ships, each carrying thousands of humans in suspended animation. Most of the ships had no crew and were controlled remotely by the command ship, where Rem and the other crewmembers navigated the ships and kept things in order. When the ships crashed, the humans in suspended animation woke up, but were presumably unaware of how to use the ship's existing systems fluently. Theoretically, they had never been crew, only passengers, and so they scavenged what they could to survive.

Some of the humans on the floating ship were either crewmen or released from suspended animation when the ship entered orbit. As of Episode Twenty, there are still humans in suspended animation on board. They never lost the technical knowledge that the rest of the world forgot, including the truth behind the plants and why they work. They managed to live and maintain their city for over 130 years, saving Vash from death at least once and giving him multiple versions of cybernetic arms to replace the one he lost at July City.

The Floating City features at least six levels and multiple living areas. It has two functioning plants and technology more advanced than any place possibly outside the four remaining major cities. At least one individual, the Doctor, can creating sophisticated cybernetic limbs, which are presumably light-years ahead of the world's current technology.

While the inhabitants were afraid of the surface dwellers while their city was airborne, it remains to be seen how that prejudice and fear affects their efforts to reconcile with the rest of humanity. Their non-violent culture may also undergo change as part of living in a more barbaric environment. Their entrance into the struggle of humanity as a whole, however, may just prove the scientific and technological leap forward that the planet desperately needs.

Wild West

The “Wild West” period of Earth lasted roughly from 1850 to 1910 and it covered the western half of the United States. Thousands of Americans and immigrants travelled west, beyond the boundaries of the established states, into what they hoped would be a land of opportunity and wealth. The hardships they endured and the paths they blazed made possible the US’s eventual expansion to the Pacific Ocean, a drive that, while cementing the wealth and potential of the US, signalled the end of a way of life for the native inhabitants of the continent.

The Wild West period was made unique by both its frontier culture and the revolver’s ease of use and availability. In the search for wealth and land, people settled in remote areas and farmed, raised livestock, mined, and otherwise established settlements and towns. For the fifty years in question, the fastest widely available method of communication was by letters, which in the furthest settlements could take months to arrive. That lack of connection with the East, combined with difficult and lengthy travel made for small population centres largely insulated from the world as a whole. Self-reliance was a necessity, both on an individual and societal level. Communities shared hardships and policed themselves to keep trouble at a minimum.



The second half of this equation is the revolver, the weapon of choice in the western community. Rifles were far more accurate, shotguns far more deadly, but the revolver was inexpensive, easy to obtain, easy to conceal, and accurate enough to be formidable. Given the rarity of truly civilized areas and the prevalence of alcohol and hard lifestyles, folks considered protection a foremost need in the frontier culture. The same barber down the street was likely the town’s sheriff, or at least a deputy or a member of the local militia. He was therefore armed, as were most farmers, ranchers, tradesmen, and bartenders. This also does not account for the itinerant lawmen, bodyguards, miners, and criminals who dotted the West’s landscape, moving from town to town as their fortunes or restless natures decreed.

The Wild West’s end came after the turn of the 19th century, when much of the West enjoyed sufficient population to petition for statehood and form their own governments. Towns were no longer few and far between, and those early rough settlements now had families and schools, churches and social clubs. Travel was far easier with the expansion of both rail and conventional roads, and law enforcement became much more organized and consistent. The telegraph spread through the West, giving people a method of quick and reliable information exchange. All these advances led to the demise of the lonesome, daredevil, dangerous lifestyle that epitomized the Wild West.





Important Organizations

Bad Lads Gang

On the planet of two suns, most organized crime stays at the local level. While globally powerful groups might exist, the lack of quick or instant long-distance communication make it unlikely. The best example of a local organized crime element in the first season is the Bad Lads Gang.

The Bad Lads Gang is a group of criminals banded together under the leadership of Brilliant Dynamites Neon, the infamous bandit. Their base of operations is the Luttenberg Canyon, a treacherous stretch of land serving as a pass for sand steamer lines, caravans and other forms of travel. The Bad Lads Gang is renowned for its effective tactics and glowing costumes, an effect Neon uses to his own benefit in cowing opposition and intimidating victims.

The Bad Lads Gang is ruthless and efficient, equally concerned with style and substance in prospective members. Neon is fair as a leader, if unforgiving. He expects obedience from his men and receives it; that is what makes his gang so dangerous. The fact Neon can rely on his men (and presumably women) to follow his orders in a given situation makes the Bad Lads far more successful than any other group of its kind.

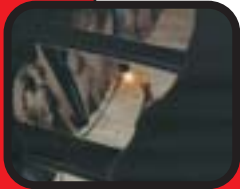

Feds

The Feds is a nickname for the desert planet's Federal Bureau (SFB — an acronym for Stantal Federal Bureau), a federal law enforcement organization. The SFB is only mentioned once by name, when Mr. Schezar introduces Marianne to Vash, Meryl, and Milly in Episode Two. While it is possible Stantal is not the name of the planet, there are no other indications one way or the other.

The marshals are part of the Feds, and they handle crimes that stretch beyond the boundaries of a specific city. They set bounties on high-profile criminals, and thus work with bounty hunters to retrieve those miscreants who may be beyond the easy reach of the marshals.

The marshals are an elite group of highly trained individuals, charged with investigating and capturing criminals who endanger the welfare of the planet's citizens. The total number of marshals is not specified, but they are rare. It is possible there is one marshal per major city, and that the surrounding towns are also under their jurisdiction. There may also be a number of floating marshals assigned to investigative or undercover work, such as Marianne.



Marius-Breskem-Kantacle Technical Industrial Union

The Marius-Breskem-Kantacle Technical Industrial Union is the coalition of engineers who maintain the production plants. They send teams across the planet to fix plants wherever required, but command exorbitant prices for their services since no one else possesses their knowledge base. The engineers are both male and female, and are probably wealthy from the high salaries they can command. All plant engineers work for the union, granting the group a monopoly on services.

The head engineers lead a luxurious lifestyle, with bodyguards to ensure their safety and see to their needs. Elizabeth was chief engineer for the repair team that came to Inepril City. For all their vaunted technical ability, however, the union cannot build plants, nor do they understand the science behind them. They can only work to keep the ancient machines running for as long as possible.

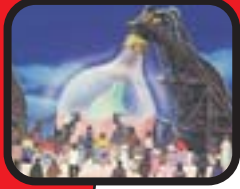
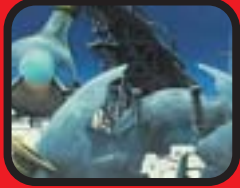

The Polo and Fris Families

New Oregon is home to the Satellite, one of the few communications stations outside the seven cities. It broadcasts radio transmissions across a wide area, complete with a whole host of programming including radio personalities and music.

The Satellite station is a lucrative business conferring no small degree of wealth and power upon its owners. Those rights of ownership are among the most prized possessions in that region, possessions that the Polo and Fris, two powerful and influential families, are contesting.

The Polo family is currently in possession of the Satellite facilities, a position backed by the Federal Cavalry. The head of the family runs the station, and is assisted by his sons (of which there are at least four). They have owned the facility for several years, as indicated by the photo of Max Simon as a young man on Mr. Polo's desk. Max Simon is a friend of the Polo family in addition to being an employee of the station; he helps Vash deal with the intruders.



The Fris family also claims right to the Satellite, though the series does not cover the origin of the dispute. The Frises are a large extended family, with many apparent branches. They are not located in New Oregon, but make their headquarters elsewhere (the series does not reveal the location). Both families also employ guards and other retainers to protect and enforce their interests, making for large blocks of involved individuals on both sides.

While the original dispute may have taken place on a legal battlefield, by the time of the series it has devolved into a war. The Polo family kills a distantly related member of the Fris family, a young woman named Aileen, to send a message to the Fris that they must cease their claims. This message has the opposite effect, especially when aided by Leon of the Puppetmaster's creation, Mr. Lurald.

Members of the Fris family band together with the intent of storming the Satellite station and killing the head of the Polo family, thus wresting away control of the broadcasting interests. The father of the murdered girl goes along as well, determined to kill Slader, his daughter's murderer.

Vash intervenes and the father spares Slader's life, but the situation is never entirely resolved. The Fris cannot hold onto the station, and their concerns are not addressed. The series does not hint at a resolution to the dilemma.

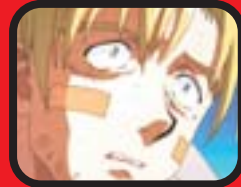
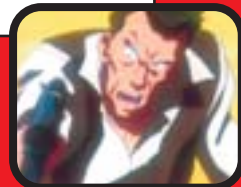

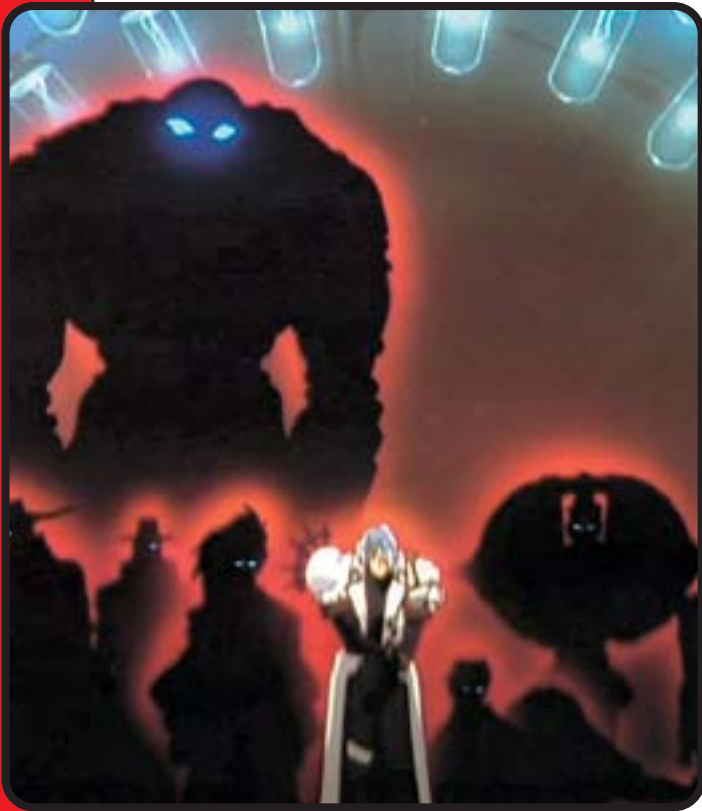

Gung-Ho Guns

The Gung-Ho Guns are a gang of mercenaries, assembled by Legato Bluesummers. Their sole purpose is to follow Knives's orders and bring Vash the Stampede to an unhappy end. While the series does not confirm this, there is evidence suggesting that the Gung-Ho Guns were assembled during the prior twenty years (following the destruction of July City). Knives may have recruited Legato before that event, but Legato almost certainly recruited the others afterwards, while Knives recovered from the near-fatal injuries he suffered at July.

While many of the Gung-Ho Guns seemed intent on killing Vash, it is probable Knives and Legato planned on sending them to their deaths all along, using that emotional distress to break Vash's will and make him suffer.

Legato Bluesummers is the leader of the Gung-Ho Guns. In turn, he takes his direction solely from their employer, Knives. Knives may dictate special assignments to the Gung-Ho Guns' individual operatives on occasion, but he typically works through Legato. It is unknown how many specific actions by the Gung-Ho Guns were engineered directly by Knives or left to Legato's discretion.

The Gung-Ho Guns appear to follow a clear ranking system within their gang. Whether this indicates the order in which they joined the group or the authority each member possesses (like a pecking order) is never specified. There are twelve members in the Gung-Ho Guns, not counting Knives, who has ultimate authority over everyone. Aside from Legato and Knives, all the others seem of equal authority and pay.

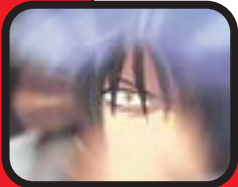

The Gung-Ho Guns break down into two camps: those who believe in Knives's cause and those who are there for the money. The former group is small, consisting only of Legato (and Midvalley as the series progresses). They seem to be the only members who know what Vash is and what he can do, as well as having some understanding of the greater strategy behind the group. The latter group base their assumptions on the rumours surrounding Vash's legend and the fact he will avoid killing at all cost. They seem largely unprepared for Vash's actual skill, a failing that leads nearly all of them to disaster.



The first member is Legato, who is also Knives's lieutenant. He leads the other Gung-Ho Guns and gives them assignments based on his own judgement. Other members of the Gung-Ho Guns speak respectfully to him, indicating that they defer to him as well. He is easily the most dangerous of all the Gung-Ho Guns.

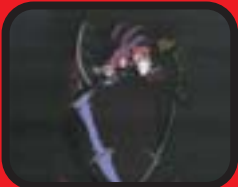

The second member is Dominique the Cyclops. Dominique's assignment was to kill Vash the Stampede. She was the second of the Gung-Ho Guns to fight Vash, the first being Money the Gale. She loses her battle with Vash and dies at the hands of the other Gung-Ho Guns, possibly Midvalley or E.G. Mine.

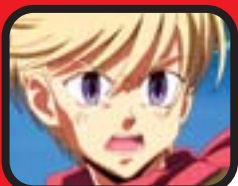

The third member is Hoppered the Gauntlet. Hoppered's assignment was to destroy the plant in the Floating City and kill as many citizens as possible. It is when he deviates from his assignment that he becomes incapacitated and nearly loses his chance to finish the job. He dies when the plant explodes.

The fourth member is Zazie the Beast. Zazie's assignment was ostensibly to kill Vash, though more likely he was to destroy Keybos and murder Vash's friends. He may have believed he was supposed to kill Vash as well, but if so, it is likely he was set up to fail. Wolfwood killed him.

The fifth member is E.G. Mine. E.G. Mine was assigned to kill Vash, but it is more likely he was sent against Vash as fodder. He bordered on disrespectful in a conversation with Legato that directly preceded his assignment to fight Vash. Rai Dei the Blade killed him as a punishment for failure.

The ninth member is Rai Dei the Blade. He was to back up E.G. Mine and intervene when the fight was over. Rai Dei did not know Vash's abilities or his belief system. He wanted to fight Vash in a death match so that he could undergo a sense of impending death and use that to achieve spiritual awareness. He did not expect Vash to refrain from killing him, and was angered when Vash refused to actively pursue his death. Wolfwood killed him after the destruction of Augusta City. The tenth rank is never determined.

The eleventh member is Midvalley the Hornfreak. He seems to function as Legato's assistant, travelling with him and carrying out Legato's direct orders. When he faces Vash, his assignment is to wear Vash down, then force him to watch the murder of innocents. When Vash defeats him, Midvalley kills himself (possibly under Legato's orders as indicated by his comment, "This is my fate, the fate of the dying," before firing his damaged weapon and blowing himself up).

The series does not establish the sixth, seventh, eighth, tenth, and twelfth rank. This leaves Monev the Gale, Leonof the Puppetmaster, Grey the Ninelives, Chapel the Evergreen, and Caine the Longshot without specific placement.



The first of these is Monev the Gale, whom Vash fought in the first half of the series. His assignment was to kill Vash, though it is likely Legato assigned him knowing he would fail. He met his death at the hands of the Gung-Ho Guns, possibly E.G. Mine, for failing his task.

Leonof the Puppetmaster was a saboteur, causing trouble and waiting for Vash's arrival. Leonof, along with two other Gung-Ho Guns, attacked the Floating City to destroy something Vash loved and burden him with guilt. Leonof tried killing Vash but Brad, a human on board the Floating City, saved Vash's life. Wolfwood killed Leonof following the assassination attempt on Vash.

Grey the Ninelives was to assist Leonof by destroying one of the plants aboard the ship, as well as causing general mayhem. He fought Wolfwood, never seeking Vash out at all. He died when he successfully destroyed the plant and caused an explosion.

Chapel the Evergreen was to force Wolfwood into killing Vash. When Wolfwood refused, Chapel attempted to execute his former student for disobedience to Knives. Wolfwood defeated him and chose to spare his life. As Wolfwood walked away, Legato took control of Chapel's body and killed Wolfwood. Knives killed Chapel when he attempted to avenge Wolfwood's death.

Caine the Longshot tried killing Vash using his extremely long-range rifle. When Vash evaded him and destroyed his gun, he killed himself with a revolver in his coat.

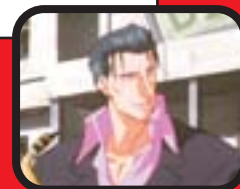



Bernadelli Insurance Society

The Bernadelli Insurance Society is among the most powerful economic forces in the world. It appears to have a near monopoly in the planetary insurance industry, and Bernadelli credentials are enough to gain entrance to almost every governmental and civil office on the planet. Bernadelli seems to enjoy an excellent reputation, as evidenced by the ease with which Meryl obtains co-operation from officials. Its headquarters are in December City.

Bernadelli policyholders are found throughout nearly every settlement on the planet. The company is aggressive in its risk management, assigning operatives beforehand to mitigate possible damages wherever such catastrophes seem likely to occur. They also seem to possess considerable pull with the government, enabling them to legally declare Vash the Stampede mankind's first human Act of God. That designation enabled them to cut their losses on Vash-related damages and remain in business.

The Bernadelli Society uses both regular and field operatives. Although it is not specified in the series, the field operatives likely receive some combat training given the high-level of bandit and criminal activity in rural areas. They also have access to various pieces of lost technology, such as the transmitter Milly used. The Society assigns these artifacts to operatives as necessary, to aid in their assignments. Any other types of artifacts to which they may have access remains unknown.

Bernadelli is the only corporation mentioned in the series. Folks mention it on the same level as the Feds, indicating the level of influence it may have in planetary affairs. Whether Bernadelli has offices throughout various cities or rely on field agents for all external actions is uncertain.

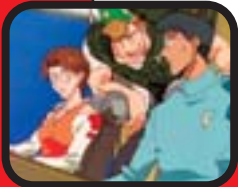

Project SEEDS

Project SEEDS was mankind's last hope for survival. After centuries of misuse, neglect, and damage, Earth was no longer capable of supporting human life. Humanity realized their folly, along with the knowledge it was too late to reverse the damage they had wrought. As a last-ditch effort to save the species, they devised a plan to save their species called "Project SEEDS."

This plan involved using the most advanced technology available to humanity at the time, and building dozens, if not hundreds of huge spaceships. Each ship could hold thousands of cryogenically frozen people in animated suspension indefinitely. There were also garden rooms — where the crewmembers could feel as though they were back on Earth again — cabins, kitchens, medical bays, cargo bays, and energy sources (the plants). There were possibly even terraforming devices for their new world, hinted at by a number of Rem's comments and Vash's reference to a "geo plant."

These ships were intended to go far beyond Earth's solar system in search of a habitable planet where humanity could start anew. It is unknown how far they travelled before finding the desert planet where they eventually landed, but one of the crew members mentions having been in the "cold sleep" at least three times already. This either indicates they had a rotating crew to extend their lives as long as possible or, more likely, the ship awoke the command crew whenever it scanned a potential planet.

Given the celebration when the desert planet appears on the monitor, it is possible this was the first halfway suitable candidate found thus far. The final decision of where to settle was not left in the crew's hands, but was determined by the "old men," a group of individuals who remained in suspended animation until the ship found a planet meeting the pre-determined criteria. It is likely the "old men" were expert scientific and/or military personnel with high status on Earth before the ships left the ground. It can be presumed that the group died when the command ship hit the planet's atmosphere and was destroyed. If the best and brightest were all housed on the command ship, this may account for why Earth's technologies (like the plants) are well beyond the grasp of the survivors.



TRIGUN d20 AND ROLE-PLAYING

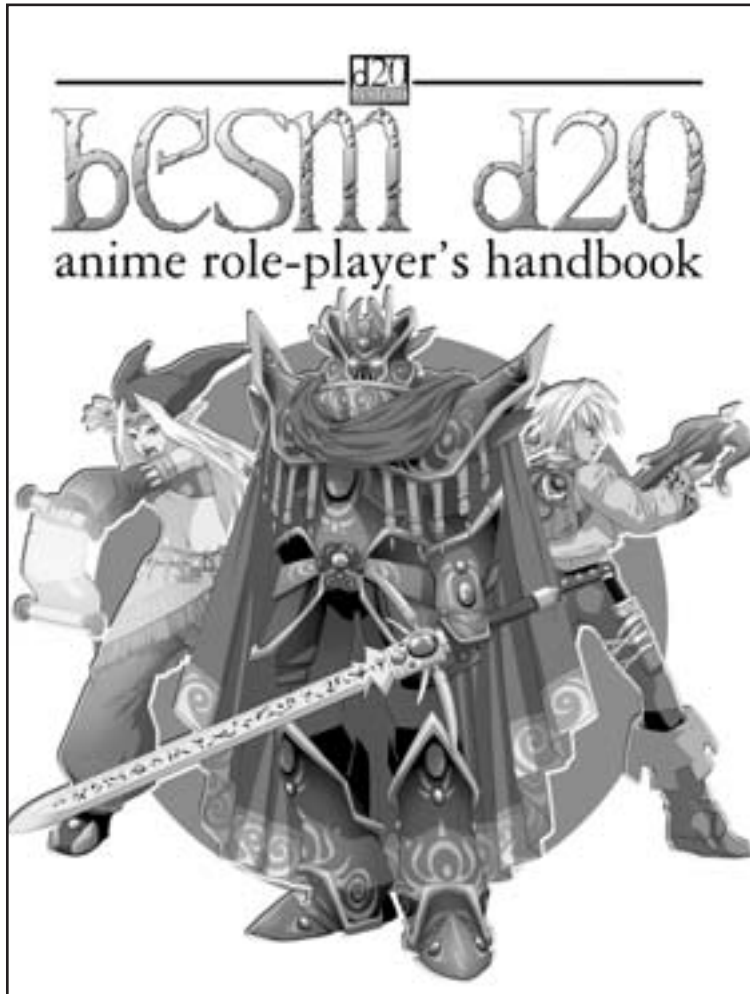

Although most of the *Trigun d20* provides resource and reference material for the series, some of the information in the following section is specifically included for those who wish to role-play in the world of *Trigun*.

GUARDIANS OF ORDER publishes a multi-genre Japanese *anime* role-playing game called *Big Eyes, Small Mouth d20* (ISBN 1-894525-72-8 standard edition and ISBN 1-894938-02-X Deluxe Limited Edition). *BESM d20*, combined with the *PHB*, contains all the game rules, mechanics, and guidelines you need to establish an anime RPG campaign in any setting, genre, or time period. If you plan on hosting your game within the *Trigun* setting, you may wish to use the game statistics provided for the series characters. Additionally, the reference lists, rules and suggestions for incorporating *Trigun* elements into your game can provide vital insight into campaign construction. The *Trigun*-specific material, in combination with the *BESM d20* rules, gives you everything you need to start role-playing right away.

If you are not familiar with that concept of table-top RPGs and would like to learn more, please visit our website at <http://www.guardiansorder.com>.

USING BESM d20 FOR A TRIGUN CAMPAIGN

- “Special” Attributes are rare, and probably have Psionic origins
- Ability Scores about 18 in the *Trigun* universe are not common
- Powerful weapons should be acquired through the Special Attack Attribute rather than Personal Gear
- The suggested starting level is 10 with a Discretionary Point range for original characters is 38+1d10 (44) points

TRIGUN REFERENCE WEBSITES

If you are searching for additional information on *Trigun*, you may find the following on-line references useful:

The Anime Web Turnpike

A source for both *Trigun* and general information links of all types. One of the leading anime portals on the web.
<http://www.anipike.com/>

That Anime Project

An excellent introduction to the basics and conventions of anime and *manga*.
<http://www.umich.edu/~anime/info.html>

ENDING CREDITS

JAPANESE CAST

Vash the Stampede **Masaya Onosaka**
 Meryl Stryfe **Hiromi Tsuru**
 Milly Thompson **Satsuki Yukino**
 Nicholas D. Wolfwood **Shou Hayami**

Written by **Yosuke Kuroda**

Animation Directors **Takahio Yoshimatsu**

Key Animators **Takuo Noda**
Tohiyuki Kanno
Mami Endo
Tomoaki Chishima
Masahiko Sasaki
Masatake Kawai
D R Movie

Ending Animation **Yoshimitsu Ohashi**

Background **Atlier Bwka**
Masumi Nishikawa
Toshiyuki Toshimura
Yuka Okamoto
Mayumi Okada
Hiroki Matsumoto
Takuya Iida
Kazuko Katsui
Yasunari Usuda

Colour Co-ordinator **Akihiko Isozaki**
Studio Oz

Colour Key **Akemi Hosoya**
D R Movie

Special Effects **Toyohiko Sakakibara**

Photography **Hitoshi Yamaguchi**
Atsuo Saito
Yukio Masumoto
Masahi Nagao
Madhouse
Ace Creation

Sound Effects **Shizuo Kurahashi**

Recording **Kazunari Tanaka**

Recording Studio **Omnibus Japan**

Sound Produced by **Arts Production**
Keiko Terao

Edited by **Ogata Editing Laboratory**
Hirotaishi Ogata
Satoshi Terauchi
Yukiko Ito

Laboratory **Tokyo Development Laboratory**

Titling **Maki Productions**

Video Editing **Video Tech**

Marketing **Junya Ito TV Tokyo**

Program Representative **Mitsuko Sekiya TV Tokyo**

Setting **Koji Nihashi**

Production Designer **Ryo Ono**

Production Assistant **Daisuke Honma**

Storyboard Unit Director **Chikahito Takayanagi**

Animation Produced by **Mad House**

Presented by **Victor Company of Japan, LTD**

English Version Produced by **Pioneer Entertainment USA L.P.**

In Association with **ZRO Limit Productions & Animaze INC.**

Executive Producer **Hideki Goto**

Producers **Yuji Moriya**
Yutaka Maseba
Haruyo Kanesaku

Production Co-ordinator **Osamu Maseba**

Assistant Producer **Taku Otsuka**

Production Assistant **Keisuke Onishi**

Translation Subtitle Timing **Anna Exter**
ZRO Limit Productions

Director **Lia Sargent**

English ADR Script Writers **Steve Nattow**
Trina Watton

Recording Facility **Magnitude 8 Post**

Digital ADR Tracking **"Big Phil" Brewster**

Final Mix **Les Claypool III**

ENGLISH CAST

Johnny Yong Bosch **Richard Plantagenet**
John Strong **Dorothy Melendrez**
Sparky Thornton **Bo Williams**
Lee Osborne **Lia Sargent**
Skip Hopper **Janet Owen**
G. Gordon Baer **Jessica Rubinstein**
Mike D'Gard **Babe**

CYBERTECHNOLOGY

Obtaining cybertechnology in a *Trigun* game should never be a simple matter. Most people in that setting live their whole lives and never see more than one or two people who have it. Receiving a limb replacement can be the basis of an entire story arc, unless the character has a shortcut through a government, corporate, or criminal organization. Even then, it is not likely to be a short or painless experience.

Finding people who can build and install cybernetic implants is not easy. The characters will have to chase rumours, travel, and ask favours of powerful individuals before tracking it down on their own. When they do find a group or individual who can install the cybernetics they want, the cost should be the next obstacle.

Given some of the costs stated in the show, the simplest cybernetic limb's projected price tag should be no less than \$\$100,000. For specially designed and obvious weaponry, either integral or hand-held, the cost should increase \$\$25,000 per feature. For concealed weaponry, raise the cost by an additional \$\$50,000 per feature. The cybernetic engineer may be willing to accept services or trade for part of the cost. Again, these costs are not stated in the series, but estimations for purposes of this section.

All cybernetic implants are custom made.

Each item requires a minimum of one month to create, with an additional week for each weapon or feature added. Cyberlimbs automatically impart the Super-Strength Attribute to that limb only. Any regular implants give the character the Marked Defect. To make the entire limb concealable and avoid the Marked Defect, double the \$\$ cost of the implant. A character who wants cybernetic modifications must have a Body Stat of at least 5 to withstand the operation stresses and work the implant successfully.

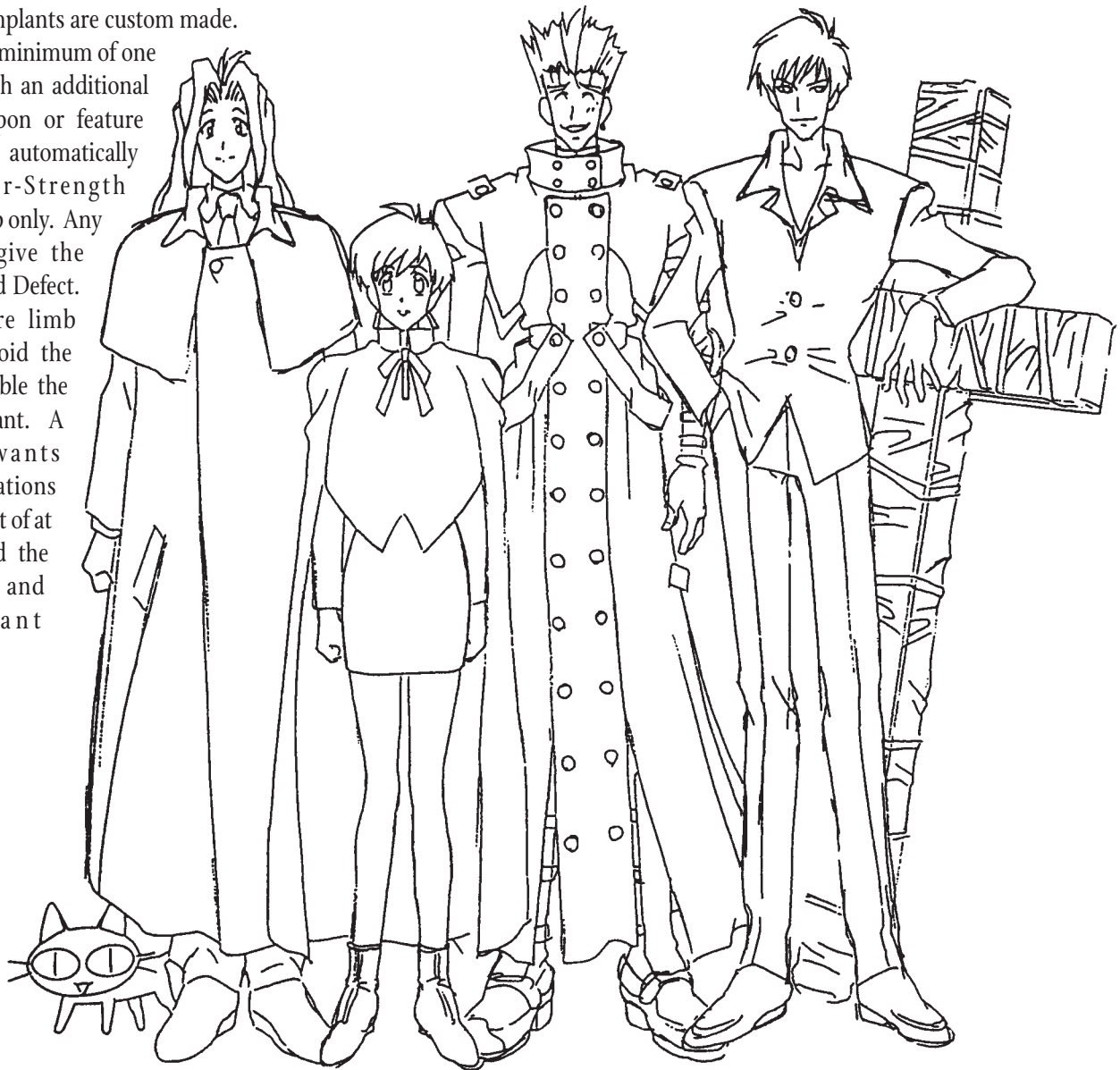

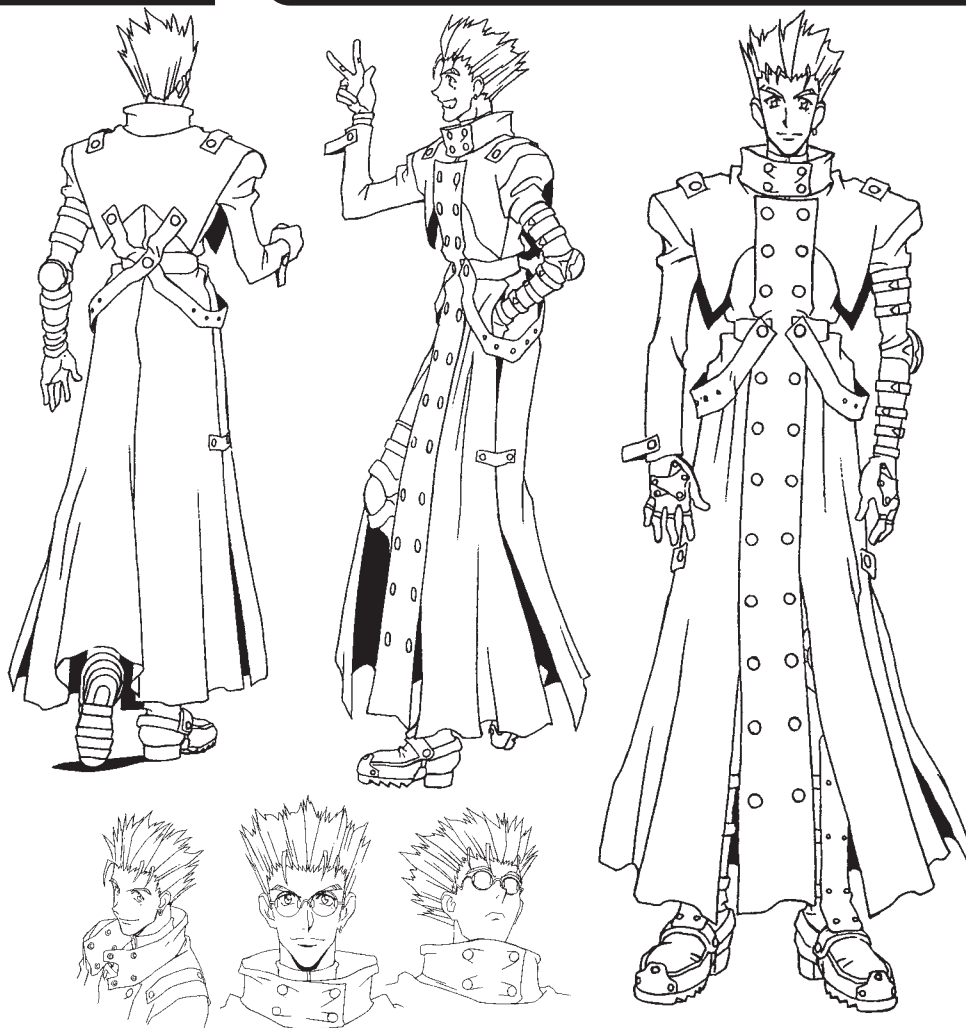

VASH THE STAMPEDE

Adventurer 18/Gun Bunny 15, Discretionary Points 44, Medium-sized Human, HD 18d4+54 plus 15d8+45, Hit Points 243, Energy Points 51, Initiative +19, Speed 51 ft., AC 10 (DCM +7, Dex +3), Base Attack +24/+21/+16/+11, Fort +14, Ref +18 Will +14, Str 17 (+3), Dex 17 (+3), Con 16 (+3), Int 15 (+2), Wis 16 (+3), Cha 17 (+3)

Attacks: +53, +53, +53, +53, +48, +43, +38 ranged (1d8+8, Limited Shots, *Revolver*) or +50, +50, +50, +50, +45 ranged (2d8+6, Auto-Fire, Penetrating: Armour, *Cybernetic Arm*) or +24 ranged (11d8+6, Flare, Penetrating: Armour x2, Backblast x2, Slow x2, Static, *Angel Arm*)

Attributes: Armour 1, Art of Distraction 4, Aura of Command 2, Defence Combat Mastery 7, Divine Relationship 5, Extra Attacks 3, Features (Longevity) 1, Heightened Awareness 2, Heightened Senses (Hearing, Vision) 2, Jumping 2, Massive Damage 3, Personal Gear 1, Special Attack (Angel Arm) 10, Special Attack (Cybernetic Arm) 4, Telepathy 2

Skills: Balance (Slippery Surfaces) 6, Computer Use (A.I.) 14, Demolitions (Safe Cracking) 6, Drive (Car) 8, Gun Combat (Pistol) 23, Intimidate (Street) 4, Knowledge: Electronics (Robotics) 16, Knowledge: Military Sciences (Tactics) 7, Knowledge: Social Sciences (Psychology) 4, Medical (Emergency Response) 8, Move Silently (Urban) 10, Ranged Defence (Personal) 20, Sleight of Hand (Pick Pocketing) 10

Feats: Accuracy, Ambidexterity, Blind-Shoot, Deflection, Dodge x2, Double Tap, Improved Initiative x 4, Judge Opponent, Point Blank Shot, Portable Armoury, Rapid Shot, Reflection, Steady Hand, Two-Weapon Fighting, Weapons Encyclopaedia

Defects: Marked (Scars across torso and arms) 2, Nemesis (Knives) 2, Recurring Nightmares (Life with Knives) 2, Significant Other (Meryl) 1, Wanted (Feds) 3

OTHER GAME NOTES

Features – Longevity

Vash's current age is unknown though he has not aged discernibly in at least twenty-seven years.

Personal Gear

Communicator Pen — Vash has a small communications device that looks like a ballpoint pen. It acts as both transmitter and receiver. The pen is one half of a pair of items, the other of which is Vash's earring.

Revolver — Knives built both Vash's silver revolver and his own twin, the black revolver. Both function as standard guns, but each is also a required component to form the Angel Arm. Knives presumably built both specifically to create the Angel Arms on command when used by Vash or himself. It can hold up to six shots at a time, and he typically carries at least one full reloader with him. Damage 1d8+2, +2 to hit, Concealable, Limited Shots (6), Short Range.

Light Armour

Vash's red coat provides 2 points of Armour. It is a full-length duster-style coat with the left sleeve missing. A minor item.

Wanted

Vash is the most wanted man on his planet, with a bounty of \$60,000,000,000 set by the federal government. His name is presumably known in every city across the planet, and every law-enforcement agency seen in the series has a poster of him on the wall.

Weapon Attack – Cybernetic Arm

At least half of Vash's left arm is a cybernetic implant with an integral gun. He only uses it in the most desperate circumstances. Damage 2d8, Auto-Fire, Flurry, Penetrating: Armour, Limited Shots (6), Short Range.

Weapon Attack – Angel Arm

Knives developed the Angel Arm to wipe the human race off the face of the planet. It is incredibly powerful, and can destroy a major city in a single shot. Apparently only mobile plants like Knives and Vash can use the Angel Arm, which requires one of Knives' revolvers to create the weapon. Both components must be in place — the plants cannot manifest the Angel Arm without the gun, and the gun alone will not allow a human to generate the Arm.

The Angel Arm has a direct damage path that kills almost any individual caught in it. It also has a massive backblast area in which only non-living objects are harmed, thus resulting in massive property damages but relatively low loss of life. The weapon manifests only when being used. Damage 11d8, Flare, Long Range x3, Penetrating: Armour x2, Unique: Backblast only damages non-living targets, Backblast x2, Slow x2, Static, Unique: Backblast radius calculated as if it was an Area Effect attack, Uses Energy x2



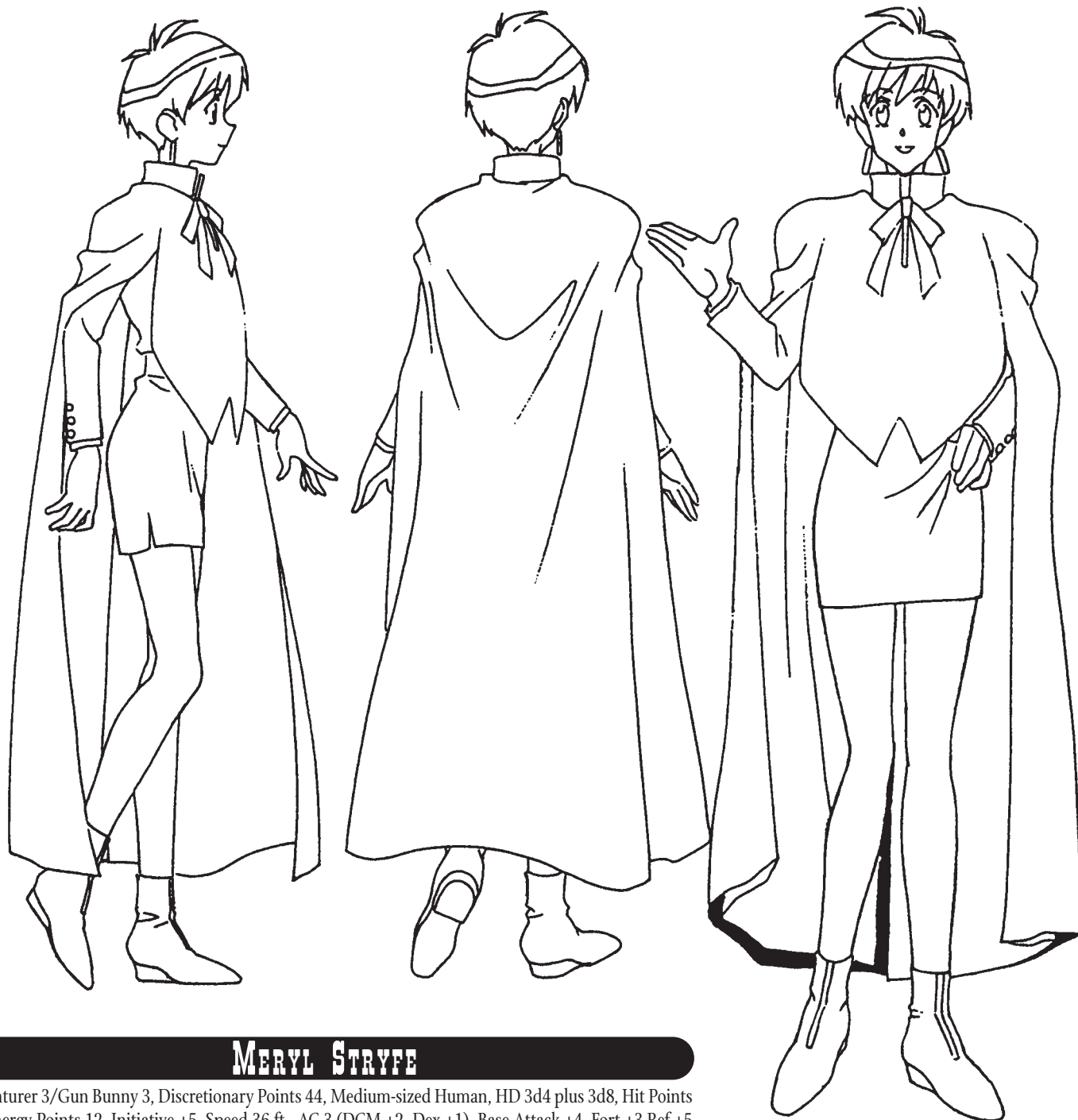

MERYL STRYFE

Adventurer 3/Gun Bunny 3, Discretionary Points 44, Medium-sized Human, HD 3d4 plus 3d8, Hit Points 45, Energy Points 12, Initiative +5, Speed 36 ft., AC 3 (DCM +2, Dex +1), Base Attack +4, Fort +3, Ref +5 Will +5, Str 10 (0), Dex 12 (+1), Con 11 (0), Int 16 (+3), Wis 14 (+2), Cha 15 (+2)

Attacks: +16, +16 ranged (1d8+2, Low Penetration, Short Range, *Derringer Pistols*)

Attributes: Damn Healthy! 3, Defence Combat Mastery 2, Divine Relationship 2, Extra Attacks 1, Personal Gear 1, Massive Damage 1, Organisational Ties (Bernadelli) 1

Skills: Gun Combat (Pistol) 9, Intimidate (Business) 7, Knowledge: Business (Insurance) 6, Knowledge: Law (Criminal) 6, Ranged Defence (Personal) 7, Ride (Thomas) 3

Feats: Great Fortitude, Improved Initiative, Iron Will, Two-Weapon Fighting

Defects: Red Tape (Bernadelli) 1, Significant Other (Vash) 1

OTHER GAME NOTES

Personal Gear

Cloak of Guns — Meryl's cloak is lined with 50 one-shot Derringer pistols. Damage 10, Concealable, Low Penetration, Short Range. A major item.

Other Items — Meryl travels with a bright pink suitcase, which carries her typewriter, slippers, and other gear.



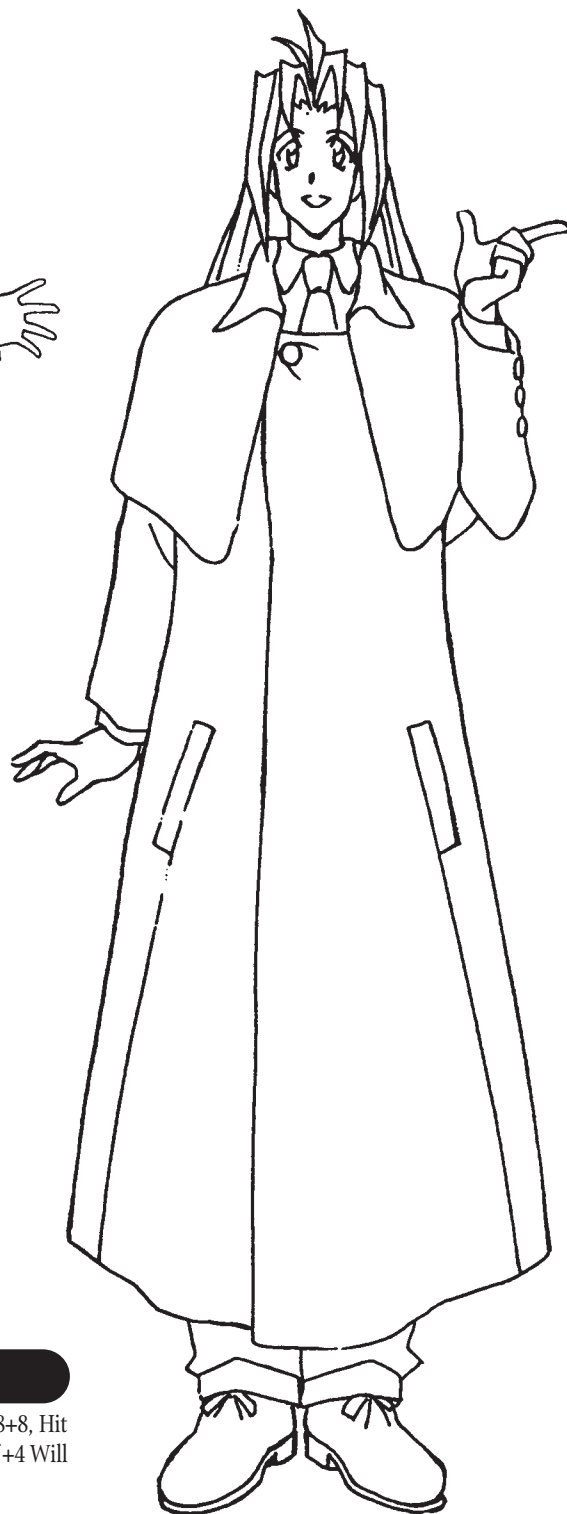
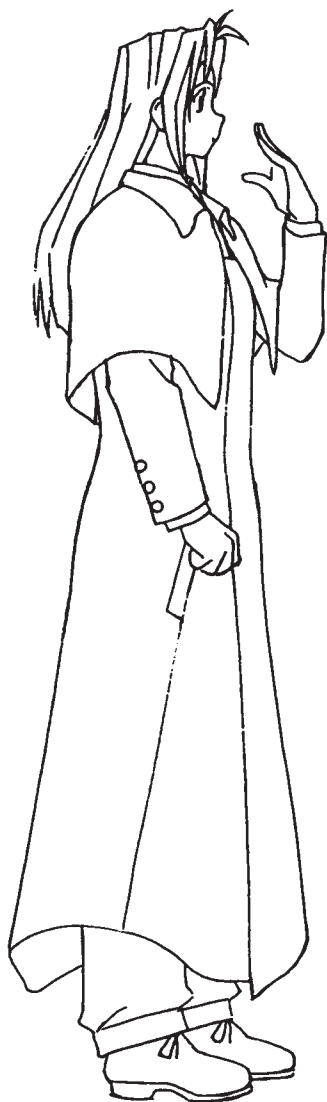

MILLY THOMPSON

Adventurer 2/Gun Bunny 4, Discretionary Points 44, Medium-sized Human, HD 2d4+4 plus 4d8+8, Hit Points 58, Energy Points 10, Initiative +4, Speed 33 ft., AC 1 (DCM +1), Base Attack +5, Fort +5, Ref +4 Will +5, Str 16 (+3), Dex 11 (0), Con 14 (+2), Int 12 (+1), Wis 14 (+2), Cha 15 (+2)

Attacks: +13 ranged (2d8+2, Stun, Short Range, *Stungun*)

Attributes: Damn Healthy! 2, Defence Combat Mastery 1, Divine Relationship 1, Heightened Awareness 1, Item of Power (*Stungun*) 2, Massive Damage 1, Organisational Ties (Bernadelli) 1

Skills: Gun Combat (Auto-Fire) 7, Knowledge: Domestic Arts (Cooking) 5, Knowledge: Business (Insurance) 3, Gamble (Card Games) 3, Ranged Defence (Personal) 5, Ride (Thomas) 3

Feats: Blind-Shoot, Great Fortitude, Improved Initiative, Iron Will, Point Blank Shot

Defects: Red Tape (Bernadelli) 1, Significant Other (Wolfwood) 1, Unique Defect (Easily Intoxicated) 1

OTHER GAME NOTES

Weapon Attack

Stungun — Milly's *stungun* is a large auto-fire weapon with a Gatling-type circular feed. Damage 30, Concealable, Stun, Short Range. The lack of a visible magazine indicates Milly possibly loads her stun rods manually directly through the barrel.

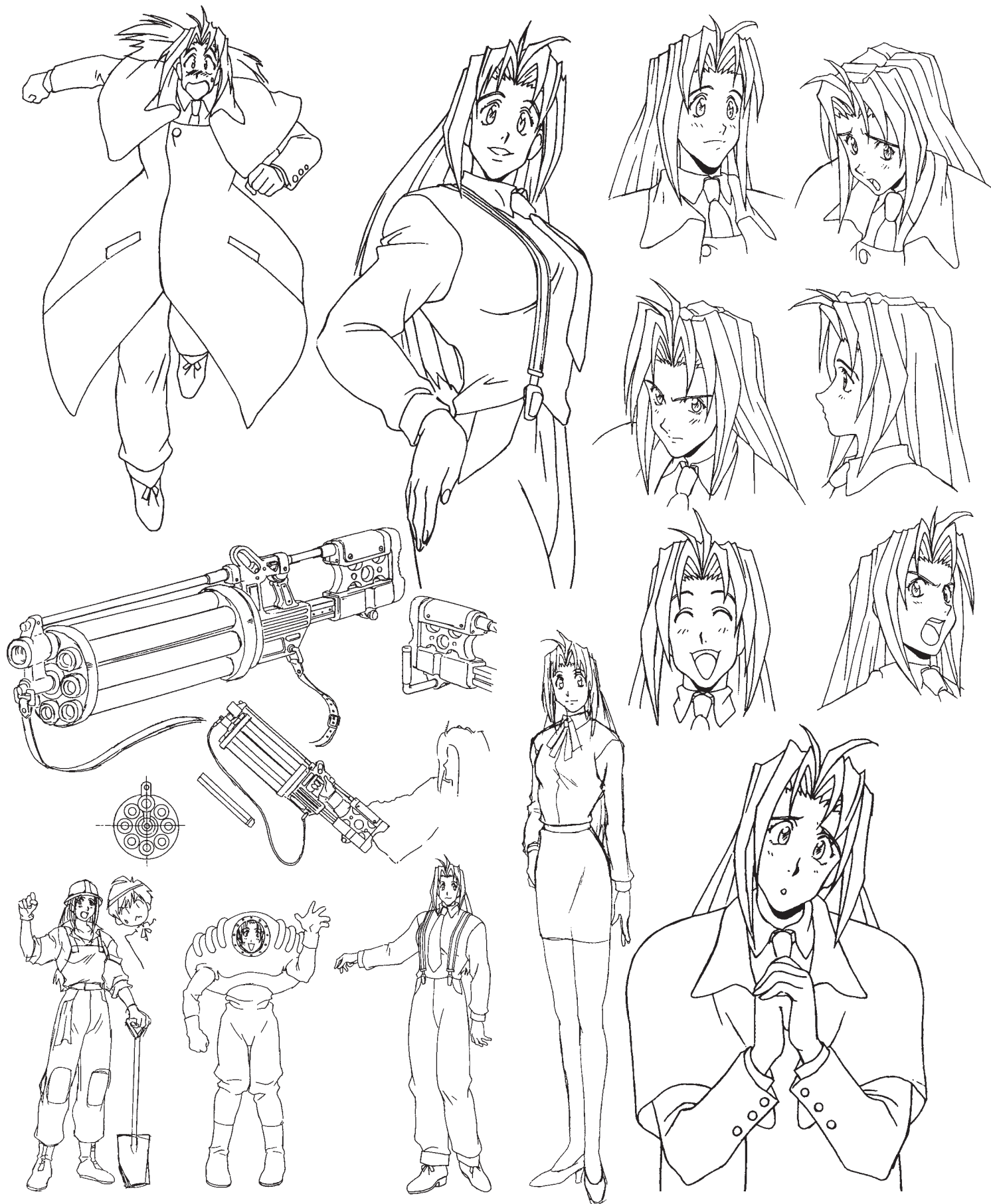

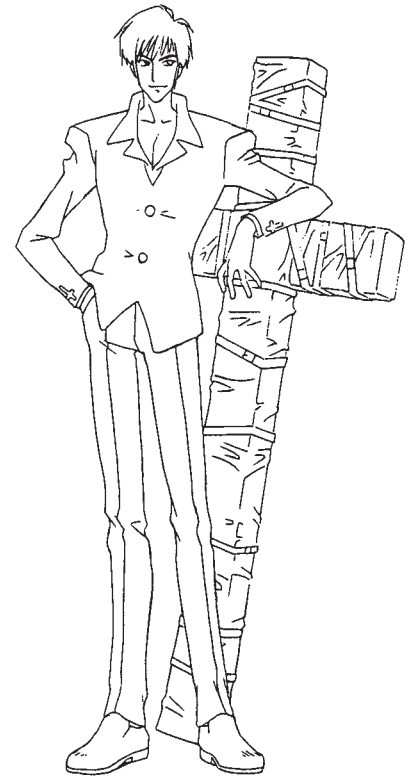
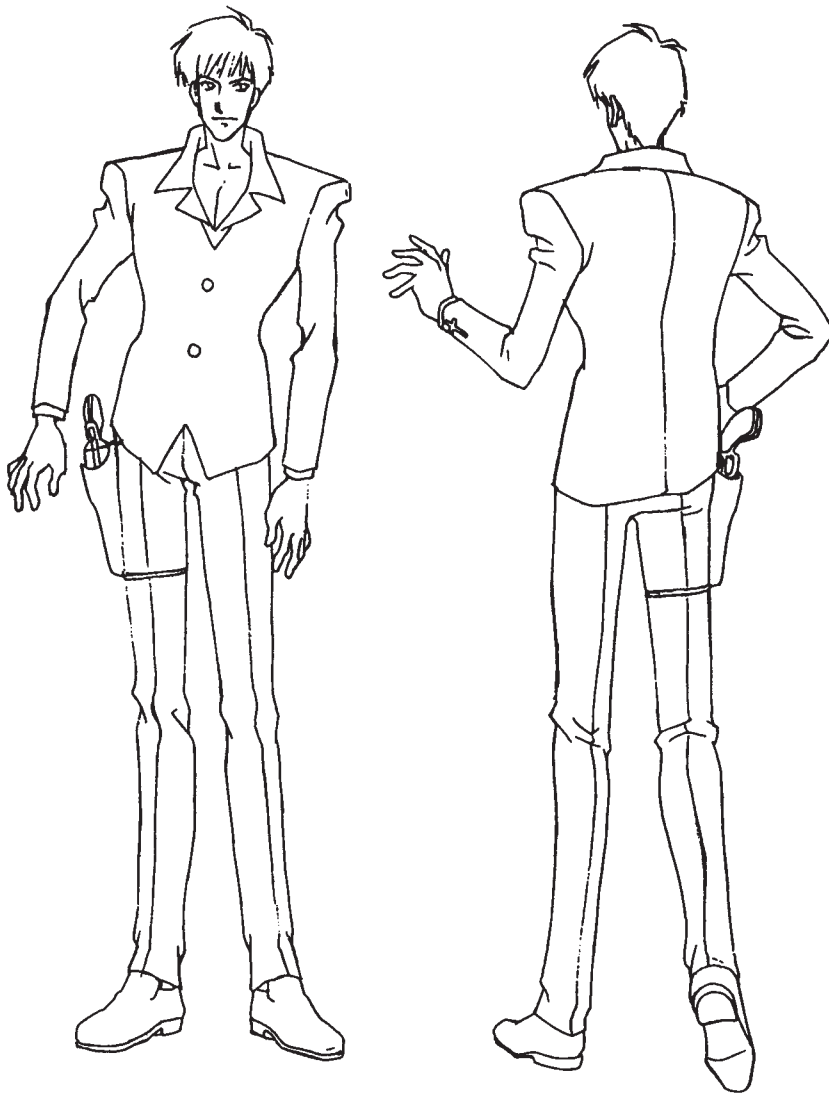

NICHOLAS D. WOLFWOOD

Adventurer 9/Gun Bunny 6, Discretionary Points 44, Medium-sized Human, HD 9d4+27 plus 6d8+18, Hit Points 108, Energy Points 23, Initiative +11, Speed 48 ft., AC 6 (DCM +3, Dex +3), Base Attack +12/+7/+2, Fort +10, Ref +11 Will +8, Str 17 (+3), Dex 16 (+3), Con 16 (+3), Int 13 (+1), Wis 14 (+2), Cha 14 (+2)

Attacks: +34, +34, +29, +24 ranged (1d8+4, Short Range, *Punisher Cross Pistols*) or +33, +33, +28, +23 ranged (4d8+4, Area Effect, Penetrating: Armour, Limited Shots (6), Static, *Punisher Cross Missile Launcher*) or +33, +33, +28, +23 ranged (1d8+4, Auto-Fire, Penetrating: Armour, Static, *Punisher Cross Machine Gun*.)

Attributes: Attack Combat Mastery 2, Defence Combat Mastery 3, Divine Relationship 1, Extra Attacks 1, Heightened Awareness 1, Item of Power (Punisher Cross) 4, Jumping 2, Massive Damage 2, Organisational Ties (Gung-Ho Guns) 1, Personal Gear 1

Skills: Gun Combat (Pistol) 11, Intimidate (Street) 6, Knowledge: Business (Small Business) 2, Knowledge: Religion (Spirituality) 5, Ranged Defence (Personal) 9, Sleight of Hand (Stage Magic) 5, Survival (Desert) 5, Unarmed Attack (Strikes) 2

Feats: Blind-Shoot, Great Fortitude x2, Improved Initiative x2, Iron Will, Portable Armoury, Steady Hand, Two-Weapon Fighting, Weapon Encyclopaedia

Defects: Owned (Gung-Ho Guns) 1, Significant Other (Milly) 1, Significant Other (Vash) 1, Skeleton in the Closet (Gung-Ho Guns) 1

OTHER GAME NOTES

Personal Gear

Motorcycle — Wolfwood's motorcycle enables him to travel from city to city throughout the desert and transport his cross easily and in style. This is a major item.

Portable Confessional — This is a church-shaped box with a coin slot, which Wolfwood uses to charge for confessions. It is a minor item.

Item of Power

Punisher Cross — The Punisher Cross is Wolfwood's primary weapon. It includes three different weapon attacks, and weighs as much as three men (approx. 150 Kilograms).

The cross's top arm is a missile launcher. Damage 4d8, Area Effect, Penetrating: Armour, Limited Shots (6) Static. The two crosspieces each hold six pistols for a total of twelve guns. Damage 1d8, Concealable, Short Range. The last weapon is a machine gun in the bottom leg of the cross. Damage 1d8, Auto-fire, Penetrating: Armour, Static.

Significant Others

Wolfwood is in the unenviable position of having two very important people in his life: Milly and Vash. He cares enough for Vash to save him by killing a child — a definite taboo in Wolfwood's belief system. He cares for Milly enormously as well, guarding over her and interposing himself between her and danger in Episode Twenty-Two, "Alternative." Vash is far more likely to find trouble than Milly is, but Milly is less capable of caring for herself (at least in comparison to Vash).

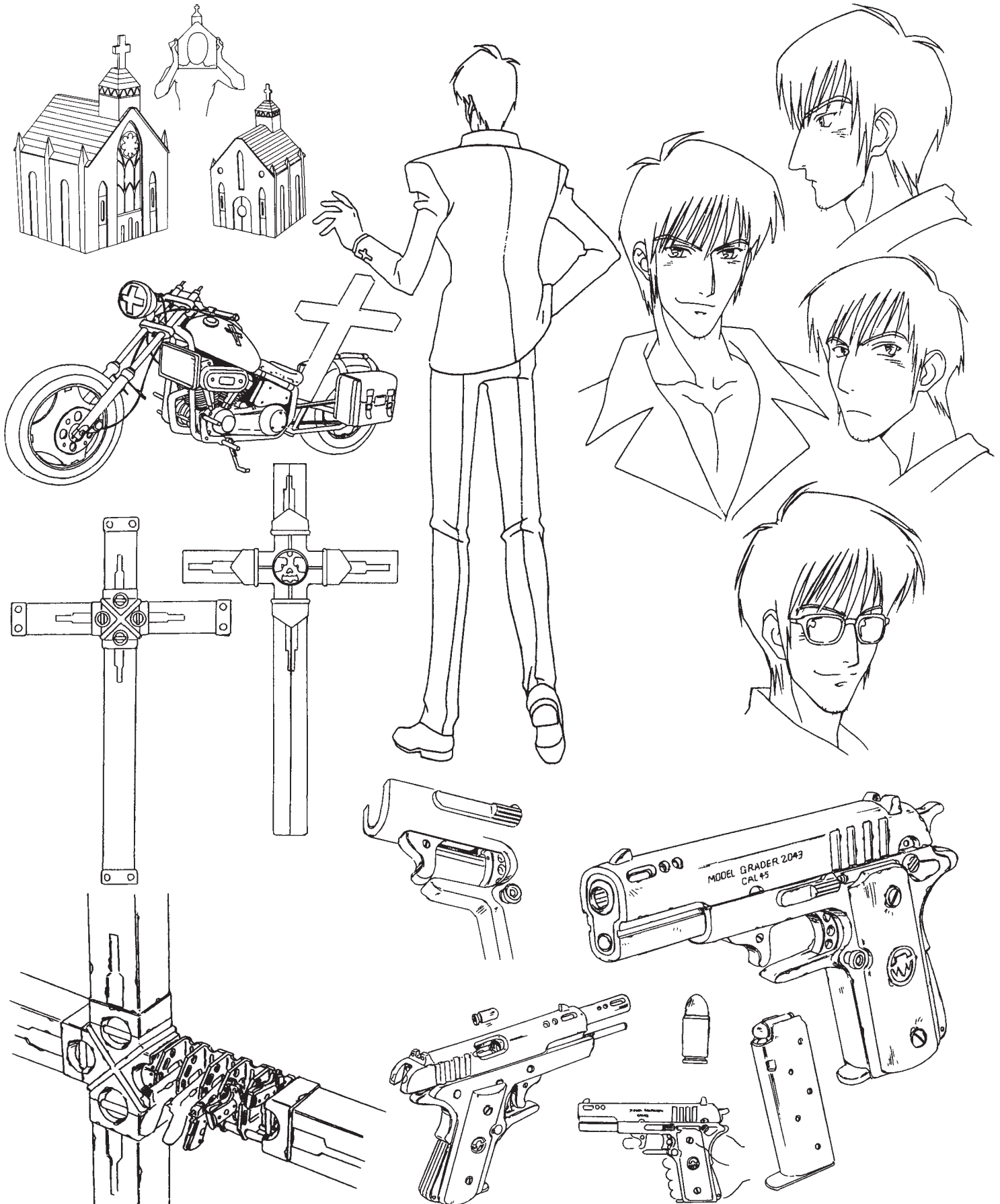

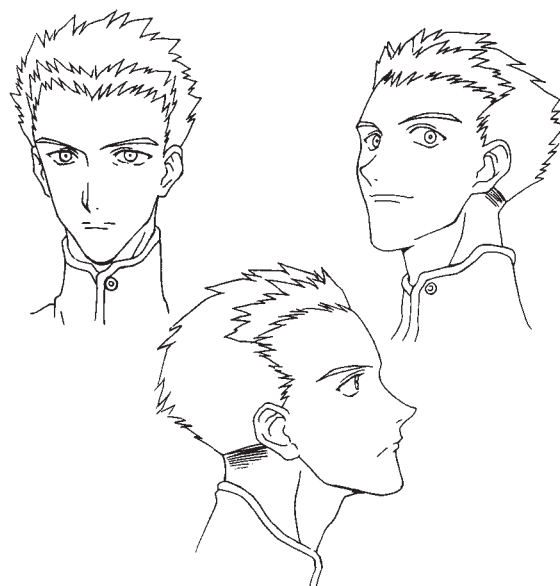
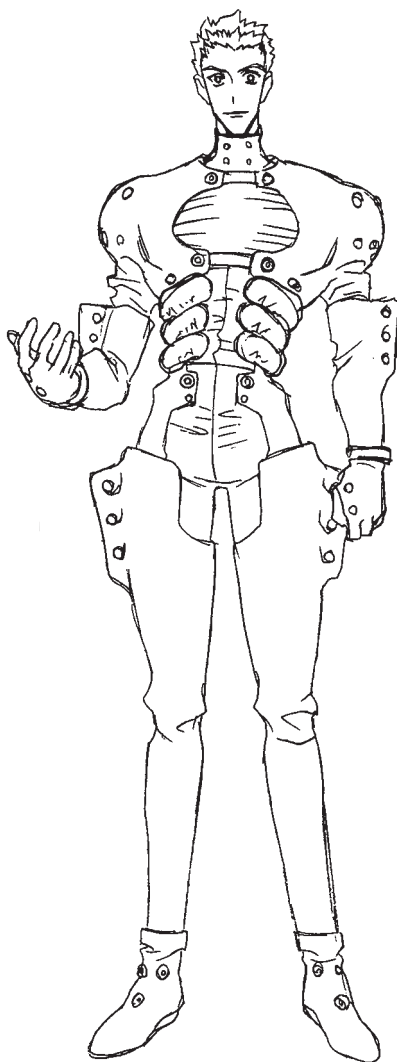
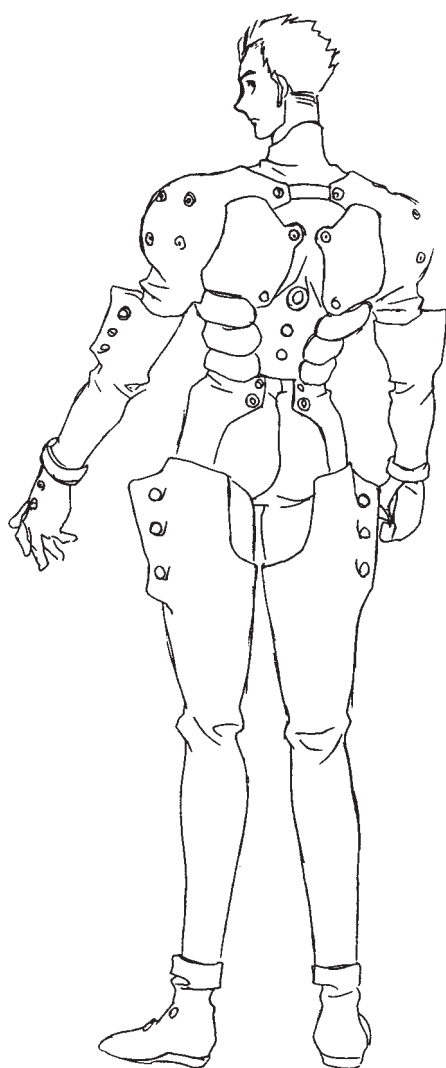

MILLIONS KNIVES

Adventurer 16/Gun Bunny 13, Discretionary Points 44, Medium-sized Human, HD 16d4+48 plus 13d8+39, Hit Points 213, Energy Points 46, Initiative +7, Speed 51 ft., AC 4 (DCM +1, Dex +3), Base Attack +21/+16/+11/+6, Fort +12, Ref +16 Will +11, Str 17 (+3), Dex 17 (+3), Con 16 (+3), Int 17 (+3), Wis 14 (+2), Cha 13 (+1)

Attacks: +45, +45, +40, +35, +30 ranged (1d8+8, Limited Shots, *Revolver*) or +22 ranged (3d8+6, Penetrating: Armour x2, Unique: Sustained, Short Range, Slow, *Negative Energy Sphere*) or +21 ranged (11d8+6, Flare, Penetrating: Armour x2, Backblast x2, Slow x2, Static, *Angel Arm*)

Attributes: Aura of Command 4, Defence Combat Mastery 1, Divine Relationship 4, Extra Attacks 1, Features (Longevity) 1, Jumping 2, Massive Damage 3, Mechanical Genius 1, Organisational Ties (Gung-Ho Guns) 5, Personal Gear 1, Special Attack (Angel Arm) 10, Special Attack (Negative Energy Sphere) 5, Telepathy 2

Skills: Computer Use (A.I.) 16, Gun Combat (Pistol) 21, Intimidate (Street) 16, Knowledge: Electronics (Robotics) 20, Knowledge: Mechanics (Gunsmith) 20, Knowledge: Military Sciences (Strategy) 10, Knowledge: Physical Sciences (Physics) 18, Knowledge: Social Sciences (Psychology) 9, Medical (Surgery) 8, Ranged Defence (Personal) 17

Feats: Accuracy, Ambidexterity, Blind-Shoot, Deflection, Dodge x2, Double Tap, Improved Initiative, Judge Opponent, Point Blank Shot, Portable Armoury, Rapid Shot, Reflection, Steady Hand, Two-Weapon Fighting, Weapons Encyclopaedia

Defects: Nemesis (Vash) 2

OTHER GAME NOTES

Organizational Ties

Knives is the leader of the Gung-Ho Guns, a group of individuals with unique powers devoted to ruining Vash's life.

Item of Power – Revolver

Knives uses a customized black Colt-45 Long Barrel revolver. It can hold up to six shots at a time, and Knives typically carries at least one full reloader with him. Damage 1d8+2, +2 to hit, Concealable, Limited Shots (6).

Weapon Attacks – Negative Energy Sphere

The Negative Energy Sphere is a power stemming from his genetic abilities as a plant. The effect can be maintained for multiple rounds once initiated, ending either on command or when Knives runs out of energy to sustain the power. Damage 3d8, Accurate, Penetrating: Armour x2, Unique Ability: Sustained, Short Range, Slow.

Weapon Attacks – Angel Arm

Knives developed the Angel Arm to wipe the human race off the face of the planet. It is incredibly powerful, and can destroy a major city in a single shot. Apparently only mobile plants like Knives and Vash can use the Angel Arm, which requires one of Knives' revolvers to create the weapon. Both components must be in place — the plants cannot manifest the Angel Arm without the gun, and the gun alone will not allow a human to generate the Arm.

The Angel Arm has a direct damage path that kills almost any individual caught in it. It also has a massive backblast area in which only non-living objects are harmed, thus resulting in massive property damages but relatively low loss of life. The weapon manifests only when being used. Damage 11d8, Flare, Long Range x3, Penetrating: Armour x2, Unique: Backblast only damages non-living targets, Backblast x2, Slow x2, Static, Unique: Backblast radius calculated as if it was an Area Effect attack, Uses Energy x2

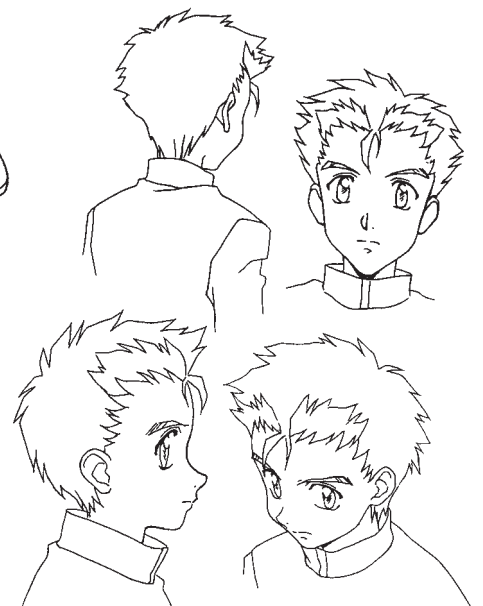
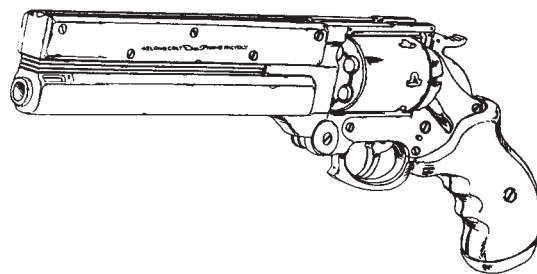
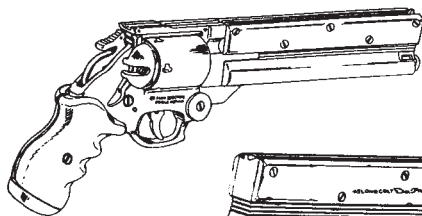
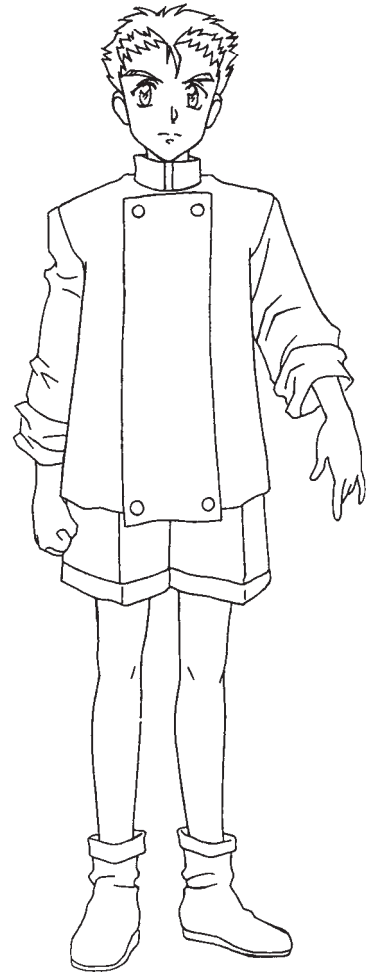
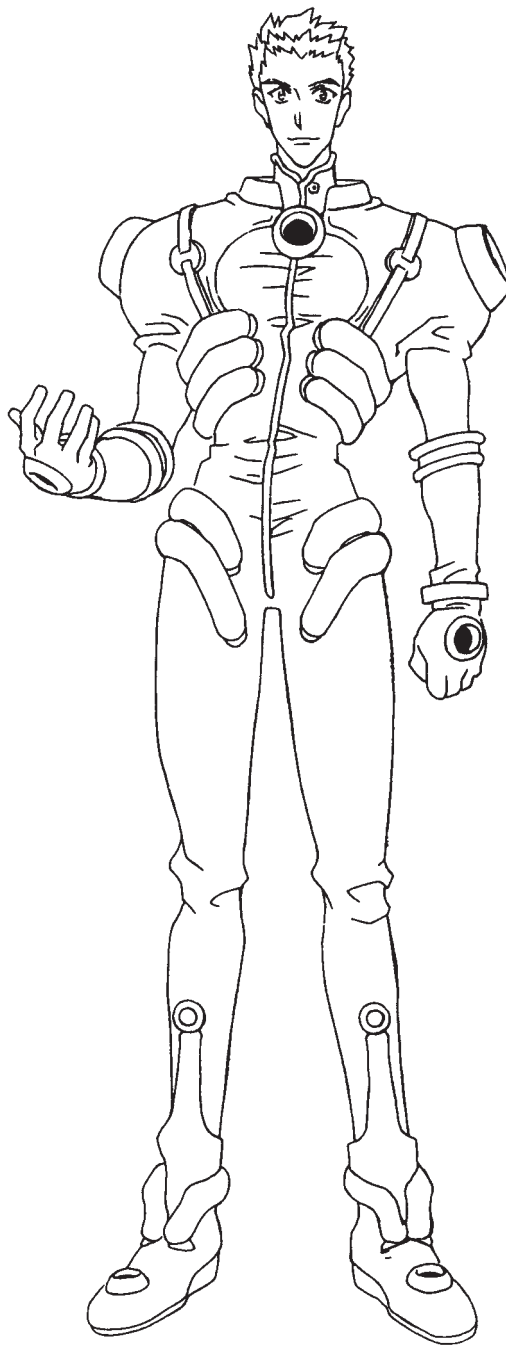
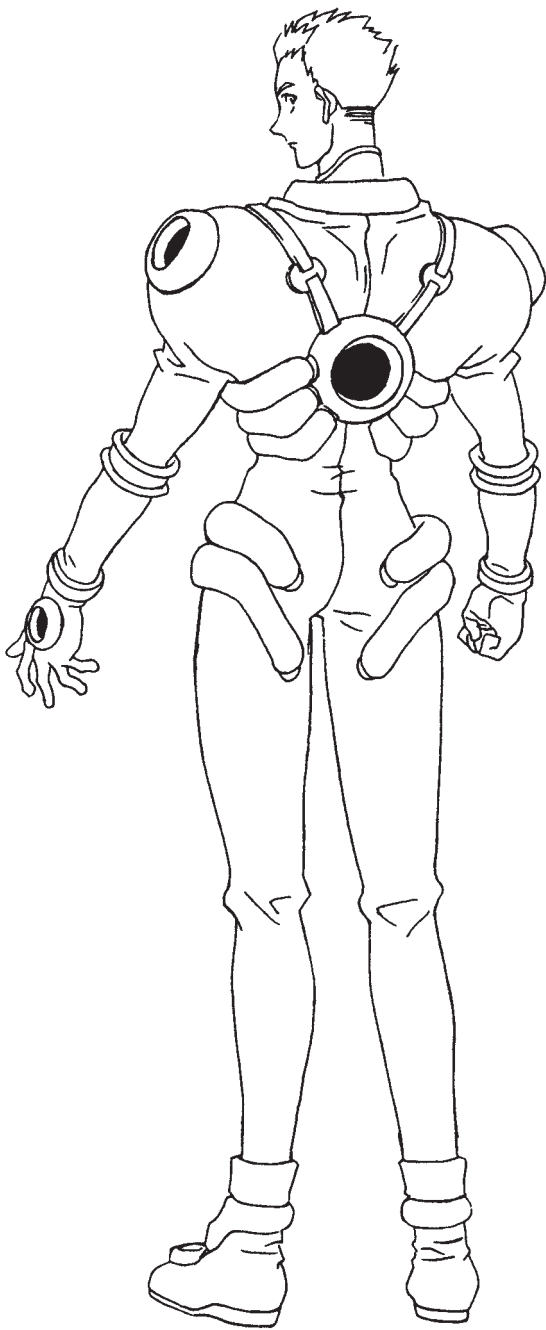

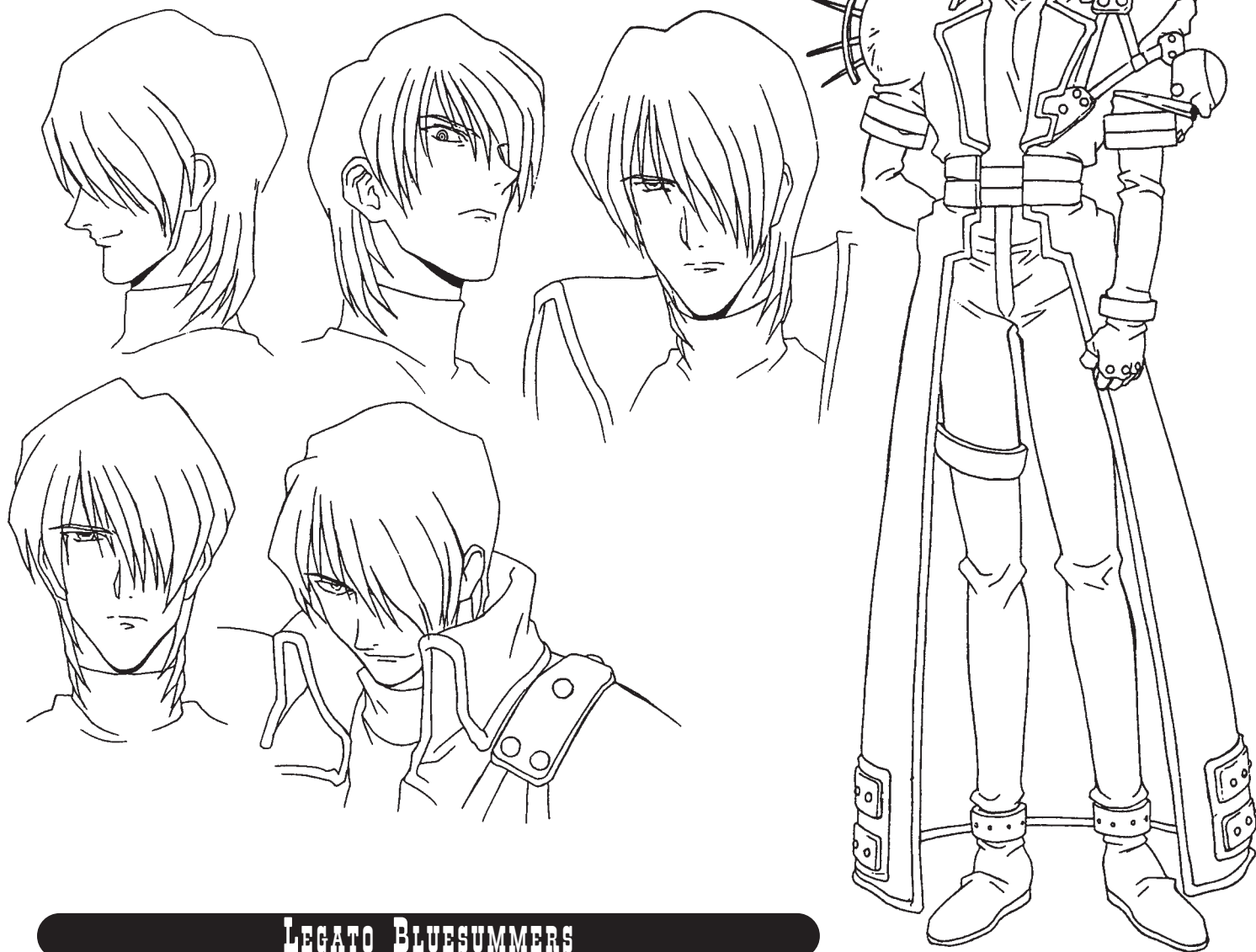

LEGATO BLUESUMMERS

Adventurer 6/Dynamic Sorcerer 9, Discretionary Points 44, Medium-sized Human, HD 6d4+6 plus 9d6+9, Hit Points 60, Energy Points 52, Initiative +1, Speed 39 ft., AC 1 (Dex +1), Base Attack +7/+2, Fort +6, Ref +6 Will +13, Str 12 (+1), Dex 13 (+1), Con 12 (+1), Int 18 (+4), Wis 16 (+3), Cha 15 (+2)

Attacks: +16, +11 melee (1d3+1, *Punch*)

Attributes: Dynamic Sorcery (Psionics) 5, Sixth Sense (Emotions) 1, Art of Distraction 2, Heightened Awareness 2, Mind Shield 3, Aura of Command 4, Organisational Ties (Gung-Ho Guns) 4, Telepathy 4

Skills: Intimidate (Street) 15, Knowledge: Military Sciences (Tactics) 11, Knowledge: Social Sciences (Psychology) 13, Move Silently (Urban) 9, Ranged Defence (Personal) 13, Slight of Hand (Stage Magic) 9, Survival (Desert) 8, Unarmed Attack (Strikes) 8

Feats: Empower Spell, Enlarge Spell, Extend Spell, Heighten Spell, Maximise Spell, Quicken Spell, Silent Spell, Still Spell, Iron Will x2

Defects: Nemesis (Vash) 1, Owned (Knives) 3

OTHER GAME NOTES

Environmental Control

Legato psionic powers allow him to summon small dust storms at will. He uses these to cover his entrances and exits when he wishes to intimidate someone.

Nemesis

Vash is Legato's nemesis. Vash abhors Legato and the suffering he inflicts. Vash is determined to find Legato and stop him somehow, although it might cost him his life.

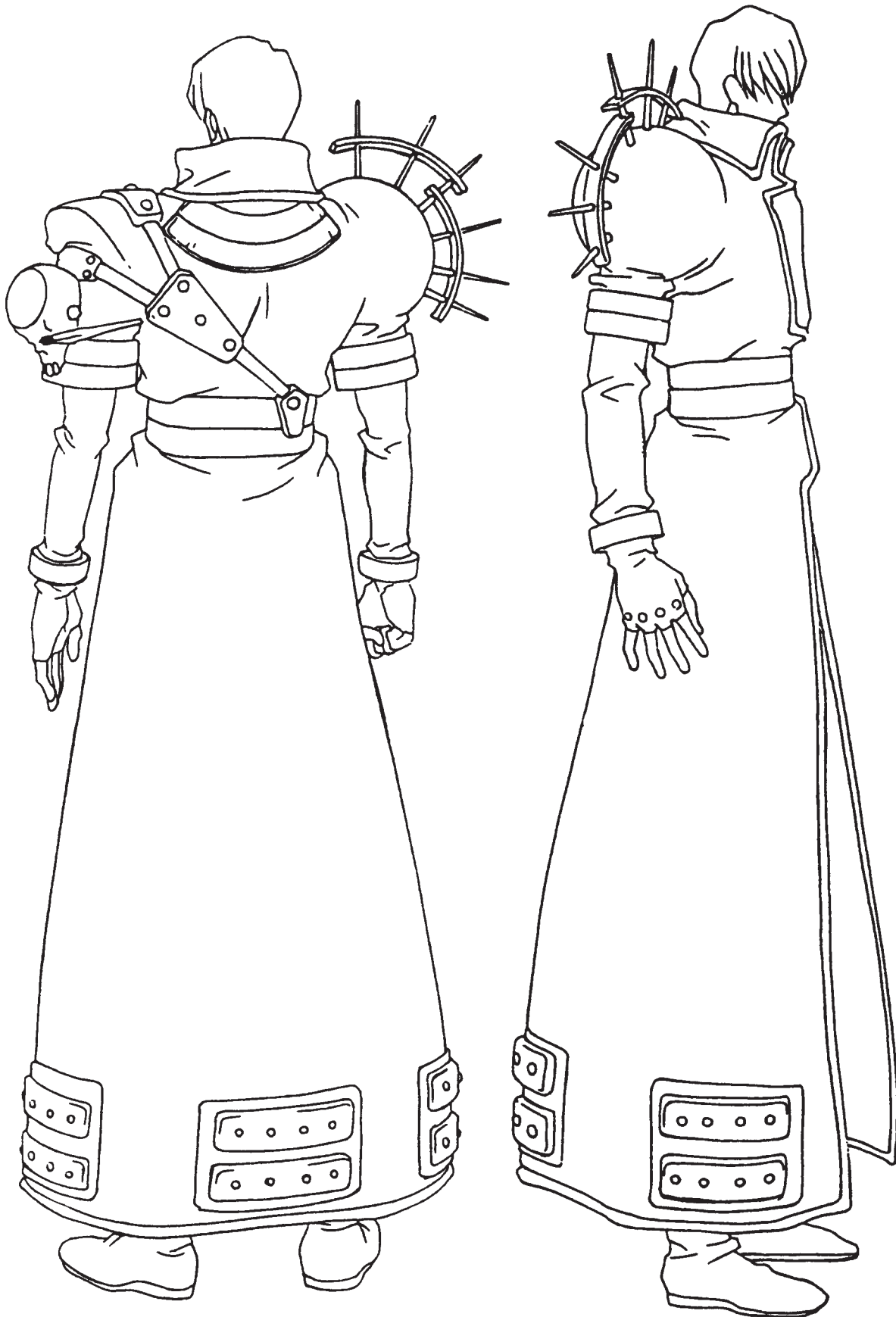



DESCARTES

Adventurer 9, Discretionary Points 44, Huge-sized Human, HD 9d4+36, Hit Points 93, Energy Points 13, Initiative +0, Speed 50 ft., AC -2 (Size -2), Base Attack +10/+5, Fort +8, Ref +4 Will +5, Str 28 (+9), Dex 10 (0), Con 18 (+4), Int 10 (0), Wis 12 (+1), Cha 6 (-2)

Attacks: +15 ranged (4d8+9, Muscle-Powered, Penetrating: Armour x 2, Short Range, Slow, Stoppable, Boomerang)

Attributes: Armour (Natural Armour: 5 points), Aura of Command 3, Damn Healthy! 3, Heightened Awareness 2, Item of Power (Boomerang) 4, Servant (x4) 2, Unique Attribute: Huge Size 1

Skills: Intimidate (Street) 10, Knowledge:Law (Criminal) 4, Spot (Tailing) 8, Thrown Weapon (Boomerang) 4, Wilderness Tracking (Desert) 6

Feats: Brawl, Improved Brawl, Stunning Fist

Defects: Marked (Cybernetic implants; ears; hair) 3, Unique Defect (Size Disadvantage) 2

OTHER GAME NOTES

Weapon Attack

Boomerang — Descartes's only weapon is a boomerang, which he throws with his cybernetic right arm. Damage 4d8, Muscle-Powered, Penetrating: Armour x 2, Short Range, Slow, Stoppable.

Servant

Descartes has four henchman at any given time for firearms support and gruntwork. He will hire more if they quit or are killed. They have standard rifles or auto-fire firearms.

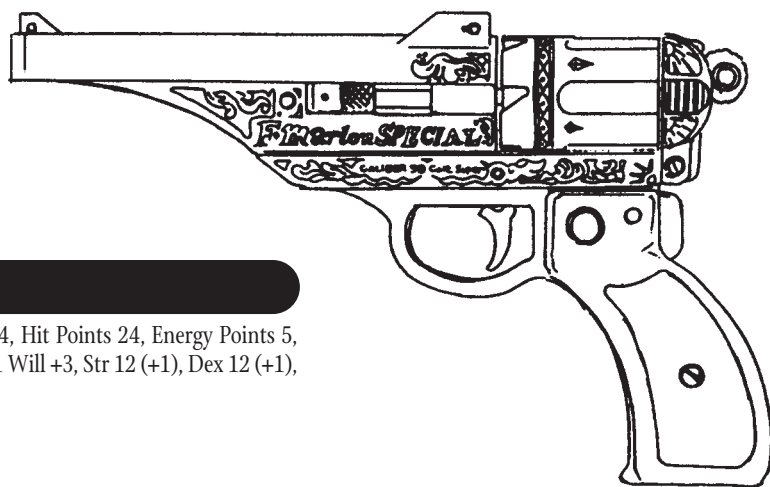
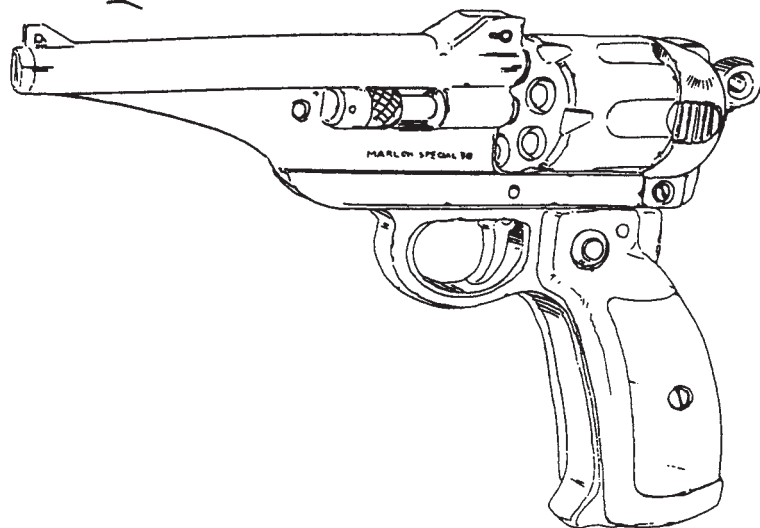

FRANK MARLON

Adventurer 2, Discretionary Points 44, Medium-sized Human, HD 2d4, Hit Points 24, Energy Points 5, Initiative +1, Speed 36 ft., AC 1 (Dex +1), Base Attack +1, Fort +0, Ref +1 Will +3, Str 12 (+1), Dex 12 (+1), Con 11 (0), Int 15 (+2), Wis 16 (+3), Cha 14 (+2)

Attacks: +4 ranged (1d8, Limited Shots, Short Range, *Revolver*)

Attributes: Damn Healthy! 3, Mechanical Genius 5

Skills: Craft (Metalworking) 5, Gun Combat (Pistol) 2, Knowledge: Mechanics (Gunsmith) 5, Move Silently (Urban) 2, Ranged Defence (Personal) 2

Feats: Weapons Encyclopaedia

Defects: Recurring Nightmares 2



GOFSEF NEBRASKA

Adventurer 9, Discretionary Points 44, Gargantuan-sized Human, HD 9d4+63, Hit Points 90, Energy Points 10, Initiative -2, Speed 36 ft., AC -6 (Dex -2, Size -4), Base Attack +20/+15/+10/+5, Fort +10, Ref +1 Will +0, Str 36 (+13), Dex 6 (-2), Con 24 (+7), Int 4 (-3), Wis 3 (-3), Cha 2 (-4)

Attacks: +20 ranged (4d8+8, Area Effect, Penetrating (Armour) x 2, Short Range, Slow, Stoppable, *Fist Launcher*)

Attributes: Massive Damage (*Fist Launcher*) 4, Armour 4 (+9 points of Natural Armour), Special Attack (*Fist Launcher*) 4, Unique Attribute: Gargantuan Size 1

Skills: none

Feats: Endurance, Great Fortitude x2, Knockout Punch

Defects: Physical Impairment (Cannot Talk) 1, Marked 3, Significant Other (Father) 3, Unskilled 3, Wanted 2

OTHER GAME NOTES

Armour

Gofsef's skin is his armour, which is incredibly tough. His fist launcher is unarmoured, however, and susceptible to Called Shot.

Weapon Attack

Fist Launcher — Gofsef's only weapon is his fist launcher. It is permanently attached to his body, and it must be retracted and reloaded after each shot. Damage 4d8, Area Effect, Penetrating (Armour) x 2, Short Range, Slow, Stoppable.

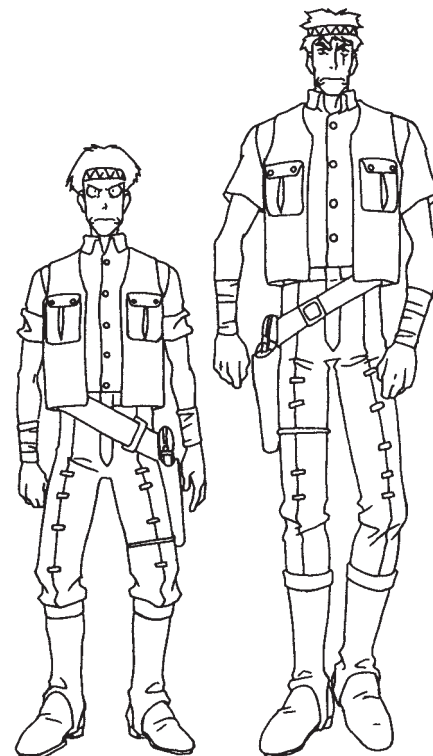
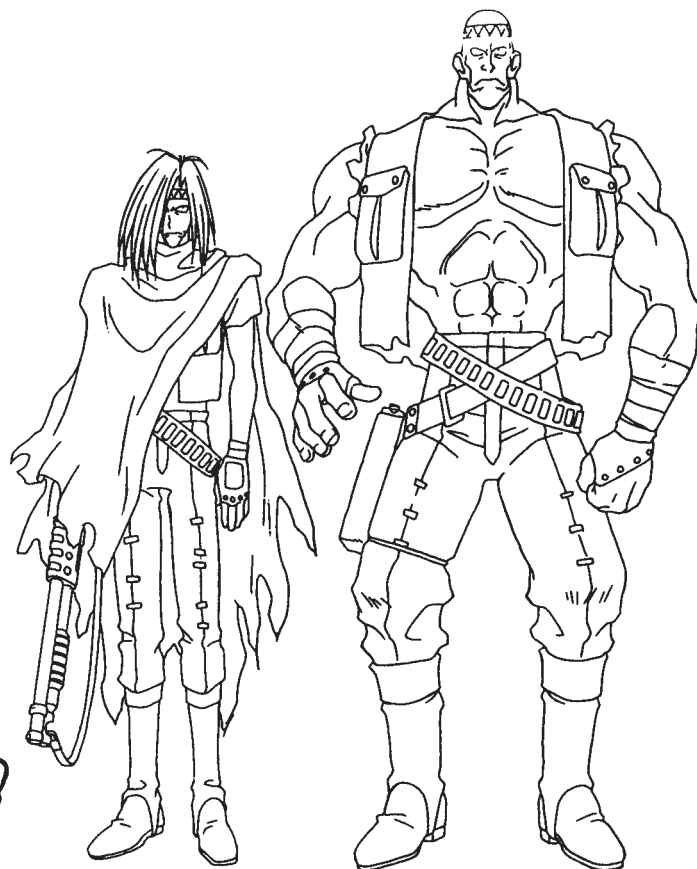

PROFESSOR NEBRASKA

Tech Genius 2, Discretionary Points 44, Medium-sized Human, HD 2d4-2, Hit Points 14, Energy Points 6, Initiative -1, Speed 24 ft., AC -2 (Dex -2), Base Attack +1, Fort -1, Ref -2 Will +3, Str 7 (-2), Dex 7 (-2), Con 8 (-1), Int 16 (+3), Wis 11 (0), Cha 9 (-1)

Attacks: +1 melee (1d3-2, *Punch*)

Attributes: Damn Healthy! 2, Flunkies (Extended Family) 6, Mechanical Genius 6

Skills: Disable Device (Traps) 5, Gather Information (Contacts) 5, Intimidate (Street) 5, Investigate (Underworld) 5, Knowledge: Biological Sciences (Genetics) 5, Knowledge: Electronics (Robotics) 5, Knowledge: Law (Criminal) 5, Knowledge: Physical Sciences (Biochemistry) 5, Knowledge: Streetwise (Gang Activity) 5, Medical (Surgery) 5

Feats: Iron Will

Defects: Significant Other (Son) 2, Wanted 2

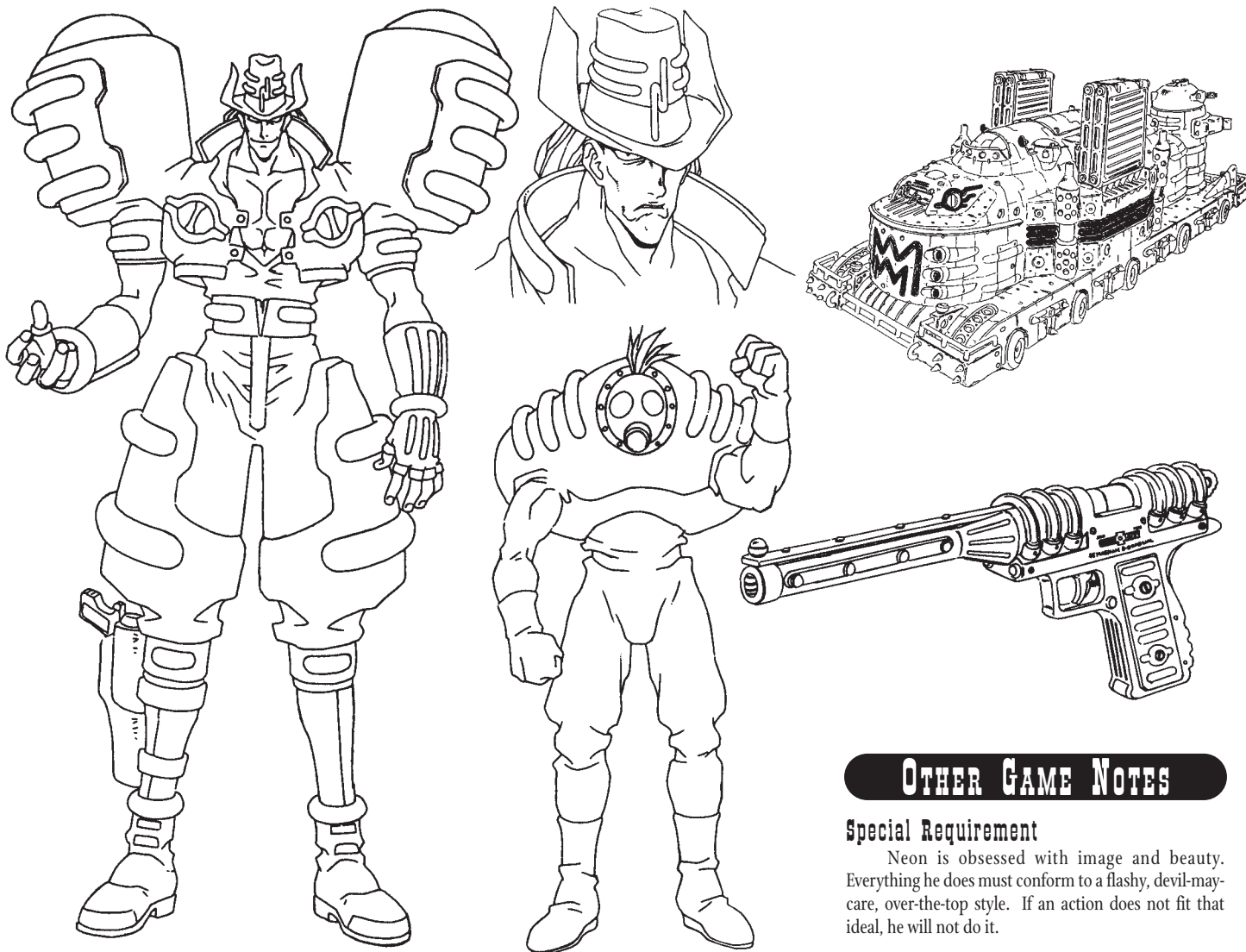

BRILLIANT DYNAMITES NEON

Adventurer 11/Gun Bunny 4, Discretionary Points 44, Medium-sized Human, HD 11d4+33 plus 4d8+12, Hit Points 102, Energy Points 24, Initiative +7, Speed 48 ft., AC 5 (Dex +3, DCM +2), Base Attack +10/+5, Fort +8, Ref +10 Will +6, Str 18 (+4), Dex 16 (+3), Con 17 (+3), Int 14 (+2), Wis 13 (+1), Cha 14 (+2)

Attacks: +10, +5 ranged (4d8+4, Penetrating: Armour, Limited Shots x 2, *Dynamos*) or +21/+16 ranged (1d8+4, Concealable, Penetrating: Armour, Short Range, *Neon Pistol*)

Attributes: Art of Distraction 2, Attack Combat Mastery 1, Aura of Command 3, Defence Combat Mastery 2, Divine Relationship 1, Heightened Awareness 2, Item of Power (*Dynamos* and *Neon Pistol*) 4, Massive Damage 2, Organisational Ties (Bad Lads) 5, Own a Big Mecha (*Gunship*) 2, Personal Gear 1

Skills: Demolitions (Safe Cracking) 7, Gun Combat (Pistol) 9, Intimidate (Street) 10, Knowledge: Military Sciences (Tactics) 7, Open Lock (Combination) 9, Ranged Defence (Personal) 12, Unarmed Attack (Strikes) 3

Feats: Accuracy, Blind-Shoot, Great Fortitude x2, Improved Initiative, Iron Will, Steady Hand, Weapon Encyclopaedia

Defects: Special Requirement (Style) 2, Wanted 2

OTHER GAME NOTES

Special Requirement

Neon is obsessed with image and beauty. Everything he does must conform to a flashy, devil-may-care, over-the-top style. If an action does not fit that ideal, he will not do it.

Item of Power

Dynamos — Neon's dynamos generate the power to make his suit glow. They are also capable of delivering an incredibly damaging ranged electrical attack. Damage 4d8, Penetrating: Armour, Limited Shots x 2.

Neon Suit

Neon Suit — B.D.N.'s suit has bands of glowing neon built into it. The dynamos on his shoulders provide the electricity for his suit. It provides 3 points of Armour.

Weapon Attack

Neon Pistol — B.D.N.'s pistol is custom coordinated with his outfit. It is powered by his dynamos and glows neon along with his suit. Damage 1d8, +1 to hit, Concealable, Penetrating: Armour, Short Range.

Mecha

Bad Lads Gunship — The lead vehicle for the Bad Lads gang, Neon's flagship (page 172) can carry a boarding party and functions as the point or lead vehicle in group tactical strikes.

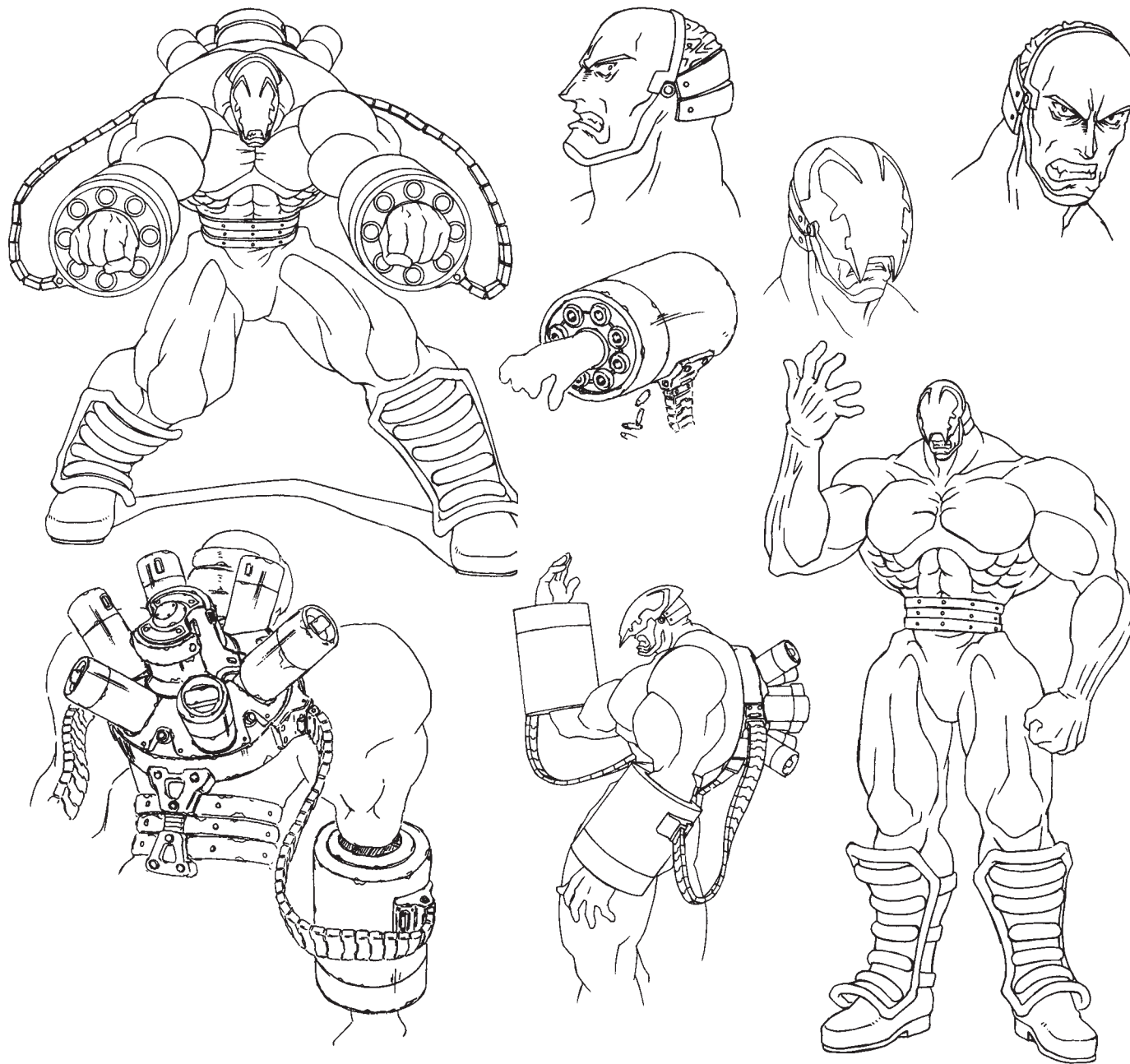

MONEV THE GALE

Adventurer 9/Gun Bunny 6, Discretionary Points 44, Medium-sized Human, HD 9d4+18 plus 6d8+12, Hit Points 101, Energy Points 19, Initiative +4, Speed 30 ft., AC 0, Base Attack +8/+3, Fort +7, Ref +7 Will +5, Str 20 (+5), Dex 10 (0), Con 14 (+2), Int 10 (0), Wis 10 (0), Cha 8 (-1)

Attacks: +21, +21, +16 ranged (1d8+2, Auto-Fire, *Arm Guns*) or +18, +18, +13 ranged (2d8+2, Auto-Fire, *Shoulder Gun*) or +18, +18, +13 ranged (3d8+2, Long Range, Limited Shots (1), *Rocket*)

Attributes: Armour (Partial: Helmet only; Bullet Optimised) 2, Damn Healthy! 3, Divine Relationship 2, Extra Attacks 1, Item of Power (Weaponry) 8, Jumping 2, Massive Damage 1

Skills: Gun Combat (Auto-Fire) 12, Heavy Weapons (Launcher) 9, Investigate (Underworld) 5

Feats: Blind-Shoot, Ambidexterity, Armour Proficiency (Light), Great Fortitude, Improved Initiative, Iron Will, Point Blank Shot

Defects: Owned (Boss) 1

OTHER GAME NOTES

Arm Guns

Monev has two Gatling guns attached to his arms, each with eight chambers. The bullets are belt fed from Monev's master ammo supply device on his back. Damage 1d8, Auto-Fire.

Shoulder Gun

This very large combination weapon must be shoulder supported to fire. The Gatling gun features 10 chambers. Damage 2d8, Auto-Fire.

Rocket

The inner chamber of Monev's shoulder gun opens to release a single-shot rocket. Damage 3d8, Long Range, Limited Shots x3.

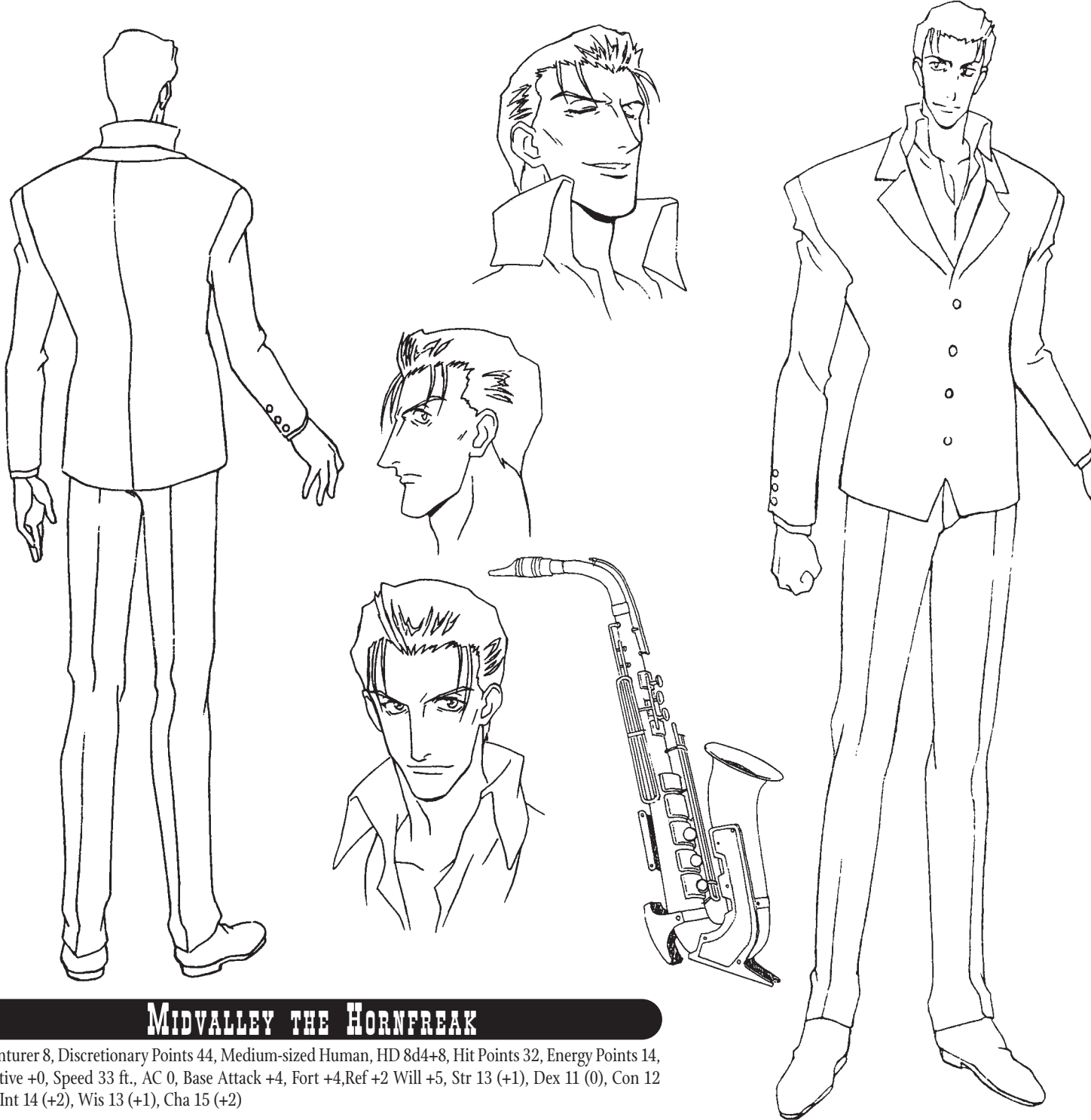

MIDVALLEY THE HORNFREAK

Adventurer 8, Discretionary Points 44, Medium-sized Human, HD 8d4+8, Hit Points 32, Energy Points 14, Initiative +0, Speed 33 ft., AC 0, Base Attack +4, Fort +4, Ref +2 Will +5, Str 13 (+1), Dex 11 (0), Con 12 (+1), Int 14 (+2), Wis 13 (+1), Cha 15 (+2)

Attacks: +10, +10, +10, +5 ranged (1d8+2, Auto-Fire, *Saxophone Mini Gun*) or +0 ranged (4d8, Penetrating: Armour x2, Spreading, Static, *Saxophone Shockwave*)

Attributes: Art of Distraction 4, Divine Relationship 2, Extra Attacks 2, Item of Power (Saxophone) 5, Organisational Ties (Gung-Ho Guns) 2

Skills: Controlled Breathing (Cyclic Breathing) 10, Gun Combat (Auto-fire) 5, Intimidate (Street) 8, Knowledge: Cultural Arts (Music History) 6, Perform (Music) 10, Seduction (Female) 8

Feats: Great Fortitude, Iron Will x2

Defects: Owned (Gung-Ho Guns) 2

OTHER GAME NOTES

Item of Power

Saxophone — Midvalley's Item of Power is his saxophone, nicknamed "Sylvia." It imparts the following Attributes: Force Field 2; Special Attack: Shockwave. Damage 4d8, Concealable, Penetrating: Armour x2, Spreading, Inaccurate, Static; Mini Gun Damage 1d8, Auto-Fire, Concealable.

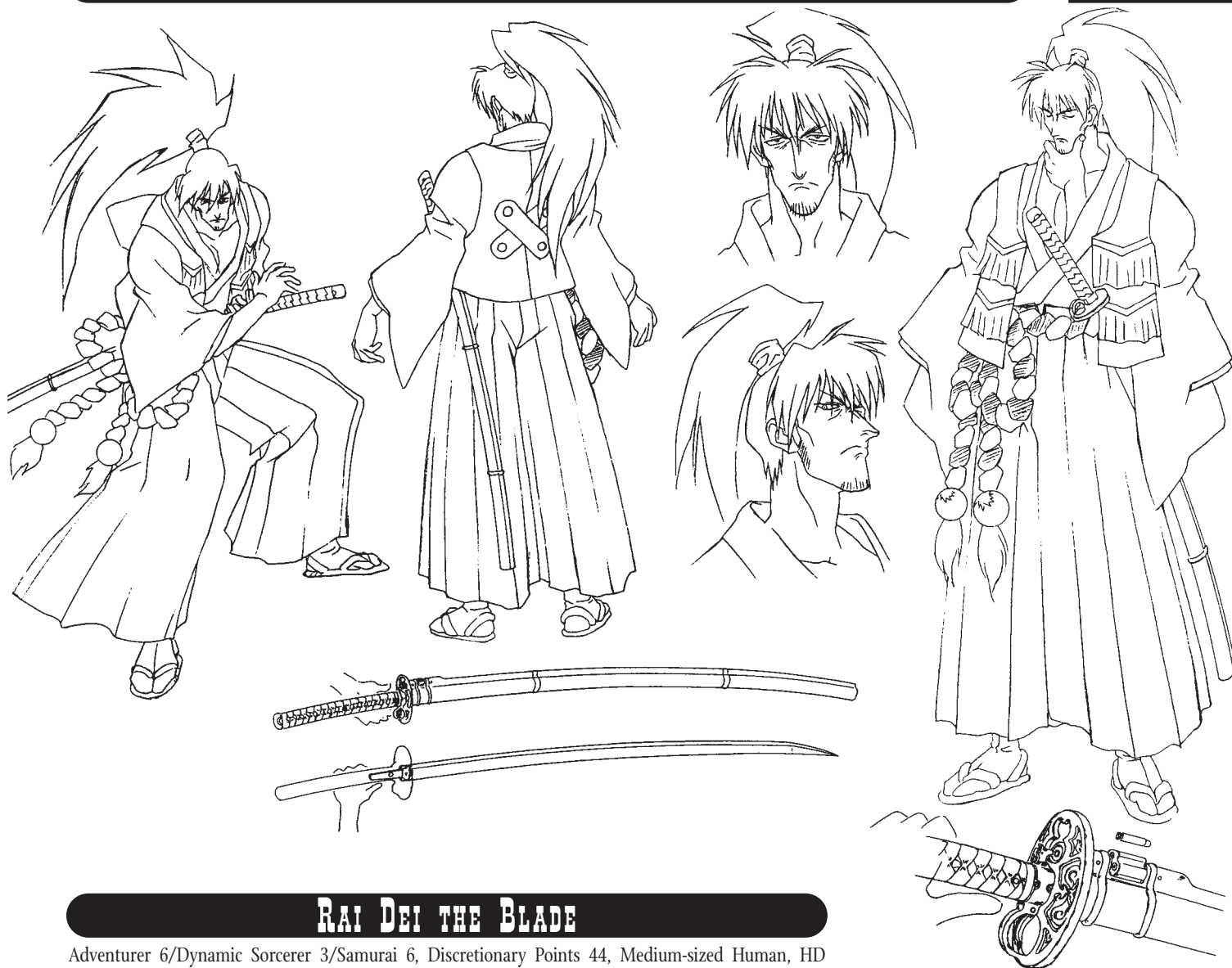

RAI DEI THE BLADE

Adventurer 6/Dynamic Sorcerer 3/Samurai 6, Discretionary Points 44, Medium-sized Human, HD 6d4+12 plus 3d6+6 plus 6d10+12, Hit Points 110, Energy Points 28, Initiative +11, Speed 51 ft., AC 6 (Dex +3, DCM +3), Base Attack +10/+5, Fort +9, Ref +8 Will +9, Str 15 (+2), Dex 17 (+3), Con 14 (+2), Int 15 (+2), Wis 15 (+2), Cha 16 (+3)

Attacks: +20, +20, +15 melee (1d8+8, *Katana*) or +11 ranged (1d8, Penetrating: Armour, Limited Shots x3, *Blade Launch*) or +11 ranged (1d8, *Scabbard Rifle*)

Attributes: Attack Combat Mastery 2, Aura of Command 1, Damn Healthy! 1, Defence Combat Mastery 3, Dynamic Sorcery (Psionics) 2, Extra Attacks 1, Heightened Awareness 1, Item of Power (Katana) 2, Massive Damage (Katana) 3, Organisational Ties (Gung-Ho Guns) 1, Personal Gear 1, Speed 1

Skills: Intimidate (Street) 13, Knowledge: Cultural Arts (Bushido) 9, Knowledge: Social Sciences (Theology) 8, Melee Attack (Sword) 9, Melee Defence (Sword) 4, Move Silently (Urban) 9, Ranged Defence (Personal) 4

Feats: Accuracy, Cleave, Great Cleave, Improved Initiative x2, Judge Opponent, Power Attack, Steady Hand

Defects: Owned (Gung-Ho Guns) 2

OTHER GAME NOTES

Item of Power

Katana — Rai Dei's item of power is his sword. It functions as a standard katana unless Rai Dei activates one of two special attacks. Damage 1d8+2, Melee.

The first special attack is **Blade Launch**. Damage 1d8, +1 to hit, Concealable, Penetrating: Armour, Limited Shots x3. The second is the sword's scabbard, which also functions as a sniper rifle. Damage 1d8, +1 to hit.

Psionic Abilities

All of Rai Dei's Psionic Abilities allow him to do a variety of things, such as:

Environmental Control — Rai Dei can summon and quell dust clouds to cover his arrivals and departures.

Special Attack: Shockwave — Rai Dei can generate shockwaves and direct them along the ground in the direction he chooses. Damage 4d8, Penetrating: Armour x2, Inaccurate, Static.

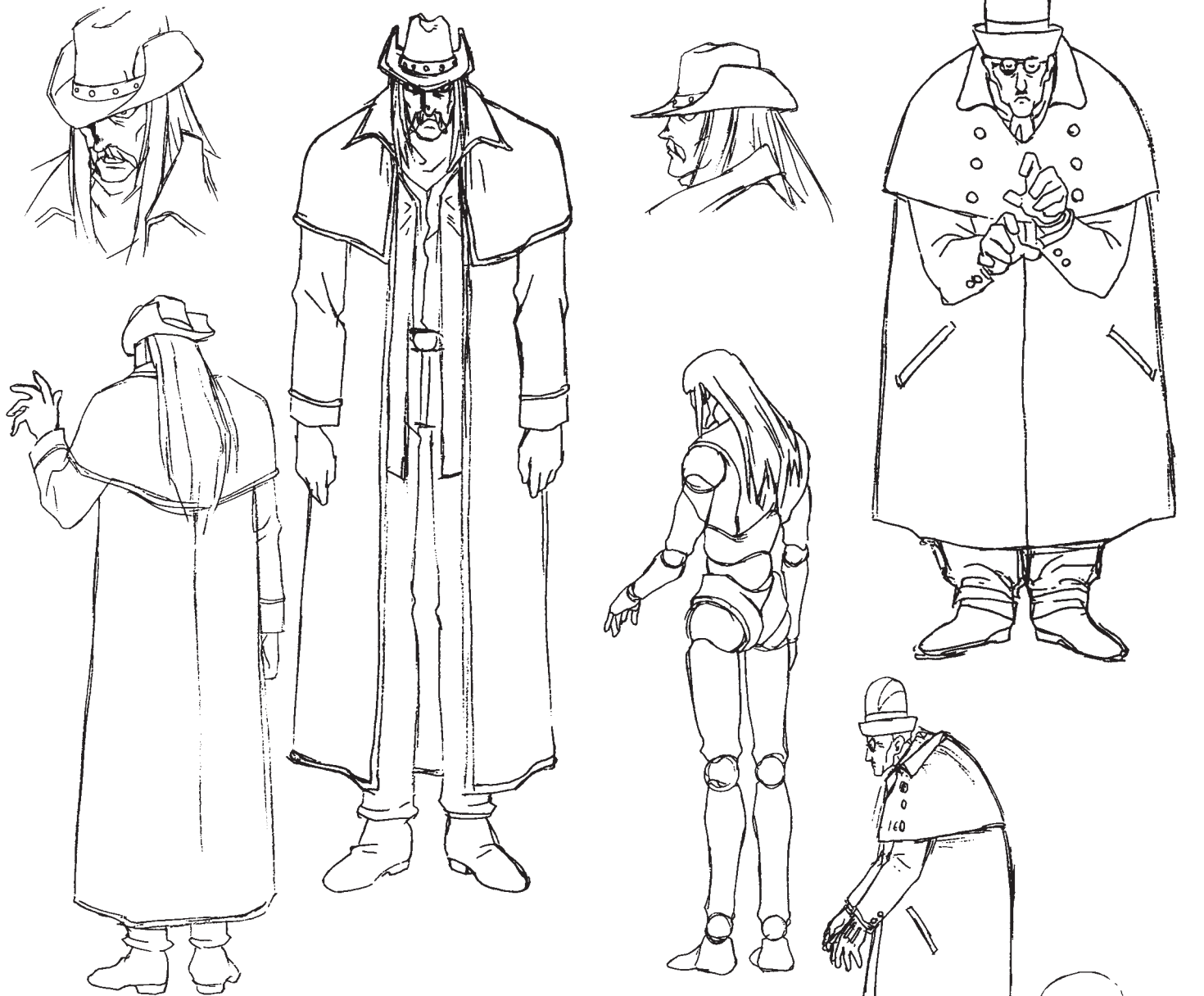

LEONOF THE PUPPERTMASTER

Adventurer 6/Tech Genius 2, Discretionary Points 44, Medium-sized Human, HD 6d4-12 plus 2d4+4, Hit Points 8, Energy Points 15, Initiative -1, Speed 24 ft., AC -1 (Dex -1), Base Attack +4, Fort +0, Ref +1 Will +8, Str 7 (-2), Dex 8 (-1), Con 7 (-2), Int 17 (+3), Wis 12 (+1), Cha 11 (+0)

Attacks: +4 melee (1d3-2, *Punch*)

Attributes: Flunkies (Puppet Servants) 1, Item of Power (Numerous Puppets) 8, Mechanical Genius 6, Personal Gear (Tools) 1, Telepathy 4

Skills: Craft (Puppets) 20, Disguise (Prosthetics) 7, Gather Information (Spying) 4, Hide (Skulking) 4, Knowledge: Mechanics (Puppets) 12, Knowledge: Military Sciences (Strategy) 13, Move Silently (Soft Step) 5, Open Lock (Puzzle Locks) 6, Perform (Puppetry) 4, Repair (Puppets) 17

Feats: Concealment, Iron Will, Judge Opponent

Defects: Owned (by Gung-Ho Guns) 2

OTHER GAME NOTES

Item of Power

Puppets — Leonof has a collection of interchangeable, mechanical puppets that he can control. See page xxx.

CHAPEL THE EVERGREEN

Adventurer 7/Gun Bunny 6, Discretionary Points 44, Medium-sized Human, HD 7d4+14 plus 6d8+12, Hit Points 83, Energy Points 20, Initiative +11, Speed 48 ft., AC 5 (DCM +2, Dex +3), Base Attack +11/+6/+1, Fort +7, Ref +10 Will +8, Str 15 (+2), Dex 16 (+3), Con 15 (+2), Int 12 (+1), Wis 17 (+3), Cha 13 (+1)

Attacks: +20/+20/+15/+10 ranged (1d8+2, Short Range, *Punisher Cross Pistols*) or +20/+20/+15/+10 ranged (4d8+2, Area Effect, Penetrating: Armour, Limited Shots (6), Static, *Punisher Cross Missile Launcher*) or +21/+21/+16/+11 ranged (1d8+2, Auto-Fire, Penetrating: Armour, Static, *Punisher Cross Machine Gun*.)

Attributes: Attack Combat Mastery 2, Defence Combat Mastery 2, Divine Relationship 1, Extra Attacks 1, Heightened Awareness 1, Item of Power (Punisher Cross) 4, Massive Damage 1, Organisational Ties (Gung-Ho Guns) 1

Skills: Gun Combat (Machine Gun) 9, Intimidate (Street) 6, Knowledge: Military Sciences (Tactics) 3, Knowledge: Religion (Theology) 4, Ranged Defence (Personal) 8, Sleight of Hand (Stage Magic) 4, Survival (Desert) 5, Unarmed Attack (Strikes) 2

Feats: Accuracy, Blind-Shoot, Improved Initiative x2, Iron Will, Portable Armoury, Steady Hand, Two-Weapon Fighting, Weapon Encyclopaedia

Defects: Owned (Gung-Ho Guns) 2

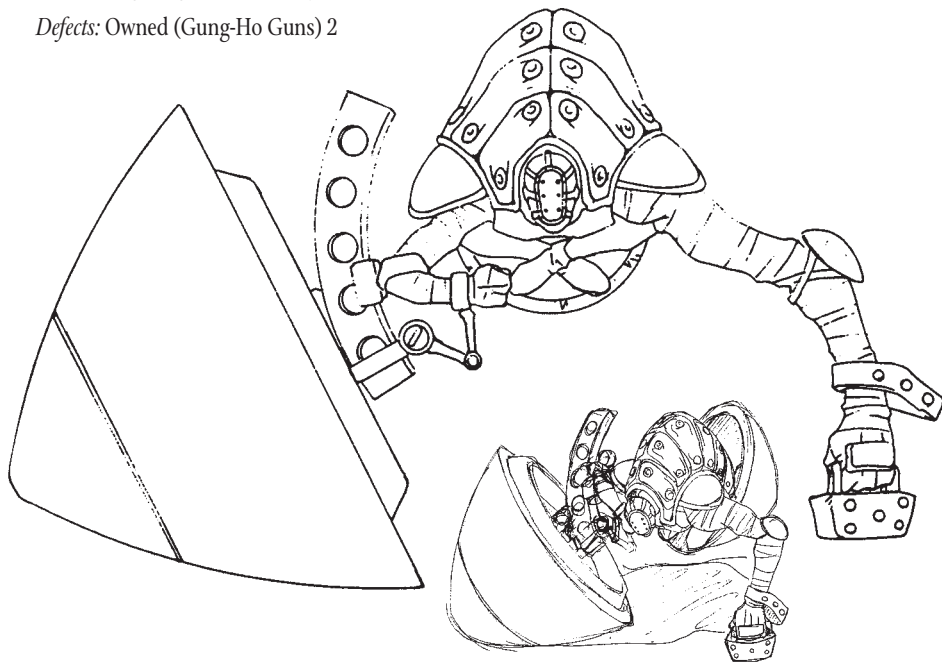

HOPPERED THE GAUNTLET

Adventurer 10, Discretionary Points 44, Medium-sized Human, HD 10d4+30, Hit Points 69, Energy Points 15, Initiative +4, Speed 51 ft., AC 6 (Dex +3, +3 DCM), Base Attack +6/+1, Fort +7, Ref +6 Will +4, Str 14 (+2), Dex 17 (+3), Con 16 (+3), Int 10 (0), Wis 10 (0), Cha 9 (-1)

Attacks: +17, +17, +12 ranged (1d8, Auto-Fire, Flurry, *Machine Guns*) or +6 melee (5d8, Penetrating: Armour x2, Slow, Stopable, *Ram*) or +6 ranged (Incapacitating: Fortitude save vs DC 20 or paralyzed, No Damage, Short Range, *Lightning Bolt*)

Attributes: Attack Combat Mastery 1, Damn Healthy 1, Defence Combat Mastery 3, Extra Attacks 1, Heightened Awareness 1, Item of Power 7, Jumping 1, Massive Damage 2, Organisational Ties (Gung-Ho Guns) 1

Skills: Gun Combat (Rifle) 10, Intimidate (Street) 5, Knowledge: Military Sciences (Tactics) 6, Ranged Defence (Personal) 5

Feats: Accuracy, Armour Proficiency (Light), Armour Proficiency (Medium), Blind-Shoot, Block Ranged Attacks, Improved Initiative, Point Blank Shot, Steady Hand

Defects: Marked 2, Owned (by the Gung-Ho Guns) 2, Physically Unappealing 2

OTHER GAME NOTES

Item of Power

Punisher Cross — Chapel possesses a Punisher Cross similar to Wolfwood.

The cross's top arm is a missile launcher. Damage 4d8, Area Effect, Penetrating: Armour, Limited Shots (6) Static. The two crosspieces each hold six pistols for a total of twelve guns. Damage 1d8, Concealable, Short Range. The last weapon is a machine gun in the bottom leg of the cross. Damage 1d8, Auto-fire, Penetrating: Armour, Static.

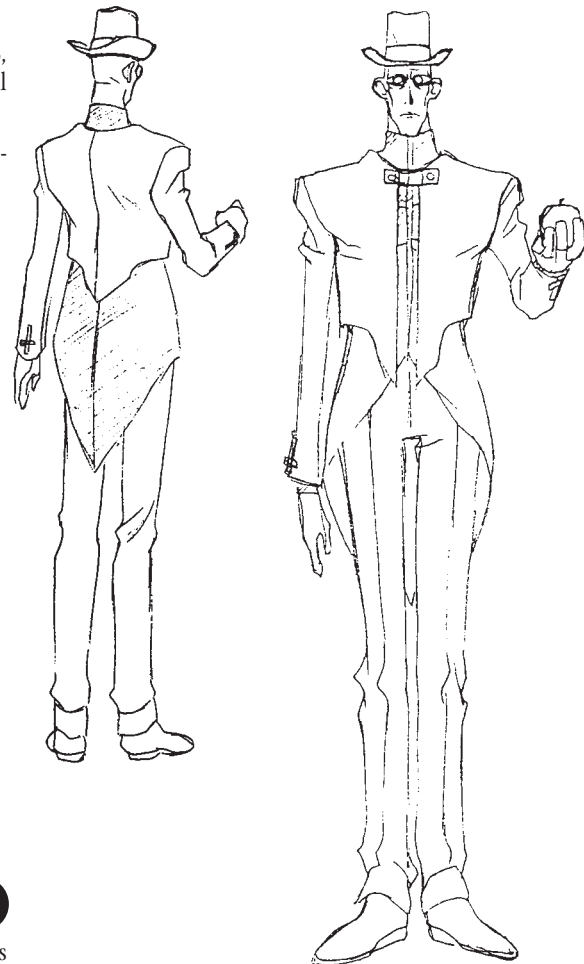

OTHER GAME NOTES

Item of Power

Hoppered wears a powerful suit of armour called the Götterer.

Armour 1, Armour: Shield 3, Special Attack: Machine Gun 2, Special Attack: Ram 3, Special Attack: Lightning Bolt 5

Special Attack

Machine Gun — Damage 1d8, Auto-fire, Flurry
Ram — Damage 5d8, Penetrating: Armour x2, Melee, Slow, Stoppable

Lightning Bolt — Incapacitating: Fortitude save vs DC 20 or paralyzed, No Damage, Short Range

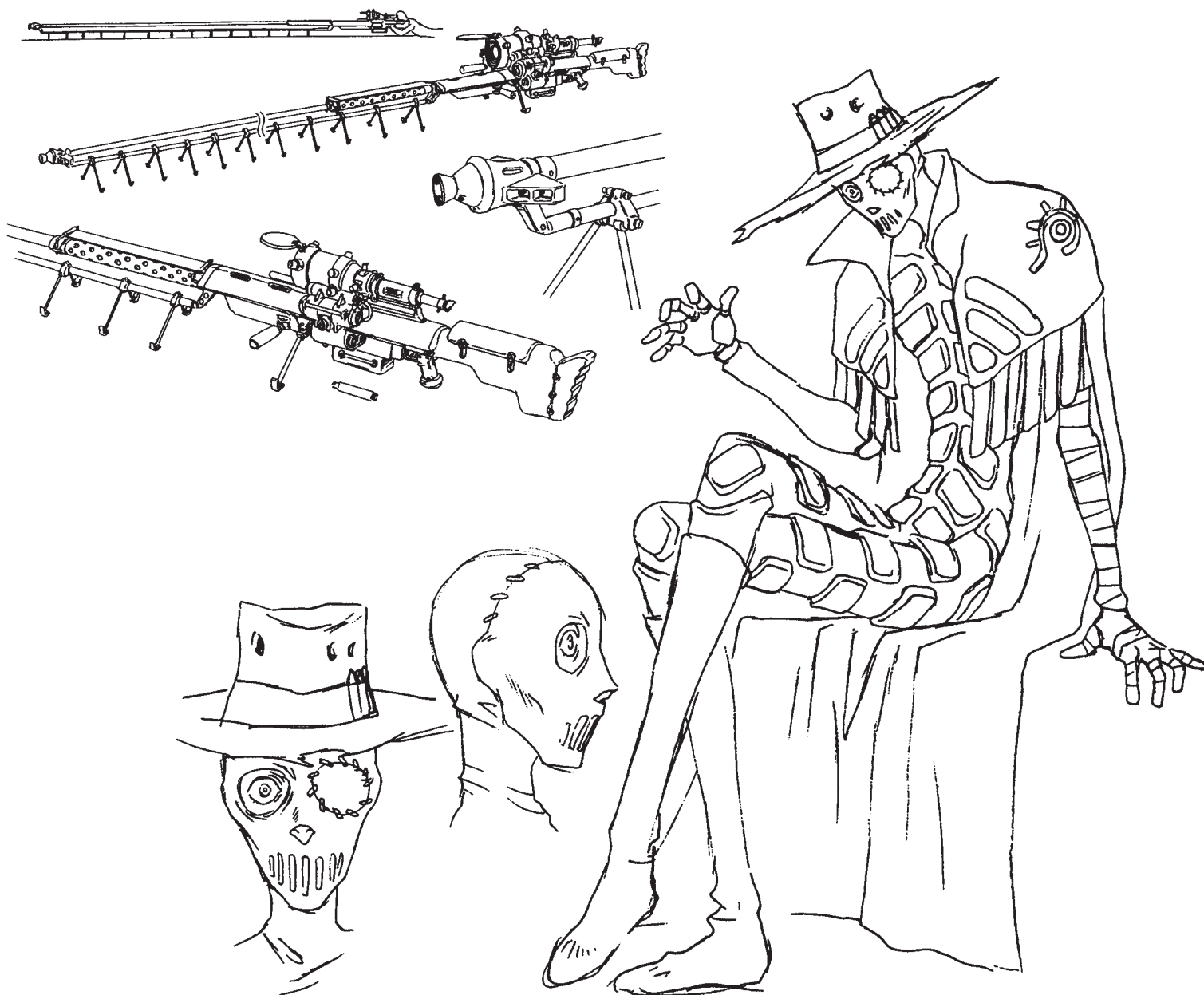

CAINE THE LONGSHOT

Gun Bunny 15, Discretionary Points 44, Medium-sized Human, HD 15d8, Hit Points 90, Energy Points 22, Initiative +6, Speed 57 ft., AC 4 (Dex +2, DCM +2), Base Attack +15/+10/+5, Fort +6, Ref +10 Will +6, Str 8 (-1), Dex 15 (+2), Con 11 (0), Int 11 (0), Wis 11 (+0), Cha 10 (0)

Attacks: +29 ranged (2d8+6, Long Range x2, Penetrating: Armour x2, Slow, Static, *Sniper Rifle*)

Attributes: Defence Combat Mastery 2, Divine Relationship 3, Heightened Awareness 2, Item of Power (Sniper Rifle and Stealth Cloak) 3, Massive Damage 3, Organisational Ties (Gung-Ho Guns) 1, Personal Gear 1

Skills: Gun Combat (Rifle) 13, Hide (Concealment) 5, Intimidate (Street) 3, Knowledge: Military Sciences (Tactics) 2, Move Silently (Soft Step) 5, Ranged Defence (Personal) 3, Spot (Movement) 6

Feats: Accuracy x4, Armour Proficiency (Light), Blind-Shoot, Far Shot, Improved Initiative, Judge Opponent, One Shot Left, Portable Armoury, Steady Hand, Weapon Encyclopaedia

Defects: Owned (Gung-Ho Guns) 1

OTHER GAME NOTES

Items of Power

Sniper Rifle — Caine uses a massive sniper rifle to eliminate targets of the Gung-Ho Guns. Damage 2d8, Long Range x2, Penetrating: Armour x2, Slow, Static.

Stealth Cloak — Caine wears a cloak that helps him blend in with his surroundings, better enabling him to strike from a distance without fear of being discovered. The cloak gives him the +10 bonus to Hide checks.

Personal Gear

Caine wears light armour that provides 3 points of protection.

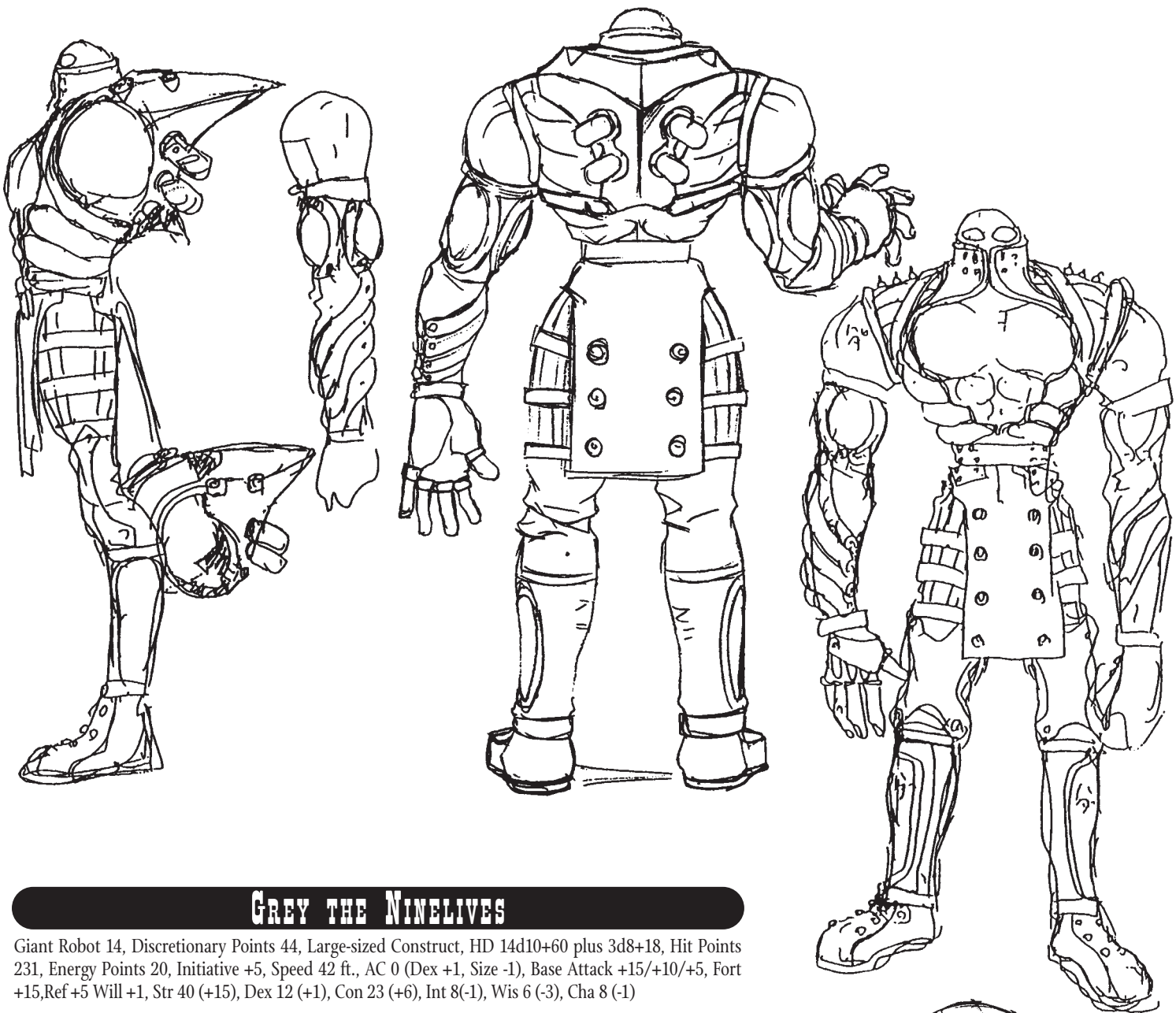

GREY THE NINELIVES

Giant Robot 14, Discretionary Points 44, Large-sized Construct, HD 14d10+60 plus 3d8+18, Hit Points 231, Energy Points 20, Initiative +5, Speed 42 ft., AC 0 (Dex +1, Size -1), Base Attack +15/+10/+5, Fort +15, Ref +5 Will +1, Str 40 (+15), Dex 12 (+1), Con 23 (+6), Int 8(-1), Wis 6 (-3), Cha 8 (-1)

Attacks: +45, +45, +40, +35, +30 ranged (1d8+2, Limited Shots, *Revolver*) or +22 ranged (3d8, Penetrating: Armour x2, Unique: Sustained, Short Range, Slow, *Negative Energy Sphere*) or +21 ranged (11d8, Flare, Penetrating: Armour x2, Backblast x2, Slow x2, Static, *Angel Arm*)

Attributes: Armour (+2 points of natural armour) 3, Attack Combat Mastery 2, Damn Healthy! 3, Features 3, Massive Damage 2, Organisational Ties (Gung-Ho Guns) 2, Size Change (Growth) 1, Special Attack: Chest Missiles 3, Special Attack: Finger Machine Guns 3, Special Attack: Lef Rocket 8, Superstrength 2

Skills: Intimidate (Street) 5, Special Ranged Attack (Finger Machine Guns) 5

Feats: Ambidexterity, Improved Initiative, Point Blank Shot, Power Attack, Steady Hand

Defects: Incomplete Training (No Flight) 12, Owned (Gung Ho Guns) 2, Marked 3, Unique Defect (Size Disadvantage) 2



SAND STEAMER FLOURISH

Speed 120 mph, Manoeuvre Bonus -4, Size 5, Cargo 40 tons, Armour 20, Hit Points 140, Skill Driving (Big Rig)

The *Flourish* has two gunnery bays, one on each side of the ship. Each bay has three cannons. Damage 4d8, Different Gunner, Slow. The *Flourish* also has a safe the size of a bank vault. It is so large that to open it with explosives would destroy the ship in the process.

BAD LADS GUNSHIP

Speed 150 mph, Manoeuvre Bonus 0, Size 5, Cargo 40 tons, Armour 20, Hit Points 110, Skill Driving (Big Rig)

Neon's vehicle is fitted with mounted machine guns. Damage 2d8, Auto-Fire.

WOLFWOOD'S MOTORCYCLE

Speed 180 mph, Manoeuvre Bonus +1, Size 1, Cargo 100 lbs, Armour 3 (vehicle only), Hit Points 40, Skill Driving (Motorcycle), Sidecar (+1 person, -10 mph, three rounds to attach or remove)

E.G. MINE'S SPIKE SHOOTERS

Item of Power 3

Armour (Partial, unarmoured) 2, Special Attack: Shooting Spikes 3, Unique Defect (Character cannot effectively use his or her hands/arms while wielding the Spike Shooter) 3

Special Attack

Shooting Spikes — Mine's Spike Shooters launch spikes at his opponents. The spikes are automatically reloaded. Damage 3d8, Penetrating: Armour, Spreading, Inaccurate, Short Range.

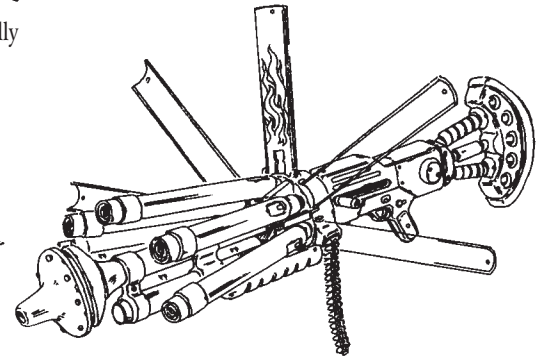
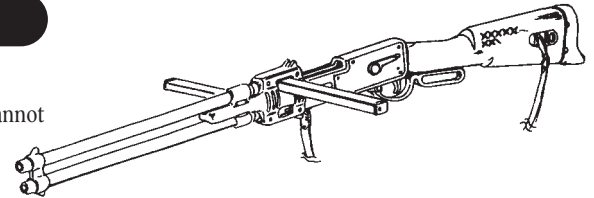
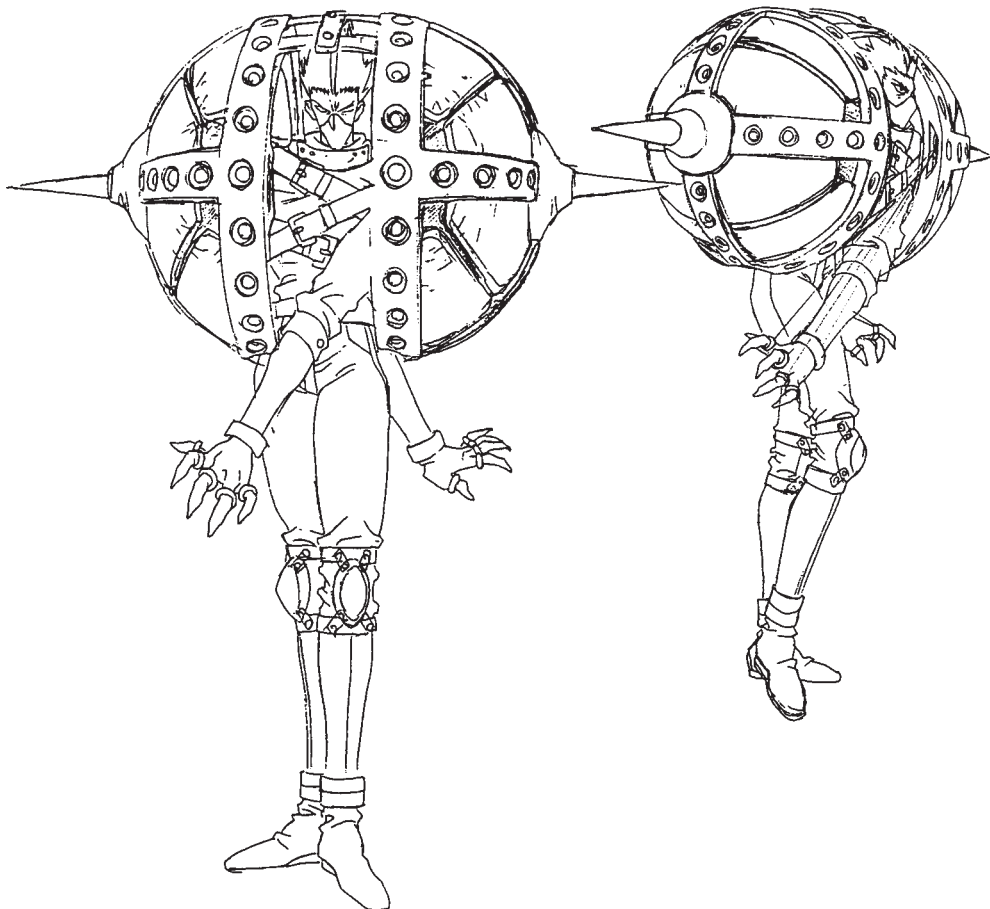

REVOLVING RIFLE

Ruth Loose's rifle features two barrels mounted one over the other, each with its own clip. After each shot, the barrels rotate to chamber a new round of ammunition. Damage 1d8, +1 to hit, Penetrating: Armour.

SIDE-MOUNTED MINIGUNS

Cliff Schezar's last-ditch defense is four miniguns, one strapped under each arm and one at each hip that he keeps hidden under his jacket. Damage 1d8, -1 to hit Auto-fire, Concealable, Static.

MULTI-BARREL POP-UP GUN

This weapon appears in Episode Three by the leader of the bank robbers. It has two attacks, one with the main barrel and one when the outer shell is "popped up." 1st Attack: Damage 1d8, -1 to hit, Auto-fire. 2nd Attack: Damage 2d8, -1 to hit, Area Effect.

OTHER INFORMATION ABOUT THE SHOW

Demislad Geyser Field

Just outside the small town of Demislad lies a natural wonder as dangerous as it is fascinating. Folks know the Demislad Geyser Field is as an area to avoid, and only the foolish or fearless venture into it. Unlike geysers on Earth, which have visible vents and often predictable timing, the steam and water sprays in the Demislad field are unpredictable in both when and where they occur, erupting anywhere within the limits of the field.

The size and boundaries of the field are seemingly fixed, but are not specified in the series. Audiences can assume the field is large, enough so that Julius and Moore reasonably expect to evade capture within it (perhaps forty square kilometres). The steam and scalding water bursts can cause moderate to severe burns on unprotected skin, and the unpredictability and placement of the geyser bursts make tracking through the field very difficult.

Endoro Precipice

The Endoro Precipice is located in the far reaches of Luttonberg Canyon. The precipice's origins remain unknown since there is little information as to whether it is a natural or artificial phenomenon. It is well off the beaten path, and only noteworthy because of its unusual perpendicular walls and the depth of the trench itself. Brilliant Dynamites Neon believed the precipice sufficient to wreck the sand steamer *Flourish* and crack open the large safe.

Luttonberg Canyon

Luttonberg Canyon is a network of mesas and valleys. Travelling through this maze is the quickest way through that region, but it is fraught with dangerous bandits and deadly rockslides. The Bad Lads Gang makes its home in the canyon, and they board any vessel its leader thinks might be carrying something valuable. While the canyon has been mapped, only Neon and his gang know it intimately. The gang has seemingly dug in so effectively that no effort to find and arrest them has worked.

The Beings Who Exist Outside of Time

Vash and Knives are not human, despite their appearance. They belong to another race, referred to as “plants” or “the beings who exist outside of time.” The series never explains the twins’s history or how they came to live among humans, though it does briefly hint at their origin. The series shows them as babies, with Rem protecting them from a group of men with guns. In the background, behind glass, a small group of scientist watch. It is never explained how they went from this infant stage to living among the humans aboard the SEEDS ship.

Knives and Vash both appear to know what they are and where they came from, but they never clearly explain it. Very few people in the series are even aware that Knives and Vash are not human. Those in the know include the Gung-Ho Guns, Brad, Doctor, Wolfwood, and Meryl. They, however, are only aware because Vash or Knives told them; Brad, for example, discovered it by seeing Vash communicate with a being inside a plant.

The beings existing outside time are the force powering the plants used for humanity’s survival. Knives calls them “our siblings,” while Vash refers to one as “little sister.” The series never explains how the beings generate power. The only scene in the series that offers any explanation shows a female plant with solid yellow eyes, floating inside the globe. Behind her is a spiralling circle that could be a portal of some type.

Knives refers to using a plant as “leeching off the living blood of our siblings,” and wonders as a child if he’ll be “eaten,” comparing himself to the apple tree on the SEEDS ship. Vash does not seem to view it with the same horror as Knives, but never gives an interpretation of the process. Humans appear to be largely unaware that their greatest resource is based on exploitation of another race ... unless, of course, that race is an artificial lifeform created by humans. In this light, Vash and Knives could be organic machines; the first of their kind “liberated” from the plants. Regardless, by the fact Rem saved the twins from being shot as babies indicates their existence was unexpected, and to an extent, feared.

The “beings who exist outside of time” appear capable of energy manipulation, telepathy, regeneration, and seem unaffected by time as humans know it. Whether this is a function of alien genetics or genetic engineering by human scientists remains a mystery. Upon reaching maturity, however, the twins do not appear to age or falter. The series hints that both Vash and Knives can be killed, but Vash also states that he cannot truly die as long as his brother lives. The series never explains whether this indicates immortality or something else.

LEONOF'S PUPPETS

Leonof the Puppetmaster uses his namesakes to accomplish his dirty work for him. These puppets are made from interchangeable component pieces usable in constructing any number of models. The templates for the human and bird forms are included below.

Leonof may possess both Telepathy and Telekinesis to control his puppets. Those powers alone would be insufficient, however, to manipulate and direct the number of puppets Leonof has used at any one time. Leonof's secret is his controller, the small red ball that floats between his hands and shows him what his puppets see.

Giant Robot 1, Discretionary Points 50, Medium-sized Construct, HD 1d10+3, Hit Points 10, Energy Points 2, Initiative 0, Speed 30 ft., AC 0 (Dex 0), Base Attack +0, Fort +5, Ref +0 Will +0, Str 14 (+2), Dex 10 (0), Con 16 (+3), Int 12 (+1), Wis 10 (0), Cha 8 (-1)

Attacks: +4 melee (1d3-2, *Punch*)

Attributes: Alternate Form (Full Powered; Bird) 2, Features 1

Skills: Move Silently (Soft Step) 3, Unarmed Attack (Strikes) 1

Feats: Sneak Attack

Defects: Owned (by Leonof) 3

Alternate Form (Bird; small-sized): -4 Strength, +6 Dexterity, -2 Constitution, +1 AC, -1 BAB, Flight 3, Heightened Awareness 3, Heightened Senses (Sight) 1, Natural Weapons (Claws and Beak) 2.

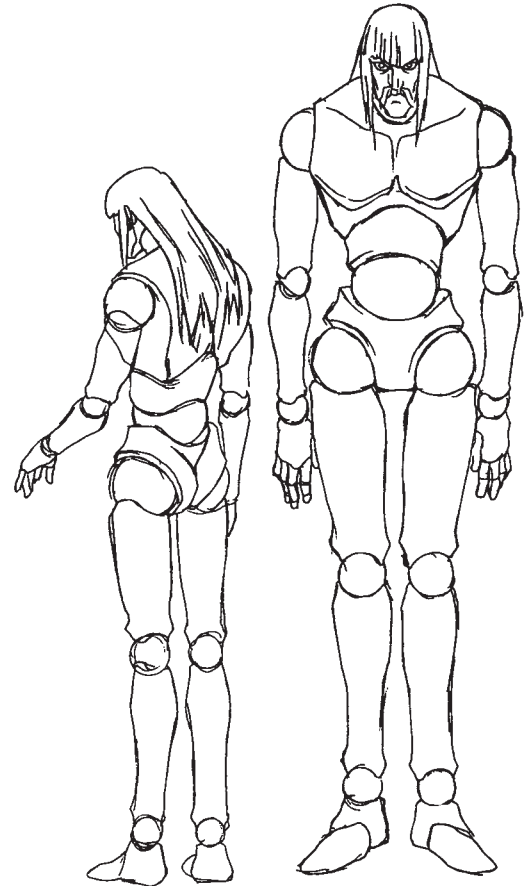

MODES OF TRANSPORTATION

Travel on the desert planet can be hazardous. Heat exhaustion, dehydration, ruthless bandits, and malfunctioning robots are only a few of the dangers just beyond the horizon. For those who must travel, however, there are ways to ensure a relative degree of safety.

The first is mass transit. There are several types available, all with varying levels of expense. First are the sand steamers, a cross between steam locomotives and luxury ocean liners. The levels of accommodations on sand steamers vary according to price from expensive staterooms to cheap floor space. Steamers are the most expensive option, but they are the most secure thanks to their heavier gun emplacements and better shielding. Additionally, steamers also protect smaller cars travelling in their wake (safety in numbers).

Second are caravans, which accept passengers along their routes in exchange for goods or money. They travel heavily armed, so security is never lacking. They do not specialize in comfort, however, and a seat in a van combined with a small tent for sleeping may be all the luxury to which one is entitled. They are probably the second most expensive option.

Third are buses, which travel from town to town. Bus lines seem regular enough, but it may be days before the next bus arrives or leaves. Security is low, but buses also present a less tempting target to would-be bandits. Many folks of low-income means choose this method of travel.

For those with less money, more courage, or a need to travel somewhere unsuitable for the aforementioned methods, there are other options. The first among these is motorized conveyance. Cars and motorcycles are available, but they are not intended for off-road travel.

The next option are creatures called thomasas. Thomasas look like a cross between an anteater and a very large chicken. They hold one rider and his or her gear comfortably, but they can carry two people if necessary. Thomasas are presumably bred to withstand the harsh environment and travel both on and off-road. They are not intelligent, but neither are they easily frightened. They travel faster than a human on foot, but not as fast as an engine-driven vehicle. Most people own thomasas instead of motorized vehicles, especially in the smaller cities and towns.

The last option is to travel on foot. Towns are typically only a few days apart, though in more hazardous areas the distance grows. Walking is the least expensive method of travel, but it is the most dangerous since it is impossible to outrun most intervening threats.

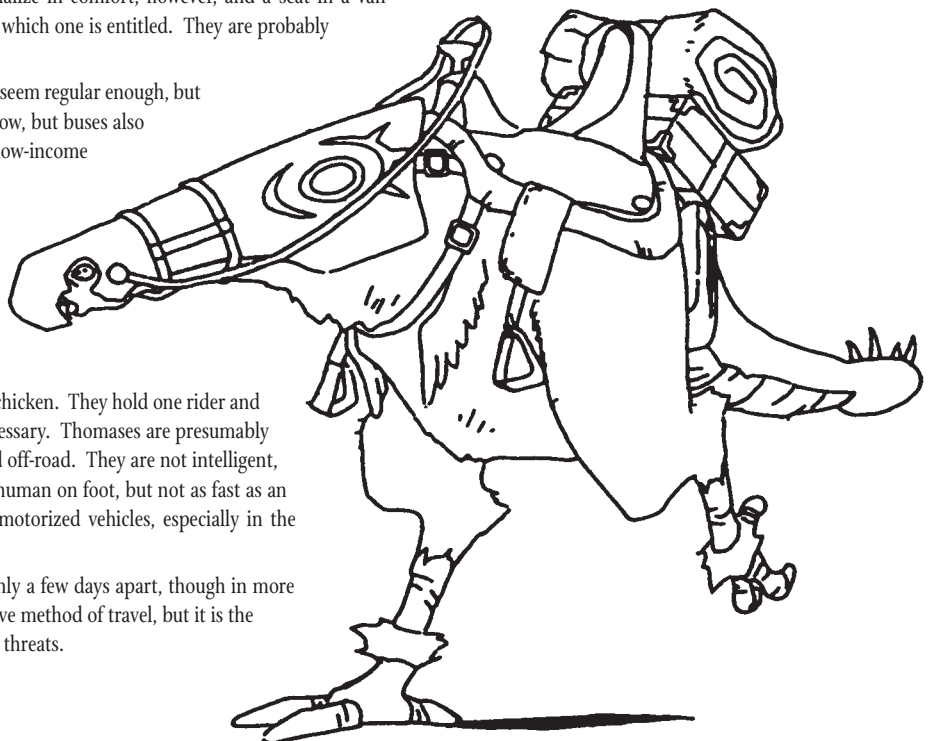

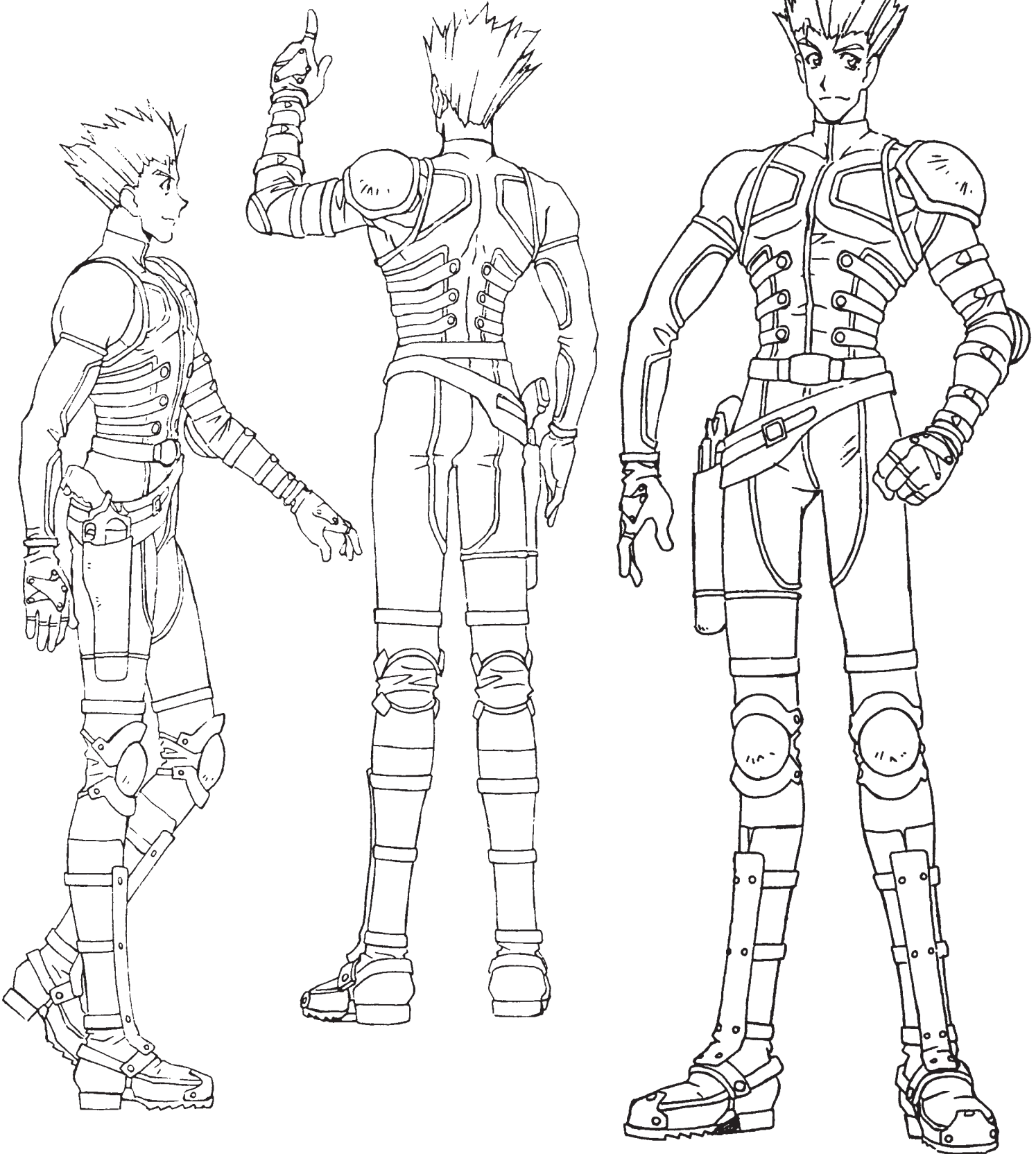





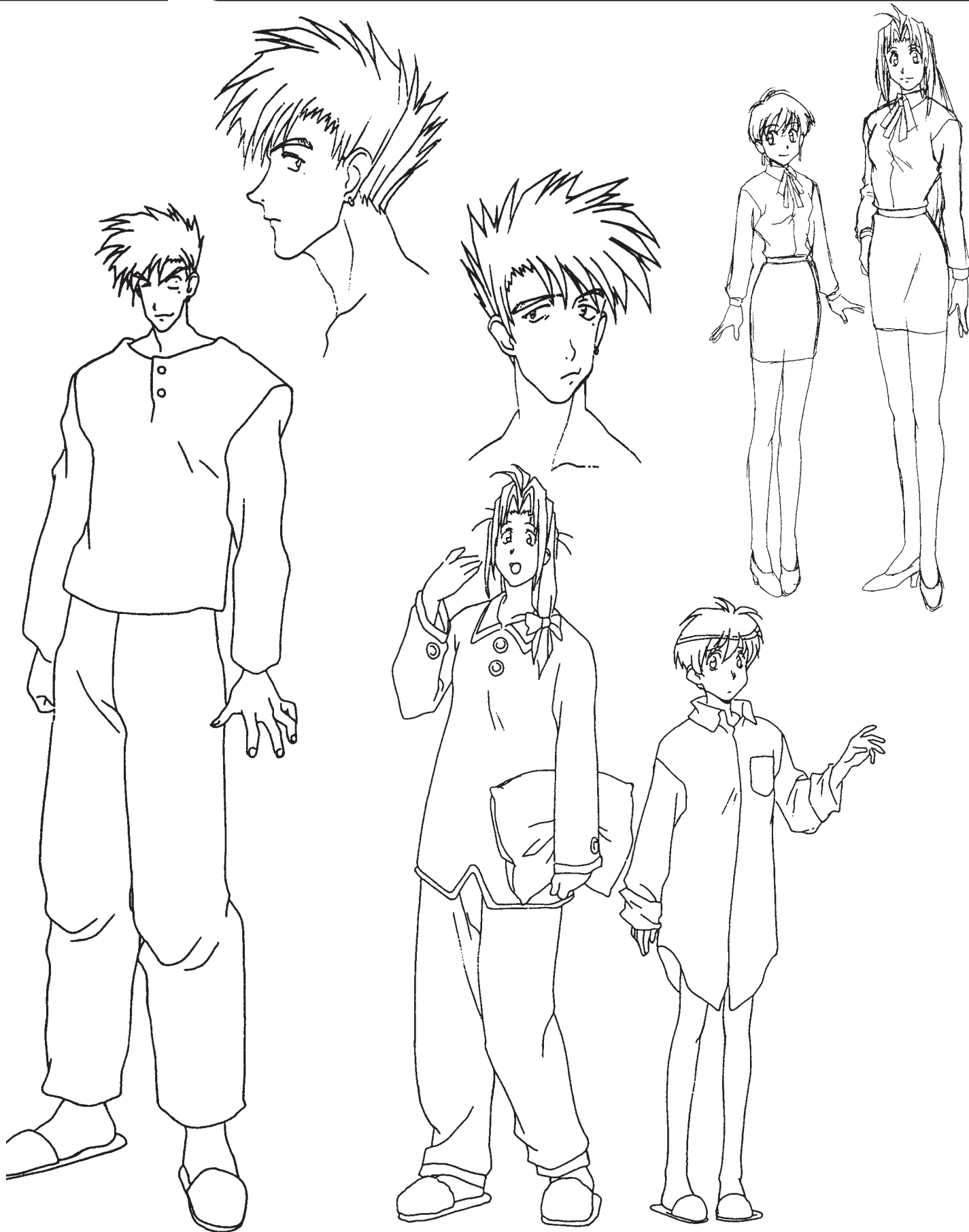

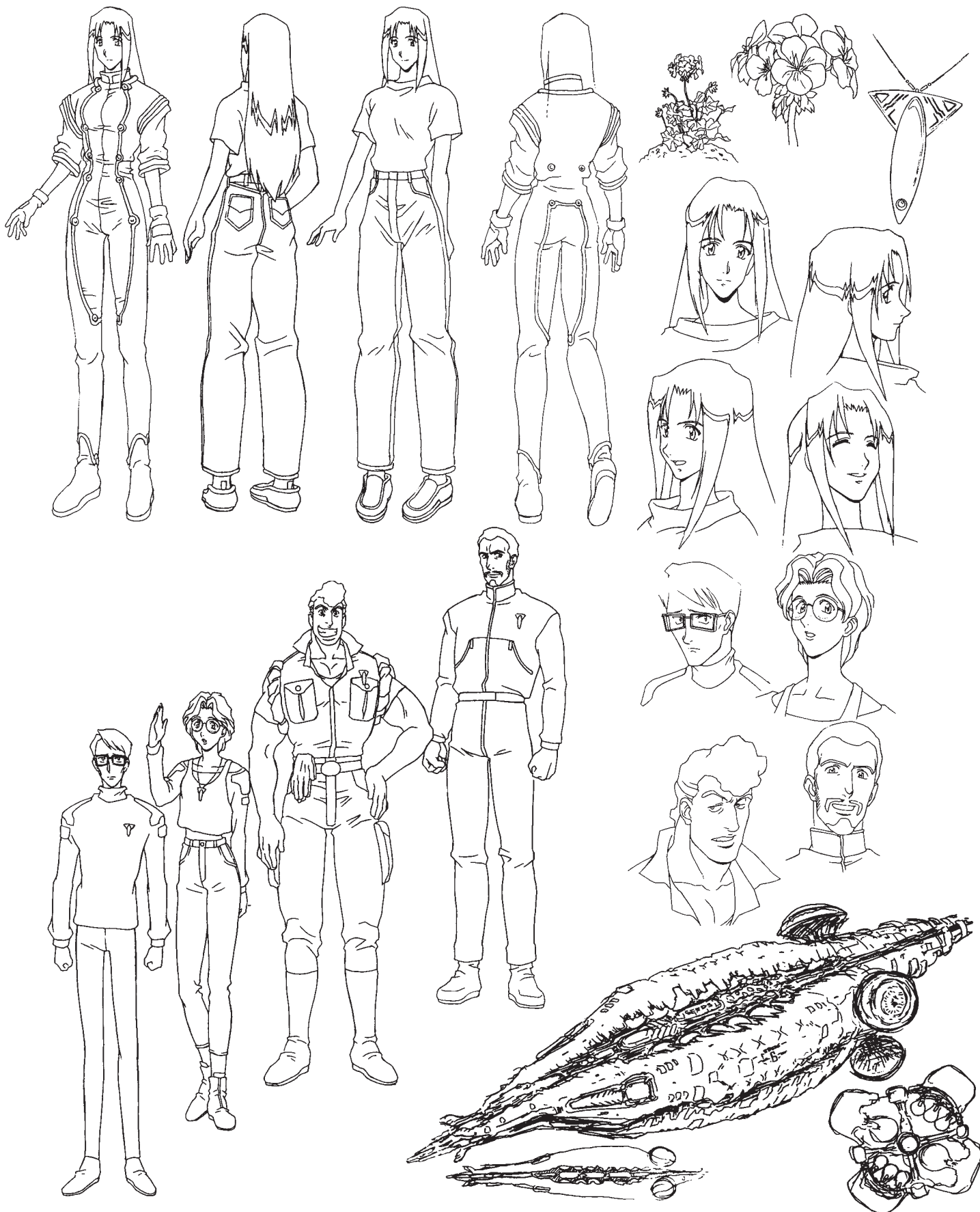

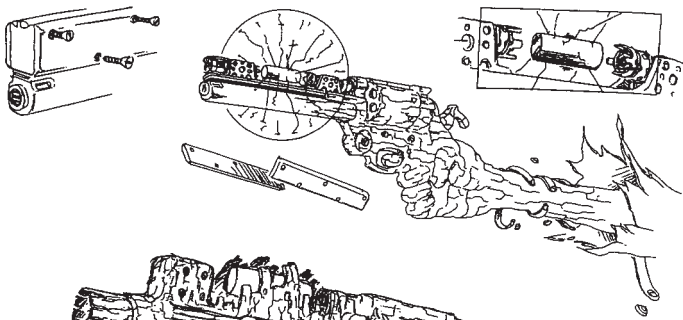
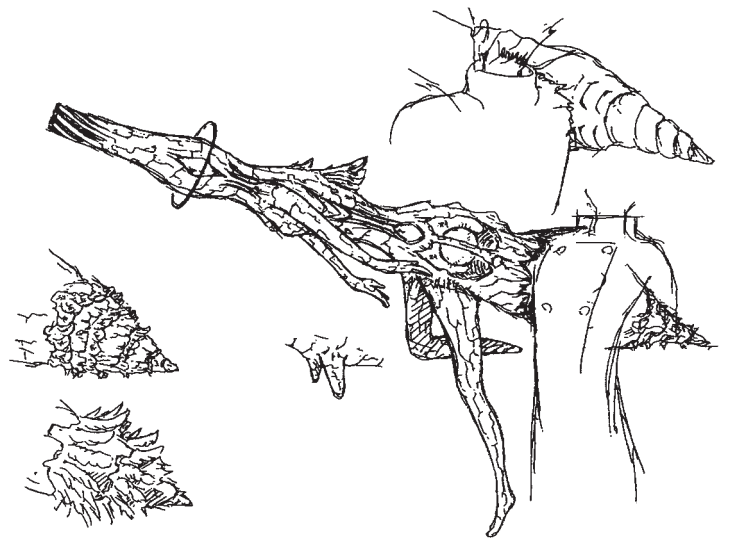
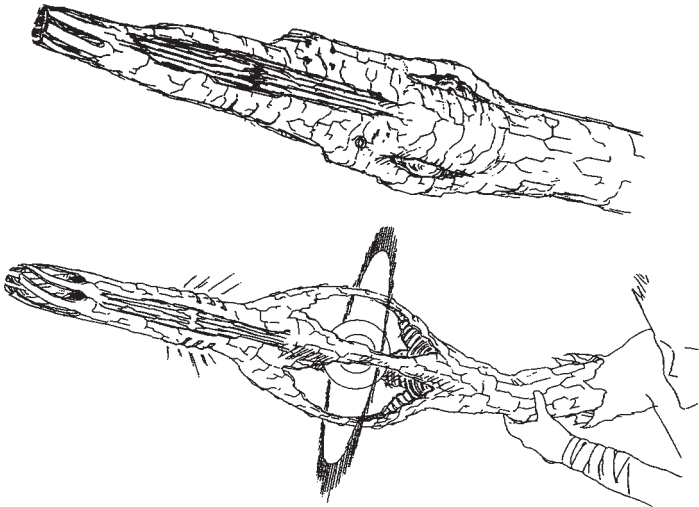
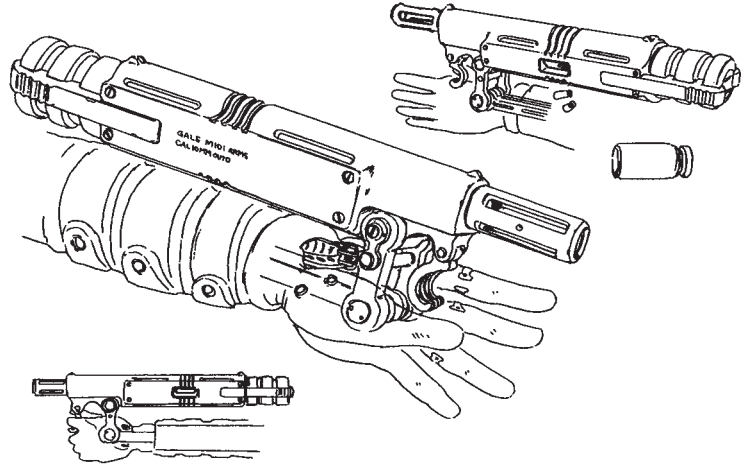
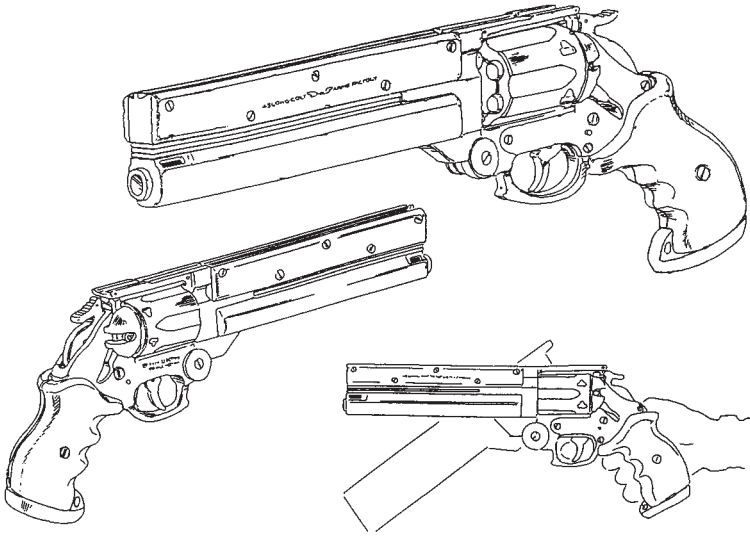



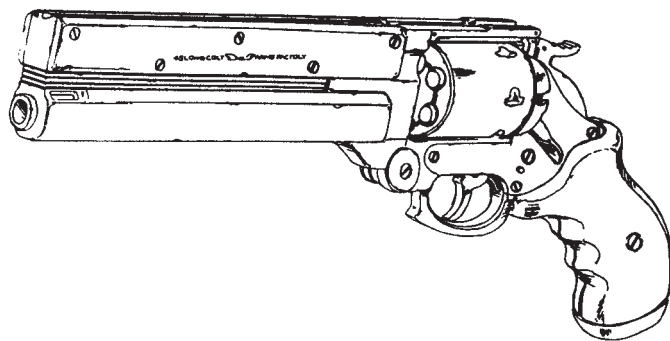
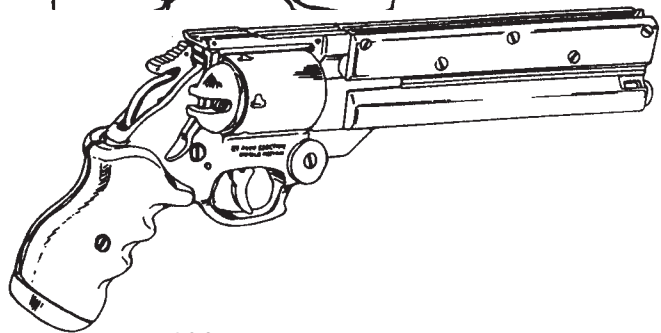
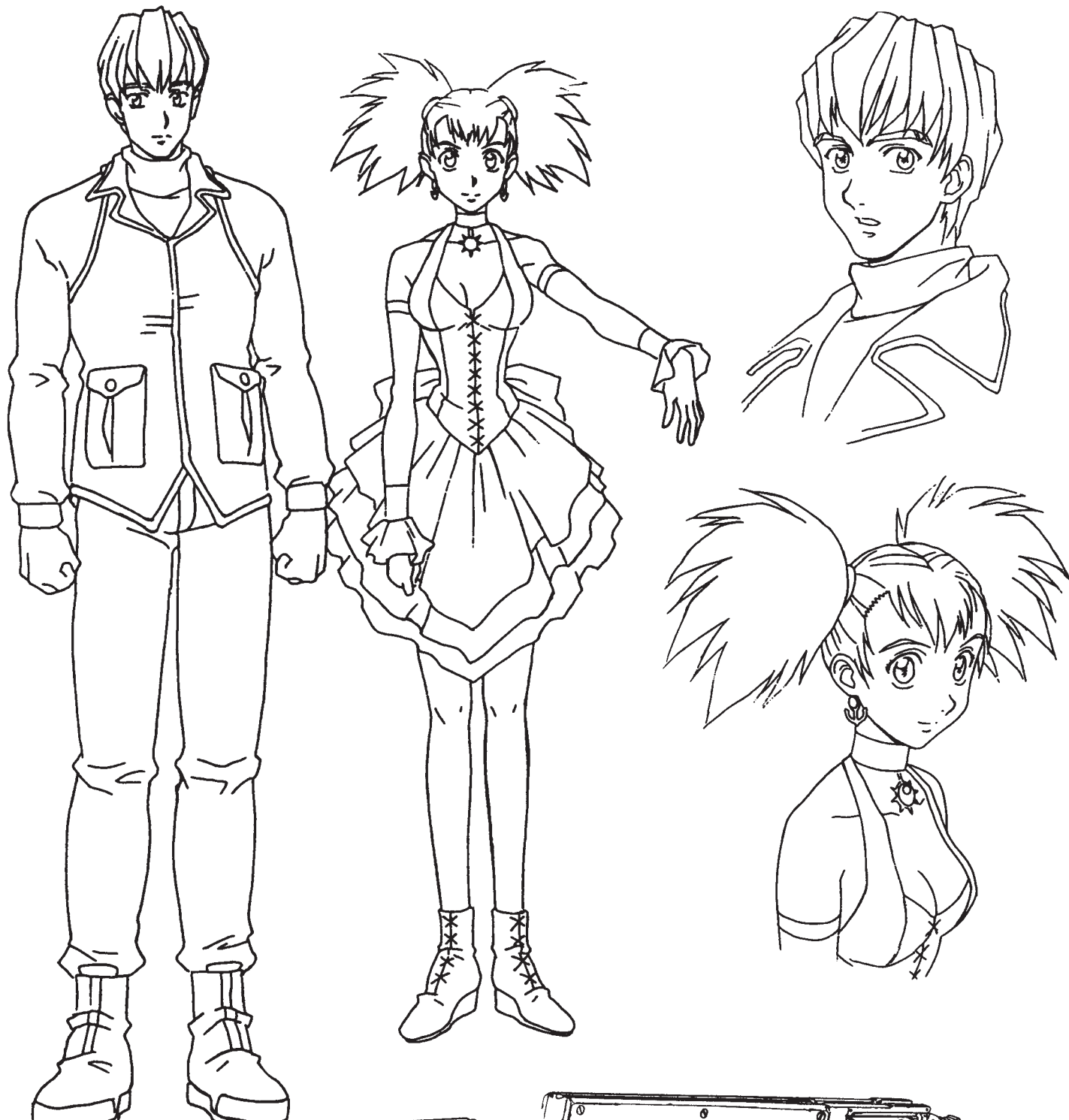

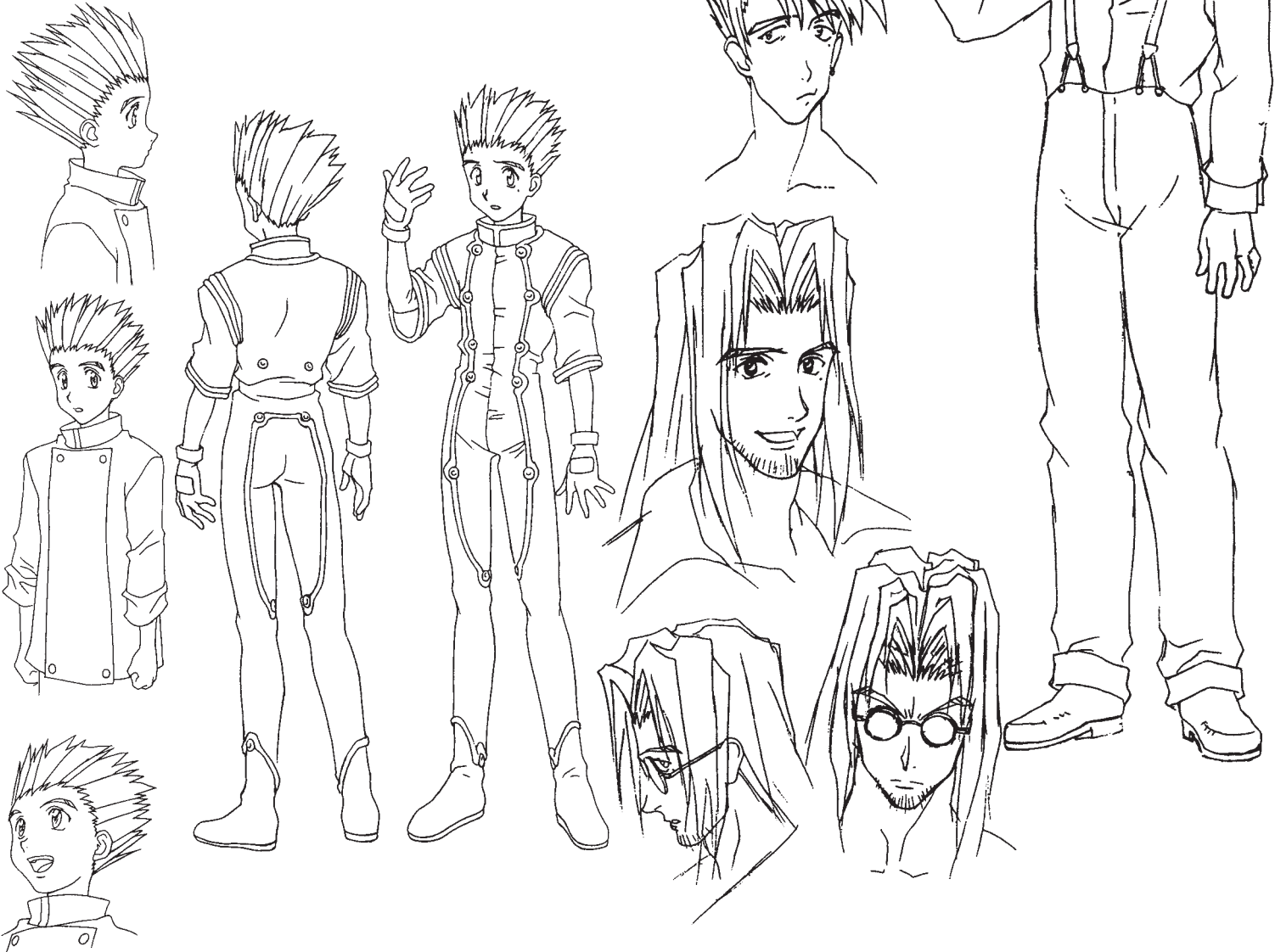
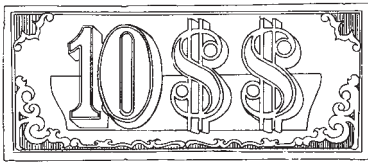
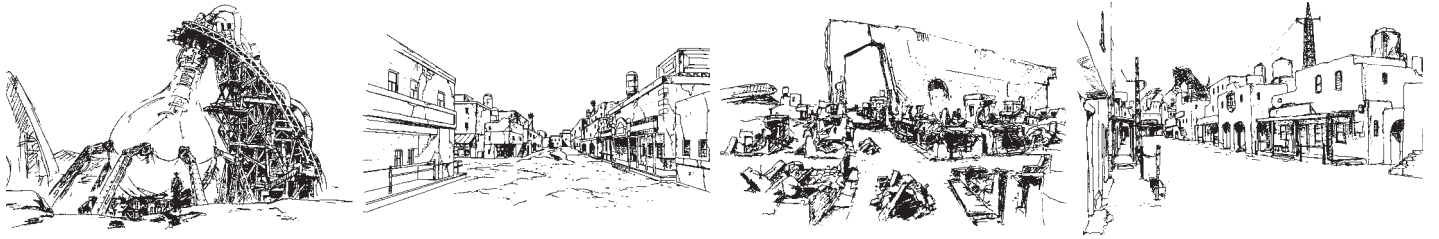

EPISODE PREVIEWS

As part of the video and DVD series, Pioneer included the episode previews that originally aired at the end of each show. The philosophical dialogue for these previews was unlike anything else being done in anime at the time. The following is a list of the previews for episodes two through 13. The previews are presented as they were originally written in the subtitled version.

TRUTH OF MISTAKE

This originally aired at the end of Episode One. The voice is Vash's.

There is something which cannot be expressed in words. People's emotions. Emotions of the heart cannot be defined. But there is one way to read the emotions. Look into their eyes. The girl lied to me. The gentleman lied to me. But the moment I looked into their eyes, the fate began to alter, to reveal the truth. Just look into their eyes. There is only one truth.

PEACE MAKER

This originally aired at the end of Episode Two. The voice is Vash's.

Those who made mistakes blame themselves and close their hearts. It's impossible to fix the mistake. Man can't return to the past. That's why we drink. Drunks, luses, sliding alcohol down their throat to dilute the memories that can't be denied. Frank Marlon the gunsmith does nothing but drink. And he questions the drained glass, "Am I wrong?" "Was I wrong?"

LOVE & PEACE

This originally aired at the end of Episode Three. The voice is Vash's.

A past which can't be buried. A past which can't even be shaken. The sentiment inside of their hearts is equal. One for beloved parents, one for a beloved daughter... Two men can only find the answer behind their triggers. The moment the sentimental bullets were fired at the other, the men stood silent and wept. The past enslaves.

HARD PUNCHER

This originally aired at the end of Episode Four. The voice is Vash's.

Whenever something is gained, something is always lost. It's impossible to live without facing that fact. What is lost will never return. Important things. Irreplaceable things. The things necessary to protect those things. The firm determination packed into a bullet. Man knows ... knows that nothing will begin unless he speaks. That nothing will change unless he moves.

LOST JULY

This originally aired at the end of Episode Five. The voice is Vash's.

The longer one holds onto a memory, the longer one lives in the past. The deeper the memory they hold onto, the more beautiful the past will become. The beautiful memories will eventually turn into hate. Even if they look ahead, they lose the ability to walk. As long as the heavy chain called Revenge continues to bind the heart, the tears of sadness will continue to flow.

B.D.N.

This originally aired at the end of Episode Six. The voice is Vash's.

The tragedy endlessly repeated in order to fulfill desires. The lust for conquest, making people bend to your will. A thrill intense enough to make you shudder. There is a man who is a slave to that ecstasy. The leader of the Bad Lads, a man who shines: Brilliant Dynamites Neon. The sand steamer will shake the moment the huge dynamos on each of his shoulders start to spark. In the pitch black darkness, the gruesome party begins.

AND BETWEEN THE WASTELAND AND THE SKY ...

This originally aired at the end of Episode Seven. The voice is Vash's.

People who sin say this: that they had to, to survive. People who sin say this: it's too late now to stop. The shadow called Sin dogs them steadily from behind, silently without a word. Remorse and Agony are repeated, only to end up at Despair in the end. But the sinners just don't know that if they'd only turn around, there is a light there ... a light which keeps shining on them ever so warmly. A light that will never fade.

MURDER MACHINE

This originally aired at the end of Episode Eight. The voice is Vash's.

I met a lone man in the desert, a travelling priest, Nicholas D. Wolfwood. He smiled and told me that I'm a troubled man. Faced with his all-seeing smile, I could say nothing in my defense. Did I meet this man because I was destined to? Or was it a small jest of God? The man's name is Nicholas D. Wolfwood ... a travelling priest I met in the desert.

QUICK DRAW

This originally aired at the end of Episode Nine. The voice is Vash's.

I think I would like to do something for somebody. I think it's good if someone smiles when you smile at them. The beauty of voluntary acts can foster goodwill in the hearts of others. Love which doesn't ask for collateral gives us respect as people. However, it is wrong to try to sustain that. In time, the strain will bloom into the flower called Lie, the thorny flower which hurts people.

ESCAPE FROM PAIN

This originally aired at the end of Episode Ten. The voice is Vash's.

A choice between two things. The forked road every person brought into the world must eventually face. A crossroad. Whichever path they choose, they lose something. Whichever path they choose, they are unable to find happiness. But are there really only two paths to a forked road? No. There are infinite paths we should take. There is more than one path we should take. There is more than one path to the future.

DIABLO

This originally aired at the end of Episode Eleven. The voice is Vash's.

All people have a sanctuary which mustn't be touched. A scar of sadness which mustn't be entered. The living confront each other to achieve their ideals. In a quiet voice, the man in the white coat told me that he had finally found me, that he wanted my life. That man smiled a smile deeper than darkness. Legato Bluesummers, a man fascinated by death ... only spoke quietly.

VASH THE STAMPEDE

This originally aired at the end of Episode Twelve. The voice is Meryl's.

Routine report, Date: July 20th ... two days after the incident caused by a man named Monev. Tension still runs high in the city. This incident made me realize something all over again. Contact with the real Vash the Stampede makes me forget his reputation ... the reason he's called the Humanoid Typhoon. Why is it that so much trouble falls into this man's lap?

EPISODE PREVIEWS

As part of the video and DVD series, Pioneer included the episode previews that originally aired at the end of each show. The philosophical dialogue for these previews was unlike anything else in anime at the time, and presents a unique view of the series. The following is a list of the previews for episodes 14 through 26. The previews are presented as they were originally written in the subtitled version of the series, and are spoken by Vash.

DEMONS EYE

This originally aired at the end of Episode Fourteen.

People judge people. Lives are cut short because of someone's personal logic. Mothers, fathers, friends... entire pasts instantly vanish. But should this take place at the whim of one individual? A beautiful woman once stood before the corpses of The Roderick Thieves. She told me that she had merely cleaned up some useless garbage. Dominique the Cyclops told me that this was spring-cleaning.

GOODBYE FOR NOW

This originally aired at the end of Episode Seventeen.

Let us regard the 5th moon... shining down upon us from the skies stained red with blood... and let us remember his name, his legend. You only need look up. Like it or not... his legend is chiselled into the 5th moon. The legend of Vash the Stampede is chiselled into the 5th moon. And then the time comes. You only need tell of the tracks leading to the future.

OUT OF TIME

This originally aired at the end of Episode Twenty.

Some things you can't give up. Some things you want to protect. Sometimes we must take a stand no matter what kind of pain awaits. The man in the red coat took up his gun once again... in order to stop the grief... in order to stop the hatred. I keep the word of the red geranium, which taught to me so long ago... I keep firm determination deep in my heart.

SIN

This originally aired at the end of Episode Twenty-Three.

Repeated tragedy. Repeated pain. The wishes of man are so strong, and yet so frail and weak. To live. To stay alive. Who would have known that survival was this hard... this painful...? I must choose. I must make the choice. In the moment of intertwining life and death... can I choose to remain a human?

FIFTH MOON

This originally aired at the end of Episode Fifteen.

A fragment of memory lost in the ravine between life and death... Is it something which will point the way to spiritual awareness? The silver-metallic gun cracked open, and my right arm metamorphosed. My past, my people, my mother... The moment I was reunited... with everything I ever protected, the light took Augusta. The Humanoid Typhoon, The \$60,000,000,000 Man... Vash the Stampede. This is the beginning of my past. This is the end of my journey.

HANG FIRE

This originally aired at the end of Episode Eighteen.

A strong will can stir the heart. But a will too strong can limit the heart's visibility. The sorrow of a man bereaved of family turns into hate... which eventually transforms into the intent to kill. The man's finger reaches for the trigger. Sins change people. Sin begets sin. Oh, but I... I still want to believe! I want to believe in the hearts that feel sin.

ALTERNATIVE

This originally aired at the end of Episode Twenty-One.

Self-protection. The means of protecting oneself. People expose their weaknesses, and thus form a group. Before they know it, they begin to exclude outsiders. But what becomes of those who have been excluded? I smiled at the children who lived in a tight group in their rickety house. Let's live today. Let's live tomorrow. And let's live the day after that... even if it means living in eternal pain.

LIVE THROUGH

This originally aired at the end of Episode Twenty-Four.

I was dreaming, Rem. Everything was so horribly dry there, on that planet... even people's hearts. As I watched the people who lived there from far away... I kept wondering why they went on living. Rem... Listen to me, Rem... I went wrong! I went wrong! What should I do?

REM SAVEREM

This originally aired at the end of Episode Sixteen. The voice belongs to a young Vash.

Rem told me that someone she loved died on Earth. She told me she boarded this ship to start over. What does it feel like to have someone you love die? I thought of what it would be like if Rem died. When I did, hot water came out of my eyes. It wouldn't stop. Rem, I'll be there for you! I won't leave you alone.

FLYING SHIP

This originally aired at the end of Episode Nineteen.

In times of hardship, in times of sadness... this is a place the traveller can let his mind return to. Home. I still don't know what kind of a past the traveller abandoned... when he left his home behind. I still don't know what kind of a sorrow he bears. But the traveller can keep walking forward... because he has something which sustains him, a place which accepts him. He can walk forward, step by careful step.

PARADISE

This originally aired at the end of Episode Twenty-Two.

To realize a mistake. To not lie. To love one another. To not kill. Those are very simple things, but the times won't allow for them. There is no green on this planet, even though we want it... though we want it so badly. A place where we can live peaceful days, with no wars nor stealing... a sacred place where people can live as people. Yes, there. That place is called...

UNDER THE SKY SO BLUE

This originally aired at the end of Episode Twenty-five.

One day, 130 years ago, you and I were born. There were nothing but peaceful days, and Rem was always close behind us. But our disagreeing thoughts changed our ways of life. I don't regret it. I will vow once again... not to kill, not to betray... to find happiness, to talk about my dreams... because the ticket to the future is always unwritten.

<http://www.pioneeranimation.com>



▲ Trigun DVD Volume 1 Trigun DVD Volume 3 ▼



▲ Trigun DVD Volume 2 Trigun DVD Volume 4 ▼





▲ Trigon DVD Volume 5 Trigon DVD Volume 7 ▼



▲ Trigon DVD Volume 6 Trigon DVD Volume 8 ▼

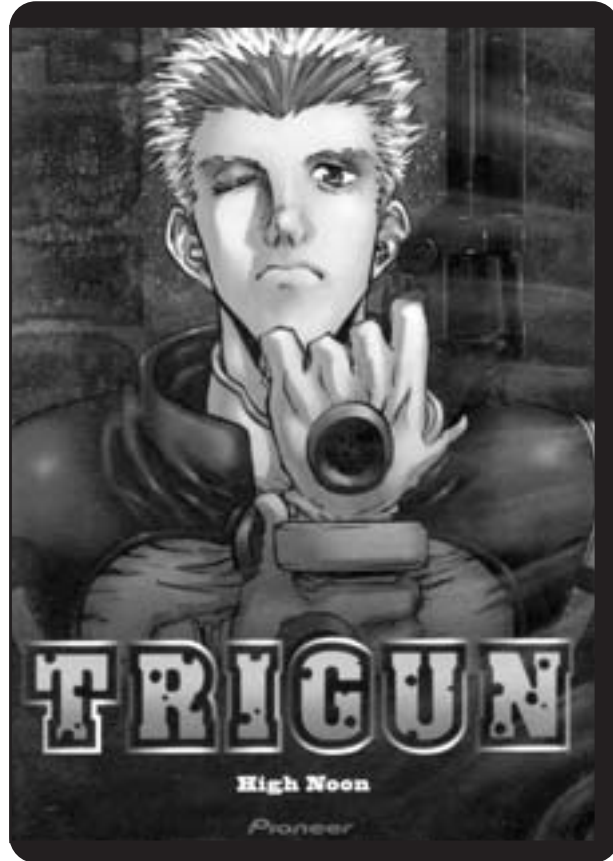

A

Augusta City 136

B

Bad Lads Gang 140
 Bad Lads Gunship 172
 Beings who Exist Outside of Time, The 173
 Bernadelli Insurance Society 144
 BESM d20 for a Trigun Campaign, Using 145
 Brad 130
 Brilliant Dynamites Neon 115
 Brilliant Dynamites Neon 164

C

Caine the Longshot 129
 Caine the Longshot 170
 Carcasses 136
 Cat, That Darn 50
 Chapel the Evergreen 125
 Chapel the Evergreen 169
 Cities 133
 Cliff Schezar 126
 Closing Song 116
 Credits, Ending 146
 Credits, Opening 3
 Cybernetics 42
 Cybertechnology 147

D

Dankin Town 133
 December 133
 December City 137
 Demislad 133
 Demislad Geyser Field 173
 Descartes 112
 Descartes 160
 Doctor 130
 Dominique the Cyclops 128

E

E.G. Mine 128
 E.G. Mine's Spike Shooters 172
 Elizabeth 127
 Ending Credits 146
 Endoro Precipice 173
 Episode 01: The \$60,000,000,000 Man 5
 Episode 02: Truth of Mistake 8
 Episode 03: Peace Maker 13
 Episode 04: Love & Peace 16
 Episode 05: Hard Puncher 19
 Episode 06: Lost July 24
 Episode 07: B.D.N. 27
 Episode 08: And Between The Wasteland and Sky... 30
 Episode 09: Murder Machine 35

Episode 10: Quick Draw 38
 Episode 11: Escape From Pain 43
 Episode 12: Diablo 46
 Episode 13: Cash the Stampede 51
 Episode 14: Little Arcadia 55
 Episode 15: Demons Eye 58
 Episode 16: Fifth Moon 53
 Episode 17: Rem Severem 66
 Episode 18: Goodbye For Now 69
 Episode 19: Hang Fire 72
 Episode 20: Flying Ship 75
 Episode 21: Out of Time 78
 Episode 22: Alternative 83
 Episode 23: Paradise 86
 Episode 24: Sin 91
 Episode 25: Live Through 94
 Episode 26: Under the Sky So Blue 97
 Episode Prvies 184
 Episode Summaries 4

F

Feds 140
 Felnarl Town 133
 Firearms 12
 Floating City, The 138
 Fondrique 133
 Frank Marlon 113
 Frank Marlon 161
 Fris Families, The Polo and 141

G

Gofsef Nebraska 162
 Grandma Sheryl 129
 Grey the Ninelives 128
 Grey the Ninelives 171
 "Grim Reaper" Bostalk 127
 Gung-Ho Guns 142

H

History 131
 Hoppered the Gauntlet 124
 Hoppered the Gauntlet 169

I

Important Organizations 140
 Inepriil City 134
 Ingway 127
 Introduction 2

J

Jenora Rock 136
 Jessica 130
 Julius and Moore 130
 July City 134
 July City 136

K

Kaite	118
Karsted City	136
Keybos	137

L

Legato Bluesummers	110
Legato Bluesummers	158
Leonof the Puppetmaster	123
Leonof the Puppetmaster	168
Leonof's Puppets	174
Lewiston Town	134
Lina	129
Little Jersey	137
Lost Technology	81
LR Town	137
Luttonberg Canyon	173

M

Marianne	126
Marilyn Nebraska and Friends	120
Marius-Breskem-Kentacle Technical Industrial Union	140
Max Simon	130
May City	134
Meryl Stryfe	102
Meryl Stryfe	150
Midvalley the Hornfreak	121
Midvalley the Hornfreak	166
Millions Knives	108
Millions Knives	156
Milly Thompson	104
Milly Thompson	152
Modes of Transportation	174
Monev the Gale	119
Monev the Gale	165
Multi-barrel Pop-up Gun	172

N

Nebraska Family, The	114
New Oregon	137
Nicholas D. Wolfwood	106
Nicholas D. Wolfwood	154

O

Opening Credits	3
Organizations, Important	140
Orleans	134

P

Planet, The	61
Polo and Fris Families, The	141
Production Plants	132
Production Plants	138

Professor Nebraska	163
Project SEEDS	144
Promontory	136

R

Rai Dei the Blade	122
Rai Dei the Blade	167
Rem Saverem	129
Revolving Rifle	172
Ruth Loose	126

S

Sand Steamer Flourish	172
SEEDS, Project	144
Side-Mounted Miniguns	172
Song, Closing	116
Stan	127
Stefany	126

T

Technology	132
Technology, Lost	81
That Darn Cat	50
Tonim Town	137
Trigun Campaign, Using BESM d20 for a	145
Trigun d20 and Role-Playing	145
Trigun Reference Websites	145

U

Unnamed Town #1	135
Unnamed Town #2	135
Unnamed Town #3	135
Using BESM d20 for a Trigun Campaign	145

V

Vash the Stampede	100
Vash the Stampede	148

W

Warrens City	135
Websites, Trigun Reference	145
Wild West	139
Wolfwood, Nicholas D.	106
Wolfwood's Motorcycle	172
World of Trigun, The	131

Z

Zazie the Beast	128
-----------------	-----

OPEN GAME LICENSE Version 1.0a

The following text is the property of Wizards of the Coast, Inc. and is Copyright 2000 Wizards of the Coast, Inc ("Wizards"). All Rights Reserved.

1. **Definitions:** (a) "Contributors" means the copyright and/or trademark owners who have contributed Open Game Content; (b) "Derivative Material" means copyrighted material including derivative works and translations (including into other computer languages), potation, modification, correction, addition, extension, upgrade, improvement, compilation, abridgment or other form in which an existing work may be recast, transformed or adapted; (c) "Distribute" means to reproduce, license, rent, lease, sell, broadcast, publicly display, transmit or otherwise distribute; (d) "Open Game Content" means the game mechanic and includes the methods, procedures, processes and routines to the extent such content does not embody the Product Identity and is an enhancement over the prior art and any additional content clearly identified as Open Game Content by the Contributor, and means any work covered by this License, including translations and derivative works under copyright law, but specifically excludes Product Identity. (e) "Product Identity" means product and product line names, logos and identifying marks including trade dress; artifacts; creatures characters; stories, storylines, plots, thematic elements, dialogue, incidents, language, artwork, symbols, designs, depictions, likenesses, formats, poses, concepts, themes and graphic, photographic and other visual or audio representations; names and descriptions of characters, spells, enchantments, personalities, teams, personas, likenesses and special abilities; places, locations, environments, creatures, equipment, magical or supernatural abilities or effects, logos, symbols, or graphic designs; and any other trademark or registered trademark clearly identified as Product identity by the owner of the Product Identity, and which specifically excludes the Open Game Content; (f) "Trademark" means the logos, names, mark, sign, motto, designs that are used by a Contributor to identify itself or its products or the associated products contributed to the Open Game License by the Contributor (g) "Use", "Used" or "Using" means to use, Distribute, copy, edit, format, modify, translate and otherwise create Derivative Material of Open Game Content. (h) "You" or "Your" means the licensee in terms of this agreement.

2. **The License:** This License applies to any Open Game Content that contains a notice indicating that the Open Game Content may only be Used under and in terms of this License. You must affix such a notice to any Open Game Content that you Use. No terms may be added to or subtracted from this License except as described by the License itself. No other terms or conditions may be applied to any Open Game Content distributed using this License.

3. **Offer and Acceptance:** By Using the Open Game Content You indicate Your acceptance of the terms of this License.

4. **Grant and Consideration:** In consideration for agreeing to use this License, the Contributors grant You a perpetual, worldwide, royalty-free, non-exclusive license with the exact terms of this License to Use, the Open Game Content.

5. **Representation of Authority to Contribute:** If You are contributing original material as Open Game Content, You represent that Your Contributions are Your original creation and/or You have sufficient rights to grant the rights conveyed by this License.

6. **Notice of License Copyright:** You must update the COPYRIGHT NOTICE portion of this License to include the exact text of the COPYRIGHT NOTICE of any Open Game Content You are copying, modifying or distributing, and You must add the title, the copyright date, and the copyright holder's name to the COPYRIGHT NOTICE of any original Open Game Content you Distribute.

7. **Use of Product Identity:** You agree not to Use any Product Identity, including as an indication as to compatibility, except as expressly licensed in another, independent Agreement with the owner of each element of that Product Identity. You agree not to indicate compatibility or co-adaptability with any Trademark or Registered Trademark in conjunction with a work containing Open Game Content except as expressly licensed in

another, independent Agreement with the owner of such Trademark or Registered Trademark. The use of any Product Identity in Open Game Content does not constitute a challenge to the ownership of that Product Identity. The owner of any Product Identity used in Open Game Content shall retain all rights, title and interest in and to that Product Identity.

8. **Identification:** If you distribute Open Game Content You must clearly indicate which portions of the work that you are distributing are Open Game Content.

9. **Updating the License:** Wizards or its designated Agents may publish updated versions of this License. You may use any authorized version of this License to copy, modify and distribute any Open Game Content originally distributed under any version of this License.

10. **Copy of this License:** You MUST include a copy of this License with every copy of the Open Game Content You Distribute.

11. **Use of Contributor Credits:** You may not market or advertise the Open Game Content using the name of any Contributor unless You have written permission from the Contributor to do so.

12. **Inability to Comply:** If it is impossible for You to comply with any of the terms of this License with respect to some or all of the Open Game Content due to statute, judicial order, or governmental regulation then You may not Use any Open Game Material so affected.

13. **Termination:** This License will terminate automatically if You fail to comply with all terms herein and fail to cure such breach within 30 days of becoming aware of the breach. All sublicenses shall survive the termination of this License.

14. **Reformation:** If any provision of this License is held to be unenforceable, such provision shall be reformed only to the extent necessary to make it enforceable.

15. COPYRIGHT NOTICE

Open Game License v 1.0a Copyright 2000, Wizards of the Coast, Inc.

System Rules Document Copyright 2000, Wizards of the Coast, Inc.; Authors Jonathan Tweet, Monte Cook, Skip Williams, based on original material by E. Gary Gygax and Dave Arneson.

Modern System Reference Document Copyright 2002, Wizards of the Coast, Inc.; Authors Bill Slavicek, Jeff Grubb, Rich Redman, Charles Ryan, based on material by Jonathan Tweet, Monte Cook, Skip Williams, Richard Baker, Peter Adkison, Bruce R. Cordell, John Tynes, Andy Collins, and JD Wiker.

d20 Character Folio Copyright 2002, Green Ronin; Authors Jeff Mackintosh, Chris Pramas
Silver Age Sentinels d20 Copyright 2002, Guardians of Order, Inc.; Authors Stephen Kenson, Mark C. MacKinnon, Jeff Mackintosh, Jesse Scoble.

BESM d20 Copyright 2003, Guardians of Order, Inc.; Author Mark C. MacKinnon.

Trigun d20 Copyright 2004, Guardians of Order, Inc.; Author Michelle Lyons, Matt Keeley

Designation of Product Identity

The following is designated as Product Identity, in accordance with Section 1(e) of the Open Game License, Version 1.0a: All Guardians Of Order names, logos, identifying marks, and trade dress; all character, creation, vehicle, spell, and place names; all examples, all artwork, symbols, designs, depictions, illustrations, likenesses, poses, and graphic design; all stories, storylines, plots, thematic elements, designer notes, episode titles, and dialogue.

Designation of Open Game Content

Subject to the Product Identity designation above, the remainder of this publication is designated as Open Game Content.

d20 mecha



The d20 System Mecha Handbook

Centauri Knights



The ultimate d20 science fiction setting
Written by David L. Pulver

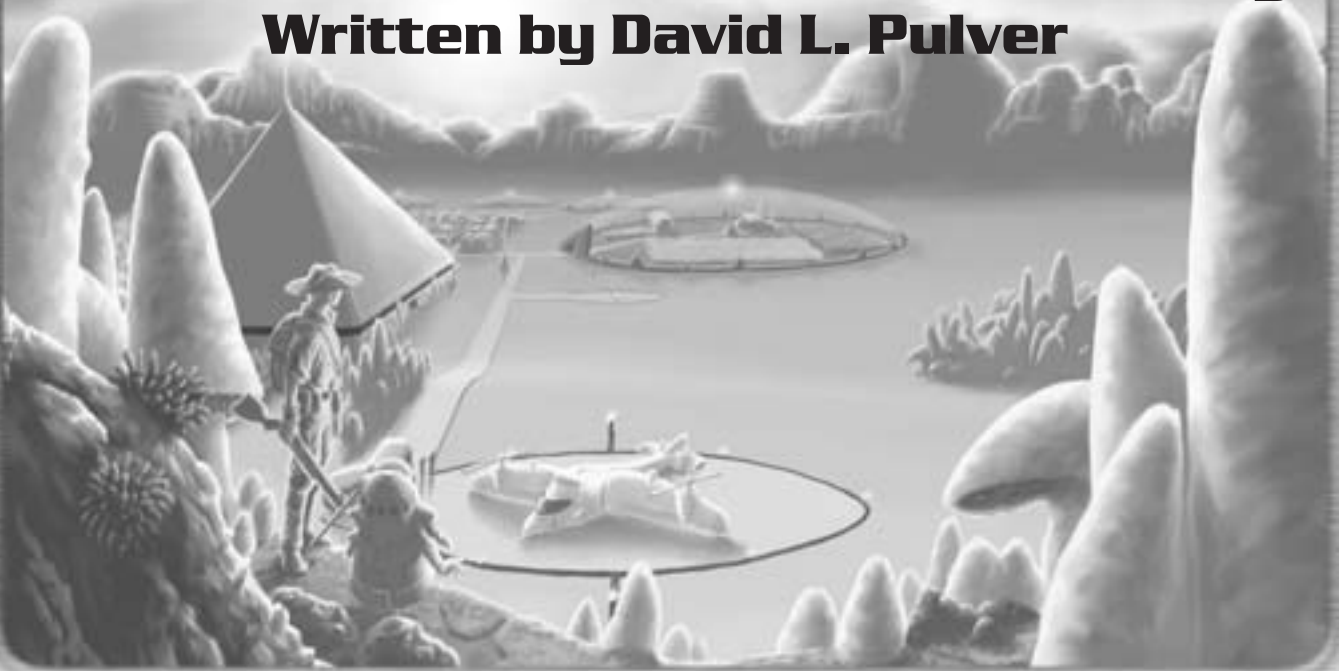

In Stores Now!

Cencor Datapad MX

MX - D112 - A132