

**FOR THE BATTLESTAR GALACTICA RPG**

# COLONIAL WARBOOK

**REVISED 2010**

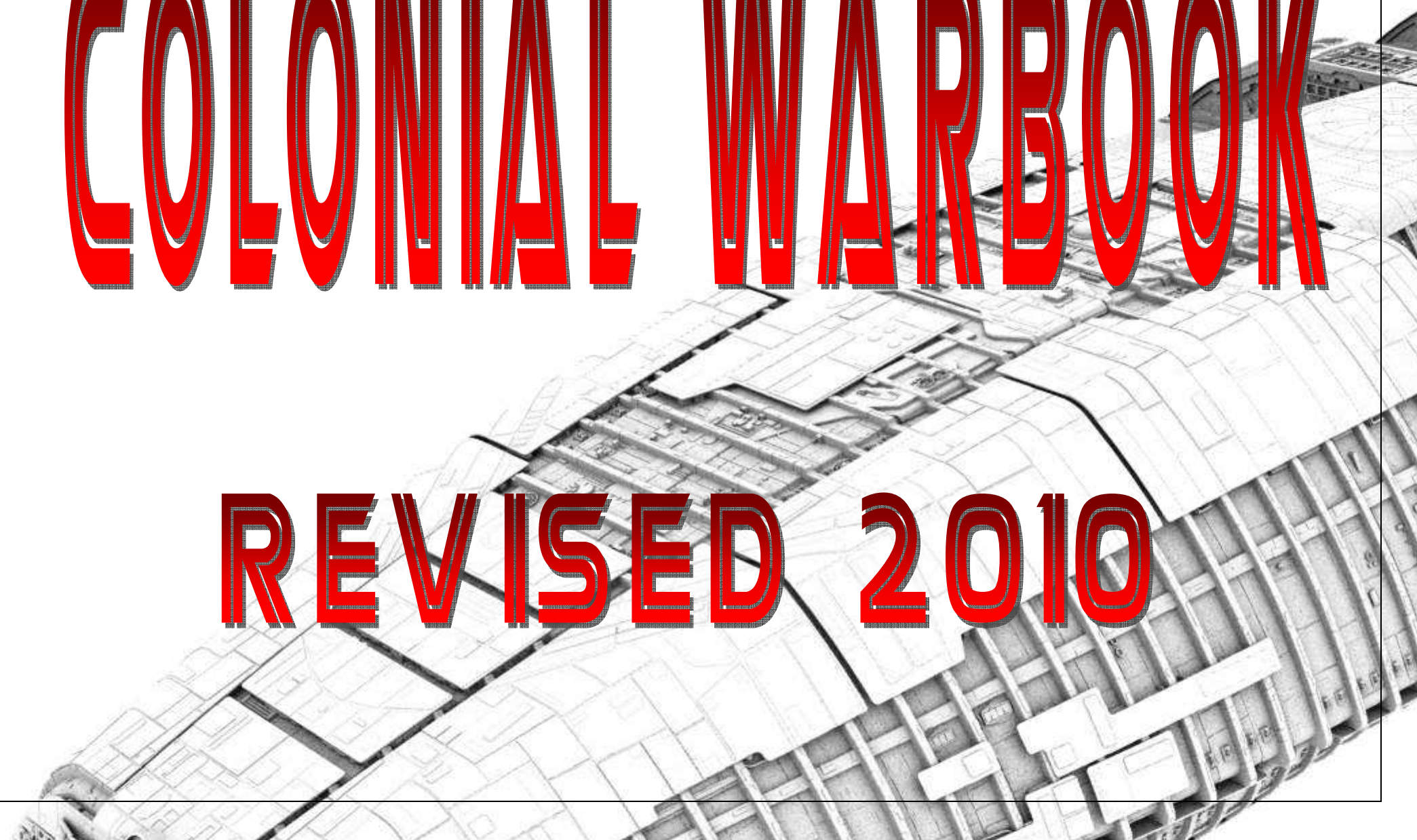

This revised and updated volume represents fanfic ships that were posted to the CortexSystemRPG.org forums as completed vessels up until April 2010. In addition it adds in certain ships that I have seen posted on a few different websites – and for which I have provided the stats.

You'll notice that it has a lot more in the way of 'fluff' text. Although some of this came from the various designers, in many cases it has come from me. This is a fan based role-playing supplement and, as such, you can ignore, or use, as much of the fluff text as you choose. It should be noted that as the BSG universe is still expanding, some of that text may not agree with things that may come later, or have already been along and I've missed them.

Where-ever possible credit is given to both the artist of each design and the person who has designed the statistics for use in the Battlestar Galactica Role Playing Game. In some cases the artist is not known. In such cases if you do know who it is, please let me know so I can credit them correctly.

I am not the creator of most of the ships that are listed here. If you use the designs listed please give credit where it is due – to the artist and designer noted for each design. Only those ships designed by myself – Limerickcot – are my own property.

### The Legal Stuff:

Battlestar Galactica Role Playing Game, and the Cortex System are property of Margaret Weis Productions. This is a fan created document and is not to be sold. It may be freely distributed, assuming it is not modified. This product requires the Serenity Role Playing Game, Battlestar Galactica Role Playing Game, or Cortex System Role Playing Game to use. Content is the intellectual property of specific creators. In layman's terms, don't sell our stuff, and don't claim it was your creation.

### Thanks:

The first big thank you goes to **Floyd Wessel**, the man who runs CortexSystemRPG.org, and ran its predecessor, 'Waves in the Black'. Admins never get their due. They are expected to keep everything running smooth, make minor miracles happen, and keep temperamental patrons calm. Floyd, we owe you a debt. [and yes, I know I'm copying the words of Lynn LeFey from an earlier work, but what the heck – its well deserved!]

Also, and especially in regard to the Battlestar Galactica part of CortexSystemRPG.org, I would like to say a big thank you to Buscadero – the moderator who seems to know all the answers and finds them every time we need them. Without his tireless efforts, many of the traditional vessels we see here would still be un-statted.

Thanks is also given to **Margaret Weis Productions**, Jamie Chambers and the crew, makers of the Serenity Role Playing Game, as well as Battlestar Galactica, Demon Hunters, Supernatural, and the Cortex System.

Finally thanks has to be given to all who have contributed their time and efforts to the boards – everyone one and all.

I'd also like to give a distinct thanks to speshul and especially Silveressa, who have previewed this work and helped spot a number of errors, the correction of which will make your reading more pleasurable.

I do hope you enjoy this revised work.

Kendal 'Limerickcot' Leask  
10th July 2010

**1<sup>st</sup> Edition – 2009**

**2<sup>nd</sup> Edition - 2010**

**Colonial Military****Small Craft**

Viper Probe	6
Viper, Mark I	7
Viper Mark IA	8
Recon Viper One/two	9
Viper Mark II	10
Viper Mark III	11
Viper Mark IV	12
Viper Mark V	13
Viper Mark VI	14
Viper Mark VII	15
Viper Mark VII Interceptor	16
Viper Mark VIII	17
Scorpion/Starhound	18
Starfighter Mk II	19
Starfighter Mk V	20
Cobra	21
Python Mark I	22
Python Mark II	23
Python Mark III	24
Stealth Star Recon Fighter	25
Micro-shuttle	26
Colonial Shuttle	27
FTL Shuttle ZIS	28
SS19/SS21	
FTL Heavy Shuttles	29
FTL Heavy Shuttles	30
Dropship DR series	31
Dropboat – Kamar	32
Gunboat – Tamar	33
Raptor	34
Raptor, Armed Variant	35
Raptor Mk II (Spooky)	36
Raptor, Heavy Cargo	37
Landing Ship Tank – 111	38

Landing Ship Tank – 119	39
Griffon X7	40
Coxorth Series Tanker	41

**Battlestars**

Hercules Class	43
Argus Class	45
Aesir Class	47
Aerie Class	49
Valiant Class	50
Valkryie Class	51
Valhalla	52
Atlantia	53
Mercury Class (Pegasus)	54
Minerva Class (Pleiades)	55
Morrigan (Raven)	56
Arvak	57
Minerva Class (Hyades)	58
Olympia	59
Talos	60
Warden	62

**Escortstars**

Berzerker Escort	64
Tiamat Class Escort	66
Defender Class Escort	68
Auriga Gunstar	69
Aegaeon Gunstar	70
Aegis Gunstar	71
Genesis Escort	73
Adrasteia Escort	75
Loki Gunstar	76
Janus Escort	77
Dione Gunstar	78
Oracle Gunstar	79
Gladius Escort	80
Ice-Dragon Gunstar	81
Ares Gunstar	82

Rusan Escort	83
Cygnus I & II Escorts	84
Cygnus III Escort	85
Centare Escort	86
Chiron Escort	87
Alliance Figate	88
V Class Escort	89
Norn Escort	90
Helios Escort	91
Colossus Escort	92
Furious Gunstar	93
Flower Corvette	94
Argonaut Gunstar	95
Arethusa Gunstar	96
Argiama Gunstar	97
Grieve Gunstar	98
Artisan Destroyer	99
Aymone Sloop	100
Diana Escort	101
Foster Gunstar	102
River Gunstar	103
Bay Frigate	104
Loch Frigate	105
Abdiel Mine Layer	106
Hesperus Gunstar	107
Perseus Light Cruiser	108
Tiger Gunstar	109
Strikestar	110
Scoutstar	111
Alicta Escort	112
Core Carrier	113
Theseus Gunstar	114
Seigestar	115
Hunter Escort	116
Black Swan Frigate	117
Type 700 Cutter	118
Moebius Light Escort	119
High Endurance Cutter	120

Bolo Corvette	121
Melaneus Gun Boat	122
Kayline Gunstar	123
Mentor Viper Launch Station	124
Mentor II Carrier	125
Mentor III (Carousel) Carrier	126
Artemis Gunstar	127
Fenrir Gunstar/Monitor	128

**Troopstars**

Mentor IV – Cochrane	130
Daedelus Troopstar	131
Pendragon Assault Lander	132
Topaz Light Troopstar	133
Peltast Troopstar	135
Aries Heavy Troopstar	136

**Auxilleries**

Oracle 76 ELINT	139
Vanguard	141
Berosus Fast	143
Replenishment	
Vector Heavy Transport	145
Salvor Salvage Ship	146
Medic Hospital Ship	147
Prometheus Repair Ship	148
Aldis Ammo Ship	149
Atlas Fleet Tug	150
Hestia Tanker	151
Tasia Water Tanker	152
Port Vindex Stores Vessel	153
Boreas Stores Ship	154
Alhena Cargo Ship	155
Keleos Provisions Ship	156
Perseus Fleet Maintenance Carrier	157

Cyclops Depot Ship	158
Athene transport	159
Jansen Kerr MAC	160

### Space Stations

Penny Class	162
Leon Way Station	163
Valhalla Yards	164
Babbler Armed Relay	165
Ragnar Anchorage	166
Cayuze Reserve	167
Anchorage	
Echo Station	168
Orbis Armed Relay	169
Sheil Defence Station	170
Colonial Ecology Station	171
Colonial Research Station	172
Scorpio Yards	173

### Colonial Civilian

#### Craft

Flattop	175
Colonial Movers	176
Colonial Movers – Tanker	177
Foundry Ship	178
LTS Scylla	179
Ulysses Cargo Carrier	180
Prometheus Support	181

Gideon Transport	182
Investigator Class	183
Rising Star	184
Demetrius Sewage ship	185
Tylium Refinery	186
Botanical Cruiser	187
Agro Ship	188
Grain Ship	189
Tubular Tramp Freighter	190
Ourobous Hospital Ship	191
Gemini Freighter	192
Mining Ship	194
Celestra	195
Zephyr/Spare Park	196
Delphi Deep Star Explorer	197
Bruiser Tug	198
Tylium/Aqua Queen Tanker	200
Capella	201
Io Transport	202
Gallow Bulk Transport	203
Firefly Mk3	205
Cerberus	206
Skalla-Etter	207
Firefly Mk 4	208
Scarab Rescue Craft	209
Colonial Tug	210
Castis Bulk Carrier	211

### Cylon

Raider GSI	213
Raider A/B	214
Reconnaissance Raider	215
Armoured Raider	216
Raider Mk XII	217
I Type Raider	218
Sparrow Raider	219
Turkey Heavy Raider	220
Goose ELINT Raider	221
Basestar Mk1 – Hades	222
Tartarus Gunstar	223
Cylon Advanced Basestar	224
Dreadnaught	225
Warstar Mk1	226
Warstar Mk V	227
Basestar – Biomechanical	228
Warstar Mk XII	229
Cylon Freighter-Tanker	230
Cylon Utility Ship	231
Cylon Hub	232
Resurrection Ship	233
Imperator	234
Intruder	235
Skirmisher	236
Communications Array 1	237
Communications Array 2	238
Communications Array 3	239

Scarab Probe Ship	240
Piris Gunstar	241
Chimaeia Troopstar	242
Pillager Gunstar	243
Kraken Boarding Ship	244
Rakshasha Gunstar	245
Assura Escortstar	246
Cylon Centurion 'Toaster'	247
II Series Cylon	248
Combat Centurion	249
Pilot Centurion	250

### Equipment

Colonial Landram	252
Colonial Snowram	253
Power Sled	254
Cylon Mobile Gun	255
Greystone Ultima Mk 3	256
TOS Rules	257
Turbines	262
Wrist Computron	263
Ravashol Pulsar Cannon	264
Rules	265



# *Colonial Small Craft*



6

## Viper, Probe

Brian O'Loughlin

Stats by Limerickcot

**Agi** d8, **Str** d6, **Vit** d8, **Ale** d10, **Int** d4, **Wil** d4

**LP** 10; **Init** d8+d10; **Scale** Planetcraft;

**Speed** 7 (7 in atmosphere)

**Traits** Past Its Prime (d8)

**Skills** Perception d8

### Armament

2 medium planetcraft scale skirmish range autocannons (d8);

**Armour** Wound 1, Stun 1

**Description** 29 x 15 x 22;

**Crew** 1

The Viper Probe or Scout was produced in response to a need for a long range scout ship that would extend the 'eyes' of the fleet. Standard Viper fighters can be used successfully for scout missions, but range has always been a limitation and weapons have to be removed to extend range.

The stellar Probe was created by combining a Starhound forward section with a totally redesigned dual mode propulsion section. Including a highly efficient (for the time) drive system, for long range (and low detection) use, the Probe switches to high capacity turbo thrusters for fast pass approaches. It mounts two autocannons on the thruster nacelles.

An advanced navigation system (C.O.R.A.) was fitted to the Stellar Probes but was soon realised to be very susceptible to Cylon Virus's, resulting in the loss of nearly all of these vessels. They were replaced by Raptor's early on in the Cylon conflict.

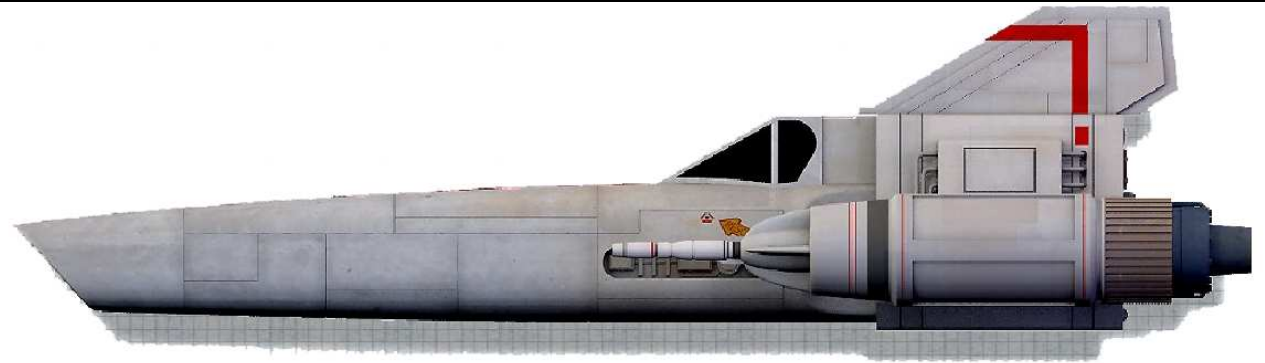

**Stellar Probe**  
by Brian O'Loughlin

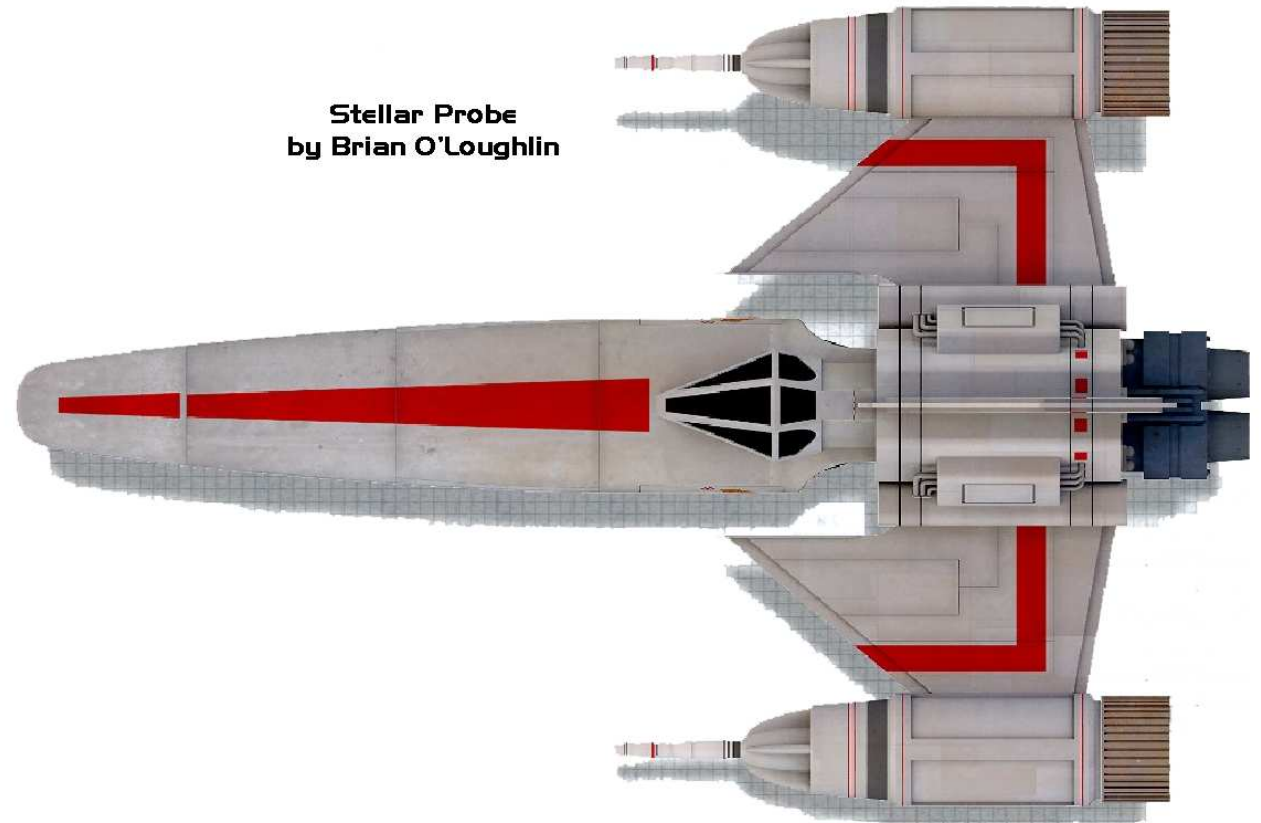

7

## Viper, Mark I

Stats by Buscadero

Picture B.J. Olejnik

**Agi** d8, **Str** d6, **Vit** d8, **Ale** d6, **Int** d4, **Wil** d4

**LP** 10; **Init** d8+d6; **Scale** Planetcraft;

**Speed** 7 (5 in atmosphere)

**Traits** Past Its Prime (d8)

**Skills** Perception d4

### Armament

2 medium planetcraft scale skirmish range autocannons (d8);

4 medium planetcraft scale skirmish range missiles (d12);

2 heavy planetcraft scale capital range missiles (d12+d4)

**Armour** Wound 2, Stun 2

**Description** 29 x 15 x 14; **Crew** 1

Various little brush wars led to Caprica developing the robotic Cylon concept, self reliant, self sustaining, and above all not producing a list of casualties that could be reported in the daily media scans. Of course Cylons were still expensive to start with but the more modern attack craft designed for them (by Caprica) were more than capable of handling the antiquated Scorpion/Starhound fighters commonly in use throughout the Star system.

The first Vipers had actually been designed sometime earlier but had never seen more than small pre-production runs. With the advent of Cylon Raiders that changed as other planets of the Colonies rushed to counter the possibility of Caprica's robotic army. The Viper was the result. More capable, a longer range, and better equipped, she was thought more than capable of dealing with the Raiders.

She was too reliant on electronics though and once her advanced electronics suite was pulled due to Cylon AI Virus's, she dropped from being

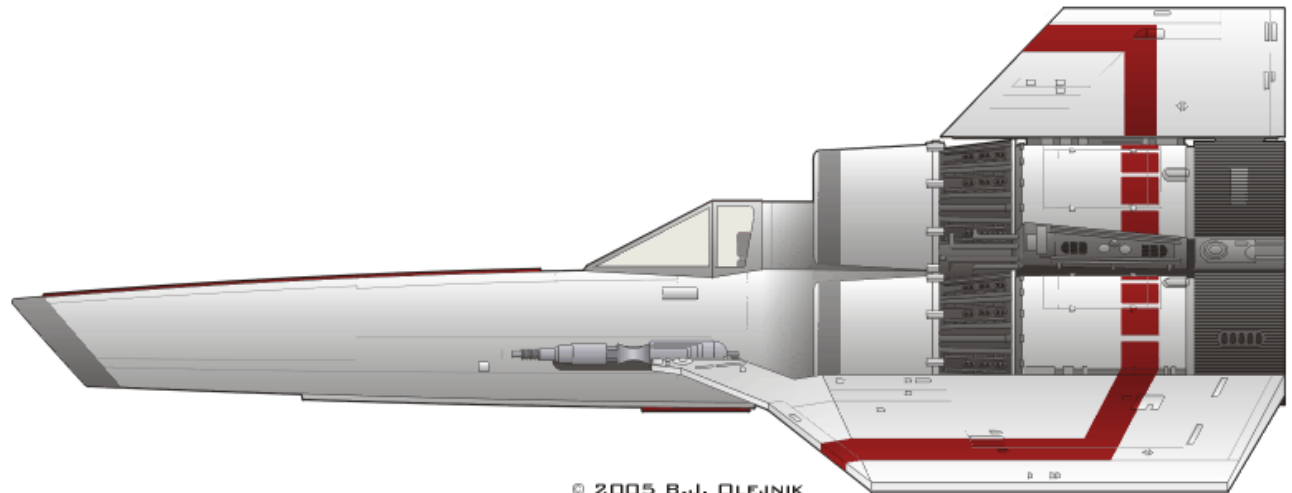
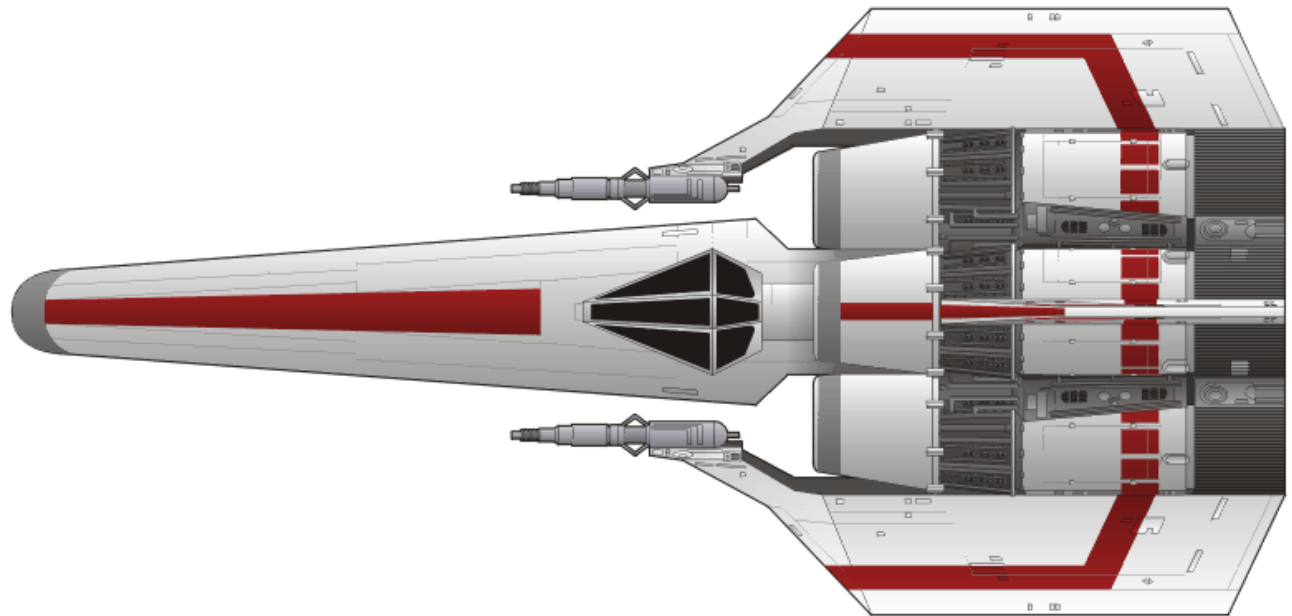

an advanced fighter to something that could just about hold her own against the Raiders. As the war progressed, Mk II Vipers were rushed to the front, replacing the Mk I. Given the nature of the war, few Mk I's made it through to the end.

8

## Viper Mark IA

Stats by Buscadero

Picture B.J. Olejnik, modified by Limerickcot

**Agi** d8, **Str** d6, **Vit** d8, **Ale** d6, **Int** d4, **Wil** d4

**LP** 10; **Init** d8+d6; **Scale** Planetcraft;

**Speed** 7 (5 in atmosphere) Gains +1 when Boosters are activated.

**Traits** Past Its Prime (d6)

**Skills** Perception d4

### Armament

2 medium planetcraft scale skirmish range autocannons (d8);

4 medium planetcraft scale skirmish range missiles (d12);

2 heavy spacecraft scale capital range missiles (d12+d4)

**Armour** Wound 2, Stun 2

**Description** 29 x 15 x 14;

**Crew** 1 to 2

The two man version of the Viper Mk I, the Ia is two man version of the standard Viper. Originally built as a trainer, it was re-designated the Ia and is capable of both atmospheric and long-range spatial flight. It is a single-to-two-pilot craft with two-forward mounted guns as standard. The Viper is capable of rapid acceleration in the form of a rapid acceleration feature, which results in greater fuel usage.

Each burst lasts up to 30 seconds and she carries enough fuel for four minutes worth of Boost. The 30 second threshold is a safety precaution – the engines heat to dangerous levels and will blow out (or up) if the safety threshold is over-ridden,

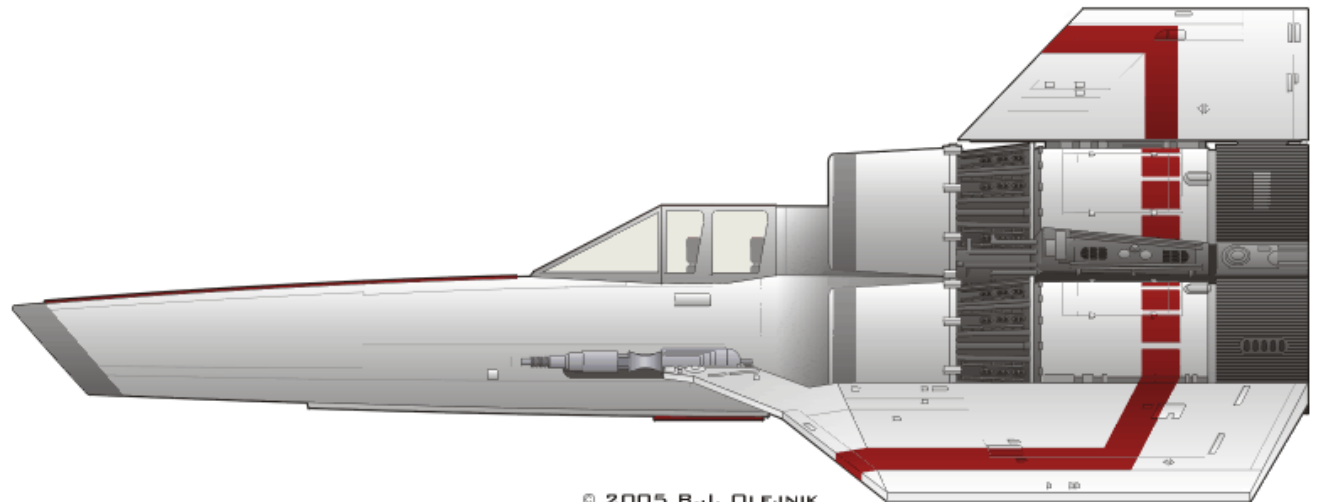
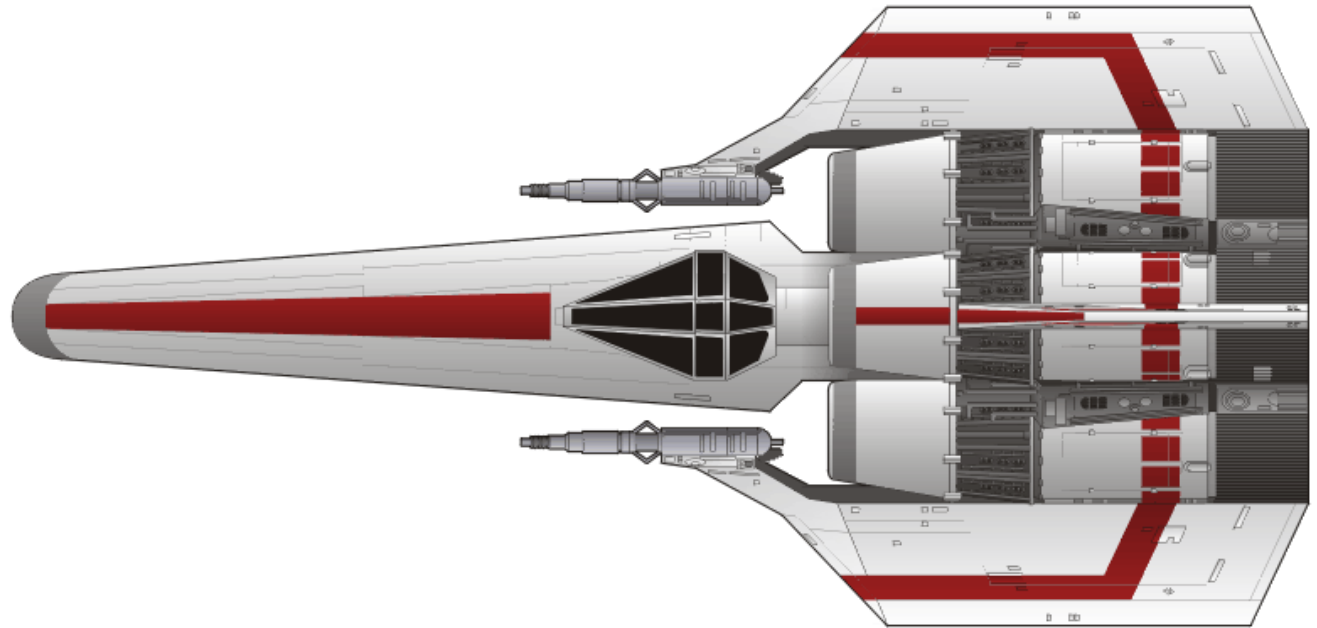

© 2005 B.J. OLEJNIK



## Recon Viper One/Two

Stats by Buscadero

### Mk I Recon

**Agi** d10, **Str** d6, **Vit** d8, **Ale** d6, **Int** d6, **Wil** d6

**LP** 12; **Init** d10+d6; **Scale** Planetcraft;

**Speed** 8 (6 in atmosphere)

**Traits** Past Its Prime (d6)

**Skills** Perception d6, Pilot d2

**Armament** None

**Armour** Wound 2, Stun 2

**Description** 29 x 16 x 6; **Crew** 1

### Mk II Recon

**Agi** d8, **Str** d6, **Vit** d8, **Ale** d6, **Int** d4, **Wil** d4

**LP** 10; **Init** d8+d6; **Scale** Planetcraft;

**Speed** 8 (6 in atmosphere)

**Traits** Past Its Prime (d6)

**Skills** Perception d6, Pilot d4

**Armament** None – replaced by 2 drones, 2 decoys and a camera

**Armour** Wound 2, Stun 2

**Description** 27.5 x 15.4 x 8.8; **Crew** 1

Before the Raptor was in use and, where a Viper Stellar Probe craft was not available, the military would produce a 'Recon Viper'. By stripping out its weaponry, the Recon Viper could achieve greater speed and manoeuvrability capabilities than a typical Viper. Early attempts utilised the advanced voice interface called CORA ("Computer, Oral Response Activated") which was designed to not only assist the pilot in flying during long patrols, but also keep him entertained. As with the stellar Probe, CORA proved to be susceptible to Cylon AI Viruses, although CORA was itself in continual development in order to try and counter the Cylon Threat. Later ships still used the CORA system but separated its scout functions from both communications and ship functions. Instead it became a 'Canary': suspect communications were relayed through it which would trip CORA's defence mechanisms, rendering any incoming transmissions harmless (but only by effectively destroying the CORA unit at the same time).

The more capable Mk II Viper proved no exception to the need for a faster recon ship, especially with the number of casualties being taken by the fleet.



Viper II  
'Recon Variant'  
B.J. Olejnik, modified by  
Limerickcot



Although many were only temporary conversions, a few had their entire ammunition bins removed and their missiles replaced by Drones, Decoys and Camera systems, plus a powerful sensor suite. These replaced the CORA electronics suite.

## Viper Mark II

Stats: RPG

Picture Unknown – Battlestar Wiki

**Agi** d10, **Str** d6, **Vit** d8, **Ale** d6, **Int** d4,  
**Wil** d4

**LP** 10; **Init** d8+d6; **Scale** Planetcraft;

**Speed** 7 (6 in atmosphere)

**Traits** Past Its Prime (d6)

**Skills** Perception d4, Pilot d4

### Armament

2 medium planetcraft scale skirmish  
range autocannons (d8);

8 medium planetcraft scale skirmish  
range missiles (d12);

**Armour** Wound 2, Stun 2

**Description** 27.5 x 15.4 x 8.8; **Crew** 1

The initial conflicts in what was to be the Cylon War soon proved that the Viper Mk I (and its older counter-parts) were to be of little long term use as technicians hurriedly attempted to provide hardwired solutions to the Cylon Networking ability. These temporary stopgaps were not enough and casualty rates were horrific.

The MK II was already finalising development at the start of the war but was sent back to have its controls totally redesigned with analogue gauges and controls. The Mark II was intended to be flown entirely without computer assistance in fear of compromise by an electronic attack. Nevertheless, a simple computer to manage the flight systems is present in the cockpit, as is a limited range DRADIS and fire-control. Some gauges, such as the altimeter, are used only in atmospheric flight.

In order to provide a simpler, easier craft, that could be easily produced, the new Colonial Administration deleted the requirement for the Viper to carry 'Base Buster' missiles that the Mk I had had. This made the Mk II smaller and lighter and, again, required less electronics. In addition was the fact that many Mk I's had been destroyed in attempts to get within the range of their



missiles, which had been seriously degraded by the Cylons electronic defence.

The Colonials final answer to this was, in the short run, the production of the Python Bomber and, in the long run, the production of Battlestars capable of dealing with the Cylon Base-stars.



**Viper Mark III**

Stats by Limerickcot

Picture B.J. Olejnik,

**Agi** d8, **Str** d6, **Vit** d8, **Ale** d6, **Int** d8, **Wil** d6**LP** 10; **Init** d8+d6; **Scale** Planetcraft;**Speed** 8 (8 in atmosphere)**Traits** Past Its Prime (d6)**Skills** Perception d6; Pilot d6**Armament**

3 medium planetcraft scale skirmish range autocannons (d8);

8 medium planetcraft scale skirmish range missiles (d12);

2 heavy spacecraft scale capital range missiles (d12+d4)

**Armour** Wound 3, Stun 3**Description** 28 x 14.5 x 16; **Crew** 1

It had already become clear early on in the war that the MK II, although a well designed and capable fighter was good enough to deal with the number of Cylon Raiders coming against them. The luxury of producing multiple prototypes was not available to Colonies struggling to hold back the Cylon masses deployed against them, and so most attempts to build a better fighter rested on making an evolutionary break-through around existing frames.

The Mark III was the most successful of those designs. Having more powerful engines and, addressing Pilots complaints about the lack of close-in weaponry, a third autocannon was fitted to the top of the tail-plane. Better, Cylon proofed, electronics would give pilots, especially those being hastily trained and thrown into the grinder, an extra edge to keep them alive. In addition, new, lighter armour development, allowed them to provide more protection to the pilot. Its major drawback was that it wasn't as agile as the Mk II, but its atmospheric speed was believed to make up for that drawback.

The Mk III saw its début at the end of the Cylon War, defending the aero plants of Colonial Aerospace Industries over Picon and Virgon. Full Production was achieved on some lines but it never over-took the Mk II before the end of the war. However, the Mk III did make enough of a contribution to see it's wide-scale deployment after the war but it was never to fully overtake the Mk II in deployment. Mk III's are still found in Planetary Defence Forces, retrofitted to more modern standards.

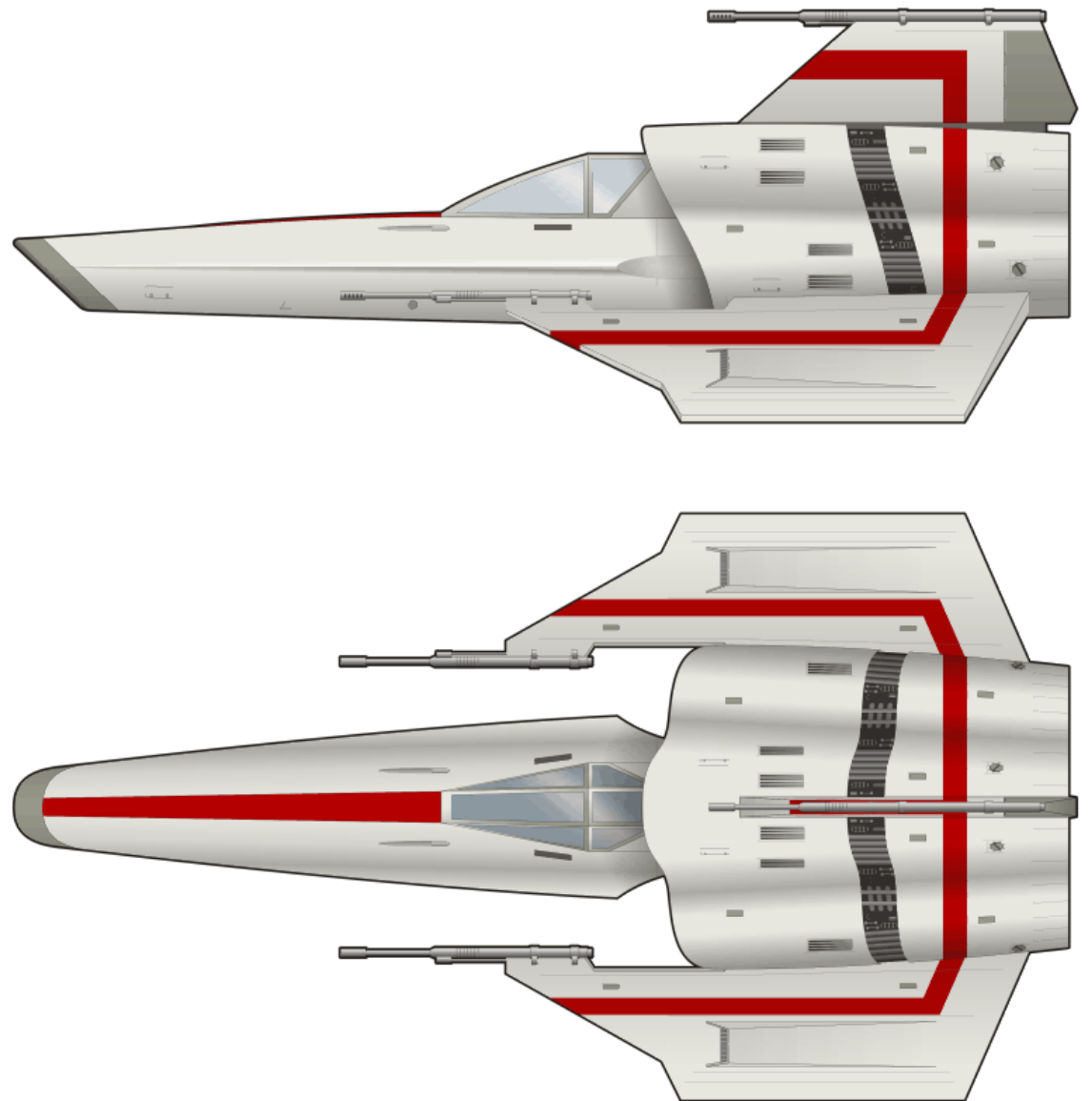

## Viper Mark IV

Stats by Limerickcot

Picture B.J. Olejnik,

**Agi** d10 [8 in atmosphere], **Str** d6, **Vit** d8, **Ale** d6, **Int** d4, **Wil** d4

**LP** 10; **Init** d8+d6; **Scale** Planetcraft;

**Speed** 8 (6 in atmosphere).

**Traits** Past Its Prime (d6)

**Skills** Perception d4

### Armament

3 medium planetcraft scale skirmish range autocannons (d8);

2 heavy planetcraft scale skirmish range autocannons (d10);

*MKIVa2*: adds four Medium range planetcraft missiles (d6)

**Armour** Wound 3, Stun 3

**Description** 26.5 x 15.4 x 9.25

Post War analysis of Viper combats indicated that many Viper missiles were incapable of maintaining their targeting solutions in the face of Cylon processing power. A detailed study, based on standard practice from WEO's on board the early Raptors, indicated that most of the Viper missiles were being jammed.

The brief furore that this created was brought to its head just as specifications for a new mark of Viper was being placed on the board. They would produce an all-gun Viper, the Mk IV. To save on costs they would utilise many aspects of the Mk II, married to some of the improvements from the Mk III.

Carrying five cannon, the Mk IV is a formidable opponent and most of the flight and combat tests seemed to prove that an all gun approach was the way forward. It had an electronics suite that could jam any known Colonial or Cylon missile within a 20 second time-span.

Production was rushed through and, although she flies like a brick in the atmosphere, in space she was considered comparable to her predecessors. This may have spelt the way forward for the Colonial Military if it had not been for a breakthrough in the electronics sector that provided a new 'firewall' capability in their missile systems (many would say the industry was driven by economic necessity if they were not to see their market disappear for military contracts). Equipped with the new missiles Mk III's were able to stay out of

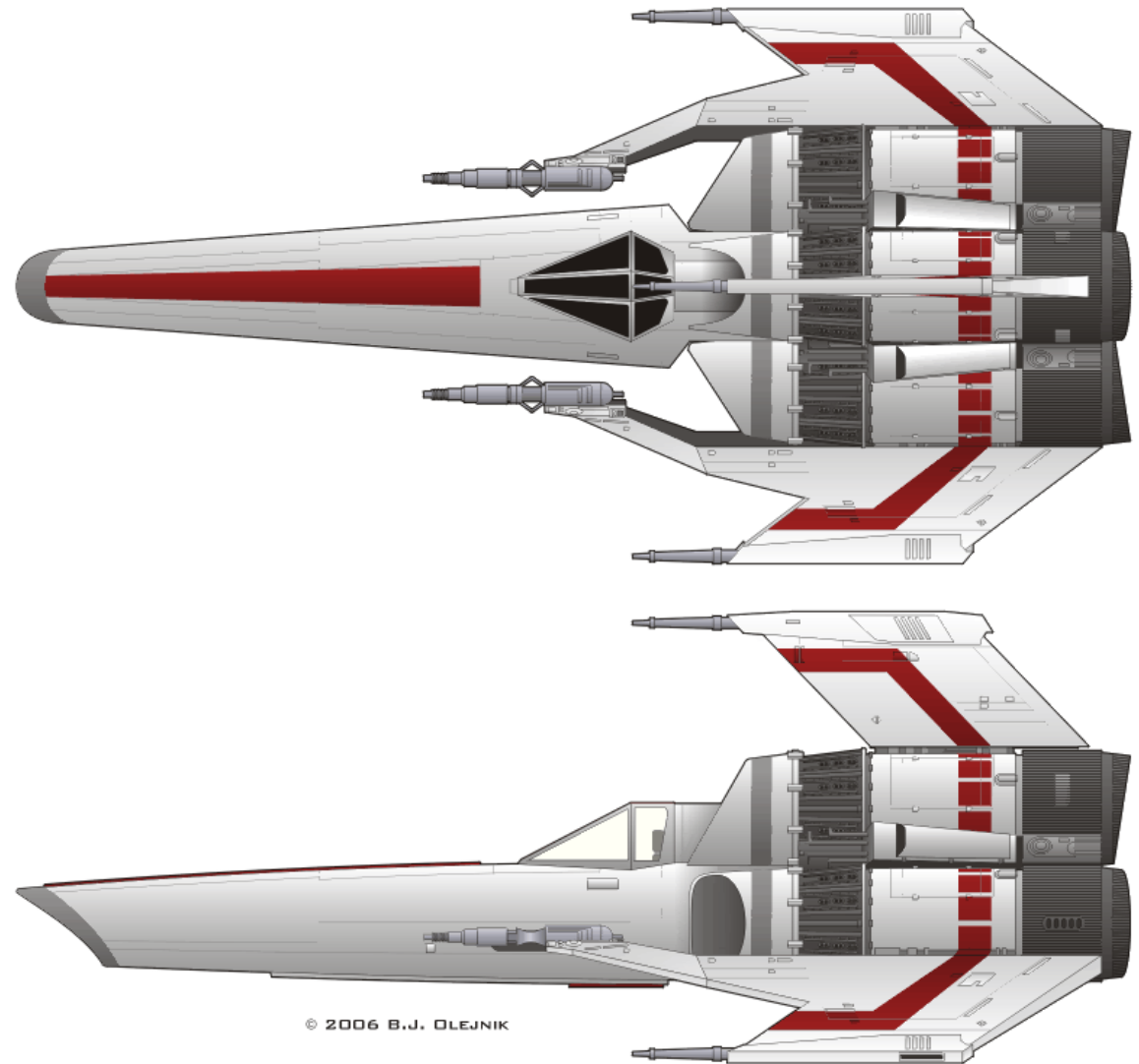

the range of the Mk IV's and hit them with missiles. Mk IV's were re-equipped with external missile stores to give them parity but at the cost of range and in the end, the production run was terminated early. This is one of the reasons why Mk II's are still so prevalent in the Colonial System, as they once again took up the slack.

## Viper Mark V

Stats by Limerickcot

Picture: Limerickcot, based on designs by B.J. Olejnik,

**Agi** d10,[d12 in Atmosphere] **Str** d6, **Vit** d6, **Ale** d8, **Int** d6, **Wil** d6

**LP** 12; **Init** d10+d8; **Scale** Planetcraft;

**Speed** 7 (7 in atmosphere) Gains +1 when Boosters are activated.

**Traits** Tough (d2)

**Skills** Perception d6, Pilot d4

### Armament

2 medium planetcraft scale skirmish range autocannons (d8);

20 medium planetcraft scale skirmish range missiles (d6);

**Armour** Wound 4, Stun 2

**Description** 26 x 14 x 19.5; **Crew** 1

The 'missile scandal' which relegated the Mk IV into the reserves resulted in a search for a vessel that was not only capable, but that was also cheap as budgetary cuts were beginning to impact onto the Colonial Military. There was also a perception that computers were not the danger that they had once been. In fact the missile firewalls that had seen the Mk IV relegated were now used to better effect to design fully networked computers for a Viper.

The new model was also designed to function equally well in atmosphere as in space. She achieves this by streamlining and better internal systems balancing.

The Mk V has the ability to boost its speed by use of special boosters similar to those found on the Mk Ia, but in the Mk V's case these are limited to boosts of only 10 seconds at a time. Good enough to get out of harms way but not overtax the engines.

Although the Mk V does carry missiles, they are of smaller capability than those used by earlier models (causing some problems in ordnance stores) but she carries more of them. She can be fitted for external missiles but doing this results in atmospheric instabilities that her flight system was not designed for.

The Mk V saw the first use of the triple boost Voram engines and if the Mk V has a flaw, it lies in the difficulty in accessing and repairing those engines. Although not a major factor for the lifetime of the model (9 years in front line operational service), the extra maintenance time caused it be hated by the deck crews who worked on her.

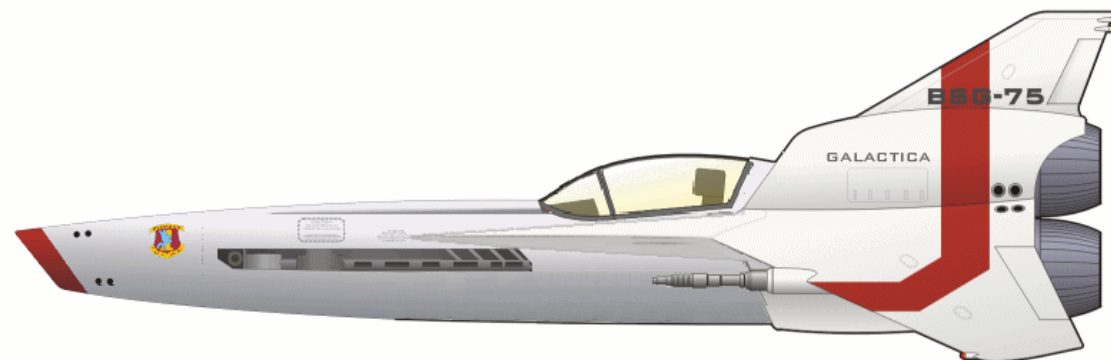

**Viper Mk V**  
Limerickcot  
Modified from designs by  
B.J. Olejnik

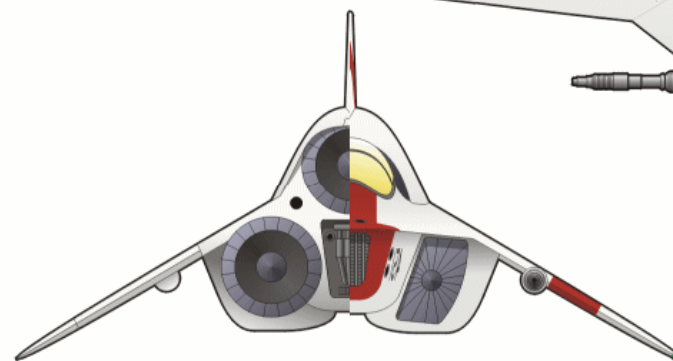
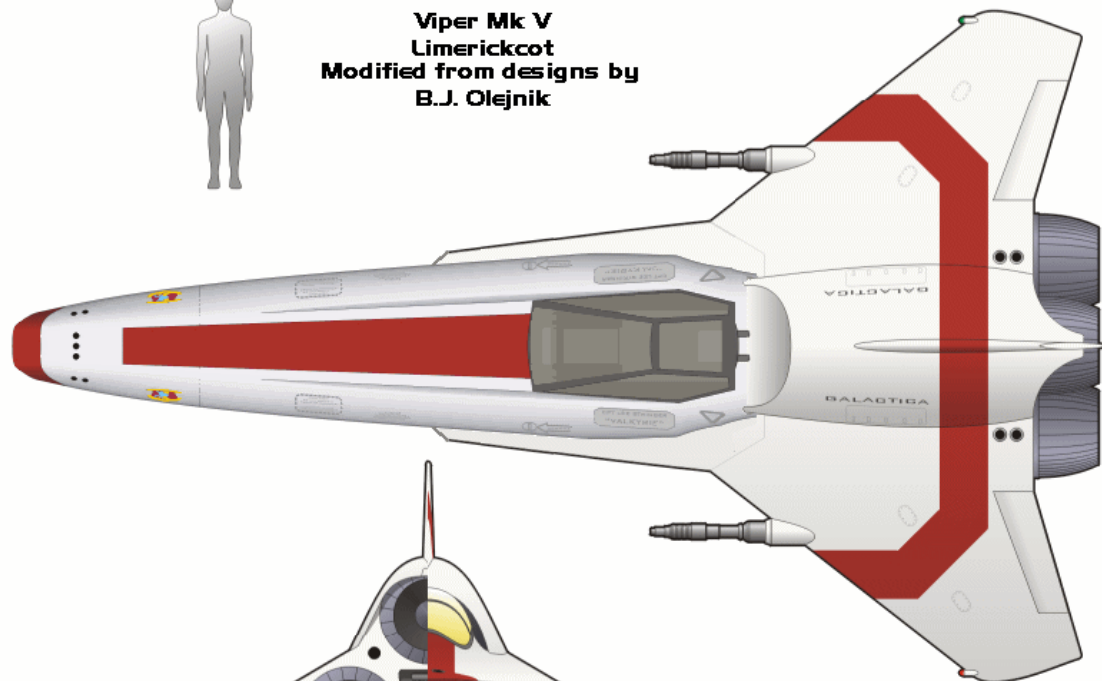

14

## Viper Mark VI

Stats by Limerickcot

Picture by Ice Dragon

**Agi** d10,[d12 in Atmosphere] **Str** d6, **Vit** d8, **Ale** d8, **Int** d6, **Wil** d6

**LP** 12; **Init** d10+d8; **Scale** Planetcraft;

**Speed** 8.(8 in atmosphere).

**Traits** Tough (d2)

**Skills** Perception d6, Pilot d4

### Armament

4 medium planetcraft scale skirmish range autocannons (d6);

20 medium planetcraft scale skirmish range missiles (d6);

**Armour** Wound 4, Stun 3

**Description** 24 x 14 x 19.5; **Crew** 1

Set against a background of increasing militancy, the MK V was supposed to be the way forward. The Mk VI Viper was a development of the successful MK V. Again concentrating on atmospheric fighting, the CDF sought to upgrade both the fighting ability of the Mk V as well as its performance. Newer Voram engines were installed, but this time in a modular package that allows for easy maintenance and replacement in combat. Despite being smaller, the Mk VI is heavier than the Mk V, due in part to the newer engines and also the additional two guns carried by the fighter, even those these are lighter than the ones carried on the Mk V. This was due, not to the ideas of fighting future Cylon threats, but rather to an increase upsurge of separatism. The demand was a fighter capable of strafing ground targets for longer. So a lighter gun system, with more ammunition was deemed the solution to this requirement of the planners.

This saw the Mk VI being favoured by Marine forces, but the Navy were more sceptical and so the Mk VI a3 replaces the four lighter autocannon with two older models (taken from the Mk IV) for ship to ship actions.

Overall, the MK VI is a good steady fighter, better than the MK V and very popular with both pilots and deck crews for both ease of handling and maintenance. The Mk VI was originally to have kept the boosters of the MK V but the cost in fuel expenditure was deemed too high. As it is, the Mk VI's main problem is that it is a gas guzzler, eating through fuel at a tremendous rate in order to achieve its target performance.

Those pilots used to older Vipers tended to detest the handling characteristics of the Mk VI due to its forward cockpit, as the centre of gravity of the fighter was totally different to former models. The MK VI is still in service and, indeed, is the standard basic trainer for the various academies in the Colonies.





## Viper Mark VII

Stats: RPG

Picture B.J. Olejnik

**Agi** d10, **Str** d6, **Vit** d8, **Ale** d8, **Int** d6, **Wil** d6

**LP** 12; **Init** d10+d8; **Scale** Planetcraft;

**Speed** 8.(6 in atmosphere).

**Traits** None

**Skills** Perception d6, Pilot d6

**Armament**

3 medium planetcraft scale skirmish range autocannons (d8);

8 medium planetcraft scale Capital range missiles (d12);

**Armour** Wound 4, Stun 3

**Description** 32.4 x 9.7 x 18.4; **Crew** 1

The Mk VII Viper went through one of the longest design processes ever in the Colonial Military. At the same time as the Mk IV was being torn apart in committee rooms, and tenders went out for a stop-gap replacement, the procurement section set up their own design section. Although mired down in problems, it finally delivered in producing the Mk VII. The Mk VII's armament is less in number than some previous models but is far more capable.

Equipped with the most up to date, fully networked systems, the Mark VII is capable of running rings around any previously designed fighter in the Colonial Arsenal and is certainly more than a match any Cylon Raider in might encounter.

To improve its performance, the Colonial Navigation Program was recently uploaded to all operational craft. Safe behind multiple fire walls, the CNP means each pilot knows exactly where any colonial craft is; allows him to use the targeting data of any other craft and allows real time communication across the vast distances of space. Its advent, married to heavier armament means that the Mk VII is capable of meeting any threat to the Colonies in the foreseeable future. The only reason for even finding older combat models of Vipers is in training and reserve units.

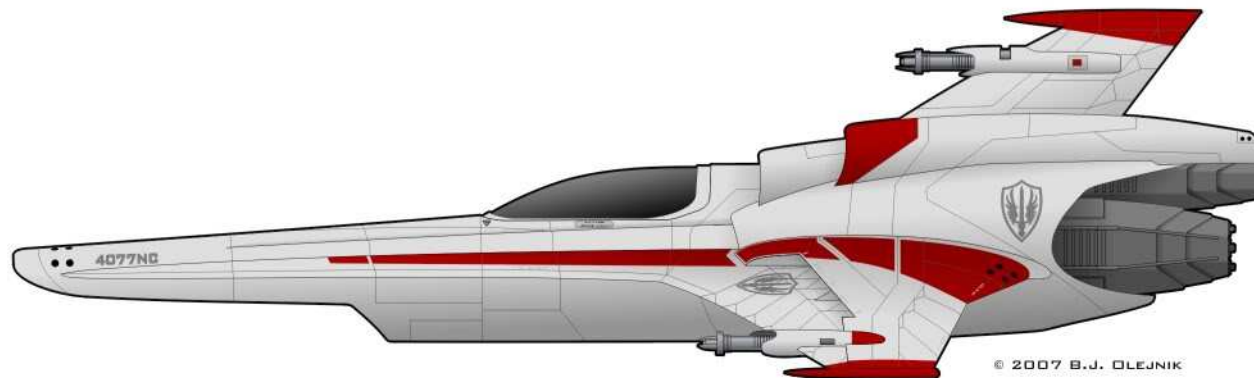
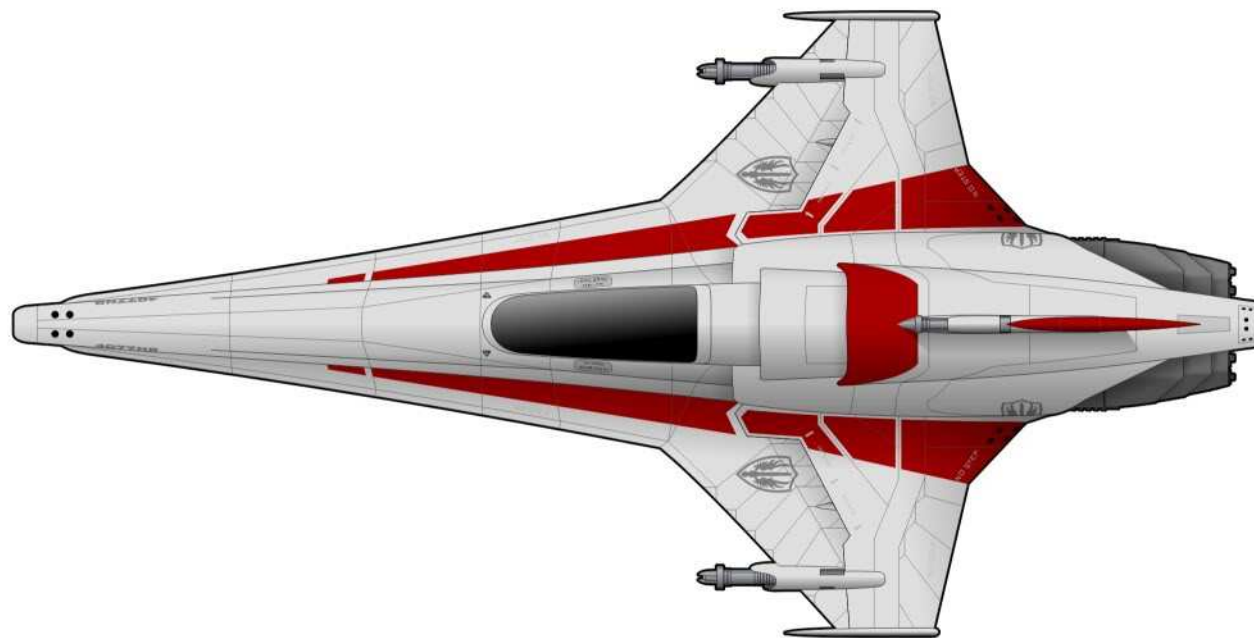

The Colonial government accepts that introduction of the Mk VII into all planetary militias will take some time but a simplified logistic system will be the result. However, due to financial restraints, each planet must fund its own militia program so the use of older models will continue for some time, although even those will normally have the CNP retrofitted to them.

## ***Colonial Interceptor (Prototype)***

By Ravensoracle

**Agi** d8, **Str** d6, **Vit** d8, **Ale** d12, **Int** d8, **Wil** d6

**LP** 14; **Init** d10+d8; **Scale** Planetcraft;

**Speed** 7.(5 in atmosphere). JC

**Traits** None

**Skills** Perception d6, Pilot d6 Mechanical Engineering d4, Technical Expertise d4

### **Armament**

4 medium planetcraft scale skirmish range autocannons (d8);

12 medium planetcraft scale Capital range missiles (d12);

**Armour** Wound 4, Stun 3

**Description** 40 x 15 x 24.5; **Crew** 1

The Interceptor was developed by the Colonial Fleet to fill a niche currently occupied by the Python range of fighter/bombers Raptors have FTL

capabilities married to an extensive electronics package, but is not a capable fighter. The Viper Mk VII is an incredible fighter but requires a carrier to travel faster-than-light. Pythons have limited capacity for dog fighting. A development of the Mk VII would have seen the introduction of a FTL fighter with most of the capabilities of the Mk VII, albeit in a larger package.

The Interceptor is uses a Viper Mark VII frame in its design. The cockpit is set up to handle a crew in tandem with the Pilot sitting in the rear seat raised slightly above the WEO's position. The major problem with the interceptor is its larger size, greatly restricting the ability for them to be flown off any current Battlestar. Talk of modifying a Battlestar to house a squadron of interceptors was not deemed to be financially sustainable.

Instead, production of the smaller Mk VIII Viper was authorised. Although limited in range, the Mk VIII had the advantage of utilising current Naval Designs, despite its other short comings.

However, one squadron of pre-production Interceptors have been built and are currently undergoing operational testing. If the Interceptor lives up to its promise then a future development may result in it becoming the basis of future Viper design.



[Note: The various models were in the final stages of flight testing when the Cylons attacked. Not all have been accounted for since that tragic day.]



17

## **Viper Mark VIII**

**Stats by Limerickcot**

Picture Zoic Studios

**Agi** d10, **Str** d6, **Vit** d8, **Ale** d10, **Int** d8, **Wil** d6

**LP** 12; **Init** d10+d10; **Scale** Planetcraft;

**Speed** 8 (7 in atmosphere) JC {Limited}.

**Traits** None

**Skills** Perception d8, Pilot d6

### **Armament**

2 medium planetcraft scale skirmish range autocannons (d8);

8 medium planetcraft scale Capital range missiles (d12);

2 external heavy spacecraft scale short range missiles (d12)

**Armour** Wound 5, Stun 3

**Description** 34 x 12.6 x 16; **Crew** 1

Although the Colonial Military is still producing the Python Mk III (qv), the desire to upgrade the systems on the Python led to the development of the Mk VIII Viper, which has now begun a limited production run. Instead of being used by the Navy, the Mk VIII is intended for use by Planetary Defence Units. Tying in its limited jump capability into the CNP will allow it to launch from orbit, target an enemy vessel, jump in and launch one or two of its externally mounted 'star-buster' nuclear missiles.

For less important targets, the Mk VIII carries much the same armament as the Mk VII which allows it to follow the same mission profile. Other ships locate the target, the information is passed via the CNP, and the MK VIII jumps in to target the enemy vessel. This seemingly 'ideal' of combat practice leaves a lot to be desired in practice. Viper '8' pilots need to be trained in FTL navigation as well as combat roles, and it also needs 'spotter' craft to allow it to jump in as close as possible to its target.

The Mk VIII is limited by its fuel capacity (a necessity of its carrying an FTL system) and its life support systems are not as well developed as they should be, as this is seen as a short hop mission vessel. Its deficiencies are made up for in its atmospheric capabilities which are superior to the Mk VII and its ability to be carried and deployed by regular Naval Vessels.



**Viper Mk VIII  
by  
Zoic Studios**



**Scorpion/Starhound**

Art by Smallworld based on a picture from  
Starship Schematics Database  
Stats by Buscadero

**Agi** d6, **Str** d6, **Vit** d6, **Ale** d4, **Int** d4, **Wil** d6

**LP** 10; **Init** d6+d4; **Scale** Planetcraft;

**Speed** 6 (4 in atmosphere)

**Traits** Past Its Prime (d10)

**Skills** Perception d2

**Armament**

2 light planetcraft scale skirmish range autocannons (d4)

**Armour** Wound 2, Stun 2

**Description** 29 x 16 x 6; **Crew** 1

Colonial History is replete with conflict between the Colonies. During one of those conflicts, 1,000 years ago, the premier fighter craft was the Scorpion. Substandard as a design even before the Cylon War, the Scorpion was such a robust, easy to adapt and maintain design that it, and its descendents nevertheless served as the basic space fighter during all that time, the principal variant in use by Caprica being the Starhound.

Its inability to accommodate a Cylon led to the development of the Cylon Raider and, subsequently, a need developed for a more capable and up-to-date fighter that could match the Raider in both space and atmosphere.

Colonial doctrine had left control of space to these fighters and larger spaceships but, once an atmospheric foothold was made, atmospheric battles were carried out by more dedicated fighters that could run rings around the Starhound. One of the later developments of this was the Cylon Raider, designed especially to overcome that difficulty and so produce a single vehicle that could cope equally in atmosphere or in space.

The Viper Mk1 is a direct descendant of the Scorpion/Starhound. The profile shown above is the Starhound configuration which was the latest to be used by the Caprican Military before they adopted the superior Viper Mk I.



## Starfighter Mk II

Picture © Limerickcot

**Agi** d6 (d8 in Atmo), **Str** d6, **Vit** d6, **Ale** d4, **Int** d4, **Wil** d4

**LP** 10; **Init** d6+d4; **Scale** Planetcraft;

**Speed** 6.

**Traits** Past Its Prime (d8), Dogfighter (atmospheric only) D2

**Skills** Pilot d4

### Armament

2 medium planetcraft scale skirmish range autocannons (d8);  
2 medium planetcraft scale Capital range missiles (d10)  
mounted externally;

**Armour** Wound 2 Stun 1

**Description** 25.5 x 15 x 12; **Crew** 1

The Starfighter was built on Aereon . The Colony has one of the poorest populations, with only a pastoral industrial base, and has commonly been the target of the other colonies. Their militia is poorly equipped and the Mk I Starfighter was a poor attempt to match the other Colonies fighters, such as the Scorpion and Starhound.

That changed after the start of the Cylon War. Aereon had an advantage initially – there weren't many Cylons on this agricultural world, they couldn't afford them. But every planet was desperately churning out Vipers for the Colonial Military and any spare capacity went to each worlds own militia. Aereon was making a fortune from its agriculture but no planet would sell what it needed so desperately. So Aereon formed its own company and told them to build a simple, easy and cheap to build fighter that could match the Viper. Time was of the essence. The result was to the take the Starfighter, upgrade it and turn it into the Mk II.

The Mk II Starfighter carries weaponry similar to the Viper but carries less armour and less powerful engines. By using an existing frame, time, money and tooling up was greatly reduced. Compared to a Viper, the Starfighter is a poor proposition out in the black. It is slower, less agile, has worse sensor systems. But it more than makes up for this in the Atmosphere. Its controls are simple, and its design gives it an aerodynamic edge over Cylon and Colonial alike.

The Starfighter helped Aereon to keep fighting – a fight they would have lost without it, But as the war progressed into their own skies, the ability for Aereon to keep up with losses told. They only just managed to keep up with losses from war and accident and it was only the sheer simplicity of the design that allowed them to keep them in production, and train new pilots.



Starfighter Mk IIa  
by Limerickcot



Based on Concept Ship  
by Ralph McQuarry





## Starfighter Series Mk V

Picture B.J. Olejnik  
Stats by Limerickcot

**Agi** d8, **Str** d6, **Vit** d8, **Ale** d8, **Int** d6, **Wil** d4

**LP** 14; **Init** d8+d8; **Scale** Planetcraft;

**Speed** 6 (SL).

**Traits** Dogfighter (atmospheric only) D4

**Skills** Perception d8, Pilot d6

### Armament

8 medium planetcraft scale skirmish range

autocannons (d6);

2 medium planetcraft scale Capital range missiles  
(d10;

**Armour** Wound 3 Stun 5

**Description** 32.4 x 6.8 x 19.6; **Crew** 1 (double  
cockpit)

Aries Instellar Shipping built the very first Starfighter for its own wars. The history of Aries was that it was always the victim of the other colonies. Their attempts to halt this was to build the Starfighter. The current model increases the capabilities of the Mk1 through IV (all of which retained the same outside look). AIS were unable to keep up with demands from the Fleet for Starfighters – they were shot out of the sky faster than they could be built in the early years. Aries still buys the Starfighter for some of its local squadrons and a few of these find their way into the Colonial fleet as a result of CDF and Militia exchange programs.

The Mk V hosts four heavy cannon in each of its nose nacelles, but only two missiles. She is designed as a dedicated, atmospheric dogfighter, which is one of the reasons that the Aries Government has resisted all attempts to replace her. Unlike the Viper though, the Starfighter is sublight capable with minimal regenerative life support, long range navigation systems, and room for a second person in the cockpit. She has a modular bay that fits either additional electronics or a series of decoys, allowing the Arians to use the Starfighter as a poor mans Raptor on patrol. Another unusual aspect of the Starfighter is its hardened electronics and construction. In space she's

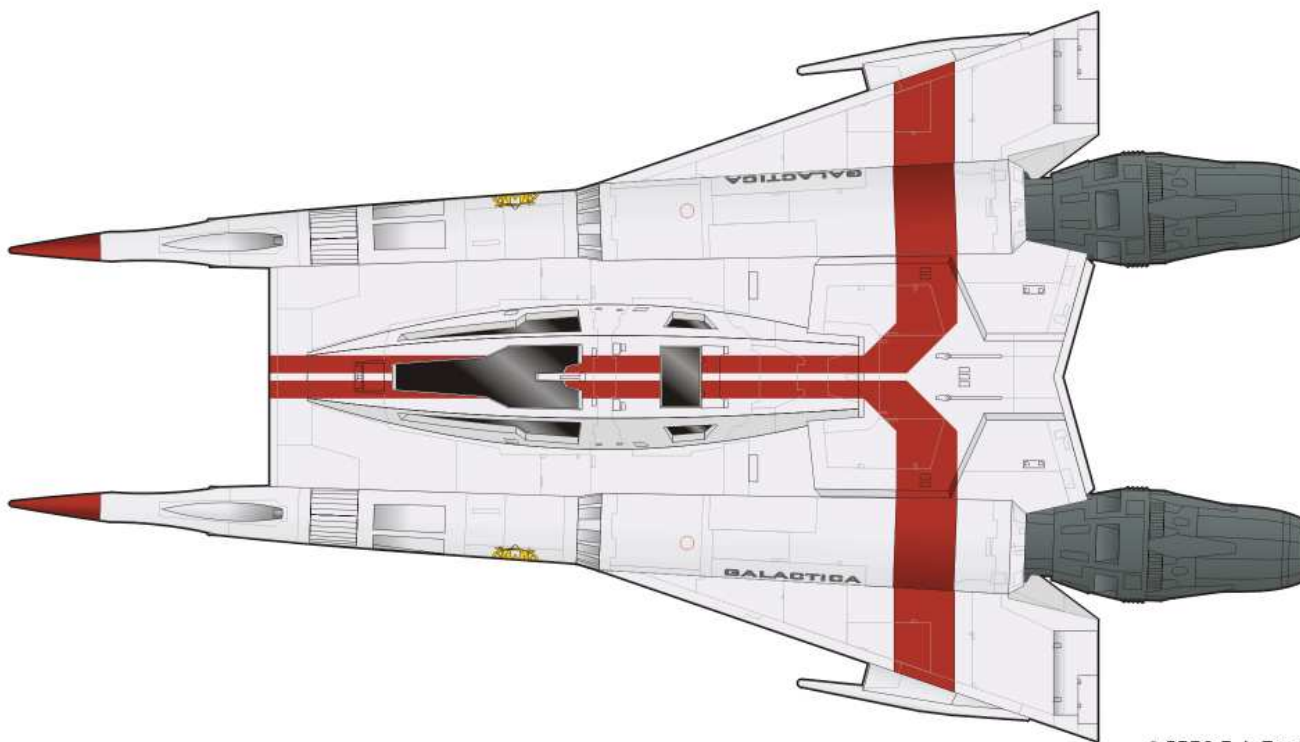
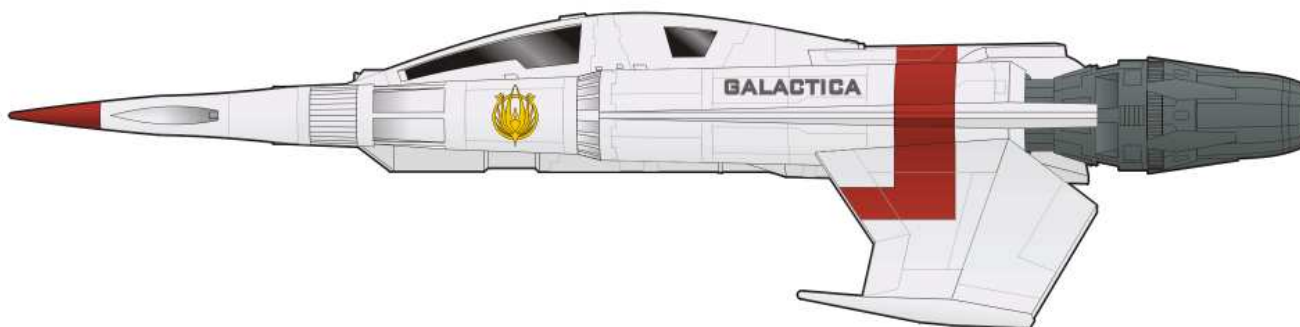

© 2006 B.J. OLEJNIK

slower than a Viper but in the atmosphere the tables are turned, indeed the Starfighter's atmospheric agility gives it a massive edge over nearly all other fighters.

The model shown is the single man version. There is a larger version used as a trainer (and which can carry up to four pilots – two instructors and two trainees. It retains all other flight characteristics except for a more complex avionics suite which can project training simulations into the controls.

## Cobra (Prototype)

Stats by Buscadero  
Picture © by Warrior

**Agi** d12, **Str** d6, **Vit** d8, **Ale** d8, **Int** d8, **Wil** d6

**LP** 12, **Init** d12+d8, **Scale** Planetcraft

**Speed** 9 (7 in atmosphere)

**Traits** None

**Skills** Perception d6, Pilot d8

**Armament**

2 medium planetcraft scale skirmish range autocannons (d8),

8 medium planetcraft scale capital range missiles (d12)

**Armour** Wound 3, Stun 3

**Description** 35 x 13 x 20 feet, **Crew** 1

**Equipment** Electronic countermeasure support, decoys

A further, although independent, adaption of the Mk III Viper design, the Cobra has evolved into a large, but lightweight triple-engine starfighter that was designed for high speed and manoeuvrability. This was Heran Aerospace's entry into the lucrative military market with the winner becoming the next Viper design, but due to delays and problems, the entry failed to impress the selection board at that time.

Regardless, Heran have pressed on with the concept, hoping to offset some of the development costs by obtaining a short run production. Although fast and well balanced, the Cobra is not a ship to be used by any but the most expert of pilots and her cockpit, reminiscent of the old Mk II, is considered cramped and hard to handle due to the sophisticated systems that are now required as standard.

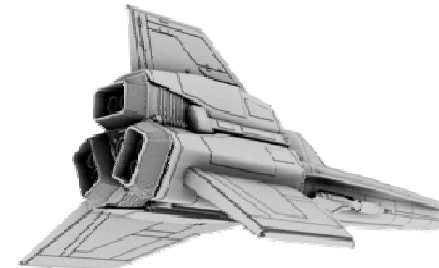
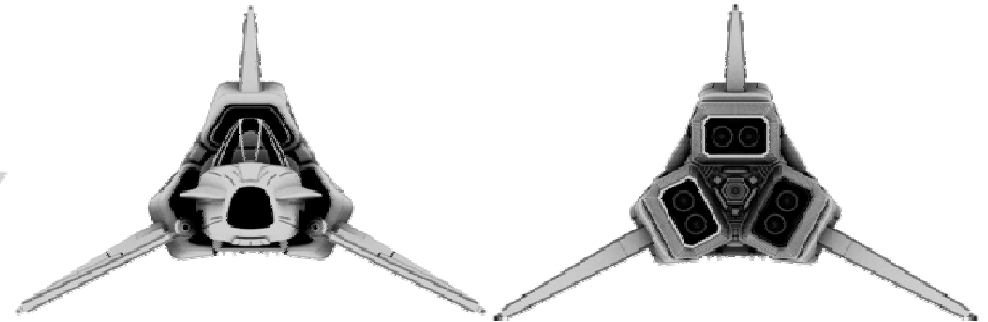
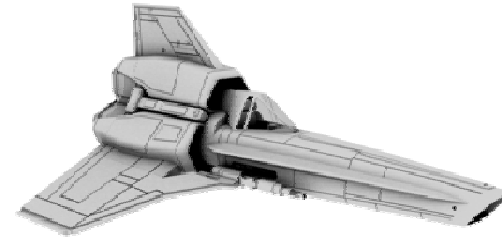
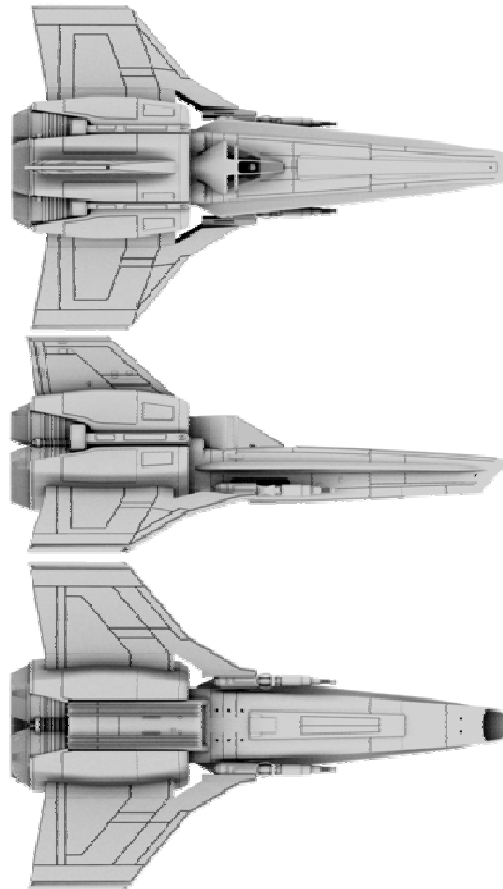

Prototypes carry two 30mm forward-firing auto-cannons and a ventral weapon system for eight missiles as well as a sophisticated targeting computer and sensor array, as well as excellent sensor and communications countermeasures. The high-speed craft were supposed to be suited to hit-and-fade operations. Test fighters have been produced but have not yet finished flight testing.

Given the military's current fighter base, it is unlikely that the Cobra will be picked up for full scale production but, if the cost unit is sufficiently low, then some of the poorer planets might pick it up as an atmospheric interceptor.

## Python Mk I

Art by Brian O'Loughlin

Stats by Limerickcot

**Agi** d6, **Str** d6, **Vit** d10, **Ale** d6, **Int** d4, **Wil** d6;

**LP** 16, **Init** d6+d6, **Scale** Planetcraft;

**Speed** 5 (4 in atmosphere; JC [limited])

**Traits** Past Its Prime (d6), Tough (d4)

**Skills** Perception d4, Pilot d4

### Armament

2 turreted medium planetcraft scale skirmish range autocannon (d8),

2 medium planetcraft scale skirmish range autocannon (d12),

4 heavy spacecraft scale capital range missiles (d12+d4)

**Armour** Wound 5, Stun 4

**Description** 43 x 38 x 15 feet, **Crew** 2

As the Cylon War increased in its intensity and brutality, it became starkly clear to the Colonial High Command that their regular fighter craft were no match for the Base Stars operated by Cylons, and that, once a base had been over-run, Starhounds, or Vipers were unable to strike over the longer ranges called for.

The Solution was to produce a heavy fighter-bomber – the Python. Large by virtue of necessity, the Python is heavily armed, hosting four internal missile bays, capable of housing nuclear missiles. Although she only carries two forward firing autocannon, these are more capable variants of those used by the Viper Mk 1 or Starhound and are capable of literally blowing away an enemy fighter with one hit in the right place.

As the Python is not very agile, she carries two smaller autocannon in a remote rear turret, giving her a good tail firing capacity which few enemy ships realised to begin with.

The Python suffered from low speeds but made up for it by incorporating a very small FTL drive, giving the Python the ability to jump in ahead of a fleet, gaining surprise and range in the process. Unfortunately she could only carry enough fuel for four such jumps and these jumps were very limited in range.

Pythons were still retained after the end of the Cylon War, but their recon functions were taken over by Raptors.

A number were updated to Mk II standard but, by the beginning of the Adar Administration, the last squadron had been converted onto Raptors. Some Pythons were sold off to Planetary Defence Forces. The very last Python MK1 in operational service now stands outside the Caprica Flight School as a testament to the design.

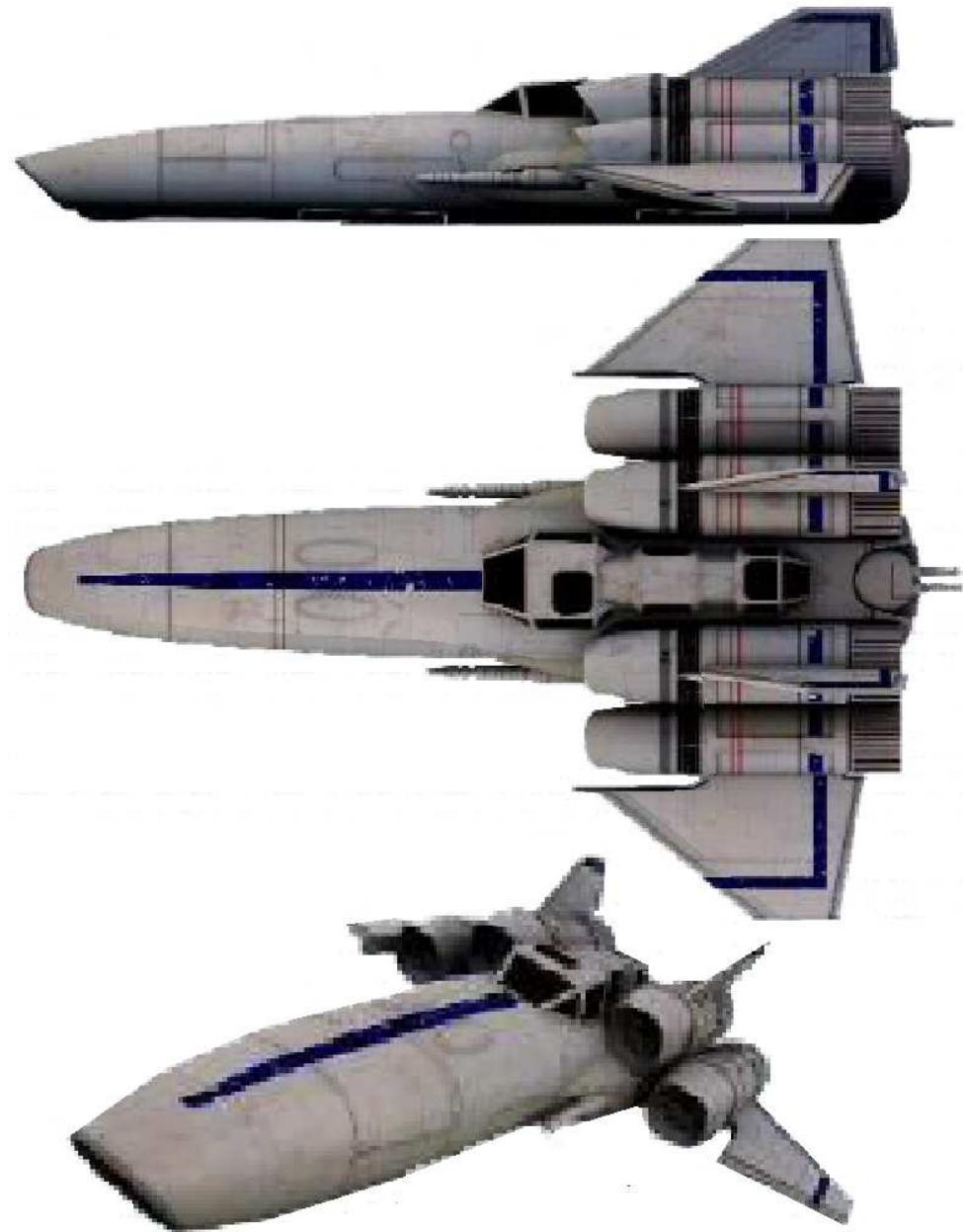



## Python Mark II

Stats by Buscadero

Picture © by David "CanisD" Briedis

**Agi** d8, **Str** d6, **Vit** d10, **Ale** d8, **Int** d6, **Wil** d6;

**LP** 18, **Init** d8+d6, **Scale** Planetcraft;

**Speed** 6 (5 in atmosphere; JC [Limited])

**Traits** Past Its Prime (d4), Tough (d4)

**Skills** Perception d4, Pilot d4

### Armament

5 medium planetcraft scale skirmish range autocannon (d8),

8 medium planetcraft scale capital range missiles (d12),

4 heavy spacecraft scale capital range missiles (d12+d4)

**Armour** Wound 5, Stun 3

**Description** 43 x 20 x 15 feet, **Crew** 2

The Mk II version of the Python was intended as an up-gunned version of the original Python. Instead of four small engines, two increased, more 'powerful' engines replaced them. The design was promising enough that nearly all the remaining Mk I models were re-equipped to the same standard.

Regrettably the engines proved to be gas guzzlers. And movement of the guns into the nose area restricted the fuel capacity. As nearly all the original Pythons were brought up to the same standard, this greatly restricted the range of the Python, effectively destroying the very purpose for which the original Python had been built.

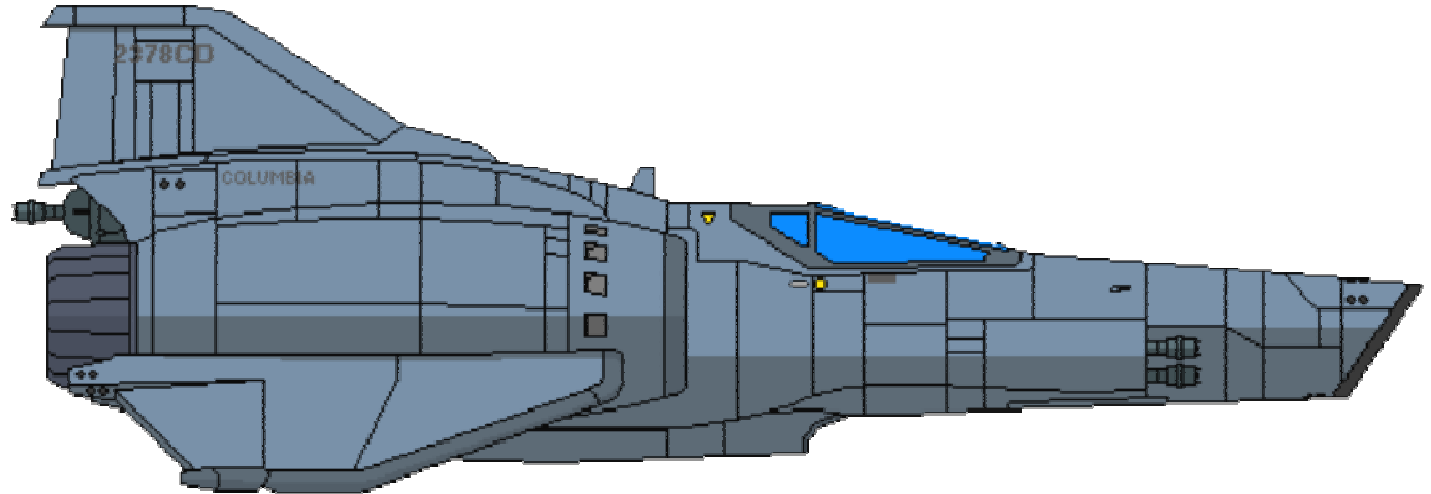
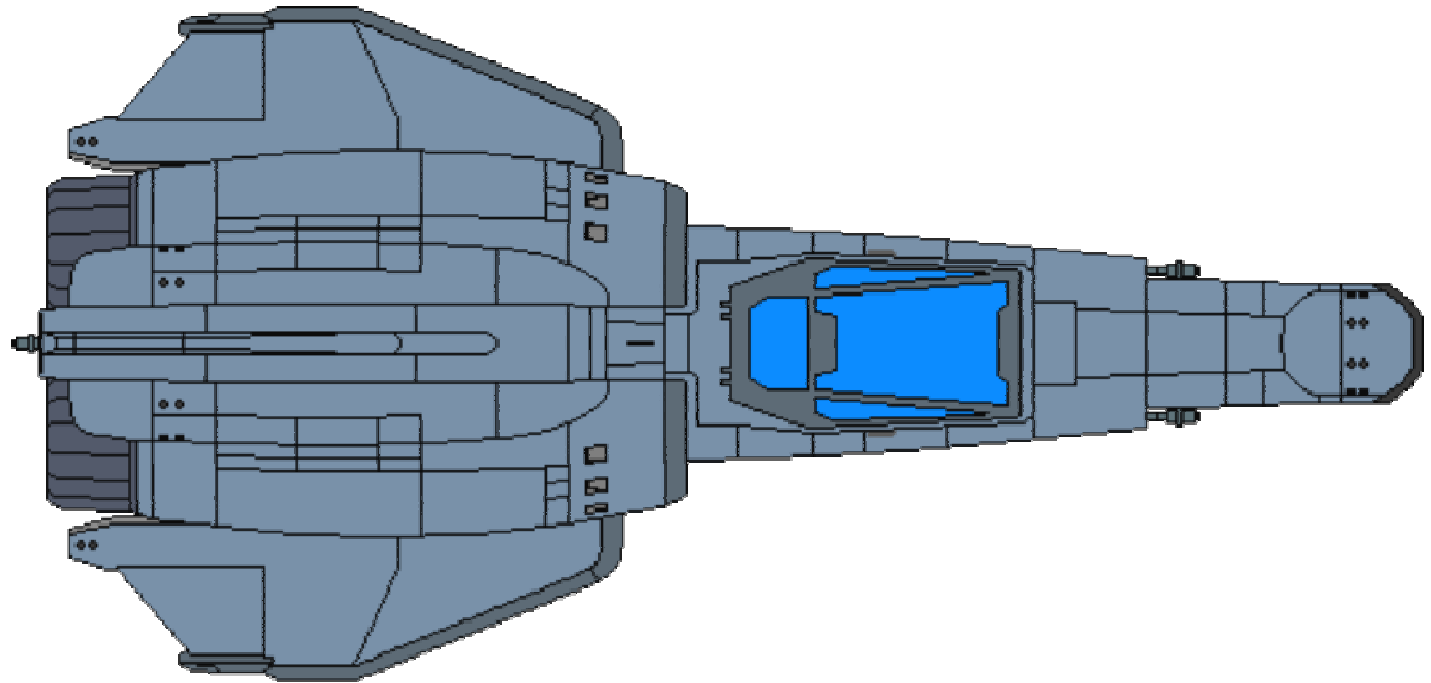

## ***Python Mark III***

Stats by Limerickcot

Picture © by B J Olejnik

**Agi** d8, **Str** d6, **Vit** d10, **Ale** d8, **Int** d6, **Wil** d6;

**LP** 18, **Init** d8+d6, **Scale** Planetcraft;

**Speed** 7 (5 in atmosphere; JC)

**Traits** Tough (d6)

**Skills** Perception d6, Pilot d6

### **Armament**

2 medium planetcraft scale skirmish range autocannon (d10),

8 medium planetcraft scale capital range missiles (d12),

6 heavy spacecraft scale capital range missiles (d12+d4)

**Armour** Wound 6, Stun 4

**Description** 43 x 21 x 18 feet, **Crew** 1

Recent years have seen the Colonial Defence Forces involved in saving cuts at the very time they are trying to update and upgrade much of their equipment. Developments in jump technology and electronics allowed Tamaron Industries of Leonis to remodel the Python MkII and, by cutting out the rear turrets, use of newer electronics to eliminate the FTL navigator, plus a more powerful set of Thrusters, gave the Python a new lease of life.

Unlike its predecessors, the Pythons have the same jump capability as Raptors and, like the Mk I, the Mk III's engines are highly efficient. She carries plenty of fuel and her life support systems are some of the best in the CDF. She has two major faults; Cost; and Pilot Training. FTL Navigation has to be done by the Pilot as he no longer has a WEO to keep him company (there are some Pilot training versions but they do not carry the smaller missile bays).

On a more amusing note, the Python Mk III was launched shortly before the Mk VII and many pilots thought that the Python was the next Viper Variant they were getting. There still exists some confusion in the Media and Civilians about this. Even more confusing is the launch of the Viper Mk VIII which has much the same mission configuration (but was actually the designated successor to the Python Mk II. Tamaron beat them by three years into production).

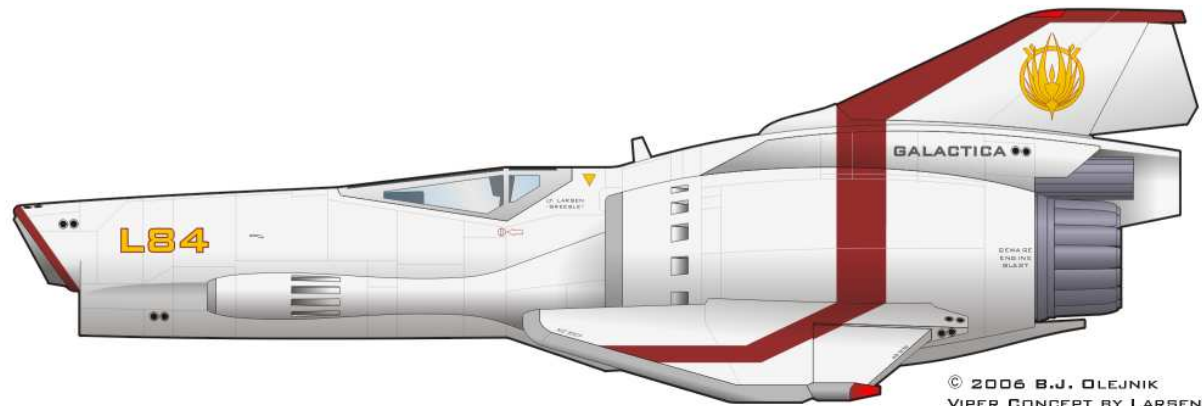
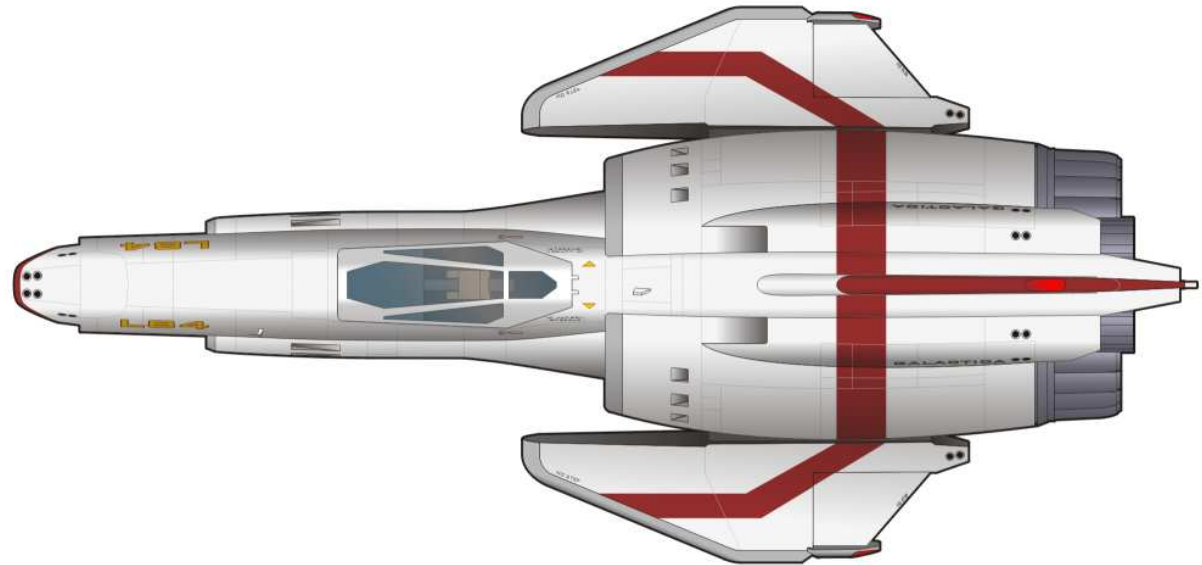

© 2006 B.J. OLEJNIK  
VIPER CONCEPT BY LARSEN

## ***Stealth Star Class Recon Fighter***

Picture © unknown

Stats from Thin Blue Line

**Agi** d8, **Str** d6, **Vit** d8, **Ale** d8, **Int** d6, **Wil** d6;

**LP** 12, **Init** d8+d8, **Scale** Planetcraft;

**Speed** 7 (5 in atmosphere; SL/JC)

**Traits** Stealthy (d4)

**Skills** Perception d4, Covert d4

**Armament** : None (Camera's; decoys)

**Armour** Wound 2, Stun 2

**Description** 31 x 15 x 14 feet, **Crew** 1

The *Stealthstar* is an experimental fighter design developed by the Colonial Fleet. The design is used primarily for intelligence gathering, and in one recent incident, in order to test Cylon response to a Colonial incursion along the Armistice Line, Lieutenant Daniel "Bulldog" Novacek from the Battlestar Valkyrie piloted a stealth recon craft, designated Stealthstar, across the Armistice Line in order to determine whether or not the Cylons were performing a military build-up.

During the mission, the Stealthstar had open comm. channels and was actively monitoring DRADIS, perhaps in an attempt to lure the Cylons with the intent of going silent at the first sign of trouble. Its position was clearly visible to Valkyrie's DRADIS. However, the Stealthstar was interdicted by a craft of unknown designation (presumably Cylon) which quickly jumped in and out. This resulted in severe damage before its stealth functions were fully utilized

### **Quirks/Special Characteristics:**

The Stealthstar utilizes a mix of standard and experimental Colonial technology. For example, the cockpit and avionics are identical to those found



on the Mk VII Viper, while the twin engines were a revolutionary low-emission design.

Stealthy\*- Carbon composite construction renders the *Stealthstar* DRADIS transparent and when operating with her transponder off and her engines on low power, imposes a -4 die step to Perception tests made to find her.

### **Notable Vessels in Class:**

7746VA (Piloted by Daniel "Bulldog" Novacek; Violated Armistice Line and destroyed by unknown forces).

26

## **Micro-Shuttle**

Picture © unknown

Stats: Buscadero

**Agi** d6, **Str** d8 **Vit** d6, **Ale** d4, **Int** d4, **Wil** d6

**LP** 14; **Init** d4+d6; **Scale** Planetcraft

**Speed** 5 (SL)

**Traits** Short Range (d4), Past It's Prime (d4), Mass Produced (d4)

**Skills** *Mechanical Engineering* d2, *Perception* d4, *Pilot* d4

**Armament:** None

**Armour:** Wound 1, Stun 1

**Description** 65 x 33 x 29 feet, **Crew** 1

**Passengers:** 3

**Cargo:** 5 tons

**Attributes:**

### **History:**

This small launch was built to fill the need for a small orbital transport and launch for vessels not having a full-sized launch/landing bay. Once in service, they proved popular, dependable, easy to operate, and easy to maintain.

### **Quirks/Special Characteristics:**

Despite their popularity and the ease with which these vessels are modified, none have been able to overcome the limitations of its small size. None of the numerous variants of this class are FTL capable, and none have regenerative life support systems. They were built as small, short range transports, and so they remain

Their one main advantage lies in their lack of FTL capability. Wherever the military doesn't need an FTL, capable small boat, especially on smaller craft, on stations and on bases, then they use the Micro. Their other advantage over the heavier Raptor lies in both the cost of buying them and, above all, the cost of running them. The shuttles engines are efficient, especially in atmosphere and low speed. A Micro (or Lander as it is sometimes known in merchant circles) can run for three times the range of a Raptor which allows it to make runs between planets and moons easily, as long as you don't mind a long trip. They also land on a dime.





## Colonial Shuttle

Stats by Buscadero

Picture by Zoic Studios

**Agi** d6, **Str** d8, **Vit** d6, **Ale** d4, **Int** d4, **Wil** d6;

**LP** 14, **Init** d6+d4; **Scale** Planetcraft

**Speed** 5

**Traits** Past Its Prime (d6)

**Skills** Mechanical Engineering d2, Perception d4, Pilot d4

**Armament** None

**Armour** Wound 1, Stun 1

**Description** 65 x 33 x 29; **Crew** 2

**Passengers** 20

The mainstay shuttle of the Colonial Fleet from before the first Cylon War. A basic but robust design, and the ability for rapid production, led to the wide-scale adoption of the Zoical Industries Shuttle. The design ended up being licensed produced by many different manufacturers during the Cylon War and afterwards.

Fast for its day, the shuttle carries its passengers on a top deck, there being no separate flight deck for the crew. A basic toilet and limited emergency supplies are standard on this model.

The bottom deck houses up to 30 tons of cargo and can fit a Landram APC which is loaded through a front ramp. A Mercury Class Battlestar carried between four and six of these shuttles and, before the wide-scale introduction of Raptors, these shuttles were the mainstay of personnel transfer within the fleet.

They were also very susceptible to damage from Cylon Raiders which would prioritise shuttles ahead of fighter craft in any battle.

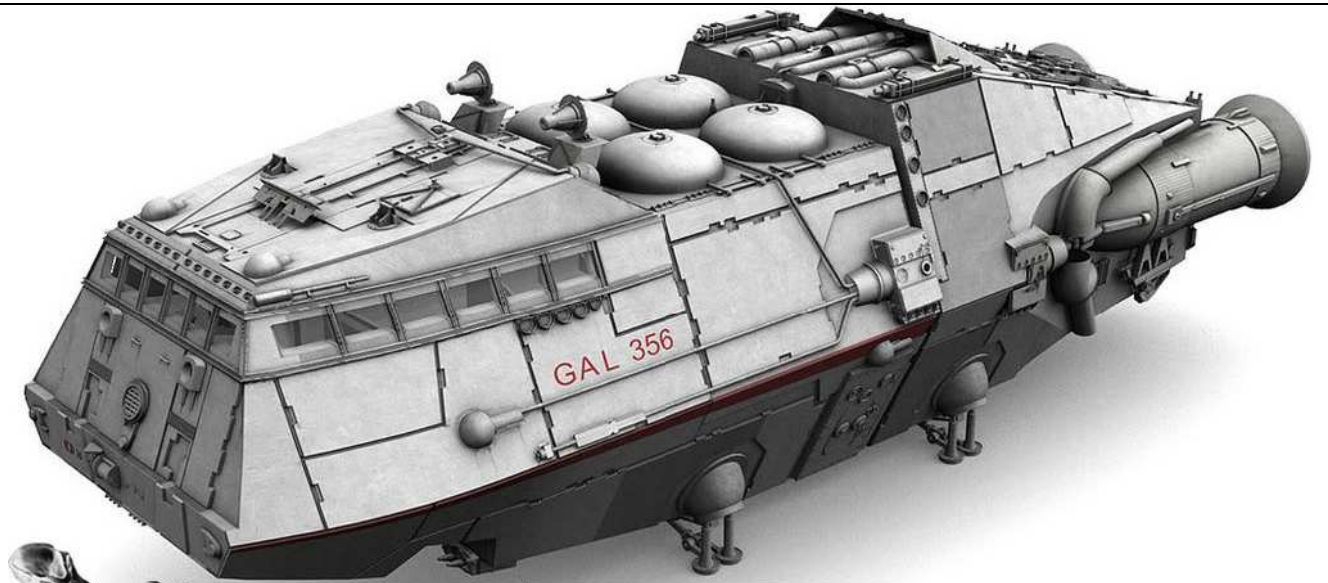

ZOIC.



SF CHANNEL

Texturing F.Passaro 2003



ZOIC.



SF CHANNEL



## Colonial Shuttle Series

stats by Limerickcot

Picture: Zoic Studios, modified by Limerickcot

Atmospheric shuttles are FTL-capable vessels whose primary role is ferrying passengers to and from the different vessels within the Fleet or to a planet's surface.

### Colonial Shuttle - ZIS SS19

**Agi** d4, **Str** d8, **Vit** d6, **Ale** d6, **Int** d6, **Wil** d6;

**LP** 12; **Init** d6+d6, **Scale** Planetcraft

**Speed** 6 (4 in atmosphere); JC

**Skills** Mechanical Engineering d4, Perception d4, Pilot d4

**Armament** None

**Armour** Wound 1, Stun 1

**Description** 65 x 25 x 15 feet, 122 tons; **Crew** 3

**Passengers** 20

**Cargo:** 50 tons

An FTL equipped Raptor was heralded with delight by the Colonial Navy, but it soon became evident that a larger capacity FTL vehicle was also needed for the fleet. Zoic Industrial Studio's introduced an FTL capable shuttle shortly after Armistice Day. Unfortunately this shuttle is not as adept in atmospheric flight as its predecessor. The layout is similar to the original but the SS19 has three cargo hatches, one forward and two side, allowing for better offloading. Its FTL allows it to make up to 10 jumps between refuelling.

The SS21 looks identical to the SS19 but it has the same speed as the Cylon War model. It also has an improved FTL capable of more jumps (16) for the same fuel capacity, due to improved drives. Both models are still in front line service.

**Variants:** As is normal in such a wide spread designs, any number of variants have been introduced over the last forty years. The main ones are:

**Fueler:** Some models have been adapted for transfer of fuel between stations and can be used as a ground or station based fueler for Viper fighters (note: not in-flight refuelling). Their fast pumps can refuel a Viper in under a minute.

**Medevac:** These shuttles are refitted with modern stasis and stabilisation tubes for casualties, allowing wounded to be medevac'd directly from service to hospital. They can be utilised as forward medical stations as well, although the preference is to use the larger shuttles (SS500 for example) for these purposes.

**Command Unit:** An on station command unit is fitted into the cargo bay creating an immediate company or battalion command post to operate, either in the air or on the ground.

**Suppression:** An armoured version of the SS19 (not the SS21) sees its armour improved and a number of missile batteries and gun bays fitted along its lower flank. Although susceptible to missile fire, this version is capable of laying down immediate, heavy ground fire and sustain it for far longer than any Raptor could do. These units are not normally used by either the Navy or the Marines but rather by Planetary units with limited resources.





29

## **Colonial Shuttle Series**

stats by Limerickcot

Picture: Zoic Studios, modified by Limerickcot, inspired by Conan Parsu

### **Zoical ZIS 200 [210]**

**Agi** d4,[210 agi d6] **Str** d8, **Vit** d6,

**Ale** d6, **Int** d6, **Wil** d6;

**LP** 14; **Init** d4 [210:d6]+d6, **Scale** Planetcraft

**Speed** 5; JC

**Skills** Mechanical Engineering d4, Perception d4, Pilot d4

**Armament** None

**Armour** Wound 1, Stun 1

**Description** 80.5 ft long, 25 ft wide [210: 35 ft], 15 ft high, 151 tons [210: 153 tons]**Crew** 3 [210: 4]

**Passengers** 20

**Cargo:** 80 tons

The ZIS 200 is a larger capacity standard shuttle, the 210 has rotating Sponsons for an extra set of engines giving it better agility.

### **Zoical ZIS 410**

**Agi** d4, **Str** d8, **Vit** d6, **Ale** d6, **Int** d6, **Wil** d6;

**LP** 14; **Init** d4+d6, **Scale** Planetcraft

**Speed** 5; SL/JC

**Skills** Mechanical Engineering d4, Perception d4, Pilot d4

**Armament** None

**Armour** Wound 1, Stun 1

**Description** 97 ft long, 25 ft wide, 15 ft high 182 tons **Crew** 4

**Passengers** 40

**Cargo:** 135 tons

The ZIS 410 is underpowered but is noted for being a good long-hauler. The passenger accommodation is separated into two sections with better fresher units. The 410 is often used as a forward MASH unit. It is also the first of the series that is truly sublight capable.



## Colonial Shuttle Series

stats by Limerickcot

Picture: Zoic Studios, modified by Limerickcot, Inspired by Conan Parsu

### Zoical ZIS 630

**Agi** d6, **Str** d8, **Vit** d6, **Ale** d6, **Int** d6, **Wil** d6;

**LP** 14; **Init** d4+d6, **Scale** Planetcraft

**Speed** 6 (5 in atmosphere); **SL/JC**

**Skills** Mechanical Engineering d4,

Perception d4, Pilot d4

**Armament** None

**Armour** Wound 2, Stun 1

**Description** 98.5 ft x 36.5 ft high x 30.5 ft wide (41 ft inc Sponsons), 526 tons **Crew** 4

**Passengers** 30

**Cargo:** 225 tons

The ZIS 630 is a heavy duty shuttle used for both transport and supply in all services. More powerful engines give it a faster speed in space and better agility. Its high ceiling allows it to carry most vehicles in use by the Colonial Defence Force.

### Zoical ZIS 1000

**Agi** d8, **Str** d8, **Vit** d6, **Ale** d6, **Int** d6, **Wil** d6;

**LP** 14; **Init** d8+d6, **Scale** Planetcraft

**Speed** 6; **SL/JC**

**Skills** Mechanical Engineering d4, Perception d4, Pilot d4

**Armament** None

**Armour** Wound 2, Stun 1

**Description** 1000 105 ft x 45 ft high x 30.5 ft wide (41 ft inc Sponsons), 560 tons, **Crew** 5

**Passengers** 60

**Cargo:** 302 tons

A further adaption of the ZIS 630, the ZIS 1000 has a higher speed, better agility and more cargo capacity.

Note: Although not normally carried all shuttle types have the ability to be retrofitted with a standard defensive suite consisting of chaff dispensers, decoys and a jammer (which tests out against colonial missile systems and Cylon warheads used during the Cylon war)..



## **Dropship [DR Series]**

Stats by Buscadero  
Picture © by Doc Rob

Dropships are landing craft used to deploy troops and small vehicles from orbiting Battlestars to battlefields on a planet's surface. They are heavily armoured, and possess autocannons for suppression fire. Dropships are not very manoeuvrable, but do have a high speed descent, making them difficult targets. Dropship ascents from planets are much slower, though.

The DR Series are an older model, being phased out in favour of newer designs.

### **DR-23 Dropship**

**Agi** d4, **Str** d8, **Vit** d8, **Ale** d6, **Int** d6, **Wil** d6;

**LP** 16, **Init** d4+d6; **Scale** Planetcraft

**Speed** 6 (5 in atmosphere, descent; 4 in atmosphere, ascent) JC

**Traits** Tough (d4), Past its Prime (d2)

**Skills** Perception d4, Pilot d4

**Armament** 2 medium planetcraft scale skirmish range autocannons (d8), 4 medium planetcraft scale skirmish range missiles (d12)

**Armour** Wound 4, Stun 3

**Description** 55 x 60 x 25 feet; **Crew** 2

**Passengers** 30 (troops)

### **DR 28 Gunship**

**Agi** d4, **Str** d8, **Vit** d8, **Ale** d6, **Int** d6, **Wil** d6;

**LP** 18, **Init** d4+d6; **Scale** Planetcraft

**Speed** 6 (5 in atmosphere, descent; 4 in atmosphere, ascent) JC

**Traits** Tough (d8)

**Skills** Perception d4, Pilot d4

**Armament**

2 light planetcraft scale personal range autocannons (d4),  
4 medium planetcraft scale skirmish range autocannons (d8),  
8 medium planetcraft scale skirmish range missiles (d12),  
2 heavy planetcraft scale capital range missiles (d12+d4)

**Armour** Wound 4, Stun 5

**Description** 55 x 60 x 25 feet; **Crew** 2



## Dropboat – Kamar Mk IV [K4]

Stats by Limerickcot

Picture © by Limerickcot

**Agi** d6, **Str** d8, **Vit** d8, **Ale** d6, **Int** d6, **Wil** d6;

**LP** 16, **Init** d6+d6; **Scale** Planetcraft

**Speed** 7 (SL/JC)

**Traits** Tough (d4)

**Skills** Perception d6, Pilot d6

**Armament** None [decoy and chaff dispensers available]

**Armour** Wound 4, Stun 3

**Description** 75 long x 18 high x 25 feet wide; **Crew** 3

**Passengers** 8 passengers (top deck), 50 troops or 50 tons cargo

The DR series of dropships, although produced in large numbers following the Cylon War, have proved to be rather lightweight for active combat areas (as proved in the guerrilla warfare that continued for a time on Aerelon). Shuttles can be used to deliver heavy armour, but are too lightly armoured for active combat areas. A heavier Dropship was needed, capable of embarking more troops, heavier vehicles and having better agility and superior speed. The Tamar Mk IV [or K4] fulfils these functions.

The K4 is designed to be sub-light capable (but any long flights are likely to be uncomfortable) with enhanced life support and damage control systems. The flight deck houses a separate passenger deck and bulkheads separate all major areas.

The cargo area is modular and can carry side-loading or bottom dropping cargo modules, allowing the quick dropping, and relatively fast pickup of cargos in active fire zones. [Illustration shows troop module in place]

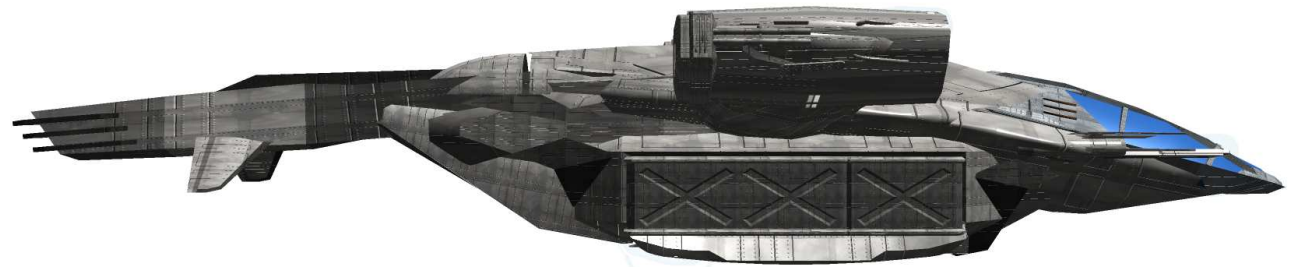

**K4 Dropship**  
**Limerickcot**

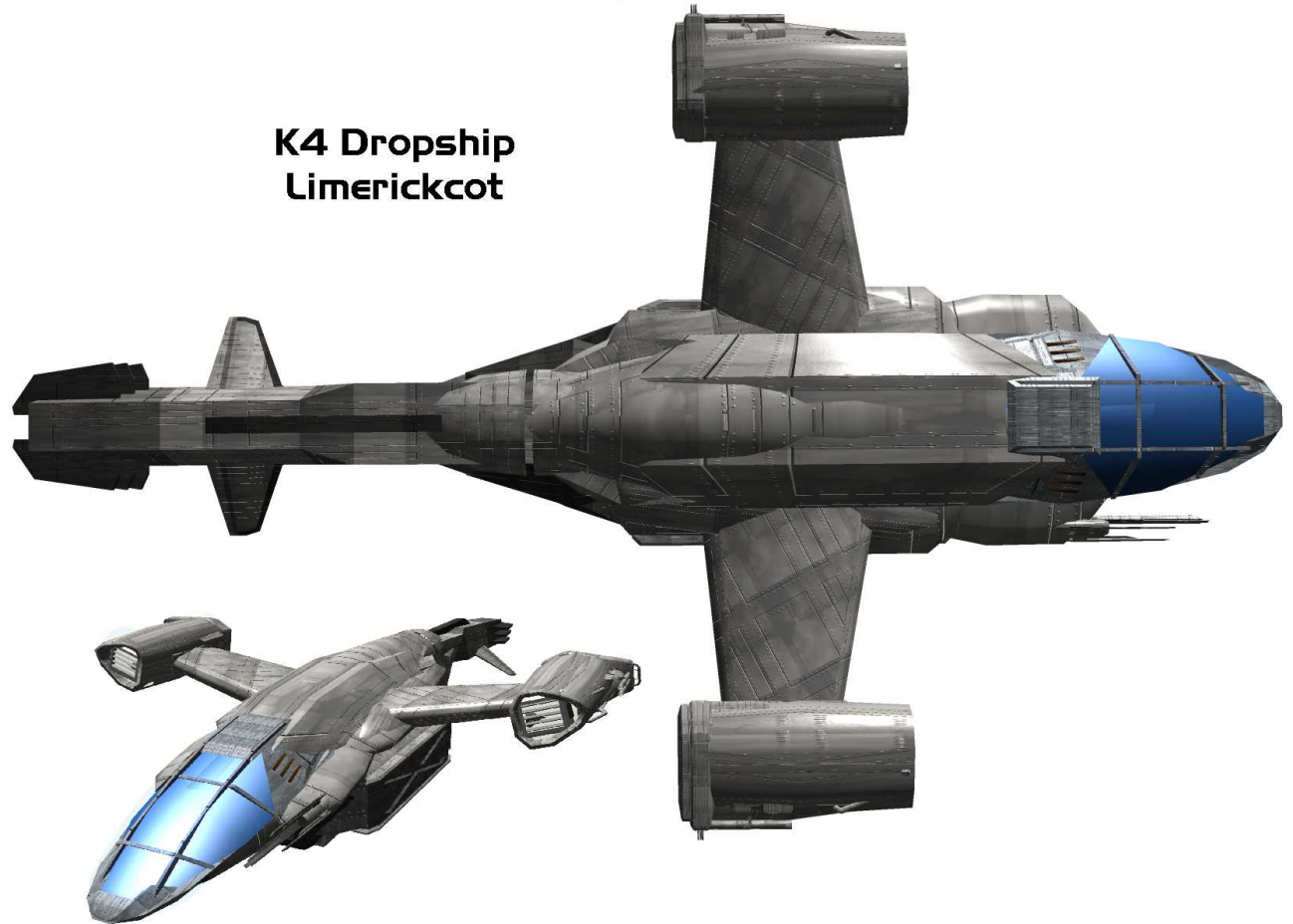



## ***Gunboat – Tamar Mk II [T2]***

Stats by Limerickcot

Picture © by Limerickcot

**Agi** d6, **Str** d8, **Vit** d8, **Ale** d6, **Int** d6, **Wil** d6;

**LP** 16, **Init** d6+d6; **Scale** Planetcraft

**Speed** 7 (6 in Atmosphere with guns deployed) (SL/JC)

**Traits** Tough (d4)

**Skills** Perception d6, Pilot d6

### **Armament**

6 Medium Range Planetcraft scale autocannon (d8), in three turrets

30 Medium Range Planetcraft Missiles (d10)

12 Capital Range Spacecraft Missiles (d6)

12 Decoys and chaff dispensers.

**Armour** Wound 4, Stun 3

**Description** 75 long x 18 high x 25 feet wide; **Crew** 5

**Passengers** 6 passengers (top deck)

The Armed Raptor is a well known for its fast deployment ability, mainly due to its jump capability. However, it suffers from lack of range and ammunition stocks in that capacity.

It was therefore a natural development to develop a larger gunship, and this was done by using a Kamar Hull and filling most of its cargo capacity with weapons and ammunition. It also serves as a VIP long distance, armed, transport. Weaponry on the Tamar is mounted in re-entry bins (for the missiles) and the side guns retract into the hull during re-entry flight. The guns produce a great deal of drag in the atmosphere slowing the boat up if they are deployed. Chaff dispensers and decoys, added to thick armour, give the Tamar good defensive qualities.

Externally, and with the weapons retracted, the Tamar can be recognised by the forward missile bins and the larger tail planes.

These gunships are much rarer than the armed Raptor variant but see deployment amongst larger Marine elements (Battalions and upwards) where heavier suppression or support is needed.

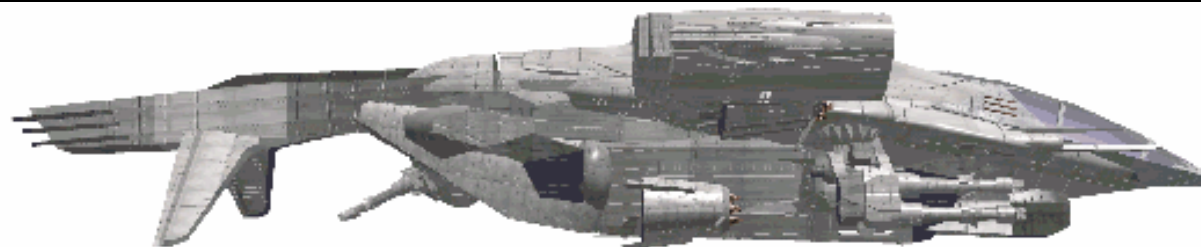

**Limerickcot  
Tamar Gunboat**

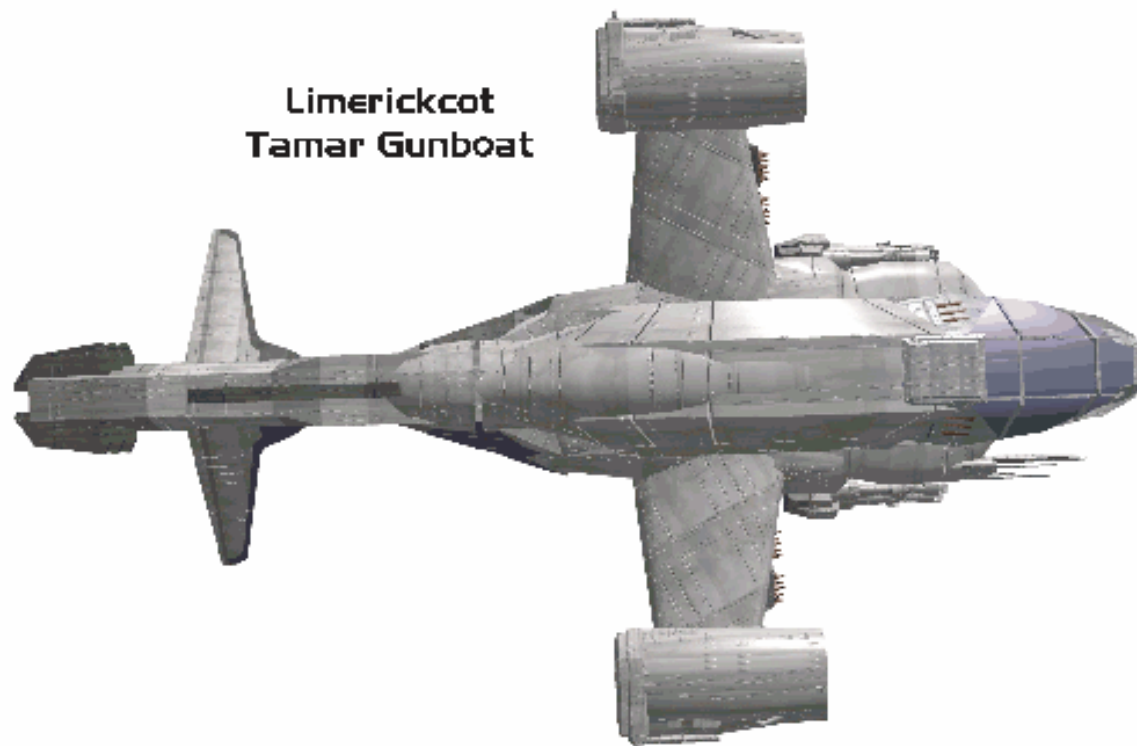



## Raptor

Image: Unknown possibly Zoic Studios  
Stats from RPG

**Agi** d8, **Str** d8, **Vit** d8, **Ale** d10, **Int** d8, **Wil** d6;

**LP** 14; **Init** d8+d10; **Scale** Planetcraft

**Speed** 7 (5 in atmosphere; JC)

**Traits** None

**Skills** Mechanical Engineering d4, Perception d6, Pilot d4, Technical Engineering d6

**Armament** None

**Armour** Wound 3, Stun 3

**Description** 28 x 9.5 x 18 feet; **Crew** 2;

**Passengers** 10;

**Equipment** DRADIS, electronic countermeasure support, decoys

The Raptor's primary function with the Colonial Defence Force is as an electronic warfare platform. It scouts ahead of the fleet, accompanies Vipers and provides targeting information and electronic counter measures (akin to the Prowler). Raptors can also carry external munitions to assist Vipers against large targets. Its non-combat roles include SAR (search and rescue) operations (akin to the SH-60 Seahawk) and transport of military personnel in hostile areas. Raptors, like Vipers are capable of atmospheric operations but unlike Vipers are also capable of short-range FTL jumps. Standard crew includes a pilot and electronics countermeasure officer (ECM)[1].

It is designed for reconnaissance, scout operations, electronic countermeasures supporting Vipers, marine assaults, ambulance, EVAC, and general transport.

It has a multitude of electronic countermeasure and monitoring tools including jamming transmissions, scrambling signals of guided weapons, and Viper Identification friend or foe operations.

As a scout it can operate independently or with other Raptors and Vipers using short and medium-range scans to detect radio, heat, or other signatures from spacecraft, scanning planet surfaces for life, energy output, and mineral content and location, scouting ahead and looking for hazards before its Battlestar takes an FTL jump, and search and rescue operations.

A Raptor can carry about eight to ten adults in addition to its two-person crew functioning as a transporter and can carry about eight marines including their equipment as an assault vessel. The crew of a Raptor operate using their flight suits and helmets in order to ensure their protection in case of any hull breach causing depressurization of its cabin.

It cannot takeoff from a Battlestar's launch tube like the Vipers because of its large size; it is launched from a flight pod instead. Battlestars carry squadrons of 8 to 10 Raptors and each Raptor is designated to a Viper squadron with two Raptors on reserve. The Raptors can fly in both atmosphere and space, but in order to maintain lift in an atmosphere its engines must be constantly running which consumes more fuel. At low speeds, Raptors may experience poor handling.

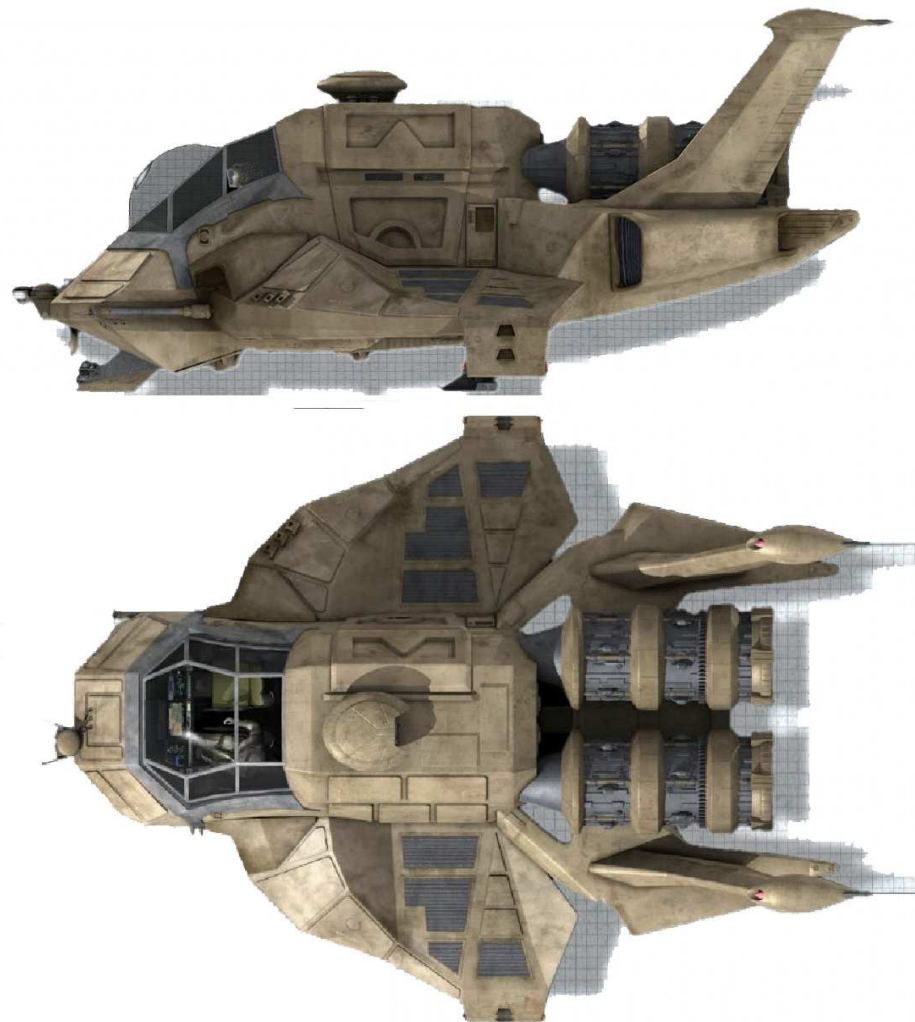

**Raptor, Armed**

Image: Unknown possibly Zoic Studios

Stats by Limerickcot

**Agi** d6, **Str** d8, **Vit** d8, **Ale** d10, **Int** d8, **Wil** d6;**LP** 14; **Init** d8+d10; **Scale** Planetcraft**Speed** 6 (4 in atmosphere; JC), Limited Range**Traits** None**Skills** Mechanical Engineering d4, Perception d6, Pilot d4, Technical Engineering d6**Armament**

2 chain-guns (d12+2 personal scale),

8 guided missiles (d4 planet craft, long range +2 steps to hit);

2 Rocket pods (19 rockets in each: d6 planet craft, skirmish range);

2 Missile Pods (12 missiles in each: d12 medium planetcraft scale, capital range)

**Armour** Wound 3, Stun 3**Description** 28 x 9.5 x 18 feet; **Crew** 3-4;**Passengers** 6-8;**Equipment** DRADIS, electronic countermeasure support, decoys

The Raptor shown to the right and outlined above is a standard adaption of the normal Raptor. Although dedicated versions of the Raptor A do exist, most have been converted from standard models and so, with a full load of guns, missiles and ammunition they are generally over-laden, restricting both speed and agility. However, as they are designed for ground support, this stricture is not seen as critical as high guard will be provided by Vipers or other craft.

All of the stores are carried externally (-1 skill step to re-entry operations) leaving enough space inside the Raptor for passengers (the crew is increased however). Its biggest problem is that the Missile pods are anchored into the doors, making them both heavy and difficult to open, especially if full. They are sometimes considered death traps because of this. With this load, the Raptor A has only half the combat radius of the original so missions have to be carefully planned and executed to make the best of this model.

Raptor A's are used for Close Marine Fire Support missions and, as such, are one of the more recognised craft known to the public and military.



## Raptor Mark II

Stats by Buscadero

Original frame by Mike "bagera4000"

Brown - "Spooky" by XRaiderV1

### Colonial Raptor, Mark II

**Agi** d8, **Str** d8, **Vit** d8, **Ale** d10, **Int** d8,  
**Wil** d6;

**LP** 14; **Init** d8+d10; **Scale** Planetcraft

**Speed** 7 (6 in atmosphere; JC)

**Traits** None

**Skills** Mechanical Engineering d2,  
Perception d6, Pilot d6, Technical  
Engineering d4

### Armament

2 medium planetcraft scale skirmish range  
autocannons (d12),

1 light planetcraft scale skirmish range  
autocannon (d8),

24 short planetcraft scale capital range  
missiles (d12)

**Armour** Wound 4, Stun 4

**Description** 30 x 15 x 10 feet; **Crew** 2;

**Passengers** 8;

**Equipment** DRADIS, electronic  
countermeasure support, decoys

The spooky gunship has a storied development history. Cancelled no less than 100 times by the Quorum of Twelve, and successfully re-instated each time upon appeal by its developer, Spaceworks systems, and subsidiary of Spaceworks industries.

The final convincing proof that the Spooky was indeed worth the estimated 150,000 cubits per unit came after a routine training mission went awry. A pair of MK I Raptors were conducting search and evasion exercises, and ran afoul of some Sagittaron pirates, with one Raptor sustaining crippling damage. Fortunately, a spec ops ship was in the area and provided rescue and evac with their MK II Spooky gunship, after first having dealt with the pirates.

Suffice it to say, this gunship has proven its mettle in a baptism by fire. Only a handful were produced, most going to newer ships like the Atlantis. Later units would see systems and avionics upgrades, such as the EWS, making them hack proof, and ECM suites, combined with their stealth coatings, make them Completely invisible to DRADIS.

Her weapons systems are also quite impressive, with a pair of 30mm auto cannons for starfighter work, a 20mm 'Avenger' auto cannon for surface suppression work, and misc missiles carried in pods mounted on the vehicle's sides, as well as external stores locations for up to 4 additional weapons systems make this a formidable gunship, and a deadly threat to Cylon forces.

MK II Raptor 'SPOOKY' Stealth Gunship Variant

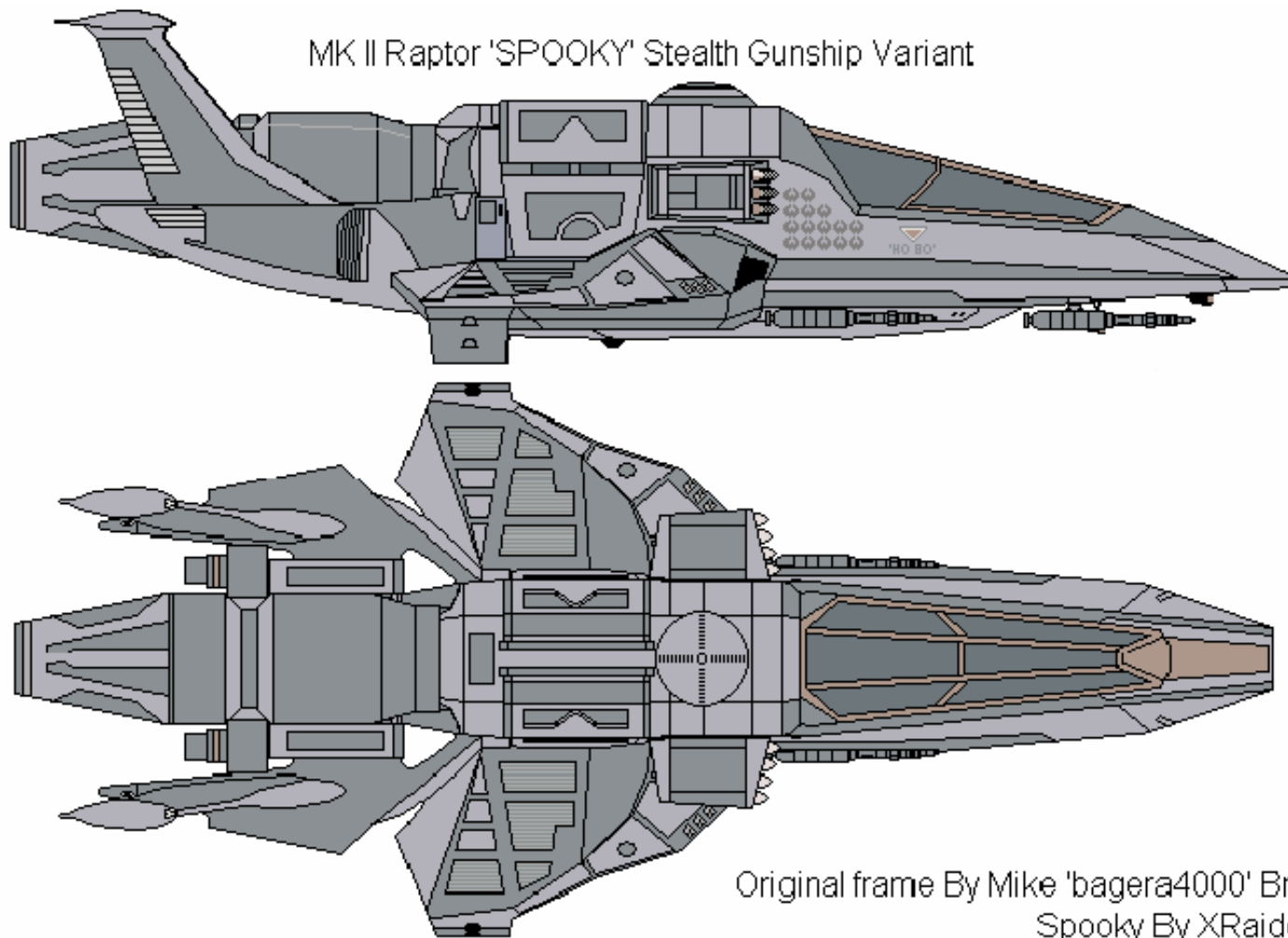

Original frame By Mike 'bagera4000' Brown  
Spooky By XRaiderV1



37

## **Raptor - Heavy Cargo**

By Limerickcot

**Agi** d8, **Str** d8, **Vit** d8, **Ale** d6, **Int** d8, **Wil** d6;  
**LP** 14; **Init** d8+d6; **Scale** Planetcraft

**Speed** 6 (5 in atmosphere; JC)

**Traits** None

**Skills** Mechanical Engineering d4, Perception d6, Pilot d4, Technical Engineering d6

### **Armament**

2 vehicle scale, skirmish range auto guns (d10),  
2 planetcraft scale, medium range missiles (d8)

**Armour** Wound 3, Stun 3

**Description** 48 x 36 x 24 feet;

**Crew** 2+2 gunners; **Passengers** 24 or 1 LCV;

The Heavy Cargo variant of the Raptor was an early adaption to the Raptor airframe designed to fit a need for a transport that is heavier than the standard Raptor and lighter and more combat capable than a standard shuttle. The RHC can fit up to 24 Marines or other passengers in its cargo hold, or up to 30 tons of stores. It has a rear ramp that allows for fast deployment as well as the carrying of light combat vehicles.

With larger engines and a good enough fuel supply the RHC is a useful addition to the marine arsenal, especially on smaller ships that don't have room for LST's.

Although not designed to engage in air-to-air combat, the need to provide some firepower was recognised and so a pair of auto-guns are carried, manned from the passenger compartment. Dedicated gunners are therefore carried to serve these weapons. The two defensive missiles that she carries are controlled by the co-pilot.

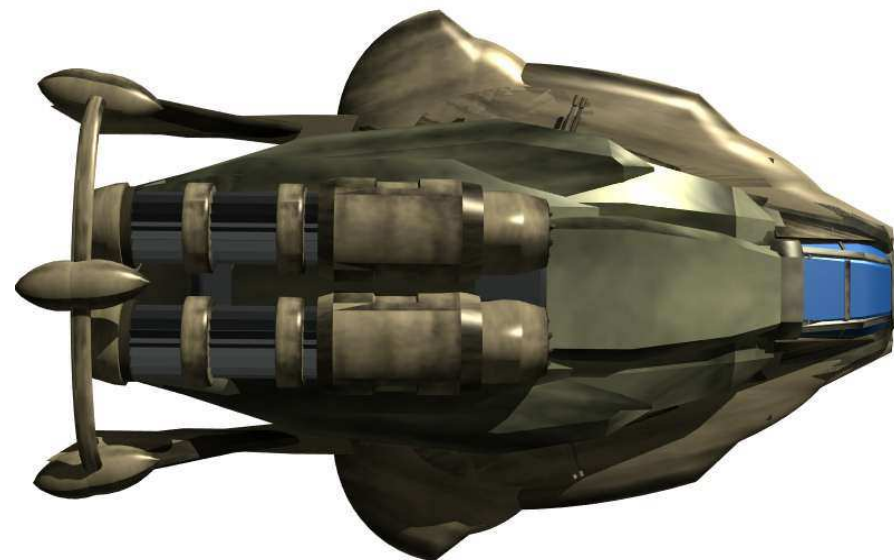

**Raptor - Cargo**  
Limerickcot





## Landing Ship Tank - Type 111

By Limerickcot

**Agi** d6, **Str** d10, **Vit** d8, **Ale** d4, **Int** d4, **Wil** d6;

**LP** 16; **Init** d6+d4; **Scale** Planetcraft

**Speed** 6

**Traits** None

**Skills** Mechanical Engineering d2, Perception d6, Pilot d6, Technical Engineering d4

### Armament

4 Heavy planetcraft scale skirmish range autocannons (d12),

Planetcraft scale, skirmish range, PDS (d6)/8 vehicle scale, skirmish range autocannons (d6)

8 decoys

**Armour** Wound 4, Stun 4

**Description** 110 x 67 x 24 feet;

**Crew** 5;

**Passengers** 120 or 120 tons or 2 tanks or 6 LCV's;

The lessons of the Cylon war were quite brutal. One of those lessons was the inability to put enough men down in one place at one time. The Colonial Fleet had to fall back on hastily armoured shuttles that had poor performance and which tended to be easy targets for the Cylons.

This led to the creation of the Raptor, but Raptors can't carry enough troops and cannot carry vehicles at all. Calls went out for a specification for an armoured transport that could land tanks or other vehicles or large numbers of troops.

A final competition produced the Type III, which was configured for the armoured vehicles then in use by the CMC. To decrease time on the ground the Type One-Eleven's are roll-on, roll-off. Her life support systems preclude long sub-light journeys and she isn't jump capable. All of these things maximise her for cargo and make her cheap to produce.

To provide ground fire, she carries two large guns on each side, allowing her to literally blast her way into a controlled LZ (a necessary requirement when fighting Cylons) and she carries a small array of guns for defence whilst in space and on the ground.



*Type 111 -  
Landing Ship Tank (Heavy)*



39

## **Landing Ship Tank - Type 119**

By Limerickcot

**Agi** d8, **Str** d10, **Vit** d8, **Ale** d6, **Int** d4, **Wil** d6;

**LP** 16; **Init** d8+d6; **Scale** Planetcraft

**Speed** 8 (SL)

**Traits** None

**Skills** Mechanical Engineering d2, Perception d6, Pilot d6, Technical Engineering d4

### **Armament**

4 Heavy planetcraft scale skirmish range autocannons (d12),  
Planetcraft scale, skirmish range, PDS (d6)/8 vehicle scale, skirmish range  
autocannons (d6)

8 decoys

**Armour** Wound 4, Stun 4

**Description** 110 x 67 x 18 feet

**Crew** 5; **Passengers** 80 or 80 tons or 6 LCV's;

The Type 119 Landing Ship Tank is a lighter version of the One-Eleven and is much faster as a result, although it is not FTL capable. However, unlike its larger cousin, the 119 is fully sublight capable and has the life support and facilities to support its marine contingent for several weeks in space (although such is not a recommended action in the CMC).

Her speed and independent airlocks make her a favourite vessel for large scale boarding actions (another area in which Raptors are restricted by their capacity) and for fast strikes against armoured targets.

Some of these vessels supply the recon arm of the Marine Corps, carrying up to six light vehicles and supplies. Others provide medical evacuation and supply duties in active combat zones where shuttles are too much at risk.

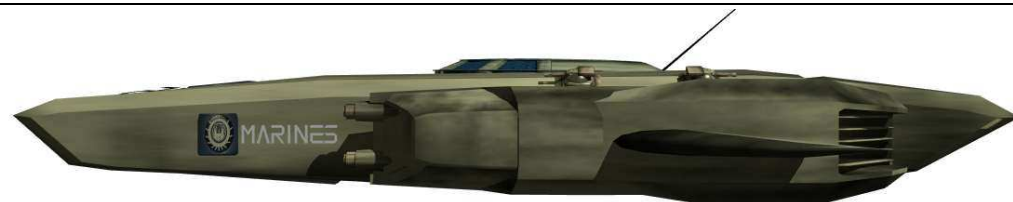

**Type 119 - Landing Ship Tank**  
**Limerickcot**

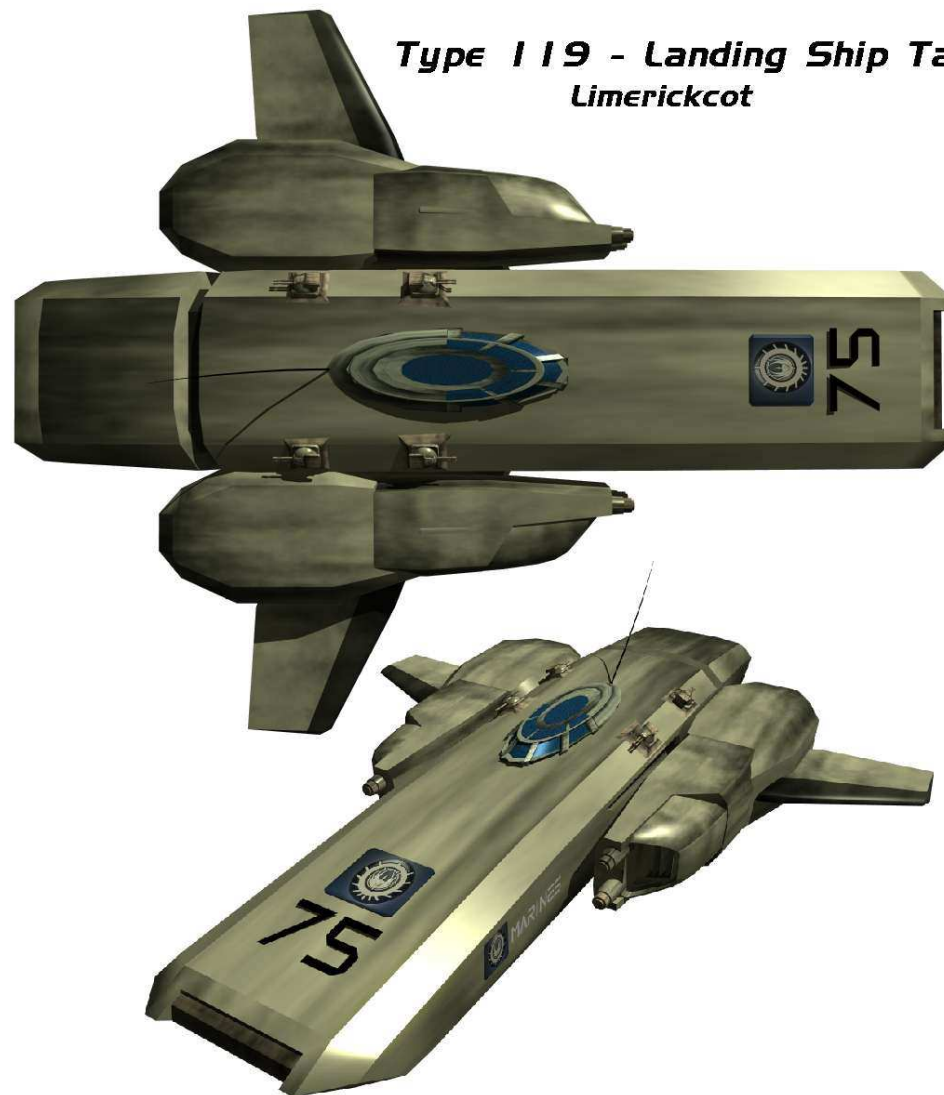

40

## **GRIFFON X7**

By Ki-Ryn

Agi D8 Str D8 Vit D8 Ale D12 Int D8 Wil D8

LP:16 Init: D8+D10 Scale: Planetcraft

**Speed:** 7 (6 in atmosphere; JC)

**Traits:** none

### **Skills:**

d6 mechanical engineering

d6 perception

d6 pilot

d6 technical expertise

**Armament:** deception missile

**Armour:** wound 3, stun 5

**Dimensions:** 155 x 75 x 33 feet

Crew: 4 Passengers: 20 (8 get bunks)

**Equipment:** DRADIS, electronic countermeasure support, signal silence mode, signal cloud, "sheep's clothing" mode, long range FTL

For further information you should buy the Battlestar Galactica Screen – which includes a full plan of this vessel.





41

## **Coxorth Series Tanker.**

Artist Coxxon

Stats by Limerickcot

**Agi** d6 **str** d8 **vit** d8 **ale** d6 **int** d6 **wil** d8

**LP** 16 **init:** d6+d6 **scale:** planetcraft

**Speed:** 6 (5 in atmosphere)

**Traits:** (Past its Prime d2)

**Skills:** d6 perception, d6 pilot

### **Armament:**

4 Decoys,

4 Planetcraft scale, short range autocanon (d8).

**Armour:** wound 3, stun 3

**Dimensions:** 160 x 87 x 45 feet

**Crew:** 5 **Passengers:** 3

The problem of taking out large targets with the relatively puny missiles being carried by the early Vipers, and their lack of targeting ability due to their restricted systems, led to a hastily conceived notion of a space 'bomber' that could carry out those missions. At the beginning of the War they did achieve an impact in slowing up advancing Cylon forces by acting as an atmospheric bomber. Attempts to take out base stars resulted impossible without masses of accompanying Viper escorts, the Coxorth's rarely surviving long enough to reach their targets.

Production was converted over to other weapon types, but one line was kept open producing the Atmo Bomber variant. Even this was to be discontinued when the Colonial Military asked for the conversion of the series over into tanker support craft. With the large scale losses of capital ships, Vipers on long range missions needed refuelling. The Coxorth was hastily converted and saw its first actions mid-way through the war. In flight refuelling is a hazardous undertaking at any time so the normal mission profile is for the Coxorth to come to a full stop (in space of course) and for the Vipers to dock with one of the two rear delivery drogues. A top mount allows for the resupply of ammunition bins (but not missiles) and, by EVA, a replacement pilot can be swapped if need be. This capable craft has continued with little addition for over 40 years with minimum changes other than to its electronics and navigation suites.





# BATTLESTARS

We do not truly know the lineal descendants of the first Battlestars. Our lack of historical knowledge leaves us with just the base knowledge known by the remaining members of the Colonial Fleets, scattered across the Galaxy.

Contemporary history tells us that the Battlestar Galactica was one of the original Battlestars constructed to fight what is now known as the First Cylon War. We must remember that the opposition at that time was the Cylon Base Stars, large vessels carrying a vast complement of fighters and missiles. To counter these vessels took ships of similar magnitude and capability.

To prevent electronic subversion, Battlestars constructed at that time had restricted networks on board with many manual systems designed to prevent Cylon infiltration or attack. Indeed, the very records that we depend on were wiped or destroyed during that war, leaving us with very few written records of what existed before that war.

We can postulate that the Colonies had many other vessels at the time of the First War. But the Cylon's ability to take over any networked system rendered them inoperable or destroyed quite quickly. Only those vessels with obsolete or un-working systems at the time would have survived. Much, indeed, like the few that would succeed them decades later....

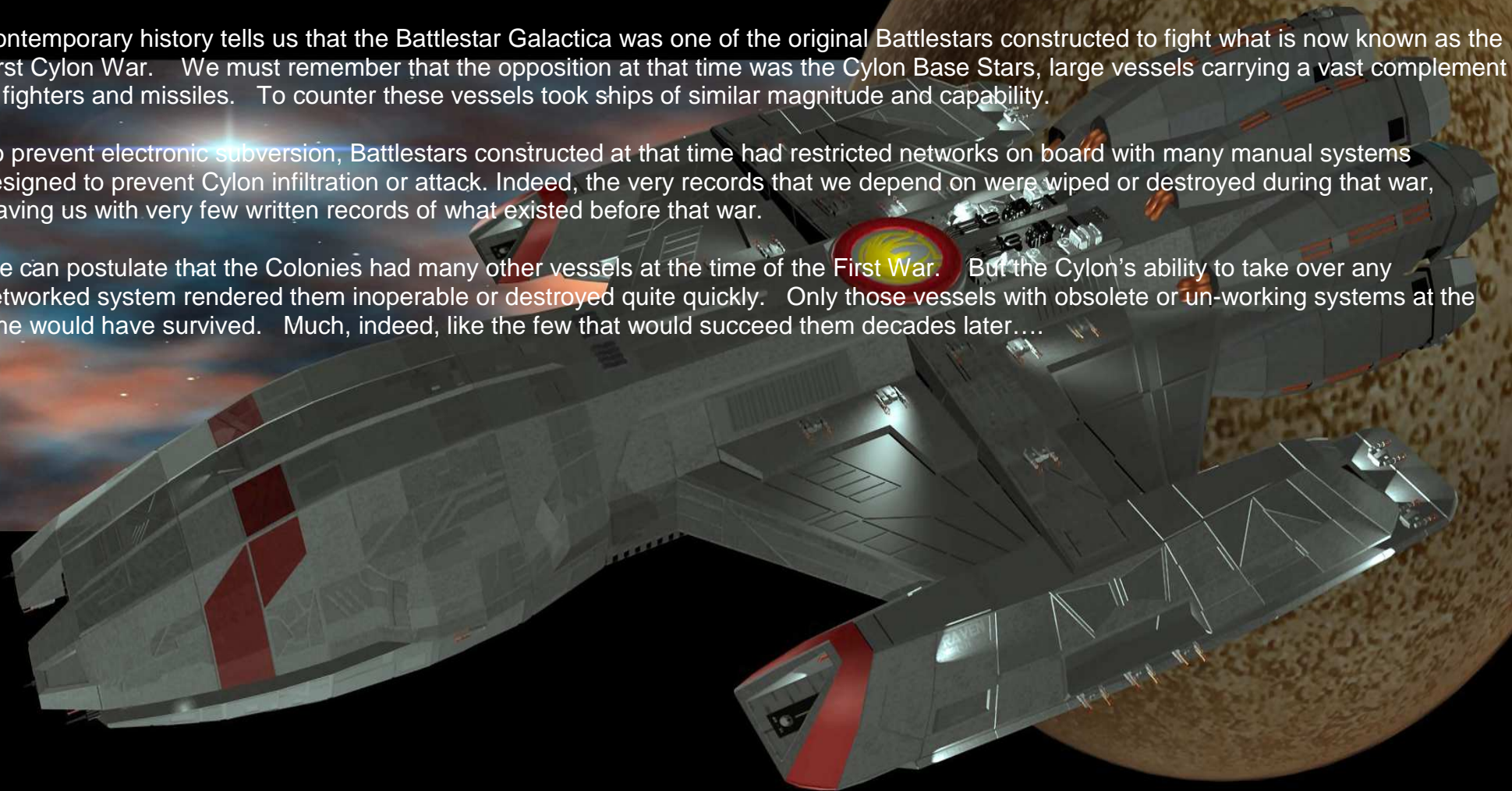

## ***Hercules***

Buscadero (stats)

Guadnacho (art)

**Agi** d6, **Str** d12, **Vit** d6, **Ale** d8, **Int** d8, **Wil** d10;

**LP** 22, **Init** d6+d8; **Scale** Spacecraft

Speed: 7 (SL/JC)

**Traits** Formidable Presence d2

### **Skills**

Heavy Weapons d6,

Mechanical Engineering d4,

Perception d6,

Pilot d6

### **Armament**

Medium planetcraft scale skirmish range point-defence system (d8);

4 medium spacecraft scale short DRADIS range railguns (d12),

6 heavy spacecraft scale short DRADIS range missile systems (d12+d4),

12 medium spacecraft scale short DRADIS range missile systems (d12),

24 Vipers, 12 Raptors, 4 assorted craft

**Armour** Wound 5, Stun 3

**Description** 2,100 x 885 x 450 feet, **Crew** 1,550

**Passengers** 3,000

The Hercules is a remnant of the Cylon War. Smaller than the Mercury class vessels such as Galactica, vessels such as Hercules were built up from whatever materials were handy in a quick and desperate effort to slow the Cylon forces. Many such ships were built, and as many were destroyed. One of the survivors was the Hercules. Small by the standards of the time, and especially by modern conventions, what the Hercules did prove was that the concept of a mix of firepower, and fighters, was the way to survive a fight against the Cylons. In many ways she paved the way for the rapid expansion of the fleet and the building of bigger and more capable Battlestars. Perhaps the true key to her own survival through, lay in her exceptional speed, a quality rarely allowed for in any class that followed her. Hercules was able to run from those fights she could not win, and she did so. By doing so she earned an undeserved reputation for cowardice that was not mitigated one jot by the fact that she was generally first into any fray. Unfortunately by being first in the line, she expended her ammunition stocks rapidly and so had to withdraw.

Her non-standard squadron of Vipers and Raptors continue to make her useful as a training vessel and she is assigned to the Viper Training School on Canceron.



# BATTLESTAR HERCULES



TOP



PROFILE



BOTTOM

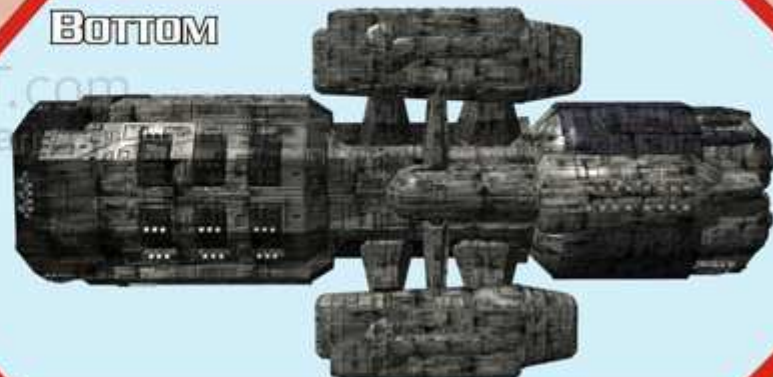

FOREWARD



AFT



## **Argus Class Battlestar**

By SeleK

**Ship Name:** Battlestar *Illustrious*

**Ship Class:** Argus-Type Battlestar

### **Attributes:**

**Agi** d4, **Str** d10, **Vit** d6, **Ale** d8, **Int** d4, **Wil** d10

**LP** 20; **Init** d4+d8; **Scale** Spacecraft

**Speed** 4 (SL/JC)

**Traits** Formidable Presence (d4), Memorable, Past It's Prime (d6)

**Skills** *Heavy Weapons d6, Mechanical Engineering d4, Perception d6, Pilot d4*

### **Armament**

- Heavy planetcraft scale skirmish range point defence system(d12);
- 16 spacecraft scale capital range primary assault railguns (d12+d2);
- 12 spacecraft scale short DRADIS range missile systems (d12+d4);
- 4 spacecraft scale short DRADIS range nuclear missile systems (d12+d8);
- 40 Vipers (full stock), 12 Raptors, 12 assorted craft

**Armour:** Wound 5, Stun 3

**Crew:** 2,800 **Passengers:** 4,500

**Dimension:** 1590 x 490 x 230 (Flight Pod dimensions 610 x 90 x 80)

### **History:**

The Argus-Type Battlestars were built just before the First Cylon War (ironically, largely with Cylon labour). They were intended to be the culmination of an arms race between the naval forces of the various colonies, and when launched, were the largest Colonial warships in existence, setting new standards for speed, armour protection, firepower, and endurance. Ships intended to be the end of an arms race became merely the first in a new generation of warship. Within three years of completion, the Argus-type was essentially obsolete- superseded by the larger and more powerful *Columbia*-type, then building to help halt Cylon aggression.

As built, each of the Argus-type Battlestars was fitted with an advanced integrated combat suite, allowing then-unprecedented coordination between the Battlestar, the ship's weaponry, her Airwing, and escorts. *Illustrious* (and her sisters *Argus* and *Invincible*) began life in the Picon building yards, and were hastily called to service when a minor revolt by the Cylons turned violent

and resulted in the loss of several Colonial naval vessels.

Confronting the Cylons over Tauron, *Invincible* discovered the Cylon ability to infiltrate and compromise computer systems the hard way. Compromised, crippled, and adrift, *Invincible* died there, along with 88% of her crew. Suddenly flawed and vulnerable, *Argus* and *Illustrious* were quickly withdrawn from service and given frantic refits to remove their integrated data systems. When the Argus-type returned to service, their crew complement had doubled, reflecting the need to do manually what had once been done by computer.

*Illustrious* had a very active war, participating in no fewer than seventeen major battles and several dozen skirmishes, twice being damaged severely enough to be returned to the yards for repairs. Eight months before the end of the war, *Illustrious* was assigned to scout the distant Delphi system for Cylon activity- and disappeared with all hands. Search efforts lasted eight months and covered three sectors, but no trace of the missing Battlestar was ever found.

When the Armistice was signed, *Argus* was declared surplus to the needs of the Colonial Fleet, and was decommissioned and mothballed. She spent fifteen years in reserve and was finally sold for scrapping.

### **Quirks/Special Characteristics:**

As built, the Argus-type Battlestar had unprecedented personal space for officers and crew alike. With the automation replaced, however, the ships were cramped, and on certain occasions, junior crewmen were forced to hot-bunk (with three crewmen sharing two beds in strictly scheduled shifts).

Though fast for their day, the Argus-type were quickly surpassed by newer designs.

A major flaw of the class derives from the shape of the landing pods. Although the tapered design streamlines the ship's jump configuration, it also results in much tighter hangar space than is necessary.

Designed to operate a full complement of 60 Vipers, 12 Raptors, and a dozen assorted support craft, *Illustrious* never embarked more than 40 Vipers (plus the Raptors and shuttles) due to aircraft handling problems caused by the cramped quarters.



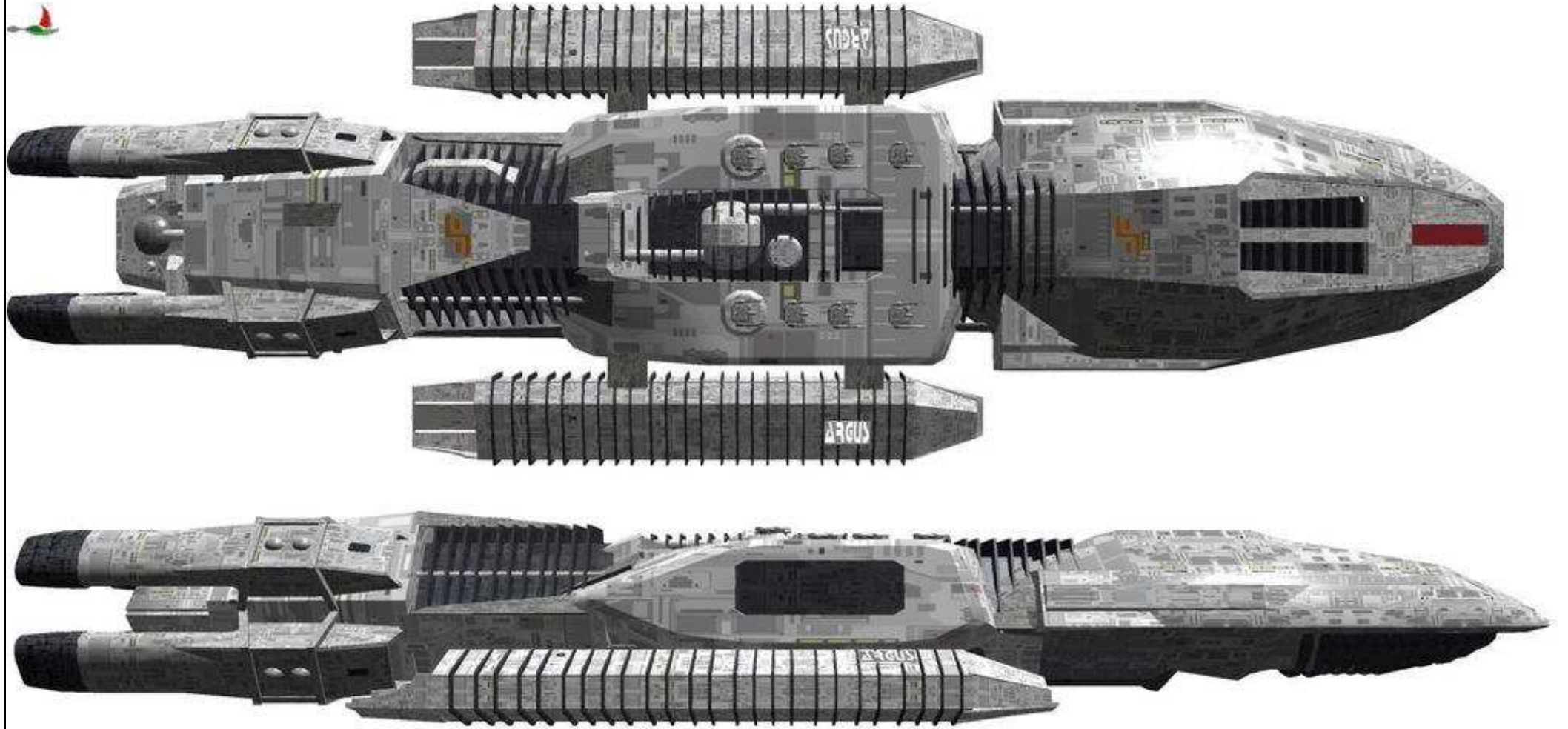

## ***Aesir* Classes**

For many years, the Colonies desperately built up its fleet to a level capable of sustaining any fight that the Cylon menace could bring against it. Although it could rely on the sheer bulk of such ships as Galactica, and indeed would continue to build such ships, it became obvious that cost cutting measures were also needed. Advances in computer protection, FTL and even sublight engine developments, and far better quality controls allowed the fleet to begin standardisation of a new type of Battlestar. Lighter and smaller than the Mercury class, but carrying almost as much firepower, the Aesir Class has become the most numerous type of Battlestar to be found in the fleet.

As is normal in any large class of vessels, built over a lengthy period of time, the *Aesir* Class has seen various sub-classes brought into production. The latest sub-class is known as the *Valhalla*, the three of which are currently undergoing final refit at the Scorpio yards, before joining the 7<sup>th</sup> fleet under Admiral Kane in the *Pegasus*.

The known subclasses, in order of production are: Aesir Class, Aerie Class, Valiant Class, Valkyrie Class, and Valhalla Class.

### ***Aesir* Class**

By King of all GM's

Art by Ice Dragon, modified by Limerickcot

#### **Class Specifications:**

Agi d6, Str d12 + d2, Vit d10, Ale d8, Int d10, Wil d10

LP 24, Init d6 + d8, Scale: Spacecraft

Speed: 5 (SL/JC)

Traits Sharp Sense (Trait, d4), Past its Prime (d4)

Skills: Heavy Weapons d6, Perception d6, Pilot d4, Mechanical Engineering d4

#### **Armament:**

Medium planetcraft scale skirmish range point defence system (d10);

12 spacecraft scale Heavy Short DRADIS range missile systems (d12 + d4);

6 Extreme Long DRADIS nuclear missile systems (12 + d8);

12 spacecraft scale capital Heavy Short DRADIS range assault railguns (d12 + d2)

**Armour:** Wound 5, Stun 4

Description: 3,675 X 1,380 X 591 feet

Crew: 1760, Passengers: 4000

### **Battlestar Air Wing**

(at time of Second Cylon War)

3 squadrons of Vipers Mk VII (60 Viper superiority fighters)

1 squadrons of Raptors (10 Raptor general support craft)

1 squadron of Raptor-Ls (4 Raptor-L logistic support craft)

1 wing of Raptor-Ks (2 Raptor-K in-flight refuelling support craft)

The Aesir Class came into being some 17 years after the end of the First Cylon War. The 12 Colonies had rebuilt all of the damage from the past and were now looking to the future, and the creation of new Battlestars was moving to high on the list of priorities. Though other support ships had been built since the end of the war, Galactica remained the Colonies' only active Battlestar. The military felt something more was needed, and needed quickly.

Rather than reinvent the Battlestar, the Aesir Class was little more than a "downsizing" of the original Battlestars such as the Galactica. The Aesir Class retained most of the same lines as the first Battlestars, though the ships were slightly smaller. One of the newest innovations were hanger decks that didn't need to be retracted into the body of the ship before executing a FTL jump. (This last was due to improvements in FTL technology.) Improvements in armour allowed the smaller Aesir Class to have as much protection as the larger Galactica. And new advances in automation allowed the Aesir Class to have a somewhat smaller crew than the one needed to run a ship the size of Galactica.

Unique to the Aesir Class is an innovative magazine feed system that allowed cannon and missiles to be fired from fixed positions on the same turret. In general fleet exercises it was discovered that the system was prone to jamming during periods of high ammo expenditure, and that there was a 27% chance that missiles would be destroyed by adjoining cannon fire. Despite these shortcomings, this system was only discontinued on the Valhalla Sub-class, although in later production models improved fire control systems had brought mishaps down to less than 1% under continuous fire scenarios.

Eventually 45 Aesir Class were built during a period spanning 19 years to 26 years following the First Cylon War. Though the Aesir Class was, at the time, considered a "prestige" command, within half a decade of the last ship built the vessels were soon overtaken by much larger and powerful Battlestars that,

while they never replaced the Aesir Class completely, somewhat cemented the class's standing as a "second-tier" vessel. (This wasn't always the case, however: certain individual Aesir Class-controlled BSG's were considered extremely prestigious commands.)

8 years before the Second Cylon War all the Aesir Class ships received electronics upgrade, improving their DRADIS and fire control systems. After these upgrades a number of BSG's built around Aesir Class ships were assigned to the Colonial/Cylon Armistice Line for picket duty; individual Aesir Class were also assigned to this region as well. A year before the Second Cylon War the 39 remaining operational Aesir Class ships (the others were

decommissioned for various reasons) were among the first in the Fleet to receive the new CNP upgrades—the upgrade that doomed the Aesir Class vessels along with the rest of the Fleet.

No Aesir Class ships are known to have survived the Second Cylon War.

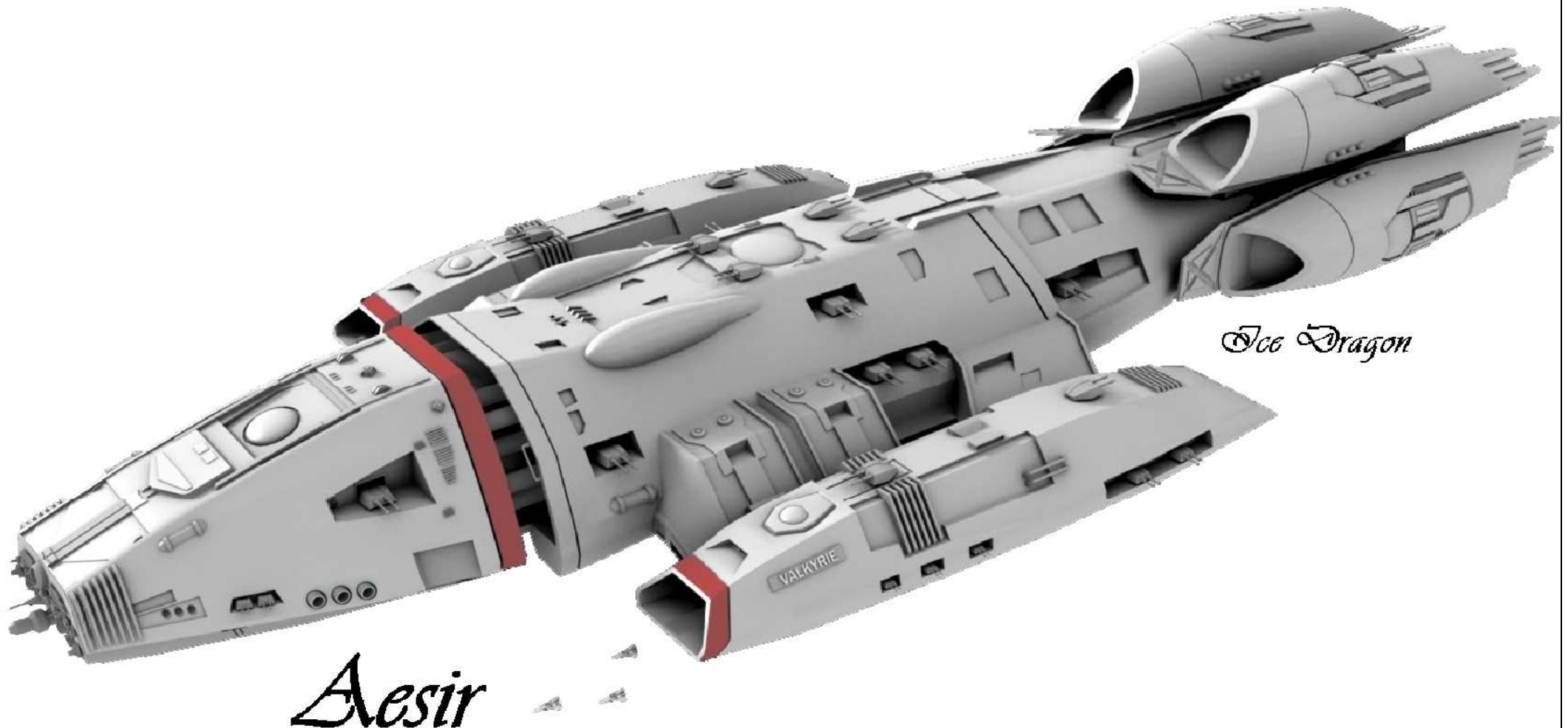

## Aerie Class

By Limerickcot  
Art by Ice Dragon (Modified  
by Limerickcot)

### Class Specifications:

Agi d4, Str d12 + d4, Vit  
d10, Ale d8, Int d10, Wil d10  
LP 24, Init d6 + d8, Scale:

Spacecraft

**Speed:** 5 (SL/JC)

**Traits:** Tough (d2)

**Skills:** Heavy Weapons d6,  
Perception d6, Pilot d4,  
Mechanical Engineering d4

### Armament:

Medium planetcraft scale  
skirmish range point  
defence system (d10);  
10 spacecraft scale Heavy  
Short DRADIS range  
missile systems (d12 + d4);  
6 Extreme Long DRADIS nuclear missile systems (12 + d8);  
12 spacecraft scale capital Heavy Short DRADIS range assault railguns (d12 + d2)  
4 spacecraft scale capital Heavy Medium DRADIS range planetary assault railguns (d12+d4)

**Armour:** Wound 5, Stun 4

**Description:** 3,765 X 1,380 X 612 feet  
Crew: 2120; Passengers: 1800

### Battlestar Air Wing

2 squadrons of Vipers Mk VII (20 each)  
2 squadrons of Raptors-A (20)  
1 squadron of Raptors (20)  
1 squadron of Dropships (20)  
1 squadron of mixed ELINT craft

*Aerie*

*Original Model by Ice Dragon  
Modified by Limerickcot*

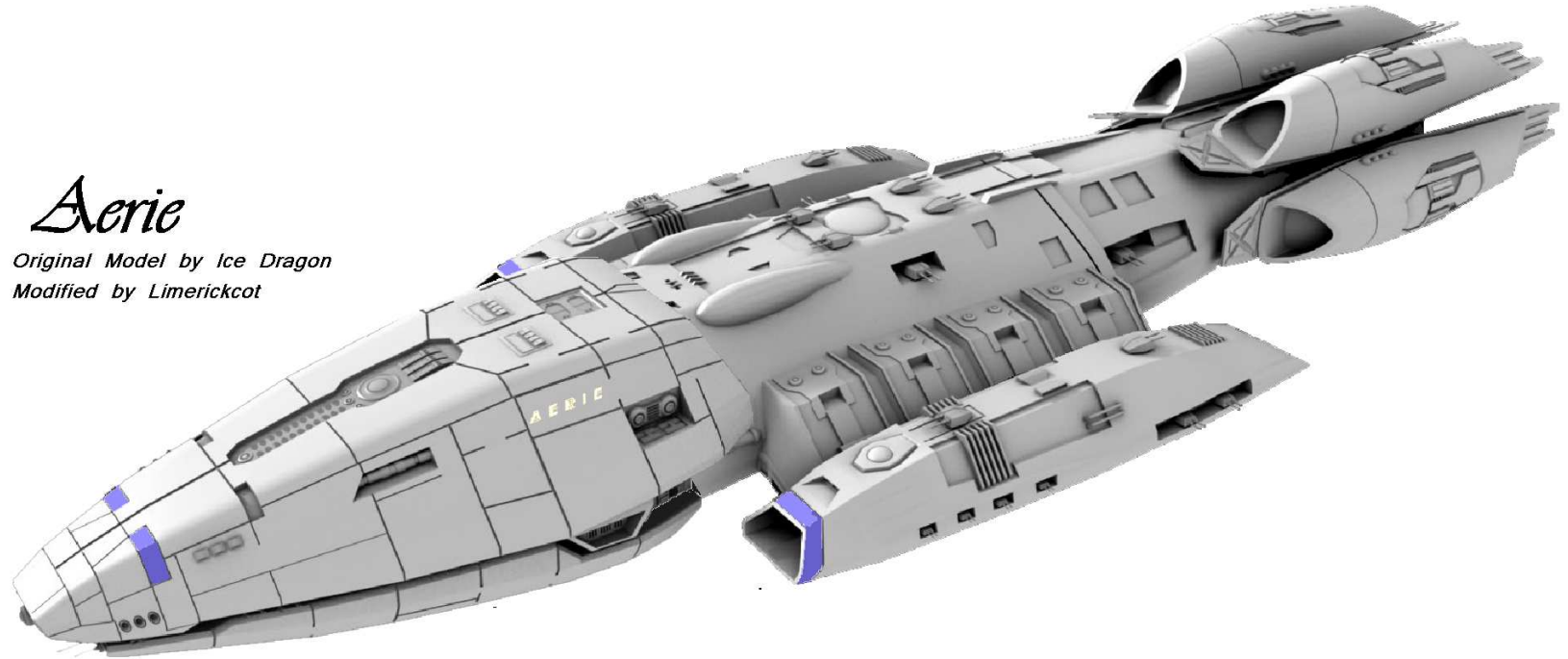

2 squadrons of shuttles (8 each)  
Various specialist craft (recon, refuelling etc)

The Aerie was one of the first major subclasses of the Aesir. Originally designed to replace that class, it was found that its upgraded engines, although providing plenty of power, were not as responsive as they should have been, due to the increased forward mass of the design. Instead of scrapping the design, the sub-class was turned into a Marine Support Vessel. It was outfitted with orbital bombardment capabilities, an excellent field hospital and sufficient support facilities to help provide air superiority over any contested air space.

Generally considered to be outclassed by the older Aesir, they still continue to provide an excellent close-in escort capability to their Marine Groups. They also act as planning, signals and logistics co-ordinators for any group they serve, usually making them the headquarters for the general commanding any marine division.



# Valiant

*Original by Ice Dragon  
Modified by Limerickcot*

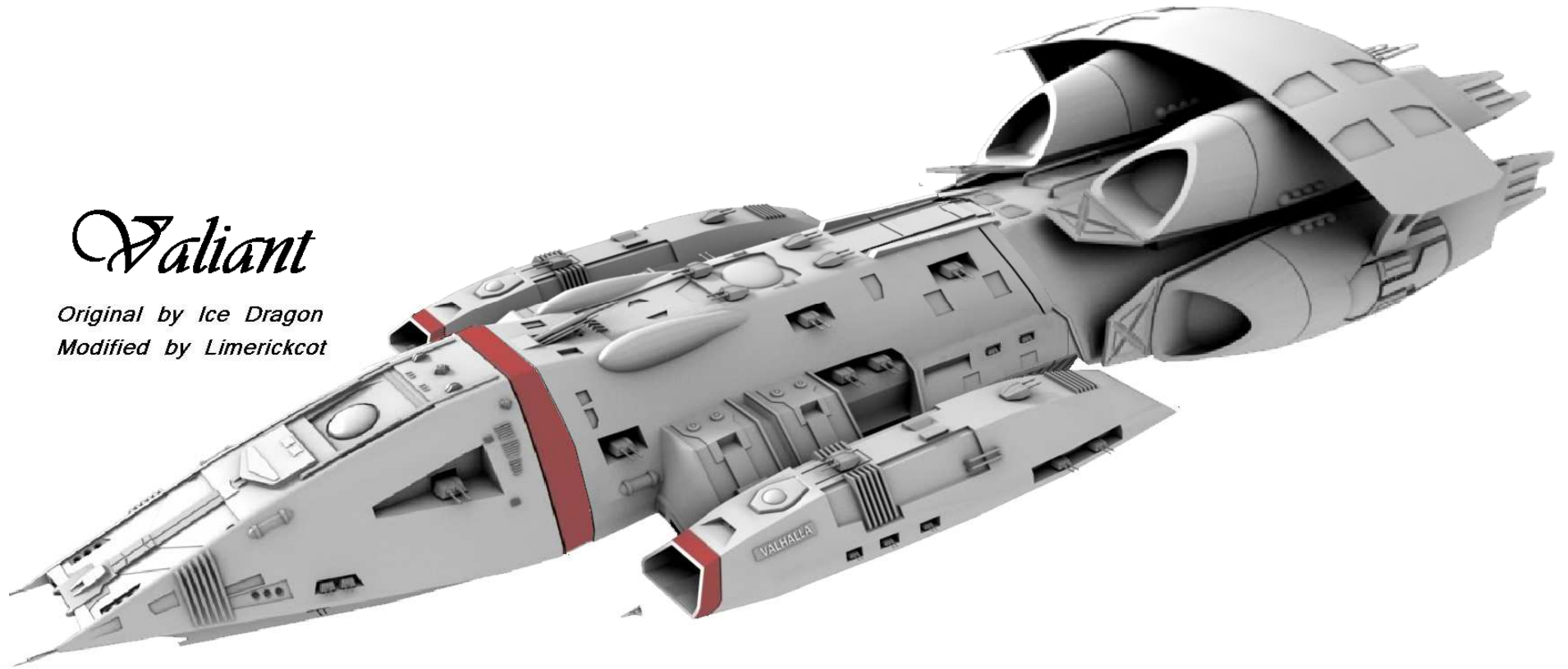

## **Valiant Class**

By Selek

Art by Ice Dragon (Modified by Limerickcot)

Agi d6, Str d12+d2, Vit d6, Ale d8, Int d8, Wil d10; Life Points 24;

Init d6+d8; Scale: Spacecraft; Speed: 5 (SL/JC)

Traits: Formidable Presence (d4), Past It's Prime (d2)

Skills: Heavy Weapons d6, Mechanical Engineering d4, Perception d6, Pilot d4

**Armament:** Heavy planetcraft scale skirmish range point-defence system (d12);

14 spacecraft scale capital range primary assault railguns (d12+d2);

12 spacecraft scale short DRADIS range missile systems (d12+d4);

12 spacecraft scale short DRADIS range nuclear missile systems (d12+d8);

**Airwing:** 68 Vipers (full stock), 20 Raptors, 12 assorted craft

Armour: Wound 6, Stun 4

Description: 3979.8 x 1,514 x 634 feet; Crew 2,800; Passengers 5,000

Yet another sub-class of the Aesir, the Valiant utilised more efficient engines and computerised system's, allowing her to carry better armour and slightly better armament. She paid for this with the need to embark more crew (she was not networked). Generally the ship was a failure, with cramped quarters and restricted range and supplies. Despite carrying a larger Airwing, the flight pods were not adequate to the job of both launch and recovery at the same time, resulting in the need for support from other vessels during critical times of landing recovery.

**Valkyrie**

By Feroz

Art: Ice Dragon

Agi: d4 Str: d12+d4 Vit: d6 Ale: d8 Int: d8 Wil: d10

LP: 28 Init: d4+8

Scale: Spacecraft

Speed: 6 ( SL/ JC )

**Skills:** Heavy Weapons d6, Mechanical Engineering d4, Perception d8, Pilot d4**Armour:** Wound 5, Stun 5**Description:** 4685 (l) x 1622 (b) x 565 (h)**Crew:** 2400 Passengers: 3000**Armament:**16 spacecraft scale  
capital range primary  
assault railguns (   
d12+d2 ),16 spacecraft scale  
short DRADIS range  
missile systems (   
d12+d4 standard,  
d12+d8 nuclear )Heavy planetcraft  
scale skirmish range  
point defence guns (   
d12 );**Airwing:**60 Vipers; 15  
Raptors; 10 shuttles  
and repair vehiclesAlthough the Valkyrie  
sub-class looks  
identical to the Valiant  
class, it is actually a

much larger craft. This increase in dimensions, especially in the flight pods, allowed the Valkyrie to break away from the short-ranged capabilities of its predecessors. This variant was the first to delete the rail guns, replacing them purely with missile turrets, primarily due to the increased sophistication of the fleets ECCM systems then being incorporated into the missile programs. It was this need that drove the increased mass of the Valkyrie. However, despite the effectiveness, especially over long range, of the missile systems, it was determined that they were incapable of keeping up the same level of firepower as conventional rail-gun armament could at shorter ranges.

Only a very few of the Valkyrie class were actually built. The remaining hulls under construction were converted into the Valhalla sub class and it is these that are designed to operate alongside vessels such as *Pegasus*, taking the place of the older vessels, such as *Galactica*, that would have once stood in their place.

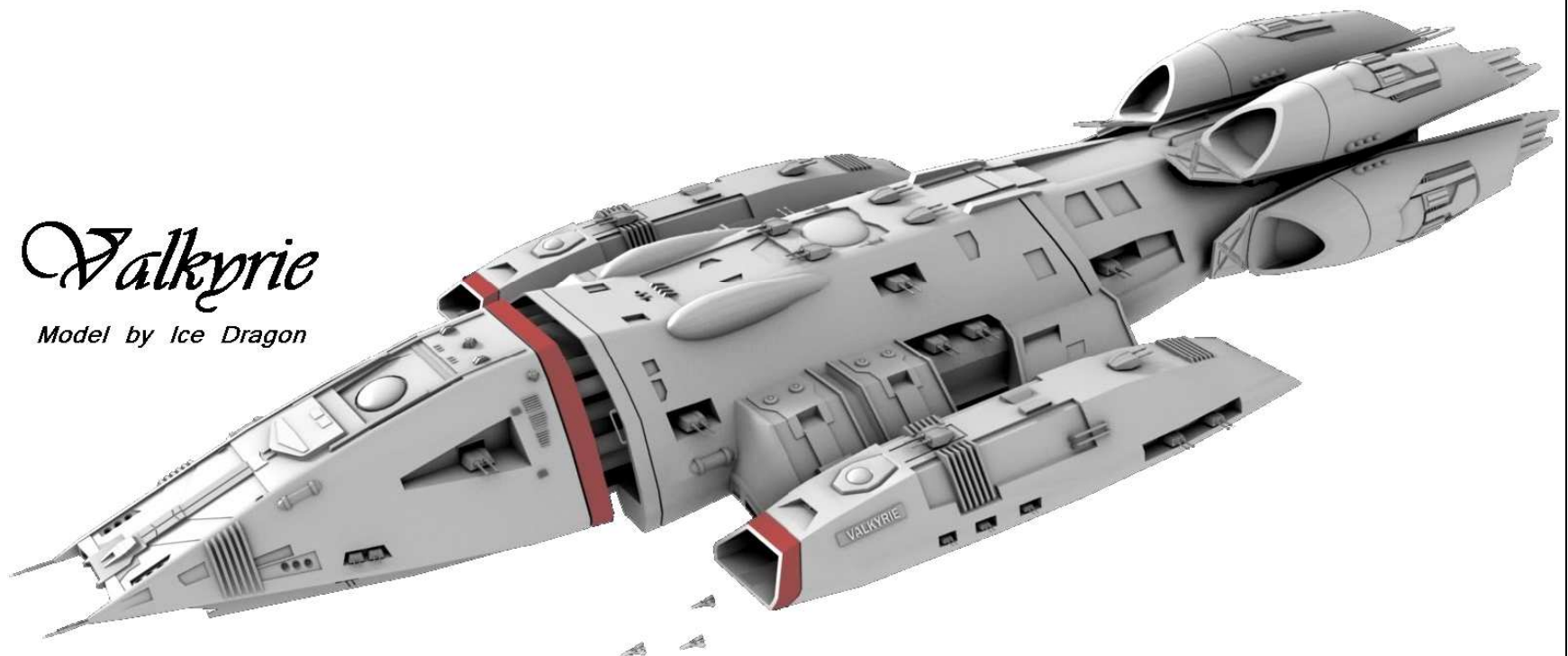

**Valhalla**

By Limerickcot  
Art: Ice Dragon

Agi: d6  
Str: d12+d4  
Vit: d6 Ale: d12  
Int: d12 Wil: d10  
LP 28  
Init: d4+d8  
Scale: Spacecraft  
Speed: 6 (SL/JC)

**Skills:** Heavy  
Weapons d6,  
Mechanical  
Engineering d4,  
Perception d8,  
Pilot d4

**Armament:**

Heavy planetcraft  
scale skirmish  
range point  
defence guns  
(d12);

16 spacecraft scale Heavy Short DRADIS range missile systems (d12 + d4);  
12 Extreme Long DRADIS nuclear missile systems (12 + d8);  
16 spacecraft scale capital Heavy Short DRADIS range assault railguns (d12 + d2)  
28 spacecraft scale Capital Medium range Railguns (d10).

**Airwing:**

60 Vipers; 15 Raptors; 10 shuttles and repair vehicles

**Armour:** Wound 5, Stun 5

**Description:** 4320 x 1622 x 610

**Crew:** 1800 Passenger: 3000

*Valhalla*  
Ice Dragon

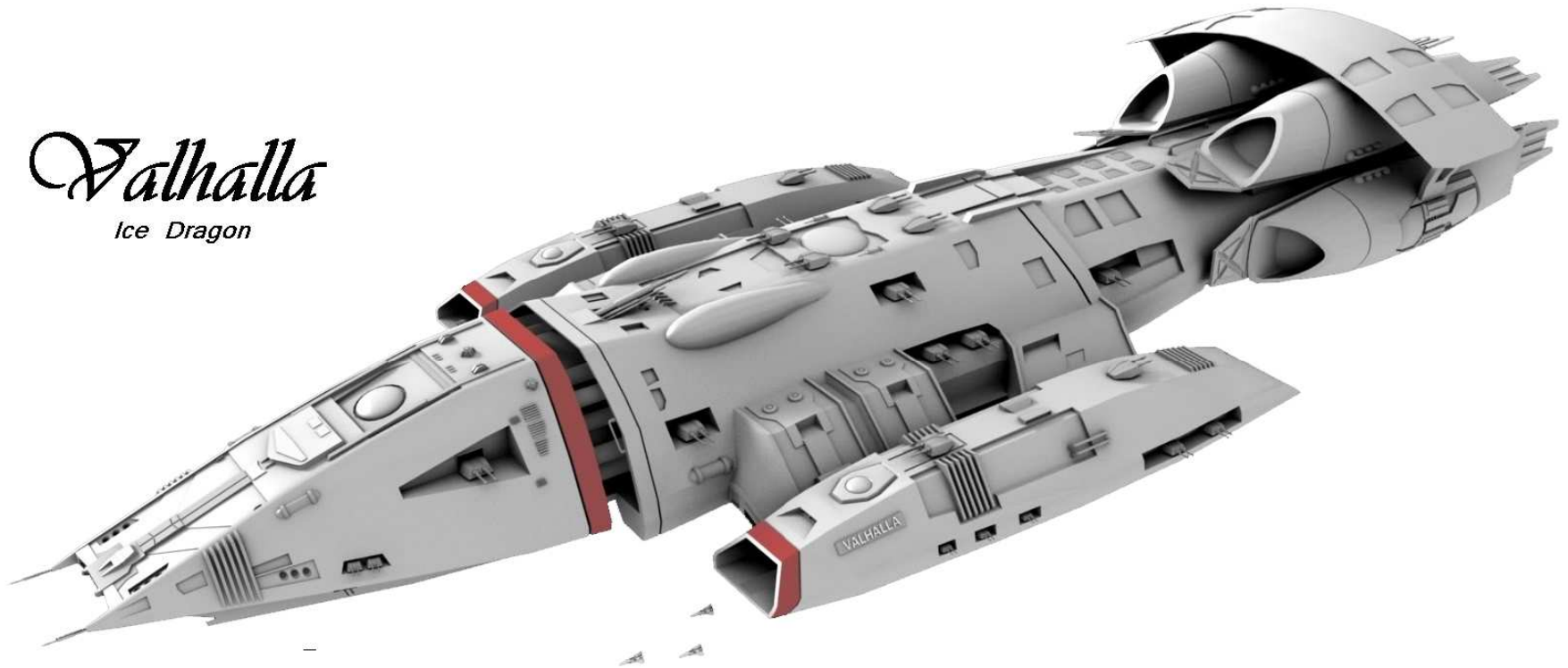

The Valhalla class is destined to become the most prolific of the current range of Battlestars to be built for the Colonial Fleet. It is the first major vessel the Fleet has built, from the keel up, to be fully networked, protected by the most sophisticated systems and firewalls designed to date in the Colonies, and rivalling, or even surpassing systems built before the Cylon War.

The only reason it has not already become the dominant vessel class is due to the ongoing budgetary issues currently plaguing the military. Although the number of main guns carried are less than on similar vessels, the Valhalla's ability to co-ordinate its fire, and its superb anti-ECCM capabilities mean that no comparable vessel can touch it, especially at long range.

She also maintains a lighter battery of guns to provide escort cover in her role as escort leader in a battle group. Her DRADIS and electronic suites allow her to effectively network with other ships of her class across the Cyrannus system and feed that information back to group flagships. In a cost cutting move, ships of the Valkyrie class are being brought up to Valhalla standards.

## Battlestar *Atlantia*

Stats by Buscadero

© by David Briedis

**Agi** d6, **Str** d12+d4, **Vit** d6, **Ale** d8, **Int** d10, **Wil** d10;

**LP** 26; **Init** d6+d8; **Scale**

Spacecraft

**Speed** 5 (SL/JC)

**Traits** Formidable Presence (d4),  
Memorable (d2)

**Skills** Heavy Weapons d6,  
Mechanical Engineering d4,  
Perception d6, Pilot d6

**Armament** Heavy planetcraft  
scale skirmish range point-  
defence system (d12), 26  
spacecraft scale primary assault  
railguns (d12+d2); 12 spacecraft  
scale short DRADIS range missile  
systems (d12+d4); 12 spacecraft  
scale short DRADIS range nuclear  
missile systems (d12+d8); 86  
Vipers, 20 Raptor, 13 assorted  
craft

**Armour** Wound 6, Stun 5

**Description** 4,750 x 1,800 x 740  
feet;

**Crew** 3,400; **Passengers** 7,500

The *Atlantia* served with great distinction during the Cylon War and was gradually modernized over the years. Now she is a command version of the original Battlestars and features integrated command and control systems. The *Atlantia* is larger and has extra Viper squadrons as well as additional firepower to compliment her flag facilities and enhanced command abilities.

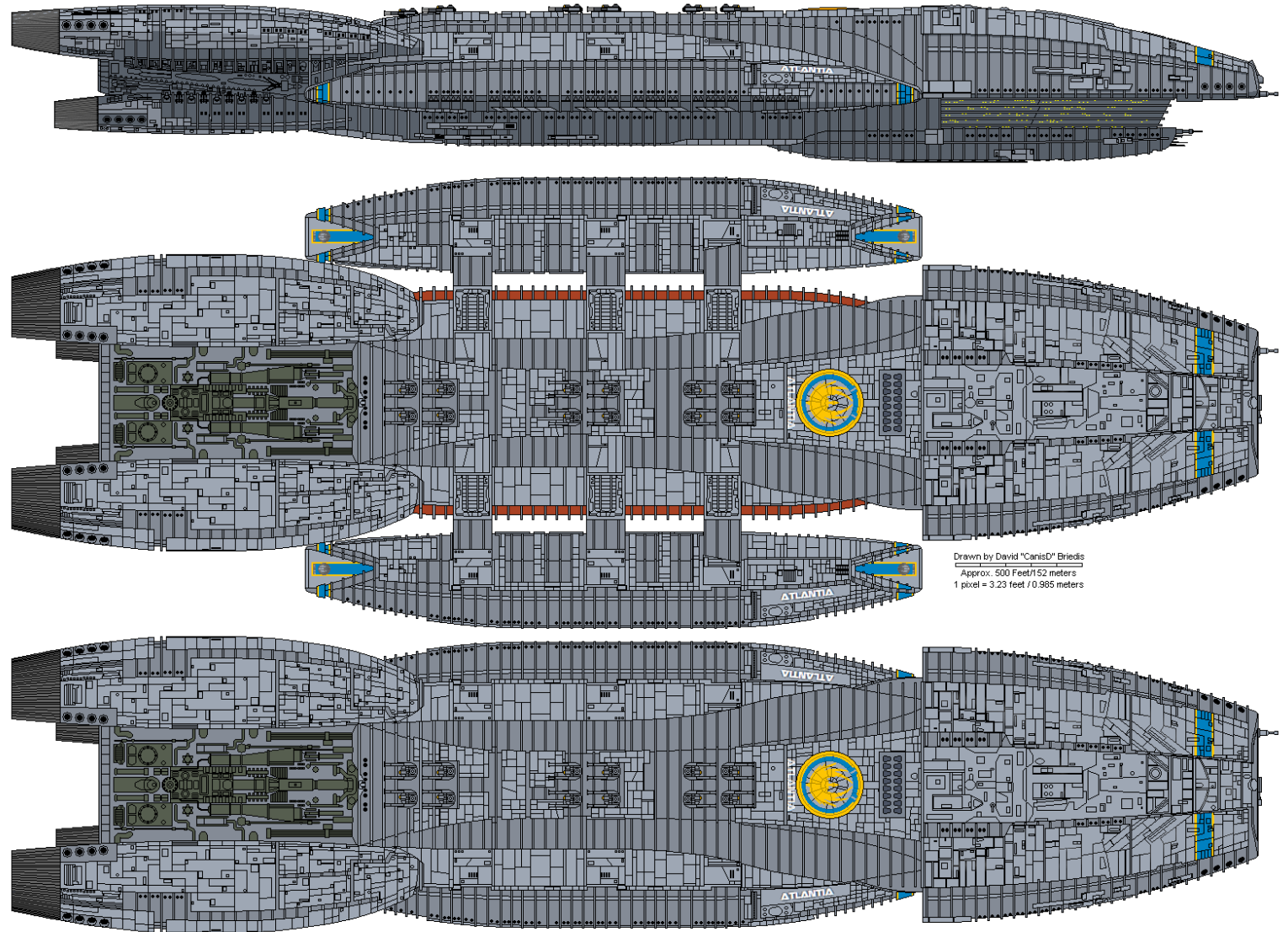

Drawn by David "CanisD" Briedis  
Approx. 500 Feet/152 meters  
1 pixel = 3.23 feet / 0.985 meters



## Mercury Class

By Blackcampbell  
Pic © Ice Dragon

Agi: D4 Str: D12+6 Vit: D8 Ale: D10 Int: D10 Wil: D10  
Init: D4+D10 Life: 26 Scale: Spacecraft Speed: 5 [SL/JC]

### Skills:

Heavy Weapons d6, Mechanical Engineering d4, Perception d6, Pilot d4

### Traits:

Formidable Presence (d4), Viper Construction Facilities (d4)

### Armament:

Heavy Skirmish  
Range Point Defence  
System [d12W  
Planetary-scale ]  
30 Capital-range  
Heavy Railguns  
[d12+d2W  
Spacecraft-scale]  
12 Short DRADIS-  
range Heavy Missile  
Systems [d12+d4W  
Spacecraft-Scale]  
12 Long DRADIS-  
Range Nuclear  
Missile Systems  
[d12+d8W  
Spacecraft-scale

### Airwing

5 Squadrons Mk VII  
Vipers  
25 Raptors  
12 auxiliary craft

**Armour:** 6 Wound, 6  
Stun

Length: 1447.8m Beam: 505m Draught: 295m  
Decks: 25 Crew: 1500 standard, 10,000 max

Essentially an updated and highly modernised version of the Atlantia, the Mercury class vessels are the flagships of the fleet. Far larger than any other production class (bar a few specialised hulls built over the years) she is a capable and deadly vessel. She pays for her heavy armament and long distance range with low speed and agility in comparison to lighter Battlestars.

The Mercury class vessels are all over ten years old (from the last built) but they are an easy class to maintain for their crews. This has been enhanced by the increased networking of the vessels allowing for the quick and easy detection and replacement of defective parts.

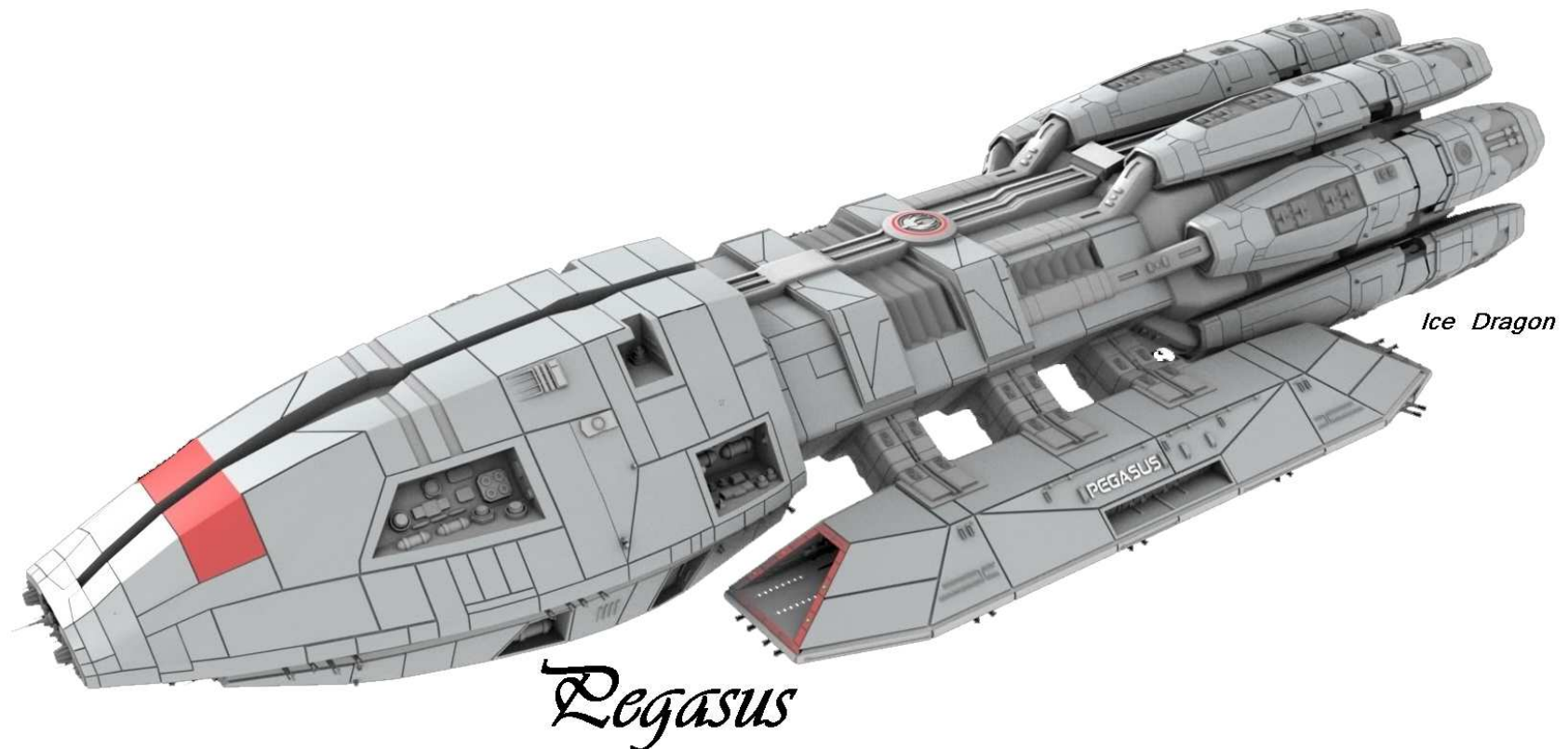

## Minerva Class

Battlestar Pleiades  
Stats by Buscadero  
© by tan.j

**Agi** d6, **Str** d12+d6, **Vit** d6, **Ale** d10, **Int** d10, **Wil** d10;  
**LP** 28; **Init** d6+d10, **Scale** Spacecraft  
**Speed** 5 (SL/JC)

**Traits** Formidable Presence (d4)

**Skills** Heavy Weapons d6, Mechanical Engineering d4, Perception d6, Pilot d4

**Armament** Heavy planetcraft scale skirmish range point-defence system (d12); 32 heavy spacecraft scale short DRADIS range railguns (d12+d2); 16 medium spacecraft scale short DRADIS range missile systems (d12); 16 extreme spacecraft scale long DRADIS range nuclear missile systems (d12+d8); 144 Vipers; 36 Raptors; 21 assorted craft

**Armour** Wound 7, Stun 5

**Description** 5,905 x 2,374 x 918 feet;  
**Crew** 3,985; **Passengers** 7,900

*Pleiades* (BSG 32) is a Minerva class Battlestar, commanded by Commander Solomon Anderson during the Fall of the Twelve Colonies.

Technologically more advanced and greater in size and firepower than the to-be-decommissioned *Galactica*, *Pleiades* was presumed destroyed in the Cylon attack, but had in fact survived.

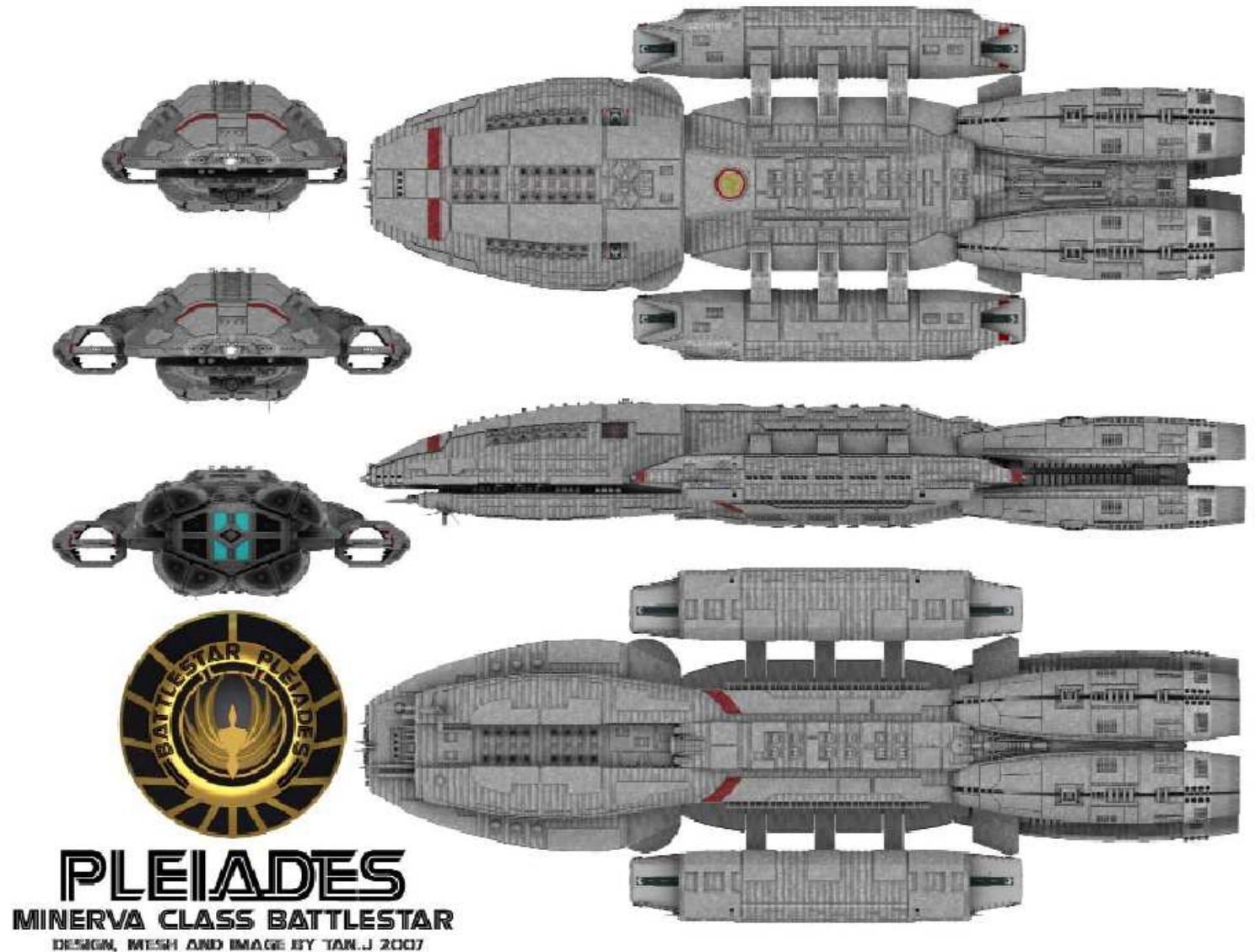

## ***Morrigan Class***

Stats by Limerickcot

Pic © Arashikami

**Agi** d6, **Str** d12+d3, **Vit** d6, **Ale** d10, **Int** d10, **Wil** d10;

**LP** 28; **Init** d6+d10, **Scale** Spacecraft

**Speed** 5 (SL/JC)

**Traits** None

**Skills** Heavy Weapons d6, Mechanical Engineering d4, Perception d6, Pilot d4

### **Armament**

Heavy planetcraft scale skirmish range point-defence system (d12);

45 heavy spacecraft scale short DRADIS range railguns (d12+d2);

8 medium spacecraft scale short DRADIS range missile systems (d12);

8 extreme spacecraft scale long DRADIS range nuclear missile systems (d12+d8);

### **Airwing**

80 Vipers

20 Raptors

21 assorted craft

**Crew** 2,200

**Passengers** 500

The two vessels of the Morrigan class – the Raven and Urantia – are attempts to overcome one of the biggest problems found in any space combat – that of bringing as much firepower to bear on a target as possible. New FTL technology has allowed the Colonial Fleet to build a ship that is much broader than normal.

And they have taken advantage of this, not by increasing the vessels airwing, but rather by increasing its firepower and ammunition storage. In much the same way as the Valhalla, these two ships are fully networked and rely on a tiny crew to keep the vessel flying. Its dedication to weapons system is also reflected in its inability to host much in the way of passengers. Most Battlestars have the facilities to carry large numbers of extra personnel – a hold over from the original Cylon war when many different specialists might be needed right on the battle line.

Even after the war, this capacity was appreciated for rescue and transport missions. But by deleting that capacity, the Morrigan is not too much bigger than a Valhalla, with all the difference in cost that that entails, but has a greater firepower than that ship class could ever put out. The Morrigan's primary problem is a matter of speed and fuel as it's engines are underpowered for its mission profile.

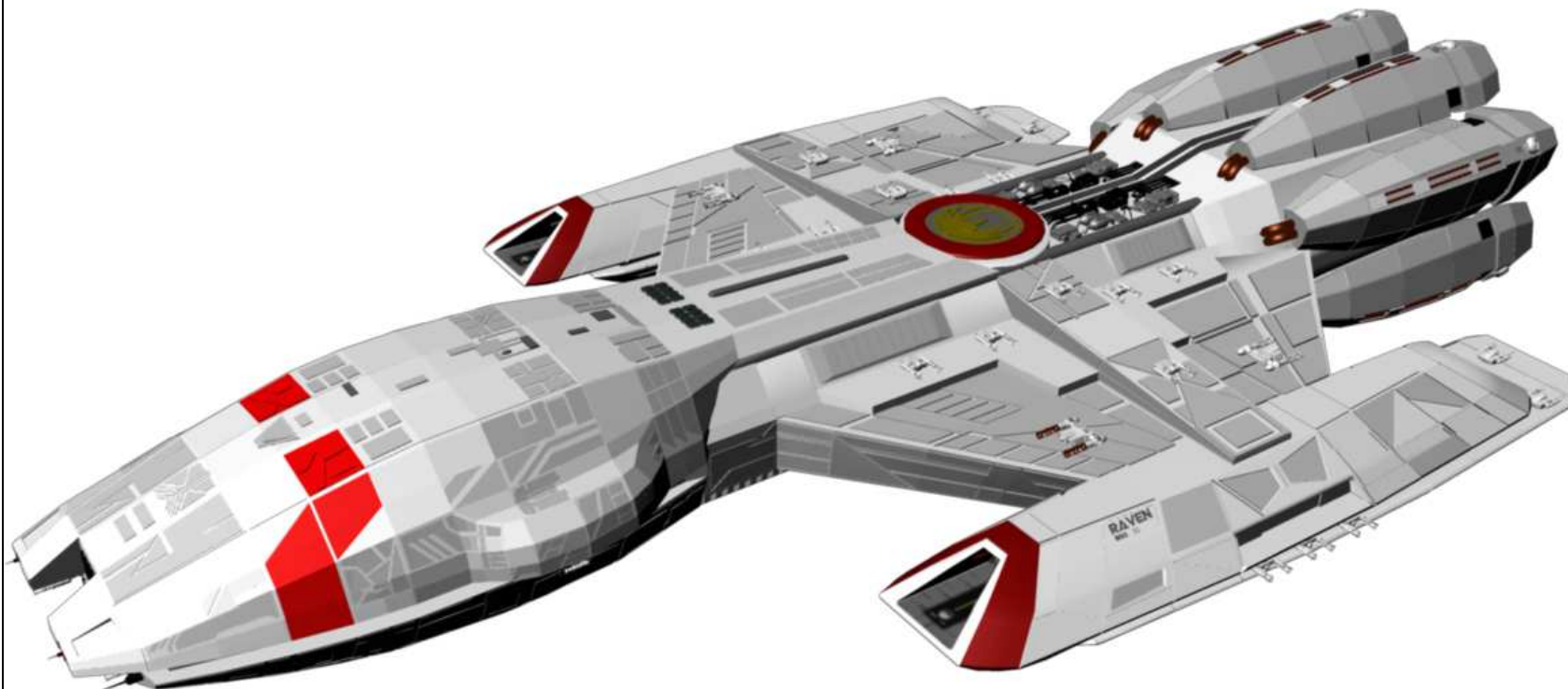



## Arvak Class Battlestar

art by Tan.J

### Attributes:

**Agi** d6, **Str** d10, **Vit** d10, **Ale** d8, **Int** d10, **Wil** d10

**LP** 24; **Init** d6+d8; **Scale** Spacecraft

**Speed** 5 (SL/JC)

**Traits** Memorable (Complication, d4)

**Skills** *Heavy Weapons d6, Mechanical Engineering d4, Perception d6, Pilot d4*

**Armament** Medium planetcraft scale skirmish range point defence system(d10);

- 12 spacecraft scale Heavy Short DRADIS range assault railguns (d12 + d2)
- 12 spacecraft scale short DRADIS range heavy missile systems (d12+d4);
- 6 spacecraft scale long DRADIS range nuclear missile systems (d12+d8);
- 60 Vipers (full stock), 25 Raptors, 12 assorted craft

**Armour:** Wound 8, Stun 7

**Size:** 3675 feet x 1380 x 591 feet

**Crew:** 1640; **Passengers:** 3,200

### History:

The eight *Arvak* Class Battlestars are contemporaries of the *Aesir Valkyrie* and *Mercury* Class designs, and like the *Aesir*'s, were an attempt to field a fully capable Battlestar on the smallest and cheapest hull possible. In that attempt, they failed, miserably. The design was too lightly built, and as a result each *Arvak* Class Battlestar had to be fitted with additional structural bracing and extra armour, which led to serious cost overruns, and in turn, political scandal. The *Arvak* class Battlestars are robust, capable, and flexible, but are not worth the price Colonial taxpayers wound up paying for them.

### Quirks/Special Characteristics:

One of the primary concerns surrounding this Battlestar design was the comparatively light construction of the hull, and as a result the class were fitted with additional armour- specifically, a cast armour shell that covered roughly two-thirds of the ship's length. These innovative laminate armour shells comprised the largest cast structures every built by Colonial science, and each boosted the cost of the Battlestar by almost thirty percent, taking them well over budget. Needless to say, in an era of tight budgets and fiscal restraint, this experiment was not repeated.

### Notable Vessels in Class:

Battlestar *Arvak* (BSG 60 Flagship; Class vessel)

Battlestar *Skinfaxi* (BSG-25; Station ship in Helios system. Responsible for steep drop in pirate operations in that system.)





## Minerva Class Battlestar

Art by Tan.J

### Attributes:

**Agi** d6, **Str** d12+d6, **Vit** d6, **Ale** d10, **Int** d10, **Wil** d10

**LP** 28; **Init** d6+d10; **Scale** Spacecraft

**Speed** 5 (SL/JC)

**Traits** Formidable Presence (d4)

**Skills** Heavy Weapons d6, Mechanical Engineering d4, Perception d6, Pilot d4

### Armament

- Heavy planetcraft scale skirmish range point defence system(d12);
- 32 spacecraft scale capital range primary assault railguns (d12+d2);
- 16 spacecraft scale short DRADIS range heavy missile systems (d12+d4);
- 16 spacecraft scale long DRADIS range nuclear missile systems (d12+d8);
- 100 Vipers (144 Pleiades), 25 Raptors (32 Pleiades), 12 assorted craft

**Armour:** Wound 7, Stun 5

**Size:** 5,905 x 2,374 x 918 feet;

**Crew:** 3,985; **Passengers:** 7,900

### History:

The eleven *Minerva* Class Battlestars were the largest Battlestars built during the Cylon War, and were roughly the same size as the later *Mercury* class.

Unfortunately, they shared many of the technological limitations of earlier designs, requiring- among other things- retractable landing pods in order to facilitate FTL jumps.

Despite these drawbacks, these vessels gave good service during the last years of the Cylon war and for several decades thereafter. As newer designs were completed and entered



**HYADES**  
**MINERVA CLASS BATTLESTAR**  
DESIGN, MESH AND IMAGE BY TAN.J 2007

service, the *Minerva* class was decommissioned until only the *Pleiades* and *Hesperides* remained.

### Quirks/Special Characteristics:

*Pleiades* was the test bed ship for the dual axial flight deck fitted to the *Mercury* Class, and so has four landing bays, with each landing pod having two flight decks- one running parallel to the ship's line of flight, the other inverted beneath it. Special elevators and airlocks bring embarked craft into sync with the ship's gravity as they are transported to the hangar deck.

### Notable Vessels in Class:

Battlestar *Hesperides* (BSG 87 Flagship;)

Battlestar *Pleiades* (BSG 32 Flagship; Commanded by Commander Solomon Anderson)

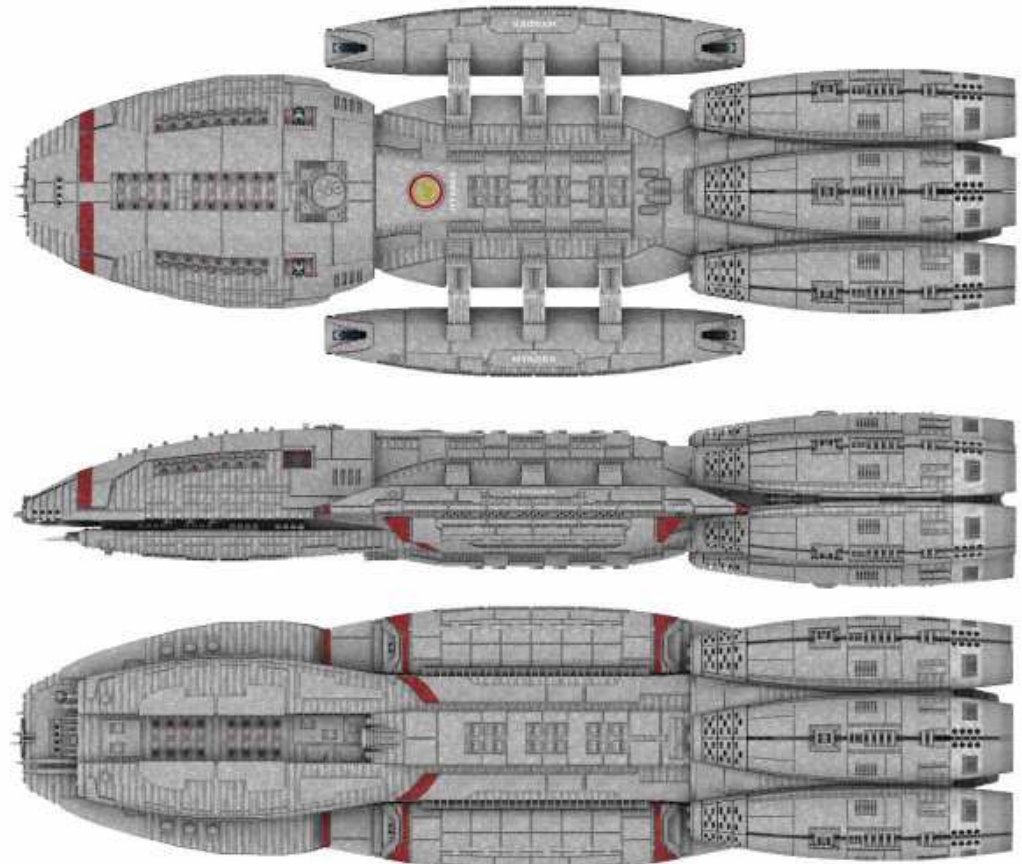

## Olympia Class Battlestar

Art by David 'Canis D' Briede

**Ship Type:** Battlestar

**Size:** 4,166 x 1,672 x 534

**Crew:** 800

**Passengers:** 2,500

**Attributes:**

**Agi** d6, **Str** d12+d4, **Vit** d8, **Ale**

d8, **Int** d10, **Wil** d10

**LP** 26; **Init** d6+d8; **Scale**

Spacecraft

**Speed** 5 (SL/JC)

**Traits** Formidable Presence (d4),

**Skills** Heavy Weapons d6,

Mechanical Engineering d4,

Perception d6, Pilot d4

**Armament**

Heavy planetcraft scale skirmish  
range point defence system(d12);

- 10 spacecraft scale capital  
range primary assault  
railguns (d12+d2);
- 10 spacecraft scale short  
DRADIS range heavy missile systems (d12+d4);
- 8 spacecraft scale long DRADIS range nuclear missile systems (d12+d8);
- 100 Vipers (full stock), 25 Raptors, 12 assorted craft

**Armour:** Wound 5, Stun 5

### History:

The three *Olympia* Class Battlestars were developed shortly after the beginning of the First Cylon War and the signing of the Articles of Colonization. The pressing need for space borne fighter support led to the conversion of almost any vessel that could carry them. As a result, three heavy cruisers were taken off the line, lengthened, and fitted with large flight decks to port and starboard. The *Olympians* gave good service throughout the Cylon War, with one, the *Triton*, being lost in action.

Following the War, both were decommissioned. Approximately ten years after the Armistice, *Olympia* was refitted and returned to service as a training

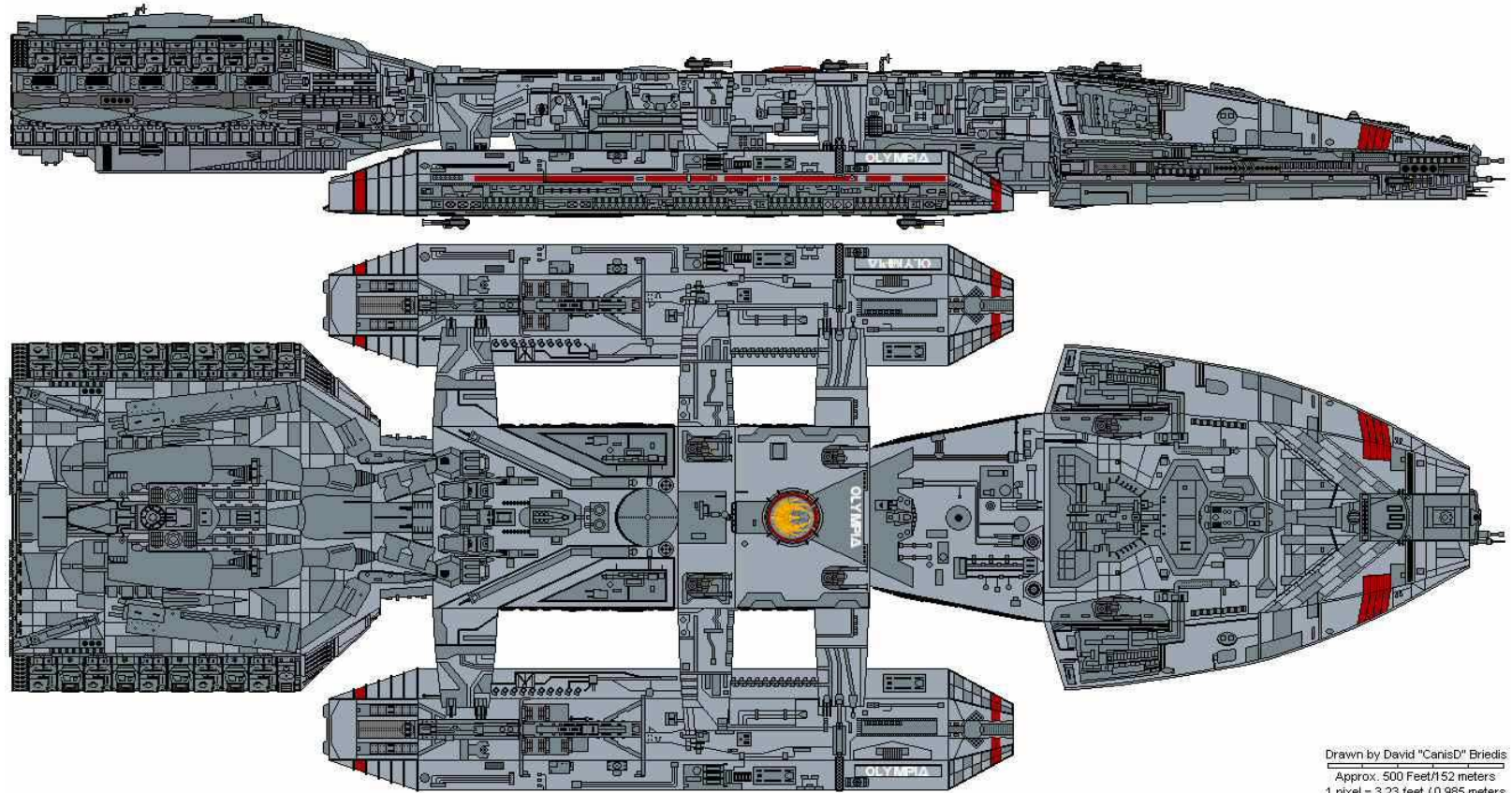

Drawn by David "CanisD" Briede  
Approx. 500 Feet/152 meters  
1 pixel = 3.23 feet / 0.985 meters

ship, but *Pegasus* was scrapped. The names and fighting spirit of both *Triton* and *Pegasus*, however, are preserved in the newer *Mercury* Class Battlestars.

### Quirks/Special Characteristics:

Because of their cruiser/gunstar origins and rather hasty conversion, these vessels are more complex than is the norm, and as a result, somewhat more difficult to service and maintain. They also retain, shielded deep within their hulls, a small emergency reserve tylium bunker, sufficient for a single FTL jump.

### Notable Vessels in Class:

*Olympia* (BSG 23 Flagship; Class vessel; Deployed as Colonial Fleet training ship.)

*Triton* (BSG 3 Flagship;

*Pegasus* (BSG-7 Flagship; Decommissioned and scrapped following First Cylon War).



## TALOS Class Battlestar BSG 85

Art By losys

Stats by Limerickcot

Agi d6, Str d12+d4, Vit d10, Ale d8, Int d10, Wil d10

LP 26; Init d6+d8; Scale Spacecraft

Speed 5 (SL/JC)

Traits Memorable (d4), Hardy Constitution (d4)

Skills Heavy Weapons d6, Mechanical Engineering d4, Perception d6, Pilot d4

Armament

Heavy planetcraft scale skirmish range point defence system(d12);

12 spacecraft scale Heavy Short DRADIS range assault railguns (d12 + d2)

12 spacecraft scale short DRADIS range heavy missile systems (d12+d4);

6 spacecraft scale long DRADIS range nuclear missile systems (d12+d8);

48 Vipers (full stock), 12 Raptors, 6 assorted craft

Armour: Wound 6 Stun 6

Size: 3675 feet x 1380 x 591 feet

Crew: 1350; Passengers: 1,000

### History:

The Battlestar Talos was built as something of a proof-of-concept vehicle some fifteen years after the end of the First Cylon War. Battlestar design in that era was trending towards making such vessels into bigger and more expensive "city-in-space" command-and-control centres, and the Talos concept stepped back from that impulse. The Talos was built as an austere, bare-bones combat machine. Rather than a space-borne command centre, Talos was built for gritty, brutal toe-to-toe combat with anything in the Cylon arsenal. As a result, Talos is more heavily built than any other vessel in the fleet, with comprehensive and redundant damage control and system backups. She can take a pounding that would cripple nearly any other Battlestar and still come back for more.

Her one-of-a-kind nature and sheer resilience in battle has made her extremely formidable, and she frequently serves as the OpFor in Fleet exercises, taking on the role the Cylons would play in real-life. Fleet Commanders seem to feel that if a ship and crew are prepared to go head to head with the Talos and survive, they're prepared for whatever else the Gods might decide to throw at them.

The price for her designers paid, however, is that Talos' living and working spaces are cramped - almost claustrophobic, making her unpopular with her crews. One crewman commented that Talos seemed more accommodating for the machines she was built to fight than for the crews sent to man her.

A further price to be paid was that Talos' air wing is also smaller than most other Battlestars, and her design and construction costs assured the experiment would not be repeated.

### Quirks/Special Characteristics:

Talos was built with more extensive redundancy than other Battlestars- more bypasses, more interconnections, and more chances to reroute and keep on fighting. As a result, she adds a d4 (for Hardy Constitution) to all Endurance rolls and rolls to resist damage to her systems.

Talos has four landing bays, with each landing pod having two flight decks- one running parallel to the ship's line of flight, the other inverted beneath it. Special elevators and airlocks bring embarked craft into sync with the ship's gravity as they are transported to the hangar deck.

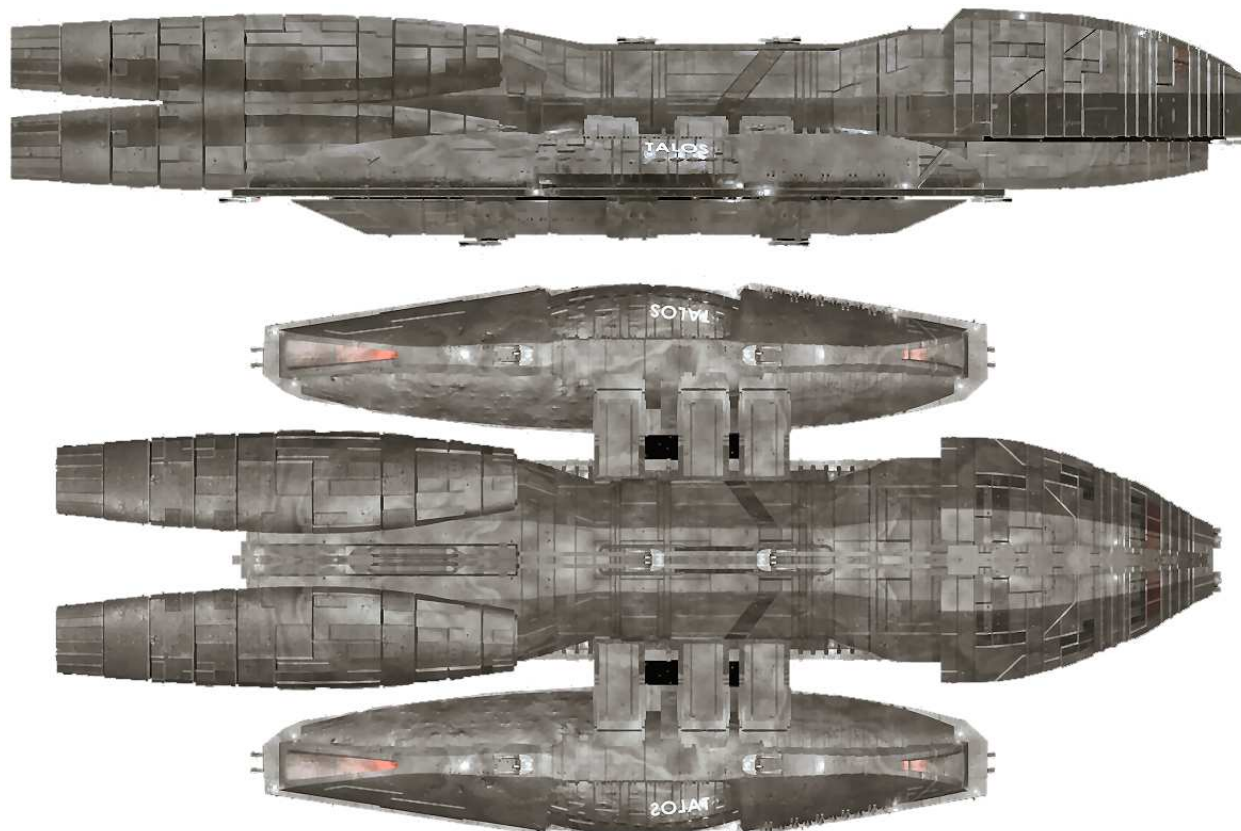



# BATTLESTAR TALOS



MODELED BY IOSYS



## **Warden Class Battlestar**

by Limerickcot

Agi d6, Str d12+d6, Vit d10, Ale d6, Int d6, Wil d10

LP 28; Init d6+d6; Scale Spacecraft

Speed 4 (SL/JC)

**Traits:** Hardy Constitution (d4)

**Skills** Heavy Weapons d4, Mechanical Engineering d4, Perception d4, Pilot d4

### **Armament**

Heavy planetcraft scale skirmish range point defence system(d12);

30 spacecraft scale Heavy Short DRADIS range assault railguns (d12 + d6)

12 spacecraft scale short DRADIS range heavy missile systems (d12+d4);

8 spacecraft scale long DRADIS range nuclear missile systems (d12+d8);

### **Airwing**

40 Vipers (

40 Pythons

20 Raptors,

6 assorted craft

**Armour:** Wound 6 Stun 6

**Size:** 5210 feet x 1380 x 597 feet

**Crew:** 8290; Passengers: 3120

For those that remember, including the Cadets at the Caprica Academy, the Cylon War's first major military conquest was the seizure of the Warden. She was the most up-to-date warship constructed (apart from the Dreadnaught Classes) and heavily relied on networked systems to achieve both speed and firepower.

Soon after the war started, Cylons boarded the Warden, killed the crew and commenced bombarding key industrial plants on Tauron. Destroying the Warden became a necessity. A co-ordinated marine attack finally boarded the Warden and, instead of destroying it, managed to infiltrate a tape worm into the ships systems and return it to Colonial control.

With ships in short supply, every effort was made to rip out the networked systems and make Warden manually controlled. The experience in doing this was later transferred to the building of the Galactica and other vessels. She still carries her exceptional armament but her engines and sensor suites are sub-par, having had their control systems replaced with very crude manual controls instead of the efficient networked ones.

Warden is still on reserve status. During the war she had been converted to carry Python Bombers as well as two squadrons of Vipers. As she is one of the few ships that were ever converted to this duty, she has never been paid off and remains commissioned at the Cayuze facility.

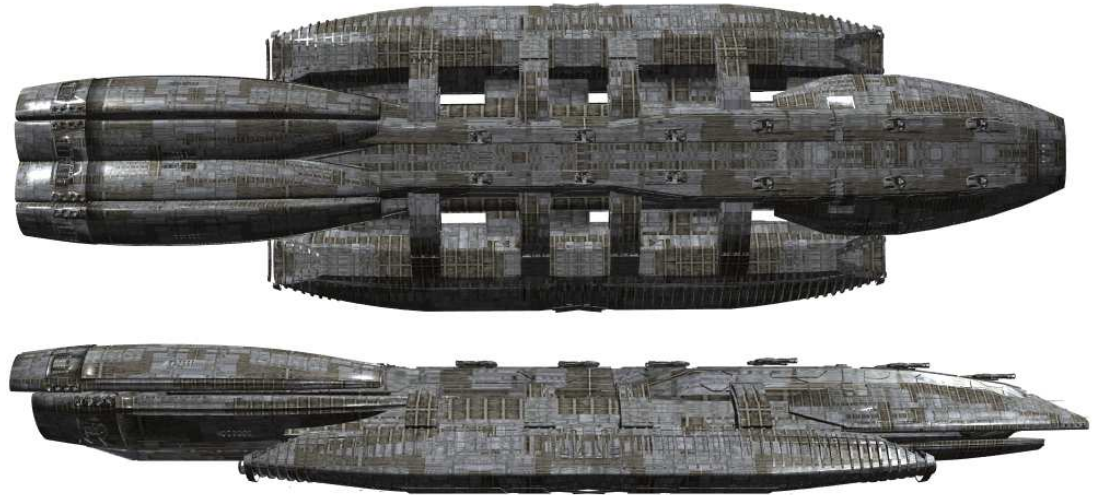

## **Warden**

by Limerickcot



## **ESCORTSTARS**

Although only a Battlestar is capable of slugging it out, toe to toe, with a Cylon Basestar, the need for a more flexible response, to meet other threats, has resulted in the Colonial Fleet using a vast array of Escorts.

Some of these vessels are pre-Colonial, in that they represent ship designs, or elements, then in use by the Independent Colony worlds before the Articles of Colonisation were signed. Indeed, without these ships it is unlikely that the Colonies would have lasted long enough to build enough Battlestars to combat the Cylons.

Although the Fleet generally labels nearly all of these craft as Escortstars, they are further subdivided by their functions. This has led, unfortunately, to a plethora of different name types, some descended from the various Colony Worlds, and which makes it hard to distinguish what function the vessel has.

The Escortstars shown here are separated into broad categories:

**Close Support** – ships designed to provide additional protection to Battlestars and to operate under the umbrella of its air cover. Such ships traditionally have few fighters.

**Escort** – Similar to the above, the Escort will carry more fighters and can act independently to protect merchant ships but is incapable of dealing with an enemy Capital Ship. These are sometimes referred to as Cruisers.

**Gunstars** – A vessel, capable of acting as Close Support, but ranging ahead of the fleet, usually quite fast, but having few fighters. Other designations are Frigate or Destroyer.

**Scoutstars** – a broad term and used for those ships capable of acting independently, ahead of the fleet, having good DRADIS and jump capability. These Probe vessels are otherwise similar to a Gunstar.

**Boats** – a generic term for sublight combat craft.

In addition to these designations there are still a number of older holdovers – vessels named for old wet navy types. These vessels tended to be originally constructed (or designed or funded) by individual planetary governments before being incorporated into the Colonial Navy. It is this offset route into the Colonial Fleet that keeps these names in existence.

## Berzerker Escortstar

(Hephaestus Variant)

Art by Limerickcot

Stats by Limerickcot

**Agi** d8, **Str** d12, **Vit** d6, **Ale** d8, **Int** d8, **Wil** d10;

**LP** 22; **Init** d8+d8; **Scale** Spacecraft;

**Speed** 6 (SL/JC)

**Traits** None

**Skills** Heavy Weapons d6, Mechanical Engineering d2, Perception d6, Pilot d2

### Armament

#### Planetcraft

18 dual heavy, short DRADIS range, point defence railguns (d12)

#### Spacecraft

2 forward-mounted, heavy, short DRADIS range, railguns (d12+d2);

10 top-mounted, dual medium DRADIS range, railguns (d10)

4 side-mounted, dual heavy, medium DRADIS range, railguns (d10+d2)

16 side-mounted, triple light, medium DRADIS range, railguns (d6)

2 extreme, long DRADIS range, nuclear missile system (d12+d8);

10 long DRADIS range missile systems (d8)

### Airwing

12 Vipers; 2 Raptors

**Armour** Wound 4, Stun 3

**Description** 2,763 x 705 x 387 feet;

**Crew** 1396

**Passengers** 250 (180 Marines)

### Overview

The first Cylon war showed how vulnerable Battlestars were, when caught on their own. Even more so, that war showed how vulnerable inter-system traffic was to Cylon attacks. A number of escort vehicles were devised and built both during that conflict and afterwards.

By the third decade of peace, however, the military began to draw up plans for newer escorts that could work alongside the newer Battlestars coming into being. The Berzerker was drawn up and has become the standard escort for most Battlestar groups. Relying on the Battlestars to provide first line air

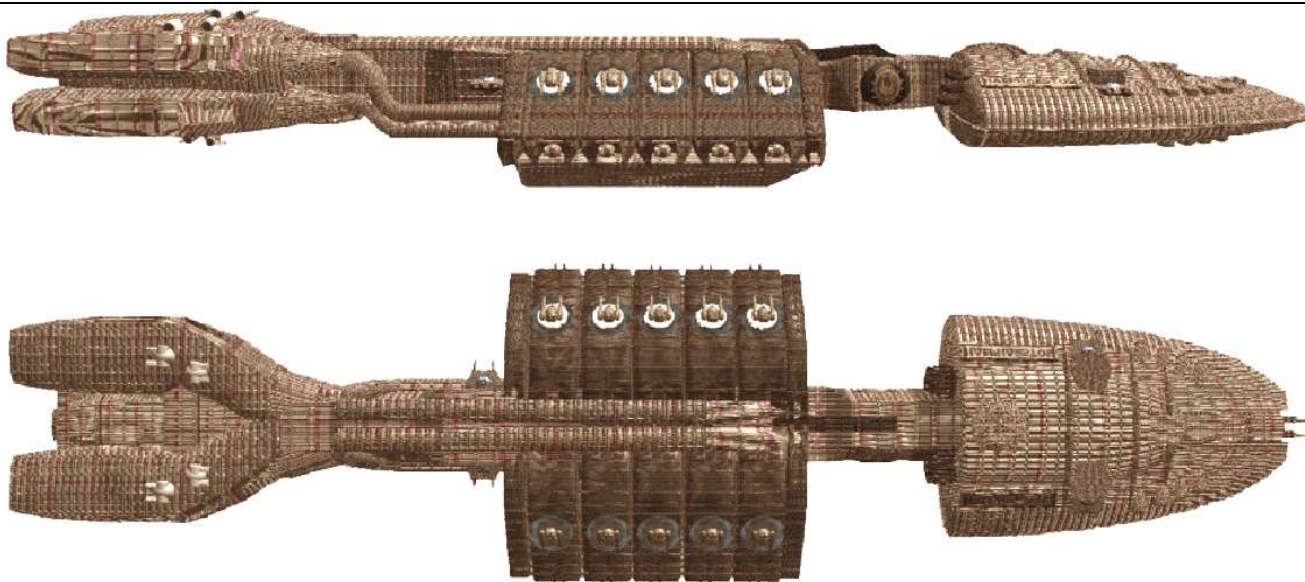

support, Berzerkers provide gun and missile support to each group, giving both supplemental support against enemy targets.

It must be remembered that the Berzerker class is not a Battlestar, although many seem to think of it as being akin to one. This class of escort is not designed to operate self-sufficiently for long, having few of the shops and stores normally seen on a Battlestar. Its cargo holds are limited to immediate needs and resupply – not long term operations. In addition, the extra guns and missile batteries swallow up much of its capacity. The ships armour is lightweight in comparison to its cousins, but then this fits in with its escort role.

One of her most lauded abilities is her modular construction – allowing swift updates and extension refits to be undertaken easily. Her other applauded benefit is her cheapness. At a time when military expenditure can be frowned on, construction of more Berzerkers continues at the Scorpio Fleet Shipyards.

The weaknesses of the class were recognised early on. Originally the Berzerker would have operated ahead of the fleet. However, it was noticed that a Berzerker was unlikely to survive in an ambush situation. Instead, the larger, more capable (and three times as expensive) Tiamat class was recently developed for forward operations.



The second Cylon war probably saw the total destruction of this class, several being destroyed at the shipyards in the opening shots of the war.

They did, however, rack up a significant amount of damage, disabled as they were, in other encounters throughout the system, as individual turret crews continued firing manually, for as long as they were able.

## Berzerker Class Heroic Variant

**Size:** 2,763 x 705 x 387 feet;

**Crew:** 1396

**Passengers:** 290 (180 Marines)

**Attributes:**

**Agi** d8, **Str** d12 **Vit** d6, **Ale** d8, **Int** d8, **Wil** d10

**LP** 22; **Init** d8+d8; **Scale** Spacecraft

**Speed** 6 (SL/JC)

**Traits** None

**Skills** *Heavy Weapons d6, Mechanical Engineering d2, Perception d6, Pilot d2*

**Armament**

Heavy planetcraft scale skirmish range point defence system(d12);

2 forward-mounted, heavy, short DRADIS range, railguns (d12+d2);

10 spacecraft scale short range primary assault railguns (d12+d2);

4 side-mounted, dual heavy, medium DRADIS range, railguns (d10+d2)

6 spacecraft scale short DRADIS range heavy missile systems (d12+d4);

**Airwing**

6 Raptors, 6 assorted craft

**Armour:** Wound 4, Stun 3

**History:**

The 'Heroic' Variant is one of the newer variants of the Berzerker Class. She carries a better distribution of armour and a longer range, but at the expense of a flight of Vipers in exchange to increase her Raptor capacity, giving her a far better ability to deploy her Marine company.

Although her PDS is a better, integrated system, she does not have the same number of independently targeting guns, reducing her abilities in line of battle.

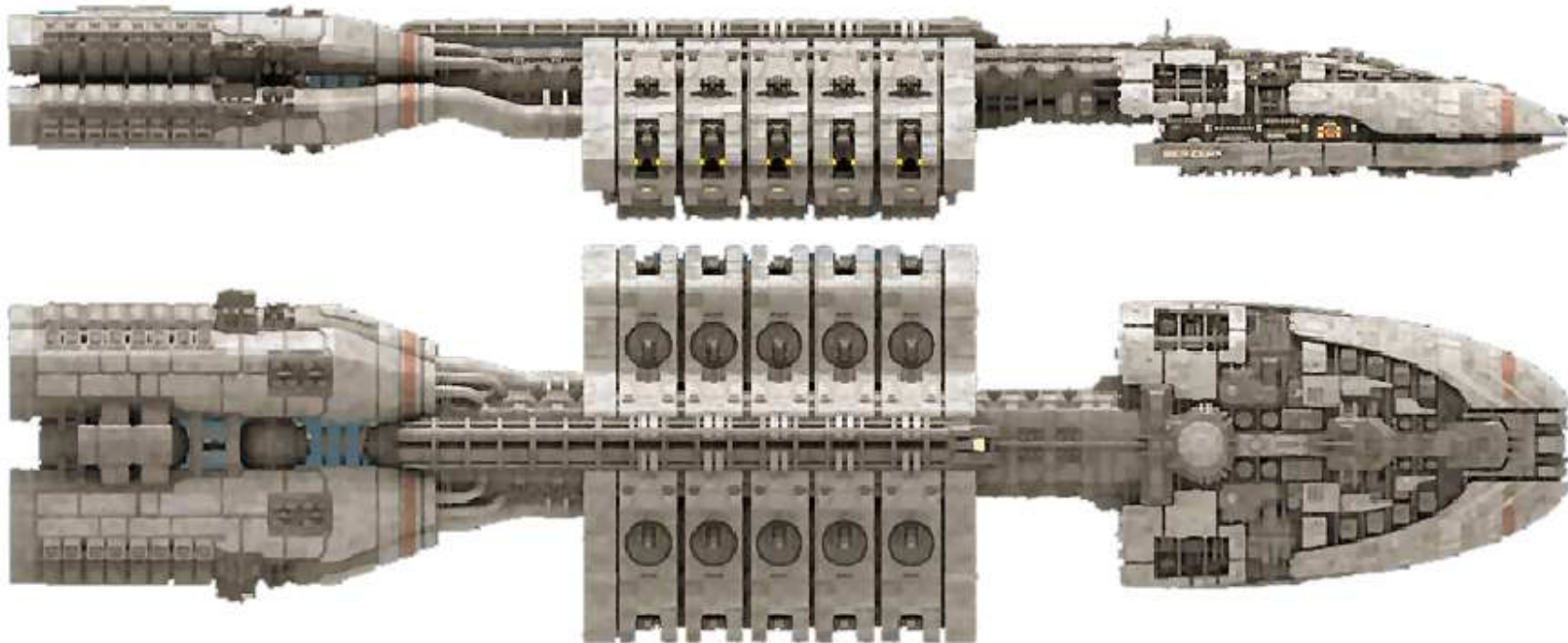



## Tiamat Class Gunstar

Art by Limerickcot  
Stats by Limerickcot

**Agi** d8, **Str** d12, **Vit** d8, **Ale** d8, **Int** d8, **Wil** d10;  
**LP** 22; **Init** d8+d8; **Scale** Spacecraft;  
**Speed** 7 (SL/JC)  
**Traits** None

**Skills** Heavy Weapons d6,  
Mechanical Engineering d4,  
Perception d6, Pilot d4

### Armament

Planetcraft  
32 medium, short DRADIS range,  
point defence railguns (d10)

### Spacecraft

8 forward-mounted, heavy, short  
DRADIS range, railguns (d12+d2);  
14 medium DRADIS range, railguns  
(d10)  
1 extreme, long DRADIS range,  
nuclear missile system (d12+d8);

### Airwing

8 Vipers; 8 Raptors, 2 other craft

**Armour** Wound 7, Stun 4

**Description** 2,524 x 868 x 765 feet;

**Crew** 178

**Passengers** 100 (60 Marines, 40  
others)

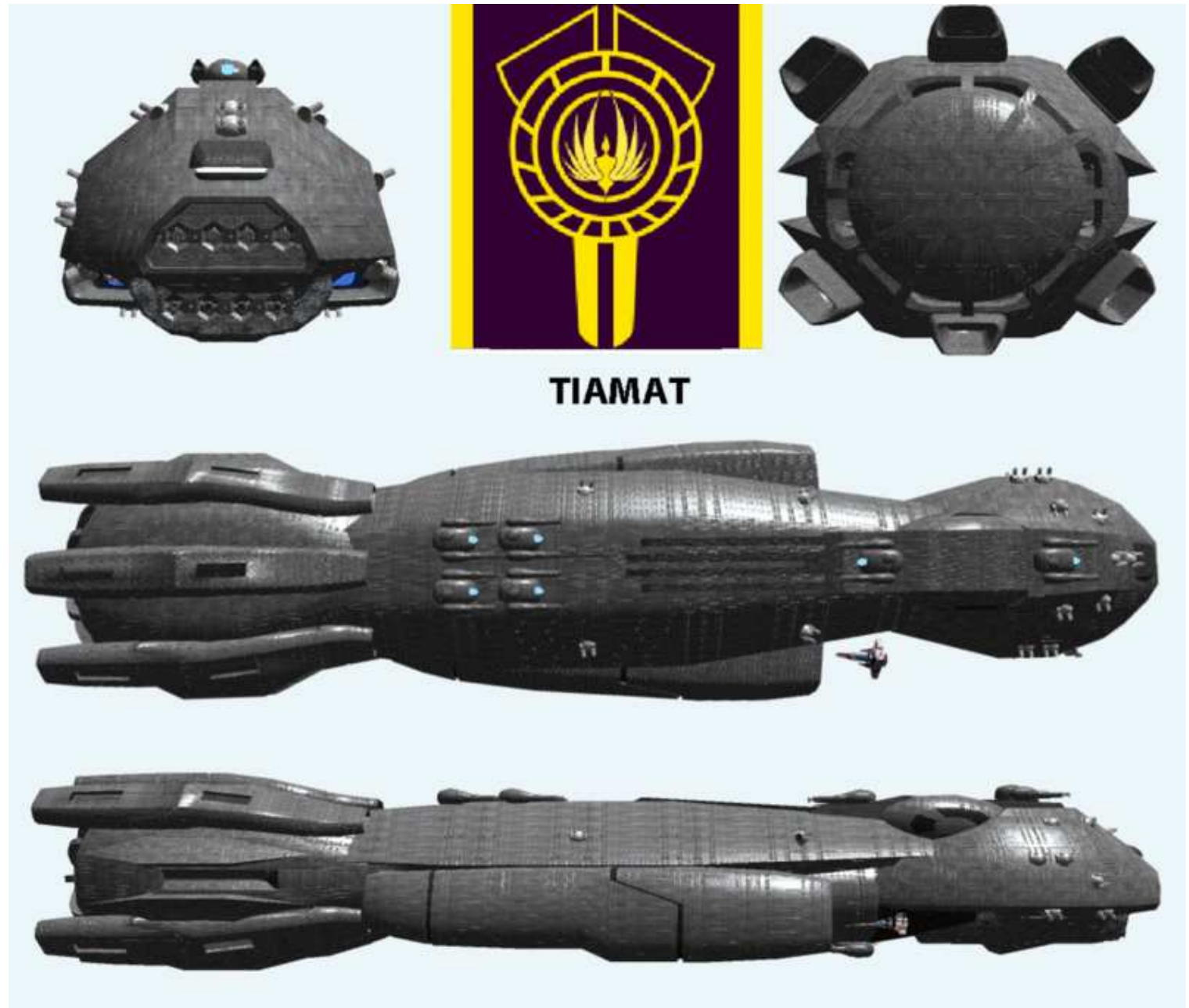

## Overview

The jump-capable Raptor's current role is to jump, ahead of the fleet, to scout, and to warn of possible ambush. If a combat situation arises however, Raptors have proven to be ill equipped to deal with it. Nor does detecting an ambush negate the need to deal with it.

To this end, the fleet has always maintained a small number of Assault capable Scoutstar's. Fast, armoured and carrying a punch (albeit a less flexible one than on other, larger ships). The latest in these designs is the Tiamat. Based on the Tiger Strikestar, the Tiamat is a third shorter, and carries less crew and marines. It is designed to jump in, *trigger* any ambush, do what damage it can and hold the jump point until the rest of the fleet arrive.

Due to the nature of its job, a Tiamat's captain, and crew, are usually noted for a gung-ho, do-or-die, attitude to any job given them.

Principal amongst the Tiamat's armament are the eight forward mounted, rapid fire heavy cannon, aligned with the ships directional vector. These weapons are designed to rapidly punch through most opposition defences.

Seven, dual turreted, guns are mounted along the spine (with one underneath) to provide a defence against secondary targets. Sixteen dual point defence weapons give protection against enemy fighters and missile's, although most of this protection is carried forward - as that is the direction the Tiamat will show towards its opposition. Nearly removed from the mix, the Tiamat carries only one missile launch tube for its nuclear arsenal (the port tube housing is sealed off).

Unlike the Tiger class, the Tiamat carries more aircraft – a wing of 8 Vipers can be accommodated (although the hanger deck floor would allow a further 4 to be carried without interrupting flight-deck activities). However, in keeping in with her purpose as a heavy scout, her other flight deck normally houses 8 raptors. These are also used to convey the small marine contingent of the Tiamat.

The Tiamat's armour is, unlike most vessels, variable in its locations, mainly to give added protection in the fore part of the hull.

Front Hull:	Wound 8, Stun 4
Main Hull, upper:	Wound 6, Stun 4
Main Hull, lower:	Wound 8, Stun 4
Flight Pods:	Wound 7, Stun 4
Engines:	Wound 6, Stun 4
Turrets:	Wound 6, Stun 3

The Tiamat is a cramped, tight, vessel for its crew to live on, having few of the creature comforts found on the more spacious craft of the fleet.

However, when designed ten years ago, the fleet was looking forward to a more automatic approach to its systems so they designed all of the Tiamat's internal systems to be modular and easily replaceable (they wanted to make fast and easy upgrades on her). To fix a problem, normal procedure calls for the Tiamat to withdraw the part, plug in a new one, and then fix the old one at leisure. To this end a Tiamat has an extensive database of the parts it needs, holds and what military and commercial parts can be used in its stead.

Operational procedure, as part of fleet operations, sees a Tiamat one jump ahead of the fleet, with a wing of Raptors one jump forward of the Tiamat. When the enemy is detected, the fleet jumps to the Tiamat's position, readies itself, and then the Tiamat jumps into the ambush point, deploying two or more Raptors that report on its progress. When all, or the lead elements of the opposing fleet is engaged, the Raptors jump back to the rest of the fleet to lead them in.

One Ship - the Galedon, was told off for search operations just shortly before the outbreak of the second Cylon War, having taken on board an additional 4 raptors to help in training exercises.

## Defender Class Escortstar

Art by Ice-Dragon  
Stats by Limerickcot

### Attributes:

**Agi** d6, **Str** d10, **Vit** d6, **Ale** d8, **Int** d8, **Wil** d10

**LP** 20; **Init** d6+d8; **Scale** Spacecraft

**Speed** 5 (SL/JC)

**Traits** Formidable Presence (d4), Memorable (d2), Loved (d6)

**Skills** *Heavy Weapons* d6, *Mechanical Engineering* d4, *Perception* d6, *Pilot* d4

### Armament

Heavy planetcraft scale skirmish range point defence system(d12);  
4 spacecraft scale capital range primary assault railguns (d12+d2);  
6 spacecraft scale short range railguns (d8)  
6 spacecraft scale short DRADIS range heavy missile systems (d12+d4);  
6 spacecraft scale long DRADIS range nuclear missile systems (d12+d8);  
12 Vipers, 4 Raptors, 6 assorted craft

**Armour:** Wound 3, Stun 3

**Size:** 2,755 x 985 x 640 feet;

**Crew:** 1750; **Passengers:** 1,000

### History:

The *Defender* Class gunstars were the largest gunstars deployed during the Cylon War and were an intermediate step between Battlestars and their smaller escorts. Fitted with a single (shortened) flight pod, they were essentially thru-deck cruisers and were used as “maids-of-all-work” during the First Cylon War. *Defenders* served as convoy escorts and training ships, then embarked shuttles and landing craft and served ably as make-shift amphibious assault ships, tenders, and even on one occasion, as a hospital ship. Following the Cylon War, the *Defenders* were gradually decommissioned and scrapped, but a small number were demilitarized (stripped of their weapon mounting hard-points) and found their way into civilian service.

The *Defender* Class gunstars were built strongly, but were rushed through the Admiralty design process, and so a number of design flaws and system incompatibilities sneaked through and had to be put right by their crews. Additionally, they were built at four different shipyards, and as a result,

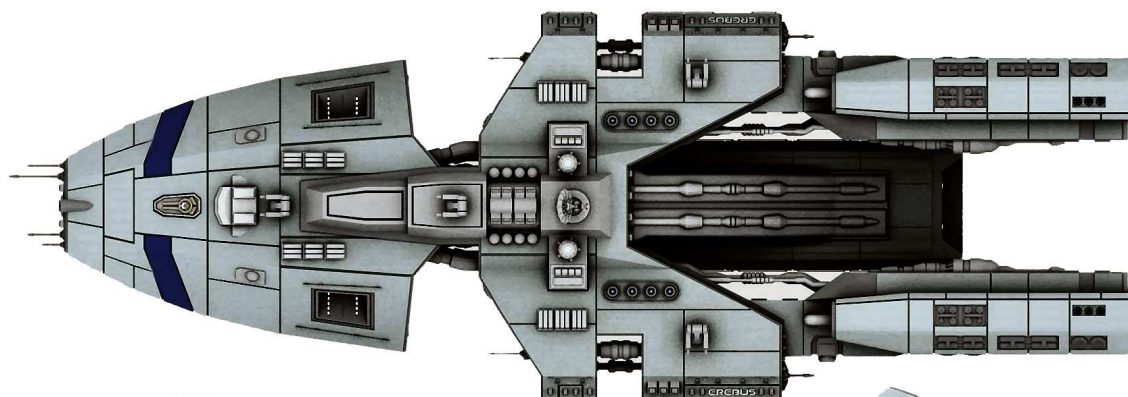
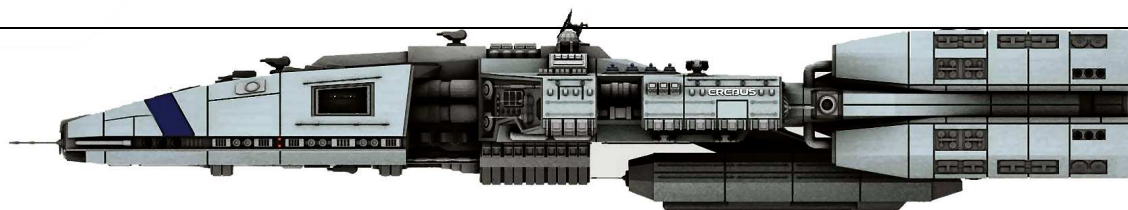

## Defender - Erebus Class

by Ice-Dragon

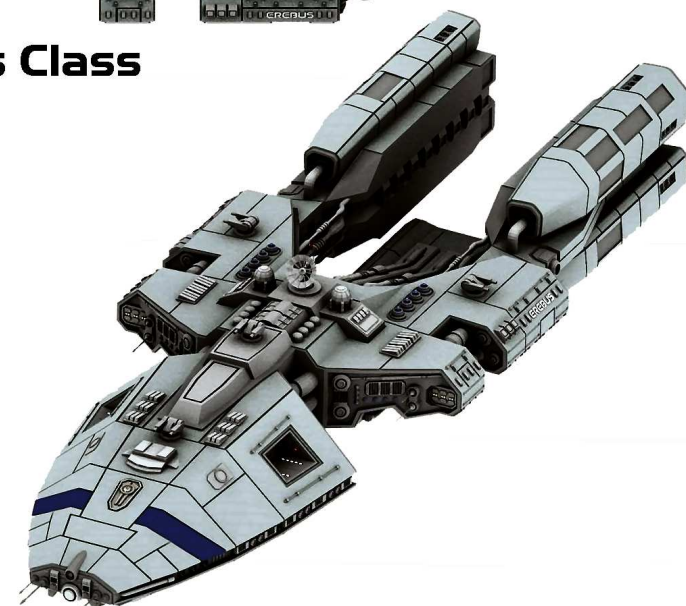
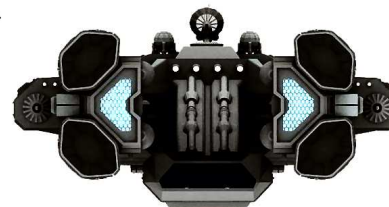

no two *Defenders* were ever exactly alike and maintenance and service requirements were always excessive. Despite this flaw, the *Defenders* were sturdy, reliable, and unyielding, and remained popular in the Fleet.



## **Auriga Gunstar**

Stats by Limerickcot  
Art by Ice-Dragon

**Agi** d6, **Str** d10, **Vit** d6, **Ale** d8, **Int** d8, **Wil** d10

**LP** 20; **Init** d6+d8;

**Scale** Spacecraft; **Speed** 6 (SL/JC)

**Traits** Formidable Presence (d4), Memorable (d2), Loved (d6)

**Skills** *Heavy Weapons* d6, *Mechanical Engineering* d4, *Perception* d6, *Pilot* d4

### **Armament**

Heavy planetcraft scale skirmish range point defence system(d12);

12 spacecraft scale long range primary assault railguns (d12+d2);

6 spacecraft scale Medium range railguns (d8)

6 spacecraft scale short DRADIS range heavy missile systems (d12+d4);

6 spacecraft scale long DRADIS range nuclear missile systems (d12+d8);

**Airwing:** 4 Raptors, 6 assorted craft

**Armour:** Wound 4, Stun 3

**Size:** 2,705 x 985 x 440 feet;

**Crew:** 1300; **Passengers:** 700

The defender was designed as an escort, providing light fighter defence and was typical of many pre-war vessels. Her sister class were the 'Guardians', none of which remain in service. The oldest variety of Guardian still in service is the Auriga. She is a more compact design designed to take on enemy vessels and is faster, better armoured and carries more munitions. In addition she carries a full Marine company for boarding operations. As a convoy escort, or patrol vessel she excels, using her speed and bulk to close on suspect vessels before carrying out boarding manoeuvres.

Unlike most colonial vessels, Auriga carries multiple armoured boarding tubes, allowing her to close on a disabled vessel, grapple and access her directly without relying on subcraft. This procedure is not recommended for

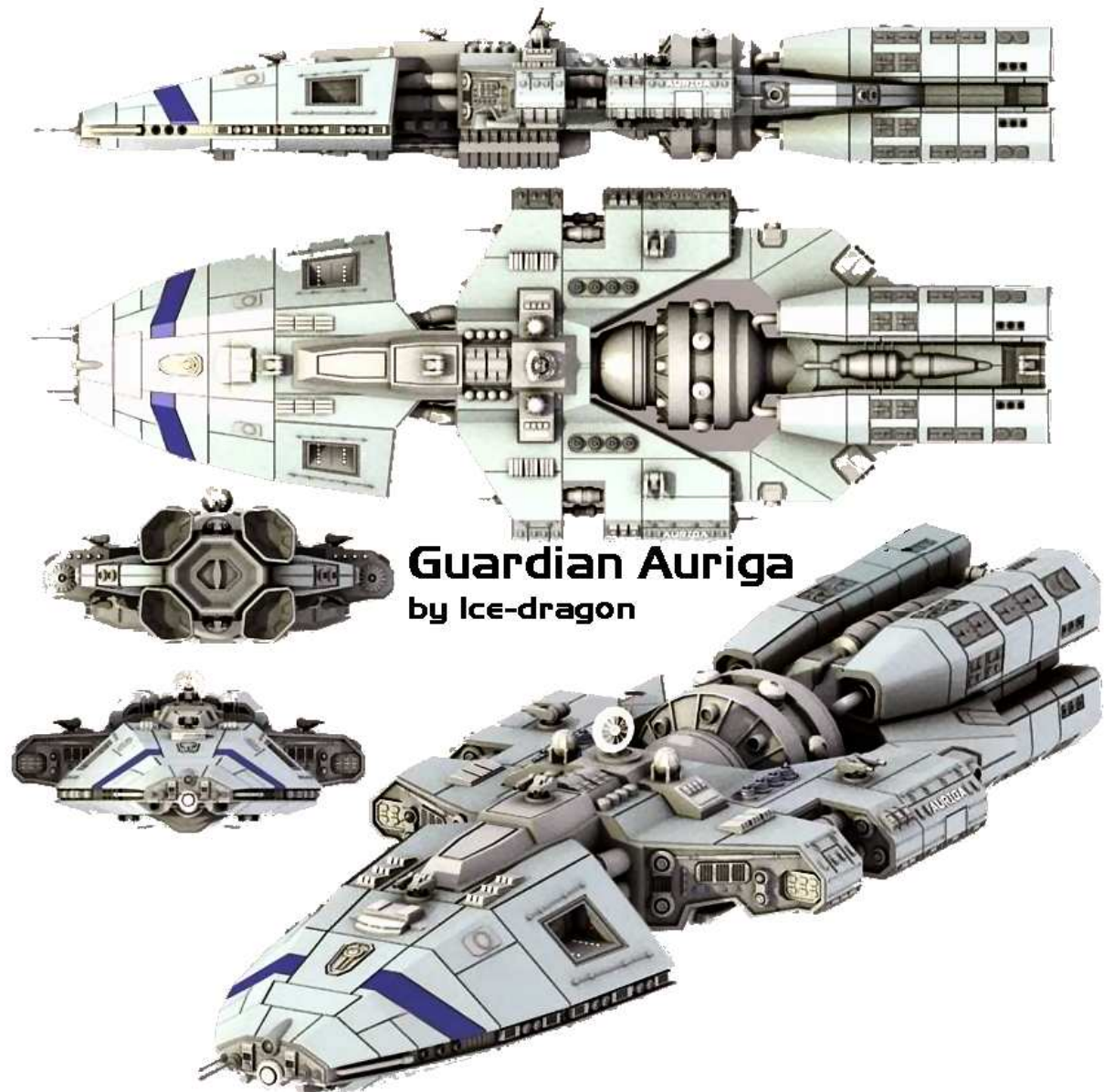

**Guardian Auriga**  
by Ice-dragon

Cylon vessels due to the possibility of counter-boarding. In case of such a possibility, the Auriga relies heavily on armoured sub-compartments to delay or stop Centurion boarders.



## Aegaeon Gunstar

Stats by Limerickcot

Art by Ice-Dragon

**Agi** d6, **Str** d10, **Vit** d6, **Ale** d8, **Int** d8, **Wil** d10

**LP** 20; **Init** d6+d8; **Scale** Spacecraft

**Speed** 7 (SL/JC)

**Traits** Formidable Presence (d4), Memorable (d2), Loved (d6)

**Skills** *Heavy Weapons d6, Mechanical Engineering d4,*

*Perception d6, Pilot d4*

### Armament

Heavy planetcraft scale skirmish range point defence system(d12);

18 spacecraft scale capital range primary assault railguns (d12+d2);

24 spacecraft scale short DRADIS range heavy missile systems (d12+d4);

8 spacecraft scale long DRADIS range nuclear missile systems (d12+d8);

**Airwing** 4 Raptors, 6 assorted craft

**Armour:** Wound 5, Stun 4

**Size:** 2,690 x 980 x 440 feet;

**Crew:** 800; **Passengers:** 700

The latest version of the 'Guardian' is the Aegaeon. A much more modern version of the Auriga Class Gunstar, the Aegaeon is almost exactly the same size, but carries a smaller crew, more accurate armament, more armour and better (yet smaller) engines and power plants. She retains her Marine Company, but only has one armoured boarding tube on each side of the ship.

Although she has a greater gun armament, the Aegaeon's long range armament has also been doubled. None of this would have been possible without the advanced electronics that this carries, allowing crew to be minimised and the armament therefore to be increased. She is a relatively new class with most hulls currently on a budgetary freeze. The older Auriga class will continue in service for a much longer period than originally anticipated.

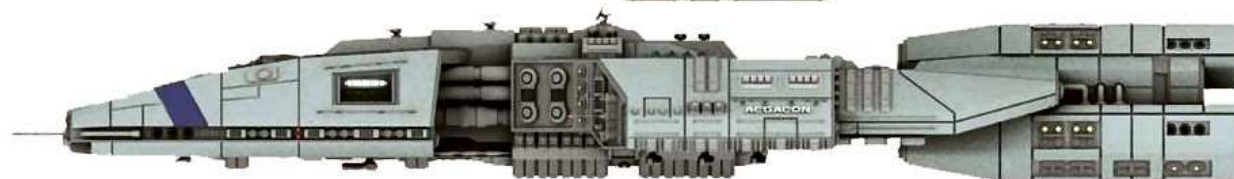
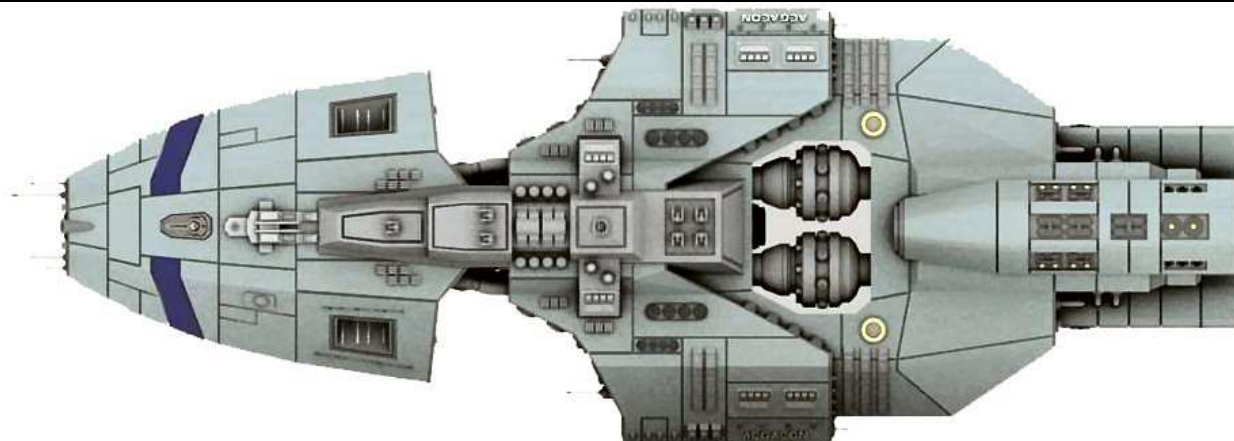

**Aegaeon**  
by Ice-Dragon



## ***Aegis Class Gunstar***

By Selek

**Ship Type:** Gunstar

**Size:** 1447.8m x 505 x 295m

**Crew:** 850

**Passengers:** 350

**Attributes:**

**Agi** d8, **Str** d8, **Vit** d10, **Ale** d6, **Int** d6, **Wil** d8

**LP** 18; **Init** d6+d8; **Scale** Spacecraft

**Speed** 6 (SL/JC)

**Traits** Tough (d4)

**Skills** *Heavy Weapons d6, Mechanical Engineering d4, Perception d6, Pilot d4*



### **Armament**

- Heavy planetcraft scale skirmish range point defence system(d12);
- 20 spacecraft scale capital range primary assault railguns (d12+d2);
- 6 spacecraft scale short DRADIS range heavy missile systems (d12+d4);
- 4 spacecraft scale long DRADIS range nuclear missile systems (d12+d8);
- 2-4 Raptors, 2 shuttles

**Armour:** Wound 6, Stun 6

### **History:**

The *Aegis Class* destroyers were built early in the 1<sup>st</sup> Cylon War when older destroyer designs proved inadequate to deal with the Cylon attack of heavy, coordinated air attacks. Colonial defences were being overwhelmed by the sheer number of small, fast Cylon fighters attacking all at the same time. Heavier anti-fighter defences were needed.

The *Aegis Class* were based upon the hulls of the earlier *Provost Class* destroyers, but were significantly lengthened and strengthened. Sponsons were added to port and starboard to mount the main anti-ship batteries, and the point defence batteries were doubled in strength and numbers.

Given the glaring weaknesses in networked computer systems exposed early in the war, the *Aegis Class* presented a decidedly low-tech, but robust approach to the problem- they were essentially floating gun batteries. While they lacked much of the flexibility of earlier classes, they excelled at one thing- placing a lot of ordinance on target in relatively short order. As a result, they saw duty primarily as convoy or Battlestar group escorts, but also fulfilled scouting, patrol, and shore bombardment missions as needed.

Following the Armistice, the surviving *Aegis class* ships were decommissioned and scrapped in favour of newer designs.

**Quirks/Special Characteristics:**

The *Aegis* Class were built from off-the-shelf components available after the completion of the first Battlestars, and share common systems with the *Galactica*-type, *Minerva*, and *Olympia* classes. The *Aegis* Class destroyers were extremely well armed for their size, with excellent, overlapping fields of fire providing comprehensive coverage, and proved to be well-suited for shore bombardment missions as their high thrust to mass ratio and heavy armour allows them to enter the fringes of the upper atmosphere and lay down precision weapons fire.

The major drawback of this class was the lack of facilities for small craft. This was partially addressed by carrying a pair of *Raptors* at external airlocks and cradles, and most of the class were later fitted with a small dorsal landing pad and attendant airlock/hangar, but maintenance facilities were always restricted and of little practical use.

**Notable Vessels in Class:**

Gunstar *Aegis* (assigned to BSG 8; Class vessel)

Gunstar *Shield* (assigned to BSG 96;)

Gunstar *Protector* (assigned to BSG 21;)

Gunstar *Enfilade* (assigned to BSG 31; destroyed in collision w/ Battlestar *Inflexible*)

Gunstar *Citadel* (assigned to BSG 31; destroyed in collision w/ Battlestar *Inflexible*) Gunstar *Advocate* (assigned to BSG 54; crippled over XP-99 but made port under her own power; accommodation ship at Picon Fleet Yards.)

Gunstar *Fortress* (assigned to BSG 13; scuttled by own crew when nearly overrun by Cylons).

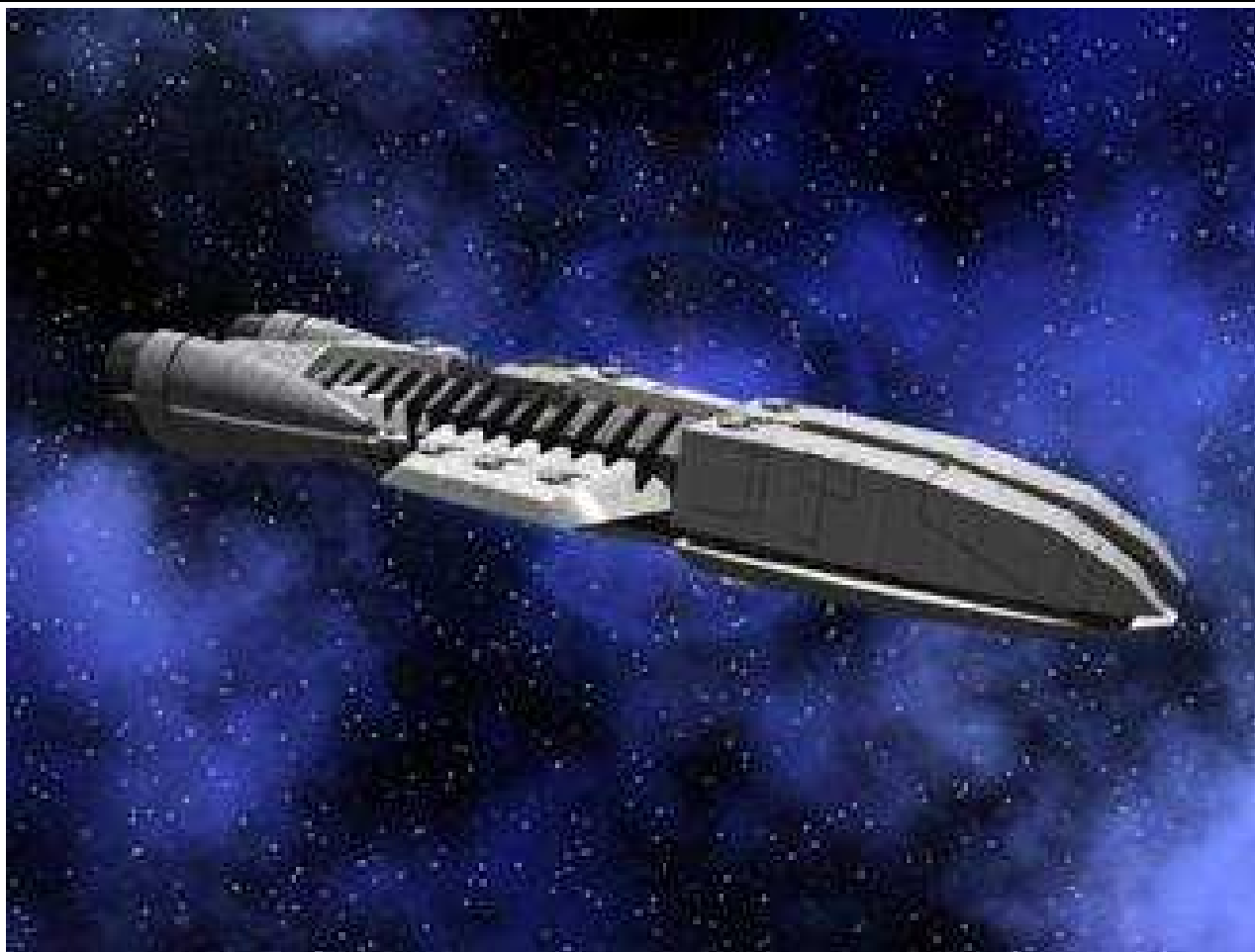



## Genesis Class Escortstar

Art by Limerickcot

### Attributes:

Agi d6, Str d8, Vit d8, Ale d8, Int d8, Wil d10  
LP 16; Init d6+d8; Scale Spacecraft  
Speed 4 (SL/JC)

Traits Memorable (d4), Ugly (d2), Past It's Prime (d6)

Skills Heavy Weapons d6, Mechanical Engineering d4,  
Perception d4, Pilot d4

### Armament

Medium planetcraft scale skirmish range point defence system(d8);  
2 medium spacecraft scale capital range primary assault railguns (d10);

### Airwing:

36 Vipers (full stock), 12 Raptors, 6 assorted craft

Armour: Wound 4, Stun 4  
Size: 3520 x 420 x 640 feet;  
Crew: 900; Passengers: 2600

### History:

The Genesis Class arose from cost-cutting measures proposed by the Adar administration some thirty-six years after the end of the First Cylon War.

After almost four decades of peace, critics within and without the Adar Administration were complaining loud and long about the increasing cost and complexity of the Battlestar fleet, as well as their utility in any future conflicts- particularly their utility for convoy escort.

Over the vocal objections of the Ministry of Defence, the Ministry of Finance commissioned a study to look at the feasibility of producing a large number of smaller fighter-capable vessels in lieu of the more massive Battlestars.

It was argued that a new fleet of smaller, less costly, moderately less capable vessels could be built to complement a reduced fleet of Battlestars, with the lesser vessels replacing frontline Battlestars for convoy escort, patrol,

replenishment, and other duties in low-threat areas, thus freeing up the Battlestars for high-threat areas and front-line combat. The result was a derivative of the Mentor class of hulls. Blocky and cheap.

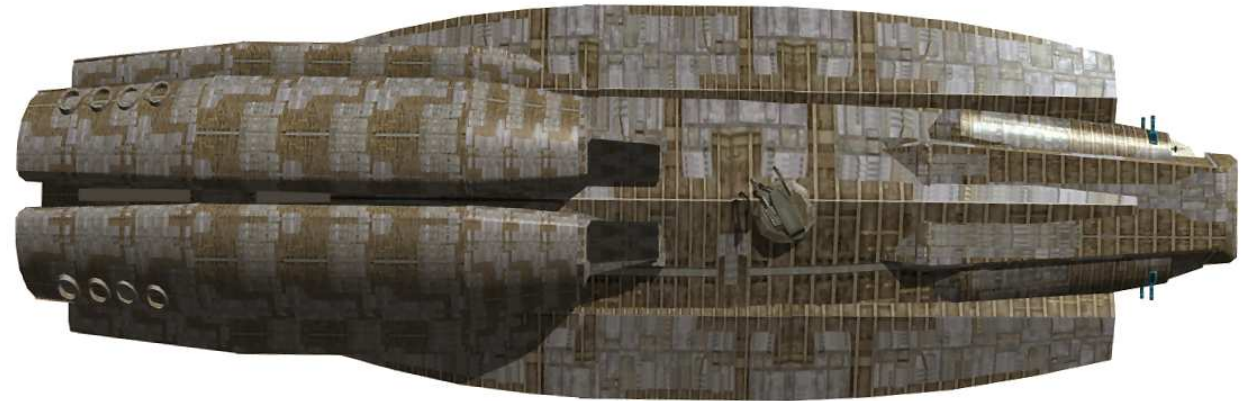

Genesis Escortstar



Limerickcot



With the cost of the newly designated Space Control Ship averaging one-sixth that of a Mercury Class Battlestar, a much larger number of ships could be built providing better comprehensive coverage of Colonial patrol routes.

The SCS concept was presented as a high-technology/low manpower solution operating a reduced fighter wing (30 to 36 Vipers and support craft, as opposed to 80 fighters aboard a Mercury Class). The SCS would be somewhat slower than a full sized Battlestar (though FTL would still allow the ship to escape attackers), with a smaller weapons suite, lighter armour, and a significantly smaller crew.

From the outset, the Admiralty fought the SCS concept, concerned that the vessel was intended to replace, rather than supplement the traditional Battlestar, potentially endangering their ability to adequately defend the Colonies.

Critics of the SCS project - both military and civilian - pointed out that the highly automated computer systems would be vulnerable to compromise by Cylon forces and that the reduced manning proposed would prevent the crews from fighting their ships effectively should the automation fail.

A reduced fighter complement would limit the ship's ability to land a weighted blow against hostile forces, and would reduce the number of aircraft available for Combat Air Patrol against a foe known to employ massed attack in number. The reduced fighter complement would also increase the sortie rate as fewer planes attempted to carry out the same missions, increasing the stress and fatigue on the already reduced crew.

In the same vein, the reduced shipboard armament would limit the ship's ability to defend herself if shorn of her fighter cover for any reason, and the lighter armour would compromise her ability to absorb damage.

It was further pointed out that with the advent of improved FTL capabilities, there really was little distinction between high-threat or low-threat areas in the event of full-scale hostilities. A sizeable raiding force could appear almost anywhere within Colonial space with little or no warning.

Despite these and other objections, construction of the first ship was approved by the Quorum of the Twelve and the keel was laid for the Genesis. In a fit of pique, the Admiralty refused to award the ship with the desired designation "light Battlestar" and classified it instead as an "Escortstar".

Riding a tide of public relations accolades, the Adar Administration approved the construction of the Sovereign, Sceptre, Regent, and Ruler before Genesis was half completed.

The SCS concept came into wide disrepute as cost overruns, substandard work, and allegations of kick-backs reached the media. Further trouble and public outrage arose when private memoranda surfaced indicating that the Adar Administration- despite repeated public statements- had no intention of building the SCS in the numbers promised or necessary to replace the Battlestars slated for decommissioning. Outrage became scandal when other memoranda surfaced suggesting that the Adar administration intended to redirect the funding into pet projects favoured by key political contributors.

A special prosecutor was appointed when investigators discovered major political contributions from the building yards to senior members of the Adar Administration, but the investigation was never completed due to the outbreak of the Second Cylon War.

Rocked by the scandal, and in an effort at damage control, the Quorum of the Twelve and the Ministry of Defence cancelled the last two vessels within months of their keels being laid.

Genesis was commissioned a bare year before the Cylon attack- eighteen months behind schedule and at more than double her projected cost. She was engaged in a public relations tour of the Colonies and outer territories and died over Tauron. Sovereign was completing her acceptance trials and was caught up in the conflagration over Virgon. Sceptre was 80% complete in the construction dock over Leonis when the attacks began, but was able to get underway nonetheless.

#### **Quirks/Special Characteristics:**

The Genesis Class Escortstar represented the reinvention of nearly all the mistakes that led to the disastrous early stages of the First Cylon War: too much reliance on automation, too much politicking, and not enough preparedness.

The ships were wonders of modern automation, exceeding even the Mercury Class, and nearly all of the ship's functions could be carried out remotely.

#### **Notable Vessels in Class:**

Escortstar Genesis (Class vessel; Destroyed over Tauron in first battle of Second Cylon War;)

Escortstar Sovereign (Destroyed over Virgon in first battle of Second Cylon War;)

Escortstar Sceptre (Destroyed over Leonis in first battle of Second Cylon War;)

## Escort *Adrasteia*

art by PsyckoSama  
stats by Buscadero

**Agi** d8, **Str** d12, **Vit** d6, **Ale** d10, **Int** d10, **Wil** d10;  
**LP** 22; **Init** d8+d10, **Scale** Spacecraft  
**Speed** 6 (SL/JC)  
**Traits** Formidable Presence (d2)  
**Skills** Heavy Weapons d6, Mechanical Engineering d4, Perception d6, Pilot d4

### Armament

Medium planetcraft scale skirmish range point-defence system (d8);  
8 heavy spacecraft scale short DRADIS range railguns (d12+d2);

### Airwing

20 Vipers; 4 Raptors; 2 assorted craft

**Armour** Wound 4, Stun 3

**Description** 2,397 x 607 x 859 feet;

**Crew** 500; **Passengers** 1,500

While the large and powerful Battlestars are the pride of the Colonial fleet, the Escorts are the unsung workhorses. For every Battlestar gloriously striding though the space lanes, exemplifying Colonial might and pride, you'll likely find a half dozen escorts obediently flying in formation covering her flanks, and on top of that there's probably another half dozen off doing all the minor jobs that would be considered undignified for a Battlestar. Convoy escort, pirate hunting, low value patrol, Battlestar group support... these are all the duties of the Colonial Escort.

Compared to a Battlestar, they're smaller, weaker, with less operational endurance. On the flip side, they're faster, more agile, and much cheaper to build and operate. Escorts are commonly commanded by Colonels, and their crews often affectionately refer to them as "Baby Battlestars". Because of their smaller size the crews, which are rarely higher than 500 crewmen and officers, are often more tightly knit than the crews of the larger and more powerful Battlestars. On the flip side, because of their lack of prestige, escorts, especially those on long duration missions, used to be sometimes seen as good dumping points for wash outs and dead end officers.

This practice, while no longer common, lead to many problems, including low moral, low efficiency, or in the worst cases, mutiny and piracy. The ship has 72 point defence mounts, 8 heavy turrets, and can carry as many as 20 vipers along with four Raptors, and a pair of heavy shuttles.

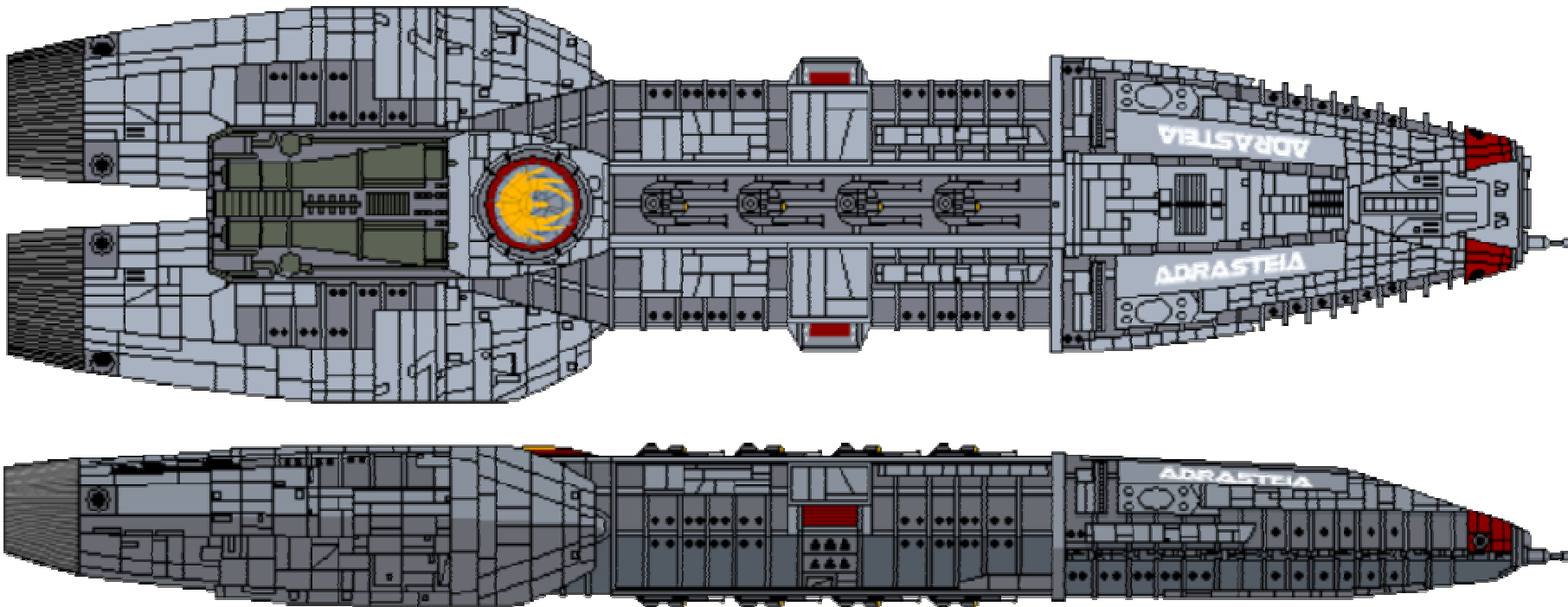



## Loki Class Gunstar

art by Limerickcot

stats by solcalgamer

**Agi** d6, **Str** d10, **Vit** d6, **Ale** d8, **Int** d6, **Wil** d10;

**LP** 20; **Init** d6+d8, **Scale** Spacecraft

**Speed** 7 (SL/JC)

**Traits** Formidable Presence (d2); Past its Prime (d4)

**Skills** Heavy Weapons d6, Perception d4, Pilot d4

### Armament

Heavy planetcraft scale skirmish range point-defence system (d12);

8 heavy spacecraft scale short DRADIS range railguns (d12+d2);

4 spacecraft scale Medium short DRADIS range Railguns (d10)

16 planetcraft light skirmish range missiles (d8)

6 spacecraft scale medium short DRADIS range Missiles (d12)

### Airwing

2 Raptors; 1 shuttle

**Armour** Wound 4, Stun 3

**Description** 1510 x 180 x 90 ft

**Crew** 300; **Passengers** 30

### History

During the first Cylon war it was decided that there was still a need for a smaller escort style warship which could act to protect and defend Battlestars by attacking the enemy capital ships directly, at a distance from its Battlestar. The Loki Gunstar was developed around the guardian/defender configuration.

These ships were designed with heavy weaponry to take the battle to the enemy capital ships, but little space was left for hosting small-craft. Since these ships were designed to be deployed alongside Battlestars, the role of carrying squadrons of Vipers and Raptors into battle was left to the larger ships. These gunstars only carried two Raptors for scouting and utility use.

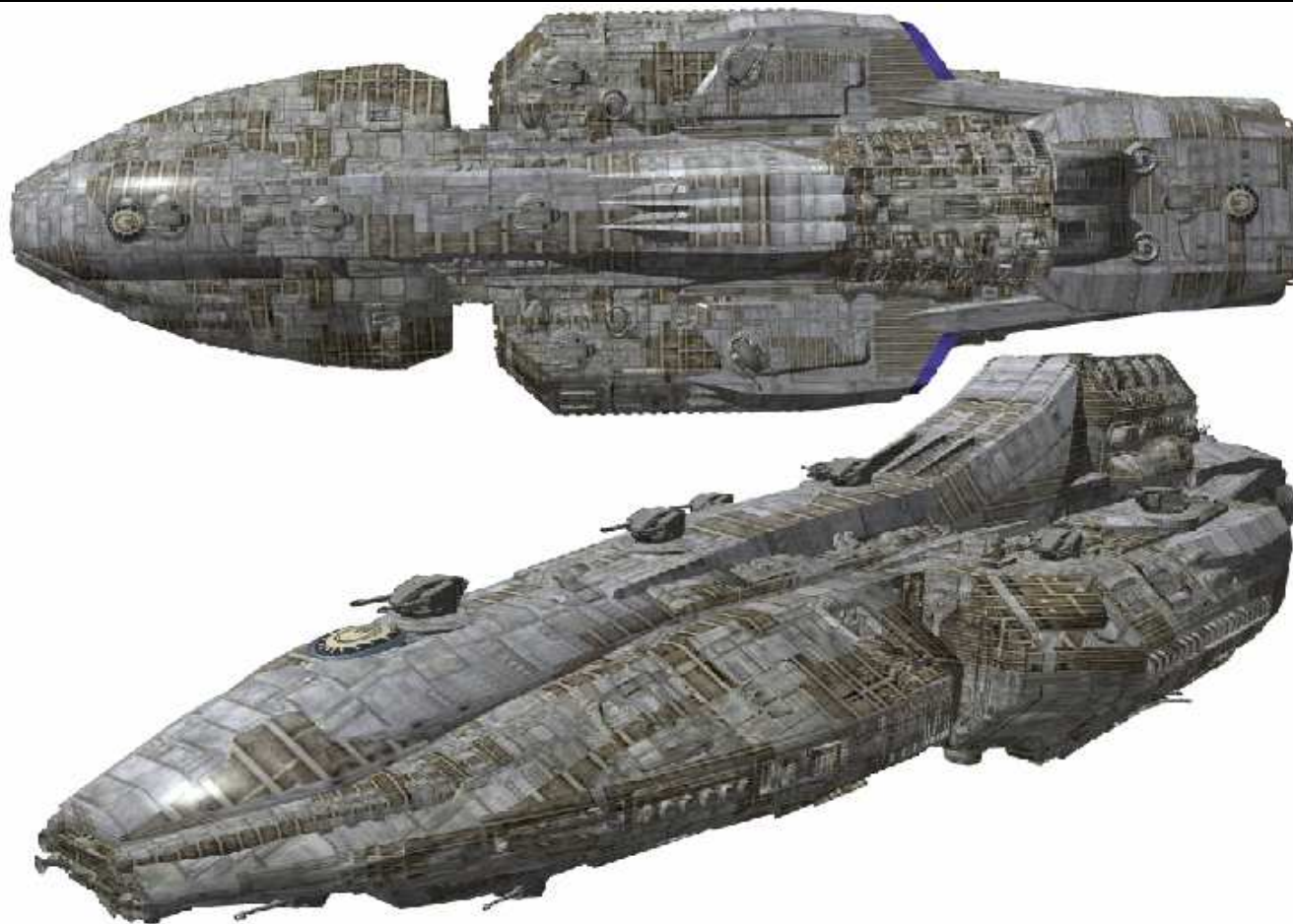

The class served well during the last few months of the first Cylon war. The 27 ships of this class that were sent into battle before the end of the war accounted for 16 Cylon Basestars destroyed (albeit at a heavy loss).

In the decades after war, these ships were scheduled to be decommissioned. However, the desired class of replacement destroyers was extremely slow in coming. (The lead ship of the Thor Gunstar Class was still in the shipyards when the second Cylon war started.) Therefore these ships were pitched back into the fray with whatever crews could be scavenged together.

When the second Cylon war started, seven of these ships were still in service. Four fought at the "Last Stand" over Picon, and were destroyed. One more was destroyed beside the Battlestar Valkyrie during its valiant last stand, and two more went missing, presumed destroyed.

## Janus Escortstar

By SeleK

Agi d4, Str d8, Vit d6, Ale d8, Int d6, Wil d8

LP 16; Init d4+d10; Scale Spacecraft

Speed 5 (SL/JC)

**Traits** Memorable (d4), Ugly (d2), Past It's Prime (d6)

**Skills** Heavy Weapons d4, Mechanical Engineering d4, Perception d6, Pilot d4

### Armament

- Light planetcraft scale skirmish range point defence system(d4);
- 2 medium spacecraft scale capital range primary assault railguns (d10);
- 36 Vipers (full stock), 12 Raptors, 6 assorted craft

**Armour:** Wound 2, Stun 4

**Size:** 1520 x 384 x 251 feet;

**Crew:** 760; Passengers: 2,000

**History:** The Colonial Escort Carrier was designed and built in the early days of the First Cylon War. The type was a stop-gap measure intended to fill the critical need for additional carrier hulls until the Battlestars then building were completed. Eighty-five escort carriers were completed, and fully half that number died in the various battles leading to the Armistice and the Cimitar Accords.

As additional Battlestars were completed, the escort carriers were relegated to training and aircraft transport duties. Following the war, nearly all were retired—usually demilitarized and sold to private shipping concerns where their huge cargo capacity and ample deck space were well appreciated. The remainder were scrapped.

**Quirks/Special Characteristics:** The escort carrier itself is essentially a modified Battlestar-style flight pod set atop a chunky and ungainly collection of prefabricated habitat modules, FTL and sublight drive systems, and bunkering and support systems necessary for survival in space. Most of the ships equipment was designed and built to civilian, rather than military, specifications and no efforts were made to keep the design aesthetically pleasing. The Colonial CVE (Carrier Vessel, Escort) is the bare bones meaning of pragmatism. Even the command and control systems and armaments were fitted almost as an afterthought. Crew habitability, comfort, and system redundancy were all sacrificed in the name of reduced construction times.

Most of these shortcomings were corrected (usually by the ship's company while underway), and armour was eventually fitted, but the haphazard nature of

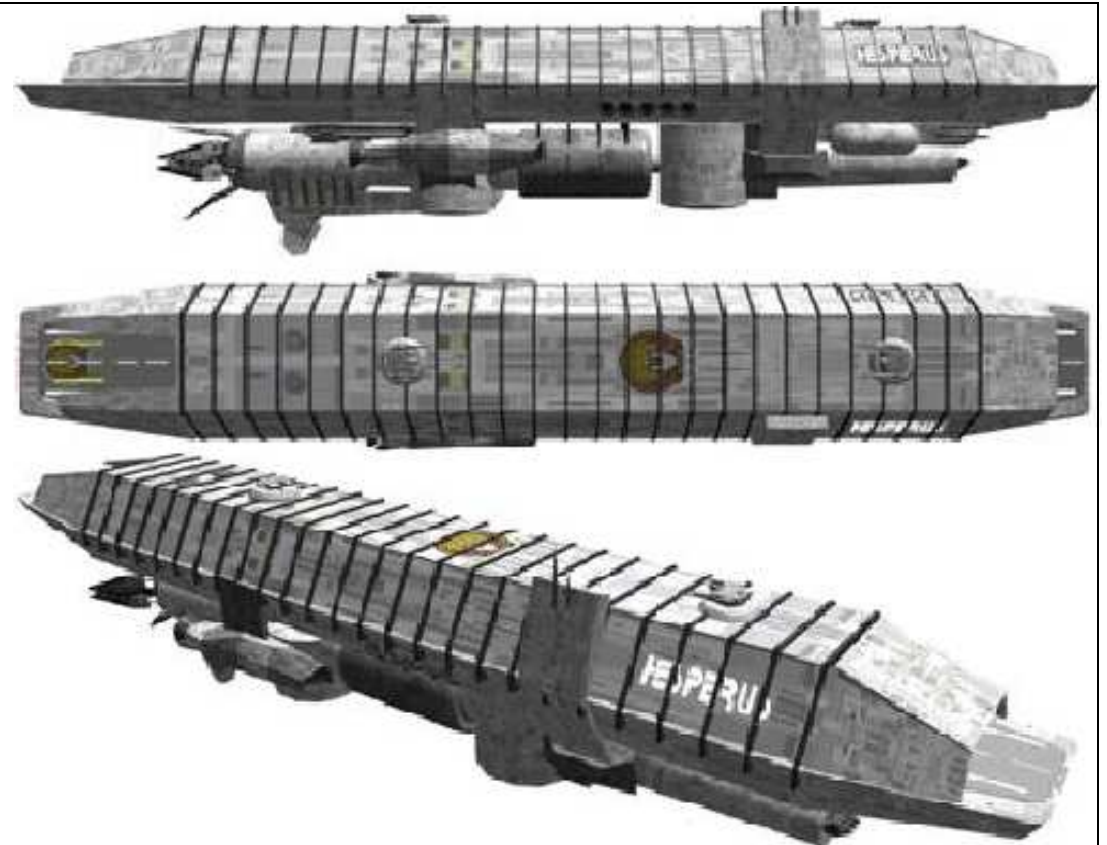

the design and construction were factors that could never be completely overcome. Nonetheless, those who served aboard the CVE's developed a back-handed affection for their cantankerous, demanding charges, though a number of wags derided their type designation as meaning, "Combustible, Vulnerable, Expendable".

CVE's are fitted with tubes to port and to starboard (the usual arrangement was the port tubes far forward and the starboard amidships). A pair of large railguns were mounted atop the flight deck, cited to give the best coverage possible.

### Notable Vessels in Class:

Escortstar Janus (TF 101 flagship; Class vessel)

Escortstar Hesperus

Escortstar Avenger (TF 111 flagship; Destroyed in Battle of Typhon)

## ***Dione Gunstar***

By Selek, (Stats by King of All GM's)

Agi d10, Str d8, Vit d8, Ale d6, Int d8, Wil d8  
LP 16,  
Init d10 + d6, Scale: Spacecraft Speed: 8  
(SL/JC)  
Traits/Complications: Sixth Sense (d4)

Skills: Heavy Weapons d4, Perception d6,  
Pilot d4, Mechanical Engineering d8

### **Armament:**

Medium planetcraft scale skirmish range point defence system (d10);

6 spacecraft scale Medium Short DRADIS range missile systems (d12);

6 spacecraft scale capital Medium Short DRADIS range assault railguns (d10)

**Armour:** Wound 3, Stun 3

Description: 2,080 X 333 X 172 feet

Crew: 670; Passengers: 250

### **Air Wing**

1 squadron of Raptors (4 Raptor general support craft)

1 flight of Raptor-Es (2 Raptor-E ELINT/ECM support craft)

1 flight of Raptor-Es (2 Raptor-E ELINT/ECM support craft)

The *Dione* and her sisters are a class of medium Colonial warships designed for picket duty, long-range patrol, and escort of shipping missions, as well as advance scouts for the fleet. They fulfil a Protection of Shipping (POS) mission for amphibious expeditionary forces, underway replenishment groups and merchant convoys. *Dione* class frigates are intended to provide black-space escort of amphibious ships and convoys in low to moderate threat environments as well as limited defence against fighters at range.

They can also conduct independent operations to perform such tasks as counter-smuggling surveillance, maritime interception operations, and fleet-level exercises. The addition of modified *Raptor* ELINT craft has given these ships a combat capability far beyond the initial class program expectations has made the ships an integral and valued asset in virtually any war-in-space scenario and particularly well suited for operation in the littoral.



Designed as cost effective deep-space combatants, they lack the multi-mission capability of modern surface combatants faced with multiple, high technology threats. The *Dione* class were originally fitted with a self-defence electronic support measures (ESM) system offering limited frequency-cover and questionable security, but were upgraded following several exercise-and-evaluation cycles. The class has only a limited capacity for further growth. Despite this, the *Dione* class is a robust platform, capable of withstanding considerable damage.

The *Dione* class was designed from the keel up as a total warfare system, capable of operating independently or as an integral part of a Battlestar or black-space action groups. Innovations in high speed digital computer technology enable the on-board weapons system to instantly detect and evaluate contacts at greater ranges with minimum human interface, thus providing increased reaction time. To enhance the on-board capabilities, the new ELINT *Raptor* adds significantly to the ship's sensor and weapons delivery range.



## Oracle Class Gunstar

Art by Ravensoracle

Stats by Limerickcot

Agi: d6, Str: d8; Vit: d6; Ale: d6; Int: d8; Wil: d8

LP: 16; Initiative: d6+d6; Scale: Spacecraft

Speed: 6 (SL/JC)

Traits: None

Skills: Hvy Weapons: d6; Perception: d8; Pilot: d4; Mechanical Engineering: d4

Armour: Wound 3, Stun 2

### Armament:

Medium Planetcraft-scale, Skirmish Range PDS (d8)

2 Heavy spacecraft-scale Railguns, Capital Range (d12))

24 Heavy spacecraft-scale, Medium range Missile Launchers (d12+2)

### Airwing:

1 shuttle

2 Raptors

Crew: 57; Passengers: 30

Dimensions: 535 ft long x 56 ft high x 168 ft wide

Corvette Gunstars combine the ability to defend a colonies' assets and interests far away from its own shores, with sophisticated weapons and surveillance equipment while being smaller and cheaper to operate than larger Escortstars. She pays for this sophistication with light armour and only a moderate speed. The Oracle Class represents the increased preponderance towards guided missiles now being deployed throughout the fleet. She retains only two railguns.

The Oracle is also equipped with a small hangar bay that passes thru the belly of the ship that allows the ship to support two Raptors for additional Fleet Support. The external pods are missile bays rather than flight decks.



**Colonial Corvette**  
by Ravensoracle

## **Gladius Class**

by Ravensoracle

Agi d8. Str d12, Vit d6, Ale d10, Int d8, Wil d8;

LP 20; Init: d8+ d10; Scale Spacecraft.

Speed: 6 (SL/JC)

Traits Formidable Presence (d2)

Skills: Heavy Weapons d6. Mechanical Engineering d4

Perception d4. Pilot d4

### **Armament:**

Heavy planetcraft scale skirmish range point defence system (d12),

12 spacecraft scale sho1 DRADIS range primary assault railguns (d12+d2);

16 spacecraft scale short DRADIS range missile systems (d12+4),

6 spacecraft scale long DRADIS range nuclear missile systems (d12+d8);

**Airwing:** 12 Vipers. 4 Raptors. 2 Shuttles

**Armour:** Wound 6. Stun 5

**Description** 1568 x 536 x 237 feet.

Crew 1.000; Passengers 400

Historically a cruiser was not a type of ship but a warship role. Cruisers were ships — often frigates or smaller vessels — which were assigned a role largely independent from the fleet. Typically this might involve missions such as raiding enemy shipping lanes. later the term ‘cruiser’ came to mean ships designed to fulfil such a role, a ‘cruiser’ was a warship larger than a destroyer but smaller than a Battlestar.

The cruiser was a fleet’s long-range force projection weapon. while the larger ships stayed nearer to home. Their main role was to attack enemy vessels. Other roles included reconnaissance, and cruisers were often attached to the Battlestar Group as additional support. Later designs such as the Gladius Class Missile Cruiser began to also act as a small carrier, equipped with a small contingent of Vipers and Raptors to provide additional support during independent missions.

The Gladius Class itself was designed as a first attack/response vessel. Containing a Large contingent of both nuclear and conventional missiles and



## **Gladius Class Escortstar**

sporting 12 railguns and an impressive point defence system. the Gladius Class is intended to hold its own against larger vessels.

To the Viper and Raptor pilots landing aboard a Gladius, it has gained an interesting reputation. The launch tubes and landing approach pass between the engine pods from the rear of the ship. This approach has been termed “Tornado Alley” because of the exhaust from the sublight engines and requires that a pilot land his craft Hands-On.

## Ice-Dragon Gunstar

By Limerickcot

Agi: d6, Str: d8; Vit: d6; Ale: d4; Int: d8; Wil: d12

LP: 20; Initiative: d6+d4; Scale: Spacecraft

Speed: 7 (SL/JC) [Ice-Dragon Pursuit – 9, sublight only]

Traits: Past its Prime (d2)

Skills: Hvy Weapons: d6; Perception: d4; Pilot: d8; Mechanical Engineering: d6

### Armament:

Light Planetcraft-scale, Skirmish Range PDS (d6)

4 Heavy spacecraft-scale Railguns, Capital Range (d12)

4 Fixed spacecraft-scale fixed bow guns, Medium DRADIS Range (d12+d6)

### Airwing:

1 shuttle

2 Raptors

Armour: Wound 6, Stun 6

Crew: 23; Passengers: 10

Dimensions: 460 ft long x 56 ft high x 198 ft wide

The Dragon Gunstar is one of the heaviest designs fielded by the Canceron government prior to unification. A short-range design, it lacked FTL capability but was armed with six heavy guns, making it an excellent, and above all, cheap, defender. It was able to carry a good crew, in comfort, for several months, carrying out customs and patrol duties.

It didn't last well at all in the coming conflict. Although it was well armed, it was under-armoured for the tasks it was being sent in to accomplish. A quick and easy replacement was needed. One that could be built simply and quickly. The new version was named the 'Ice-Dragon' after a mythical creature on Kobil.

Installation of an FTL drive was seen as essential, but this meant a reduction in passengers, stores and endurance to only 30 days. Her DRADIS suite was sub-par. A defensive suite was added for close in protection. Duplication of controls, passageways and everything needed to operate and fight the ship was made essential. Extra armour surrounded the vulnerable engines. The combination made a vessel capable of withstanding a fight against quite overwhelming odds.

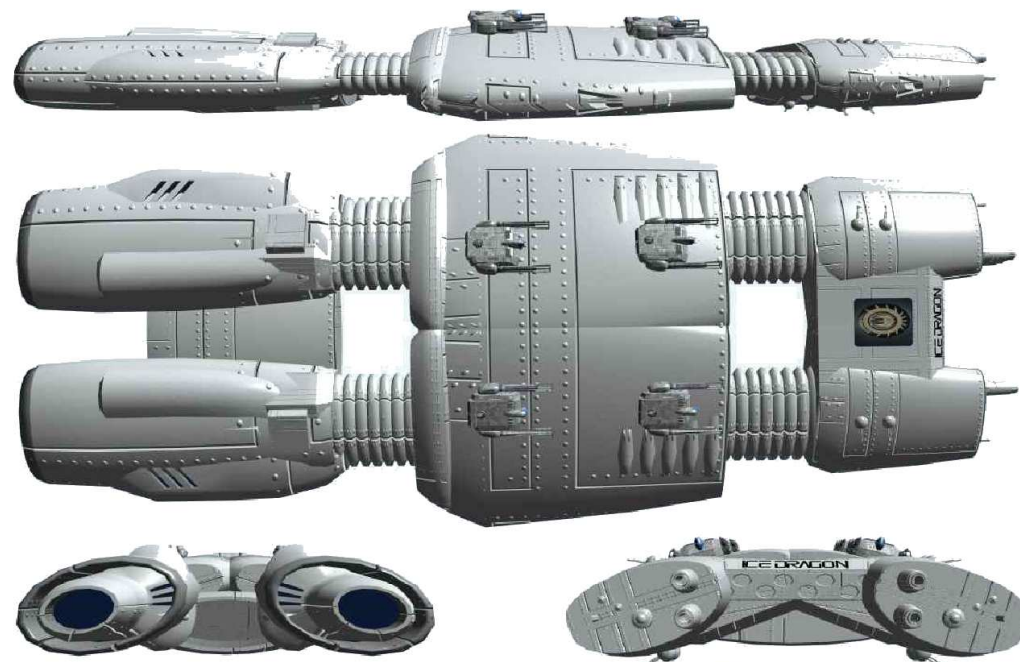

## ICE-DRAGON

By Limerickcot

based on a model by Ice-Dragon



Canceron still continues to manufacture this ship up to current times, although the more modern varieties have upgraded electronics and computers. The sensor suite was totally refitted. A further variant is also available that has no FTL capability but does have larger engines, making it one of the fastest gunstars currently available.



## Ares [Hercules] Gunstar

Stats by Buscadero

render by © by [Alexzandyr](#)

**Agi** d6, **Str** d12+d2, **Vit** d6, **Ale** d8, **Int** d8,  
**Wil** d10;  
**LP** 22; **Init** d6+d8;  
**Scale** Spacecraft; **Speed** 6 (SL/JC)

### Traits

Mass-Produced (d4), Loved (d6)

**Skills** Heavy Weapons d6, Mechanical Engineering d4, Perception d6, Pilot d4

### Armament

Heavy planetcraft scale skirmish range point-defence system (d12),  
 16 spacecraft scale capital range primary assault railguns (d12+d2);  
 8 spacecraft scale short DRADIS range missile systems (d12+d4);  
 8 spacecraft scale short DRADIS range nuclear missile systems (d12+d8);

### Airwing

52 Vipers, 12 Raptors, 8 assorted craft

**Armour** Wound 5, Stun 4

**Description** 3,106 x 1,381 x 515 feet;

**Crew** 1,200; **Passengers** 2,500

An attempt to provide the balance between escort and gunstar produced the Hercules Class Gunstar. Carrying over two squadrons of Vipers for local defence and yet also managing to cram in as many guns as normally seen on a Battlestar, its six engines also manage to give it a very respectable speed. This paragon of balance has its shortcomings however. The principal one is that of expense, a second is restricted quarters and stores. Unfortunately the worst aspect of the Hercules Class is caused by the large number of fighters it carries. The lack of large and easily accessible flight pods restricts the ability of the Hercules to recover its Vipers quickly or easily. In effect, in any

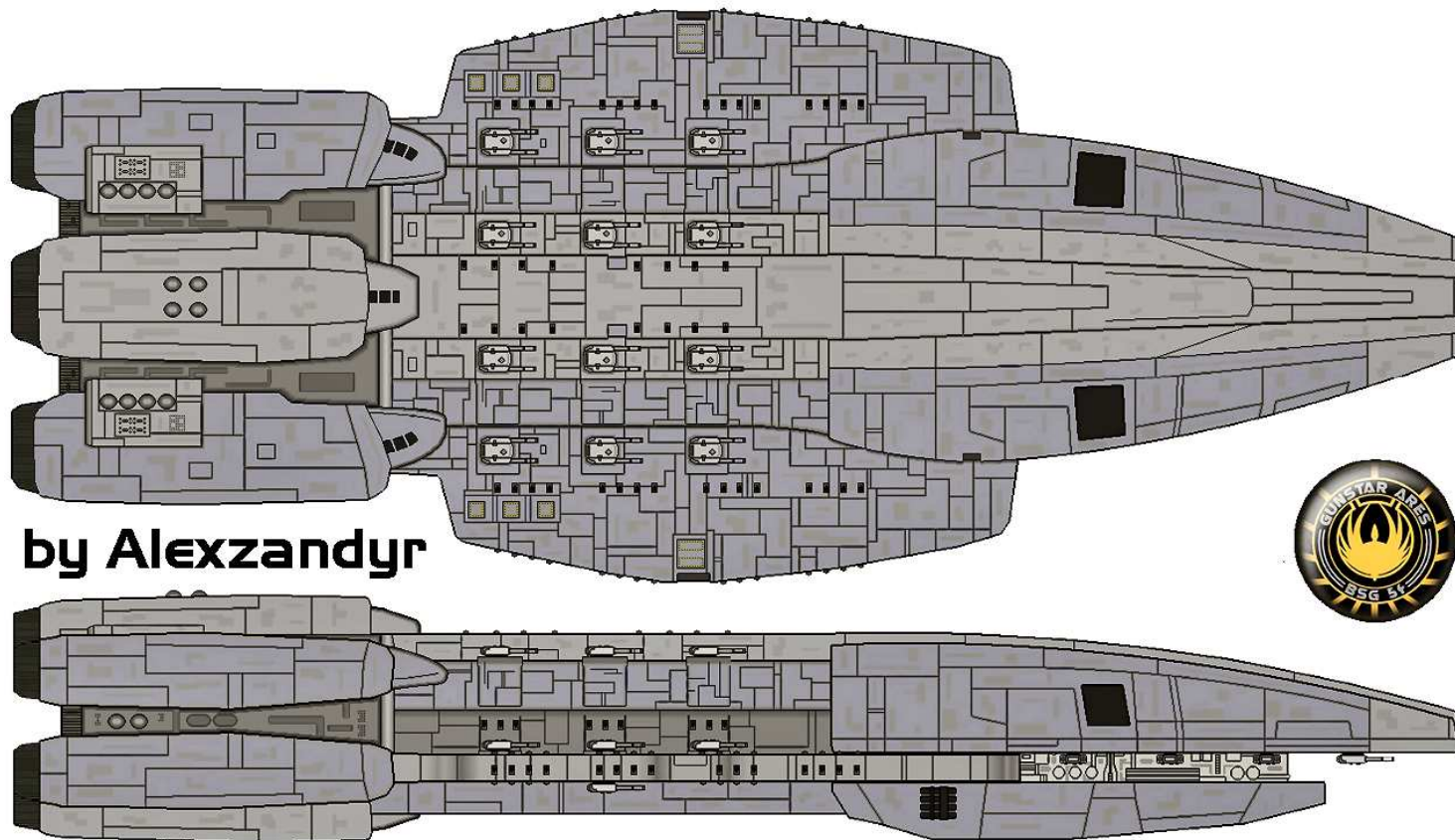

by Alexzandyr

fight where the Hercules is outnumbered it has to stay and fight to the end – or run and see its fighters destroyed behind it.

It is fairly obvious then, to see why Viper Squadrons assigned to the few vessels of this class occur more insubordination infractions than any other similar stationed Squadron is likely to incur. Added to tight quarters, a high crash rate and an almost impossible transfer rate out, it is also somewhat surprising (but only to those who haven't survived these ships) that those pilots are also some of the tightest knit to be found in the fleet.

Another major flaw of the class is its concentration of major armament into its dorsal arcs. She mounts only two guns capable of covering her ventral arc and none of the Dorsal guns can cover the rear arc. Luckily the experience of the Hercules was resolved in other escorts and gunstars that followed.

## Russan Class Escortstar

stats by HeroLover  
art by SeleK

Agi d8, Str d8, Vit d6, Ale d8, Int d6, Wil d10  
LP 16; Init d8 + d8, Scale:  
Spacecraft  
Speed: 8 (SL/JC)

**Traits/Complications:** Past it's Prime (d6), Destiny (d10), Quick Repair\* (d4), Jury-rigged\*\* (d6)

**Skills:**  
Heavy Weapons d4, Perception d6, Pilot d4, Mechanical Engineering d8

### Armament:

Light planetcraft scale skirmish range point defence system (d4);  
4 spacecraft scale Medium Short DRADIS range missile systems (d12);  
4 spacecraft scale capital Medium Short DRADIS range assault railguns (d10)

**Armour:** Wound 3, Stun 3  
Dimensions: 460 X 172 X 60 feet  
Crew: 315 Passengers: 150

### Air Wing

1 Flight of Raptors (4 Raptor general support craft)  
2 Flights of Vipers (8 x Mk II Vipers)

\*Based upon asset Quick Healer. Most of the Damocles systems are easily jury-rigged.

\*\*Based upon the complication Illness. Most of the Damocles systems are jury-rigged so they may fail at any moment.

The Russan class were built late in the First Cylon War as Colonial industry began making good the losses suffered early in the war. Because of the urgent need for hulls, the class was both simple in design and lightly built with an



emphasis on speed of construction, modular design, and survivability. Most shipboard systems were built to take advantage of the ship's modular design and allowed for damaged sections to be bypassed or replaced to temporarily circumvent damage. One drawback to this system, however, was that the modular connections meant more points at which shock damage could break connections, taking systems off-line.

Because of the speed of their construction and simple design, Russan Class frigates were built less as line-of-battle ships, and were far more frequently used as small patrol craft, or as an outlying DRADIS pickets (as part of a Battlestar's protective screen).

Because of their potential as advance scouts for the Fleet, and their more mundane tasking as patrol ships, the Russan class was fitted with a centreline hangar to accommodate a small complement of Raptors and Vipers for patrol and intercept duties. Four launch tubes on the portside allow the Vipers to launch rapidly, but the Raptors launch, and all landings take place on the ship's dorsal landing pad/elevator.

Following the Armistice, the Russan class was assigned more mundane duties of routine patrol and customs enforcement along Colonial trade routes.

As newer, more capable, and more carefully constructed vessels came on-line, the Russan Class were largely phased out as their worn-out systems became less cost-effective in the face of newer and more capable designs.

## ***Cygnus I & II Class Escortstars***

Artwork by Backstept  
Stats by Limerickcot

Agi d8, Str d8, Vit d8, Ale d6, Int d6, Wil d6, LP 16, Init d8 + d6,  
Scale: Spacecraft  
Speed: 8 (SL/JC)  
Traits/Complications: past it's prime (d4)  
Skills: Heavy Weapons d4, Perception d6, Pilot d4, Mechanical Engineering d8

### **Armament:**

Medium planetcraft scale skirmish range point defence system (d10);  
4 spacecraft scale Medium Short DRADIS range missile systems (d12);  
18 spacecraft scale capital Medium Short DRADIS range assault railguns (d10)  
Armour: Wound 3, Stun 3  
Description: 1153 long X 83.25 high X 144 feet wide

Crew: 470 (type II); 618 (Type I)  
Passengers: 150 (type II); 31 (Type I)

### **Air Wing**

2 squadron of Raptors (8 Raptor general support craft)  
1 flight of Raptor-Es (2 Raptor-E ELINT/ECM support craft)  
1 Shuttle

The original Cygnus was a pre-Unification Battle-Cruiser. Soon to be outclassed by the super carriers and cruisers of the first Cylon War, at the time Cygnus was a fast and well armed vessel, well able to deal with the inter-planetary conflicts being practised at the time. Lightly manned due to extensive computerised systems, the Cygnus was able to carry a small air wing of Adders or Starhounds and a commando wing for ship to ship actions, in addition to double the armament it originally started with.



With the advent of the Cylon War, such ships were quickly found to be liabilities as Cylon AI viruses quickly overcame the firewall defences and destroyed the vessels. A new Cygnus (the second vessel of her name) was built quickly to the same design, but the need to replace electronics with crew necessitated the replacement of the Airwing and most of the missile weaponry with life support and crew facilities. Instead of being a cruiser, the new class were now Gunstars – support ships meant to help larger vessels or protect merchant vessels. They were no match for either Basestars or the many raiders sent against them.

A Cygnus class is renowned for the cramped crew quarters and lack of privacy. Fleet policy is to use the vessels only on short term duties, regularly rotating crew to other duties at the conclusion of each tour.

The Type I & II Cygnus classes were withdrawn from active service seventeen years ago, being assigned to local defences in outlying systems.



## **Cygnus III Escortstar**

Art by Ice-Dragon

Stats by Limerickcot

Agi d8, Str d10, Vit d8, Ale d6, Int d8, Wil d8

LP 18, Init d8 + d8,

Scale: Spacecraft,

Speed: 7 (SL/JC)

Traits/Complications: none

**Skills:** Heavy Weapons d4, Perception d6, Pilot d4,  
Mechanical Engineering d8

### **Armament:**

Medium planetcraft scale skirmish range point defence system (d10);

10 planetcraft scale Short DRADIS range railguns (d12+4)

12 spacecraft scale Long DRADIS range assault railguns (d12)

4 fixed, spacecraft scale Short DRADIS range assault railguns (d12+d4)

16 spacecraft scale short DRADIS range missile systems (d12)

**Armour:** Wound 4, Stun 3

**Description:** 1525 long X 111 high X 530 feet wide

**Crew:** 312 Passengers: 175

### **Air Wing**

2 flights of Raptors (8 Raptor general support craft)

1 flight of Raptor-Es (2 Raptor-E ELINT/ECM support craft)

2 flights of Vipers Mk VII (8 in total)

2 Shuttles

The Cygnus III was an enlarged Cygnus II vessel in all dimensions. Problems with producing an enlarged engine for the design meant that the original Mk III's speed was slightly less than that of the Mk II's but the most serious design flaw was actually the constantly changing nature of the design specification itself. Although originally intended to be only a gunstar, there was a massive outcry for an independent patrol craft that could carry a squadron of Vipers. In the end, however, the fighter wing was reduced to

## **Chiron III**

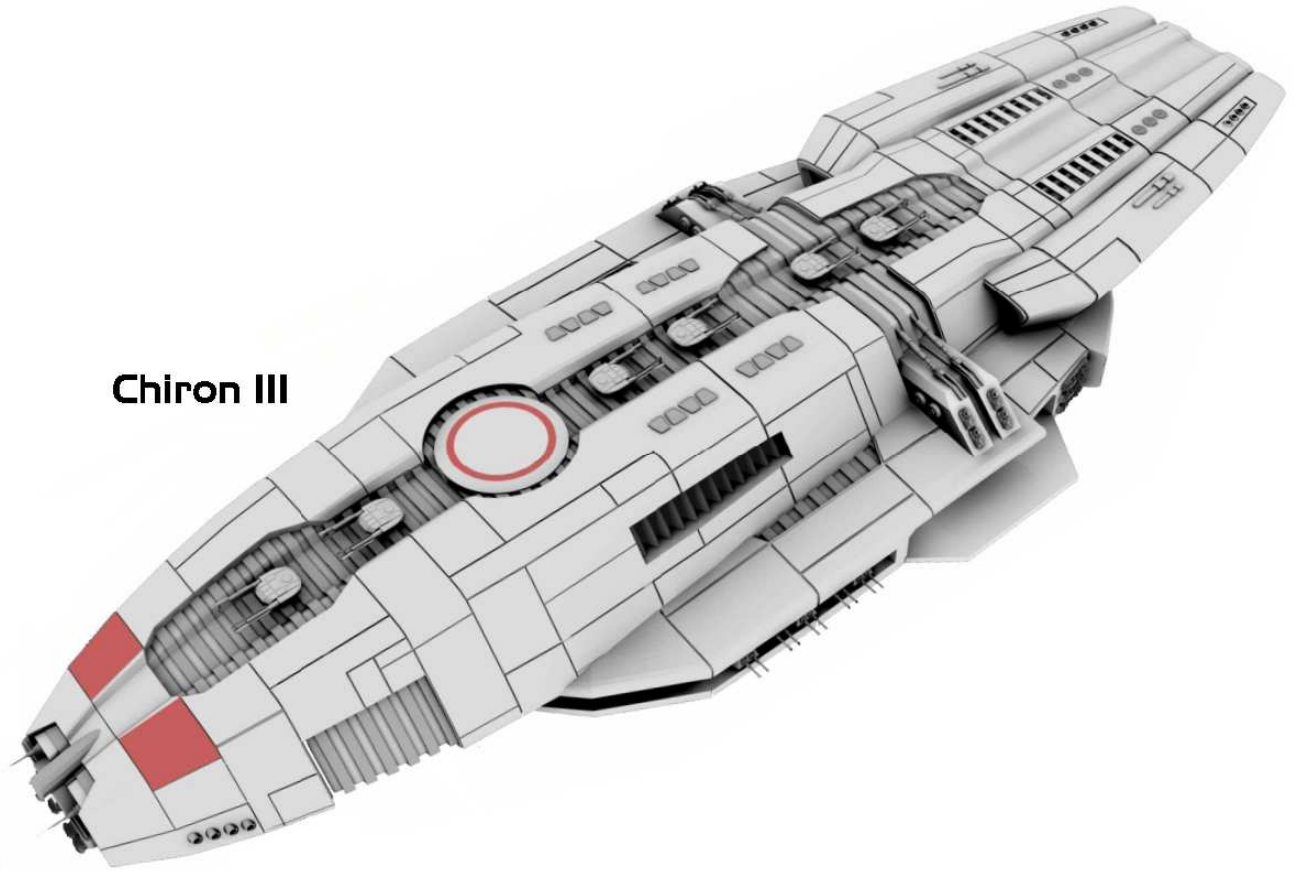

just two flights of Vipers – sufficient for patrolling and most independent actions. Introduction of new, hardened computer systems, invulnerable to Cylon AI infiltration methods, allowed a reduction in crew numbers whilst increasing the armament capacity of the Cygnus. A long range anti-fighter array was introduced, giving the vessels a capacity to engage fighters at a much longer distance but without tying up the main batteries with suppression fire.

One of the most welcome changes to the vessel type though is the expansion of Crew Quarters. With individual bunk rooms, generous recreation facilities and as generous a capacity for passengers, the Type III are considered a pleasure to serve aboard, as well as being well suited to long range patrol duties in the outlying systems.

## ***Centare Escortstar***

Art by Limerickcot, based on an original by Ice-Dragon  
stats by Limerickcot

Agi d8, Str d10, Vit d8, Ale d8, Int d8, Wil d8  
LP 18, Init d8 + d8,  
Scale: Spacecraft,  
Speed: 8 (SL/JC)

**Traits/Complications:** none

**Skills:** Heavy Weapons d8, Perception d6, Pilot d4, Mechanical Engineering d8

### **Armament:**

Medium planetcraft scale skirmish range point defence system (d10);  
10 planetcraft scale Short DRADIS range railguns (d12+4)  
15 spacecraft scale Long DRADIS range assault railguns (d12)  
4 fixed, spacecraft scale Short DRADIS range assault railguns (d12+d4)  
24 spacecraft scale short DRADIS range missile systems (d12)

**Armour:** Wound 5, Stun 3

**Description:** 1784 long X 111 high X 530 feet wide

Crew: 430

Passengers: 1 Marine Boarding Company + 250 others, extensive hospital facilities

### **Air Wing**

1 Squadron of Raptors (20 Raptor general support craft)

1 flight of Raptor-A (4 in total)

1 Squadron of Vipers Mk VII (20 in total)

1 Refueler

8 Shuttles

The Cygnus III's development stage had a number of shortfalls in her perceived role as an Escortstar. In a bid to find a cheaper alternative to the Berzerker class of cruiser, the Centare, its keel already laid, was lengthened in the dockyard to allow her to provide this role.

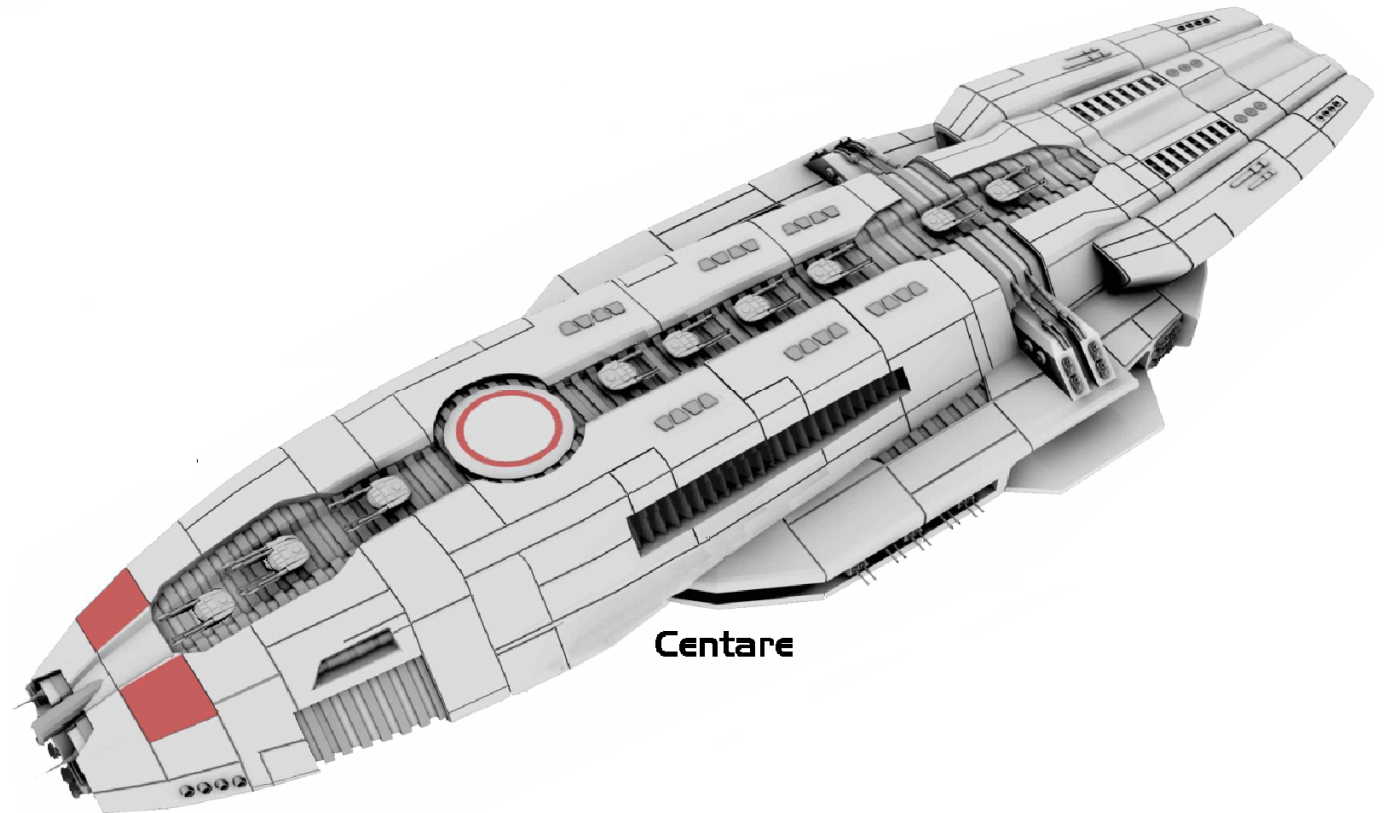

**Centare**

She would carry a full squadron of Vipers, a Marine boarding company and all the support necessary to act as an Escortstar controlling merchant convoys and providing in-system patrol duties.

In addition, the Centare was the first vessel to utilise the more powerful engines that were destined to re-equip the Cygnus III's. This gave the Centare the same speed as her predecessors. She is also more heavily armoured than the Cygnus classes, and carries a much better DRADIS suite, a necessity needed for the co-ordination of many civilian ships all travelling in convoy.

The Centare also carries an extensive fleet medical facility unrivalled by many, older, Battlestars. This feature was brought about by the decision to rectify the needs of the Hermes class. A single Centare is able to provide the necessary backup facilities for the Hermes SAC (including providing back up troops from its own Boarding company).

## Chiron Escortstar

Art by Limerickcot, based on an original by Ice-Dragon; stats by Limerickcot

Agi d8, Str d10, Vit d8, Ale d8, Int d8, Wil d8

LP 18, Init d8 + d8,

Scale: Spacecraft,

Speed: 8 (SL/JC)

**Traits/Complications:** none

**Skills:** Heavy Weapons d8, Perception d8, Pilot d4, Mechanical Engineering d8

### Armament:

Medium planetcraft scale skirmish range point defence system (d10);

16 planetcraft scale Long DRADIS range railguns (d12+4)

16 planetcraft scale Long DRADIS range missile launchers (d10)

19 spacecraft scale Long DRADIS range assault railguns (d12)

4 fixed, spacecraft scale Short DRADIS range assault railguns (d12+d4)

24 spacecraft scale short DRADIS range missiles systems (d12)

**Armour:** Wound 7, Stun 5

**Description:** 1834 long X 111 high X 530 feet wide

Crew: 497

Passengers: Marine surface assault company + 110 passengers

### Air Wing

1 flight of Raptors (4 in total)

1 flight of Raptor-A (4 in total)

1 flight of Raptor LC (4 in total)

2 flights of FTL capable LST (landing ship tank – 8 in total)

1 Squadron of Vipers Mk VII (20 in total)

2 Flights of Python Bombers (8 in total)

2 Refueler

4 Shuttles

Chiron is an oddity. Originally a heavily modified Cygnus I, she survived the Cylon War and helped serve as a model for the Cygnus III class. Instead of being withdrawn from service she has been extensively remodelled

## Chiron

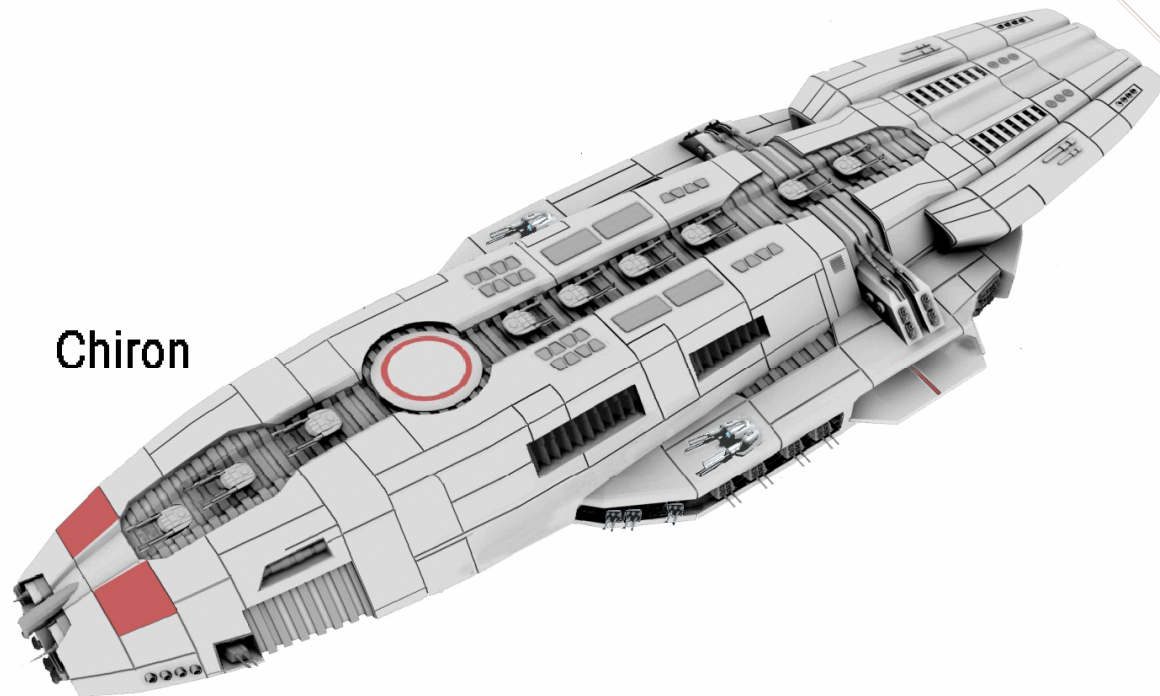

throughout her service in the fleet. She has been rebuilt so often that it is claimed that the only original part of her left is her nameplate!

Her latest rebuild, which then led to the development of a class under the same name, is of a similar nature to the Hermes class. Chiron's principal difference is that she carries a more potent landing force. A flight of 8 python bombers (now rare in colonial service) gives her an advanced striking force.

In addition to FTL heavy shuttles, she also carries FTL capable LST's (normal LST are sublight only). Additional armament and armour allows the Chiron to advance this force against the most determined of resistance. A capacious cargo hold, munitions and repair shops put her on a par with some of the lighter Battlestars, but she is not capable of standing toe to toe with a Cylon Basestar.

If there is a disadvantage to the Chiron, it is that she does not carry the more sophisticated computer systems now available to the fleet. This is a systems failure due to her age (it is a design flaw that is not easily rectified). She also mirrors some of the cramped crew quarters of the original designs, although she does carry extensive recreation facilities that mitigate this to a large degree. Crewmen bunk in 20 men dormitories, officers in four man rooms.



## Alliance Class Frigate

By Selek

(Stats by King of All GM's)

Agi d10, Str d8, Vit d8, Ale d6, Int d8, Wil d8

LP 16, Init d10 + d6,

Scale: Spacecraft

Speed: 8 (SL/JC)

Traits/Complications: Sixth Sense (d4)

**Skills:** Heavy Weapons d4, Perception d6, Pilot d4, Mechanical Engineering d8

### Armament:

Medium planetcraft scale skirmish range point defence system (d10);

6 spacecraft scale Medium Short DRADIS range missile systems (d12);

6 spacecraft scale capital  
Medium Short DRADIS  
range assault railguns (d10)

**Armour:** Wound 3, Stun 3

**Description:** 2,080 X 333  
X 172 feet

Crew: 670; Passengers:  
250

### Air Wing

1 flight of Raptors (4 Raptor  
general support craft)

1 demi-flight of Raptor-Es  
(2 Raptor-E ELINT/ECM  
support craft)

Although technically larger than most of the gunstars being deployed at that time, the Alliance Class was designed as an Advanced ELINT vessel.

Capable of outpacing most of its sister ships, the

Alliance can rapidly deploy to most parts of the colonial systems where its superior DRADIS systems and ECCM suites can be put to use ahead of the fleet. She is also an orbital survey vessel and an Alliance Class vessel may operate far from home carrying out both astro-cartography and settlement sweeps of nearby star systems. Rumour states that at least two of these ships are on permanent patrol along the Cylon-Colonial border.

In a stand-up fight, the best means of defence for the Alliance is simply to run, and not fight. Running is what she does best.

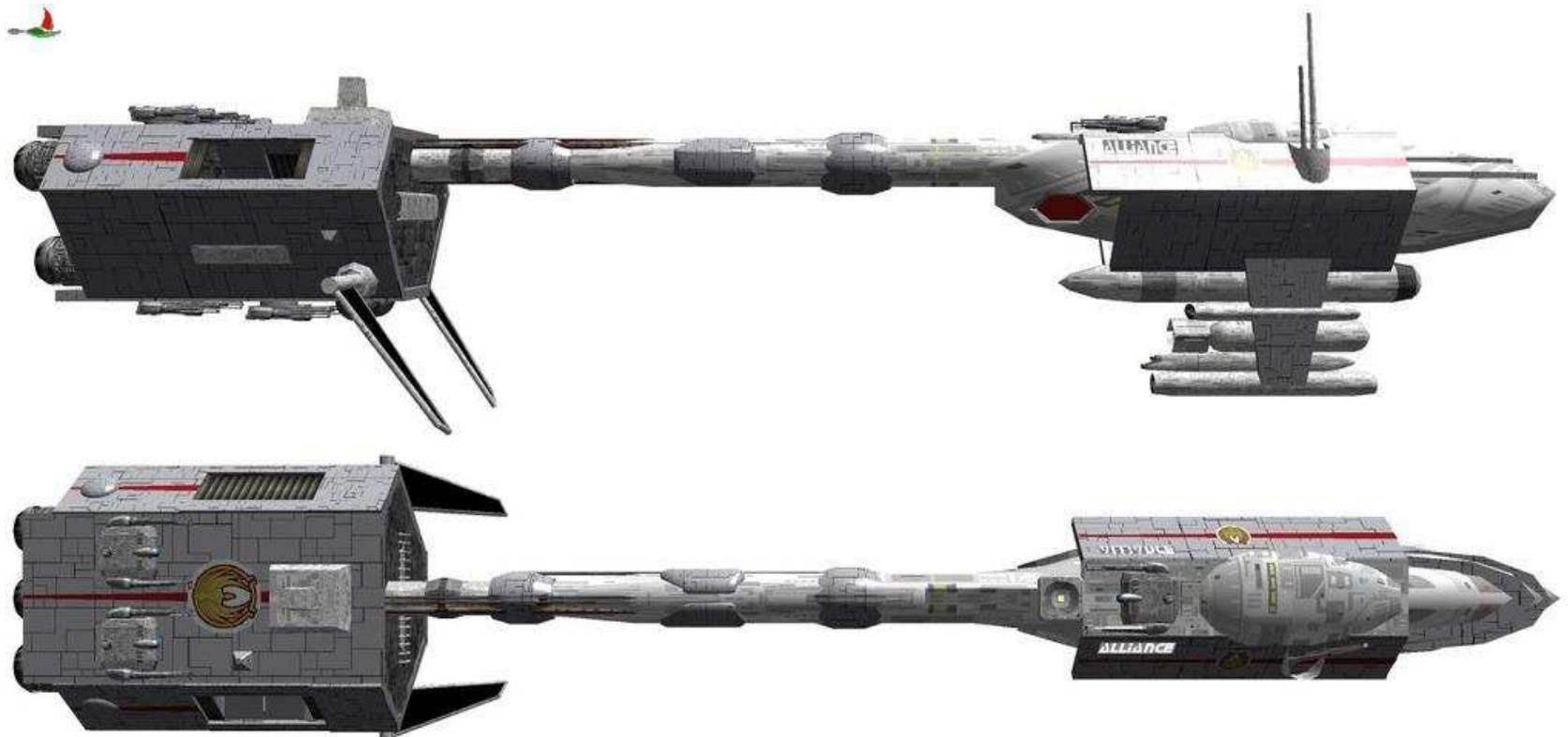

## V Class Escortstar

Stats by Raptor

Art by SeleK

**Agi-D4 Str-D12 Vit-D10 Alt-D10 Int-D8 Wil-D10**

**Lp-22 Init-D4+D10 Speed-6 (SL/JC)**

**Traits-** Mass Produced-D4

**Skills-** Covert-D6; Heavy Weapons-D4; Perception-D6; Pilot-D4

### Armament

-Medium Planetcraft Scale Skirmish PDS (D8);  
16 Spacecraft Scale Medium Railguns (D10);  
14 Spacecraft Scale Short DRADIS Missile Systems (D12);

8 Spacecraft Scale Long DRADIS Missile Systems (D12+D8)

**Air Wing-** 24 Mk VII Vipers; 6 Mk IV Pythons; 14 Raptors; 4 Dropships; And 2 Gunships

**Armour-** Wound 5/Stun 5

**Dimensions-** 1430'x385'x130'

**Crew-** 1200 **Troops-** 145 (reinforced rifle company with support platoon);

The V Class Strike Cruiser was developed to provide a hard hitting raiding platform for the Colonial Fleet in the years following the 1st Cylon War. The V Class is bristling with missile launchers and have given the Mercury class Battlestars a lot of grief in simulated engagements.

This class of Strike Cruiser currently consists of 12 ships organized in 3-4 ship squadrons. Cruiser Squadron 21 (CruRon 21) was detached from the Colonial Fleet to ascertain the fate of the long range survey vessel *Colonial Explorer* and was declared overdue and presumed lost. The remaining ships are operational and are in the process or have been refitted with the CNP.

The strike capability of the V Class has been further enhanced by the introduction of the new Python Mk IV (update of the Python Mk II) which have been optimized for long range strike and attack missions. The addition of the new Dropships and Gunships for the Colonial Marines have truly made the Marines onboard these cruisers a force to be reckoned with.

The V Class was designed to operate independently for extended periods of



time. The Colonial Fleet hopes to operate around 40 of this class in the coming years. The V Class is the brainchild of Admiral Isaac Matthews, project head of the V Class. Adm Matthews developed these Strike Cruisers to tie up the Cylon Fleet in the event of a Cylon re-emergence. In the meantime, the V Class Strike Cruiser has successfully been used in anti piracy sweeps, peacekeeping/making operations, sovereignty patrols and long range picket patrols.

## ***Norn Class Escortstar***

By Lynn de Fey

**Agi** d8, **Str** d8, **Vit** d8, **Ale** d10, **Int** d10, **Wil** d10, **LP** 18; **Init** d8+d10; **Scale** Spacecraft;

**Speed** 5 (SL/JC)

**Traits** Past its Prime (d6)

**Skills** Athletics d6, Mechanical Engineering d4, Perception d6, Pilot d4

### **Armaments**

Heavy planetcraft scale skirmish range point-defence system (d12),

8 spacecraft scale capital range primary assault railguns (d6),

6 spacecraft scale short DRADIS range missile system (d6),

4 raptors

**Armour** Wound 3, Stun 3

**Dimensions** 514 x 223 x 89; Crew 270;

**Passengers** 100

### **Additional info**

35,000 tons; **fuel** 875 tons;

**Cargo Capacity** 8000 tons,

**Price** 8,825,000 credits, **Maintenance Cost:** 315,000 credits

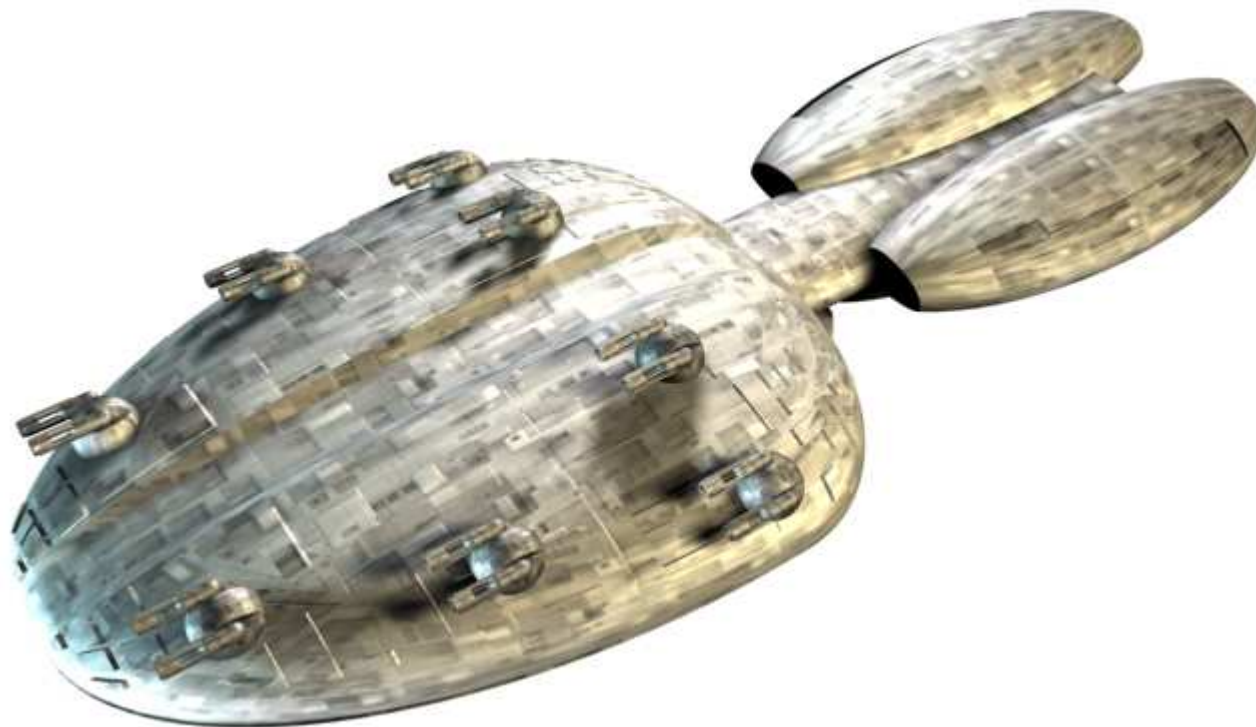

The Norn Class Escortstar was an easy-to-manufacture vessel designed to replace the Eris class Escortstar whose numbers had dwindled toward the end of the last Cylon War. Few actually made it into action before the Armistice ceased hostilities, and the Norns that had been completed served out their days having been designed for a role that was no longer necessary. Within ten years, they were phased out and replaced with the Aereon class Escortstar. Those few remaining in service were relegated to menial tasks like escorting cargo convoys through areas occasionally frequented by pirates. The few Norn's that remain have largely not been upgraded to more advanced avionics, since their duties are so minor.

The Verthandi is one of the few remaining Norn Class ships in Colonial Fleet service. Getting a duty assignment aboard her is a clear indication of how poorly your military career is going, and a sure sign that promotion is not in your future. The crew is largely comprised of wash-outs, screw-ups, and trouble makers. Morale remains reasonable due to a competent but overworked CO. The Verthandi usually performs convoy escort duties into the Keiper Belt to various mining stations.

The ship was on one such routine trip when the Cylons attack.

Other ships of the class still in service: Urd, Skuld, Akashwani, and Kuten



## **Helios Class Escort**

By Electricbadger

Agi d8, Str d12, Vit d10, Ale d8, Int d6, Wil d8 LP 16, Init d10 + d6

Scale: Spacecraft

Speed: 7 (SL/JC)

Traits/Complications: None

Skills: Heavy Weapons d4, Perception d6, Pilot d4, Mechanical Engineering d8

### **Armament:**

Medium planetcraft scale skirmish range point defence system (d10);

6 planetcraft scale Short-range missile systems (d10)

2 spacecraft scale Medium Capital DRADIS range missile systems (d12+2);

7 spacecraft scale Medium-range assault railguns (d12+d2)

Armour: Wound 5, Stun 4

Description: 1530 X 310 X 511 feet

Crew: 500; Passengers: 16 + 48 Marines

### **Air Wing**

4 Vipers

4 Raptors

4 Raptor 'Spooky' Variant

2 Shuttles

Helios was designed very specifically for the insertion of small, special-ops units into a hostile, remote, environment. She is capable of orbital insertion and has landing capability. Her mix of fighters, raptors and covert 'spooky' qv



subcraft allow her to deploy and recover her assault team quickly and easily, giving her a spare capacity to do all required of her at all times. Both Helios or Shiloh (her only sister ship to date) are publically registered in the fleet as 'fast transports' and publically known as VIP transports, effectively covering their operational status (and follow the practice of the more numerous 'Pendragon' qv Class). Unlike that much smaller vessel, the Helios is capable of dealing with major threats in order to either insert/extract its strike group or to provide top cover to its troops on the ground.

If there is any complaint of the class it is their lack of carrying capacity for the size of craft. This tends to ignore the fact that the Helios carries a varied package of sub-craft and even has space for Landram's, APC's and even a tank in her hold. With such a ready-to-hand capacity the Helios sports a well rounded assault platoon. Or can eliminate those vehicles to make way for an extra two platoons if required.

## **Colossus Class Escort Carrier**

Art by Limerickcot

Stats by Gazza

Agi D6, Str D6, Vit D6, Ale D6, Int D10, Wil D12;  
LP 18; Init D6+D6; Scale Spacecraft;  
Speed 4 (4 in atmosphere; SL/JC)

Traits: Past its Prime (d6)

### **Skills:**

Heavy Weapons D6; Knowledge D4; Mechanical Engineering D6; Perception D6; Pilot D6; Technical Engineering D6

### **Armament**

Heavy planetcraft scale skirmish ranges PDS (d12)  
24 spacecraft scale short DRADIS range railguns  
(d12+d2)  
84 Vipers, 12 Raptors, 12 assorted craft

**Armour** Wound 3, Stun 3

Description 3200 x 785 x 835 feet;  
Crew 1300; Passengers 1300

Notes:-

The Colossus-class of Light Fleet Carriers (CVLs in naval parlance) came from the failed concept of the Perseus-class Fleet Maintenance Carrier. Perseus performed well as an improved Escort Carrier, so the concept was reviewed and refined. The CVLs have been a successful concept and a cheaper means of projecting power. One CVL even performed bombardment with its cannon armament on a rogue planetoid base!

However the CVL was slow, under-armoured and, although she carried a plentiful supply of armament, it is easily outranged by those normally carried by other vessels. As a light carrier, not intended for battle, the two ships of this class make excellent training vessels and are capable (and usually used) for disaster relief. Her four Viper squadrons have been reduced to just one, the rest of her hanger space being taken up with shuttles and disaster pods. Colossus and Civica are due for a SLEP (Service Life Extension Package) within the next decade that will equip them with more modern electronics, and see the ships converted to long-range colonisation vessels.

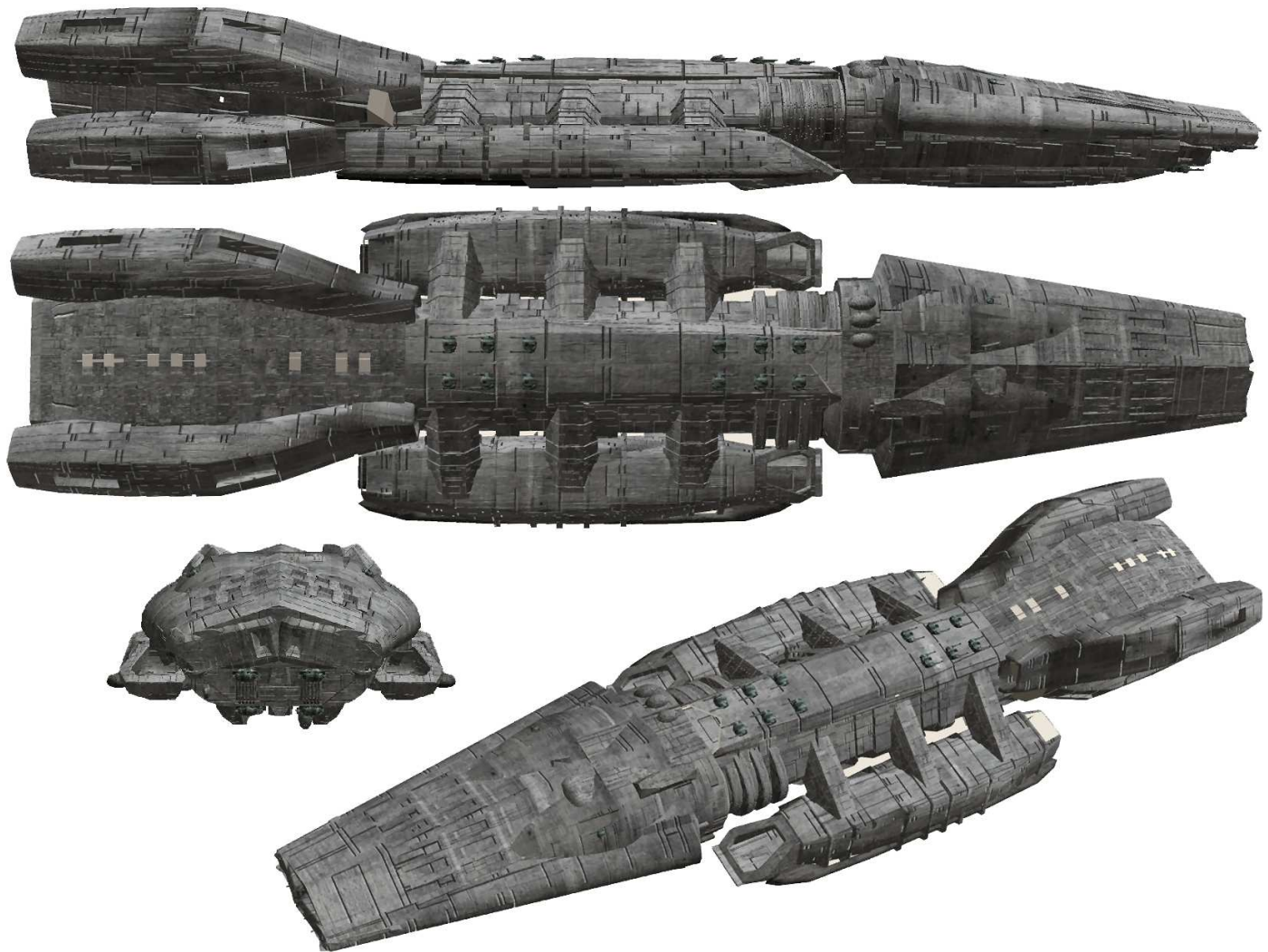



## ***Furious-class Gunstar*** **[Monitor]**

Stats By Gazza

Art by Limerickcot

Agi D8, Str D8, Vit D8, Ale D8, Int D6, Wil D8;  
LP 16; Init D8+D8; Scale Spacecraft;  
Speed 3 (3 in atmosphere; SL/JC)

### **Traits:**

Formidable Presence (D8) –A Furious-class Monitor is a very imposing sight

Memorable (D4) –The Furious-class Monitor is memorable for its weaponry

### **Skills:**

Heavy Weapons d6, Perception d6, Pilot d6, Mechanical Engineering d8

### **Armament**

2 spacecraft scale long DRADIS range missile systems (d12+d8)  
8 spacecraft scale short DRADIS range missile systems (d12+d4)

16 spacecraft scale long range railgun systems (d8)

Medium spacecraft-scale skirmish range PDS (d8)

Heavy planetcraft-scale skirmish range point-defence systems (d12)

**Armour:** Wound 8, Stun 2

Description: 1850 x 450 x 200 feet;

Crew 400; Passengers 60;

Subcraft 2 Raptors, 4 Vipers, 10 Shuttles

Notes: -

A Monitor style Gunstar is designed for devastating planet and space-based facilities and is usually accompanied by an Ammunition Ship and some minor Escorts.

Relatively small, the Monitor was designed to 'anchor' points in orbit, and giving heavy supporting fire to less well armed ships in orbit. It included not only a point-defence system against fighters, but also against heavier craft that came into its range. This last, and a massive amount of armour, gave the

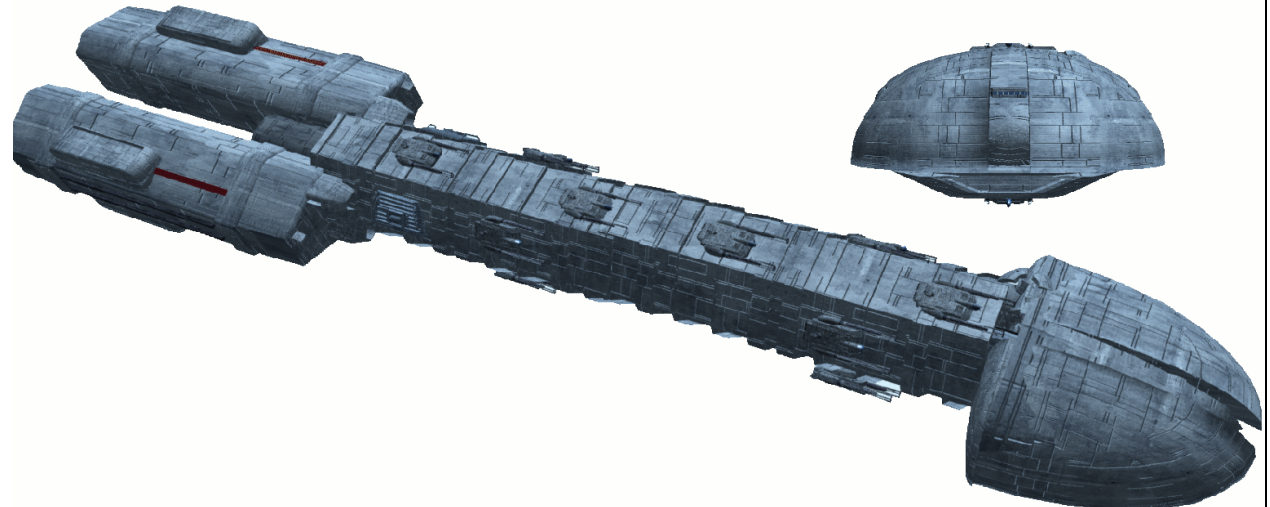
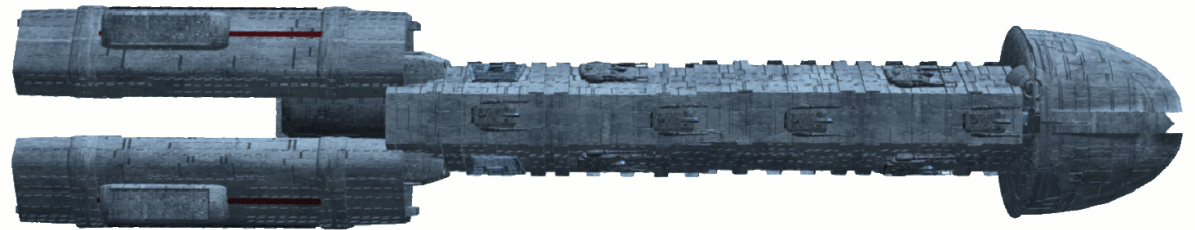
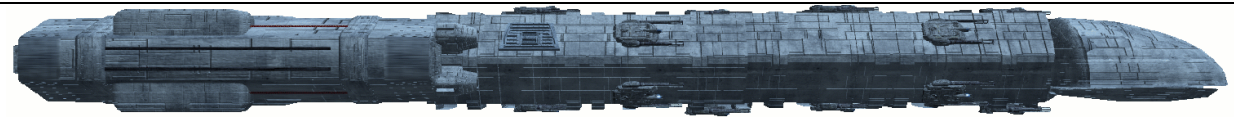

Furious a deadly name for in-fighting. The rest of its systems would allow it to extend its umbrella over its 'anchorage'. Her shortfalls, however, meant that she would only ever be a temporary expedient. She is too slow to keep up with the rest of the fleet and her ammunition requirements are staggering.

Handled well and intelligently, she was an excellent vessel. Handled like either a Battlestar or an Escort, and she failed, taking both the ship and any others with her. The last vessel was withdrawn to the Cayuze anchorage thirty years ago.



## **Flower- Class Gunstar**

Stats by Gazza

Art by Limerickcot

Agi D8, Str D6, Vit D6, Ale D6, Int D6, Wil D6;  
LP 12; Init D8+D6; Scale Spacecraft; Speed 2 (2 in  
atmosphere; SL/JC)

Traits: Mass-Produced (D4) --The Flower-class Corvette  
is a very common Escort

### **Skills:**

Heavy Weapons d2, Perception d2, Pilot d4, Mechanical  
Engineering d4

### **Armament:**

1 spacecraft scale short DRADIS range missile system  
(d12)

1 planetcraft scale skirmish range PDS (d8)

72 planetcraft scale skirmish range missile systems (d8)

**Armour:** Wound 1, Stun 1

Description: 200 x 35 x 25 feet;

Crew 109; Passengers 25;

Notes: -

Based on a Mining Tender, The Flower-class Corvette  
is fairly basic and is often used for Training, Convoy  
Escort and Patrol.

The Corvettes are named after common flowers such  
as Heartsease (Called the "Heart Disease" by its crew),  
Sunflower, Snowflake, Dianella, Arabis etc.

The 72 HD-70 Lightning Javelin missiles are loaded by  
pallets into a specialised launcher which can fire missile  
singly or in salvos of various configurations, with 4 to 6  
missiles being a favourite launch configuration.

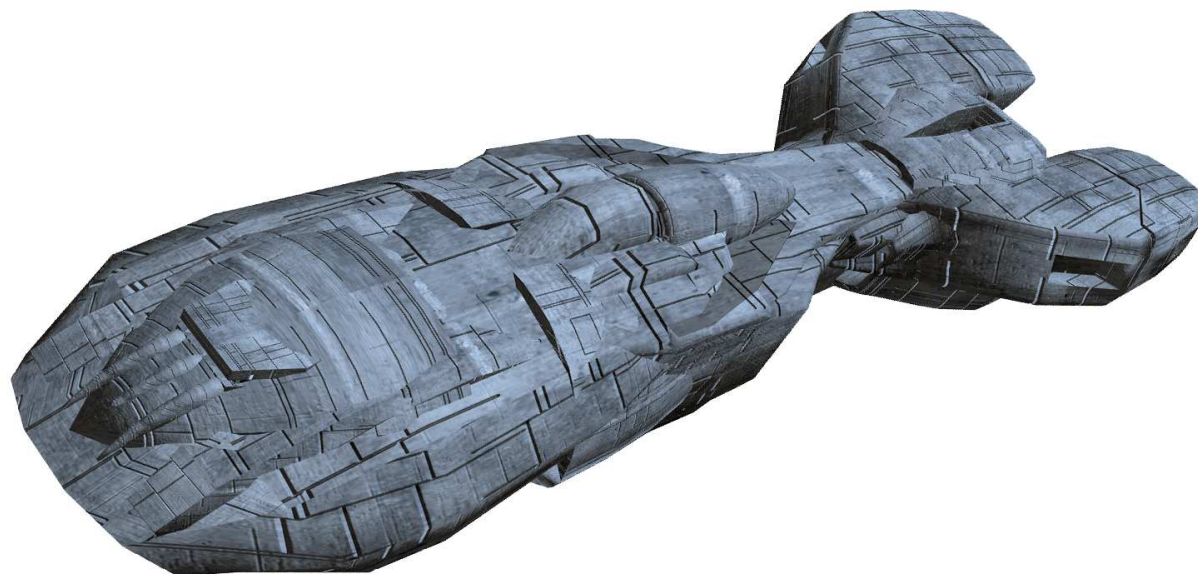
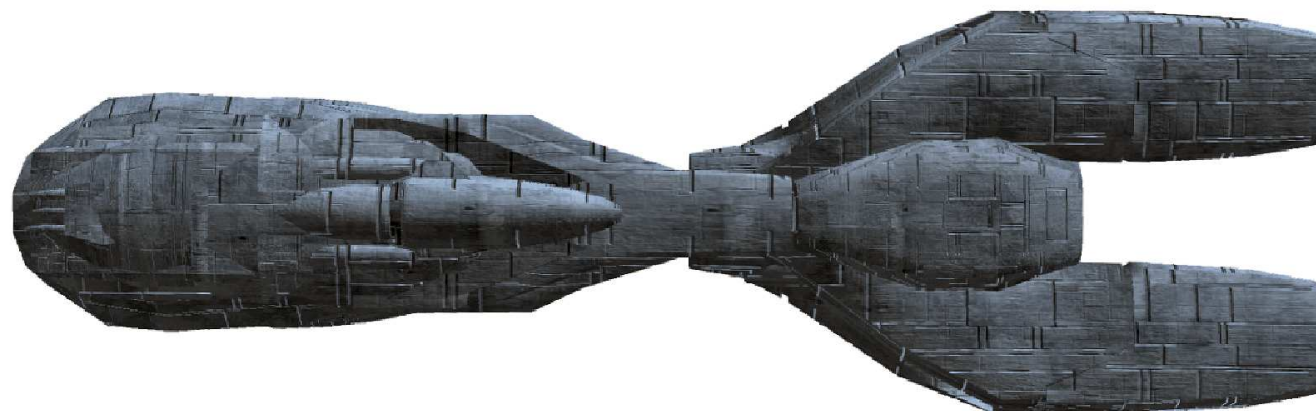

## Argonaut Gunstar

Stats by Gazza  
Art by Limerickcot

Agi D8, Str D8, Vit D10, Ale D10, Int D8, Wil D10;  
LP 20; Init D8+D10; Scale Spacecraft; Speed 6 (6 in atmosphere; SL/JC)

Traits: Sixth Sense D8

### Skills:

Heavy Weapons d6, Perception d6, Pilot d6,  
Mechanical Engineering d6

### Armament:

planetcraft scale skirmish ranges PDS (d8)  
6 spacecraft scale long DRADIS range missile  
systems (d12+d8)  
10 spacecraft scale short DRADIS range  
railgun systems (d10)  
Medium planetcraft scale skirmish range  
missile system (d8)

**Armour:** Wound 6, Stun 4

Description: 512 x 50 x 45 feet;  
Crew 530; Passengers 85;

### Airwing:

4 Raptors

Notes: -

The Argonaut-class Light Cruisers are designed as Anti-Small Craft vessels and Fighter Direction Controllers and are named after the Argonauts of Legend

The HD-70 Javelin missiles form the basis of a missile PDS and are loaded by pallets into a specialised launcher which can fire missile singly or in salvos of various configurations, with 4 to 6 missiles being a favourite launch configuration.





## ***Arethusa Gunstar***

Stats by Gazza

Art by Limerickcot

Agi D8, Str D8, Vit D8, Ale D8, Int D8, Wil D8;  
LP 16; Init D8+D8; Scale Spacecraft; Speed 6 (6  
in atmosphere; SL/JC)

Traits: None

### **Skills:**

Athletics D6; Heavy Weapons D6; Knowledge D4;  
Mechanical Engineering D6; Perception D4; Pilot  
D6; Technical Engineering D6

### **Armament:**

2 spacecraft scale long DRADIS range missile  
systems (d12+d8)  
6 spacecraft scale skirmish range railguns (d8)  
8 spacecraft scale capital range railguns (d6)  
Medium planetcraft scale skirmish range point-  
defence system (d8)  
Medium planetcraft scale skirmish range missile  
system (d8)

**Armour:** Wound 6, Stun 4

Description: 506 x 51 x 40 feet;

Crew 500; Passengers 125; Cargo 1500 lbs.

Subcraft: 2 Raptors

Notes: -

The Arethusa-class Light Cruisers were designed as Trade Protection Cruisers and as such are possibly the largest Convoy Escorts ever built. Extremely popular in the Colonial Fleet as bridging the best qualities of Destroyers and Light Cruisers.

The HD-70 Javelin missiles form the basis of a missile PDS and are loaded by pallets into a specialised launcher which can fire missile singly or in salvos of various configurations, with 4 to 6 missiles being a favourite launch configuration.

Cruisers include the Arethusa herself, Galatea, Penelope, Aurora etc.

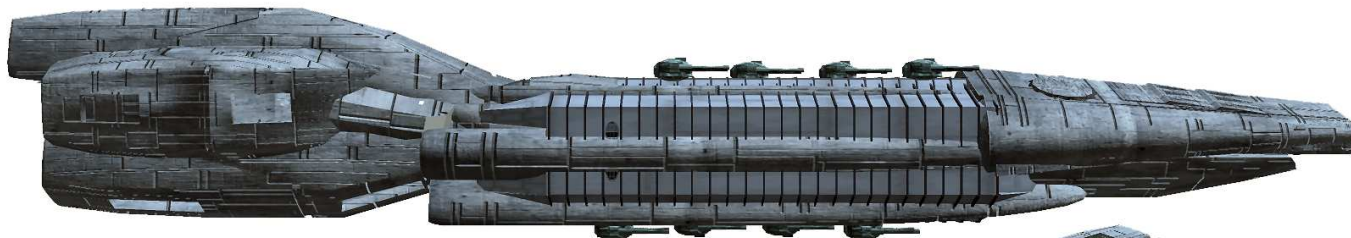
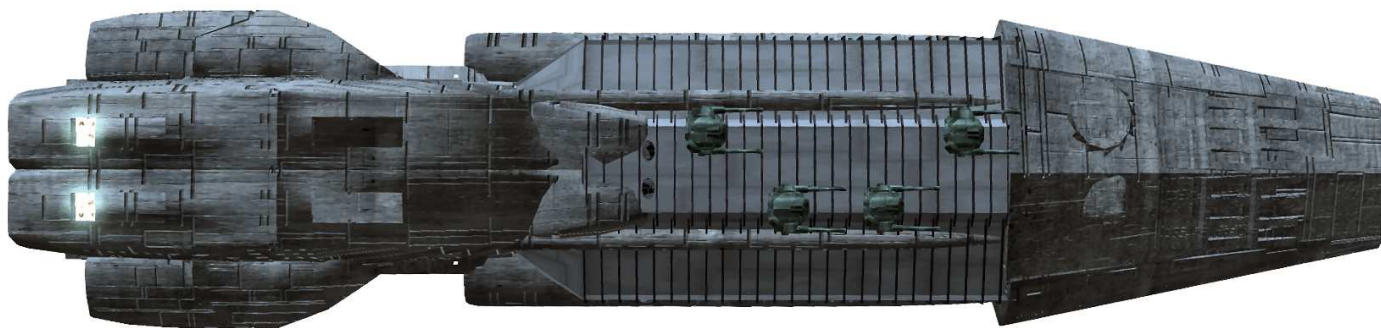



## **Argiama Gunstar**

by Gazza

art by Limerickcot

Agi D8, Str D10, Vit D8, Ale D8, Int D8, Wil D8;

LP 16; Init D8+D8;

Scale Spacecraft; Speed 6 (SL/JC)

### **Traits:**

Allure (D12)

Loved (D4)

### **Skills:**

Athletics D6; Heavy Weapons D6; Knowledge D4; Mechanical Engineering D6; Perception D4; Pilot D6; Technical Engineering D6

### **Armament:**

6 spacecraft scale long DRADIS range missile systems (d12+d8)

6 spacecraft scale capital range railgun systems (d12)

12 spacecraft scale skirmish range railgun systems (d8)

Medium planetcraft scale skirmish ranges point-defence systems (d8)

Medium planetcraft scale skirmish range missile systems (d8)

### **Armour:** Wound 6, Stun 5

Description: 562 x 58 x 36 feet;

Crew 780; Passengers 150; Cargo 5000 lbs.

Subcraft: 4 Raptors

Notes: -

The Argiama and the Ventirico make up the 174th Cruiser Squadron (reserve).

These Gunstars were popular with their crews and are a prized posting in the Colonial Fleet. The HD-70 Javelin missiles form the basis of a missile PDS and are loaded by pallets into a specialised launcher which can fire missile singly or in salvos of various configurations, with 4 to 6 missiles being a favourite launch configuration.

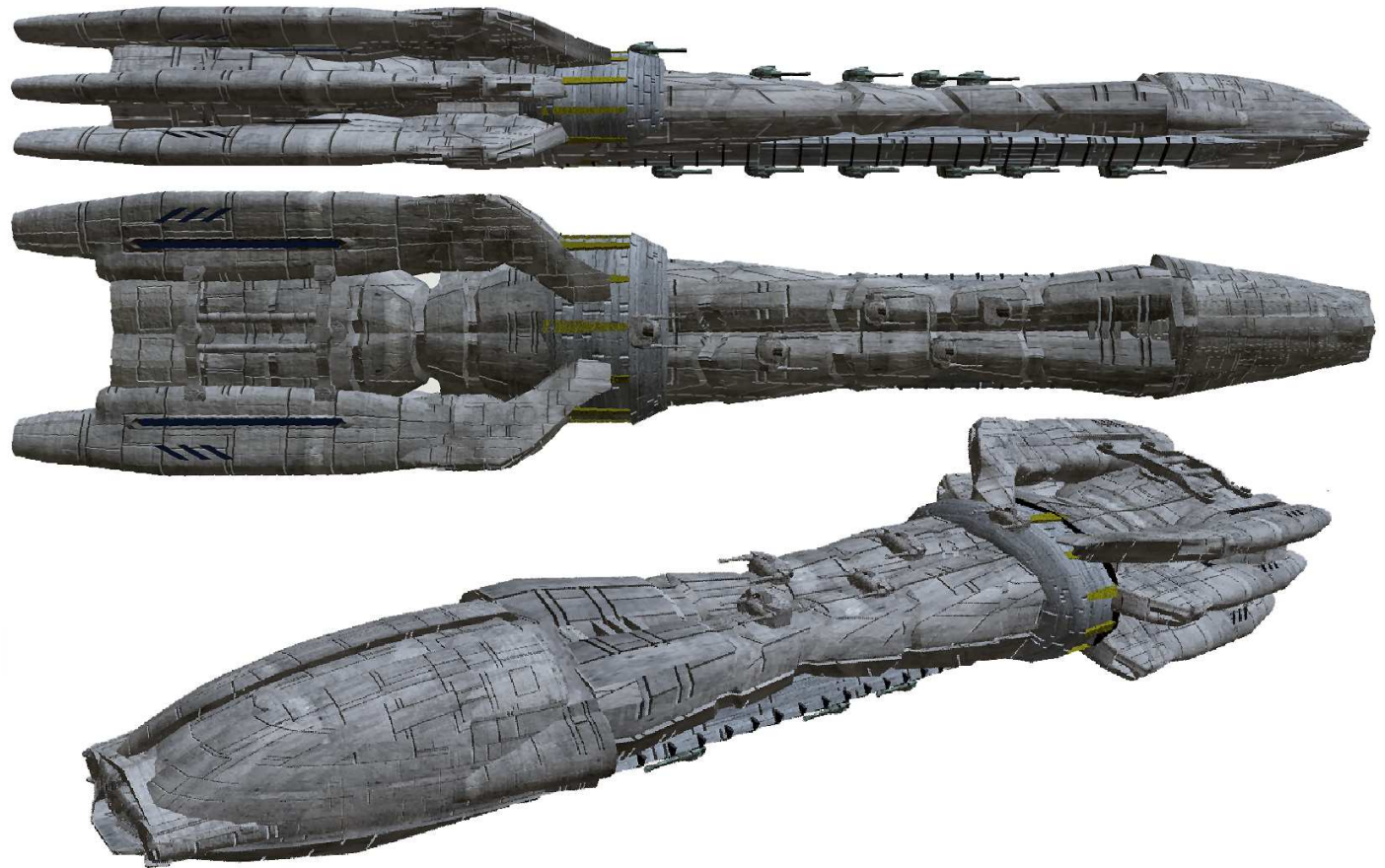

**Grieve-class**

art by Limerickcot

By Gazza

Agi D8, Str D8, Vit D8, Ale D8, Int D8, Wil D8;  
 LP 16; Init D8+D8; Scale Spacecraft; Speed 8 (8 in  
 atmosphere; SL/JC)

**Traits:**

Allure (D6)

**Skills:**

Athletics D6; Heavy Weapons D6; Knowledge D4;  
 Mechanical Engineering D6; Perception D4; Pilot  
 D6; Technical Engineering D6

**Armament:**

8 spacecraft scale short DRADIS range missile  
 systems (d12+d4)

8 spacecraft scale skirmish ranges railguns (d10)

Medium planetcraft scale skirmish ranges point-  
 defence systems (d8)

Medium planetcraft scale skirmish range missile  
 systems (d8)

130 mines can be carried depending upon mission  
 profile.

**Armour:** Wound 5, Stun 5

Description: 455 x 48 x 36 feet;

Crew 418; Passengers 75; Cargo 2000 lbs.

**Subcraft:** 4 Raptors

Notes: -

The Grieve-class Light Cruisers are designed as Fleet Scouts and Destroyer Leaders and are named after famous captains of the Colonial Fleet, such as Grieve, Arthur, Lovett, Purnell, Wyatt, Seabrook, Sara, Taylor, Aked, Rutherford, Bunyan, etc

The HD-70 Javelin missiles form the basis of a missile PDS and are loaded by pallets into a specialised launcher which can fire missile singly or in salvos of various configurations, with 4 to 6 missiles being a favourite launch configuration.

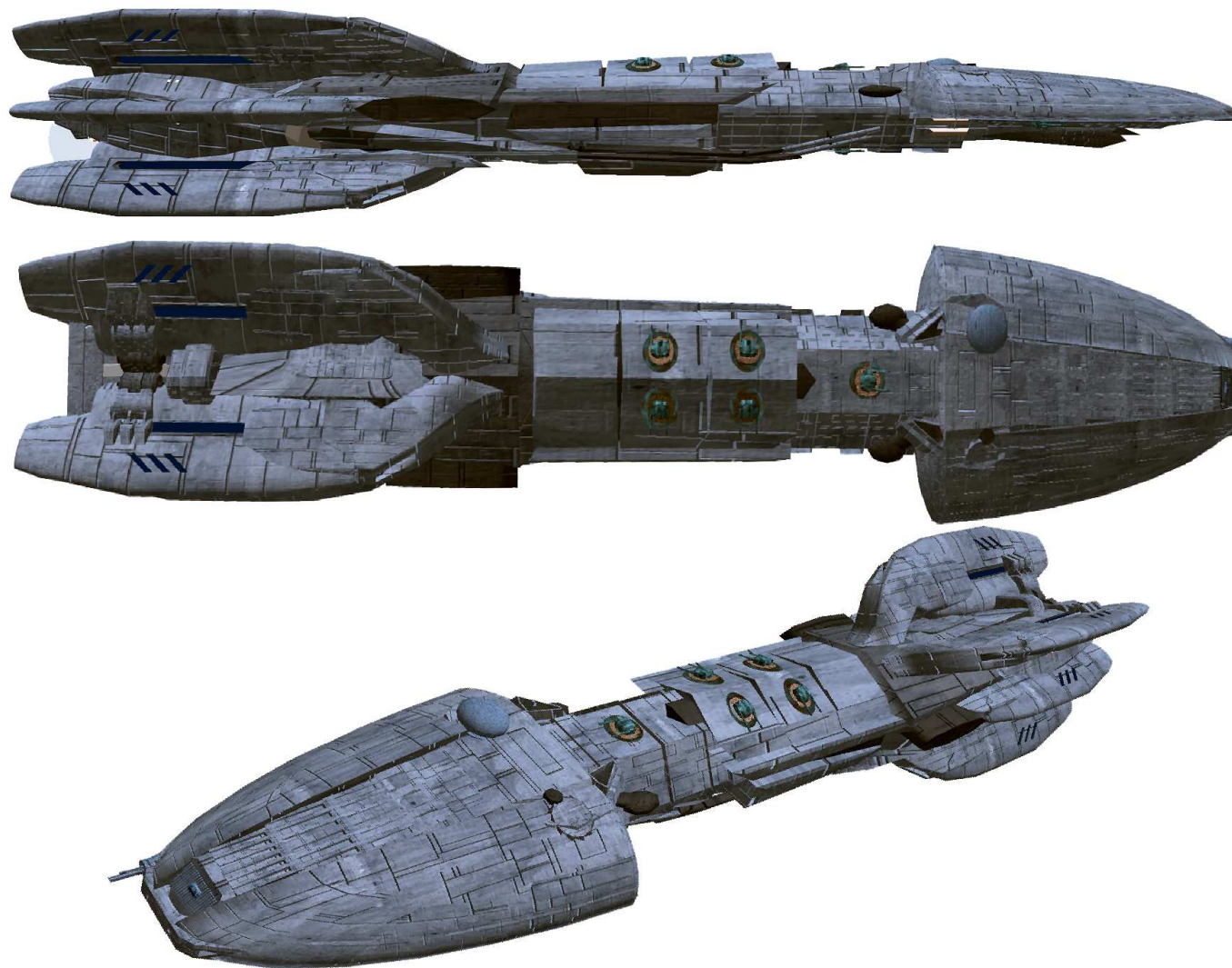



**Artisan-class**

art by Limerickcot

By Gazza

Agi D8, Str D8, Vit D6, Ale D8, Int D8, Wil D8;  
 LP 14; Init D8+D8;  
 Scale Spacecraft; Speed 6 (6 in atmosphere;  
 SL/JC)

**Traits:**

Allure (D4); Formidable Presence (D4) ; Mass-  
 Produced (D4) ; Memorable (D4)

**Skills:**

Athletics D6; Heavy Weapons D6; Knowledge  
 D4; Mechanical Engineering D6; Perception  
 D6; Pilot D6; Technical Engineering D6

**Armament:**

10 spacecraft scale short DRADIS range missile  
 systems (d12+d4)  
 5 spacecraft scale skirmish ranges railguns (d8)  
 Medium planetcraft scale skirmish ranges point-  
 defence systems (d8)  
 Medium planetcraft scale skirmish range missile  
 systems (d8)

**Armour:** Wound 4, Stun 3

Description: 380 x 40 x 25 feet;

Crew 329; Passengers 50;

Subcraft: 2 Raptors

**Notes:** -

The Artisan-class Gunstar is the latest in a long-line of Gunstars designed by the famous Arun Brothers shipyard and was joining the Colonial Fleet in substantial numbers just before the Cylon Strike on the Colonial Homeworlds. They are usually seen in divisions of 5 Destroyers, usually accompanied by a Grieve-class Light Cruiser.

The 260 HD-70 Javelin missiles are loaded by pallets into a specialised launcher which can fire missile singly or in salvos of various configurations, with 4 to 6 missiles being a favourite launch configuration.

Ship names are after groups of Artisans such as Artisan herself, Blacksmith, Wheelwright, Cooper, Carpenter, Fletcher, Waller, Potter, Seaman etc

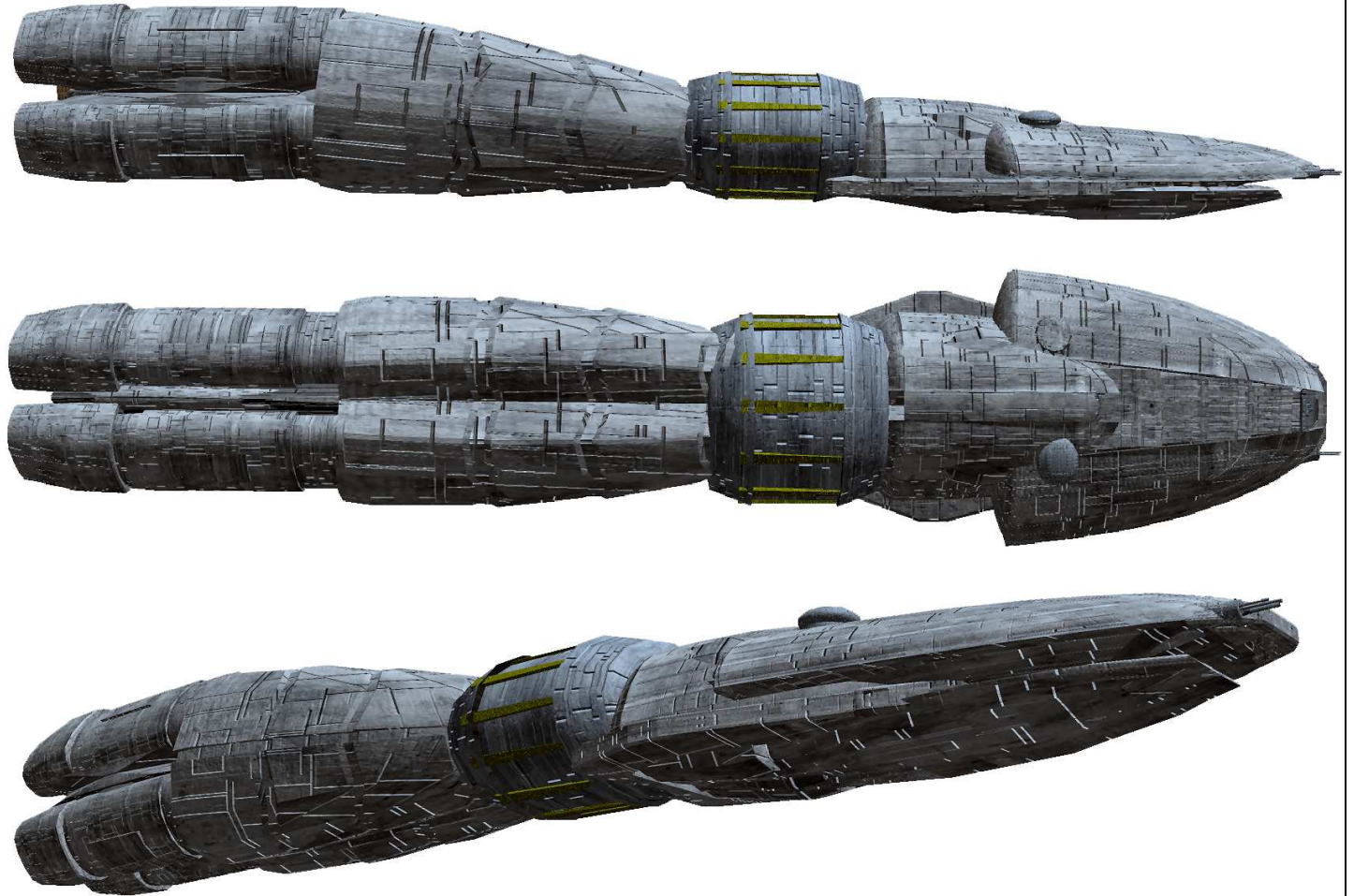



100

## ***Amygone-class Sloop***

art by Limerickcot

By Gazza

Agi D6, Str D6, Vit D6, Ale D6, Int D6, Wil D6;  
LP 12; Init D6+D6; Scale Spacecraft; Speed 3  
(3 in atmosphere; SL/JC)

Traits: None

### **Skills:**

Athletics D4; Heavy Weapons D2; Knowledge  
D2; Mechanical Engineering D4; Perception  
D2; Pilot D2; Technical Engineering D4

### **Armament:**

2 spacecraft scale short DRADIS range missile  
systems (d12+d4)  
Medium planetcraft scale skirmish ranges point-  
defence systems (d8)  
Medium planetcraft scale skirmish range missile  
systems (d8)

Armour: Wound 2, Stun 2

Description: 250 x 34 x 25 feet;  
Crew 135; Passengers 25;

Notes: -

The Amygone-class Sloop is used for Training, Convoy Escort and Patrol.

The Sloops are named after common Female names such as Amygone, Andromeda, Cassandra, Danae, etc. They are little more than very slow, poorly armoured patrol boats. Amygone's are known for the part they played in the Cracker Conspiracy. Cracker engines heralded a new high power-to light-bulk ratio that would have propelled these ships at excellent speeds for the best fuel economy possible. Rushed through with little testing, the engines proved to have the excellent qualities wanted – for approximately three months (or two years at normal operational tempo). Then power levels fell rapidly and significantly. There is no apparent reason for this, but test results were kept back from the Navy. From being an excellent craft, these sloops are little more than poorly armed, armoured and slow defence boats. Twenty-seven were built before the series was cancelled.

The 72 HD-70 Javelin missiles are loaded by pallets into a specialised launcher which can fire missile singly or in salvos of various configurations, with 4 to 6 missiles being a favourite launch configuration.

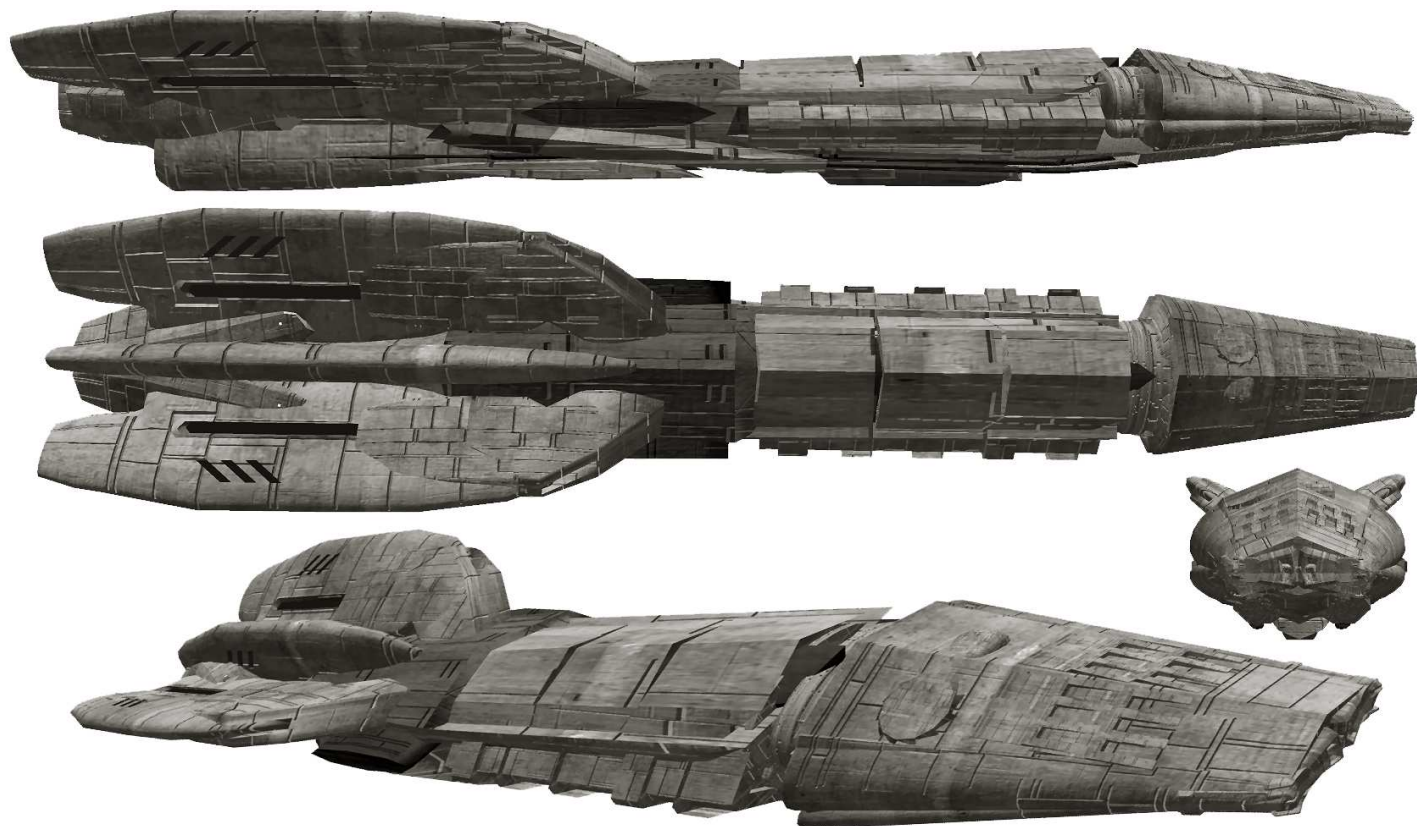

## ***Diana-class Escort***

By Gazza  
art by Limerickcot

Agi D8, Str D8, Vit D6, Ale D8, Int D6, Wil D6;  
LP 12; Init D8+D8;  
Scale Spacecraft; Speed 5 (SL/JC)

Traits: Mass-Produced (D4)

### **Skills:**

Athletics D4; Heavy Weapons D2; Knowledge D2; Mechanical Engineering D4; Perception D2; Pilot D4; Technical Engineering D4

### **Armament:**

2 spacecraft scale short DRADIS range missile systems (d12+d4)  
4 spacecraft scale capital range railguns (d12)  
Medium planetcraft scale skirmish ranges point-defence systems (d8)  
Medium planetcraft scale skirmish range missile systems (d8)

**Armour:** Wound 4, Stun 3

Description: 280 x 34 x 25 feet;  
Crew 168; Passengers 25

**Subcraft** 1 Raptor

Notes: -

The Diana-class Destroyer Escort is a fairly basic vessel and is often used for Training, Convoy Escort and Patrol Vessel. They suffered from a lack of standardisation, being rushed through construction to provide a perceived need for convoy protection to outer colonies. She has one good, redeeming feature – her crew staterooms, recreation facilities and stores are copious and generous, designed for long range operations in terms of years, not months. This feature kept her in service for a decade after she was due to be replaced.

The Destroyer Escorts are named after famous mythological hunters such as Diana herself, Orion, Artemis, Meleager, etc.

The 110 HD-70 Javelin missiles are loaded by pallets into a specialised launcher which can fire missile singly or in salvos of various configurations, with 4 to 6 missiles being a favourite launch configuration.





## **Foster-Class Gunstar**

art by Limerickcot

By Gazza

Agi D10, Str D8, Vit D8, Ale D8, Int D8, Wil D8;

LP 16; Init D10+D8;

Scale Spacecraft; Speed 6 (SL/JC)

### **Traits:**

Formidable Presence (D6)

Memorable (D6)

### **Skills:**

Athletics D6; Heavy Weapons D6; Knowledge D4;

Mechanical Engineering D6; Perception D6; Pilot

D6 Technical Engineering D6

### **Armament:**

40 spacecraft scale long DRADIS range missile systems (d12+d8)

7 spacecraft scale skirmish range railguns (d8)

2 spacecraft scale capital range railguns (d6)

Medium planetcraft scale skirmish ranges point-defence systems (d8)

Medium planetcraft scale skirmish range missile systems (d8)

50 mines

**Armour:** Wound 4, Stun 4

Description: 500 x 45 x 60 feet;

Crew 450; Passengers 50;

**subcraft:** 4 Raptors

Notes: -

The aim of a Foster-class Missile Cruiser is to saturate its targets with missiles. For this reason it is very common to see an Aldis-class Ammunition Ship in attendance. The Missile Cruisers are named after Colonial Fleet Flag Officers, like Foster, Dalmas, Resnik, Ambaugh, etc.

The 144 HD-70 Lightning Javelin missiles are loaded by pallets into a specialised launcher which can fire missile singly or in salvos of various configurations, with 4 to 6 missiles being a favourite launch configuration.

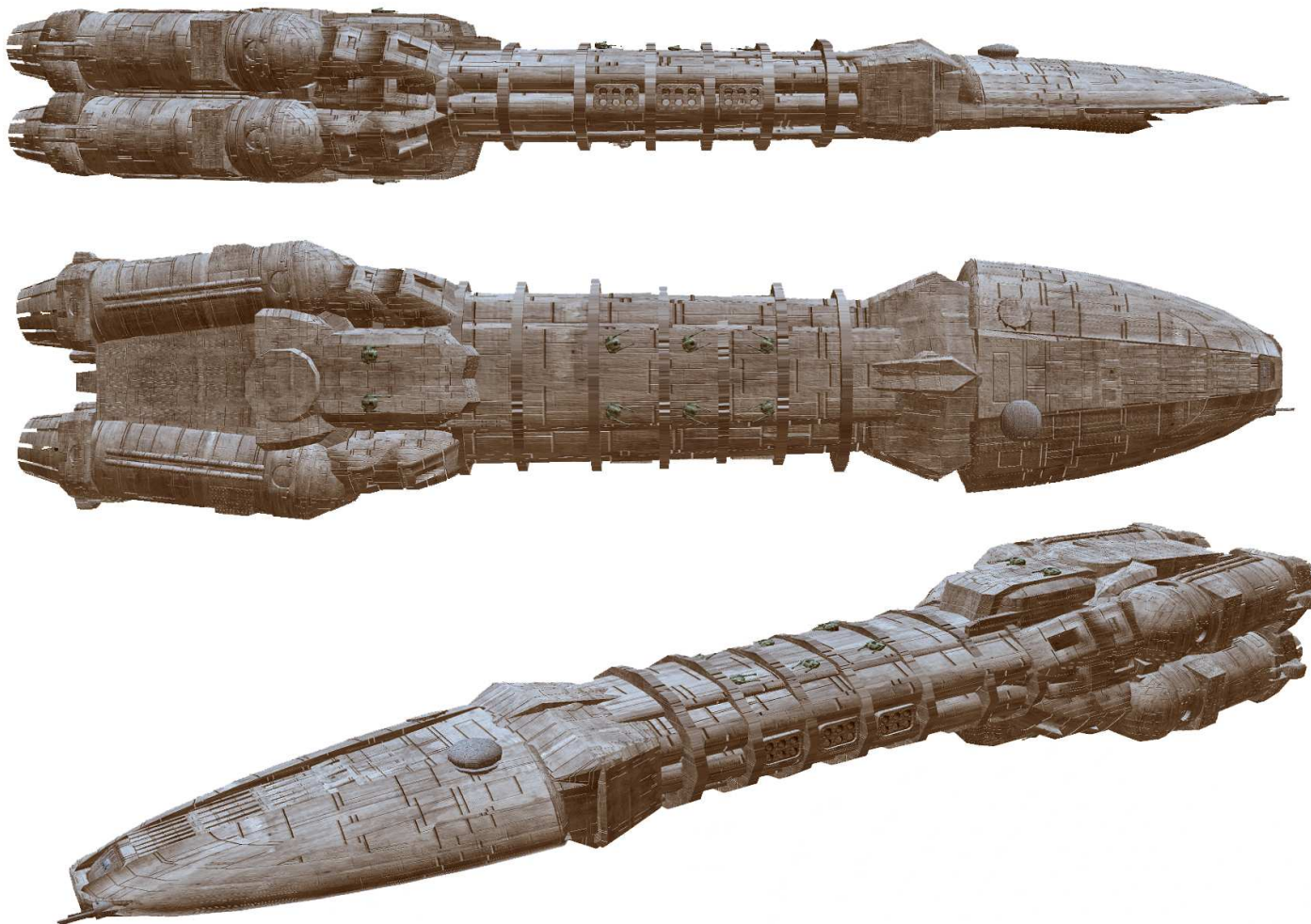



## **River-class Gunstar**

art by Limerickcot  
By Gazza

Agi D8, Str D8, Vit D6, Ale D8, Int D6, Wil D6;  
LP 12; Init D8+D8;  
Scale Spacecraft; Speed 4 (SL/JC)

Traits: Mass-Produced (D4) --The River-class Frigate is a very common model

### **Skills:**

Athletics D2; Heavy Weapons D4; Knowledge D2; Mechanical Engineering D4; Perception D4; Pilot D4; Technical Engineering D4

### **Armament:**

2 spacecraft scale short DRADIS range missile systems (d12)  
1 spacecraft scale capital range railgun (d6)  
Medium planetcraft scale skirmish ranges point-defence systems (d8)  
Medium planetcraft scale skirmish range missile systems (d8)

**Armour:** Wound 2, Stun 2

Description: 280 x 36.5 x 40 feet;  
Crew 110; Passengers 30;

Notes: -

Designed as a Convoy Escort, Patrol Vessel, the River class excelled as an anti-small craft Escort proving very successful against Cylon Raiders.

Typical names are Darling, Torrens, Yarra, Barcoo, Diamantina etc.

Considered one of the ugliest ships in the fleet, the river class was sturdy but temperamental in performance, with too light a frame to take her original spinal gun system. Instead a lighter gun was fitted and her defence system was supplemented by the Javelin HD-70.

Her old fashioned design proved her death knell, with far better and more capable vessels taking over from her and an inability to easily modify her (or even adapt her to civilian roles) has left her in store, awaiting the time when they will be scrapped.

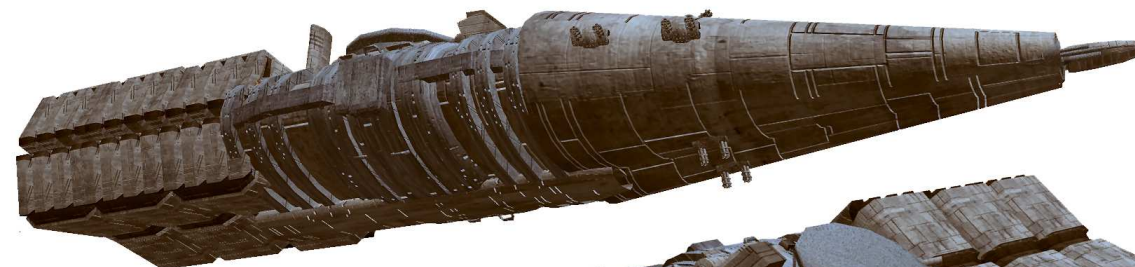
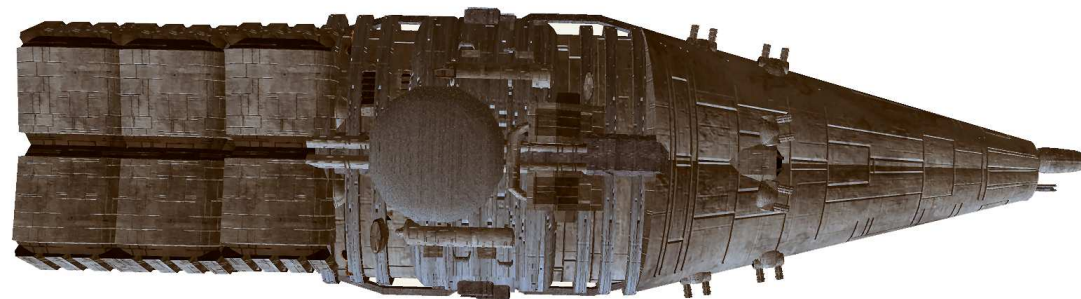

## **Bay-class Frigate**

By Gazza

Art by Limerickcot

Agi D8, Str D8, Vit D6, Ale D8, Int D6, Wil D6;  
LP 12; Init D8+D8; Scale Spacecraft; Speed 4 (4 in  
atmosphere; SL/JC)

Traits: Mass-Produced (D4) --The vehicle is a very  
common model

### **Skills:**

Athletics D2; Heavy Weapons D4; Knowledge D2;  
Mechanical Engineering D4; Perception D6; Pilot D4;  
Technical Engineering D4

### **Armament:**

4 spacecraft scale short range missile (d12)  
8 spacecraft scale capital range railguns (d6)  
1 spacecraft scale short DRADIS range missile system  
(d12+d4)  
Medium planetcraft scale skirmish ranges point-  
defence systems (d8)  
Medium planetcraft scale skirmish range missile  
systems (d8)  
50 mines as required

### **Armour:** Wound 2, Stun 2

Description: 286 x 39 x 25 feet;

Crew 157; Passengers 25;

Subcraft: 2 Raptors

### **Notes:** -

Designed as an anti-small craft Escort, The Bay  
class can also fill in as a Patrol Vessel, Light  
Minelayer/Heavy Minesweeper. It can be used as a  
light minelayer by embarking 50 Mk 277 configurable mines which can be mated to standard nuclear missile warheads as required.

The 110 HD-70 Lightning Javelin missiles are loaded by pallets into a specialised launcher which can fire missile singly or in salvos of various configurations, with 4 to 6 missiles being a favourite launch configuration.

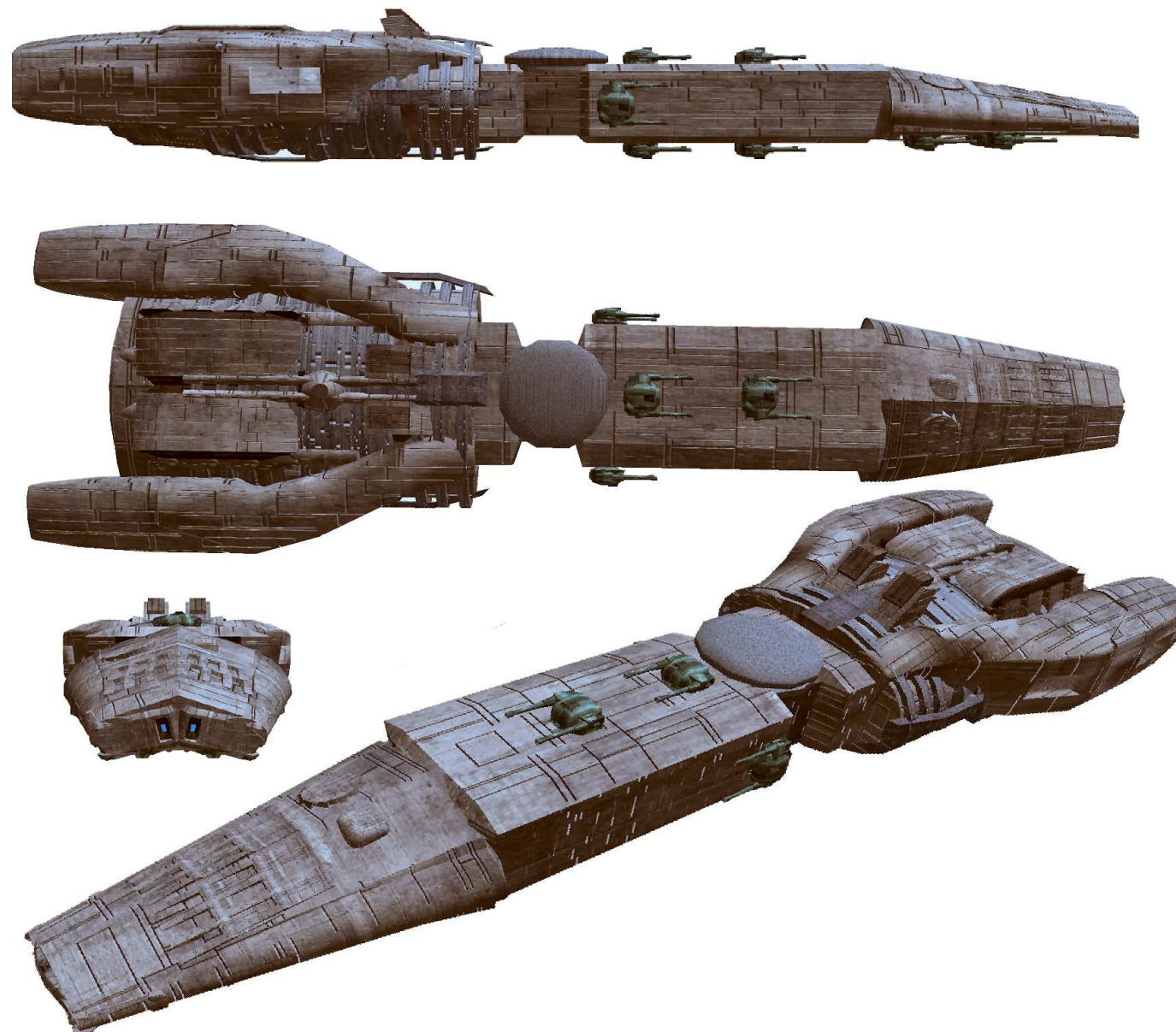



## Loch-class Frigate

By Gazza

Art by Limerickcot

Agi D8, Str D8, Vit D6, Ale D8, Int D6, Wil D6;  
LP 12; Init D8+D8; Scale Spacecraft; Speed 4 (4 in  
atmosphere; SL/JC)

Traits: Mass-Produced (D4) --The vehicle is a very  
common model

### Skills:

Athletics D2; Heavy Weapons D4; Knowledge D2;  
Mechanical Engineering D4; Perception D4; Pilot D4;  
Technical Engineering D4

### Armament:

1 spacecraft scale short range missile system (d12)  
4 spacecraft scale capital range railguns (d6)  
2 spacecraft scale short range missile systems  
(d12+d4)  
Medium planetcraft scale skirmish ranges point-  
defence systems (d8)  
Medium planetcraft scale skirmish range missile  
systems (d8)  
50 mines as required

**Armour:** Wound 2, Stun 2

Description: 310 x 39 x 25 feet;  
Crew 120; Passengers 25;

**Subcraft:** 2 Raptors

Notes: -

Designed as a Convoy Escort, The Loch class can also fill in as a Patrol  
Vessel, Light Minelayer/Heavy Minesweeper.

It can be used as a light minelayer by embarking 50 Mk 277 configurable  
mines, which can be mated to standard nuclear missile warheads as required.

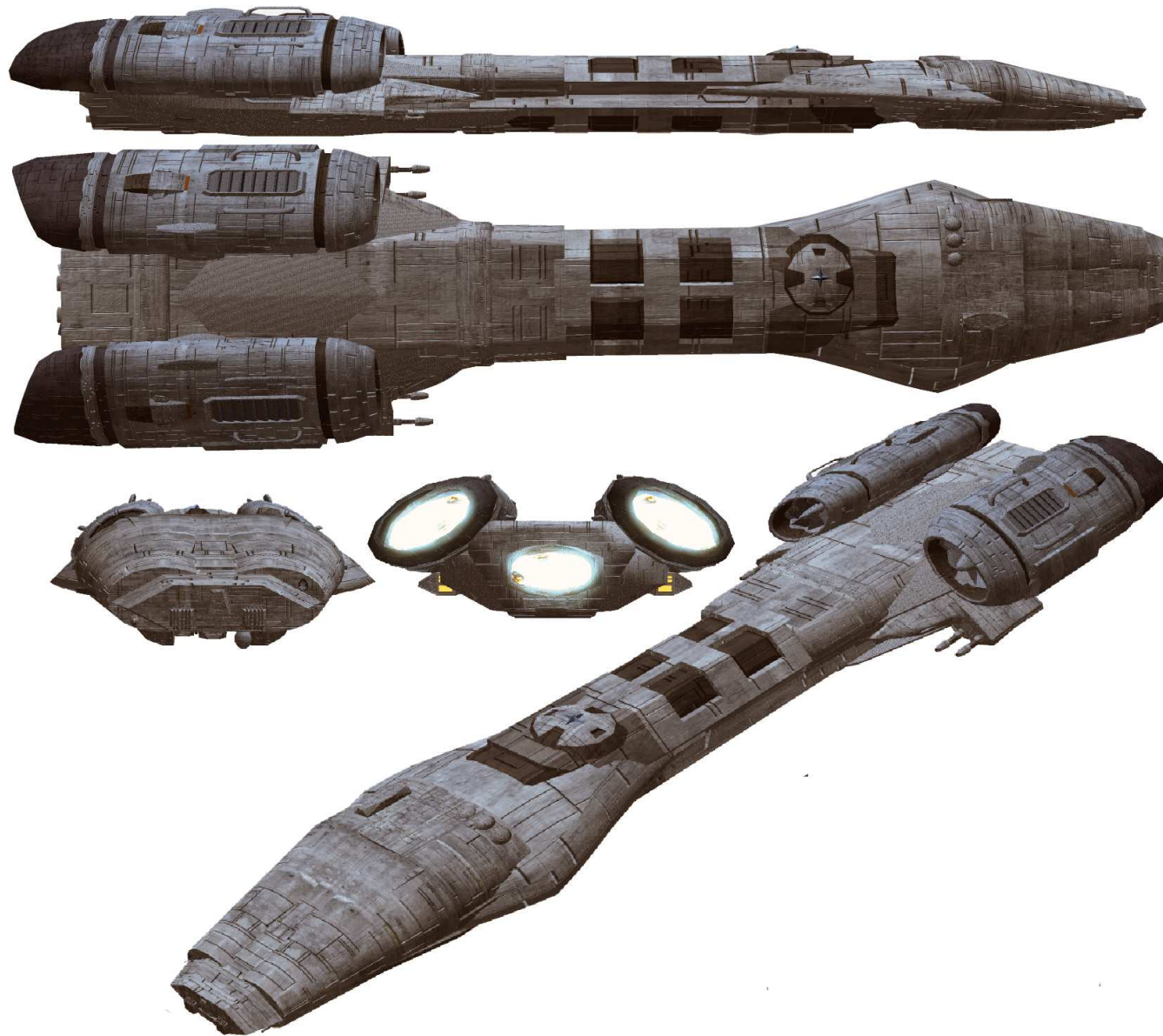

The 110 HD-70 Lightning Javelin missiles are loaded by pallets into a  
specialised launcher which can fire missile singly or in salvos of various  
configurations, with 4 to 6 missiles being a favourite launch configuration.

Typical names are Loch Aegeon, Loch Fremantle, Loch Nomen, etc



## **Abdiel-class Minelayer**

art by Limerickcot  
By Gazza

Agi D8, Str D8, Vit D8, Ale D8, Int D8, Wil D8;  
LP 16; Init D8+D8; Scale Spacecraft; Speed 8 (8 in atmosphere; SL/JC)

Traits: Memorable (D2) --The vehicle has a distinct and recognizable feature

### **Skills:**

Athletics D6; Covert D6; Heavy Weapons D6; Knowledge D4;  
Mechanical Engineering D6; Perception D6; Pilot D6;  
Technical Engineering D6

### **Armament:**

6 spacecraft scale short range missile systems (d12)  
6 spacecraft scale skirmish range railgun systems (d8)  
8 spacecraft scale capital range railguns systems (d6)  
Heavy planetcraft scale skirmish ranges point-defence systems (d12)  
Medium planetcraft scale skirmish range missile systems (d8)  
156 mines

Armour: Wound 6, Stun 4  
Description: 410 x 40 x 40 feet;  
Crew 245; Passengers 120;  
**subcraft:** 2 Raptors

Notes: -

The Abdiel-class Cruiser-Minelayers were designed to lay minefields in the shortest time possible using their speed as a their main defence. Extremely popular in the Colonial Fleet for their speed and fittings and often enviously referred to as "gold-platers".

The HD-70 Lightning Javelin missiles are loaded by pallets into a specialised launcher which can fire missile singly or in salvos of various configurations, with 4 to 6 missiles being a favourite launch configuration.

Cruiser-Minelayers included the Abdiel herself, Perchance, Ocean, Unguarded, etc.

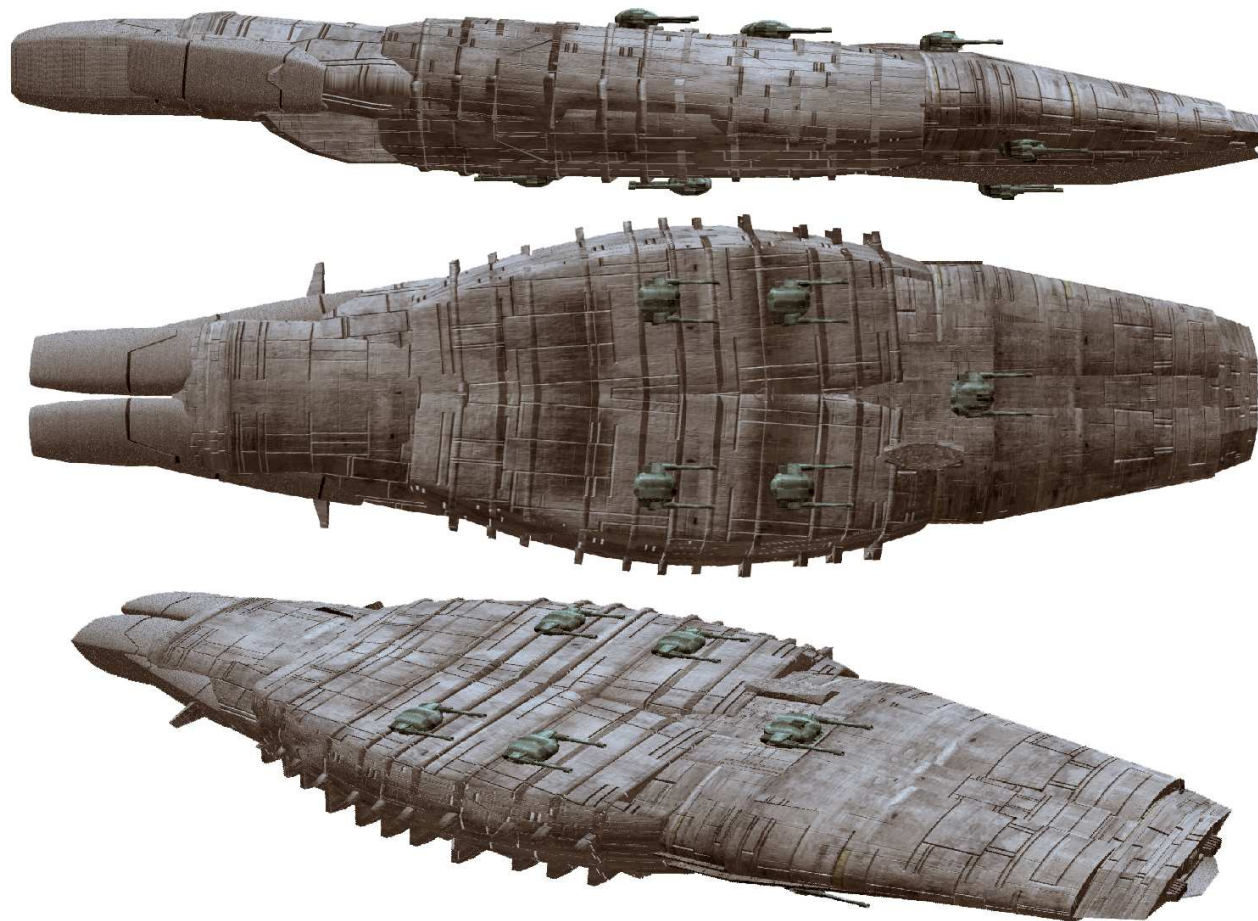

## **Hesperus-class Gunstar**

art by Limerickcot

By Gazza

Agi D8, Str D8, Vit D6, Ale D8, Int D8, Wil D8;  
LP 14; Init D8+D8; Scale Spacecraft; Speed 6 (6  
in atmosphere; SL/JC)

Traits: None

### **Skills:**

Athletics D6; Heavy Weapons D4; Knowledge  
D4; Mechanical Engineering D6; Perception D6;  
Pilot D6; Technical Engineering D6

### **Armament:**

2 spacecraft scale short range railguns (d12)  
1 spacecraft scale capital range missile systems  
(d12+d4)  
10 spacecraft scale short range missile systems  
(d12)  
Medium planetcraft scale skirmish ranges point-  
defence systems (d8)  
Medium planetcraft scale skirmish range missile  
systems (d8)

**Armour:** Wound 4, Stun 3

Description: 325 x 35 x 27 feet;

Crew 145; Passengers 20;

**Subcraft:** 2 Raptors

Notes: -

The Hesperus-class Destroyer is customised for  
Convoy Escort and not built for Fleet actions.

They are usually seen in Escort Groups as the Leader of the group. Escort  
Groups are usually made up of between 5 and 10 Escorts, and are usually a  
mix of Destroyers, Frigates, Corvettes and Fleet Tugs.

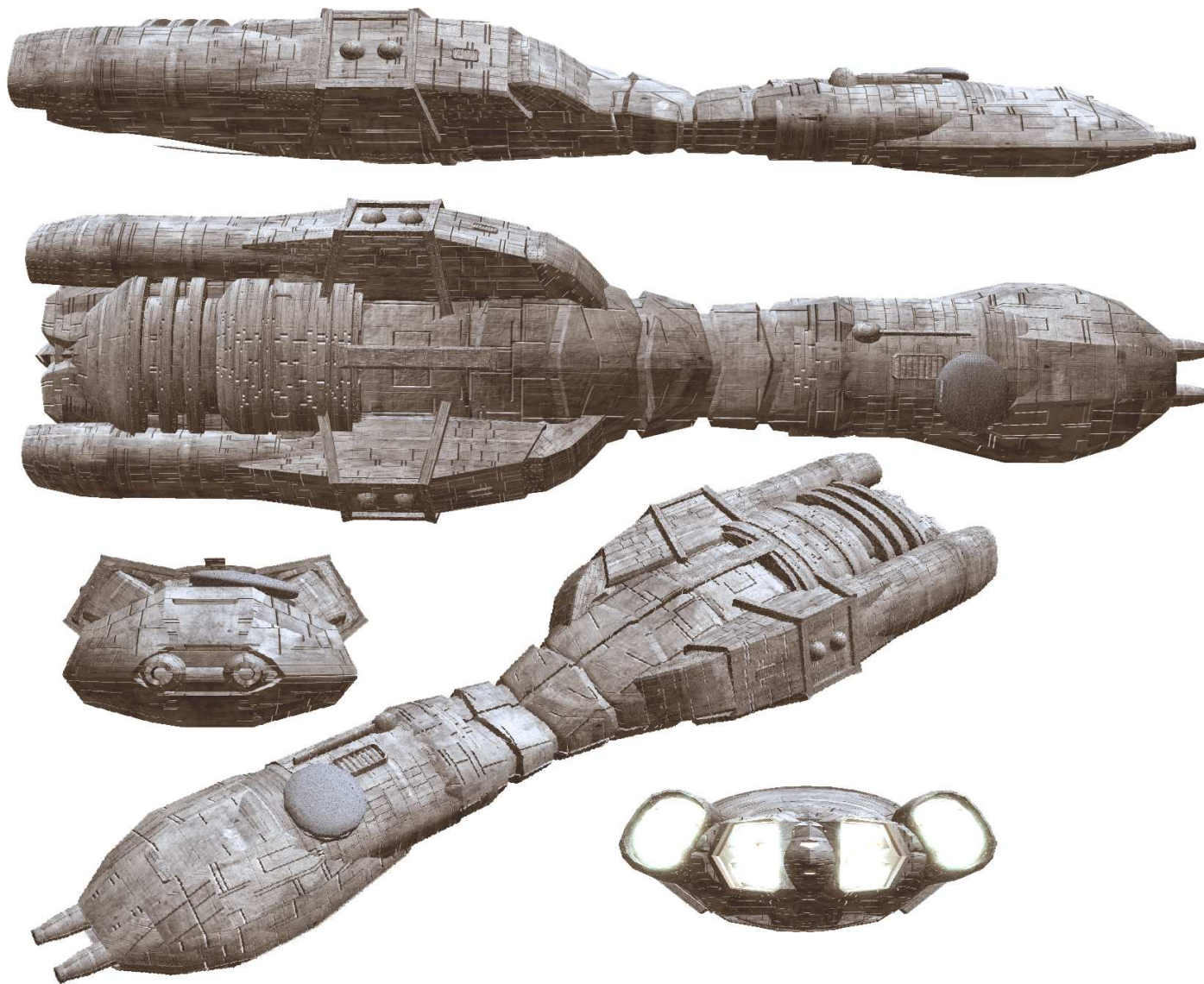

The 300 HD-70 Lightning Javelin missiles are loaded by pallets into a  
specialised launcher which can fire missile singly or in salvos of various  
configurations, with 4 to 6 missiles being a favourite launch configuration.

Ship names start with an "H", such as Hesperus herself, Harvest, Hardy,  
Hurricane, etc.



**Perseus**

Light Cruiser

Stats by Buscadero

[Starship Schematic Database](#)**Perseus****Agi** d6, **Str** d12, **Vit** d6, **Ale** d6, **Int** d4, **Wil** d6;**LP** 18; **Init** d6+d6; **Scale** Spacecraft**Speed** 3 (SL/JC)**Traits** Past Its Prime (d6)**Skills** Heavy Weapons d4, Perception d2, Pilot d2**Armament**

18 medium spacecraft scale short DRADIS range railguns (d8),

12 medium spacecraft scale short DRADIS range missile systems (d12),

2 heavy spacecraft scale short DRADIS range missile systems (d12+d4);

**Airwing**

24 Mk. I Vipers, 2 Shuttles

**Armour** Wound 4, Stun 3**Description** 4,260 x 415 x 160 feet;**Crew** 1500, **Passengers** 3400

The Perseus is known to all Fleet Technical and Tactical officers as the predecessor of the Battlestars. Unlike the heavy carriers and dreadnaughts of her day, the Perseus was considered fast (although slow by modern standards) and incorporated an elite squadron of Viper Mk 1's backed by good armament.

Unfortunately the Cylon War proved that vessels of this sort were too slow, lightly armoured and didn't carry enough fighters to fend off the enemy. Nether-the-less Perseus is renowned for the stand over Caprica City. The picture of her breaking up in orbit hangs in the Wardroom of the Memorial Hall in Delphi to this day. From Perseus Fleet Tacticians and Engineers were able to take her strengths and enhance these to produce the Battlestars that we know and recognise today. No Perseus class vessels survived beyond the second year of the war.

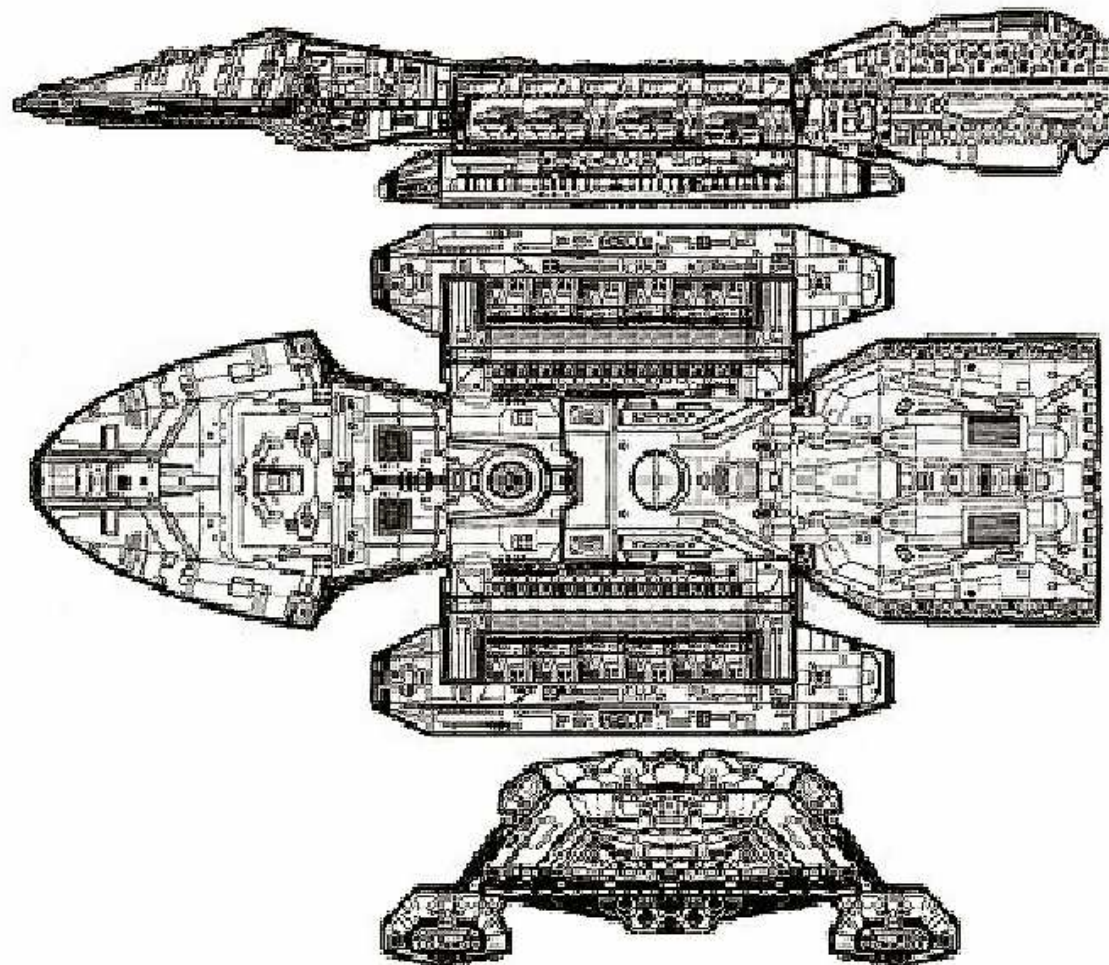



## Tiger Class Gunstar

**Stats by** Buscadero, David 'CanisD' Briede  
from a design by Dexter Smith

**Agi** d8, **Str** d12+d2, **Vit** d8, **Ale** d8, **Int** d8,  
**Wil** d10;

**LP** 24; **Init** d8+d8; **Scale** Spacecraft;

**Speed** 6 (SL/JC)

**Traits** Formidable Presence (d2), Past Its  
Prime (d6)

**Skills** Heavy Weapons d6, Mechanical  
Engineering d4, Perception d6, Pilot d4

### Armament

Medium planetcraft scale skirmish range  
point-defence system (d8);

6 forward-mounted heavy spacecraft scale  
short DRADIS range railguns (d12+d2);

18 medium spacecraft scale short range  
railguns (d10);

50 light spacecraft scale capital range  
railguns (d6);

6 heavy spacecraft scale short DRADIS  
range missile systems (d12+d4),

4 extreme spacecraft scale long DRADIS range nuclear missile systems  
(d12+d8);

4 Vipers; 8 assorted craft

**Armour** Wound 6, Stun 4

**Description** 3,524 x 1,218 x 565 feet;

**Crew** 264

**Passengers** 200 (troops)

Many a Battlestar was destroyed in the early days of the Cylon war, when fighters were drawn away and the massive Battlestars were forced to confront the deadly Cylon Baseships. Thus humanity struck at the Cylons with massive fleets, combining the impressive fighter deployment of the Battlestar with more heavily armed frigates, destroyers and cruisers.

The Colonial fleets found themselves ill equipped to deal with the onslaught of the Cylons' latest breed of Capital ship, the Hades Class Basestar. The new Cylon warship was armed with three-hundred fighters, more than 100 railguns

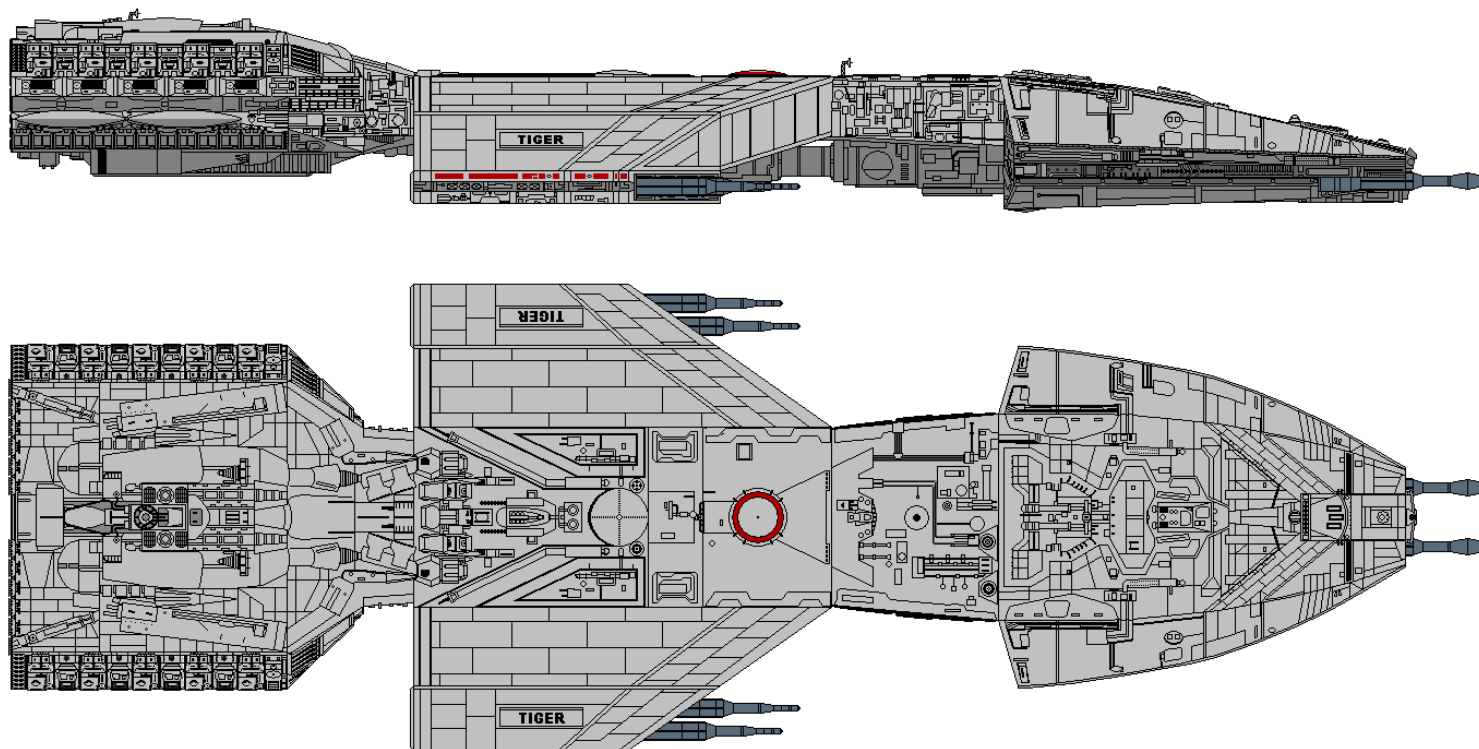

and nuclear missile systems capable of destroying almost any capital ship, and thus the time for a new breed of Colonial attack cruiser had arrived.

The premier gunstar placed into service by humanity was the "Tiger class". The Tiger was the most heavily armed warship built to that date, armed with 50 light railguns, 18 medium railguns, and four heavy primary assault railguns in the wings. Upgraded variants came to include two heavy railguns in the bow. In ship-to-ship combat, no vessel in the known universe could best the Tiger.

Measuring 1,074 meters, about 5/6 the length of the Battlestars, the Tiger was nearly as powerful, was faster, significantly more manoeuvrable and carried only half the crew of her cousin. In addition to her massive weapon payload, the Tiger also carried 8 Mk I Vipers, 4 Landram surface transports and 4 Mk. VI space shuttles.

In the last days of the war, all of the Colonial fleet made one last strike at the Cylons, at their primary Tylum mining and starship construction yards. Almost all the starships that participated in the battle, including the valiant Tigers, were destroyed.

## Strikestar

Stats by Buscadero

© by David Briedis

**Agi** d6, **Str** d12+d2, **Vit** d6, **Ale** d8,  
**Int** d8, **Wil** d10,  
**LP** 24; **Init** d6+d8; **Scale** Spacecraft;  
**Speed** 5 (SL/JC)

**Traits** Formidable Presence (d4)

**Skills** Heavy Weapons d6,  
Mechanical Engineering d4,  
Perception d4, Pilot d4

**Armament** Heavy planetcraft scale skirmish range point-defence system (d12); 6 spacecraft scale short DRADIS range primary assault railguns (d12+d2); 8 spacecraft scale short DRADIS range missile systems (d12+d4); 4 spacecraft scale short DRADIS range nuclear missile systems (d12+d8); 20 Vipers, 5 Raptors, 25 assorted craft

**Armour** Wound 6, Stun 5

**Description** 2,950 x 1,555 x 700 feet;

**Crew** 1,900

**Passengers** 500

Strikestars carry out three standard mission types: planetary defence, planetary assault and troop support. One of this vessel's biggest advantages is its ability to enter the lower levels of a planet's atmosphere and to land on its surface which the bigger and bulkier Battlestars cannot do. This permits precision ground attacks as well as the pursuit of small craft that enter a planet's atmosphere in a futile attempt to escape.

Drawn by David "CanisD" Briedis

Approx. 500 Feet/152 meters

1 pixel = 3.23 feet / 0.985 meters

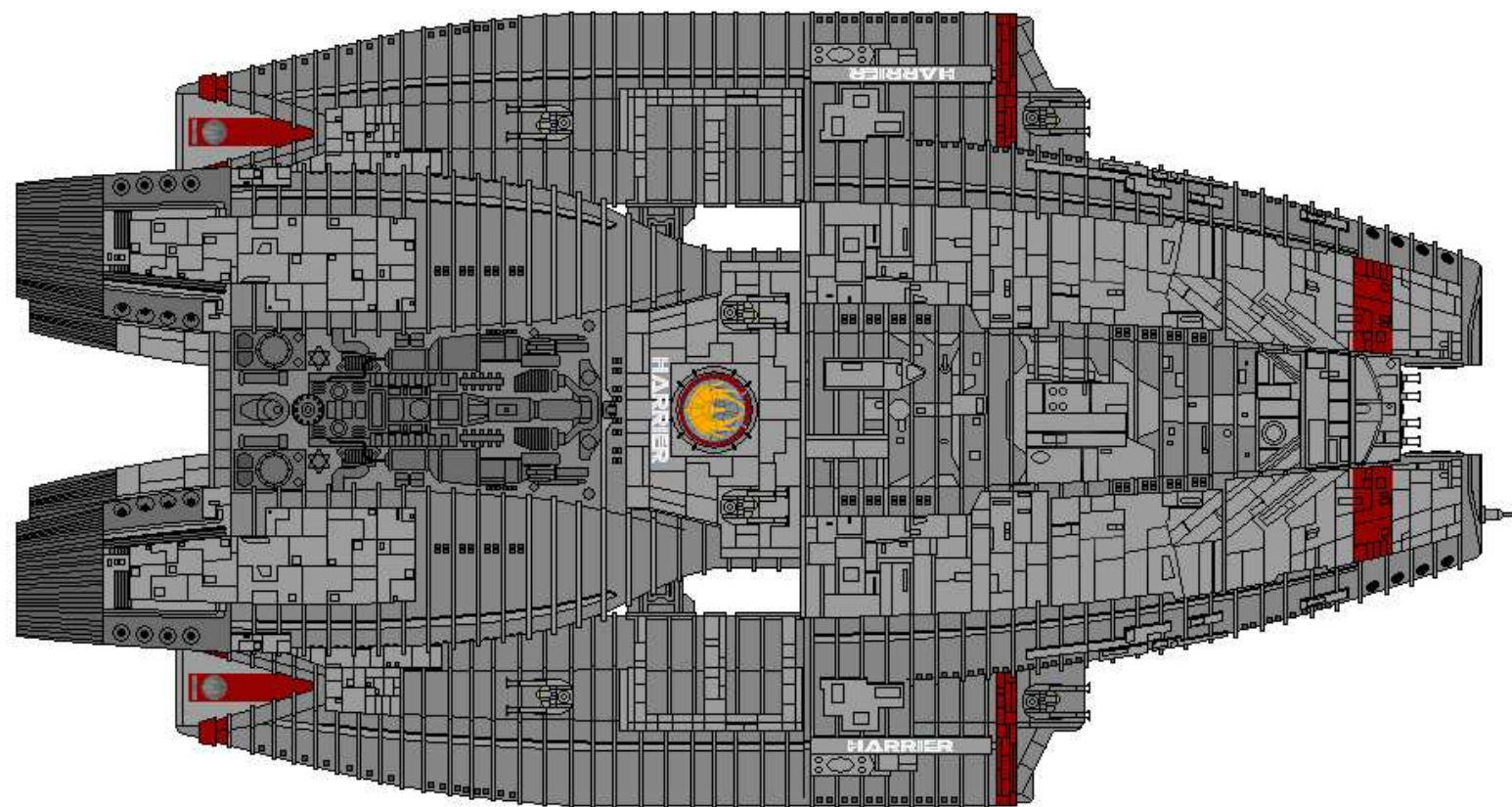
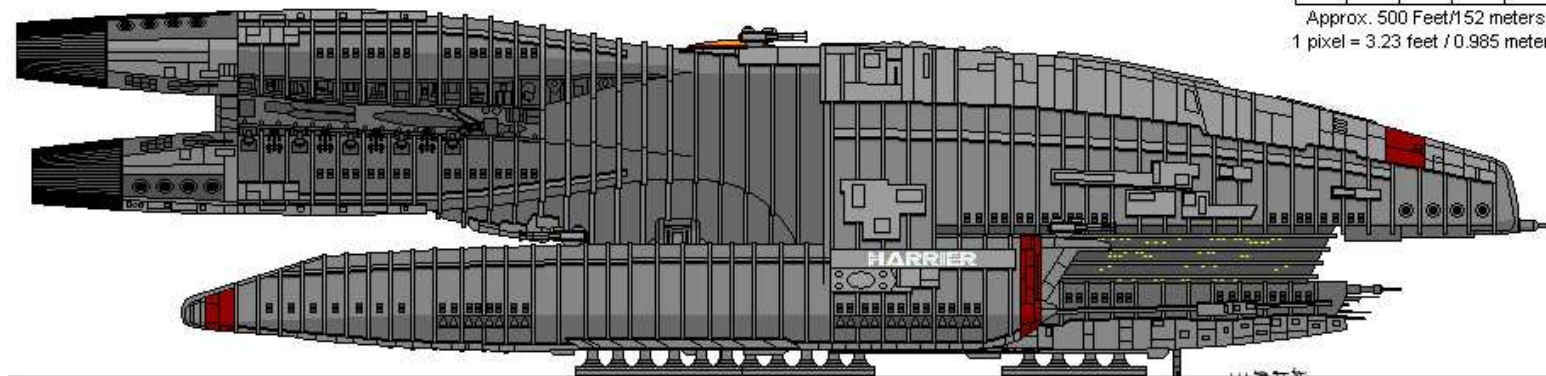



## Lowbow Scoutstar

© by Jake Kerton

**Agi** d6, **Str** d12, **Vit** d6, **Ale** d10, **Int** d8, **Wil** d10,  
**LP** 22; **Init** d6+d10;  
**Scale** Spacecraft; **Speed** 6 (SL/JC)

**Traits** Memorable (d2)

### Skills

Heavy Weapons d4, Mechanical Engineering d4, Perception d6, Pilot d4

### Armament

Medium planetcraft scale skirmish range point-defence system (d8);  
 12 spacecraft scale short DRADIS range primary assault railguns (d10),  
 6 spacecraft scale short DRADIS range missile systems (d12);  
 4 spacecraft scale short DRADIS range nuclear missile systems (d12+d8),

### Airwing

10 Raptors, 6 assorted craft

**Armour** Wound 4, Stun 3

**Description** 1,900 x 755 x 310 feet;

**Crew** 1,250 **Passengers** 1,000

Scoutstars are often teamed with smaller vessels and patrol the borders of the system. Their primary directive is to apprehend smuggling vessels, but they also serve as the Twelve Colonies' first line of defence. A scoutstar's crew must be constantly on watch for threats from within the system as well as those from beyond.

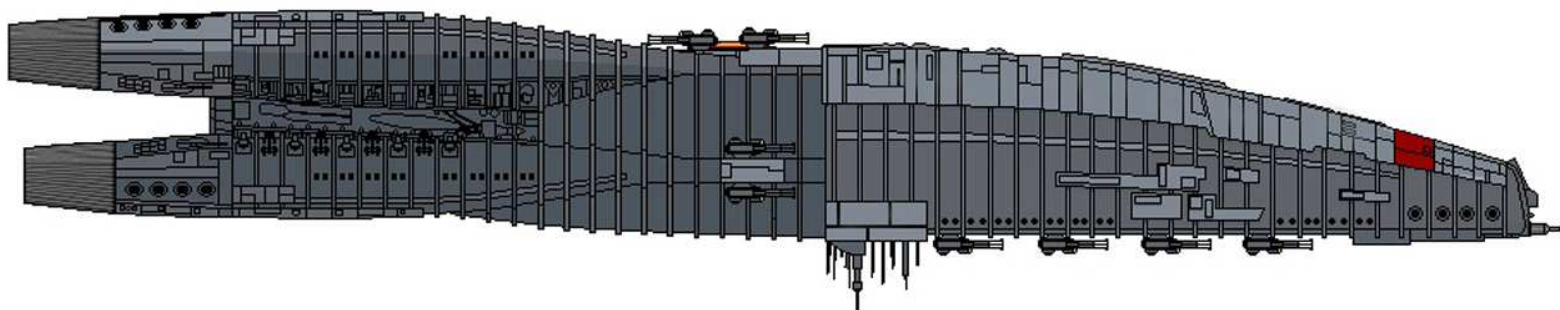
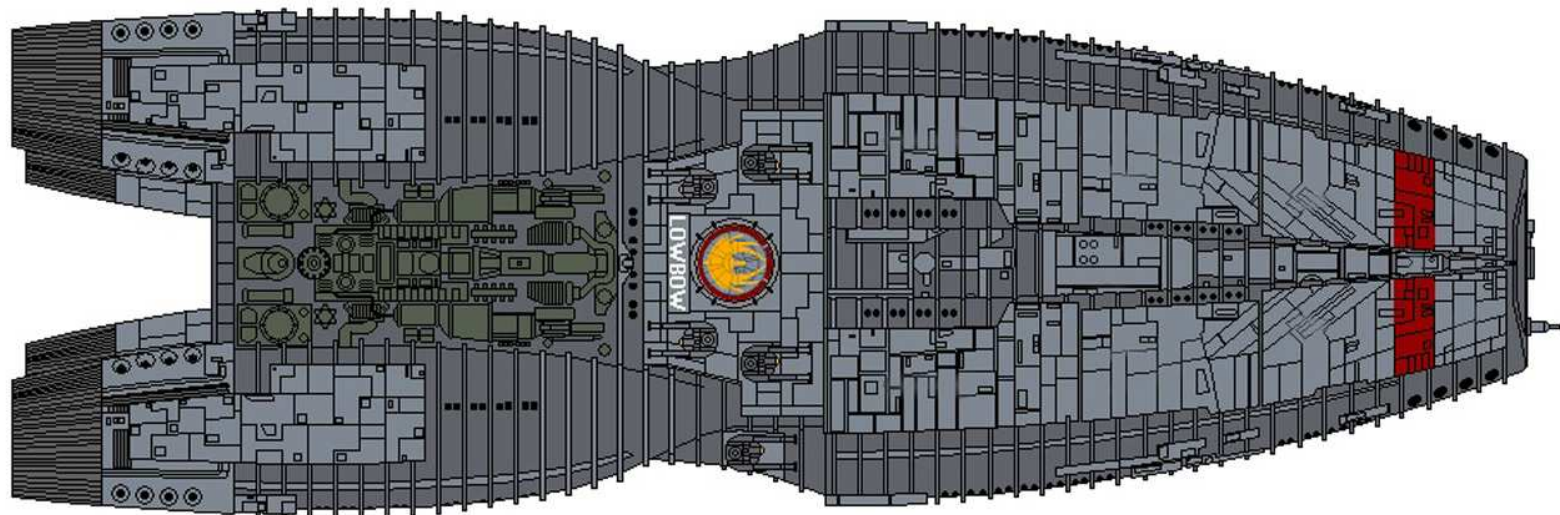

Originally designed to be fitted with a centreline 'dropped' flight pod for operating two squadrons of Vipers, the performance drop-off with this was enough to see that aspect of the design dropped. Instead more guns were fitted, additional passenger quarters allocated and a redundant FTL system fitted. Internal armour protects this last, the bridge, magazines and passenger compartment. It is hardly surprising therefore that the Scoutstar has earned itself a reputation for survivability during its fifteen years in the fleet.



## ***Alicta Escortstar***

© by Alexzandyr

**Agi** d8, **Str** d12+d2, **Vit** d6, **Ale** d8, **Int** d8, **Wil** d10,  
**LP** 24; **Init** d8+d8; **Scale** Spacecraft;  
**Speed** 4 (SL/JC)

**Traits** Formidable Presence (d2)

**Skills** Heavy Weapons d6, Mechanical Engineering d4, Perception d4, Pilot d4

### **Armament**

Heavy planetcraft scale skirmish range point-defence system (d12);  
 16 spacecraft scale short DRADIS range primary assault railguns (d12+d2);  
 8 spacecraft scale short DRADIS range missile systems (d12+d4);  
 8 spacecraft scale short DRADIS range nuclear missile systems (d12+d8);

### **Airwing:**

56 Vipers, 12 Raptors, 8 assorted craft

**Armour** Wound 5, Stun 4

**Description** 3,070 x 1,630 x 335;  
**Crew** 2,000 **Passengers** 1,500

The Alicta Class of Escortstars were introduced as a stop-gap measure to provide local fighter defence in the absence of more capable vessels. Although well armed and armoured, her under-powered engines and her large Airwing both combine to make her a liability when unsupported. However her heavy armament, and her heavy Airwing also combine to make her a deadly vessel in the right circumstances,, or when protecting other vessels.

As she cannot run from her enemies, it is needful that she be capable of fighting them – and that is what the Alicta can certainly do. Her major

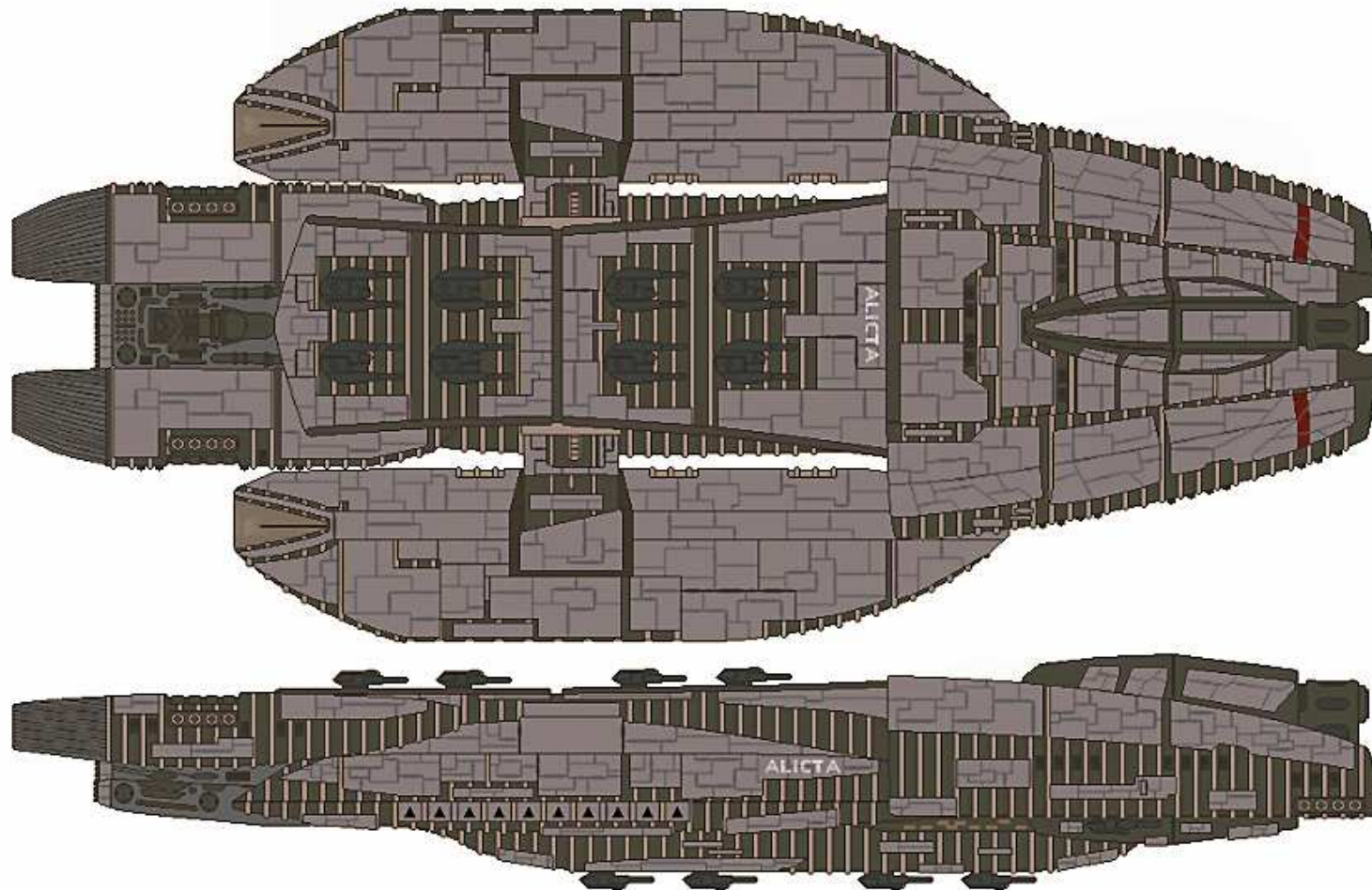

problem is the inability to fight for long, but then as an Escort, the Alicta relies either on the fleet train to supply her, or on short battles whilst she shepherds her charges from planet to planet.

## Core Carrier

art © by Casual Observer

**Agi** d6, **Str** d12+d2, **Vit** d6, **Ale** d6, **Int** d8, **Wil** d10;

**LP** 24; **Init** d6+d6;

**Scale** Spacecraft; **Speed** 6 (SL/JC)

**Traits:** None

**Skills** Heavy Weapons d4, Mechanical Engineering d4, Perception d4, Pilot d8

### Armament

Medium planetcraft scale skirmish range point-defence system (d8);

6 spacecraft scale short DRADIS range primary assault railguns (d10);

4 spacecraft scale short DRADIS range missile systems (d12),

2 spacecraft scale short DRADIS range nuclear missile systems (d12+d8),

### Airwing:

80 Vipers, 12 Raptors, various assorted craft

Armour: wound 5, stun 4

**Description** 3,772 x 984 x 574 feet;

**Crew** 2,500, **Passengers** 1,200

The main duties of carriers are to augment the fighter strength of the Battlestar group they are attached to, and to transport support shuttles that do not have FTL drives from planet to planet. They do not engage enemy targets and try to stay away from actual battles as possible. The Core Carrier's main flight deck is integrated into the main hull maximising protection for her carried fighters. However, she pays for this design feature by critically reducing the stores and machine shops that would be needed if she were expected to be used on any long range missions.

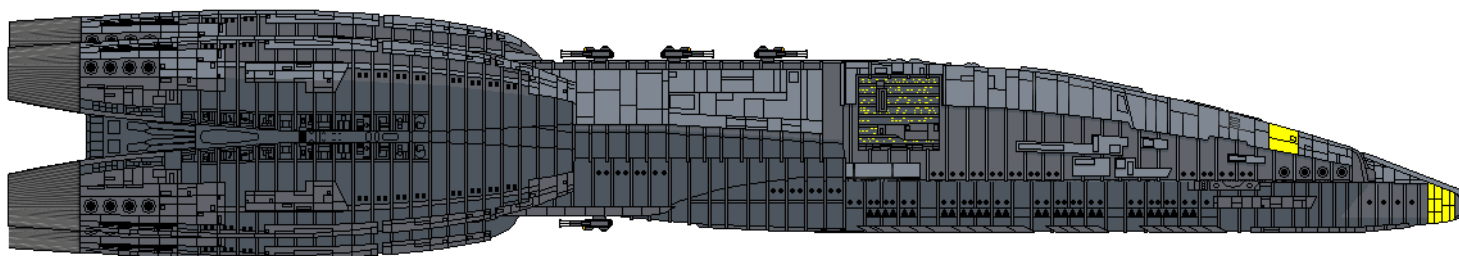
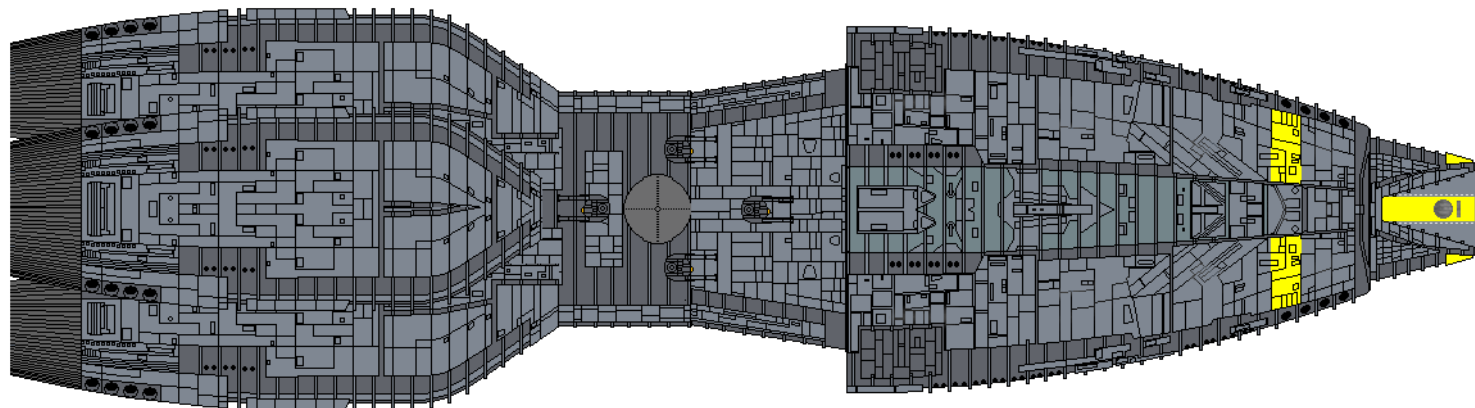

It is also this that requires her to carry such a light weapons array and her only saving grace is a reasonable turn of speed. The flaws of this system were noted and partially resolved by the introduction of the Perseus light carrier before the Cylon War. Core Carriers, even then obsolete, were refitted and rushed into service but as a concept the Carrier was proven to be inferior to the Escorts already in service and vastly more expensive than the auxiliary carriers that became common during the Cylon war.

However, despite these shortcomings the Core Class did survive the conflict and the last three of this design have been upgraded on a constant basis. New engines boosted performance and her PDS system was also upgraded. In a recent move even her electronics have been stripped out and replaced with a far more sophisticated system than even the original designs had.

The statistics shown are for the latest modification of this vessel. The Cylon war model had a speed of four (five at the end of the war), armour of 4, carried 60 Vipers and had a crew of 5000.

## ***Theseus Gunstar***

© by Mike Brown

**Agi** d8, **Str** d12, **Vit** d6,  
**Ale** d10, **Int** d8, **Wil** d8;  
**LP** 20; **Init** d8+d10;

**Scale** Spacecraft;  
**Speed** 8 (SL/JC)

**Traits** Formidable  
Presence (d2) loved  
(d4)

**Skills** Heavy Weapons  
d6, Mechanical  
Engineering d4,  
Perception d4, Pilot d4

### **Armament**

Heavy planetcraft scale  
skirmish range point-  
defence system (d12);  
18 spacecraft scale  
short DRADIS range  
primary assault railguns  
(d12+d2);

10 spacecraft scale  
short DRADIS range  
missile systems (d12+4),

5 spacecraft scale long DRADIS range nuclear missile systems (d12+d8);

### **Airwing**

10 Vipers, 4 Raptors, 2 assorted craft

**Armour** Wound 6, Stun 5

**Description** 1,681 x 533 x 246 feet;

**Crew** 1,100

**Passengers** 500

With the realisation of the failings of the Hercules class Gunstar, the trend back to specialist vessels began all over again. One of the latest developed was the Theseus 'Combatstar'. A pair (normal deployment) will operate a

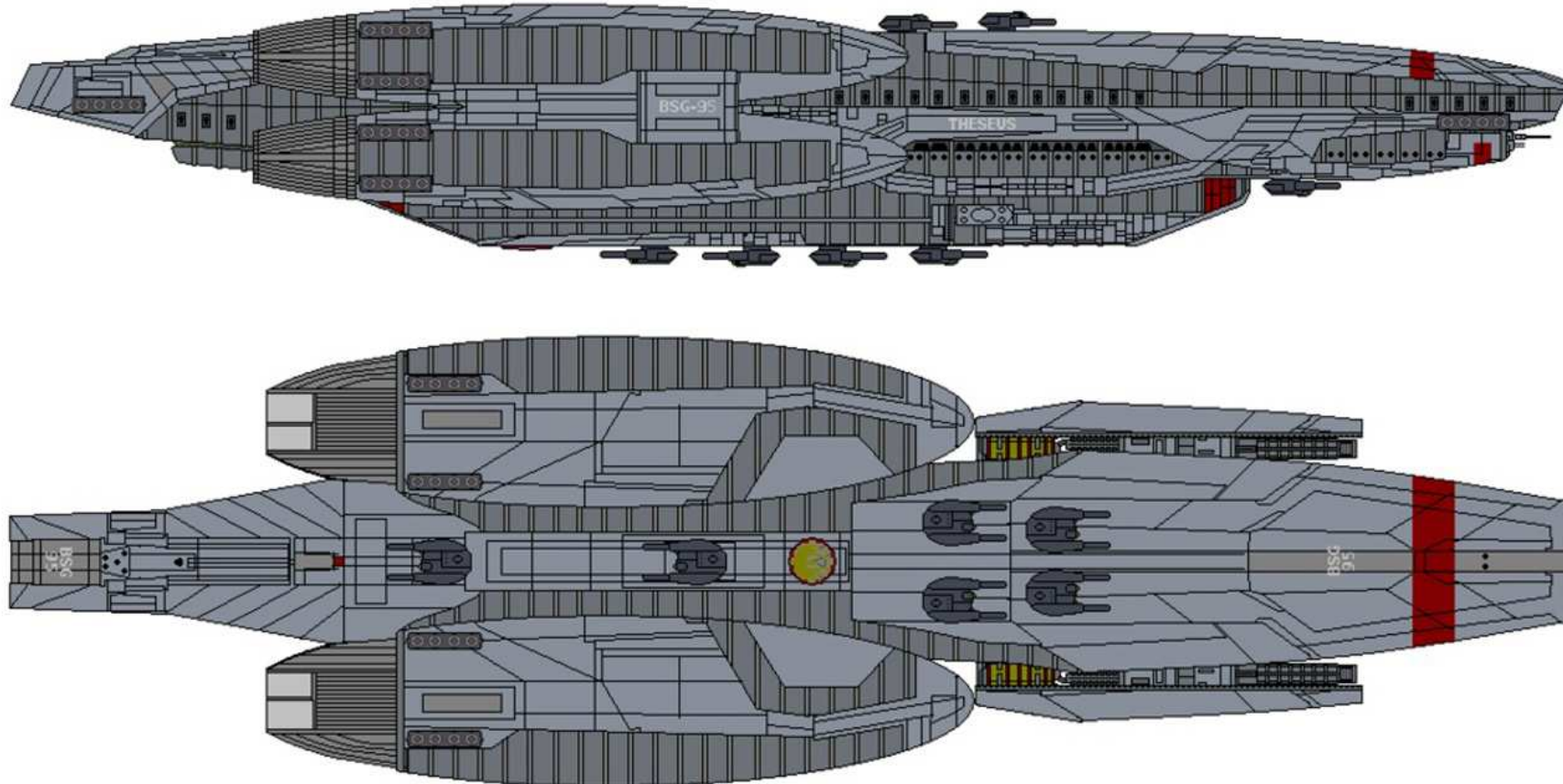

single Viper squadron. Added to their own firepower, this is good enough to provide a more than adequate fast primary response to any threat. The firing arcs of these vessels is also better than many other vessels with a far more impressive all round coverage. It should be pointed out that a combatstar is far more capable of long-range patrols than most other gunstars and she carries the stores and munitions to stay out on the line for months at a time. Her armour also allows her to stay in the thick of battle far longer than most contemporaries and her centreline landing pod allows for easy recovery of her viper complement.

Nearly all of these improvements have come about from the extensive electronic controls in use throughout the class. The bridge crew can control nearly all electronic functions aboard. Without these, the estimated manning requirements would be in the order of 2500 men and women.



## ***Siegestar***

© by Marcus Starkiller

**Agi** d4, **Str** d12+d6, **Vit** d6, **Ale** d6, **Int** d8, **Wil** d10  
**LP** 28; **Init** d4+d6;  
**Scale** Spacecraft' **Speed** 4 (SL/JC)

### **Traits**

Formidable Presence (d6), Past Its Prime (d4)

### **Skills**

Heavy Weapons d6, Mechanical Engineering d4, Perception d4, Pilot d4

### **Armament**

Heavy planetcraft scale skirmish range point-defence system (d12);  
 48 spacecraft scale short DRADIS primary assault railguns (d12+d2);  
 24 spacecraft scale short DRADIS range missile systems (d12);  
 18 spacecraft scale short DRADIS range missile systems (d12+d4);  
 12 spacecraft scale extreme DRADIS range nuclear missile systems (d12+d8);

### **Airwing**

72 Vipers, 18 Raptors, 10 assorted craft

**Armour** Wound 7, Stun 5

**Description** 9025 x 3389 x 820 feet; **Crew** 6,095  
**Passengers** 8,000

This massive and dedicated siege platform was originally designed to accomplish one mission – to overcome planetary defence grids which protect a planet from orbital bombardment. It is easier and far less expensive to destroy a planet's grid than it is to order troops to assault it. Unfortunately it was also proved that such techniques were unsatisfactory when dealing with areas being taken by Cylon Centurions. In the end, its copious use of massive suppression barrages was proven to be the most effective way of gaining sufficient air superiority to allow troops to land and either retake ground – or to evacuate it.

The 'Siegestar' was a reversion from the Cylon equipped Dreadnaught, which had been equipped for the same purpose (and of which only three were built).

Regretfully, just like Battlestars, the Siegestars were prime targets for the Cylon fleet and all but one of these was destroyed during the war. The remaining vessel – Haldara, and two others completed after armistice day, were finally decommissioned 15 years ago. One was broken for scrap, another stripped of the bulk of her armament and equipped for long range colonisation.

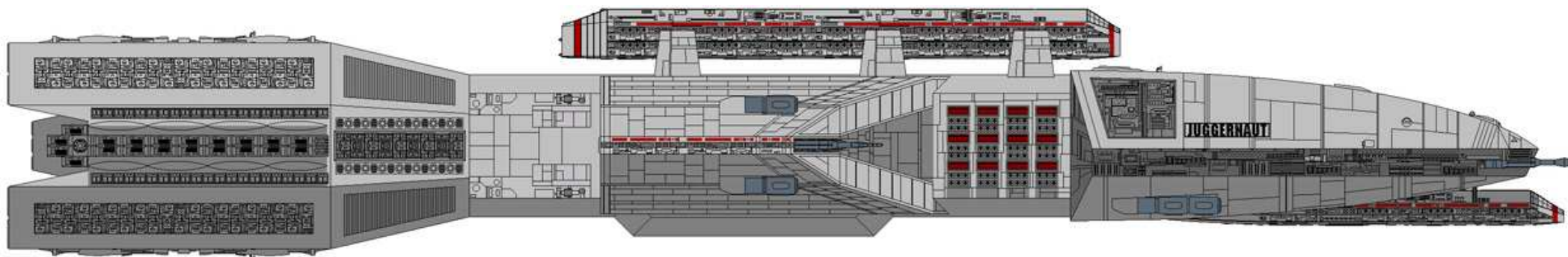

## Hunter-Class Escortstar

By Ferox

Agi: d6 Str: d10 Vit: d6 Ale: d6\*\* Int: d6\* Wil: d8  
 LP: 18 Init: d6 + d6\*  
 Scale: Spacecraft  
 Speed: 6 ( SL/ JC )

Traits: Mass-Produced (d4): see text

Skills: Heavy Weapons d4, Mechanical Engineering d4,  
 Perception d4\*, Pilot d2\*\*

\*add one step fifteen years after the First Cylon War

\*\* add one step thirty-five years after the First Cylon War

### Armament:

6 spacecraft scale capital range primary assault railguns (d12),

2 spacecraft scale short DRADIS range missile systems (d12 standard, d12+d8 nuclear, needs 5 rounds to change ammunition,

20 medium planetcraft scale skirmish range PDS (d8);

### Airwing

28 Vipers, 8 heavy fighter craft, 6 Raptors, 8 shuttles and repair vehicles

**Armour:** Wound 4, Stun 2 (3- twenty years after the First Cylon War )

Description: 991,5m ( l ) x 266,53m ( b ) x 217,43m ( h )

Crew: 800 Passengers: 1050

In the later part of the First Cylon War the Colonials had suffered several blows to their fleet, including losses of more than one Battlestar. However, as the need for more fighter craft rose even more yet the shipyards could hardly produce more Battlestars – those still functional were just sufficient to maintain the fleet as it was.

As a consequence the Hunter-Class was developed. Based on a freighter design, the ships were equipped with hangar bays, larger engines to accelerate them to combat velocities and of course armament. Armour plates were added and the hull as a whole was strengthened. They still share a 50% parts compatibility with the merchant hulls.

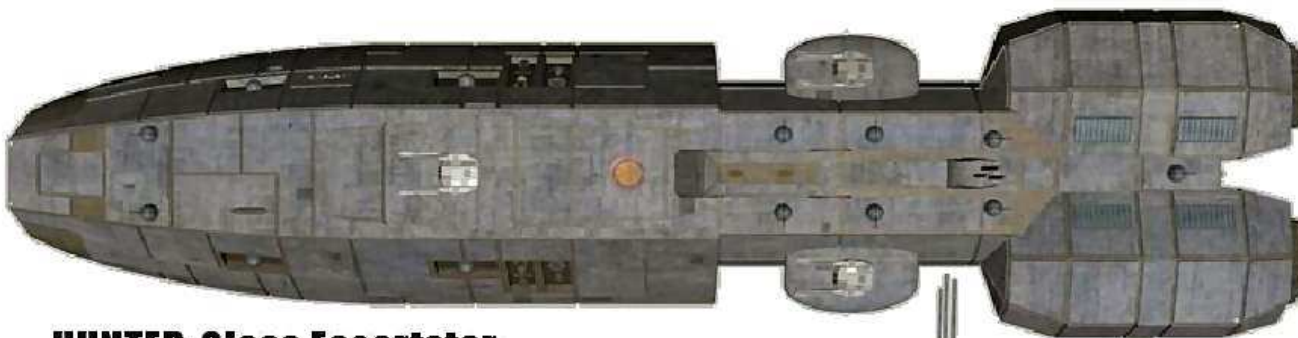

## HUNTER-Class Escortstar

Picture & Mesh by Gargoyle



The designs proved to be successful and even after the war more ships of the class were produced. While first envisioned as a support-ship for Battlestars, acting as escort and fighter supply, the ships soon began undertaking missions on their own. Partly they were even used as landing ships since they are capable of making planet fall.

After the war they were used as police cruisers, training and research vessels and reserve ships. In the decades after the war these ships received several updates in software and systems, but they are aging by now.



## ***Black Swan (Frigate)***

By Gazza

art by Limerickcot

Agi D8, Str D8, Vit D6, Ale D8, Int D6, Wil D6;  
LP 12; Init D8+D8; Scale Spacecraft; Speed 3 (3 in  
atmosphere; SL/JC)

**Traits:** Allure (D4); Loved (D4); Mass-Produced (D4) --The  
Black Swan is a very common model

**Skills:** Athletics D4; Heavy Weapons D4; Knowledge D2;  
Mechanical Engineering D4; Perception D6; Pilot D6;  
Technical Engineering D4

### **Armament:**

6 spacecraft scale short DRADIS range missiles (d12)  
4 spacecraft scale capital range railguns (d6)  
Medium planetcraft scale skirmish range PDS (d6)  
Medium planetcraft scale skirmish range missile PDF (d8)  
50 mines as required

**Armour:** Wound 2, Stun 2

**Description:** 300 x 38 x 25 feet; Crew 180; Passengers 30;

**Subcraft:** 2 Raptors

Notes: -

Designed as a Convoy Escort, Patrol Vessel, Light Minelayer/Heavy  
Minesweeper, the Black Swan class excelled as an anti-small craft Escort  
proving very successful against Cylon Raiders. It can be used as a light  
minelayer by embarking 50 Mk 277 configurable mines, which can be  
mated to standard nuclear missile warheads as required.

She uses multiple short-range HD-70 Javelin missiles to provide a  
skirmish range PDS in place of the heavier gun based PDS usually found  
on most vessels. These can fire missiles singly or in salvos of various  
configurations, with 4 to 6 missiles being a favourite launch configuration.

The last vessels were withdrawn to the Cayuze facility a few years ago.

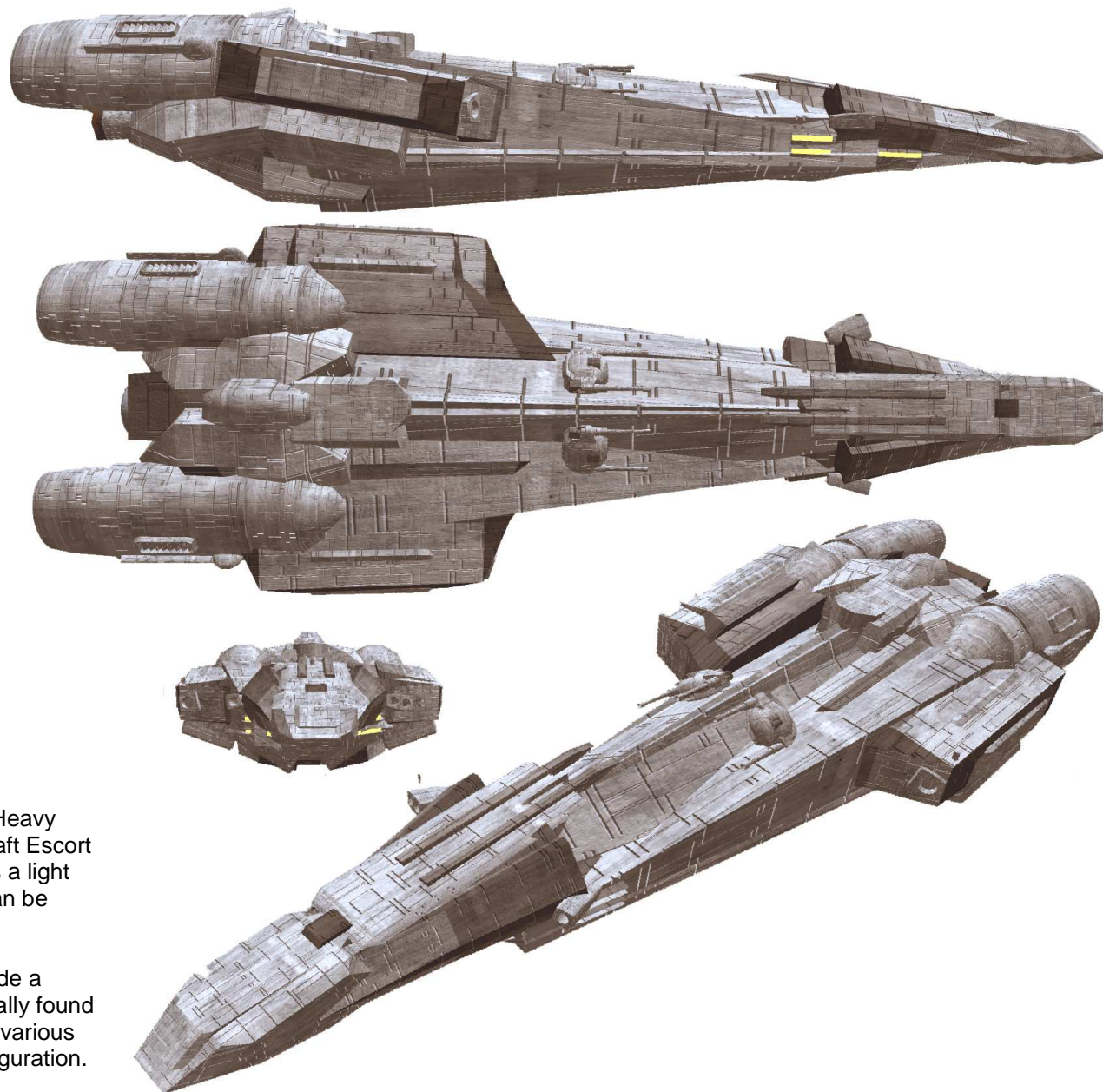



## **Type 700 System Patrol Cutter**

By Raptor

**Agi-D6 Str-D8 Vit-D6 Alt-D8 Int-D6 Wil-D8**  
**LP-16 INIT-D6+D8 SPEED-5 SL**

**Traits-** Mass Produced-D4

**Skills-** Heavy Weapons-D4; Perception-D6; Pilot-D4; Knowledge-D4

### **Armament-**

6 Spacecraft Scale Light Railguns (D6);  
 4 Spacecraft Scale Capital Missile Systems (D8)

### **Air Wing**

1 Raptor or Dropship

**Armour-** Wound /Stun 2/2

**Dimensions-** 215'x20'x25'

**Crew-** 34 **Troops-** 12 (CMC personnel or armed CF personnel)

**Known Ship Names-** This type of vessel uses alpha-numeric designations. I.E. Quasar Delta 721 and Constellation X-Ray 987 are cutters that patrols near the Ragnar Anchorage

### **Class Notes:**

The Type 700 SPC performs constabulary duties in Colonial space. It conducts boarding and inspection operations to confirm civilian spacecraft are safe and they are not carrying any contraband.

This patrol cutter is manned by reserve elements of the Colonial Fleet and Colonial Marine Corps. The reasoning this is done is to maintain the reservists qualifications. The class is sufficiently armed to deter a civilian vessel that may want to make a run for it or if necessary to defend against piracy.

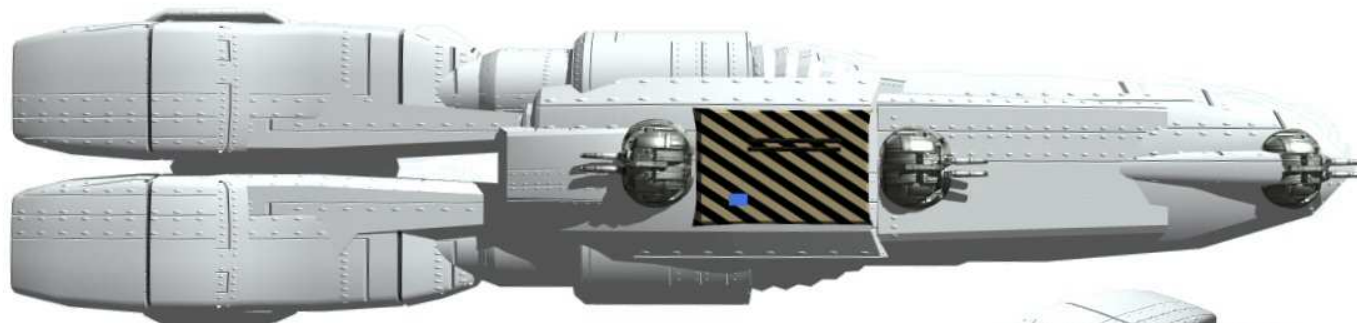

**Type 700 Cutter**  
 by Limerickcot

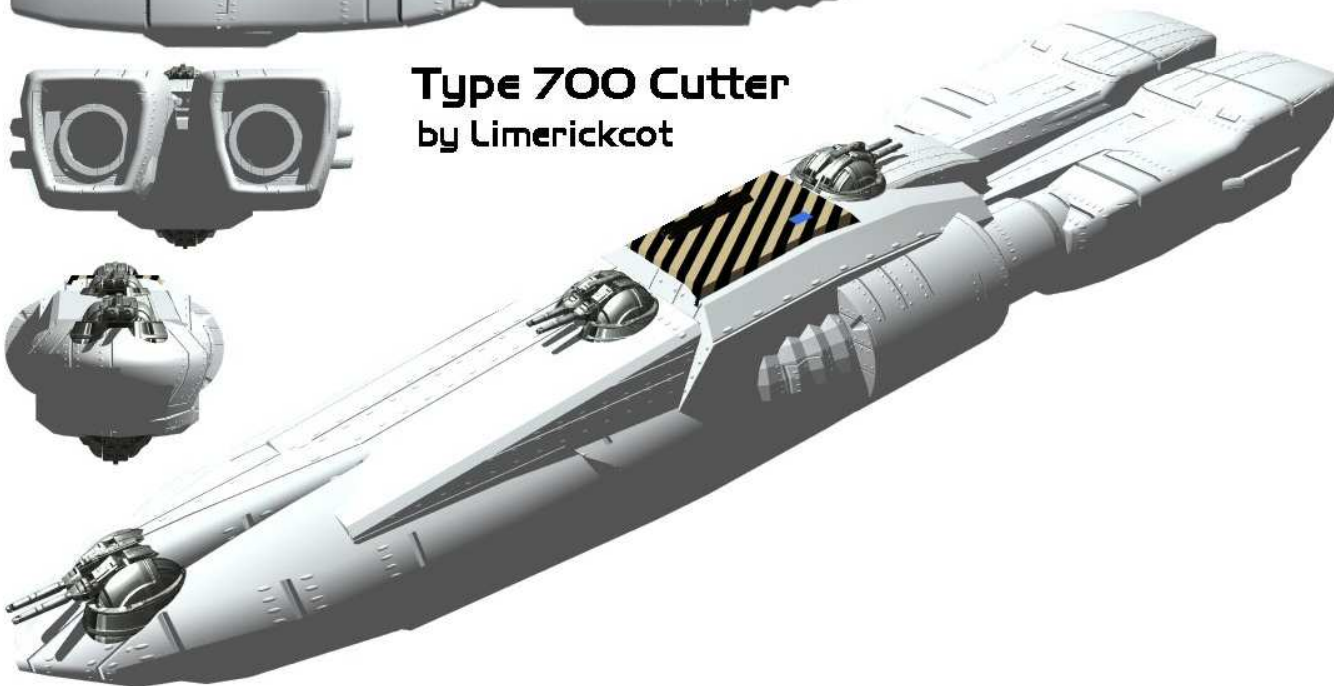

## **Moebius Light Escort**

Art By Raptor

Stats by Limerickcot

**Agi-D6 Str-D8 Vit-D8 Alt-D8 Int-D6 Wil-D8; LP-16 INIT-D6+D8 SPEED-8 [SL/JC]**

**Traits-** Mass Produced-D4

**Skills-** Heavy Weapons-D6; Perception-D6; Pilot-D4; Knowledge-D4

### **Armament-**

**1 planetcraft scale, light PDS (d6)**

1 Spacecraft Scale Light Railguns (D6);

4 Spacecraft Scale Capital Missile Systems (D8)

### **Air Wing**

2 Raptor's

**Armour-** Wound /Stun 2/2

**Dimensions-** 223'x56'x25'

**Crew-** 74 plus – 18 Marine or Army

### **Class Notes:**

Similar in size to the Class 700 cutter, the Moebius serves a similar function on a rapid response basis either in or out of the Colonial Systems.

The Moebius is designed for use within an atmosphere and in areas where backup and support is low. She carries long term supplies for her crew and troops and an excellent life support system.

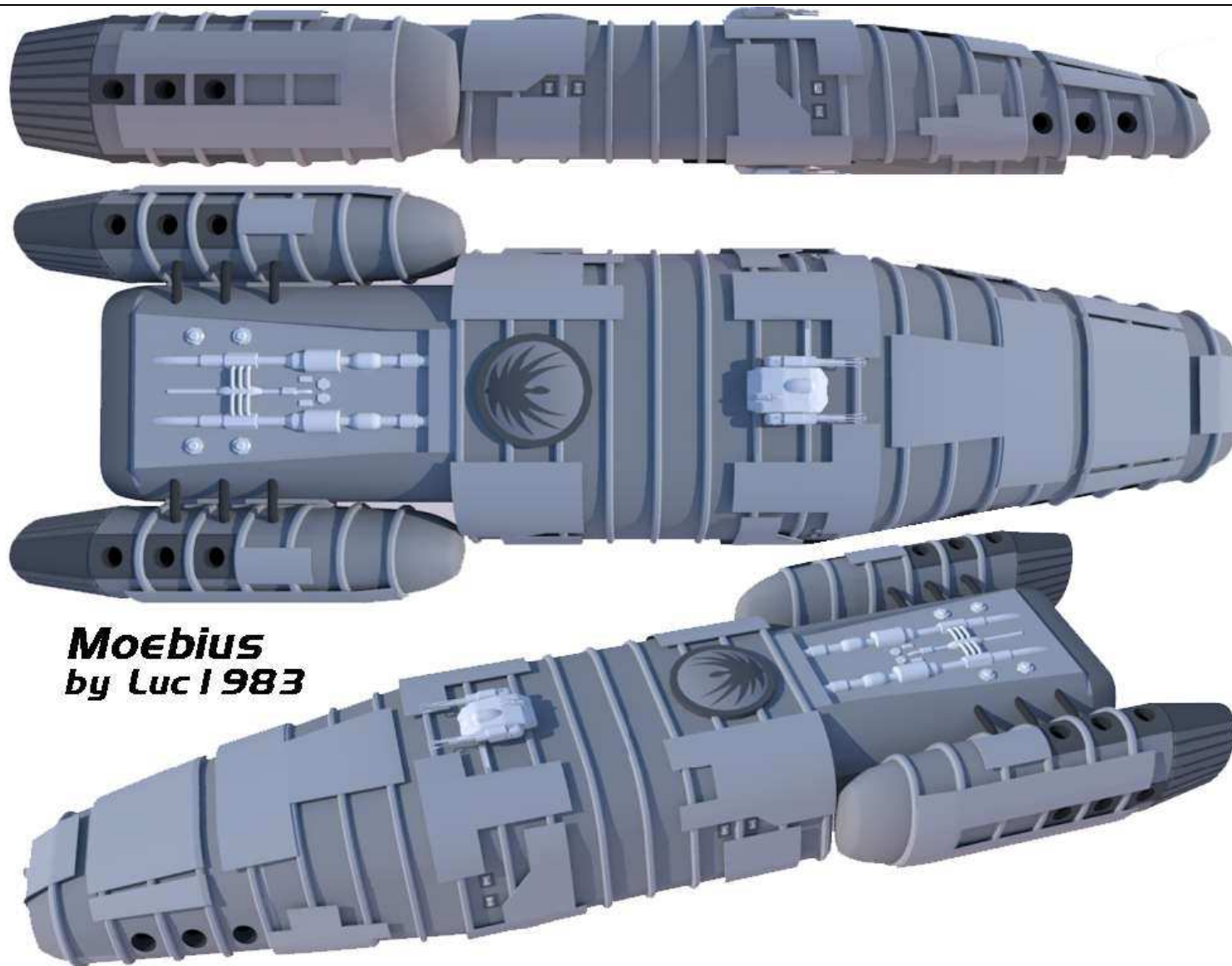

Normally these craft carry out custom inspections and relief of police and other outposts. The normal operating procedure within the colonial systems is to group these ships in flotillas of six to twelve craft and operate them as escorts and forward picket vessels to auxiliary and civilian craft.

## High Endurance Cutter

By Selek

**Agi-D6 Str-D8 Vit-D6 Ale-D8 Int-D6 Wil-D8**  
**LP-16 INIT-D6+D8 SPEED-5 SL only**

Traits- None

Skills- *Heavy Weapons-D4; Perception-D6; Pilot-D4;*  
*Knowledge-D4*

### ARMAMENT-

2 Spacecraft Scale Light Railguns (D6);  
 9 Planetcraft Scale Autocannon (D8)  
 1 Spacecraft Scale Capital Missile Systems (D8)

### AIR WING-

2 SAR Raptors  
 2 Aero-shuttles Or Dropships

**Armour-** Wound 1, Stun 1

**Crew-** 185 **Troops-** 12 (CMC personnel or armed CF personnel)

In reality, border patrol and customs enforcement craft need not be that heavily armed- especially in peace time, nor do they normally carry a full weapons load out (especially expensive munitions like missiles).

Even lightly armed like this, the cutter will outgun nearly anything she's going to encounter in the local space lanes.

The guns were reduced to two medium spacecraft scale rail guns, two (or one) battery of missiles (to be shipped only in time of war) and nine planetcraft scale autocannons

The SAR Raptors are configured for SAR/cargo duties , including a ramp and removal of the secondary weapon hard points. They can accommodate up to 12 people (rather squashed) or six stretcher cases. SAR units are noticeable by their White paintwork – a colonial standard.

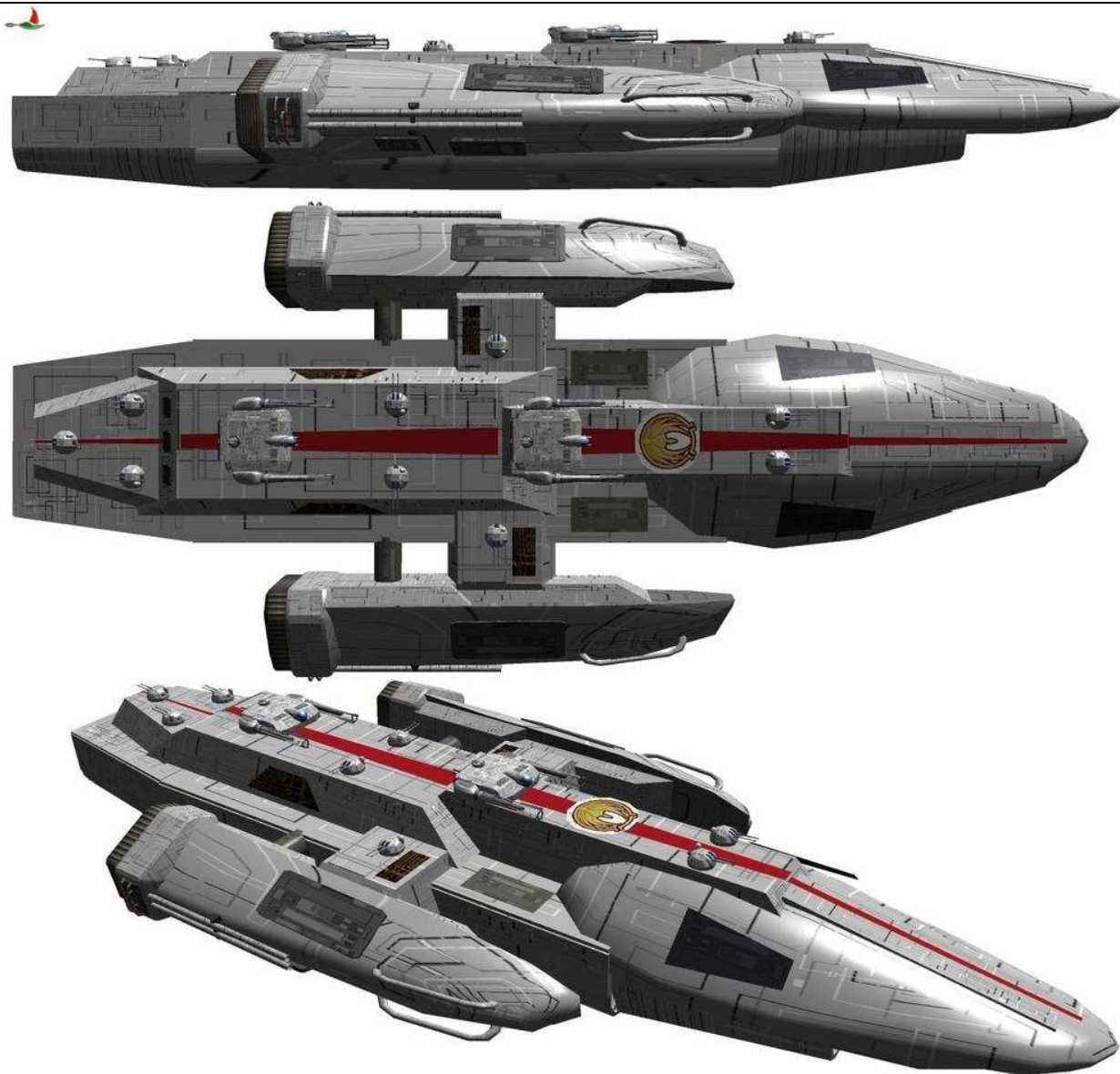



## **Bolo Class Corvette**

Stats by Limerickcot

Art by Limerickcot based on a concept by Starslayer

Agi-D6 Str-D8 Vit-D6 Ale-D8 Int-D6 Wil-D8

Lp-16 Init-D6+D8 Speed-6 [SI/JC]

Traits- None

Skills- *Heavy Weapons-D4; Perception-D6; Pilot-D4; Knowledge-D4*

### **Armament-**

Medium Planetcraft Scale, Skirmish Range, PDS (d8)

3 Spacecraft Scale, Medium Range, Light Railguns (D6);

2 Spacecraft Scale, Long Range, Missile Systems (D8)

2 Raptors

**Armour-** Wound 2, Stun 1

Dimensions: 295 long x 77 beam x34 high

**Crew-** 80; Passengers: 24

The Bolos was derived from a concept ship called the Bolitho. Designed originally as a customs craft, her adaptability, speed and responsiveness have led to redesign and redeployment as a convoy and patrol vessel. Mounting three large turrets; the Bolos packs a very powerful punch. However, given her very small size, she is unable to carry sufficient ammunition for long engagements. In addition, firing of all three turrets at once, over any sustained engagement, can lead to excessive wear and structural failure in the frame of the ship. To that end, further reinforcements of the hull were required for all extant vessels.

Another problem is that, in order to achieve that, her fuel requirements were cut, and the engines can be overtaxed if used at full throttle, leading to a wastage in fuel consumption.

Bolos Class vessels are, therefore, a not uncommon sight patrolling the main shipping lines in the Inner Colonies, where they are near to supply lines and do not have to worry about fuel expenditure. A few examples have been denuded of their jump capability in order to provide longer endurance. Some others have deleted the fore battery (usually considered a better idea).



**Bolo Patrol Vessel**  
by Limerickcot

They are considered to be something of a Defensive Vessel, being easily housed at many Colonial bases as a quick response vessel, with a small crew. Her boarding party is not made up of marines but rather of customs agents (usually far better trained than regular Marines for this type of duty).

## **Melaneus (Gunboat)**

By Gazza

Art by Limerickcot

Agi D6, Str D6, Vit D6, Ale D8, Int D6, Wil D6;  
LP 12; Init D6+D6; Scale Spacecraft; Speed 3 (3 in atmosphere;  
SL/JC)

Traits: None

### **Skills:**

Athletics D2; Heavy Weapons D4; Mechanical Engineering D4;  
Perception D4; Pilot D4; Technical Engineering D4

### **Armament:**

4 spacecraft scale short DRADIS range missiles (d12)  
16 spacecraft scale capital range railguns (d6)  
8 planetcraft scale personal range point-defence systems (d4)  
50 mines as required

1 Raptor

Armour: Wound 2, Stun 2

Description: 328 x 41 x 30 feet; Crew 236; Passengers 50; Cargo 1000 lbs.

### **Notes: -**

Sometimes a Battlestar is overkill, sometimes a Colonial Shuttle with a squad of Colonial Marines isn't convincing enough. Sometimes you have to send a Gunboat.

The Melaneus class of Gunboats are popular in the fleet having useful roles both in peacetime and in wartime where it is the premier convoy escort. The only limitation on this class of Gunboats is the imagination of its commanders.

The passenger space is reserved for platoon-sized units of Colonial Marines or other forces

It can be used as a light minelayer by embarking 50 Mk 277 configurable mines, which can be mated to standard nuclear missile warheads as required.

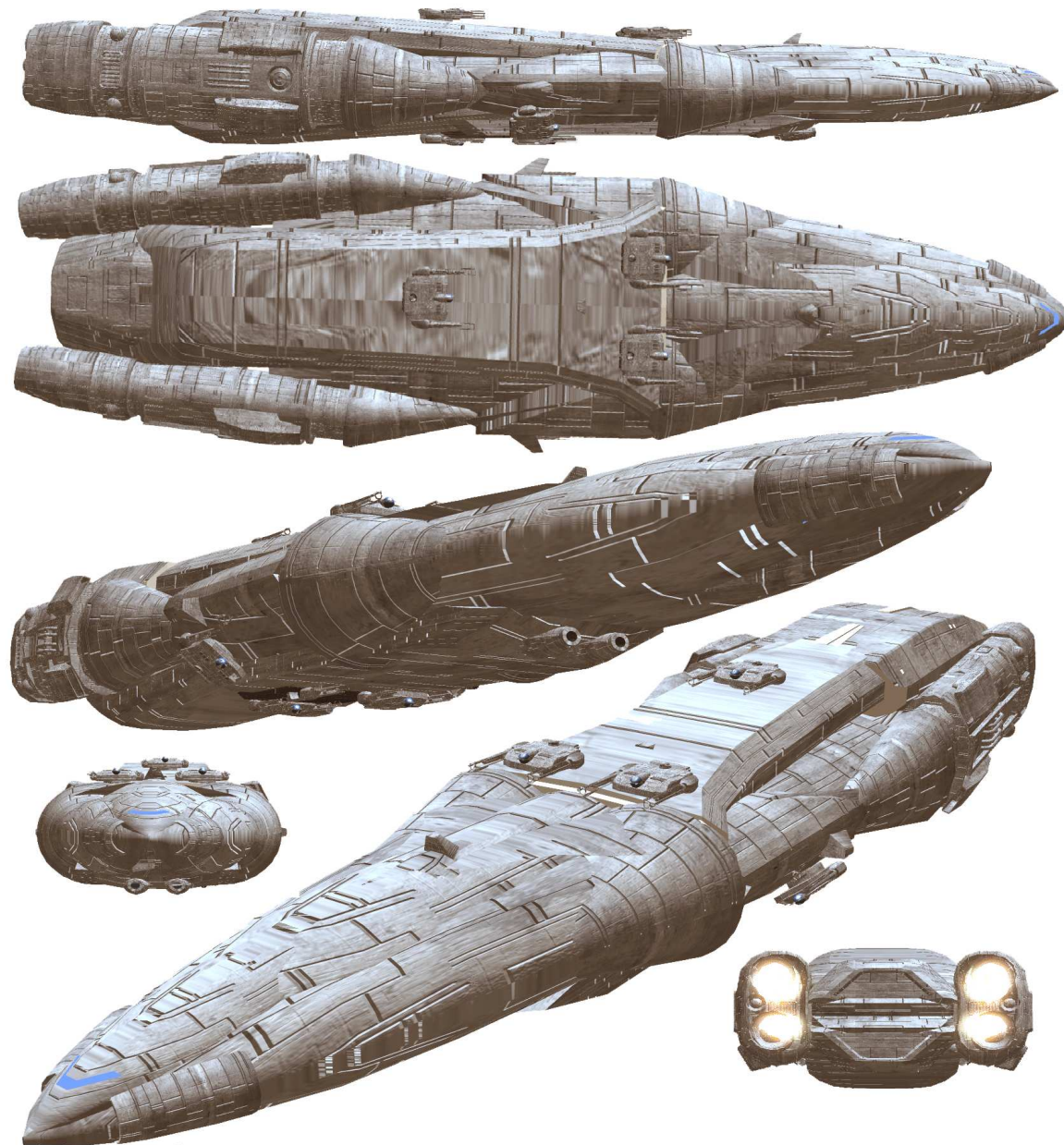



## ***Kayline Gunstar***

By Limerickcot  
Art by Limerickcot

Agi D10, Str D6, Vit D8, Ale D6, Int D8, Wil D10;  
LP 18; Init D6+D6;  
Scale Spacecraft; Speed 8 (SL/JC)

### **Traits**

Mass-Produced (D4) --The basic hull and engines of this model form the backbone of one of the auxiliary classes making it easy to find parts.

### **Skills**

Knowledge D4; Mechanical Engineering D2; Perception D4; Pilot D4; Technical Engineering D2

### **Armament**

Heavy planetcraft scale skirmish range PDS (d12)  
34 heavy planetcraft scale, long-range missile systems (d12)  
4 fixed space-craft-scale, short-range railguns (d12)

### **Subcraft:**

4 Shuttles

Description 3800 x 999 x 172 feet;  
Crew 130; Passengers 130  
Armour Wound 5, Stun 4

Based on the OH series of auxiliaries (see that section) the Kayline series was developed to make the most out of a communality of parts and a cheap construction contract.

By stripping out the space normally dedicated to cargo additional munitions, bracing and armour could be fitted onto the ships hull. Crew requirements were greatly reduced and although she has a passenger complement this is only sufficient to allow a second crew to be carried – allowing a fast paced and extended operational tempo to be maintained for much longer than standard vessels.

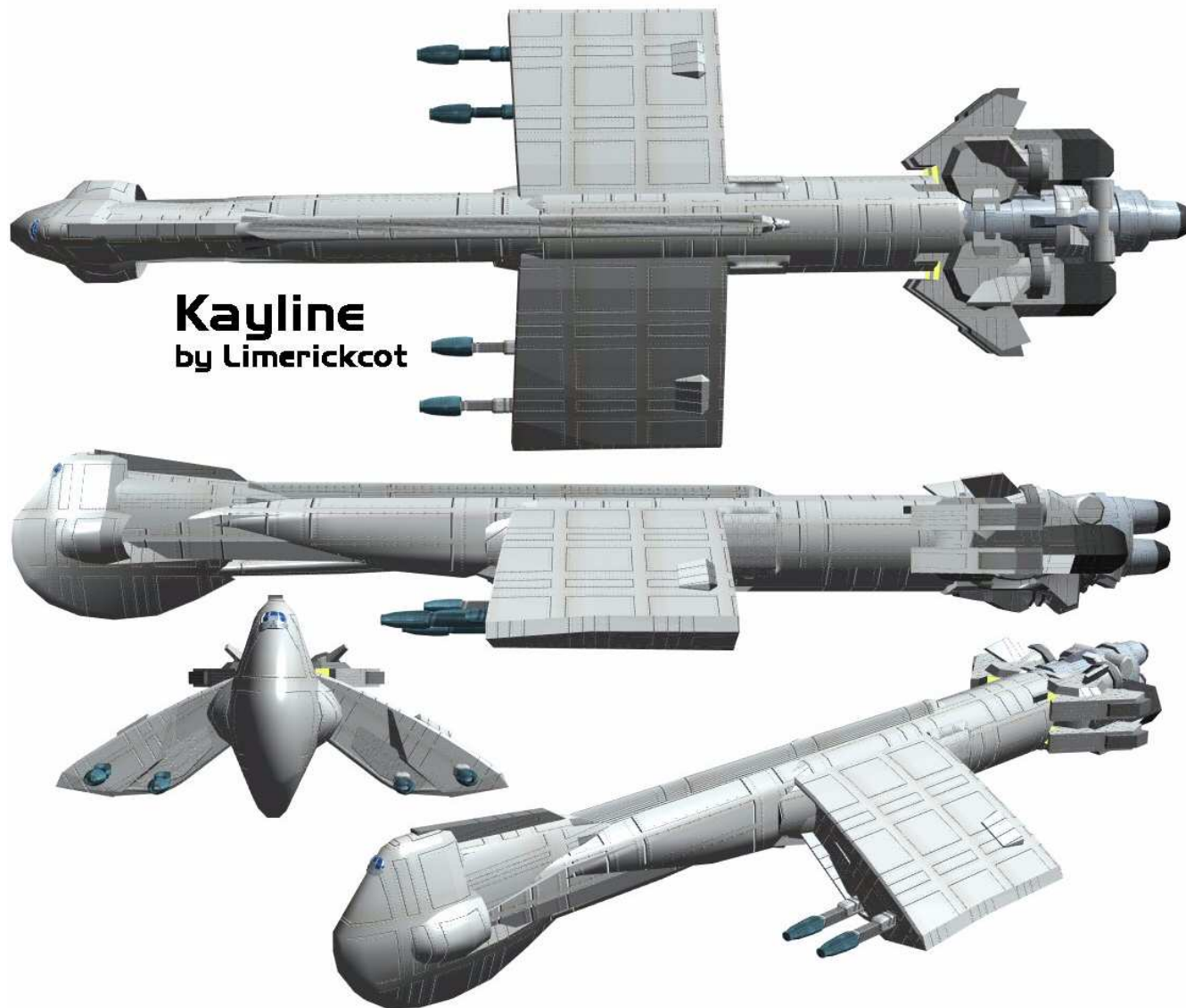

**Kayline**  
by Limerickcot

Her defences are heavy, carried in 'pop' turrets and the main way to differentiate this vessel from her sisters are the two large gun-pods on either side which carry fixed rail-gun mounts. Overall the ship is excellent as an attack vessel, but much less so as an escort.



## **Mentor Viper Launch Station**

Art & Stats by Limerickcot

Agi D4, Str D6, Vit D6, Ale D8, Int D6, Wil D4;  
LP 10; Init D4+D6; Scale Spacecraft;  
Speed 2 (SL only, later versions were Jump Capable)

Traits: Past its prime (d4)

### **Skills:**

Heavy Weapons D4; Mechanical Engineering D4; Perception D4; Pilot D4; Technical Engineering D4

### **Armament:**

2 spacecraft scale short-range railguns (d12)  
Planetcraft scale Skirmish-range point-defence systems (d6)

### **Subcraft:**

2 flights of either Vipers or Raptors  
1 permanent shuttle

### **Armour: Wound 2, Stun 2**

Description: 297 x 150 x 60 feet;  
Crew 26; Passengers 132;

The Viper Launch Station was designed and built long before the Cylon War. It is a basic landing and launching platform designed for training Viper (and later Raptor/shuttle) pilots in the skills of landing on moving platforms. The first ones were un-armoured but later ones were also utilised as semi-fixed bases for a few flights of patrolling fighters or recon boats.

As a result the vessel was armed and armoured to its current standards. The normal crew is very small – consisting of engineering, a few gunners and the bridge crew. Visiting fighter flights bring their maintenance personnel with them. There is a permanent hanger space for either 8 fighters or Raptors and their launch mechanisms, plus one permanent shuttle.

In an emergency the Mentor can carry four flights of Vipers but this will reduce its maintenance capability to just one fighter. The VLS's were never considered much of a target during the Cylon war and several are still in operation over 80 years after being built. Even today, nearly every Viper pilot will have spent some time on an VLS before graduating from Flight School

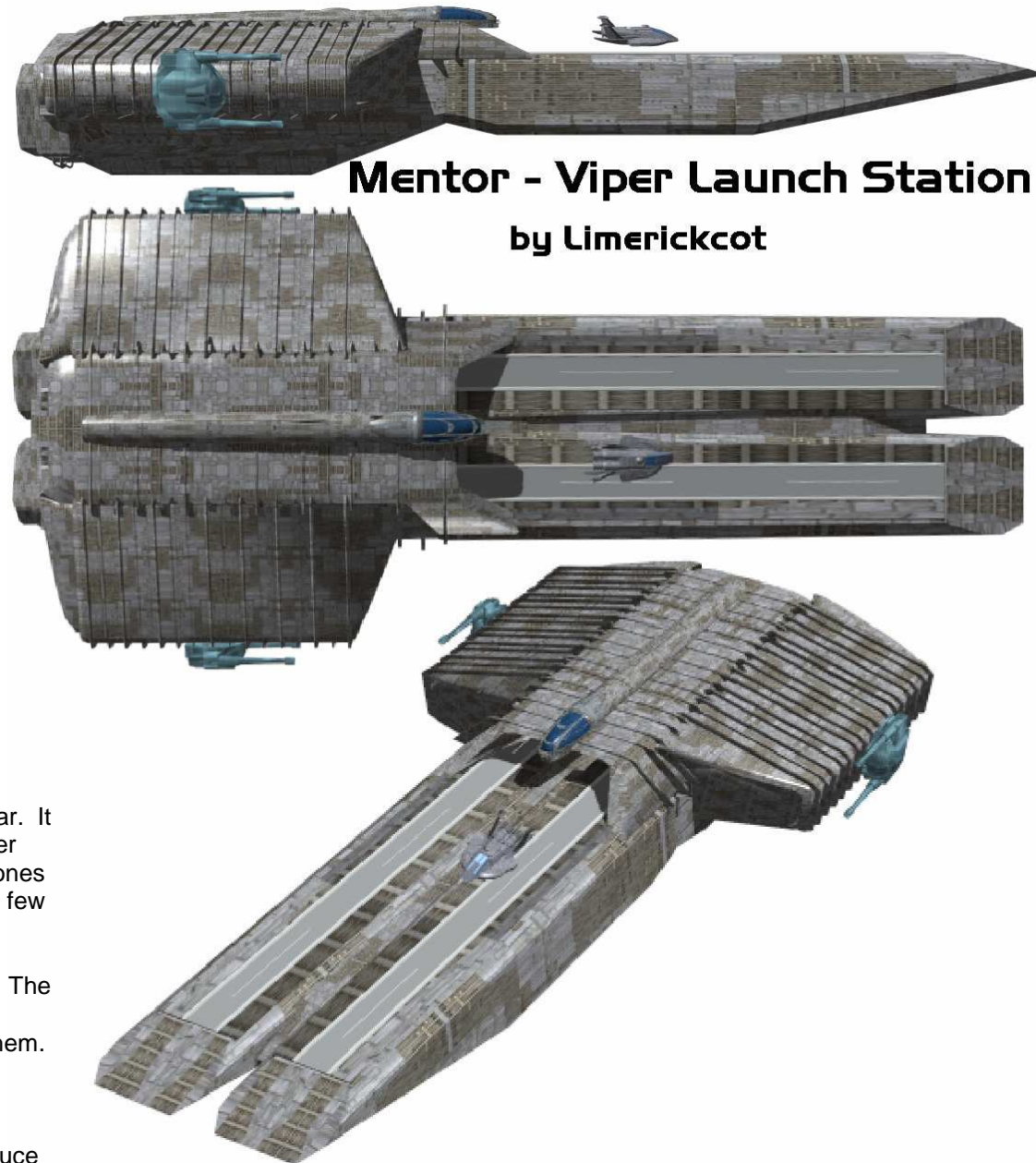

## **Mentor II**

Art & Stats By Limerickcot

Agi D6, Str D6, Vit D6, Ale D8, Int D6, Wil D4;  
LP 10; Init D4+D6; Scale Spacecraft;  
Speed 3 (SL/JC)

**Traits:** None

### **Skills:**

Heavy Weapons D4; Mechanical Engineering D4;  
Perception D4; Pilot D4; Technical Engineering D4

### **Armament:**

2 spacecraft scale short-range railguns (d12)  
Planetcraft scale Skirmish-range point-defence systems (d6)  
Planetcraft scale, Medium-range PDS (d8)

### **Subcraft:**

2 flights of either Vipers or Raptors  
1 permanent shuttle

Armour: Wound 3, Stun 2  
Description: 328 x 41 x 30 feet;  
Crew 26; Passengers 132;

Essentially an up armed and up armoured version of the Mentor I, this vessel also incorporated more powerful drives. The additional armour over the flight deck gave additional protection during combat operations and also allows the through deck to be sealed off and pressurised if required. Alongside the Mentor I, the Mentor II still continues in training use to this day.

A typical training exercise sees a group of three vessels operating together with cadets flying from one to another several times per day, with the vessels operating at different speeds and under different conditions.

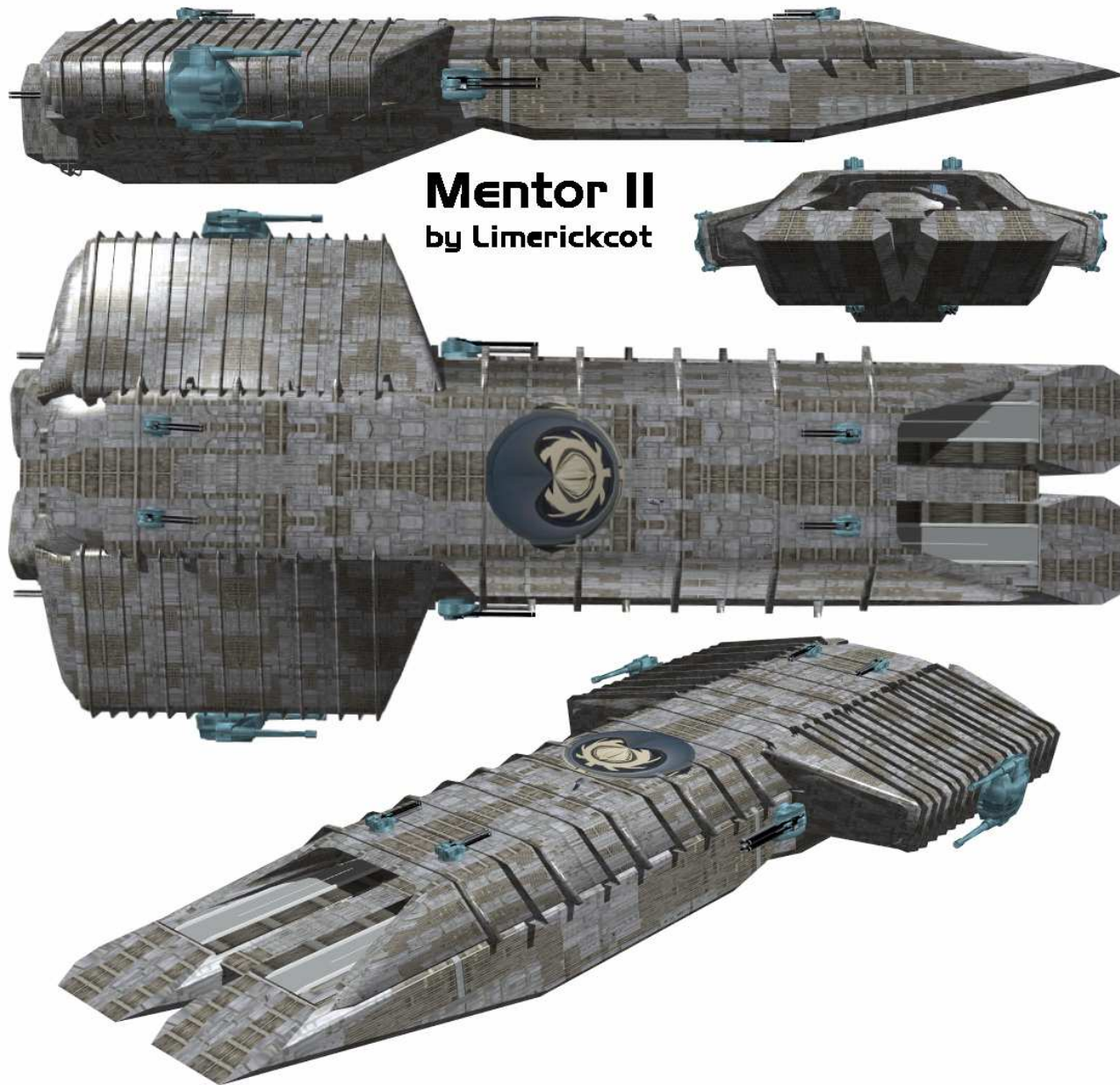



## ***Mentor III - Carousel***

Art & stats By Limerickcot

Agi D6, Str D6, Vit D6, Ale D8, Int D6, Wil D6;  
LP 10; Init D4+D6; Scale Spacecraft;  
Speed 4 (SL/JC)

**Traits:** None

### **Skills:**

Heavy Weapons D4; Mechanical Engineering D4; Perception D4; Pilot D4; Technical Engineering D4

### **Armament:**

2 spacecraft scale short-range railguns (d12)  
6 spacecraft scale capital-range missiles (d12+d2)  
Planetcraft scale Skirmish-range point-defence systems (d6)  
Planetcraft scale, Medium-range PDS (d8)

### **Subcraft:**

1 squadron either Vipers or Raptors  
1 permanent shuttle

Armour: Wound 3, Stun 2  
Description: 328 x 41 x 30 feet;  
Crew 60; Passengers 400;

With a need to expand the training capacity of the fleet, and with a continuing need to establish 'safe' orbital interdiction zones for the colonies, the Mentor III was brought into being. With a much greater hanger capacity, the Carousel (named for the constant change over of units to each vessel), was far more capable than its predecessors, able to stay on station for months with little resupply needed. At full capacity the Carousel is cramped, but it rarely has all of its capacity full at any one time.

Normal deployment is for it to take up station, have one flights on CAP, one flight on Ground Support and the other three resting or training. In the event of overwhelming odds her mission statement is to jump clear to a rendezvous point with another Carousel. If those two are threatened then they do the same until they have gathered together a sufficient force to deal with the threat.

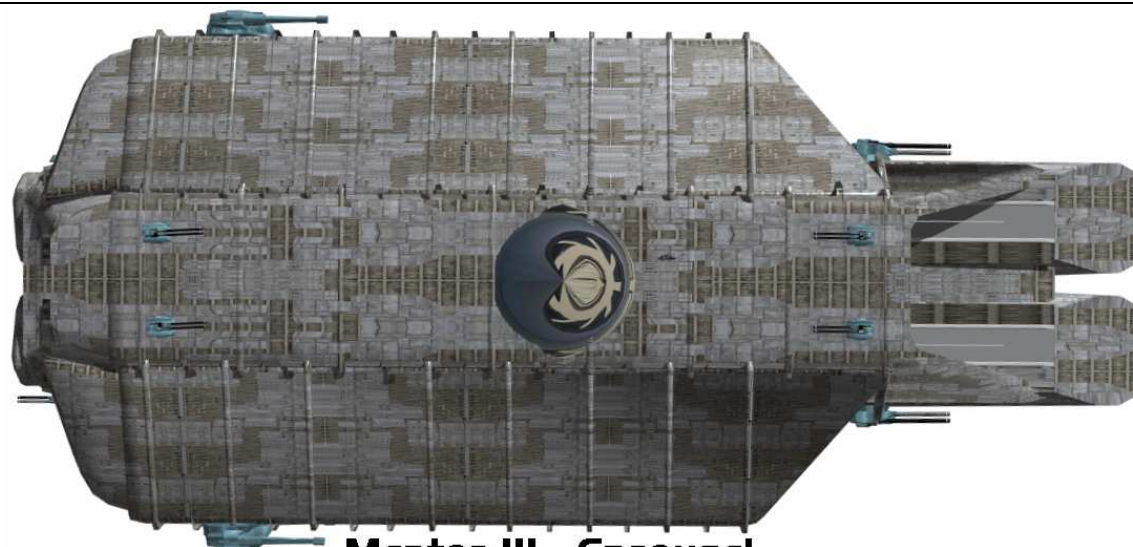

**Mentor III - Carousel**



**by Limerickcot**





## Artemis Gunstar

Stats by Limerickcot

Art by Somacruz145

Agi D8, Str D12+d4, Vit D6, Ale D8, Int D8, Wil D8;  
LP 24; Init D8+D8; Scale Spacecraft;  
Speed 7 (SL/JC)

**Traits:** Fuel hog (at speed 6 above)

### Skills:

Heavy Weapons D8; Mechanical Engineering D4; Perception D4; Pilot D4;  
Technical Engineering D4

### Armament:

29 spacecraft scale short-range railguns (d12)  
14 fixed spacecraft scale short-range railguns  
(d12+d4)  
2 spacecraft scale long-range railguns (d12+d8)  
4 spacecraft scale nuclear capital-range missiles  
(d12+d2)  
16 planetcraft scale, short-range missile systems (d8)  
Planetcraft scale Skirmish-range point-defence  
systems (d12)

### Subcraft

2 flights Raptors  
2 Shuttles

### Armour:

Wound 6, Stun 4  
Description: 4820 x 2310 x 772 feet;  
Crew 3200; Passengers 400;

The Artemis was originally designed to be a Battlestar. Her initial keel had already been laid before a massive parliamentary debate began over funding and tactical doctrines.

Funding was shifted instead to a new, more massive Battlestar – a replacement for the Galactica and larger

than Pegasus. Funding on other projects was cut back. Artemis was redesigned as a pure Gunstar – one of the largest.

To cut costs parts were borrowed from other boats. Her hangers were 'borrowed' from a Chiron class gunstar, armaments from various ships throughout the reserve fleet. The whole has combined into a mean looking and capable vessel.

Massive automation allows her to emplace a massive number of guns for both attack and defence. She is capable of taking damage that only a Battlestar would normally absorb. Her price for all of this is a restricted flight deck. She carries only Raptors and shuttles. She is also a fuel hog at high speeds but helps make up for this by being capable of operating in-atmosphere.

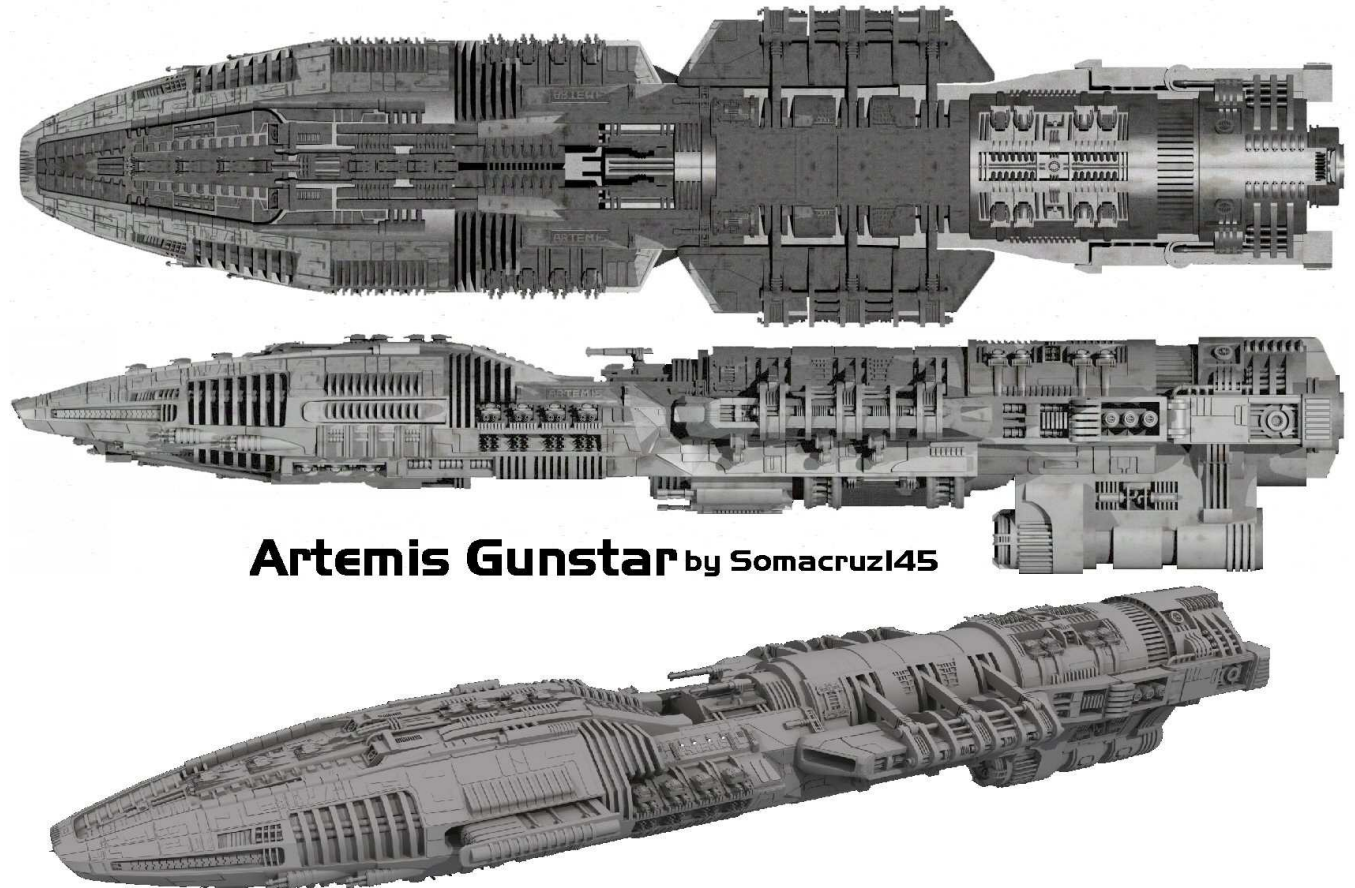

**Artemis Gunstar** by Somacruz145

## ***Fenrir Class Gunstar/Monitor***

Art by Fongsunder

Stats by Limerickcot

**Agi** d8, **Str** d8, **Vit** d6, **Ale** d8, **Int** d6, **Wil** d10

**LP** 18; **Init** d8+d8; **Scale** Spacecraft

**Speed** 5/4 (SL/JC)

**Traits** None

**Skills** *Heavy Weapons* d6, *Mechanical Engineering* d4, *Perception* d6,

*Pilot* d4

### **Armament**

Heavy planetcraft scale skirmish range point defence system(d12);

12 spacecraft scale capital range primary assault railguns (d12+d2);

**Armour:** Wound 3, Stun 3

**Size:** 755 x 554 x 180 feet;

**Crew:** 412; **Passengers:** 120

Fenrir is a close-escort in the truest meaning of the name. Although she has a top speed that puts her in the Gunstar range, she is only capable of maintaining that speed for up to an hour before her cooling systems are overwhelmed and her engines shut down. The reason for this 'oversight' was a constantly changing specification that saw the Fenrir's armament doubled from its original concept.

To make space for the guns, all of her subcraft (bar a single shuttle) were deleted, her cargo holds reduced to bare stores and her coolant systems redesigned.

What the Fenrir can do though, is fight. She carries twelve assault railguns with the ammunition to stay in a fight long after other ships exhaust their supplies. When added to the firepower of Battlestars she is an excellent asset. If fighting alone then she must be fought intelligently or lose the fight to faster ships carrying longer range weaponry.

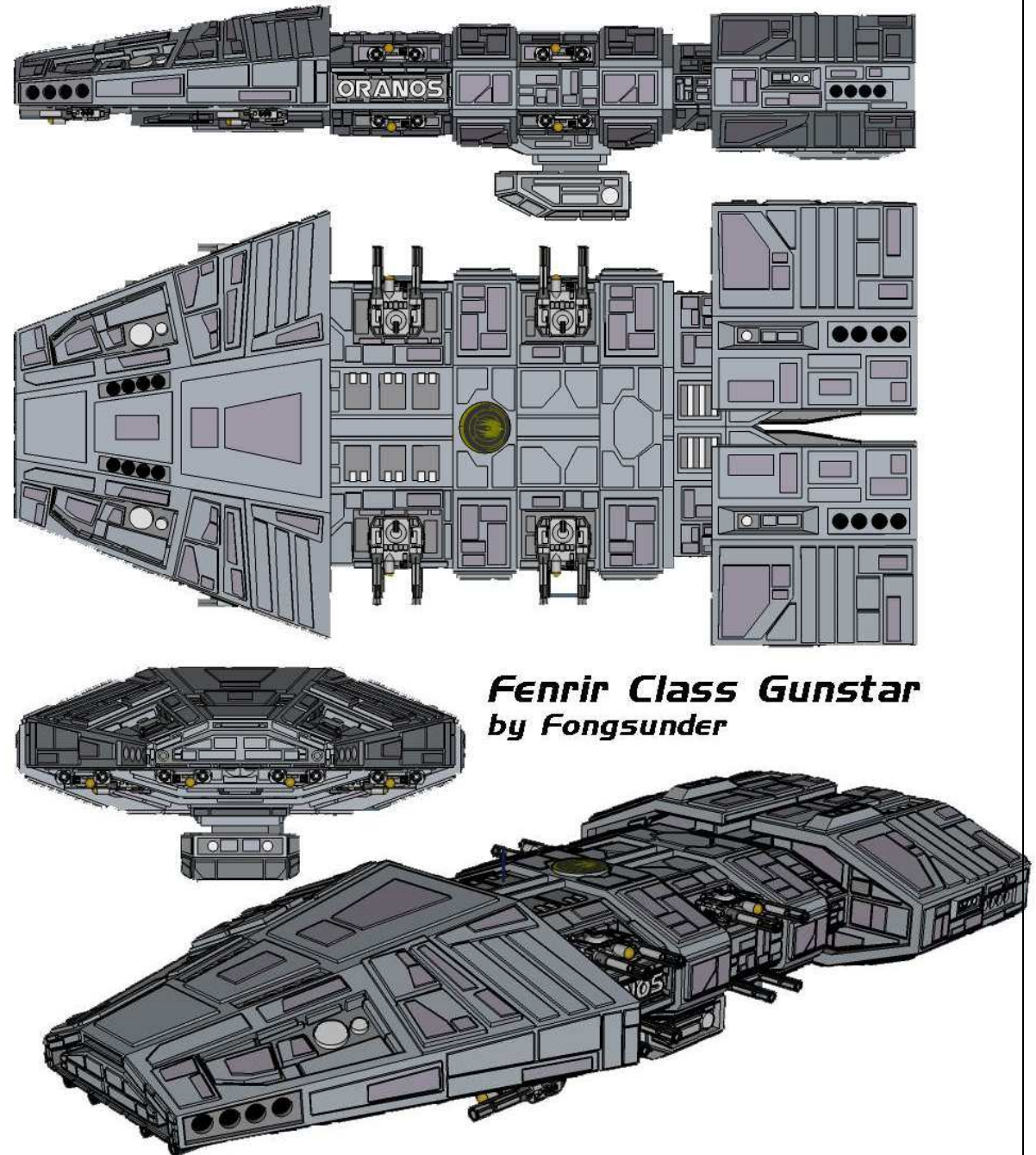

***Fenrir Class Gunstar***  
***by Fongsunder***



# TROOPSHIPS





## ***Mentor IV – Cochrane Troopstar***

By Limerickcot

Agi D8, Str D10, Vit D6, Ale D8, Int D6, Wil D6;  
LP 16; Init D8+D8; Scale Spacecraft;  
Speed 6 (SL/JC)

**Traits:** None

### **Skills:**

Heavy Weapons D8; Mechanical Engineering D4; Perception D4;  
Pilot D4; Technical Engineering D4

### **Armament:**

4 spacecraft scale short-range railguns (d12)  
4 fixed spacecraft scale short-range railguns (d12+d4)  
6 spacecraft scale capital-range missiles (d12+d2)  
Planetcraft scale Skirmish-range point-defence systems (d10)  
Planetcraft scale, Medium-range PDS (d10)

### **Subcraft:**

1 squadron Vipers

2 flights Vipers or others

2 flights Raptors

2 shuttles

### **Or:**

1 squadron of LST's  
(already loaded)

2 flights Vipers

2 flights armed Raptors

2 Shuttles

**Armour:** Wound 5, Stun 4

Description: 650 x 210 x 201 feet;

Crew 800; Passengers 400;

The final and most up-to-date version of the Mentor Class (qv) is the Cochrane (named for Sire Cochrane who was instrumental in drawing up the articles of Colonisation). This vessel is a long-range patrol variant of the original. Her increased size, bunkering and hanger space make her a true escort-star.

However, her principal duties have recently seen her taken from these duties and tasked to transportation duties. Instead of a squadron of Vipers, Laden shuttles are loaded into her side and rear dock (keeping one clear for viper and raptor operations).

In this configuration she has become far more of an asset for Marine Operations compared to the escort she was designed to be.

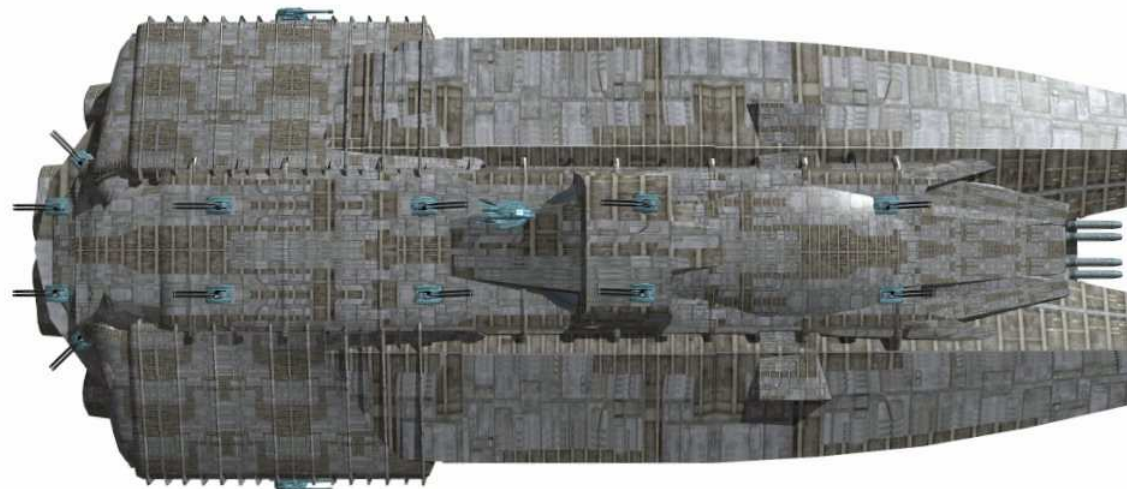

**Mentor IV - Cochrane** by Limerickcot



## **Daedelus Troopstar**

Art by Limerickcot, based on an original by Wolff 6.0, stats by Limerickcot

Agi d8, Str d10, Vit d8, Ale d6, Int d8, Wil d8  
LP 18, Init d8 + d8,  
Scale: Spacecraft,  
Speed: 7 (SL/JC)  
Traits/Complications: none

**Skills:** Heavy Weapons d4,  
Perception d6, Pilot d4,  
Mechanical Engineering d8

### **Armament:**

Medium planetcraft scale skirmish range PDS (d10);  
4 spacecraft scale Short DRADIS range missile systems (d12);  
18 spacecraft scale Long DRADIS range assault railguns (d12)  
Armour: Wound 4, Stun 3  
Description: 1525 long X 111 high X 680 feet wide  
Crew: 407  
Passengers: 220 + 1 Reinforced Company of Marines

### **Airwing:**

2 flights of Raptors (8 Raptor general support craft)  
2 flights of Vipers Mk VII (8 in total)  
2 flights of LST (landing ship tank – 8 in total)  
2 flights of Shuttles (8 in total)  
1 flights of Raptor-A (4 in total)  
1 flight of Raptor-LC (4 in total)  
Provision for 4 other subcraft (such as the 'spooky')

The Daedelus is another Cygnus variant and deployed as a 'commando-carrier'. Its mission is to deliver its reinforced company of marines onto a



**Cygnus MkIII**  
by Ice Dragon  
based on a concept  
by Limerickcot  
**Daedelus**

contested landing zone. To do this, a good deal of its weaponry and some of its speed was sacrificed to make way for the necessary subcraft and cargo space needed to do this. The vessel is not designed to operate on its own, but in company to other ships acting as escorts.

Although a Battlestar may also carry companies of Marines, for boarding and defence actions, the Hermes carries a Surface Assault Company. This SAC consists of a normal Marine infantry company backed up with artillery, armour, mechanised, air-cav and fighter elements. SAC units are equipped to carve out a landing zone against all odds, so allowing heavier units to fly in. These 'Commando' units are not special forces but do consist of an elite amongst the rest of the Marine forces deployed with the fleet.

To help it deploy its many sub-craft, the Hermes utilises two short 'pods' on either side of the ship, and independent shuttle lifts as well as the main flight deck. The two pods can be sealed off and pressurised separately from the main hanger, which helps quick recovery, loading and launching of the various marine components whilst still allowing Viper recovery to proceed.



## ***Pendragon Assault Lander***

by Limerickcot

Agi d8, Str d8, Vit d10, Ale d8, Int d6, Wil d8 LP 16, Init d10 + d6  
Scale: Spacecraft  
Speed: 6 (8 in Atmosphere) (SL/JC)  
Traits/Complications: Sixth Sense (d4)

Skills: Heavy Weapons d4, Perception d6, Pilot d8, Mechanical Engineering d8

### **Armament:**

Light planetcraft scale skirmish range point defence system (d6);  
2 spacecraft scale Medium Short DRADIS range missile systems (d12);  
4 spacecraft scale Medium-range assault railguns (d8)  
24 Planetcraft scale short/skirmish range auto guns (d8)

### **Armour:** Wound 3, Stun 3

Description: 330 X 65 X 140 feet  
Crew: 59  
Passengers: 16 + 50 Marines

### **Air Wing**

2 Raptors  
2 Raptor 'Spooky' Variant  
either 2 Raptor LC or 1 LST or Shuttle

Pendragon was designed very specifically for the insertion of small, special-ops or recon units into a hostile environment. She is capable of orbital insertion and has landing capability. Her raptors and covert 'spooky' subcraft allow her to deploy and recover her assault team quickly and easily, giving her



**Pendragon**  
By Limerickcot

a spare capacity to do all required of her at all times. All Pendragon craft are publically registered in the fleet as 'fast transports' and publically known as VIP transports, effectively covering their operational status. These ships were not designed to counter any Cylon threat but rather as a means to counter on-going human threats within the colony worlds and the smaller outlying systems.

As such, they are fast, lightly armed and armoured, and fully capable of dealing with any small scale human threat that could arise, from insurgents to smugglers.

What these ships do NOT have are any more than the most basic of onboard maintenance facilities for their subcraft. Pendragon's load up their Marines, vehicles and subcraft at 'base'. They are designed to insert their teams and pick them up again, using their smaller guns to saturate any landing zone. A Pendragon has more than sufficient armour and close range armaments to deal with any non-military threat. Other variants include command posts, evacuation, and ELINT.



133

## **Topaz Class Light Troopstar**

Stats by Raptor  
Art by Limerickcot

Agi-D4 Str-D8 Vit-D8 Alt-D8 Int-D6  
Wil-D10  
Lp-18 Init-D4+D8 Speed-SL/JC 6

**Traits** - Mass Produced-D4

**Skills** - Heavy Weapons-D4;  
Mechanical Engineering- D6 Perception-  
D6; Pilot-D4

### **Armament**

Medium Planetcraft Scale Skirmish PDS  
(D8);  
8 Spacecraft Scale Medium Railguns  
(D10);  
6 Spacecraft Scale Short DRADIS  
Missile Systems (D12);  
4 Spacecraft Scale Long DRADIS  
Missile Systems (D12+D8)

### **Air Wing**

3 Flights Mk VII Vipers;  
14 Raptors (or 10 Raptor Utility)  
8 Dropships or LST's  
4 Gunships or LST's

**Armour:** Wound 4; Stun 4

Dimensions- 1430'x385'x130'  
Crew- 500 Troop Lift- 390 (reinforced  
rifle company with support elements)

**Known Ship Names-** *Topaz; Ruby;  
Sapphire; Tourmaline; Opal; Peridot;  
Emerald; Amethyst; Aquamarine; Citrine*



# Topaz Troopstar

by Limerickcot

are some of the ships of this class. There are also more vessels under construction.

The Topaz class is the first type of troop star, dedicated in the transportation and support of a Colonial Marine company. This type of Troopstar is almost as numerous as the larger Peltast class. Many senior CF personnel feel that the Topaz class is a waste of funds as it only carries one reinforced company others see the versatility of the class. The Topaz class is a favourite of the Colonial Marine Corps Force Reconnaissance Companies. This class is also used to carry independent Colonial Marine Armoured Squadrons, Sapper Squadrons and Artillery Regiments. This class will also be normally detached to perform special and covert operations.

The *Spinel* is a Topaz class troopstar that is used by Colonial Fleet

Intelligence for GEOINT, SIGINT, TECHINT and MASINT missions. This troopstar's troop areas and vehicle bays have been gutted and refitted with various sensors and equipment. It also has a hangar reduced in size and consequently only carries the squadron of 12 Vipers and 14 Raptors. A rumour commonly told throughout the fleet is the Spinel also carries a flight of Stealth Vipers. This specialized troopstar can usually be found near Cylon space.

Generally the Topaz class does not travel with escorts unless under extreme circumstances and then it generally has 2 Escortstars.

As was mentioned above, the Topaz class are organized into EAG's which are squadrons of 4 plus 2 escort stars. For a total of 4 troopstars and 8 Escortstars. The EAG is placed under the command of a Commander with a Marine Colonel in charge of the CMC elements.

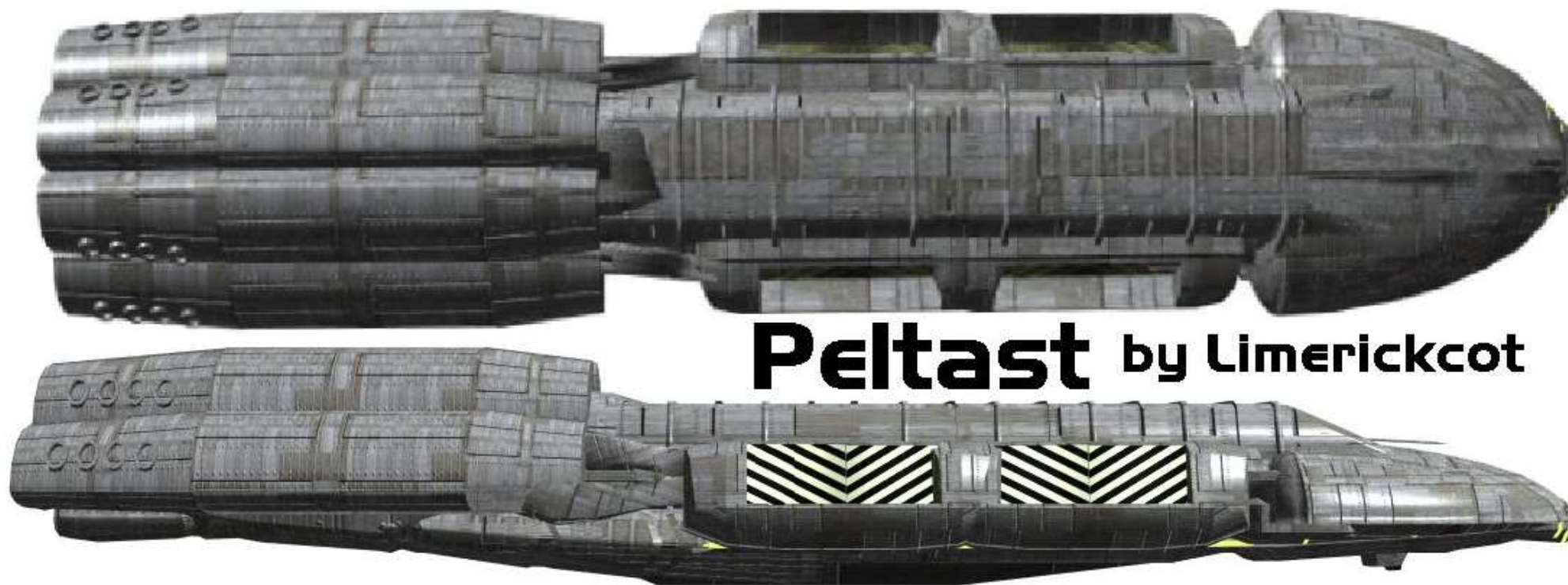

**Peltast** by Limerickcot



## ***Peltast Class Medium Troopstar***

Stats by Raptor

Art by Limerickcot (see previous page)

Agi- D4 Str-D10 Vit-D8 Alt-D8 Int-D6 Wil-D10

LP- 20 Init-D4+D8 Speed-SI/Jc-6

**Traits:** None

**Skills-** Heavy Weapons- D4; Perception- D6; Mechanical Engineering- D6  
Pilot- D4

### **Armament:**

Medium Planetcraft Scale Skirmish PDS (D8);

10 Spacecraft Scale Medium Railguns (D10);

8 Spacecraft Scale Short DRADIS Missile Systems (D12);

6 Spacecraft Scale Long DRADIS Missile Systems (D12+D8)

### **Air Wing**

6 Flights Mk VII Vipers;

1 Flight Python bombers;

16 Raptors or 12 Raptor Utility

12 Dropships or LST's

8 Gunships or LST's

**Armour-** Wound-5; Stun-5

Dimensions- 1950'x490'x190'

Crew- 1200; Troop Lift-1100 (reinforced battalion plus support units)

Known Ship Names- *Peltast*; *Legionnaire*; *Huscarle*; *Janissary*; *Lancer*; *Gallowglass* are some of the ships in this class. There are more ships under construction.

The Peltast Class Medium Troopstar is the most common troopstar type in the Colonial Fleet. It is designed to carry a Colonial Marine Corps Battalion with support units. A distinguishing feature about this class is

it embarks a flight of Mk IV Pythons to jump ahead of the Peltast to help soften up a target or to provide air cover. Each of these troopstar's is escorted by 2-4 Escortstars to provide close protection and fighter suppression missions.

Two of these have been converted to carry armoured vehicles and their landing craft for the mechanized and tank units of the CMC (*Cavalier* and *Donegal*). Two other Peltast class ships have been converted into forward casualty treatment ships (*Herald* and *Mercy*). Neither of these two variants of the Peltast class embarks Vipers. The Herald and the Mercy's Raptors are the casualty evacuation variant.

One Peltast class, the *Gladiator*, was lost in deep space after her engines had a catastrophic failure. Power was knocked out and life support was at a minimum. The crew and marines were rescued by her two Escortstars, but all stores, vehicles and air wing were left onboard. When several fleet tugs were brought in no trace of the Gladiator was ever found. On occasion, sightings of the Gladiator do occur but as of yet no one has ever managed to board and reclaim it.

The Caceron Penitentiary System have asked Colonial Fleet Command for the use of one Peltast class to be converted into one large travelling prison. At this time though, Colonial Fleet has stated none are available for that purpose.





## Aries Class Heavy Troopstar

Stats by Raptor

Art by Limerickcot

Agi- D4 Str-D12 Vit-D8 Alt-D8 Int-D6 Wil-D10

LP- 22 Init-D4+D8 Speed: 6 [SL/JC]

**Traits:** Mass Produced: D4; Past Its Prime:D4

**Skills:** Heavy Weapons: D4; Perception: D6; Mechanical Engineering: D6 Pilot: D4

### Armament:

Medium Planetcraft Scale Skirmish PDS (D8);

12 Spacecraft Scale Medium Railguns (D10);

10 Spacecraft Scale Short DRADIS Missile Systems (D12);

10 Spacecraft Scale Long DRADIS Missile Systems (D12+D8)

### Air Wing:

36 Mk VII Vipers;

12 Mk IV Pythons;

26 Raptors or 19 Raptor Utility

24 Dropships or LST's

12 Gunships or LST's

**Armour:** Wound 6; Stun 5

Dimensions- 2350'x790'x300'

Crew: 2100; Troop Lift: 3100 (reinforced regiment plus support units)

Known Ship Names-named for the 12 colonies.

The Aries Class Heavy Troopstars were built in the Cylon War and are still in commission. Several attempts by the Chief of Naval Operations to build replacements have been stymied due to tight fiscal environments and the need to replace the Battlestars - funds went to upgrading and refitting them instead.

It is CF policy to have 2-4 Escortstars with the Aries class at all times.

At one point, Fleet Command wanted to convert half the Aries class into space control ships, embarking up to 50 more Vipers and landing half the marines and their drop/gunships. The Marines protested and the conversion only occurred on the *Virgo*. These conversions were later removed in *Virgo's*

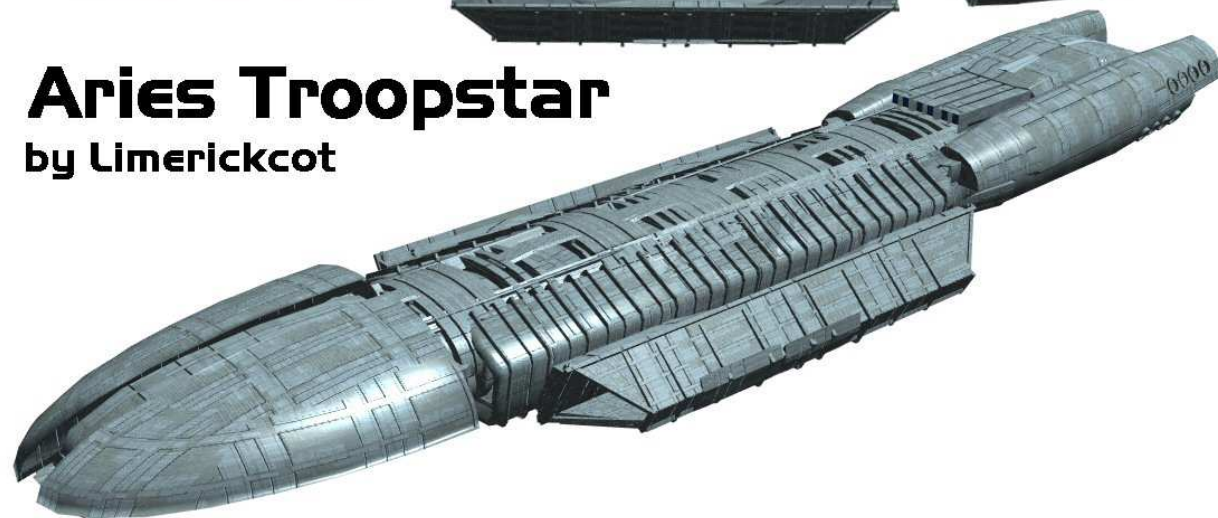
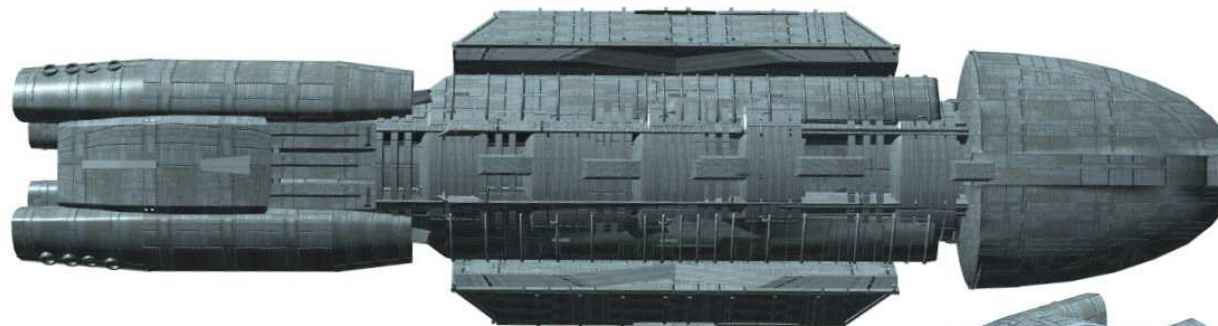

## Aries Troopstar

by Limerickcot

next refit and she reverted back to a full troopstar.

The *Sagittarius* and the *Libra* were involved in one of the largest peacetime rescues in Colonial history. Eleven years after the 1st Cylon War, the Picon registered Passenger Liner *Pride of Pythia* lost power and was struck by several meteors. This caused the heavily damaged liner to spiral out of control and drift towards a dwarf star. The 2 Heavy Troopstar's were in the area conducting landing exercises with their marines and responded to the distress call. For their efforts both troopstars rescued four thousand passengers and crew before the gravity of the dwarf star pulled the civilian vessel into its photosphere.

Veterans groups want to convert *Capricorn* into a museum ship focusing on the Marines in space and the Colonial Fleet personnel that support them. This all depends on when the Fleet decides to take the *Capricorn* out of service.

## Storm Front Class Patrol Craft

Art & Stats by SeleK

Ship Type: Escortstar/Patrol Craft

Agi d8, Str d6, Vit d8, Ale d8, Int d8, Wil d10  
LP 18; Init d6+d10; Scale Spacecraft  
Speed 6 (SL/JC)

**Traits** Tough (d4)

**Skills** Heavy Weapons d4, Mechanical Engineering d4,  
Perception d4, Pilot d4

### Armament

- Twin Light planetcraft scale autocannon turrets (d8);
- Twin Light Spacecraft scale skirmish range primary assault railguns (d4);
- Under body mounting points for up to six missiles (sold separately).

**Armour:** Wound 1, Stun 2

Size: 154 x 66 x 28 feet

Crew: 12 Passengers: 5 (standard), 8 (emergency)

### History:

The Stormfront class cutter was designed as a short-ranged, deep-space patrol and rescue craft capable of independent operation along major shipping routes and jump points. Despite their comparatively small size, the Stormfronts are extremely well armed, mounting both capital and planetcraft scale weaponry. As they are also intended to deal with the occasional smuggler or blockade runner, the Stormfronts are all extremely fast and manoeuvrable.

Stormfront Class cutters were built and deployed in the hundreds, and were used throughout the Colonies for custom enforcement, patrol, and rescue duties in the decade leading up to the Second Cylon War. Most operated independently, but Stormfront Class cutters were also occasionally deployed in three-ship task groups in high-activity or high risk areas.

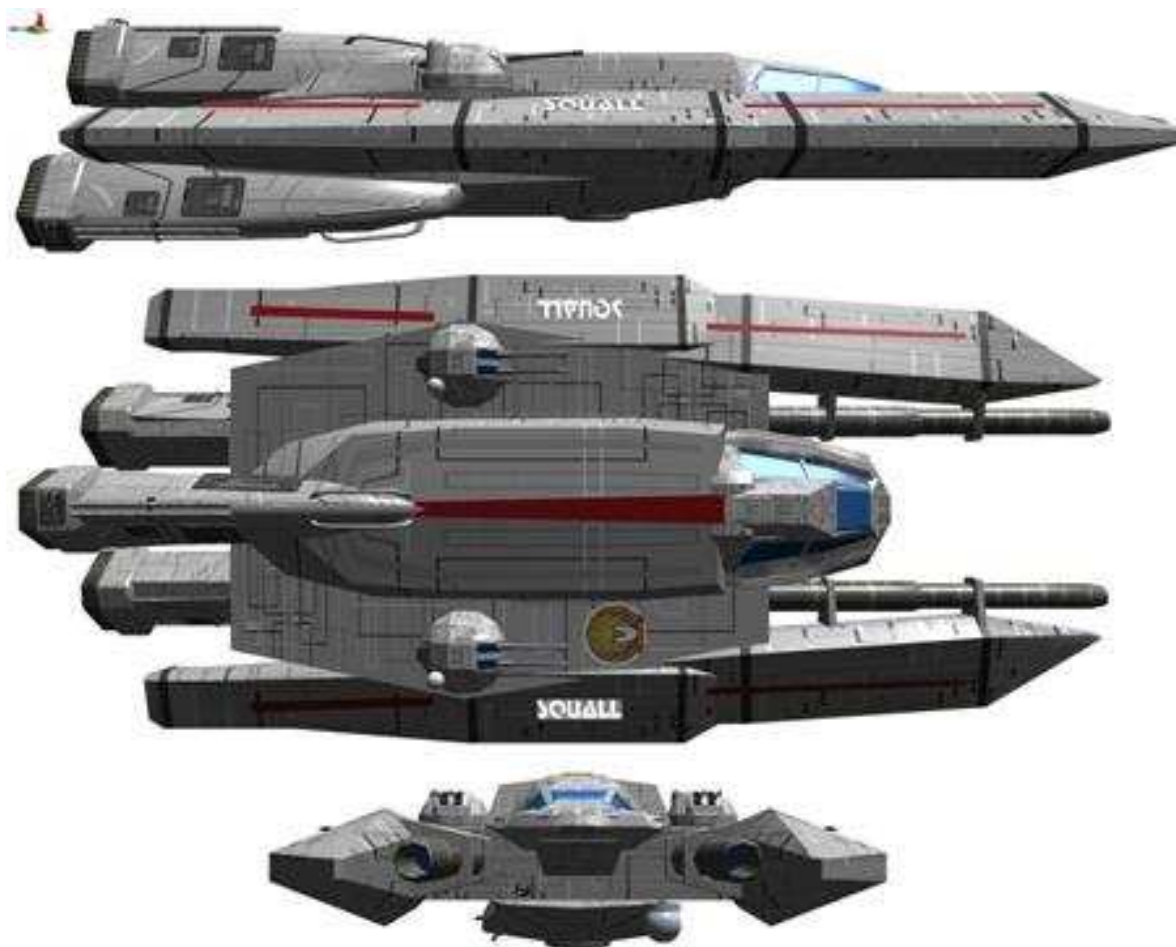

### Quirks/Special Characteristics:

Stormfront Class cutters have a large lower cargo hold and an integral ventral airlock allowing them to mate up with other vessels in the course of their duties (though they are required to dock belly-first). The gravity in the belly lock is not stabilized concurrent to the rest of the ship, which can cause disorientation and vertigo in those unprepared for the transition.

### Notable Vessels in Class:

Stormfront (Class vessel); Tempest ; Squall ; Blizzard ; Hurricane



# AUXILLERIES



No matter how good the vessel, it requires outside supply for it to continue. Following the loss of the Colonies the Colonial Civilian Fleet fulfilled this function for the Battlestars *Galactica* and *Pegasus*.

However, the Colonial Fleet had its own Auxilleries to serve its needs, as well as a wide variety of specialist craft for other purposes.



## Oracle 76

By Selek

Agi d6, Str d8, Vit d6, Ale d10, Int d4,  
Wil d6; Life Points 14;  
Init d6+d10; Scale: Spacecraft; Speed: 6  
(SL/JC)

**Traits:** Memorable (d6), Sixth Sense,  
So Say We All

**Skills:** Mechanical Engineering d4,  
Perception d6, Pilot d8

**Armament:** None    **Armour:** Wound 6,  
Stun 4

**Description:** 277 x 49 x 81 feet;  
Crew 23; Passengers 50 (standard),  
200 (emergency)

Signal Jammer: The *Oracle* can fill near  
space with electronic noise that  
obstructs DRADIS and communication  
frequencies. All craft within long  
DRADIS range of the *Oracle* must make  
an opposed Alertness test against the  
*Oracle* each round. Vessel which  
succeed have their DRADIS and  
communications ranges reduced to  
capital range. Vessels which fail are limited to Skirmish range for communications and DRADIS. The exception to this is when attempting to locate the *Oracle* itself.

When in jammer mode, the transceiver puts out enough energy to attract the attention of a blind man in a fur coat.

Fire Control: The *Oracle* can serve as a forward fire control platform for allied craft within Long DRADIS range, and can direct up to eight missiles (two per ECO) at hostile targets within Medium DRADIS range of the of the *Oracle*. Multiple action penalties apply to ECO's.

Missile Jammer: The *Oracle* can use it's transceiver array to broadcast false fire control signals to jam incoming missiles. The ECO engages the countermeasure and makes a Difficult (7) Intelligence + *Pilot, Planetary Vehicle, or Technical Engineering* check. Multiple action penalties apply to the ECO's.

Fighter Control: This ability acts like the *So Say We All* trait at d6 level. The Craft Commander (or lead ECO) may spend Plot Points to add bonus dice to any action made by those under his command, as long as they are currently acting under his orders or believe they are acting to fulfil those orders. These combine with any Plot Points the followers might spend on the same action.

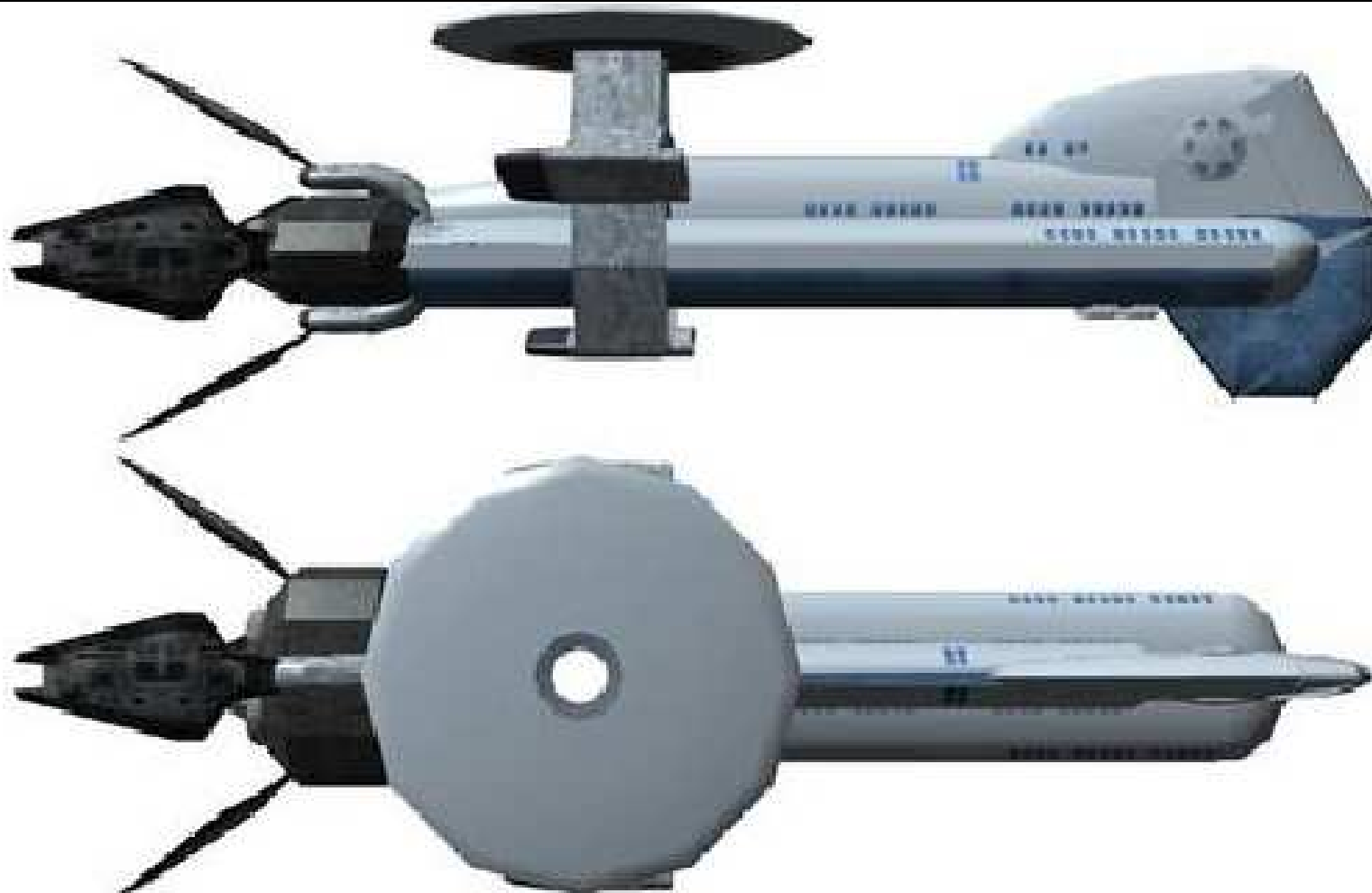

*Oracle 76* is one of five experimental Airborne Early Warning craft based on a modified heavy freighter design. Passenger accommodations were removed and revamped to accommodate an airborne command post, extensive communication centre, and crew quarters.

The *Oracle* series is envisioned as a multi-purpose craft intended for use as a maritime patrol craft, for long-range surveillance missions, and as a TACAMO (Take Charge And Move Out) command post in the event of large scale disruptions to the military command and control network.

Based off of an older freighter space frame, the *Oracle* design is far less robust than traditional Battlestars, but is also far less manpower intensive and expensive. A typical ship's company includes 3 flight crew, a five man command staff, and up to fifteen electronic specialists.

The heart of the *Oracle* Operating System is a series of high-powered, frequency-agile transceivers grouped into a cluster in the dorsal radome mounted high on the hull. The transceiver array can operate on normal wireless frequencies, DRADIS bands, and even fire-control bandwidths. This capability allows the *Oracle* to serve as an airborne communications nexus, maritime patrol and surveillance craft, and to coordinate large-scale fighter engagements, and even forward fire control platforms for long-range munitions.

The *Oracle* is normally unarmed, but does contain a munitions bay well forward on the fuselage to accommodate expendable drones, probes, decoys, and jammer pods (the same munitions carried aboard the *Colonial Raptor*). Additionally, depending upon the mission profile and range, the *Oracle* is normally accompanied by at least two *Viper* fighter escorts.

The *Oracle* Project has come under fire from respected sources, citing expense and high-maintenance requirements (as compared to a *Colonial Raptor*), as well as reduced endurance, and increased vulnerability when compared to the *Battlestar* in its role as an airborne command post.



## Vanguard Class

Art by Hobbes

Stats by Limerickcot

Ship Type: Fleet Auxiliary

Agi d6, Str d6, Vit d8, Ale d6, Int d8, Wil d10

LP 16; Init d6+d8; Scale Spacecraft

Speed 6 (SL/JC)

Traits Mass Produced (d4)

Skills Heavy Weapons d6, Mechanical Engineering d4, Perception d6, Pilot d4

Size: 3,800 X 333 X 172 feet

Crew: 670; Passengers: 250

### Armament

Medium planetcraft scale skirmish range point defence system (d8);

6 spacecraft scale capital range primary assault railguns (d12+d2);

### Airwing

1 flight of Raptor-LCs (4 subcraft)

1 flight Refueler

2 flights shuttles

Armour: Wound 4, Stun 4

### History:

The Vanguard Class Fleet Auxiliary represents a rare flash of collective brilliance on the part of the Admiralty and the Ministry of Finance. In order to reduce costs, a bare-bones, easily customizable hull design fitted with modular systems was developed and procured.

Instead of having to design and construct more than a dozen different designs to accommodate different mission types, the common origin hull



# Vanguard

by Hobbes

can be customized during construction to fill a specific need within the fleet. Each auxiliary type is considered a separate class, but all fall into the Vanguard family.

As a result, Vanguard-type hulls can be found in service as amphibious/planetary assault vessels, hospital ships, repair ships, supply ships, munitions ships, and tylium colliers.



**Quirks/Special Characteristics:**

Because the Vanguard-type all use the same basic hull design, their basic capabilities are generally well known.

**Variant Classes:**Amphibious Assault- ***Hector Class***

This Vanguard variant is designed to transport assault troops and land them on the surface of a planet, together with all their necessary supplies, munitions, and equipment. The basic stats are unchanged, but passenger capacity is increased to 2,000 troops. The air wing is comprised of six Raptors reconfigured for close air support, and with up to a dozen atmospheric shuttles or landing craft.

Aviation Support Ship- ***Aerie Class***

Basic stats unchanged,  
add Trait "Viper Construction Facilities (d4)",  
passengers reduced to 100,  
Capacity for a further 12 subcraft in maintenance bays

Hospital Ship- ***Aesclapius Class***

All weapons except Point Defence System removed. Passenger capacity increased to 2500,  
30 surgery suites and laboratories added  
8 Med evac Raptors, 8 shuttles.

Munitions Ship- ***Vulcan Class***

This Vanguard variant is configured to transport bullets, bombs, and other munitions from weapons depots ashore to the vessels of the fleet. As such, they represent both high risk and high value targets. The basic stats are unchanged, but security and safety measures aboard exceed caution and approach paranoia.  
six Raptors and six shuttles for logistical support.

Fleet Repair Ship- ***Hephaestus Class***

Basic stats unchanged,  
2 Raptors, six shuttles.  
Passengers 100

Tylum Collier- ***Prometheus Class***

Basic stats unchanged,  
2 Raptors, 2 shuttles., 4 Refueler

**Berosus**

by Limerickcot

Agi d8, Str d8, Vit d6, Ale d6, Int d6, Wil d6;  
LP 12; Init d8+d6; Scale Spacecraft

Speed 9 (SL/JC)

Traits: None

Skills Heavy Weapons d6, Perception d4

**Armament**

4 dual point-defence turrets (Light planetcraft scale skirmish range point-defence system (d4));

4 dual Primary Assault Guns (spacecraft scale; short DRADIS range (d8))

4 Rotary Primary Assault Guns (Spacecraft Scale, Short DRADIS range (d10)), forward arc only

9 quad Area Suppression Guns (spacecraft scale; Short DRADIS axis (d6))

**Subcraft**

Hanger for 2 shuttles, 6 Vipers, 2 Raptors

Flight pod can accept another 18 Vipers, 4 Raptors

**Armour**

Wound 3, Stun 3

**History**

The first Cylon War involved a tremendous strain on the resources of the twelve colonies. With production running to the fullest extent possible, the Colonies struggled to hold back the Cylon war machine. One problem frequently encountered throughout the war was to get war materiel out to the fleet.

One of the many solutions found was to equip a fast, light monitor with an extended, and armoured, flight pod, capable of holding a two full Viper squadrons, their spares and replacement crew. Numbers of different commercial craft were upgraded to the 'Berosus' modification, their only primary requirement being size and speed.

The Modification Mark I through XXI represented these differences in the originating classes of ships. Damage tended to be high on these ships and



the decision was finally made to modify these ships on the slipways, giving them more armour and creating the Berosus Mk XXX.

To protect itself, it had a reasonable armour complement, a good anti-fighter array of weaponry and several flights of Vipers. Truly, though, where it excelled was in its speed. The less time spent in transit, the more supplies it could deliver. The Berosus' ferry tasking was finally replaced by heavily protected convoys and, instead, the class became a fast raider before the Armistice brought an end to the war. The Mk XXXI was the first one to carry anti-ship guns and missile tubes.

For another two decades, the Berosus was used as a replenishment vessel for isolated colonies and facilities. It was occasionally pressed into use as a search and rescue vehicle. As such, it saw one of its cargo holds replaced with disaster pods.

The Mk XXXV saw the ship's flight pods upgraded to deal with the new Viper Classes now being used in the fleet and the five surviving craft were used both for flight testing of the new Vipers and for housing the initial Operational Conversion Unit's being trained up in their use.

Once this phase was completed, the Berosus Class was withdrawn from service.

About a decade ago, the fleet required a test bed for new weaponry systems then in development. The cheapest way to provide this was to bring the Berosus Class out of retirement and take them into a new phase. Called the Mk40's, these vessels (four out of the five) saw one of their internal hangers removed, and internal cargo bays converted into large magazines for new ships guns.

The four dual anti-ship guns of the Mk 21's were complemented by a set of four rotary assault guns. The concept for this was to improve the slow rate of fire suffered by the primary guns used in Battlestars. A total of four rotary style assault guns were fitted to each Mk40. Although the primary aim was achieved, reaching a rate of fire of 60 rounds per minute, their limited firing arc, problems with vibration and electronic controls rendered them unsuitable for installation throughout the rest of fleet.

Two further ships were updated to become the Mk41's. In addition to the primary guns, their original anti-flak guns were all but removed (only four dual turrets were retained) and replaced with nine, quad firing, short range area

suppression guns.

With their testing over, it seemed inevitable that the Class would, once again, be relegated back to either mothballs, or to the scrap yards. Events conspired against this though, when the remaining MkXXXV (Marjuk) was refitted as a medical evacuation ship and dispatched to deal with various emergencies throughout the colonies.

The Casseas, a Mk41, was one of the ships that was dispatched to Armistice Station on the eve of the second Cylon war, following the lack of a response from the officer assigned there. She did not return to the Colonies following the outbreak of the war. The Marjuk was destroyed above Tauron after trying to place herself between a missile salvo and the Battlestar Delphai. Disposition of the other craft was never reported.

## Characteristics

A Berosus is essentially a shortened flight pod mounted on a set of crude engines. Normal practice has Vipers approaching down the centre line of the pod, moving to the hanger lifts at the end and then being brought down to the hangers. Vipers (or other craft) in transit are moved to each side of the hanger pod to allow recovery operations to be maintained.

A large armoured door protects the flight pod. This also allows the pod to be pressurized (originally to allow work to be carried out on Vipers in transit). Normally, however, the flight pod is left unpressurized to allow fast recovery.

A double launch tube is located directly under the hanger pod with access from the under floor hanger(s).

Although the later conversions on the Berosus Class lost most of its cargo capacity, none altered the large fuel tanks under the hanger pod (mainly because of their location). Large gun magazines take up nearly all of the original main cargo deck (leaving only about 30,000 tons capacity, scattered throughout a number of smaller bays, and mainly slaved to spares). The original class had missile tubes fitted.

These systems were removed during the various refits and have not been reinstalled



## **Vector Class Heavy Transport**

By Selek

Agi d4, Str d8, Vit d6, Ale d4, Int d4,  
Wil d4  
LP 10; Init d4+d4; Scale Spacecraft

Speed 4 (SL/JC)

Traits: Memorable, Past It's Prime

Skills: Mechanical Engineering d2,  
Perception d2, Pilot d4

Armament: None

Armour: Wound 1, Stun 1

Description 260 x 60 x 60 feet;  
Crew 12 Passengers 12

### **Quirks & History**

One quirk common to the entire class is that when loaded to near maximum capacity (over 1000 tons), the vessel is top-heavy and will tend to roll so that her cargo faces the largest/nearest gravity well.

The Vector Class Heavy transport is a Colonial civilian design that entered service right around the signing of the Cimtar Accords. The vessels themselves follow an inexpensive, modular design with a massive overhead deck for accommodating cargo of all shapes and sizes, as well as numerous anchor points along the sides for additional modules.

The vessels are used primarily as bulk transports for container cargo, but their large deck space also allows them to transport over-sized or irregularly shaped loads that will not fit in internal bays or standardized containers aboard other ships.

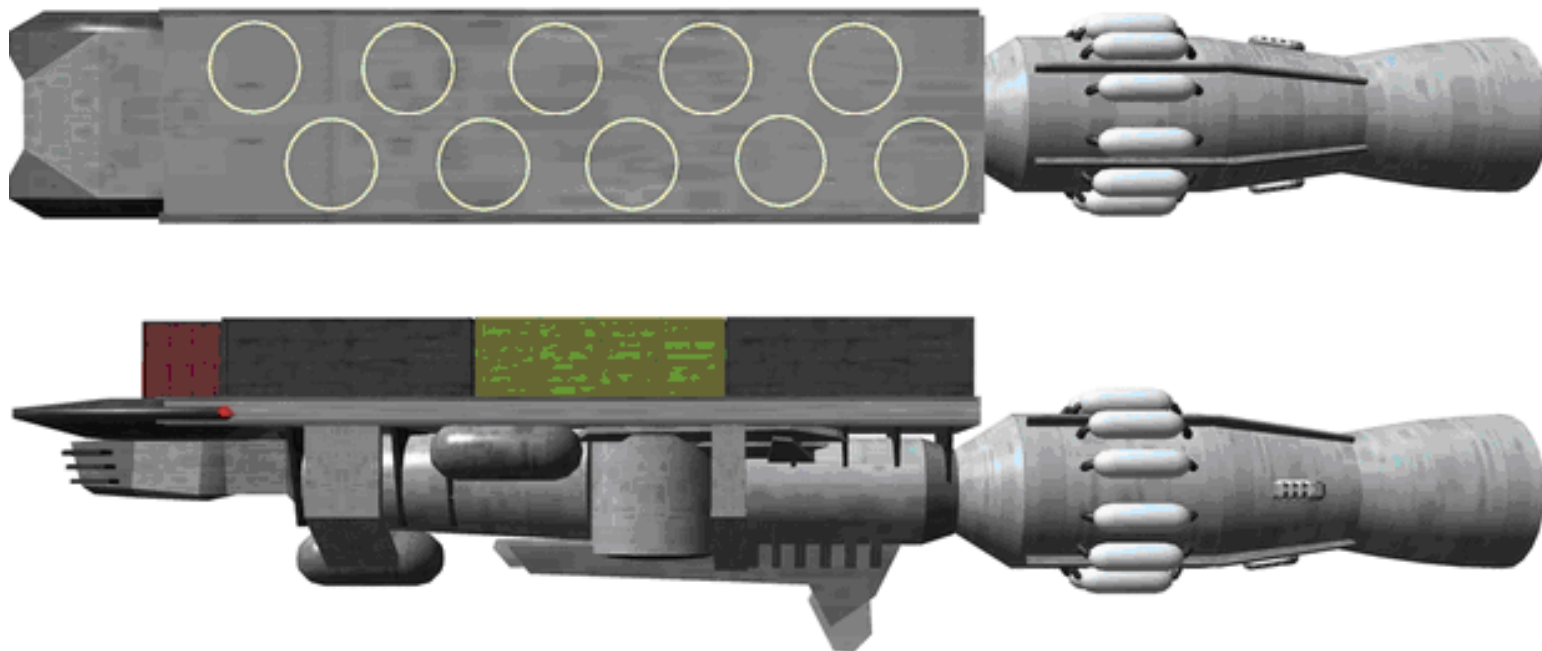

They were primarily employed on inter-system runs, though a fair number also made jumps between the Cyrannus and outlying systems, as well.

At least one of these vessels survived the Holocaust. The Colonial registered freighter *Adelante* was carrying just over a dozen obsolete and junked Mk II Vipers and 280 tons of scrap parts as deck cargo when the attack began and went to ground. She was later converted by Colonial resistance forces into a makeshift "jump carrier", allowing her Vipers to carry out fast hit-and-fade attacks against the Cylons without spending hours traversing the system at sublight speeds. The main drawback to this arrangement was that the Viper pilots either needed to remain in their cockpits for the duration of the mission or make a slow and awkward EVA to and from the ship's main airlock.

146

## **Salvor (Salvage Ship Mk 2)**

Stats By Gazza  
Art by Limerickcot

Agi D6, Str D6, Vit D8, Ale D6, Int D8, Wil D10;  
LP 18; Init D6+D6; Scale Spacecraft; Speed 8 (8  
in atmosphere; SL/JC)

### Traits

Mass-Produced (D4) --The vehicle is a very  
common model

### Skills

Heavy Weapons D2  
Mechanical Engineering D6  
Perception D4  
Pilot D4  
Technical Engineering D2

### Armament

Planetcraft scale skirmish range PDS (d12)  
4 spacecraft scale short DRADIS range missiles  
(d12)

Armour Wound 4, Stun 4

Description 3800 x 333 x 172 feet;  
Crew 600; Passengers 250

Notes: -

The Salvor -class Salvage Ship is based on a  
standard naval auxiliary hull as used by tankers  
etc. It is able to recover and stabilise battle-  
damaged ships as well as recover any items that  
can be of use to the fleet. If it can't scavenge, it can melt down material for re-  
use.

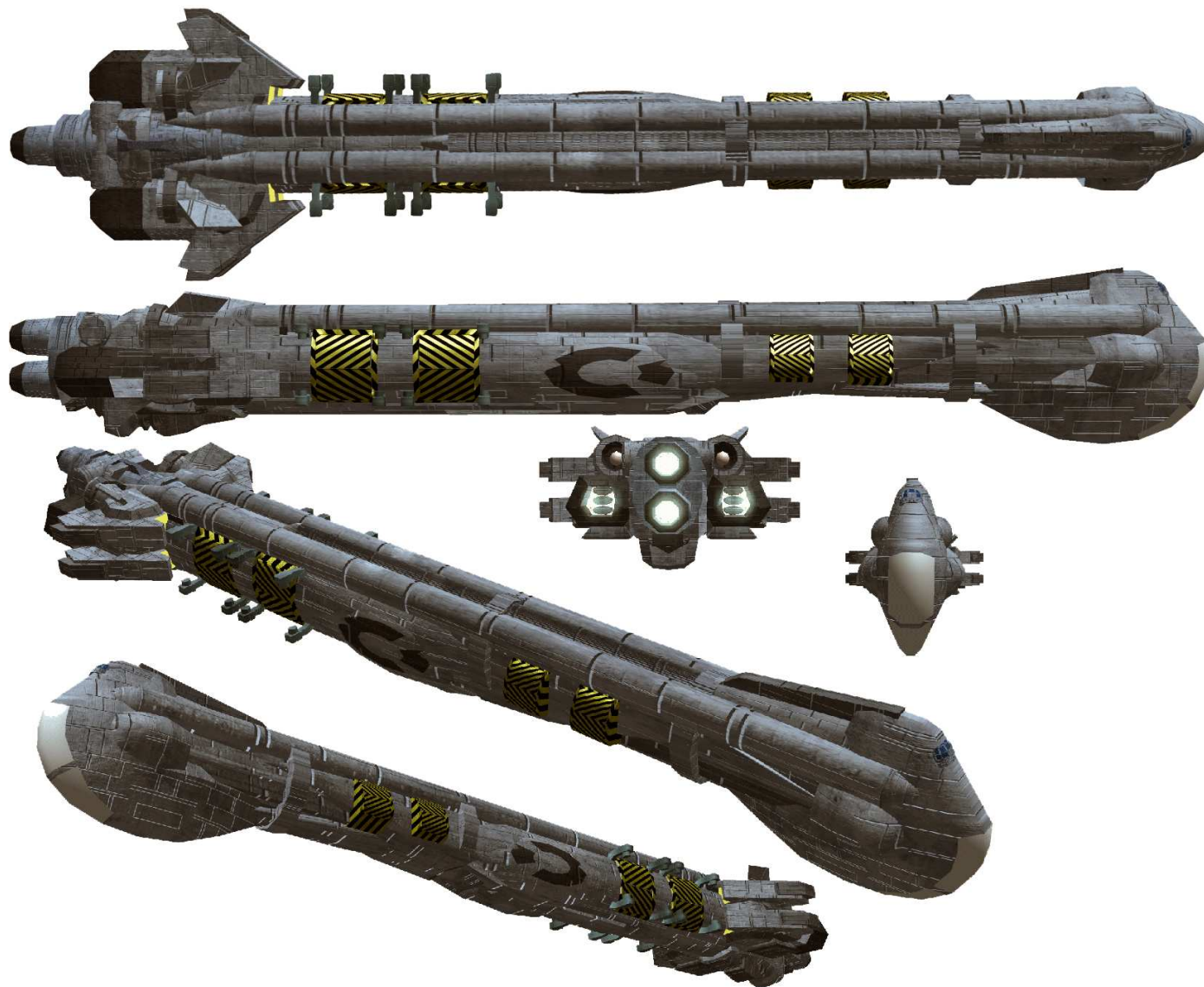

## **Medic (Hospital Ship)**

Stats By Gazza  
Art by Limerickcot

Agi D6, Str D6, Vit D8, Ale D6, Int D8, Wil D10;  
LP 18; Init D6+D6; Scale Spacecraft; Speed 8 (8 in atmosphere; SL/JC)

### Traits

Destiny (D12) --Vehicle a role to play in the grand scheme of things  
Loved (D4) --Crew has a deep connection with the vehicle  
Mass-Produced (D4) --The vehicle is a very common model  
Memorable [Hospital Ship] (D6) --The vehicle has a distinct and recognizable feature

### Skills

Knowledge D4  
Mechanical Engineering D2

Perception D4  
Pilot D4  
Technical Engineering D2

Armament: None

Armour: Wound 4, Stun 4

Description 3800 x 333 x 172 feet;  
Crew 550; Passengers 1000

### Notes: -

The Medic -class Hospital Ship is based on a standard naval auxiliary hull as used by tankers etc. It is able to recover, stabilise and provide medical services to all manner of casualties. These vessels are in immaculate condition and placed in ready reserve to meet any emergency. By custom, all hospital ships are unarmed. The passengers are actually patients.

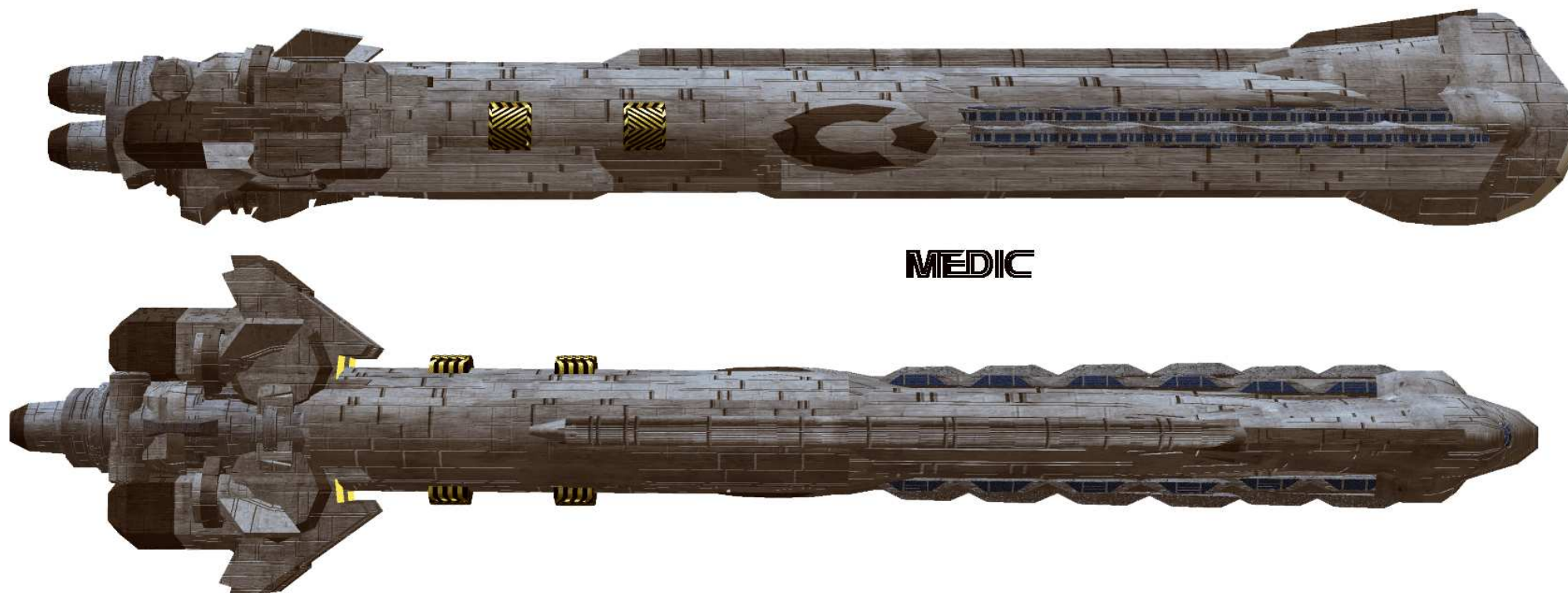

**MEDIC**



## ***Prometheus (Repair Ship Mk 2)***

Stats By Gazza

Art by Limerickcot

Agi D6, Str D6, Vit D8, Ale D6, Int D8, Wil D10;  
LP 18; Init D6+D6; Scale Spacecraft; Speed 8 (8 in atmosphere; SL/JC)

### Traits

Mass-Produced (D4) --The vehicle is a very common model

### Skills

Heavy Weapons D2; Mechanical Engineering D6; Perception D4; Pilot D4;  
Technical Engineering D6

### Armament

Planetcraft scale skirmish range PDS (d12)

4 spacecraft scale short DRADIS range missiles (d12)

Armour Wound 4, Stun 4

Description 3800 x 333 x 172 feet; Crew 600; Passengers 250

### Notes: -

The Prometheus -class Repair Ship is based on a standard naval auxiliary hull as used by tankers etc. It is fully equipped to repair up to the largest of naval vessels battle damage.

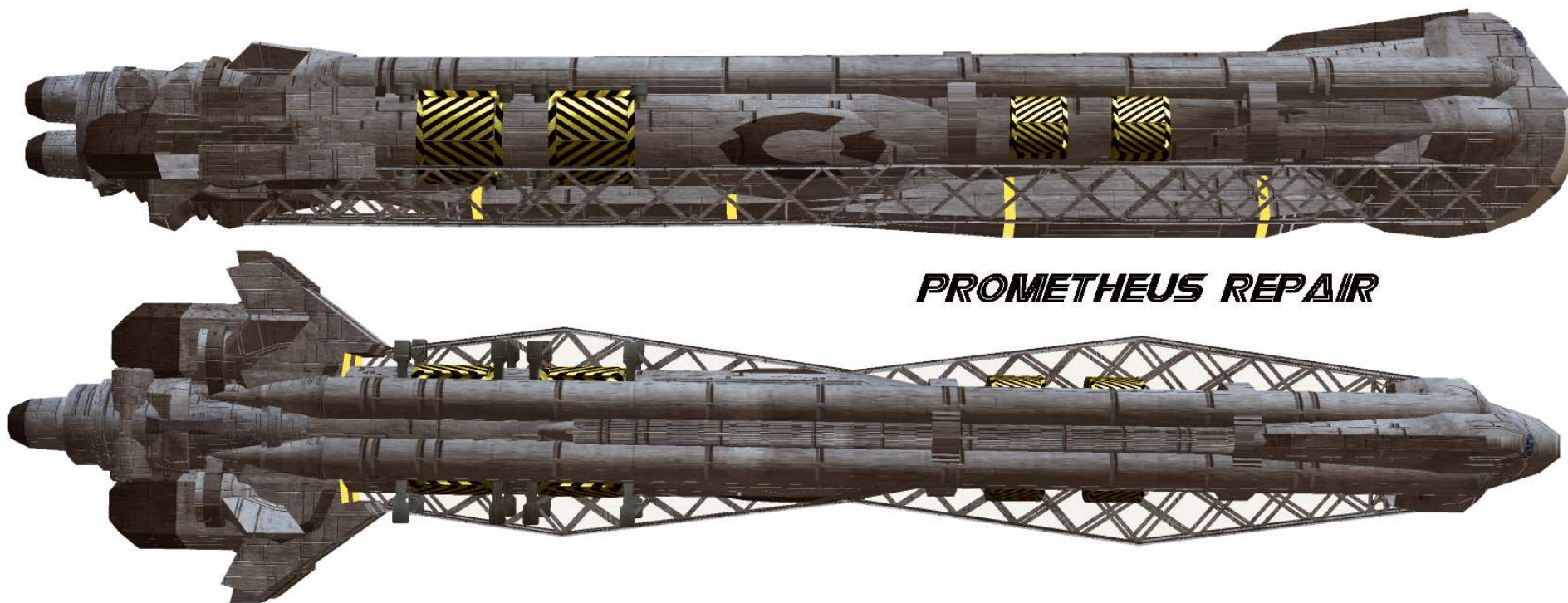

**Aldis (Ammunition Ship Mk 2)**

Stats By Gazza

Art by Limerickcot

Agi D6, Str D6, Vit D8, Ale D6, Int D8, Wil D10;  
 LP 18; Init D6+D6; Scale Spacecraft; Speed 8 (8 in atmosphere; SL/JC)

## Traits

Mass-Produced (D4) --The vehicle is a very common model

## Skills

Heavy Weapons D6; Mechanical Engineering D6; Perception D4; Pilot D4

## Armament

2 spacecraft scale short DRADIS range railguns (d10)

4 spacecraft scale short DRADIS range missiles (d12)

Planetcraft scale skirmish range PDS (d12)

400 Mines

Armour Wound 4, Stun 4

Description 3800 x 333 x 172 feet; Crew 600; Passengers 250

## Notes: -

The Aldis -class Ammunition Ship is based on a standard naval auxiliary hull as used by tankers etc but it has the ability to use some of its cargo offensively and lay mines.

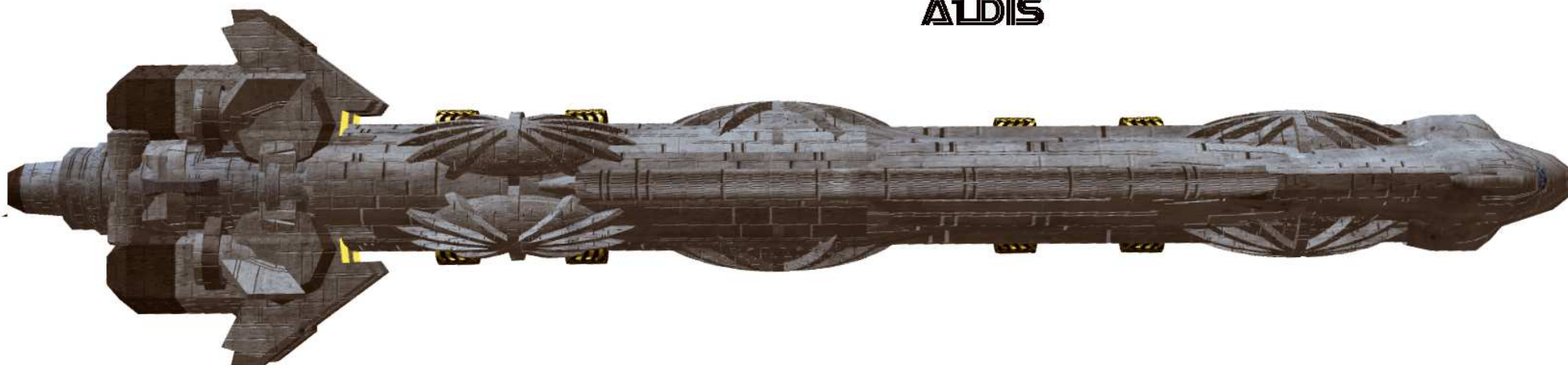
**ALDIS**



## ***Atlas (Fleet Tug)***

Stats By Gazza

Art by Limerickcot

Agi D8, Str D6, Vit D6, Ale D6, Int D2, Wil D6;  
LP 14; Init D8+D6; Scale Spacecraft;  
Speed 3 (3 in atmosphere; SL/JC)

### Traits

Mass-Produced (D4) --The vehicle is a very common model  
Tough (D4)

### Skills

Athletics D4/Grappling D6; Mechanical Engineering D2; Perception D4; Pilot D4; Technical Engineering D2

### Armament

Planetcraft scale skirmish range PDS (d4)

Armour Wound 1, Stun 1

Description: 226 x 46 x 30 feet;  
Crew 20; Passengers 25;.

Notes: -

The Atlas-class Fleet Tug is a common sight at any Spaceport. It's often used to tow barges; targets and other non-jump capable craft and can be pressed into service as a light patrol vessel. Using sophisticated but easy to use grappling systems the Atlas can manipulate towed traffic as well as nudge even the heftiest of Battlestars in the right direction.

As a naval auxiliary the Atlas has slightly better sensors and uses its passenger space for specialist naval officers and ratings from barge crews to Special Forces teams. After all one tug looks just like any other doesn't it?



**Atlas/Bruiser Tug**  
by Limerickcot



## ***Hestia (Naval Replenishment Tanker)***

Stats By Gazza

Art by Limerickcot

Agi D4, Str D10, Vit D10, Ale D6, Int D8, Wil D10;  
LP 20; Init D4+D6; Scale Spacecraft; Speed 4 (4 in atmosphere; SL/JC)

### Traits

Formidable Presence (D4) --Vehicle is a very imposing sight  
Mass-Produced (D4) --The vehicle is a very common model

### Skills

Athletics D6; Heavy Weapons D2; Mechanical Engineering D4; Perception D4;  
Pilot D4; Technical Engineering D4

### Armament

Planetcraft scale skirmish range PDS (d12)  
4 spacecraft scale short DRADIS range missiles (d12)

Armour Wound 2, Stun 2

Description 660 x 220 x 80 feet;  
Crew 400; Passengers 20;.

### Notes: -

An OH 10-class tanker of 200000 tons, the Hestia and her sisters serve as naval auxiliaries, transporting fuel and small amounts of other cargo as part of the Fleet Train. The ships could carry 800,000 barrels of fuel, 600 tons of munitions, 200 tons of dry stores and 100 tons of refrigerated stores and could refuel and replenish up to 6 ships simultaneously depending on size, for example Hestia could manage 2 Battlestars at a time. Hestia is lightly armed as a naval auxiliary with hangar space for 2-4 Raptors.

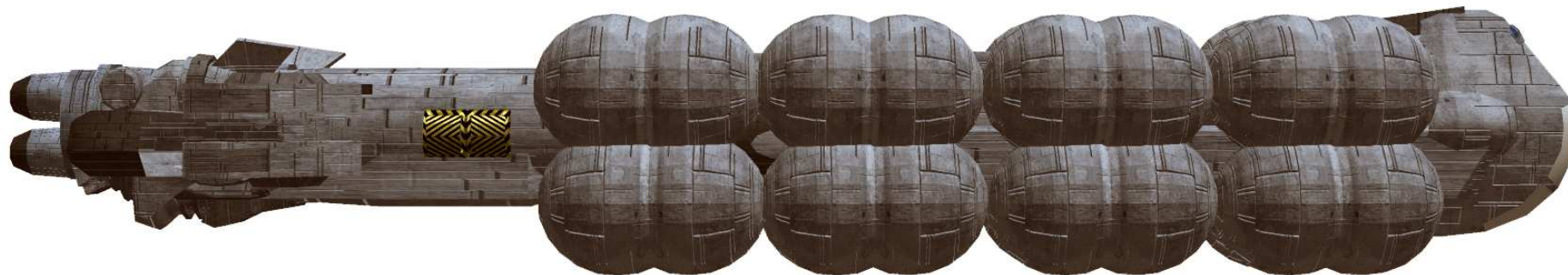

## ***HESTIA FUELER***



## ***Tasia (Naval Water Tanker)***

Stats By Gazza  
Art by Limerickcot

Agi D4, Str D10, Vit D10, Ale D6, Int D8, Wil D10;  
LP 20; Init D4+D6; Scale Spacecraft;  
Speed 4 (4 in atmosphere; SL/JC)

### **Traits**

Formidable Presence (D4) --Vehicle is a very imposing sight  
Mass-Produced (D4) --The vehicle is a very common model

### **Skills**

Athletics D6; Heavy Weapons D2; Mechanical Engineering D4; Perception D4;  
Pilot D4; Technical Engineering D4

### **Armament**

Planetcraft scale skirmish range PDS (d12)  
4 spacecraft scale short DRADIS range missiles (d12)

Armour Wound 2, Stun 2

Description 660 x 220 x 80 feet;  
Crew 300; Passengers 20; Cargo 2000000 lbs.

### **Notes: -**

An OH 11-class water tanker of 200000 tons, the Tasia and her sisters serve as naval auxiliaries, transporting water and small amounts of other cargo as part of the Fleet Train. The ships could carry 800,000 barrels of water, 600 tons of munitions, 200 tons of dry stores, and 100 tons of refrigerated stores, substantial distillation equipment and could replenish water in up to 6 ships simultaneously depending on size, for example Tasia could manage 2 Battlestars at a time. Tasia is lightly armed as a naval auxiliary with hangar space for 2-4 Raptors.



***TASIA WATER TANKER***





## ***Port Vindex (General Stores Ship)***

Stats By Gazza

Art by Limerickcot

Agi D6, Str D8, Vit D6, Ale D6, Int D6, Wil D6;  
LP 12; Init D6+D6; Scale Spacecraft; Speed 4 (4 in atmosphere; SL/JC)

### Traits

Mass-Produced (D4) --The vehicle is a very common model

### Skills

Knowledge D2; Mechanical Engineering D4; Perception D2; Pilot D4;  
Technical Engineering D4

Armament: None

Armour Wound 2, Stun 2

Description 1100 x 150 x 50 feet;  
Crew 50; Passengers 5;

### Notes: -

The 100000 ton Port Vindex-class used to be known as a "Reefer" ship as its prime duty is to ship refrigerated cargoes of foodstuffs and can also carry 1000 tons of general cargo and room for 5 passengers. The ship can carry up to 95000 tons of cargo.



***PORT VINDEX - STORES***

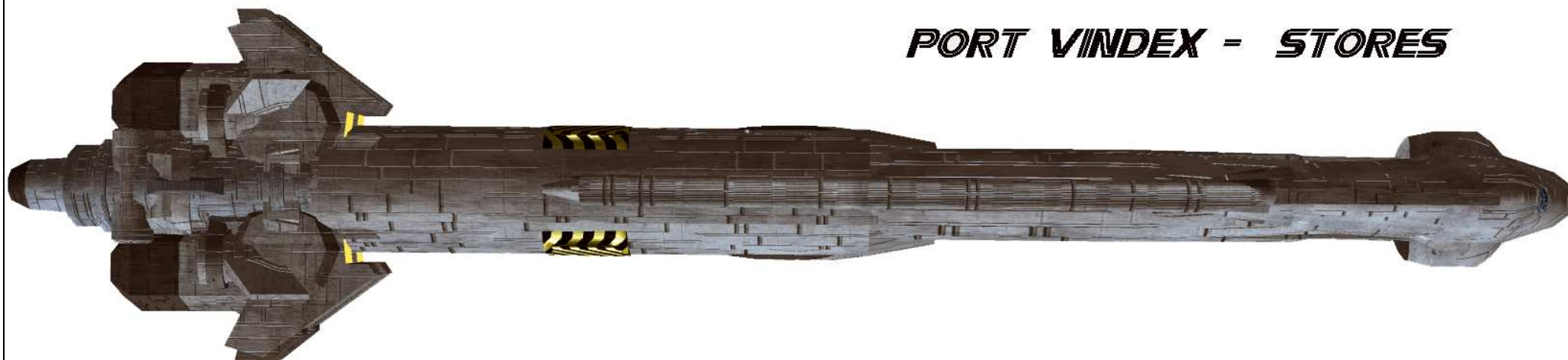



## ***Boreas (Fleet General Stores Ship)***

Stats By Gazza

Art by Limerickcot

Agi D6, Str D8, Vit D6, Ale D6, Int D6, Wil D6;  
LP 12; Init D6+D6; Scale Spacecraft; Speed 4 (4 in atmosphere; SL/JC)

### Traits

Mass-Produced (D4) --The vehicle is a very common model

### Skills

Knowledge D2; Mechanical Engineering D4; Perception D4; Pilot D4;  
Technical Engineering D4

### Armament

Planetcraft scale skirmish range PDS (d12)

2 spacecraft scale short DRADIS range missiles (d12)

Armour Wound 2, Stun 2

Description 1100 x 150 x 50 feet;  
Crew 150; Passengers 5;

### Notes: -

This is the Colonial Fleet version of the Port Vindex-class of General Cargo Ships. It's holds are divided 50% for refrigerated cargo, and 50% for Fleet Stores which can include items like equipment, spare parts, uniforms, small arms weapons and ammunition and other materials that will benefit the fleet. How the ship is loaded is very important, especially for active military operations, as things may not be where they may be required, and if you're looking for that fire control motherboard that the Fleet Gunnery Officer needs RFN you may be in a fix. The Boreas class can carry up to 95000 tons of cargo.



**BOREAS**



***Alhena (Fleet General Cargo Ship)***

Stats By Gazza

Art by Limerickcot

Agi D6, Str D8, Vit D6, Ale D6, Int D6, Wil D6;  
LP 12; Init D6+D6; Scale Spacecraft; Speed 4 (4 in atmosphere; SL/JC)

## Traits

Mass-Produced (D4) --The vehicle is a very common model

## Skills

Mechanical Engineering D4

Perception D4

Pilot D4

Technical Engineering D4

## Armament

2 planetcraft scale skirmish ranges (d12)

2 spacecraft scale short DRADIS range missiles (d12)

Armour Wound 2, Stun 2

Description 1100 x 150 x 50 feet; Crew 150; Passengers 5; Cargo see notes.

Notes: -

This is the Colonial Fleet version of the Capella-class of General Cargo Ships (see that entry in the Civilian Ship section). Its holds are large enough to carry the equipment of a full Colonial Marine Brigade. The Alhena class can carry up to 95000 tons of cargo.

## ***Keleos (Fleet Provisions Ship)***

Stats By Gazza  
Art by Limerickcot

Agi D6, Str D8, Vit D6, Ale D6, Int D6, Wil D6;  
LP 12; Init D6+D6; Scale Spacecraft; Speed 4 (4 in atmosphere; SL/JC)

### Traits

Mass-Produced (D4) --The vehicle is a very common model

### Skills

Knowledge D2; Mechanical Engineering D4; Perception D4; Pilot D4;  
Technical Engineering D4

### Armament

Planetcraft scale skirmish ranges PDS (d12)  
2 spacecraft scale short DRADIS range missiles (d12)

Armour Wound 2, Stun 2

Description 1100 x 150 x 50 feet;  
Crew 150; Passengers 5;

### Notes: -

A Colonial Fleet variant of the Boreas-class of General Stores Ships. Perhaps one of the more important ships in the fleet. As well as carrying food they can provide fresh food from hydroponic systems and other means. The Keleos class can carry up to 95000 tons of cargo.

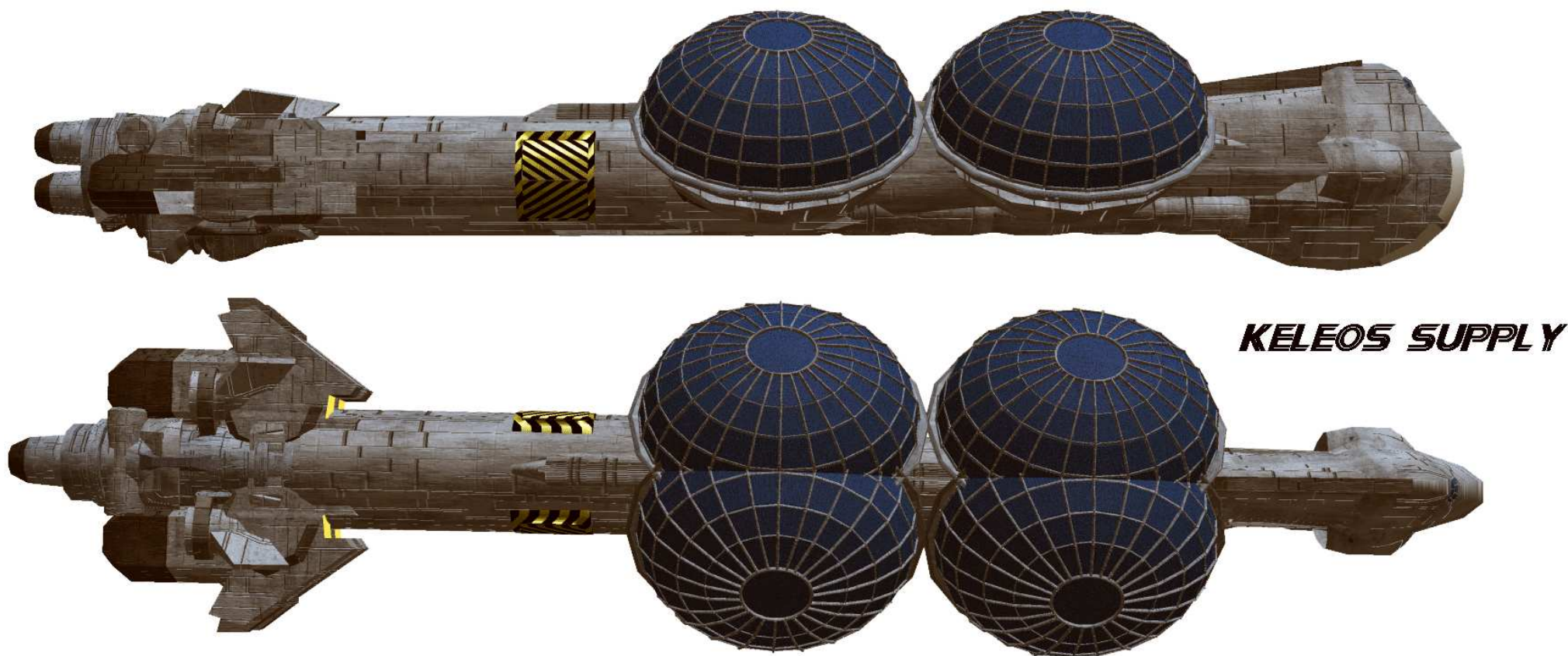



## ***Perseus (Fleet Maintenance Carrier)***

Stats By Gazza

Art by Limerickcot

Agi D6, Str D6, Vit D6, Ale D6, Int D10, Wil D12;  
LP 18; Init D6+D6; Scale Spacecraft; Speed 4 (4 in atmosphere; JC)

### Traits

Loved (D4) --Crew has a deep connection with the vehicle

Memorable (D6) --The only Maintenance Carrier in the Colonial Fleet!

### Skills

Heavy Weapons D4; Knowledge D4;  
Mechanical Engineering D6; Perception D6;  
Pilot D4; Technical Engineering D6

### Armament

Planetcraft scale skirmish ranges PDS (d8)  
8 spacecraft scale short DRADIS range  
railguns (d10)

### Subcraft

80 Vipers, 20 Raptors, 12 assorted craft

Armour: Wound 3, Stun 3

Description 1501 x 784 x 412 feet;  
Crew 1140; Passengers 1300

### Notes:-

The concept for a Fleet Maintenance Carrier was that craft needing repair could be flown on-board for repairs and then sent back to their base carrier. In practice craft were more often destroyed than able to make a flight to the maintenance carrier. The Perseus was pressed into service as a light carrier and craft transport and with the cessation of hostilities

was quickly mothballed as not being a successful concept.

It can carry 80 Vipers and 20 Raptors as well as 12 other minor craft, and has excellent repair and maintenance facilities. It's relatively lightly armed in that its weapons are sufficient to keep small craft at bay but not mix it with capital ships. Perseus has simulators for the Viper and the Raptor – only one of each, but this makes Perseus even more valuable as a resource

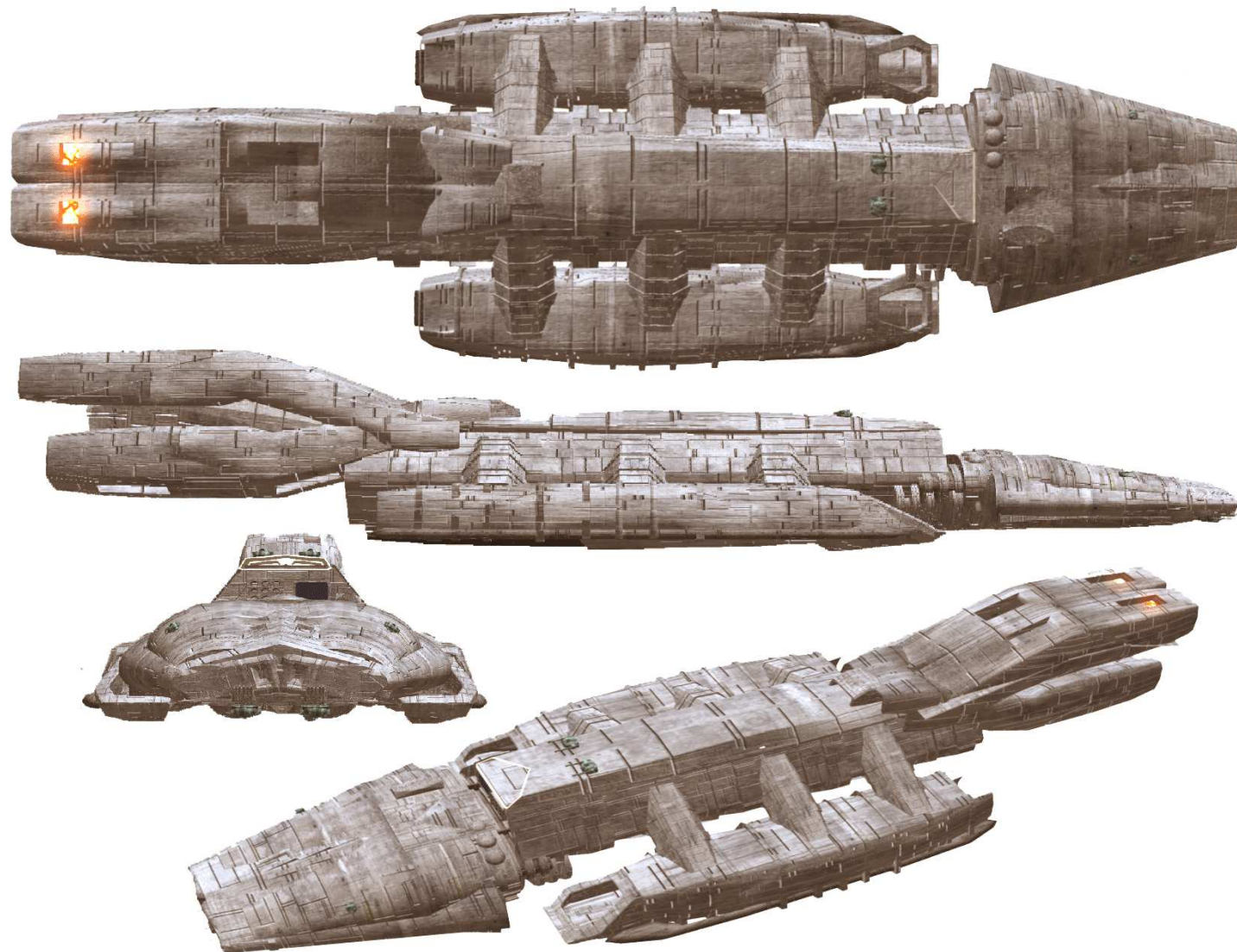

## ***Cyclops (Depot Ship)***

Stats By Gazza

Art by Limerickcot

Agi D4, Str D12+D4, Vit D12+D2, Ale D8, Int D12, Wil D12;  
LP 30; Init D4+D8; Scale Spacecraft; Speed 2 (2 in atmosphere;  
SL/JC)

### Traits:

Formidable Presence (D6); Memorable [You can't mistake a  
Depot Ship!] (D6);  
Tough (D8); Ugly (D6) – A Depot Ship just isn't pretty

### Skills

Heavy Weapons D6; Knowledge D6; Mechanical Engineering  
D6; Perception D6; Pilot D4; Technical Engineering D6

### Armament

Planetcraft scale skirmish ranges PDS (d12)  
24 spacecraft scale short DRADIS range railguns (d12+d2)  
24 spacecraft scale short DRADIS range missiles (d12+d4)

### Subcraft:

120 Vipers, 45 Raptors, 23 other craft.

Armour Wound 4, Stun 4

Description 6200 x 2000 x 1720 feet;  
Crew 5600; Passengers 5000;

### Notes: -

These are mobile bases that as well as being a headquarters  
can provide almost any means of supporting Colonial Fleet units.  
They are able to conduct ship repairs, conversions, and even  
build craft depending on resources. They're not the fastest ships  
in the Colonial Fleet but some of the most efficient and effective.  
A Depot Ship can service between 4 and 8 Battlestars or an equivalent  
number of smaller ships, carrying 200000 tons of stores, parts and equipment  
as well as the fuel supply of a Tanker Squadron. The Depot Ship's crew are  
responsible for the operation of the ship and the care and maintenance of the

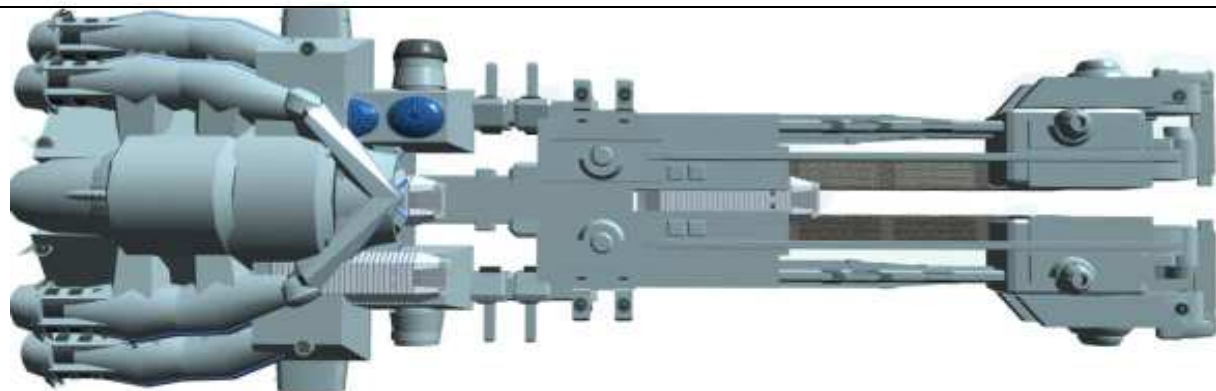

## ***Cyclops Depot Ship*** ***by Limerickcot***

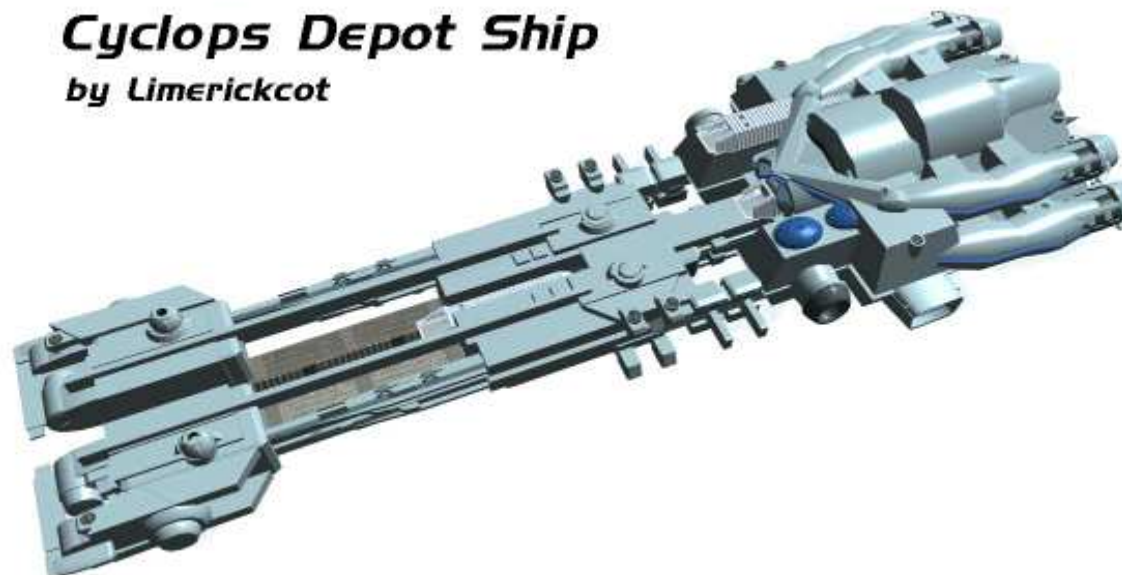

ships docked with it. The "passengers" include a complete Naval Hospital, a  
Battalion-Group of Fleet Marines, a Training and Resources Group, and a  
Naval Construction Battalion. It is possible that a Naval Special Forces Team  
of up to platoon-size could be based on the Depot Ship, but the Fleet generally  
makes no admissions on the deployment of such forces.



## ***Athene (Small Craft Transport)***

Art by Limerickcot

Stats by Gazza

Agi D4, Str D8, Vit D6, Ale D6, Int D6, Wil D6;  
LP 12; Init D4+D6; Scale Spacecraft;  
Speed 3 (3 in atmosphere; SL/JC)

Traits: None

Skills:

Heavy Weapons D2; Mechanical Engineering D2; Perception D4; Pilot D4; Technical Engineering D2

Armament:

1 spacecraft scale short DRADIS range missile system (d12)  
2 spacecraft scale short DRADIS range railguns (d8)  
Planetcraft scale skirmish range point defence systems (d8)

Armour: Wound 2, Stun 2

Description: 488 x 63 x 45 feet;  
Crew 100; Passengers 25;

Subcraft: 20 Raptors and 40 Vipers as cargo.

Notes: -

The Athene-class Small-craft Transport is used to deliver Vipers,

Raptors and other small craft to operational bases and units. Raptors are flown off from a capacious hanger, and Vipers from two launch tubes. Generally, however, they're usually unloaded as cargo at any Port complex.

The Athene is not a warship and shouldn't be used as one. It can protect itself against light craft and can launch its cargo if its got any pilots on board as passengers.

It's not uncommon for an enterprising crew to have two elderly Raptors and a pair of Viper IIs salvaged from a scrap yard as ship "hacks".

As well as small craft it carries munitions and fuel for its charges - 700 barrels of tylium is standard.



## ***Athene Ferry Carrier***

***Limerickcot***





## ***Jansen Kerr (MAC Ship)***

Stats by Gazza

Artist unknown

Agi D4, Str D8, Vit D6, Ale D6, Int D6, Wil D6;

LP 12; Init D4+D6; Scale Spacecraft;

Speed 4 (4 in atmosphere; SL/JC)

Traits: None

**Skills:** Heavy Weapons D4; Mechanical Engineering D4; Perception D6; Pilot D4; Technical Engineering D2

### **Armament:**

1 spacecraft scale short DRADIS range missile system (d12)

1 skirmish range PDS (d8)

24 planetcraft scale skirmish range missiles systems (d8)

**Armour:** Wound 2, Stun 2

**Description:** 846 x 321 x 209 feet; **Crew** 75; Passengers 150;

**Equipment:** 8 Raptors

Notes: -

The MAC Ship is a minor conversion to any reasonably sized Merchant Ship often on an older hull such as the Astral Queen-class Transport.

As little conversion as possible is performed apart from the installation of improved sensors, self-defence weapons, and facilities for a Squadron of 8 Raptors. 2 Raptors are the ELINT version, 2 are standard models and the other 4 are Gunships.

Existing hangar facilities are used. Some consideration was made to including Vipers in the Squadron mix, but the addition of launch tubes made the conversion too costly, and the idea was rejected (except for converted Celestra classes).

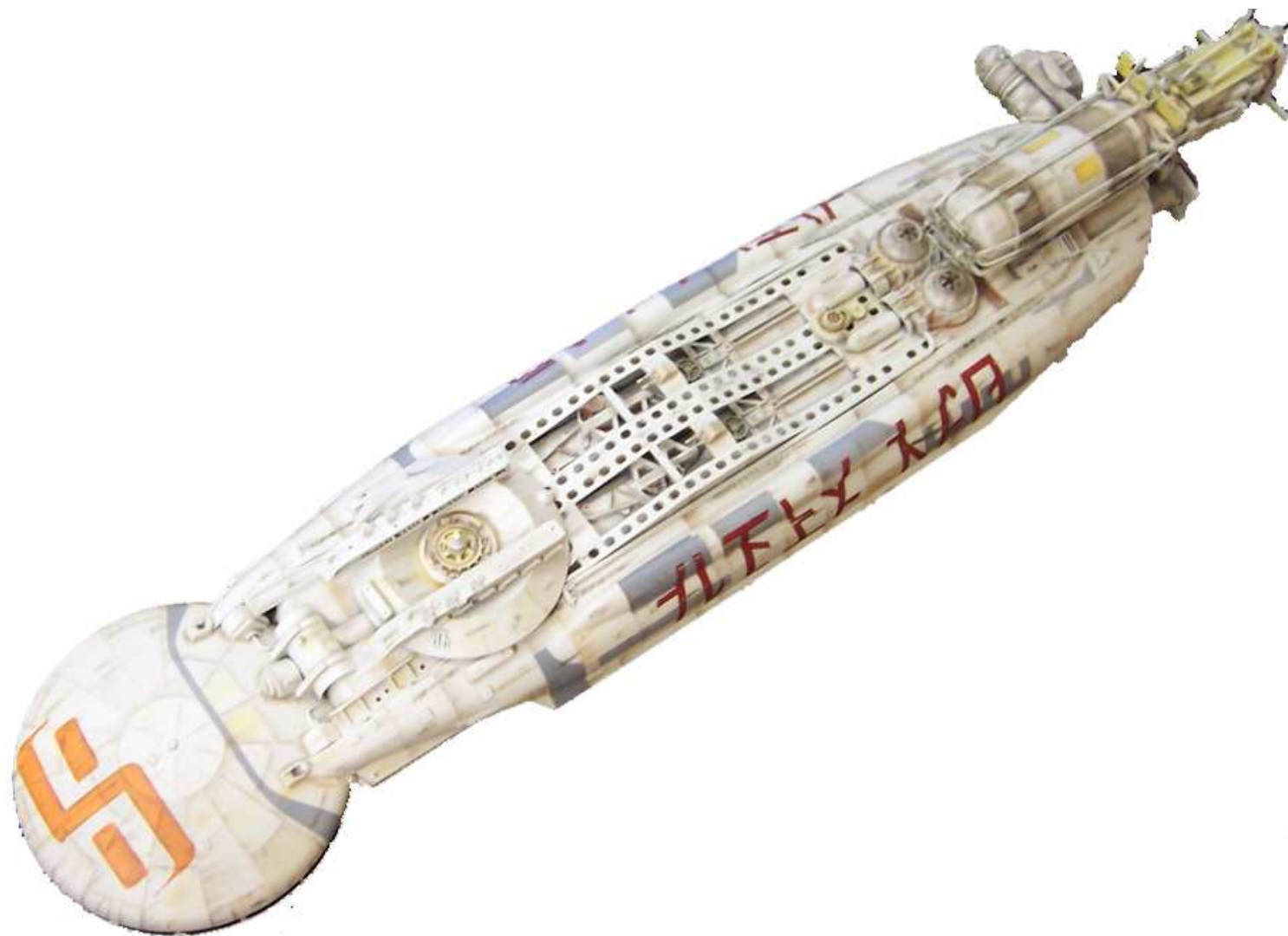

The MAC Ship maintains its full cargo load and makes a useful addition to a convoy escort for very little outlay. The MAC Ships are not commissioned and retain their commercial names..

The 24 HD-70 Lightning Javelin missiles are loaded by pallets into a specialised launcher which can fire missile singly or in salvos of various configurations, with 4 to 6 missiles being a favourite launch configuration.

# SPACE STATIONS





## ***Penny-class Space Station***

Stats By Gazza

Art by Limerickcot

Agi D2, Str D8, Vit D8, Ale D8, Int D2,  
Wil D8;  
LP 16; Init D2+D8; Scale Spacecraft;  
Speed 0

Traits: None

Skills: Heavy Weapons D4; Knowledge  
D4; Mechanical Engineering D4;  
Perception D6; Technical Engineering  
D4

Armament:

Medium, planetcraft scale, skirmish  
range point-defence systems (d8)  
4 spacecraft scale short DRADIS range  
missile systems (d12)  
12 planetcraft scale skirmish range  
missile systems (d8)  
8 spacecraft scale short DRADIS range  
railgun systems (d12+d2)

Armour: Wound 3, Stun 3

Description: 60 x 80 x 250 feet; Crew  
360; Passengers 45;

Subcraft

1 Squadron of Vipers, 6 Raptors, 4 ELINT/EW Raptors, 10 Python Mk IIs, 5  
Cobra Mk Is, 5 Shuttles

Notes: -

The Penny-class Space Station is a common sight used as a  
communications centre, patrol base, training centre, research base, command  
and control facility, and even a brig.

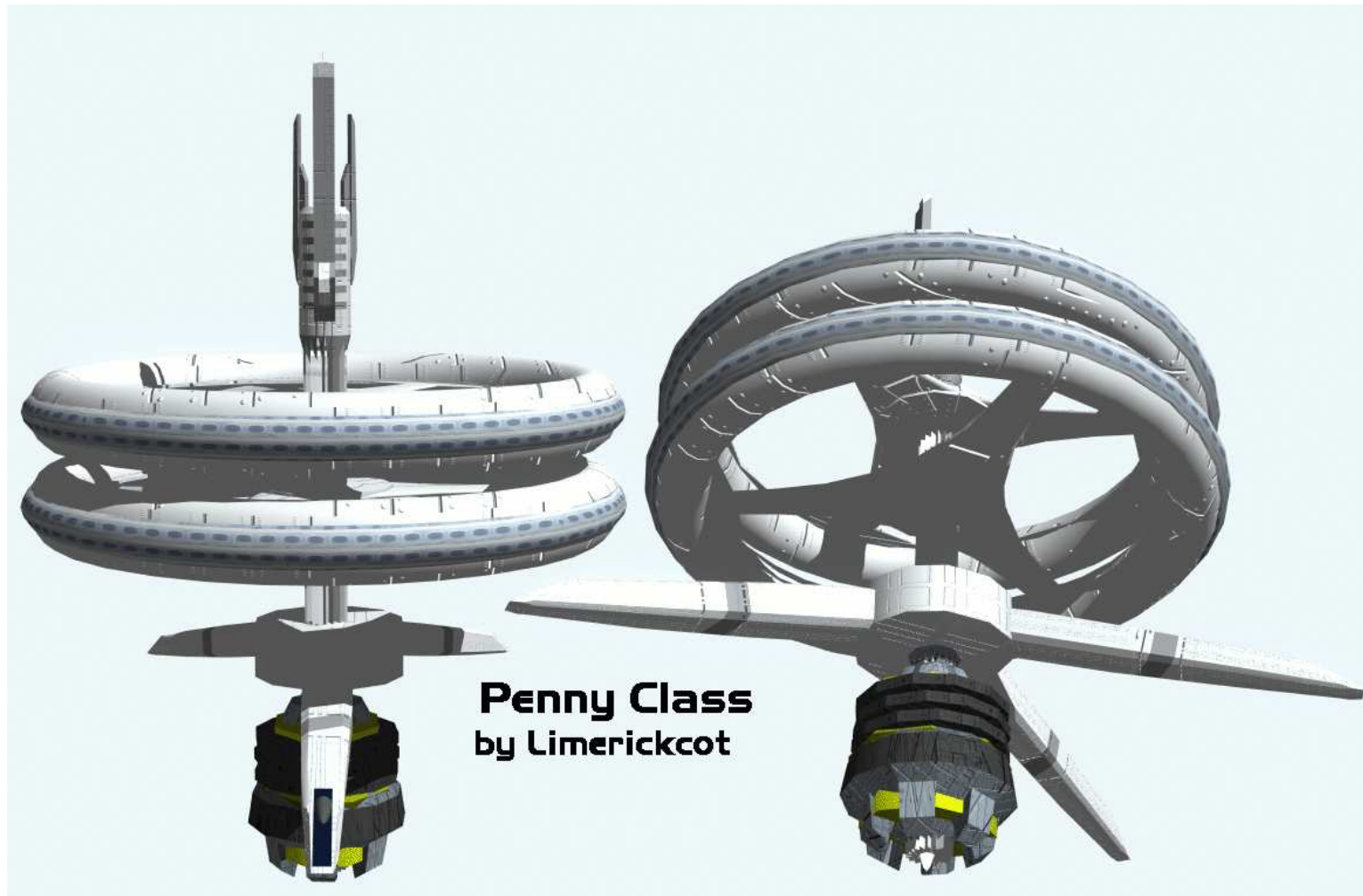

### **Penny Class by Limerickcot**

The Stations are named after Colonial Fleet Master Chief Petty Officers who were distinguished in battle.

The Stations can't move by themselves, needing an Atlas-class Fleet Tug or a civilian Bruiser-class Heavy Tug to move them into position. They do have station-keeping thrusters for position keeping.

The 144 HD-70 Lightning Javelin missiles are loaded by pallets into a specialised launcher which can fire missile singly or in salvos of various configurations, with 4 to 6 missiles being a favourite launch configuration.



## **Leon Class Way station**

Art & stats by Limerickcot

Agi D2, Str D8, Vit D8, Ale D8, Int D2, Wil D8;  
LP 16; Init D2+D8; Scale Spacecraft; Speed 0  
(0 in atmosphere; SL/JC)

Traits: None

Skills: Knowledge D6; Mechanical Engineering  
D4; Perception D6; Technical Engineering D4

Armament:

Planetcraft scale skirmish range PDS (d8)  
Hard-points for Rail guns and missile systems  
(not normally fitted)

Craft:

6 Shuttles

Capacity for various others (for instance she can  
house 160 Vipers but has no launch tubes).

Dimensions: 3091.5 ft high x 2355 ft wide

Armour: Wound 3, Stun 1

Crew: 200-1200 depending on requirements

The Leonid's were the first to construct 'way-stations' throughout the colonial systems, back before faster-than-light travel was possible. Although many have been destroyed over the centuries, Leon stations are still to be found throughout Colonial Space. They are only lightly armed (a holdover from the Cylon war) but have a capacity to have heavier weapons fitted to them.

Normally they are used as scientific outposts, hospitals, university annexes and, above all, as construction platforms. During wartime, they can serve as bases for fighter and subcraft squadrons. The central dome is holographic (removed on some models) and contains a hydroponic 'park'. This addition makes long-term occupation more amenable to its crew. The area under the



**Leon Class Station**  
by Limerickcot



park provides both quarters and factory space. At the apex lies offices and the 'bridge' of the station.

Stores and hanger space is provided under each of the four landing pods. Due to the way these are constructed all incoming and outgoing launches must be cleared with the bridge, due to a risk of collision. Venting from the stations factories (if present) occurs between each flight pod. The positioning of the central dome is well protected from incoming fire due to the protuberances of both flight pods and support stanchions. These provide the central dome with a 50% armour coverage.

## Valhalla Yards

Art by Ice Dragon

Stats by Limerickcot

**Agi** d2, **Str** d12+d10, **Vit** d10, **Ale** d12, **Int** d10, **Wil** d12;

**LP** 34; **Init** d2+d12; **Scale** Spacecraft

**Speed** 0

**Traits:** None

**Skills** Mechanical Engineering d8, Perception d8, Pilot d8, Heavy Wpns: d8, Knowledge: d10

**Armour** Wound 4, Stun 2

**Dimensions:**

Height: 28706 ft

Width: 45930 ft

Ring Dimensions:

3994 ft wide x 1389 high

Dock Dimensions:

15156 long x 2297 wide x 918 high

Mass: 6,055,717,001,940 tons

**Capacity:**

3 Capital repair slips

Water purification

Ordnance works

Tyrium Depots

**Armament**

288 Heavy Rail Guns, Short DRADIS

Range d12+d6

Multiple Heavy PDS, planetcraft scale, skirmish range d12+2

36 Heavy Missile Batteries, Long DRADIS Range, d12+d8

**Subcraft:**

Capacity for 18 Viper squadrons

3200 small craft

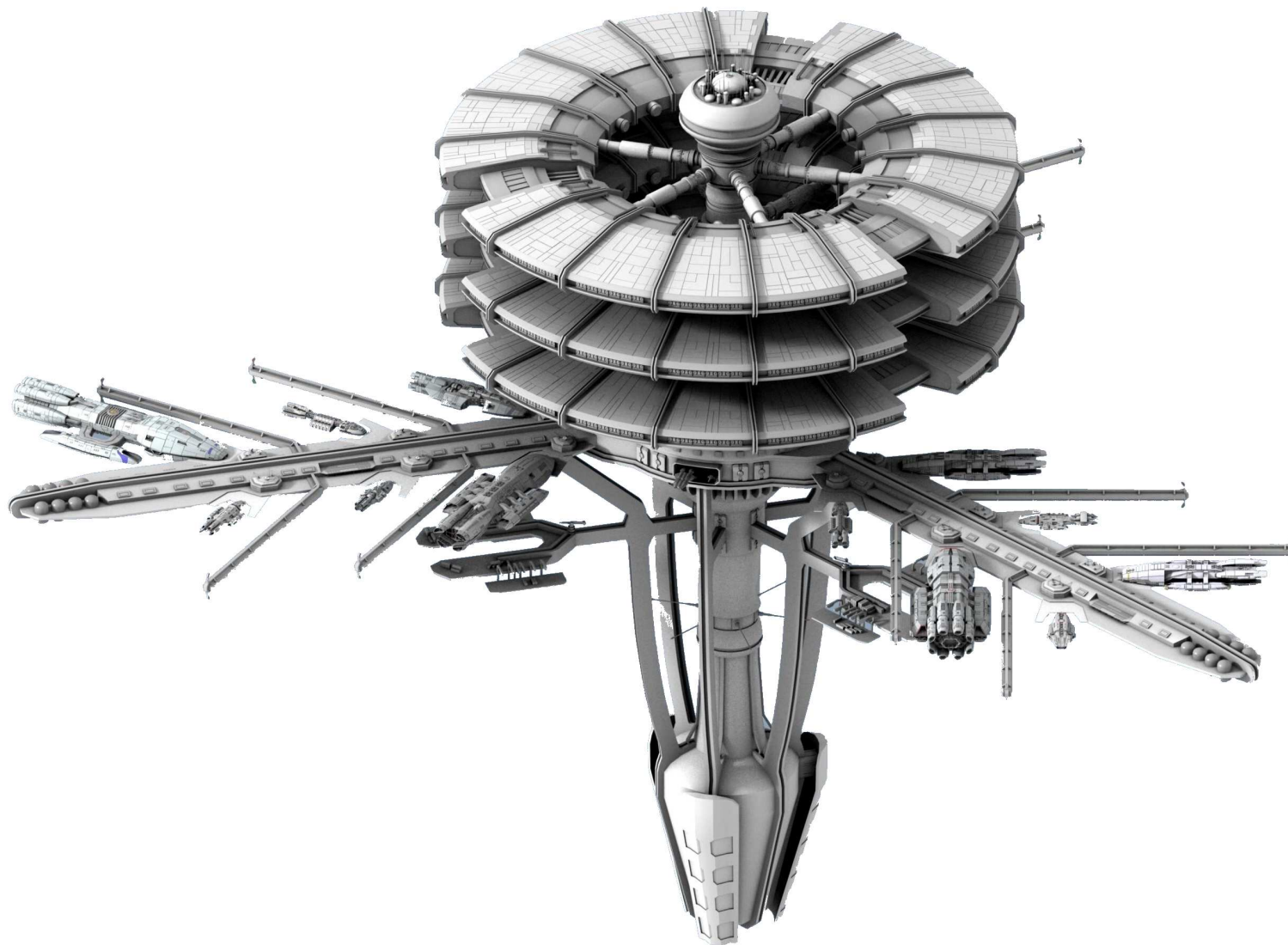

Permanent Naval & Civilian Establishment: 36,000

Troop Complement: 58<sup>th</sup> Marine Brigade

Valhalla & Midguard Defender Flotilla's

Visitor Capacity: 160,000 at normal capacity, 480,000 maximum life support capable

Valhalla, Ragnar and Midgard were all envisaged as the necessary support and logistics hubs of the massive fleet dreamt of at the end of the Cylon Wars, a fleet that would have greatly outnumbered the one currently in being. Of the three stations, only Valhalla was completed to the original design, occupying an orbit between the Helios and Cyrannus stars. Ragnar was completed as an ammunition reserve, Midgard was changed on the drawing board to become Picon Fleet Headquarters.

Valhalla houses all the necessary facilities to keep a full fleet in operation. It houses its own Marine and Security Brigades, can house up to 18 full Viper Squadrons (although only three are currently on permanent establishment –

\*\*\*\*\*

## ***Babblers Armed Relay***

**Art by Ice Dragon**

**Stats by Limerickcot**

**Agi** d0, **Str** d6, **Vit** d4, **Ale** d2, **Int** d2, **Wil** d4;

**LP** 10; **Init** d0+d2; **Scale** Spacecraft

**Speed** 0

**Traits:** None

**Skills** Perception d4, Heavy Weapons d6

**Armour** Wound 1, Stun 1

Dimensions: 100 ft x 104 ft x 104 ft

Mass: 2704 tons; Crew: None, capacity for two

Armament:

Light PDS, Planetcraft scale, skirmish range (d6)

The Babblers array is a basic communication relay but can also be deployed as an orbital 'interdiction' satellite, targeting vessels without the correct ID code and passing that information on to a local defence facility (via an Orbis usually).

the rest are rotated), over 3000 various subcraft and 36,000 defence staff and civilians. Its facilities include three repair slips capable of taking Battlestars, an ordnance plant, water purifications, tylium refineries, research laboratories, testing facilities, construction and engineering works as well as all the necessary recreational and operational offices for such a vast facility. A series of hospitals, training and educational are also present. Finally Valhalla is one of the centres for Naval Security (every Battlestar relies on security personnel instead of Marines for dockside security).

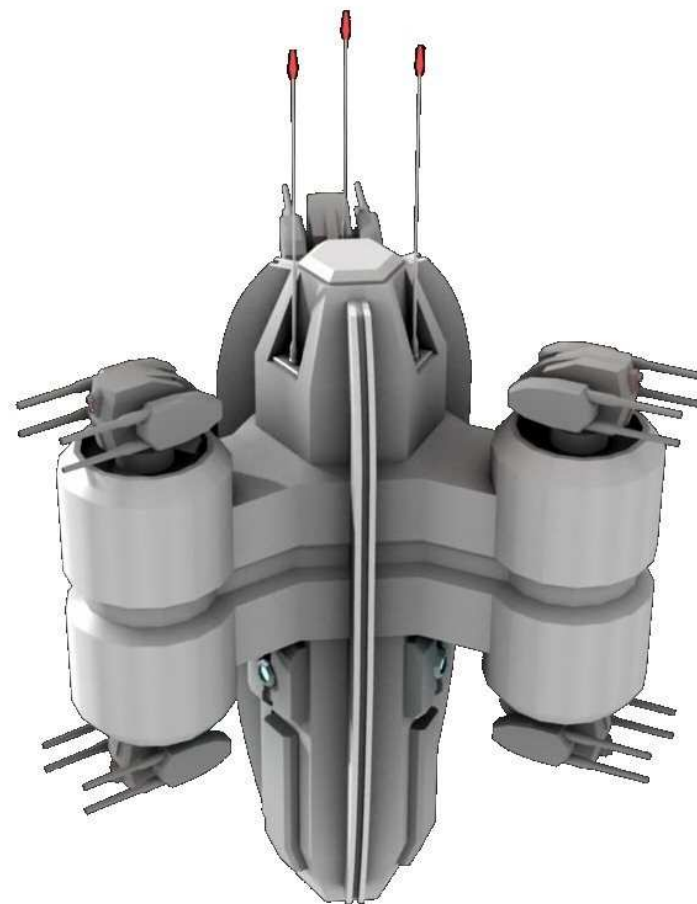



## ***Ragnar Station Ammunition Reserve***

art by [Ice-Dragon](#)

stats by Limerickcot

### **Ragnar Anchorage**

**Agi** d2, **Str** d12+d6, **Vit** d6, **Ale** d6, **Int** d6, **Wil** d10;

**LP** 28; **Init** d2+d6; **Scale** Spacecraft

**Speed** 0

**Traits** Past Its Prime (d6)

**Skills** Mechanical Engineering d6, Perception d4, Pilot d2

**Armour** Wound 2, Stun 2

Designed as one of the three anchorages demanded by the Colonial Navy at the end of the Cylon War, Ragnar was dramatically downsized when the true cost of construction of the Valhalla Anchorage was realised.

Ragnar was never fully completed, lacking the extensive docks, construction and refuelling facilities and even the most basic of defence systems. Instead she was converted to a simple ammunition and stores reserve.

She was later removed to her current position, suspended (and hidden) within the upper reaches of the Ragnar Gas Giant, off limits to civilian traffic and with navigational co-ordinates restricted to colonial pilots only.



## ***Cayuze Reserve Anchorage***

Art by Ice Dragon  
Stats by Limerickcot

**Agi** d2, **Str** d12+d6, **Vit** d6, **Ale** d6, **Int** d6, **Wil** d10;

**LP** 28; **Init** d2+d6; **Scale** Spacecraft

**Speed** 0

**Traits** Past Its Prime (d6)

**Skills** Mechanical Engineering d6, Perception d4, Pilot d6

Armament:

Heavy, skirmish range, PDS (d12)

32 planetcraft scale, medium range missile systems (d10)

18 spacecraft scale, short range railguns (d8)

Crew: 3200 plus ship crews

200 security personnel

**Armour** Wound 2, Stun 2

Subcraft:

74 shuttles & raptors

6 flights of Vipers on security patrol

With the re-designation of the Midguard Anchorage as Picon Fleet Headquarters, designers were free to re-designate a new anchorage under that name. However, with budgets already under strain in the recovery period following the Cylon war, a smaller anchorage facility was finally decided upon.

One of these 'Anchorage' stations was assigned to the small moon of Cayuze, which follows an orbit around the gas giant Zeus. Cayuze is a fleet reserve facility, where older or obsolescent vessels are stationed until refitted or scrapped.

Cayuze can accommodate up to 12 main vessels in its main booms, another six smaller craft on lower booms, and more internally, whilst they are stripped, refurbished or scrapped. Indeed, Cayuze technically makes money for the Fleet as it strips out weapons and electronics and refurbishes hulls for the civilian market.

Ships are constantly on the move to and around the facility. Ships moved to the reserve are given a thorough survey, new parts are ordered and, once all supplies are received, they are moved to the station itself where it is totally refurbished. Once finished, the ships are put on a care and maintenance routine and then moved to a secure parking orbit.

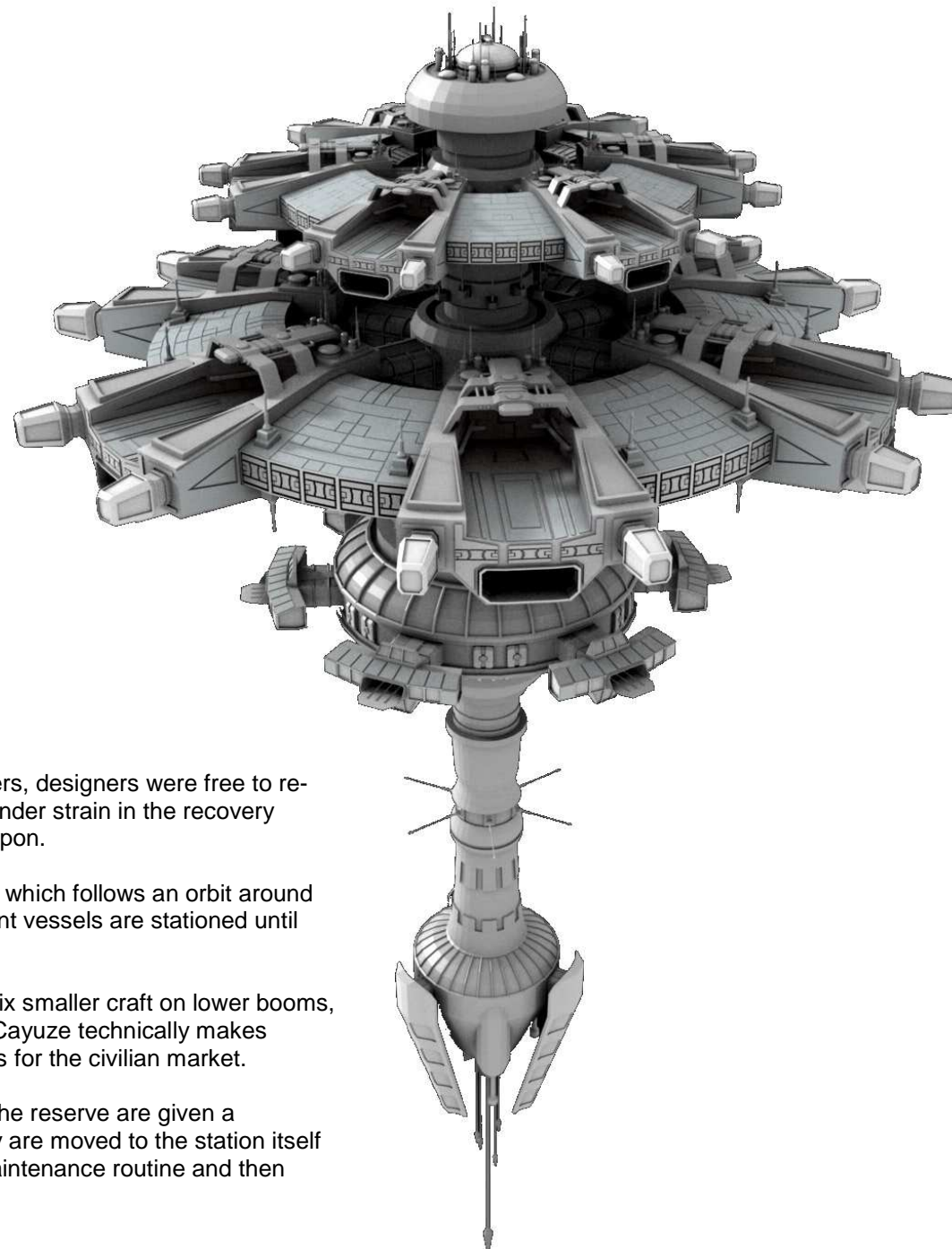

## Echo Station

Art by Electricbadger

Stats by Limerickcot

**Agi** d2, **Str** d10, **Vit** d8, **Ale** d6, **Int** d6, **Wil** d4;

**LP** 14; **Init** d4+d6; **Scale** Spacecraft

**Speed** 0

**Traits:** None

**Skills** Perception d4, Pilot d4, Heavy Weapons d6

**Armour** Wound 1, Stun 2

Dimensions: 1531 ft high x 1632 wide (3417 w panels)

Crew: 400

Armament:

28 Light Rail Guns. Spacecraft scale, short DRADIS Range d12

Multiple PDS, planetcraft scale, skirmish range d10

4 Heavy Missile Batteries, Long DRADIS Range, d12+d8

Subcraft:

1 Squadron of Vipers

2 Flights of Raptors

8 other subcraft

Echo class stations are the Colonial Governments solution to garrisoning systems beyond its own. Ground bases are always susceptible to orbital attack and have an unacceptable ground-to-orbit delay launching factor. They also require an inordinate amount of effort to construct that is rarely justified by the presence of an outpost or new colony.

Echoes are easily and cheaply constructed back in the colonies and then shipped out, a piece at a time, to their new destination where they are assembled. The four large horizontal cylinders are living space. The other four spokes (beneath the solar panels) consist of a hangar, two sets of storage containers, and fuel tanks. The central hub is CIC and the meat of the thing. The lower boom is the reactor, ammunition magazine, engineering and the large communications/DRADIS boom.

Life aboard such a station is better than aboard a Shiel class, but the amenities are still fairly basic. Getting groundside tends to be an overwhelming desire of most regular crews. (see also chapter title illustration, also by Electricbadger)

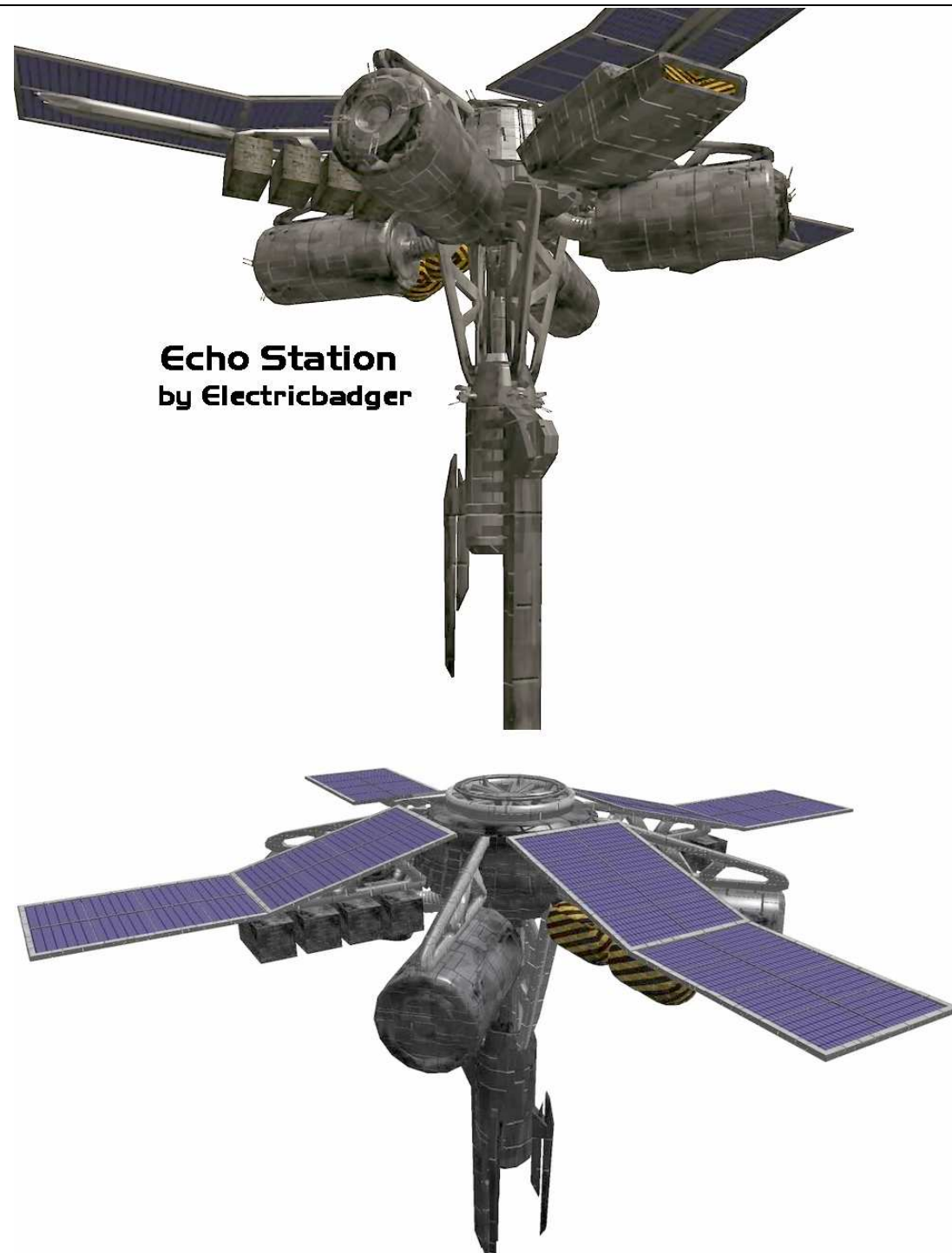

**Echo Station**  
by Electricbadger



## ***Orbis Armed Relay***

Art by Limerickcot

Stats by Limerickcot

**Agi** d4, **Str** d6, **Vit** d6, **Ale** d6, **Int** d6, **Wil** d4;

**LP** 10; **Init** d4+d6; **Scale** Spacecraft

**Speed** 0

**Traits:** None

**Skills** Perception d4, Pilot d2, Heavy Weapons d6

**Armour** Wound 2, Stun 2

Dimensions: 130 ft x 130 ft x 130 ft

Mass: 5493 tons; Crew: none, capacity for eight

Armament:

Heavy PDS, Planetcraft scale, skirmish range (d10)

The Orbis Class armed relay was designed for scanning and relaying of remote areas of the Colonial System (and others). There are many other similar satellites that are unarmed, but these tend to lie closer into the system cores. The Orbis forms part of the vast communications array that allows the quick and speedy transmission of messages across the vastness of space.

An Orbis must be serviced on a regular basis and so each is on a regular service route for a patrol flotilla that maintains and upgrades these. Any object that triggers the Orbis guns will also trigger an 'alert' signal that will bring an investigating craft in under a day.

**Orbis  
Armed Relay  
by Limerickcot**

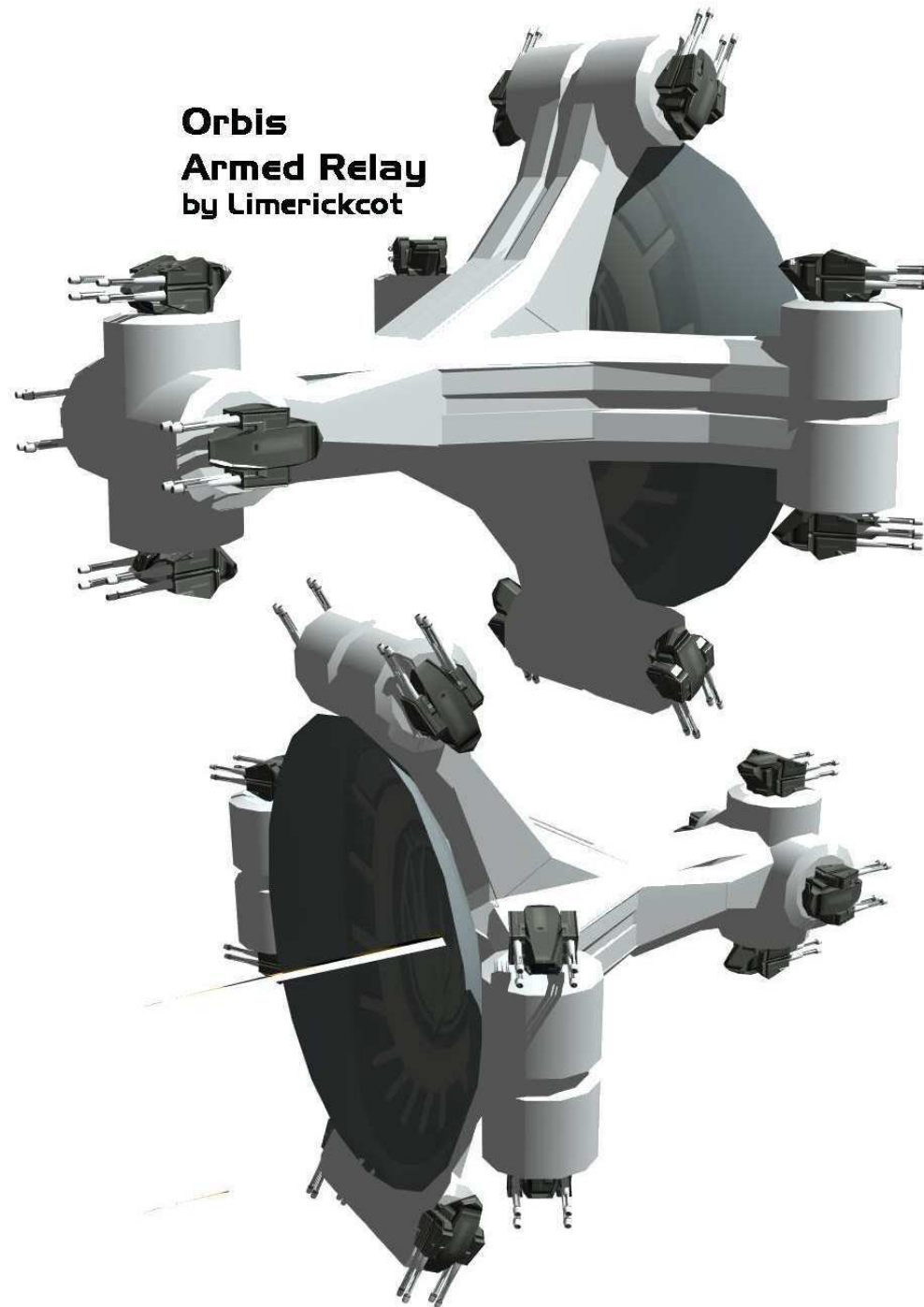

## ***Sheil Class Defence Station***

Art by Ice Dragon  
Stats by Limerickcot

**Agi** d2, **Str** d10, **Vit** d6, **Ale** d6, **Int** d6, **Wil** d6;  
**LP** 16; **Init** d2+d6; **Scale** Spacecraft  
**Speed** 0

**Traits:** None

**Skills** Mechanical Engineering d2,  
Perception d6, Heavy Wpns: d8,

**Armour** Wound 5, Stun 2

### **Dimensions:**

Height: 474.5 ft

Width: 1131.5 ft

Gun Platform Dimensions:

328.5 ft dia x 198 high

Main Hub

474.5 ft high, 328.5 ft diameter

Mass: 393,275 tons; Crew: 100

### Armament:

Heavy PDS, Planetcraft scale, skirmish range (d12)

8 Heavy Railguns, Spacecraft Scale, Short range (d12+d8)

10 Missile systems, Spacecraft Scale, Extreme range (d12+d8)

### Subcraft:

1 Shuttle (no internal dock), 4 docking points

### History:

The Sheil Class Defence Station is a typical approach to retrenchment. These defence stations are typically emplaced along approach routes to space based installations (Valhalla has 23 of these in its immediate vicinity) and relies on its ability to target spacecraft with its heavy guns (normally seen only as spinal weapon mounts), backed with longer range missile systems and close in, interlocking anti-fighter defences.

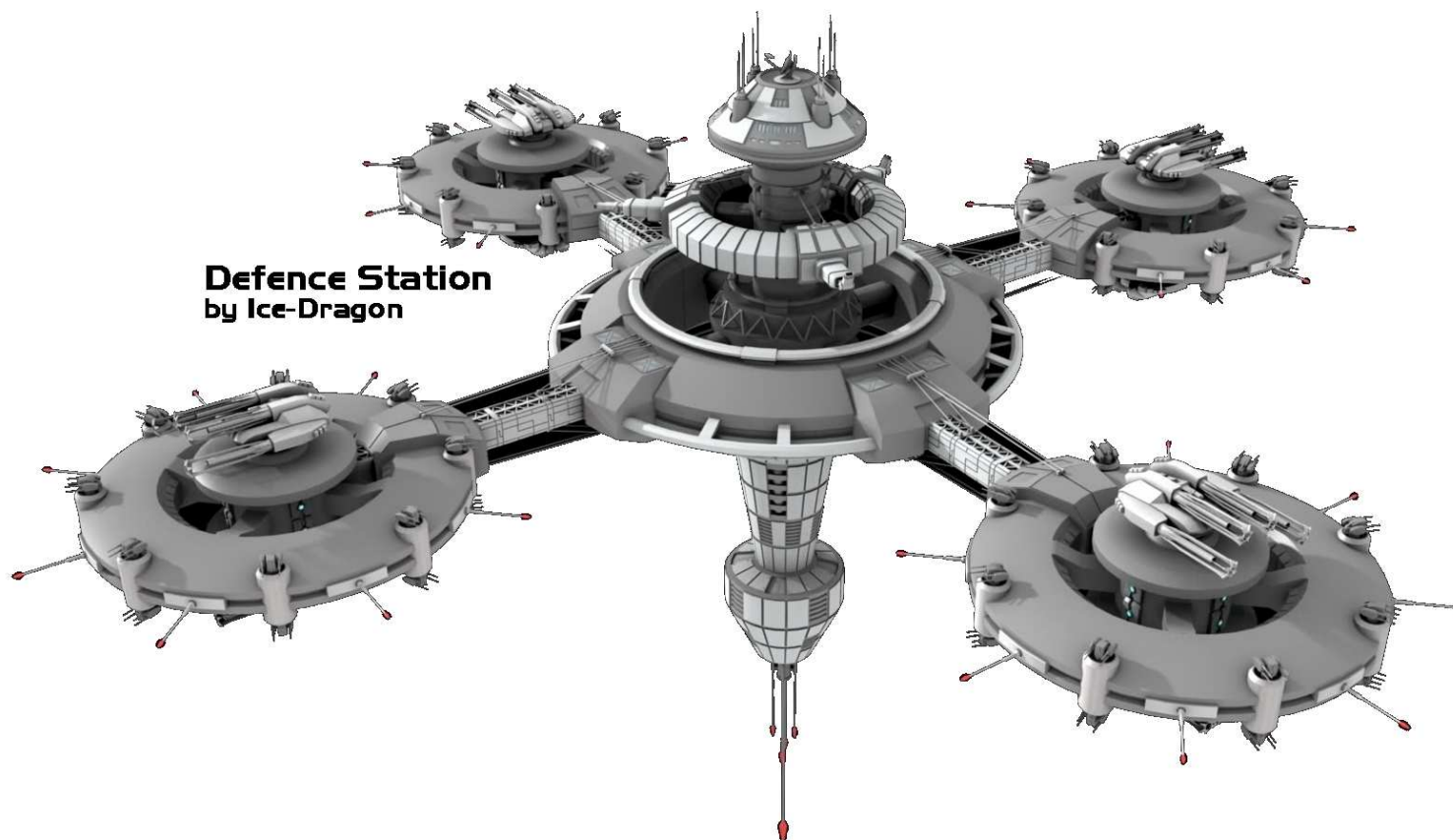

A Sheil is a formidable installation but suffers from limited ammunition stocks and an inability to manoeuvre, although it makes up for this last by carrying substantial armour on its gun platforms.

Its crew normally keep on their toes by co-ordinating defence runs against attacking viper and escort squadrons, against which they are invariably successful, although non-standard tactics and a willing to sacrifice vessels has shown a tendency to defeat these platforms. Sheil crews are trained for platform defence against Cylon incursions and they tend to throw themselves into these exercises with enthusiasm, presumably due to the isolation of each platform. Discipline infractions on shore leave are notably heavier amongst platform crews than against regular ship crews.

## ***Colonial Modular Station's - Ecology***

Art by Ice Dragon

Stats by Limerickcot

**Agi** d2, **Str** d10, **Vit** d4, **Ale** d2, **Int** d6, **Wil** d6;

**LP** 16; **Init** d2+d2 **Scale** Spacecraft

**Speed** 0

**Traits:** None

**Skills** Mechanical Engineering d2, Perception d2, Knowledge d10

**Armour** Wound 0, Stun 1

### **Dimensions:**

Height: 474.5 ft

Width: 1131.5 ft

Main Hub

474.5 ft high, 328.5 ft diameter

Mass: 393,275 tons; Crew: 100 + up to 200 research personnel.

**Armament:**

none

### **Subcraft:**

2 Shuttles (no internal dock), 3 docking points on main hub, 1 docking point on each sub-frame.

This modular station is built to almost the same specifications as the Sheil defence platform. It was a simple matter for the manufacturers to turn their skills to adapt the frame to governmental work. In this example that is an ecological research facility.

The colonies do not encompass a wide diversity of life. A constant fight continues to develop new strains of food crops without overtaxing planetary ecology's. These stations allow the research to be done away from the harmful effects that could occur if this was done on a planetary surface. Laboratories surround each dome and, when ready, the new crop can be tested in any of the attached domes. This example has only three domes. Some examples have as many as 30.

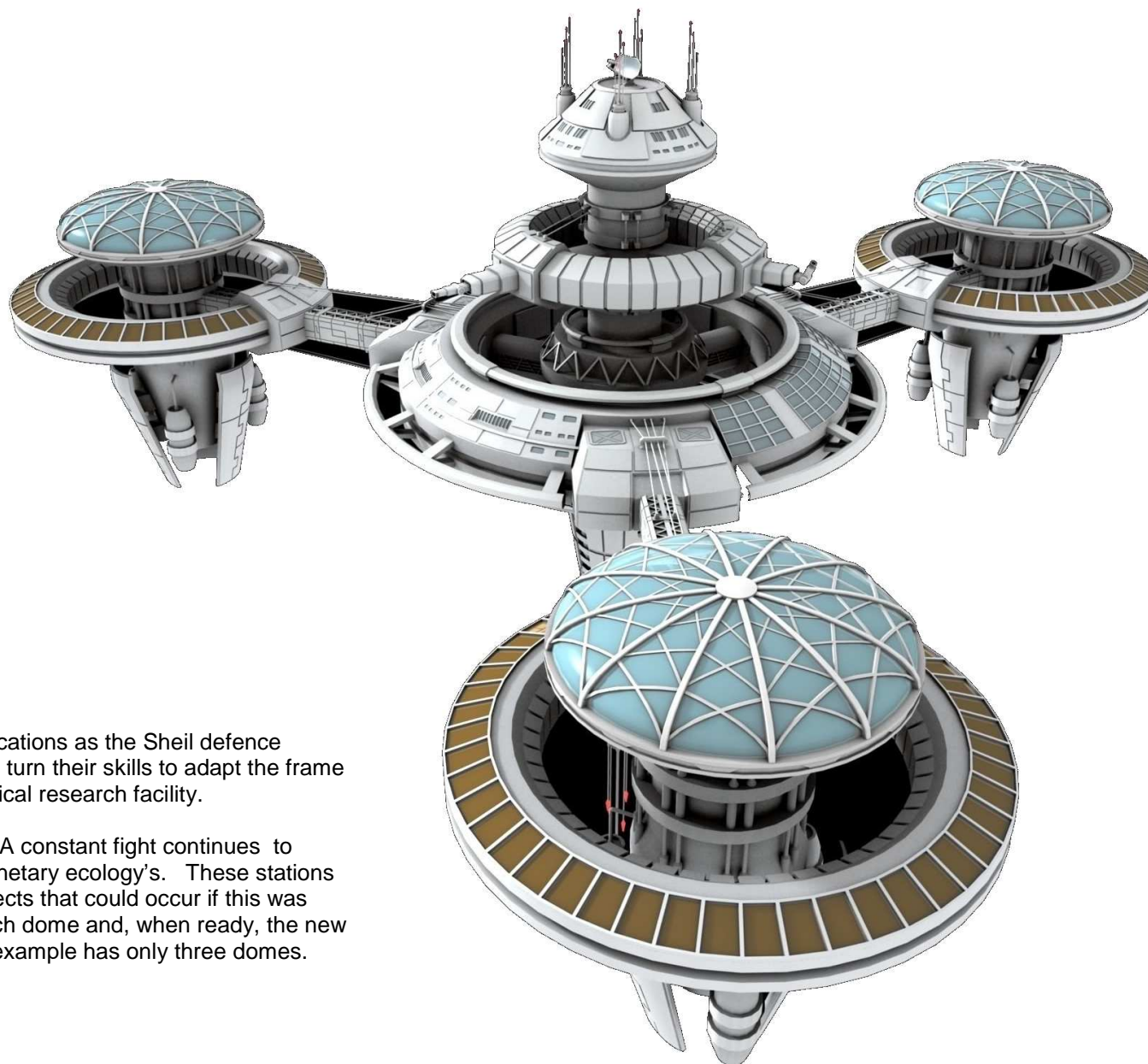



## ***Colonial Modular Station's - Research***

Art by Ice Dragon

Stats by Limerickcot

**Agi** d2, **Str** d10, **Vit** d4, **Ale** d2, **Int** d6, **Wil** d6;

**LP** 16; **Init** d2+d2 **Scale** Spacecraft

**Speed** 0

**Traits:** None

**Skills** Mechanical Engineering d2, Perception d2, Knowledge d10

**Armour** Wound 0, Stun 1

### **Dimensions:**

Height: 474.5 ft

Width: 1131.5 ft

Main Hub

474.5 ft high, 328.5 ft diameter (985.5 ft total with spurs)

Mass: 393,275 tons; Crew: 100 + up to 200 research personnel.

**Armament:**

none

**Subcraft:**

2 Shuttles (no internal dock), 3 docking points

As with the Ecology modular station, the Research Station is also built to the same specifications. As most of the research required on these stations is not as bulky as that of the Ecology station, the laboratories can be accommodated on one of three long spurs instead. Each lab can be built on a planetary surface, moved to the station and quickly attached to the spur. In the example shown, only one spur houses labs. Another houses dangerous or hazardous supplies and a third is being used as a separate docking facility. Each facility is different in its accommodation. Those housing more labs normally require that one spur, or part of a spur, be given over to additional quarters. One example is attached to a small construction facility for engineering testing. Others are used as hospitals.

Only one thing characterises all of these stations as far as the colonial government is concerned. They are easily constructed; they are cheaply constructed; they are quickly constructed.

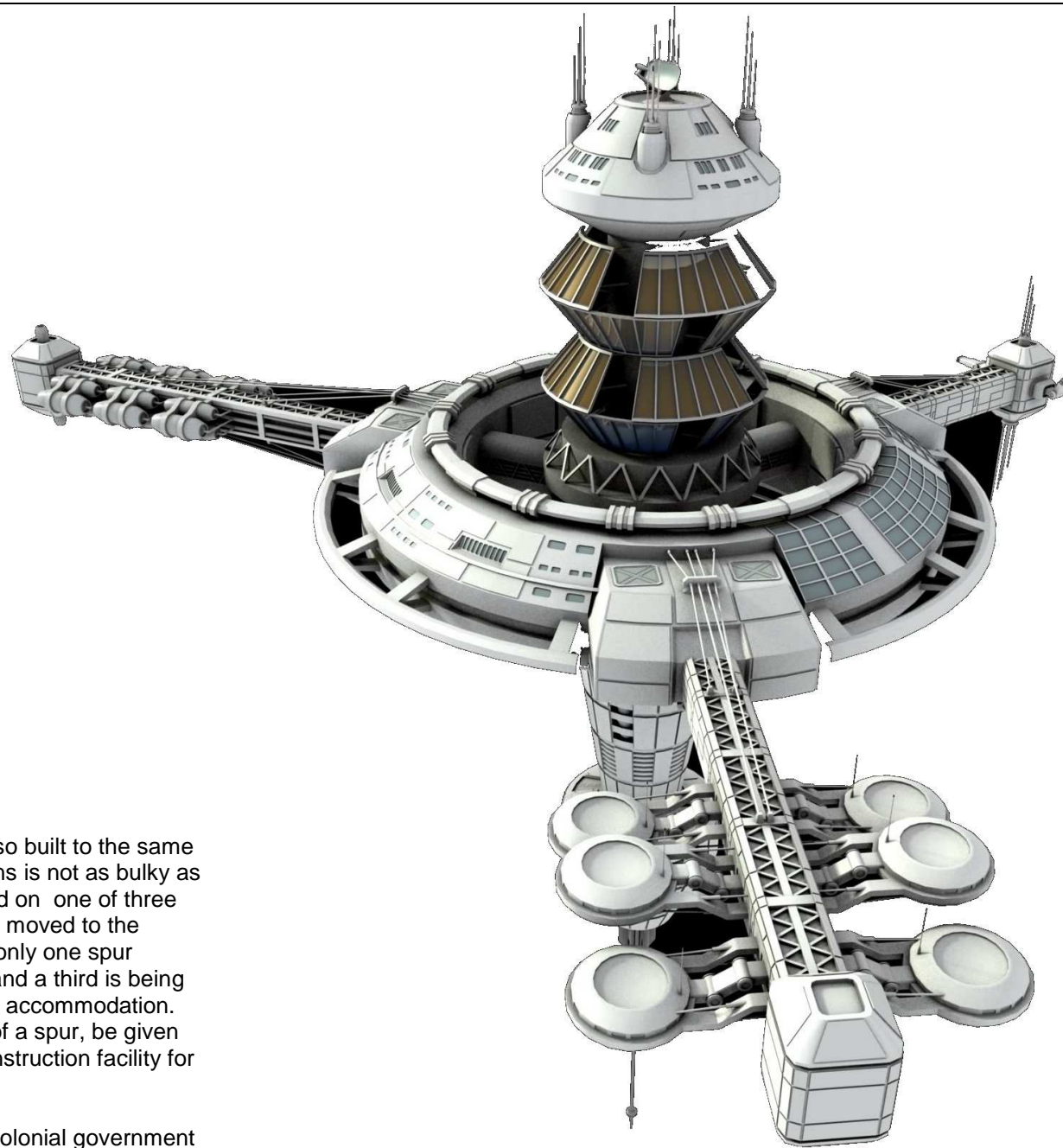

## Scorpio Yards

**Agi** d0, **Str** d12+d12, **Vit** d4, **Ale** d2, **Int** d6, **Wil** d12;

**LP** 36; **Init** d2+d2 **Scale** Spacecraft

**Speed** 0

**Traits:** None

**Skills** Mechanical Engineering d8, Perception d4, Knowledge d10

**Armour** Wound 0, Stun 1

Crew: 20,000 (approx)

1 Security Brigade

3 Viper Squadrons on permanent assignment

2 Escort Flotillas on permanent assignment

13 Defence stations

Armament:

none

It is not possible to provide a fully detailed account of the full extent of the Scorpio shipyards. In effect this vast facility is the premier refitting and docking facility for the Colonial fleet.

The yards include Battlestar Row – capable of holding three Battlestars in various stages of refit. A tylium farm is located nearby that supplies half of the fleet's daily operating reserves. The construction yards located here are capable of building both Berserker and Aesir series vessels. A much larger slipway is currently building the 'Colossus'. Outside appearances show that this resembles a Galactica or Mercury class Battlestar – in all but size. Its size makes it double the size of the Pegasus.

Other facilities include training, educational and above all, testing facilities. One of the principal flight testing yards has its headquarters here, where it has ready access to some of the best and brightest of the fleet.





***CIVILIAN VESSELS***





## Flattop

Stats by Buscadero

© by [Emile Smith](#)

Flattop-class foundry ships are mobile construction docks employed by both military and non-military organizations to process ore, build replacement hardware and conduct repairs to disabled ships. Often this class vessel can be found in asteroid fields or tucked within a fleet of ships, building the necessary hardware and tools a fleet needs to survive. In addition to its foundry operations these ships were also sometimes used as mobile bases for mining companies.

Battlestar Galactica: Tech-Manual

### Flattop

**Agi** d4, **Str** d10, **Vit** d8, **Ale** d4, **Int** d4 **Wil** d6;

**LP** 16; **Init** d4+d4; **Scale** Spacecraft

**Speed** 4 (SL/JC)

**Traits** Memorable (d2)

**Skills** Mechanical Engineering d4, Perception d4, Pilot d4

**Armament** None

**Armour** Wound 2, Stun 2

**Description** approx. 2,950 x 350 x 1,300 feet; **Crew** 100

**Passengers** 500 (standard), 2,000 (emergency)

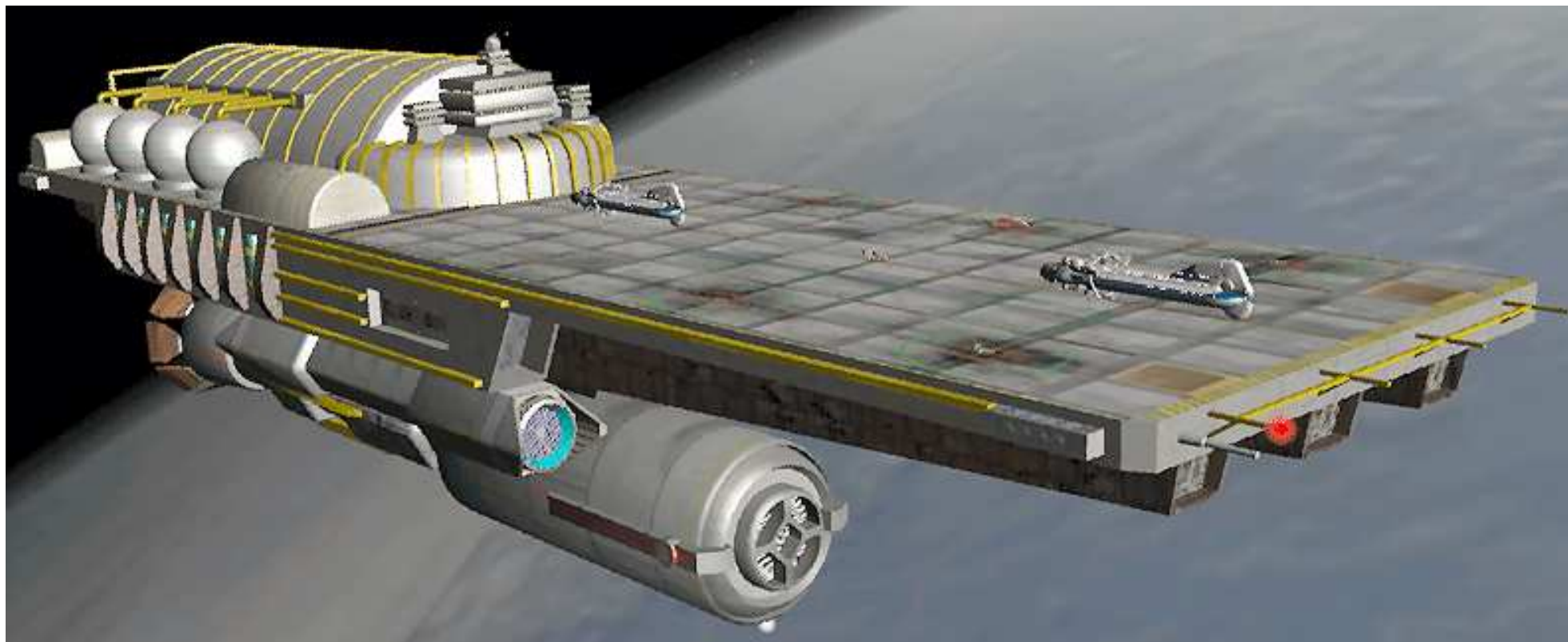

## Colonial Movers

Stats by Buscadero

© by Ice Dragon

### Colonial Mover

**Agi** d4, **Str** d8, **Vit** d6, **Ale** d4, **Int** d4, **Wil** d4

**LP** 10; **Init** d4+d4; **Scale** Spacecraft

**Speed** 4 (SL/JC)

**Traits** None

**Skills** Mechanical Engineering d2, Perception d2, Pilot d4

**Armament** None

**Armour** Wound 1, Stun 1

**Description** 450 x 75 x 75 feet; **Crew** 24

**Passengers** 6 to variable

Colonial Movers Corporation own one of the largest (albeit made up of small vessels) transport fleets in the colonies. Dedicated to moving freight from one planet to another these midrange transports are common place amongst the Twelve Colonies and many a Space Trucker work or flies these transport vessels for a living.

The standard vessel, shown below, comprised of a series of docking hard points and connecting collars that could be added to as needed – allowing CM to provide an inexpensive shipping service even to smaller clients.

The containers themselves are insulated, pressurised and have power hook-ups, again allowing for a vast array of goods to

be transported from point to point without requiring expensive, specialised cargo pods. CM also provide cheap passenger accommodation from time to time, in which case standard pods are re-equipped (locally) with seats, beds, sanitation and cooking facilities. Not a very comfortable solution, such methods were used constantly during the Cylon War in order to evacuate populations.

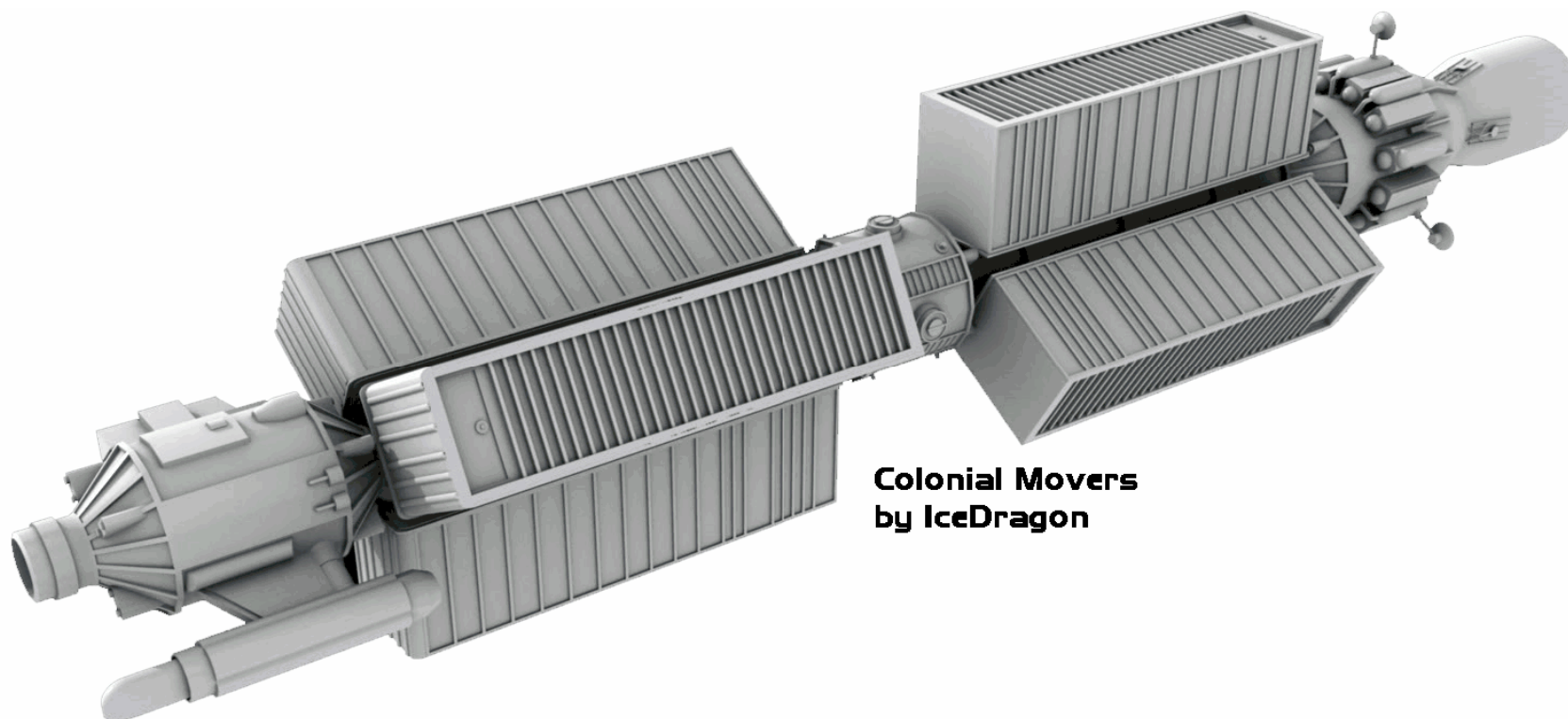

**Colonial Movers**  
by IceDragon

## Colonial Movers - Tanker Variant

Stats by Limerickcot

© by Ice Dragon

### Colonial Mover

**Agi** d4, **Str** d6, **Vit** d6, **Ale** d4, **Int** d4, **Wil** d4

**LP** 10; **Init** d4+d4; **Scale** Spacecraft

**Speed** 4 (SL/JC)

**Traits** None

**Skills** Mechanical Engineering d2, Perception d2, Pilot d4

**Armament** None

**Armour** Wound 1, Stun 1

**Description** 200 x 80 x 80 feet; **Crew** 8

**Passengers** none

Based around the central 'Movers' spinal arrangement, the Tanker variant is the next most common vessel in Colonial Movers vast fleet. This vessel is not a refinery but instead transports refined fuel from depot to depot (she is not set up for in-flight refuelling). The design easily allows for other bulk liquids to be carried – usually water, liquid oxygen or other chemicals. Due to the ease of loading, the Tankers crew is greatly reduced – a welcome saving to the company back home – and also allows more spacious quarters for the existing crew members.

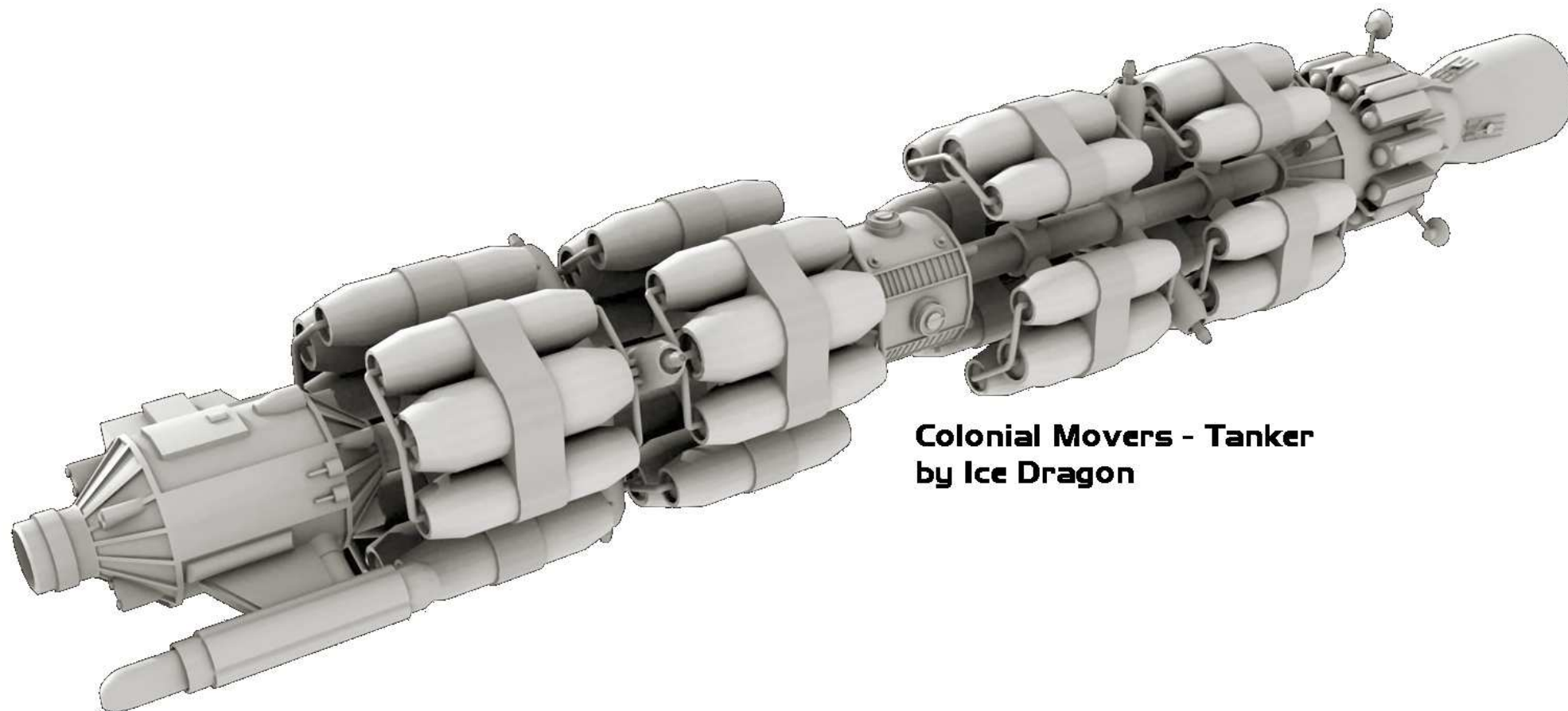

**Colonial Movers - Tanker**  
by Ice Dragon



## Foundry Ship

Art by Ice Dragon

Stats by Limerickcot

**Agi** d4, **Str** d12, **Vit** d8, **Ale** d4, **Int** d4 **Wil** d6;

**LP** 14; **Init** d4+d4; **Scale** Spacecraft

**Speed** 4 (SL/JC)

**Traits** Memorable (d2)

**Skills** Mechanical Engineering d4, Perception d4, Pilot d4

**Armament** None

**Armour** Wound 2, Stun 2

**Description** approx. 4,100 x 3020 x 1,500 feet; **Crew** 82

**Passengers** 1700 (standard)

Iskelian's Foundry ships are well renowned throughout colonial space.

Although most space-borne industrial needs are met by the use of habitats, there is also a need for on the spot manufacturing plant, especially in out-of-the way places or over new colony's or outposts.

These vessels take the raw materials, refine them (if not already done) and then produce a wide range of products dependant on the needs of its current market, from civilian earth movers to ammunition. This version also has an assembly plant added to one side for shuttle production. Its other side includes a space dock befitting its use a mobile shipyard serving both civilian and military vessels operating in its area.

Iskelian also operates a large number of flat-tops (the Foundry Ship was based around that design). The listing of passengers refers to the manufacturing staff as opposed to just ship systems staff.



**Foundry Ship**  
by Ice Dragon

## Light Transport Ship – LTS Scylla

Stats by Limerickcot  
© by Ice Dragon

*Figures in parentheses are based on no external cargo pods being carried.*

**Agi** d4[d6], **Str** d8[d6], **Vit** d6, **Ale** d4, **Int** d4, **Wil** d4

**LP** 12 [10]; **Init** d4+d4 [d6+d4];

**Scale** Spacecraft

**Speed** 4 [7] (SL/JC)

**Traits:** None

**Skills** Mechanical Engineering d2, Perception d2, Pilot d4

**Armament** None

**Armour** Wound 1, Stun 1

**Description** : 420 x 60 x 140 feet;

**Crew:** 79

**Passengers:** 20

**Cargo:** 1000 tons internal in a centre-line cargo hold (some variants delete this)

Capacity for nine to twelve large cargo pods.

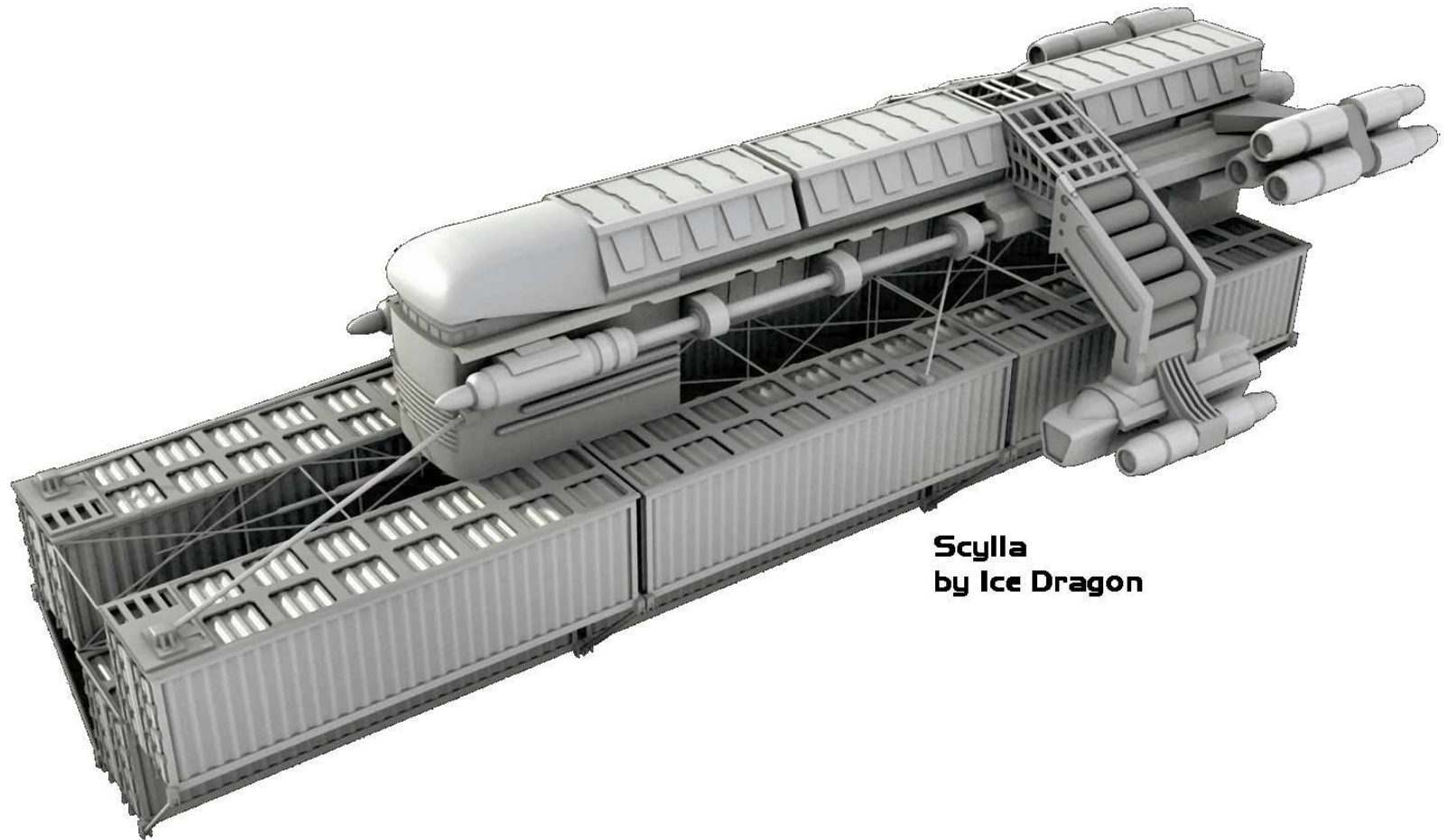

**Scylla**  
by Ice Dragon

Scylla is typical of a number of light cargo carriers owned and operated by independent transport lines. Unlike Colonial Movers, which utilise older technology, the LTS Scylla uses better and more efficient engines to allow her to travel faster when not carrying bulk cargo containers. The fact that her interior holds can take up to 1000 tons of cargo also makes her ideal for transporting more delicate goods that can normally be carried in one of up to twelve large containers. LTS Scylla has become a popular ship amongst her crews and passengers as quarters for both were based on long-term occupation. They are some of the most uxorious standard quarters to be found on any common transport within the colonies.

When not carrying the bulk containers, Scylla's speed rises appreciably (speed 5 with only four pods, and speed 6 with only two). Scylla has one problem with her cargo pods – she can only land safely with four pods at any

one time. If she carries more than this, she has to disconnect her support frame, reconnect four of the pods and land. Then fly back into orbit to pick up the rest of the pods and so forth. Scylla LTS' can be landed with more pods but the lack of control when attempting to do so seriously impairs the skill of the pilot. They are not quite so constrained when taking off and so it is legal for an LTS to depart port with up to nine pods attached to its frame. On a final note, the fuel for her engines is transported in plug-in fuel cells, making her easy to replenish in out of the way outposts and small towns. She can still refuel directly from main pumps though.

Some of these class have the centreline hull section removed. This allows them to operate as a recovery vessel for smaller ships, by attaching the disabled vessel to her centreline and outriggers.

## ***Ulysses Cargo Carrier***

Stats by Limerickcot

© by Ice dragon

**Agi** d6, **Str** d8, **Vit** d8, **Ale** d4, **Int** d4, **Wil** d8

**LP** 16; **Init** d8+d4; **Scale** Spacecraft

**Speed** 3 to 5 (SL/JC)

**Traits** None

**Skills** Mechanical Engineering d6, Perception d6, Pilot d6

**Armament** None

**Armour** Wound 2, Stun 1

**Description** 410 x 160 x 115 feet; **Crew** 37

**Passengers:** variable

The latest ship to be built for the Colonial Movers Company is the Ulysses. This mover was designed specifically to carry pressurised cargo in various temperatures and environments.

From passengers to livestock to live plants, Ulysses is capable of transporting all of these safely and from point to point (an improvement on their normal transportation arrangements). The framework that Ulysses sits upon is extendable and consists of a pressurised walkway (leading from the living/engineering section through to the fore-dock). This connects with multi-airlock connectors (which also serve as the ships lifeboats). From these, access can be made to each of the cargo pods carried. This picture shows only 12 pods connected to the frame but she can actually carry up to sixteen,

although doing so will reduce her speed (to 4). In addition to this regular space containers can be fitted to the top of the frame (reducing speed to 3). Fuel and the main bulk of the engines are located under the frame. A standard passenger pod will carry 200 passengers in relative comfort (for a week or so) or 100 passengers (for longer durations). However, long term carriage of passengers or animals requires a cargo container to be carried with additional supplies as the pods only carry limited recycling arrangements.

This ship carries no sub-craft (unless it utilises the container grapnels on the upper frame).

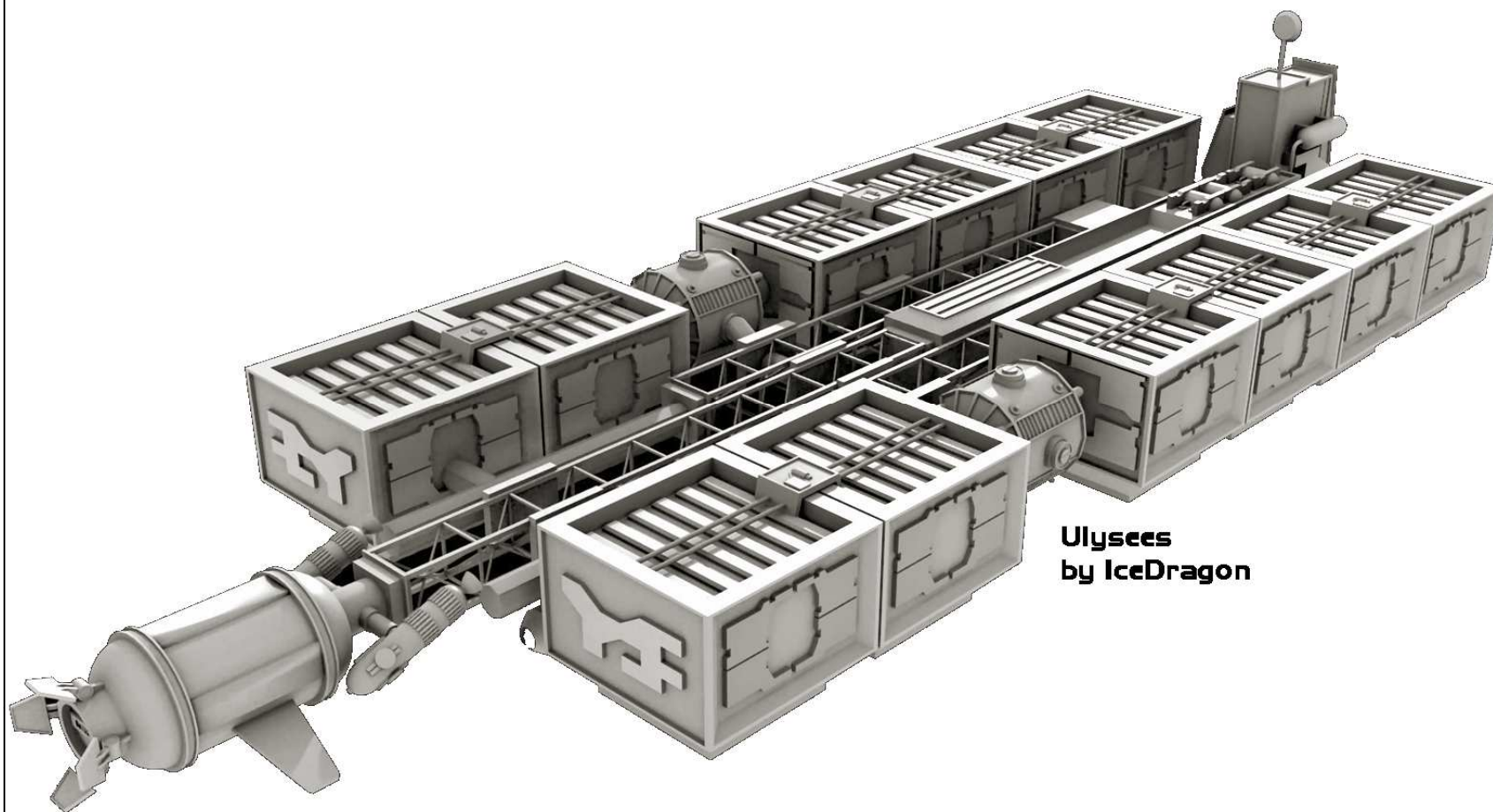

**Ulysses**  
by IceDragon



## **Prometheus Utility Support Vessel**

Stats by Limerickcot

Art by Ice Dragon

**Agi** d6, **Str** d12, **Vit** d8, **Ale** d8, **Int** d8, **Wil** d8

**LP** 20; **Init** d6+d8; **Scale** Spacecraft

**Speed** 5 (SL/JC)

**Traits** None

**Skills** Mechanical Engineering d8, Perception d6, Pilot d6

**Armament** None

**Armour** Wound 2, Stun 1

**Description** 3236 x 730 x 1006 feet;

**Crew** 1400 **Passengers** see text

Utility Support Vessels are what makes life bearable out in space. Capable of carrying large amounts of cargo, able to carry out light engineering and manufactory work and finally, usually equipped with recreation facilities for its clientele, these ships are a welcome addition to any area carrying out work in the wilderness.

By the same token, they have sometimes become a haven for the criminal elements who feed off the quite high wages brought in by those who work far out in space and who have nothing else to spend their money on. On a USV you can gamble, find a socialator, drink, swim (they have several pools), watch the latest tri-D, work out, shoot or even find something a little more risqué, if the money is right and that is being catered for in that vessel. The CIBS keep a close eye on the comings and goings of these ships. So do corporate interests who use the vessels to control or spy on their outer concerns. Its communications arrays also allow the UTV to serve as a point of contact between the colonies and the outposts and perhaps the longest queue of any, on board, is at the Post Office. Here both physical and recorded mail is delivered and received.

This USV maintains a fleet of thirty shuttles and tugs (including a Scylla) to handle the large containers it shuttles out to the industrial bases. Although Jump Capable, these ships rarely utilise that facility in system, as the ship will move from outpost to outpost at sublight speeds, continually serving as a base for the various places it visits.

Over 3000 cabins can accommodate passengers, ranging from single staterooms to quad rooms. In addition she carries a further 2000 box cabins – banks of single person 'boxes' set up in rows, each with a small locker and communication panel. Communal showers and heads are the norm for these. This capacity also makes a USV the ideal ship to use when establishing a new outpost. They are rarely used for colonisation ventures, unless that colony is also supporting a mining venture.

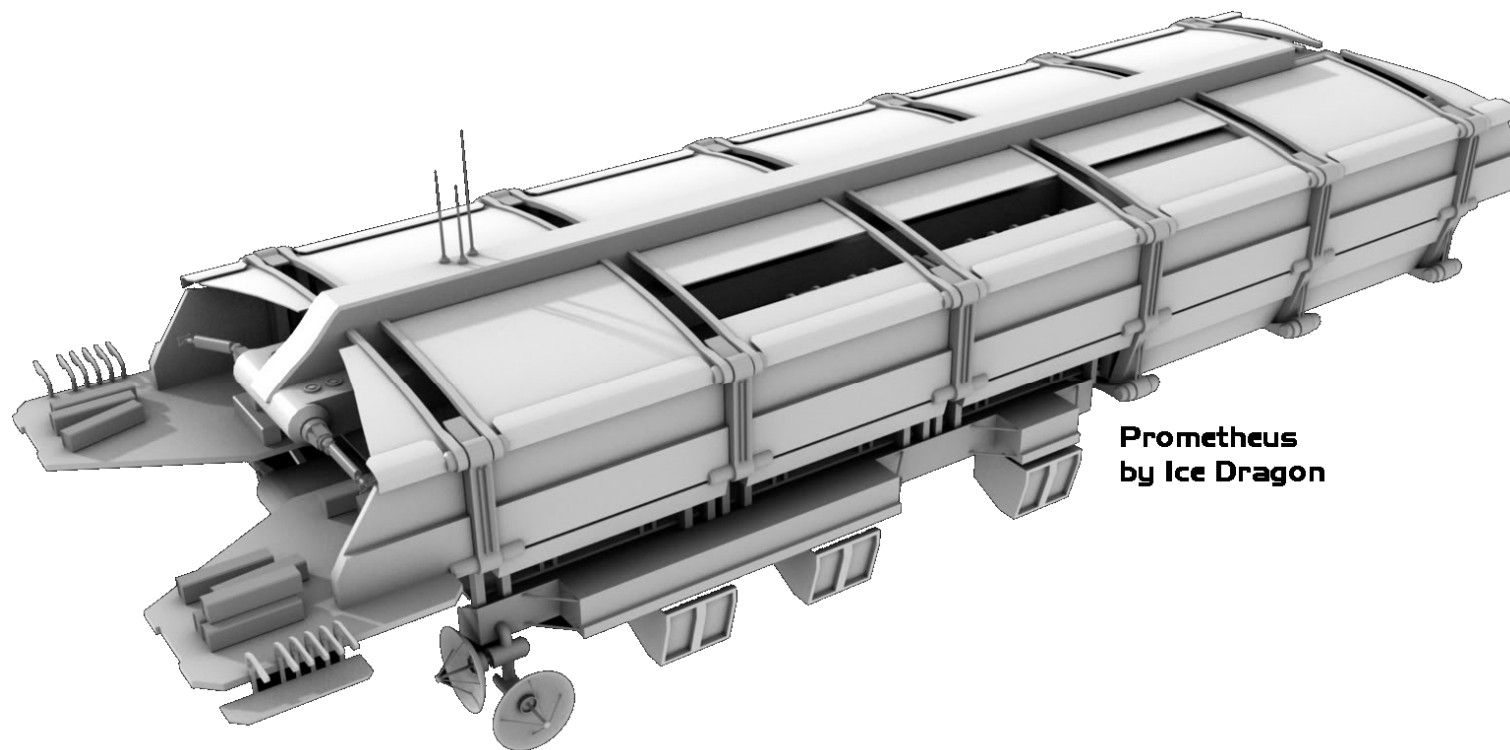

**Prometheus**  
by Ice Dragon

## ***Gideon Transport***

Stats by Limerickcot

**Agi** d6, **Str** d12, **Vit** d6, **Ale** d6, **Int** d6, **Wil** d4

**LP** 16; **Init** d6+d6; **Scale** Spacecraft

**Speed** 6 (SL/JC)

**Traits** Healthy as a Horse

**Skills** Mechanical Engineering d6, Perception d4, Pilot d4

**Armament** None

**Armour** Wound 1, Stun 1

**Description** 1787 x 480 x 750 feet;

**Crew** 500 **Passengers** 700

**Internal Cargo:** 10000 tons

**Subcraft:** 3 shuttles

Gideon is designed to carry a multitude of non-standard cargo pods, mainly those carrying liquids. In addition she can carry varieties of pods in under-slung attachments.

Other than a set of large and capacious cargo holds the Gideon has a mass of plumbing and pumping equipment, designed to deal with everything from liquid oxygen to grain to bulk milk supplies, and to keep the contents of the tanks at the correct pressure and temperature for the correct content.

The success of the Gideon lies in her own abilities and the skills of her crew. Two of the top mounted tanks are the ships own, used to clean and disinfect and sterilise both her own, and other ships, cargo tanks. As such the Gideon earns money from this facility as well as her own transport capacity. She also carries a distillation facility which allows her to recycle water. And has been used, from time to time in the manufacture of industrial alcohol.

Passage aboard this ship is rough and ready.

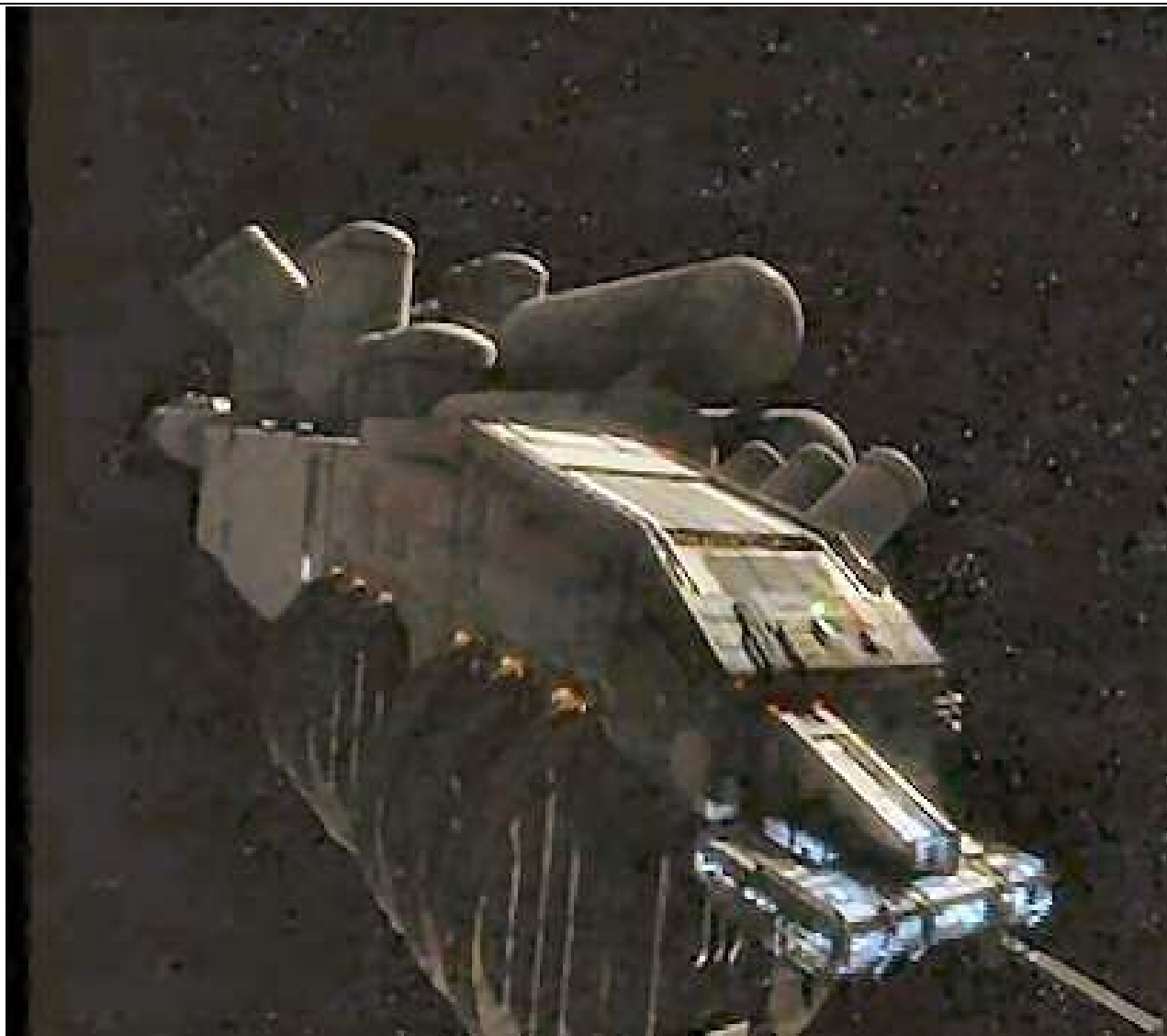

## ***Investigator Class***

Art by Chris Foss  
Stats by Limerickcot

**Agi** d4, **Str** d10, **Vit** d8, **Ale** d6, **Int** d8, **Wil** d8;

**LP** 18; **Init** d4+d6; **Scale**

Spacecraft;

**Speed** 3 (SL/JC)

**Traits:** None

**Skills** Mechanical Engineering d4, Perception d4, Pilot d6, Knowledge d8

**Armament** None

**Armour** Wound 2, Stun 2

**Description** 4,500 x 1,250 x 1,250;

**Crew** 210; **Staff** 600

Although based around the same design that forms the basis of the famous 'Space Park', the Investigator science vessels are designed for long endurance trips. In addition to FTL and a very efficient (but low powered) drive system, the Investigator also carries a solar array to save on fuel consumption (and also because a regular power plant can sometimes interfere with certain types of observation or experiment).

Living quarters are found within the rings (again normal centrifugal forces allow savings on power helping to extend the vessels endurance). Sets of supplies in modular pods are attached to the aft shaft. Supply ships bring in pods and take back empty ones to the vessels home base. The actual laboratories are mounted on either side of the hull located between the rings. These rely on standard anti-grav within their structure. One standard feature aboard all of these ships is the optical telescope that runs almost the entire length of the ship, stem to stern. Removing this feature is not considered cost-effective and observations taken by this telescope can always bring in a little bit of extra income. Most ships, no matter their actual purpose, always develop a few amateur observers – as its one of the few free hobby's that can be easily accommodated for in the waste of space.

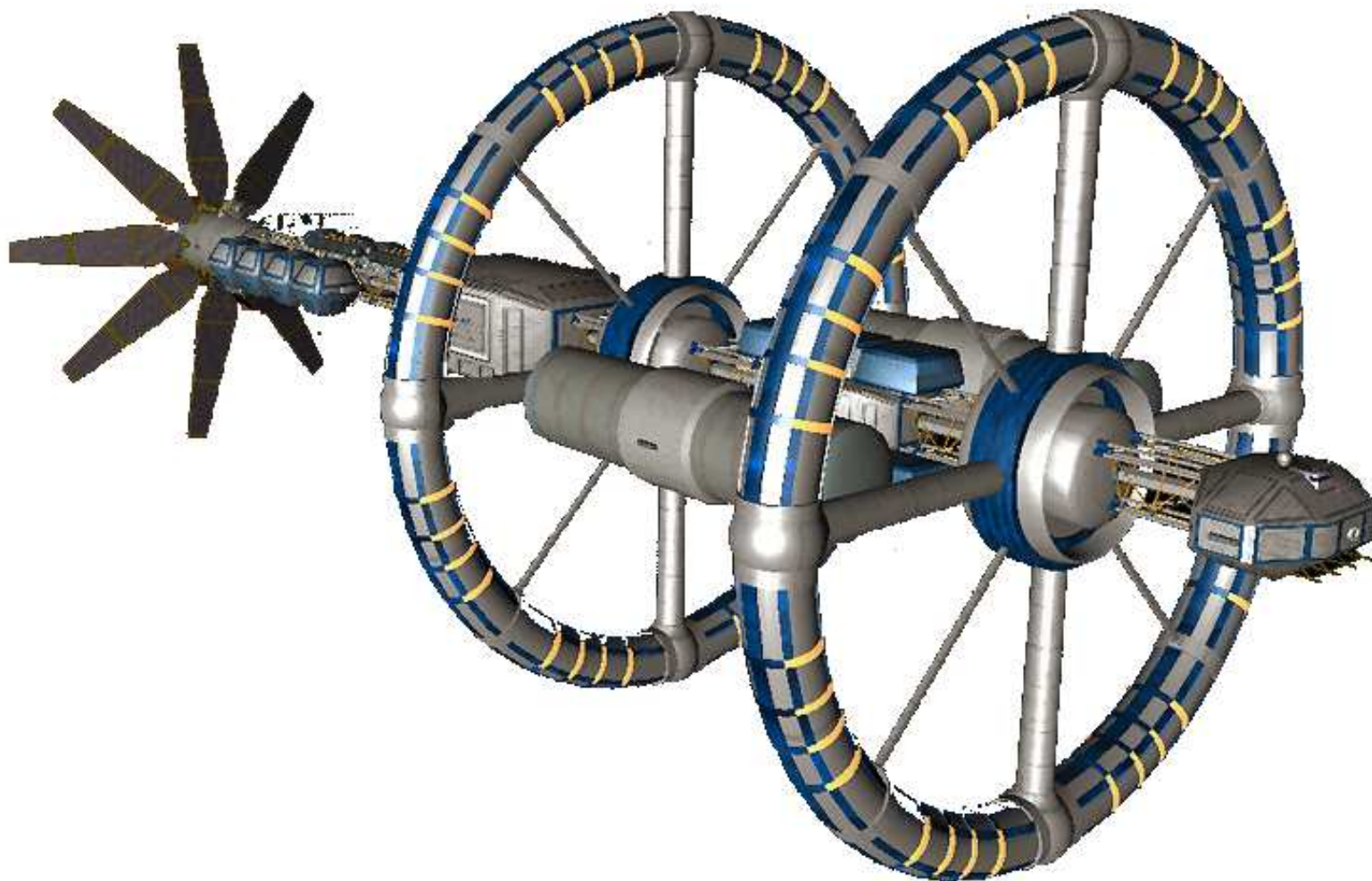



## ***Rising Star***

Art by Coxxon

Stats by Limerickcot

**Agi** d6, **Str** d8, **Vit** d6, **Ale** d4, **Int** d4, **Wil** d6

**LP** 14; **Init** d8+d4; **Scale** Spacecraft

**Speed** 5 (SL/JC)

**Traits** None

**Skills** Mechanical Engineering d6, Perception d6, Pilot d6

**Armament** None

**Armour** Wound 1, Stun 1

**Description** : 1430 ft long x 1040 ft wide x 455 ft high

**Crew** 314, **Passengers**: 1800

**Subcraft**: Up to 8 shuttles

The Rising Star is an older style liner (similar to the Astral Queen). This type of vessel has seen many conversions and is a regular sight on the interplanetary runs. One of the most common variants is that of a hospital ship, usually maintained by a planetary government for civil defence needs.

The two large vents on the upper surface are actually the shuttle bays for this class. Her ability to carry up to 8 large shuttles make's her an invaluable class of ship for expeditions and colonisation attempts.

As a liner, even a second-class one, her insides are sumptuous and includes cinemas, holo-suites, bars, shops, recreational facilities, a casino, ball-room, conference centre, offices and some of the best communications facilities to be found on any ship in the colonies. Her 1800 passengers are accommodated in two-person staterooms of various sizes (several are interconnecting). A few liners have converted some of those staterooms to accommodate 4 people instead (the cut-price lines as they are nicknamed).

As a hospital, the ship has seen most of its public areas gutted and replaced with sophisticated operating theatres, regeneration and life stations, whilst many of the cabins are converted into wards instead. These ships have a crew of 110, a medical staff of 460 and can carry up to 2000 patients (depending on whether the ailments are infectious or not – a plaque vessel will cut the numbers of patients down to 500)

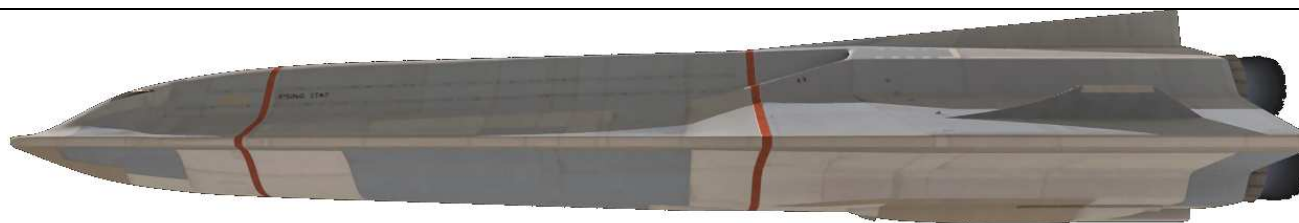

**Rising Star**  
by coxxon

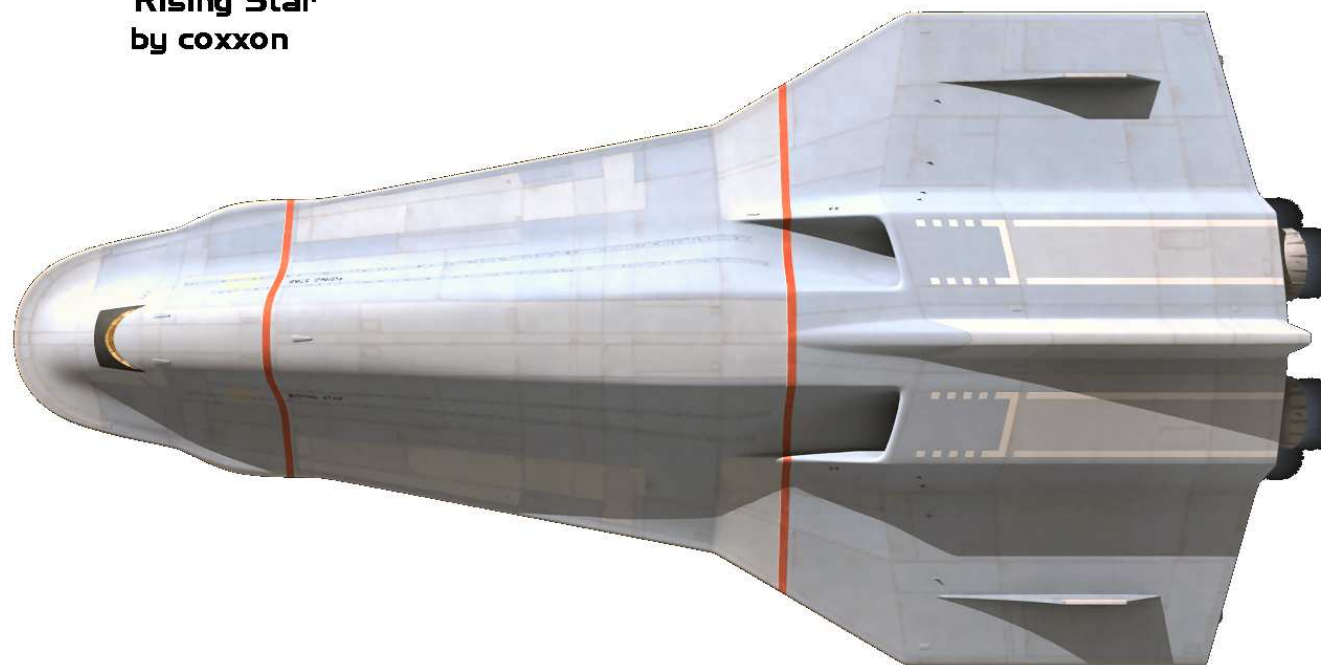

## ***Demetrius Sewage Ship***

Art assumed to be Zoic Studios

Stats by Limerickcot

**Agi** d8, **Str** d8, **Vit** d6, **Ale** d4, **Int** d4, **Wil** d6

**LP** 14; **Init** d8+d4; **Scale** Spacecraft

**Speed** 5 (SL/JC)

**Traits** None

**Skills** Mechanical Engineering d4, Perception d6, Pilot d4

**Armament** None

**Armour** Wound 2, Stun 2

**Description** : 373 ft long x 81 ft wide (97ft with detachable tanks) x 170 ft high

**Crew** 36 Passengers: up to 50 in bunkrooms

Small Craft: 2 shuttles

Demetrius style ships are found throughout Colonial space, especially on the frontiers where they service many outposts. The need to recycle or clean human waste is a constant problem for many smaller ships and outposts that only have limited capability to deal with this problem. For small mining or police posts or smaller ships that don't deal with this problem at regular ports, a Sewage Ship deals with the problem. At its most basic level the ship can transport over 5000 tons of raw sewage to a processing plant. However its more common use is to treat the waste, siphoning off any byproducts for later sale or disposal (the treated solid waste is usually sold back to stations and outposts for use in their gardens.

Demetrius carries two shuttles and has extensive EVA facilities, temperature control for its cargo element and even a 400 ton cargo facility and 200 ton refrigerator – it normally fulfils the post of mail carrier, crew replacement carrier and stores supply at the same time it deals with its other function. Deck fixings allow it to carry additional small craft easily (usually a few extra shuttles to replace ones damaged at outposts.)

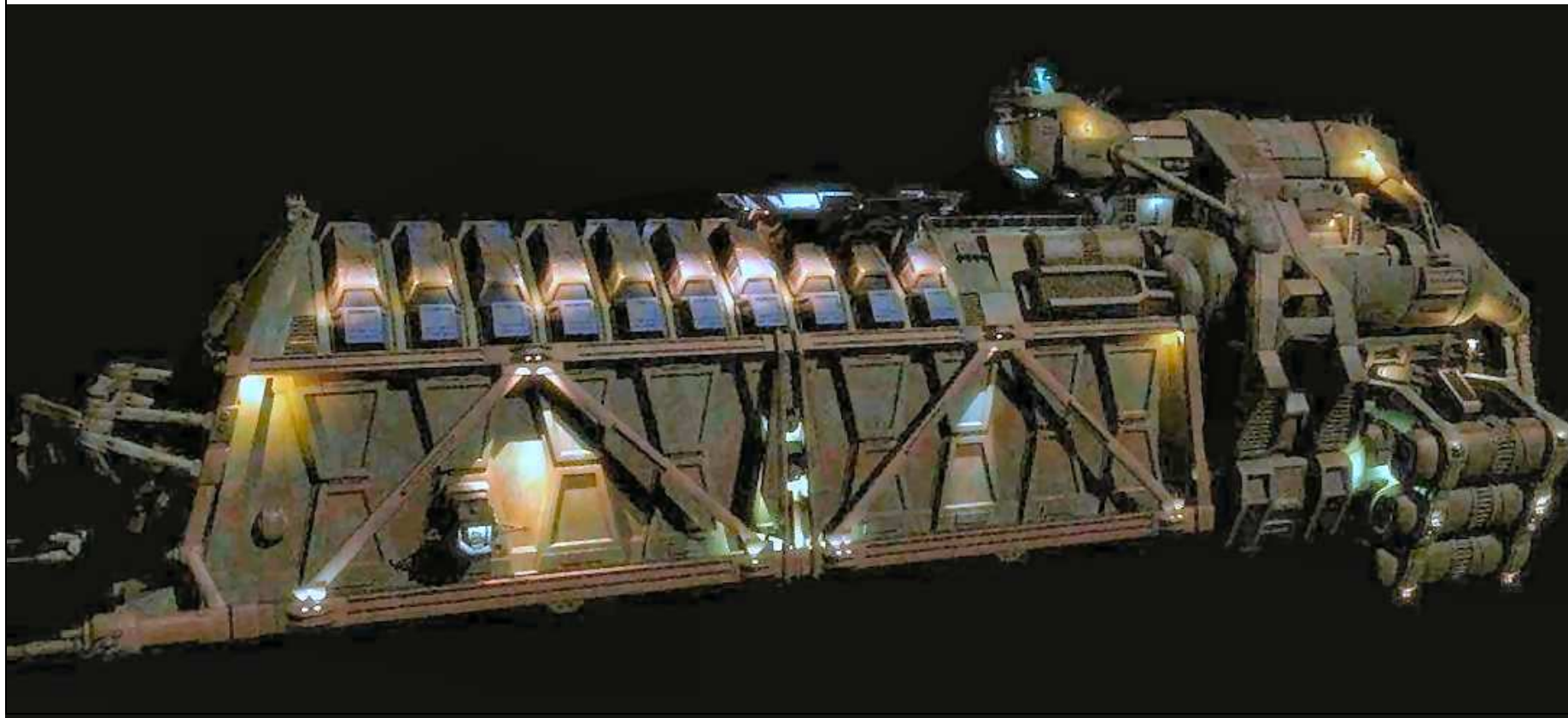

## ***Tylium Refinery Ship***

**Stats by Buscadero**

© by Paul Ghezzeo

**Agi** d4, **Str** d10, **Vit** d6, **Ale** d4, **Int** d4, **Wil** d6

**LP** 16; **Init** d4+d4; **Scale** Spacecraft

**Speed** 4 (SL/JC)

**Traits** None

**Skills** Mechanical Engineering d4, Perception d4, Pilot d4

**Armament** None

**Armour** Wound 2, Stun 2

**Description** approx. 1,650 x 450 x 350 feet ; **Crew** 75

This commercial vessel illustrates the hazards in dealing with Tylum and with supplying widely scattered outposts in both the Colonial Coreworlds and their outlying systems.

The Refinery ship processes the raw ores via conveyor belt, taking the raw ore, crushing it, separating, purifying it and finally storing it in its most basic form, before passing it on to for conversion to fuel.

As Tylum is so volatile at certain steps in its production, the vessel is heavily compartmented internally to give its crew some measure of protection and each Tylum bin is also heavily armoured with blow out valves to allow any explosive decompression to blow outward and away from the ship. Tylum Refinery ships rarely breach atmosphere. Instead shuttles carrying the raw (non-volatile) ores dock with the Refinery ship (or stations) for processing away from more vital industrials and infrastructures.

The largest refinery station is located above Canceron's North Pole and is comprised of eight equidistant semi-automated habitats, all linked into a



central hub. Only habitat 7 is original. All the others have suffered catastrophic explosions and severe damage over the years, resulting in their replacement. Salaries aboard a Tylum Refinery are some of the highest in the industry.

Further complications on the refinery vessels themselves come from docking manoeuvres with other vessels. Colonial Military Refineries are more heavily armoured and refuel using long umbilical tubes to both lessen any impact dangers and to allow multiple refuelling at any one time.



## **Botanical Cruiser**

Stats by Buscadero

© by Ice Dragon

**Agi** d4, **Str** d10, **Vit** d6, **Ale** d4, **Int** d4, **Wil** d6

**LP** 18, **Init** d4+d4, **Scale** Spacecraft

**Speed** 4 (SL)

**Traits** Memorable (d2), Tough (d4)

**Skills** Mechanical Engineering d4, Perception d2, Pilot d4

**Armament** None

**Armour** Wound 1, Stun 2

**Description** 3,250 x 600 x 650 feet; **Crew** 500

**Passengers** 500 (standard), 2,000 (emergency) or more if frame is adapted.

Botanical Cruisers are vessels with domes that may serve as space-borne vacation ships. Normally they are used to grow and replenish plants for the stations and other vessels that they dock with along the way. The example shown is used for cargo and passenger transport as well. Other vessels are equipped with domes along their entire length. They are also capable of growing foodstuffs that are needed in a convoy or Fleet for long periods of time. These vessels have translucent hull plates interconnected in a structural enforcement grid, which allow the plants to receive the necessary sunlight.

Botanical Cruisers are unarmed, but can withstand an assault for some period of time. Although not normally jump capable, a small number have been converted to this end to allow the seeding of colonies outside of the home systems. Indeed, a BC is amongst the first colonisation vessels on station at a new colony, adapting colonial plants to the new ecosphere they are being introduced to.

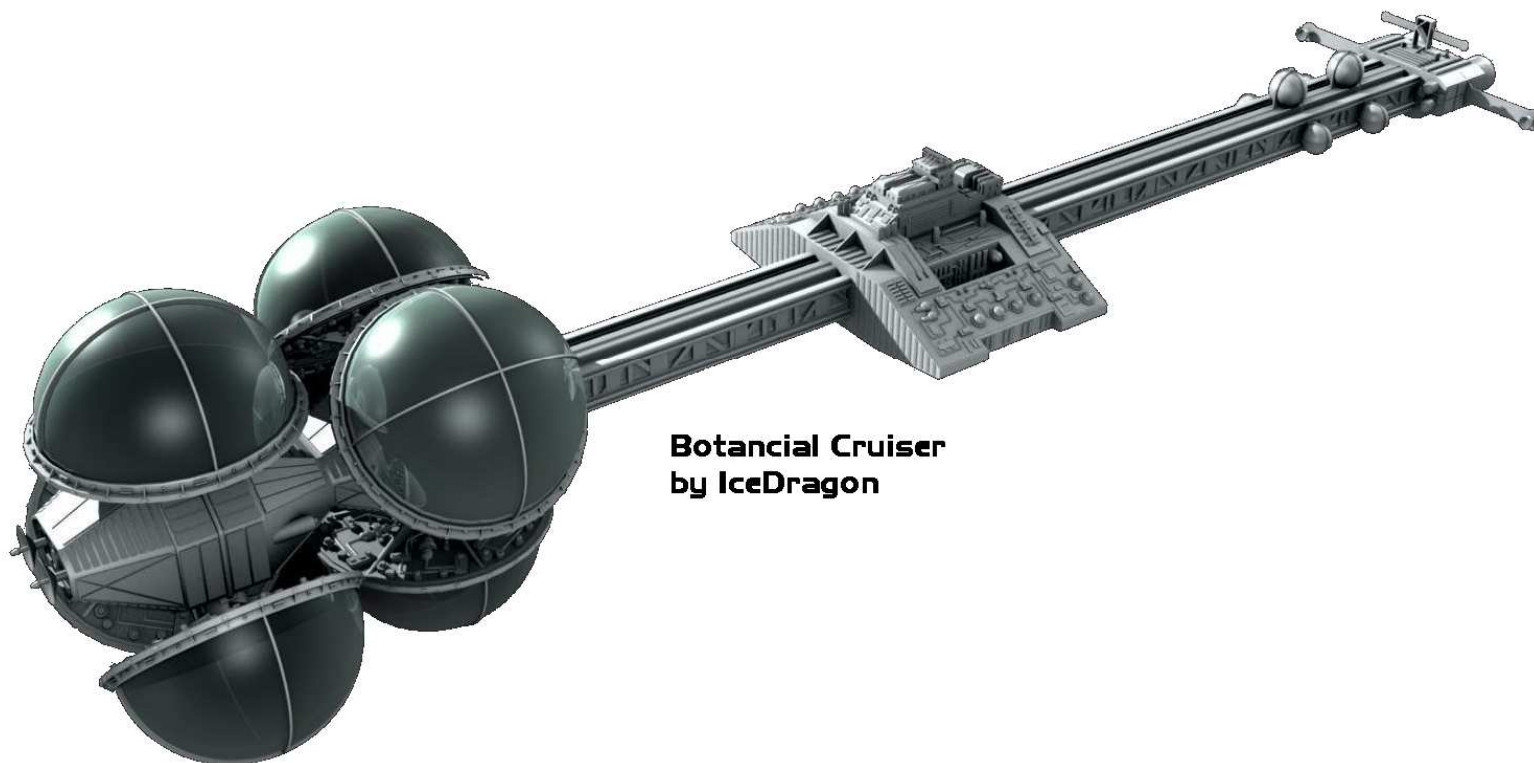

**Botanical Cruiser**  
by IceDragon

## **Agroship**

Stats by Limerickcot

© by Coxson

**Agi** d4, **Str** d8, **Vit** d6, **Ale** d4, **Int** d4, **Wil** d6

**LP** 14, **Init** d4+d4, **Scale** Spacecraft

**Speed** 5 (SL/JC)

**Traits** None

**Skills** Mechanical Engineering d2, Pilot d4

**Armament** None

**Armour** Wound 2, Stun 2

**Description** 2,250 x 600 x 650 feet; **Crew** 620

**Passengers** 400 (standard), 1600 (emergency)

Although the Botanical cruiser is the vessel usually associated with the

public and media as the forefront of agriculture in space, the work horse of such projects are the Agroships.

These vessels carry up to 14 agro-domes, each of which can maintain and support life independently of the ships power grid. The translucent panelling that allows sunlight through into each dome also generates power via photo-voltaic cells embedded into each panel. Together with a recycling water supply the domes need little additional input during any agricultural life cycle.

However, if used to grow crops, then additional water and nutrients must be added to each dome to allow the crop to reach full viability.

In civilian use the most common use of this vessel is to 'piggy-back' replenishment agro domes out to various stations. The domes are an essential element of the oxygen replenishment cycle on such bases. When the existing domes age or are contaminated, a new one is shipped out and the old one shipped back for gutting and sterilisation before it is reused and replanted, ready for the next base. As a result, there is a constant need for such ships, although the total number in service is very few.



**Agroship  
by Coxson**

## **Grain Ship**

Stats by Limerickcot

© by Coxxon

**Agi** d4, **Str** d8, **Vit** d6, **Ale** d4, **Int** d4, **Wil** d10

**LP** 18, **Init** d4+d4, **Scale** Spacecraft

**Speed** 6 (SL/JC)

**Traits** None

**Skills** Mechanical Engineering d6, Pilot d6, Perception d6

**Armament** None

**Armour** Wound 2, Stun 2

**Description** 1100 x 650 x 600 feet; **Crew** 110

**Passengers** 270 (standard)

Subcraft: 30 Shuttles

The Grain Ship is a specialised bulk carrier that plies its trade from grain silo to grain silo across the various worlds.

It will land, hook up to a number of silo's and transfer the grain to one of its onboard silos. Here the individual temperature is maintained for the type of grain being transported (the transfer mechanism also involves a sterilisation program to deal with insects and other vermin.

Then the ship moves onto another pick-up point until all of its silo's are full. From there it will then proceed to the factory for offloading and processing.

Many of these massive vessels (in comparison to the silo's they operate around) are the first sight of a space ship that a farmer (or small town folk) will ever see. The construction of the ship allows for the easy dismounting of individual 'silo's' for easy of cleansing after its grain has been delivered. Due to the restrictions on landing in some areas, the Grain Ship carries 30 shuttles designed for bulk grain transport so that they can service



***Plynn Grain Ship  
by Coxxon***

smaller farms on their route. It also carries a cargo hold that holds many specialised supplies for those farmers, which the shuttles also deliver.



## ***Tubilar – Tramp Freighter***

Stats by Limerickcot

© by Coxxon

**Agi** d6, **Str** d8, **Vit** d10, **Ale** d6, **Int** d4, **Wil** d10

**LP** 18, **Init** d6+d6, **Scale** Spacecraft

**Speed** 4 (SL/JC)

**Traits** None

**Skills** Mechanical Engineering d4, Pilot d6, Perception d2

**Armament** None

**Armour** Wound 2, Stun 2

**Description** 900 x 376 x 310 feet;

**Crew** 57, **Passengers**

500 (standard)

Subcraft: 12 Shuttles

The Tubilar Class is a series of Tramp Freighters – ships

designed to carry both passengers and cargo to its destination.

Deliberately designed to land in out of the way places where support and other facilities are generally lacking, all the Tubilar actually needs is a stable are of ground large enough to take it. Its cargo hold is located in the centre portion of the ship, with shuttle bays in each cylinder. The passenger facilities are located in the centre top decks. Due to the need for security passengers have no access to the cargo holds or the crew areas. Crew quarters and facilities are located in the forward nacelle.

If Tubilars have one fault, it is their slow speed. Built with older but reliable parts, the ship class is known for its ability to soldier on, despite multiple breakdowns and considerable damage being incurred.

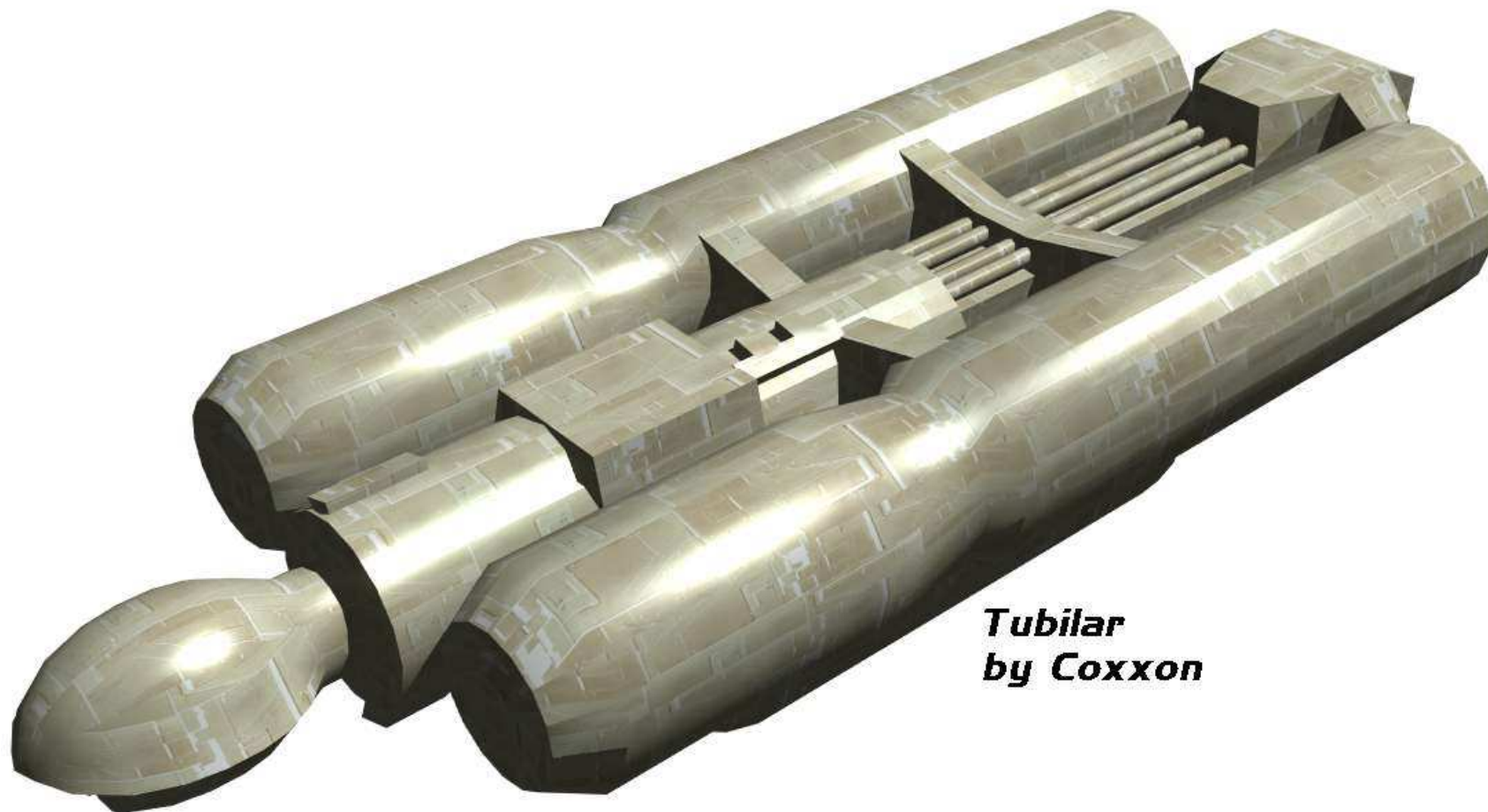

***Tubilar  
by Coxxon***

## **Ourobous Class** – Converted to Forward Close Support Hospital Base

**Agi** d4, **Str** d12, **Vit** d10, **Ale** d10, **Int** d12, **Wil** d12  
**LP** 24, **Init** d4+d10, **Scale** Spacecraft  
**Speed** 7 (SL/JC)

**Traits** Memorable (d6)

**Skills** Mechanical Engineering d6, Pilot d6, Perception d12\*, Heavy Weapons d6

\*The Perception skill is shown above normal ship standards in order to represent:

1. the automated tracking systems for incoming/outgoing ships
2. medical needs
3. logistic needs

### **Armament**

Planetcraft scale, skirmish range, Heavy PDS (d12)

**Armour** Wound 2, Stun 2

**Crew** 583,

**Other Accommodation** (mainly single or bunk room):

800 Primary Care Staff, 2000 Secondary Care Staff (cooks, cleaners, lab personnel, shuttle pilots etc), 120 troops/security staff

A mix of quarters, extensive training, recreational and rest facilities are aboard in addition to the strictly medical facilities.

66 wards of 22 people each

13 wards of 14 people each

For a total of 1634 primary patients, And up to a further 250 capacity of patients undergoing care at any time

Morgue capacity of 4000

Cyro-tube capacity of 6000

Reserve electronics suites, Swimming Pool, Bowling Alley, Gymnasium, Restaurant, Café's, Night Club/Theatre, PX Shops, Holographic Suites, Conference Rooms,

### **Subcraft:**

5000 Lifeboats, 100 'Ambulance' Shuttles, 12 200 ton Long Range Transports, 6 2000 ton tenders

Art & Stats by Limerickcot

### **Dimensions:**

**Spirals:** 1872 x 156 x 156

**Dock:** 624 x 156 x 156

**Crew:** 936 x 312 x 312

**Engine:** 1872 x 156 x 156

### **Hospital Facilities:**

Pre-op & Triage, Operating Theatres, Laboratories, Dressing Stations, Scanner Rooms, Burns Regeneration, Intensive Care, Intermediate Care, Convalescent Care, Pharmacy, Sanitation Units, Equipment Stores & Repair, Chapel, Reconstruction, Ears, nose & Throat, Neurosurgical Ward, Dental Ward, Maternity Wards, Physiotherapy, Cybernetics (artificial limbs), Reconstructive Surgery, Psychiatric evaluation, Administration, Isolation Treatment Spheres

### **Notes:**

Ourobous was designed as a science vessel and incorporated a unique spiral design wrapped around a massive telescope. Each of the spirals could accommodate two 'slot-in' quadrants, each independent of every other spiral if required. Redundant life support, catering and other systems are found in the ceilings and floors of each spiral. Four lifts traverse along the entire length and interior corridors follow the spirals for the length of the ship. Its support sphere supports most of the living quarters and the luxurious facilities designed to support a large community in spare.

However, due to a severe lack of funding, only four of these ships were completed before a halt was called on the budget. The other eight ships, in various states of completion, were left standing in the yards.

Finally, the Colonial Civil Defence Corps bought up the vessels and had them finished as Forward Close Support Hospital Ships. Larger docking facilities were fitted plus the whole of the equipment for an independent hospital facility. Not forgetting the lessons of thirty years past, they also added a heavy anti-fighter/missile system.

Each ship has a massive control station designed for the operations of over 100 craft constantly going to and fro from the ship to ground, and operating as an emergency rescue co-ordination centre.

One interesting note should be made. Each vessel still retains the original telescope in its core. Most vessels have an active astronomy club.

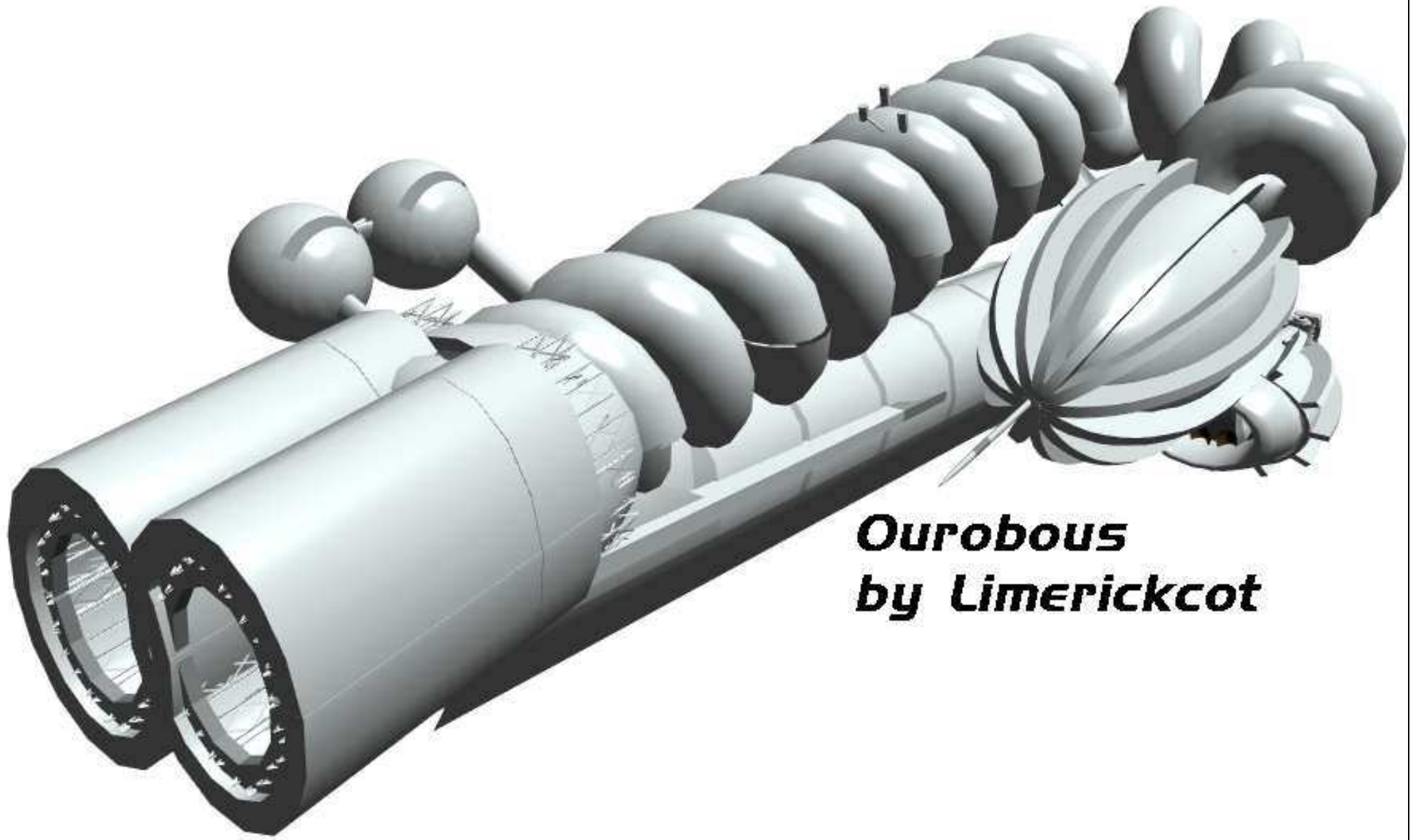

***Ouroboros  
by Limerickcot***



## Gemini Freighter

stats by Buscadero

© by Warrior

**Agi** d4, **Str** d10, **Vit** d6, **Ale** d4, **Int** d4, **Wil** d6

**LP** 16; **Init** d4+d4; **Scale** Spacecraft

**Speed** 4 (SL/JC)

**Traits** Past Its Prime (d4)

**Skills** Mechanical Engineering d4, Perception d2, Pilot d4

**Armament** 6 spacecraft scale short DRADIS range primary assault railguns (d10), 2 Vipers

**Armour** Wound 2, Stun 2

**Description** 1,950 x 550 x 265 feet; **Crew** 87

**Passengers** 600

### Quote

Amongst the older ships in the Colonial Rag-Tag fleet the Gemini freighters have some of the worst living conditions of any vessels in the fleet.

This is to be expected as Gemini Freight Corporation was well known for owning and operating the largest and, in many cases, the oldest cargo haulers' in the Twelve Colonies.

By far and away the Gemini Freighters have the greatest cargo hauling capability of any ship in the fleet, able to haul upwards and over a million metric tons of cargo, from hazardous waste and raw ore, to consumable and clothing these ships are best known for now hauling human cargo in the way of refugees from the colony world Gemenon. Unlike most ships in the fleet the Gemini Freighters are armed, primarily to protect the slow moving freighters from pirates.

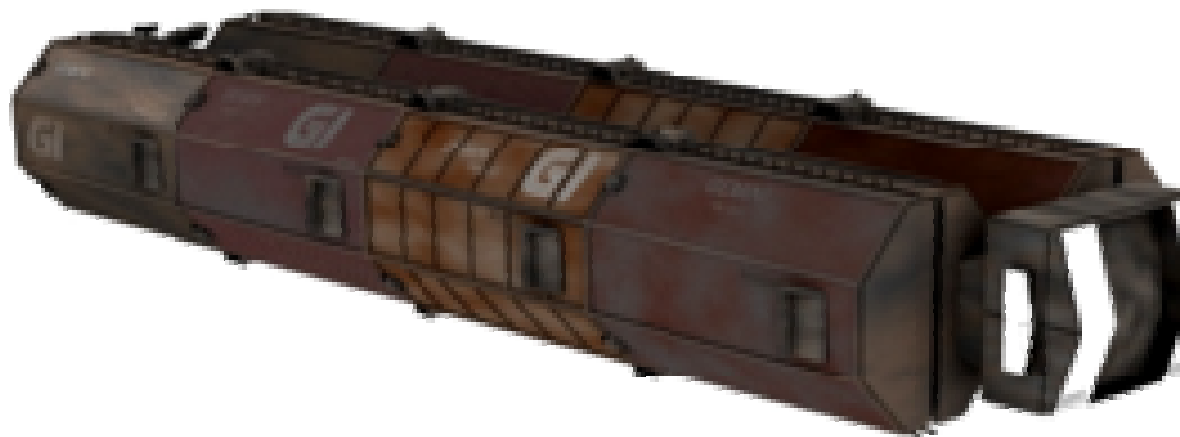

[Battlestar Galactica: Tech-Manual](#)

## ***Mining/Horticultural Ship***

Stats by Buscadero

Art by Ice Dragon

**Agi** d4, **Str** d8, **Vit** d8, **Ale** d4, **Int** d4 **Wil** d6;

**LP** 14; **Init** d4+d4; **Scale** Spacecraft

**Speed** 4 (SL/JC)

**Traits** Memorable (d2)

**Skills** Mechanical Engineering d4, Perception d4, Pilot d4

**Armament** None

**Armour** Wound 1, Stun 2

**Description** 2,600 x 650 x 220 feet; **Crew** 150, Passengers variable

A mining ship is a ship designed to extract raw metals and minerals. This one is typical. The ore is mined, semi-prepared and then passed along to a refinery ship for final processing.

Some variants mine for metals, others for liquids

(including water). Its design allows the bulk of the workers to operate in a pressurised environment even if the mining site is not. Only those workers setting up the initial part of the operation have to work in pressure suits, the rest work within the ships. The design of the vessel has also made it popular as an animal transport, from Cattle to smaller livestock such as chickens and pigs. Only a small percentage of such vessels are equipped this way, and usually only those also involved in the colonisation and development on other worlds.

However, small convoys of these vessels can be seen leaving the more agricultural based planets, at the end of each breeding season, transporting valuable live stock to other worlds. Transportation in such vessels also allows the animals to be acclimatised to a new planetary atmosphere, temperate and pressure system very easily.



**Colonial Mining and Horticultural Ship  
by Ice Dragon**

**Celestra**

stats by Buscadero

© by Coxson

**Agi** d4, **Str** d12, **Vit** d6, **Ale** d6, **Int** d4, **Wil** d6**LP** 18; **Init** d4+d6; **Scale** Spacecraft**Speed** 5 (SL/JC)**Traits** None**Skills** Mechanical Engineering d4, Perception d2, Pilot d4**Armament** None**Armour** Wound 1, Stun 2**Description** 2,000 x 800 x 565 feet; **Crew** 50**Passengers** 500

Celestra is typical of a number of long-duration research vessels found throughout the colonies. Approximately one third of this type is taken up by a large landing bay. This capacity makes it a common vessel to be appropriated and converted as a Merchant Carrier in times of hostilities.

One variant, the Pugin Holme, is renowned as the control craft for the Pugin Races which occur each year. Consisting of a series of orbital races around each of the planets of the Colonial System (with the longest stretches reaching in a figure eight from Caprica to Aquaria and back). The Pugin Holme is the home base for each contestant in the race and is equipped to maintain and fix the racers.

The largest numbers of such vessels (23) are employed by the Colonial Ministry of Civil Defence for Navigation charting and close space surveys. Their spacecraft – probes, shuttles, and specialist craft, sweep and clear space for debris; conduct assistance (and sometimes rescue) missions and above all, conduct a regular maintenance and repair program on all Colonial relays and beacons.

One interesting adaption was made by the Pluto Study Centre for astrophysical planning, who have converted the landing bay of the Celestial Voyeur into a sophisticated telescope for deep space analysis. The CV operates on the fringes (and sometimes beyond) the bounds of Colonial space.





## Space Park

stats by Buscadero

**Agi** d4, **Str** d10, **Vit** d8, **Ale** d6, **Int** d8, **Wil** d8;

**LP** 18; **Init** d4+d6; **Scale** Spacecraft;

**Speed** 3 (SL/JC)

**Traits** Allure (d2), Memorable (d6)

**Skills** Mechanical Engineering d4, Perception d4, Pilot d6

**Armament** None

**Armour** Wound 1, Stun 2

**Description** 4,000 x 1,250 x 1,250; **Crew** 950

**Staff** 500; **Passengers** 3,000

### Quote

The Space Park is an FTL-capable civilian passenger liner. This passenger liner design was so successful that it was adapted for scientific and military uses by replacing passenger accommodation with laboratories, auxiliary power generators, and computer cores.

Its enormous ring section was designed in the days when artificial gravity was too expensive to utilize on a commercial ship of that size.

Some of the Space Park liners were later upgraded to include affordable artificial gravity therefore eliminating the need for their rings to rotate. A few modernized ring liners have maintained their rotation for aesthetic reasons . [Battlestar Wiki](#)

Probably one of the major issues for the ring liners is their inability to transfer passengers and supplies without docking. Normal lading takes place at orbital docks in place above most worlds. The vessels do have a good internal dock, but its own shuttles can only load/unload a few hundred passengers (or tons of supplies) per hour. Travel aboard one of these luxury liners is pleasant and relaxing. Shopping malls, theatres, restaurants, swimming pools and the like make travel aboard these true liners a truly pleasurable experience.

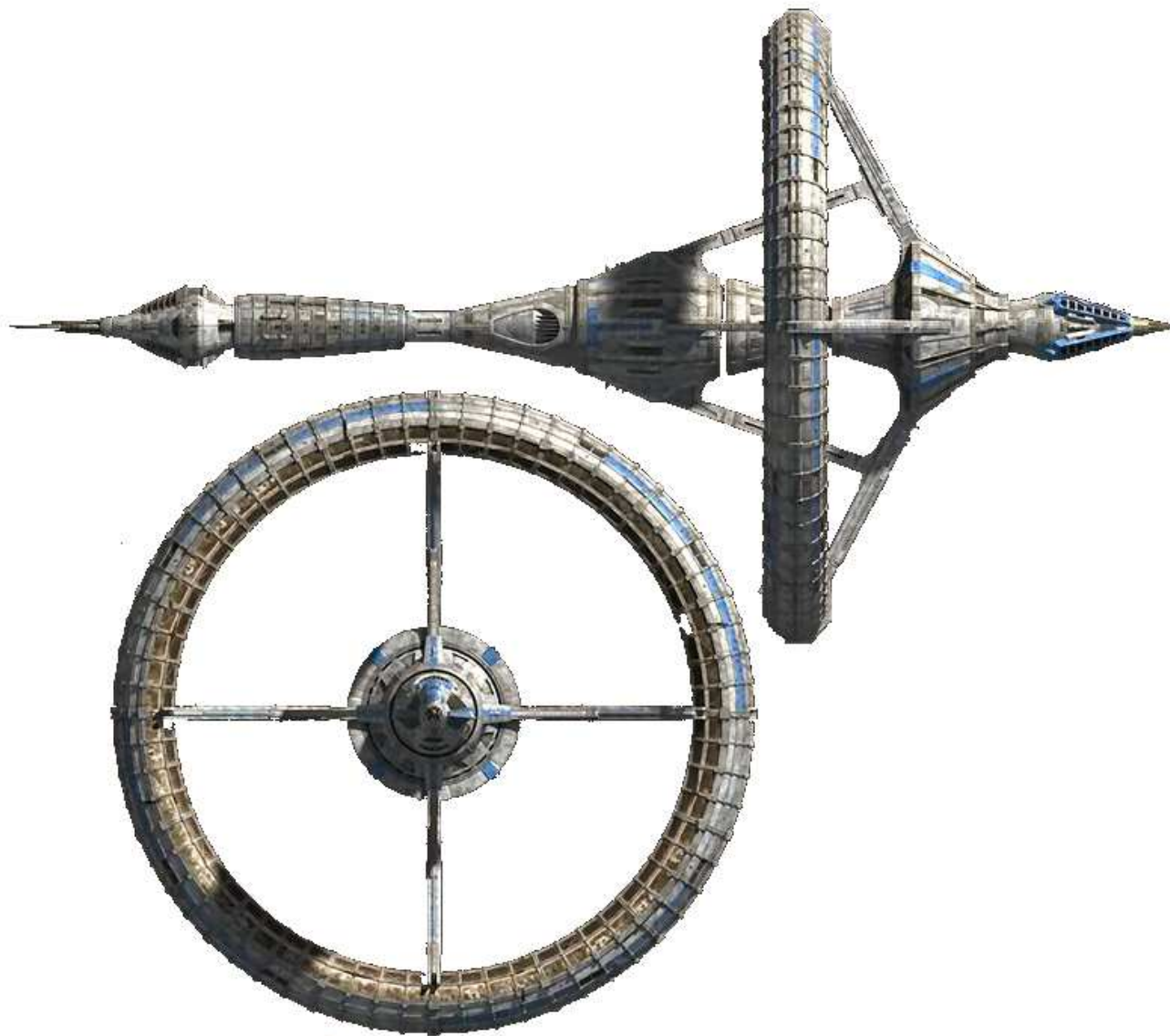

## Delphi-Class Deep Star Explorer

By John Starhawk

**Agi** d6, **Str** d12+d2, **Vit** d8, **Ale** d10, **Int** d8, **Wil** d10;  
**LP** 24; **Init** d6+d10; **Scale** Spacecraft;  
**Speed** 6 (SL/JC)

**Traits** Formidable Presence (d2)

**Skills** Heavy Weapons d8, Mechanical Engineering d2,  
 Perception d6, Pilot d6

**Armament** Medium planetcraft scale skirmish range point-defence system (d8); 3 heavy spacecraft scale short DRADIS range railguns (d12+d2); 10 medium spacecraft scale short DRADIS range missile systems (d12); 6 Vipers, 2 Raptors, 4 assorted craft

**Armour** Wound 4, Stun 3

**Description** approx. 4,200 x 1,575 x 720 feet;

**Crew** 2,500; **Passengers** 5,500

Note: the Heavy Weapons skill breaks the d6 cap to partly reflect the advanced nature of the automatic fire control system as a whole.

Forty years ago, the Cylons vanished into the depths of space. For all those years, the Colonial Fleet remained at a high state of alert, ever watchful against the return of the most deadly enemy ever faced by Man.

As time passed, there were those who came to believe that the resources spent on heavily armed, single-purpose warships represented a waste of those resources. One of those was Calandan, whose family owned one of the largest private shipyards in the Scorpion sphere of influence. He had a vision of a new Colonial Fleet, one dedicated as much to expanding the boundaries of

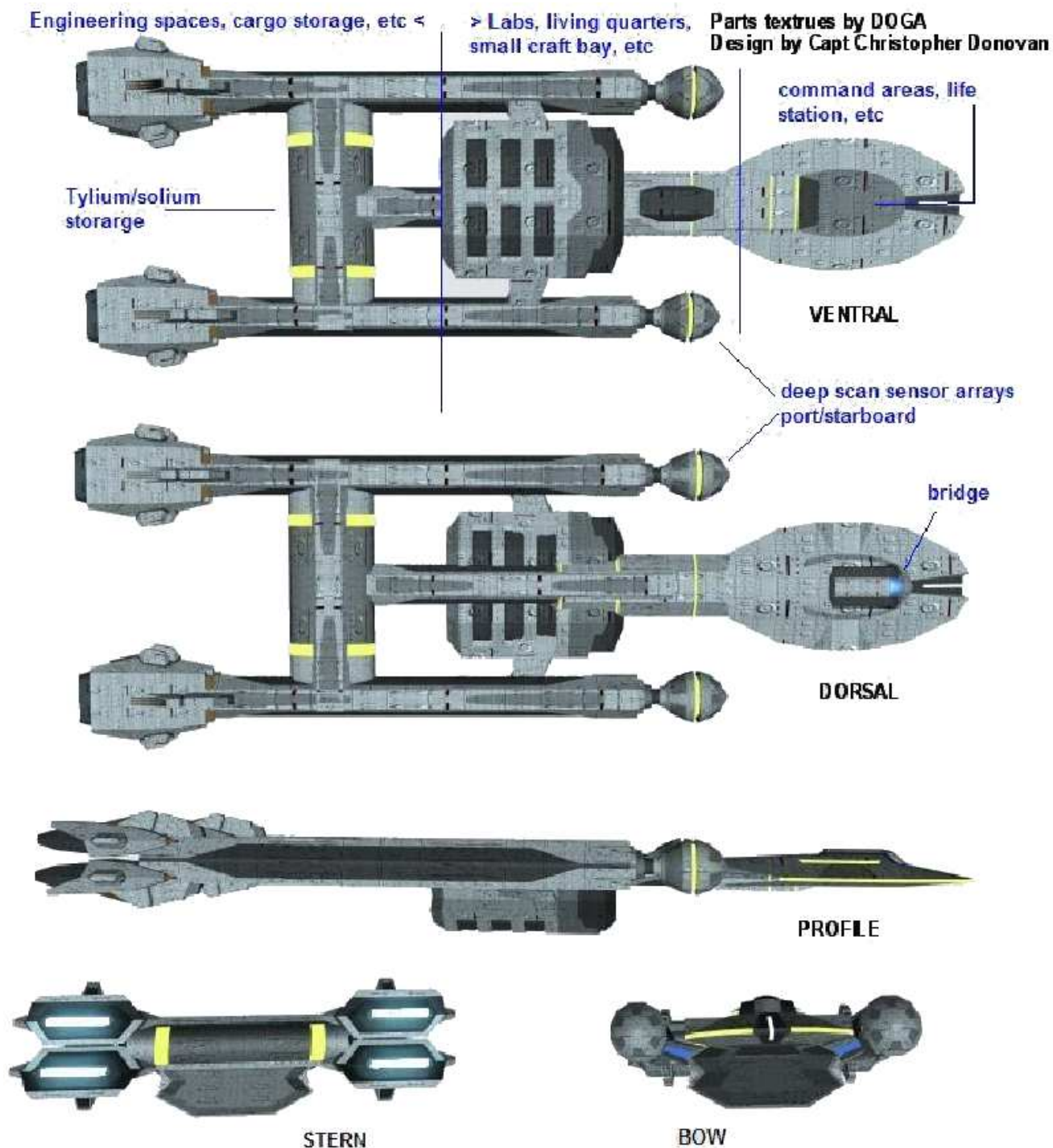

Colonial knowledge as it was to the expansion and protection of Colonial space.

The *Delphi*-class Deep Star Explorer was to be the first of the "new breed". The same overall size of a Columbia-class Battlestar, the *Delphi* incorporated the latest advances in engine technology, sensor systems, and crew support/survivability.

Her main thrusters, while smaller than a Battlestar's, were capable of the same thrust while also being approximately 15% more fuel efficient. This, combined with the ship's lesser mass, gave it an advantage in sub-light acceleration and a slightly higher real-space maximum speed. Incorporated into her Engineering spaces was the latest generation of micronized tylium ore processing equipment, which allowed her to stretch her onboard fuel supplies while still in deep space.

The latest advances in automated ship handling were incorporated into all systems. This resulted in a 15-20% reduction in the required number of flight crew, allowing for more spacious crew quarters and other amenities to be installed.

Defensively, *Delphi* was modestly equipped by war-time standards. Her primary armament consisted of a pair of capital scale heavy weapons emplacements forward and one aft. Anti-fighter turrets were fewer in number, but the improved tracking and targeting software was considered a sufficient compensation. Provision was made for three elements of Viper fighters (a total of six ships), in addition to both personnel and cargo shuttlecraft. Forty Colonial warriors (in addition to the Viper pilots) made up the primary ground

defensive force, but could be augmented by the use of Ship's Security at need.

It was the sensor arrays that were the true marvels incorporated into the design. Deep scan range remained roughly the same, but resolution was vastly increased and improved. The *Delphi* could easily finish a preliminary assessment scan of a star system in a matter of centaur's while still at its outer fringe.

Calandan petitioned the Colonial government to put his design into production, and (after much discussion) funds were allotted for the construction of the first vessel. Utilizing all the resources of the family's yards, the *Delphi* was constructed in just under 14 months.

She left her space dock for shakedown trials three weeks before the Holocaust. During the attack, the Cylon override program overwhelmed the ship particularly quickly, shutting the life support system down and emergency venting all compartments to space.

Curious about the ship, so very different from the Battlestars and other military craft they were used to encountering, the Cylons took the ship and studied it. Impressed by some of the advances the Colonials had made (esp. the sensor improvements); they decided to keep the ship for their own uses. Many a civilian craft was destroyed when caught out by *Delphi's* advanced sensors, and fooled into approaching by her Colonial lines.

Commander Morrigan and the Battlestar *Isis*, nearly became the latest victims of the Cylon-controlled ship, but quick thinking and daring on the part of the Battlestar's crew and warriors turned the tables and liberated the *Delphi*, which became a key vessel in the Second Exodus Fleet.



## **Bruiser (Heavy Tug)**

By Gazza

Art by Limerickcot

Agi D8, Str D6, Vit D6, Ale D6, Int D2, Wil D6;  
LP 14; Init D8+D6; Scale Spacecraft; Speed 3 (3 in atmosphere; JC)

### **Traits**

Mass-Produced (D4) --The vehicle is a very common model  
Tough (D4)

### **Skills**

Athletics D4/Grappling D6  
Mechanical Engineering D2  
Perception D2  
Pilot D4  
Technical Engineering D2

Armament None

Armour Wound 1, Stun 1

Description 226 x 46 x 30 feet; Crew 20; Passengers 25; Cargo 3650 lbs.

Notes: -

The Bruiser-class Tug is a common sight at any Spaceport. It's often used to tow barges and other non-jump capable craft. The space for 25 passengers is used for salvage jobs, barge crews and the odd paying passenger. Using sophisticated but easy to use grappling systems the Bruiser can manipulate towed traffic as well as nudge even the heftiest of Battlestars in the right direction.

A military variant is also built by Heran yards and is called the Atlas (see that entry)



## ***Tylium/Aqua Queen (Tanker)***

By Gazza

Art by Limerickcot

Agi D4, Str D10, Vit D10, Ale D6, Int D8, Wil D10;  
LP 20; Init D4+D6; Scale Spacecraft; Speed 4 (4 in atmosphere; SL/JC)

Traits: None

### Skills

Mechanical Engineering D4; Perception D2; Pilot D4; Technical Engineering D4

Armament: None

Armour: Wound 2, Stun 2

Description 660 x 220 x 80 feet;  
Crew 260; Passengers  
10;

Notes: -

An OH 10-class tanker of 200000 tons, the Tylium Queen and her sisters are a common sight, transporting fuel and small amounts of other cargo from port to port. The ships could carry 800,000 barrels of fuel, 600 tons of trade goods, 200 tons of dry stores and 100 tons of refrigerated stores. Tylium Queen has a hanger for 2-4 Shuttles, but doesn't usually carry them.

The Aqua Queen replaces the Tylium Tanks with water tanks and a pumping arrangement that allows it to transfer water without it freezing. Otherwise it looks identical to the Tylium Queen. Colonial manning requirements mean that both these vessels, but especially the Aqua Queen are on a constant cycle of resupply amongst various fleet elements. Aqua Queen can also purify contaminated water within its tanks but, if doing so, can only carry half her normal mass in water (as she requires use of several empty tanks to achieve this).

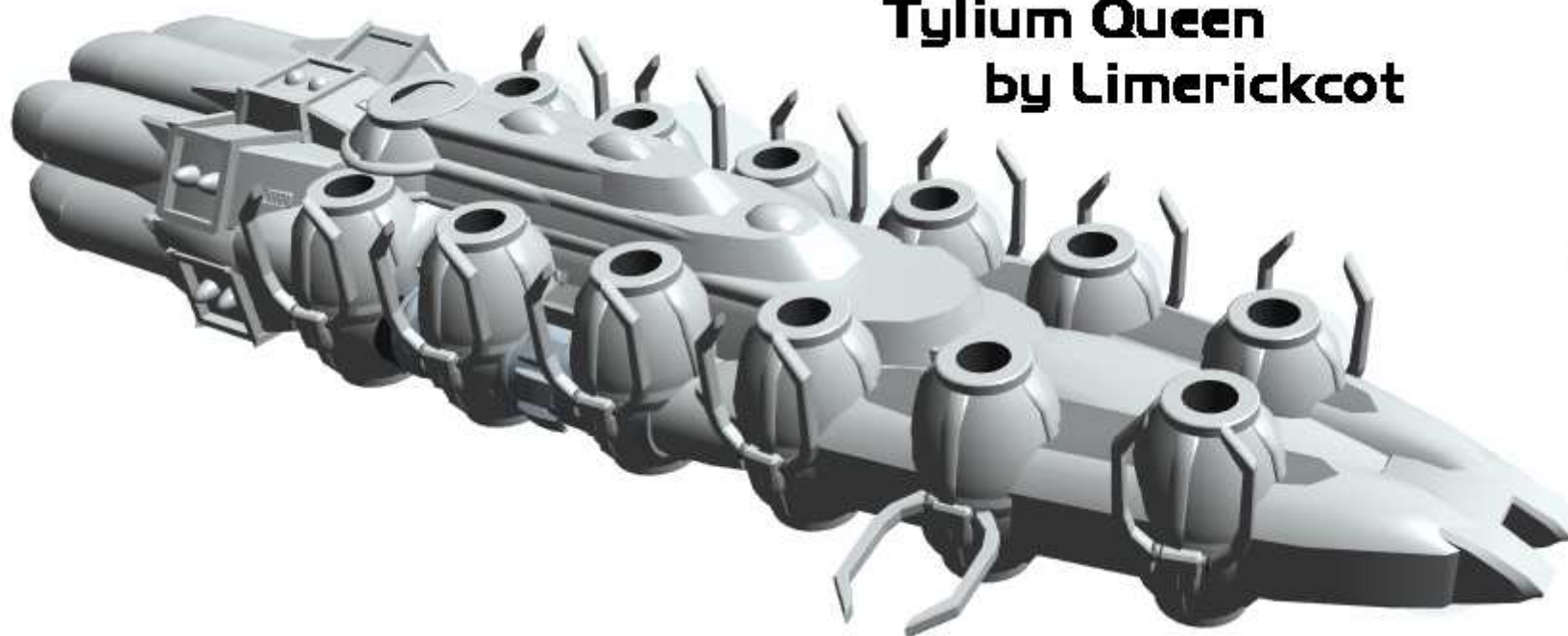

**Tylium Queen**  
**by Limerickcot**

201

## **Capella (General Cargo Ship)**

By Gazza

Art by Limerickcot

Agi D6, Str D8, Vit D6, Ale D6, Int D6, Wil D6;  
LP 12; Init D6+D6; Scale Spacecraft; Speed 4 (4 in atmosphere; SL/JC)

### Traits

Mass-Produced (D4) --The vehicle is a very common model

### Skills

Mechanical Engineering D4

Perception D2

Pilot D4

Technical Engineering D4

Armament None

Armour Wound 2, Stun 2

Description 1100 x 150 x 50 feet;  
Crew 50; Passengers 50;

### Notes: -

The 100000 ton Capella-class is known throughout the Colonies as a standard Cargo Ship that can store anything from bulk goods to containers. It has room for 50 passengers.



**Capella**  
**by Limerickcot**



## ***Io Class Colonial Transport***

**Agi** d4, **Str** d8, **Vit** d4, **Ale** d4, **Int** d4, **Wil** d4

**LP** 12; **Init** d4+d4; **Scale**

Spacecraft

**Speed** 3 (SL/JC)

**Traits** Mass Produced, Memorable, Past It's Prime

**Skills** *Mechanical Engineering* d2, *Perception* d2, *Pilot* d2

**Armament** None

**Armour:** Wound 1

**Description** 192 x 69 x 42 feet;

**Crew** 12 **Passengers** 120-350

### **Quirks & History**

The *Io* Class hull form is not particularly aerodynamic nor is it a well-balanced design, with much of the weight aft and low in the hull. As a result, the class tends to "wallow" in atmosphere. Lightly loaded models also tend to be unbalanced (all the weight is aft) and have been known to "wander" on inattentive pilots- with the nose pivoting off the pilot's preferred flight axis, and in some extreme cases putting the vessel into a flat spin which can be difficult to correct due to thruster placement. In at least one case, a pilot was cashiered for intentionally putting the vessel into such a spin (though he recovered handily), and upset a

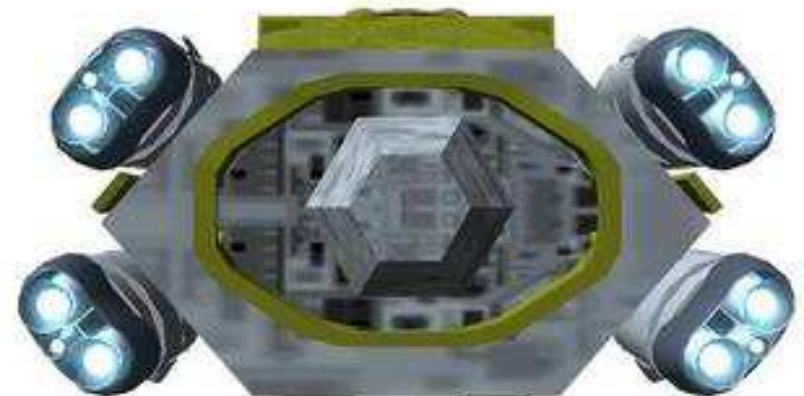

number of “more-important-than-he'd-initially-realized” passengers on that particular run.

The *Io* Class transport is derived from a (rejected) military lighter intended to carry assault troops and heavy gear into combat and disperse them quickly. Although the Fleet rejected the design based on concerns over vulnerability and instability, the manufacturers quickly retooled the prototype as a cheap, heavy-lift civilian craft intended for regular inter- and intra-system trade, and the class saw extensive usage throughout the Inter-war period, though they were replaced in Colonial service as newer designs came online.

Not surprisingly (given the original military design), the *Io* Class are ruggedly built, with an unusually thick hull and heavy trusses to withstand hard use. The landing gear is particularly rugged and forgiving, softening the blow of careless or overloaded landings. The *Io*'s are powered by four Kieran K-2900 tylium-turbine engines. The three reaction chambers per engine offer a mix of power, adaptability, and fuel economy, with simple (but comparatively man-power heavy) maintenance requirements.

The entire lower hold has been reserved for cargo stowage, and is rapidly on- and off-loaded through the use of large twin ramps to port and starboard. Up to 1000 tons of container cargo can be carried, but there are provisions for

bulk and vehicle storage in the large lower decks.

The upper two decks are reserved for passengers, and can be configured for short or long term occupancy. Most vessels still in service are configured for a mix of coach seating and small cabins for up to 180 passengers, with small lounge and dining areas amidships. Short-term (coach seating) only arrangements have been used to pack in as many as 400 passengers for relatively brief flights, but are generally uncomfortable and avoided by the larger lines.

Because of their steady reliability and comparative economy, the *Io* Class quickly became involved in the “packet” trade- short, regular routes between the Colonies and the few outer-system settlements carrying mail, passengers, and cargo as cheaply as possible.

One persistent bit of folklore the class has been unable to shake is the idea that the ungainly design was named for the young woman turned into a cow by her lover Zeus in order to hide her from his jealous wife.

Whether this is because of the wayward tendencies the class exhibits or the general look of the craft is anyone's guess.

## ***Gallow Class Bulk Liquid Transport***

by Selek

**Agi** d4, **Str** d8, **Vit** d6, **Ale** d4, **Int** d6, **Wil** d6

**LP** 14; **Init** d4+d4; **Scale** Spacecraft

**Speed** 3 (SL/JC)

**Traits:** Memorable (d4), Past It's Prime(d6)

**Skills** *Mechanical Engineering* d2, *Perception* d2, *Pilot* d2

**Armament** None

**Armour:** Wound 1

**Description** 192 x 69 x 42 feet;

**Crew** 12 **Passengers** 5

### **Quirks**

The *Gallow Class* is not atmosphere capable (no provisions have been made to protect the cargo modules during re-entry. This weakness also becomes apparent during combat situations- depending upon the cargo (such as pressurized tylium, liquid oxygen, liquid hydrogen, or others) the ship becomes essentially a floating bomb (there is a 1 in 6 chance that any "wound" damage to the ship will start a chain reaction of explosions in the cargo).

Another quirk of the class is that while it has a dorsal mounted docking/transfer boom, the ship has no provisions to transfer liquids or fuel for its own use.

The *Gallow Class* bulk liquid transports were designed and built to provide inter- and intra-system transport of large amounts of temperature stabilized, pressurized liquid, and routinely carry everything from water and industrial lubricants to liquid oxygen and industrial alcohol.

The midships section of the hull is essentially a large transfer and monitoring facility for the various cargo modules aboard. The *Gallow class* were designed to use rapidly swappable tanks and larger "pressure tree" modules to reduce loading/unloading time in port and increase flexibility.

Each pressure tree is an independent module with twenty-four 12-foot pressure cylinders (for an aggregate of 21,704 cubic feet of storage). Each tree can be routinely detached for maintenance, cargo transfer, or delivery-

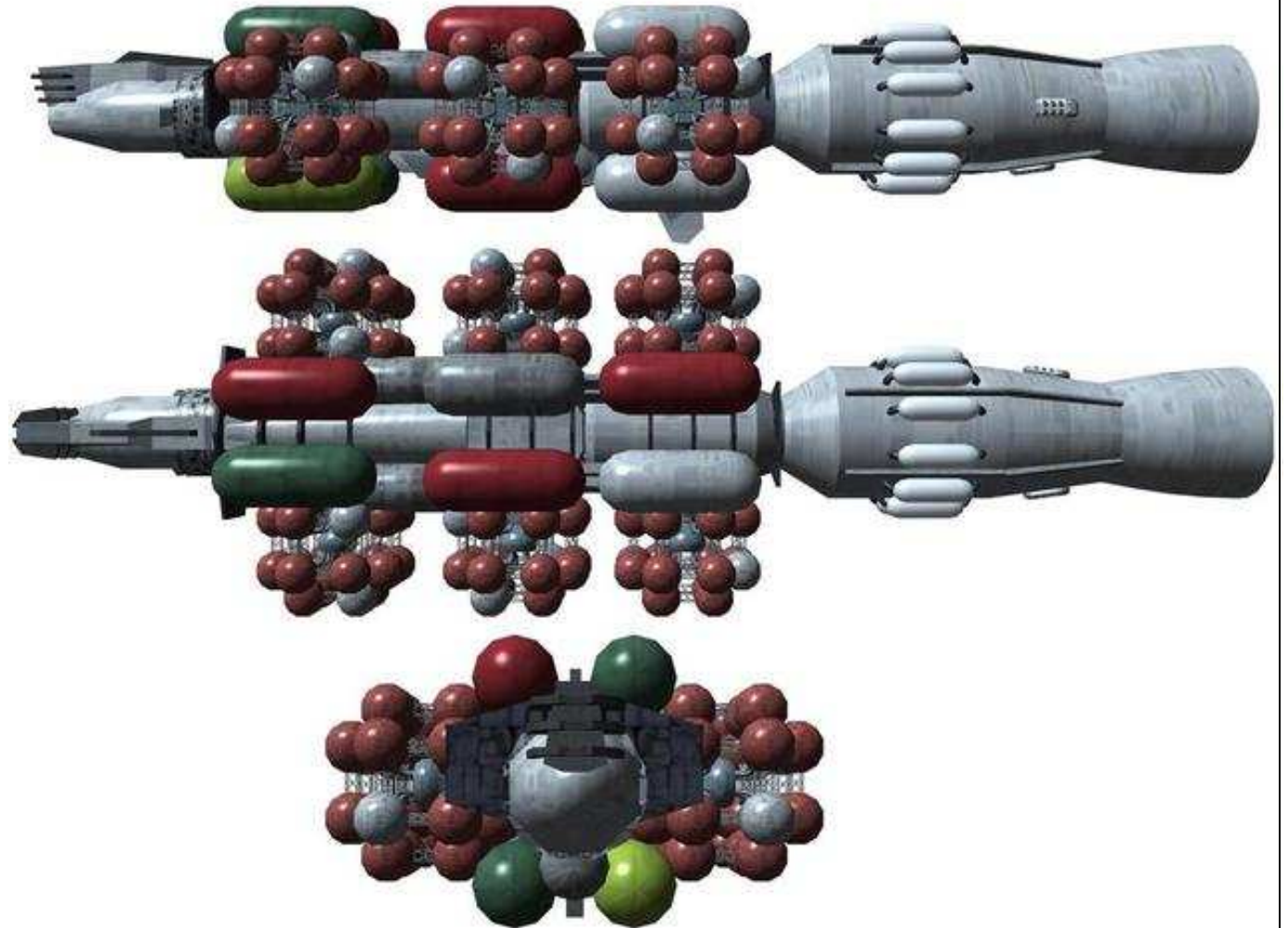

making the class highly mission flexible and adaptable to customer needs. Between the pressure trees and the larger tanks, the *Gallow Class* is capable of hauling more than 140,000 cubic feet of pressurized liquids and gases.

Crew accommodations and flight systems are comparatively Spartan and are crowded into the forward hull, with propulsion and FTL drive systems aft. The hull is otherwise unremarkable, and most of the systems aboard are off-the-shelf modules rather than custom designs.

The end result is a large, slow, reliable transport which can accommodate a wide variety of cargos on long- and short-term missions.



## **Firefly Mk3**

Art: unknown

Stats: Limerickcot (adapted from Serenity)

**Agi** d8, **Str** d6, **Vit** d6, **Ale** d2, **Int** d2, **Wil** d4

**LP** 8; **Init** d8+d2; **Scale** Spacecraft

**Speed** 5 (SL only)

**Traits:** Memorable (d4), Past It's Prime(d6)

**Skills** *Mechanical Engineering* d2, *Perception* d2, *Pilot* d2

**Armament** None

**Armour:** Wound 1

**Description** 191 x 128 x 53 feet;

Mass: 2400 tons

**Crew** 7 **Passengers** Varies – from nil to seven

Subcraft: 2 20 ton shuttles

The original Firefly Class merchant 'tramp' is one of the oldest recorded, still extant ship classes in use within the colonies. This vessel is so old that it's grav 'boot' is mounted on an external ring and that it uses a large fusion plant powered drive instead of Tylum ones used nowadays. Over 100000 of these ships had been built prior to the Cylon War. Many of them became victims of it but even now some Mk3's still fly in their original configuration.

Parts for the Mk3 are extremely easy to find and to fix and can be found in most bone yards. Although a sublight vessel, a number of mk3's have been upgraded to include an FTL drive. Unfortunately, unless they also convert their main system drives, this usually results in losing half of their cargo space. On the other hand, for those few Mk3's that were fully converted, the cost of doing so could be gained in either a larger cargo space or a reduction in bulk in the craft. Regretfully there are so many variants of this classic ship that it is impossible to list even a few. However, see the entries for the Cerberus and Mk4 in this chapter.

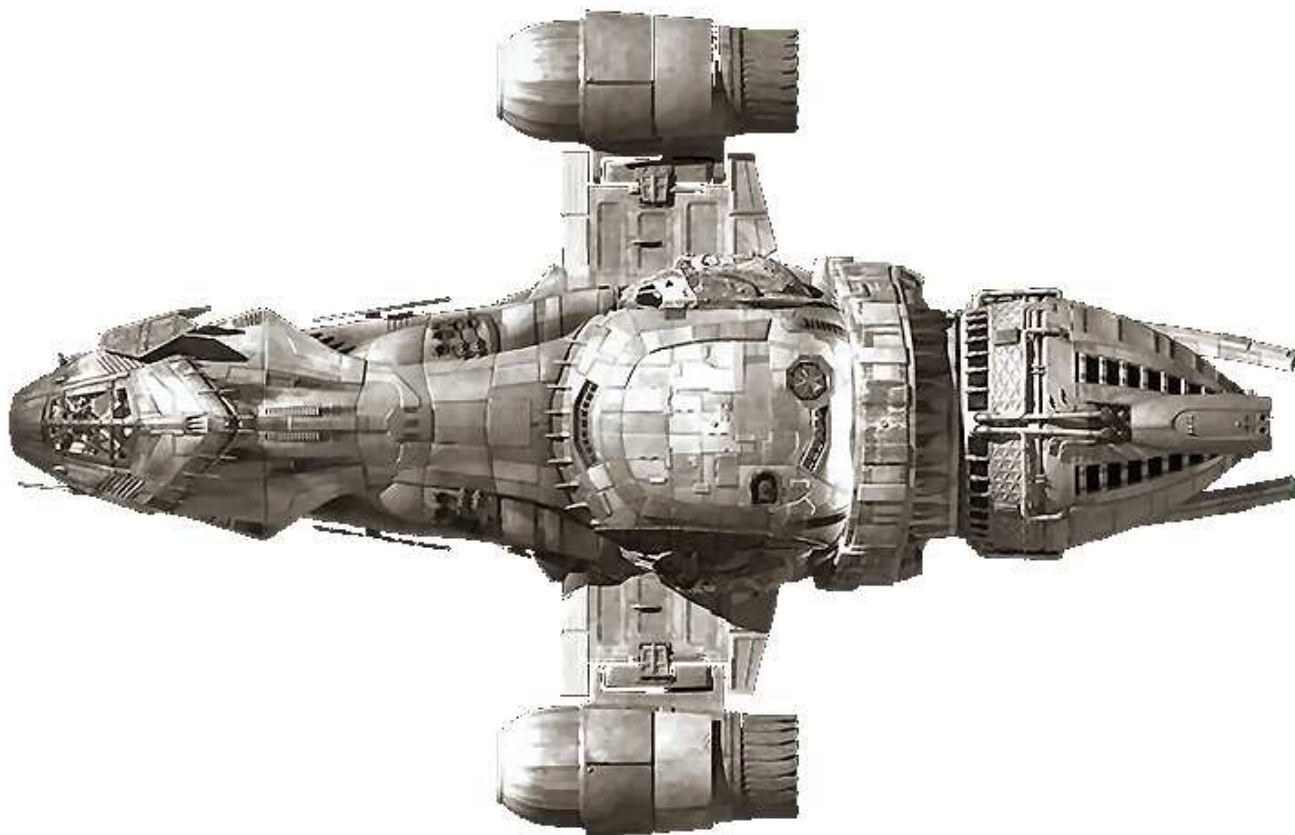

**Cerberus:**

Art from QMX Website

[/store.quantummechanix.com]

Stats by Lynn LeFey

Firefly Series 3 – Military Variant

**AGI** d10, **STR** d6, **VIT** d8, **ALE** d10, **INT** d8, **WIL** d10; **Life Points:** 16

**Dimensions:** L270xW170xH80

**Tonnage:** 7000 tons; **Speed Class:** 9 [SL only]

**Fuel Capacity:** 105 tons (300 hours of operation)

**Cargo Capacity:** 2297 tons

**Passenger Capacity:** 0

**Skills:** Covert d6, Heavy Weapons d2, Perception d6, Pilot d2

**Traits:** Healthy as a Horse, Gas Guzzler, Fast Throttle

Armour: Wound 5, Stun 4

**Crew:** 4 officer, 18 enlisted (Minimum Complement of 6)

**Armaments:****Guns**

1: Four waist turrets, Rail Guns (d0 Ship Scale damage, or d12 Vehicle Scale)

Armour Piercing Ammo (Ignore first 3 points of W Armour), 200 rounds each

2: Two Ventral neck ball turrets and Turret under Bridge, (d0 Vehicle Scale, or d12 Personal Scale, Auto fire), 1000 round magazine each

3: Two Forward Cargo Area Turrets. 155mm AGS (d2 Ship Scale) Replaced with anti-personnel guns in troop transport variant.

4: Dorsal Turret: Cannon, (d6 Ship Scale)

**Missiles**

4 hard points, each able to hold one of the following:

Medium range missile with 500-lb warhead (d10 Ship Scale)

Long Range missile with 200 lb warhead (d8 Ship Scale)

Countermeasure launcher - 50 10-lb decoy Jiggers

**History**

With so many Firefly merchant vessels available at the beginning of the Cylon War, it was inevitable that many would be pressed into battle. Indeed, as a class



of ships, the Firefly Mk3, in either its Cerberus or other armed variants, saw over 10,000 converted or produced.

Cerberus was a stop-gap measure that worked far beyond expectations, possibly due to its antiquated systems that proved totally immune to AI system infections and the fact that keeping the ships flying usually just meant cannibalising or stripping other Firefly classes - of which there were so many available that supply never became an actual problem during the war itself. Indeed such was the importance of this class in escorting and carrying troop reinforcements, the Cylons made several determined attempts to destroy the various manufacturers that produced the firefly's. Unfortunately they succeeded and so Cerberus and Firefly Mk3's are in much reduced numbers. Out of the 10,378 Cerberus variants produced or converted in the war-time years, only 2300 survived to see the wars end.

These ships then carried out light patrol duties, carrying recovery parties everywhere within and without the colonies. Quite a number are known to be used, even to this day, as pirate vessels

## Skalla-Etter

By Sean 'Treybor' Kennedy

**Agi D4, Str D8, Vit D4, Ale D4, Int D4, Wil d4; Life Points: 12**

**Dimensions:** L270xW170xH80, Initiative d4+d4

**Tonnage:** 10,500 tons; **Speed Class:** 3 [SL only]

**Cargo Capacity:** 8 cargo pods

**Passenger Capacity:** 0

**Skills:** Perception d2, Pilot d2

**Traits:** Healthy as a Horse, Gas Guzzler, Fast Throttle

Armour Wound 1

**Crew:** 15, **Passengers:** nil

**Dimensions:** L 500' W 186' H 60'

The primary body of the ship includes the crew section at the front, a long reinforced "Spine" with connecting finger clamp mechanisms, and a large drive section at the rear. Three sets of Manoeuvring/VTOL engines are mounted along the frame. Along each side is a set of four cargo holds. The holds are two stories tall, with gantries as the upper deck. (cross-section)

The crew section of the ship contains four decks with docking area, cockpit, crew quarters, med-bay, passenger quarters, and mess. The spine contains four decks as well. Each is essentially a long hall running from bow to stern. The bottom deck hall has access to the bottom of the cargo holds, the mid deck halls have access to the gantries, and the top deck hall provides access to the finger clamp mechanics. The drive section of the ship contains a top of the line fusion drive, and some extra births.

The standard crew for the ship is 10-15 people.

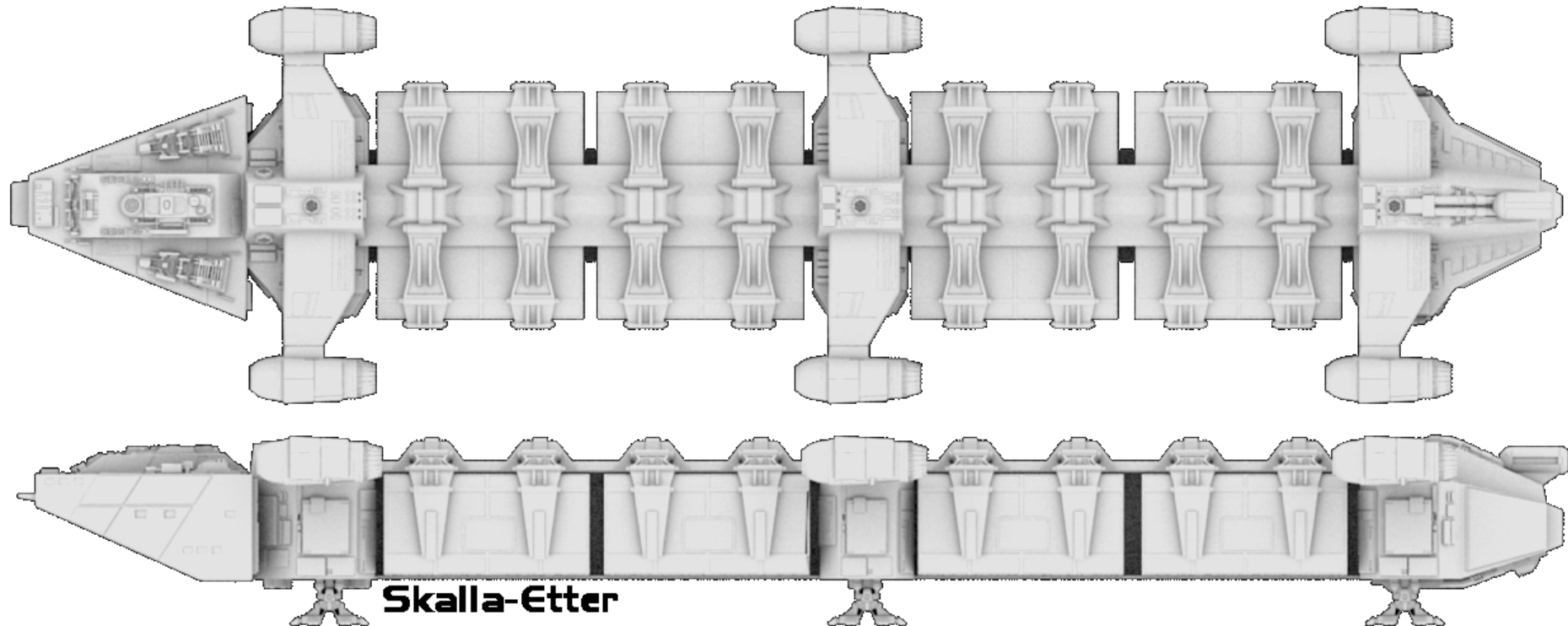

**Skalla-Etter**  
by Sean 'Treybor' Kennedy



## Firefly Type 4

Art – unknown; assumed QMX website  
Stats - Limerickcot

**AGI** d10, **STR** d6, **VIT** d8, **ALE** d10, **INT** d8, **WIL** d10

**Life Points:** 16

**Dimensions:** L320xW180xH87

**Tonnage:** 9900 tons; **Speed Class:** 6  
[SL/JC]

**Cargo Capacity:** 3800 tons

**Passenger Capacity:** 23

**Skills:** Perception d6, Pilot d4,  
Technical d4

**Traits:** Healthy as a Horse,

Armour Wound 1, Stun 0

**Crew:** 8

**Armaments:** None

### History

Following the destruction of their Firefly plants on Aquaria and Caprica, Firen Industries were a priority investment for a Colonial administration that desperately needed new civilian ships to allow a fast and speedy economic recovery.

Although Firen could have reverted to producing the classical Type 3 Firefly, they were asked to design a modernised ship that fulfilled all the same requirements as the Type 3, but could carry more passengers, more cargo and be capable of FTL jump capability. Firen's Type 4 Firefly shares many of the same components of its predecessor (about 47%) but incorporates more powerful engines, a separate passenger deck and an enlarged cargo bay (the

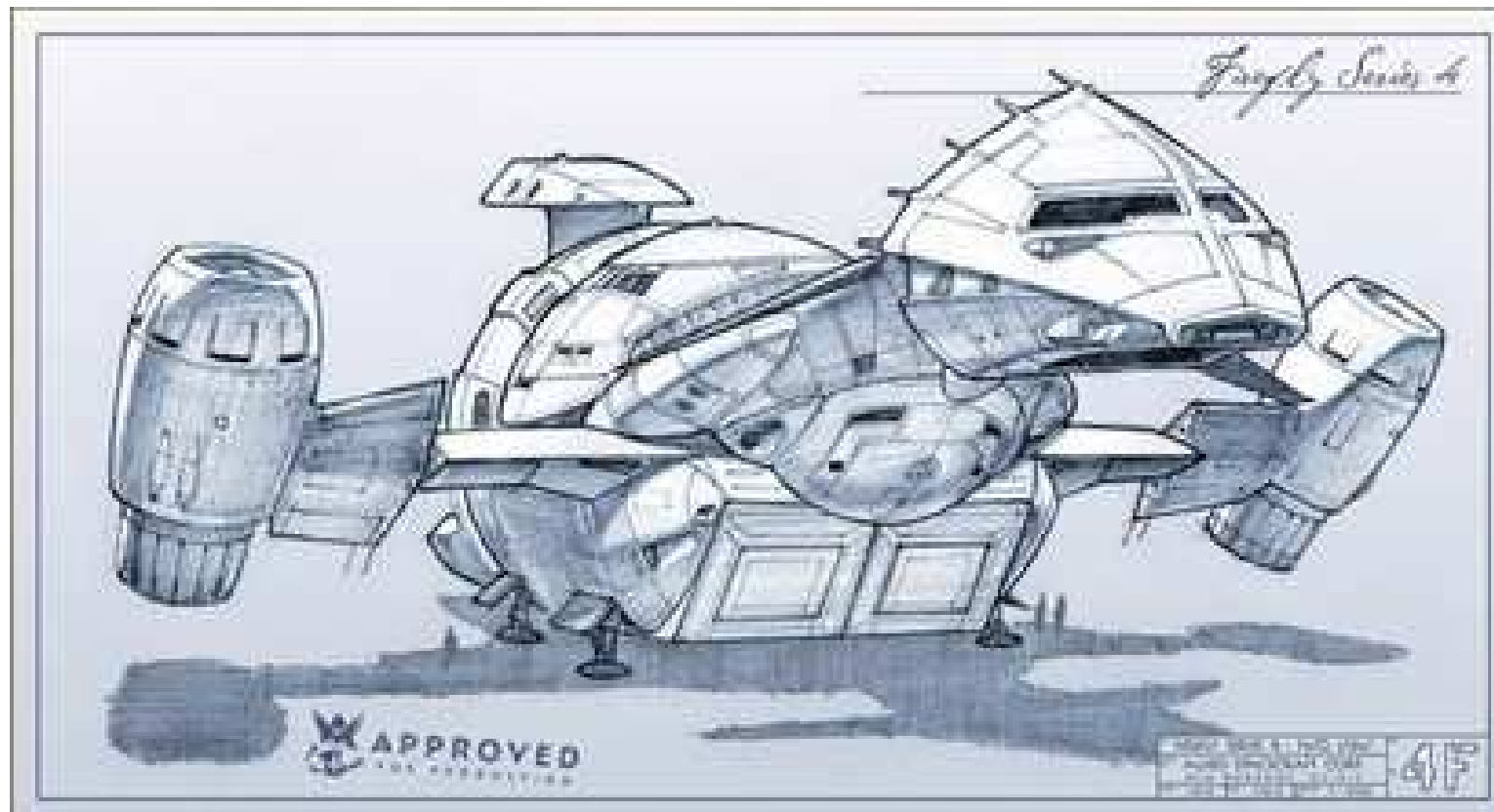

rear bay can be refrigerated – another requirement of the Colonial Design Bureau).

Types 4's also use Tylum as a common fuel base instead of the much older fusion based Type 3's. Unfortunately this made the Type 4's twice as expensive as their predecessor – a problem solved by cut-price loans provided by the administration, boosting sales and making the Type 4 a common freighter within the colonies. However, its best feature is its fuel economy, allowing it to cruise (at half speed) for months if needed. This makes her very popular for transportation between the outer colonies and outposts.

A small number have been converted to a Cerberus configuration by the military and police forces.

## Scarab Rescue Craft

Stats by Limerickcot

Art by Sean 'Treybor' Kennedy

Agi D8, Str D6, Vit D8, Ale D6, Int D8, Wil D8;  
LP 18; Init D4+D6;  
Speed 7 (SL/JC) Scale Spacecraft;

Traits: None

Skills: Mechanical Engineering D6;  
Perception D8; Pilot D4; Technical Engineering D4

Armament: None

Armour: Wound 3, Stun 1

**Dimensions: 78 ft x 42 ft wide x 70 ft high**

Crew 3; Passengers 30;  
Cargo: 37 tons

The civilian market has been competing with the military for the Raptor for over 50 years. Generally, given the needs of the military, dedicated civilian models have only been viable during periods of budget cuts.

Instead, Kennedy manufacturing came up with the Scarab to fill the Raptor niche for the civilian market. Although much bigger than the Raptor, the Scarab has a true sub-light endurance (including an advanced life-support system) allowing it to operate away from ships and bases. It is commonly used in civilian areas for situations where a shuttle cannot do.

This version has medical evacuation colours, being attached to the Medical Vessel, "Karparski". Others are commonly used for deep range or planetary surveys where they can carry far more gear than a raptor can in one trip.

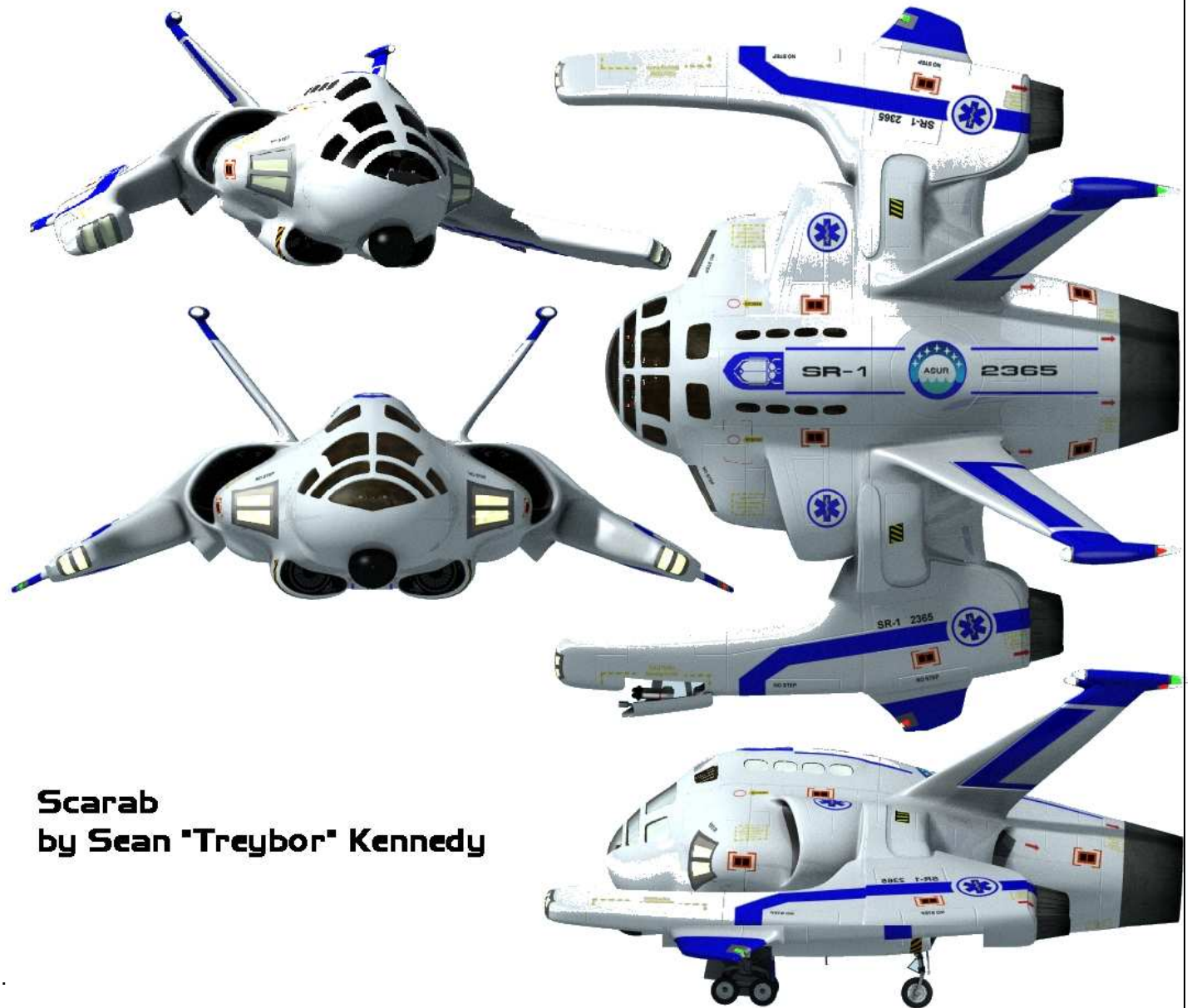

## Scarab by Sean "Treybor" Kennedy

They also carry a far larger fuel load. Like a Raptor, the Scarab can be fitted with a variety of electronics – these are housed in the outer pylons.

210

## ***Colonial Tug.***

By Vincent

Agility: D4  
Strength: D8  
Vitality: D6  
Alertness: D6  
Intelligence: D4  
Willpower: D10

LP: 16  
Init: D4 + D6  
Scale: Planetcraft  
Speed: 3

Traits: None  
Skills: Perception D4, Pilot D4  
Armament: None  
Armour: 2W, 2S  
Crew: 3  
Passengers: 10  
Equipment: DRADIS



The design uses three extendable hydraulic rams.

It is mainly used only for civilian vessels as it lacks the raw power to deal with the heavier fleet vessels. When dealing with vessels above its weight class, several tugs must work together to overcome the opposing ships inertia.



## **Castis Bulk Carrier**

By Limerickcot

Agi D4, Str D12, Vit D6, Ale D6, Int D6, Wil D6;  
LP 18; Init D4+D6;  
Scale Spacecraft; Speed 3 (SL/JC)

Traits: None

Skills:  
Mechanical Engineering D6; Perception D2; Pilot D4;  
Technical Engineering D4

Armament: None

Armour: Wound 1, Stun 1  
Dimensions: 7410 ft x 825 ft wide x 562 high

Crew 56; Passengers 10;  
Cargo:  
Carries 768 Star-Containers measuring 390ft x 75ft x 75ft each  
200 tons internally

Castis is a typical mass container ship plying the trade routes between the main star-ports on each planet of the colonies. Whereas many smaller vessels take on containers to smaller cities and outposts across space, the bulk of consumer goods move from world to world aboard container ships typical of Castis. Castis is a medium sized vessel carrying only 768 shipping containers. There are much larger vessels and larger ones are continually being designed to satisfy the demand for bulk shipping.

A container ship normally lands at a specialist port facility and then offloads the containers due at that port. Its internal framework allows it to rapidly redeploy containers internally depending on where it is going to next and what cargo it has ready for that destination. From these ports the containers are moved by road, rail and ship to their onward destinations (it is not uncommon for some container vessels to just move from port to port on a single world and for smaller vessels to move the containers to smaller facilities.

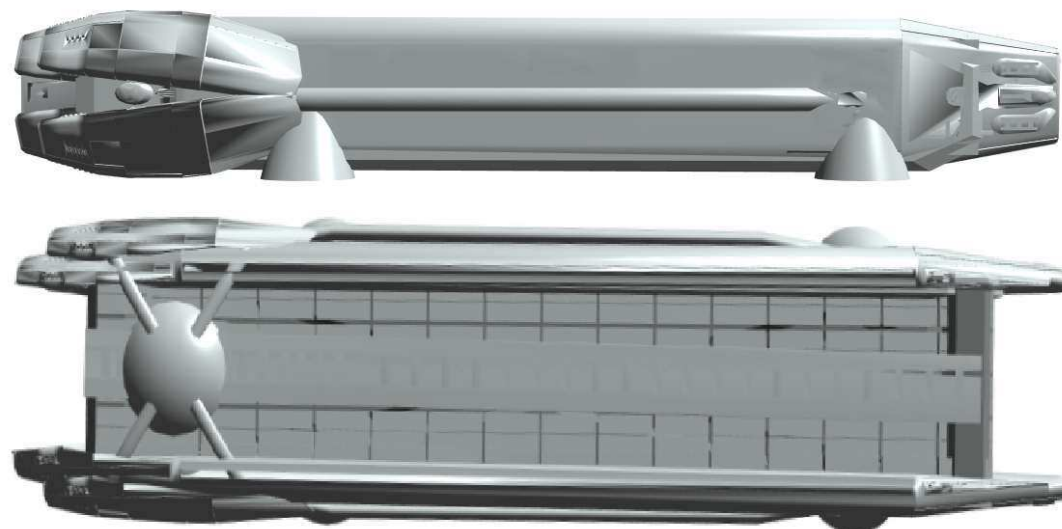

**Castis Bulk Carrier**  
**Limerickcot**



# *CYLON VESSELS*

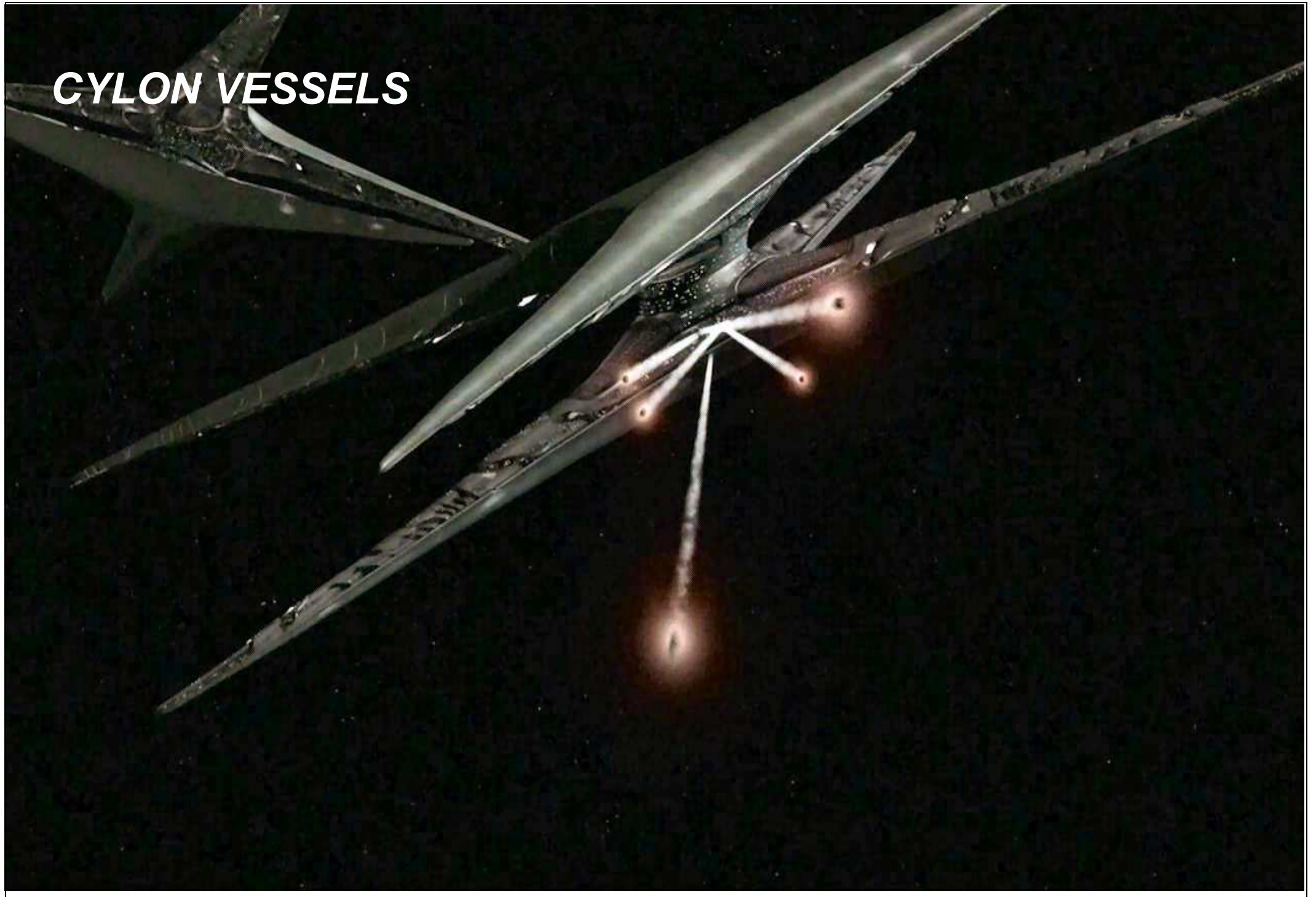

**Raider GSI**

stats by Buscadero  
Art by Jim Stevenson

**Agi** d10, **Str** d8, **Vit** d8, **Ale** d6, **Int** d6, **Wil** d6  
**LP** 14, **Init** d10+d6[12]; **Scale** Planetcraft

**Speed** 7 (6 in atmosphere) (SL)

**Traits** Past Its Prime (d4)

**Skills** Perception d4, Pilot d4

**Armament**

2 medium planetcraft scale skirmish range autocannons (d8),  
8 medium planetcraft scale skirmish range missiles (d12),  
4 heavy planetcraft scale capital range missiles (d12+d4)

**Armour** Wound 3, Stun 2

**Description** 45 x 56 x 13 feet;

**Crew** 3

The GSI prototype 'Raider' bomber was originally rejected by Colonial Military procurement staffs as being too large for its purpose, although its armament outweighed anything currently available. With the advent of the Cylon Centurions, the Raider was redesigned (mainly to incorporate a larger cockpit and more advanced avionics).

To overcome fears about the independency of Cylon's, and the lack of human supervision, the design accommodates three Cylon's. At least two of these are needed to fly the craft and a third is carried, both as spare, and because original program safeguards require the consensus of two out of the three before any offensive operation may commence. This was the human's ultimate safeguard against the possibility of a 'rogue' Cylon.

When operating together, the third Cylon acts as an additional WEO and adds its own Alertness to that of the ship. Ships systems are designed to wireless interact with the Cylons and so only minimal control motions are needed. However, as the original ships were also designed for use by humans, manual flight controls and DRADIS systems are still installed.

The Cylons never changed the design of their 'manned' raiders and so these styles of controls are still found in the more recent types of 'manned' raiders still in operation. However, a number of these later types seem to use bio-gel interfaces which are only operable by humanoid Cylons. Such craft are very rare.

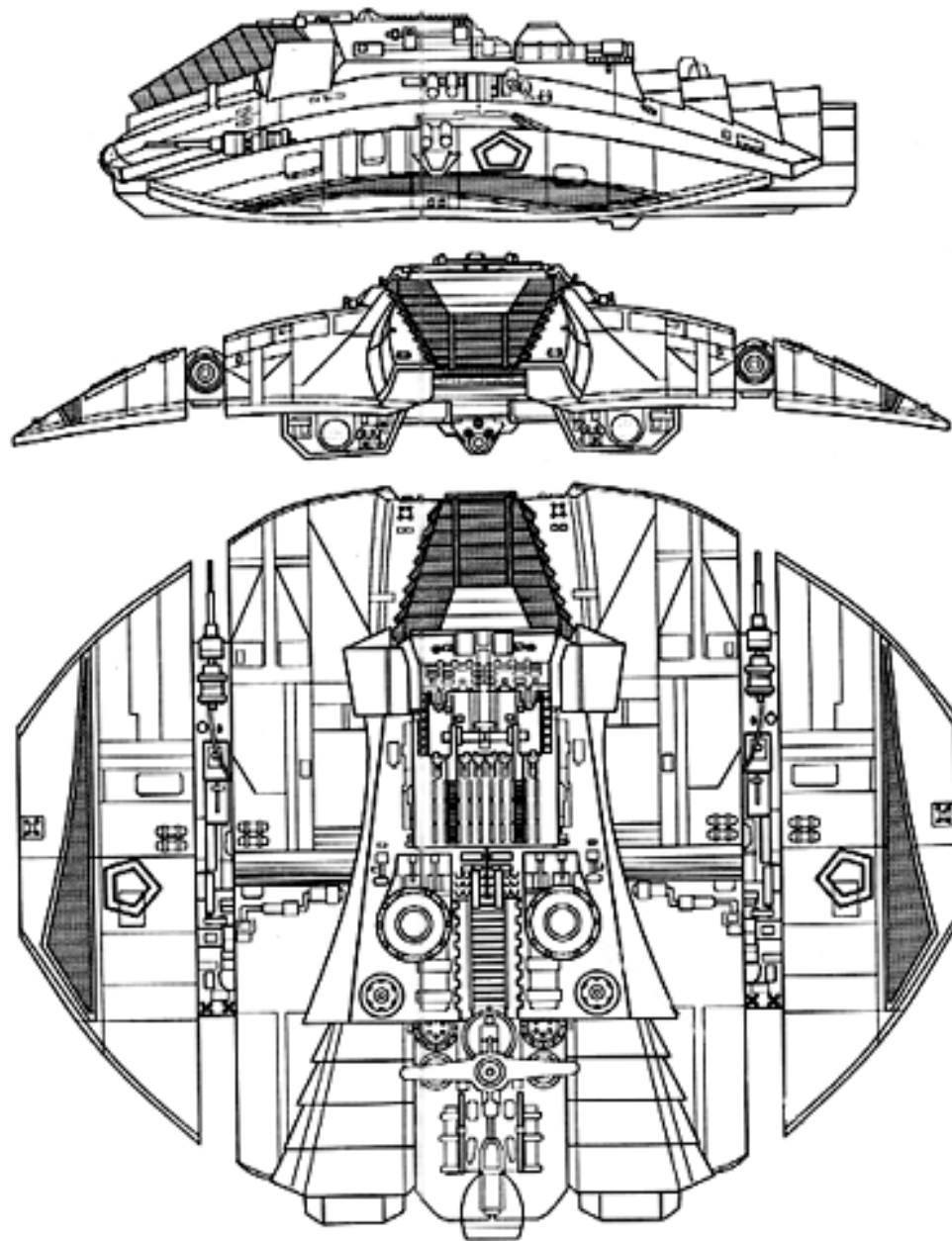



# Cylon A/B Fighter

## Raider A/B

Stats by Buscadero  
Art by Jim Stevenson

**Agi** d10, **Str** d10, **Vit** d8, **Ale** d8, **Int** d6, **Wil** d6;  
**LP** 16, **Init** d10+d8; **Scale** Planetcraft

**Speed** 8 (7 in atmosphere) (SL)

**Traits** Past Its Prime (d4)

**Skills** Perception d6, Pilot d4

### Armament

2 medium planetcraft scale skirmish range autocannons (d12),  
8 medium planetcraft scale skirmish range missiles (d12),  
4 heavy spacecraft scale capital range missiles (d12+d4)

**Armour** Wound 4, Stun 3

**Description** 65 x 90 x 15 feet;

**Crew** 5

The A/B fighter-bomber was only seen towards the end of the Cylon War and saw limited action against Colonial Forces. It was manned by a regular 3 Cylon crew but strategic direction was provided by a further 2 Cylons (originally designed to a humanoid android pattern, they were replaced after the war by 'human' Cylons). Colonial forces have determined that they were used both as bombers (similar to the Python) and as command leaders for Cylon Squadrons.

The A/B's were some of the first Cylon small craft to be fitted with a micro FTL engine but this reduces the ships sub-light range and overall speed (FTL versions have a speed of 6 (5 in atmosphere)).

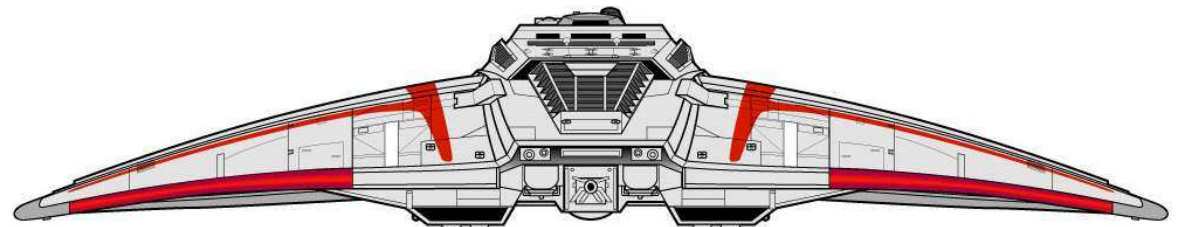
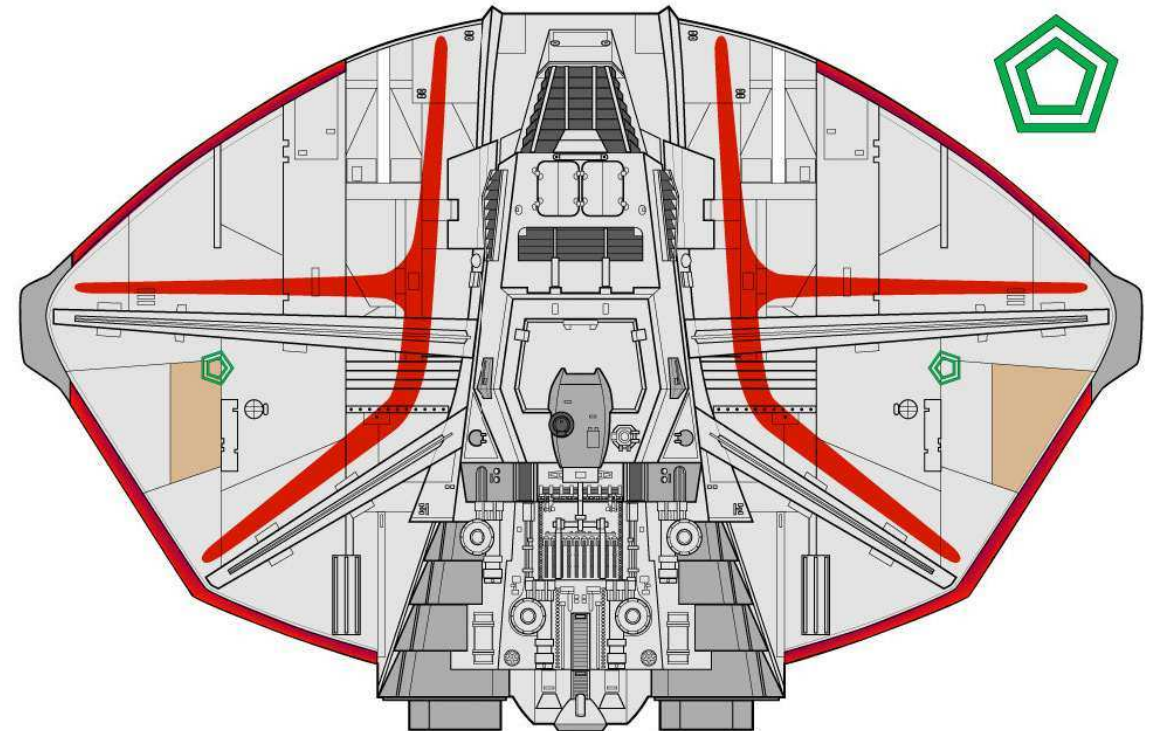
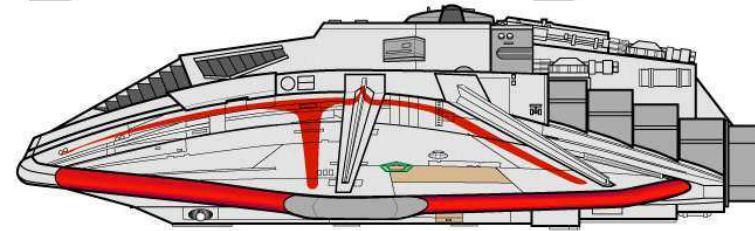

Copyright © 2010 by Jim Stevenson (137th Gebirg)

## ***Cylon Reconnaissance Raider***

stats by Buscadero  
Art by Jim Stevenson

Source: "Rob Liefeld Presents: Battlestar Galactica Special Edition" by Chris Scalf and Rob Liefeld; Maximum Press, 1996

**Agi** d8, **Str** d8, **Vit** d8, **Ale** d12, **Int** d8, **Wil** d6;  
**LP** 14, **Init** d8+d12; **Scale** Planetcraft

**Speed** 7 (5 in atmosphere) (SL/JC)

**Traits** Past Its Prime (d6)

**Skills** Covert d6, Perception d6, Pilot d4

### **Armament**

2 medium planetcraft scale skirmish range autocannons (d8),  
4 medium planetcraft scale skirmish range missiles (d12)

**Armour** Wound 3, Stun 4

**Equipment** DRADIS, electronic countermeasure support

**Description** 56 x 56 x 13 feet;

### **Crew** 3

A further adaption of the standard Raider, although the Reconnaissance Raider is designed to perform multiple roles, it most commonly takes part in reconnaissance and scouting operations. It is capable of atmospheric flight and is also equipped with a short-range FTL engine, allowing it to make short faster-than-light jumps.

As a scout, Reconnaissance Raiders can undertake short and medium-range scans to detect electromagnetic, heat or other signatures from other vessels, scan planetary surfaces for signs of life, energy output, or to locate and assess mineral deposits, scout ahead of its parent warship in other planetary or celestial systems for any signs of hostile intent or stellar conditions prior to the parent ship's arrival, and undertake search and rescue operations after an engagement with Colonial forces.

In addition to reconnaissance and scouting, the Reconnaissance Raider can also serve as an airborne warning, control and electronic countermeasures platform supporting Raider operations and secure communication with other vessels.

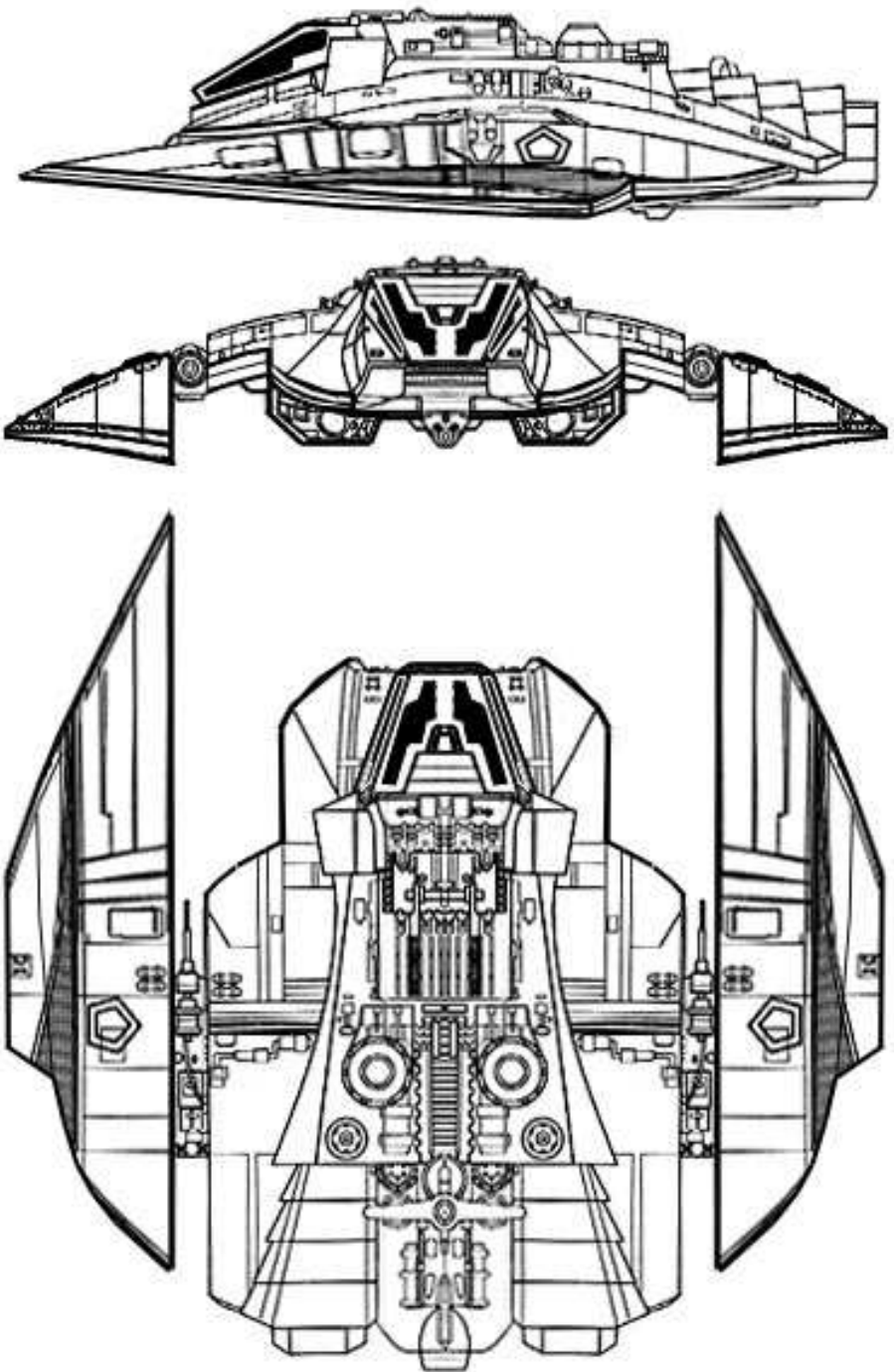

## ***Cylon Armoured Raider***

**Agi** d8, **Str** d8, **Vit** d8, **Ale** d6, **Int** d8, **Wil** d6;  
**LP** 14, **Init** d8+d6; **Scale** Planetcraft

**Speed** 7 (5 in atmosphere) (SL)

**Traits** Past Its Prime (d6)

**Skills** Covert d6, Perception d6, Pilot d4

### **Armament**

4 medium planetcraft scale skirmish range autocannons (d8),  
 12 medium planetcraft scale skirmish range missiles (d8)

**Armour** Wound 4, Stun 3

**Equipment** DRADIS, electronic countermeasure support

**Description** 52 x 48 x 13 feet;

**Crew** 2

The Armoured Raider was the Cylon's attempt to conserve resources by building a smaller vessel. Utilising the designs of the Reconnaissance Raider, they incorporated the control circuitry from damaged centurions directly into the ship to eliminate the third Cylon normally carried. They then placed the two pilots behind each other, allowing more space to be used for fuel and ammunition.

The armament is different, relying on four autocannons, instead of two, and carrying twelve lighter missiles for ship to ship combat. The CAR is not designated for ship attack but purely as a defensive fighter for their own ships.

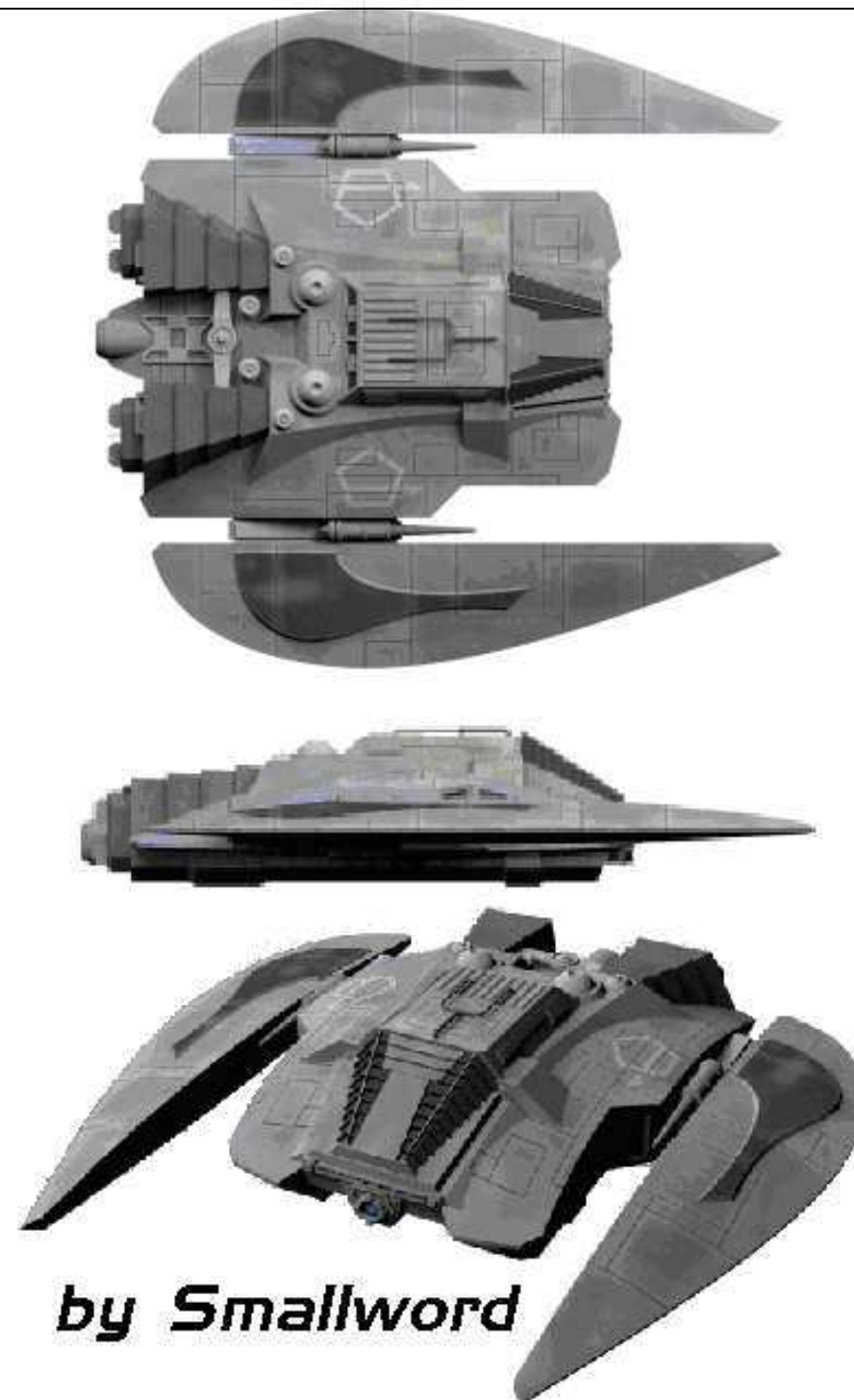

**by Smallword**



## Raider MkXII

Artist unknown

**Agi** d10, **Str** d8, **Vit** d8, **Ale** d8, **Int** d6, **Wil** d6;  
**LP** 14, **Init** d10+d8[14]; **Scale** Planetcraft

**Speed** 7-8 (SL)

**Traits** None

**Skills** Perception d6, Pilot d6, Heavy Weapons d6

### Armament

2 medium planetcraft scale skirmish range autocannons (d10),  
12 medium planetcraft scale skirmish range missiles (d12),

**Armour** Wound 3, Stun 2

**Description** 45 x 52 x 15 feet;

**Crew** 3

The Raider Mark XII was the most advanced Cylon Raider in use at the end of the Cylon War. The Cylons saved weight by using advanced hull plating and control systems, although they still seated (and needed) three crew, Heavier guns were fitted to deal with the up-armoured vipers that were appearing in the Colonial ranks and to support ground strafing operations.

However it is their speed and agility that made them a feared sight with these ships normally more than able to outclass the vipers they were facing. Cylon tactics were to dive through an air cover screen, tearing a hole through it for their slower squadron types to follow. In cruising speed the Mark XII is on a parity with the latest of Colonial Vipers, but its ability to maintain short bursts above that speed tax the colonial fighter's ability to respond adequately. Of far more concern is the ability of the XII to operate without loss of speed within an atmospheric envelope.

The Mark XII is one reason why the Colonial Fleet has endeavoured to maintain a program of fast, responsive, fighters that are capable of dealing with these craft. This type of craft was encountered by Battlestar Pegasus.

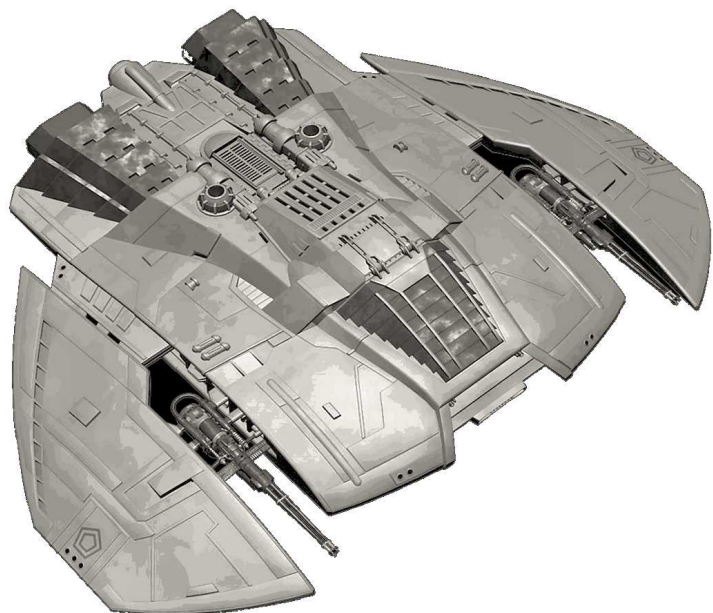

## 'I Type' Cylon Raider

[CoolSciFi.com](http://CoolSciFi.com)

**Agi** d10, **Str** d10, **Vit** d8,  
**Ale** d10, **Int** d6, **Wil** d8;  
**LP** 18, **Init** d10+d10; **Scale**  
 Planetcraft

**Speed** 7 (8 in atmosphere)  
 (SL/JC)

**Traits** None

**Skills** Perception d4, Pilot d4

### Armament

2 heavy planetcraft scale  
 skirmish range autocannons  
 (d12),

4 medium planetcraft scale  
 skirmish range missiles  
 (d12),

2 heavy spacecraft scale  
 capital range missiles  
 (d12+d4)

**Armour** Wound 4, Stun 2

**Description** 50 x 75 x 15  
 feet; **Crew** 2

Surmised to be an offshoot of the A/B class of fighter-bomber, the I or Improved Raider seems to have been deliberately designed to overcome normal problems encountered by Raiders in atmosphere. As a result, this design is far more at home in the atmosphere than outside it and has significantly increased speed inside the atmospheric envelope. Its streamlined design and large intakes means that it is as efficient at fuel use as its older cousins are not.

The I type is also notable for its heavier gun's and improved sensors, both of which allow it to engage Colonial fighters with an accuracy that is frightening. Thankfully this is offset by its lower missile coverage which suffers from the vessel carrying an FTL engine and the need for additional streamlining in the design.

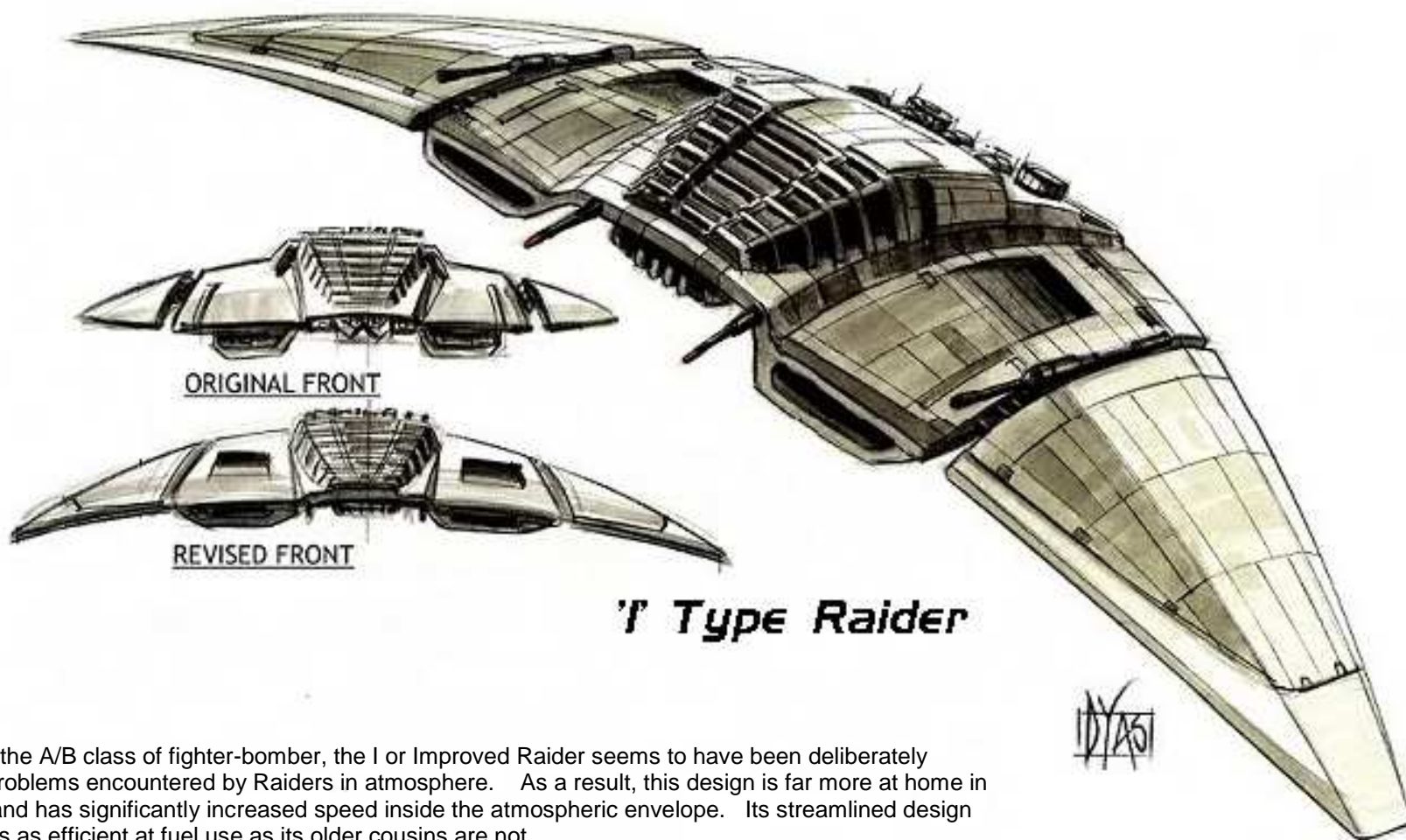

## ***Sparrow Raider***

**Art by Zoic Studios**

**Agi** d12, **Str** d8, **Vit** d8, **Ale** d8, **Int** d6, **Wil** d6;  
**LP** 14, **Init** d12+d8; **Scale** Planetcraft

**Speed** 9 (7 in atmosphere) (SL/JC)

**Traits** Biomechanical [d8], Formidable Presence [d4], Stealthy [d4; adds to difficult to spot with the naked eye.]

**Skills** Perception d4, Pilot d4

### **Armament**

2 heavy planetcraft scale skirmish range autocannons (d8),

6 medium planetcraft scale capital range missiles (d12); or

2 spacecraft scale capital range nuclear missiles (d12+d4)

**Armour** Wound 2, Stun 2

**Description** 29 x 18 x 5 feet; **Crew** Biomechanical

The Sparrow class of Raider came as a complete shock to Colonial Analysts. This Raider design is faster, more agile and far smaller than any of the original Raider designs. In large numbers they seem to operate far more like natural animals than warships and this likeness to swarms of birds has earned it the name of Sparrow amongst the pilots they face.

That the Sparrow is FTL capable has been seen on too many occasions. Its range and capabilities are not truly known but is assumed to be limited.

Unlike older Raiders, the Sparrow occupies narrow bays found around the bases of the necks that hold each part of the new style Basestars together. The smaller Basestars host over 400 of these raiders.

It was not until the capture and post examination of one of these craft that it was realised that its occupant was not mechanical or computer but rather a grown bio-construct that lives permanent within the ship.

[Sparrow Raiders have inhibitors fitted to them that prevent them engaging Human Cylon's.]

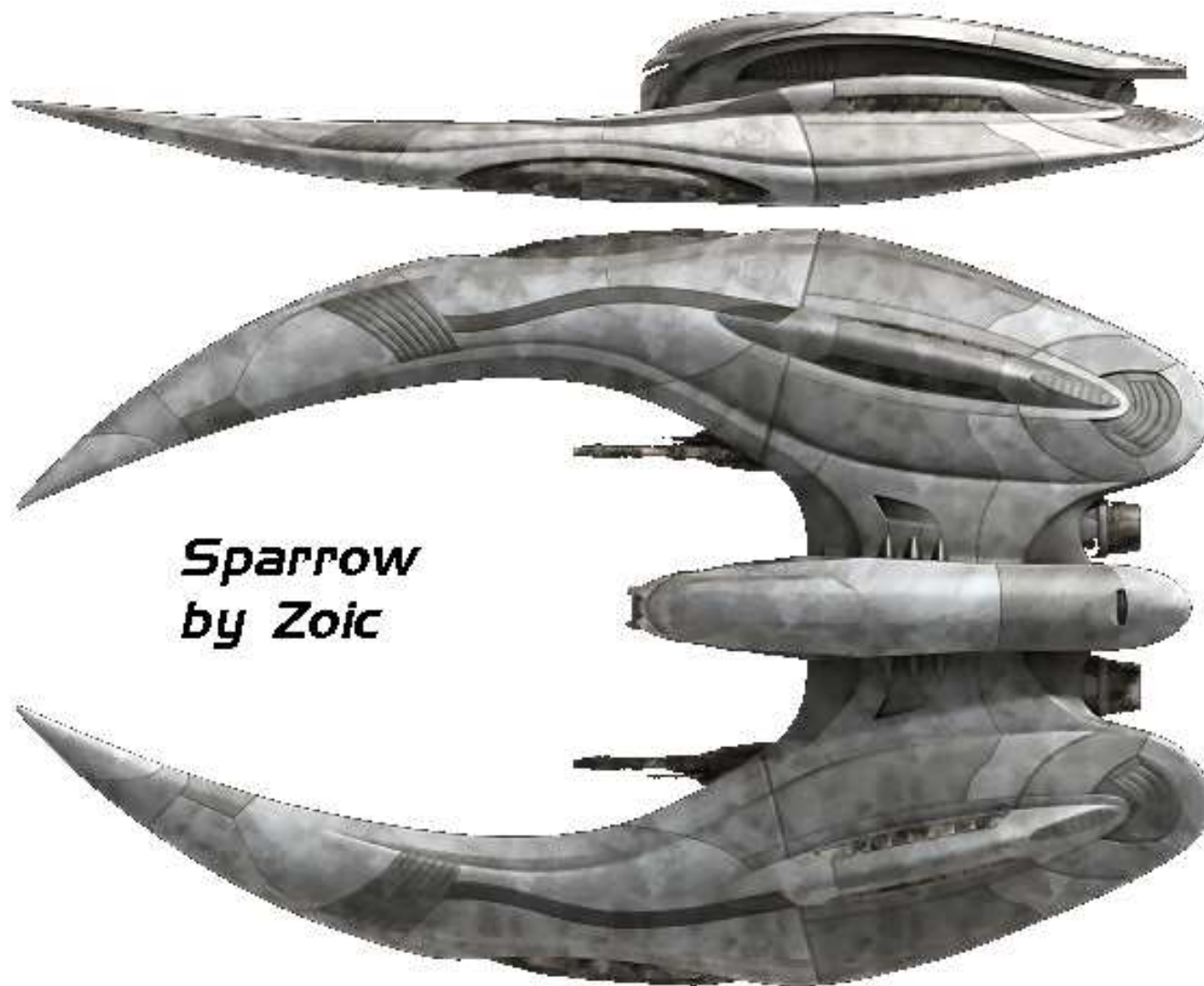



## Turkey Heavy Raider

Art by Zoic Studios

**Agi** d6, **Str** d10, **Vit** d10, **Ale** d6, **Int** d6, **Wil** d6;  
**LP** 16, **Init** d6+d6; **Scale** Planetcraft

**Speed** 7 (5 in atmosphere) (SL/JC)

**Traits** Biomechanical [d8]

**Skills** Perception d4, Pilot d4

### Armament

1 Quad heavy planetcraft scale skirmish range autocannons (d8),  
6 medium planetcraft scale  
capital range missiles (d12);

**Armour** Wound 4, Stun 2

**Description** 66 x 29 x 16 feet;

**Crew** Biomechanical\*;

**Passengers:** 12 Centurions

The Heavy Raider or troop transporter seems to be a hangover from the days when ships similar to this boarded Colonial warships and the Cylons on board would then make their way to the Damage and Weapon control centres. This allowed them to both vent the ships of their human crews and then turn the ships armament against any other ships. Turkey's are fairly well armoured and armed for their purpose, although the guns are in a fixed forward array. They also carry missiles and the centurions on board are capable of dismantling these

and setting up a ground based Surface to Air Missile battery, separate from the ships functions.

Turkey's also make ground support and patrol vehicles, strafing targets and then landing their centurions to mop up afterwards. Although control normally rests in a bio-construct, it is possible for a humanoid type being (Cylon or otherwise) to assume manual control of the ship. As with the Sparrow these vessels are jump capable although its range is not known.

These ships definitely support an atmosphere, principally designed to support the bio-construct pilot. It is known though, that its onboard systems will also support longer operations by its passengers.

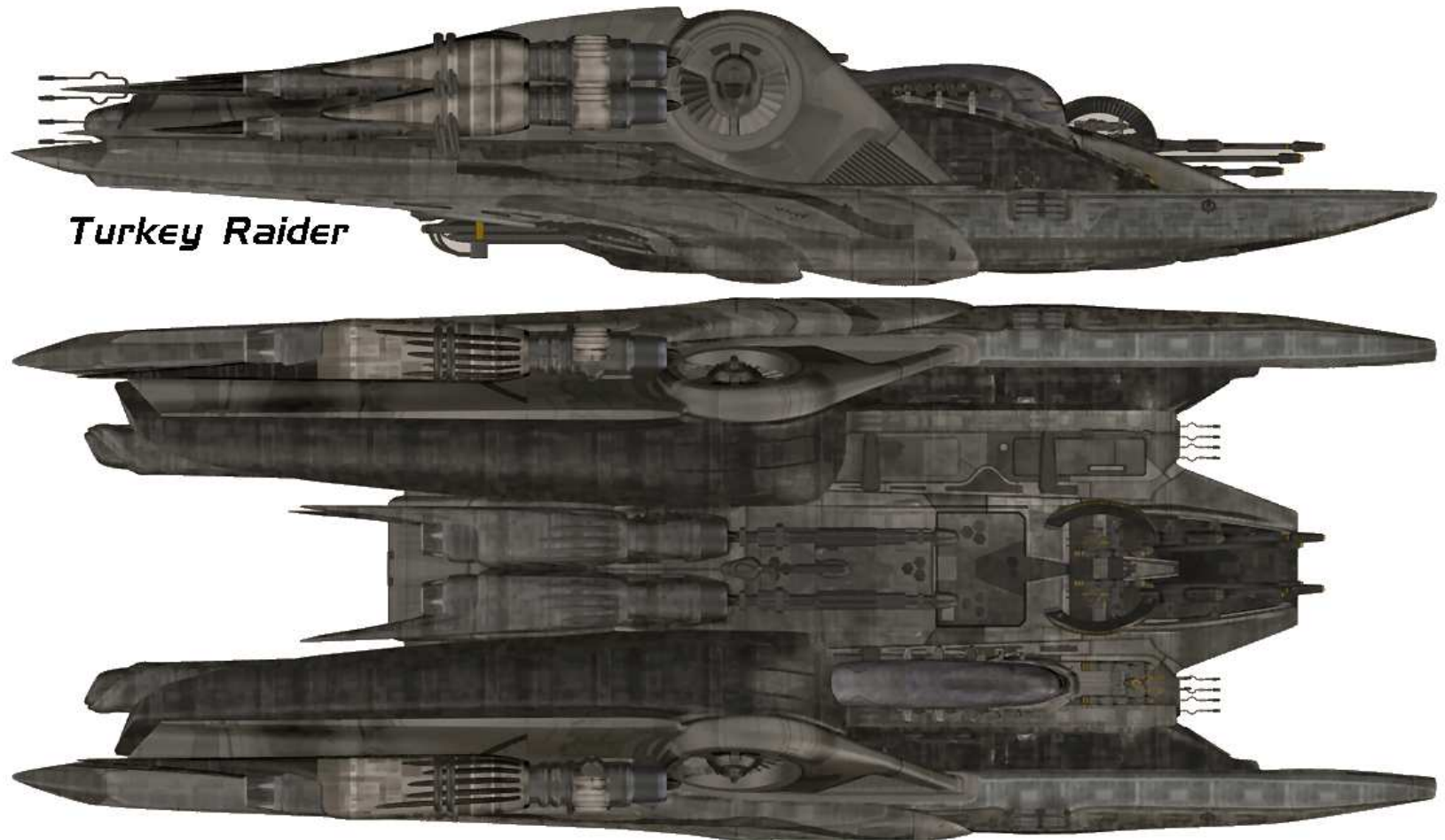

## ***Cylon ECM/ELINT Heavy Raider variant (Goose)***

By Gazza

Art by Limerickcot

**Agi** d6, **Str** d10, **Vit** d10, **Ale** d6, **Int** d6, **Wil** d6;  
**LP** 16, **Init** d6+d6; **Scale** Planetcraft

**Speed** 7 (5 in atmosphere) (SL/JC)

**Traits** Sixth Sense d6

**Skills** Perception d8, Pilot d4, Covert d6

### **Armament**

1 Quad heavy planetcraft scale skirmish range autocannons (d8),  
6 medium planetcraft scale capital range missiles (d12);

**Armour** Wound 4, Stun 4

**Description** 66 x 29 x 16 feet;

**Crew** Biomechanical\*; **Passengers:** none

A variant of the Heavy Raider, the Goose (named after a similar type in use in the Colonial Fleet) provides additional ECCM and ELINT capabilities to Cylon Raiders.

Remarkably the Goose retains her weaponry and most of the abilities of the originating craft, with the exception of the boarding ability. Its passenger/cargo compartment has been given over to extensive electronics. These are run by the biomechanical Cylon that runs the rest of the ships functions.

A goose helps cover the approach of other heavy raiders by jamming enemy DRADIS and missiles, effectively blinding enemy ships to the oncoming raiders and preventing them from reacting to the attack. If a Goose can jump in early enough, it is capable of rendering the automated navigational programs being run by such as a Battlestar ineffective, relying on the crew to fall back on manual star fixes and thus preventing anything except an emergency jump (the Cylons used this technique at several points during the Cylon War).

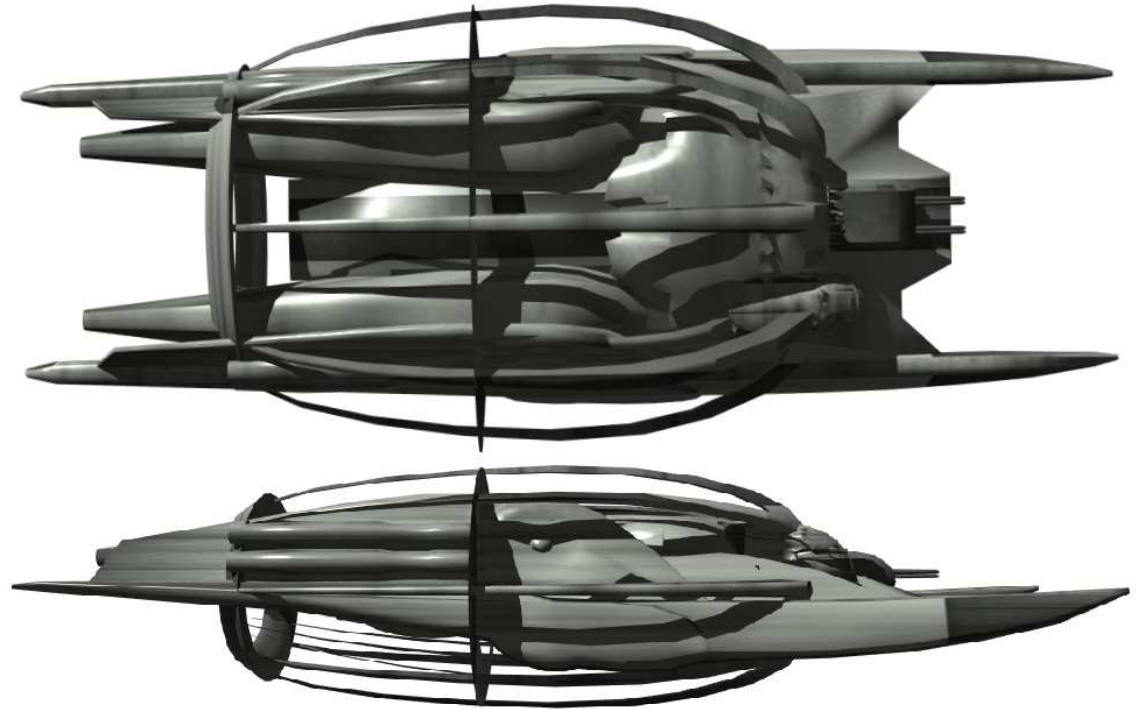

***Heavy Raider  
Goose ELINT***

***Limerickcot***

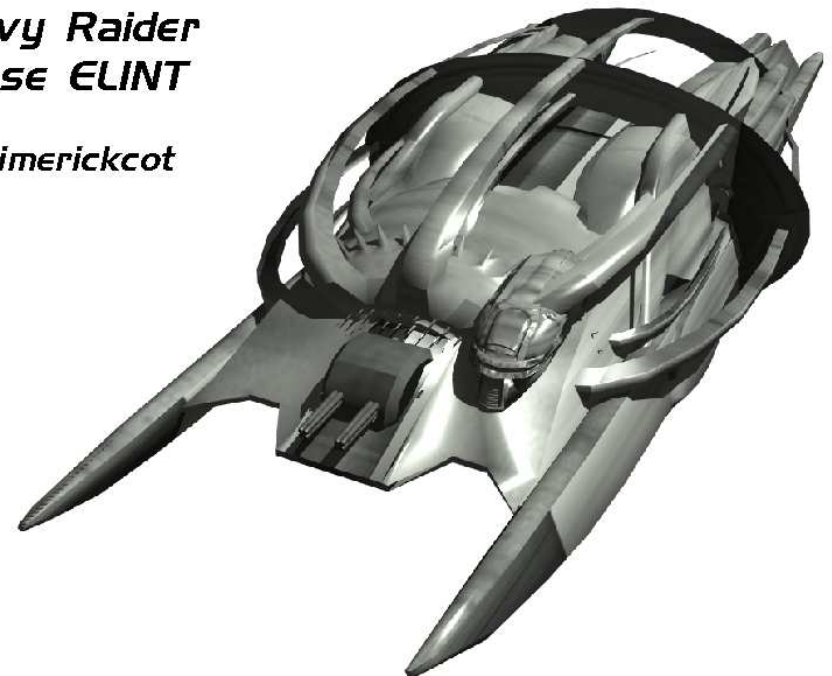



## ***Basestar Mark I (Hades Class)***

**Agi** d4, **Str** d12+d4, **Vit** d6, **Ale** d8, **Int** d8, **Wil** d10;  
**LP** 26, **Init** d10+d8; **Scale** Spacecraft  
**Speed** 5 (SL/JC)  
**Traits** Past Its Prime (d4)

**Skills** Heavy Weapons d6, Mechanical Engineering d4,  
 Perception d6, Pilot d4

### **Armament**

100 spacecraft scale capital range primary assault railguns (d12+d2);  
 30 planetcraft short range missile systems (d12)  
 2 spacecraft scale short DRADIS range nuclear missile systems (d12+d8);

### **Subcraft:**

300 Mk. IX Raider class Fighters,  
 30 surface transports, 2 drop ships

**Armour** Wound 4, Stun 4

**Description** 5,905 x 5,905 x 2,823 feet;

**Crew** 1005 (5 officers, 1000 warriors / fighter pilots)

**Passengers** 2,000 troops

The Hades Class was conceived and built by the Colonies as a vessel totally capable of waging war without human participation (except for a command crew of five humans). With a far larger number of fighters than any comparable ship could carry, and a vast array of railguns to protect it, the Hades lived up to its reputation as the ultimate warship. A PDS was not fitted to the ship as its own fighters were assigned to ship defence.

Only six of these craft were fully completed at the time of the Cylon revolt but the rapid seizure of production facilities (already fully automated in most areas) allowed the Cylons to rapidly build more of these vessels. The Cylon's ability to take over most military craft remotely at that

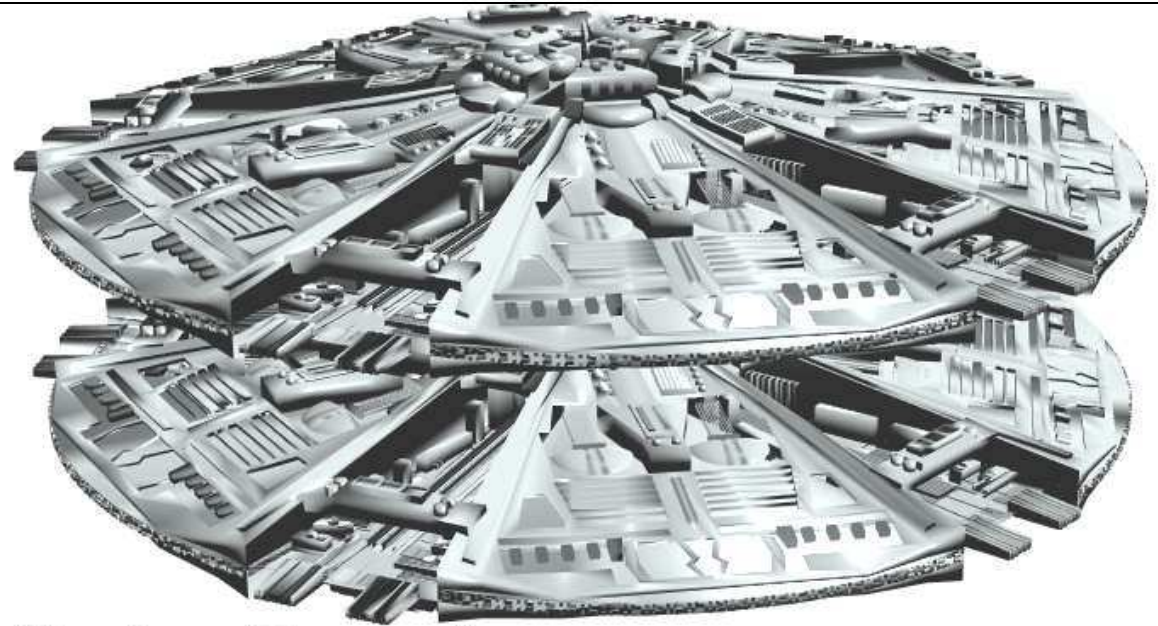

## ***Hades Basestar***

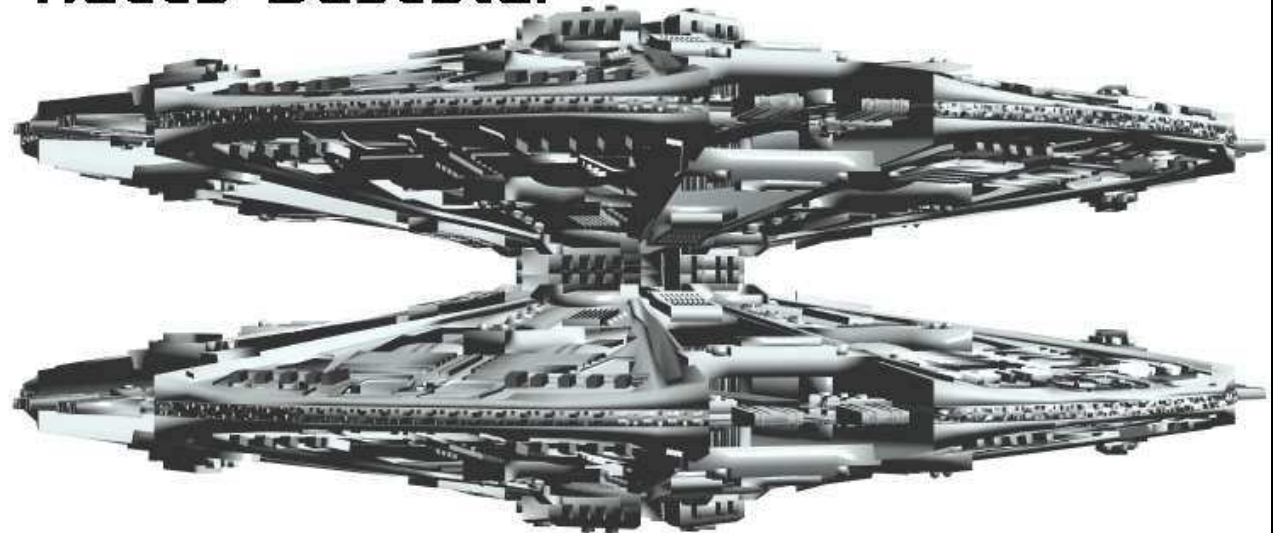

time left them facing few ships capable of dealing with them. Heroic efforts crippled the Cylons principal Shipyards and delayed the production of many of these, and other, ship types.



## Tartarus Class Gunstar

Stats by Buscadero

### Tartarus Class Gunship

**Agi** d6, **Str** d12+d6, **Vit** d8, **Ale** d10, **Int** d8, **Wil** d10;  
**LP** 28; **Init** d6+d10; **Scale** Spacecraft;

**Speed** 6 (SL/JC)

**Traits** Past Its Prime (d6)

**Skills** Heavy Weapons d6, Mechanical Engineering d4, Perception d6, Pilot d4

### Armament

10 heavy spacecraft scale short DRADIS range railguns (d12+d2);  
 50+ medium spacecraft scale short DRADIS range railgun turrets (d10);  
 24 heavy spacecraft scale short DRADIS range missile systems (d12+d4),  
 18 extreme spacecraft scale long DRADIS range nuclear missile systems (d12+d8);

### Subcraft

50 Raiders; 10 surface transports;

**Armour** Wound 6, Stun 5

**Description** 5,905 x 5,905 x 1,118 feet;

**Crew** 205; **Passengers** 1,000 (troops)

Following a devastating attack on their own shipyards, the Cylons adapted their Hade's design to produce a faster to build vessel. Designated Tartarus by the Colonials, this ship still carries a deadly punch. Faster and more heavily armoured than the Hades, the Tartarus was a match for the newer Battlestars coming on line. During the "Battle of Aegis", the Colonials' Seventh Battlestar Group of 100 ships (including sixteen Battlestars) was decimated by a Cylon force of 20 Tartarus and Hade's class vessels. This battle effectively broke the Colonials' offensive and turned the tide of the war back into the Cylons' favour.

The Cylons' new offensive was checked, as Colonial tacticians quickly devised countermeasures to the Cylons' new weapon. The Tartarus, despite her massive weapon payload, had several inherent design problems, which the Colonials were quickly able to seize advantage of.

Unlike Colonial vessels, which concentrate their firepower into only a few arcs, the Tartarus firing arcs are spread around her entire axis. By advancing along a single axis, fire from the Tartarus was restricted to only those weapons within a 72 degree arc – or about 2/5ths of her armament at any one time. On the other hand, the Tartarus was able to rotate damaged sections of her hull away from incoming fire if it was maintained for too long.

The most dangerous approach was to attack from either top or bottom, where either the entire dorsal or ventral weapons could engage the aggressor. But by doing so the Tartarus could not rotate her damage away. The most dangerous use of these ships occurs in units of six or more, as their overlapping firepower makes them almost impossible to overcome without taking severe damage

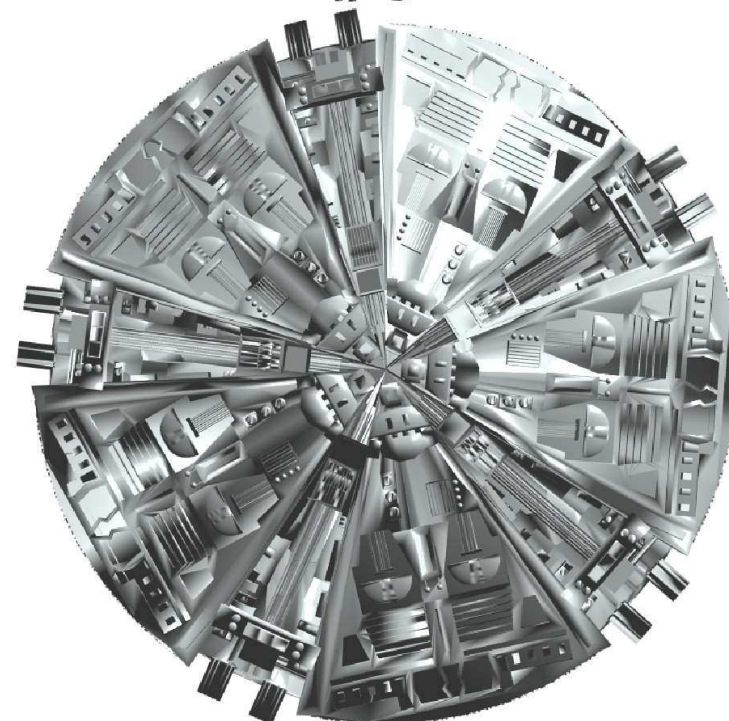

**Tartarus**



## ***Cylon Basestar – Advanced First War Variety***

Picture from Galactica BBS

Stats by Buscadero & Limerickcot

**Agi** d8, **Str** d12+d2, **Vit** d8, **Ale** d10, **Int** d10, **Wil** d10;

**LP** 24; **Init** d8+d10; **Scale** Spacecraft;

**Speed** 5 (SL/JC)

**Traits** Past Its Prime (d2)

**Skills** Heavy Weapons d6, Mechanical Engineering d4, Perception d6, Pilot d4, Tactics d4

### **Armaments**

12 Heavy, Short DRADIS range Railguns (d12+2)

12 Medium planetcraft scale short DRADIS range missile systems (d12)

12 heavy planetcraft scale short DRADIS range missile systems (d12+d4),

12 extreme spacecraft scale long DRADIS range missile system (d12+d8);

### **Subcraft:**

50 Raiders

8 Troop carriers

**Armour** Wound 4, Stun

4

**Description** 3600 x

3600 x 980 feet;

**Crew** 1; **Passengers**

2100

This advanced, and much smaller Basestar, was spotted just prior to the Armistice agreement that ended the Cylon War. Its shape is a curious mix of old and newer styles of baseship. Still well armed, it is not a true match for modern Battlestars, although it would give them a tough fight in a slugging match.

Later intelligence suggests that this is the first vessel to be piloted by a 'hybrid' – a humanoid being bred for the sole purpose of interacting and controlling the baseship. Maintenance and other duties are carried out by Centurions following the directions of the Hybrid. However, the hybrid itself does not 'command' the ship under normal circumstances but just follows the orders given to it. Hybrids may have some kind of special link to one another that allows them to communicate. Further details are unknown.

It should be noted that the ships ability to rapidly communicate amongst its component parts gives it a special advantage over its opponents (see skills above).





## ***Dreadnaught***

By Limerickcot

**Agi** d4, **Str** d12+d6, **Vit** d6, **Ale** d8, **Int** d8, **Wil** d10;

**LP** 28, **Init** d4+d8; **Scale** Spacecraft

**Speed** 5 (SL/JC)

**Traits** Past Its Prime (d4)

**Skills** Heavy Weapons d6, Mechanical Engineering d4, Perception d6, Pilot d4

### **Armament**

720 spacecraft scale capital range primary assault railguns (d12+d2);

360 planetcraft short range missile systems (d12)

360 spacecraft scale long range missile systems (d12)

60 spacecraft scale short DRADIS range nuclear missile systems (d12+d8);

12 spacecraft scale, skirmish range, Laser arrays (d12+d12) – see notes

### **Subcraft:**

1620 Mk. IX Raider class Fighters,

150 surface transports (2 Hades or Tartarus can dock with the ship as well)

**Armour** Wound 5, Stun 4

**Description** 18,012 x 18,012 x 8,469 feet;

**Crew** 26 human, 10,000 Cylons

Invincible, Relentless and Supreme – the biggest, most heavily armed and most advanced ships that humanity had ever built. These dreadnaught class vessels were the first to utilise the new Reaction-less Drive Systems that were to become a standard feature on the Cylon ships. Only one shipyard had the ability to build these engines and the Cylons seized that early on in the war. Its inventors were killed and, to date, no colonial scientist has yet been able to duplicate the design. In addition to standard armament, the designers also installed a new laser system. Its arrays could, in theory, lock on and destroy any target that came into close proximity with the ship.

That was the theory. In reality the Cylons soon found that the array could only operate at very short range, needed constant cooling and

engendered a backlash on the system that disabled their weapons control systems. This would not have happened on the original design, but that design required living humans to allow the circuitry to work.

It was not possible to bypass this system and so the Cylons used ‘parts’ of humans to work the system. These ‘live’ systems could not stand the backlash from the lasers.

In addition all Dreadnaughts could be overridden by their part-human controls for short periods of time – time that could cost them dearly in battle. All vessels were thought lost in the war. It is likely that this is what spurred the Cylons to produce the Hybrids that control their newer Basestars.

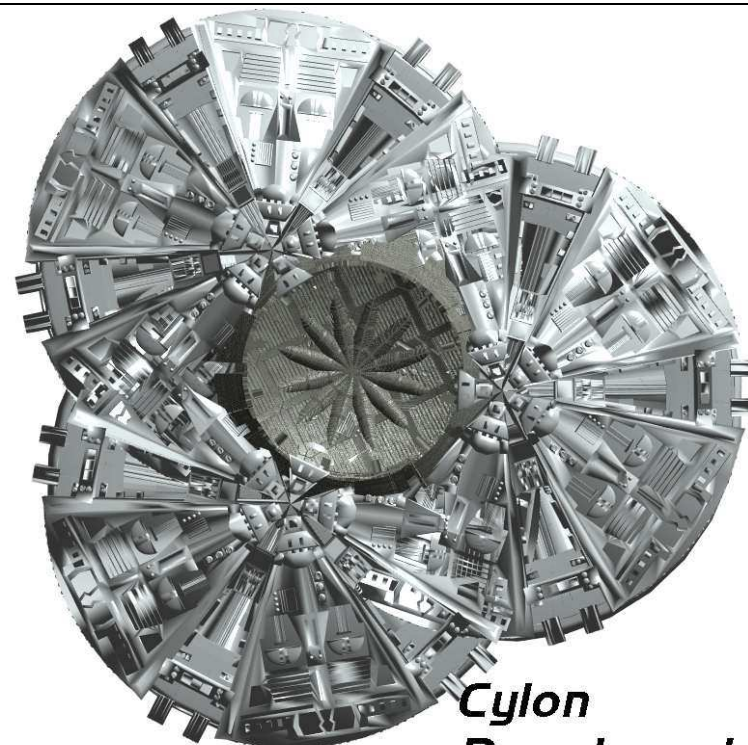

***Cylon  
Dreadnaught***

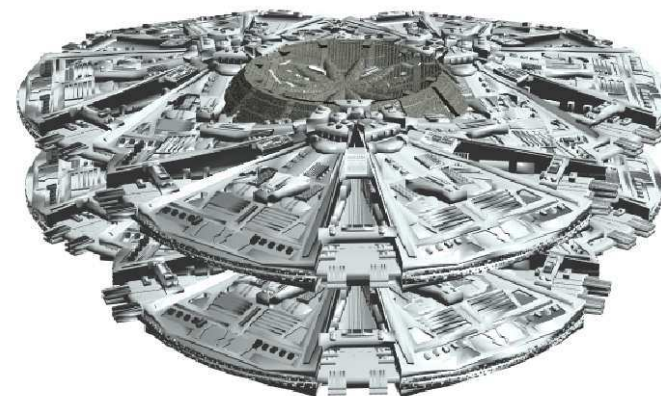
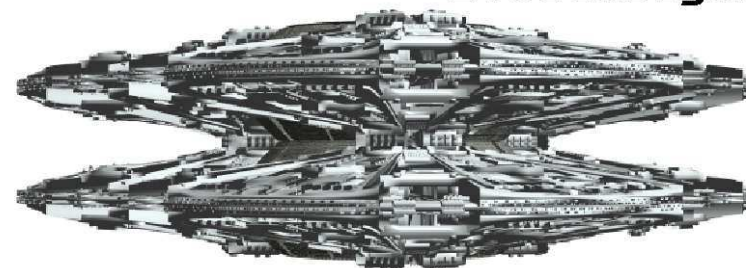



## **Warstar Mk I**

By Limerickcot

Artist – Steve Wilson

**Agi** d4, **Str** d12, **Vit** d8, **Ale** d10, **Int** d8, **Wil** d10;

**LP** 22; **Init** d4+d10; **Scale** Spacecraft;

**Speed** 2 (SL/JC)

**Traits** Past Its Prime (d6)

**Skills** Heavy Weapons d6, Mechanical Engineering d4, Perception d6, Pilot d4

### **Armament**

Heavy PDS system (D12+d2)

12 heavy spacecraft scale short DRADIS range railguns (d12+d2);

36 medium spacecraft scale short DRADIS range railgun turrets (d10);

12 heavy spacecraft scale Medium DRADIS range missile systems (d12+d4),

Mass-Driver space-craft scale, planetary bombardment (d12+d4)

### **Subcraft**

360 Raiders

60 transports

**Armour** Wound 6, Stun 5

**Description** 3,110 x 3,110 x 3,000 feet;

**Crew** 2600; **Troops:** 6700

The Warstar is designed to hold an orbital position and keep it against all comers. Its slower speed allows it maintain a steady spin to offset damaged sections in battle, and allows it to move and change orbital position when it must.

In addition to its need to maintain air superiority over a target area (by using its raiders), the Warstar also carries a Cylon division (these being much smaller than human equivalents) and the ships to land them. Part of its hull is devoted to repair and ammunition production to support its division.

A comprehensive communications array allows it to maintain communication with both its ground forces, its air forces and the other Cylon units operating in its area. The bottom of the Warstar hosts an orbital bombardment mass-driver. This device can only fire once every hour (the energy requirements to do so more often would shut down the Warstars defences and communications) and its targeting system means that it can only be used against static defences. The deployment of a Warstar over a combat area

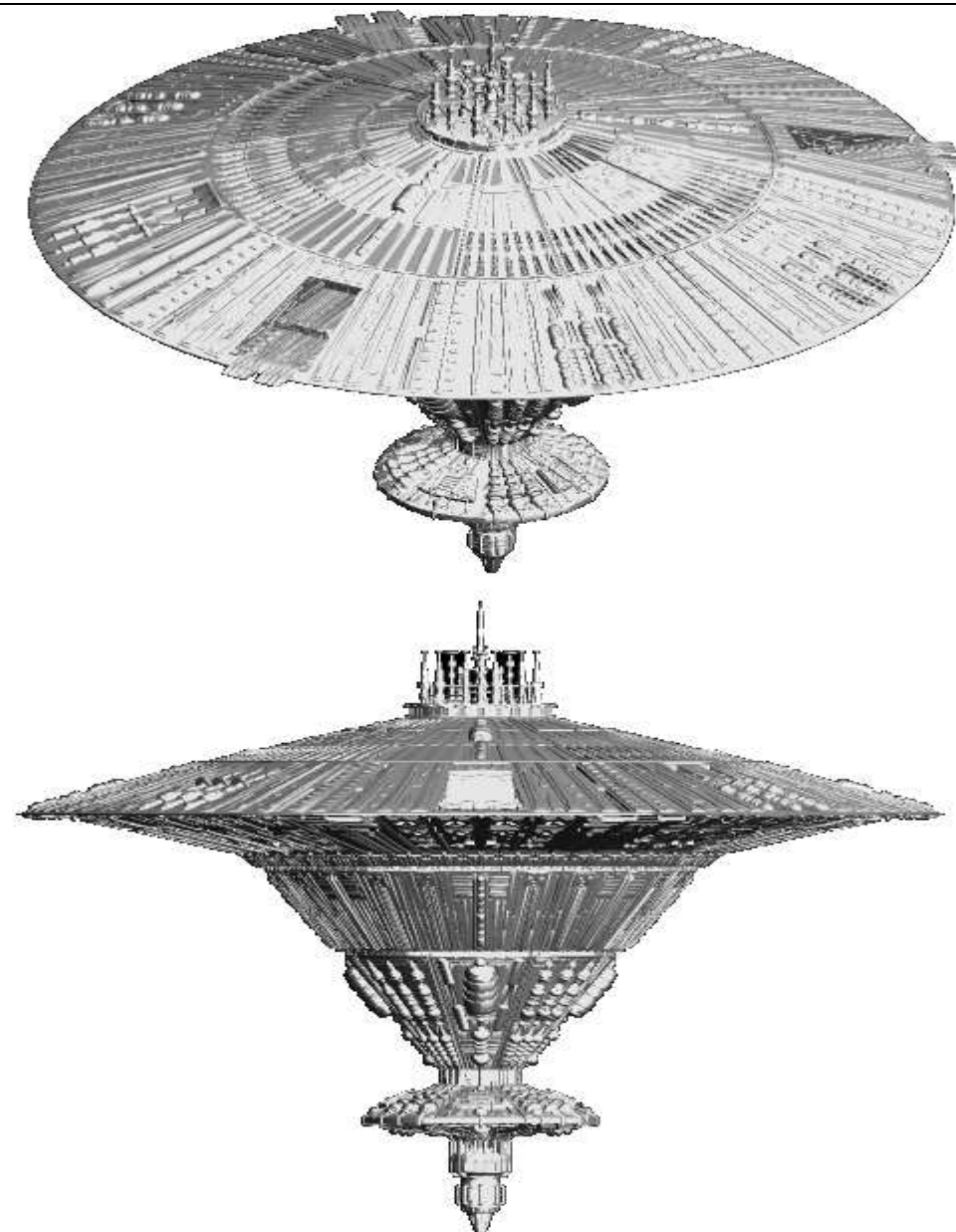

usually requires the fleet to deploy its own forces in return. The use of mass driver weapons on colonial ships has been outlawed since the end of the Cylon War (especially as the Cylons provided few static ground targets for their use).

## **Warstar Mk V**

By Limerickcot

**Agi** d4, **Str** d12+d2, **Vit** d8, **Ale** d10, **Int** d8, **Wil** d10;  
**LP** 24; **Init** d4+d10; **Scale** Spacecraft;

**Speed** 4 (SL/JC)

**Traits:**

**Skills** Heavy Weapons d6, Mechanical Engineering d4, Perception d6, Pilot d4

### **Armament**

Heavy PDS system (D12+d2)

24 heavy spacecraft scale medium DRADIS range railguns (d12+d2);

36 medium spacecraft scale short DRADIS range railgun turrets (d10);

12 heavy spacecraft scale Capital DRADIS range missile systems (d12+d4),

Mass-Driver space-craft scale, planetary bombardment (d12)

### **Subcraft**

420 Raiders

60 transports

148 ground vehicles

**Armour** Wound 6, Stun 5

**Description** 5,905 x 5,905 x 2,950 feet;

**Crew** 1100; **Troops** 6700

Various other types of Warstar were noted during the twelve years of the Cylon War, including the Patrol Star variant which carried double the number of raiders at the expense of much of the vessels armament. The Mark V variant was seen in the last years of the war and was considered an improvement over the original, being bigger and better armed than the original.

The original mass driver was replaced with an updated version which, although it caused less damage, could fire every half hour. The Mark V was also the first Cylon Warstar to carry ground vehicles for its troops. A mix of light missile and gun sleds were common, but these were backed up by a battalion (74) of heavy tanks, totally 'wired' up and utilising the brain components of Cylon Centurions that had been recovered damaged from earlier in the war.

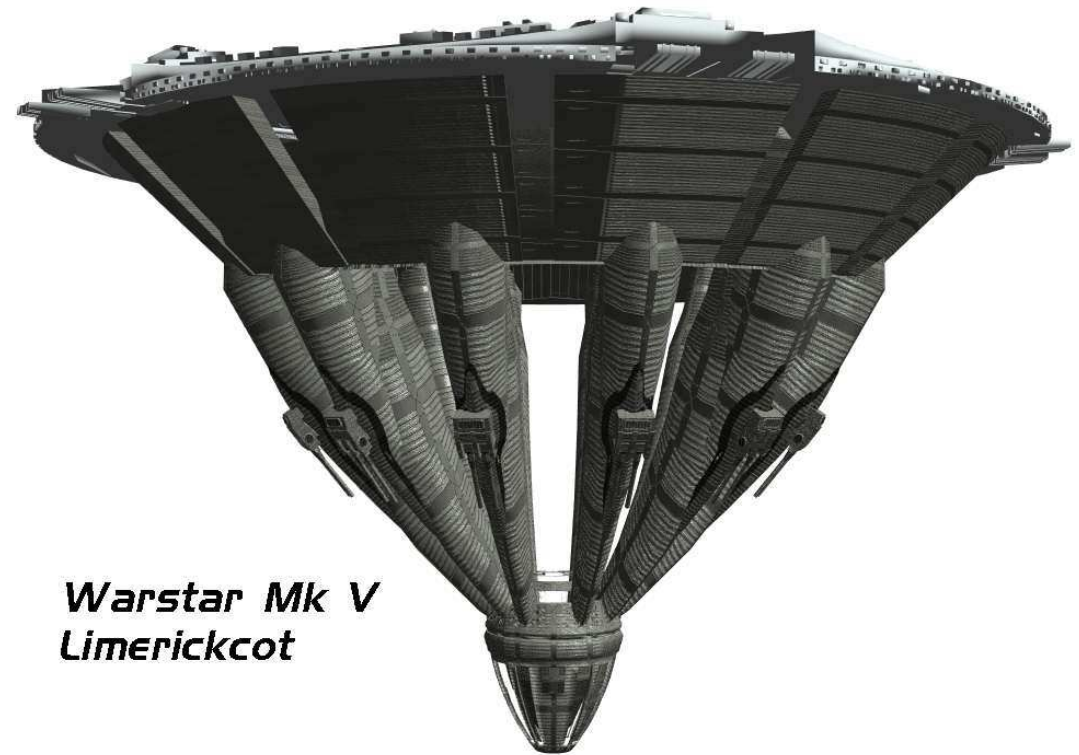

**Warstar Mk V**  
**Limerickcot**

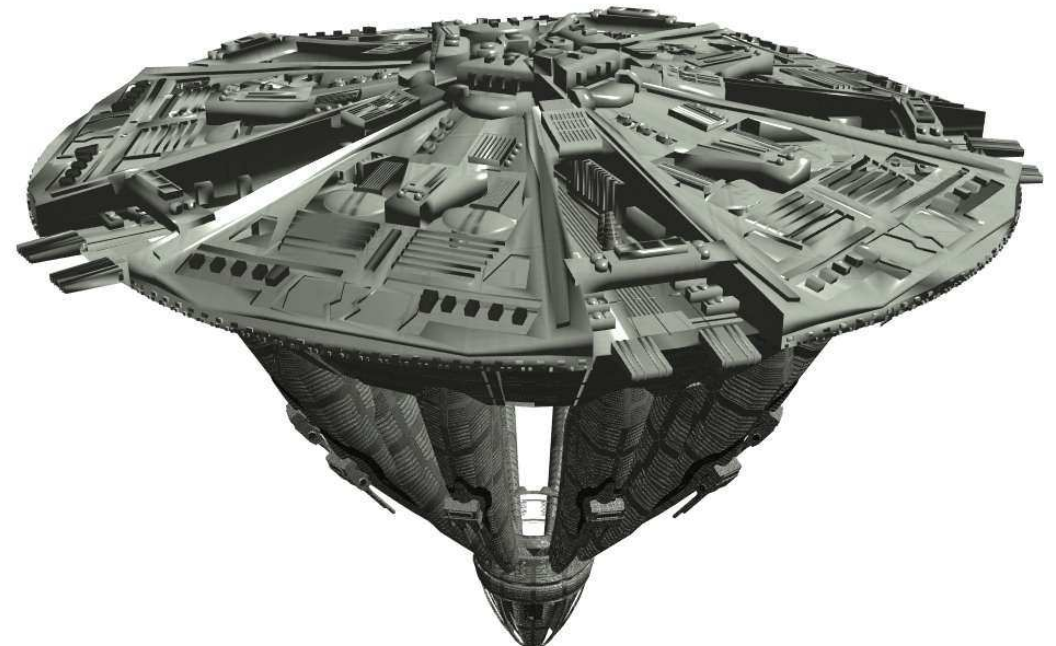

## **Basestar – Biomechanical**

Art by Zoic

Stats by Limerickcot

**Agi** d6, **Str** d12+d2, **Vit** d10, **Ale** d12, **Int** d10, **Wil** d8;

**LP** 22, **Init** d6+d12; **Scale** Spacecraft

**Speed** 6 (SL/JC)

**Traits:** Self-repair (d2), Formidable Presence (d4)

**Skills** Heavy Weapons d4, Mechanical Engineering d6, Perception d6, Pilot d6, Tactics d6.

### **Armament**

24 Medium Planetcraft scale Skirmish Range Missile Systems (d6)

24 Heavy Planetcraft scale Capital Range Missile Systems (d12+d4)

36 Heavy Spacecraft scale Medium Range Missile Systems (d12+d4)

6 Nuclear Spacecraft scale Capital Range Missile Systems (d12+d8) or 6 x 24 MIRV nuclear warheads for ground targets (d10)

### **Subcraft:**

Standard – 300 Raiders, 124 Heavy Raiders

Heavy – 864 Raiders and Heavy Raiders

**Armour** Wound 4, Stun 5

**Description** 4500 x 2250 x 625 feet;

**Crew** 1 – unknown numbers of Cylons

The latest types of Cylon Basestar use a mix of mechanics and biological technology to produce a vessel that is far more capable than its predecessors. It should be noted that it is not readily possible to tell if the Basestar is a standard type or one of the heavier 'carrier' variants.

Piloting and communications is handled by a hybrid humanoid pilot that is plugged into the ships structure. This allows the ships small craft to operate in a unified manner that gives it a special advantage over its opponents (see skills above)



The ship can also self-repair itself, using on-board materials, but requires access to larger stores to repair major damage. In game terms this means that the ship will self-repair one life-point every second day. Damage can still be repaired manually of course. It should be noted that, with the introduction of this vessel, nearly all other ship types that came before it have been rendered obsolescent in Cylon culture and most older ship types have been salvaged or withdrawn from front-line service.



## **Warstar Mk XII**

Art by Fury of Seraph

Stats by Limerickcot

**Agi** d6, **Str** d12+d4, **Vit** d10, **Ale** d12, **Int** d10, **Wil** d8;

**LP** 24, **Init** d6+d12; **Scale** Spacecraft

**Speed** 6 (SL/JC)

**Traits:** Self-repair (d2), Formidable Presence (d6)

**Skills** Heavy Weapons d4, Mechanical Engineering d6, Perception d6, Pilot d6, Tactics d6.

### **Armament**

48 Medium Planetcraft scale Skirmish Range Missile Systems (d6)

48 Heavy Planetcraft scale Capital Range Missile Systems (d12+d4)

72 Heavy Spacecraft scale Medium Range Missile Systems (d12+d4)

6 Nuclear Spacecraft scale Capital Range Missile Systems (d12+d8) or 6 x 24 MIRV nuclear warheads for ground targets (d10)

### **Subcraft:**

Heavy – 864 Raiders, 864 Heavy Raiders

**Armour** Wound 4, Stun 5

**Description** 4500 x 4500 x 800 feet;

**Crew** 1 – 14200 Centurions

With the realisation that the fight against the humans would require the deployment of large numbers of centurions, it was decided to update the Warstars of the first war. Essentially the Warstar is four times the volume of a heavy Basestar, although its armament is only doubled. Instead of the slow acting mass drivers of the earlier versions, the Mark XII deploys nuclear missiles instead. A double division of the newer centurions are carried and deployed by these vessels and, indeed, they have a far more unique ability than their predecessors in that the Mark XII is capable of making planet fall. Instead of deploying armoured vehicles like the Mark V, the Mark XII utilises heavy raiders to provide ground support capability to its troops.

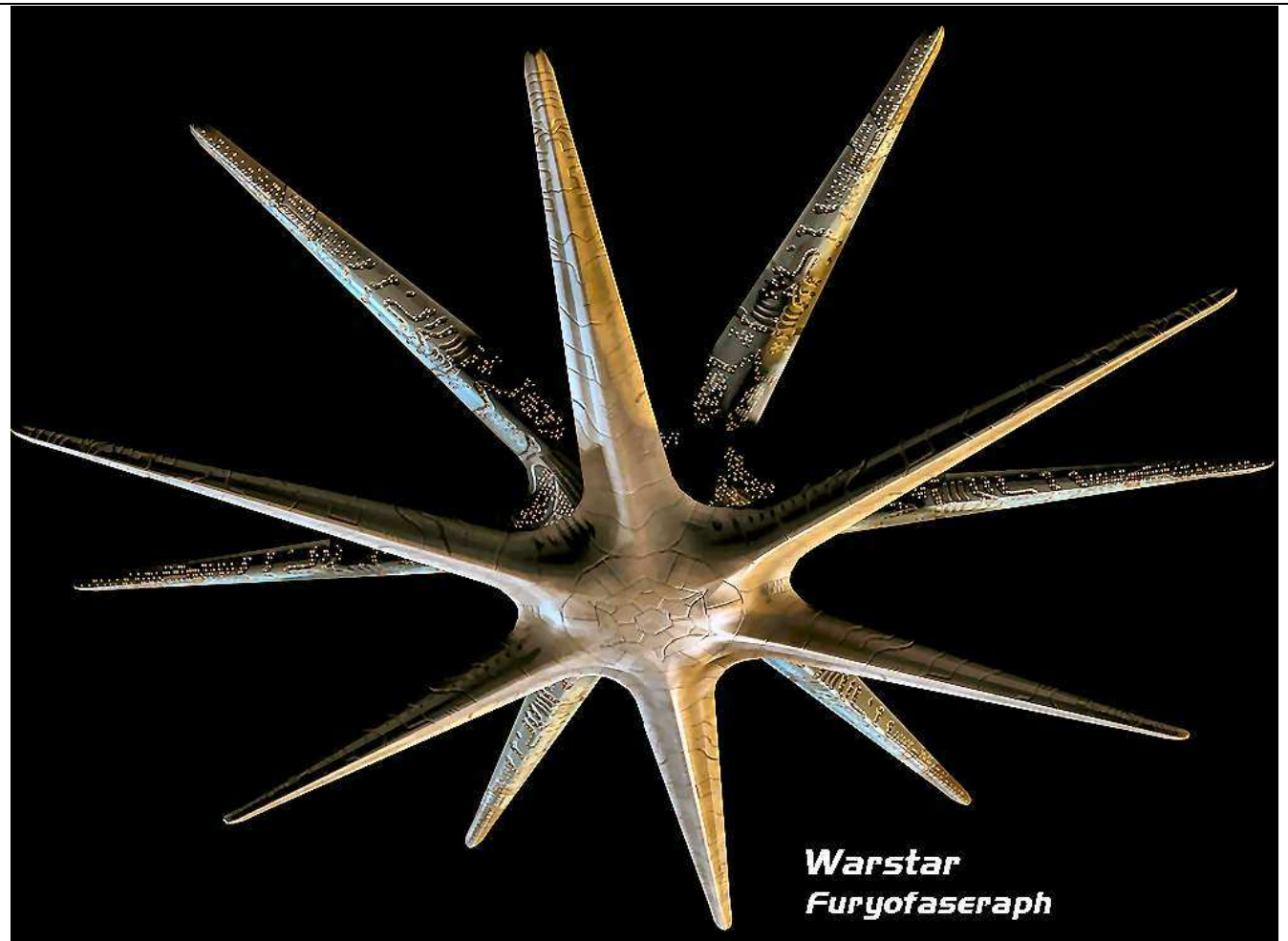

Another difference between the War and Base stars is the use of two Hybrids aboard the Warstar. One pilots the ship, the other maintains the vast communications network needed to control so many Raiders and Centurions all at once. This split of duties allows for a speedy control of any tactical situation that the Cylons might meet.

**Cylon Freighter**

stats by Buscadero  
art by Coxson

**Agi** d4, **Str** d6, **Vit** d6, **Ale** d4, **Int** d4, **Wil** d6;

**LP** 12; **Init** d4+d4; **Scale** Spacecraft;

**Speed** 4 (SL/JC)

**Trait** Mass-Produced (d4),

**Skills** Mechanical Engineering d2, Perception d2, Pilot d4

**Armament** None

**Armour** Wound 1, Stun 1

**Description** 195 x 35 x 25 feet; **Crew** 2

The Cylon freighter (or Cylon tanker) began life as one of a large number of semi-automated vessels belonging to a number of large colonial companies. They had taken the opportunity to update their ships and reduce crews (and salaries). With the advent of war, these ships were easily assimilated by the Cylon network, their crews vented into space and control either fully automated or run by Cylons.

**Cylon Freighter [2<sup>nd</sup> Cylon War]**

**Agi** d4, **Str** d6, **Vit** d6, **Ale** d6, **Int** d8, **Wil** d6;

**LP** 12; **Init** d4+d6; **Scale** Spacecraft;

**Speed** 4 (SL/JC)

**Traits** Mass-Produced (d4), Past Its Prime (d4)

**Skills** Mechanical Engineering d4, Perception d6, Pilot d6

**Armament** None

**Armour** Wound 1, Stun 1

**Description** 195 x 35 x 25 feet;

**Crew** biomechanical

The updated freighter uses a hard-wired Cylon brain network and no longer requires manual control. Cylons are still carried for maintenance purposes.

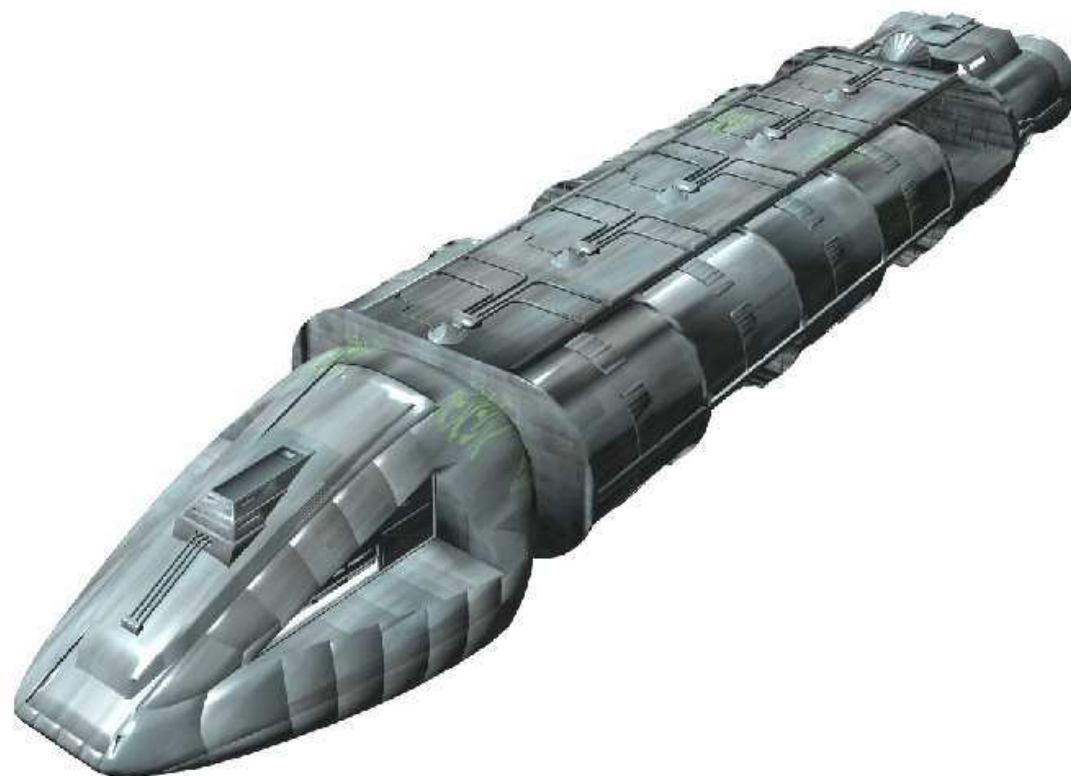
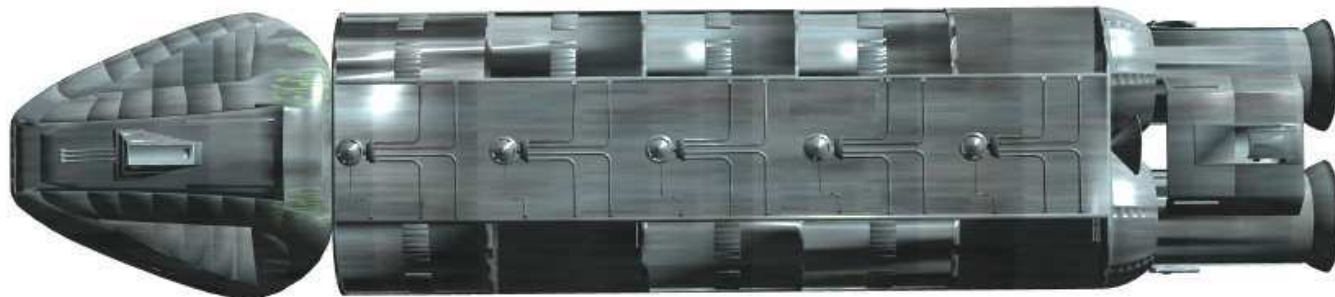

## ***Cylon Utility Ship***

By Limerickcot

**Agi** d6, **Str** d8, **Vit** d6, **Ale** d6, **Int** d8, **Wil** d6;  
**LP** 14; **Init** d6+d6; **Scale** Spacecraft;  
**Speed** 6 (SL/JC)

**Traits:** None

**Skills** Mechanical Engineering d4, Perception d6, Pilot d6,  
 self-repair (d2)

**Armament** None

**Armour** Wound 1, Stun 1

**Description** 500 x 96 x 52 feet;

**Crew** biomechanical pilot, 6 Cylon loaders

A larger and purely Cylon designed vessel, the utility ship comprises a control and fuel module, drives and then a series of eight modular cargo pods that can be dismantled as and when required. Capable of long jumps and reasonably fast, the Utility Ship serves as tanker and jack of all trades to the Cylon forward fleets.

If threatened by combat, the ship is programmed to jump to safety, unless over-ridden by a Baseship's hybrid.

As with a Baseship, the utility ship utilises a bio-mechanical hull system that is capable of self repair. It also carries a small crew of Cylons designated to help with the loading and offloading of cargo and to carry out repairs. The forward control module can also carry up to 100 Centurions for transfer to a Basestar, or quarters for 20 humanoid Cylons.



## ***Cylon Utility Ship*** ***Limerickcot***





## **Cylon Hub**

Art by Kreargh

Stats by Limerickcot

**Agi** d2, **Str** d12+d6, **Vit** d8, **Ale** d6, **Int** d8, **Wil** d8;

**LP** 26; **Init** d2+d6; **Scale** Spacecraft;

**Speed** 2 (SL/JC)

**Traits:** Memorable (d4)

**Skills** Mechanical Engineering d6, Perception d6, Pilot d6, self-repair (d2)

**Armament** None

**Armour** Wound 1, Stun 1

**Description** 8,985 x 8,985 x 3089 feet;

**Crew** Unknown

**Passengers:** Unknown

The Hub is a crucial and unique part of the Cylon Network. It is this device that controls all the links to the various Resurrection Ships and Baseships. And all resurrection technology is controlled via the Hub. Without it, the Cylons cannot upload into a new body following death. Indeed all the Hybrids talk to each other, somehow relaying their messages through the Hub. Directions from the governing council of the Cylons likewise are relayed back through the Hub from wherever they are.

As a result, the Hub, although individually relatively weak, is always protected by a number of Basestars. To further protect it, it makes frequent, random jumps.

## **Cylon Hub by Kreargh**

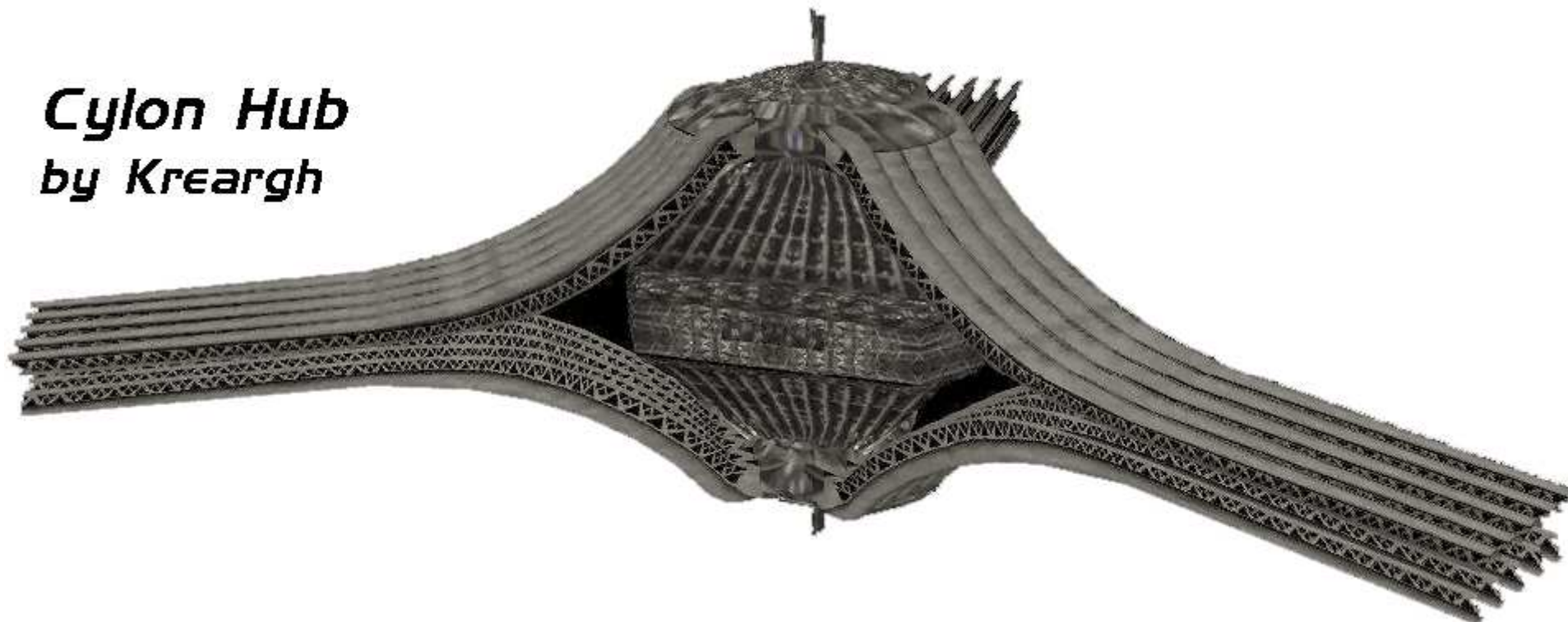

## ***Resurrection Ship***

By Limerickcot

**Agi** d4, **Str** d10, **Vit** d8, **Ale** d6, **Int** d8, **Wil** d8;  
**LP** 18; **Init** d4+d6; **Scale** Spacecraft;  
**Speed** 5 (SL/JC)

**Traits:** Memorable (d4)

**Skills** Mechanical Engineering d6, Perception d6, Pilot d6, self-repair (d2)

**Armament** None

**Armour** Wound 1, Stun 1

**Description** 2010 x 465 x 784 feet;

**Crew** Unknown  
 Passengers: Unknown

The Resurrection Ship is a mix of store, supply and manufacturing vessel. Linked to the 'Hub' it acts as a forward extension to the Cylon 'consciousness'. As long as a Cylon dies within range (unknown, but possibly as much as several hundred light years), then they can be uploaded into a new body. The sheer size of the vessel is needed as these Cylons are not merely human (and therefore need new physical bodies) but are also Raiders and possibly Centurions as well.

The Resurrection Ship manufactures the new Raiders and Centurions as well, shipping them off to new Base Stars. It should be noted that at least some Base Stars also have resurrection technology but their capacity is severely limited.



## ***Resurrection Ship*** **by Limerickcot**

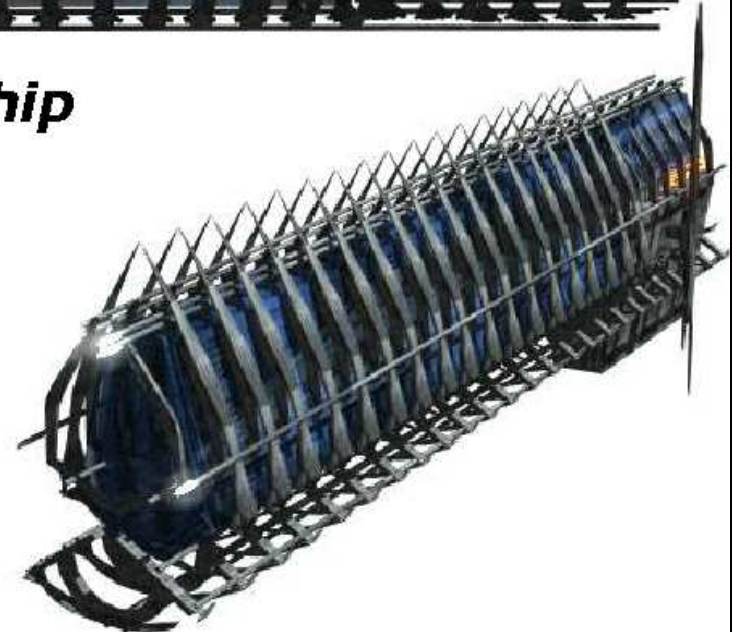

## ***Imperator***

Supplied by AXG423 from a Mesh by Steve Wilson  
Stats by Limerickcot

**Agi** d6, **Str** d12+d2, **Vit** d8, **Ale** d8, **Int** d10, **Wil** d8;  
**LP** 22; **Init** d6+d10; **Scale** Spacecraft;

**Speed** 6 (SL/JC)

**Traits** Past Its Prime (d6)

**Skills** Heavy Weapons d6, Mechanical Engineering d4, Perception d6, Pilot d4

### **Armament**

10 heavy spacecraft scale short DRADIS range railguns (d12+d2);  
12 medium spacecraft scale short DRADIS range railgun turrets (d10);  
12 heavy spacecraft scale short DRADIS range missile systems (d12+d4),  
2 extreme spacecraft scale long DRADIS range nuclear missile systems (d12+d8);

### **Subcraft**

150 Raiders; 60 troop transports;

**Armour** Wound 3, Stun 3

**Description** 5,905 x 5,905 x 623 feet;

**Crew** 410; **Passengers** 720 (troops)

Originally named the Canopus by its Builders, it was renamed the Imperator by the Colonial Fleet that had to fight against it. Another vessel designed for use by Cylons (with a tiny human oversight crew), it was designed as an escort to the larger Hades Basestar. Unfortunately, at the time of building the engineers had been unable to build a reactionless drive sufficient for the class and so a regular engine mounted was built instead. The Cylons seized the vessels that were built, and improved on it, building more.

It was only later that the Cylons would realise that they needed a Gunstar and so produce the Tartarus. But at the beginning of the war, the Imperators pressed home the attacks against the Colonies, facing off against their opposite numbers and preventing the Colonies from pressing home an early offensive against the Cylon Basestars.

When the Cylons withdrew the few remaining types went with them. Their current deployment is on long range missions. As these have returned back to base, the ships have been salvaged for parts.

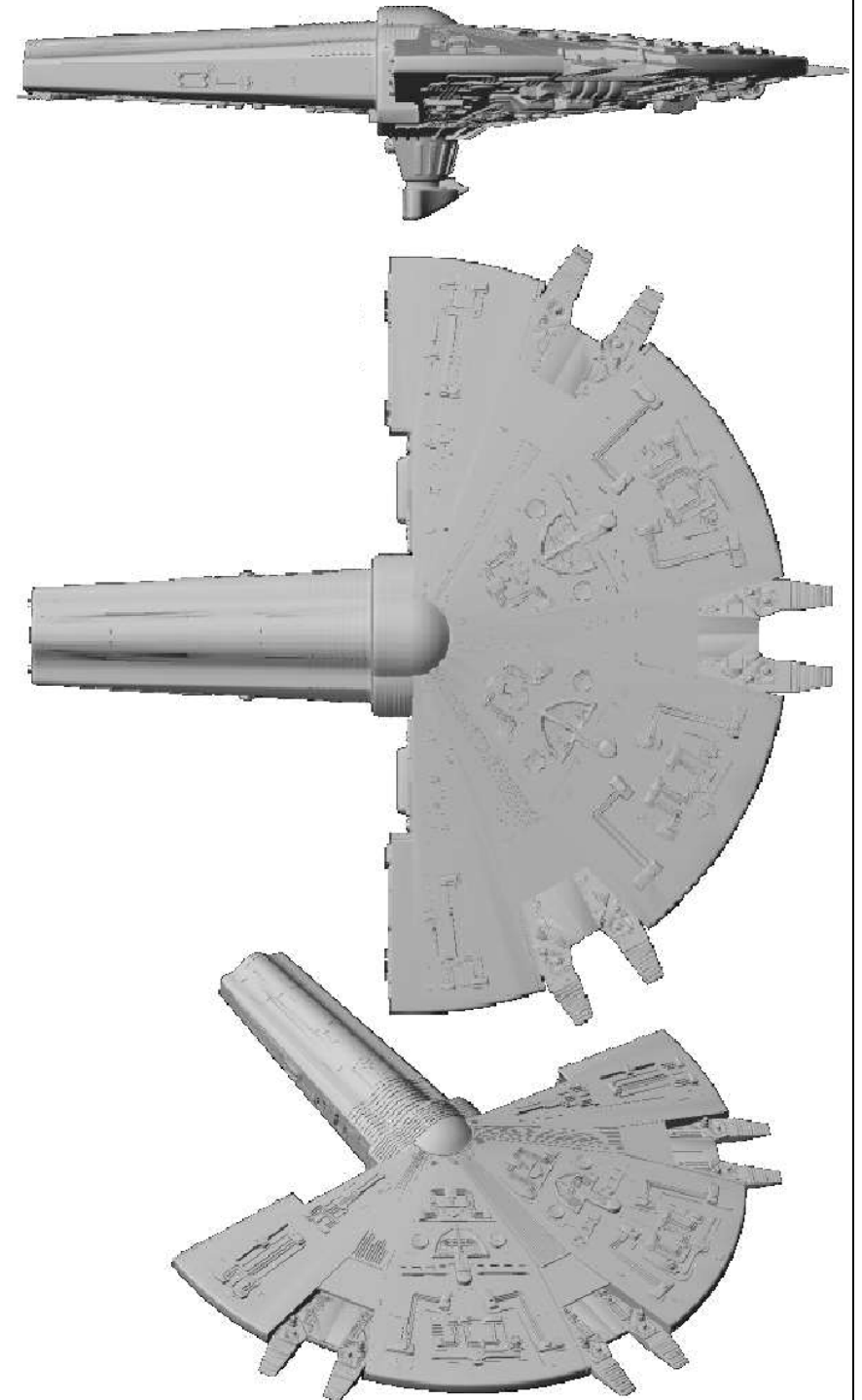



## ***Intruder***

Supplied by AXG423 from a Mesh by Steve Wilson  
Stats by Limerickcot

**Agi** d10, **Str** d8, **Vit** d8, **Ale** d12, **Int** d8, **Wil** d8;  
**LP** 16; **Init** d10+d12; **Scale** Spacecraft;

**Speed** 7 (SL/JC)

**Traits** Past Its Prime (d6)

**Skills** Heavy Weapons d6, Mechanical Engineering d4, Perception d6, Pilot d4

### **Armament**

Medium, planetcraft scale, skirmish range, PDS (D8)

2 heavy spacecraft scale short DRADIS range railguns (d12+d2);

6 medium spacecraft scale short DRADIS range railgun turrets (d10);

6 heavy spacecraft scale short DRADIS range missile systems (d12+d4),

24 medium planetcraft scale Medium DRADIS range missile systems (d10)

### **Subcraft**

6 troop transports; 12 Raiders

**Armour** Wound 4, Stun 3

**Description** 1,300 x 1,000 x 320 feet;

**Crew** 104 **Passengers** 72 (troops)

The ease with which the Cylons took over ships and facilities cannot be more easily illustrated than with the wholesale takeover of the advanced Intruder Class Gunstar. Over 34 of these vessels were in service at the time. Using advanced computer systems, these ships had an excellent blend of weaponry, fighters and detection systems, putting them at the forefront of the navies using them. Unfortunately that sophistication led to their rapid takeover, their computers assimilated by the Cylons and their crews vented out to space.

Cylon centurions rapidly took them over, replacing Viper bays with Raiders and troop transports. These ships would plague the Colonial Fleet with their ability to jump in on top of a target, speed in, hit it, and then jump out.

If there was one disadvantage with the ship design, it was its rapid fuel expenditure, restricting their tactical usage. Once enough ships were available, smaller ones were despatched in flotillas to locate and destroy the Cylon tankers that these ships used.

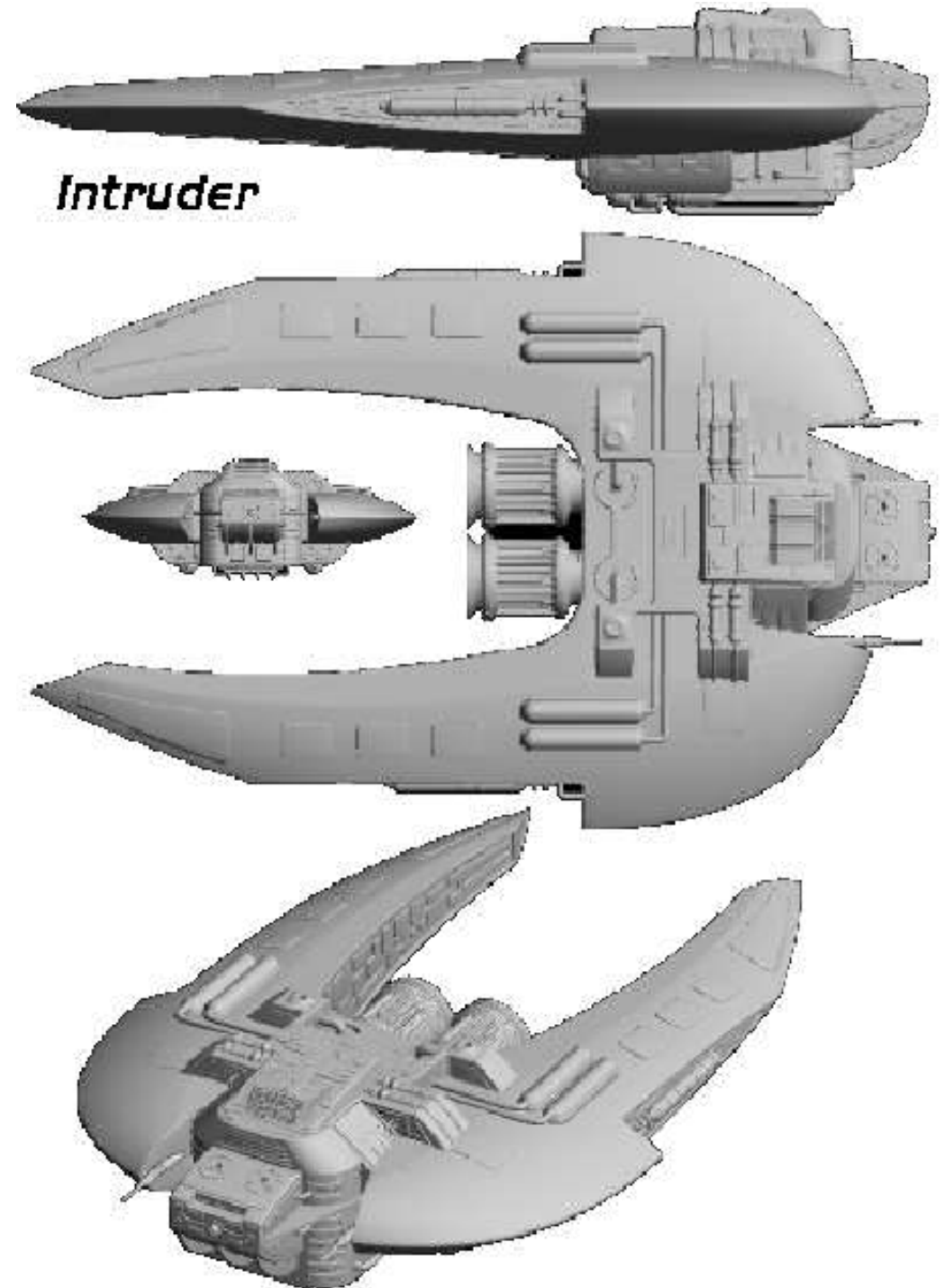

## **Skirmisher**

Supplied by AXG423 from a Mesh by Steve Wilson

Stats by Limerickcot

**Agi** d8, **Str** d8, **Vit** d8, **Ale** d8, **Int** d8, **Wil** d8;  
**LP** 16; **Init** d10+d12; **Scale** Spacecraft;

**Speed** 4 (SL/JC)

**Traits** Past Its Prime (d6)

**Skills** Heavy Weapons d6, Mechanical Engineering d4, Perception d6, Pilot d6

### **Armament**

Medium, planetcraft scale, skirmish range, PDS (D8)

4 medium spacecraft scale short DRADIS range railgun turrets (d10);

6 heavy spacecraft scale Capital DRADIS range missile systems (d12+d4),

24 medium planetcraft scale Medium DRADIS range missiles systems (d10)

### **Subcraft**

36 Raiders

**Armour** Wound 3, Stun 3

**Description** 2,300 x 1,200 x 520 feet;

**Crew** 312 **Passengers** none

Designed as an escort carrier, the Skirmisher was an older design at the time of the Cylon war and, like the Intruder, was in extensive use at that time. Its four squadrons of Vipers and a good missile armament made this a popular escort craft, although its cramped quarters and tight companionways made it unpopular with most of its crew.

The reason it had stayed in service, although technically outclassed, was (in addition to its vipers) the simplicity with which its modular components could be upgraded. Again, this made the Skirmisher an easy target for the Cylons who took over many (and built more). They quickly stripped out the Viper bays to fit Raiders, and upgraded the control functions significantly.

Of notable interest was the battle of Caprica High Port in which the Caprican Fleet (just renamed the 2<sup>nd</sup> Colonial Fleet) met with a Cylon task force. Both forces used Skirmishers in their forces. The newer Raiders of the Cylons soon proved their mettle over the larger numbers of Mk I Vipers which had their control chips removed. The last Colonial Skirmisher crashed into the planetoid G451 just after the Armistice was signed. Cylon Skirmishers have been withdrawn as they are not operable except by 'Toaster's'.

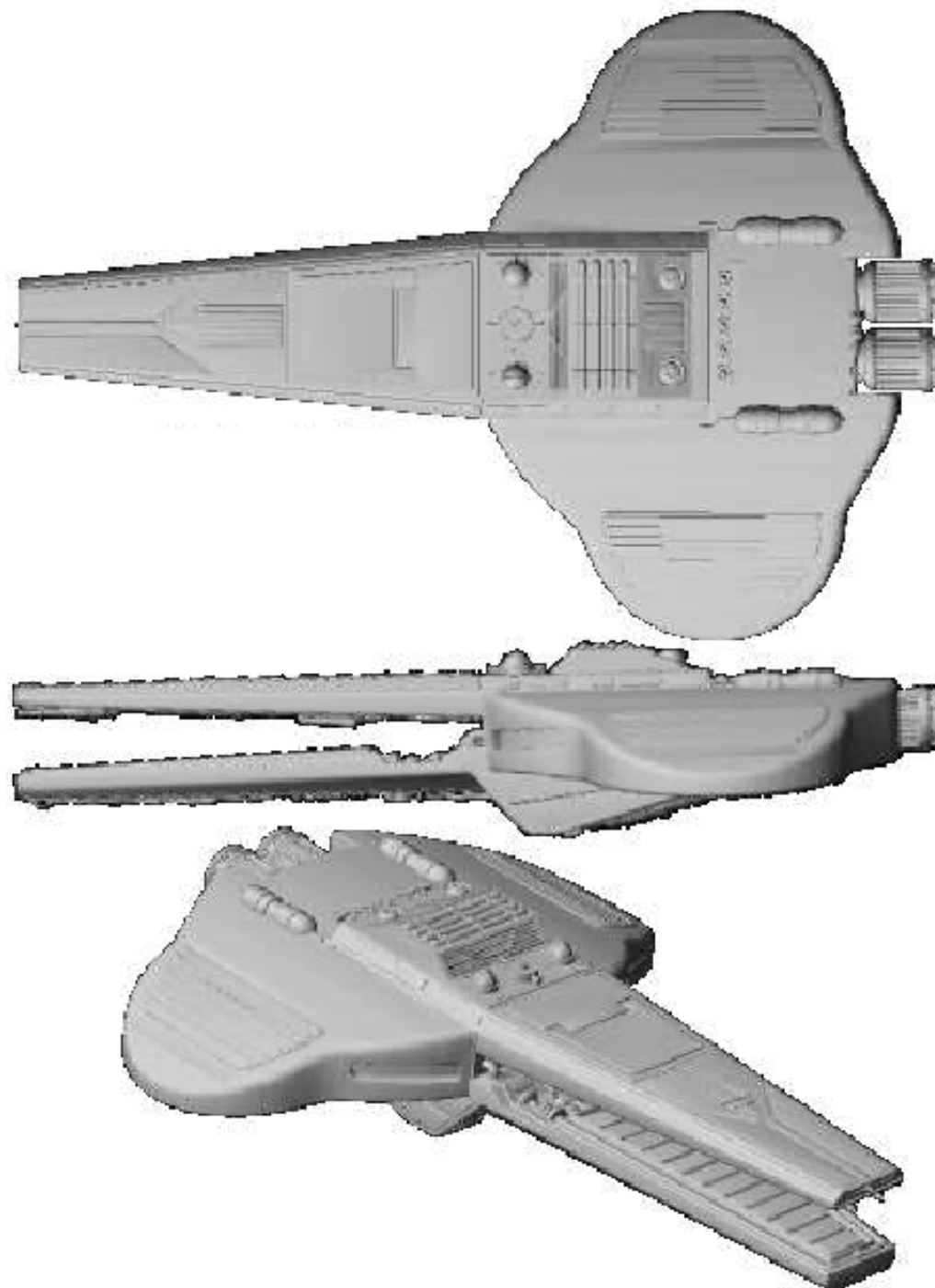

## Communications Array No 1

**Agi** d2, **Str** d8, **Vit** d4, **Ale** d8, **Int** d8, **Wil** d4;  
**LP** 12; **Init** d2+d8; **Scale** Spacecraft;

**Speed** 1 (SL)

**Traits** Biomechanical (d2)

**Skills** Mechanical Engineering d4, Perception d6, Pilot d4

**Armament**

None

**Subcraft**

None – 4 docking points

**Armour** Wound 2, Stun 3

**Description** 391.5 x 290 x 290 feet;

**Crew:** None (automated)

This communications array is a standard sight throughout Cylon space. It is designed to send and receive long distance messages using the large receptors (which, like the Scarab) can be adjusted. It also relays shorter range messages using the smaller arrays at its apex.

Docking points are provided for the array to allow the entry of other Cylons to upgrade and resupply the array, but most repair functions are carried out by the array itself.

Although conventional radio systems do not allow for interplanetary communications on any meaningful level, it is known that the Cylons are able to communicate in some form across those distances. This model array is not capable of originating such a signal but it is capable of boosting an incoming signal onto another station.

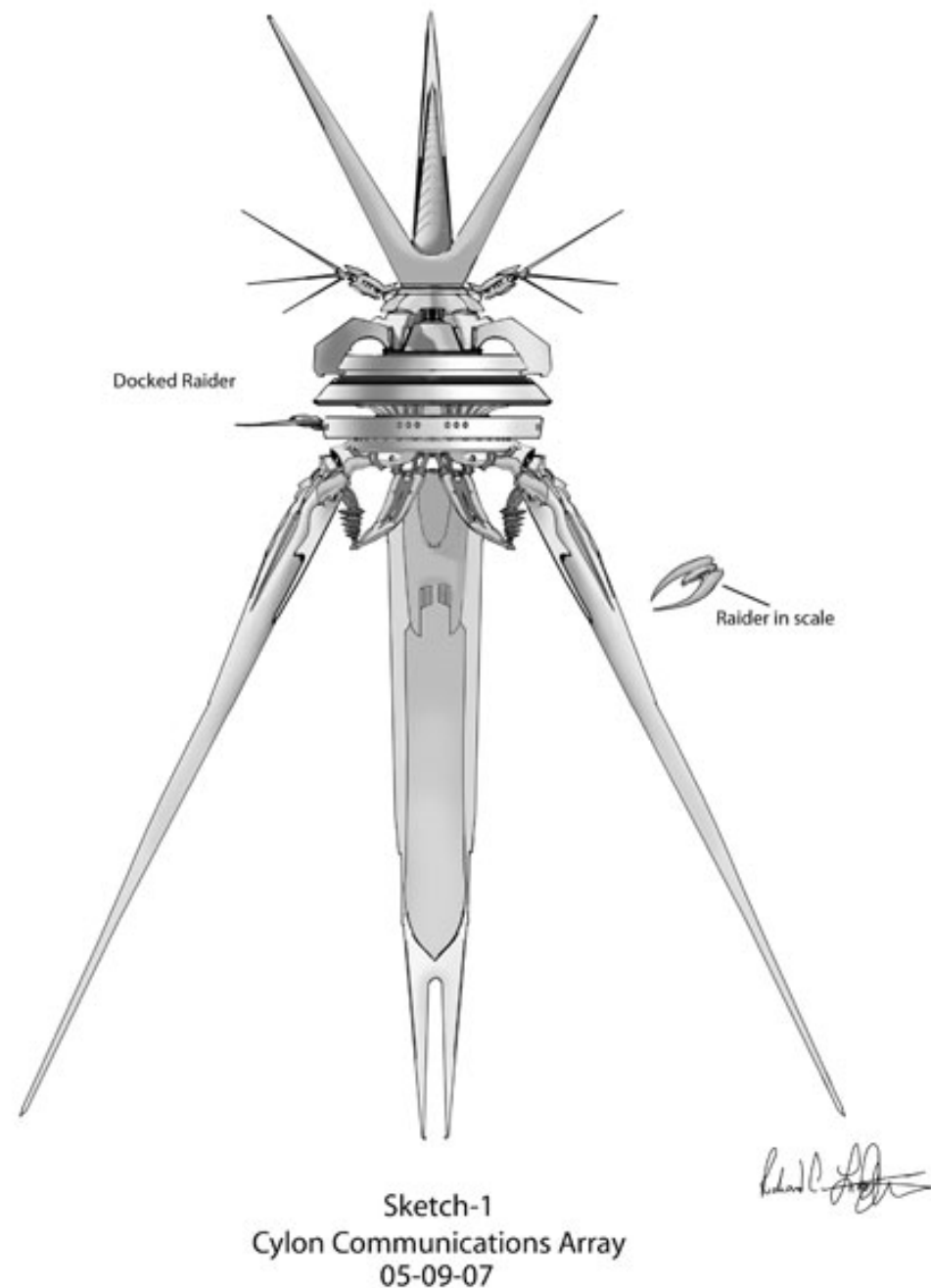



## Communications Array No 2

**Agi** d6, **Str** d8, **Vit** d4, **Ale** d8, **Int** d8, **Wil** d4;  
**LP** 12; **Init** d6+d8; **Scale** Spacecraft;

**Speed** 3 (SL/JC)

**Traits** Biomechanical (d2)

**Skills** Mechanical Engineering d4, Perception d6,  
 Pilot d4

### Armament

13 decoy launchers

### Subcraft

None – 1 docking points

**Armour** Wound 4, Stun 5

**Description** 471 x 292 x 183 feet;

**Crew:** None (automated)

Unlike Array No 1, the second type of array normally seen is a combat booster. Although relatively slow she is a support vessel capable of both boosting interplanetary signals emanating from the Hybrids and providing a secondary hub for battlefield signals.

Normally this type of array is not seen on any DRADIS readout, keeping well out of the way of any active combat and jumping when threatened and relying on decoys to take care of any incoming missiles.

Certainly these ships are a major factor in coordinating massive raider attacks when they operate away from their base stars.

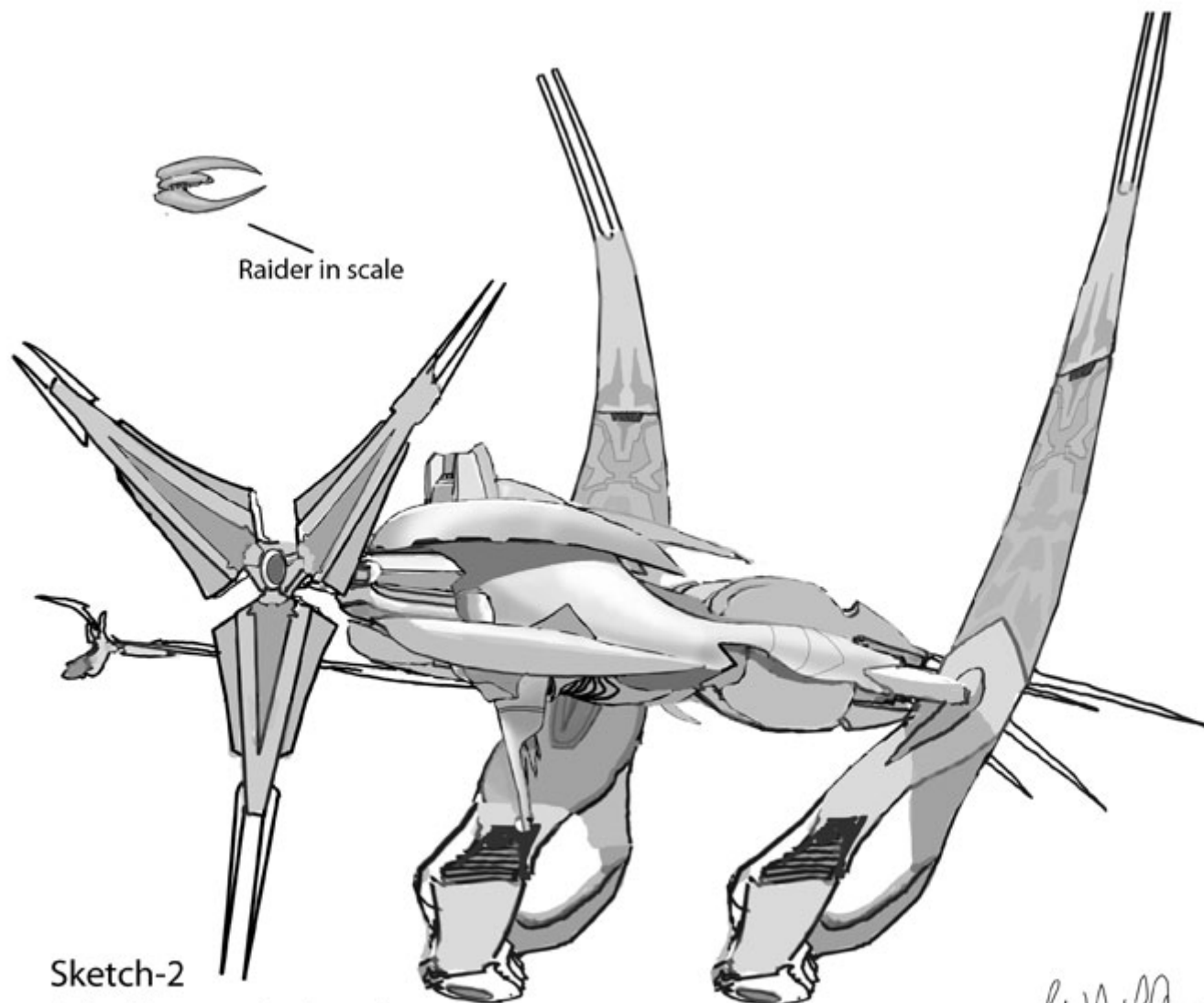

Sketch-2

Cylon Communications Array

05-09-07

## Communications Array No 3

**Agi** d6, **Str** d8, **Vit** d4, **Ale** d10, **Int** d8, **Wil** d4;  
**LP** 12; **Init** d6+d10; **Scale** Spacecraft;

**Speed** 4 (SL/JC)

**Traits** Biomechanical (d2),

**Skills** Mechanical Engineering d4, Perception d6, Pilot d4, covert d6

### Armament

13 decoy launchers

13 heavy planetcraft scale, short range missile systems (d12)

1 extreme spacecraft scale long DRADIS range missile system (d12)

### Subcraft

9 Raiders

**Armour** Wound 1, Stun 3

**Description** 292 x 292 x 292 feet;

**Crew:** None (automated)

Array No 3 was spotted moving in deep space. Unlike the other arrays, this one carries a tiny squadron of nine raiders and a limited anti-ship capacity. Certainly not strong enough to defend against a military vessel, the arrays systems are enough to disable commercial vessels and probe fighters.

The notable feature of this array is its ability to absorb DRADIS signals without giving a return signal, making it ideal as a spy satellite. Its signals power is close to Colonial standard and does not seem to incorporate a direct signal similar to the other two arrays. Supposition indicates that this is another reason for the array to carry Raiders as these allow the array to stay on station whilst a raider carries its message back to a base star for onward propagation.

## Battlestar Galactica Season 4

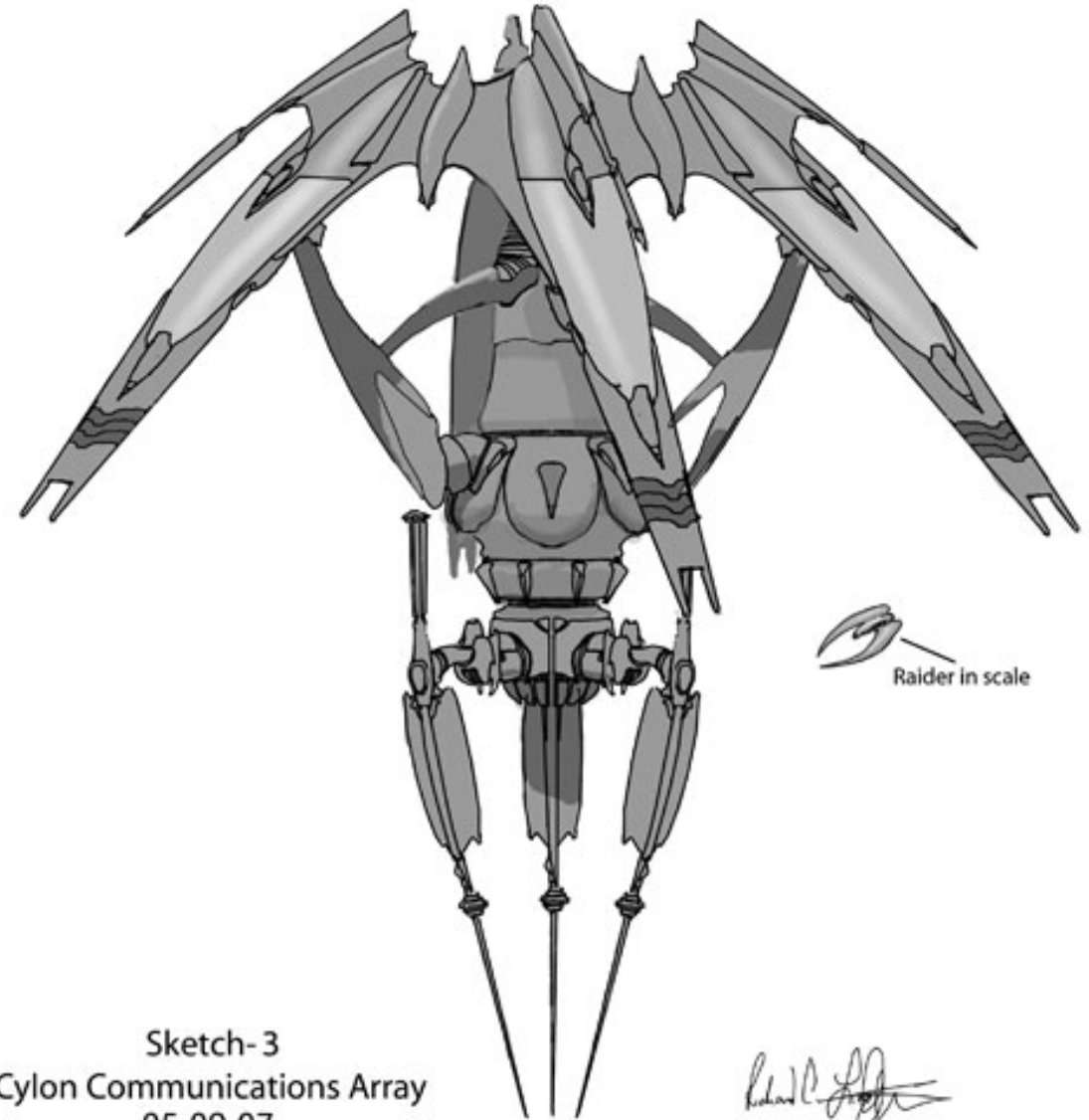

Sketch-3  
 Cylon Communications Array  
 05-09-07

*Richard C. [Signature]*

240

## **Scarab**

By Limerickcot

**Agi** d6, **Str** d8, **Vit** d6, **Ale** d10, **Int** d8, **Wil** d8;  
**LP** 16; **Init** d6+d10; **Scale** Spacecraft;

**Speed** 5 (SL/JC)

**Traits** None

**Skills** Heavy Weapons d4, Mechanical Engineering d4,  
Perception d6, Pilot d4, Covert d10

**Armament**

6 Planetcraft, Capital Range Missile Launchers (d10)

**Subcraft**

None, 4 docking points

**Armour** Wound 2, Stun 2

**Description** 832 x 255 x 255 feet;

**Crew** 5; **Passengers** none

Although the use of various communication stations allow for the speedy transmission of information between Cylon outposts, the eyes and ears of the Cylon fleet is the long range probe craft nicknamed 'Scarab'.

The Scarab can be seen in two configurations. In travelling mode it resembles a streamlined figure. In this mode it has extensive local DRADIS and ECCM capabilities. It is used for detailed analysis of systems and, if needed, to provide additional electronic support for the Cylon fleet.

In its splayed form, the Scarab acts as a silent, passive sensor array, studying the worlds and stars around it – and monitoring any signals, communications and jump events that may occur within its search pattern. In this mode the vessel is almost undetectable except to visual sightings. Its disadvantage in this mode is its lack of speed and agility – it can only maintain station keeping – and its agility is reduced by 2 steps for all except aspect changes (i.e. pivoting around its axis). To move at speed, or in combat, it must close down its 'legs' – an operation that takes up to ten minutes. Only a small Centurion crew is carried – enough to maintain the ship – and no small craft, although the Scarab has four landing docks .

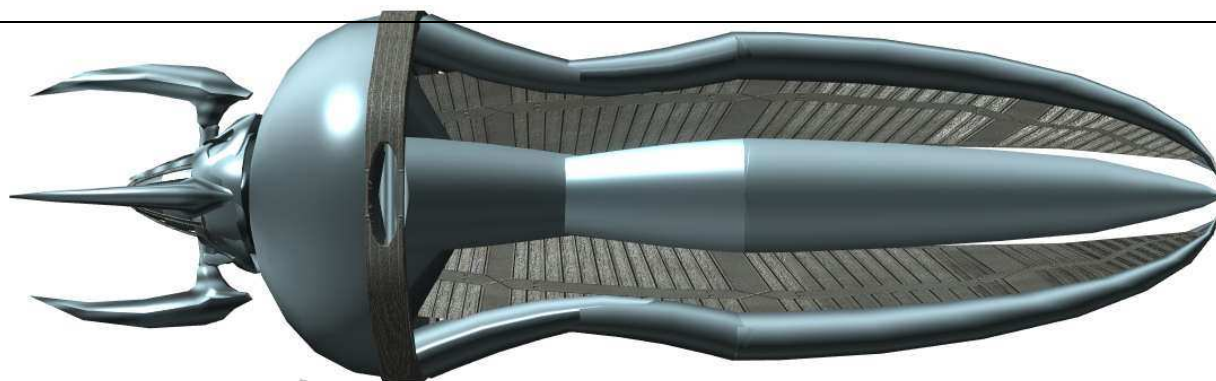

**Scarab**  
by Limerickcot

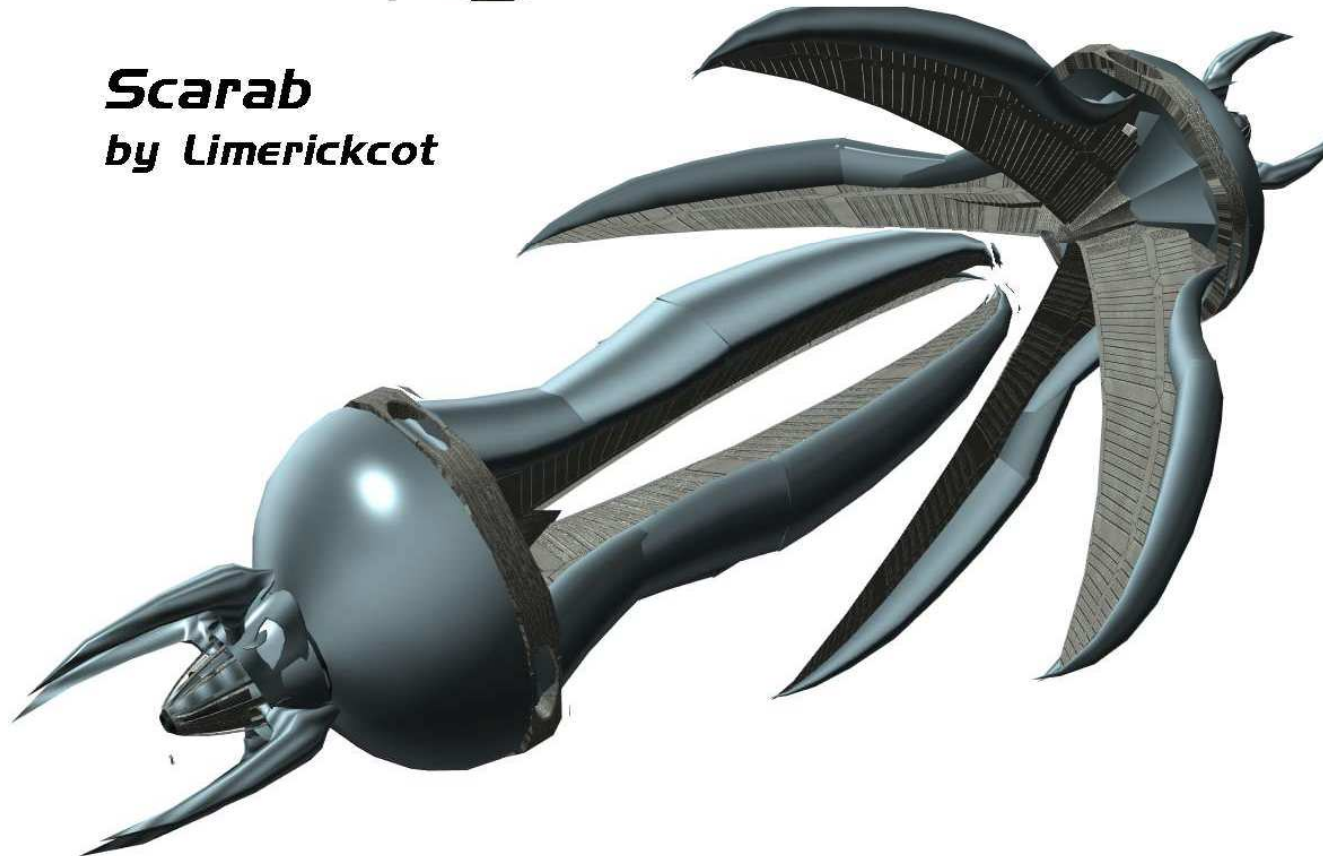



241

## ***Piris Class***

By Limerickcot

**Agi** d6, **Str** d12+d6, **Vit** d8, **Ale** d8, **Int** d10, **Wil** d10;  
**LP** 28; **Init** d6+d10; **Scale** Spacecraft;

**Speed** 6 (SL/JC)

**Traits** Past Its Prime (d2)

**Skills** Heavy Weapons d6, Mechanical Engineering d4, Perception d6, Pilot d4

### **Armament**

Heavy, planetcraft scale, skirmish range PDS (d12)

10 heavy spacecraft scale short DRADIS range railguns (d12+d2);

3 Primary spacecraft scale short DRADIS range railguns (d12+d6)

96 Heavy spacecraft scale, medium range missile systems (d12+d4)

12 extreme spacecraft scale long DRADIS range nuclear missile systems (d12+d8)

78 heavy planetcraft scale, short range missile systems (d12)

### **Subcraft**

26 Raiders; 10 troop transports;

**Armour** Wound 7, Stun 4

**Description** 5,691 x 2,018 x 888 feet;

**Crew** 620; **Passengers** 120 (troops)

As the war progressed, Cylon analysts realised that although they had an incomparable drive system fitted to their capital ships, the armament fitted to those vessels could rarely be brought efficiently on target. In many real ways, the Colonial Battlestars were, ship for ship, an even match if deployed correctly. Once the armistice was signed, fears developed amongst them that Human forces would initiate another war for which the Cylons were not yet ready.

To counter this future move, they developed their own Battlestar in the form of Piris. Assigned to the best of their combat Centurions these were to form the backbone of the new fleet. However, as human Cylons took over the governance of Cylon's, these were seen as a threat to their own existence. Only a small number were completed before the series was relegated to home defence. The guns on the Piris are all fixed, but their positions are on the flank and underneath the vessel. An under-slung hanger accommodates the raiders and troop carriers.

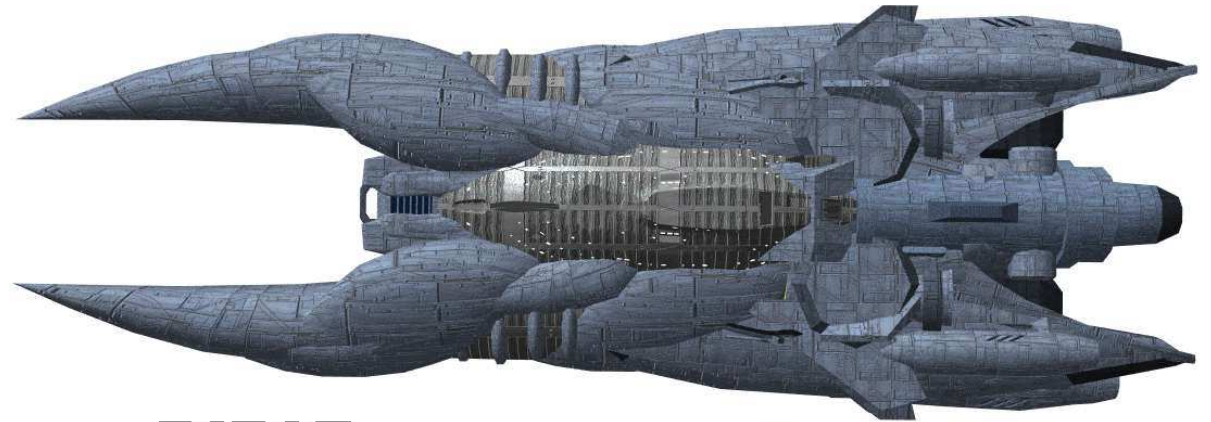

## ***PIRIS*** By Limerickcot

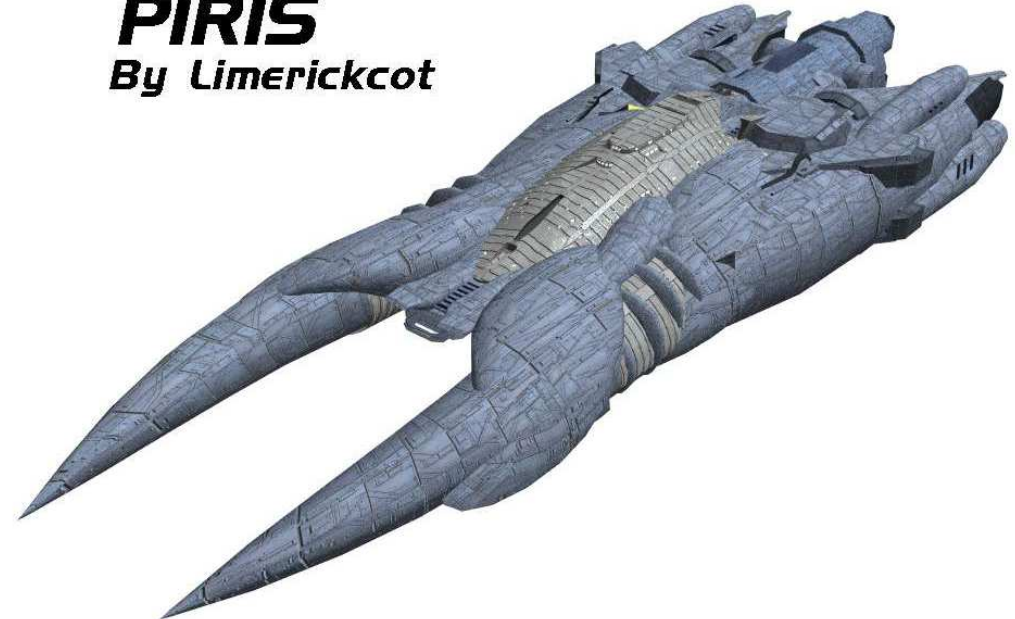

## Chimaeia

by Limerickcot

**Agi** d6, **Str** d12, **Vit** d8, **Ale** d10, **Int** d10, **Wil** d8;  
**LP** 20; **Init** d6+d10; **Scale** Spacecraft;

**Speed** 4 (SL/JC)

**Traits** Past Its Prime (d6)

**Skills** Heavy Weapons d6, Mechanical Engineering d4, Perception d6, Pilot d4

### Armament

6 medium spacecraft scale short DRADIS range railgun turrets (d10);  
 12 heavy spacecraft scale short DRADIS range missile systems (d12+d4),  
 48 planetcraft scale, capital DRADIS range missile systems (d10)  
 48 vehicle scale, long range auto guns (d12)

### Subcraft

36 Raiders; 72 troop transports;

**Armour** Wound 3, Stun 3

**Description** 4312 x 4312 x 423 feet;

**Crew** 410; **Passengers** 7200 (troops)

The Chimaeia is, like the Tartarus, a response to Cylon needs. In this case it was the need to transport and land large numbers of ground troops. It was also the Cylons first truly new design of their own. The ship mounts only a limited amount of ship guns, preferring to rely on long range missiles. However, its multiple missile launchers are more than capable of dealing with incoming enemy fighters. On the ground, the ship relies on a series of heavy cannon to deal with enemy troops and vehicles.

Although the Chimaeia can land its large complement of troops directly, it also uses large troop transports to discharge its deadly cargo. It can also swap out some of its troops for an armoured element, but it needs to land to discharge these. Generally these comprise of some heavy armoured units backed up by light sleds carrying large calibre guns or missiles for use against emplaced bunkers. The problem with dealing with heavy, fixed emplacements, led to the addition of mass drivers onto Warstars and their deployment alongside Chimaeia.

Her main weaknesses are her lack of a PDS and low speed. Her raiders are designed to secure passage of the ship and then to escort her troop



**Chimaeia**

[based on a miniature from Ravenstar]



**Limerickcot**

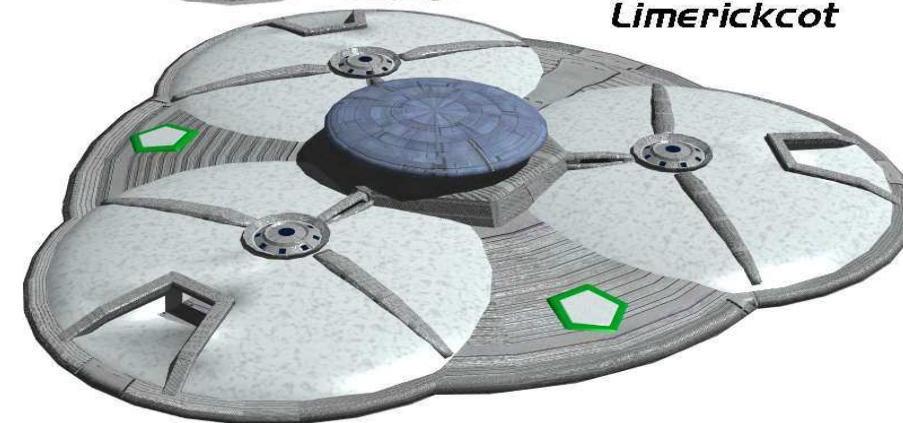

transports down to the ground. Once there the ship may stay or, and far more likely, it will return to base for another load of troops.



243

## **Pillager Class**

By Limerickcot

**Agi** d8, **Str** d12+d2, **Vit** d8, **Ale** d8, **Int** d10, **Wil** d8;  
**LP** 22; **Init** d8+d10; **Scale** Spacecraft;

**Speed** 7 (SL/JC)

**Traits** Past Its Prime (d2)

**Skills** Heavy Weapons d4, Mechanical Engineering d4, Perception d4, Pilot d4

### **Armament**

Heavy, planetcraft scale, skirmish range PDS (d10)  
2 heavy spacecraft scale short DRADIS range railguns (d12+d2);  
1 Primary spacecraft scale short DRADIS range railgun (d12+d6)  
48 Heavy spacecraft scale, medium range missile systems (d12+d4)  
4 extreme spacecraft scale long DRADIS range nuclear missile systems (d12+d8)  
12 heavy planetcraft scale, short range missile systems (d12)

### **Subcraft**

26 Raiders; 10 troop transports;

**Armour** Wound 5, Stun 4

**Description** 4,300 x 1,389 x 164 feet;

**Crew** 400; **Passengers** 120 (troops)

Built at the very end of the Cylon War the Pillager was another vessel designed to negate the Colonial ships advantage in agility and speed. Lighter overall to a Battlestar of the period, her multiple engines would have allowed her to run rings around such ships. The Pillager shows the trend towards massive missile armament that was to become prevalent in later Cylon designs.

As with the Pirus, the Pillager design was seen as a potential threat to human Cylons. None of these 'inter-war' designs are equipped for use by hybrids

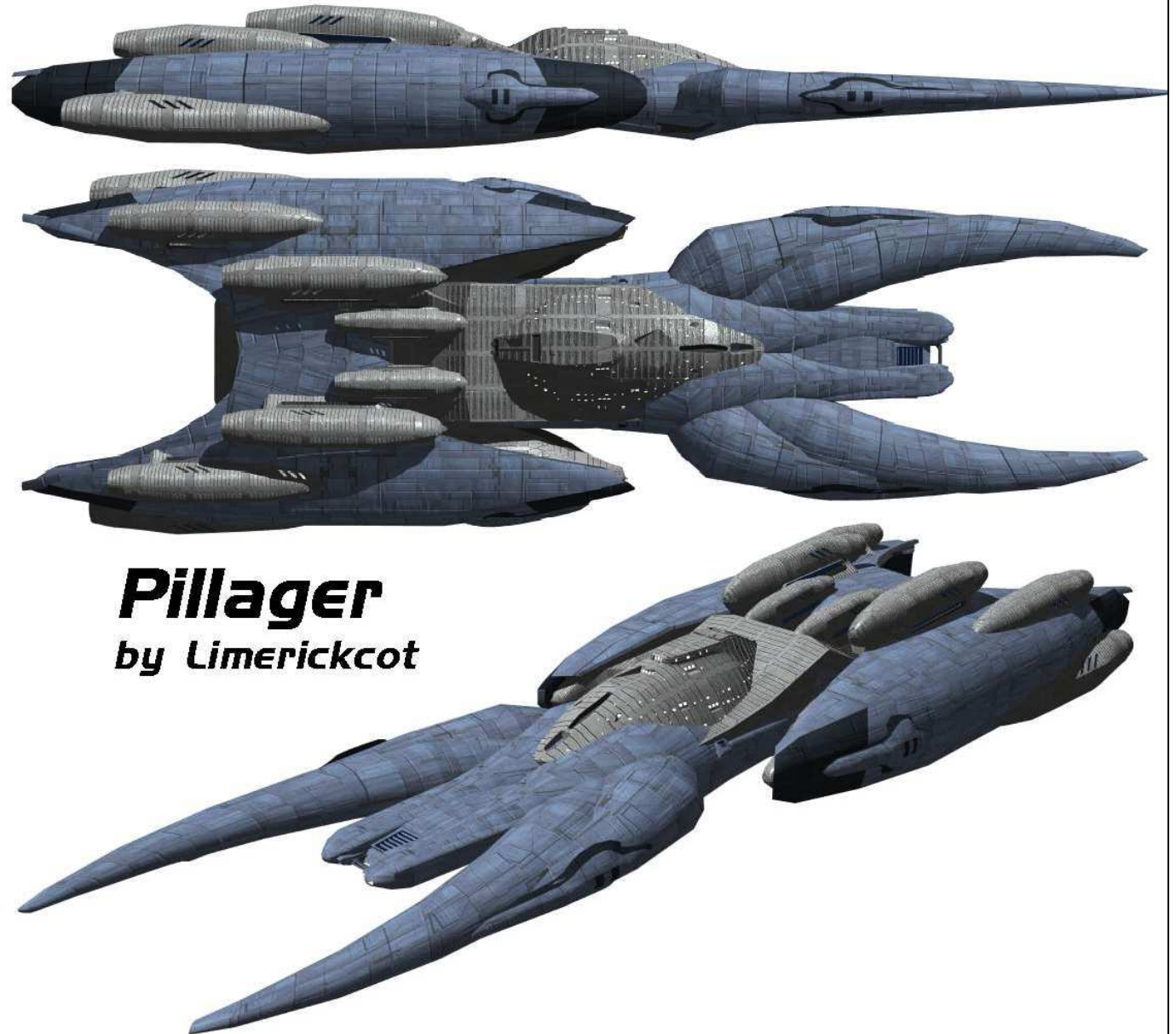

## **Pillager** by Limerickcot

and their control circuitry requires a direct hands-on approach, relegating their use to defensive in the modern Cylon fleet. These vessels were deployed in the second war as defensive shields around the Cylon worlds and Colony.



## Kraken Boarding Star

Design by Belschaft  
Stats by Limerickcot

**Agi** d12, **Str** d8, **Vit** d6, **Ale** d10, **Int** d8, **Wil** d8;  
**LP** 16; **Init** d12+d10; **Scale** Spacecraft;

**Speed** 8 (SL/JC)  
**Traits** None

**Skills** Heavy Weapons d4, Mechanical Engineering d2, Perception d2, Pilot d4

### Armament

2 Planetcraft, short Range Missile Launchers (d10)  
Skirmish Range PDS, (d8)

### Subcraft

None, 1 docking point

**Armour** Wound 4, Stun 2

**Description** 342 x 153 x 153 feet;

**Crew** 5; **Passengers** 200 Centurion Warriors

After the Cylon war, with an Armistice declared, the Cylons looked on as the Colonies built up a fleet far superior to anything that had been built before it. The Cylons had lost many of their kind in various boarding actions during the war, actions that could have been even more successful if more Centurions could have boarded Colonial vessels.

Although the Kraken would be relegated in favour of the smaller and lighter Turkey Heavy Raider (which could be deployed easily by the new Basestars being designed), in its day it would have been a serious threat to the larger ships.

Krakens operate in squadrons of six. Their objective is simple. Ram home and, using the forward 'claws', anchor themselves to the enemy vessel. The centre dome would then pierce the enemy hull and 200 Centurions would take the enemy ship. If the Colonials could stand, even against these odds, then the Kraken would self-destruct, taking the enemy vessel with it. To achieve this, the Kraken would jump in, and using their superior speed and

## Kraken by Belschaft

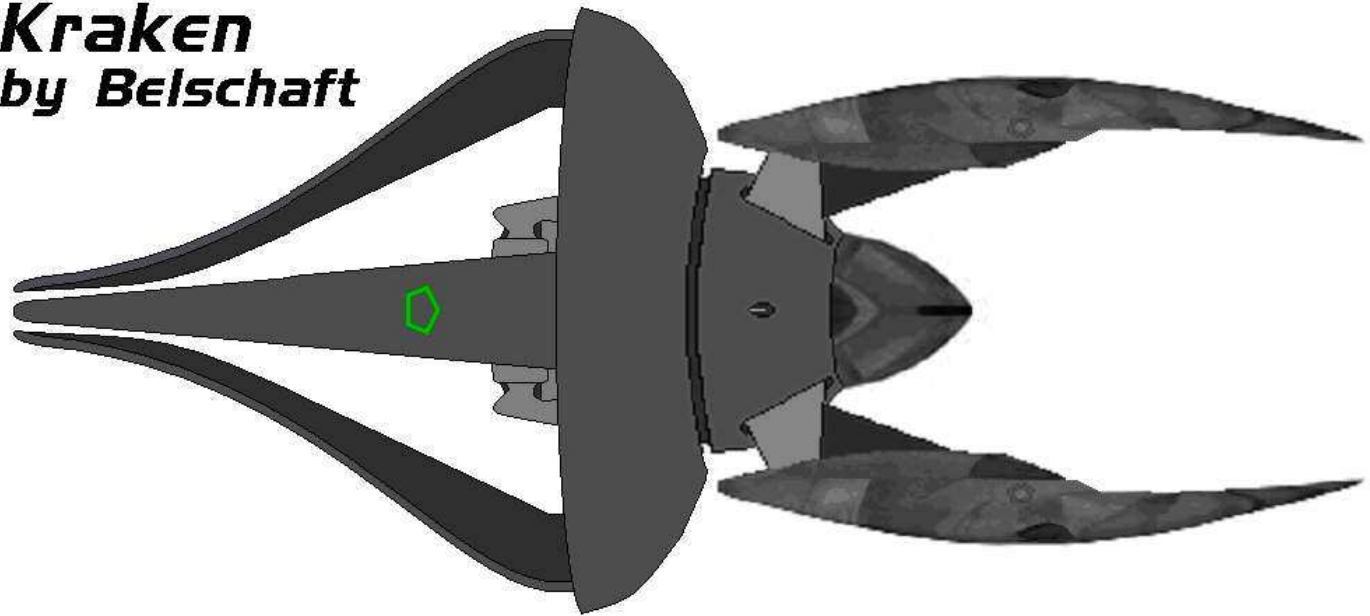

agility, approach their target, using their missile systems to engage enemy vipers and their Point Defence System to engage any incoming missiles.

Numbers of Kraken were built, but they were finally withdrawn after the Cylons discovered a way to disable the Colonial Ships without boarding.

## ***Rakshasha Gunstar***

By Limerickcot

**Agi** d8, **Str** d10, **Vit** d8, **Ale** d8, **Int** d8, **Wil** d12;  
**LP** 22; **Init** d8+d8; **Scale** Spacecraft;

**Speed** 6 (SL/JC) Atmospheric Capable

**Traits** Past Its Prime (d2)

**Skills** Heavy Weapons d6, Mechanical Engineering d4, Perception d6, Pilot d4

### **Armament**

Heavy, planetcraft scale, skirmish range PDS (d12)

6 heavy spacecraft scale short DRADIS range railguns (d12+d2);

1 primary spacecraft scale short DRADIS range railguns (d12+d6)

8 heavy spacecraft scale capital DRADIS range missile systems (d12+d4),

16 heavy planetcraft scale, long DRADIS range missile systems (d10)

### **Subcraft**

26 Raiders

**Armour** Wound 3, Stun 4

**Description** 1,237 x 590 x 245 feet;

**Crew** 500; **Passengers** none

The Rakshasha was another attempt by the Cylons to deal with the ever expanding human fleet. Noting the numbers of escort vessels, especially those dedicated to pure attack roles, the Cylons developed their own. This developed through a number of classes until they reached a satisfactory model in the vessel now designated Rakshasha.

Atmospheric capable, the Rakshasha is principally a gunstar. Its ability to operate fully within the atmosphere gives it an advantage over many colonial vessels. In addition to this, the ship is marine capable, able to sustain its systems to a limited depth under water, making it almost ideal for ambush and system defence purposes (although its armour is limited, its internal structure is one of the heaviest built).

As with many of these early inter-war ships, the continued development of humanoid Cylons spelled the end for the independent older style centurions. Rakshasha's are therefore limited to purely defensive formations around

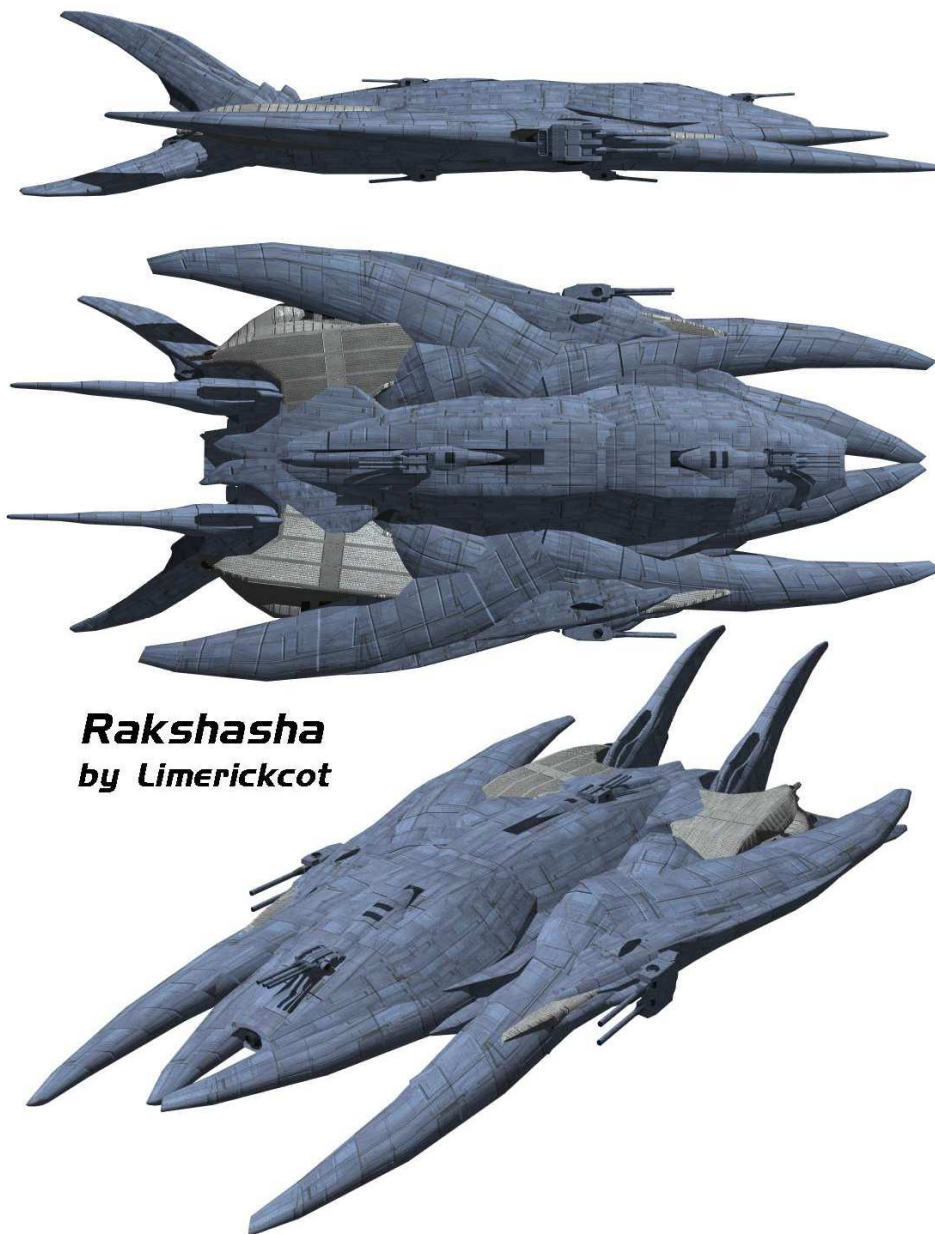

***Rakshasha***  
 by Limerickcot

outposts or in support of non-military operations (such as tylium or other mining operations). Several are also used for military reconnaissance where their ability to get in and out, despite heavy firepower, is appreciated.

246

## ***Assura Escortstar***

*By Limerickcot*

**Agi** d8, **Str** d10, **Vit** d8, **Ale** d8, **Int** d8, **Wil** d12;  
**LP** 22; **Init** d8+d8; **Scale** Spacecraft;

**Speed** 6 (SL/JC) Atmospheric Capable

**Traits** Past Its Prime (d2)

**Skills** Heavy Weapons d6, Mechanical Engineering d4, Perception d6, Pilot d4

### **Armament**

Heavy, planetcraft scale, skirmish range PDS (d12)

1 primary spacecraft scale short DRADIS range railguns (d12+d6)

12 heavy spacecraft scale capital DRADIS range missile systems (d12+d4),

16 heavy planetcraft scale, long DRADIS range missile systems (d10)

### **Subcraft**

98 Raiders

**Armour** Wound 3, Stun 4

**Description** 1,115 x 570 x 201 feet;

**Crew** 700; **Passengers** none

Assura is a sister ship design to the Rakshasha and built along the same lines (although she is not fully atmospherically or marine capable). In this case, the Cylons found that deploying a base star (of whatever design) was a waste of resources when defending minor outposts. To that end they borrowed the Human idea of the Escortstar.

The Assura uses its solid hull to house nearly a hundred raiders and the necessary support operations. Many of its crew are dual purpose and also act as both support personnel, assault troops and raider pilots.

Most minor outposts can expect to have an Assura and a Rakshasha in attendance unless they are required for more pressing needs elsewhere within the Cylon dominion. Assura's have been retrofitted to carry humanoid Cylons and a small number also carry hybrid pilots. These special escorts form a fast response cadre available to instantly reinforce defences if, at any point, the Colonial Fleet encroaches on the Armistice line.



***Assura***  
***by Limerickcot***

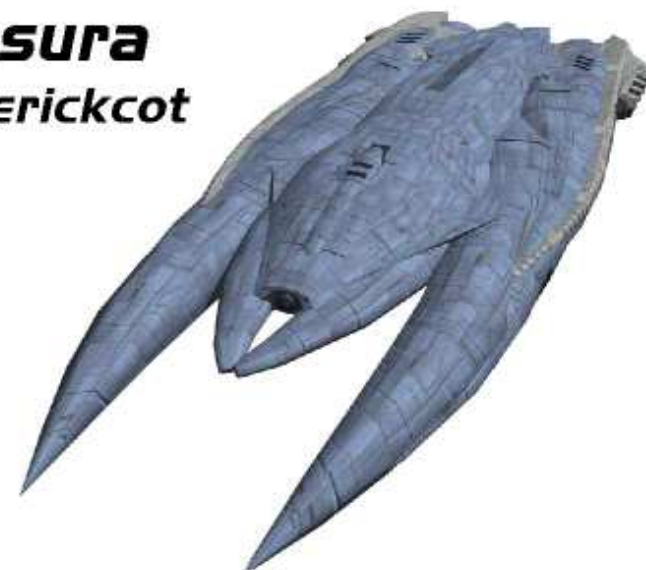



## Centurion Model 0005

[GalacticaBBS](#) [CoolSciFi.com](#)

**Agi** d6, **Str** d10, **Vit** d8, **Ale** d6, **Int** d6, **Wil** d6;

**LP** 14; **Init** d6+d6

**Skills** Athletics d6, Covert d4, Discipline d6, Guns d6 / Pistols d10, Heavy Weapons d6, Mechanical Engineering d4, Melee Weapon Combat d6 / Swords d8, Perception d6, Pilot d6 / Raider d8, Technical Engineering d4

**Equipment** Armour 3W, pistol (DMG d6W, RNG 15 yards, MAG 15) or submachine gun (DMG d6W, RNG 55 yards, MAG 40), retractable blades (DMG d2 W; each blade counts as one weapon)

Cylon Centurions ignore Stun damage and do not suffer Wound penalties.

## Centurion Model - Command (Gold)

**Agi** d6, **Str** d10, **Vit** d8, **Ale** d8, **Int** d8, **Wil** d8;

**LP** 16; **Init** d6+d8

**Skills** Athletics d6, Covert d4, Discipline d6 / Leadership d8, Knowledge d2, Guns d6 / Pistols d10, Heavy Weapons d6, Mechanical Engineering d4, Melee Weapon Combat d6 / Swords d8, Perception d6 / Tactics d8, Pilot d6 / Mark I Raider d8, Technical Engineering d4

**Equipment** Armour 3W, pistol (DMG d6W, RNG 15 yards, MAG 15) or submachine gun (DMG d6W, RNG 55 yards, MAG 40), retractable blades (DMG d2 W; each blade counts as one weapon)

Cylon Centurions ignore Stun damage and do not suffer Wound penalties.

Centurions were divided into two groups, command and subordinate. A Command Centurion's position was denoted by its gold-plated armour. They typically commanded Basestars and military outposts.

Early Centurions carried less armour than later models (2W) and were upgraded into the 0005 model quite rapidly. A later model (the 0007) still survives but looks less well armoured, although there is no effective difference between the models. However the 0007 is fitted with an inhibitor that

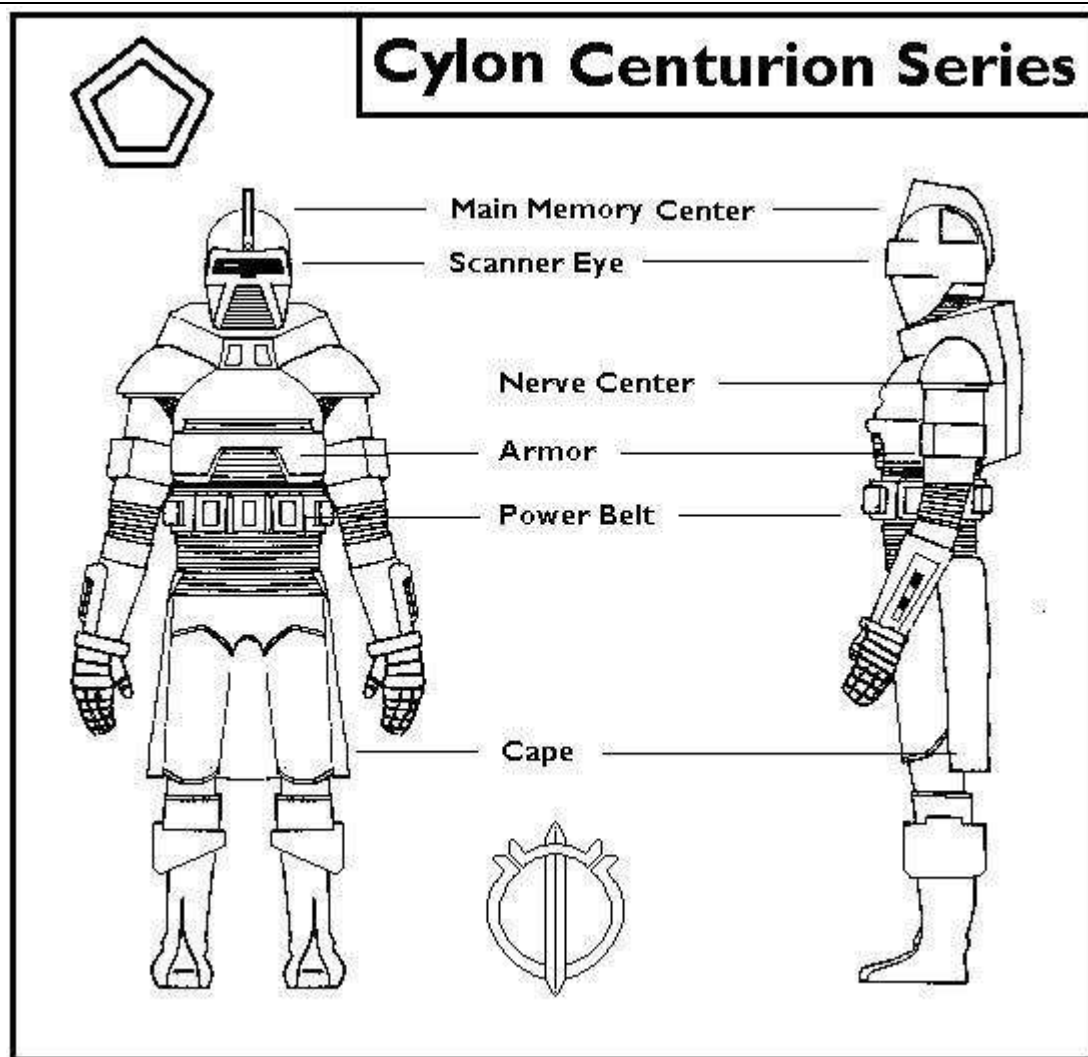

prevents it 'rebelling' against human Cylons. The 0005 does not carry this inhibitor as standard.

## ***IL-Series***

*stats by Buscadero*

**Agi** d6, **Str** d6, **Vit** d6, **Ale** d8, **Int** d12, **Wil** d10;

**LP** 16; **Init** d6+d8

**Skills** Athletics d4, Covert d2, Discipline d6 / Leadership d12, Influence d6 / Persuasion d10 / Politics d8 , Knowledge d6 / Strategy d12, Guns d4, Mechanical Engineering d4, Melee Weapon Combat d4, Perception d6 / Tactics d10, Technical Engineering d4

IL series Cylons took on the duties to maintain the non-military aspects of the Cylon Empire. They were the brains behind the whole of Cylon civilization. IL's did the thinking, the strategizing and the governing of all those territories the Cylons had either come to subjugate or wipe from the cosmos. At the heart of every Cylon Basestar there was an IL droid giving the orders.

Unlike the Cylon Centurion, they had two eyes, in proportion similar to the eyes of humans. They did not speak in a robotic monotone. Moreover, they were known to express emotion, after a fashion, such as jealousy or power lust.

When combined together the IL series models helped work out such things as the construction needs of the ongoing war against the colonies, and how to fulfil the underlying principles of their existence – a belief in a single, one god and how to become more human.

These principles led to the production of more advanced ships and centurions and the breeding of the hybrid's and resolved itself in the construction of enhanced human clones. Cylon histories are not generally available but anecdotal evidence suggest that this series was shut down (or eradicated) upon the supremacy of the Number One series of humanoid Cylons.

If any survive it is likely that they occupy only minor posts, well away from the centre of current Cylon occupation.



## ***Cylon Centurion, Combat Model\****

stats by Buscadero

**Agi** d6, **Str** d10, **Vit** d10, **Ale** d6, **Int** d8, **Wil** d8;

**LP** 18; **Init** d6+d6

**Skills** Athletics d6, Covert d4, Discipline d6, Knowledge d2, Guns d6 / Pistols d10, Heavy Weapons d6 / Demolitions d8 / Mortars d8, Mechanical Engineering d6, Melee Weapon Combat d6 / Swords d8, Perception d6, Pilot d6, Technical Engineering d4

**Equipment** Armour 4W, Assault Gun (DMG d8W, Range 70 yards, Ammo 40 + Grenade Launcher)

Cylon Centurions ignore Stun damage and do not suffer Wound penalties.

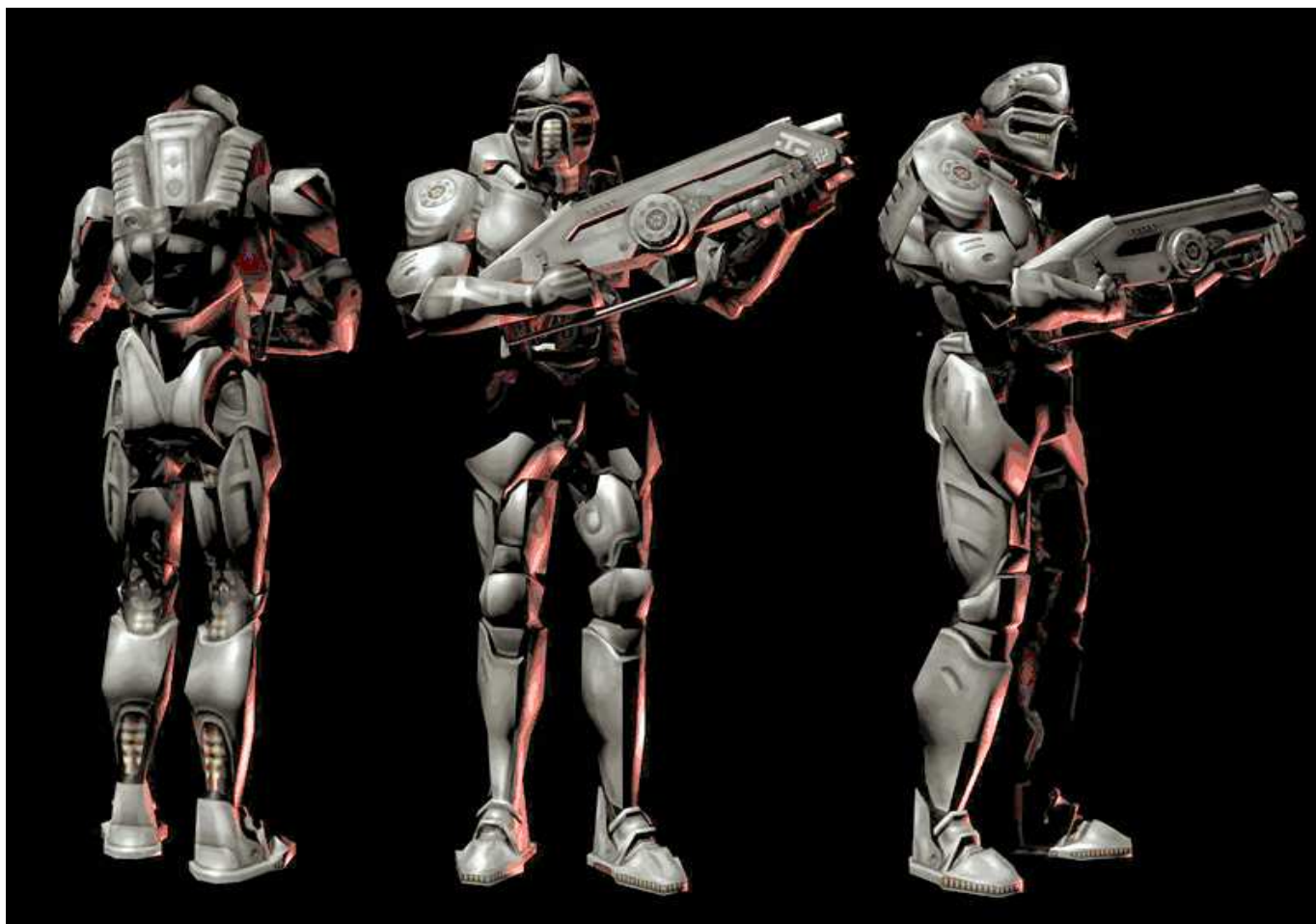



## **Cylon Centurion, Pilot Model** [CoolSciFi.com](http://CoolSciFi.com)

**Agi** d6, **Str** d10, **Vit** d10, **Ale** d6, **Int** d8, **Wil** d8;

**LP** 18; **Init** d6+d6

**Skills** Athletics d6, Covert d4, Discipline d6, Knowledge d2, Guns d6 / Pistols d8, Heavy Weapons d6 / Demolitions d8, Mechanical Engineering d6, Melee Weapon Combat d6 / Swords d8, Perception d6, Pilot d6 / Raider d10, Technical Engineering d4

**Equipment** Armour 3W, submachine gun (DMG d6W, Range 55 yards, Ammo 40)

Cylon Centurions ignore Stun damage and do not suffer Wound penalties. The Pilot model was designed as a lightweight version designed to pilot a new series of Raider then being developed. Few were built before the newer, wireless, Centurions were produced. Most are assigned positions well away from the Cylon home.

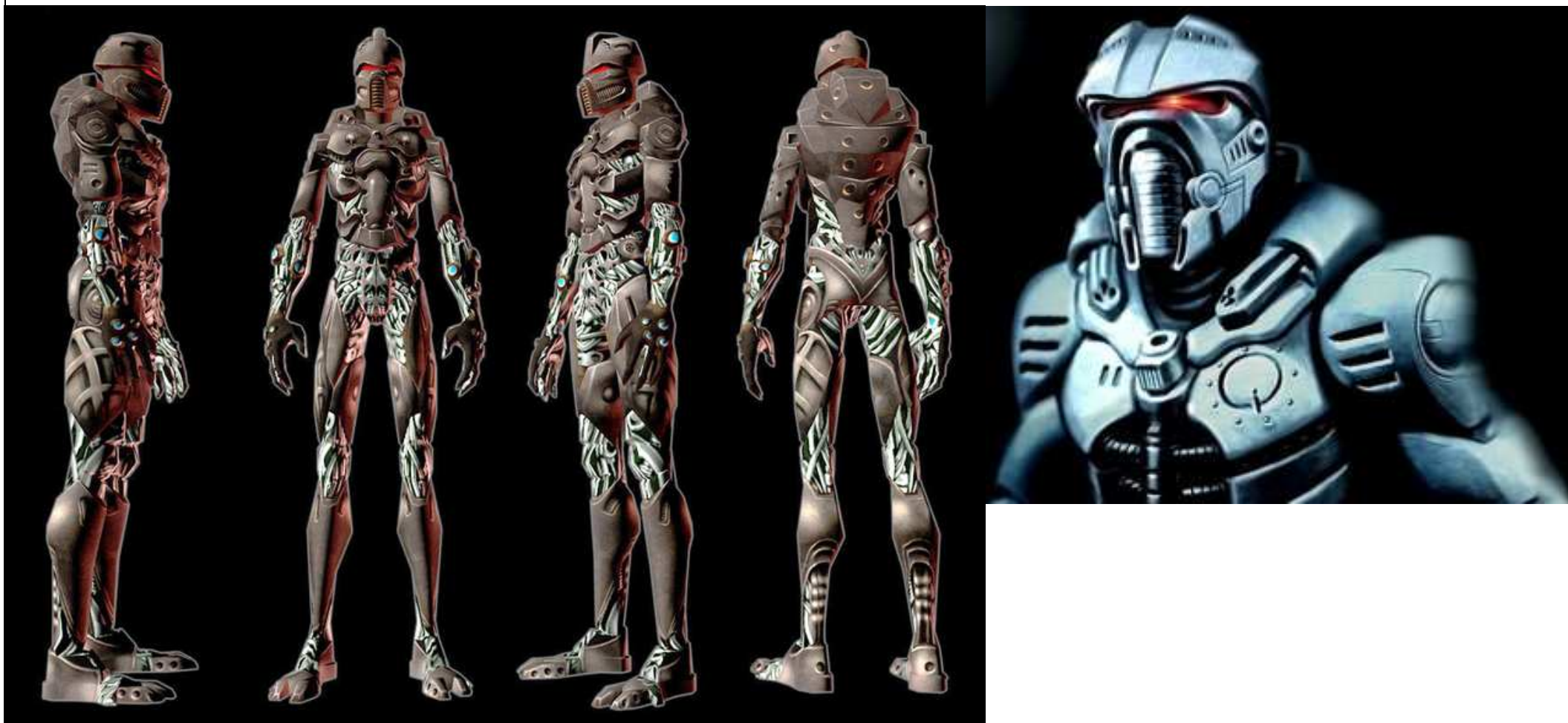

*GROUND CRAFT  
AND INTERESTING NOTES*



## Colonial Landram

Stats by Buscadero

pic by Limerickcot

**Agi** d4, **Str** d8, **Vit** d6, **Ale** 0, **Int** 0, **Wil** d6;

**LP** 14, **Init** d4;

**Scale** Planetcraft;

**Speed** 1

**Traits** Tough

**Skills** None

**Armament** 1 personal scale double-barrelled heavy machinegun (d12+d2; auto fire capable)

**Armour** Wound 3, Stun 2

**Description** 17 x 9 x 8 feet; **Crew** 1

**Passengers** 5; **Cargo** 1,500 lbs;

**Range** 450 miles;

**Towing Capacity** 7,500 lbs

The Colonial Landram is a standardised tracked utility vehicle. Pictured to the right is the basic, unarmed, model.

Adapted for use both in extreme temperatures and even in vacuum, these power-cell fuelled vehicles are ideal for use in closed-atmospheres and have found use even on board Battlestars, where they are used to clear wreckage from the flightpods. This variant normally has a dozer blade fitted to the front and a winch on the rear.

Although the standard model only carries five people, more can be carried by utilising the cargo bay. This is always done where the vehicle is being used as a 'cheap' APC, especially in hostile environments. In vacuum, a small airlock is provided in the rear and the main doors are 'locked' down to prevent accidental decompression. Even if the interior must be exposed to

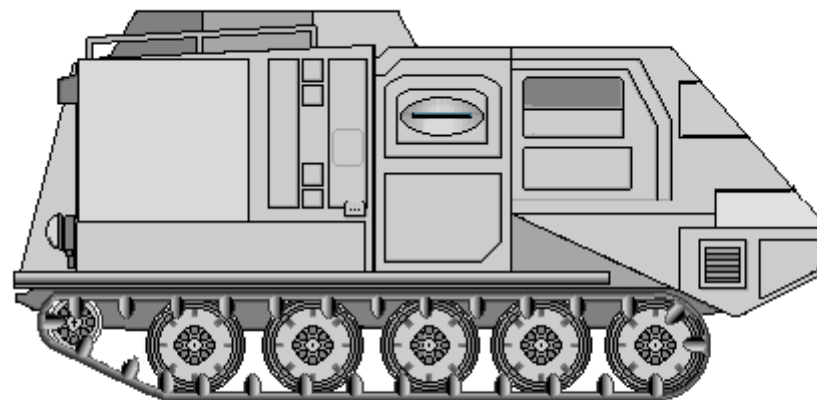
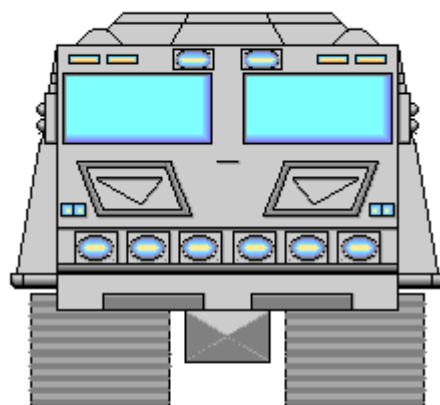

**Landram Mk1  
(unarmed version)**

**Limerickcot**

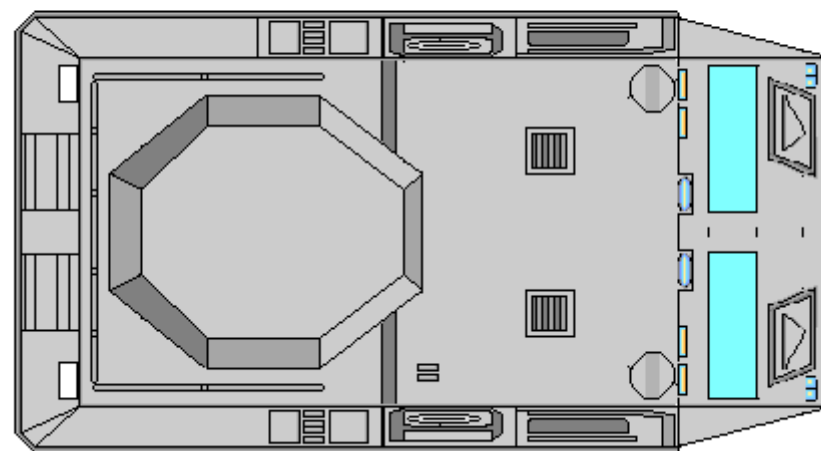

vacuum, an air supply can be fitted to extend the use of any space suits that are being worn. The passengers simply disconnect their airhose and plug into the Landram's air supply instead.



## ***Snow ram***

### **Snow ram**

**Agi** d4, **Str** d8, **Vit** d6, **Ale** 0, **Int** 0, **Wil** d6;

**LP** 14, **Init** d4;

**Scale** Planetcraft;

**Speed** 1

**Traits** None

**Skills** None

**Armament** 1 heavy planetcraft scale skirmish range autocannon (d12)

**Armour** Wound 3, Stun 3

**Description** 17 x 9 x 8 feet;  
**Crew** 1

**Passengers** 5;

**Cargo** 1,500 lbs; **Range** 450 miles;

**Towing Capacity** 7,500 lbs

A snow ram is a Landram that has been altered for use in arctic environments and equipped with a top-mounted turret.

Its internal heating system will allow the vehicle to function for as long as it has power.



## ***Colonial Power Sled***

stats by Buscadero

**Agi** d4, **Str** d6, **Vit** d4, **Ale** 0, **Int** 0, **Wil** d4

**LP** 10; **Init** d4; **Scale** Planetcraft; **Speed** 2

**Traits** None

**Skills** None

**Armaments** None

**Armour** Wound 1

**Description** 12 x 6 x 6 feet; **Crew** 1

**Passengers** 3; **Cargo** 1,500 lbs.; **Range** 500 miles;

**Towing Capacity** 7,500 lbs.

The Colonial Power Sled is a simple, tracked, all terrain vehicle used for carrying, or towing, other loads. As with most Colonial equipment, the Power Sled is equipped with a powerful set of lights, both for driving, and for working under. Power feeds can be taken off the engine and it has two tow points fore and rear.

It is unprotected from both elements and any real firepower. Most drivers, and passengers, need to wear goggles when driving, although some models have a fold up wind shield to provide a limited protection against the dust and flying debris of travel.

## ***Colonial Power Sled***

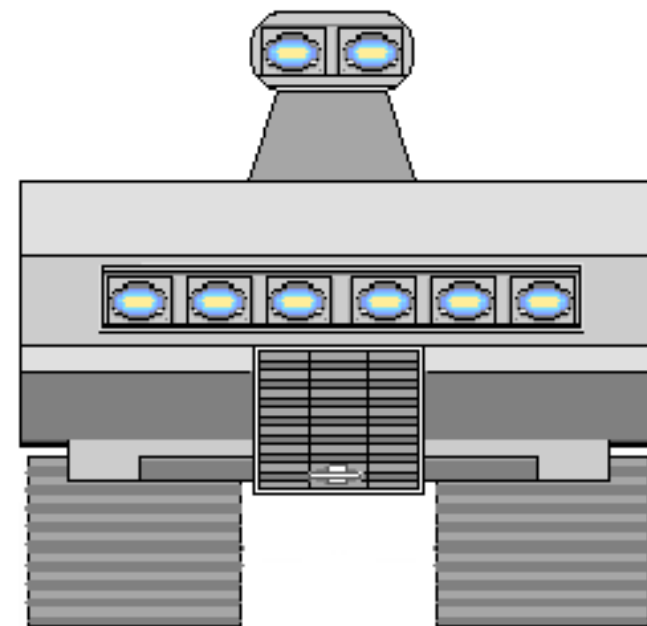
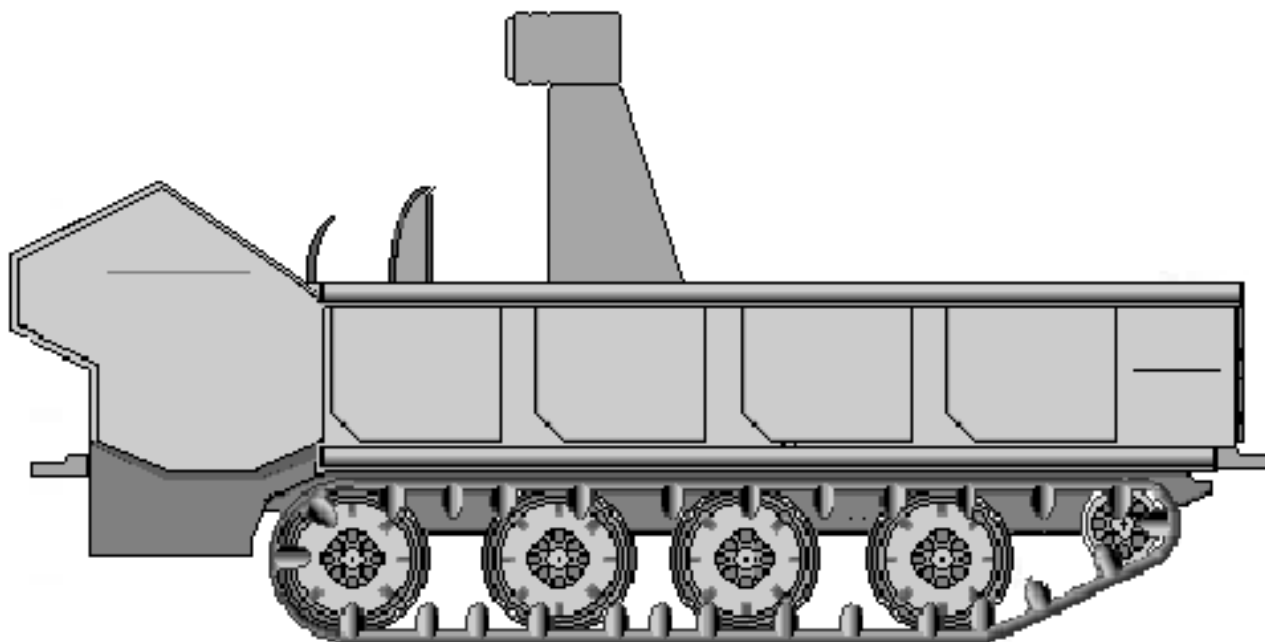

## ***Cylon Mobile Gun***

**Agi** d4, **Str** d8, **Vit** d6, **Ale** 0, **Int** 0, **Wil** d6;

**LP** 14, **Init** d4;

**Scale** Planetcraft;

**Speed** 1

**Traits** Tough

**Skills** None

**Armament** 1 vehicle scale , long range auto-cannon(d12+d2; auto fire capable)

**Armour** Wound 1, Stun 1

**Description** 14 x 9 x 12 feet;

**Crew** 2, **Passengers** 0;

**Range** 500 miles;

**Towing Capacity** 12,500 lbs

Initial Cylon advances were easily able to cope with Colonial Force armour elements and so the need for anything other than the Cylons themselves was not immediately foreseen by them (although they had already used heavier tanks – see the entry for the Ultima Mk 3)

However, when colonial forces dug themselves in, the Cylons biggest advantage – that of mobility – was degraded, as they were unable to penetrate the bunkers crossfire. They utilised missiles and mortars to try to overcome this difficulty but understood that they needed a variety of techniques and weaponry to overcome these defenders. They quickly adapted a small utility vehicle to deal with these. It gives very little protection to its Cylon crew but is capable of traversing most terrain. A turret mounted gun mount allows it use the weapon for air as well as ground targets. The picture shows a flame thrower installed. Others mounted heavy guns, or multiple missile racks,

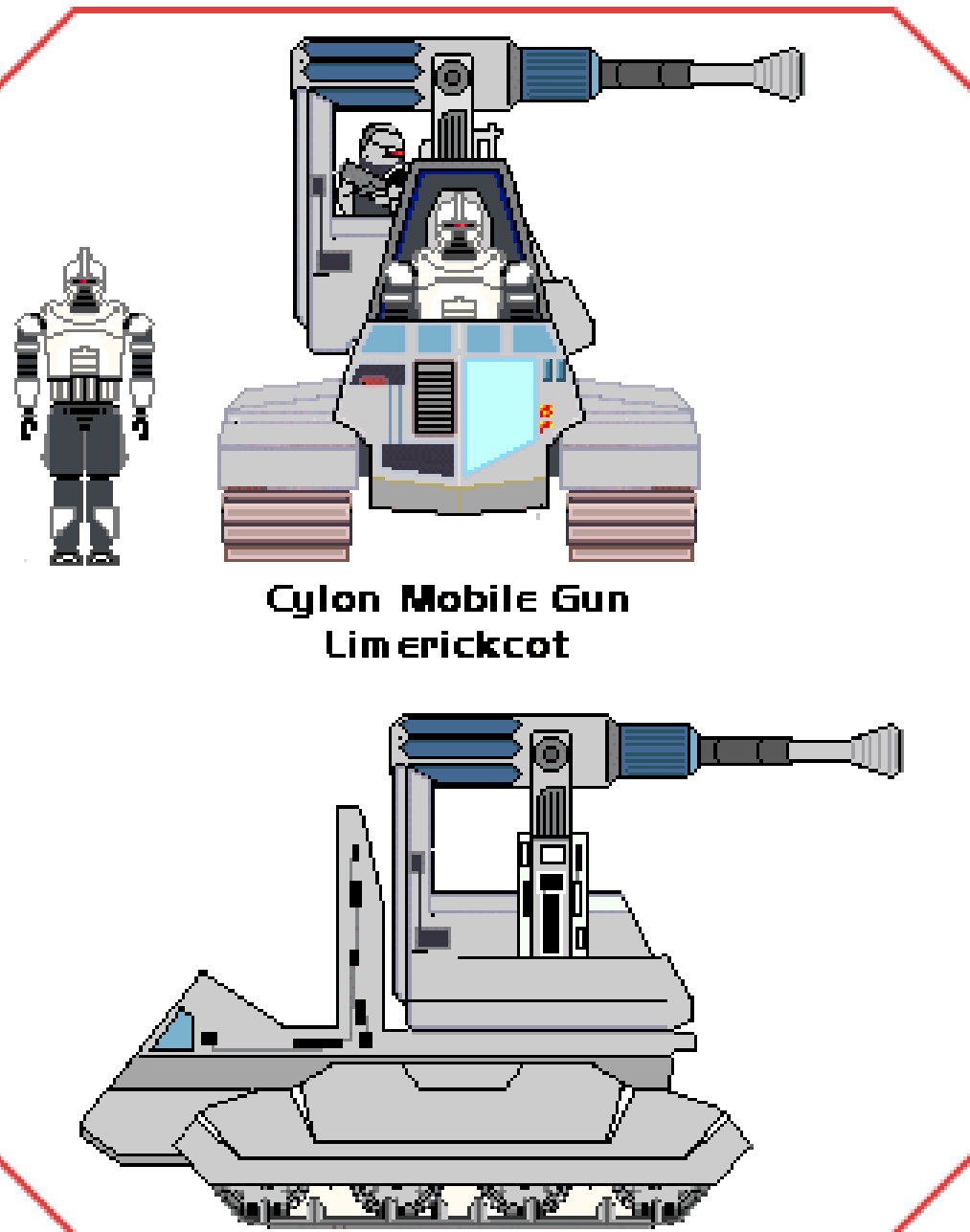



## ***Greystone Ultima Mk 3***

**Agi** d6, **Str** d10, **Vit** d6, **Ale** d6, **Int** d8, **Wil** d8;

**LP** 18; **Init** dd6+d6; **Scale** Vehicle; **Speed** 2

**Traits** None

**Skills** Heavy Weapons Targeting d6; Perception d4, Piloting d4

### **Armaments**

2 personal scale personal range medium machineguns (d8, auto-fire capable), mounted to rear

2 vehicle scale skirmish range medium cannon (d6),

1 vehicle scale skirmish range heavy cannon (d12+2),

6 Medium planet-craft scale medium range Missiles (d12)

**Armour** Wound 8, Stun 5

**Description** approx. 50 x 21 x 15 feet;

**Crew** None: Artificial Intelligence

**Passengers** None;

**Cargo** None;

**Range** unlimited

One of the last designs of the Greystone conglomerate was an updated version of their Ultima series grav-tank. Few other companies had ever attempted to produce an actual tank that used gravimetric suspension but Greystone had cracked the problems surrounding this early in its history. It did suffer from two major problems, which were cost and pilot training. Production of the Ultima was not destined to sink Greystone – they had a guaranteed contract to make a limited number of these each year as they had specialist uses.

When the Cylon project was first initiated, it was always anticipated that a limited number of Ultima's would be switched over to Cylon crewing/ However, another analyst realised that an AI system built into the tank would be far superior and so this was done instead. The Cylon war thankfully only found a handful of such conversions available, but those few wreaked havoc out of all proportions to their numbers.

Most were hunted down systematically by dedicated anti-tank teams. Their early days of relatively easy kills did not last for long, though. The distraction caused by the Ultima's allowed other Cylons to consolidate their own positions.



To begin with, the vehicles in use by those Cylons were simple converted sleds. Attempts to use manned Ultima's against the Cylons were doomed from the start as the Cylons took over their advanced electronics, rendering the tanks useless and usually crashing them into Colonial targets. Towards the end of the war as more and more manually operated tanks came into production, the Cylons began to convert Ultima tanks, using the salvaged brains from downed Centurions contained within a radically different, and armoured, head. When the war ended, over a hundred of these tanks withdrew with the remaining Cylon forces and were never seen again.

## ***The Original Series: Rules***

### ***Cortex – a matter of scaling.***

The thing to remember about combat in cortex is that it is done in scales:

- Personal
- Planetcraft (for vehicles, including Vipers and Raiders)
- Spacecraft (for ships).

Each scale is a multiple of 10 – so a planetcraft weapon that does d12+4 will always do a minimum of 60 points of damage at personal level, 6 points of damage at planetcraft level and no points at all at spacecraft level.

A personal weapon that does d10 damage and scores a 10 on the roll will do 10 damage at personal level, 1 point at planetcraft and no points at any scale above that.

And a d10 weapon at spacecraft level that scores a mere 2 points at that level, does 20 points at planetcraft and a whopping 200 points damage at personal level (otherwise known as a crater!).

### ***Why don't projectile weapons work in the Colonial Star System?***

Well, they do. Originally both Colonials and their opponents used projectile weaponry, but the development of both improved armour systems and an inherent shield technology that 'dampened' kinetic properties (assuming that a mild EM field was put through the armour in question), greatly reduced the damage caused by kinetic weapons, especially at long range (and this helps, in my own thoughts, the reason why you see mentions of shields and deflectors in the series).

So, for instance, a numo is fired at a Cylon. Despite the fact that it can kill a human outright, it only leaves a mild dent in the Centurion's armour. If it had been fired at long range, it probably wouldn't have done that much damage.

### ***How to reflect this in cortex:***

A projectile weapon that hits an object protected by EM armour (i.e. Centurions) is treated as if it were firing at an object scaled up by one level. So a personal level damage weapon firing at a Centurion is hitting a planetcraft (vehicle) scale object. If the weapon does more than 10 wound damage then it inflicts one point of damage to the Centurion (which is absorbed by its armour).

Although this gave an advantage to the Centurions in the early fifth millennium, the Colonials countered this by using armoured vehicles with the same armour properties and by deploying heavy weapon squads armed with heavier weaponry.

To overcome this difficulty, the Colonials took the primitive laser weaponry then in use and, over time, developed it into the blasters now commonly in use. The Cylons did the same and both sides now found itself back in parity.

### ***Blasters etc.***

Blasters ignore the EM properties of armour. So a personal level blaster will do full damage equally to Cylon or human. The armour of a Cylon still works normally as any armour does so in this situation.

The same works in space. So a railgun in space will have its damage treated as if its hitting a target at the next scale.

And so, with a huge grin on my face, I look at the Re-imagined Galactica, see her fire her main guns, each doing, say 1d12 W damage to a TOS Cylon Basestar. Yep - Galactica does damage, but only if a gun scores a 10 or more on each damage die! If a Basestar had an armour of 3, then no hits would actually get through, unless they scored an extraordinary success (another part of cortex rules). Oh dear.... so much for the RDM's eh (Big, very big, Grin).

However, don't get too cocky. Those Cylon blasters don't do any extra damage, and the RDM armour still counts normally against that type of damage.

## **Missiles**

Missiles are used in TOS Galactica, but they rely on Solenite warheads to bypass the absorbing effects of armour. So regular missiles from cortex are affected thus:-

- Nuclear Missiles do normal damage (see the tables later in this Warbook)
- Normal Missiles are treated as per rail guns.
- Solenite Missiles work normally.

## **Skills:**

There is no need to change any of the skill areas in use in cortex. These can all be used by simply adjusting what the skills apply to (blaster instead of pistol etc)

## **Time Units**

For those unsure about what the times mean, and for the rest who keep forgetting (like myself), here is a breakdown of the Colonial time units.

Centuron (100 yahrens)  
 Yahren - 1 year  
 Quatron - 1 lunar month (4 weeks)  
 Sectors - 1 week  
 Time cycle - one day (24 hours)  
 Centar (centares) - 60 minutes (1 hour)  
 Milicenton - 10 minutes  
 Centon - 1 minute  
 Micron (micro centon)- 0.6 seconds

so

1 Centuron = 100 yahren  
 1 Yahren = 13 Quatron

1 Quatron = 4 Sectors  
 1 Sector = 7 Time Cycles  
 1 Time Cycle = 24 Centares  
 1 Centar = 6 Milicentons  
 1 Milicenton = 10 Centons  
 1 Centon = 100 Microns

## **Ship Weapons:**

### **Viper/Raider Lasers**

The rules for using 'lasers' or blasters by both Vipers and Raiders are handled in the same way as for auto-cannon. However, the weapons have a limited shot capacity driven, not by the need for power (as their power plants produce more than sufficient power) but by the need to recharge with 'lason', a chemical needed to create the blaster reaction in such small ships. Every round after the tenth, the referee should roll a d6 to see how soon the ship will need to come in for recharging. This is simplistic and covers the aspect of 'walking' the lasers across targets that is common. A person with the Talented: Ships Cannon trait, gains the same amount of dice as their trait roll. i.e. Starbuck has been fighting Cylons for ten rounds and the referee rolls a 3 on d6. Normally that means that Starbuck's guns will run dry on the fourteenth round. But Starbuck has Talented: Ships Cannon at d6, so he gets to roll an additional d6 and gets a 4. So Starbuck can keep fighting for a total of 17 rounds before he is totally out of firepower.

### **Turbo-Lasers**

Blaster Turrets are those defensive plasma bolt weapons lining the hulls of Cylon and Colonial vessels. These weapons, although referred to as lasers, are not lasers. Blaster Turrets are in fact plasma bolt weapons. This assertion is based on the fact that these so-called Turbo-Lasers, fired beams at sub-light speeds, thus clearly demonstrating that they were not lasers as a laser bolt would travel at the speed of light.

A Main advantage of these type of weapon over the Laser-Torpedoes found on fighter craft, is that pure plasma weapons have greater range over hybrid plasma bolt weapons and can sustain maximum power for greater distances. Turbo-Laser plasma batteries, like those seen being used by Battlestars and Base-Stars, are primarily for anti-starfighter defence but can be adjusted for



ship-to-ship combat, as well as orbital bombardment.

Turbo-Lasers on the Galactica are powerful enough to destroy fighters, asteroids and their combined power is capable of destroying another vessel.

Standard Damage varies between D2 to D12 (spacecraft scale). It takes a turn to change the setting of a Turbo Laser from one damage setting to another.

D2	Skirmish	PDS
D4	Skirmish	PDS (+1 skill step, halve numbers of targets that can be acquired)
D6	Short	Planetcraft
D8	Short	Planetcraft (+1 skill step, halve numbers of targets that can be acquired)
D10	Long	Spacecraft
D12	Long	Spacecraft (+1 skill step, halve numbers of targets that can be acquired)

#### ***Laser-Cannons:***

Galactica is also armed with two heavy laser cannons set to either port and starboard of the forward hull. This spinal weapons concentrate all their fire forward and are considered to be linked weapons, therefore gaining a +1 skill step to firing (the damage is included below)

Laser Cannon: Range: Long; Damage: D12+D6

#### ***Mega-Pulsar Guns:***

Of all the weapons mentioned in the universe of "Battlestar Galactica", the Pulsar weapons are the only true anti-capital ship weapon ever mentioned. Capable of destroying another vessel with only a few shots, the Pulsar weapons are an extremely powerful type of fusion gun and only the dreaded Cylon Base-Star is armed with them (guns located at the top of the north saucer, and bottom of south saucer).

Essentially the Mega-Pulsar gun is a hybrid Neutron / Particle beam cannon. Neutrons are condensed together as they are accelerated within a magnetic chamber at speeds near that of light. When two masses of neutrons becomes too great to contain, they are allowed to collide together. The massive energy

release of this collision is then forced through the weapon's projection matrix creating a beam of pure destructive energy comprised of protons, x-rays and neutron particles.

Mega-Pulsar cannons are the heavy weapon of choice for the Cylon's largest capital ships and planetary defence as the proton/x-ray burst is capable of cutting through any known armour. Electronic countermeasures are equally useless against this weapon as the defensive electromagnetic shields employed by both Cylon and Colonial forces offer no resistance to neutron weapons, as a neutron has a neutral electrical charge.

Mega-Pulsar weapons require a massive amount of energy to be fired and, while the power reserves of a Base-Star are impressive, firing this weapon drains the ship of almost all her energy, every time it is fired, leaving her without any defences, except for her Raiders, for ten turns. This includes the targeting needed for missile arrays.

Mega-Pulsar Gun: Range: Long; Damage D12+D10; -1 skill step to hit; Stun effect (d8 effective at all scales) on all ships within Skirmish range after firing.

### ***Optional Rule: Cloaking Devices***

A cloaking device is a generator that creates a nearly perfect invisibility field around a vessel, making it almost impossible to detect with sensors or the naked eye.

A cloaked vehicle cannot be spotted if it remains immobile, ceases all communications transmissions, and doesn't attack. A cloaked vessel that moves or communicates without attacking can be spotted at personal or skirmish range, but the Difficulty for *Alertness + Technical Engineering* or *Alertness + Perception* Skill rolls made to find it are increased by two categories. A cloaked vehicle that makes an attack automatically reveals its range to any ship within DRADIS range. It can be detected with sensors, although the Difficulty for *Alertness + Technical Engineering* or *Alertness + Perception* Skill rolls is increased by one category.

### ***Time Warp Synthesizer***

The time warp synthesizer is a device that permits travel back and forth through time, which the Colonials consider to be the fourth dimension.

The device is small enough to be installed in a Colonial Viper and works on the generally accepted principle that once a person exceeds the speed of light, one can travel back in time. As a result of going through time, the molecules of synthetic fibres change colour, thus the uniforms worn by time travellers are turned white. This includes the helmet and other equipment on a person.

## Optional Rules

### New Skill: Temporal Operation

The *Technical Engineering / Temporal Operation* Skill is used to run time machines which may prove to be useful if, for example, a crazed Colonial Warrior and member of the Council of Twelve has to be pursued to 1944 and stopped from giving the Germans advanced technology. Successful Operation rolls get the travellers precisely to the target place and time, without unpleasant side effects. Failed or, worse still, botched rolls cause them to arrive too early or too late, a few feet in the air, or without some of their equipment. The GM may establish a "failure table" or just make it up as he goes along.

### New Complication: Time sickness [d4/d8/d12]

You suffer from a sickness that is characterized by a feeling of nausea and, in extreme cases, vertigo experienced after travelling through time. Time sickness can be a debilitating condition and can be dangerous if the sufferer has an important mission to carry out, such as stopping a madman from giving the Nazis advanced technology.

**d4:** After travelling through time, you must make an AVERAGE (7) Endurance roll. Failure indicates that you have to roll your Trait die. For that many turns, you can't take any actions.

**d8:** As above, but you also take d6 points of Stun damage. Double this on a Botch!

**d12:** As above, but damage is Basic type.

### New Asset: Straight-faced [d2+]

You are able to keep a serious or impassive facial expression that conceals your true feelings about something, especially an irresistible desire to laugh. Add your Trait die to any roll made to avoid laughing yourself to tears in view of ridiculous situations (e.g., you realize that your uniform has suddenly turned white) or missions (e.g., you are ordered to travel back in time to stop a madman from giving the Nazis advanced technology).

**d6:** At level d6 or above, you can spend one Plot Point to immediately regain control even after failing a roll to do so.

## Adama



**Agi** d8, **Str** d6, **Vit** d8, **Ale** d10, **Int** d10, **Wil** d12;

**LP** 18; **Init** d8+d10

**Traits** Cool Under Fire d6, Duty d10, Elderly d6, Faith d2, Idealist d4, Political Pull d12, Renowned d2, So Say We All d6

**Skills** Athletics d4, Discipline d6 / Leadership d12 / Morale d10, Guns d6, Influence d6 / Persuasion d8, Knowledge d6 / History d8 / Religion d10, Perception d6, Performance d4, Pilot d6 / Small Spacecraft (Viper) d10, Survival d6, Unarmed Combat d2

**Description** Adama is the commander of the great

Battlestar Galactica, commander of the refugee fleet, and military commander of the evacuees of the Twelve Colonies. He is also the spiritual leader of the surviving Colonists, leading the quest for Earth. He has a daughter, Lieutenant Athena, and son, Captain Apollo. His wife Ila, and his second son, Zac, are killed in the Cylon attack on the Twelve Colonies. Adama is a native of the planet Caprica, which is where he graduated from military academy. Early in

his career Adama was involved in a para-psychological research project at the Colonial Military Institute. He flew with his executive officer Colonel Tigh in their younger days, and later served as an aide to Commander Kronus aboard Battlestar Rycon. As well as being a career military officer, Commander Adama is also a member of the Quorum of Twelve, the governing body of the Colonies.

## Apollo



**Agi** d8, **Str** d8, **Vit** d8, **Ale** d8, **Int** d8, **Wil** d8;  
**LP** 16; **Init** d8+d8  
**Traits** Good-Natured d6, Duty d6, Dogfighter d2, Renowned d2

**Skills** Athletics d6 / Dodge d8, Covert d6, Discipline d6 / Leadership d10, Guns d6 / Pistols d8, Influence d6 / Persuasion d8, Knowledge d6, Mechanical Engineering d4, Medical Expertise d2, Perception d6, Pilot d6 / Small Spacecraft (Viper) d10, Survival d6, Technical Engineering d4

**Description** Captain Apollo is Galactica's lead Viper pilot, leading Blue Squadron in the defence of the rag-tag, fugitive fleet.

## Starbuck



**Agi** d8, **Str** d8, **Vit** d8, **Ale** d10, **Int** d8, **Wil** d6;  
**LP** 14; **Init** d8+d10

**Traits** Brawler d4, Duty d6, Dogfighter d4, Lustful d4, Overconfident d4, Renowned d2, Split-Second Timing d6, Talented: Pilot / Small Spacecraft (Viper) and Ship's Cannons d6, Wise-Ass d4

**Skills** Athletics d6 / Dodge d8, Covert d6, Discipline d6, Guns d6 / Pistols d8, Influence d6 / Seduction d10, Knowledge d6, Mechanical Engineering d4, Medical Expertise d2, Perception d6, Pilot d6 / Small Spacecraft (Viper) d12, Survival d6, Technical Engineering d4

**Description** Lieutenant Starbuck is a handsome, fumarello-smoking, womanizing, smart-aleck Colonial Warrior. He's also one of Galactica's finest pilots.

Starbuck was born on Caprica in the agro settlement of Umbra. He was orphaned when a Cylon raid destroyed the settlement.



## ***Turbines***

**Stats by Buscadero**

[BattlestarWiki](#)

### **Turbines**

**Agi** d4, **Str** d2, **Vit** d2, **Ale** d2, **Int** d2, **Wil** d4,  
**LP** 6, **Init** d4+d2, **Scale** Planetcraft, **Speed** 3

**Traits** None

**Skills** Perception d2, Pilot d2

**Armaments** 1 personal scale heavy  
machinegun (d12; auto fire capable)

**Armour** Wound 1

**Description** 6 x 2.5 x 3 feet; **Crew** 1

**Passengers** 1; **Ceiling** 6,000 feet; **Range**  
250 miles

Turbines, also known as flying motorcycles and turbo cycles due to their similarity to the Earth bike, help Colonial Warriors to get around quickly, and escape quickly if necessary.

The motorcycles appear normal and are usually operated as wheeled ground vehicles, but can also be used as aircraft if the situation requires it. They can also be rendered invisible by pressing a hidden switch located between the left handle and the seat, in order to avoid detection when parked. Additionally, the motorcycles are outfitted with forward mounted guns.



## Wrist Computron

A wrist Computron is a portable device that has five basic functions: communication, translation, data storage and retrieval, scanning capabilities, as well as personal invisibility.

The invisibility field is based on the incontestable fact that each colour and sound has its own frequency, some of which are too high to be perceived by the human eye or ear and that by generating a nuclear field in a frequency above the perception of conventional electronic equipment or even the human eye, whole ships or personnel can be rendered invisible. The power cost, however, is too high for this to be used in all applications, and thus must be used only in "life or death" situations. Those using the invisibility field emitted

by the device cannot see others who are also invisible using the same device.

The Computron is also capable of scanning communication frequencies, including those used by the Cylons, medical probing, and making scientific analyses, analyzing various mineral and chemical content. The scanner function is also capable of making medical diagnoses and translations.

A wrist computron's invisibility field grants a +3 step Skill bonus on *Covert / Stealth* rolls, while its scanning function grants a +1 step Skill bonus on *Perception / Appropriate Specialty* rolls. Its scientific functions grant a +2 step Skill bonus on *Medical Expertise* as well as *Scientific Expertise* rolls. Moreover, the wearer receives a +1 step Skill bonus on *Influence / Seduction* rolls because a wrist Computron is a chic and sexy accessory. A character may add his Straight-faced Trait Die to any roll to operate a wrist Computron.



## ***Ravashol Pulsar Cannon***

Stats by Buscadero

The Ravashol pulsar was actually intended to be a peaceful but powerful communications device that transmitted information through laser energy. The Cylons, however, captured it and converted it into a very powerful weapon.

<b>Scale</b>	<b>Weapon</b>	<b>Range</b>	<b>Damage</b>
Spacecraft	Heavy	Long DRADIS	d12+d12

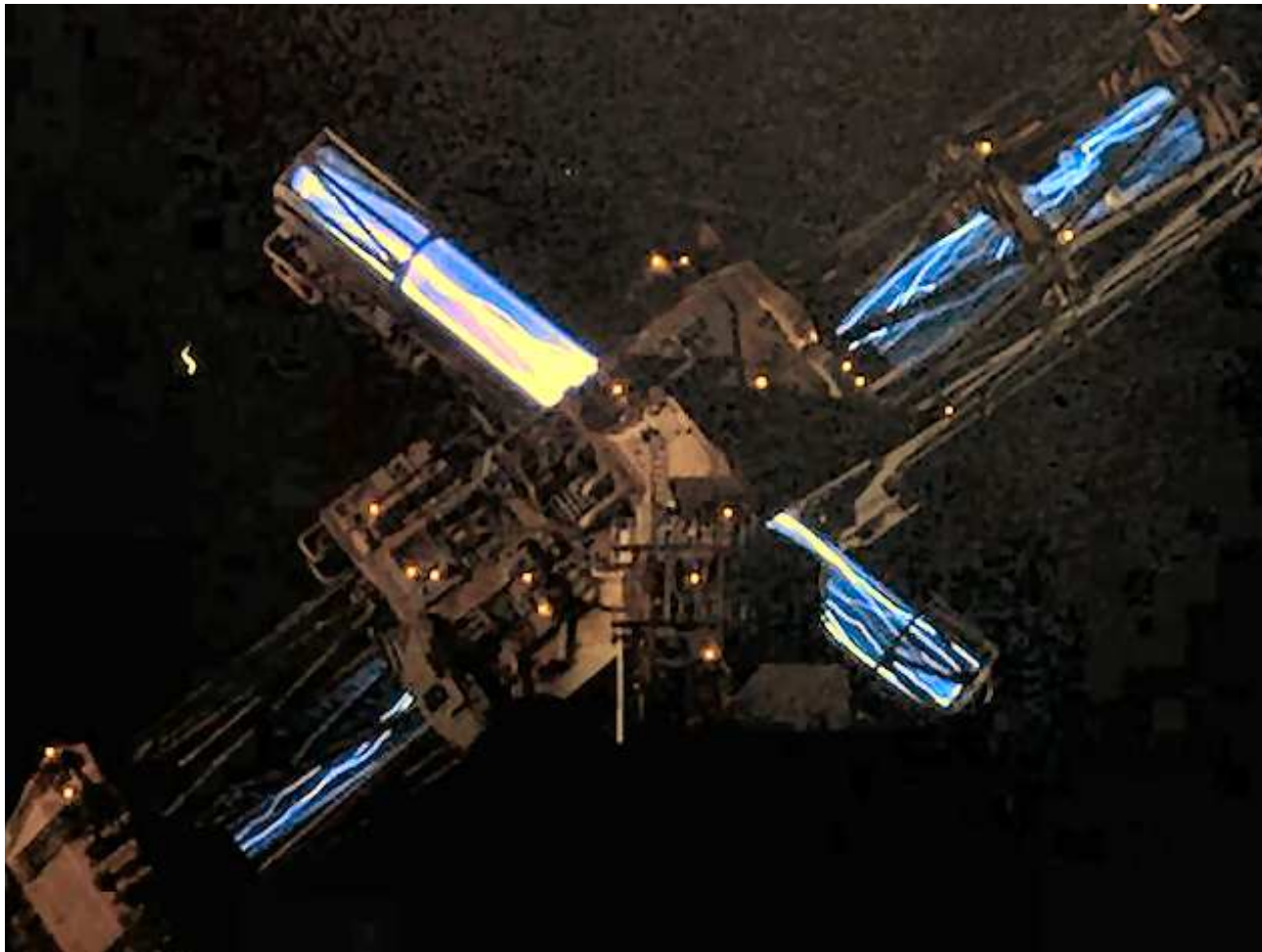



## Alternate Hit Locations

Adapted from a post By FCWesal

Since BSG has armour (Body Armour) that specifically covers part of the body, and therefore only offers protection to that location this means that a bullet may not hit the amour you're wearing.

As such, when random bullets fly, you can either assume that they hit only in the torso or roll randomly to see where a round goes. It's also a good device for role-playing to help either you, or the GM, to add flavour to your game. Don't just assume this is for hits to a character. It can also be used against NPC's and Cylons. Remember, even if a Cylon has its legs blasted off, it will still try and use its arms to kill you.

The first column is the random roll to see where a round hits.

The third column is the extra difficulty for a called shot that you want to hit a specific area.

### Roll 3D6

3-5	Head	+4 Step
6	Hand	+2 Step
7-8	Arm	+2 Step
9	Shoulders	+2 Step
10-11	Chest	+0 Step
12	Stomach	+0 Step
13	Vitals (Heart, Kneecaps)	+6 Step
14	Thighs	+2 Step
15-16	Legs	+2 Step
17-18	Feet	+4 Step

## Explosive Decompression

By Buscadero

If a character is suddenly exposed to vacuum, you must make a FORMIDABLE (15) Endurance (Vitality + Willpower) roll to avoid decompression damage. Failure means that the Difficulty is treated as an attack. Damage is Basic.

After that, the character begins to suffocate. He can't hold his breath without damaging his lungs. Thus, you must immediately begin making Resistance rolls. The first time, the Difficulty is HARD (11), but it increases by 4 each turn.

Once the character fails a roll, he begins to suffer d2 Stun damage every turn. Once the character has passed out, he suffers d2 Shock Points and d2 Wound damage every turn.

## Dogfighting

By Dustinstrong

Basic Assumptions and rule interpretations:

Watching the DVDs, most of the dogfights start with both sides closing on each other in formation and each ship firing a salvo of missiles at what could be considered "Capital" range.

According to the CRB, capital range missiles "can lock and track targets with and Easy (3) Difficulty."

A MAW attack use's the vehicle's Agility + operator's Pilot, Planetary Vehicle or Heavy Weapons skill (a missile attack is the same but uses the vehicle's Alertness instead).

- According to the errata, Raiders have a Heavy Weapons d6 skill
- Scar has a Heavy Weapons d6 and specialties of cannons and guided weapons
- Viper pilots do not have a Heavy Weapons skill

- Raiders use Agility (or Alertness) + Heavy Weapons to fire because they are autonomous. This is the same as using Starbuck's Agility + Guns to fire a pistol or rifle.
- Viper pilots use Agility (or Alertness) + Pilot to fire. This is because the Viper is the weapon; it takes the place of Starbuck's pistol.

Traits, such as Talented, Dogfighting, Split-second Timing, etc., are used while trying to manoeuvre and gain a firing position. Unless specified, they **do not** apply when firing (you already have the position and it now just a matter of pulling the trigger).

Dogfights take place at a much higher rate of speed than personal combats. As such, Initiative is handled a little different.

In personal combat, the higher Initiative acts first, because that person reacted faster

In dogfights, the higher Initiative simply gives you a slight edge over you opponent, but because of the faster pace, your opponent can quickly turn the tables on you (i.e. he guessed your tactic and countered it before you could fully execute the manoeuvre).

Everyone with me so far?

### **Dogfight, Round 1:**

*Colonials and Cylons are preparing to engage. All fighters have been launched and are formed up, ready to press their attacks. As they close to within capital range, the squadron commanders order a missile salvo. All pilots roll Initiative.*

At this point, each pilot decides whether to fire a salvo, or hold fire and evade incoming. If they choose to fire, roll ship's Alertness + Heavy Weapons (for Raiders) or Alertness + Pilot (for Vipers) at an Easy (3) Difficulty, targeting any ship which rolled a lower initiative than their own.

Any targeted ship must now roll to escape missile lock (as described in the CRB). The first test is made with no penalty, the second suffers -1 step skill, the third suffers -2 step skill (as the missile closes, it is harder to avoid). If the target had chosen to fire, then the first test suffers -1 step skill, the second -2, and the third -3.

### **Round 2:**

*All fighters are now within "skirmish range" and break off to engage individual targets. Pilots choose their prey and roll Initiative.*

The higher Initiative has a slight advantage in gaining a firing solution, but doesn't quite have the target "in the crosshairs" and must manoeuvre to gain a better position. A step skill bonus is awarded based on Degree of Success: 3+ grants a +1; 7+ grants +2; 11+ grants +3 etc. and is considered the "shooter."

Pilots then make opposed manoeuvre rolls to "scoot" into a firing position. If the shooter wins, they now have a firing solution and may "shoot" the weapon of their choice (guns or missiles) as described above, suffering a -1 skill test penalty for multiple actions. The target may now attempt to dodge by making a manoeuvre roll (Agility + Pilot), suffering a -1 step skill penalty, or may choose to roll Innate defence (Agility) at no penalty.

If the shooter loses, the target manages to evade a weapons lock. No weapons are fired, no dodge attempts need to be made.

*Starbuck singles out a Raider and engages. She wins initiative by 5, gaining a +1 step skill bonus to her "scoot". She now attempts to manoeuvre into firing position, rolling the Viper's Agility + her Pilot(Viper) skill + Traits (Dogfighter, Split-second Timing, and Talented-Viper Pilot) against the Raider's Agility + Pilot(Raider) + any Traits. She gains position, beating the Raider by 5.*

*Choosing to use her cannons, Starbuck "shoots", rolling the Viper's Agility + her Pilot(Viper) + Traits (Talented-Ship's Cannons). Because this is her second action this round, she suffers a -1 step skill penalty.*

*The Raider attempts to dodge the incoming fire, rolling Agility + Pilot(Raider) against Starbuck's "shoot". If successful, the Raider evades all of Starbuck's shells. If failed, the Raider suffers basic damage and Starbuck rolls her weapons' damage dice.*

*Starbuck's cannons find their mark, inflicting 10 points of basic damage (5S, 5W). Because she is flying a Mk.II armed with two autocannons, she rolls 2d8W damage. (If she had been flying a Mk.VII, she would roll 3d8W damage as it is equipped with 3 cannons.)*

### **Round 3:**

*Starbuck had severely damaged the Raider, but it is still in the fight, and dangerous. She decides to finish it off with a missile attack. Both roll Initiative.*

Since Kara has the advantage, she gains a +1 step skill bonus to her Initiative roll against the Raider. The Raider is heavily damaged, suffering a -2 step penalty to all Attributes, and must make an Endurance check at an Average (7) difficulty. She easily wins the roll by 11, gaining a +3 step skill bonus to her "scoot".

*Starbuck and the Raider now make their "scoot" rolls (1st action). Kara*

wins the contest and fires a single missile using the Viper's Alertness + her Pilot(Viper) at an Easy (3) difficulty, suffering a -1 step skill penalty (2nd action). Kara rolls a 10, inflicting 7 points of Basic damage (4S,3W) to the Raider, if it fails to evade.

Survival dictates that the Raider attempt to evade the incoming missile. The Raider makes the first evasion roll using Agility + Pilot(Raider) with a -1 step skill penalty (2nd action) at a Difficulty 7; the second evasion with a -2 step skill penalty (3rd action) at Difficulty 7; and the third evasion with a -3 step skill penalty (4th action) at Difficulty 7. Unfortunately, the Toaster fails the second roll (and suffers 10W from Kara's d12W missile), exploding into a huge fireball (suffering 2S and 11W after applying armour of 2S,2W)

## Multiple Guns on Fighters & other craft (fire-linked weaponry)

Most planetcraft and some vehicles have fire-linked guns: groups of identical weapons that point and fire in the same direction, dealing greater damage than either weapon alone.

Example:

A Viper has 2 autocannons (d8 planetcraft damage) and inflicts 2d8 damage.

So, a pilot can fire both guns 'singly', getting a separate skill roll for each, or they can use auto-fire and have both guns treated like an automatic weapon. Instead of making two rolls, the player makes one, but gains a +1 step to both to hit and to damage.

They can also choose to 'spray-fire', gaining a +2 step to hit, but a -1 step to damage. This latter defence is for firing on things like missiles, not for taking out enemy fighters.

For each doubling of the number of fire-linked weapons (two, four, eight, and so forth), the attack roll gains a +1 Skill step. Thus, if six weapons are fire-linked, they would attack together and grant a +2 Skill step bonus.

Fire-linked weapons are fired with a single attack roll.

So to put it all together simply:

### Fire Linked Weapons Table

Attack	Skill Modifier	Damage	Notes
Single Shot (one barrel)	--	d8	--
Single Shot (all barrels)	+1 Skill step	d8	--
Auto fire (one barrel)	--	d12+d4	No other attack is possible that turn. Cannot be a called shot. One-tenth of ammo is expended.
Auto fire (all barrels)	+1 Skill step	d12+d4	No other attack is possible that turn. Cannot be a called shot. One-third of ammo is expended.



## Variant Rule: Mixing Scales

### Using the Charts

Find the scale of the thing that is doing the shooting along the left hand row. Find the scale of the target on the column across the top. Find where the row and the column cross.

#### Scale Chart 1: To Hit

This chart is used when an attacker of one scale shoots at something of a different scale.

	<i>Personal</i>	<i>Planetcraft</i>	<i>Spacecraft</i>
<i>Personal</i>	--	+1 step	+2 step
<i>Planetcraft</i>	-1 step	--	+1 step
<i>Spacecraft</i>	-3 step	-1 step	--

#### Example:

Starbuck is shooting at a Sparrow. Starbuck's player finds the personal row along the left of the chart, reads it across to the planetcraft scale column, and sees that Starbuck's Skill is increased by +1 step.

#### Scale Chart 2: Damage, Life Points, and Armour

This chart is used when a target takes a hit from a weapon of a different scale.

	<i>Personal</i>	<i>Planetcraft</i>	<i>Spacecraft</i>
<i>Personal</i>	--	LP / AR x2	LP / AR x5
<i>Planetcraft</i>	DMG x2	--	LP / AR x2
<i>Spacecraft</i>	DMG x5	DMG x2	--

#### Example:

Going back to the previous example, if Starbuck hits the Raider, the Sparrow's Life Points are increased from 14 to 28. Its Armour is increased to Wound 4 and Stun 4.

If the Raider hit Starbuck, she'd suffer d8x2 points of Wound damage in addition the doubled Basic damage dealt by the attack.

#### Scale Chart 3: Called Shots

When an attacker of one scale is making a called shot against something of a different scale, Skill penalties apply as normal. Moreover, the Difficulty of the rolls made to resist the called shot's special effects is modified as follows.

	<i>Personal</i>	<i>Vehicle</i>	<i>Spacecraft</i>
<i>Personal</i>	AVERAGE	EASY	--
<i>Vehicle</i>	HARD	AVERAGE	EASY
<i>Spacecraft</i>	FORMIDABLE	HARD	AVERAGE

*Note:* A character can make a called shot against a Basestar, for instance. It won't trigger any special effects, though. There is no way to take down an capital ship with one shot from a pistol.

## Optional Rule: Collisions

Collisions occur when a vessel strikes a solid object or when a vessel's pilot decides to ram into an object on purpose.

To avoid an obstacle, the pilot must make a Skill roll. The *Difficulty* is determined by the obstacle's size, speed, and course. You can use the following table to determine the *Difficulty* to avoid a randomly created obstacle.

Use the smallest size of the two colliding objects to determine the base Difficulty for the Skill roll the pilot makes to avoid the obstacle.

d10 Roll	Obstacle Size	Pilot Difficulty
1	Gigantic: spacecraft scale Str d12+	INCREDIBLE (23)
2 – 3	Colossal: spacecraft Str d8 – d10	HEROIC (19)
4 – 5	Huge: spacecraft scale Strength d4 – d6	FORMIDBLE (15)
6 – 7	Large: planetcraft scale Str d10+ / spacecraft scale Str d2	HARD (11)
8 – 9	Medium: planetcraft scale Str d6 – d8	AVERAGE (7)
10	Small: planetcraft scale Str d2 – d4	EASY (3)

Use the highest speed of the colliding objects and modify the Difficulty accordingly.

**d8 Roll    Obstacle Speed    Difficulty Modifier**

1	Very High: 9+	+8
2 – 3	High: 6 - 8	+4
4 – 5	Medium: 3 – 5	±0
6 – 7	Slow: 1 – 2	-4
8	Stationary: 0	-8

Finally, decide a second Difficulty Modifier based on the movement vectors of the colliding objects.

d6 Roll	Obstacle Direction	Difficulty Modifier
1 – 2	Moving Toward	+4
3 – 4	Moving Perpendicular	±0
5 – 6	Moving Away	-4

If the Difficulty drops below EASY (3), no roll is required to avoid the obstacle.

Failing a Pilot Skill roll to avoid an obstacle means that the pilot's vessel has collided with it. The Difficulty is treated as an attack roll while the Skill roll made to avoid the obstacle is treated as a defence roll. Damage is Basic type.

If the obstacle is another ship, its pilot can also attempt a Skill roll against the oncoming vessel. If both Skill rolls fail, the two ships collide.

*Example:* A nugget's Viper (planetcraft scale Str d6) is about to collide with a Cylon Raider (Speed 9). It is a HEROIC (19) task to avoid the Sparrow that is moving toward the pilot's fighter. The pilot rolls a 9 and collides with the Raider. His Viper takes 5 points of Stun and 5 points of Wound damage.

## Optional Rule: Strafing Runs

A strafing run allows a pilot of a planetcraft scale vessel to skim the surface of a spacecraft, reducing the chance of being hit by the spacecraft's defensive fire. Strafing runs can also be made against installations on a planetary surface.

As a pilot closes to within 30 feet of the target, he must succeed at an *Agility* + *Pilot / Appropriate Specialty* Skill roll to avoid collision with it (see above). A collision immediately aborts the strafing run.

If the pilot avoids collision, a second Skill roll must be made to determine whether the strafing run succeeds. The *Difficulty* depends on the size of the target: *Strength* d10-d12+, AVERAGE (7); *Strength* d6-d8, HARD (11); *Strength* d2-d4, FORMIDABLE (15). If the roll is successful, the pilot's vessel flies so close to the target that only its point-defence weapons can attack.

## Optional Rule: Battle Damage

When a spacecraft has suffered Wound damage greater than or equal to half of its *Life Points*, roll d10 each time it is hit thereafter. Add the result of this roll to the Wound damage dealt by the attack and refer to the following table to determine which specific systems are damaged or destroyed.

If the result clearly does not apply, use the damage result one category higher. If, for example, a spacecraft's FTL drive has already been destroyed and a roll yields another 21 – 25, use the result for 26 – 30 instead.

d10 + Wound damage	Damaged System and Effect
2 - 5	Sensors damaged: All Skill rolls to operate the spacecraft's sensors take a -2 step Skill penalty.
6 - 10	Sublight engines damaged: Spacecraft's <i>Speed</i> drops by one-half, rounded down.
11 - 15	Weapon damaged: Randomly determine one weapon that ceases to function.

16 - 20	Weapon system destroyed: Randomly determine one weapon system (e.g., heavy planetcraft scale skirmish range point-defence system) that ceases to function.
21 - 25	FTL engine destroyed: Spacecraft's FTL drive ceases to function.
26 - 30	Sublight engines destroyed: Spacecraft cannot perform any manoeuvres.
31+	Widespread damage: Divide Wound damage by 2. Roll twice on this table, adding that result to each d10 roll.

## Optional Rule: Fighter Wing

Fighters that comprise a wing move together by matching velocity and direction, trading versatility for concentrated firepower.

Because the wing can only manoeuvre as well as the worst pilot's fighter, this manoeuvre is often performed by squadrons of equally skilled pilots.

Forming a wing requires that the fighters are close to one another and move at the same speed as well as in the same direction. A pilot who wishes to join a wing must succeed at an AVERAGE (7) *Agility* + *Pilot / Appropriate Specialty* Skill roll. Forming a wing of different vessels (e.g., fighters of different *Strength* Attribute die types) increases the *Difficulty* to HARD (11). No more than six fighters can be in a wing.

A wing operates like a single ship in most respects. All Skill and Attribute rolls such as Initiative are made by the less-skilled pilot. If a roll is successful, all ships in the wing succeed. If it fails, the entire wing fails.

When attacking, the fighters in the wing can combine fire and fire at the same target. The less-skilled fighter pilot is designated as the primary shooter. Only this fighter's attack roll is used, but it gains a +1 step Skill bonus for each additional fighter in the wing, to a maximum of +5 Skill step. On a successful hit, the weapon's damage die gains a +1 step. Extraordinary success adds an additional stepped-up damage die to the total.

*Example:* Six Vipers successfully form a wing to attack a Cylon tanker. The primary shooter makes an attack roll at +5 Skill step and rolls a 15. The Cylon tanker's defence roll (7) is subtracted and the initial damage is 4 Stun and 4



Wounds. Since the wing was extraordinarily successful, their autocannons' damage die is increased by +2 step to d12. The damage die yields a 7. The Cylons tanker suffers 4 points of Stun and 11 points of Wound damage.

If a wing is attacked, the attacker gains a +1 step Skill bonus for every two ships in it. Attacking a wing that consists of six fighters, for example, gives the attacker a +3 Skill step bonus. Only the less-skilled pilot defends against the attack.

When a wing is hit, it is either determined randomly which fighter within it suffers damage or the player running the wing may decide which ship takes damage. Note that only the worst of all defence rolls is used for the entire wing.

### **Optional Rule: Weapon Batteries**

Spacecraft have identical weapons that can be grouped in a battery, a group of up to six weapons that fire as one. These weapons battery can be designated to fire at a specific target.

When attacking, a single attack roll is made. Each additional weapon after the first adds a +1 step Skill bonus to the attack roll, to a maximum of +5 Skill step. On a successful hit, the weapon's damage die gains a +1 step. Extraordinary success adds an additional stepped-up damage die to the total.

*Example:* The *Galactica* delivers a broadside at a Cylon Basestar. 12 of the *Galactica's* 24 assault railguns that can fire at the Basestar are grouped in two batteries, each consisting of 6 railguns. Two attack rolls are made at +5 Skill step. The attack roll yields a 13 as well as a 14 and the Basestars defence rolls (6 and 9) are subtracted. Since both attacks were successful, the railguns' damage dice are increased by +1 step to d12+d4. The Basestar takes a heavy beating.

### **Variant Rule: Establishing and Breaking Missile Locks**

Establishing a missile lock against any target is EASY (3) at capital range, an AVERAGE (7) task at short DRADIS range, or a HARD (11) feat at long DRADIS range. Missile locks cannot be established at skirmish or personal range.

To establish a missile lock, the attacker makes an attack roll. The missile, however, is not fired as part of this action. If the attack roll succeeds, a missile lock is established, allowing the attacker to fire the missile at any point later in the combat. The missile lock remains established until the missile weapon is

fired.

Once fired, it takes the missile a number of turns to close in on its target. The number of turns of movement depends on the distance the missile has to travel:

Range	Turns of Movement
Capital	1
Short DRADIS	2
Long DRADIS	5

Any ship can attempt to destroy a missile before it reaches its target. Due to their size and speed, it is a FORMIDABLE (15) task to hit missile weapons. If the attack roll succeeds, the missile is destroyed.

It is an EASY Complex Action (15 vs. Agility + Pilot) to out-fly a missile. Each Skill roll requires one turn. The pilot of the targeted ship must reach or exceed the Difficulty Threshold within the number of turns it takes the missile to close in on its target.

The most uncertain method of avoiding a missile attack is to distract it with another target before it collides with the targeted ship and detonates. The pilot of the targeted ship can attempt to trick a missile's guidance system into pursuing a different target by flying very close to another ship or object which requires an Agility + Pilot Skill roll to avoid collision (see above). If the Skill roll is successful, the pilots of both vessels make opposed Agility + Pilot Skill rolls. The vessel with the lower result becomes the new target of the missile. It is an AVERAGE (7) task to distract a missile with an unpiloted obstacle such as an asteroid or a derelict ship.

*Example:* At capital range, a Cylon raider has established a missile lock against Kat's Viper. Out-flying the missile is an EASY Complex Action. Since Kat has only one turn to shake the missile off, this is effectively a FORMIDABLE standard action. Because her chances of success are rather slim, Kat tries to trick the missile into pursuing a nearby raider. An action, but no roll is needed to close in on the sparrow. Kat's second action requires an Agility + Pilot Skill roll to avoid collision. She succeeds and both Kat and the

raider\* must make opposed Skill rolls. Since this is her third action, Kat is at -2 Skill step and rolls an 8. The raider's result, however, is a 10. The raider does not become the new target of the missile which collides with Kat's Viper and detonates.

### **Optional Rule: Point-Defence Weapons**

Many spacecraft have point-defence systems, shipboard weapon systems that consist of multiple rapid-fire medium-calibre guns, designed to destroy incoming missiles and enemy fighters at skirmish range.

If a vessel enters the point-defence system's range, its pilot must make a HEROIC (19) Agility + Pilot Skill roll to defend against the attack. If the roll fails, the vessel not only suffers Basic damage, but also the point-defence system's damage. Its damage die is increased by +1 step. If the pilot botched, damage is increased by +2 step.

*Example:* While pursuing a Cylon raider, Flat Top accidentally enters the point-defence kill zone around the *Galactica*. His Agility + Pilot Skill roll result is an 11. Initial damage is 4 Stun and 4 Wounds. The point-defence system's damage die is increased to d12+d2. Flat Top's Viper suffers 9 additional points of Wound damage. Since his fighter is severely damaged, Flat Top heaves to and makes off as fast as he can.

### **Optional Rules: Characters as Crew**

Result	Modifier
Botch (2)	-1 Skill step
Failure (3 – 10)	±0 Skill step
Success (11 – 17)	+1 Skill step
Extraordinary Success (18+)	+2 Skill step

Starship battles excite players only as long as their characters are directly involved. If every player has a Viper to pilot, all players can contribute to the outcome of the skirmish. When all the characters are aboard the same

Battlestar, however, not everyone can play a CO or a tactical officer. The experience turns rather dull when only one or two players are making all the decisions and rolling all the dice. When running starship battles, try to involve as many of the players as possible.

Battlestars have multiple stations, covering a full range of systems. These stations, and what can be done at them, are described below. Note that they aren't strictly necessary. All a Battlestar really needs is a pilot, if nobody else particularly wants to contribute.

Once per turn, the players may attempt a Skill roll that is characteristic of the PC's station. It is a HARD (11) feat to grant a Skill step bonus to a subsequent action. Usually, either the helm officer's Skill roll or the ship's Attack roll is increased. The actual Skill step modifier depends on the Skill roll's degree of success.

### **Commanding Officer and Executive Officer**

The commanding officer and the executive officer coordinate the various stations aboard the Battlestar, analyze the battle as it unfolds, and look for weaknesses in the enemy's ships and tactics. The CO and the XO can assist a particular crew member operating a ship's system.

Skill roll: *Willpower + Discipline / Leadership*

Note: The Skill step modifier applies to either the helm officer's Skill roll or the ship's Attack roll.

### **Tactical Officer**

The Tactical Officer is an officer stationed at the console that controls a ship's weaponry and DRADIS system. His job is to maintain weapon readiness along with executing firing solutions.

Skill roll: Ship's *Alertness* + PC's *Technical Engineering / DRADIS Operations*

Note: The Skill step modifier applies to both the helm officer's Skill roll and the ship's Attack roll.

## Helm Officer

The helmsman controls both the speed as well as the attitude of the ship and projects its course. He also determines a ship's position, velocity and direction in relationship to a course.

## Other Officers

Skill roll: Ship's *Agility* + PC's *Pilot / Large Spacecraft*  
Tactical Manoeuvring

Result	Attack roll Modifier
Botch (2)	-1 Skill step
Failure (3 – 10)	±0 Skill step
Success (11 – 17)	+1 Skill step
Extraordinary Success (18+)	+2 Skill step

A ship may either perform one attack manoeuvre or one defensive manoeuvres per turn. If a ship performs more than one attack or defensive manoeuvre, multiple action penalties apply to the rolls.

Attack manoeuvres or tactical patters are a sequence of movements and involve weapons targeting.

Result	Attack Roll Modifier
Botch (2)	-4 Skill step
Failure (3 – 10)	-2 Skill step
Success (11 – 17)	-1 Skill step
Extraordinary Success (18+)	±0 Skill step

Note: A ship that performs an attack manoeuvre is an EASY (3) target unless its *Agility* die is rolled as a free action to raise the attack Difficulty.

Evasive manoeuvres are employed by starship commanders to evade enemy weapons fire or capture. These movements are specified by predefined or on the spot course changes. The Skill roll's result is the attacker's Difficulty. Furthermore, all attacks made by the ship are penalized. The modifier depends on the helm officer's degree of success.

Those players whose characters are not directly involved in the battle should keep track of the damage suffered by the ship and make all the attack rolls although their characters don't have a system to operate.

Skill roll: Ship's *Agility* + Ship's *Heavy Weapons / Appropriate Specialty*

## Ship Weapons By Skygalleons

### Missiles

Are the primary long range weapons of the Colonial military and are the only weapons used by the Cylons. There are ten standard types of warheads: blast-explosive, cluster, decoy, EMP, fragmentation, jammer, kinetic, nuclear, pyrotechnic, or shaped charge. Kinetic, blast-explosive, cluster, fragmentation, and shaped charge do Wound damage. EMP do Stun damage, while jammers, decoys, pyrotechnic, and nuclear warheads have special effects.

**Kinetic:** Solid is the standard warhead and does the listed damage

**Shaped Charge:** Use a focused blast of heat to penetrate armour, allowing them to ignore 3W of armour, but doing one step less damage than a comparable sized warhead.

**Blast-Explosive:** These weapons add two steps of damage compared to an equal sized warhead, but armour is twice as effective and if the blast fails to do enough damage to penetrate the armour, then no damage is done. If fired at a target in space, the lack of an atmosphere prevents the two-step increase.

**Cluster:** Are extremely effective ground attack weapons used primarily against personnel or unarmoured targets, this warhead is ineffective against ships or armoured targets as they do no damage against armour. Against personnel, they do the listed damage in vehicle scale over an area forty times the size of the die rating in meters. Example: a 200 pound cluster missile warhead does d8W vehicle scale damage over a 320m x 320m area. If desperation requires firing this type of missile at an armoured target, armour rating is tripled and the warhead damage is reduced by two steps. If fired at an



unarmoured ship, treat the target as having an adjusted armour rating of 3W (do not triple).

**Decoy:** emit a fake signature to fool missiles and other ships. Decoys giving the firing ship an Opposed Roll of *Intelligence + Piloting / Sensors* or *Technical Engineering / Sensors* versus the same skills against the ship the decoy launcher is trying to fool.

**EMP:** Do Stun Damage.

**Fragmentation:** Are a dual purpose weapon used both offensively and defensively. In their offensive role they are effective against ground or unarmoured targets, but are largely ineffective against ships or armoured targets as, being primarily an anti-personnel weapon, they do no damage against armour. Against personnel, they do the listed damage in vehicle scale over an area twenty times the size of the die rating in meters. Example: a 200

pound fragmentation missile warhead does d8W vehicle scale damage over a 160m x 160m area. If firing this type of missile at an armoured target, armour rating is tripled and the warhead damage is reduced by two steps. If fired at an unarmoured ship, treat the target as having an adjusted armour rating of 3W (do not triple). In their defensive role these weapons scatter their payload in front of incoming projectiles to disrupt and destroy them giving the pilot a two-step bonus to skill when evading attacks for that Combat Turn.

**Jammer:** Flood an area with electronic and thermal noise to fool missiles and other ships. A Jammer gives the firing ship an Opposed Roll of *Intelligence + Piloting / Sensors* or *Technical Engineering / Sensors* versus the same skills against the ship the jammer is trying to fool.

**Pyrotechnic:** These warheads do no damage as they create coloured light to illuminate an area or for signalling purposes.

<b>Standard Missile Table</b>							
Weight	Kinetic	Shaped Charge	Blast-Exp in atmosphere	Blast-Exp in space	Frag/Cluster v. Personnel	Frag/Cluster v. Ship	EMP
10 Pound	0	0	d4W	0	0	0	0
20 Pound	d2W	0	d6W	d2W	d2W	0	d2S
50 Pound	d4W	d2W	d8W	d4W	d4W	0	d4S
100 Pound	d6W	d4W	d10W	d6W	d6W	d2W	d6S
200 Pound	d8W	d6W	d12W	d8W	d8W	d4W	d8S
500 Pound	d10W	d8W	d12+d2W	d10W	d10W	d6W	d10S
1000 Pound	d12W	d10W	d12+d4W	d12W	d12W	d8W	d12S

## ***Nuclear Warheads***

Weight	Yield	Nuclear: Space	Nuclear: Ground
50 Pound	50 Kiloton	d8W+d6S	d10W+d8S .125 mile radius
100 Pound	100 Kiloton	d10W+d8S	d12W+d10S .25 mile radius
200 Pound	500 Kiloton	d12W+d10S	d12+d2W+d12S .5 mile radius
500 Pound	1 Megaton	d12+d2W+d12S	d12+d4W+d12+d2S 1 mile radius
1000 Pound	5 Megaton	d12+d4W+d12+d2S	d12+d6W+d12+d4S 3 miles radius

**Nuclear:** The Colonial military and the Cylons have one additional warhead available: the Nuclear Payload. Firing one of these powerful weapons can only be done at the command of and with the concurrence of the Captain and First Officer. Nuclear warheads do a devastating combination of Wound and Stun damage to a space target, but are even more effective in an atmosphere due to blast damage.

## ***Mass Accelerator Weapons***

<i><b>Mass Accelerator Weapons</b></i>		
Weight	Kinetic	Explosive
10 Pound	0	d4W
20 Pound	d2W	d6W
50 Pound	d4W	d8W
100 Pound	d6W	d10W
200 Pound	d8W	d12W

**MAWs fire either explosive or Kinetic projectiles:**

- **Kinetic:** Solid is the standard round and does the listed damage
- **Explosive:** Add two steps of damage, but armour is twice as effective and if round fails to do enough damage to penetrate, then no damage is done.

