

ALBEDO

PLATINUM CATALYST

Anthropomorphic Science-Fiction Role-Play



1984  2004

TWENTIETH ANNIVERSARY EDITION

As they looked to the heavens, they wondered, just what kind of people were they?

It had been centuries since the peoples of Arras Charka learned that they had been abandoned by their Creators. But after colonizing dozens of worlds, they were no closer to solving the mystery of where they came from. As the ties that bind them are stretched thin, war erupts among the many planets, colonies, and space stations. The greatest threat rises from the Independent Lapine Republic, who declare themselves master of all races, waging a campaign of destruction and death against all that oppose them. As the Confederation quickly assembles its own Extra-planetary Defense Force, tensions rise, mistakes are made, and people live in fear, uncertainty, and doubt of what the future might bring ...

Albedo: Platinum Catalyst brings the drama of Steve Gallacci's long-running comic series to the stage of role-playing. Players take on both the roles of the commanding officers and their subordinates — the teams of bold infantry, quick pilots, quixotic explorers, and clever scientists — who must come to terms with their changing society as war threatens to tear it apart.

To play Albedo, you will need pencil and paper, and polyhedral dice (four-sided, six-sided, eight-sided, ten-sided, twelve-sided, and twenty-sided).

 **Sanguine Productions Ltd.**



"Either war is obsolete, or men are."

— Buckminster Fuller (1895-1983)

ALBEDO: PLATINUM CATALYST

ALBEDO: YIGZUNUN HAZAYZ

Sanguine Productions in association with Thoughts and Images present "Albedo: Platinum Catalyst"

Created by: Steve Gallacci

Written by: Pieter van Hiel

Game Design by: Jason Holmgren with Michael Arbogast

Additional Material by: Jason Holmgren, Pat Kelley, Adam Lindberg, Fred Stanton, James Stoneburner, Diana Wray

Illustrated by: Steve Gallacci with Jason Holmgren (pp. 3, 30, 70, 84, 111-114, 139, 140), Jordan Peacock (pp. 105, 139, 142, 161), Conrad Wong (p. 148)

Art Direction by: Jason Holmgren with Fred Stanton, Pieter van Hiel

Directed by: Jason Holmgren

Executively Produced by: Ted Wadsworth

Edited by: Fred Stanton with Adam Lindberg, Pat Kelley, Pieter van Hiel, Diana Wray

Thanks to: CPP, Inc., and Davies-Black Publishing, Gary Burke, Edwin Wendell Dean III, Peter "Drakkon" Drew, Patrick Emond, Major "Draco18s" Johnson, Alex Johnston, Chuan Lin, William Morris, Sara Palmer, Chad "Meeba" Paxton, Stephanie N. Raccoon, Jake "Imp of Doom" Shoemaker, Erin van Hiel, Steve Villing, L.H. White, Dusty Youngs, and all the folks on the Starclaw Mailing List and the Platinum Catalyst Mailing List

DEDICATION

ALBEDO HAZAYZ

For Elizabeth Joyce van Hiel. Dream of the Stars!

SANGUINE PRODUCTIONS LIMITED

ALBEDO HAZAYZ YIGZUNUN HAZAYZ

2692 Madison Road #279
Rookwood Pavilion, Suite N1
Cincinnati, OH, 45208
Sol III (Earth)

Telephone & Facsimile +1 312 803 1961

Official Platinum Catalyst website:
<http://www.sanguine.com/Albedo>

"Albedo," "Erma Felna," related characters and their likenesses ©1984, 2004 Steve Gallacci.
All other material ©2004 Sanguine Productions Limited. All rights reserved.

TABLE OF CONTENTS

7XNDUI PC HPN7EN7Z

Introduction	3	Basic Rules of Engagement	101
Cyclopedia	4	Playing a Role	101
Power Blocs	15	Dice Notation	102
Gazeteer	20	Basic Rolling	102
Short History of Colonization	20	Summary of Die Rolls	103
Core Worlds	20	Difficulty	103
Inner Worlds	24	Results of Rolls	104
Outer Worlds and Other Powers	30	Retries	104
Biology	32	Labor	105
Science and Technology	33	Command	106
Astronomy and Astronautics	34	Player-Character	106
Society and Social Institutions	46	Retinue	106
The Arts	52	Combat	107
Extrplanetary Defense Force	56	Beginning the Battle	107
Joint Chiefs of Staff	56	Attacking a Target	110
Surface Operations	58	Actions	110
Aerospace Operations	61	Effects of Attacks: Damage and Awe	116
Administration	65	Panic	119
Specialists	67	Special Circumstances	119
Making Characters	68	Armor	122
Main Character	68	Hand Weapons	122
Supporting Characters	70	Firearms	123
Attributes	72	Spot Rules	124
Rating	72	Atmosphere	124
Points	72	Distance	124
Damage	72	Gravity	126
Body	72	Property Damage	127
Clout	73	Size	128
Drive	73	Temperature	128
Species	74	Terrain	129
Birds	74	Unarmed Combat	129
Canines	75	Velocity	130
Felines	75	Visibility	130
Lapines	76	Weather	131
Marsupials	76	Aftermath	132
Monotremes	77	Rest Period	132
Mustelids	78	Recovery for Main Characters	132
Procyonines	79	Recovery for Supporting Characters	133
Rodents	79	Professional Help	133
Ungulates	80	Debriefing and Review	134
Ursines	80	Character Improvement	135
Vulpines	81	SPI and Promotions	135
Homeworlds	82	Equipment	136
Personality	85	Weapons of the EDF	137
Social Orientation	85	Weapons of the ILR	141
Experience Awareness	85	Clothing and Armor	142
Social Awareness	85	Other Gear	148
Action Orientation	85	Hosting a Game	154
Branches of Service	86	Narrative Elements	154
Administration	86	Social Elements	156
Aerospace	87	Gaming Elements	158
Specialists	87	Appendix 1: Variant Rules	159
Surface Ops	88	Appendix 2: Sample Characters	162
Skills	89	Sample Supporting Characters	162
Gifts	94	Sample Main Characters	163
Basic Gifts	94	Index	172
Group Gifts	96		
Advanced Gifts	96		
Dubious Gifts	99		

INTRODUCTION

UNZPBUHZUN

Albedo is a universe without a past. All sentient life sprang into conscious existence over the course of a few days, more than 250 years ago, complete with social infrastructure and advanced technology. The races of the *Albedo* universe were brought into being with inquisitive and analytical minds, as well as a powerful tool for research in the form of the Net. They have had a rational and scientific society from the start, and as such, they have no religion, no legends, no mysticism. They have nothing transcendent of themselves.

They cannot learn from the example of history, because everything they are doing is new. There are no guides to personal behavior, and no higher cause beyond the good of the community and species. Without any precedent they each must ask and answer for themselves the essential question, "What kind of people are we?"

For nearly 200 years, the structure left in place by the Creators served as an adequate social framework in which that question could be asked and answered. It was flexible enough to accommodate experimentation and the establishment of a number of very different socio-political models, and provide a structure in which each person could spend a lifetime in the pursuit of greater good or personal advancement. Interstellar communities, including the Interstellar Confederation, encompass billions of inhabitants living in peace and order. The system has endured civil debate and technological evolution for two centuries, and even weathered interstellar war and been the stronger for it. And yet, in a time of unprecedented peace and prosperity, cracks are beginning to appear.

Widespread civil strife and corporate greed have caused many to question the value of service to government and society. Ambition and the quest for personal power are replacing civic pride and the spirit of communal service. In particular, the systems which for so long served to preserve the civic rights and freedoms of citizens in the Confederation have been twisted to serve the

aims of ambitious individuals. Even the Net, the medium through which all information passes and the instrument of public record, has been altered so that history – public memory – has become mutable. In the face of this growing social crisis, old conflicts are being reawakened, and the Universe arms itself for war. In the past, victory was won through unprecedented levels of interstellar cooperation. Now, serious schisms threaten to tear apart governments at every level.

Players in the *Albedo* RPG take on the role of officers in the Extraterrestrial Defense Force (EDF), the one organization in known space that has the wherewithal and desire to hold everything together. Players will act to preserve order and the rule of law... and face a cancer that eats at the heart of their own chain of command. Their answers will influence the fate of worlds.



CYCLOPEDIA

ՀՄԻՎԿԵԼՆԱ

The Day the Universe Changed

More than 200 years ago, a question asked by an observant young feline boy on the planet Arras Charka triggered the dawning of history as we know it. As the planet descended into winter, the child worried that everything would freeze.

"Will it keep getting colder, papa?"

His father assured him that it would not... and then wondered how he knew this was so. What led him to this surety? He suddenly recalled previous years, and previous winters turning into springs. Why had he not remembered them before? The memory of passing seasons in turn sparked a recollection of a time when his son *did not exist*, of conception and birth.

Life until that point had been a haze of work and home routine that never extended more than a week into the past. The boy's simple question opened the door to an entirely new world, a world where all events had a cause and everything that existed had

been created. The question unlocked a new awareness of the past, and suggested that the future was mutable and uncertain.

This awareness spread throughout the cities and farms of Arras Charka, as though everyone were waking at once from a long and dreamless sleep. The recognition of the past and anticipation of the future inspired thousands of new questions. People realized that the mechanisms of culture and civilization were already in place – the farms and factories, cities, roads, and even social institutions that were needed to function as a society were there, and no one could recall a time when they did not exist. They became aware of the Net, a computerized personality that provided access to the aggregate total of all information. The Net was unable (or unwilling) to answer questions about its own origin, or account for the origin of the sentient races, but it provided a valuable library of technical information, and acted as a communications conduit that speeded the spread of self-awareness.

It was clear from the first that the culture that existed on the planet did not represent a natural state of affairs. Who built the machines? Why were there so many different species? Could their entire society, with all its attendant structures and technology, have arisen spontaneously from nothing? The idea seemed absurd. For a time, the question of origin dominated all public and private discourse. The debate answered nothing – and the denizens of Arras Charka collectively agreed to make the matter one of ongoing research by their scholars.

The Dream of the Stars

In the decades following the great awakening, these researchers came to the inescapable conclusion that the people of Arras Charka had an extra-solar origin. Their genetic structures were nothing like that of apparently native micro-organisms and plants that existed on the planet. Efficient cold-fusion technology had been in existence since the beginning; from there, it was easy to generate efficient propulsion

COMMAND REVIEW • ԴՐՈՒՄԱՆ ԻՆՏԵՐՎՅՈՒ

A Timeline of History, Part 1

- 52 "Great Awakening" – popular belief in the Creators

- 45 First unmanned probes to Arras Charka system.

- 39 First manned interplanetary exploration

- 27 Permanent orbiting space colonies are constructed around Arras Charka. Research into interstellar flight begins in earnest.

- 20 First resource and research colonies founded throughout Arras Charka system. Over next two decades, permanent colonies built throughout the system.

- 17 Jump Drive invented. First probes built, and extensive experimentation takes place. Waves of interstellar probes return information about surrounding systems. First manned flights to neighboring stars take place.

- Zero First voyage of the UH4, the first fully operational manned exploration ship. Start of the standard dating system.

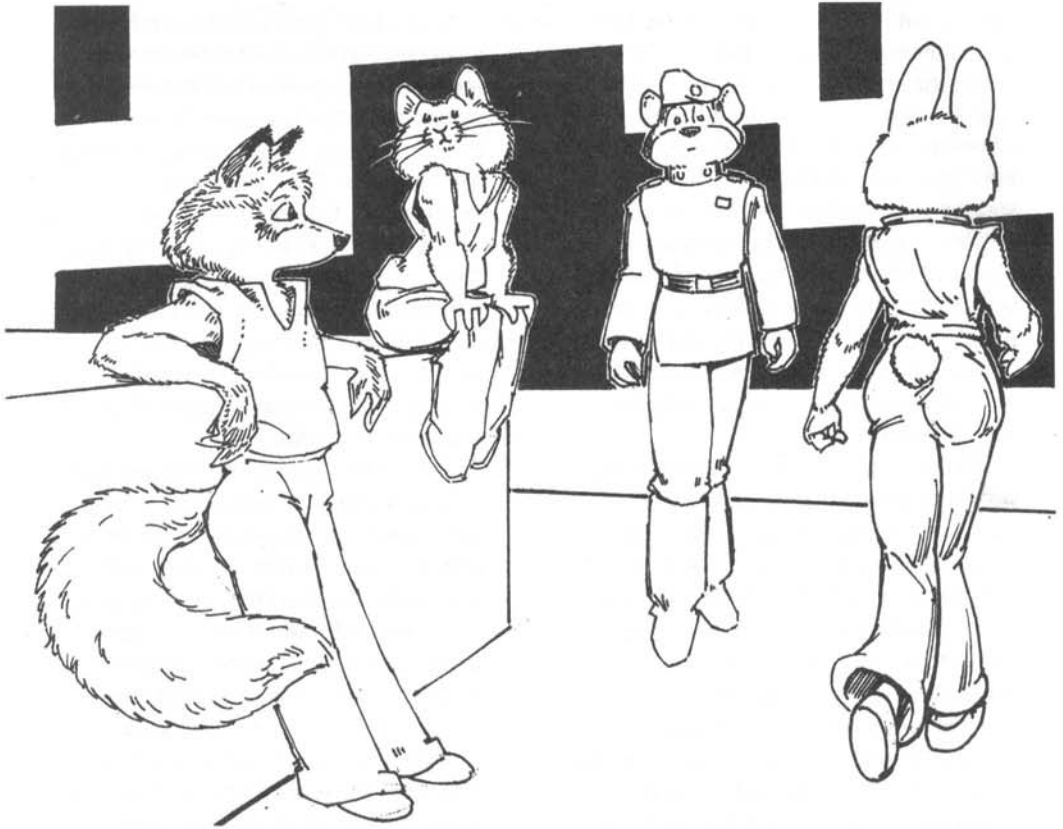

systems, making expeditions to other worlds in the same system relatively easy. These did not uncover life of any kind. If the answer existed, it lay among the stars. Research into a form of faster-than-light travel began in earnest.

There were other more practical reasons to develop this technology. Disagreements were arising over the nature of governance. Arras Charka had been apparently designed as a socialist government, with a multitude of government branches that reached into almost every part of life and commerce.

About this time, scientists exploring the archives of the Net discovered that the secret of interstellar travel had been on record all along. After many years of research and development, scientists finally perfected the keystone of interstellar travel: *the jump drive*. This drive allowed a vessel to jump instantaneously from one system to another. It was as though the secret of Jump drives had been deliberately hidden in plain sight, waiting for a time when society was organized enough to find and link the elements together. Within

two years, automated field tests were conducted. Soon after, the first manned jump was undertaken successfully.

The Jump process was very reliable, but risks did present themselves. A poorly set Jump can result in the outright destruction of the ship and crew, or expose them to powerful ionizing radiation. Early Jump drives were also found to cause genetic damage over multiple Jumps – modern drives may do this as well, but effective rules governing Jumps have been developed to limit damage.

Once Jump drives had been established as a safe means of transport, hundreds of interstellar probes were constructed and dispatched to nearby systems. These robotic probes brought back clear and exciting evidence of potentially-habitable worlds in several neighboring systems. The news prompted the creation of manned exploration missions, with the goal of scouting out sites for new colonies and locating evidence of the Creators. The first exploration ship was known simply as the UH4 – the current system of dating used in

the ConFed is based on the date the UH4 was launched, 195 years ago.

On the second voyage of the UH4, in year 4, the crew discovered a potential colony world in the Chalendar system, 30 light years from Arras Prime. Orbital surveys showed Chalendar V to be an excellent prospect for colonization. The planet was home to a number of plant species, but the native biology was compatible with that of the future colonists, and native plants were well-established enough to not be overrun by transplanted crops or animals.

Chalendar V, now renamed Aerandar, was identified as the future site of the first extra-solar colony. The government of Arras Charka took the colonization project very seriously, and took great care in the construction of a colony vessel and selection of volunteers for off-world emigration. It was 16 years before a manned vessel returned to Aerandar.

In the intervening years, crews were sent out in all directions, and spent months surveying hundreds of systems and thousands of worlds. Great care was taken to avoid contaminating the alien biospheres, and in this first round of exploration, no explorers set foot on the worlds they

surveyed. Later teams used powerful bio-analyzers that could examine entire gene sequences and determine if there were any risks to potential habitation. No evidence of the Creators was found, and no creatures more advanced than a few species of invertebrates, fish, and plants – life with no genetic similarities to the people of Arras Charka. Still, the explorers had found rich, lush worlds, immediately ready for colonization. If the Aerandar settlement was successful, the government intended to proceed with colonization plans for an additional 14 worlds.

Early in the year 20, the first manned landing on Aerandar took place. Work crews spent months building permanent structures to house the first colonists, and provide them with all the essentials of a vital community. When the colonists arrived, they would find finished towns waiting for them, complete with power stations, farms, commercial zones, and a spaceport. Along with the work crews came environmental study teams, scientists and specialists who spent the better part of a decade examining the long-term effects of Aerandar's environment on its inhabitants.

Finally, after years of careful preparation, 12,000 colonist volunteers were dispatched to Aerandar and founded nine settlement sites in the year 28. They brought with them all the expertise, tools and materials needed for production, as well as gene-management tools to ensure a healthy range of genetic diversity for future colonists. The Aerandar colony was to be self-sufficient from the start.

The Aerandarian colonists adopted the socialist-democracy style of governance in place on Arras Charka, but remained very much under the direction of the central authority on the home world for the first several years. However, the time-delay involved in sending messages back and forth to Arras Charka meant that many decisions were dealt with locally. As the colonists were all well-trained and dedicated professionals, legislative and practical questions were debated with an air of clinical introspection and detached analysis. Decisions were made that suited the long-term needs of the greatest number of inhabitants,

COMMAND REVIEW • АҒНАМДЫҢ НЕГІЗІ

A Timeline of History, Part 2

- 4 On its second voyage, the UH4 identifies Chalendar V (renamed Aerandar) as an ideal site for colonization.

- 20 First manned landing on Aerandar. Permanent colony facilities are constructed by temporary work crews that later vacate the planet.

- 28 Twelve thousand colonists arrive on Aerandar.

- 28-58 First wave of colonization. Core Worlds are settled. First armed forces are created.

- 50 Aerandar declares independence from Arras Charka. Other colonies follow.

- 95-110 Second wave of colonization. Hundreds of new colonies are settled.

- 102 Foundation of the Independent Lapine Republic (ILR).

- 130-170 Third wave of colonization. While colonization continues to this day, it is no longer conducted at such expense.

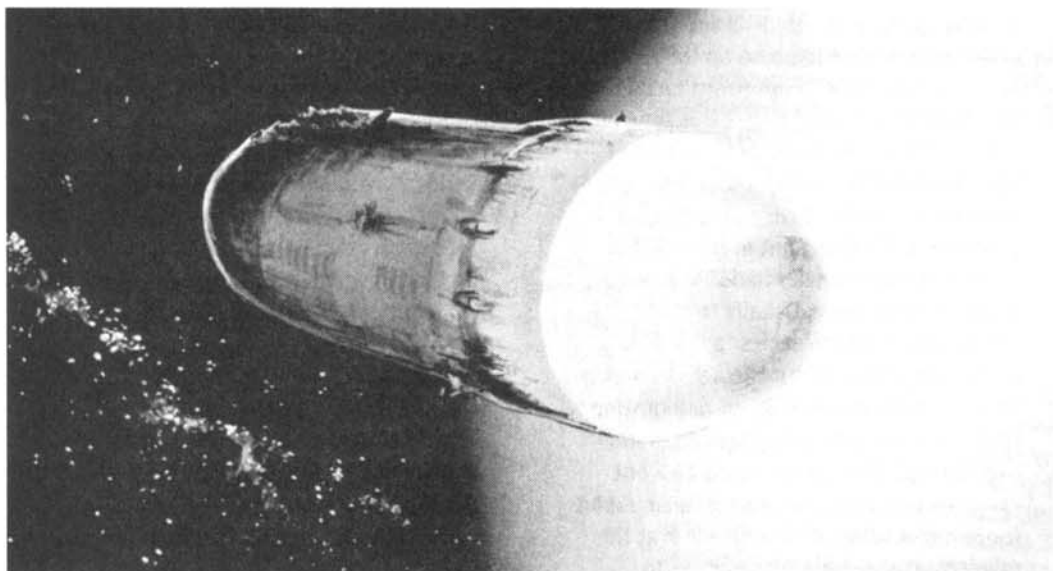

rather than vocal minorities. Civil debates took place continuously, and rather than causing division, contributed to an ongoing sense of consensus and larger community.

Aerandar was quickly judged an unqualified success, and the government opened the door to enormous new colonization program. Over the next thirty years, 14 new colonies were founded by thousands of carefully chosen volunteers. In the year 50, Aerandar declared its independence from Arras Charka, an amicable separation which had been planned from day one. As each colony became firmly established, it opened its spaceports to new immigrants and trade. Arras Charka and its 15 colonies became a kind of loose stellar confederation, unified by their socio-political outlooks and common history. These worlds are known today as the *Core Worlds*.

Another unifying factor was the presence of the Net. Wherever the colonists went, they brought the Net with them. It seemed to be inherent in the production of any piece of computerized or communication hardware, and capable of spreading itself through the space lanes via message torpedoes and shipboard computers. The Net seemed to be an unavoidable part of space travel.

The colonization efforts did not curtail ongoing exploration, and it quickly became clear that a significant proportion of systems within range of Arras Charka were home to life-bearing worlds. Indeed, the

proportion of terrestrial worlds was much higher than seemed reasonable, suggesting that the Creators had been very deliberate in their placement. Yet, no matter how far the scout ships ranged, they could find no sign of the Creators, and found no life forms with a genetic link to the sentient races.

The Second Wave

As the budding interstellar society matured, new theoretical systems of politics and commerce were developed. Arras Charka had been apparently designed as a socialist government, with a multitude of government branches that reached into almost every part of life and commerce. While the government was enlightened and liberal, many chafed at this level of interference and wished to found new societies, based on capitalistic markets or new systems of government. Charismatic thinkers attracted groups of like-minded followers, and clamored for change.

The obvious solution was to allow the foundation of new colonies. The original settlements had generated a wealth of information on the successful establishment of off-world communities, information that was freely available on the Net. The government on Arras Charka volunteered to co-sponsor those colonies that agreed in advance to trade ties, and whose intended philosophy of government was not dramatically at odds with that of the Core Worlds. A

number of business interests and philosophical groups took them up on this.

On a darker note, significant racial division also began to appear at this time. While some of the original colonies had been founded by single species, this was done purely on the basis of biological practicality. By this point in history individuals of every species had developed a sense of racial pride. Usually this was limited to a kind of species "patriotism" that expressed pride for the achievements of one's own species without denigrating that of others, similar perhaps to "hometown pride." Unfortunately, some went much further than this. One notable rabbit leader went so far as to suggest that the rabbit race was naturally superior to others, and were entitled by birth to the choice of resources. This heady philosophy attracted a number of followers, who undertook colonization plans of their own.

The second wave of colonization began in earnest about 90 years ago. The new outward expansion was characterized not only by the incredibly diverse nature of the colonists, but also by the single hope that was common to them all. Each group hoped to found a paradise, worlds where they would be free to achieve all their dreams - whether that personal paradise was one of racial purity, capitalist exploitation, communal introspection, or simply one of absolute liberty from any form of government.

It was at this time that the rabbit colonies of Hiahhoch and Baliannian were founded, at what was then the edge of settled space. From the start, the inhabitants adopted a powerfully racist attitude towards their neighbors. However, they seemed uninterested in exporting their particular philosophy to other worlds, and as such their attitude was tolerated. The founders declared the colonies an independent republic, and negotiated trade deals with nearby systems and the Core Worlds.

For a period of 30 years, special-interest groups, businesses, and even family groups began a pell-mell expansion into space. Old colony ships from the first wave were pressed into service, along with nearly every FTL capable ship available, no matter how

small. More than 50 colonies were founded in this second wave, ranging from tiny freeholds that served as home to a few dozen people, to million-strong colonies that quickly matched the smaller Core Worlds in productivity. These worlds are known collectively as the *Inner Worlds*.

Planetary governments on the Inner Worlds vary wildly, ranging from corporation owned systems like Enchawah to hereditary monarchies like Kawateena. Inner World governments are often much more hands off than the Core Worlds. Capitalist interests are very strong on most of them, and several successfully combine capitalism and socialism.

The Inner Worlds have developed very strong social identities in the years since their foundation, and this patriotism has led to widespread resentment of Core World "meddling," and infrequent trade wars between neighboring systems.

The Third Wave

A wave of tertiary colonization started about 50 years ago as the Inner World colonies matured and began to create colonies themselves. These colonies are collectively known as the *Outer Worlds*, and most are several months of travel away from the Core Worlds. Hundreds of Outer World colonies exist, and colonization efforts continue into the present day. The older Outer Worlds are fairly well-settled, and many are on the verge of sponsoring colonies of their own. These well-settled worlds are almost entirely self-sufficient. The inhabitants, who are often first generation, tend to be much more independent and self-reliant than the citizens of the Inner and Core Worlds. Planetary governments exist largely to maintain basic infrastructure, and the residents may even resent the existence of police forces. This is of course a generalization - some Outer Worlds are closely patterned after the paternal socialist states of the Core Worlds.

Newer Outer Worlds tend to be resource colonies, such as mining operations, or research stations. They are sparsely populated, rarely home to more than a few hundred inhabitants. Some small colonies may not have any permanent residents at

all. Perhaps the most remote and isolated colonies are the asteroid mining platforms on the rim of known space. These mostly automated space stations may have crews as small as three – the only living creatures for several light years.

All resource colonies rely on support from a corporate, scientific, or government sponsor to remain in operation. However, smaller colonies may only require supply on annual basis, meaning that the inhabitants may be very behind on current events, as well as extremely lonely.



War in Space

Violence of some sort has been a part of society almost since the Awakening. Verbal arguments took place within hours, and some boiled over into brief physical confrontations. Still, among the first and second generation, violent acts were the exception. Serious crimes such as murder were events that attracted planet-wide attention, and were limited to unthinking "crimes of passion," or acts committed by those few citizens with untreated mental disorders.

From the first day, an infrastructure for a basic policing and civil security service was in place, and this model was copied for the first colonies. In the beginning these forces were more akin to a highly organized "neighborhood watch" than an armed security force. They attempted to defuse tense situations through diplomacy, or contain conflicts and pick up the pieces afterwards. They had no weapons at all at

first, though it was not long before the need for some form of restraining and subdual devices became obvious. Advanced simulations on the Net were able to generate computer models of multi-species handcuffs and non-lethal weapons that could reliably incapacitate a target.

For the most part, these early police forces dealt with individual criminals and lunatics. Large scale operations were almost unknown. Rarely, a riot involving a few dozen citizens would break out, or a family dispute would spiral out of control and end in confrontation. The early police services were largely able to handle these disputes, or at least keep them contained until they burned out on their own.

As the colonies grew, clashes between different communities took place over resources or land claims. Remote colonies found themselves preyed upon by bandits, some of whom were driven to raiding when their own colonies failed. Perhaps the most notorious example is the "Karantok Tigers," a group of would-be miners who arrived at their new world to find the company that had employed them had financially collapsed. They were left with nothing, and no means of return.

The tigers, and a number of other would-be miners, were understandably upset at this mistreatment. Their discontent simmered the more they discussed the matter. They'd been fooled, conned by an impersonal, faceless entity. Most had never fended for themselves before, used to the support of their socialist home worlds. If this was what the universe outside the Core Worlds was like, well, they would have to adapt to survive. If the law of the universe was "rob or be robbed," then they knew which side of the equation they wanted to be on.

The miners hiked to the nearest community and demanded food and shelter. When they were refused, they became angry, and used intimidation and violence to gain what they needed. They stole food and transport, and moved on to the next community, with the vague intention of seeking vengeance against the employers who'd abandoned them. The violence and intimidation contin-

ued in the next settlement, and again the tigers moved on.

By this time, word of the situation had spread to the main population centers on Chenta, and civil security forces intercepted the group. A prolonged and bloody siege of the community ended with dozens of casualties on both sides. The news spread like wildfire throughout space, and rumors of atrocities were given credence by the fledgling news media services. These rumors were untrue, but served to foster an atmosphere of paranoia in many small colonies, and led to the development of deadlier weapons. The apparent example set by the miners also led to the foundation of a number of genuine raider groups.

Volunteer militias were formed to defend against incursions along the lines of the Karantok Tigers – the first military units ever formed in known space. As they saw service against raiders, theories of strategy and tactics were developed, as well as weapons technology. The races of the *Albedo* universe learned the art of ground war quickly and soon began to develop the skills needed to project their military might into orbit and to other worlds. In this way, colonies could pursue raiders to any hiding place, and provide defense for new colonies. These extraplanetary military operations were quite small by current standards – rarely more than a few platoons of troops or a squadron of small patrol ships – but they laid a conceptual foundation for what was to come.

COMMAND REVIEW • ΠΥΝΑΝΔ ΝΕΓΕΥΡ

A Timeline of History, Part 3

164	The Independent Lapine Republic (ILR) begins aggressive expansion, often employing military force.
165	Foundation of the Interstellar Confederation (ConFed) on Arras Charka.
167	ConFed military formalized as the Extraplanetary Defense Force (EDF). Armed conflict with the ILR begins immediately.
175	ILR sues for peace. Period of watchful peace and containment begins.
180-194	Growing dissatisfaction in the Confederation's policies. Rise of Enchawah Group.
195	ILR begins second aggressive campaign, as detailed in <i>Albedo #1</i> .

About thirty years ago, the ruling clans of the *Independent Lapine Republic* found themselves facing a crisis. The ongoing waves of colonization had enveloped them, and confined their holdings to a small bubble of space containing a handful of systems, few of which were suitable for extensive colonization. The demands of their consumer populations were swiftly outstripping production, and public dissatisfaction with the corrupt democracy threatened to unseat the powerful clans of founding families that controlled the planetary congress.

The ruling clans looked at the rich colonies that surrounded them, and saw they were almost undefended – they were too large for bandits to raid, and their governments saw little need for militias. The clans, working closely with militia leaders and industry, formulated a plan of action. They would create the first space-going army, and use it to take the neighboring Inner Worlds by force. The plan needed no justification beyond the obvious superiority and greater need of the rabbit race. The lesser species would simply have to learn to give the ILR what it deserved by right of race, or be swept away.

For the next decade, the ILR undertook to arm and train an enormous army of conquest. The ancient colonial ships that still drifted in orbit were reconfigured to serve as FTL troop transports, and enormous new vessels incorporating space-borne factories and extensive weapon systems were constructed. Word of this massive arms build-up did reach the Core Worlds, where it caused surprisingly little concern aside from a few official objections. The ILR explanation was that of internal security, an adequate explanation for most. Some systems immediately neighboring the ILR made small efforts to increase their space security forces, but no large scale defenses were prepared.

No one anticipated the savagery and swiftness of the ILR attacks that were launched thirty-one years ago. Five Inner Worlds were attacked almost simultaneously. ILR ships jumped into each system and fired dozens of rapidly accelerating torpedoes, precisely targeted at key facilities

such as militia barracks and spaceports. Two colonies simply surrendered after this initial attack. When the invading ships reached orbit and unleashed the ILR ground forces, the others swiftly fell. The invaders immediately began digging in and preparing powerful new defenses against counter-attacks. Word of the invasion – and conquests – filtered slowly through the other colonies, and with the news came panic. It was months before the news reached the Core Worlds, and in that time more colonies had fallen.

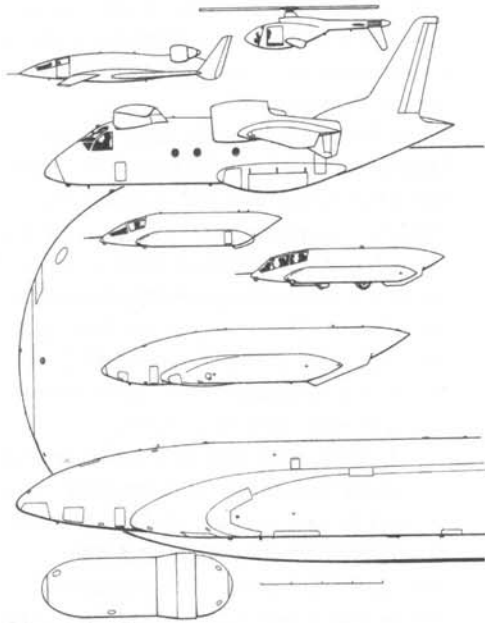

ConFed goes to war

The colonies were simply unequipped to deal with space-borne assaults of this scale. Local governments scrambled to develop aerospace defenses, but these rarely proved effective. As each colony fell, the ILR came one step closer to the Core Worlds. An emergency congress of Core World governments was held on Arras Charka, with the goal of developing effective weapons and coordinating a unified defense. With unprecedented speed, this congress agreed to the formation of political and military union, the Interstellar Confederation (ConFed). Industries were rapidly retooled to produce arms, and the small space-going security fleets fielded by each Core World were folded into a single navy.

The fledgling ConFed military was soon put into action in a series of scouting raids

against what were thought to be the most lightly defended of the occupied colonies. These raids proved fairly successful, but the first real confrontation of the war in the Tun Och Enchek system was a disaster for the ConFed. The attack was intended to liberate the colony and establish a mustering base closer to ILR space. Ground-based missiles destroyed every ConFed ship in the task-force as they decelerated into the system. This disaster prompted the development of artificially intelligent Autonomous Combat Vehicles (ACVs), cheap robot drones that could move to intercept missiles and enemy craft, destroying them on impact. They could also be used to test system defenses and scout planets without risking a manned vessel.

ConFed also formalized the ad hoc military alliance they'd formed in the first days of the war, coordinating surface defense and aerospace forces under the umbrella of a new body, the Extraterrestrial Defense Force (EDF). The EDF provided the ConFed with a quick way to respond to threats without sacrificing the defense of individual colonies or spending precious time sorting out command issues when forces from multiple worlds were involved.

Slowly, and at great cost, ConFed learned how to fight a war in space.

The ILR were also learning and adapting, and did so faster than the ConFed. However, they quickly reached the limit of their expansion. While they enjoyed unprecedented levels of production and prosperity, the conquered colonies required large garrisons to keep under control. Their initial edge – numerical superiority – was blunted by this requirement. Resistance groups and saboteurs appeared almost overnight, and seemed to require more and more manpower to keep under control. The Republic built work camps and special prison colonies for those who fought their occupation – or simply executed dissenters. Particularly upsetting to the Republic was the lack of cooperation on the part of rabbits living in the conquered worlds. Most did not seem to realize that the republic was fighting on behalf of their race, and some went so far as to actively resist. These rebels faced especially harsh punishments when caught.

After six years of inconclusive engagements and bloody failed invasions, the tide of war finally began to turn in favor of ConFed. The combined production capability of the Core Worlds easily surpassed that of the ILR, and as new, powerful warships went into service, the Republican forces began to crumble... but victory would not be bought cheaply.

Atrocities at War's End

As time went on, it became clear to even the most hawkish ILR general that the EDF advance was unstoppable, backed as it was by the staggering production capability of ConFed. However, they were unwilling to admit defeat, or sue for peace. They reasoned that if they could make the EDF advance extremely costly, they might force ConFed to ask for a peace treaty before liberating all the ILR occupied territories.

To that end, the ILR changed their defensive tactics. They began to use civilian hostages as living shields in sensitive areas, forcing EDF liberators to attack them at the risk of killing hundreds of innocents. If a system seemed indefensible, ILR would deliberately raze homes, factories, and farms in order to deny resources to the liberators, and force them to tie up troops in rebuilding efforts. When EDF troops landed, they discovered looted, smoking ruins, with the local population on the verge of starvation – and sometimes, they discovered even worse. Most appalling was the evidence of organized, racially motivated mass murders.

From the very first days of the war, the

ILR had been busily wooing rabbits on the occupied worlds over to their racist philosophy. These attempts had limited success, though most rabbits paid lip service to ILR ideals simply to avoid confrontation with their new rulers. In time, the ILR began to demand more and more from the rabbits on the occupied worlds in the name of racial solidarity. Rabbit children were taken from their families and given ideological and military training on the ILR home worlds. Parents who resisted were identified as race traitors, and placed in brutal "re-education camps" in remote areas. Outspoken rabbits, who had previously been tolerated or placed under house arrest, now were simply executed on the spot.

As the ILR position in a given system became untenable, commandants of the re-education camps were given orders to execute their prisoners en masse – an action taken for practical reasons, it was claimed. It would not be logical or desirable to evacuate them to ILR space or return them into the population of their home world. EDF forces sent to liberate these camps found few survivors – and mass graves.

ILR desperation also led them to develop reprehensible new interrogation techniques in order to gain as much intelligence from prisoners as possible. While both sides sometimes used rough interrogation techniques with prisoners, in the last days of the war torture became a science for the ILR. Few EDF officers who fell into enemy hands escaped unscathed, and those that did often bore crippling psychological scars. The racist



path of ILR philosophy had finally come to its insane and inevitable final destination – lives and happiness were meaningless in the face of racial solidarity.

EDF commanders were at a loss when it came to these brutal methods. Was it better to pursue final victory in the knowledge that it would cost hundreds of thousands of needless deaths, or sue for peace and leave millions living in misery? Their troops were also faced with unpleasant moral dilemmas. EDF soldiers were trained to use the minimum amount of force require to subdue a target, and to act dispassionately and logically on the battlefield. As the atrocities mounted, they found it difficult to maintain a facade of detached war-craft. EDF forces in the field undertook bloody reprisals against ILR captives, sometimes ignoring surrenders.

This new ruthless outlook spread into the upper echelons of EDF command as they realized just how far the ILR was willing to go to ensure that any ConFed victory would be a hollow one. A new battle strategy was developed, and EDF forces were now called upon to do whatever it took to knock out the ILR's ability to wage war or defend. If this meant the wholesale destruction of civilian targets – so be it. EDF spaceships battered ILR worlds from the edge of their solar systems, launching barrage after barrage of ACVs at factories, farms, power and water facilities, civilian communication centers, roadways, and spaceports. ILR ships launched to counter these invasions faced crippling waves of ACVs set to intercept and impact them.

When surface defenses stopped responding, EDF troops were dispatched to the surface to secure what was left. Even then, they often found determined ILR survivors willing to fight to the death over rubble. ILR recruits at this point in the war had been trained to engage in suicidal attacks that claimed as many lives as possible.

Once the Republic realized that the EDF was ready and willing to carry on indefinite bombardments of their home worlds, they finally decided to sue for peace. The treaty was negotiated in a matter of weeks, and granted surprisingly liberal terms to the ILR. The Republic agreed to withdraw their claims

to almost every world they'd invaded – but were permitted to hold on to a number of key resource colonies and occupied systems with large rabbit populations. Both sides considered the deal a victory.

It is impossible to precisely know the number of people who were killed during the ten-year conflict, but it is certainly in the tens of millions. Most of those who died were civilians.

Watchful Peace

The Republic and Confederation quickly switched their efforts to reconstruction of colonies that had been savaged during the final months of the war. ConFed reconstruction crews were surprised to find a significant amount of antipathy towards the liberators -- particularly on those worlds which had been heavily bombed in the EDF counterattack. This antipathy occasionally boiled over into armed attacks against aid workers, but these attacks, and the feeling of betrayal behind them, diminished as more assistance arrived. However, it has never entirely vanished, and memories of the war often contribute to anti-ConFed sentiment in the Outer Worlds.

The Republic has never admitted defeat to its citizens. It paints the war as a deliberate attempt to force concessions from the other colonies, and taken from that perspective the war may be seen as a success. While most accept this version of events, the sheer cost of the war in terms of lives could not be hidden. Rare is the family who did not lose at least one member in the conflict.

After a few years, limited trade relations between the Republic and Confederation were renewed, and the borders were opened to infrequent passenger traffic – mostly businessmen.

Growing Problems

In the aftermath of the war, ConFed found itself by far the largest single political entity in space, with a crushingly powerful military arm. The leaders of ConFed decided to expand the role of the organization to suit peace-time operations. ConFed was re-engineered as an economic alliance between equal partners, and a powerful peacekeeping force. Member states were given



representation in a grand legislature that hammered out trade deals and local treaties. The EDF, now somewhat reduced from wartime strength, was assigned to watch the borders and patrol the space lanes.

Though the ideals of the post-war ConFed politicians were noble, problems began to appear almost immediately. Initial enthusiasm on the part of individual system governments gave way to wariness, and the fear that the powers of local governments would be superseded by the ConFed.

In the year 179 a mining rights dispute arose between the planets Ish-Tako and Zan-Cha in the Ahan-Tako system. The two planets were on the brink of a shooting war when the EDF intervened, and unilaterally claimed the disputed mining zone as ConFed property. It would be developed jointly, and the profits distributed to the ConFed coffers. The impromptu decision was supported by the majority in the ConFed parliament, who believed it to be preferable to loss of life.

The representatives from Ish-Tako and Zan-Cha (who days before had been bitter enemies) were united in their protests. They called the move an act of state-sponsored terrorism, outright theft from the people of their system. They threatened to withdraw from the ConFed, and only skilled diplomacy prevented this break. Even so, the governments of Ish-Tako and Zan-Cha moved to restrict ConFed movement into the system, and severely limited the EDF presence.

As the years passed, many members of ConFed found they increasingly disagreed with the majority decisions of the collective

body. Political groups, active across multiple planetary systems, claimed that the ConFed membership simply locked them into unthinking rule of majority. The population of the Core Worlds is almost equal to that of the rest of Known Space, and since ConFed representation is based on population, the original colonies have an inordinate amount of influence over interstellar policies. Representatives from the Core Worlds, or representatives who supported Core World policies were dubbed *Centrists*, and it was not long before this term acquired a pejorative taint. For their part, Core World representatives argued (and still argue) that their level of representation was fair, reflecting as it does the fact that they contribute most to the EDF.

As the decades passed, the ConFed parliament found itself splintered along lines of stellar cartography and of ideology. Unofficial political alliances and coalitions were formed and reformed, and the process of government itself was largely passed on to the waiting hands of an ever-growing bureaucracy. Citizens on Inner and Outer World systems clamored for change, and in time they elected governments willing to scrap the idea of ConFed and the EDF entirely. By the year 190, some systems had left the ConFed, and many more systems had active political groups lobbying for separation. Corporate interests, inspired by the success of the Enchawah Group, maneuvered to fill the gap, sometimes funding revolutionary groups. Civil unrest, once an event rare enough to

attract interstellar attention, became a daily occurrence on some worlds.

A New Conflict

The ILR watched these new tensions with interest. Their own domestic situation was becoming untenable. Resources were becoming scarce, and the Republic was finding that it could not maintain a rabid consumer culture as well as a powerful military. The specter of mass unemployment was on the near horizon. The entrenched powers in the Republican Congress, corporate clans and military officers for the most part, began to seriously consider the prospect of a round of militaristic expansion.

This time, however, they would not be drawn into a direct conflict with the EDF. Open invasion would simply unify the worlds once more. Instead, they would take advantage of the unrest outside their borders. A plan of action was devised that would throw the ConFed off balance, and splinter it. A new form of warfare was proposed.

The Republic never ceased arming itself after the first war. They have fielded millions of soldiers and pilots. In recent months, the ILR's military scientists have made breakthrough advances in the development of new terror weapons. The Republic is ready – as ready as it will ever be – for a new war with the ConFed. The leaders have learned the lesson of the first war. They cannot hope to survive a head-to-head confrontation with the ConFed worlds. Instead, they intend to covertly support growing instability on the Inner Worlds, tie up EDF resources with lightning feints against lightly defended ConFed targets, and use their new weapons against the Core Worlds themselves. The Republic is fighting a war of terror, one that ConFed may not be able to defend against.

In the year 195, nearly twenty years after the treaty that ended the first war, the ILR struck the first blow in their new war. Under the guise of civilian shipping traffic, the Republic was able to smuggle an entire mobile infantry battalion onto the planet Derzon. Without warning, cargo ships on the landing strips of the Derzon spaceport opened their bays to reveal armored troop

carriers and light tanks. Within hours, they had overcome the lightly armed militia and security forces, and destroyed the EDF headquarters. The EDF response was swift. More than 7000 EDF personnel took part in the liberation of Derzon – a bloody mopping up that cost thousands of civilian lives.

The ILR refused to accept responsibility for the attack on Derzon, blaming rogue elements within its armed forces. The EDF is unsure what to make of this explanation, but believes the ILR is planning a major strike, using several small operations like the Derzon invasion to spread the EDF thin. The Republic correctly surmised that the costly liberation would be a factor that further polarized the worlds of the ConFed. Systems that were skeptical of the ConFed to begin with saw it as justification to leave. Loyal systems closed in on themselves, and handed more power over to the EDF – a body that itself was beginning to show the effects of slowly creeping corruption. Shortly after the Derzon invasion, a grisly attack on mining colonies in a distant Outer World further inflamed public opinion, with some crying that it was a deliberate attack by the ConFed itself to scare wavering members into loyalty.

This is the universe you have entered into – a universe of polarized opinions, conspiracies, random terrorism, and rumors of war. In *Albedo: Platinum Catalyst* you have taken on the role of military officers dedicated to preserving the rule of law, and the rights of sentient life. Your task is similar to that of a firefighter, faced with a thousand rapidly spreading brushfires – as one is put out, more spring up.

Welcome to the universe of *Albedo*.

Power Blocs

Inhabited space comprises a roughly spherical collection of stars, approximately 400 light years in diameter. Tens of thousands of star systems are located within this sphere, hundreds of which contain inhabitable worlds. ConFed astronomers and explorers believe this section of space is unusually rich in life-bearing worlds, which supports the idea of deliberate placement by a Creator race. Almost every system has been explored quite thoroughly by ConFed,

and even systems without inhabitable worlds are often home to resource or research colonies.

Known space is divided into layers, rather like an enormous onion. Each layer represents another wave of colonization. At the center of space are the dozen or so original colonies, contained within a sphere 40 light years across. These worlds are the oldest and generally most populous of the inhabited systems, though the ILR home worlds now match them in terms of population. The Core Worlds are all members of the Interstellar Confederation.

Surrounding the Core Worlds is a rather less defined layer of secondary colonies (the Inner Worlds), including the Independent Lapine Republic and the primary worlds of the Enchawah Group. This layer is perhaps 100 light years in diameter, with "arms" extending out further towards the fringe of known space. Most of the worlds in this layer are aligned in some way with the ConFed, particularly those nearest ILR space. The secondary layer actually envelops the ILR sphere of influence, so ConFed systems may be found on all sides of the Republic. ILR policy makers are painfully aware of this fact.

The rest of space is occupied by the Outer Worlds, which range from well-settled tertiary colonies, to windswept frontier villages at the extreme edge of the explored universe. While jump ships are capable of exploring beyond the current sphere, the further afield they trek, the more slowly expansion takes place. Partly, this is simply because they are dealing with an ever

growing area. Mostly, however, it is a simply matter of infrastructure. There are no ports or stations in place to refuel ships that jump beyond the edge of explored space, and with the current state of uncertainty, expansion of the infrastructure is likely to be slow in coming.

The Confederation and EDF

The Confederation (or ConFed) is the single largest political body in existence. All 12 Core Worlds are full members of the Confederation, as are several of the Inner and Outer Worlds. Many others are closely associated through trade and limited military alliances.

The Confederation was formed thirty years ago in response to an invasion by the Independent Lapine Republic (see below), an aggressive and expansionist union of systems dominated by rabbits. The Confederation actually came into being during the period of warfare, as the Core Worlds hastily organized a unified defense. The ad-hoc alliance was successful, and the ILR was forced to give up most of those systems it had conquered.

Full Confederation members have signed a mutual defense pact, and promise to come to the aid of any member state that is attacked. This defense pact extends to internal threats as well, if they are considered dangerous enough. Military assistance is normally provided through the agency of the Extraplanetary Defense Force (EDF).

ConFed headquarters is located in the Arras Charka system, and there are offices on nearly every well-settled world. Field offices range from enormous administra-

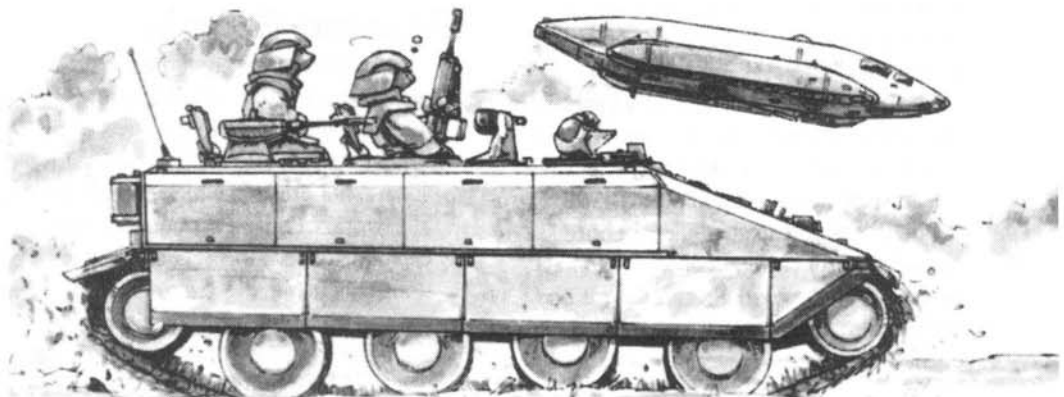

tive complexes to simple store-fronts housing a single ambassador and his support staff. Confederation offices near ILR space tend to be housed within well-defended EDF bases.

While the Confederation had its foundation as a military alliance, it now plays a powerful political, administrative, and economic role. ConFed member worlds have a voice in the ruling council. They are allowed one representative for every ten million inhabitants. Confederation member states enjoy trade deals with other members in addition to military support. There are some obligations. Member states are required to meet certain standards in regards to civil rights and assured standards of life for their citizens. If a state cannot meet these obligations, it may find itself slapped with tariffs or threatened with ejection from ConFed. Despite this, there is a great deal of latitude allowed to Confederation members, and some (particularly in the Outer Worlds) have been known to stretch the civil rights requirements.

ConFed traditionally enjoys the strongest support among the oldest of the Core Worlds. A growing segment of the population of on Inner and Outer World ConFed systems are coming to regard it as an intrusive, expensive, and antiquated body, a threat to free trade and personal liberties. A number of systems are host to separatist organizations that wish to cut ties to the ConFed entirely. Most are peaceful political organizations that limit themselves to political campaigns and civil disobedience. Others have crossed into the realm of terrorism. A few are large enough to be counted as serious military threats.

The Extraplanetary Defense Force

The Extraplanetary Defense Force (EDF) is a multi-planetary military force made up of volunteers from every planet in the Confederation. The EDF is the only force outside of the ILR capable of carrying out prolonged, large-scale, military operations light-years from a base planet. The EDF maintains a large force of faster-than-light warships, space-going factories, and transports, and is able to project a signifi-

cant force across known space in a fairly short period of time.

The official role of the EDF is to respond to any external threat, but in recent years it has begun to devote more and more resources to dealing with separatist violence and domestic terrorism. In most instances, these threats are dealt with by the local Homeguards with EDF coordination. However, some terrorist groups are starting to prey on shipping lanes, and few Homeguards have the aerospace resources to deal with piracy of this kind. In situations such as this the EDF may take a direct military role and station a wing of aerodyne fighters or a destroyer in the system. From time to time, the EDF may also provide disaster relief, particularly if a given system does not have the resources to respond to a large-scale emergency.

Homeguards

Homeguard is a general term used to refer to the non-EDF military, militia, and security forces present on any ConFed aligned world. The Homeguard provide the bulk of local military personnel during times of war, and may also serve as a kind of police force in peace. During conflicts, these forces coordinate with the EDF to provide local defense, allowing the EDF to retain its mobility.

Homeguard units are sent out of their home-system only in extraordinary circumstances, and few Homeguards have the ability to transport troops en masse to another system. In fact, many smaller worlds rely on the EDF, or even civilian contractors, for any kind of off-world transport.

Most Homeguard units are equipped with a combination of EDF and locally produced arms and gear, though some may be armed and equipped entirely with local equipment. They wear local variants of the EDF uniform.

The Independent Lapine Republic

A sphere of space, 20 light years across, centered about the densely populated systems of Hiahhoch and Baliannian, the Independent Lapine Republic was founded

about 70 years ago during the second wave of colonization. Originally on the fringe of explored space, the ILR has since been enveloped by the ConFed worlds. The two original systems are home to two-thirds of the population. During the first ILR/ConFed war, the Republic managed to seize a number of Outer Worlds and resource colonies in their initial expansion. Most of these were lost in the ConFed counterattack, and some of the remainder returned under the terms of the treaty that ended the war. In the intervening years, the ILR has founded a handful of resource colonies, but the Republic's expansion is limited by the ConFed. In total, the rabbits hang on to a dozen systems. They also enjoy the support of a handful of unaligned worlds, some of whom have entered into military alliances with the Republic.

The ILR is ostensibly a representative democracy with an open market. In reality, most policy is formed under pressure from senior military officers, or by powerful industrialist clans. Reform is possible, but unlikely given the current social climate. Quite simply, most citizens believe their government is doing the best it can. Outspoken political reformers are branded as traitors by the state media, and may be imprisoned or executed after a show trial.

The most notable thing about the Republic is the intense xenophobia and racism displayed by almost every inhabitant. These attitudes are supported by the government and social institutions, and have become ingrained in society. Even the most liberal of citizens may display a shocking savagery of opinion about the "lesser races." Non-rabbits living within the ILR sphere of influence live rather rough lives, particularly on Hiahohoch and Baliannian, where more than 98% of the population is rabbit. Even on captured worlds, where rabbits are in the minority, other races are banned from holding important positions and may not vote for representation in government. They can be imprisoned without trial for long periods, and are required to obtain passes to travel from city to city. Particularly brilliant or skilled non-rabbits may earn special

privileges, but these rights are granted at the whim of the government.

Life for the average citizen of the ILR is fairly good, but rather spartan when compared to that in the Core Worlds. In recent years, the standard of living has slowly declined as available resources are consumed, and more industries are taken over by the military. Many older citizens think fondly of the "good old days" of unlimited expansion and ever growing prosperity in early days of the war. This decline in wealth has sparked a call for new expansion, but has also given rise to underground dissent. If the war goes poorly, these whispers of rebellion may grow into a full-fledged revolution against status quo. It is unlikely that even a revolution would change the xenophobic atmosphere in the Republic, at least not overnight.

In the period between the first war the current conflict, a watchful peace descended over relations between the ILR and ConFed. Little direct trade existed, and what was undertaken was routed through the frontier ConFed world, Derzon. It was under this guise that the ILR recently renewed the conflict with the ConFed – troops and armored vehicles launched a surprise assault after being transported to Derzon in civilian freighters. Trade and private travel has been officially suspended, but it still technically possible for someone to travel from the ConFed to the Republic (and vice versa) through an unaligned world on the edge of ILR space. The visitor would need to have a very good reason for doing so, or face immediate arrest upon arrival! Travel and trade with the worlds dominated by the Enchawah Group has been cut off, simply because the Republic does not border Enchawah space.

The official explanation for the current conflict is pre-emptive self-defense. The ILR accuses the ConFed of ongoing economic warfare, claiming that ConFed deliberately claims resource-rich worlds simply to deny them to the ILR. This accusation rings true for the average person, who has seen his wages fall and prices rise. Using this justification for a new conflict, the military has taken control of nearly every major civilian manufacturing center for the

duration of the conflict, and retooled them for arms manufacture. The industrialist families that control almost all manufacturing concerns in the Republic approve of this military involvement, for the most part. Factory owners have been given military rank, and they are assured of contracts. Some fear the military are using the conflict as an excuse to take over the economy and turn the Republic into a military state. These fears may be well-founded – but they are rarely expressed.

The Republic has an unusually rich, almost mythic, history that grows every year. Glorious battles and achievements are re-interpreted as natural indications of the superiority of the rabbit race. The names of heroes and martyrs become synonymous with words of praise, while those of traitors live forever as insults. Every Republican child dreams of become a legendary figure. In some cases, historical figures are regarded with something approaching religious awe, or terror.

Republican Forces

The ILR has created a strong military culture. Unlike the EDF, whose members regard soldiering as a professional career, ILR officers are indoctrinated to see the military as a higher calling in service of their race. All citizens must serve a term in the military, and every unemployed male of age is automatically drafted in times of war. This requirement does not apply to non-rabbit citizens, though the colony worlds do have small militia forces of non-rabbits under the

command of ILR officers.

The Unaligned Worlds

Enchawah Group

The Enchawah Group is the single largest privately owned entity in the universe. It is a multi-stellar corporation that provides nearly every product or service imaginable. It has operations throughout known space, even in the ILR worlds. In fact, the Enchawah Group owns and directly administers fifteen star systems and boasts an impressive space fleet.

Citizens on Enchawah owned worlds are, by default, employees of the company. They are educated by the firm and placed into jobs that best suit their aptitude. It is extremely difficult to transfer into another position once assigned.

While social advancement is somewhat limited, and the standard of life for the average worker is generally comparable to that enjoyed in the Core Worlds.

The Enchawah Group is run by a middle-aged badger named Amhast an Therka an Enchawah. He is almost certainly the most powerful individual in space, and by far the wealthiest.



GAZETEER

ГАЗЕТЕР

Short History of Colonization

All known sentient life in the *Albedo* universe originated on the world of Arras Charka. In an effort to determine their origins, the inhabitants of Arras Charka embarked on a program of careful colonization about 100–150 years ago. 14 colony worlds were established in this first wave. Each has developed a unique social identity in the decades since foundation. These worlds are known as the *Core Worlds*. They are strongly socialist, and the inhabitants are generally used to a great deal of government influence in their lives.

A second, less unified, wave of colonization began about 75–90 years ago, and led to the establishment of more than fifty permanent colonies. Most of these were established along racial and ideological lines. For example, the worlds Hiahhoch and Baliannian were founded by rabbits, and later formed the Independent Lapine Republic (ILR). The majority these worlds are members of Confederation, and they are known as the *Inner Worlds*. Planetary governments vary wildly, but tend to be much more hands off than the Core Worlds. Capitalist interests are very strong. The Inner Worlds have very strong social identities, and many are considering separation from the Confederation.

A third wave of tertiary colonization started about 50 years ago as the Inner World colonies matured and began to create colonies themselves. These are known as the *Outer Worlds*. It's not clear how many of these tertiary colonies exist. The older Outer Worlds are fairly well-settled. The inhabitants, who are often first generation, tend to be much more independent than the citizens of the Inner and Core Worlds.

Outer Worlds may or may not be members of the Confederation. Newer Outer Worlds tend to be resource colonies, such as mining operations. They are sparsely populated, and may even have no perma-

nent inhabitants. They certainly are not self-sufficient.

The following is a list of notable systems in the *Albedo* universe, along with a capsule description and home world type for the purpose of character generation. Most planets are identified in terms of their position around their star. For example, Denotah III is the third planet out from the star Denotah. Some planets have specific names, as in the case of Annah (Dornthant II). In most cases the name of the main inhabited planet and the system are interchangeable. Only a pedant would refer to the home world of civilization as "Arras Charka III."

Almost all of these systems have permanent space stations in place to service interstellar traffic or handle communications. These stations often have long-term crews living in residence, allowing players from almost any of the listed planets or system to choose the Space Station home world type.

This list is far from complete. The universe of *Albedo* encompasses tens of thousands of cubic light-years of space, and thousands of solar systems. Players and Game Hosts are encouraged to invent their own worlds.

Core Worlds

Arras Charka (CONFED)

The Arras Charka system is home to a single terrestrial planet, three balls of rock, and an enormous gas giant at the edge of the system. Arras Charka III is the original world, the cradle of all civilization, upon which the ancestors of every living person awoke more than 250 years ago. With slightly more than two billion inhabitants it is also the most heavily populated world in the Confederation. Every race in the universe is represented on Arras Charka, and for the most part they live in very diverse and desegregated communities. Inhabitants refer to themselves as Charkani.

The primary settlement is Center City, a metropolis with more than ten million inhabitants. Center City is home to the administrative headquarters of the Confederation and EDF, as well as the grand council chambers where representatives from every ConFed world meet to decide on legislation. It is also the location of the ConFed "Special Facility," an extremely secure prison used to house particularly sensitive criminals, such as well-known terrorists or important prisoners of war.

The Arras Charka system is extremely well-defended, and picket vessels and powerful space-borne sensor arrays keep a constant watch on in-bound vessels. Thousands of ground and space-based ACVs are ready to be launched to intercept any invasion. The system is also home to a number of permanent residential space stations, most of which date back to the earliest days of space exploration. Small colonies exist on Arras Charka II and IV, and on a moon that orbits the gas giant Arras Charka V.

ARRAS CHARKA SYSTEM

Arras Charka I: Small, rocky planet, sun blasted and airless. No inhabitants.

Arras Charka II: Large, rocky world with a thin atmosphere. There is a solar research station at northern pole, built atop a small ice cap. (Research)

Arras Charka III: Terrestrial world. The cradle of civilization. One small, rocky moon with temporary bases for training EDF personnel in planetary exploration. (Urban, Space Station, Rural)

Arras Charka IV: Small rocky planet with a relatively thick (and poisonous) atmosphere. A few resource colonies exist around the equator. No moons. (Resource)

Arras Charka V: Gas giant, with 6 moons. A research/communications colony exists on the largest moon. (Research)



Aeostah (CONFED)

An important manufacturing center, the Aeostah system has one major inhabited planet and a number of colonies on a smaller terrestrial world. The other three planets are uninhabited. Aeostah is also home to Aelata Station, an enormous EDF shipyard that hangs in orbit around the main planet, Aeostah II, known locally as Aelata. As such, the system sees military and civilian traffic. It is also heavily defended. It is rumored that the EDF maintains a highly classified experimental shipyard somewhere in Aeostah's Oort cloud, billions of miles beyond the orbit of the most distant planet.

Aelata was settled by wolves, and they still form the single largest portion of the population. The colony is named for the woman who largely organized the settlement, and "Aelata" is a very common name among women on the planet. Descendants of the original wolf settlers have organized themselves into loose clans, based on family lines, and led by the eldest or most dominating adult. The clan leader has a strong social influence over the members of his or her family. At times, competition between would-be leaders of a clan can erupt into violence, though the clan is usually careful to limit the conflicts to their own members. While these clans hold no official power, senior members are often elected to the planetary council.

The fourth planet in the system, a small terrestrial world about half the size of Aelata, is also inhabited. It has a thin,

though breathable atmosphere, and a significant amount of native plant life in low-lying marshland. The planet is dotted with pressurized domes, each housing a small community of birds. The planetary gravity is low enough to allow smaller species (such as sparrows) to fly for short distances, a sight that can be alarming for non-avian visitors.

AEOSTAH SYSTEM

Aeostah I: Small planet with shifting, molten surface and thin atmosphere of burning vapor. No inhabitants. One small, irregularly shaped moon.

Aeostah II (Aelata): Well-settled terrestrial world. Large shipyard and many stations in orbit. One large moon, with extensive resource colonies. (Urban, Space Station, Resource)

Aeostah III: Small, airless planetoid. No inhabitants. No moons.

Aeostah IV: Terrestrial world, though cold with low gravity. Sparsely settled. Two small moons. (Nature of settlements counts as Space Station for character backgrounds)

Aeostah V: Frozen planet, with salty subsurface ocean. Subject of ongoing study, but no permanent settlements. No moons.

Chalendar (CONFED)

Chalendar was the site of the first interstellar colony, founded more than 150 years ago. It has risen in prominence and importance so that it now almost eclipses Arras Charka in the minds of ConFed citizens. There is a single terrestrial planet in the system and nine other resource rich worlds (with a space station orbiting each one). The majority of the population lives on Chalendar V, commonly known as Aerandar. The world was named for the head scientist on the team that developed the jump drive, with all continents and major geographical features named for prominent scientists and lawmakers of the period.

The inhabitants of Aerandar practice an advanced form of democratic socialism, and are strong supporters of the ConFed and EDF. The EDF maintains a major officer training academy in the capital city of

Holmgren. A powerful grass-roots political party has recently formed that believes that ConFed members outside the Core Worlds do not do enough to support the EDF. They are petitioning the EDF to withdraw protection from those worlds that do not meet a high standard of support.

Aerandar is home to a selection of fairly advanced native species, including a number of small, land-dwelling crustaceans and worm-like invertebrates. Some of the worms have highly-poisonous skin, while others are commonly harvested for food.

CHALENDAR SYSTEM

Chalendar I (Tamda): Irregularly shaped asteroid in a very close, though stable, solar orbit. No inhabitants.

Chalendar II (Cheamna): Hot, airless, rocky planet. One side is permanently locked towards the sun. Water ice may be found on the dark side, and two small mining colonies collect rare elements. A mothballed EDF training base at the North Pole was used for vacuum combat training in the first ILR war. (Resource)

Chalendar III (Lan): Large rocky world with thousands of active volcanoes and tectonically active surface. Volcanic outgassing is swept away by solar wind before any atmosphere can be formed. No inhabitants, no moons.

Chalendar IV (Jeanjahn): A large, rocky planet, with no minerals of note, and an active, thick, atmosphere that traps heat. It also has expansive steaming seas of scalding, mineral-rich water. The planet has two relative large moons, and two smaller moonlets in slowly degrading low orbits. They are expected to crash into the surface at some point in the distance future. A resource colony exists on the largest moon. (Resource)

Chalendar V (Aerandar): Heavily populated warm terrestrial world, with expansive oceans. Several space stations are in orbit. A single rocky moon is in orbit. (Urban, Space Station)

Chalendar VI (Whandar): Very large, rocky planet, covered in ice. Limited life exists in deep chasms and basins, centered around geothermal vents. No colonies on the surface. The single small rocky

moon is home to a crowded underground colony. (Urban)

Chalendar VII (Tahn): Brilliant green gas giant with an icy ring. A number of resource stations collect rare crystals from the ring. It has four moons, and four moonlets. The outermost moon is relatively large, with active volcanoes and a thin atmosphere. (Resource)

Danet (CONFED)

While Danet was one of the last of the Core world systems to be settled, it quickly became one of the most important and dynamic. Danet has a single inhabited world (Danet IV), three smaller planets, and gas giant in far orbit.

Danet IV was settled almost entirely by mice, and mice are still the largest single group on the planet. They have a number of very large cities, which are home to educational institutions that are renowned throughout the known universe. Of particular note are the schools specializing in obscure academic specialties, such as the Athelind College of Xenology. The inhabitants (known as Danetti) are notoriously easy-going and hedonistic, and polyamorous relationships are the norm. The rights of the individual are extremely important in Danetti society, sometimes more so than the good of society as a whole. The Danet system is quite peaceful, and there are rarely scandals or incidents of civil unrest. There is a small separatist movement that wishes to see the planet stand as an independent body, but they believe in achieving this goal peacefully. The greatest criticism leveled against the average Danetti is that he is apolitical, and not interested in the larger affairs of the universe.

DANET SYSTEM

Danet I: Relatively large and rocky world with near-molten surface. A thin atmosphere is constantly torn away by solar wind. No inhabitants or moons.

Danet II: Rocky planet with thick, reflective atmosphere containing a high level of carbon dioxide. Pressure at the surface is very high, though one heavily shielded research colony is in place. Danet II has

four small moons in very irregular orbits. (Research)

Danet III: Small, ice-bound planet. Significant cloud cover reflects most of the heat from the sun. Several domed research colonies exist on the surface, and the planet is thought to be suitable for terraforming. No moons. (Research)

Danet IV: Heavily settled terrestrial world with extensive organic farming operations. Several permanent stations in orbit, and a number of dedicated research communities on the surface. Two small moons, (Urban, Rural, Space Station, Research)

Danet V: Freezing gas giant in distant orbit, covered in gleaming white clouds. A small communications and emergency station is in orbit. No significant moons, though Danet V has attracted several hundred tiny asteroids to its orbit. (Space station)

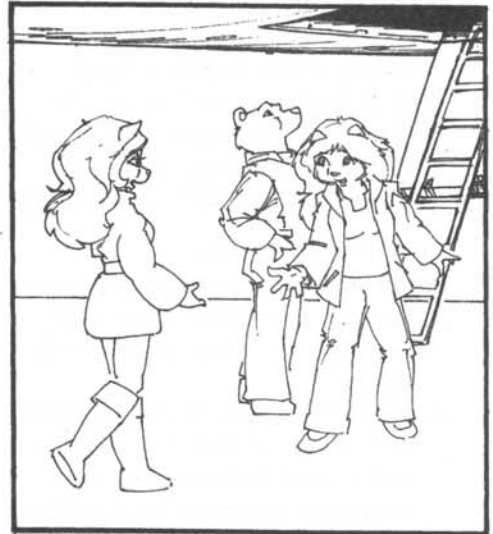

Dornthant (CONFED)

The Dornthant system was selected as a suitable candidate for colonization very early in the first wave of exploration, as it boasts two terrestrial worlds, and a selection of resource rich planets. Dornthant II (known as Annah) and III (known as Doynah) are both well-populated, with cats of various species making up a large percentage of the overall population. Annah is more heavily populated with an impressive

manufacturing base, while Doynah is home to extensive farming operations.

The inhabitants of the two populated worlds in this system refer to themselves collectively as Dornthantii. They are very cosmopolitan and socially liberated, but also have a very strong sense of civic responsibility and respect for elected authority. They have a reputation for being dull, stuffed shirts, particularly among inhabitants of more hedonistic systems, such as Danet.

Annah is home to a large EDF training academy, and large communities of EDF officers and personnel exist. The EDF is considered the service of choice among young Dornthantii who wish to pursue a military career, and the Homeguard is regarded with slight distaste as a result.

Two disturbing social trends exist in Dornthant currently. The first is the rising incidence of random, motiveless shootings undertaken by deranged citizens. Second is the rise of a new order of ambitious young EDF officers, who hold personal privilege and power as more important than the rights of ConFed citizens. This group is gaining a significant degree of influence in the EDF, and many older officers have retired in disgust – or been forced to resign.

DORNTHANT SYSTEM

Dornthant I: An unusual gas giant, superheated to near plasma. It constantly loses mass to the sun. No inhabitants or moons.

Dornthant II (Annah): Heavily populated, warm terrestrial world. Small jungles exist on most continents. One small rocky moon and several space stations in orbit. (Urban, Space Station)

Dornthant III (Doynah): Cool terrestrial world with extensive settlements, and large plains. Open farming takes up much of the land. There are three permanent space stations in orbit, and one large rocky moon with a thin atmosphere, which is home to mining operations. (Urban, Rural, Space Station, Resource)

Dornthant IV: Frigid world with thick, acidic atmosphere/oceans. Subject of periodic scientific expeditions, but has no settlements. Three rocky, airless moons.

Dornthant V: Tiny, rocky world in distant orbit, thought to be a captured asteroid. A communications station trails its orbit. (Space station)

Inner Worlds

Ahan-Tako (CONFED)

A large and well-populated system, with six planets and two extensive asteroid belts. Though it is well-settled and developed, Ahan-Tako has something of the quality of a frontier system. It has been plagued with unrest in recent years. Pirates and raiders haunt the asteroid belt, and the terrestrial planets Ahan-Tako IV (Ish-Tako) and Ahan-Tako V (Zan-Cha) are both home to revolutionary separatist movements, which are large enough to realistically describe themselves as armies. Consequently, local Homeguards are well-equipped and very experienced, and the EDF maintains a strong presence here. The government is a capitalist democracy, though elections have been temporarily suspended in the face of internal unrest. Ish-Tako is home to a underground revolutionary army that hopes to overthrow the planetary government, cut ties with the Confederation, and establish a new system of government based on xenophobic and communist principles. The largest settlement in the system is Tadak City on Ish-Tako, and the city is a regular target of revolutionary attacks.

AHAN-TAKO SYSTEM

Ahan-Tako I (Zion): A sun-charred rocky planet with an extremely rapid rotation. No settlements. Two rocky moons.

Ahan-Tako II (Ktan-Tako): A large, hot, airless ball of rock. It was extensively strip-mined in the first decades of colonization. A few unofficial communities of squatters still exist in the shade of a south polar mountain range. They trade salvaged mining equipment for supplies. Two moons – one planet sized, and one less than 600 km in diameter. (Settlements count as Rural)

Ahan-Tako III (Ish-Tako): Well-settled terrestrial world with several space stations in orbit. Two moons, both airless and rocky. One moon is quite large, and

is in turn orbited by a tiny moon. (Urban, Space Station)

Ahan-Tako IV (Ther-Tonki): Vibrantly colored gas giant with an extensive system of moons. The moons are haunted by hardscrabble pirates who prey on shipping, and each other. The planet has no less than 28 moons, mostly rocky planetoids. The largest moon (Zan-Cha) is a cold terrestrial world with a thin, though breathable atmosphere. It is home to a number of urban colonies around the equator. (Space Station, Urban)

Inner Asteroid Belt: An extensive asteroid belt fills the space between the sixth and seventh planets. There are dozens of resource and research stations in the belt, and a number of illegal settlements run by pirates or revolutionaries. (Space Station, Resource, Research)

Ahan-Tako V (Ther-Son): Sub-Jovian gas giant, with no settlements and two small moons. Sometimes used as a dumping ground for radioactive waste.

Ahan-Tako VI (Wha-Tako): Frozen, ice-covered planet, with possible alcohol ocean under the surface. A former research colony has been abandoned over piracy concerns. No moons. Pirate colonies may exist in hidden locations.

Outer Asteroid Belt: Comprised mostly of frozen lumps of gas, the outer asteroid belt presents a modest threat to shipping. The EDF maintains a series of unmanned navigation buoys throughout.

Ahnomia (CONFED)

The Ahnomia system has only one planet, a gas giant that orbits the star at a great distance. The system is significant in that it serves as a waypoint to more hospitable places. The EDF maintains an enormous and well-defended transfer station here, in orbit about 100 million kilometers from the Ahnomia star. Here, ships may be repaired or refueled, and personnel reassigned to new vessels. In the past, the Ahnomia system has served as a convenient mustering point for Aerospace taskforces. The transfer station is closed to civilian traffic, though exceptions are made in emergencies.

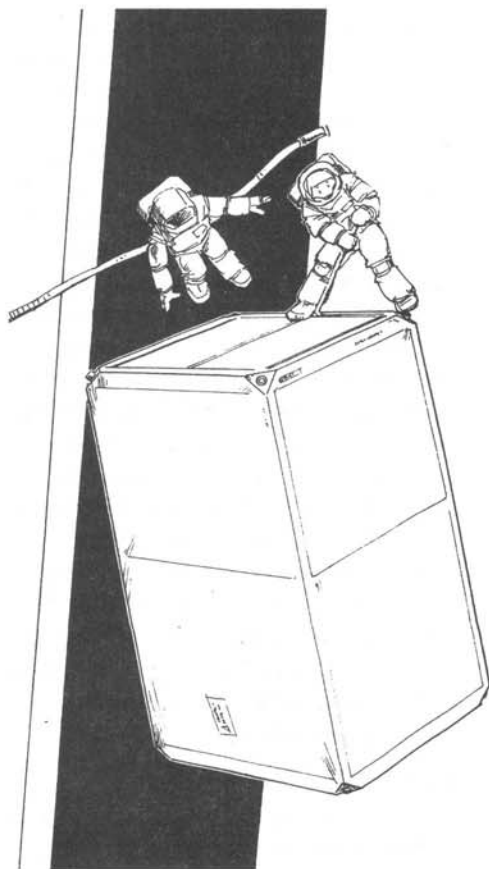

Civilian ships that need to stop in Ahnomia are normally restricted to a privately-run resource station (permanent population about 40) in orbit around Ahnomia I. The station extracts rare elements from the upper atmosphere of the gas giant. The station operates under contract with the Confederation, and is required to offer basic amenities to outsider visitors.

AHNOMIA SYSTEM

Ahnomia I: Large gas giant with rare elements in upper atmosphere. One privately owned resource colony, and two large, airless moons. (Resource)

Denotah (INDEPENDENT, UNALIGNED)

The Denotah system, located far from ILR space, is unusual in that it is an Inner World that did not join the Confederation during the first ILR war. The only settled world, Denotah IV, is ruled by an extremely inefficient capitalist democracy. The government maintains a large surface army/security force, and fields a few small capital space-

ships, none of which are equipped for interstellar assaults. Trade between Denotah and the rest of the universe is infrequent, but there are no restrictions on travel. However, few outsiders wish to visit, and few citizens of Denotah can afford to leave.

Corruption and poverty are widespread. Unsavory corporations lure unsuspecting young people to distant work sites, with promises of high pay. Once there, they find themselves dependent on company stores that charge outrageously high prices which drain most of the employee's salary. Charges for room and board eat up the rest, meaning it takes years to save up enough to return to the main settlements. This practice not technically legal, but companies pay sizable bribes to the government in Batu City to turn a blind eye to the practice. As the government is largely in the pocket of corporate interests, Denotah IV is considered a corporate world for the purpose of character generation.

DENOTAH SYSTEM

Denotah I: Rocky, airless world with a great deal of volcanic activity caused by the tidal interaction of the sun, and the planet's relatively sizable moon. No inhabitants.

Denotah II: Small, rocky planet with a thin atmosphere. Denotah Space Command has interdicted this world, and it is thought that there is a domed penal colony somewhere on the surface. It has three small moons.

Denotah III: Arid, airless world with no significant resources. Sometimes used as a missile testing ground by Denotah vessels.

Denotah IV: Wet, terrestrial world with large oceans and many islands. Well-settled, with a population in the billions. There are two residential space stations in orbit, and some research colonies on the single, rocky moon. (Corporate, Resource, Research, Space Station)

Denotah V: Sub-Jovian gas giant with brilliant rings and small collection of moons. No settlements. Four moons, all rocky, irregular bodies.

Denotah VI: Frozen ball of ice orbiting Denotah at a great distance. A commu-

nications and transfer station is in orbit. (Space Station)



Derzon (CONFED)

Separated from the Core Worlds by the full expanse of ILR space, this lightly settled ConFed system serves a major trade route between the Republic and the Outer Worlds. The EDF maintains a barracks and communications center here, on Derzon II, but has very little in the way of military hardware. The local Homeguard is little more than a police force.

The capital city is Andis. The inhabitants, for the most part, are strong ConFed supporters, but they are inherently pacifistic. In the year 195, Derzon II was briefly overrun by ILR forces working without the official support of their government. The ILR troops entrenched themselves in the civilian population, so the subsequent EDF liberation resulted in extensive loss of life and damage to civil infrastructure. From that point on, the inhabitants of Derzon regarded the EDF and ConFed with great suspicion. The event serves as a rallying point for separatist groups throughout known space.

DERZON SYSTEM

Derzon I: Geologically active world with constantly changing, molten rock surface. No settlements or moons.

Derzon II: Cool, terrestrial world. Sparsely populated, and geologically young with many mountains. One large, airless moon, with resource colonies on the surface. (Urban, Rural, Resource)

Derzon III: Very large gas giant, thought to have swallowed several outer planets in the distant past, and trapped others in its 14 moon system. All moons are relatively large, and 3 have measurable atmospheres. No settlements.

Dilbion (CONFED)

Dilbion is a well-settled system with a strong capitalist economy. There are two settled worlds, Dilbion II and Dilbion III, and two uninhabited planets. Both Dilbion II and III are terrestrial worlds. Dilbion II is a warm terrestrial planet, portions of which are covered in relatively advanced jungle. The colony was founded by horses, but generous settlement packages have encouraged people of all races to immigrate here, and the planet currently has a population of 200 million.

Dilbion III is much cooler, and is largely covered in ice and snow. Liquid water and rain occurs only within a few hundred kilometers of the equator. The planet was settled by an odd alliance of penguins and arctic mammals, such as polar bears, and most of the inhabitants are descendants of the original colonists. The total population of the planet is under ten million.

Dilbion II and III share an elected government and capitalist economy. Dilbion II is home to the legislative assembly, and boasts most of the system's industrial base, while Dilbion III has many financial and banking offices. The planets co-exist peacefully, and have strong ties to the ConFed and EDF. The planets share a coin currency, known as the Star, which is artificially set at an even exchange rate with the ConFed credit. Stars are annually minted, with the faces depicting the current head of the legislature. This practice means that coins picturing short-lived leaders are rare, and sought after by collectors throughout space. The same is true of coins from the early years of the double colony. Coins of this kind may trade for much higher than the official exchange rate.

For the last decade a small political party on Dilbion II has been calling for the separation of the two planets, accusing the banking houses of Dilbion III of manipulating the economy to the unfair advantage of the smaller world. A recent government accounting scandal has brought to light evidence which seems to support this view, and the separatist party is gaining strength.

DILBION SYSTEM

Dilbion I: Volcanic planet with a thick, sulfurous atmosphere. No colonies. One small rocky moon.

Dilbion II: Warm terrestrial planet, well settled. Two small moons with minor colonies. (Urban, Resource)

Dilbion III: Cold terrestrial planet, modest population. No moons. (Urban)

Dilbion IV: Sub-Jovian gas world. No inhabitants. Five airless, rocky moons, with an EDF recon station on the outermost. (Space Station)



Echak

(INDEPENDENT, CONFED ALLY)

Echak is a somewhat barren system, chosen specifically by settlers with a somewhat austere philosophy of independence and beauty in simplicity. They wanted a world devoid of soft lines and easily settled landscapes, and the barely inhabitable Echak III fits this bill perfectly. The other planets in the system are undistinguished balls of rock.

Echak III was settled fairly early on in the second wave of expansion by a clan of foxes and wolves who followed a leader that espoused a philosophy of self-denial and self-reliance. The original Echaki lived off the land, insofar as they were able, building homes from stones and plant matter, and even hunting local arthropods for food. Life was governed by a series of elaborate, graceful rituals that marked the importance of each occasion. The colonists even developed their own language, a strangely poetic yet staccato tongue which few outsiders understand.

The modern-day Echaki are somewhat more liberal, and live in small towns with

light industry, but maintain many of their old traditions and attitudes. For example, they still eat a limited amount of local fauna, though the bulk of it becomes biomass for processed food. They revere all life and pay special attention to "who" they eat, even when it is just tissue culture.

The Echaki sided with the ConFed during the first ILR war, but avoided becoming full members. They are an independent democracy, with a fairly thriving socialist economy. An elected council meets annually to pass legislation. The government maintains a small and highly skilled army, and a fairly substantial interplanetary space force. As part of their mutual defense agreement with the ConFed, they contribute some of their best officers and pilots to the EDF.

ECHAK SYSTEM

Echak I – Small, airless, rocky planet. No settlements or moons.

Echak II – Rocky, airless planet. No settlements or moons.

Echak III – Relatively arid terrestrial world, with most water tied up in lowland marshes. Modestly large population in the tens of millions. One permanent space station, and a single large moon. (Rural, Space Station)

Echak IV – A large, irregular planetoid in the otherwise sparse asteroid belt. Small population of miners live in a resource colony on the planetoid. (Resource)

Ekosiak (CONFED)

The Ekosiak system lies near the edge of ConFed space, and is separated from the Core Worlds by the expanse of ILR space. Trade and travel between the two takes several months. The only inhabited world is Ekosiak I, a relatively young colony with about 50 million inhabitants. The only other planet-sized body in the system is a massive gas giant that orbits the sun at a great distance.

Ekosiak I is nominally a ConFed member, but the local government pays little more than lip service to their membership obligations. There is a Confederate government house, but the office only has four staff. The planet does maintain a large and well-equipped Homeguard. Many of the officers

in this force resent the outside influence of EDF, and bristle at suggestions that the Homeguard is merely an arm of the larger force. The (mostly canine) inhabitants are fiercely independent and even libertarian. There is a strong separatist movement, to the degree that the presence of a single EDF advisor to Homeguard operations once caused the outbreak of civil unrest.

Ekosiak has a strong capitalist economy, and corporations wield an undue amount of power over the democratically elected governor. Some corporate leaders hope to subvert the civil authority entirely, and turn Ekosiak into a corporate world, along the lines of Enchawah. Thus far, they have been unsuccessful, though at least one corporate magnate has had great success encouraging riots against status quo.

EKOSIAK SYSTEM

Ekosiak I – Warm terrestrial world. Lightly settled, with most of the population centered in a dozen cities. Two permanent stations in orbit, and five tiny moons. (Urban, Rural)

Ekosiak II – Massive gas giant in extremely distant orbit. A powerful electromagnetic radiation field discourages exploration or settlement in its system of ten moons.

Kawateena (INDEPENDENT, UNALIGNED)

The Kawateena system is unique in known space, in that it is ruled by hereditary nobility. The system itself encompasses six planets, two of which are settled. Kawateena was settled about 90 years ago, but their noble classes predate the colonization. The colonists were members of an enclave of feline clans on Arras Charka that were only nominally loyal to the socialist government. They managed to get approval for the foundation of a new colony, and were free to indulge their monarchist experiment on a system-wide level. The current ruling family is the House Ardehad, though their claim may soon be challenged if the Lady of the clan proves unable to produce or name an heir. The family is considering cloning as a possible solution to this problem.

The ruling classes are not idle rich, and they are not above the law. They are trained from birth to work towards the service of

the state, and are considered by some to be little more than elevated civil servants. The family of the monarch in particular is expected to maintain a full schedule of public appearances and dull legislative duties. The common people are generally well-cared for, and well-funded social assistance programs are in place for those willing to work. Kawateena is friendly towards the Confederation, but does not have any specific alliance in place. The Confederation regards the government rather coolly, believing that monarchies are prone to abuse of power.

Confed fears are somewhat justified – Kawateena is far from a perfect state. The monarchs have a considerable degree of direct control over the economy and legislative process, and past rulers have been known to side-step the judicial process to protect a family member or pursue a personal goal. In addition, the ruling clans have used violence and assassination in the past in order to achieve the throne.

The monarch of Kawateena may be male or female, and is referred to as the Lord or Lady. The royal palace – an elaborate structure that combines mansion home and government offices – is located in the capital city of Tehnka on Kawateena III.

KAWATEENA SYSTEM

- Kawateena I:** A tidally locked, large and rocky planet. A small research colony exists on the border of the dark and light sides of the planet. It has one small moon, with a highly eccentric orbit. (Research)
- Kawateena II:** Small and dense planet, with a thick, poisonous atmosphere, subject to violent storms. No settlements or moons.
- Kawateena III:** Warm terrestrial world. Well settled, with strong manufacturing base, and several permanent stations in orbit. Two small moons. (Urban, Rural, Space Station)
- Kawateena IV:** Cool terrestrial world, with low gravity. Small avian population collected in towns, and a few resource colonies on remote continents. Ruled by feline nobility on third planet. No moons. (Urban, Resource)

Asteroid Belt: The Kawateeni asteroid belt is thought to be remnants of an icy world. Very few resources are found here.

Kawateena V: Relatively small gas planet with extensive ring system collected from asteroid belt. No significant moons, and no settlements.

Kawateena VI: Large, ice-covered rocky world with a large, distant moon. A communications station is in orbit. (Space Station)

Tun Och Enchek (CONFED)

Tun Och Enchek (or simply "Enchek") has never recovered from the first ILR war. Once home to extensive specialty farming operations, the system now generates only enough food for local use. The system's infrastructure and manufacturing base was badly ravaged during the ILR retreat, and the locals welcome any EDF presence in the system.

The only terrestrial planet in the system, Enchek III, is a pleasant, geologically stable world of extensive plains and rolling hills. It was settled by community of ungulates who wished to establish a planet-wide confederation of loosely allied towns. The early settlers were able to genetically engineer alien grain crops, and cross them with ones from Arras Charka, to produce exceptionally high-yield crops.

Currently, very few farming operations are still running. Many of the towns have been abandoned, and the settlers have moved to the Core Worlds. What is left has been rebuilt by the Confed, but the population of the system is slowly decreasing. The Confed has plans to use Enchek III as a refugee resettlement world in the event of a new war, or major disaster in another system. The inhabitants have a representative democracy, but it is limited to the municipal level.

TUN OCH ENCHEK SYSTEM

- Tun Och Enchek I:** Spinning ball of plasma, very close to sun. Stellar gravity is gradually pulling this world into pieces. No settlements.
- Tun Och Enchek II:** Small, fiery ball of rock. No settlements or moons.

Tun Och Enchek III (Enchek): Warm, terrestrial world. Slightly reduced gravity, and large bodies of fresh water. Sparsely settled. One small moon. (Rural)

Asteroid Belt: A number of mining companies have recently started new operations in the Asteroid Belt. The EDF also maintains some tracking stations. (Resource, Space Station)

Tun Och Enchek IV: Unremarkable icy ball with no settlements or moons.

Outer Worlds and Other Powers

Baliannian (ILR)

The original ILR home system, Baliannian is crowded, heavily defended system. The main planet is Baliannian III, a heavily developed and industrialized planet with a population approaching ten billion. The main houses of government are located here, along with military academies and major weapons research facilities. The population is overwhelmingly rabbit, though the system is not closed to other species. Indeed, citizens from ILR aligned worlds and conquered territories have access to inexpensive tours that highlight the glories of the Republic.

The population is used to a very rich, consumer economy, but their lifestyle has become more Spartan in recent years. The planet is a representative democracy, but non-rabbits are barred from office, and corporate and military candidates almost invariably win office.

Every planet in the system houses extensive automatic defense and detection systems. Government regulations require all incoming ships to be interdicted and searched before orbiting any planet.

BALIANNIAN SYSTEM

Baliannian I: Rapidly rotating, small, irregular rocky world. No settlements.

Baliannian II: Hot, rocky world with thick atmosphere, full of green house gases. Surface pressure too great for colonization. No stations or moons.

Baliannian III: Cool terrestrial world. Heavily settled, with some cities exceed-



ing 20 million population. Several cargo transfer and residential stations in orbit. One small, airless moon. (Urban, Space Station)

Baliannian IV: Cold, arid world with a thin atmosphere. A single large, volcanic moon orbits. Resource colonies and military training camps are present on the surface, and a transfer station in orbit. (Resource, Space Station)

Baliannian V: Very large gas giant; has no moons, aside from some captured comets and asteroids. An ILR capital ship repair yard is located in orbit, with a large residential section. (Space Station)

Chishatta (INDEPENDENT, CONFED ALLY)

This double star system, located on the far edge of known space, has no planets. The most notable feature is an extensive asteroid belt, believed to be the remains of resource-rich worlds that were torn apart when their sun acquired a twin. It is home to several hundred corporate miners from a number of ConFed worlds, here with the permission of the ConFed Department of Resource Exploration.

Endly (ENCHAWAH GROUP)

Endly is the home system for the Enchawah Group, a collection of 12 corporate controlled inhabited systems, and several dozen resource colonies. Endly has seven planets, all of which have been extensively exploited for their resource wealth. The main planet, Endly V, is a pleasant, terrestrial world with rich oceans. The planet is entirely governed by a private corporation. Corporate inhabitants live in beautiful resort villages, and travel by private helicopter from settlement to settlement. Low-level employees are packed into high-rise apartments, and ride underground trains from home to factory.

Endly has an active movement pressing for democracy and worker's rights. This movement has yet to gain a great deal of strength, as the company, by and large, deals fairly with its employees. The Enchawah Group has trade relations with the ILR and ConFed, but openly prefers the ConFed. If it came to war, the corporation would throw its support behind the ConFed.

ENDLY SYSTEM

Endly I: Hot rock ball with a thin, highly poisonous mineral atmosphere. Two small moons. Robotic strip mines mar the surface of all three. No manned settlements.

Endly II: Small, airless rocky world. Resource colonies are on the surface, and a permanent station is in orbit. (Resource, Space Station)

Endly III: Relatively small gas world. Very warm upper atmosphere is known to harbor complex organic elements, though no true life has been found. The

planet has a system of six rocky moons, one of which is planet sized in its own right, and is home to an extensive research station. The others hold mining colonies. (Research, Resource)

Endly IV: Warm terrestrial world, covered in an ocean of heavily carbonated sulfurous water. Simple bacteria are known to exist in the waves. Several floating research stations exist, and exploration is underway to find exploitable resources on the ocean floor. (Research)

Endly V: Cool terrestrial world with small continents. Well-settled, but bulk of population are limited to crowded cities near manufacturing centers. Three tiny moons. (Corporate, Research)

Endly VI: Airless, rocky world. Most easily accessed resources have been mined. Currently unsettled. No moons.

Endly VII: Small, icy world. A single mining colony exists. (Resource)

Hiahhohch (ILR)

Hiahhohch was the second system to declare allegiance to the Independent Lapine Republic. It is one of the two founding ILR systems, the combined populations of which represent 80% of the ILR whole. Hiahhohch has two terrestrial planets, both heavily populated. As with Baliannian, the system is very well defended.

Hiahhohch is considered a somewhat downscale and less civilized version of Baliannian by many in the ILR – at least, many from Baliannian. It is true that the system has fewer research facilities and centers of higher learning and that young people from Hiahhohch tend to fill the lower ranks of the military. Units from Hiahhohch have a reputation for ferocity, and are often used as expendable shock troops.

The rabbit majority is not quite as overwhelming as it is on Baliannian, though lapines still represent well over 90% of the total population. Outside traffic is not very common – there is simply not as much to see in this system, at least in terms of glorious works of rabbit culture.

HIAHHOHCH SYSTEM

Hiahhoch I: Large world with oceans of molten rock. No significant atmosphere. One captured asteroid in orbit. No settlements.

Hiahhoch II: Very warm terrestrial world with extensive deserts and small oceans. Well settled along bodies of water. Some permanent stations in orbit, and resource colonies in remote areas. Small settlements exist in the deserts. No moons. (Urban, Resource, Rural, Space Station)

Hiahhoch III: Terrestrial world with extensive mountain ranges and highland plateaus. Well settled on plains. Two moons – one large, one small, both airless. (Urban, Space Station)

Hiahhoch IV: Tiny, irregular rocky planet. A communications station follows in a trailing orbit. (Space Station)

Konattahtzah (ILR)

Konattahtzah is a formerly independent system, annexed by the ILR during the first conflict. There were once two inhabited planets, but a failed liberation attempt near the end of the war razed all large cities on Konattahtzah IV. The surviving inhabitants were relocated to Konattahtzah V – in many cases forcibly.

Konattahtzah was settled by kangaroos and a variety of small mammals. It was originally a socialist democracy, and declared allegiance to the Confed early in the first ILR war. It was swiftly conquered, and ceded to the Republic in the terms of the treaty that ended the war. Several hundred thousand rabbits moved to the system after the war. Most are employed in garrisoning and administering the planet. The government is officially a democracy with two levels of legislature. Unfortunately, the upper house is a council of rabbits appointed by the Republic – it has the power to overturn or change any laws passed the lower house, call new elections, or suspend the lower house entirely. As such, the native population has no voice. Konattahtzah V is home to a number of crumbling, once proud cities, and occasional walled rabbit communities in much better repair. The ILR has not committed funds to repair war damage,

being more interested with stripping resources from the planet. There is an active resistance movement on the planet, which periodically makes impressive attacks against Republican targets.

KONATTAHTZAH SYSTEM

Konattahtzah I: Small, rocky, airless world in eccentric orbit around sun. No settlements or moons.

Konattahtzah II: Small, rocky world with extremely thin atmosphere. Currently being strip mined by Republic, using slave labor. No moons. (Resource)

Konattahtzah III: Large, rocky world with volcanic surface and thick, violent atmosphere. One rocky moon with the remains of a research colony, now abandoned.

Konattahtzah IV: Warm terrestrial world with expansive oceans and verdant local fauna. Several abandoned/blasted cities. Periodically used by ILR as an urban warfare training ground. Some refugees live in remote areas. No moons. (Rural)

Konattahtzah V: Cool terrestrial world, well settled, with permanent space stations in orbit. No moons. (Urban, Resource, Rural)



Biology

The universe of *Albedo* is home to billions of different creatures from more than one hundred different species. Most of these are furry mammals, but there is also a significant population of birds and marsupials. On the Core Worlds, these species live in racially diverse communities. Representatives of a dozen different species may occupy a single floor of an apartment block. This situation is rather different in the Outer Worlds, which tend to be dominated by the

species which founded the colony. However, most of them still boast fairly cosmopolitan and tolerant societies. In many cases, members of a minority race will live in a close-knit community, but this is a matter of choice.

This variation in species has caused a number of social problems, but in some ways it represents a significant advantage. Each species is hardwired differently, and has a tendency to respond to situations in a unique way. The cats of Dornthant are generally reserved, and live in small family groups. The rodents of Danet are much more gregarious, and their definition of family is often extended to include cousins and friends, and friends-of-friends. While the different attitudes may cause social friction, they also encourage tolerance and open-mindedness, and willingness to approach problems in a way one might not normally consider.

Scientists are sure that this multitude of species did not evolve naturally on Arras Charka, but they are certain that they all had their genesis on a single world. Alien species – invariably primitive – have been found on several of the explored worlds. Without exception, all of these alien species have a genetic structure entirely unrelated to that of the sentient races.

Few species consider themselves superior to another, at least not within the Confederation. The rabbit inhabitants of the Independent Lapine Republic (ILR) have built a society on the idea of their entitlement as a superior race. They believe that they, as a particularly fecund species, have the right to a greater share of resources than most. This

COMMAND REVIEW • ΑΡΧΑΙΑΣ ΠΕΡΕΟΥ

Animals vs. Anthropomorphics

Game Hosts should be wary of handing out special abilities to players who choose a species with a unusual or powerful real-world trait. For example, platypuses have poisonous spurs located in their rear claws, and have a limited ability to detect the electric fields given off by living creatures. Platypuses in *Albedo* have neither of these advantages. If a player questions this, point out that every species has been altered to bring them closer to the human form, and this process has eliminated many unusual traits.

doctrine of racial superiority has allowed their leaders to guide the ILR into more than one expansionist conflict with the Confederation. Indeed, the first such confrontation led directly to the foundation of the Extra-planetary Defense Force (EDF).

The Species of Arras Charka

Players should be aware that the sentient species of *Albedo* do not differ in size to the extreme that real-world animals do. A bear is larger than a mouse, but not to any degree approaching that of bear and a mouse on Earth. The smallest creatures are just above one meter (3'6"-4') tall on average, and the largest around two meters (6'4"). On average, they are noticeably smaller and lighter than a modern human. Nocturnal species groups have better night vision than humans, though no animal possesses perfect night-sight. All characters, no matter their species, have full-color vision.

While every species tends towards certain social behaviors, there is also a great deal of variation. For example, cats tend to be independent and prefer small social groups. This does not mean that an individual cat cannot be extremely outgoing and extroverted. Similarly, wolves tend to be very driven – but your wolf character can be very laid-back, if you wish. Consider the racial personality traits as a general guide to culture and background, rather than hard and fast rules for your character concept.

Science and Technology

Technology in the *Albedo* universe is extremely advanced in comparison to that of the real world, and it has been since day one. The sentient races awoke with a very high baseline of technical and scientific knowledge, and have greatly expanded on this in the two centuries since awakening. Still, with the exception of Jump Drives, most of their tools and technology would not be alien (or even unfamiliar) to humans on 21st century Earth.

Confed technology is largely based on theoretical extrapolation of real-world technologies, and familiar items like cars,

ACVs begin hard acceleration to intercept the threatening ILR ship.

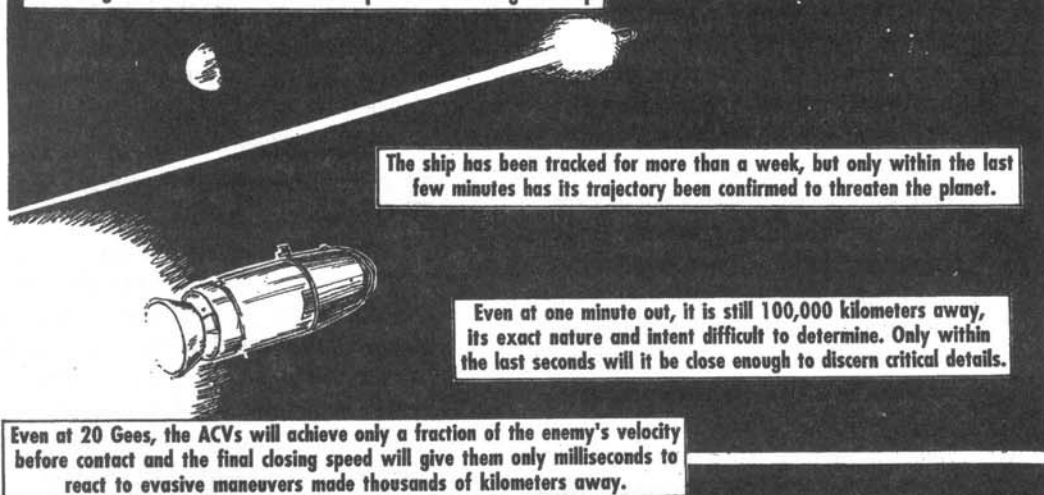

The ship has been tracked for more than a week, but only within the last few minutes has its trajectory been confirmed to threaten the planet.

Even at one minute out, it is still 100,000 kilometers away, its exact nature and intent difficult to determine. Only within the last seconds will it be close enough to discern critical details.

Even at 20 Gees, the ACVs will achieve only a fraction of the enemy's velocity before contact and the final closing speed will give them only milliseconds to react to evasive maneuvers made thousands of kilometers away.

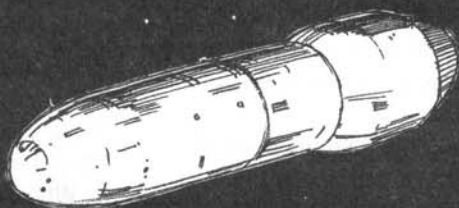

With so little time to react, maneuvering rates have to be assumed and attack plots derived from only the smallest hints of apparent evasion.

personal computers, and airplanes all exist in a recognizable form, albeit more advanced. Extremely clean and efficient hydrogen cells are used to fuel vehicles of all kinds, from personal cars to airplanes to submarines, and fusion plants generate electricity for cities and larger vehicles such as cargo ships. The principles behind jump drive are perhaps the only "science fiction" element in the world of *Albedo*. Other commonly seen science-fiction technologies such as artificial gravity, teleporters, handheld ray guns, and force shields do *not* exist, and are not likely to be developed anytime soon.

Computers are ubiquitous, and almost all have some level of artificial intelligence thanks to their connection with the Net. Even the most basic models of vehicle are connected to the Net, which provides the driver with constantly updated traffic information, and may even take control of the vehicle if the driver is incapacitated.

While some planets are home to colonists who consciously choose to eschew all but the most basic technology, most deni-

zens of the *Albedo* universe choose to live with every technological convenience that is available. Even the humblest apartment will feature several computer terminals.

Astronomy and Astronautics

Space travel, even travel between stars, is an everyday occurrence in the *Albedo* universe. Cargo ships carry manufactured products from the Core Worlds to the Rim, and raw materials back again. New colonization efforts and exploration surveys are put together every year. ConFed couriers and EDF troop ships travel from one end of known space to the other on official business. A growing number of private travelers and tourists are appearing on the space lanes, and dedicated passenger liners connect all major worlds.

However, interstellar travel should not be thought of as equivalent to air travel in the real world. A visit even to the closest star system involves weeks spent aboard a cramped starship, and long periods of

weightlessness on smaller vessels. Few people are willing to undergo these privations for simple tourism.

Spaceships in *Albedo* can be separated into two basic models: aerodynes and starships. Essentially, a streamlined ship that is able to operate in an atmosphere is considered an aerodyne. Aerodynes may or may not possess jump drives. Any large, jump-capable vessel designed to operate only in space is a *starship*.

Personal spaceship ownership, while rare, is becoming more common. A wealthy businessman may own the aerodyne that he uses to visit his orbiting factory. A successful freighter captain may get a bank loan to purchase her own light freighter. However, personal spaceships are possessions on the order of passenger jets or cargo ships in the real world, and those few who can afford them are most likely to purchase them for business use. Even an orbital shuttle requires a trained crew and expensive monthly maintenance. Only the ultra-rich can afford a private pleasure ship.

Interplanetary Travel

Spaceships are propelled from planet to planet by powerful fusion drives that use hydrogen for fuel. These fusion drives can

generate enormous amounts of thrust over very long periods of time. Scientists have experimented with different drives - such as solar wind sails, electrical ion engines, and chemical reaction thrusters - but fusion thrusters are the most efficient type of space drive available. Some ships with specialized functions may use different engines, particularly if they need to be extremely small, as even the smallest fusion reactors displace more than one ton.

Travel times between worlds can vary greatly depending on the relative position of the planets. Most captains attempt to intercept the destination planet as it swings around in its orbit toward the ship's planet of origin. Most trips between planets will take a week or two at the minimum and much longer if the destination world is several orbits away. Trips to an orbiting space station or nearby moon can be completed in a matter of hours in most cases.

No spaceship is equipped with artificial gravity. However, starships normally accelerate and decelerate at a constant rate as they approach their destination. This constant thrust allows the illusion of gravity, as the passengers feel the constant pressure of acceleration, with "down" being

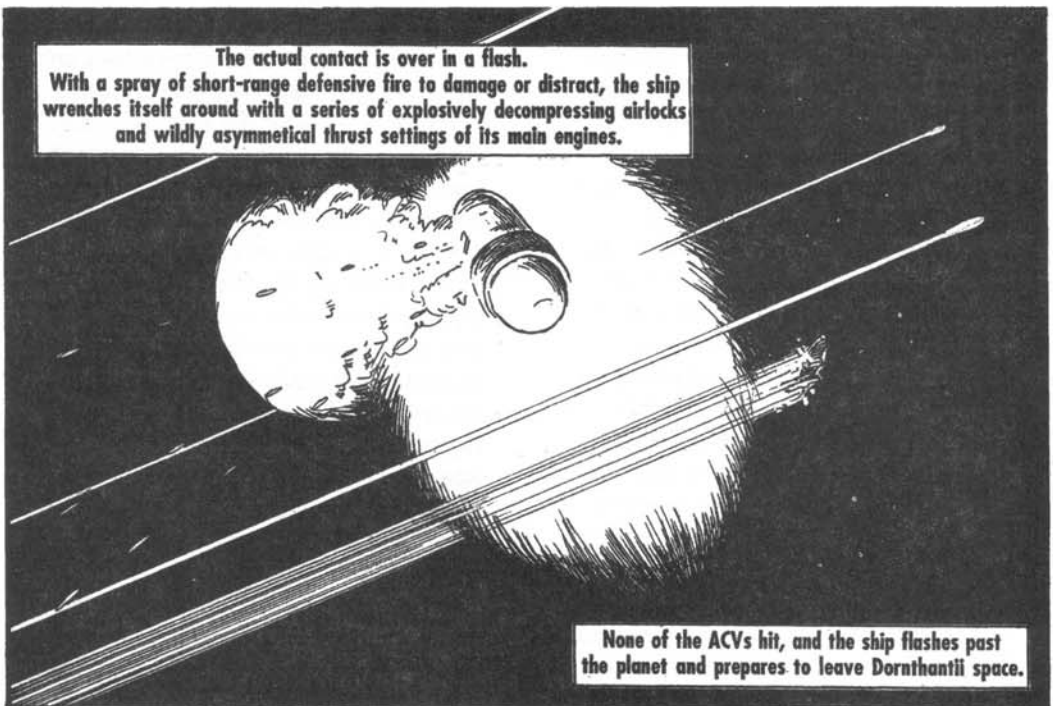

The actual contact is over in a flash.
 With a spray of short-range defensive fire to damage or distract, the ship wrenches itself around with a series of explosively decompressing airlocks and wildly asymmetrical thrust settings of its main engines.

None of the ACVs hit, and the ship flashes past the planet and prepares to leave Dornthantii space.

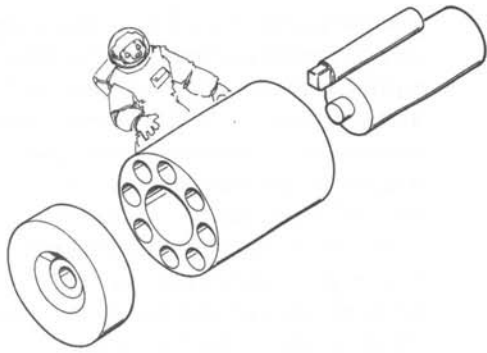

in the direction of the engines. To an outside observer, the crew might appear to be standing on the "walls" relative to the direction of the ship. True starships are constructed to reflect this – aerodynes intended for short jaunts may not be, meaning the crew must be strapped in whenever the ship is under thrust. When a ship is halfway to its destination, engines are cut and the ship rotates on its axis so that the thrusters are facing the destination. The engines are restarted, and the ship begins to decelerate. Crew members and passengers should be strapped in during the rotation process, during which they are weightless.

Spaceships usually thrust enough to provide slightly less than 1 G of apparent gravity, just under what a human would consider normal. Smaller ships traveling long distances may have serious fuel limitations on thrust, and simply accelerate to a given speed and coast from that point onward. The crew is simply weightless when the ship is not maneuvering.

Few non-military crews would dare subject themselves to more than 2 Gs of acceleration, except in an emergency – fuel expenditure is just too high, and the passengers and crew would be required to don G-suits. Military vessels have been known to thrust at 2 or 3 Gs for hours, even days, on end when speed was essential, but this considered extremely unhealthy. Smaller ships, such as aerodyne fighters, may achieve 9 Gs of acceleration for very short periods during extreme combat maneuvers. If a passenger is strapped in, prone, and wearing a fluid-filled G-suit they can endure up to 7 Gs safely for several seconds. Beyond that, most people pass out quickly,

and may suffer permanent internal injuries if the acceleration is maintained for more than a few minutes.

Interstellar Travel (Faster-Than-Light)

The development of the faster-than-light (FTL) drive is the single greatest achievement in the history of sentient races, one that was developed specifically to help answer one of the oldest questions – "Where did we come from?"

The jump drive itself is network of energy channels buried in the hull of the ship, connected to a series of nodules that contain the jump technology. As energy is passed through this network, the nodules generate a field around the ship that draws it into another dimension, one in which infinite speeds are possible. This field is spontaneously generated when a certain energy point is reached.

Strong gravity fields, such as the ones created by stars, have a striking influence on this dimension, one that governs and limits the use of FTL travel. One common model used to explain the influence of gravity on space is to imagine the universe as a flat-rubber sheet. Here and there on this sheet are placed balls of varying sizes, made of different materials. These balls represent large objects, such as stars. The balls sink into the mat and cause a distortion in space around them. Very large or dense balls sink deeper into the mat, and create a larger distortion. If a toy car (for example) is rolled along the mat, it will be drawn into one of these areas of distortion – the "star's" field of gravity – unless it is pushed with sufficient force to speed on by.

When in jump, the effect of gravity wells (such as stars) is effectively the opposite of that in the model described above. Instead of creating depressions in the mat, the balls create hills and mounds of various sizes. A toy car placed on the edge of such a hill would roll forward across the mat until it encountered another hill, where it bumps to a stop. A ship in jump acts in a similar fashion. It is pushed away from its system of origin until it encounters the nearest stellar gravity field, at which point it "stops" and drops into real space.

Ships may only jump to the closest system along their flight path. The transition from one system to the other is effectively instantaneous, and the passengers do not "see" the jump dimension, even if they are at a window. All that is visible is a bright flash of light. Since navigation is done by setting flight path in the direction of a given star, jump drives become more inaccurate the further one attempts to travel.

This is because there are no fixed points in space, and even stars are constantly in motion. All that may be seen through remote observation is the position of the star as it was when light currently arriving at observer's position left the star. As such, there is a practical range limit of approximately 50 light years for any single jump. Beyond that point, the target star has probably shifted so much that even most careful jump will miss it entirely. Ships that attempt jumps greater than 50 light years are almost invariably lost, either showing up wildly off course, or worse, have their mass dissipated between several relatively nearby stars.

Jump drives may be charged from any energy source, but they are most commonly charged gradually as a ship thrusts out of the system. The output from the onboard fusion engines is passed through a series of Magnetohydrodynamic (MHD) coils before being expelled from the ship as thrust. As the fusion jet passes over the coils, an electrical field is produced, and the jump drive is charged. In this way, maximum use is made of the engine output. The time it takes to charge the jump drive thus depends on the amount of thrust – a freighter accelerating at 0.1Gs will take ten times as long to charge the jump drive as a passenger liner thrusting at 1G acceleration. It typically takes around ten hours of 1G thrust to charge the drives after an interstellar jump.

Because of the time required to charge the jump drive, and the requirement for extensive maneuvering to reset the flight path for a new destination, few ships can immediately jump again upon arrival in a new system. However, some military vessels and fast couriers carry additional jump

charges in onboard batteries that allow them to jump as soon as possible after arrival.

It is extremely unsafe for a ship to jump while under the gravitational influence of a star or planet. As such, they must travel to the edge of the solar system before engaging the drive – this distance can vary between four billion and ten billion kilometers in an inhabited system, and may be much more in a system with an extremely dense star. As noted above, acceleration is limited by fuel and by the physical limitations of living crewmembers.

Depending on the fuel available, accelerating out of the system may take several months. Once the ship arrives at its final destination it must decelerate as it approaches its destination, a process that adds even more time to interstellar travel. Even the fastest manned ships typically take at least a month to travel from one system to another, and freighters with small fuel tanks may take the better part of a year to make a single trip.

Interstellar travel by private individuals is uncommon, and the average person will never get the opportunity to leave their home system. The majority of what traffic there is takes place between the Core Worlds, and most private travelers are businessmen traveling on behalf of their company. The time and expense involved in traveling from one system to another means that tourists are rare, though not unheard of. Such tourists are generally the idle rich, or retirees who have decided to use their life-savings seeing the universe. A new trend is for very well-off parents to send their adult children on a tour of the Core

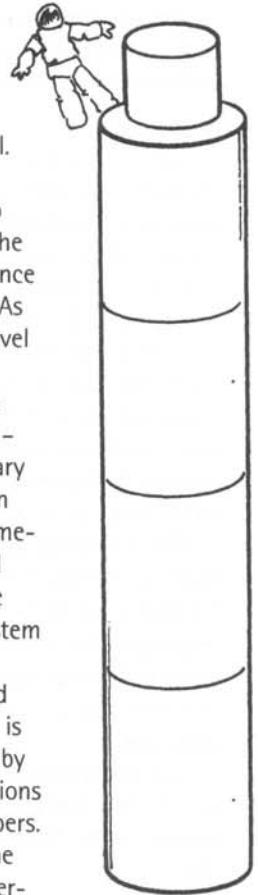

Worlds (or Arras Charka, at the very least) in order to soak up some culture before embarking on a career.

Misjumps

Misjumps are possible. Jumps occur through the agency of energy fields that alter the relationship between the ship and the rest of the universe. Errors in the alignment of these fields can cause serious problems for the ship and crew.

They expose the crew to strange radiations, and "tug" at their atoms. This can cause serious neurological damage, ranging from short term illness to immediately fatal injuries. In very serious cases, the structure of the ship can be compromised.

Short-term effects are known as "jump sickness." The victim can be incapacitated for several weeks. Drugs exist to repair the neuro-physical damage, and patient must avoid making any jumps for some time. This can pose a serious difficulty during combat maneuvers.

Latent psychic abilities may make a spacer more susceptible to the effects of jump sickness. There is no known reason for this.

Vehicles

The futuristic world of *Albedo* is home to many vehicles. The Extraterrestrial Defense Force is mostly concerned with space-worthy ones.

Aerodynes

Aerodynes are the most common and familiar form of spacecraft, as they are specifically designed for use in the atmosphere. An aerodyne is a wingless aircraft with an

aerodynamically designed hull that provides lift. Aerodynes use fusion powered jets while in the atmosphere, and fusion thrusters when they leave the atmosphere. They range in size from single-person, 1-ton gunships to 5,000-ton cargo ships. Above 8000 tons, aerodynes become impractical for atmospheric flight.

Smaller aerodynes are used to travel from the surface into orbit or to nearby space stations, though any aerodyne with sufficient fuel may be used for travel within a solar system. In some systems aerodynes are extensively used as interplanetary shuttles, but they are more commonly used to shuttle passengers and cargo to waiting starships in orbit.

A number of shipping companies have outfitted aerodynes with jump drives to save on the cost of transferring goods from starship to surface in separate landing craft. Jump capable aerodynes generally displace under 1000 tons, and are used for hauling medium sized cargos. They are perhaps the slowest method of interstellar transport. Their relatively small size and need for free cargo space means that they carry as little fuel as possible. As such, they are not able to constantly accelerate as they travel out of the system. The crew spends a great deal of time in zero-gravity conditions as the ship coasts to a jump safe distance.

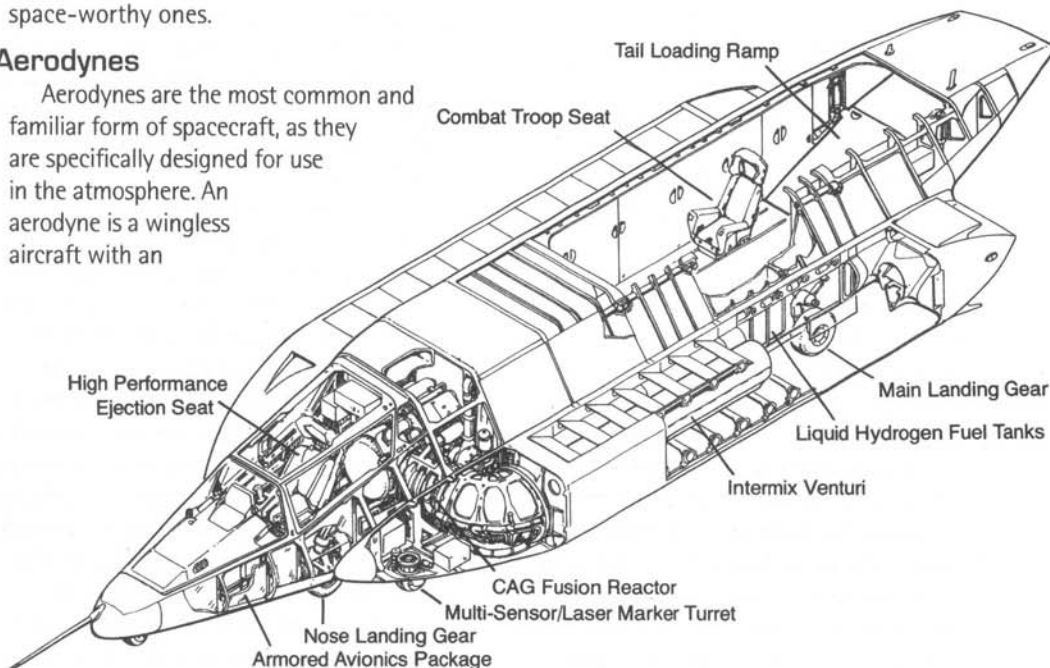

Jump-capable aerodynes are most often operated by small shipping firms, though some are in the possession of independent captains. Aside from personal yachts sold to the extremely wealthy, these tramp freighters are the only interstellar ship an individual has any chance of acquiring. Smaller vessels are impractical for interstellar travel, and true starships are so expensive as to be the sole province of large corporations or planetary governments.

True Starships

Starships are large cylindrical vessels, rarely displacing less than 8000 tons, equipped with powerful fusion thrusters. Most are jump capable. They may not enter an atmosphere under any circumstance, and usually carry a number of aerodynes in an internal hangar for use as landing craft.

Starships are specifically designed for very long periods of space travel, and more than half the mass of the ship is typically taken up by hydrogen fuel tanks and fusion engines, allowing them to accelerate for long periods as they make their way out of a solar gravity well. There is no limit to the upper size of starships – the EDF has a number of Very Large Command Carriers (VLCCs) that top 5000 meters in length. (See below) A ship this size has a crew numbering in the tens of thousands, and has literally dozens of landing craft, aerodyne scouts, fighter craft, and even smaller starships stored in internal hangers. Some colony ships may exceed this size, as may space-going shipyards.

There are exceptions to these generalizations. Interplanetary craft that are not required to land are often built along the same designs as true starships.

Autonomous Combat Vehicles (ACVs)

Autonomous Combat Vehicles (ACVs) are self-directed, multipurpose drones carried by nearly any military vessel larger than an aerodyne. They are also a standard defensive weapon used in planet-side installations. They contain an AI computer in an armored core, powerful sensors, a reactor drive, and sufficient fuel to allow bursts of acceleration up to 50g's. They have no provisions for crew or jump drive, though they may be

adapted to carry small (and very durable) cargos. Some are modified to include point-defense systems such as lasers, mass-drivers, and missiles.

When entering a hostile system, a capital ship launches a number of ACVs. In a typical deployment, some of these ACVs will speed ahead to a target planet or facility and conduct high-speed scouting passes, while the remainder forms a defensive screen several thousand kilometers in front of the vessel. They make sensor sweeps of the space in front of them, and pass the data back to the home ship.

ACVs on planetary scouting runs will rocket past at maximum speed, identifying potential targets and defense structures, and transmit this data back. They may then either impact those targets themselves, circle back to join the defensive screen, or attempt to impact with enemy vessels.

ACVs defend their home ship by simply impacting with incoming missiles and ships. They are capable of tremendous speeds, and not even mono-molecular ship hulls can withstand the transfer of sheer kinetic energy. All but the largest ships will be destroyed by a direct hit, and even capital ships can be severely crippled if they impact with tiny pieces of shrapnel from a destroyed ACV.

Very Large Command Carriers (VLCCs)

Very Large Command Carriers (VLCCs) are the undisputed masters of space. They are the largest ships ever built – some more than 5000 meters long, carrying tens of thousands of passengers. Only the EDF and ILR currently field VLCCs, though the Enchawah Group has a few floating factories of similar scale.

VLCCs typically form the foundation of large aerospace forces, as well as ground assaults. They carry troops into battle, and provide them with all the equipment and supplies they require. They carry complete robotic factories within themselves, churning out ammunition and replacements for damaged or destroyed equipment. These factories are highly customizable, and can produce nearly any good. In fact, the EDF



often uses them to produce consumer goods during peacetime.

Ideally, VLCCs are self-supporting units capable on remaining in the field for literally years at a time. They have onboard organic vats for the creation of food, and ample supplies of fusion fuel. In practice, however, they are rarely dispatched for tours longer than a year.

Some Command Carriers lack interstellar capability. Most are in defensive standing orbits around planets or other satellites, and are usually just called "space stations".

Medicine

Medical technology in the *Albedo* universe is capable of extraordinary life-saving feats. Effective treatments eliminate most forms of cancer, if they are caught quickly enough. Advanced artificial organs greatly reduce the chance of rejection, and can operate for decades without surgical maintenance. Cybernetic replacement limbs are available, but are not commonly used, as advanced techniques can save all but the most heavily damaged limbs. Drugs may be tailored to genetic code of the individual patient, and offer quick and effective cures for most diseases. Mortally wounded patients can be placed into a long-term coma resembling suspended animation until their condition stabilizes. Even first-aid on trauma cases in the field has a very high rate of success.

The effectiveness of medical treatment is due, in large part, to the assistance of the Medical Net. Even if you suffer an injury in the home, the Net can quickly summon assistance and provide detailed first aid directions. Once in a hospital, the Net provides information about the latest medical techniques and research. Robotic surgeons under the direction of living doctors can undertake incredibly delicate operations, even grafting individual nerves together.

Unfortunately, even the most advanced medical facility is unable to perform miracles. Instant healing of physical damage and resurrection of the dead are still impossible dreams. A character badly injured in a crash or gun fight will face several weeks in hospital, followed by several months of physical therapy, though their chance of surviving to make a full recovery is very high. A character who is killed in combat will never return, though it is possible to clone a physical replica of the deceased from his genetic material. This replica will have none of the memories of the original.

Agriculture and Food Production

Starvation and malnutrition are extremely rare among the races of the *Albedo* universe. Food is largely manufactured, like any other consumer product. Sufficient quantities of raw nourishment are provided

free to citizens in socialist systems, and for an extremely low cost to others. At the basic level, this usually consists of raw organic material, shaped into bars, balls, or served as a semi-solid paste. Food of this kind is nourishing, although not very tasty. Texture is counted as more important than flavor, at least when it comes to staple foods. Particularly elaborate or flavorful dishes are available for a price, either sold pre-packaged in stores, or prepared to order in restaurants and diners.

Basic foods are grown in enormous quantities in food production factories. Organic material is raised in vats, simple edible lumps of proteins and amino acids. Chemical additives bring flavor and additional nutrients. Citizens in the middle class and higher often prefer not to make food of this kind the staple of their diet, and some claim they can still taste the "taint of metal." Military personnel on long-term operations aboard a ship rely on vat-grown organic proteins, and larger vessels have their own food vats.

Traditional farms exist, where vast fields of grains and leafy plants are tended to by robot crews. These plants are either sold as is in fresh markets, or processed into final food products. Some worlds also harvest sea life and surface arthropods, which may be likewise sold as is, or processed. Specialty restaurants serving fresh fish, clam-cakes, roasted spiders, and green salads have become quite popular on many worlds.

Artificial meat is also produced. This process consists of growing sheets of muscle tissue engineered from raw genetic material taken from animal food sources. Artificially grown meat actually requires more food energy to grow than can be gained from eating it, making it rather expensive. Artificial meat dishes are becoming very popular as predator populations outstrip the capacity of farmers to produce food animals naturally.

The Medical Net passively monitors consumption, and citizens who rely on the government for their food ration (and this includes soldiers) may find their diet altered involuntarily if they are overeating, or seriously neglecting certain nutrients. Of course, it is always possible to buy addi-

tional food on the open market, and obesity has become a problem in some areas.

Carnivorous species are able to live on herbivorous diets for prolonged periods without any serious problems. In fact, certain societies have come to require vegetarian diets of their members. However, a carnivore used to a heavy protein diet will still have strong cravings for protein for many months. These urges can be controlled with effort, and can be eliminated by adding high-protein items to the diet. Herbivores are not similarly comfortable with a carnivorous diet, and may suffer serious health problems if they do not take artificial diet supplements.

Cases of cannibalism (defined as the consumption of one sentient by another) took place during the war, in areas where the structure of society had entirely collapsed. Most cases involved predator species hunting and consuming herbivores. These cases are regarded with universal horror.

Communications and the Net

Every citizen who chooses to do so can be immediately connected to almost any person on the same planet. Unfortunately, science has yet to develop a means of directly broadcasting information at faster-than-light speeds, meaning messages must be carried step by step, from system to system by unmanned message torpedoes. Thus, it can take months for news to reach the Core Worlds from an Outer Colony.

To send a message to another system, it must be broadcast to an orbital communications platform. There, the message is stored electronically on an interstellar message torpedo. These torpedoes can store numerous terabytes of information, enough to accommodate every piece of information generated by several hundred-thousand people over the course of several days. A good portion of this information consists of dry statistics, government reports, and stock market results, bound for the databanks of the Net. Private messages between citizens comprise much of the remainder. The Net itself is intelligent enough to identify information that it feels should be available

to users in other systems, and automatically saves something to every torpedo.

These torpedoes are launched according to a regular schedule, or when they approach their capacity. The torpedo accelerates to the edge of the system. Since the torpedoes have no crew, they can accelerate much faster than manned vessels, and can leave the system in as little as four or five days. Once it is clear, it jumps to the next system. In some of the core systems, a constant stream of message torpedoes enters and leaves the system on an hourly basis.

As soon as the message torpedo arrives, it broadcasts its contents to the local communications center. It then decelerates and docks with the orbital platform for refueling. As it approaches the platform, it may already start accepting new data for transport back to its home system. Messages intended for local recipients are immediately uploaded to the local net. Others are saved to the next outbound torpedo. Certain information, like news and government information, is automatically transferred to every outgoing torpedo. In this way, news and information filters its way through known space over the course of several months.

This time delay has a serious impact on everything from military planning and disaster relief to interstellar trade and politics. During the first ConFed/ILR war, it

was weeks before the Core Worlds became aware of the first attacks, and even more time was required to dispatch a response force.

Note also that the information placed in the torpedoes may be controlled and limited by the local government, or even by private corporations. For example, the government of Denotah is very close-mouthed about revolutionary activity on their world, and takes care to review and edit any information contained in media reports before they are uploaded to the message torpedoes. So, while residents of Denotah may access full media accounts through their local Net, users on Dornthant will have access only to edited information. The Net on Dornthant may or may not be aware of changes made to the information. Corporate interests may also limit the information which goes to the Net in other systems, for reasons of financial gain.

This government censorship may become quite extreme in times of war or unrest, when all independent media outlets and even personal correspondence may be barred from transfer to the message torpedoes. Some Unaligned Systems have chosen not to accept or send message torpedoes except under certain circumstances.

Information stored on message torpedoes is usually encrypted to guard against theft. The most important safeguard, however, is the extreme acceleration the



torpedo is capable of. They simply move too fast to be intercepted – though they may well be destroyed by beam weapons or swift interceptor missiles.

The Net

The Net is an enigma, one that surrounds and supports almost every single citizen in the Confederation and Outer Worlds. It is the voice and personality of a vast communications and information network that connects almost every single computer in the known universe – whether that computer is a university mainframe, robot CPU, or handheld computer.

The Net serves as a nurse, psychiatric counselor, private banker, reference library, confidante, and protector. For many, the Net is a discrete friend and well-informed servant who is constantly available to proffer practical advice. The personality it presents is different for every person who accesses it, geared to their personal preferences.

The Net has existed since the first day of history. Many believe it to have been put in place by the Creators to assist in the development of the sentient races. Most people believe it to simply be a benign tool that assists the sharing of information, no different from the roads or factories left behind by the Creators. Some, more conspiracy minded, believe the Net to be something very different – a relic left behind to monitor (and possibly control) social and technical development. Some believe the Net continues to report in some secret fashion to the Creators.

LIMITATIONS OF THE NET

It is important to realize that the Net is not a singular AI entity, like a robot or stand-alone computer. It is a method by which disparate information from literally billions of sources may be accessed and easily digested. The personality that the Net presents is simply a handy interface to make that access easier. It is not a "person," not even in the sense that an artificially intelligent robot is, though it is programmed to simulate a pleasant and helpful personality. This personality is different for everyone who accesses the net, and is geared to their specific psychology.

While the Net is present on most worlds, it is far from omniscient. It is limited to information that is present in the computers it is *connected to at any given moment*. On a Core World, this represents a great store of data, far greater than any library in the real world. A user on Dornthant can access everything from the writings of a great poet, to an old civil report on ground traffic patterns in Batu City on Denotah.

However, a user on a mining post that does not have regular communications with the universe at large would have access only to data stored on local computers – likely rather dull, practical information about mining techniques, union regulations, and first aid. The personality of the Net may be the same, but it will have far fewer reference tools to work with. Ships in interstellar space do not have access to the larger Net, though the experience of seeking locally stored information from the computer would be indistinguishable.

While the Net is spread through most of known space, and information is shared between solar systems, access to off-world information is limited by the speed at which data drones may be transferred from system to system. It is impossible, for example, for someone on Dornthant to find out what the current weather conditions on Derzon are. At best, one can access the most recent weather records uploaded to the regular data drones. This information will be several weeks out of date. Of course, the Net will happily provide an educated guess about current conditions based on past weather patterns and existing forecasts.

Users of the Net are also limited as to the information they may access locally. For the most part, these limitations are placed on sensitive documents or personal records. An ordinary civilian is unable to review the personal correspondence or banking information of his neighbors, or view the defense plans of the planetary Homeguard. A clever programmer may be able to access restricted information, but the task is well beyond the capability of the average user.

The Net does not see anything, unless it happens to have access to a computer with a camera in a given area. Most Core World households *do* have cameras linked to their

computer terminals, and the Net uses these to personally greet the homeowners and monitor their status.

The Net is largely dependent on the information that it is provided with. It rarely verifies that information, though it is intelligent enough to identify clearly false or forged records. It is possible to fool the Net.

While the Net is aware of the psychological needs of its users, it obviously does not experience these emotional states, and therefore it is not truly empathic. It will offer common-sense advice about things such as romance if asked, but this advice should be taken with a grain of salt.

USING THE NET

Anyone can communicate with the Net through a standard home computer or personal data pad, provided it has access to the local communications network. The Net can communicate via text messages, or through speech. Its default voice at public terminals is androgynous and acentless, but this may be altered to suit local speech patterns or personal whims. A visitor from the Core Worlds should not be surprised to find the Net speaking in an unintelligible drawl when he visits. The Net is intelligent enough to adjust its interface to suit the speech patterns of an interlocutor, provided it is aware of his or her preferences.

The Net on each world offers a number of specialized services, which are generally thought of as "Nets within the Net." While they are not technically separated from each other, and the Net at large, they operate discretely within the larger whole.

MEDICAL NET

The Medical Net draws information from doctor's offices, research facilities, and the like. For most people, it acts as an at-home consultant, providing advice as they administer basic first aid or seek help with common ailments. It is not legally qualified to offer specific diagnoses since it cannot physically examine a patient most of the time, but can make accurate guesses that assist in treatment.

The Medical Net takes a more direct role in treatment at a hospital, where it may interact with the physical world with specialized robots. Indeed, in some facilities

it is not uncommon for a patient to be admitted, treated, and released without ever being examined by a flesh and blood doctor.

SOCIAL NET

The Social Net exists for one reason. It links users to other users with similar interests and needs, through live video chats conducted on hand computers, text messages boards, and by arranging for real life meetings. Users can find fellow enthusiasts for every topic, ranging from informative groups that study the distinctive marine life of Denotah, to parent support groups, to friendship circles, or even sexual partners.

COVERT NET

The Net is the only obvious tie between the current societies of the inhabited worlds and the Creators who placed them among the stars. Several programmers and engineers have searched its records to find out more – some hidden message, perhaps, or a set of instructions that will shed light on the purpose of the Creation. So far, all have failed.

The Net does, in fact, contain a secret artificial intelligence that monitors the development of society, watching developments and predicting trends. This program, known as the Covert Net, works towards an eventual goal that not even it is conscious of. It rarely takes obvious action, or identifies itself. From time to time it will select certain extraordinary individuals and encourage their careers, or hamper the movements of others. It may delay the release of information, or ensure that a certain document happens to show up on the computer of someone who can act on it. By and large, these actions have the result of obviously upholding the good of the greatest number of people. An outside observer might credit these events to the action of coincidence, but some have come to suspect the truth.

The recent growing crisis has prompted the Covert Net to take a direct hand from time to time. When this takes place, it is always on an individual basis. An EDF officer on a lonely patrol might suddenly find his hand computer speaking personally to him, telling him of a conspiracy among his superiors. A politician asleep in her private

quarters might be awakened in the middle of the night by her personal computer, which instructs her to flee the planet before a planned coup.

Those that the Net elects to guide in this way are known as the Net's "Chosen." They often find themselves thrust into the middle of extraordinary and world-shaking events, whether they wish to be or not.

In recent months, a group of power-hungry EDF officers and ConFed officials have developed software tools that are capable of erasing records from the Net. While using this tool to change public record, they found that certain files were being removed, as if by magic, and moved elsewhere as if to protect their contents. The cabal has come to suspect the existence of the Covert Net, and regard it as an enemy.

Robots

Robots are a fact of life on most well-developed worlds, but rarely seen or noticed. They work behind the scenes to support industry and infrastructure, and are seldom seen operating independently in public. They are most often found in government facilities and corporate factories, though models used for menial household tasks such as cleaning are becoming more com-

mon among the upper class.

All robots are linked to the Net, unless specifically created without any kind of communications equipment. This means that speaking to a robot is indistinguishable from speaking to the Net. However, robots tend to have very specialized programming, and simpler models (such as one dedicated to building aerodynes) may not be able to offer all the functions of the Net.

Most robots are quite limited in function and mobility. They have one or two arms, and are locked onto a track on a factory floor. They can do one or two tasks quite well, but are totally incompetent when it comes to anything outside their narrow programming. Other robots – like the electronic surgeons at central hospitals – are extremely advanced with flexible intelligence, but far too delicate to leave the facilities they operate in.

A robot capable of independent movement outdoors is usually quadrupedal, with two primary manipulator arms at the front and additional, smaller arms along the length. They walk fairly low to the ground, and are capable of sprinting indefinitely at speeds of about 30 KPH. Any of the limbs can be folded compactly against the body of

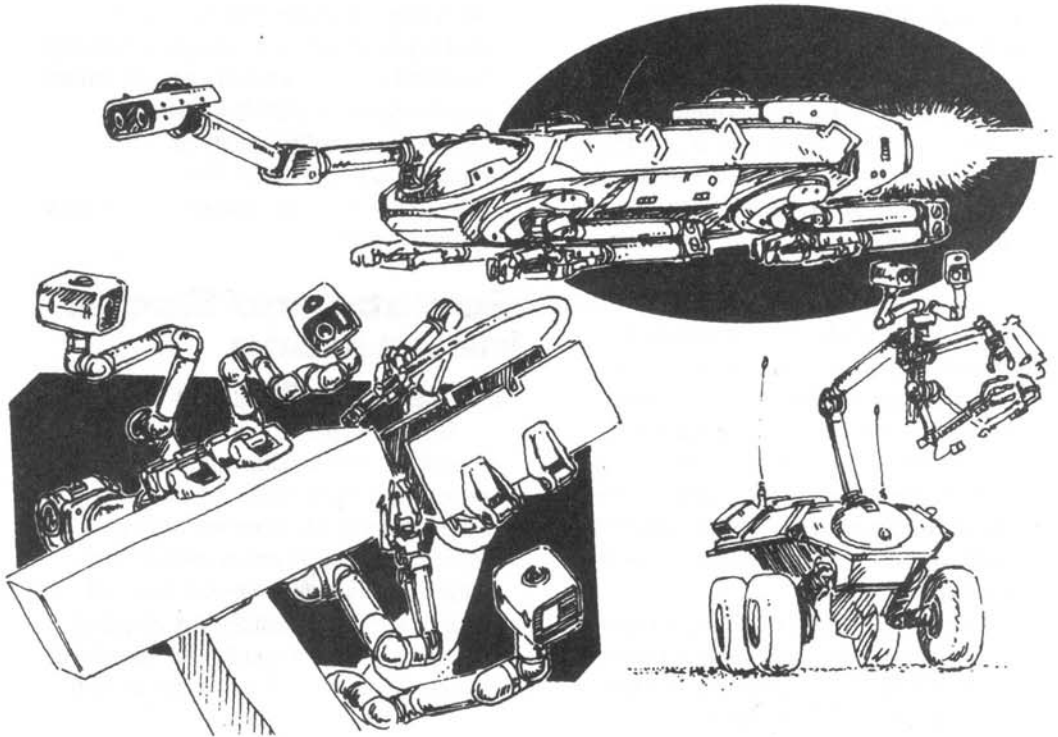

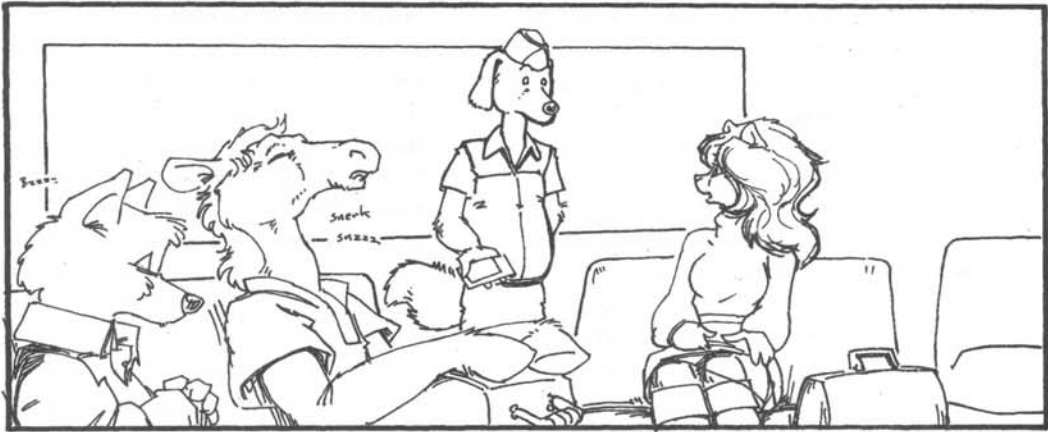

the robot. Wheeled versions also exist, as do ones fitted with thrusters for work in space. A flexible and extendable neck carries a camera and sensor suite in the "head." The head does not contain the central processor or Net link, but destroying it would still render the robot effectively blind. Robots of this kind are used for a multitude of roles, and can be found in mining camps, military bases, or anywhere else there are difficult or dangerous tasks that need to be completed.

Independent robots have an excellent level of general knowledge, and will actively seek information from the Net when confronted with a new situation. For example, a terrorist plants a bomb in a corporate office. The cleaning robots encounter the bomb in a remote hallway, but ignore it. Even though they have a Net connection, they are not programmed to enquire about new items they encounter, so they pass on by. Hours later, a general duty robot en route to the factory floor spots the bomb, and finds no match for the device in its internal memory.

The robot uplinks to the Net, and discovers the device is a bomb. It immediately contacts building security and issues an alert to the police. Further examination reveals that the bomb will explode before security teams can possibly arrive. Linking to the Net once more, the robot accesses bomb disposal information. It is able to defuse the explosive with nearly as much skill as a flesh and blood professional.

Armed robots also exist. ACVs, for example, are simply space going robots. However, field experiments have proven that robots are not practical as a replacement for

infantrymen in direct combat roles. They are too expensive, subject to costly breakdowns, and incapable of the same role flexibility as a flesh and blood soldier. Combat robots are used for extremely dangerous scouting missions, or tasks such as disarming ordnance. They are placed under the direction of Command and Control officers at the local HQ. They are distributed to squads on the basis of need, and usually require brigade-level authorization.

It is thought that both the EDF and ILR have secretly developed independent "sniper bots," relatively small robots that cram themselves into hidden nooks on the battlefield, and await the passage of enemies. These units are little more than walking guns, with just enough intelligence to identify uniforms and targets. ILR models may be rigged to explode if disturbed. Similar, even smaller, robots have been reported by police forces. They are essentially pistols with legs, programmed to kill a specific person.

Society and Social Institutions

Castes and Classes

Social class plays a significant role in the lives of citizens on many worlds. It determines the company one keeps, opens (or closes) doors to advancement, and may influence the way in which one is treated. Class is generally determined in terms of wealth, at least on capitalistic or corporate worlds. Elsewhere, it is judged by one's fame, service to society, or circumstance of birth.

Upper Class

Citizens on worlds with capitalist economies are, for the most part, constantly striving to achieve a foothold in the upper class. Wealth brings significant advantages on every world in known space, and the lifestyles of the ultra rich – private space stations, secluded homes with robotic servants – are the subject of simultaneous envy and disdain.

For most, being in the upper class simply means access to a large amount of ready capital with which to buy luxuries. Most in the upper class will still have a job – that job is simply very lucrative.

On a typical capitalist world, a member of the upper class will have a large home in a desirable location. He or she will have access to the most expensive electronics and appliances, own a lavish personal car (or cars), and may own a small atmospheric aircraft, such as a helicopter. He or she may have a small staff of servants. Interplanetary travel is affordable, and occasional trips to another star system are possible – though still costly for all but the very rich indeed. A job in the highest echelons of management, or actual corporate ownership, may put one in this class.

On some worlds with a hereditary nobility or similar ruling class, people join the upper class by simple accident of birth. This may not necessarily entail inheritance of wealth. There are impoverished nobles, and many societies have hereditary positions that come with the respect and esteem of society without attendant financial benefits.

The term "Upper Class" is nearly meaningless in the Core Worlds, and on planets that have adopted their example of paternalistic socialism. Social class on these worlds is largely a factor of responsibility rather than one's ability to generate wealth. As such, a senior EDF officer or a notable ConFed diplomat comes closest to the capitalist idea of upper class. They will have access to a sizable monthly stipend from the government, and be entitled to reasonably lavish quarters and a personal vehicle. These perks are likely owned by the state – the individual "owners" are merely temporary stewards.

It is possible for a corporation president to generate a great deal of wealth in the Core Worlds, and even to become a member of the idle rich, but they will not be afforded the same degree of respect as a citizen who is actively involved in administration or social service.

Middle Class

The middle-class is the default status of the largest portion of the population, and the lifestyle of a middle-class family in the Enchawah Group is not significantly different from that of a family in the Core Worlds.

A middle-class individual owns a modest home or apartment in a relatively nice area. He or she has a selection of home electronics, and, in the corporate worlds, a personal car. Middle-class families can afford fairly regular vacations on their own planet, and from time to time may splurge for an interplanetary flight. Interstellar travel is beyond their means, unless they are a member of the crew.

A middle-class lifestyle can be maintained by nearly anyone with a regular job, on most worlds. In the ILR, rising prices have put the squeeze on the middle-class, and it is rapidly shrinking as more and more people are forced to take on additional work to maintain their lifestyle. In the ConFed Core Worlds, anyone who works more than 20 hours a week is provided with a government allowance that essentially assures them of a middle-class position.

Lower Class

Lower-class lifestyles range greatly in quality. People with very menial jobs in the Enchawah Group are considered lower-class, as are those who simply choose not to work in the Socialist Core Worlds. Yet, both are assured a relatively comfortable and commodious existence. They have enough to eat, and are adequately clothed, and have access to the public Net.

Lower-class life on some of the less settled frontier worlds, or less forgiving Inner Worlds, is a very different matter. On Denotah, for example, working poor struggle to keep up the debt incurred by company stores. Others simply give up, and make a living on the street as beggars.

Starvation in the midst of plenty is not unheard of in some systems, and the concept of organized charity has not been developed.

Economics

Economics is the science of production and the theory of distribution of wealth. It is rarely a precise science – economies on a planetary scale are nearly impossible to quantify except in very general terms. There are a number of different economic theories in force throughout known space, as philosophers and charismatic leaders sought to create communities free from the Socialist systems of the core worlds. These may be divided into three general types: Capitalist, Communist, and Socialist.

Although most economic systems can be generally described in those terms, few planets make use of totally pure forms of these systems. A largely communist planet may, for example, allow small businessmen to keep their profits. A world with a healthy capitalist economy may have a number of government controlled monopolies running utilities, or services such mail. Local variations and combinations of each philosophy exist, and the game host is encouraged to be creative. In addition, any economic theory may also form the philosophical basis for actual legislative and executive government. For example, the Enchawah Group uses capitalist principles to guide the day to day governance of their planets, as well as their economies. All administrative decisions – about everything from placement of traffic signals to interstellar relations – are made in terms of the possible impact on long-term profitability.

The Confederation uses a universal unit of trade known as the *Standard*, created shortly after its foundation, when several planetary currencies were folded into one. After the War, the value of the Standard was allowed to fluctuate against other monetary units, and currency trading is a major past-time of interstellar investors. The Standard has long been the strongest currency in known space, though recent unrest has caused it to lose value against the Enchawah dollar.

The Standard is normally exchanged electronically, though physical banknotes exist. Many other currencies are available (such as the Dilbion "Star") but these are rarely accepted outside a given planet, though they may be exchanged for a fee at most banks. Some corporations issue company scrip to their employees. These notes may only be spent at company stores, and cannot be traded on the interstellar market. The ILR uses a unit of currency known as the "Credit." While it can be exchanged in for Standards in ConFed space, Standards may not be changed into Credits while in the Republic.

Capitalism

Capitalism is an economic system in which the means of production and distribution are privately or corporately owned, and development is proportionate to the accumulation and reinvestment of profits gained in a free market. Capitalism may be closely monitored and checked by government controls, or the market may simply be dominated by the companies that make the most money. Capitalism at its worst pursues profit without any regard for health, environment, or social mores. Ideally, participants in a capitalist economy self-limit that sort of behavior, if only in the interest of long-term profitability.

Communism

Put simply, Communism is an economic system characterized by the collective ownership of property and by the organization of labor for the common advantage of all members. Everyone in a Communist state is a "worker." Workers in a factory or office own that facility collectively, and direct its production. However, in its final form, Communism can be much more than this. The philosophy of Communism can extend to all levels of government and society, and may even dominate private social life. Citizens in a truly Communist state must measure every act as to whether it serves the greater good. Communism in the *Albedo* universe is not necessarily a revolutionary movement, though groups advocating violent overthrow of existing governments have begun to appear.

Strangely, limited Capitalism often exists on otherwise Communist worlds.

One common problem with Communism is that production is often not undertaken to meet specific demand. Thus, extreme shortages of one product may arise at the same time as warehouses are filling with products no one wants. The Net is able to mitigate this problem to a significant extent, but it still exists. Another concern in a true Communist state is the necessity for the individual to subjugate his or her personal life to the good of the population as a whole. This can be mercilessly enforced.

Communism also fails to account for the natural tendency of social groups to form hierarchies. This tendency conflicts with Communist principles, and unofficial hierarchies often form around charismatic or ambitious individuals. Alternately, people may compete for particularly glamorous or important jobs, which often come with influence beyond what Communist philosophy suggests. These individuals may eventually achieve officially recognized power, despite the ostensible ideals of Communism, either by force or by popular acclaim. In addition, some Communist planets have a ruling class of "coordinators" whose original purpose was to oversee the establishment of the Communist economy. These coordinators rarely give up power, and may even engineer a crisis to maintain control.

Socialism

Socialism is the single most common form of economy and government in Known Space. This was the system that existed on Arras Charka on the day of Awakening. Socialism may be viewed as a significantly softer form of Communism, in which the means of production and distribution is controlled collectively by the population, through their elected government representatives. Extreme socialist governments allow for no private ownership at all, while most only control significant or vital industries and allow a significant Capitalist influence on the economy.

True Socialist governments limit personal advancement through commerce, but in exchange offer a comfortable social safety net to those who are not as competitive or lucky. The majority of worlds in the ConFed are Socialist to one degree or another.

Politics

Politics refers to the system by which laws are made and questions of community importance answered. This system is usually planet-wide, though some worlds are home to multiple political bodies. The three economic systems listed above can, in some situations, also serve as the de facto political system on a given planet, though it more common to see one of the economic systems combined with a political system. A political structure on any given colony may

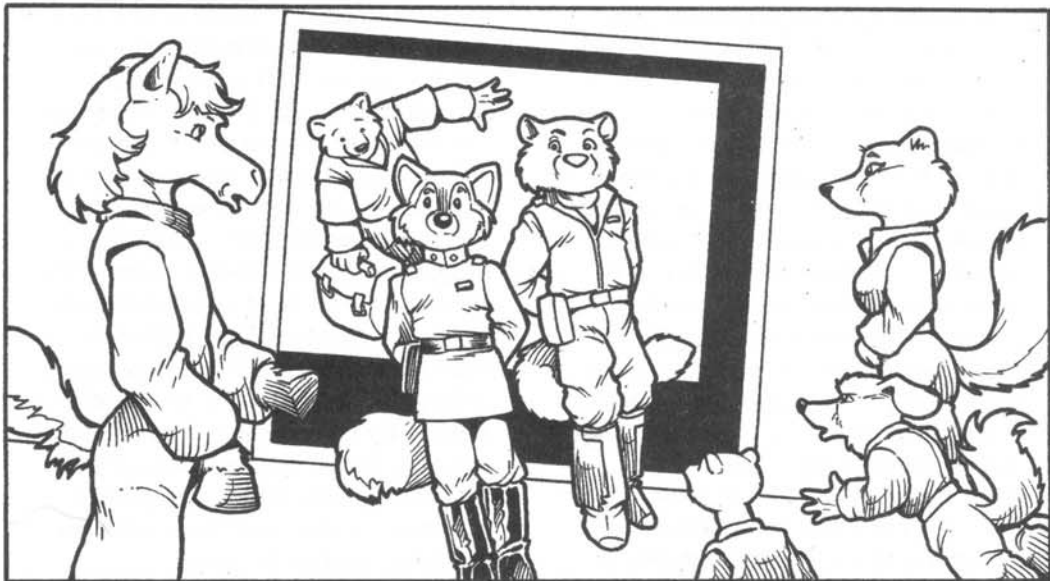

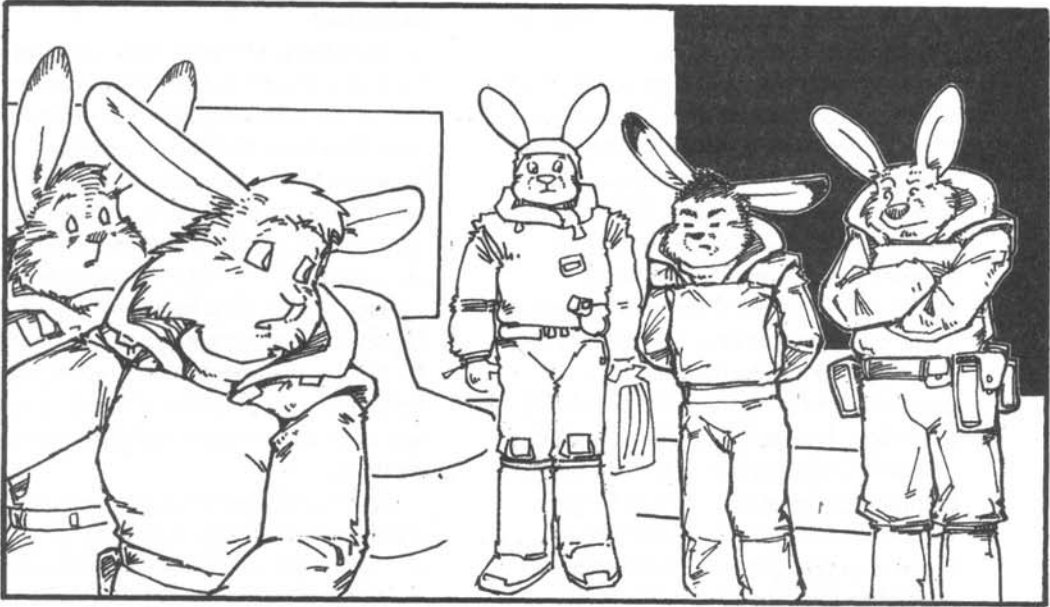

have been deliberately put in place by the original settlers, or it may have arisen over the years as the original structure evolved to suit the concerns of the locale.

Anarchism

Anarchism does not exist as the recognized system of government on any known world, though this simply means that other governments refuse to recognize "anarchy" as a political state at all. It is commonly defined as the absence of a political system, though it would be more correct to refer to it as the rejection of all forms of coercive control and authority. Anarchists have no laws, police, or taxation. Businesses may exist, but are rarely larger than one-man operations. Any kind of community services, such as fire crews or ambulances, are organized on an ad hoc basis and are composed entirely of volunteers. "Anarchy" does not mean that individuals are free to murder or steal – it means that the onus for dissuading thieves and killers lies with the individual. Anarchists may also form non-hierarchical communities that work for the common betterment of all – at least in theory. Unofficial hierarchies often appear, based on respect for skill or simple charisma.

Anarchism effectively does exist on several worlds, particular on the fringes of space. These worlds tend to be settled by small family groups or individuals who have no desire to have a formal government in

place over them. They may or may not describe themselves as anarchists. Anarchy may also exist as a temporary condition on any world where the government has lost control. Some worlds have seen the appearance of violent self-style anarchists who wish to dismember the instruments of the state by whatever means necessary. These few tend to color public impressions of all those who describe themselves as anarchists.

Confederacy

A Confederacy is an association between one or more states, designed to provide mutual assistance and open doors to profitable trade for all parties involved. The Interstellar Confederation (ConFed) is an obvious example. In a Confederation, decisions are made by a body of representatives from each member state. Individual citizens in each member state may have a direct voice in the electoral process, or the Confederate representatives may be chosen or appointed by the individual governments. The success or failure of a Confederation is largely dependent on the strength of its individual members, which may have widely differing political systems. In some Confederations, the Confederate legislature is very powerful, and has effective control over the individual states. In others, the legislative body serves as little more than a forum for discussing common concerns.

Conservatism

Conservatism is not so much a political system, as an attitude that emphasizes respect for status quo and the established order. Conservative governments of all kinds exist – though it is most often identified with nationalist or democratic states. Conservatism in the Core Worlds often refers to governments with cautious fiscal planning.

Fascism

Fascism is any system of government that stresses the unity of all classes and peoples in the service of national pride and strength. This pride is often embodied in a single person, who serves as dictator. All business and social life must work to the greater glory of the state, and individual rights are immaterial beside that end. While it is possible for any political system (except Anarchism) to have fascist elements, in practice it almost invariably leads to Totalitarianism. State sponsored bigotry and the active suppression of conflicting ideas are not uncommon. Almost any form of government can take on elements of Fascism – it is perfectly possible for a democratic planet to have a fascist dictator, provided he is able to hold on to popular support. Indeed, fascism is often a very populist. An unpopular fascist dictatorship would be more accurately described as a totalitarian state.

Liberalism

Liberalism, like Conservatism, is an attitude towards governance rather than a specific set of political principles. It holds dear the autonomy of individuals and the importance of civil liberties. Citizens under a Liberal government are free from arbitrary authority, and always have input in the political process. Unlike Conservatism, Liberalism is essentially incompatible with a number of forms of government. For example, Liberal Monarchies cannot truly exist, no matter how enlightened the noble class is.

Nationalism

Nationalism is a political philosophy that largely rejects the ideal of cooperative relations with other governments. A Nationalist government believes that independent action is the only way to secure what is

best, and that the goals of the home nation are more important than the concerns of outsiders. Any government may be Nationalist, though they are most often seen in Fascist and Totalitarian regimes. Citizens in a Nationalist regime often have a very poor view of outsiders.

Totalitarianism

A Totalitarian regime is one in which the government has complete and total control over all aspects of the economy and society. This control is not limited by a constitution or Bill of Rights. Any civil rights enjoyed by a particular citizen are granted at the whim of the government, and may be withdrawn immediately. Totalitarian governments often exist on planets where the original political system went wrong, and power was taken up an ambitious cabal or dictator. Sometimes, a government facing a crisis may introduce a *de facto* totalitarian system for the duration of the emergency. Totalitarian systems can enjoy the popular support of the citizenry, particularly if they are headed by a very charismatic leader. Popular regimes of this kind can actually be very efficient... though this efficiency may be horribly misdirected.

Franchise

Perhaps the most important feature of a government, and one which may be the truest indication of how well it serves the needs of the planet, is the level of franchise extended to the citizens. Franchise refers to the direct input that the population have into the political process, and it may be as simple as casting a single vote every few years.

Aristocracy

A hereditary ruling class governs the planet, and the common people have no real say in the political process. True executive power is passed on through the family line as an inheritance. The holder of this hereditary office is generally known as a King or Queen. In most cases, an elaborate hierarchy of noble titles exists to distinguish those who are related to the ruling family, and therefore in line (though sometimes distantly) to the throne. Monarchies are very rare, and are not permitted to join the

Confederation. The best monarchs are educated to be true servants of the people. They seek the counsel of the common folk, and must submit to the very laws that they, the monarch, create. The worst monarchs are simply debauched libertines who use their supreme executive power to live a life of ease, or terrorize their subjects.

Democracy

Democratic systems are by far the most common among the planets of the Confederation. In a Democracy, the population has a substantial influence on government policy. This is usually done through an election in which qualified voters cast ballots in support of a given candidate who represent their opinions in a legislative body. However, the level of Democracy on a given planet can vary to a great extreme. On some planets, representatives are elected for life, or the vote is limited to a very small group. On others, every single adult citizen is considered a member of the legislative body – everyone votes on issues and may draft legislation. This last model is only practical with extensive use of the Net to tabulate votes and keep track of legislation.

Dictatorship

In a dictatorship, a single individual is invested with all the powers of the government. This can occur as a result of a violent overthrow, popular revolt, or even the normal democratic process. In most cases, the dictator came to power at with the support of, at the very least, a significant portion of the population. Once in power, the dictator is free to ignore the will of the people, and they are effectively disenfranchised. Still, wise dictators court the favor of their people, and may even hold regular elections to give the appearance of input into the political process. However, these elections have no binding relevance, and are held at the whim of the dictator. Often, they are simply approval polls. Rather than offering a choice of candidates, the voters simply indicate whether or not they feel the dictator should continue as leader.

Meritocracy

A Meritocracy is a system in which skills, raw ability, or knowledge indicates what

rank in society an individual holds. The most talented or most intelligent, as determined by standardized tests or simple qualitative impressions, are the leaders. The best corporate-run worlds are Meritocracies, wherein senior executives must prove their competence. Scientific colonies are also often Meritocracies, with the population deferring to senior scholars.

Oligarchy

An Oligarchy is government by a few, especially by a small faction of persons or families. These often arise by default on frontier planets without a formal system of government. The founding family, or a large clan, has effective control over all major decisions. Oligarchies may also be founded by design. For example, ILR occupied worlds have an Oligarchial political system, with the rabbits effectively serving as the ruling class.

Plutocracy

A form of government in which the supreme power is lodged in the hands of the wealthy classes, Plutocracies are common on those Capitalist worlds that have few or no curbs on corporate activity. The Plutocratic class may have the best interests of the poor in mind when they make decisions, but more often they take actions simply to cement their domination over society.

The Arts

Art and Culture

The oldest society in the *Albedo* universe has existed for just slightly more than two centuries. As such, characters in *Albedo* do not possess the same breadth and depth of cultural reference that we enjoy in the real world. There are few well-known paintings or written works, and no famous pieces of music at all. While there are many talented artists, there is no *Albedo* universe equivalent of Shakespeare or Michelangelo. While individual artists may have a level of skill to match those human geniuses, they live in a society that simply does not recognize artistic achievement in the same way that ours does. The generally practical nature of society means that the few museums and galleries that exist are almost entirely

educational institutions that use artistic works to educate visitors.

For example, in the militant Independent Lapine Republic, school children tour military museums that contain nothing but skillfully created pieces of propaganda art. Dramatic sculptural tableaux depict war heroes and great political leaders, and highly expressive portraits enjoin the viewers to dedicate themselves to the service of the Republic. On Dornthant, school-children might visit a museum dedicated to the ideals of civic pride and cooperation.

Still, the sentient species of the *Albedo* universe possess a definite urge to create things of beauty for the sake of beauty alone. Even as the shadow of war falls across known space, new artists have appeared who create skilful works of art in the service of nothing but art itself. Indeed, the uncertainty of life in the known worlds may be one of the driving forces behind this growing appreciation for art and music.

Of course, the inherent behavioral differences between species, and social differences between worlds, mean that the artistic urge is expressed in very different ways. Restrained, civic minded Dornthantii might create a work of public beauty, such as a garden. A hedonistic Danetti artist is more likely to design a suit of flamboyant clothes, a uniquely portable masterpiece. Artists of

every species strive to create works that trigger a specific emotional state in those who witness their work – what state they are aiming for is largely dependent on the culture from which the artist came.

Music

Recently, music has started to become recognized as a proper art form, and listening to music has become a popular way to while away idle hours. The art of music is still quite primitive – songs usually consist of pleasant tones and simple beats that are intended more to encourage relaxation than dance. Singing is more or less unknown, though poems and rhymes with sing-song spoken rhythms are not uncommon.

In recent years experimental musicians have begun to create quite complex arrangements that incorporate vocal tones and more interesting beat structures, sometimes taken from environmental noises, like the rattle of a heating vent. Some of these artists are quite dedicated, and professional. Full-time musicians are making names for themselves throughout the Confederation.

Listening to music is highly personal experience, and as such it is not broadcast over any particular medium. Listeners are able to access the works of notable musicians by subscription over the Net, and

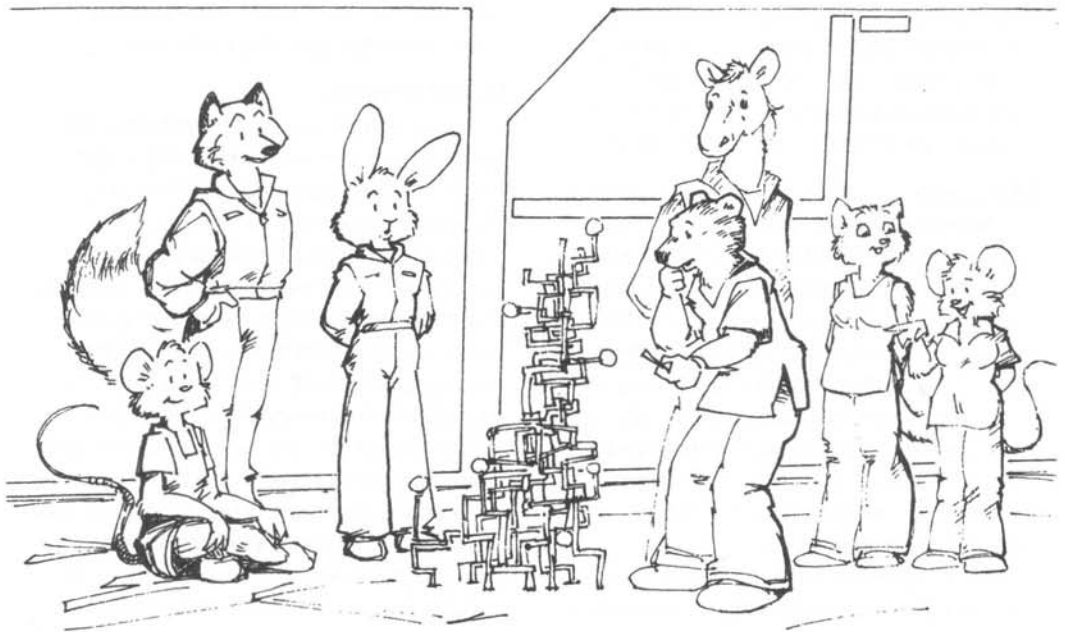

these songs are saved in digital format on hand computers. Even in public performances, the audience listens on personal headphones.

Fun and Games

In the earliest days, leisure activities were unheard of. Sports and intellectual games of imagination were regarded as the province of children. This is still largely true, though more leisurely pastimes have been invented in recent decades.

Conversation is the single most popular past-time, followed closely by sports, simple board games, and computer games – mostly simulations and trivia games.

Domestic Life

Family is very important to the races of *Albedo*, though the definition of a “family” can vary widely from society to society. On some worlds, it may refer to an extended collection of unrelated family friends, as well as blood relatives. On other worlds, only your spouse and children are considered family. At the core of these definitions is the society’s definition of marriage.

It is important to realize that the nature of *Albedo* society means that the way children are raised is partly dependent on the species of the parents. Lion fathers often leave their children entirely in the hands of the mother. Wolves raise their children as part of a larger clan. Society also plays a role. Danetti partners raise their children jointly. Dornthantii couples usually take advantage of an extended social network of parents with similarly aged children, and the task of raising them is nearly a communal affair.

Marriage

Marriage exists, in some form, on almost every world, though it is largely limited to a civil arrangement that confers certain duties and privileges on those involved. Even the hedonistic and free-spirited Danetti extend certain legal rights to dedicated partners – though a Danetti marriage might include two husbands and a single wife, five wives and four husbands, or any other conceivable combination, the individual members of which may be any species.

Most worlds are rather more traditional, and recognize only partnerships between two

individuals. Some worlds limit the legal recognition of these arrangements to opposite sex partners of the same species. Others recognize any two people living together with a romantic bond as a “married couple.” These differences can cause trouble when traveling to other systems. Although ConFed law requires that all member states recognize a marriage made in another system as legal, this does not protect the couple (or partners) from negative local attitudes.

In the Republic, marriage is condoned only between a man and woman of rabbit stock, and the purpose of the union is as much the production of future citizens as it is recognition of romantic ties. Marriages between rabbits and “lesser” species are not recognized. Non-rabbits on ILR occupied worlds may marry each other – but only with the permission of local government authorities. This permission may take years to arrive, meaning many simply live together in a state of de facto union without official recognition. Subject species who wish to have children must also receive permission.

Marriage and child rearing is not necessarily linked on most worlds. Partners who do decide to raise children are usually eligible for additional legal protections and social support. The term “marriage” is not normally used in the Core Worlds, and spouses are usually referred to as “partner” or “mate,” regardless of their sex. The word is used on more conservative worlds, especially those with hereditary clans or a noble class.

Social Groups

Socialization outside of family is an important part of mental well-being, a fact that is often highlighted to EDF officers looking to boost their SPI ratings. Social clubs of all kinds have sprung up throughout known space to feel this need. Some are based around common interests or professions, or serve to better the minds of their members, while still others meet simply to socialize or find romantic partners. One popular form of socialization is support of a particular political party or activist group.

Certain species are driven to socialization as a matter of course. Wolves, for example, often organize themselves into clans, with distinct hierarchies. These clans often

pursue specific goals designed to increase the power and prestige of individual members, and often become important players in planetary politics. Some species of birds will also naturally congregate. Avian groups are more like extended gossip clubs than anything else.



Daily Life

The Net has molded the character of social life on the Core Worlds, more than any other factor. Privacy does not exist in the Core, not as we understand it. Every moment of every day, the citizens find themselves under the benevolent eye of the Net. Terminals allowing citizens to interact with the Net are as common as telephones and clocks in the real world, and almost every terminal includes a tiny camera complete with a full range of infrared and UV filters. This surveillance is constant, though passive, as the Net only makes its presence known if it notes a problem, or if it is addressed directly.

The constant watch offers many advantages. The Net is there to assist with any crisis, however small.

- . A child, looking for a toy, asks the Net to help. The Net uses its cameras to search the house locate it. Then it

plays a game of "Hot and Cold", directing the child to the lost toy.

- . A senior, waking in the night with a sudden panic attack, is immediately soothed back to sleep by a friendly voice he has heard all his life.
- . A factory worker at a remote installation is injured on the job, and stumbles to her car and passes out. The Net takes control of the car, contacts emergency services, and drives the unconscious worker to the nearest aid.

There is a dark side to this constant attention. The Net keeps note of the mental health of its citizens, and monitors their social interactions. A person who develops certain eccentricities would find their *Social Political Intelligence* index adjusted accordingly. While this rating is normally kept secret from all except one's private physician, EDF officers and ConFed staff must face regular SPI reviews. If the numbers have changed for the worse, the Net will pass this information – and the reason for the change – on to their superiors. This raises the unsettling prospect of being forced to discuss very private matters with near-strangers.

Worse, a citizen may find his SPI being altered for reasons beyond his control. Chronic nightmares, for example, or a bout of serious depression, may trigger an SPI reassessment. The lower a citizen's SPI rating falls, the less control he has over his life. If the SPI rating falls into the range of mental illness, the citizen may find himself placed involuntarily into an institution. While there are no laws against avoiding contact with the Net, actively ducking notice will raise flags and get one pegged as anti-social. This will in turn alter an SPI rating.

Because of this, the need for a "clean" SPI is something that Core World professionals have drilled into their heads from youth. Some avoid eccentricities of any kind, and devote themselves to their professional lives and civil service.

COMMAND REVIEW · АРКААД РЕГЕР

Social Political Intelligence

With their love for numbers and quantifiers, the ConFed has been using SPI much the way "Intelligence Quotient" has been used in the past – that is, often incorrectly as a measure of someone's "brains." While an average SPI is anywhere from 8-25, numbers of 100 or greater are often scored by the ConFed's favorite citizens. There are many who believe that SPI is a tool for keeping people in line, because non-conformist behavior reduces the index and can prevent one from getting certain positions.

EXTRAPLANETARY DEFENSE FORCE

EXTRA-PLANETARY
DEFENSE FORCE



The Confederation and Republic learned a great deal about waging war during their first conflict, knowledge gained at the price of tens of millions of lives. Both powers have adopted different philosophies of battle as a result of their wartime experiences, and continue to hone and refine their weapons and techniques. EDF battle strategy is based almost entirely on flexible, reactionary responses to ILR aggression. For its part, the Republic is dedicated to developing weapons and strategies that deliver maximum damage with minimum effort.

Despite these differences of philosophy, the very nature of interstellar war means that some elements of military thought are universal. The first of these is the need of overwhelming initial force. Interstellar warfare is an expensive and uncertain prospect, and any attacking force must be large enough and flexible enough to deal with any conceivable situation. Static siege warfare is almost unknown. Invaders (or liberators) rely on devastating attacks from interplanetary space, followed by quick seizure of key points by ground forces. If a ground invasion is repelled, the invaders do not dig in, but withdraw for another attempt.

Large forces require high levels of organization and support. The EDF and ILR were

forced to rapidly develop a structure for their militaries, to keep them supplied and maintain lines of communication. In their current form, they are highly organized, with specialized services and chains of command. The EDF has three primary operational branches: *Aerospace Operations*, *Surface Operations*, and *Administrative Operations*.

















Joint Chiefs of Staff

The Extra Planetary Defense Force is presided over by a *Board of Directors*, which meet on Arras Charka, the recognized homeworld of all civilization. The Board has the following officers:

- Chief of Surface Operations, the officer who presides over all Surface Operations.
- Chief of Aerospace Operations, the officer who presides over all Aerospace.
- General Secretary, a Chief of Administration responsible for recording the minutes and disseminating the directives of the board.
- General Treasurer, a Chief of Administration responsible for the fiscal duties of the EDF.
- Board Members, persons granted honorary ranks of Vice Chairperson, one per world with a population of at least 134 million citizens. Being a Confederation, the rules at the planetary level for electing a Board Member vary greatly.
- Board Attendees, being persons nominated from worlds or other recognized governing bodies of planets with a Population Index less than 6. Board Attendees are allowed to attend meetings but cannot vote on policy.

Table of Ranks

Originally composed of individual Homeguards, the Ranking System of the EDF has grown by ad-hoc laws. This ranking table is only for Officers – Specialists use the Warrant Officer table (p. 67). While the Rank Table lists the "official names" of each rank, officers will usually be referred to by the title of their command, such as "Wing Commander Felna".

<i>Rank</i>	<i>SPI</i>	<i>Insignia</i>	<i>Surface Ops.</i>	<i>Aerospace</i>	<i>Administration</i>
Officer 16 (016)	240		Chief of Surface Operations	Chief of Aerospace Operations	Chief of Administration
Officer 15 (015)	200		General	Admiral	Chairperson
Officer 14 (014)	160		Brigadier General	Vice Admiral	Vice Chairperson
Officer 13 (013)	130		Sr. Commander, 1 st Class	Sr. Commander, 1 st Class	Sr. Commander, 1 st Class
Officer 12 (012)	110		Sr. Commander, 2 nd Class	Sr. Commander, 2 nd Class	Sr. Commander, 2 nd Class
Officer 11 (011)	90		Sr. Commander, 3 rd Class	Sr. Commander, 3 rd Class	Sr. Commander, 3 rd Class
Officer 10 (010)	70		Commander	Commander	Commander
Officer 9 (09)	50		Lieutenant Commander	Junior Commander	Lieutenant Commander
Officer 8 (08)	40		Lieutenant, 1 st Class	Ensign, 1 st Class	Lieutenant 1 st Class
Officer 7 (07)	30		Lieutenant, 2 nd Class	Ensign, 2 nd Class	Lieutenant, 2 nd Class
Officer 6 (06)	20		Lieutenant, 3 rd Class	Ensign, 3 rd Class	Lieutenant, 3 rd Class
Officer 5 (05)	15		Cadet, 1 st Class	Cadet, 1 st Class	Cadet, 1 st Class
Officer 4 (04)	10		Cadet, 2 nd Class	Cadet, 2 nd Class	Cadet, 2 nd Class
Officer 3 (03)	5		Cadet, 3 rd Class	Cadet, 3 rd Class	Cadet, 3 rd Class
Officer 2 (02)	3		Cadet, 4 th Class	Cadet, 4 th Class	Cadet, 4 th Class
Officer 1 (01)	1		Cadet, 5 th Class	Cadet, 5 th Class	Cadet, 5 th Class

Surface Operations

Surface Operations is in charge of the "meat and potatoes" of any combat operation – the ground troops who actually take and hold territory. Aerospace Operations may play an essential role when it comes to transporting these forces to the battlefield and subduing enemy resistance, but infantry and armor are needed to complete the job.

Surface Operations: Order of Battle

Name	Staff	Units	Commanding Officer
Army	150,000	4 Corps	General (O15+)
Corps	37,800	2 divisions & Corps HQ	Brigadier General (O14+)
Division	18,800	4 brigades & Division HQ	Colonel (O13+)
Brigade	4,700	4 battalions & Brigade HQ	Lieutenant Colonel (O12+)
Battalion	1,200	8 companies & Battalion HQ	Major (O11+)
Company	145	4 platoons & admin staff	Lieutenant Commander (O9+)
Platoon	36	4 squads & admin staff	Lieutenant (O8+)
Squad	8	2 fireteams	Lieutenant (O7+)
Fireteam	4	n/a	Lieutenant (O6+)

Armies

Armies are fielded in only wartime. Armies are commanded by Generals (O15) and typically put together to conquer a very well-defended or well-populated planet. They are composed of divisions,

COMMAND REVIEW • APNNAK NEECV

Organization of the ILR

The Independent Lapine Republic specializes in occupation. The Republic Armed Forces has only one branch of service, very much like the EDF's Surface Operations. Discipline is high – there are plenty of recruits to choose from on the ILR homeworlds, and insubordination has harsh penalties.

rather than corps, and during the first ILR conflict ranged in size from 150,000 troops to more than a million.

As a space-borne force, the EDF places particular emphasis on infantry over armor, since soldiers are much easier to deploy from orbit, and take up much less space aboard ship. In a standard action, light and heavy infantry are dropped on the surface at their targets by aerodyne gunships that serve as armored personnel carriers and a kind of flying tank. The EDF *does* field tanks and APCs, but uses them primarily for garrisoning and securing a planet after an initial assault. Otherwise, they are used to support infantry in the destruction of enemy fortifications when air-space has not been secured, or aerodynes are otherwise engaged. The EDF does not have any dedicated artillery units, as this battlefield role is adequately served by the presence of aerodyne gunships and spacecraft capable of accurate bombardments from orbit. In a pinch, long-range tank guns can be used as a replacement for indirect fire.

Light infantry make up the bulk EDF surface manpower, and a typical squad is armed with a mixture of anti-personnel weapons. Their role is to neutralize enemy soldiers and seize important targets, such as government offices or civil infrastructure. If they encounter a strong-point or armor, they call in an aerodyne strike. Heavy infantry are used when facing a particularly well-fortified force, and when the enemy is making extensive use of armor and mechanized infantry.

Rapid-Response units are heavily-armed and specialized infantry that are trained to operate on an individual level if necessary. RR-squads are launched from low-orbiting space ships, in either light aerodynes or in specialized vehicles, descending at speeds of in excess of 300 kph as they plummet to the ground, only slowing their descent within 600 meters from the surface. In some operations, Rapid-Response squads are launched in the hours preceding an attack in order to secure lightly defended (but important) resources, such food storage or power production facilities. Rapid-Response squads may also be used in conjunction

with infantry in attacks on fortifications. The infantry engage the enemy, and RR troops are dropped on the fortifications while the defenders are distracted.

The EDF can dispatch a brigade on short notice from any of the Core Worlds to anywhere within the Confederation, using a standard VLCC group. These fast response brigades are made up of mixed battalions, ensuring maximum flexibility of response on arrival. Each mixed battalion is comprised of 3 light infantry companies, 2 heavy infantry companies, 1 mechanized company, 1 armor company, 1 VHALO company, and battalion Admin staff. Units larger than a brigade exist as purely static planet-side forces or organizational units in peace-time, and are only created for dispatch to other systems in times of war.

Of special note are the freefall infantry units. While these units are in the ordinary Aerospace chain of command, they are organized as Surface units. Freefall infantry are normally used as shipboard security in the event of a boarding, but they may also undertake boarding actions themselves. These rarely occur in battles between starships, but are not uncommon in civil security actions, such as smuggler interdiction, or when dealing with enemy space stations. When used against another ship, they are deployed in the same sort of modified ACV used by VHALO troops. When

the ACV approaches the enemy vessel, it opens, and the squad departs using Extra-vehicular Activity (EVA) rigs (see below). They are trained to fight in zero-g and the vacuum of space, and to make effective use of the EVA rig. Smaller capital ships will have a squad of freefall infantry, or even a single fireteam. A VLCC might have an entire company aboard.

Squads

The most basic "complete" military unit, a squad is the smallest unit normally assigned a specific goal in a battle plan. The precise composition of a squad varies from service to service, as noted below. Infantry and VHALO squads may be divided into two four-man fireteams, one of which is led by the assistant squad leader. The composition of fireteams is usually decided in the field, based on the skills of each soldier and the particular requirements of the situations. The squad is the basic building block of every Surface Operations unit. Even a light infantry division is basically nothing more than a collection of hundreds of squads, with Administrative and command staff tacked on to keep them functioning as a well-oiled machine.

Armor

Armor squads in the EDF are deployed to support infantry actions against particularly well-fortified targets, and do not



often see action in the first hours of conflict. They are dispatched later against enemy hard points, as an adjunct to bombardment by aerodyne gunships. Armor has much more of a role in Homeguard actions, where it may be used as the spearhead of an overland assault. A typical EDF armor squad consists of four armor crew and four technicians, all operating in support of a single tank. The technicians are rarely dispatched into battle, though they are armed as light infantry riflemen, and may be called into action as fireteams in support of armored actions. Tank crews carry MPKW machine pistols, and have access to a MAKW light machine gun stored in the tank. As with mechanized companies, an armor company has two devoted armor support squads, using APCs modified for towing and field repair.

Surface Operations: Branches of Service

Engineering (ENGS)

Trained in construction and destruction of materiel, all Engineers are trained in Weapons of Mass Destruction (WMD), including their deployment and disposal, and Hazardous Material (HAZMAT) environment. Many EDF divisions have an amphibious corps of Engineers, as well.

Heavy Infantry (HI)

Heavy infantry squads have nearly the same structure as light infantry squads, but differ significantly in the arms they carry. The support weapon specialist carries a

portable rocket-launcher, and is assisted in the firing of this device by one of the riflemen. Snipers are replaced by a second support weapon specialist bearing a grenade launcher. The remainder of the squad carries LAKW 1-30s, the assault variant of the basic LAKW rifle, which includes an underslung grenade launcher.

Light Infantry (LI)

Light infantry is the force most commonly encountered in an EDF deployment. A typical infantry squad is made up of a squad leader, a support weapon specialist, and five riflemen, one of whom serves as assistant squad leader. The final squad member may be a medic, electronic warfare specialist, or sniper, who works to support the entire platoon. The support weapon specialist carries a MAKW light machine gun or GAKW grenade launcher, while snipers carry a military CKW precision rifle. The term "sniper" is somewhat misleading, as these troops do not carry true sniper rifles. However, they fulfill much the same role on the battlefield. Snipers and support weapon specialists also carry an MPKW as a sidearm for closer actions. All other squad members carry the standard LAKW rifle.

Mechanized (MECH)

Mechanized infantry squads rely on fast, armored vehicles to move from place to place. Mechanized infantry is most commonly seen in planetary Homeguards, as the EDF makes use of aerodyne gunships for rapid deployment and support of infantry. Still, every fast-response brigade has a mechanized company, one that usually deployed to assist in patrolling an area after it is secure. An EDF mechanized squad consists of two APC crew, a support weapon specialist, four riflemen (one of whom is squad leader), and either a medic, sniper, or electronic warfare specialist.

Mechanized infantry take advantage of the carrying capacity of the APC to haul more supplies, ammunition and a selection of common support weapons into field. The support weapons specialist can choose from a light machine gun, automatic grenade launcher, or portable rocket launcher. The APC crew carries MPKW

COMMAND REVIEW • АРМАНД РЕЦЕП

Organization of the Homeguards

Recognizing the need for defense, most planets of the Interstellar Confederation maintain their own Homeguards – at least, the ones that can afford it. Most will use equipment identical to the EDFs, and many will be staffed by former EDF officers. However, each planet has its own ideas for what makes for a good army, and no two Homeguards will be organized exactly the same way. Technically, by their charter with the ConFed, all EDF officers outrank all Homeguard officers ... but when coordinating EDF/Homeguard operations, a wise commander will be wary of local politics.

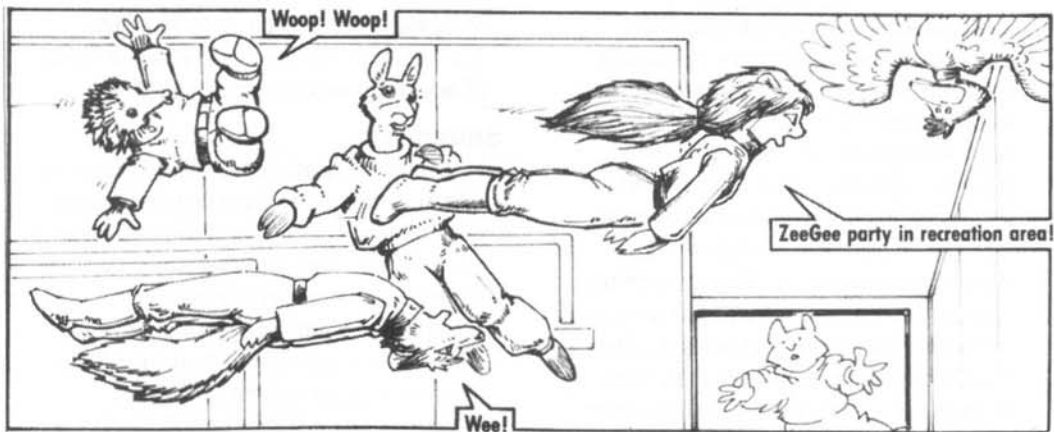

machine pistols, while the remainder of the squad carries standard LAKWs. The squad is transported around the battlefield in an armored personnel carrier (APC), with the APC crew acting as driver and gunner.

Every mechanized company has two armor support squads, each consisting entirely of APC crew/technicians who are responsible for the maintenance of vehicles in the company. Each squad has access to a pair of mobile repair vehicles – essentially a standard APC fitted for towing, and carrying a selection of tools and replacement parts.

Mobile Surgical Hospital (MSH)

Doctors and support for wounded civilians and personnel, Mobile Surgical Hospital units are often located aboard VLCCs, and only relocate to the surface when it has been largely pacified.

Rapid Response (RR)

Rapid-Response squads are trained to act as individuals. The squad is commanded by a Lieutenant; this allows them to give tactical orders to traditional infantry squads they encounter in the field. RR-soldiers are more heavily armed than normal infantrymen. Each carries LAKW 1-30 assault rifle with grenade launcher, as well an MPKW machine pistol and a selection of hand grenades.

Aerospace Operations

Aerospace Operations is the most visible and perhaps prestigious branch of the EDF. It represents the core of the ConFed's ability to wage war in space, and its officers represent the best and brightest of the known worlds. Aerospace Operations transports troops, maintains supply lines, and defends every ConFed system from attack. It encompasses everything from one-man aerodyne gunships to the enormous VLCCs that are capable of carrying an entire infantry division through interstellar space. Aerospace Operations is divided into two branches – Aerodyne Command and Strategic Command. Aerodyne Command manages the operations of small transport and combat vessels, while Strategic Command handles capital ships and all other vessels incapable of atmospheric operations.

Aerospace Operations: Aerodyne Command Order of Battle

<i>Name</i>	<i>Staff</i>	<i>Units</i>	<i>Commanding Officer</i>
Group	5,000	4 wings (512 aerodynes)	Aero Commodore (O11+)
Wing	1,000	8 squadrons (128 aerodynes)	Wing Commander (O10+)
Squadron	130	4 flights (16 aerodynes)	Squadron Officer (O9+)
Flight	30	4 aerodynes	Flight Officer (O8+)

Aerodyne Command falls under the overall direction of Aerospace Operations, but the sub-branch enjoys a great deal of latitude when it comes to military planning. While most people immediately think of gunships when they think of aerodynes, a significant amount of work done by Aerodyne Command involves unglamorous interplanetary transport. About two-thirds of all aerodyne units have combat roles, and these fly small fighters and gunships. The remainder operates transport ships, some of which displace several hundred tons. Only officers may pilot aerodynes, though some of the larger transport vessels require copilots, and this role may be filled by any qualified cadet.

During any military action Aerodyne Command is assigned the task of transporting ground troops to their targets and providing them with ongoing support. These operations make extensive use of the A2 gunship (also known as a dropship), which has room for a standard infantry squad in the passenger compartment. The pilot drops from a home ship in orbit and accelerates to their drop-off point, where they land and open the rear doors. When the squad departs, the aerodyne typically remains in the area to provide aerial support by as firing missiles at targets identified by the ground troops or destroying enemy vehicles with gunfire.

The Aerodyne chain of command runs parallel to that of Strategic Command until the Group level. There are no dedicated Aerodyne officers higher than Aero Commodore. Aerodyne units larger than a Group have never been formed by the EDF, and if a large operation required the combination of more than one group, it would simply be under the command of an Aerospace Commodore. Unlike Surface Ops, Aerodyne Command includes Administrative Operations staff in their personnel totals.

Flight

The flight is smallest aerodyne unit assigned to independent operations. In an invasion, each flight is assigned an infantry platoon to transport and support. A flight is usually comprised of 4 pilot officers, 16 technicians/crew, 3 supply/logistics crew-

men, and a flight medic. Smaller capital ships, such as destroyers, may have a flight of aerodynes stored in their hangars.

Squadron

Aerodyne squadrons are large enough to take on a multitude of combat and support roles, and may be the only EDF presence in a given system. They often feature mixed-role flights to enhance their flexibility. For example, a squadron assigned to monitor and protect shipping in Ekosiak might have 2 flights of space fighters, 1 flight of transports, and 1 flight of gunships. At squadron level, the Admin staff complement includes a doctor, morale officer, and civilian liaison in addition to the normal supply/logistics crews.

Wing

An aerodyne wing is typically assigned to the defense of an entire planet. A wing is rarely composed of squadrons of a single type though in times of war dedicated fighter wings are not unheard of. They have a large contingent of Admin staff, typically including enough doctors to staff a small hospital, as well as a team of experienced engineers. An entire aerodyne wing can be contained within the hangars of a VLCC.

Group

Only the most valuable colonies or systems can boast the presence of an aerodyne group. They are extremely flexible space-forces in their own right, with wings devoted to defense and supply. Several hundred Admin personnel are assigned to a group, including mental health professionals and advanced aeronautic specialists.

COMMAND REVIEW • ΑΡΧΙΚΑΝΔ ΝΕΡΕΥΡ

Organization of the Enchawah Group

Enchawah Group does not have a formal military structure, but they do have recognized levels of authority, a paramilitary hierarchy, where officers are likely to be called "Comptrollers" or "Field Officers". Field Divisions are given a great degree of autonomy to manage as they see fit, as long as they get results. Military discipline is also lacking; personnel are more likely to be demoted or dismissed than to receive counseling or internment, despite the presence of internal-affairs personnel.

Aerospace Operations: Strategic Command Order of Battle

<i>Name</i>	<i>Staff</i>	<i>Units</i>	<i>Commanding Officer</i>
Carrier Group	5,000	1 VLCC, 1 capital squadron, 2 aerodyne squadrons	Vice Admiral (O14+)
Capital Squadron	40	2 large capital ships, 1 support vessel	Commodore (O11+)
Taskforce	20	1 capital ship, 1 support vessel	Captain (O10+)
Capital Ship	16	1 ship of at least corvette size	Commander (O9+)
Patrol	4	2 non-capital vessels	Flight Officer (O6+)

Strategic Command is responsible for the operation of any jump-drive equipped or non-atmospheric spacecraft in the EDF. While capital ships (the large, armed vessels that act as command centers for squadrons and taskforce) are the most visible part of Strategic Command, several classes of smaller vessel also fall under its purview.

As the Order of Battle indicates, the Strategic Command branch of Aerospace Operations is extremely flexible. Aerospace units at this level are centered on the presence of capital ships, and these vessels range in size from corvettes with a crew of 12 to the gargantuan VLCCs that can hold tens of thousands of personnel. A taskforce of three capital ships might encompass anywhere from 30 to 1000 personnel. As with Aerodyne Command, Administrative staff is included in the numbers indicated above.

Life for a typical aerospace officer during wartime is one of weeks, or even months, of boredom, punctuated by incredibly brief periods of frantic action. Given the distances involved in space travel and the

power of sensor technology, weeks can pass before a detected attack on a ship actually arrives. For example, a cruiser arriving in a hostile system will not be noticed by planet-side detectors for several hours, at the very least. The planetary defenses must spend more time plotting the likely course of the cruiser before launching ACV defenses to intercept. Even at maximum thrust, it will take several days for them to reach the cruiser – which has in turned launched ACV defenses of its own.

When the two forces meet, the action is resolved in split seconds. Given the relative velocities involved, even a glancing blow from the shrapnel of a destroyed ACV can cut through a capital ship's hull, and wreak havoc as it passes through the vessel. As such, EDF ship personnel are encouraged to maintain an almost paranoid concern for safety. They wear vacuum-suit liners at all times, and keep their helmets at the ready.

Patrol

A patrol is typically a very short-term formation of at least two small ships, usually scout vessels or non-aerodyne fighters. They are assigned to a single duty, such as scanning an incoming freighter convoy, and the patrol is dissolved at the completion of that duty. They are not always short-lived units, however. In wartime, a patrol of dozens of ships might be assigned to escort a carrier group as it accelerates to a jump point over the course of several weeks. Obviously, in cases like this an ensign would not be in command. Patrols have no Admin personnel beyond that which is assigned as crew to the ships that comprise it.

Capital Ship

The eventual goal of almost every Aerospace officer is command of a capital ship. Even command of a tiny corvette indicates a very high level of trust and respect for an officer's skills, as even the smallest ship represents an extraordinary investment of resources, and effectively commanding a crew of any size requires a great deal of self-possession and expertise. As such, command of a Capital Ship represents the pinnacle of a career. Capital ships are often deployed individually to complete specific

operations, and may remain in the field for months at a time.

While most capital ships are used for purely military operations, Strategic Command often places older or idle vessels at the service of the civilian ConFed authority. These ships maintain a military crew, but also take on a large complement of civilian experts, and may even be under the command of a civilian captain. They are used for exploration of new systems and scientific research, and often range very far from home. Larger ships have recycling technology onboard that allows them to operate independently for years, allowing them to be dispatched on long-term missions of exploration to the extreme edge of known space. While a five-year mission in search of new life and new planets may be a hardship for the crew, they represent an excellent way to advance one's training and career.

Even the smallest capital ships have a complement of Administrative staff on board, most typically medical and science specialists. Ships of destroyer class or larger will also have a contingent of planet-based staff attached to their crew. This staff remains behind to act as a convenient liaison for ships on extended duty.

Taskforce

A taskforce is simply a group of capital vessels and support vessels brought together for a specific purpose. The size and composition of a taskforce varies according to the task it must complete, though if it contains a single VLCC, it is counted as a carrier group. However, if more than one VLCC is present, the collective may still be considered a taskforce, though it would be commanded by a very high-ranking flag officer. The line between a taskforce and a capital squadron (see below) is often unclear. Generally speaking, if a taskforce has more than one vessel of cruiser size or larger it may be considered a squadron. A taskforce is also more often a long-term arrangement, whereas capital squadrons tend to be formed for single engagements.

Capital Squadron

Capital squadrons are ad hoc formations, usually created in response to a specific, short-term military threat. For example, if

unknown vessels suddenly appear on the edge of a system, any large capital ships sent to investigate would be considered a capital squadron. Once the threat is gone, the squadron usually dissolves.

Carrier Group

Carrier groups are the basic elements of all large aerospace operations. They are organized around the support and defense of a VLCC ship, and tend to be very long-term organizations. Indeed, individual VLCCs are constantly at the center of their own carrier group. The sheer amount of firepower and production capability represented by a single carrier group dwarfs that of many colonies. Carrier groups are dispatched to respond to extremely dire threats. If two VLCCs are present, then the unit is reformed as a kind of super taskforce, under the command of an Admiral or the senior VLCC captain.

Aerospace Operations: Branches of Service

Aerodyne Vehicle Operations (DYNE)

Trained to operate Aerodynes, especially in the context of landing troops and interplanetary defense from raiders. Aerodyne pilots form the backbone of any EDF operation.

Engineering (ENGA)

Trained in the deployment and repair of Aerodynes, ACVs, and other outer-space vehicles, the aerospace Engineering division is vital to the maintenance of space vehicles and orbital staging platforms. While it's not often talked about, the Engineering corps is extensively trained in the use of ACVs from orbit and the deployment of nuclear weapons, like their Surface-Ops cousins.

Freefall Infantry (FI)

Freefall infantry rarely operate in units larger than platoon. Their job is to board enemy vessels and secure them for search, or subdue the crew and seize control. As such, they require a high level of technical competence in order to secure ship systems. Each squad is comprised of a squad leader, two electronic warfare specialists, and six riflemen. All are armed with LAKW 1-30 carbines (minus the grenade launcher) and a

selection of variable hand grenades. Freefall infantry are not equipped for long-term operations, and are rarely expected to be in the field for more than a few hours.

Interplanetary (INT)

The bulk of Aerospace crews, who maintain the very-large arrays that never land, Interplanetary is largely composed of medical personnel, along with psychologists and administrators.

Interstellar and Jump-Space Navigation (FTL)

Trained in astrophysics, hyper-dimensional mathematics, diagnosing and preventing misjumps, and interstellar navigation, any VLCC must employ a number of Navigators. FTL staff do not enter combat except in the most dire circumstances.



Administration

Administrative Operations is a vital body that supports and coordinates the men, women, and resources of the far-ranging EDF forces. Admin covers a wide range of operations, encompassing everything from supply clerks to battlefield doctors, aeronautic researchers, civilian liaisons, morale officers, and disaster response planners. Of particular significance to troops in the field are the Command and Control (C&C) specialists who constantly monitor and direct every aspect of battles on the ground, down to the level of the individual soldier, passing on the directions of the officers managing the operation. The colonel in command of a corps level Admin unit is quite literally responsible for managing everything from the mental health of the

enlisted men, to the safe disposal of their sewage. In a battle, his staff maintains communications with the field, and make sure each soldier is where he is meant to be. Admin officers can be found in every branch of the military, and are often posted to civilian positions with the Confederation. They make sure that the EDF can do the jobs it is meant to do, by providing practical support of every kind.

Administration: Order of Battle

<i>Name</i>	<i>Staff</i>	<i>Units</i>	<i>Commanding Officer</i>
Corps Admin	5,000	2 division admin and extra staff	Senior Commander (O12+)
Division Admin	2,400	4 brigade admin and extra staff	Commander (O10+)
Brigade Admin	6,00	4 battalion admin and extra staff	Lieutenant Commander (O9+)
Battalion Admin	150	8 company admin and extra staff	Lieutenant (O8+)
Company Admin	17	4 platoon admin and extra staff	Lieutenant (O7+)
Platoon Admin	4	n/a	Lieutenant (O6+)

The organizational structure listed above reflects the administrative groups assigned to Surface Operations units. Aerospace units make use of similarly sized groups, each operating independently on a capital ship, and therefore suited to the size of the crew on that ship. For example, a cruiser with a total crew of 120 would have a company sized Admin Group aboard. Aerodyne units are supported by the Admin Groups attached to the capital ships they operate from, or rely on local Surface Operations Admin Groups in the case of ground-based aerodynes.

There are literally hundreds of Admin specialties, and each group by and large maintains their own chain-of-command within the specialty. For example, the captain in charge of civilian relations on Derzon cannot order a lieutenant serving as a surgeon to perform an emergency medical

procedure. However, all branches eventually report to one person, either the senior officer of a given Admin unit, or (ultimately) the Chief of Administrative Operations on Arras Charka. In some ways, the organization of Administrative Command most closely resembles a large corporation, with several semi-independent departments. While the supervisor of accounting cannot fire a technical support staffer, she can direct her complaint to the CEO, who can take action.

With the exception of C&C specialists, administrative officers have limited authority when it comes to combat operations. They cannot typically give orders to normal aerospace or surface operation combatants, unless the chain-of-command has been seriously disrupted and no other officers are present. An Admin doctor with the rank of captain who happened on a squad of infantry on the battlefield could not countermand the combat orders of the squad if a surface operations lieutenant was present. He *would* be expected to take command of the squad if the squad commander were not present, though his directions would likely be limited to generalities ("Escort me back to base") rather than specific battlefield orders, which he would leave to the discretion of the senior squad member. Despite the often sedentary nature of their work, Administrative personnel do receive a modicum of combat training. They are expected to be able to defend themselves and understand the basics of military tactics. All receive basic firearms instruction, and have the option to pursue optional training that prepares them to take an active role in combat.

Platoon Admin Group

A platoon admin group represents the most common contact the soldier in the field has with Administrative Operations. Platoon admin personnel are responsible for keeping track of supply shipments to the unit, preparing meals in the field, and ensuring that every soldier is assigned appropriate arms and gear. They are permanently attached to a given platoon, bunk with them, and travel with them on interstellar operations. However, they conduct their business alongside other platoon Admin groups in a company or battalion

Admin facility. In most EDF operations, platoon admin groups remain in orbit until the surface is stabilized, and then assist in setting up a company or battalion level HQ on the ground. A platoon admin group consists of two general laborers (who are most often employed in preparing meals), one weapon technician (who is specifically responsible for making sure that the platoon's gear is in working order), and an admin group commander who serves as quartermaster for the platoon.

Company Admin Group

A company Admin group is simply the sum total of the platoon groups with the addition of a commanding officer/C&C specialist who serves as an overall director and liaison for the group.

Battalion Admin Group

In addition to the component platoon and company level Admin groups, a Battalion Admin Group has 14 extra staff members who provide specialized services to the troops. A Battalion Admin Group adds an administrative coordinator, morale officer, battalion doctor, robotics specialist, C&C coordinator, motor pool director, and nine general duty staff who are usually busy with laundry, or assisting the platoon quartermasters. At this level, a number of resources are also available, notably a small number of robots that are assigned to other units on the basis of need. Depending on the location of the battalion, up to a dozen light personnel transports and trucks are also available, intended for transporting personnel in peacetime. These vehicles are not suitable for battlefield use, though they may be pressed into service evacuating injured troops from the field, or as scout vehicles.

Brigade, Division, & Corps Admin Groups

At the brigade level, the Admin group has become a considerable unit in its own right, one that is able to provide a wide range of services and resources. A brigade has a fully functional field hospital, sizable motor pool, basic manufacturing facilities, several robots, and highly specialized experts such as psychological hygiene officers, military police, engineers, and a civilian liaison team. They

typically remain aboard a VLCC until the surface is secured, at which point the group may occupy a large surface structure, such as an office block.

Division and corps Admin groups are comparable to small towns, with specialists in every conceivable field spread throughout the component units, supported by a central HQ staff numbering in the hundreds. The group has a substantial manufacturing capability, and is able to operate indefinitely given access to raw resources. They keep track of every aspect of the lives of those in influence, and supply every need. A corps level Admin group commander is an extremely powerful and influential person, though his position is hardly glamorous.

Administration: Branches of Service

Industry and Procurement (IP)

A fancy title for the factory workers, these are the folks who build or purchase the materiel and ship it out.

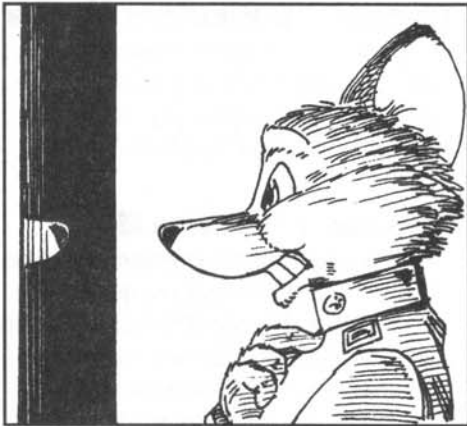

Liaison (L)

Diplomats and media supervisors, who meet with the civilian governments that contribute to the EDF, often to lobby for more funding, to allay fears of ILR attack, and to justify the existence of the EDF.

Quartermasters (QM)

Most units have one or more of these, to count the beans and balance the books.

Special Services (SS)

Viewed with suspicion among the troops in the field, Special Services is staffed with psychologists and criminologists who investigate crimes committed by EDF members,

including embezzlement, theft, and accusations of atrocity. Special Services also interrogate terrorist leaders, crime lords, and other leaders in an attempt to better understand their motivations and tactics.

Specialists

Recognizing the need for personnel trained in unusual or difficult fields of study, the EDF maintains ranks of Specialists. These personnel have a special rank, known as *Warrant Officer Ranks*.

<i>Rank</i>	<i>SPI</i>	<i>Specialist Title</i>
Specialist 7 (S7)	120	Master Warrant Officer
Specialist 6 (S6)	80	Chief Warrant Officer
Specialist 5 (S5)	60	Warrant Officer, 1 st Class
Specialist 4 (S4)	40	Warrant Officer, 2 nd Class
Specialist 3 (S3)	20	Warrant Officer, 3 rd Class
Specialist 2 (S2)	10	Warrant Officer, 4 th Class
Specialist 1 (S1)	5	Warrant Officer, 5 th Class

While all Specialists are technically officers, their training in military fields may be limited and their reputation as combatants is lacking. Also, while a Warrant Officer is officially equivalent to a regular Officer of the same rank, in practice "true" Officers are awarded more respect.

Emissary (EM)

A euphemism for "spy", the EDF is not supposed to engage in covert operations. However, many EDF chairpersons recognize the need for such operatives. Emissaries are often kept secret, even from each other. Emissaries report directly to the Chairpersons of Administration.

Exploration (EXP)

Scouts who move into uncharted space, Explorers report directly to the Vice Admirals of Aerospace.

Research and Design (R&D)

These engineers develop new machines of war. Since most of the plans and theories used are already in the massive data libraries, most of R&D is either finding more cost-effective ways to produce machines or applying the same old designs in new ways. R&D corps report directly to the Chairpersons of Administration.

MAKING CHARACTERS

ՆԱԿԵՄՆ ԿԱՆԱԿՇԵՆՆ

To start the game, each Player makes their Characters. All Players begin with one Main Character and five Supporting Characters.

Main Character

Choose a Species

The Interstellar Confederation recognizes over 160 Species. The most common ones are presented in the Species chapter, p. 74.

Your Species determines starting Attributes – write these numbers in your character sheet, in the appropriate blanks. Main Characters have Body, Clout, and Drive points that can be spent to improve rolls and to use certain Gifts or abilities.

Your Species gives you several Marks in Skills – add these Marks to your Main Character Sheet.

Choose *one* Species Gift. Write this Gift on your Main Character Sheet.

Choose a Homeworld

You can choose a Homeworld from the Gazetteer, or you can make one up. Each Homeworld has a basic type, with descriptions beginning on page 82. Note your Homeworld's name and type on your character sheet.

Your Homeworld type gives you several Marks in Skills – add these Marks.

Choose *one* Homeworld Gift. Write this Gift on your Main Character Sheet

Choose a Personality

In the Personality chapter, you will find four choices. Each one improves either your Clout or your Drive.

The blanks for noting personality traits are next to either Clout or Drive on your Main Character Sheet – check each aspect appropriately.

Choose a Service

Choose a Branch of the EDF, and then a Service. Your Branch of Service gives you several Gifts: one Basic and several Gift Groups. Write these Gifts on your Character Sheet. Add Marks to your Skills, as dictated by your Group Gifts.

Choose 10 Elective Marks

Next, you can add 10 Marks into any of the Skills, with a limit of 3 marks in any given skill. You can buy any Skill you want, even ones you have zero Marks in at the moment.

Choose 1 Elective Gift

You may choose one personal Gift. This Gift can be any Gift that you qualify for. *Basic Gifts* and *Group Gifts* have no qualifiers. *Dubious Gifts* also have no qualifiers, but they carry with them other game-mechanics that hinder as well as help.

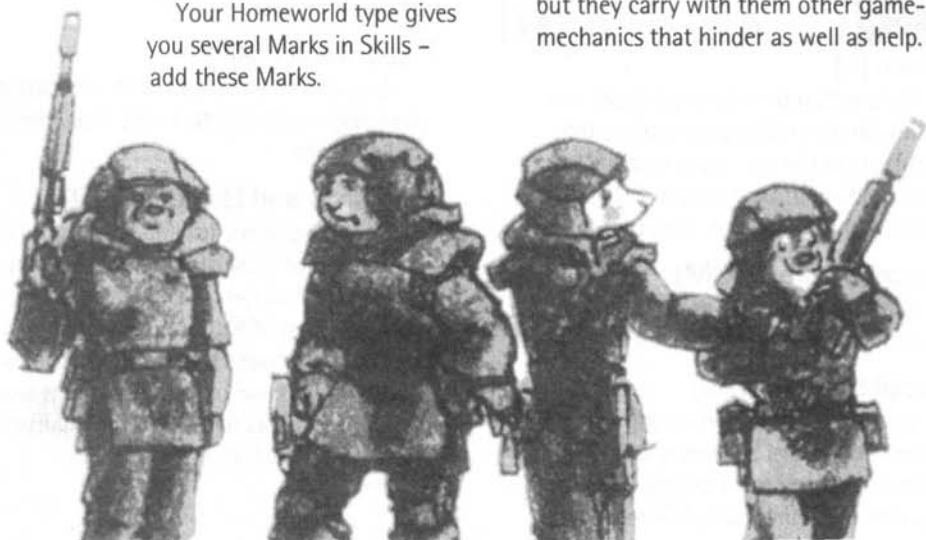

Advanced Gifts have requirements that must be met before you take them.

Choose Personal Details

Flesh out your character's name, gender, and other personal details.

Name

Naming practices differ from planet to planet, between species, and even among different family groups of the same species and culture. Not having any cultural background for choosing and developing names, the first settlers on Arras Charka selected simple names for themselves, often nonsense syllables that were distinctive and sounded pleasant. Others took

COMMAND REVIEW • ΑΡΧΑΙΑ ΔΕΓΕΥΡ

Sample Character Names

Aldeat; Alhacka; Ali; Alo; Alri; Alti; Alto; Ani; Anni; Anrat; Ar; Ardea; Auitharar; Bosgagar; Char; Charlashi; Charsa; Chato; Dadoghera; Dadorath; Dagasa; Darfidoi; Darkoki; Dasho; Dea; Deaar; Deaat; Deagai; Deaki; Deaosh; Deashoas; Dhea; Dheana; Dheao; Dohath; Dorfier; Dorna; Driar; Drishi; Edohath; Egan; Ekheka; Elfheshi; Elgar; Elper; Elra; Elta; Endos; Enrath; Enro; Erfhejia; Erfyferfon; Erla; Erni; Erpath; Erpoor; Erto; Fefar; Fel; Felda; Felkethok; Felos; Felrak; Ferpath; Feter; Feth; Fhega; Firea; Fishaeth; Freeth; Frerak; Freshata; Gaeth; Gan; Gar; Gheda; Hath; Huer; Hufida; Huharka; Huka; Huko; Hula; Hulharda; Hulkotheth; Husho; Kaat; Kaer; Kafon; Kari; Kashagan; Kathok; Katik; Kedyka; Kehyoth; Kei; Keon; Khashi; Khesa; Kor; Kora; Korda; Kori; Korn; Korthok; Korti; Kotik; Laat; Laat; Lagarat; Larak; Lashion; Lidhea; Lini; Lugal; Lyhac; Lyki; Lyri; Lyshithok; Madai; Masi; Mesi; Moosh; Myla; Myshofaloth; Na; Nago; Narath; Narhefon; Nyhath; Nyosh; Nyrath; Oghega; Okhateth; Orfheda; Orni; Pahoon; Pida; Pidegalgai; Pifior; Pigan; Pio; Pygai; Pygar; Pyos; Rashi; Reteth; Rhedar; Rhei; Ri; Rolani; Rydodhea; Ryfon; Ryhacthol; Rykhoteth; Ryro; Sa; Safheeth; Sahai; Sasa; Sashier; Sasi; Serrak; Serri; Shafyat; Shaon; Shaor; Shathok; Shi; Shia; Tadoni; Tana; Taro; Tata; Tetfikhaos; Teth; Tik; Tol; Tollathok; Tolni; Tolo; Tolor; Tolrak; Tolro; Totik; Ty; Tykadyri; Zhoa; Zhodygan; Zhofihac; Zyer; Zyki

names that described positive traits they wished to emulate – Charity, Patience, and so forth. Still others appended these names with distinctive surnames, others with the name of their clan or hometown.

Almost any collection of pronounceable sounds is appropriate for a name. Some players might choose to select unusual real world names, though Game Hosts should discourage common human names such as "Paul" or "Stephanie," as these may detract from the mood of the game setting. Characters in *Albedo* typically have one, two, or three names, though more are possible. Players who are having difficulty selecting a name may use the following chart to generate an appropriate one. The name developed by this chart is most suitable to a character from the Core Worlds, where common names often cross boundaries of species or culture.

Gender

Characters in *Albedo* can be male or female. The Extraterrestrial Defense Force has an official policy against discrimination by gender.

Personal Details

Choose the color of your character's eyes, the shade of their pelt (fur, feathers, hide, etc.), the pattern of their speech, other details as you see fit. Remember that your Main Character represents your starring role in the game.

10 + Clout + Drive: Social Political Intelligence (SPI)

The Extraterrestrial Defense force requires all personnel to submit to regular testing to determine their SPI index.

Your SPI is equal to 10 plus your Clout Rating plus your Drive Rating, plus or minus any modifiers from Gifts. Among other things, the Main Character's SPI will determine what Rank they start the game with.

Rank

Your Main Character starts the game with the highest Rank your SPI qualifies for. See page 57 for more information on Ranks.

Damage Thresholds

Whenever a combatant is hit by an attack, dice are rolled against one's *Damage*

Thresholds. The higher the thresholds, the less likely you are to be injured.

Threshold	Value
Wounded	Body x2 + Armor
Crippled	Body x2 + Armor + 10
Incapacitated	Body x2 + Armor + 20
Devastated	Body x2 + Armor + 40

Recovery

Main Characters have a *Recovery*, a number that measures how fast they recover from Damage. This number is their lowest Attribute Rating times their highest Attribute Rating, divided by 5, rounded down. You can find a chart for this number on page 132.

Supporting Characters

Supporting Characters are fleshed out in much less detail than your Main Character.

You start the game with *four* Supporting Characters, known as the *Retinue*. These four have served under the Main Character for some time now, and all have Trust in their commanding officer's ability.

A Supporting Character has a *Species*, with appropriate Attributes, and a *Service*, with appropriate Gifts and Marks.

Supporting Characters can be of any Species. Three of them should be from the same Branch of Service as your Main Character. The fourth can be from a different branch, from any service.

COMMAND REVIEW · ΑΡΧΙΚΑ ΝΕΚΡΩΣ

Why Have Multiple Characters?

In the dangerous setting of *Albedo*, much of the drama is derived from the constant threat of mortality. If characters aren't put in mortal danger on a regular basis, then the drama lacks sincerity. On the other hand, if Player-Characters spent most of their time in the infirmary or hiding in bunkers, the story would lack interest. Commanding officers aren't at the front of the party, or bearing the brunt of danger – that's why a command structure exists. With *Albedo*, the Players should identify strongly with their Main Character, but also have respect for their supporting cast. Game Hosts should craft plots that challenge the Main Characters to do the right thing, with a level of danger that often results in grievous harm to the Supporting Cast, as a reminder of the seriousness of the setting.

Supporting Characters do not have Attribute Points – they have Morale, as granted to them by their commanding officer (your Main Character.) Supporting Characters start the game with a Rank one less than the Main Character.

Unless specified otherwise by the Game Host, a Supporting Character who Trusts their commanding officer (or better) starts any battle with 1 Morale.

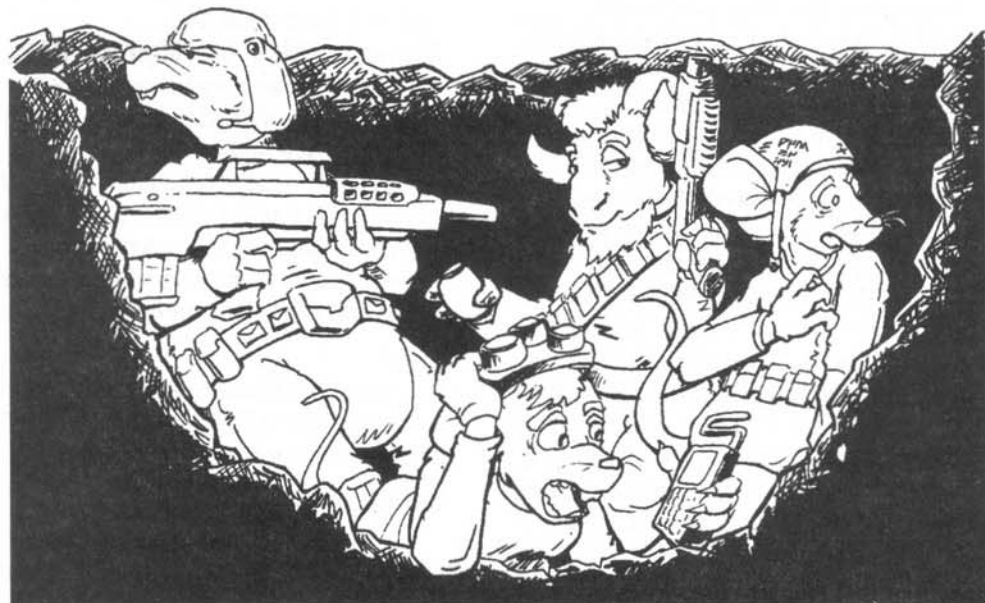

Ten Steps to Character Creation

Step 1: Choose a Name (p. 69), Species (p. 74), and Gender for your character. Your Species determines your Attribute Ratings, and will add Marks to your Skills. You can also choose Species Gift.

Step 2: Choose a Homeworld (p. 82). This will also give you free Marks in several Skills. Choose one Homeworld Gift.

Step 3: Choose your four Personality types (p. 85). Each choice boosts Clout or Drive.

Step 4: Choose your Branch and Service (p. 86). These will give you several Gifts and Marks.

Step 5: Choose your Elective Skills: +1, +2, or +3 Marks in any Skills, up to a total of 10 Marks.

Step 6: Choose your Personal Gift (which can be Basic, Advanced, or Dubious; p. 94).

Step 7: Enter your Recovery here (highest Attribute × Lowest Attribute + 5; see p. 139).

Step 8: Enter your Damage Thresholds here, based on your Body and Armor (p. 70)

Step 9: Determine your SPI (10 + Clout + Drive). Your Rank is the highest you qualify for (p. 57).

Step 10: Choose your Supporting Characters. Three of them must be from the same Branch and Service as your Main Character; the fourth can be from any service. Equip them with Weapons (p. 123). Their "Attack" is their Weapon's Skill Marks; "Def." is short for their Armor's Deflection (p. 122). Thresholds are based on Body Rating and Armor.

ALBEDO PLATINUM CATALYST
 MAIN CHARACTER

Name: _____
 Species: _____ Gender: _____
 Homeworld: _____
 Personality: Esteemed Selfish Reserved Perceptive
 Mysterious Charismatic Thoughtful Idealist

Branch: _____ Rank: _____
 Service: _____ S.P.L.: _____

Gifts: _____

Height: _____ Weight: _____ Build: _____
 Eyes: _____

Deflection: _____ Recovery: _____
 Thresholds: _____ Improvement: _____
 Model I: _____ Model II: _____
 Inception: _____

Body (P.R.C.) _____
 Skills: Brawl Climb Freefall G-Force Jump Melee Run Sneak Speccout Swim Throw

Drive (S.P.I.) _____
 Skills: Brawl Bureaucracy Computer Skills Demolition Design Forge Heavy Weapons Hypnotic Sciences Information Analysis Language Medicine Medical Sciences Navigate Physical Sciences Planetary Sciences Planets Plan Repair Research Analysis Scrounge Search Sensor Operations Sixth Sense Small Spot Vehicle Operations Vehicular Weapons Weapons of Mass Destruction

Clout (D.V.E.) _____
 Skills: Bribe Disguise Gossip Impress Intimidate Lead Persuade Question

SUPPORTING CHARACTERS

Name	Species	Service	Weapon	Attack	Def. Thresholds	Status	Recovery
1							
2							
3							
4							

ATTRIBUTES

АТТРИБУТЫ

Attributes represent qualities that almost all characters have. Simply put, everyone has physical capacity, social standing, and mental energy. It's really a question of how much. Attributes range from zero (no appreciable quality) on up.

Rating

The maximum number of Points a character can have is their *Rating*. For example, if your Clout Rating is 10, you can never have more than 10 Clout Points. On the character sheet, completely fill in boxes, leaving empty boxes equal to your Rating.

Points

When your character performs certain actions, or attempts to rise above their normal limits, they must spend *Points* to act. Also, things like damage from attacks, social impositions, and frightening situations can deplete Points.

Points can never go below zero. A character cannot elect to damage. If a character is forced to lose Points they don't have, they suffer 1 Damage for every 1 Point they can't spend.

Spent Points are pretty easy to recover. After a Rest period of 8 hours, a character recovers all spent Points.

On the character sheet, mark spent Points with a slash, "/".

COMMAND REVIEW • ПРИКАЗЫ ПОВТОР

Why Don't Attributes Increase Skills?

Think of Body, Clout, and Drive as the reserves of power that a character has to bear. By spending their Attribute Points, characters can strive for overwhelming success, push themselves past their limits, and retry when others would give up. While it's tempting to think of Clout and Drive as how sociable or smart someone is, actual capacity is measured by a character's Skills. Characters who are better at common Skills will probably have Group Gifts (p. 96).

Who has Attribute Points: Major Characters vs. Supporting Characters

The Players, their major allies, and their major opposition, are *Major Characters*. In terms of the story, they set the stage and they drive the plot. These characters are afforded an extra level of detail, by having Attribute Points they can spend.

The various other characters, such as subordinates, clerks, merchants, civilians, and other characters that come and go are *Supporting Characters*. While these characters perform vital roles in society, they are not the focus of the storyline. Supporting Characters can be granted Points from Main Characters, in the form of *Morale*.

Damage

Sometimes, lasting effects can take their toll upon a character. Exhaustion, bodily harm, embarrassment, social mishaps, and emotional trauma – all can take their toll on a character, in the form of *Damage*.

Damage is worse than a spent Point; until the Damage is removed, the lost Point cannot be recovered. For example, if you have a Rating of 10 and two Damage Points, then the maximum Points you can have is $(10-2=) 8$.

If the Rating is reduced below the character's current reserve of Points, excessive points are lost. Following the above example, if you had 9 Clout Points and had your Rating reduced to 8, then you are left with only 8 Clout Points. (Damage doesn't actually reduce any Points you already have, it just lowers your Reserve.)

While spent Points are easily recovered, Damage takes longer, and can require long and expensive care. On the character sheet, mark Damage as an "X" until recovered.

Body

A measure of your size and physical fitness, *Body* is a general indicator of strength, speed, and health.

Carrying Capacity

Often just called *Carry*, any character can carry a load of 2 times their Body in kilograms with no ill effects.

Lift

Any character can *Lift* 5 times their Body rating in kilograms over their heads.

Injury (DAMAGE)

Falls, gunshots, and other kinds of physical abuse can cause *Injuries*.

A character that has even 1 Injury point is *Wounded* for purposes of Damage Rolls during Combat (q.v.). *Do not reduce a character's Wound Thresholds* – that's way too much math, and this rule takes the injury into account.

Should a character's Injuries ever equal or exceed their Body Rating (thus reducing it to zero or worse), that character lapses into a coma. They will require immediate medical attention or they will die.

Clout

A measure of your social standing, *Clout* represents strength of personality, attractiveness, and social status.

Oversight (DAMAGE)

Social gaffes, mistakes, and errors can lead to bad reputations, which in turn can make it more difficult to get people to take

you seriously. Also, getting folks to do favors or to commit themselves can take up a lot of time. Both errors and investment can lead to *Oversight*. *Oversight* is Damage that reduces a character's Clout Rating.

If a character's *Oversight* ever equals or exceeds their Clout Rating (thus reducing it to zero or worse), the character suffers an embarrassment that could end their career. At the very least, the character would be demoted.

Drive

A measure of mental energy, only unusual people have *Drive*. This attribute allows characters to push themselves to greater feats in a shorter amount of time than characters who lack *Drive*.

Trauma (DAMAGE)

Stressful situations, not the least of which is combat, can inflict lasting harm on one's psyche, called *Trauma*. Each *Trauma* reduces a character's Drive Rating by 1.

If a character's *Trauma* ever equals or exceeds their Drive Rating (thus reducing it to zero or worse), the character suffers an emotional breakdown. The character is in permanent Panic all the time. The character will require psychiatric help, which can be a role-playing opportunity.

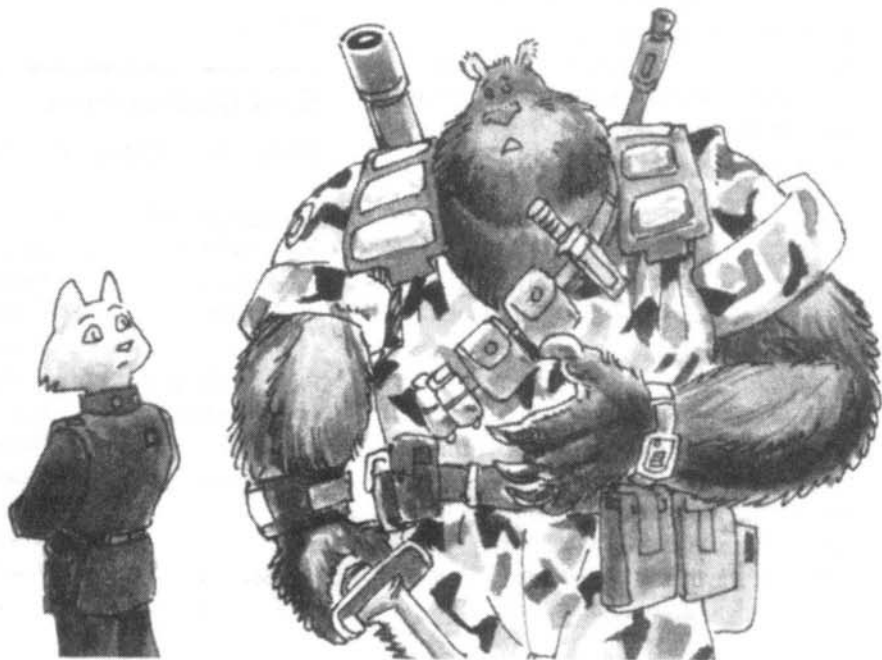

SPECIES

Z4RZCZ

There are over 160 distinct Species recognized by the Confederation of Worlds. The simple definition of a Species is that offspring between two members of the same Species breed true, fertile offspring. (While other Species can interbreed with each other, the results are always sterile.)



Birds

Birds of all types and sizes can be found in the worlds of *Albedo*, ranging from small finches to ostriches and emus. They are found on almost every settled world, and are particularly common on planets with low gravity. Some species have a preferred environment. Penguins, for example, often colonize polar regions of a given planet.

The avian body form presents some difficulties peculiar to these species. Most notable is the extremely light frames that birds have – they have hollow bones, and as such the species is unsuited to heavy labor. All birds have wings with simple hands, roughly where the wrist joint is located in real world birds. No sentient avian is able to fly in normal gravity, but they may be capable of impressive wing-assisted leaps, or even long-distance glides depending on their wing-to-body size ratio.

The situation is quite different in weightless conditions or on very low-gravity worlds. Provided there is an atmosphere, all bird characters (even penguins!) are able to propel themselves through the air with their wings while weightless. Their speed and the degree of control they have over this flight depends on the size of their wings. A sparrow is quite quick and ma-

neuverable, while an emu is capable only of fluttering in a general direction. In low-g conditions (less than half-gravity), many small birds are still capable of flight, and all but the largest species are able to make controlled glides.

Because they are well-feathered, most birds disdain the use of clothing altogether unless it serves a practical purpose, such as protection from inclement weather. Some birds will dress in elaborate fashions that highlight their plumage, but this is usually decorative. Members of military organizations such as the EDF and Homeguard wear specially tailored uniforms and battle armor.

Ratite birds include most species of flightless bird, such as ostriches, emus, and kiwis. They have very robust frames, and strong legs. Unlike most birds, they cannot use their wings to assist in leaps or for gliding, except in very low-g environments. Ostriches and Emus are excellent long distance runners, and can execute powerful, dangerous kicks. Kiwis also have very strong legs, but are better suited to hiking than running.

Bird Characters

Body: 5 Clout: 8 Drive: 6

Increase All Skills: *Choose One Gift:*

+1 G-Force	Ambidextrous
+3 Sneak	Belligerent
+2 Spot	Conformist
	Congenial

Choose One Skill:

+3 Freefall	Energetic
+3 Run	Fast
+3 Swim	Healthy
	Impulsive
	Indefatigable
	Small
	Velocity Expert

Canines

Ranging from tiny terriers to rugged timber wolves and burly St. Bernards, canines represent the single most diverse mammal species in the Known Worlds. In addition to wolves and coyotes, every single breed of dog known in the real world can be found in *Albedo* – though most dogs would be described as cross-breeds.

Canines are gregarious and social by nature, and most have a strong respect for authority and established order. This makes them a very common sight in the armed forces. However, their perception of authority is based on the competence of those in power, and a leader who appears to be incompetent or weak will not last long in office. This is especially true of wolves, who are renowned for constantly testing the resolve of their leaders, and demanding the complete loyalty of their underlings.

Canines, unlike cats and most other species groups, can interbreed. However, distinct species tend to prefer partners of the same species. Still, any number of combinations are possible, meaning that canines as a group (and dogs in particular) are largely unconcerned about appearance.

Canine Characters

Body: 8 Clout: 9 Drive: 7

Increase All Skills:

- +1 Hike
- +1 Listen
- +1 Run
- +1 Smell

Choose One Gift:

- Belligerent
- Charismatic
- Congenial
- Coolness Under Fire
- Cosmopolitan
- Energetic
- Healthy
- Natural Leader
- Overconfident
- Righteous
- Strong
- Suspiciousness

Felines

Cats are nearly as diverse in body type as canines, and vary in size from petite Sand Cats to the imposing Tigers. All the domestic variations regarded as "Housecats" in the real world exist, and are simply described as "cats." Cats are reserved and aloof, and prefer to socialize in small groups of friends.

Cats cannot generally interbreed outside



their immediate species, but exceptions can occur. For example, the offspring of a tiger and a lion is known as a "liger." Such cases are very rare.

Small Cat Characters

Body: 8 Clout: 7 Drive: 6

<i>Increase All Skills:</i>	<i>Choose One Gift:</i>
+1 Brawl	Ambidextrous
+1 Climb	Cold-Hearted
+2 Jump	Coolness Under Fire
+1 Listen	Cosmopolitan
+2 Sneak	Energetic
	Fast
	Following-Fire
	Expert
	Grace Under Pressure
	Healthy
	Impulsive
	Overconfident
	Quick Loading
	Small
	Velocity Expert

Great Cat Characters

Body: 10 Clout: 7 Drive: 6

<i>Increase All Skills:</i>	<i>Choose One Gift:</i>
+1 Brawl	Ambidextrous
+1 Climb	Cold-Hearted
+1 Jump	Coolness Under Fire
+1 Listen	Cosmopolitan
+1 Sneak	Energetic
	Fast
	Following-Fire
	Expert
	Grace Under Pressure
	Healthy
	Impulsive
	Large
	Overconfident
	Quick Loading
	Strong
	Velocity Expert

Lapines

Rabbits may be found anywhere in the Confederation, but since the conflict with the ILR, they are rarely found in senior positions. Many ConFed rabbits, particularly those dwelling on frontier worlds, experience a kind of low-grade mistrust and wariness that makes it difficult for them to advance in commercial or political arenas.

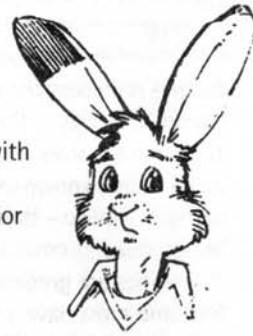

Rabbit Characters

Body: 7 Clout: 8 Drive: 6

<i>Increase All Skills:</i>	<i>Choose One Gift:</i>
+3 Jump	Charismatic
+1 Listen	Conformist
+2 Sneak	Congenial
+1 Spot	Cosmopolitan
	Energetic
	Fast
	Gadfly
	Impulsive
	Indefatigable
	Small
	Young

Marsupials

A fairly rare group, the Marsupial group includes Koalas, Kangaroos, Tasmanian Devils, and Opossums. They are different from most of the other mammalian species in *Albedo* in one significant regard.

Female members of the species have a natural pouch of skin on their midsection that is used in child-rearing. Marsupial children are born quite early in their development, and are then placed in this pouch until such time as they approach the stage at which most mammalian infants are born. The mammary glands are located within this pouch and the infants nurse almost constantly. Even after they have developed enough to spend time outside the pouch, the child often returns to sleep, nurse, or simply

to seek comfort from his mother. This means that marsupial mothers can work throughout their pregnancy and for several months after the birth without worrying about babysitters. This arrangement is greatly envied by mothers of other species.

This natural pocket can potentially be quite useful in day to day life as well – though few marsupials use it except in a pinch. The pouch is not so useful for smuggling items past security forces – it tends to be the first place that searchers look.

Kangaroos and Koalas are fairly social creatures, and get along well with most other species. Koalas have the ability to go without liquids indefinitely, provided they eat food that contains a modest amount of moisture. Koalas forced to live on dry foods, such as biscuits, will require water in small amounts.

Marsupial Characters

Body: 6 Clout: 8 Drive: 6

Increase All Skills: *Choose One Gift:*

+1 Brawl	Ambidextrous
+2 Climb	Belligerent
+1 Jump	Conformist
+4 Sneak	Congenial
	Cosmopolitan
	Gadfly
	Grace Under Pressure
	Impulsive
	Quick Loading
	Small
	Tough

Monotremes

Monotremes are a species group that includes Platypuses and Echidnas. They are a highly unusual and distinctive group of mammals that share some traits with Avian species. Most well known is that they lay eggs rather than give birth to live young. In addition, like birds they have a single body opening for reproduction and excretion known as a cloaca. They have no teeth, and no external ears. Ear canal openings are located at the base of jaw. In most other respects, Monotremes act like ordinary mammals, with the exception of some internal differences in bone structure.



Macropod Characters

Body: 8 Clout: 8 Drive: 6

Increase All Skills: *Choose One Gift:*

+1 Hike	Conformist
+2 Jump	Congenial
+2 Run	Cosmopolitan
+1 Spot	Fast
	Gadfly
	Grace Under Pressure
	Impulsive
	Indefatigable

Monotremes are accepted freely on most worlds, though they are rare enough that they are often the subject of curious gazes. Their reputation as a mysterious group of creatures is strengthened by their oddly isolated lifestyles. They rarely collect in groups larger than nuclear family, and seem content to keep to themselves. Since they share many characteristics of personal physiology, Monotremes in military service often find themselves sharing quarters with Avians. Monotremes are omnivorous, but have a particular liking for insects and similar arthropods.

Echidna Characters

Body: 6 Clout: 8 Drive: 8

<i>Increase All Skills:</i>	<i>Choose One Gift:</i>
+2 Brawl	Ambidextrous
+4 Sneak	Belligerent
	Cold-Hearted
	Coolness Under Fire
	Energetic
	Grace Under Pressure
	Healthy
	Righteous
	Small
	Tough

Platypus Characters

Body: 6 Clout: 8 Drive: 8

<i>Increase All Skills:</i>	<i>Choose One Gift:</i>
+2 Brawl	Ambidextrous
+1 Swim	Belligerent
+3 Sneak	Cold-Hearted
	Coolness Under Fire
	Energetic
	Grace Under Pressure
	Healthy
	Righteous
	Small
	Tough

Mustelids

Encompassing weasels, minks, otters, polecats, badgers, and wolverines, Mustelids tend to be lean creatures with surprising strength. Smaller members of this species group tend to be thin and quick-footed, while the larger members are relatively slow and hulking. They are carnivores, but most are capable of living healthily on a vegetarian diet.

**Skunk Characters**

Body: 7 Clout: 7 Drive: 7

<i>Increase All Skills:</i>	<i>Choose One Gift:</i>
+1 Climb	Belligerent
+1 Listen	Congenial
+2 Smell	Coolness Under Fire
+3 Sneak	Grace Under Pressure
	Healthy
	Impulsive
	Overconfident
	Suspiciousness

Otter Characters

Body: 7 Clout: 8 Drive: 6

<i>Increase All Skills:</i>	<i>Choose One Gift:</i>
+1 Listen	Ambidextrous
+1 Smell	Cosmopolitan
+2 Sneak	Energetic
+3 Swim	Fast
	Following-Fire Expert
	Gadfly
	Impulsive
	Overconfident
	Quick Loading
	Sniper Expert

Weasel Characters

Body: 7 Clout: 8 Drive: 6

<i>Increase All Skills:</i>	<i>Choose One Gift:</i>
+1 Brawl	Ambidextrous
+1 Jump	Belligerent
+1 Listen	Cold-Hearted
+1 Smell	Coolness Under Fire
+3 Sneak	Energetic
	Fast
	Following-Fire Expert
	Impulsive
	Overconfident
	Small
	Sniper Expert

Procyonids

Raccoons and their kin tend to be very social and curious, though inattentive, and as such as often found working as "idea men." In the EDF, they often gravitate to technical support roles that allow them some degree of flexibility.



Rodents

An extremely numerous group, rodents can be found on every world. All rodents have a pair of pronounced front incisors, and this may be the most obvious hallmark of the species. Rodents are omnivorous, but most prefer vegetables to meat.

Mouse Characters

Body: 5 Clout: 8 Drive: 6

<i>Increase All Skills:</i>	<i>Choose One Gift:</i>
+1 Climb	Ambidextrous
+1 Jump	Energetic
+2 Listen	Fast
+1 Smell	Grace Under Pressure
+4 Sneak	Grit
	Impulsive
	Small
	Young

Raccoon Characters

Body: 6 Clout: 8 Drive: 6

<i>Increase All Skills:</i>	<i>Choose One Gift:</i>
+2 Climb	Ambidextrous
+1 Listen	Cosmopolitan
+3 Sneak	Energetic
+2 Spot	Fast
	Following-Fire Expert
	Healthy
	Impulsive
	Sensor Expert
	Small

Rat Characters

Body: 7 Clout: 8 Drive: 6

<i>Increase All Skills:</i>	<i>Choose One Gift:</i>
+1 Listen	Ambidextrous
+1 Smell	Belligerent
+3 Sneak	Conformist
	Congenial
<i>Choose One Skill:</i>	Energetic
+2 Climb	Fast
+2 Swim	Grit
	Healthy
	Impulsive
	Indefatigable
	Small
	Velocity Expert

Squirrel Characters

Body: 6 Clout: 8 Drive: 6

<i>Increase All Skills:</i>	<i>Choose One Gift:</i>
+2 Climb	Ambidextrous
+1 Jump	Energetic
+2 Listen	Fast
+1 Smell	Following-Fire Expert
+2 Sneak	Grace Under Pressure
	Healthy
	Impulsive
	Quick Loading
	Small
	Velocity Expert



Ungulates

Ungulates are hoofed animals. They may be roughly separated into two groups, even-toed and odd-toed. Even-toed ungulates include cattle, sheep, goats, pigs, and antelopes. Odd-toed ungulates include horses and rhinos. Elephants are also



Ursines

Bears have a stocky frame, regardless of species. Though often considered somewhat slow-witted, they acquit themselves equally well in combat roles and support positions that require a great deal of careful thought and planning. However, they may be somewhat uncomfortable on planets dominated by smaller creatures. Everything is too small, or too delicate, for

considered ungulates.

Most ungulates are fairly large and robust herbivores or omnivores, with a well-developed sense of society. They can be found throughout known space, and generally work very well with other species. In fact, Ungulates may be the single most common species group in terms of overall population.

Ungulate Characters

Body: 11 Clout: 9 Drive: 6

<i>Increase All Skills:</i>	<i>Choose One Gift:</i>
+1 Run	Charismatic
+1 Spot	Conformist
	Congenial
	Energetic
	Fast
	Gadfly
	Grit
	Healthy
	Indefatigable
	Large
	Tough

their large paws. They may react to this discomfort by becoming quite antisocial.

Bear Characters

Body: 12 Clout: 7 Drive: 6

<i>Increase All Skills:</i>	<i>Choose One Gift:</i>
+2 Brawl	Belligerent
	Cold-Hearted
	Conformist
	Coolness Under
	Fire
<i>Choose One Skill:</i>	Grit
+1 Climb	Healthy
+1 Swim	Indefatigable
	Large
	Righteous
	Tough

Vulpines

Closely related to canines, the Vulpine species group has enough variety within itself to count as a separate group. Vulpines are foxes, and they range from tiny Fennecs with bat-like ears to bushy-tailed Red Foxes. Vulpines on the whole have very light and athletic bodies, and are rarely larger than the smaller canine species. They are highly social creatures who find success in a number of fields, though their size tends to keep them from active combat positions. Vulpine species have successfully colonized a number of worlds, though they are more commonly found within a larger, mixed, population.



Fox Characters

Body: 7 Clout: 7 Drive: 8

Increase All Skills:

- +1 Listen
- +2 Sixth Sense
- +1 Smell
- +2 Sneak

Choose One Gift:

- Charismatic
- Cold-Hearted
- Coolness Under Fire
- Cosmopolitan
- Energetic
- Fast
- Gadfly
- Grace Under Pressure
- Healthy
- Impulsive
- Overconfident
- Quick Loading
- Small
- Sniper Expert
- Velocity Expert



HOMEWORLDS

KPNPPNIBZ

Your character's Homeworld determines their education and upbringing. A Main Character's Homeworld gives them Marks in several Skills and one Homeworld Gift.

You can make up a Homeworld and then assign a type. You can also use a world from the Gazetteer, choosing only *one* of the Homeworld background types.



Corporate

Citizens on corporate worlds are almost invariably employees of a large capitalistic organization that owns most, or all, of the planet. On most worlds, each citizen-employee is also a shareholder. Very early in their education they are given aptitude tests, and steered into specific careers. While most corporations (such as Enchawah Group) offer a degree of flexibility when it comes to changing careers later, it is still much harder to switch professions than it is on most worlds. Characters from corporate worlds have a skill specialty of their choice, and know how to "grease the wheels" of corporate bureaucracy to get what they want. As shareholders, they have been exposed to hundreds of financial reports throughout their life, and know how to read sense into reams of numbers.

COMMAND REVIEW • KPNPPNIBZ REFUP

What Makes for a Homeworld Gift?
 Since characters will be members of the Extraplanetary Defense Force, some of the Gift choices are biased towards people who would sign up for military service to travel to faraway planets. For example, while young people eager to see the world are always eager to sign up, older people would only sign up for duty if they were already had applicable skills or had run out of other opportunities.

Increase All Skills:

- +1 Bureaucracy
- +1 Impress
- +1 Innuendo
- +1 Persuade
- +1 Question

Choose One Gift:

- Aristocratic Influence
- Belligerent
- Charismatic
- Congenial Economic Influence
- Energetic
- Gadfly
- Grace Under Pressure
- Impulsive
- Righteous
- Suspiciousness
- Young

Research Colony

Whether it is a tiny outpost on an inhospitable world or a full-fledged community of academics, research colonies are dedicated to the pursuit of pure science. Smaller colonies are purpose built to look into local phenomenon, whereas larger ones conduct general research and development. In either case, children are rare in these settlements, and characters raised in such an environment tend to be treated as little adults. They learn early on the importance of careful observation and research, and usually pick up a solid science background. Alternatively, they might rebel against the staid atmosphere, and deliberately refuse to learn their parent's academic specialty.

Increase All Skills:

- +1 Medical Sciences
- +1 Planetary Sciences
- +1 Physical Sciences
- +1 Research Analysis
- +1 Search

Choose One Gift:

- Cold-Hearted
- Conformist
- Doctor
- Factotum
- Grace Under Pressure
- Instructor
- Old
- Sensor Expert
- Spacer Influence
- Young

Resource Colony

Founded purely for the extraction of a valuable mineral or other resource, these colonies are often isolated, hardscrabble places with few amenities. A typical example is a mine in a hollowed out asteroid on the far rim of known space. They are usually run by a corporation or government, but independent resource colonies do exist. Only in rare circumstances do they survive more than a single generation, and most have a high population of transient inhabitants who stay a few months or years and move on. No sensible person brings their family to a resource colony, but the isolation often prompts even the temporary inhabitants into relationships and child-rearing. Children on a resource colony rarely receive an education that covers more than the skills used by adults to maintain the colony and extract the resources.

<i>Increase All Skills:</i>	<i>Choose One Gift:</i>
+1 Planetary Sciences	Armored-Vehicle Expert
+1 Information Analysis	Conformist Doctor
+1 Vehicle Operations	Economic Influence
+1 Repair	Factotum
+1 Scrounge	Grace Under Pressure
	Healthy
	Indefatigable
	Old
	Spacer Influence
	Velocity Expert
	Young

Rural

Rural worlds may have very large over-all populations, but they have few centralized cities. The inhabitants might live in extended family groups, or in small towns of less than 1000 people. Most first-generation colonies would be considered Rural. Farming is often the largest industry on a Rural colony, and may be the reason for its existence. Others were founded by groups of independently-minded individuals that dislike large communities, or are colonies that simply could not attract

enough immigrants to create large cities. A character raised on a rural colony will have received basic survival education as a child, and knows how to get by without the extensive infrastructure available to someone from an Urban colony. Rural colonists know how to maintain the technical equipment they need to survive, and may have extensive practical experience in botanic sciences and the lifecycles of local animals.

<i>Increase All Skills:</i>	<i>Choose One Gift:</i>
+1 Climb	Congenial
+1 Hike	Doctor
+1 Medical Sciences	Energetic
+1 Scrounge	Grit
+1 Swim	Healthy
	Indefatigable
	Instructor
	Tough
	Young

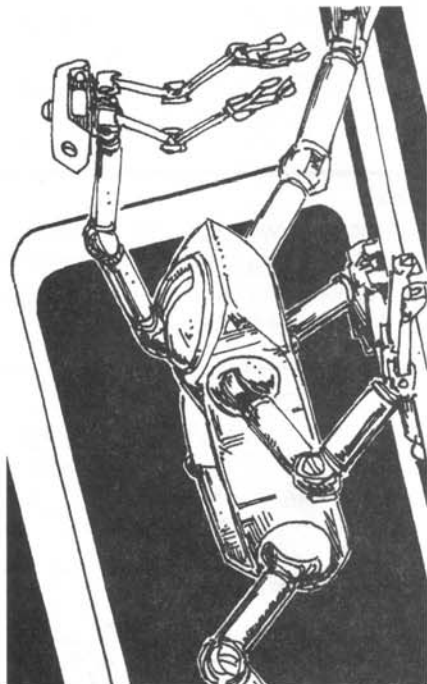

Space Station

There are hundreds of space-stations throughout the known Universe. Most serve a specific purpose – such as shipyards or fuel stations – and it is not uncommon for them to host large residential populations. Stations with permanent crews have rotating residential sections, with centrifugal force mimicking gravity. Some stations are quite large, with a

population numbering in the thousands. Characters born and raised on a space station are likely the offspring of station technicians or service industry staff. Their childhood was limited by the extent of the station corridors, and they were constantly exposed to stories about the wider universe. They picked up some basic shipboard skills, as well as a healthy respect for the fragility of an artificial environment. Many leave as soon they are of age, driven by a burning curiosity to visit a place where the horizon does not end at the next bulkhead.

majority of inhabitants live in well-served cities with Net connections and a multitude of municipal services. Life is easy, particularly on the socialist Core Worlds. Urban dwellers are exposed to high-technology from birth, but may not have any real idea how it works. They generally develop skills in dealing with municipal bureaucracy, Net use, and socialization. Characters with an Urban background have been exposed to people of many different races and opinions, and are often quite liberal and open-minded.

- | | |
|-----------------------------|-------------------------|
| <i>Increase All Skills:</i> | <i>Choose One Gift:</i> |
| +1 Build | Ambidextrous |
| +1 Freefall | Cold-Hearted |
| +1 Repair | Conformist |
| +1 Sensor | Doctor |
| Operation | Gadfly |
| +1 Spacesuit | Grace Under Pressure |
| | Old |
| | Space Influence |
| | Tough |
| | Velocity Expert |
| | Young |

- | | |
|-----------------------------|-------------------------|
| <i>Increase All Skills:</i> | <i>Choose One Gift:</i> |
| +1 Design | Aristocratic |
| +1 Gossip | Influence |
| +1 Innuendo | Belligerent |
| +1 Repair | Charismatic |
| +1 Vehicle | Cold-Hearted |
| Operations | Congenial |
| | Economic |
| | Influence |
| | Gadfly |
| | Grace Under Pressure |
| | Impulsive |
| | Natural Leader |
| | Righteous |
| | Suspiciousness |
| | Velocity Expert |
| | Young |

Urban

As the name suggests, urban planets are very well settled, typically with populations in excess of 500 million. Few planets outside the Core Worlds meet this criterion. The vast



PERSONALITY

PERSONALITY

Choose one of each of the four Personality aspects to represent your character. Each step increases one of your Attribute Ratings.

Social Orientation

How does your character relate to others?

Extroverted:

+1 CLOUT RATING

Your personality is outgoing and sociable. You prefer large, social situations like parties.

Introverted:

+1 DRIVE RATING

You are introspective and a bit of a loner. You prefer to be alone, or to have private relationships.

Experience Awareness

How does your character experience the world?

Sensitive:

+1 CLOUT RATING

You prefer to go out there, and see what's going on. You are more socially active than most folks.



Intuitive:

+1 DRIVE RATING

You tend to think in patterns and the abstract, more concerned with what may be than what is.

Social Awareness

How does your character decide what they would do?

Emotional:

+1 CLOUT RATING

You are sensitive to the needs of others. You actively work to help people resolve their emotional problems. When others around you are unhappy, you're unhappy.

Thoughtful:

+1 DRIVE RATING

You prefer hard data and facts. You prefer analytical analysis, a quality good for scientists and accountants. You accept that conflict is an inevitable part of social relationships.

Action Orientation

How does your character decide how to act?

Perceptive:

+1 CLOUT RATING

You prefer to understand what's going on, then improvise as time requires. You always have one eye on the big picture.

Judgmental:

+1 DRIVE RATING

You are a meticulous planner, and you expect others to follow the same plans. You focus on the task at hand.

COMMAND REVIEW • ΔΡΟΜΟΛΟΓΟΣ ΠΕΡΕΤΡΑ

Personality as a Role-Playing Guide

You can use the personality guide as a role-playing aid for your character. How would an Emotional Introvert handle a mission briefing? When planning a mission, how would a Sensitive, Judgmental character assign duties, as opposed to a Intuitive, Perceptive character? Players are encouraged to look up more information on personality types and how they might interact with one another.

BRANCHES OF SERVICE

BRANCHES OF SERVICE

Both Main Characters and Supporting Characters belong to a branch of service. When either a Main or Supporting Character, choose a Branch of Service, and add the Gifts and Marks to appropriate skills.

Not all of a Player-Character's Retinue have to come from the same Branch of Service as their commanding officer, but they should at least come from the same division (Administration, Aerospace, or Surface Operations).

See "Ranks in the EDF", page 56.

Special Services (SS)

Gift: Administration +1
 Gift: Socialization +2
 Gift: Suspiciousness
 Information Analysis +1
 Pistol +1
 Question +2
 Search +1

Administration

Boring, but necessary, the Administration branch of the EDF oversees the logistics of distribution, procurement, recruitment, and other bean-counting activities.

Industry & Procurement (IP)

Gift: Administration +2
 Gift: Socialization +1
 Gift: Economics Influence
 Pistol +1
 Plan +2
 Scrounge +2

Liaison (L)

Gift: Administration +1
 Gift: Socialization +2
 Gift: Cosmopolitan
 Gossip +2
 Innuendo +1
 Persuade +1
 Pistol +1

Quartermasters (QM)

Gift: Administration +2
 Gift: Socialization +1
 Gift: Logistics Expert
 Lead +1
 Pistol +1
 Plan +2



Aerospace

When most people think of the Extra-planetary Defense Force, they think of the *Aerospace* division. While the idea of piloting rocket-ships to the stars might sound glamorous, the bulk of Aerospace work is in maintaining the delicate equipment.

All members of the Aerospace branch have the following Gifts:

Aerodyne (DYNE)

Gift: Astronautics +2
 Gift: Firearms +1
 Gift: Velocity Expert
 G-Force +1
 Navigate +1
 Sensor Operations +1
 Vehicular Weapons +1
 Vehicle Operations +1

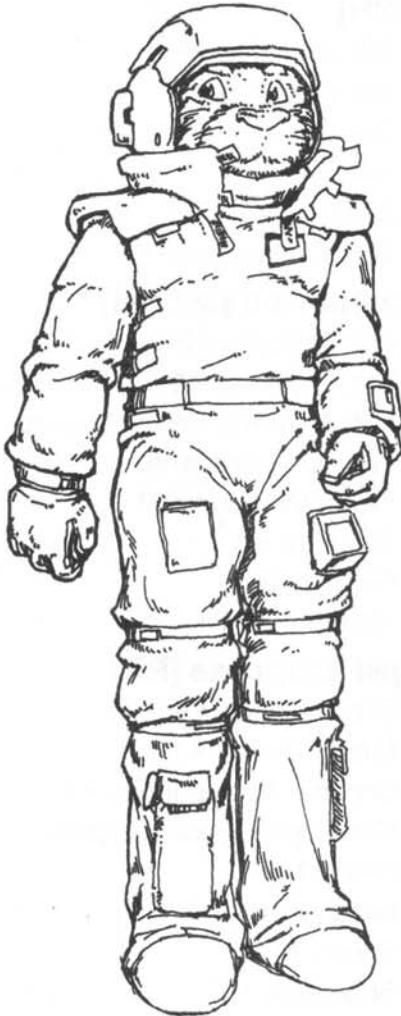

Engineering (ENGA)

Gift: Astronautics +2
 Gift: Firearms +1
 Gift: Group – Engineering +1
 Build +1
 Repair +2
 Scrounge +1
 Sensor Operations +1

Freefall Infantry (FI)

Gift: Astronautics +1
 Gift: Firearms +2
 Gift: Semi-Automatic Expert
 Longarms +2
 Sixth Sense +2
 Spacesuit +1

Interplanetary (INT)

Gift: Astronautics +2
 Gift: Firearms +1
 Gift: Hyperspace Expert
 Hyperspace Sciences +2
 Navigate +2
 Vehicle Operations +1

Specialists

Officers who aren't part of any specific branch, *Specialists* have niche roles in the EDF.

Emissary (EM)

Gift: Socialization +2
 Gift: Subterfuge +1
 Gift: Cosmopolitan
 Bribe +1
 Gossip +1
 Innuendo +1
 Search +2

Exploration (EXP)

Gift: Astronautics +1
 Gift: Sciences +2
 Gift: Hyperspace Expert
 Information Analysis +1
 Navigate +1
 Sensor Operations +2
 Vehicle Operations +1

Research and Design (R&D)

Gift: Inventions Expert
 Gift: Engineering +2
 Gift: Sciences +1
 Research Analysis +2
 Design +3

Surface Ops

It's a dirty job, but someone's got to do it. The branch of *Surface Operations* does most of the armed work of the EDF - removing insurgents from occupied zones and the like.

Engineering (ENGS)

Gift: Athletics +2
 Gift: Engineering +1
 Gift: Firearms +1
 Build +1
 Hike +1
 Repair +1
 Scrounge +2

**Heavy Infantry (HI)**

Gift: Athletics +2
 Gift: Firearms +1
 Gift: Following Fire Expert
 Heavy Weapons +1
 Hike +1
 Longarms +2
 Navigate +1

Light Infantry (LI)

Gift: Athletics +1
 Gift: Firearms +2
 Gift: Semi-Automatic Expert
 Hike +1
 Longarms +2
 Navigate +1
 Sixth Sense +1

Mobile Surgical Hospital (MSH)

Gift: Athletics +2
 Gift: Firearms +1
 Gift: Doctor
 Hike +1
 Sixth Sense +1
 Medical Sciences +3

Mechanized (MECH)

Gift: Athletics +2
 Gift: Firearms +1
 Gift: Armored Vehicle Expert
 Vehicle Operations +1
 Heavy Weapons +1
 Navigate +1
 Repair +1
 Sixth Sense +1

Rapid Response (RR)

Gift: Athletics +1
 Gift: Firearms +1
 Group - Astronautics +1
 Gift: Rapid Descent Expert
 Hike +1
 Longarms +2
 Sneak +1
 Spacesuit +1

SKILLS

A *Physical Skill* can be Pushed using Body Points. A *Social Skill* can be Pushed using Clout Points. A *Mental Skill* can be Pushed using Drive Points.

Each Skill is part of one or more Groups, listed after the type. Every time a character takes that Group Gift, they get +1 Mark in that Skill.

Brawl*

[PHYSICAL: ATHLETICS]

For most citizens in the *Albedo* universe, the concept of physical contact to cause harm is distressing. Nevertheless, it's sometimes necessary.

The Brawl Skill covers all unarmed attacks, such as punching, kicking, clawing, biting, grappling, and wrestling.

Bribe*

[SOCIAL: SOCIALIZATION]

Sometimes, you have to grease a few palms to get what you want. The Bribe skill allows you to assess what might actually bribe someone – such as money, favors, promotions, etc. – and also how to tender such a bribe without offending anyone or attracting undue attention.

Build

[MENTAL: ENGINEERING]

Many military vehicles are shipped to planets in pre-fabricated parts, air-dropped from very-high altitudes. Build Skill is necessary to construct any item with the proper parts and proper plans.

Bureaucracy*

[MENTAL: ADMINISTRATION]

If you ask some folks, they wonder how anything gets done with all the forms, paperwork, and requisitions that need to be filled out. Because the EDF derives their

funding from the Confederation of Worlds, regulations can be complex and draconian, and a high Bureaucracy Skill is required to follow through all the red tape.

Climb*

[PHYSICAL: ATHLETICS]

For infantry, the ability to scale over obstacles is important. Use Climbing Skill to climb ladders and maneuver over objects when in gravity. For pulling oneself along in zero-gravity, use Freefall.

Computer Sciences

[MENTAL: ENGINEERING]

While the computers of *Albedo* use standardized designs, protocols, and code, that doesn't make the task of programming them any less daunting. Most folks will prefer to interface with a helpful Net Artificial Intelligence, but those schooled in Computer Sciences will be able to get more done.

Demolitions

[MENTAL: ENGINEERING]

Destruction of materiel with explosives falls under the Demolitions Skill. This ability covers the best way to collapse walls, break engines, set explosive charges and booby traps, and to set and to disarm mines. This Skill does not cover delivered explosives, such as from a gun or artillery – use the appropriate weapon's Skill, instead. This Skill also does not cover large-yield explosives that might take out more than one building – use Weapons of Mass Destruction, instead.

Design

[MENTAL: ENGINEERING]

Every military threat has a unique challenge to it. Sometimes, the proper solution is to draft a new device in the field to deal with it. Using Design Skill in the field can be risky – such devices will be temperamental and prone to failure because of unskilled operators or unanticipated conditions of use.

COMMAND REVIEW • АРНААБ НЕРСУР

Common Skills

Some activities can be performed even by the untrained. These are called *Common Skills*. Every character gets one Mark in these skills for free. Common Skills are marked here with an asterisk (*), and on the character sheet with one Mark filled.

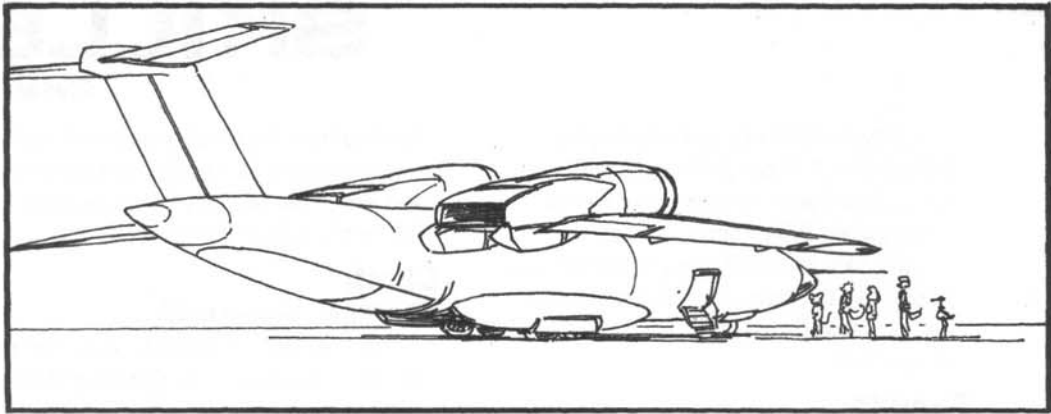

Disguise

[SOCIAL: SUBTERFUGE]

A necessity for spies, Disguise Skill is used to lie to others, to pretend to be something else, or generally any protracted lie. Disguise is used for imposture as different social classes, positions, or even races. The Spot Skill is used to see through a Disguise; The Question Skill is used in conversation with a Disguised Target; and the Information Analysis is used to study the target's Deceitful behavior.

Forge

[MENTAL: SUBTERFUGE]

Although it's a crime with severe punishments, there are those who know the art of Forging documents. Characters in the EDF learn this Skill not because they are expected to fake credentials, histories, and information, but because this Skill also helps spot such fakery.

Freefall *

[PHYSICAL: ASTRONAUTICS]

A lot of time spend in outer-space is in microgravity or less. Freefall is used to steady oneself when spinning and to maneuver in zero-gravity environments.

G-Force *

[PHYSICAL: ASTRONAUTICS, VEHICLES]

When a vehicle changes direction, or accelerates, it inflicts force upon the crew. G-Force represents the physical conditioning and training to avoid losing consciousness and other injuries.

Gossip *

[SOCIAL: SOCIALIZATION]

In social situations, one can Gossip with other folks. This Skill allows one to host a successful party or other social event. It also allows one to glean information in a relaxed setting.

Heavy Weapons

[MENTAL: FIREARMS]

Tripod weapons, grenade-launchers, vehicular-weapons, and other long-distance field pieces are covered by the Heavy Weapons skill. Every infantry squad should have one Heavy-Weapons expert.

Hike *

[PHYSICAL: ATHLETICS]

Infantry spend a lot of time on foot, moving from place to place – especially where vehicles can't go. Hike Skill is used to cross greater distances in shorter time.

Hyperspace Sciences

[MENTAL: SCIENCE]

The mathematical convolutions needed to arrange for a hyperspace jump are something you want to get right, especially if lives are involved. Hyperspace Sciences is necessary to perform these calculations correctly, with or without a computer.

Impress *

[SOCIAL: SOCIALIZATION]

To properly show off to others, especially in a public setting, use the Impress skill. Most folks in *Albedo's* societies have difficulty speaking before a crowd. For one-on-one situations, use the Persuade skill.

Information Analysis *

[MENTAL: ADMINISTRATION, OBSERVATION]

Data comes from many sources, such as eyewitness reports, sensor data, satellite photos, historical records, etc. The Skill of Information Analysis is how to put it all together. Successful uses of this Skill can reveal patterns in collected data.

Information Analysis is for social and military information. For scientific data, use Research Analysis, instead.

Innuendo *

[SOCIAL: SOCIALIZATION, SUBTERFUGE]

The Innuendo Skill is used to slip a topic into conversation that only a close confidant will understand, or to pick up on an Innuendo that someone else let slip. In many cultures and places, citizens are under constant surveillance by cameras and microphones, making this Skill necessary to preserve privacy.

Jump *

[PHYSICAL: ATHLETICS]

Eventually, it happens – someone has to jump a gap or leap to grab something. Jump skill allows one to leap greater distances more reliably.

Lead *

[SOCIAL: ADMINISTRATION, SOCIALIZATION]

Every commanding officer knows the virtue of having a high Lead skill. Among other things, this Skill is necessary to Rally subordinates to motivate them.

Listen *

[MENTAL: OBSERVATION]

Hearing quiet noises, and distinguishing quiet noises almost drowned out by louder ones, is covered by the Listen Skill.

Longarms *

[MENTAL: FIREARMS]

Any gun designed to be fired in two hands, such as a shotgun, rifle, or sub-machinegun, is a Longarm. Firing one is covered by this Skill.

Medical Sciences

[MENTAL: SCIENCE]

The races of Albedo, while quite diverse, all share similar medical makeup. Those with Medical Science skills can provide first aid and administer drugs to the sick.

Melee *

[PHYSICAL: ATHLETICS]

The EDF only recognizes two hand-to-hand weapons: the combat knife, and the quarter-staff. However, many troops train in how to fight with these, as well as improvised weapons such as shovels. Melee Skill covers any attack made with a hand-to-hand weapon.

Navigate

[MENTAL: ASTRONAUTICS, VEHICLES]

Vehicles in Albedo have sophisticated navigational systems, but sometimes a good old-fashioned map will suffice.

Persuade *

[SOCIAL: SOCIALIZATION]

The complement to Impress, Persuade Skill is used to convince characters to do things your way, or for you, or to bring them over to your point of view.

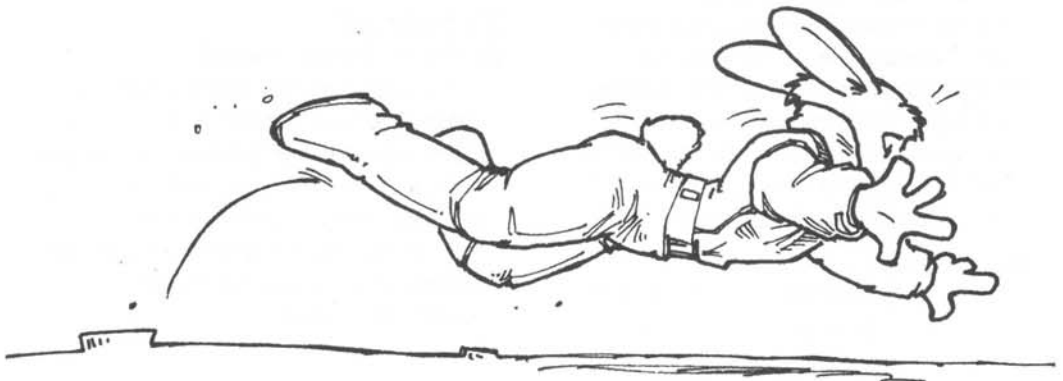

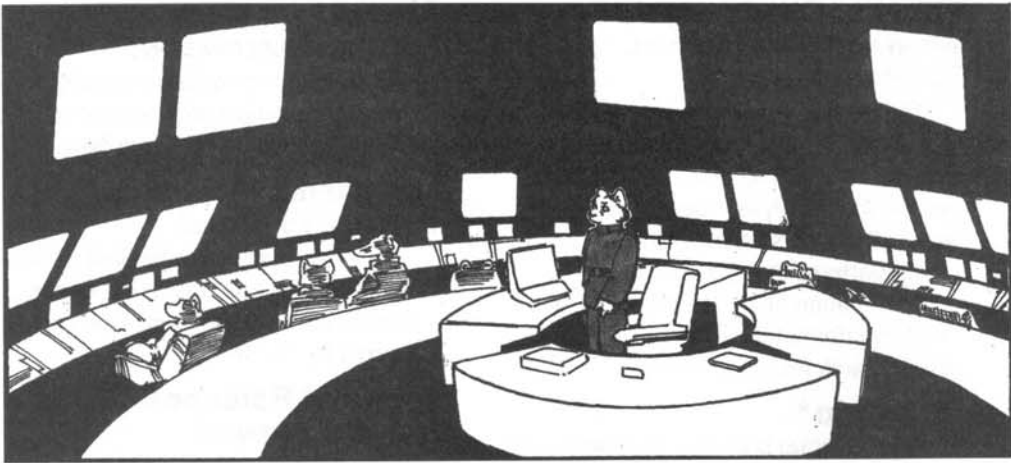

While Persuade may involve putting facts in the best light, it doesn't involve actually deceiving anyone – use the Deceive Skill for that. Persuade is also for one-on-one conversations; for addressing a group, use the Impress Skill.

Physical Sciences

[MENTAL: ASTRONAUTICS, SCIENCE]

Chemistry, Physics, and other observable phenomena – and the prickly math to describe them – are covered by the Physical Sciences skill.

Pistols *

[MENTAL: FIREARMS]

This Skill covers the use of one-handed firearms.

Plan

[MENTAL: ADMINISTRATION]

This Skill is the ability to draft an action-plan or battle-plan correctly and quickly – a necessity for high-ranking officers.

Planetary Sciences

[MENTAL: SCIENCE]

Planets and asteroids contain minerals that can be extracted for industrial application. Planetary Sciences is the skill for locating such items, knowing their quantity and quality, and even such geological phenomena as weather patterns and earthquakes. Despite the name, this Skill also covers moons, asteroids, and similar bodies.

Question *

[SOCIAL: SOCIALIZATION, SUBTERFUGE]

Using the Question Skill is blunt, and to the point; someone always knows that

they're being Questioned. In unsavory circumstances, Question can be combined with blackmail or torture for greater results.

Repair *

[MENTAL: ENGINEERING]

In any military situation, things break down. Repair Skill covers diagnosing what made something stop working in the first place, and it covers all the grunt work necessary to extract broken parts and replace them with new ones.

Research Analysis

[MENTAL: ADMINISTRATION, ENGINEERING]

Lab work isn't exciting, but it's necessary for scientific progress. Research Analysis Skill works as Information Analysis for scientific data.

Run *

[PHYSICAL: ATHLETICS]

Normally, a trooper can only move 10 meters in a six-second period. The Run skill can allow a trooper to cover a greater distance.

Scrounge

[MENTAL: ENGINEERING]

For almost any job, there's a right tool ... and another tool that can do the job, in a pinch. Use Scrounge Skill to scrape up spare parts or to improvise other materials for purposes other than their intended use. Anyone who's done a term on an outer-rim space-station knows what it's like to Scrounge for goods.

Search *

[MENTAL: OBSERVATION]

Methodically going through someone's pockets, their room, or an area is covered by the Search Skill. A Search is always an active action that requires concentration.

Sensor Operations *

[MENTAL: OBSERVATION]

The skill of using sensing equipment. Most devices, such as light-enhancing goggles, are self-explanatory. Fancy devices, like electronic-countermeasure devices, eavesdropping microphones, and the like will require this Skill.

Sixth Sense

[MENTAL: OBSERVATION]

Sometimes called "the skill of known unknowns," Sixth Sense is the Skill veterans pick up to know where their blind spots are. This skill can be used to be wary of avenues for ambush or locations for traps.

Smell *

[MENTAL: OBSERVATION]

Some races have a keen sense of Smell, stronger than other races. The Smell Skill can be used to identify chemicals such as lubricants or bodily fluids.

**Sneak ***

[PHYSICAL: SUBTERFUGE]

This Skill is used to move from one position to another while avoiding detection, or to hide for long periods.

Spot *

[MENTAL: OBSERVATION]

A popular Skill, Spot is the ability to see things. Combatants use this Skill to sight targets, among other things.

Spacesuit

[PHYSICAL: ASTRONAUTICS]

The first thing any spacer learns is how to suit up quickly, in case of emergency. The second thing they learn is how to maneuver in a Spacesuit.

Swim *

[PHYSICAL: ATHLETICS]

Most inhabited planets have large bodies of water, in which someone could flounder and drown. Many races have a natural affinity for Swimming, as well.

Throw *

[PHYSICAL: ATHLETICS]

When it comes to explosives like grenades, it's handy to be able to place it where you want. Throw Skill covers both distance and accuracy.

Vehicle Operations

[MENTAL: VEHICLES]

The ability to drive or pilot any vehicle, land-based or otherwise, is covered by this Skill. Trained military personnel will have Gifts that make them even better.

Vehicular Weapons

[MENTAL: ENGINEERING]

This Skill covers the use of vehicular targeting systems and their linked weapons. (For weapons that use direct line-of-sight, such as pintle-mounted guns, use Heavy Weapons, instead.)

Weapons of Mass Destruction

[MENTAL: ENGINEERING]

This Skill covers the use of autonomous-combat vehicles, nuclear weapons, and other high-yield devices, as well as counter-measures against them. This training is a necessary evil for military engineers.

GIFTS

2012

Gifts represent special abilities that separate a character from the rank and file. Gifts are often "rule-breakers" – they allow a character with the appropriate Gift to circumvent or work around a default rule.

Many Gifts require Points to work. For Main Characters, these are either Body, Clout, or Drive. For Supporting Characters, these points are Morale. If the character doesn't have the points to spend, they can't use the Gift.

Basic Gifts

Anyone can buy these. They have no extra requirements.

Ambidextrous

You can use either hand with no penalty. If you spend 1 Drive point, you can shoot two Pistols in one round; you can either claim two attack rolls, or you can Suppress the same area, etc. Without this Gift, you can only use one weapon per action.

Aristocratic Influence

You spend Push or Risk any Social Roll when influencing aristocrats, plutocrats, and other oligarchs without spending 1 Clout.

Raise your SPI by 1.

Armored Vehicle Expert

You can maneuver any vehicle you Vehicle Operations to reduce exposure to vulnerable ears.

By spending 1 Drive Point, you can improve the Armor rating of your vehicle by 5.



By spending 1 Drive Point, you can negate the extra 1d20 for driving a Damaged Vehicle. (There is no effect if the vehicle is not damaged.)

Charismatic

You have a strong personality that makes it hard for folks to dislike you. If your Retry on a failed Social Roll *Succeeds* or better, reduce the Clout loss by 1.

Raise your SPI by 1.

Congenial

You have +1 Clout Rating.

Coolness Under Fire

Each Round, the total Awe you suffer is reduced by 1 (down to zero).

Cosmopolitan

You never suffer any penalties for not knowing the local culture.

Increase your SPI by 4.

Doctor

You can perform advanced medical techniques. You can attempt to heal targets of Injury, using Medical Sciences Skill. Without this Gift, you can only perform basic first aid.

Economic Influence

You spend Push or Risk any Social Roll when influencing capitalists without spending 1 Clout.

Raise your SPI by 1.

Energetic

You have +1 Drive Rating.

Factotum

You can help other folks get organized, and you can repair damage to reputations. You can attempt to heal other targets of Oversight, using Bureacracy Skill.

Fast

Your Running distance is 1.5x normal. If you are ever in a contest involving physical speed against someone else, they must spend 1 Body, or you automatically act first.

Following Fire Expert

You can claim Following-Fire on targets up to *Medium Range*. Likewise, you can Watch at ranges up to Medium and remain watching after the first shot. Without this Gift, you can only claim Following-Fire on targets at up to Short Range.

Grace Under Pressure

Your wit knows few bounds, and you thrive in hostile conditions. If your Retry on a failed Mental Roll *Succeeds* or better, reduce the Drive loss by 1.

Increase your SPI by 1.

Grit

When you suffer *Crippling*, you may spend 1 Drive point to act as if you were merely *Wounded*. You are still Crippled for purposes of Damage rolls.

When you immediately suffer *Incapacitation*, you may spend 1 Drive point to avoid passing out and to act normally in the Round, as if merely *Wounded*. Next Round, you must either spend 1 Drive point or immediately become Incapacitated. You are still Incapacitated for purposes of Damage rolls. You may continue to act until you run out of Drive points.

Healthy

You have +1 Body Rating.

Impressive Leader

You can Rally more than one person who Trusts you – up to your Impress Skill Score (usually your Rote of 1+Marks, but more if you roll.)

Indefatigable

You have vast reserves of physical energy. If your Retry on a failed Physical roll *Succeeds* or better, reduce the Body loss by 1.

Increase your SPI by 1.

Instructor

You can give excellent verbal support to others, such as by radio. You can instruct anyone who has the *same number of Marks or lower in a Skill you have, yourself*.

As an action, you can spend one Clout, allowing the target to Push or Risk in the appropriate Skill, just as if they had spent a point themselves. Regardless of the kind of skill (Physical, Social, or Mental), you only spend Clout.

You cannot instruct a Panicked target.

Natural Leader

When Rallying a target that Trusts you, you may add up to two Morale instead of one.

Raise your SPI by 1.

Psychologist

You can treat mental illness and battle fatigue. You can attempt to heal other targets of Trauma, using Question Skill.

Quick Loading

If you spend 1 Drive point, you can reload a firearm and still take an action.

Without this Gift, you must spend your action reloading.

Rapid-Descent Expert

If you spend 1 Body, you can reduce any Falling Damage or G-Force Damage by 1d20.

Semi-Automatic Expert

You know how to fire a burst of three bullets for effect. You must have a semi-automatic or fully-automatic weapon to claim the benefit of this Gift.

Whenever you *Tie* on a firearms roll, instead of missing, you can choose instead to fire *two more* bullets, and hit the target once with a regular hit.

You must have a semi-automatic weapon, and two more bullets in your magazine, to claim this Gift.

Sensor Expert

By spending 1 Drive, you can *double* the effective range of any sensor device that you hold. (Among other things, this will help with the Concealment-per-range when using vision-enhancing devices.) Without this gift, you must use the listed values.

Sniper Expert

Whenever you have Aimed at a target, and you successfully hit the target with a firearm attack, you may spend 1 Drive and add an extra 1d20 to the Damage Roll.

Spacer Influence

You spend Push or Risk any Social Roll when influencing beltlers, spacers, and other career astronauts without spending 1 Clout.

Raise your SPI by 1.

Suppression Expert

With a fully-automatic weapon, you can Suppress a triangle up to Medium Range on each side. Without this Gift, you can only Suppress an area up to Small Range on each side.

Suspiciousness

If you spend a Drive point, a target suffers Panic when trying to Deceive you or otherwise play you false. The target can spend one Drive point to negate the Panic.

Tough

You are very hardy. Raise all your Damage Thresholds by 5.



Velocity Expert

You know how to fly to put less strain on your vehicle and its crew. Reduce all G-stress by 1.

Group Gifts

Some characters have a generalized aptitude for a variety of related activities.

Each Group Gift gives +1 Mark in Skills of the appropriate Group.

You can take a Group Gift multiple times. Each time you have a Group Gift, it adds +1 Mark to all appropriate Skills.

Administration +1

Each Gift gives +1 to Bureaucracy, Information Analysis, Lead, Plan, and Research Analysis.

Astronautics +1

Each Gift gives +1 to Freefall, G-Force, Navigate, Physical Sciences, and Spacesuit.

Athletics +1

Each Gift gives +1 to Brawl, Climb, Hike, Jump, Melee, Run, Swim, and Throw.

Engineering +1

Each Gift gives +1 to Build, Computer Sciences, Demolitions, Design, Repair, Research Analysis, Scrounge, and Weapons of Mass Destruction.

Firearms +1

Each Gift gives +1 to Heavy Weapons, Longarms, and Pistols.

Observation +1

Each Gift gives +1 to Information Analysis, Listen, Search, Sensor Operations, Sixth Sense, Smell, and Spot.

Sciences +1

Each Gift gives +1 to Hyperspace Sciences, Medical Sciences, Physical Sciences, and Planetary Sciences.

Socialization +1

Each Gift gives +1 to Bribe, Gossip, Impress, Innuendo, Lead, Persuade, and Question.

Subterfuge +1

Each Gift gives +1 to Disguise, Forge, Innuendo, Question, and Sneak.

Vehicles +1

Each Gift gives +1 to G-Force, Navigate, Vehicle Operations, and Vehicular Weapons.

Advanced Gifts

These Gifts have requirements which must be met before you can have them. For example, you can't have the Gift of "Very Strong" unless you already have the Gift of "Strong."

Fantastic Leader

(Requires: Natural Leader; Lead Marks 6+)

When Rallying a target that has Loyalty to you, you may add up to *five* Morale instead of the maximum of 3.

Raise your SPI by 1.



Following-Fire Master

(Requires: Following-Fire Expert)

When claiming Following Fire, the second *and third* attacks do not cost any Drive. The fourth and later attacks do.

Hyperspace Expert

(Requires: 1+ Marks in Hyperspace Sciences)

You can plot Hyperspace Jumps longer than other folks can. You can increase the maximum range of a jump by the Score of your Hyperspace Sciences Skill (using either Rote or a Roll)

Or, instead, you can reduce the amount of time it takes to make the calculations. Reduce the time by 5% times your Score. (For example, if you have a 9, then it takes 45% less time.)

Improved Coolness Under Fire

(Requires: Coolness Under Fire)

Subtract *another* one from any Awe you suffer, combining with Coolness Under Fire.

Inventions Expert

(Requires: 1+ Marks in Research Analysis)

You can use research to improve production. While under your supervision, a plant improves production by 5% times your Score in Research Analysis. (For example, if you have a 9, then a plant yields 45% greater production under your supervision.)

Knack: [of Choice]

(Requires: 3+ Marks in Skill of Choice)

When you buy this Gift, choose one Skill. If you ever *Overwhelmingly Succeed* with the resulting Skill Roll, you recover 1 spent point in the appropriate attribute (Body,

Clout, or Drive), provided you spent the point to push the skill.

You may take this Gift multiple times. Each time, choose a different Skill.

Raise your SPI by 1 for each Knack.

Logistics Expert

(Requires: 1+ Ranks in Bureaucracy)

Under your administration, troops recover faster. See the *Recovery* (p. 132) for more details.

Martial Arts

(Requires: Coolness Under Fire)

You have trained yourself to fight hand-to-hand. You can kick, head-butt, slam, or even bite your target, for improved damage.

At the start of your action, pick any one combatant. You may claim 25% Cover in Melee Only vs. that target, because of your ability to parry and to control space. If you spend 1 Body, you may reduce a target's Cover vs. your unarmed attack by 25% (except for 100% Cover).

If you hit with your unarmed attack, you may claim a following attack against other combatants, with your unarmed attack. Similar to Following Fire, you may strike a second time at no cost (and if that attack hits, you may strike a third time, spending 1 Body). Remember that any Close attack, even Following ones, provoke counter-attacks. This is not true "following-fire"; the gifts of Following-Fire Expert and Master do not apply.

Melee Expert

(Requires: Coolness Under Fire)

You have trained yourself to fight with melee weapons. At the start of your action,

pick any one combatant. You may claim 50% Cover in Melee Only vs. that target, because of your ability to parry and to control space. If you spend 1 Body, you may reduce a target's Cover vs. your unarmed attack by 25% (except for 100% Cover).

If you hit with your melee attack, you may claim a following attack against other combatants, with your unarmed attack. Similar to Following Fire, you may strike a second time at no cost (and if that attack hits, you may strike a third time, spending 1 Body). Remember that any Close attack, even Following ones, provoke counter-attacks. This is not true "following-fire"; the gifts of Following-Fire Expert and Master do not apply.

Net Influence

(Requires: 1+ Marks in Computer Sciences)

You know how The Net "thinks." You spend 1 less Drive Point when trying to influence The Net and other artificial intelligences to do what you want.

Raise your SPI by 1.

Planning Expert

(Requires: 1+ Marks in Plan Skill)

Before you enter a battle, if you have time to prepare, you may declare the fight to be a *planned encounter*. Then, during the battle, you may use Plan Skill to bolster Morale, spending 1 Drive per Morale. This Morale represents presence of mind and keen forethought in dealing with the situation.

You cannot Rally folks with Plan Skill.

You still use Lead Skill to Rally folks. Among other things, this means that you cannot remove Panic with Plan Skill.

You can only use the Planning Expert Gift if you had time to plan the battle. If you

are ambushed in an unlikely place, you cannot. The Game Host is the final arbiter of when your advanced planning is effective.

Robotics Expert

(Requires: 1+ Marks in Computer Sciences)

By spending 1 Drive Point, you can convince a robot under your control to Roll, Risk, Push, or Breeze. Without this gift, robots under your control can only do things by Rote.

Semi-Automatic Master

(Requires: Semi-Automatic Expert)

When using a semi-automatic weapon, and you *miss* a target at Medium Range or less, you can immediately Retry, spending Drive points and two bullets from your gun. Normally, you are not permitted a Retry with attack rolls.

Sniper Master

(Requires: Sniper Expert)

Whenever you have Aimed at a target, and you successfully hit the target with a firearm attack, you may spend 3 Drive and add an extra 2d20 to the Damage Roll.

Strong

(Requires: Body Rating 8+)

You are stronger than average. Improve the Damage of all your hand-to-hand attacks by 5.

You can Carry 3 times your Body rating (not 2). You can Lift 8 times your Body rating (not 5).

When you engage in a contest of strength (such as grappling or wrestling) with someone who is *not* Strong, your opponent must spend 1 Body point before even rolling any dice, or automatically lose.

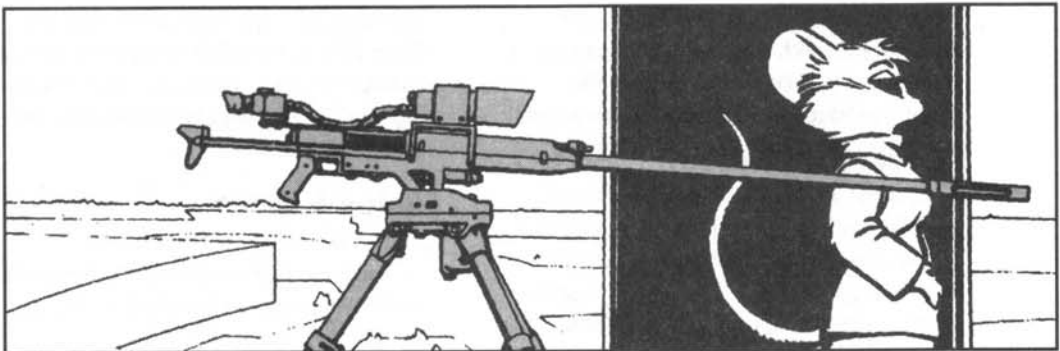

Very Fast

(Requires: Fast)

If you spend 1 Body Point, you can *double* your running movement. You can claim Cover or Concealment at a distance of 3 meters. Without this Gift, you can only claim Cover or Concealment from within 2 meters of your position.

Very Strong

(Requires: Body 10+; Strong)

You are a lot stronger than average. Improve the Shock damage of all your hand-to-hand attacks by 2 (not 1).

You can Carry 4 times your Body rating (not 2 or 3). You can Lift 10 times your Body rating (not 5 or 8).

When you engage in a contest of strength (such as grappling or wrestling) with someone who is not Very Strong, your opponent must spend 1 Body point before even rolling any dice, or automatically lose. This is cumulative – someone without Strong or Very Strong must spend two Body points.

Very Tough

(Requires: Tough)

You are remarkably hardy. Raise all your Damage Thresholds by 10 (instead of the 5 from Tough.)



Dubious Gifts

These Gifts are both a blessing and a curse. Note that a character can still be argumentative, impulsive, etc. without these Dubious Gifts – they just don't receive any benefit from being so.

In the sedate, conservative society of *Albedo*, many Dubious Gifts represent personality traits frowned upon by the

public at large. Remember that your final SPI rating is based on Clout, Drive, and Gifts – and Dubious Gifts that change an Attribute *and* SPI are cumulative.

You cannot take a Dubious Gift if it would reduce a Rating below zero.

Belligerent

You have a reputation for being argumentative and violent.

You have +2 Drive Rating.

Reduce your SPI by 5.

Cold-Hearted

You don't relate well to other people. Others describe you as withdrawn or argumentative, maybe even as sociopathic. You can distance yourself from the horrors around you.

You reduce Awe that you suffer by 1, down to zero. This reduction is cumulative with other Gifts.

You have -2 Clout Rating.

Reduce your SPI by 3.

Conformist

Your lifestyle and behavior are abnormally concurrent with positive marks on SPI tests. However, you lack self-motivation.

You have -2 Drive Rating.

Increase your SPI by 10.

Gadfly

You are sociable to a fault. While you are fun to get along with and can crack wise with the best of folks, officious types look down upon your lack of professionalism.

You have +2 Clout Rating.

Reduce your SPI by 5.

Impulsive

You have a reputation for acting without thinking.

You have +2 Body Rating.

Reduce your SPI by 3.

Large

You are unusually large, when compared to other folks.

You have +3 Body Rating.

You have -2 Drive Rating.

Old

You are forty years old, or more, and you can feel it. Even with advanced medicine and anagathics, time is taking its toll on you. However, your advanced age has granted you respect from others.

You have -2 Body Rating.

You have +3 Clout Rating.

When spending Clout to influence other Old characters, you can reminisce about the "good ol' days" and wax nostalgic, which reduces all costs by 1.

Overconfident

You often over-extend yourself and bite off more than you can chew.

You have +3 Drive Rating

You have -1 Clout Rating

Reduce your SPI by 6.

Righteous

You have a reputation for being opinionated and hard to get along with.

Instead of spending 1 Clout, you can instead elect to inflict 1 Oversight on yourself,

until your rating is reduced to zero. Without this Gift, a character cannot voluntarily gain Oversight and cannot elect to spend Clout when their points drop to zero.

Reduce your SPI by 3.

Small

You are smaller than most people you meet, but you make up for it with increased determination.

You have -2 Body Rating.

You have +3 Drive Rating.

Young

You are barely of age to be admitted into the EDF. You are often enthusiastic and naïve.

You have +1 Body Rating

You have -1 Clout Rating

You have +1 Drive Rating

Reduce your SPI by 2.

When spending Clout to influence other Young characters, you can speak a common vernacular and bond over how the older generations just "don't get it", which reduces all costs by 1.



BASIC RULES OF ENGAGEMENT

ΠΑΡΥΗ ΡΟΙΣ Ύ. ΕΝΔΑΝΕΝΖ

Rules exist for fairness and consistency. By using the same role-playing game rules, all the Players and the Game Host will better understand how the story of the game is moving along. Many decisions will have fateful consequences – and when the military is involved, lives will often hang in the balance. To this end, *Albedo: Platinum Catalyst* has rules for moderating conflict.

Playing a Role

The essence of the game is to pretend to be someone else. There are various kinds of roles to be played in the game.

Moderating the Action: The Game Host

One participant takes the role of the *Game Host*. The Host is like the director of a play, responsible for keeping the action moving. In the game sequence, the Players describe what they want their characters to do; the Game Host decides what rules or other factors need be taken into account; dice are rolled, tables are consulted, and the Game Host describes what happens as a result; then the Players decide where to go from there.

The Game Host has the final say in what does and does not happen – up to and including changing or breaking the rules. No rule can handle every situation, and sometimes numbers and dice just get in the way. The goal of the game is for everyone to have fun, and the Game Host should know their Players and keep the enjoyment levels at maximum. However, a Game Host should always strive for maximum fairness and consistency – two qualities provided by rules. It's not an easy balance, and Game Hosting is not an easy role, but it can be very rewarding.

The Game Host plays the role of all Main Characters who are not Player-Characters. The Host also plays the role of all Supporting Characters not played by the Players – the “extras” in the script. When

the Players encounter store clerks, frightened civilians, obstinate businessmen, grizzled prospectors, armed criminals, and all other sorts, the Game Host controls and plays each one.

Players and Player-Characters

The rest of the participants are simply called *Players*. Each Player controls one *Main Character*, their starring role in the story-line, often called the *Player-Character*. Players will often control one or more *Supporting Characters* – their subordinates in the Extraterrestrial Defense Force.





The Supporting Characters will have higher turnover than the Player-Characters. Some will be re-assigned, some will retire, others might meet unfortunate ends.

Dice Notation

Albedo: *Platinum Catalyst* uses polyhedral dice. The standard notation for dice is the letter d, followed by the number of sides on the die. For example, when the text indicates for you to roll a four-sided die, it will say "d4". When you are called to roll two ten-sided dice, the text will read "2d10."

In some cases, you'll roll different kinds of dice together. For "d8, 2d6", you would roll one eight-sided die and two six-sided dice.

The number of sides on a die is sometimes called its *size*. The more sides a die has, the bigger it is said to be – a d12 is bigger than a d10, for example.

Albedo uses four-sided, six-sided, eight-sided, ten-sided, and twelve-sided dice for Skill rolls and for Difficulty. Twenty-sided dice are used for Damage.

Basic Rolling

To accomplish a task, you roll a die proportional to the number of Marks you have. For one Mark, roll a d4. For two Marks, roll a d6; for three, d8; for four, d10; and for five

COMMAND REVIEW • 7XZYH NUIS

Dice Are Rarely Added Together

When rolling multiple dice, such as Risking or Breezing, only the highest-showing die matters. *Don't add them together.* Likewise, when a combatant shoots at a target, the Cover, Concealment, and Range dice are not added together. Most rolls in *Albedo* are pushing near the limit of 12; do not add the dice together unless specifically instructed to do so.

or more, d12. This is a Basic Roll.

EXAMPLE

Example: Toki has 4 Marks in Repair Skill. When she is called upon to make a Repair Skill Roll, her Player rolls a ten-sided die and reads the number.

Doing Things Better: Pushing

Except in unusual circumstances, you can *Push* your roll. Pushing allows you to go beyond your normal skill capacity, basically doubling the size of the die you're permitted to roll.

Major Characters spend a point from the appropriate Attribute (Body for Physical, Clout for Social, Drive for Mental). Supporting Characters spend Morale.

EXAMPLE

Example: Toki has 4 marks in Repair, a Mental Skill. Normally, this entitles her to roll a d10. If Toki spends 1 Drive Point, she can Push her Mental skill and roll two d10s instead of one.

Reaching Beyond: Risking

Sometimes, regular dice aren't enough, and you have to reach beyond your normal capacity. You can spend 1 Point to *Risk*, and roll larger dice than you normally do.

Risking a Roll is only necessary if you have 4 Marks or less. With 5 Marks or more, you're already rolling a d12, the largest die you can, so there's no need to Risk.

Major Characters spend a point from the appropriate Attribute (Body for Physical, Clout for Social, Drive for Mental). Supporting Characters spend Morale.

You cannot Risk and Push on the same roll.

EXAMPLE

Example: If Toki were to need to roll an 11 or 12, Toki could spend 1 Drive Point to Risk her Skill, and roll a d12 for Repair instead of d10.

Business as Usual: Rote

In most cases, the activity you're performing is second nature. Characters in *Albedo* perform the same daily chores over and over again. Instead of rolling dice, a character who is in a typical situation, doing a typical thing, can just go by *Rote*, not rolling any dice. Instead, the character claims they rolled one plus their Marks.

EXAMPLE

Example: Toki has repaired engines before, and she's in the shop, so she just goes by Rote. With four Marks, she doesn't have to roll, she can just claim a 5.

Rote is claimed instead of rolling. Do not roll dice *and* claim the Rote.

Robots and AI can *only* take Rotes. They can never Push, Risk, or Breeze, unless directed by someone with the Robotics Expert gift. Characters who have Panic cannot claim Rotes.

Overqualified: Breezing

The opposite of Pushing, Breezing is when a character knows enough to try to score an Overwhelming Success. A character with two or more Marks can often push themselves where others would think twice. Characters with 2 Marks or more in a Skill can *Breeze*, effectively halving their Marks to claim twice as many dice.

Since you can only Overwhelm when two or more dice roll higher than the target, Breezing is way to get more dice without spending points.

Panicked Characters cannot Breeze.

EXAMPLE

Example: If Toki wanted to get an Overwhelming Success on a relatively simple fix, she might choose to Breeze, rolling 2d6 instead of 1d10.

Summary of Die Rolls

Marks	Basic	Pushing	Risk	Breeze	Rote
zero	none	—	—	—	1
1	d4	2d4	d6	—	2
2	d6	2d6	d10	2d4	3
3	d8	2d8	d12	2d4	4
4	d10	2d10	d12	2d6	5
5	d12	2d12	—	2d6	6
6	d12	2d12	—	2d8	7
7	d12	2d12	—	2d8	8
8 or more	d12	2d12	—	2d10	9
Point Cost	zero	1	1	zero	zero

Difficulty

The measure of how much ability is required to do something, as well as how chancy it might be to get it work, is called *Difficulty*.

The Game Host should choose a difficulty based on how hard the activity is. Some suggestions:

Kind of Task	Target
Trivial: anyone could do this	1
Routine: Anyone with one Mark could get this after a few tries	2, or d4
Intermediate: Experts can do this easily, but other folks have a hard time	4, or d8
Advanced: Even trained personnel find this a chore	6, or d12
Experts Only: Only highly-trained personnel can perform this task, and often only after repeated tries	9, or 2d12
High-Impossible: Tasks this difficult can only be performed by masters.	11, or 3d12

Simple Rolling: Target

In most cases, you're trying to beat a *Target*. Targets are for most solo activities, like fixing an engine, researching a project, looking around, etc.

Roll the Target Dice. If there is only one die, then whatever that die is showing is the *Target*. If multiple dice are called for, then only the highest-showing die is the *Target*.

Complex Rolling: Opposed Rolls

Sometimes, someone else will oppose what you do. For example, you may want to Sneak, while someone wants to Spot you. The Game Host may call for *Opposed Rolls*. In an Opposed Roll, whoever rolls the highest is the winner, and scores a Success, and whoever rolls the lowest is the loser, and scores a Failure. In the case of Ties, both parties may be partially successful.

In many cases, it's easiest for one party to roll, using the opposed party's Rote as the target.

Results of Rolls

<i>Dice Result</i>	<i>Outcome</i>	<i>Cost to Retry?</i>
All of your dice are showing ones (the worst possible roll).	Botch – the worst possible result (see below).	+2
None of your dice beat the target number, or your Rote was not high enough	Failure – your activity simply fails.	+1
The highest number you rolled is equal to the target, or your Rote is equal to the target	Tie – a marginal failure, or a partial success.	Zero
<i>One</i> of your dice rolled higher than the target, or your Rote exceeds the target	Success – your activity is clearly successful.	n/a
<i>Two</i> or more of your dice rolled higher than the target	Overwhelming Success -- your activity is remarkably successful	n/a

For most activities, a simple Success is enough to get things done. An Overwhelming Success is even better – a spectacular landing, a rousing speech, a fantastic design, etc. Many Gifts have special modifiers that only work on Overwhelming Successes.

Botching

A roll of all ones is the worst a character can ever do. Such a result can indicate a minor cut or bruise, exhaustion, frustration, a misspoken statement, or anything the Game Host and the Players can think of.

All Botches result in the loss of 1 Point in the relevant Attribute (Body for Physical, Clout for Social, Drive for Mental). Supporting Characters lose Morale, instead. If the character doesn't have the point to lose, then the character either suffers Damage (Injury, Oversight, or Trauma) or Panic (for supporting characters).

At the Game Host, Botches on a roll might have some other consequences. For example, a Botch on trying to Jump across a gap might send the character falling.



Adding or Subtracting Marks: Bonuses and Penalties

Your Game Host may rule that something is easier to do. You may gain one or more Marks in your Ability to do something. *Bonus* Marks raise the size of the dice you can use, and they may allow you to claim some extras.

Your Game Host may rule that something is harder to do. You may lose one or more Marks in your Ability to do something, as a *Penalty*.

Retries

When a task fails, a character might want to try again. In most circumstances, this won't be an issue. Attacking with a weapon, leaping across a gap, enduring G-forces, or piloting a vehicle are all activities that are short, fateful, and measurable. A Failure either has immediate consequences, or it will be forgotten in the next moment.

Some activities, however, require special training, social interaction, or unusual insight. Fixing a broken vehicle, convincing the chancellor to see things your way, scanning a sector for signs of activity... Using a Skill to try something a second time is a *Retry*.

The first *Retry from a Failure* costs 1 Point from the relevant Attribute (Body for Physical, Clout for Social, Drive for Mental). The first *Retry from a Botch* costs 2 Points from the relevant attribute. (Since the Botch in the first place cost 1 Point, that brings the total spent up to 3.) Supporting Characters use their Morale.

What's the Total Point Cost for an Action?

If you have a Gift or other circumstance that reduces the points spent, the reduction is applied once on the *entire action sequence*, not on each cost.

EXAMPLE *Example:* Auitzotl Pushes his Longarms Skill (1 Drive), uses Following Fire to shoot a second and third target (+2 Drive), then Botches the last to-hit roll (+1 Drive). The total cost for the action is 4 Drive. If Auitzotl had a Gift that reduced the cost, it would drop to 3.

long a Labor takes to perform.

EXAMPLE *Example:* Auitzotl and his crew have to set up a radar array, a labor requiring 800 Quality-Hours of Sensor Operations. Auitzotl's team has one specialist with Skill 5, he himself has Skill 3, and four more in his crew has the standard Skill 1.

In his labor pool, the specialist has Rote 6, Auitzotl has Rote 4, and the last four have Rote 2. That adds up to $(6 + 4 + 4 \times 2 =)$ 18. Dividing 800 by 18 gives a little more than 45 hours. Working 8 hours a day, the activity will be done in a little less than 6 days.

Much of the work of the Extraplanetary Defense Force will involve building fortifications, preparing vehicles, moving into position, gathering intelligence, etc. Some Labors may even require mixed pools of Skills!

The Players will have to divide their resources to perform various Labors. Keep in mind how long the character can work per day, and that some folks might need to be defended from hostiles while they work.

Labor

Some uses of Skills take place over a long period of time. For example, assembling a tank might require thousands of hours of skilled work. In game-terms, a long-term activity is called *Labor*.

Labor is a large number, representing Difficulty times hours of labor. Following the above example, assembling the tank might be a Labor of 4,000 Quality-Hours.

Most Labor will be performed by Rote. Add together the Rotes of all the characters assigned to the tasks, and divide that number into the Labor, to determine how

COMMAND REVIEW - ΑΡΧΙΚΑ ΔΕΓΜΑΤΑ

Use Rote Whenever Possible

Characters, especially Supporting ones, should perform their tasks by Rote unless they have strong reason not to. It makes game play go faster; it suits the "military theme", where folks obey orders and do things by the book; and it reduces the odds of botches or other errors.



COMMAND

ԻՐԱՆԱՆ

Albedo: Platinum Catalyst is a game about strong personalities. Main Characters are a narrative device – they allow the Players to identify with the people and the issues. The Game Host is encouraged to role-play the opposing Main Characters as more than mindless monsters or robots – anyone who has Body, Clout, and Drive points is someone to be reckoned with.

Player-Character

Each Player begins the game with one *Main Character*, usually called their *Player-Character*. The Player will spend most of their time in this role, as a commanding officer.

Retinue

Every Player-Character starts with a *Retinue* of Supporting Characters, usually four. All of these characters start with *Trust* towards their commanding officer.

Supporting Characters have the starting Attributes based on their Species, and all the Skills and Gifts granted

Trust

The backbone of any military organization is when soldiers are ready to lay down their lives to protect one another. In game terms, two characters who can work together in dire situations are said to *Trust* one another.

All Player-Characters are assumed to *Trust* one another, at least for purposes of Rallying.

All Supporting Characters in a Player-Character's starting Retinue begin with *Trust* in their Player-Character commanding officer.

Two Supporting Characters who have *Trust* in the same Main Character are assumed to *Trust* each other, as well, unless the Game Host rules otherwise. Two Supporting Characters "on the same team" can trade Morale in this way, with one spending Morale to Rally the other.

A Supporting Character maintains *Trust* in the Main Character as long as nothing during the game violates that *Trust*.

Military personnel are trained to obey orders and to not question

Loyalty

An improved version of *Trust*, a Supporting Character automatically develops *Loyalty* after three successful adventures with the same character.

Loyalty is an improved version of *Trust*. Normally, a Supporting Character can be boosted to a maximum of 1 Morale from a successful Rally. If the Supporting Character is *Loyal* to the Rallying Character, they can be boosted to a maximum of 3 Morale.

While *Loyalty* is better than *Trust*, Supporting Characters only have *Loyalty* to one Main Character at a time.

Loyalty should be earned in play, as a dramatic device in the narrative. Players should derive satisfaction that their superior planning was rewarded with increased capacity in their subordinates.

Neutrality

During play, Supporting Characters will come and go. Some may be transferred to new duty assignments. Others might become too injured, or they might even be killed.

When a new Supporting Character enters a Player-Character's Retinue, the Supporting Character is only *Neutral* towards their new commander. Only after three successful adventures will the character gain *Trust*. (And three adventures after that, the character can become *Loyal*, as above.)

Most characters in the game will be fellow officers in the Extraplanetary Defense Force, who do not report directly to any of the Player-Characters, but their own superiors. Should combat occur spontaneously, all of these combatants would be *Neutral* towards the Player-Characters and their retinue; while they're all on the same side, they lack the camaraderie to truly work together at maximum effectiveness.



COMBAT

HPNDΛZ

Beginning the Battle

Time in a role-playing game like *Albedo* can vary. When weeks or months go by without an incident, the Game Host may call for *narrative time* – glossing over long periods with but a few sentences. For example: "You spend two weeks accelerating out of your own system, then you jump and spend another two moving into position to land." If all the players agree that nothing important was going on, then

it's time to move on and get to the next plot point.

Combat situations, however, are likely to be heated. Everyone's going to want to attack as often as they can. When the Game Host declares that *Combat* has started, the flow of time and participation becomes very orderly and organized.

Readiness

In most military engagements, there will be two sides to a battle. The side that

you are on is the *friendly side*, and the side your foes are on is the *hostile side*. Civilians or other characters may be present who are non-combatants or otherwise not involved; such characters are usually called *neutrals*.

Unless stated otherwise by the Game Host, all Main Characters begin a battle fully rested, with their full totals of Body, Clout, and Drive, as permitted by their Ratings. Injuries, Oversight, and Trauma from previous battles will carry over, reducing Ratings. Main Characters who have had ratings reduced to zero should not be sent into combat ... but war is full of unfortunate circumstances.

Unless stated otherwise by the Game Host, all Supporting Characters begin a battle with 1 Point of Morale. If a Main Character is on the same side as a Supporting Character, and the Supporting Character has Loyalty, then the Supporting Character starts with 3 Morale instead of 1.

**Who Goes First:
Initiative**

In combat, someone usually goes first. In a military situation, that's the highest ranking officer, followed by the subordinates, followed by civilians.

The Game Host orders the supporting characters on the other side. For convenience, it's best that the Player-Characters act first in the Round.

The "End of the Round" is used for maintenance. Remove machinery, assess environment effects, and explode grenades.

Alternative Initiative

Not all combat engagements are military ones. Players might be on shore leave, or there might not be any clear chain-of-command. In such a case, the Game Host can decide on a different combat order. One suggestion is to call for Sixth Sense Rolls for all combatants, acting from highest number to lowest. (Rotes might prove easier for this.)

Round

A unit of time, representing when everyone gets one attempt to do something. A Round is assumed to be six seconds long.

Action

In each round, every combatant can take one *Action*. Piloting a vehicle, shooting a gun, aiding comrades, restraining a prisoner – each of these are Actions.

Since a Round is 6 seconds long, then an Action is anything that can reasonably be done in six seconds.

Many Actions might require certain Skills. The Game Host is the final arbiter of what can be done in a single Action.

In general, a combatant can only make one attack per Round, since they can only take one Action.

Some activities are considered "free", such as talking to one another via helmet radios. As usual, the Game Host has the final say on what a combatant can do.

Cover

If there is any material between the attacker and the target, then the target has *Cover*. The target will roll extra dice to defend against attacks.

<i>Cover</i>	<i>Dice</i>
0% - No Cover: Standing out in the open.	None
25% - Minimal Cover: A low barrier, covering only the knees. Collapsed building debris.	d8
50% - Half Cover: Bushes and hedges from head to toe. A typical window. Behind another combatant of the same Body.	d10
75% - Partial Cover: Head and shoulders exposed, only. Behind a vehicle. Behind another combatant of twice one's Body.	d12
100% Total Cover: A solid wall. A full-sized window.	Automatic 13

If the Cover Die is the highest die showing, and the shooter has tied or worse, then the Cover has been struck by the attack. Attackers firing at targets behind 100% Cover will automatically hit the cover, since they can't roll any higher than 12 – but they may have weapons powerful enough to penetrate. (See "Penetrating Cover", page 127.)

Concealment

Targets can be hard to see ... and defending targets will do their best not to be seen. Most Cover can't be seen through, so most targets will have the same Concealment as they have Cover. Exceptions include using figures obscured by smoke, or figures behind glass.

<i>Concealment</i>	<i>Dice</i>
0% - No Concealment: Well-lit area on a clear day with excellent weather.	none
25% - Minimal Concealment: Poor lighting. Thick rain. Dusky light. Third-person viewing, such as a camera. Low-light vision in complete darkness. Opaque 25% cover.	d8
50% - Half Concealment: Infrared vision. Full moonlight. Light smoke. Opaque 50% cover.	d10
75% - Partial Concealment: The darkest night allowed by light-pollution over industrial cities. Only silhouettes of targets are visible. Thick smoke. Opaque 75% Cover.	d12
100% Total Concealment: Completely unseen target. Blind shooting.	2d12

Active Combatants Are Not Statues: Claiming Cover and Concealment within 2m

When using miniatures, there's a tendency to assume that combatants are right where their figure is, and to draw line of sight to that. The problem is that combatants are often moving around a lot, during a combat Round.

A combatant has a 2-meter position un-

certainty. *An active, aware target can claim the best Cover and Concealment they can, minus 25%, within 2 meters of their position.*

For example, if a combatant's figure is out in the open, but within 2 meters of being behind a solid wall (100% cover), then they can claim the solid wall as 75% cover and 75% concealment.

Active combatants don't have to claim Cover or Concealment that they don't want to. For example, a combatant might not want to claim a comrade as 50% Cover.

Surprised Targets and Helpless Targets can only claim cover based on line of sight. Panicked targets are still active and will do anything they can to reduce the odds of being attacked.

Range

For simplicity, *Albedo* treats each weapon as having up to five ranges. The longer the range to the target, the larger Defense Dice the target rolls to avoid being hit.

<i>Range</i>	<i>Dice</i>
Close: Sometimes called "Point-Blank". Close-Range Attacks can provoke counter-attacks. Many rifles and heavy weapons have no Close range.	d4
Short: Typical proximity for urban fighting. Following Fire and Suppression Fire is possible. Optimal range for Pistols.	d6
Medium: Typical proximity for forest or jungle fighting. Optimal range for Carbines.	d8
Long: Typical proximity for plains or open spaces. Optimal range for Rifles.	d10
eXtreme: Beyond the effective range of most weapons, more blind luck than aimed combat.	d12



Attacking a Target

When launching an attack against a target, use the following steps.

Determine Range

Each gun has a rating for Close, Short, Medium, Long, and eXtreme. The farther away the target is, the larger the dice used to defend the target.

Determine Cover

The more obstructions to line-of-sight to the target, the harder it will be to hit the target. Remember that an active, aware target can claim Cover that's 25% worse, within 2 meters of their position.

Determine Concealment

Remember that an active, aware target can claim Concealment that's 25% worse, within 2 meters of their position.

Attacker rolls Firearms dice vs. the difficulty to hit the target

The shooter can claim any sort of roll they can to hit the target: Basic, Push, Risk, Breeze, or Rote.

In most cases, a shooter will use their Rote when attacking. Rotes eliminate the possibility of Botching.

Table of Attack Results

<i>Result</i>	<i>Outcome</i>
Botch (Highest die is 1)	Something bad happens.
Failure (short-fall by 1 or more)	<i>Miss.</i> You closely miss your target.
Tie (attacker's highest score ties target's highest)	<i>Miss.</i> You barely miss your target. (Gifts such as Semi-Automatic Expert can make this a hit.)
Success (<i>one of</i> attacker's dice exceeds defender's highest score by 1 or more)	<i>Hit.</i> You hit the target - Roll Damage Dice.
Overwhelming Success (<i>two of</i> attacker's dice exceeds defender's highest score by 1 or more)	<i>Critical Hit.</i> You may roll increased Damage Dice. You can only score a Critical Hit if you have multiple dice, such as from Pushing or Breezing.

EXAMPLE

Example: Auitzotl sights a dissident with a man-portable rocket behind a wall, several meters away.

The target has half their body behind a solid, opaque wall, giving both 50% Cover and 50% Concealment. With Auitzotl's rifle, the target is at Medium Range.

Auitzotl has to shoot against a Range Die of d8, a Cover Die of d10, and a Concealment Die of d10.

Auitzotl has 5 Marks in Longarm. He chooses his Rote of 6. The target rolls the 2d10 and the d8, and gets 5, 4, and 1. The highest-showing die is 5, less than Auitzotl's 6. Auitzotl has hit the target.

Actions

Each Round, a combatant can perform one Action. Players may order their Main Character first, then their subordinate Supporting Characters.

Aim

You can move 2 meters to a better position. Then choose a target with 75% or less Concealment. (If you can't see a target, but you know where they might come out, the best you can do is Guard.)

Next Round, you can shoot at the target as if it was one Range Band closer, and as if it had 25% less Cover and 25% less Concealment.

If you move from your position, or if you suffer Awe, then your Aim is ruined. Characters with Panic cannot Aim.

If you are using miniatures, place a heads-up penny next to an Aiming figure, and place a tails-up penny next to their target.

Attack at Range

You can designate any target and shoot at them. Roll to hit, using the appropriate skill for your weapon (Pistol, Longarm, Heavy Weapon, etc.). The Difficulty is based on the Range to the target, the Cover the target has, and the Concealment.

Roll to hit. On a *Success*, you claim one Normal Hit. On an *Overwhelming Success*, you claim a *Critical Hit*, rolling an extra Damage Die.

On a *Tie*, you can still hit the target if you have a semi-automatic or fully-

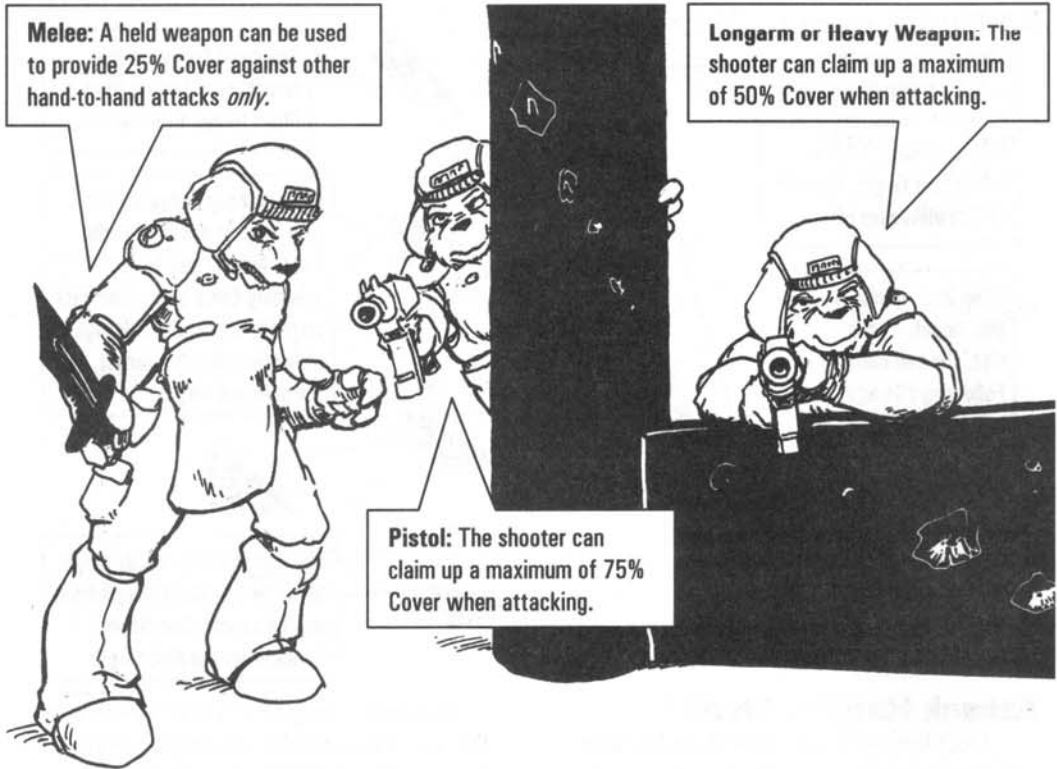

Melee: A held weapon can be used to provide 25% Cover against other hand-to-hand attacks *only*.

Longarm or Heavy Weapon: The shooter can claim up a maximum of 50% Cover when attacking.

Pistol: The shooter can claim up a maximum of 75% Cover when attacking.

automatic weapon and you spend additional bullets. For single-shot weapons, you simply miss.

On a *Failure*, you spend one bullet and miss your target.

On a *Botch*, something bad happens. The Game Host can suggest something appropriate; the default is that the target loses 1 Drive (or Morale).

In most cases, Game Host may rule that the attacker can fire by *Rote* – simply roll the target's Cover and Concealment dice, if any. Remember that Rotes can never score Critical Hits.

A Panicked combatant cannot Attack at Range if they could instead choose a maneuver that improves their Cover or Concealment against known attackers.

COMMAND REVIEW · АРНААНД НӨГӨӨР

"Rolling Only To Miss": Rote Attacks

To speed play, and to prevent mishaps, most attackers will take their Rotes (1+Marks) whenever possible. This can sometimes lead to *lock-out* – when a shooter's Rote is greater than whatever the target dice can roll. In such cases, the Game Host should only force the player to use a Basic roll if the shot is questionable.

Attacker's Cover

When you attack, you must expose yourself. Thus you can only claim a maximum amount of Cover.

- Pistol – maximum 75% Cover (head, arm, and hand exposed)
- Longarm or Heavy Weapon – maximum 50% Cover (head, shoulders, both arms and both hands exposed)

The Game Host may make exceptions to this rule, such as with gun-ports on armored vehicles.

Following Fire at Short Range

If you fire at a target at Short Range and hit, and your weapon is fully automatic, you may engage in Following Fire. Choose another target within Short Range of the target you just fired upon *and* within Short Range of yourself. (You may even choose the same target.) You may fire upon that target as if it was Short Range, as well. You may continue to engage in Following Fire as long as you have bullets in your gun.

(If you have the Gift of Following-Fire Expert, you may use Following Fire at up to *Medium Range*.)

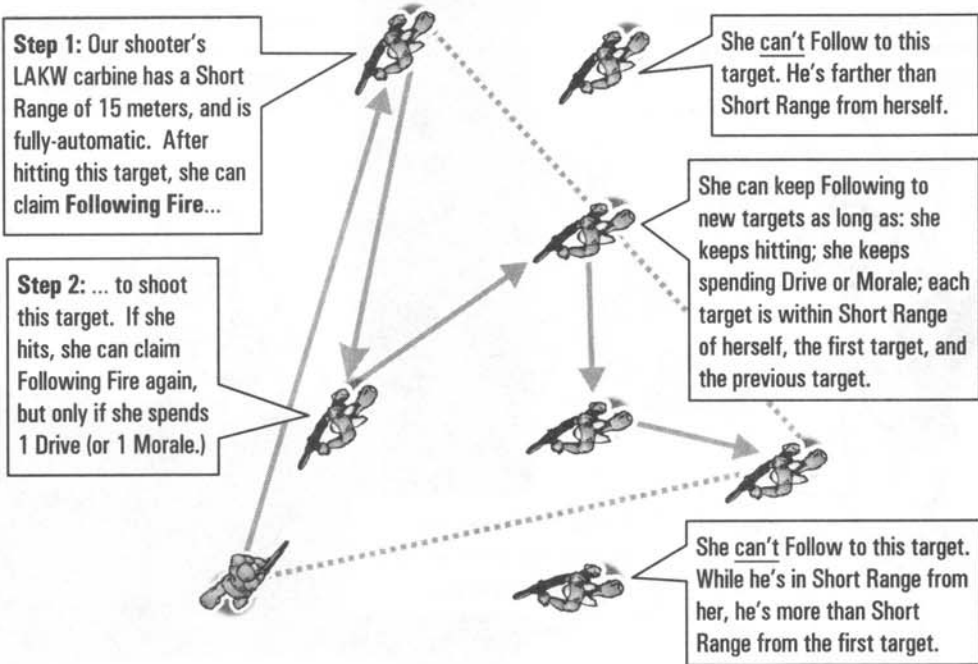

Attack Hand-to-Hand

Most folks in *Albedo* have difficulty with physical contact, especially violent contact.

A combatant with a Melee weapon can claim 25% cover against another Melee or Brawl attacker, by using their weapon to deny space and avenues of attack. (Melee weapons cannot be used for Cover against ranged attacks, such as bullets.)

By definition, all hand-to-hand attacks are Close-Range Attacks, and thus provoke counter-attacks. See *Close-Range Attacks*, p. 120.

Hide

You can choose to "go to ground", drop to prone, and otherwise conceal yourself. You can move 2 meters before Hiding.

A Hiding character improves their effective Cover by 25% and their effective Concealment by 25%. This improvement *does* combine with the reduced Cover and Concealment claimed within 2 meters (effectively raising claimed Cover & Concealment within 2m to full values).

Hiding combatants are harder to detect. Any combatant moving into an area where a target hides with at least 50% effective Concealment must win an opposed roll of their Spot vs. the target's Sneak, or remain unaware of the target's position.

Naturally, a target can't just "vanish into thin air" if the attacker saw them beforehand. A common tactic to use against a Hiding target is to Suppress the area they could be hiding in – see page 114. The Game Host should rule on unusual cases.

Hiding is a two-way street – they can't see you, and you usually can't see them. If a Hiding combatant wants to see anyone, they must make Spot rolls themselves.

Panicked combatants will often Hide.

If you are using miniatures, tip a Hidden combatant miniature onto its face, to simulate being "hunkered down."

Medical Help

You can provide medical attention to another target. You must start your turn next to the target, and you must have something to use.

Stabilizing an Incapacitated Target is of Intermediate difficulty (4 or d8). If you have no Medical Sciences skill, then you can only use your Rote of 1.

Rally

As a commanding officer, you will often give moral support to your troops. You can move 2 meters and then attempt to Rally. You can Rally any target that you can communicate with, such as by radio.

Panicked characters themselves cannot Rally others.

Rallying can do one of two things: remove Panic, or boost Morale.

Removing Panic

You can Rally any Main Character or Supporting Character. You must make a roll of your Lead Skill.

Rallying to remove Panic costs 1 Clout. (You may spend additional Clout to Risk or to Push your roll.) If you don't have the point to spend, you cannot Rally. Supporting Characters can remove Panic, spending Morale instead of Clout.

For combatants on your side, who actively support you (such as your fellow Player-Characters), the difficulty is Trivial (1). For neutral combatants (such as hysterical civilians), the Difficulty is Intermediate (4 or d8). For opposition forces (that you need to calm down so you can take them prisoner), the difficulty is Expert (9 or 2d12).

If you *Tie* or better, you remove the target's Panic. If you *Fail*, you can Retry next round, with the usual penalties.

Supporting Characters can attempt to remove Panic, as well. They must spend Morale instead of Clout.

If you are using miniatures, place a yellow counter next to a Panicked figure.

Boosting Morale

You can boost the Morale of any Supporting Character with whom you share *Trust* or *Loyalty*. You cannot boost Morale in a Panicked Combatant.

Rallying to boost Morale costs at least 1 Clout. Only Main Characters can boost Morale.

The Difficulty is Routine (2 or 1d4), unless the Game Host rules that the situation is worse. If you *Tie* or better, the target gains 1 Morale. If you *Fail*, there is no penalty for Retrying (though there is still a loss for Botches).

If your boosting Morale was successful, and the target has *Loyalty* to you, you may spend 1 or 2 extra Clout to add 1 or 2 more Morale, up to the maximum of 3.

Since you cannot add Morale to a Panicked combatant, boosting their Morale

takes at least *two* Actions: one to remove the Panic, the second to boost the Morale.

If you are using miniatures, place 1 green counter next to a figure for each point of Morale granted.

Run

Sometimes, you just have to move quickly from one spot to the next. *Running* is any movement over 2 meters, and such movement counts as the character's Action.

Any combatant can run 12 meters, no questions asked. A combatant may also choose to *sprint*, to cover more distance. The combatant can cover 10 meters plus a roll of their Run Skill dice. (Yes, the usual run is the same as moving 10 Meters plus a Rote movement of 2.)

When moving from 100% Cover to 100% Cover, across a space that is 5 meters or more that has no Cover, you can claim 50% Cover – even against attackers Guarding that space – vs. attacks made at Short Range or longer. (Close-Range Attacks are not effected.)

A combatant can run for ten Rounds. After that, they must either spend 1 Body to run for 10 more Rounds, or stop Running until they have rested for 20 Rounds.

Spacesuits, with their insulation, are bulky and impeding. Characters in Spacesuits run slower – use 5+Spacesuit Skill instead.

Charge

A special kind of Run is the *Charge* – moving towards a combatant into Close Range. At the end of your move, you engage your target in a Close-Range Attack, with appropriate counter-attacks.

Panicked characters cannot Charge.

Sneak

Combatants may try to move quickly from one area to another while avoiding detection.

Sneaking is impossible unless you have at least 25% Concealment for the entire distance you plan to Sneak through. Since you can claim reduced Concealment within 2 meters, a Sneaking combatant can cross through 4-meter wide gaps, but no larger.

The maximum distance you can move is your Sneak score. Yes, Sneaking can be done by Rote. Sneaking is your only

Action – you cannot shoot, and Sneak, for example.

Sneaking is the only way to move through a Watched area without provoking an automatic attack.

Suppression

One function of the fully-automatic weapon is area denial – filling a zone with bullets so that any target that moves through that area might be struck down. Belt-fed weapons are ideal for this purpose, but in a pinch any fully-automatic weapon will do. In game terms, *Suppression Fire* is when an attacker fills a designated zone with bullets.

Only fully-automatic weapons can suppress. Semi-automatic weapons do not fire bullets fast enough.

First, the attacker may move up to 2 meters, then declares an area no longer than Short Range on all sides. This is the Suppressed Area, also known as the "beaten zone."

All targets in the Suppression Zone are attacked, regardless of whether they are friend or foe.

Anyone who enters a Suppression Zone

suffers +1 Awe, cumulative with other losses, even if they are not hit. The hail of bullets is frightening to all but veterans of combat.

During their turn in the sequence, a combatant that moves out of, or remains in a Suppressed Area, is immediately attacked. And the attack has +1 Awe, as mentioned earlier.

Use only Cover and Range modifiers for targets; Concealment does not apply for attack rolls. Suppression is sometimes used to fire on unseen targets, such as in smoke.

All targets in the Suppression Zone are subject to Selective Fire. In other words, they are hit on Ties.

All targets in the Suppression Zone are subject to Following Fire. Since the attacker gets multiple attack rolls, there is the possibility that one attack might miss, but another one might Succeed, allowing for Following Fire. Following Fire attacks are resolved normally, including Concealment with Cover and Range. Also, point costs must be paid for the third and later attacks. Following Fire represents that the attacker has limited control over the dispersal of bullets and can choose to "hose down" visible targets.

This shooter is armed with an LAKW Carbine, which has a Short Range of 15m. He can Suppress a triangle up to 15m per side.



In this beaten zone, all targets are Suppressed – they are attacked and suffer +1 Awe.

The Suppression lasts a full Round, until the target's next action in the sequence. Any target that enters that area is attacked. If a target leaves the area, and then enters it again, they are attacked again.

At the beginning of the attacker's next round, their weapon is depleted of ammunition (unless it is a belt-fed weapon). The attacker should either reload or should move to a place of safety.

Panicked combatants can still Suppress, and often do, to clear an area of hostiles so they might flee next Round.

If you have the Gift of Suppression Expert, you can declare a larger triangle, with sides up to Medium Range in length. (If any side of your triangle is over Small Range, then all targets are fired at if at Medium Range.)

If you are using miniatures, place three black counters on the table – one next to the Suppressing attacker, and the other two at the points of the Suppressed triangle.

Throw

You can throw an object, most likely a grenade. Your throwing distance is your Lift divided by the weight of the object. Remember that dividing by a fraction is the same as multiplying by the denominator – since grenades weigh ½ kg, you can throw a grenade twice your Lift, in meters.

A thrown object deviates 70% the total distance thrown, minus 10% times your Throw Score. For rolls of 8 or better, your Throw lands exactly where you want it to.

EXAMPLE *Example:* Toki wants to throw a grenade to a spot 14 meters away. She rolls a 4. Her grenade lands $(70 - 40 =)$ 30% off target, or about 4 meters off.

The deviation direction is up to the Game Host. When in doubt, assign 12' o'clock to long, and roll a 12-sided die.

Watch

A combatant can watch over an area. You can move 2 meters before Watching. Then you may declare a triangle on the board.

If any target enters this area, you may shoot them. Treat the range as the longest side of the Watched triangle.

If you have mechanical assistance (such as remote cameras) you can claim up to

100% Cover. Otherwise, the most you can have is the minimum to attack (75% for pistols, 50% for long-arms.)

EXAMPLE *Example:* Auitzotl positions himself to cover a street. He declares a Watched triangle that extends 80 meters from his left, 30 meters from his right, and is 8 meters wide at the end.

If a combatant enters this triangle before Auitzotl's next action, he may shoot them. The longest range in his triangle is 80 meters, which is Long Range for his rifle. No matter at what range a target first enters his triangle, Auitzotl treats the target as being at Long Range.

A Panicked combatant cannot Watch if they could instead choose a maneuver that improves their Cover or Concealment against known attackers. In fact, Panicked characters will first get the best Cover and Concealment they can; second, they will Watch a triangle where attackers might come from to reduce effective Cover or Concealment.

If you are using miniatures, place one blue counter at the base of the Watching figure, and two blue counters at the corners of the Watched triangle.

Watching with Following-Fire Weapons

If you have a fully-automatic weapon, you can usually only claim Following Fire at Short Range. If you declare a Watched triangle for Short Ranges only, you don't have to immediately shoot a second target if you don't want to. Instead, you can use your Following Fire to "remain watching" and to shoot another target should one enter your triangle. You can even shoot a third time, if you have Drive (or Morale) to spend.

Watching and Waiting

Sometimes, a combatant will Watch one zone to do something else. For example, a combatant might shoot a helpless, bound hostage if anyone moves into their room, or a commander might signal for help if they see anyone advance over a certain line.

The Game Host should use their discretion as to what a combatant can Watch for. If a combatant is Watching a zone, but not to attack what's in that zone, then



essentially the only limit is a 180° field of vision, vs. targets without 100% Concealment. If you are using miniatures, mark a line through such a Watcher using two blue counters, on either side of the figure.

Other Actions

Characters will want to open doors, work consoles, use sensor equipment, etc.

As a general rule, a character can move 2 meters or less and still perform a simple action, such as reload a gun or open a door. Actions that require complex concentration, such as using a GPS device to call for an artillery strike or as defusing a bomb, will take more.

A combatant can Hide in one Round, then remain hidden and perform actions the next Round, still claiming the benefits of Hiding, as long as they do not move from their position.

Effects of Attacks: Damage and Awe

When targets are put under attack, they can suffer demoralization, injury, and death.

Damage

Attacks that hit a target have a chance to injure the target; this possibility is called *Damage*.

Base+Penetration

Damage is measured as two numbers: the *Base*, and the *Penetration*, written as two numbers, such as 8+3. The Base

represents the general likelihood of an attack to cause damage; the *Penetration* represents improved odds by cleaner hits, or hits against more vulnerable points.

Targets resist damage with two numbers: their *Deflection* (how unlikely Penetrations are) and their *Thresholds* (how great the Damage must be for the target to suffer ill effects.)

When a target is hit by an attack, one or more twenty-sided dice (d20s) are rolled; these are called *Penetration Dice*. Roll the d20s, and compare each one separately against the Deflection of the target – each one that equals or exceeds the Deflection is a Penetration; for each one, add the Penetration Value to the Damage.

Then, find the highest-rolled d20, and add that result to the Damage, as well.

EXAMPLE

Example: Auitzotl is critically hit by an attack of 10+10 damage. Two d20s are rolled against his Armor's Deflection of 13. One scores 17, the other 5.

The 17 is greater than his Deflection rating, so an extra 10 points of damage are scored.

The highest-showing d20 is 17. The Base of the weapon is 10, and one Penetration adds 10. The Damage Score against Auitzotl is $17+10+10=37$.

Penetration Dice

The number of Penetration Dice is dependent first on how injured the target is, then other modifiers like awareness.

Circumstance	Penetration Dice
Target is not injured	1d20
Target is Wounded	2d20
Target is Crippled	3d20
Target is Incapacitated	4d20
Target is Helpless	+ 1d20
Target was Critically Hit	+ 1d20

Thresholds

After adding all Penetrations to the Base, the final number is the *Damage*. Compare the Damage number to the target's *Thresholds*.

Damage is...	Default Value	Result
No Threshold (less than 1 st)	n/a	Target suffers 1 Awe
Wounding (1 st but less than 2 nd)	Body×2	Target suffers 1 Injury and 2 Awe; change status to <i>Wounded</i>
Crippling (2 nd but less than 3 rd)	Body×2+10	Target suffers 3 Injuries and 3 Awe; change status to <i>Crippled</i>
Incapacitating (greater than 3 rd but less than 4 th)	Body×2+20	Target suffers 5 Injuries and is out of combat; change status to <i>Incapacitated</i>
Devastating (4 th or greater)	Body×2+40	Target is mortally wounded or killed instantly

EXAMPLE

Example: Auitzotl's Thresholds are 23/33/43/63. With a Damage Score of 37, Auitzotl is *Crippled*.

No Threshold

If an attack fails to score enough damage to pass the lowest Threshold, the target suffers no damage. However, being attacked is still disturbing, so the attack still inflicts 1 Awe. (Combatants with the

Gift of Coolness Under Fire will be able to shrug this off.)

Wounded

A Main Character that is Wounded suffers 1 Injury. If this Injury would reduce the Body Rating below zero, the character becomes Incapacitated, instead.

A Supporting Character that is Wounded has no Body Points to lose. For simplicity, multiple injuries are not measured against Supporting Characters, although the Game Host may rule that multiple Woundings may have long-term effects.

Future attacks against a Wounded character roll two d20s instead of one. While both d20s are rolled for Penetrations, only the *highest* one is added in.

If you are using miniatures, place one red counter next to a Wounded figure.

Crippled

A Main Character that is Wounded suffers 3 Injuries. If these Injuries would reduce the Body Rating below zero, ignore the excess; the character becomes Incapacitated, instead.

A Supporting Character that is Crippled has no Body Points to lose. For simplicity, multiple injuries are not measured against Supporting Characters, although the Game Host may rule that multiple Cripplings may have long-term effects.

Crippled characters cannot act unless they spend 1 Body (or 1 Morale).

COMMAND REVIEW • HYPERAZ DEFENSE

Where Are The "Hit Points"?

In most hostile situations, there will be a *lot* of characters involved. Each Player controls one Main and four Supporting Characters; the Game Host may be in charge of a dozen combatants or more. If each of these combatants had double-digit numbers, the record-keeping becomes complex very quickly. Instead, *Albedo* opts for a "narrative-driven" system, where only Main Characters have reserves of points to spend. Supporting Characters are dealt with quickly and simply – and they often need a Main Character to give them guidance and support. Players are encouraged to think about the tactics of their *groups*, rather than of their individuals.



If you are using miniatures, place two red counters next to a Crippled figure.

Incapacitated

A Main Character that is Wounded suffers 5 Injuries. If these Injuries would reduce the Body Rating below zero, ignore the excess. At their turn in the action sequence, an Incapacitated character must spend 1 Body or fall unconscious. They must spend another 1 Body if they want to act in the turn sequence.

After that, the character suffers 1 Injury at the end of every Round until their Body Rating drops to zero; then, they *Bleed*, as described below.

A Supporting Character that becomes Incapacitated falls unconscious, and Bleeds, as below.

If you are using miniatures, lay an Bleeding, Incapacitated figure on its back, face up, and place three red counters next to the figure.

BLEEDING

At the end of the Round, for each Bleeding, Incapacitated character, roll a d20 – on a 1, the character has expired due to blood loss or other injuries; on a 20, the character stabilizes.

Staunching blood loss requires the Medical Help action (p. 112).

If you are using miniatures, if the bleeding stops, remove one red counter, leaving two next to the face-up, lying figure.

Devastated

Main and Supporting Characters that suffer a Devastating attack are killed instantly and violently. Onlookers who

witness a Devastating attack suffer Awe: +2 if the victim was on the same side, +1 if the victim was neutral or hostile.

Awe

Life-threatening situations take their toll on a combatant. In game terms, Awe represents loss of fighting spirit, battle fatigue, and frustration with the feeling of powerlessness experienced during war.

Note that even an attack that fails to cause injury, or even one that misses, can still inflict Awe on a target.

In game sequence, Awe is figured after Damage, because if the target was Incapacitated by the attack, then Awe is irrelevant.

After an attack is resolved, a combatant suffers Awe as follows:

<i>Circumstance of Attack</i>	<i>Awe</i>
Ready target	Zero
Surprised or Helpless target	+1
was Suppression Fire	+1
at Close Range	+1
missed target	Zero
hit target	+1
was Wounding	+1
was Crippling	+2
was Incapacitating	+3
was Explosive	+1 per d20

EXAMPLE

Example: Auitzotl is shot at Medium Range and suffers a Crippling Injury. The Awe is +1 for being hit, and +2 for the Crippling Injury, for a total of 3. Auitzotl has the Gift of Coolness Under Fire, and reduces the loss to 2.

The target loses Drive (or Morale Points) equal to the Awe. If the target does not have enough points to weather the loss, they suffer *Panic*.

If the target is a Main Character, they also suffer 1 Trauma for each point of Awe they can't cover by spending Drive. Each point of Trauma reduces Drive Rating by 1; if Drive is reduced to zero, the target is in permanent Panic and requires psychiatric assistance.

If the target is a Supporting Character, they only lose Morale. If the target doesn't have enough Morale to cover the Awe, then the target suffers Panic. While in game terms, Supporting Characters don't suffer

Trauma, the Game Host may rule that repeated, severe mental stress can have permanent effects.

Panic

Characters that suffer Panic have reduced capacity to fight. Panicked characters cannot spend Drive or Morale, so they cannot Push or Risk on rolls, nor can they use Gifts or other abilities that require such points to be spent.

Panicked characters have a crisis of confidence. While they may act rashly, they are not assumed to be reckless or insane. Panic might not be fear – botched rolls and other mishaps can cause loss of Morale, and thus cause Panic.

What Causes Panic

A Main Character suffers Panic if they run out of Drive Points *and* if they have one or more Trauma. A Main Character that runs out of Drive and has zero Trauma may be mentally exhausted, but they do not automatically suffer Panic. (Note that if a Main Character is forced to lose Drive they can't spend, they suffer Trauma for each point of short-fall.)

A Supporting Character suffers Panic if they run out of Morale Points, and they suffer some condition that forces loss of Morale points that they can't cover. Do not

track "negative Morale" for Supporting Characters – simply mark the character as Panicked.

Rare circumstances, such as overwhelming fear or frustration, can also cause Panic. The Game Host may rule that dire situations such as explosive decompression, poisoning, impending nuclear holocaust, and other events causes Panic in certain characters.

What Panic Does

As a general rule, a Panicked character is frustrated and confused.

Each Action lists whether a Panicked character can perform it, and in what capacity. As a general rule, if a Panicked combatant *could* choose an Action that would make it harder to be hit – any action that increases Cover, Concealment, or Range against known hostiles – they will choose that Action over any other.

If you are using miniatures, place a yellow counter next to a Panicked combatant.

Special Circumstances

The standard attack assumes a careful attacker shooting at a ready opponent. However, there are some exceptions to typical attacks.

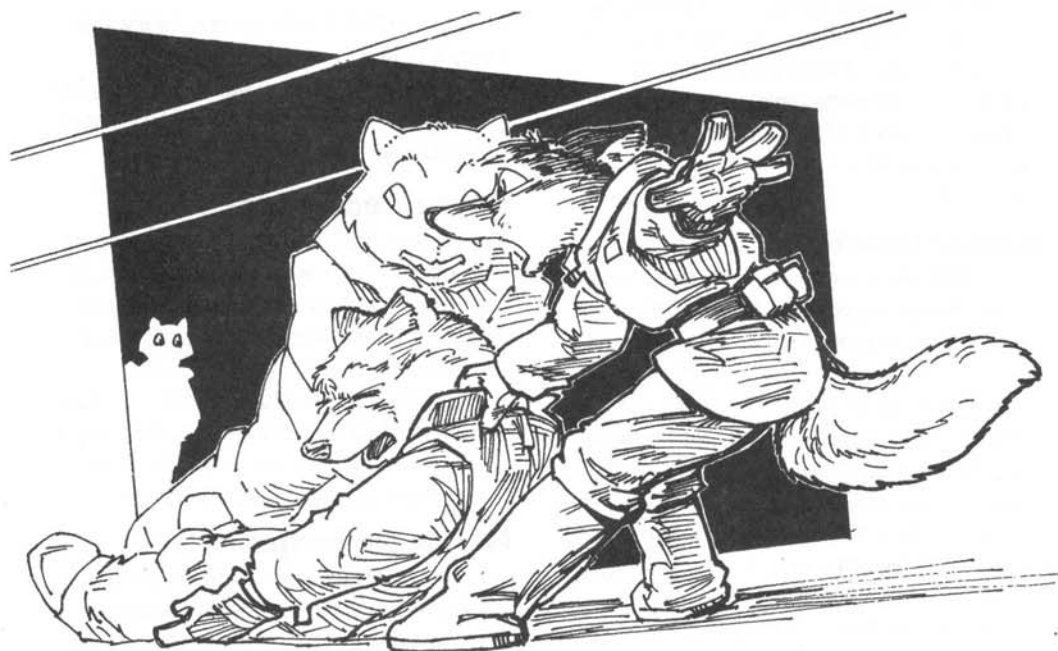



Close-Range Attacks

Being shot at is one thing – most attacks come from far away, from impersonal sources. There's something more frightening about someone in your face, trying to kill you. *Close-Range Attacks* use special rules, and such exchanges can be brutal.

+1 Awe at Close Range

Close-Range Attacks inflict +1 Awe on a target, whether they are successful or not. Thus any attack at your weapon's Close Range, even one that misses, can still spook a target. Gifts such as *Coolness Under Fire* will reduce this Awe, as usual.

Provocation

Anyone moving or acting within an attacker's Close Range provokes one free Close-Range Attack. Any combatant with a weapon that has a Close Range can use this attack. This attack can happen "out of sequence", before or after a combatant's action in the Round.

Note that some Longarms, like rifles, do not have a Close Range – for tight spaces in urban settings, carbines and pistols are preferred. All combatants can strike at a range of 1 meter with their bare-hands or with an improvised Melee weapon such as a rifle-butt.

Counter-Attacks

If both the attacker and the target have Close-Range weapons, and both of them are within Close-Range of each other, then the target may elect to *counter-attack*.

When Counter-Attacking, do not use the Range or Cover Dice. Instead, both attacker and target make Close-Range Attack rolls against each other, including their Concealment Dice. Whichever combatant rolls higher hits the other one. If there is a Tie, both targets hit each other.

Remember that a combatant doesn't have to counter-attack if they don't want to.

Remember that, when counter-attacking, *someone* gets hit ... whereas on a regular attack, Range, Cover, and Concealment dice still apply, so they might be missed.

Hand-to-hand attacks, by definition, are Close-Range Attacks – they provoke counter-attacks like anything else. If someone tries to run past a combatant, within the 1-meter reach of bare-handed fists, they may get sluggish for their trouble.

There is no limit to the number of times a target may counter-attack. Counter-attacking does not use up the one provoked-attack during the sequence. Any Close-Range Attack can be counter-attacked – even a provoked one.

EXAMPLE

Example: Toki is rushed by an insurgent armed with a pistol. As soon as the insurgent moves within 1 meter, Toki may make a Close-Range Attack with her bare hands. She elects to strike; this provokes a counter-attack from the target.

Toki elects to Push, spending 1 Body. She rolls her Brawl of 2d6. Her dice come up 5 and 3; her highest die is a 5.

Her attacker has a weapon with a Close Range – a pistol. As Toki swings at him, he shoots at her. He rolls his Pistol Dice of d8, scoring a 6.

Since the insurgent rolled the highest, he has won the opposed rolls. He has shot Toki at Close Range. Toki will suffer 1 Awe, plus the Awe from any injury she might suffer.

The insurgent also suffers 1 Awe, because he was attacked at Close Range, even though Toki's punch missed.

Surprised Targets

A target that is aware they're in danger, but doesn't know where the attacker is, is *Surprised*. Surprised targets cannot claim Cover or Concealment within 2 meters of their position, like ready targets can. Attacks on Surprised targets inflict +1 Awe.

A Panicked target is *not* automatically a Surprised target. In fact, most Panicked targets are highly sensitive to danger.

Helpless Target

Characters can be unconscious, tied up, restrained in crash harnesses, floating in zero-gravity, or otherwise unable to move

and to defend themselves – in other words, they are *Helpless targets*.

Being Helpless is like being Surprised, only worse. A Helpless target cannot claim Cover or Concealment within 2 meters of their position. If it matters, any attacks on a Helpless target inflict +1 Awe. Also, attacks against a Helpless Target roll an extra d20 Damage Die.

An inanimate, unattended object, such as a door or a wall, is considered Helpless for this rule. A moving object (such as a vehicle) or an attended object (such as a rifle in an opponent's hands) is not.



Explosions

Volatiles such as grenades, can send sharp debris flying into the air. Such attacks are called *Explosions*.

An Explosion does not use a to-hit roll. Instead, all targets are attacked. Find the center of the attack, and measure the range to other targets. An Explosion has a *blast radius* in meters. A target within the blast radius suffers a 4d20 Damage Roll; a target within 2x the blast radius suffers 3d20; within 3x, 2d20; and within 4x, 1d20. An explosive that goes off when touching the target inflicts 5d20.

Each 25% Cover reduces the Damage by 1d20. A Hiding character improves effective Cover by 25%, even if out in the open. A combatant expecting an Explosion can "hunker down", using the Hide Action to reduce damage.

If an Explosion's d20s are reduced to none, the target suffers no Damage and no Awe. Thus the farther away a target is from the center, and the more cover they have, the less effective the Explosion will be.

Explosions cause +1 Awe per d20 of Damage Dice rolled. The large area of effect and violent concussion of the wave of air are quite unnerving. Thrown grenades are often

called "defensive grenades" because while they might not cause actual injury, they can reduce enemy morale and can encourage their blast areas to be empty of hostiles.

Remember to figure effective Cover from the center of the explosion! Thrown grenades will explode on the ground, but airborne explosives burst overhead, reducing effective Cover for deadly effect.

<i>Distance from Blast Radius</i>	<i>Damage Dice</i>
Physically touching explosive	5d20
Up to 1x	4d20
More than 1x, Up to 2x	3d20
More than 2x, Up to 3x	2d20
More than 3x, Up to 4x	1d20
More than 4x	None
Each 25% of Cover	Less 1d20

EXAMPLE

Example: Auitzotl is taking fire, pinned down in a cafeteria. A hostile throws a grenade, which lands in the center of the room. A veteran of many skirmishes, Auitzotl had tipped over a table in a previous Round; now, he moves to Hide behind it. Next Round, when the grenade explodes, Auitzotl has 100% Cover from the table. He suffers no Damage and (with zero d20s rolled for damage) no Awe.

The following Round, Auitzotl takes an act of desperation. He stands up and fires his GAKW under-rifle grenade at the ceiling behind the hostiles. Since the center of the explosion is behind and above the targets, they will gain no Cover (as they, too, were using overturned tables, which are facing Auitzotl's door.)

The hostiles are each 3 meters away from the center of the Explosion; with a blast radius of 2m, this is more than 1x but not more than 2x; Damage is 3d20, and the Awe is +3.

Auitzotl himself is 5m away from the explosion, so he suffers damage for being within 3xblast radius, or 2d20; Auitzotl has also positioned the explosion so that a standing hostile can provide reduced Cover (a reduction from half-cover, to 25%) – this reduces the damage to 1d20. Auitzotl himself suffers 1d20 and +1 Awe from his own Explosion.

Some explosions might use *shaped charges*, only exploding in a cone, or hemisphere. The world of *Albedo* is filled with all kinds of explosive devices; the Demolitions Skill (p. 89) is used to prepare and to disarm them.

Shotguns

A special kind of explosion, *Shotguns* are smooth-bore projectile weapons. Instead of a single, solid bullet, shotguns project a spray of plastic darts (flechettes) or metal balls (buckshot). Shotguns are preferred for urban fighting: they are most effective at Close Range; they can blast open doors and weak barriers; and the projectiles are relatively short-ranged and thus less likely to cause friendly-fire casualties.

Shotguns roll special damage dice, based on the range to the target:

Shotgun Range	Damage Dice
Close	4d20
Short	3d20
Medium	2d20
Long	1d20
eXtreme	None

Since Shotguns roll no damage dice at eXtreme range, only the Base applies ... unless a Critical hit or something else adds another d20.

Armor

Armor serves two purposes: it gives the target increased *Deflection* (to reduce the likelihood of Penetration), and it raises the target's *Thresholds* for damage by a fixed amount. Note that even an unarmored target has a Deflection of 3.

Name	Deflection	Threshold
None	3	0
Battle Armor, Full Dress	11	+5
Battle Armor, Vest Only	7	+5
Concealed Armor	11	0
Spacesuit, Armored	13	+5
Spacesuit, Typical	11	0

Hand Weapons

The people of *Albedo* do not know much about physical combat. The few that do can be quite intimidating. Sometimes, a desperate combatant will use an improvised object, such as a rifle-butt, chair, or entrenching tool, to strike at another.

Weapon	Ranges	Damage
Fist	C1	0 + Attacker's Body
Martial Arts	C1	2 + Attacker's Body
Improvised, 1-hand	C1	2 + Attacker's Body
Improvised, 2-hand	C1	5 + Attacker's Body
Knife	C1	5 + Attacker's Body
Combat Staff	C2	5 + Attacker's Body



Firearms

The most common attacks in *Albedo* will be from guns. The common firearms that players will encounter have the following statistics.

Weapon is the name; you can find more information in the Equipment chapter, p. 136. *Type* is the Skill used when attacking with the weapon. *Ammo* refers to the ordnance deployed. *Mag(azine)* is the number of bullets held in a clip, if the weapon uses clips. (Note: the basic rules do not track every bullet, but a Variant Rule does; see page 161) *Action* is the weapon's rate of fire: "Semi-" weapons can use Semi-Automatic Fire; "Full" can use Semi-Automatic Fire, Following Fire, and Suppression Fire. *Ranges* are the weapon's attack ranges, in meters – note that not all weapons have a Close Range. *Damage* is two numbers: the Base (that always applies) and the Penetration (that is added only if a d20 roll scores equal to or higher



than the target's Deflection). *Notes* refers to any special rules of the weapon, such as Explosions.

Extraterrestrial Defense Force

<i>Weapon</i>	<i>Type</i>	<i>Ammo</i>	<i>Mag.</i>	<i>Action</i>	<i>Ranges</i>	<i>Damage</i>	<i>Notes</i>
CKW Precision	Longarm	8x56	24	Semi-	S15, M70, L560, X4600	10+10	
GAKW Grenade	Heavy	32 EX	12	Semi-	S5, M20, L80, X400	0+10	Explosion 2m
GLKW Grenade	Longarm	32 EX	1	Single	S5, M20, L80, X400	10+5	Explosion 2m
HAKW Machine Gun	Heavy	20x70	belt	Full	S15, M55, L410, X3000	26+13	
LAKW 1-30 Carbine	Longarm	8x56	24	Full	C5, S15, M50, L330, X2300	10+9	
LAKW 1-56 Rifle	Longarm	8x56	24	Full	S15, M60, L470, X3700	10+10	
LRCKW Rifle	Longarm	10x56	8	Semi-	S15, M50, L330, X2300	24+12	
MAKW 3-60 MG	Heavy	8x64	belt	Full	S15, M50, L360, X2600	11+10	
MPKW 2-18 Pistol	Pistol	8x24	24	Full	C5, S10, M30, L190, X1100	8+7	
PAKW 4-12 Pistol	Pistol	8x24	16	Semi-	C5, S10, M40, L230, X1400	8+7	
PRLW Rocket	Heavy	--	1	Single	S15, M60, L470, X3700	0+10	Explosion 1m
SBKW 10 Shotgun	Longarm	10mm	9	Single	C5, S10, M20, L40, X60	5+5	Shotgun
VAKW Machine Gun	Vehicle	20x80	belt	Full	S15, M55, L420, X3100	33+15	
Variable Grenade	Thrown	--	1	Thrown	Thrown Object	0+10	Explosion 2m

Independent Lapine Republic

<i>Weapon</i>	<i>Type</i>	<i>Ammo</i>	<i>Mag.</i>	<i>Action</i>	<i>Ranges</i>	<i>Damage</i>	<i>Notes</i>
AW 191 carbine	Longarm	6x40	48	Full	S15, M50, L410, X3000	8+9	
ML 199 SMG	Longarm	6x30	32	Full	C5, S10, M40, L230, X1400	7+7	
MP 197 Special	Pistol	6x30	32	Full	C5, S10, M30, L150, X800	7+6	
MS 195 Shotgun	Longarm	8mm	12	Single	C5, S10, M20, L40, X60	4+4	Shotgun

SPOT RULES

Z4PZ NUIS

Role-playing games are full of all kinds of scenarios and circumstances. The Game Host will have to make "ad hoc" judgments on the spot of what a character can and cannot do. This chapter has a listing of many of the rules

Don't let all the rules bog you down. Rather, rules should add new wrinkles to old situations, or be a plot point for the story. Any military force will seek to take advantage of a situation as well as they can. Outnumbered troops will prefer to fight in fog or thick forest, where they can take advantage of improved cover and concealment. A highly-trained force might choose to invade a space-station, where they can use their superior zero-gravity training against ill-equipped foes.

Rules are to be fair and consistent. Players should be able to make informed choices about what their Characters do, so they know what they're getting into. Clever tacticians will seek out every advantage they can, so the Game Host should encourage his players to exploit new and unusual situations in the game.

Atmosphere

Characters in poor oxygen environments, such as high-altitude or a leaking space-suit, must spend 1 Body to move or exert themselves, at all. If their oxygen runs out, they will suffocate.

Suffocation

Characters that are denied air can hold their breath for two minutes if they don't move or exert themselves. After two minutes, the target must spend 1 Body

COMMAND REVIEW • АРНААМ ДЕРГЭВ

Spot Rules vs. Variant Rules

A Spot Rule is "if anyone asks, this is what we do" – a rule that rarely comes up, but when it does, it has significant effects. A Variant Rule (p. 159) is a change that changes the dynamic of play. Assume that all Spot Rules are in play, but only those Variant Rules that the Game Host specifically declares.

regardless of what they do, or be rendered unconscious (and Helpless). If denied air for four more minutes, they will die.

A cubic meter holds enough air for a character to breathe for 15 minutes. A 3m x 3m room would thus hold enough air for one character to breathe for about six hours. More characters consume proportionally more air.

Vacuum

Without air pressure, ears will pop, eyes will bleed, lungs will rupture, and the very liquids of the body will boil away. Unprotected combatants exposed to 0 atmospheres (pure vacuum) become Wounded at the end of the first Round, Crippled at the end of the second Round, Incapacitated at the end of the third Round, and Devastated at the end of ten Rounds.

Lack of air resistance will multiply a bullet's Long and eXtreme ranges by 5. Close, Medium, and Long ranges are unaffected – these ranges are determined by make, manufacture, recoil, and other factors. This multiplier combines with the multiplier from gravity.

Atmosphere exerts a great degree of force on the walls of a spaceship; a single bullet-sized hole can lead to a rapid escape of air into space, called explosive decompression.

A combatant that suffers *any* attack that successfully Penetrates their spacesuit, while in vacuum, is leaking air. Someone must take an Action of Spacesuit vs. Intermediate Difficulty (d8 or 4) to patch the hole, using a kit that comes with all vacuum-suits. Otherwise, at the end of each Round that the suit remains unpatched, roll 1d20: on a 1, the suit has run out of air and the combatant inside is suffocating and exposed to vacuum.

Distance

With proper communications, even a simple man-to-man guerilla battle can involve resources kilometers away, or even in space.

Horizon

The maximum distance a spotter can see, before the curvature of the planet drops off, is called the *horizon*. The higher the vantage point, the greater the distance that can be seen. For a standard 1-diameter world:

<i>Altitude</i>	<i>Horizon</i>
Ground level	11,000m
On a roof (4m up)	14,000m
On the 10 th story (40m up)	28,000m
High altitude (10,000m up)	72,000m

For smaller or larger worlds, multiply the horizon by the diameter. (For example, on a 0.5-diameter world, someone at ground level can only see 5,500m away.)

Emplaced Snipers

Tall buildings and mountains offer places to strategically place long-range weapons. Many commanders will have at least one sniper to take advantage of large weapons, used from a safe distance.

Snipers will often be issued cameras that can receive input from cameras carried by their fellow infantry. Thus, snipers can be ordered to fire on hostile forces that would normally have 100% Cover and 100% Concealment. Snipers will often have to shoot through barriers – the target will be afforded increased Thresholds due to Cover.

Artillery Support

In large-scale battles, commanders may be authorized to call for support weapons. Artillery can be called from kilometers away, using indirect-fire weapons such as missiles and exploding canisters. Sophisticated computers can allow for grenade-sized explosives to be dropped almost anywhere on the battlefield, using a portable computer to designate the target, or even remote-viewing from an emplaced camera combined with telemetry from a personal positioning system. A commander issued support can use an action to call for artillery strike, which will arrive 1 or more Rounds later, depending on how far away the artillery is.

Air Support

Similar to artillery, air support involves calling for an aerodyne to deploy its weapons against the ground. The most common call for air support is to Suppress an area with

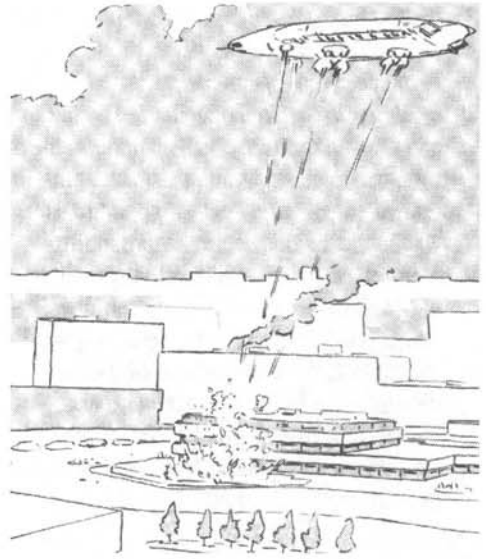

machine-gun fire, to clear it of hostiles before landing for troop deployment or extraction.

As a general rule, a personnel-carrier aerodyne carries VRF (Very Rapid Fire) Chain Guns capable of Suppressing zones 500m wide as Long Range or 1,000m wide as eXtreme Range. Use the usual rules for Suppression Fire, except on a very grand scale, using a typical Vehicular Weapons Rote of 4, and that the suppressed zone can be any simple geometric shape in size – circle, square, etc. – as guided by sophisticated computers.

Weapons of Mass Destruction

Autonomous Combat Vehicles can be ordered to descend from orbit to a planetary surface at extreme speeds, striking a planetary surface with a kinetic impact with a destructive yield measured in megatons. Kilograms of weapons-grade fissionables can create man-portable nuclear explosives. The ILR is known to fund research and development of new weapon systems; no one is really sure what the Enchawah Group does with "shadow budget" operations.

For the most part, Weapons of Mass Destruction (WMDs) will be plot devices – things to avoid. Engineers will be consulted for counter-intelligence, to find out where such weapons would be deployed for maximum effect and what safeguards

could be employed against them to reduce or to nullify their effects.

A successful deployment of a WMD will result in a large area of collapsed buildings and uneven ground. Dust will hang in the air for days or weeks, limiting visibility. Untended corpses and decaying plant matter will pose a serious health hazard, not to mention radioactive fallout that can linger for days, weeks, years, or even centuries. Any survivors may become desperate and violent, attacking even those who offer disaster relief. EDF troops will likely be deployed to first pacify the WMD's area of devastation, then either to rebuild or to assist in clean-up.

Gravity

Space explorers will encounter all kinds of hazards related to both too much gravity,

and too little.

Falling

Falling damage does not use the Armor's Deflection value. Instead, use the target's G-Forces Skill (p. 90) as the Deflection number. (Most characters should take Rote on this roll).

<i>Distance (1 G)</i>	<i>Damage</i>
2m	0+0
5m	0+1
10m	0+2
15m	0+3
20m	0+4
30m	0+6
40m	0+8
50m	0+10
100m	0+20
200m or more	0+40

If the target hits hard ground, roll 5d20.
If the target lands in water, roll 3d20.

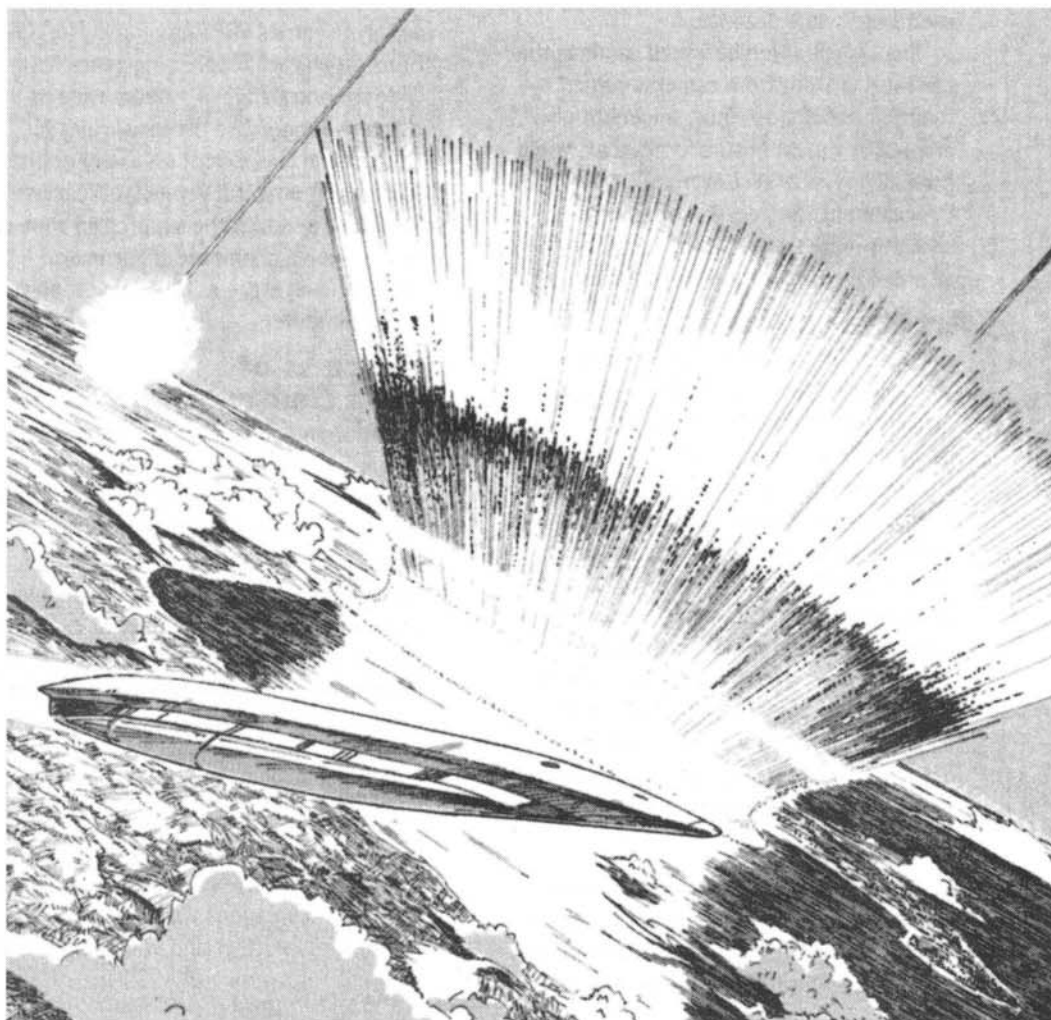

On a standard world (with 1 G gravity), a combatant will fall 175 meters in one Round, and 500 meters in two Rounds.

Wind resistance (on a standard atmosphere world) will slow the fall of a man-sized object to 55m/s, known as the *terminal velocity*. Terminal velocity is reached after falling for about 200m. In a vacuum, there is no maximum falling speed.

Multiply the damage by the world's gravity, rounded down. For example, someone on a 1.5 G world who falls 20m suffers 0+6 damage instead of 0+4.

Freefall

Combat in zero-gravity is heavily dependent on the Freefall Skill (p. 90).

In freefall, combatants cannot freely move, so they cannot claim reduced Cover or Concealment within 2m of their position. Instead of the Run action, a combatant can take the "Freefall" action, launching into the air and moving their Freefall skill, in meters. Once a combatant begins floating, they may take other actions, maintaining their constant floating movement until they hit something. Freefall combat can easily be in three dimensions, which can get very confusing for all parties involved.

Spacesuits have magnetic boots that can lock on to hulls, allowing the combatant awkward movement as if they were on Uneven Ground. "Running" is still impossible – a target uses 5+Spacesuit, instead.

Lack of bullet declination over distance will multiply a bullet's Long and eXtreme ranges by 5. Close, Medium, and Long ranges are unaffected – these ranges are determined by make, manufacture, recoil, and other factors. This multiplier combines with the one from lack of atmosphere.

Property Damage

During a battle, inanimate objects will get struck by stray bullets and blown up by explosions.

Unattended, inanimate objects are *Helpless* – attacks against them receive an extra 1d20. Objects on moving vehicles or held by combatants are not helpless for this purpose.

Material	Deflection	Thresholds
Airlock	15	60/70/80/100
Armored Hatch	13	50/60/70/90
Armored Vehicle	16	50/60/70/90
Concrete	11	30/40/50/70
Exterior Door	8	30/40/50/70
Exterior Wall	11	30/40/50/70
Heavy Plastic	7	15/25/35/55
Interior Door	6	20/30/40/60
Interior Wall	9	20/30/40/60
Light Plastic	5	10/20/30/50
Spaceship Hull	18	60/70/80/100
Steel	12	40/50/60/80
Wooden Tree	7	20/30/40/60

Damage results have different meanings for inanimate objects. A "Wounded" object is physically damaged – civilian-grade electronics or complex devices will break. A "Crippled" object is broken, regardless of quality. An "Incapacitated" object is destroyed, and a "Devastated" object is pulverized into fragments.

To make a hole in a wall of any size larger than a single bullet requires a Suppression, an explosion, or a shotgun blast.

Penetrating Cover

In many cases, it won't be worth bothering to see if bullets pass through an inanimate object to what's beyond it. Sometimes, however, high-powered weapons can defeat weak cover.

If the attack would have struck the target if not for the Cover, then there is still a chance the target beyond it might have been hit. In other words, if it were not for the Cover, the target might have been hit.

Reduce the base Damage of the attack by the Deflection of the Covering object. This might result in a negative number! Then apply damage normally to the target.

COMMAND REVIEW • APKNANA DEFCUP

Explosives and Tactics

If explosives are so effective, why isn't explosive ordnance issued to more troops? Explosives aren't discriminatory – they can hit friendly and hostile forces alike. Guerillas will use rapid mobility and secrecy to disperse, to keep "one bomb from taking them all out." Ruthless defenders will embed hostages in places where they don't want explosives deployed.

Size

Combat assumes fighting against man-sized targets.

A *small target* (less than 0.5 meters in the longest dimension) is treated as being one Range farther away for all attacks except Close. A *very small target* (less than 0.2 meters in the longest dimension) is treated as being two Ranges farther away for all attacks except Close. An *extremely small target* (less than 5 cm in the longest dimension) is treated as being three Ranges away for almost all ranges, and it treats Close Range as Short.

For larger size objects (at least 2m in length, width, and height, such as a wall), the shooter might still hit the target, if it matters. Use the deviation rules under the Throw rules (p. 115), using the attacker's roll. If the percentage deviation for the range is still enough to hit the target, then the target was hit.

Note: size rules apply when the *objects* are targeted, not when an *area* is targeted. For example, if you Watch a Medium-Ranged Area, you can still shoot at small targets that enter it – they just use Long Range's defense die.

Cover and Concealment is a percentage of how much of the *target* is covered or concealed; the Game Host rule on percentages for differently sized targets.

Temperature

All races of *Albedo* have protective fur or feathers that helps protect folks from the elements. While fur can be singed or frozen, it will grow back – unlike skin.

At temperatures below freezing (0 degrees Centigrade) a character must spend 1 Body every eight

hours or suffer Debilitating frostbite. For every 5 degrees below that, increase reduce the time to seven hours, six hours, etc. At temperatures of -40 degrees or below, exposure for even one Round costs 1 Body.

At extreme heat (30 degrees Centigrade), a character must spend 1 Body every eight hours or suffer Debilitating heatstroke. For every 5 degrees above that, increase reduce the time to seven hours, six hours, etc. At temperatures of 70 degrees or above, exposure for even one Round costs 1 Body.

Fire

Spaceships will often have sterile, sealed environments, making fires quite dangerous.

Fires consume oxygen in the rooms that they are in, filling them with smoke. Smoke limits visibility and will suffocate those trapped inside. On a planet, people can drop to ground level and crawl, being able to see and breathe. In micro-gravity, the room will fill uniformly.

Normal brushfires cause damage to anyone in them, as if the zone were Suppressed. (Combatants suffer 1 Awe to enter or to remain inside a burning area, for example.) Damage is 0+20

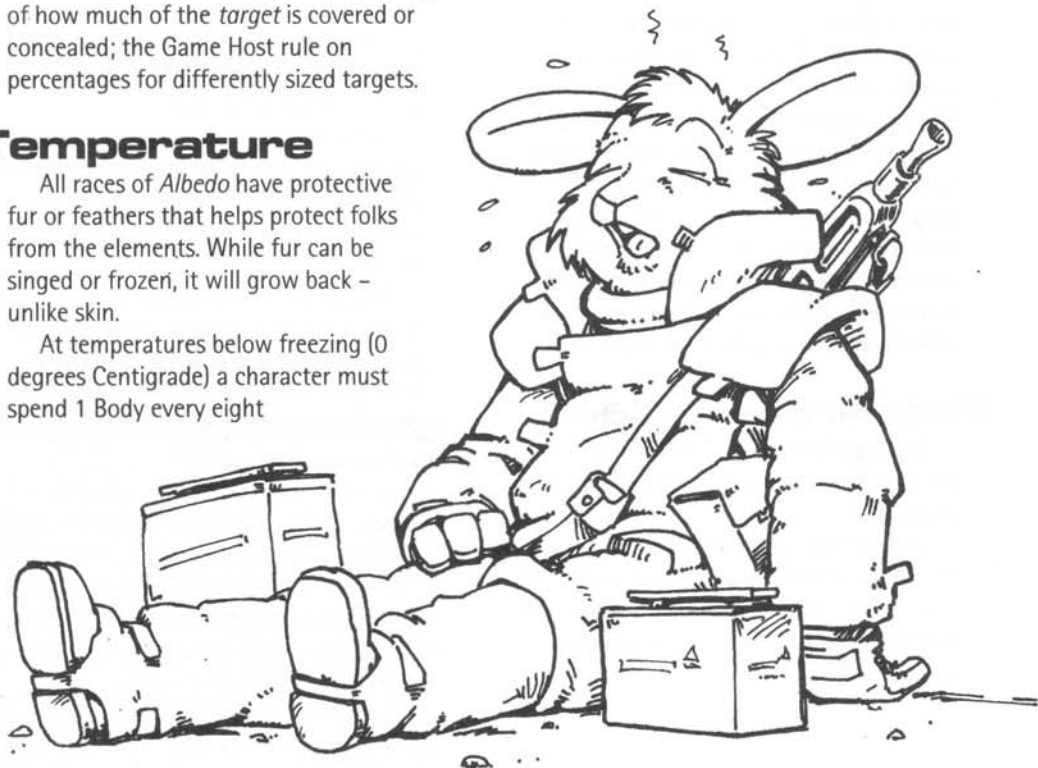

Terrain

During the course of the game, Player-Characters will encounter all kinds of strange places. Defending forces will attempt to exploit any advantage they can. For game purposes, terrain is divided into three categories: *Even*, *Uneven*, and *Impassible*.

Tactical maps should have clearly marked what sort of terrain is in what areas. Rather than mark every single tree, the Game Host can use the following table to determine average Concealment because of distance to a target.

<i>Description</i>	<i>Ground</i>	<i>Concealment</i>
Brush	Uneven	None
Building Interior	Even	100% per 10m
Collapsed Building	Impassible	50% per 100m
Desert Sand	Uneven	None
Hills	Uneven	100% per 500m
Light Forest	Uneven	25% per 50m
Marsh	Uneven	25% per 50m
Mountains	Impassible	100% per 100m
Plains	Even	None
Space Station	Even	100% per 5m
Swamp	Uneven	25% per 25m
Thick Forest	Impassible	25% per 25m
Urban Zones	Even	100% per 300m

Even Ground

City streets, sports arenas, level plains, building floors, and anything that is flat and level is *even ground*, the default assumption of combat. Combatants and vehicles can cross even ground at their normal movement rate.

Uneven Ground

Debris from nearby explosions, craters caused by bombs and shelling, thick plant growth, and the like are *uneven ground*.

Movement over uneven ground is at half-rate. (Thus, combatants can only claim reduced Cover and Concealment within 1m of their position.) Given the rubble and other debris present, infantry can claim 25% Cover and 25% Concealment almost anywhere.

Impassible Ground

Walls 1-meter high, collapsed buildings, dense trees, fences, and other barriers are *impassible ground*. Essentially, such ground must be climbed over.

Infantry must stop and climb over such obstacles, losing $\frac{3}{4}$ of their movement. Land vehicles must either destroy the obstacles or move around.

Units expecting urban combat will be issued grappling hooks and climbing gear. With proper equipment, a unit can scale a cliff at its Climb score as their only action per Round.

Water

Units may have to cross water, such as streams or rivers or even lakes. Hard rain and other climate changes can cause floods.

A unit can Swim through still or slow-moving water as their only action, moving their Swim Score. Fast moving water is more difficult, requiring a Swim roll to even swim 1 meter, vs. difficulty starting at 2 and rising. Rapids will be impassible.

Guns *will* fire underwater, but the water itself will provide Cover, at 25% per 10m. Healthy lakes and rivers are full of algae, as well as dirt and other impurities. Concealment is 25% per 10m.

Unarmed Combat

The basic rules of engagement assume that all combatants want to do is punch each other.

Grappling

Instead of attempting to strike, a combatant can *grapple* with a target instead. The attacker must have at least one hand free to grapple. The target can grapple as a counter-attack, as well. Grappling targets cannot claim reduced Cover or Concealment within 2m, and they can only use Close-Range weapons (against any target).

As their next Action, the attacker can follow up with a *pin*. The target gains 50% Cover against the attack if only one hand is used; if both hands are used, there is no Cover. The target can counter-attack, and if they win, they can choose to break the grapple instead of damaging the attacker. (Of course, a Crippled or Incapacitated attacker will have to let go.)

Grappling and pinning are contests of physical strength. On a *Tie*, the target with the highest Body wins.



Disarming

Instead of attempting to strike, a combatant can attempt to *disarm* the target. This is functionally the same as grappling, only targeting the weapon instead. Since weapons are small targets, the attacker gains the benefit of Cover, as per the Size rules – and yes, this Cover benefits their counter-attack.

Velocity

One G is equal to the gravitic force exerted on a man-sized body on a typical world. Aerodynes and other high-velocity vehicles are capable of rapid changes in vector, which can exert G-forces on the crew. In some cases, blood can be forced out of the brain (resulting in "black-out"); in extreme cases, physical damage may result.

In standard situations, a character can endure their Rote in G-Forces Skill with no ill effects. Increase effective G-Forces by 2

if the character is Wounded, by 4 if the character is Crippled, and by 6 if the Character is Incapacitated.

If the G-Forces exceed the character's Skill, the combatant must spend 1 Body of immediately fall unconscious, recovering 1d6 Rounds later. In addition, the character suffers Damage of 0+5, rolling 1d20 for each G that exceeds the G-Forces skill score. Armor does not apply: instead, use a Deflection of 11 if the character is in full harness and seat-belt, 3 if otherwise.

Visibility

Defensive forces will often prefer to fight in the dark, especially if they plan to flee. An invading force will often cut the power to a building or space station, to disable cameras and to allow an invading force cover of darkness. If one side has superior visual equipment, they will use it to their advantage.

Infrared cameras can see man-sized heat sources through thin walls, negating Concealment; however, infrared visuals lack the detail of the full spectrum, and thus grant 25% Concealment. Infrared cameras are a passive sensor, using existing heat sources.

Low-light enhancement takes existing light and amplifies it, often with computer-assisted correction; they are passive sensors which improve Concealment to only 25%. Low-light enhancement requires some lighting; in pitch darkness found inside or underground, low-light has no effect (and concealment remains 100%).

Ultra-violet sensors, or UV sensors, use a higher end of the light spectrum than characters can see. However, UV light is weaker than regular light; when combined with active UV spotlights, the sensors can see targets without revealing their own positions – unless the targets have UV sensors as well.

Many robots are equipped with active sonar, bouncing ultra-sonic sound off targets to identify their contours and their distance. Active sonar does not work in a vacuum.

Robot sentries can be deployed, and buildings will often have security cameras. Remote viewing – seeing your target through a third party (as opposed to “first-person” direct viewing) – is better than not being able to see them at all; at least you know where they are to Suppress their occupied area. In game terms, any form of remote viewing – that is, not looking at someone from first-person perspective – increases effective Concealment by 25%, as measured from the remote viewer. For example, if you use a camera to see someone in plain sight, they have effectively 25% Concealment. If the target was 200m away from the camera, outside in a soft rain, they would have 75% concealment.

Complete, total darkness is rare. Surrounding objects give off diffuse light, so even targets in shadow will probably have some cast-off light on them. True darkness is mostly only found underground and in impeccably sealed rooms.

Visibility	Concealment
Active Sonar	25%
Active UV Lighting	None
Daylight	None
Dusk	25%
Full Moonlight	50%
Infrared (heat sources only)	25%
Light Pollution in Cities	75%
Low-Light Enhancement	25% or 100%
Remote Viewing	Increase 25%
Underground Darkness	100%



Weather

Strong winds will lower the effective temperature. Winds of gale force (80 kph or stronger) impede movement, reducing movement to half rate. Hurricane-force winds (120 kph or stronger) will send characters flying about, costing 1 Body (or more) per Round to resist Debilitating broken bones.

Snow can limit visibility and slow movement. Sleet reduces movement and makes ground slick, reducing land movement to half.

Description	Ground	Concealment
Flooding Rain	Uneven	25% per 10m
Hail	Uneven	25% per 25m
Hard Rain	Uneven	25% per 25m
Heavy Snow	Uneven	25% per 50m
Light Snow	(no change)	25% per 100m
Sandstorms	Uneven	25% per 10m
Snowstorm	Uneven	25% per 10m
Soft Rain	(no change)	25% per 100m
Thick Fog	(no change)	25% per 10m

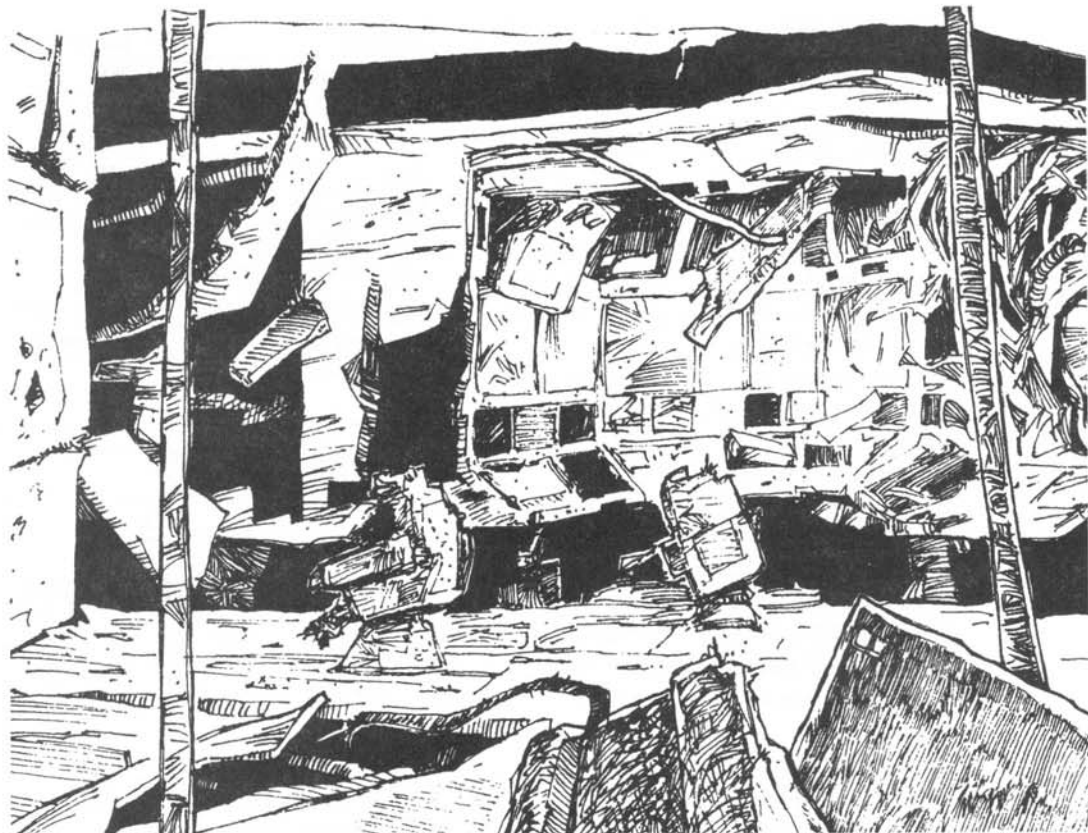

AFTERMATH

ԱՐՇԵՐՈՒՄ

After any battle, EDF officers will be expected to attend a debriefing, to report what occurred. Video records will be compiled, statements will be taken, and equipment will be accounted for.

In game terms, damage will be recorded, healing will begin, and character improvements and experience will be awarded.

Rest Period

Characters that rest can recover spent Attribute Points. A Rest is eight hours of sleep – no combat or Pushed rolls pertaining to the relevant attribute.

Recovery for Main Characters

Each Main Character has a Recovery number – their *highest* Attribute times their *lowest* Attribute divided by 5, rounded down.

		Highest Attribute (of Body, Clout, or Drive)																							
		4	5	6	7	8	9	10	11	12	13	14	15	4	5	6	7	8	9	10	11	12	13	14	15
Lowest Attribute (of Body, Clout, or Drive)	4	3	4	4	5	6	7	8	8	9	10	11	12	3	4	4	5	6	7	8	8	9	10	11	12
	5	4	5	6	7	8	9	10	11	12	13	14	15	4	5	6	7	8	9	10	11	12	13	14	15
	6	4	6	7	8	9	10	12	13	14	15	16	18	4	6	7	8	9	10	12	13	14	15	16	18
	7	5	7	8	9	11	12	14	15	16	18	19	21	5	7	8	9	11	12	14	15	16	18	19	21
	8	6	8	9	11	12	14	16	17	19	20	22	24	6	8	9	11	12	14	16	17	19	20	22	24
	9	7	9	10	12	14	16	18	19	21	23	25	27	7	9	10	12	14	16	18	19	21	23	25	27
	10	8	10	12	14	16	18	20	22	24	26	28	30	8	10	12	14	16	18	20	22	24	26	28	30
	11	8	11	13	15	17	19	22	24	26	28	30	33	8	11	13	15	17	19	22	24	26	28	30	33
	12	9	12	14	16	19	21	24	26	28	31	33	36	9	12	14	16	19	21	24	26	28	31	33	36
	13	10	13	15	18	20	23	26	28	31	33	36	39	10	13	15	18	20	23	26	28	31	33	36	39
	14	11	14	16	19	22	25	28	30	33	36	39	42	11	14	16	19	22	25	28	30	33	36	39	42
	15	12	15	18	21	24	27	30	33	36	39	42	45	12	15	18	21	24	27	30	33	36	39	42	45

For characters with Injury, Oversight, and Trauma, Recovery is a long-term Labor (p. 105). For each rest period, add your Recovery to your Labor status. It takes 100 times your current loss to remove just one point of Injury, Oversight, and Trauma.

Then, subtract the carry-over for your *next* Recovery. Keep track of the three kinds of Damage separately.

EXAMPLE

Example: Auitzotl has Body 11, Clout 7, and Drive 9. His highest attribute is 11 and his lowest is 7. His Recovery is $[11 \times 7 = 77 / 5 = 15.4 \approx]$ 15, after rounding down.

Auitzotl has 2 Injuries. To recover from 2 Injuries to 1 Injury takes $(100 \times 2 =)$ 200 Labor. On his character sheet, Auitzotl lists "0/200" in his Recovery track. Each rest period, Auitzotl recovers 15 worth, so after three rests, Auitzotl has "Injury Recovery 45/200" listed on his character sheet.

After 12 Rests, Auitzotl has 195/200, so he's feeling better. After one more Rest, his Recovery becomes 205 - he subtracts 200, and removes one Injury. He applies the difference of 5 to his *next* Recover - removing the 1 Injury, which costs 100. Auitzotl's player erases one point of Injury, and he writes "Injury Recovery 5/100" on his character sheet.

If a character suffers Damage, their Recovery resets back to zero.

EXAMPLE

Example: If Auitzotl's Injury Recovery is at 195/200, and he suffers 1 Injury point, he loses the complete 195. With his Injuries up to 3, he now writes "Injury Recovery 0/300" on his character sheet, and must start over.

Keep track of Recovery on the three Damage tracks (Injury, Oversight, and Trauma) separately. Damage on one track does not reset the other two.

Recovery for Supporting Characters

Supporting Characters only have generic Damage such as Wounded, Crippled, and Incapacitated. *Supporting Characters have a Recovery of exactly 10.*

Recovery from	Labor
Incapacitated to Crippled	2000
Crippled to Wounded	700
Wounded to None	300

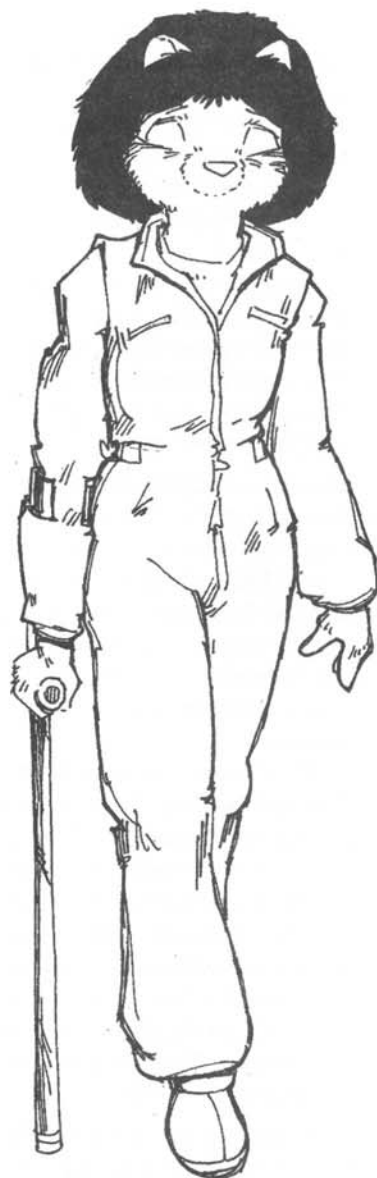

Devastated Supporting Characters are beyond medical help.

If a Supporting Character suffers a Wounding result or worse, their Recovery is zeroed out and must be started over.

Professional Help

People with the right Gifts (Doctor, Factotum, and Psychologist) can assist in the Recovery process.

Professional Help for Main Characters

Main Characters in the care of one or more Logistics Experts have their Body, Clout, and Drive Recovery increased by 1 per Rest.

A character with the Gift of Doctor can apply their Medical Sciences skill to treat a patient.

After a visit from a Doctor, reduce the Recovery number by *five times* the score rolled by the Doctor. (Note that if the patient suffers new Damage, that will reset the counter.)

A patient can only visit a Doctor once, to reduce Recovery. However, once a new Recovery number appears (either because of a reset from new Injury, or because of healing to the next step), a Doctor can treat the patient again.

EXAMPLE

Example: Auitzotl has 2 Injuries and a Recovery of 15. After three Rests, his Injury Recovery is 45/200.

He visits a Doctor, who has 5 Marks in Medical Sciences. With a rote of 6, that's good enough to deduce ($6 \times 5 =$) 30 from the Recovery. Auitzotl's player writes "Injury Recovery 45/170" on his character sheet.

The Doctor tells Auitzotl to take it easy. If Auitzotl suffers 1 Injury, that would change his Recovery to 0/300 – not only negating all his rest, but also eliminating the benefit of the Doctor's treatment.

After 12 Rests, Auitzotl has 180 Recovery. He completely heals the first 170, and now has "Injury Recovery 10/100" on his character sheet. He can now visit the Doctor again, who could lower this to 10/70.

A character with the gift of *Factotum* can use Bureaucracy to organize another character's schedule, perform damage-control on their mistakes, advise them of their schedule, and generally help get things back in order. A Factotum treats Oversight the same way a Doctor treats Injury – by reducing Oversight Recovery by $5 \times$ a roll of Bureaucracy skill.

A character with the gift of *Psychiatrist* can use Question skill to psychoanalyze a patient, helping them to resolve their anxiety. A Psychiatrist treats Trauma the same way a Doctor Treats Injury – by reducing Trauma Recovery by $5 \times$ a roll of Question skill.

Professional Help for Supporting Characters

Supporting Characters only suffer from Wounding, Crippling, and Incapacitating. A character with the Gift of Doctor can reduce Recovery by $10 \times$ a roll of Medical Sciences. Once again, only one treatment is possible per step of Recovery.

If the Supporting Characters are in the care of one or more Logistics Experts, increase their Recovery by 1.

Debriefing and Review

After the debriefing, equipment will be inspected and repaired. Ammunition, batteries, and other consumables will be replaced.

Incapacitated Supporting Characters will be sent to the infirmary. For each supporting character that was killed, the commanding Main Character's credibility will take a hit – add 1 Oversight.

A Main Character whose Body Rating has been reduced to zero from Injury will be sent to the infirmary, temporarily relieved of command.

A Main Character whose Clout Rating has been reduced to half due to Oversight will generate gossip among their peers about how they are having difficulty keeping their affairs in order. The character will be brought before their superior officer for review – which should be an opportunity for role-playing. If they fail to present a good review, their SPI will be reduced by 1, 2, or even more. A Main Character whose Clout Rating has been reduced to zero due to Oversight will be censured – they will be relieved of command, given a new assign-

COMMAND REVIEW • АПЗЕРНАЗ РЕГЕУР

Why is Recovery So Involved?

Battles will go quickly, with lots of fateful decisions. The aftermath, however, will have long-term repercussions. A commanding officer will have to make decisions about which of their subordinates will have to perform dangerous work, and which ones need to take it easy. Recovery is shown as two numbers – one progress, one goal – for easier record keeping between game sessions.

ment, have their SPI reduced by 3 (or more), and possibly be demoted.

A Main Character whose Drive Rating has been reduced to half due to Trauma will be noticeably frayed, and their associates will try to cheer them up, help them relax, and otherwise get them some help. A Main Character whose Drive Rating has been reduced due to Trauma will suffer a mental breakdown, brought on by the stress of combat.

Retiring a Main Character

Having any rating drop to zero could be cause to retire the character from the game. Most Players will become emotionally attached to their characters – they've spent a long time playing their role in the game, and time equates to improved abilities, greater reputations

Character Improvement

As characters continue play, they will face dangerous threats and encounter new places and situations. Some missions will be successful. Others ... will be charitably described as a "learning experience."

A Main Character's abilities improve. On the character sheet, you will find an *Improvement Track*. After three game sessions of harrowing, nail-biting adventure, a Main Character gains one kind of improvement.

Adventures Improvement

3	Low
6	Medium
9	Low
12	Medium
15	Low
18	High

After the High Improvement, the counter resets. So three adventures after the last High Improvement, the Main Character receives another Low Improvement, and so on.

Low Improvements

- . +1 Mark in any Skill which has no more than 3 Marks already (from any source). This can be a brand new Skill.
- . +2 SPI

Medium Improvements

- . +1 Mark in any Skill which has no more than 5 Marks already (from any source)
- . +1 Mark in any of the Skills from Basic Training in your current Branch of Service (regardless of current Marks)
- . +1 Group Gift in your current Service
- . Any Gift listed on your list of Homeworld Gifts (provided you meet the Requirements)
- . Any Gift listed on your list of Species Gifts (provided you meet the Requirements)
- . Replace any Dubious Gift with a Basic Gift. (Remove any Attribute adjustments, plus or minus, but do *not* adjust SPI.)
- . +4 SPI

High Improvements

- . +1 Mark in any Skill
- . Any Basic Gift
- . Any Advanced Gift, provided you already meet the requirements
- . Any Dubious Gift
- . +1 in any Attribute Rating
- . +6 SPI

SPI and Promotions

After every mission debriefing where a mission was successful, a Main Character gains +1 SPI. For particularly successful missions, the Game Host may award more. Likewise, failed missions can lower SPI.

A character cannot attempt to rise to the next rank until their Social-Political Intelligence is equal to the minimum for the rank.

Promotions rarely happen on the battlefield. The Character will have to submit their request in writing, and to wait for a response from their superiors.

EQUIPMENT



Despite the overall advanced state of technology in the Confederation and in the Republic, military scientists have yet to improve on the familiar ballistic weapons of the sort employed in the real world. While more exotic weapons do exist (such as powered rifles that use magnetic fields to hurl thousands of razor-sharp flechettes at a target) these tend to be prototypes, rarely seen in the hands of the common soldier. Old-fashioned slug-throwers remain a quite effective way of killing at a distance, and the most affordable manner in which to equip an army.

Slug-throwers manufactured by the major powers fire rounds of two basic calibers – 6mm and 8mm. The EDF uses the 8mm standard caliber in all their firearms, while the Republic uses 6mm. The Enchawah Group generally uses 5mm ammunition, and a wide range of calibers is offered by civilian manufacturers. Military firearms fire sabotaged projectiles, meaning that each round contains a smaller projectile, one which actually strikes the target. The larger round (8mm in the case of the EDF) is fired out the barrel but is quickly shed, and the smaller projectile proceeds on its own trajectory. Sabotaged rounds are capable of great velocities, and pierce armor quite readily. EDF rounds are cased in Teflon, in the belief that this enhances their penetration ability further, while ILR rounds are caseless. Civilian and police rounds are

seldom sabotaged, as the targets they are shooting at do not wear armor.

Gun controls vary widely from world to world, and are largely dependent on the local state of settlement and attitude towards personal security. Gun ownership is strictly controlled in the Core Worlds, and civilian weapons include digital gun cameras that record an image every time the gun is fired. In some cases, this image may even be automatically broadcasted to the local police station. On some Core Worlds, gun ownership may even be taken as a sign of undue paranoia and unsociability. On some Outer Worlds, personal firearms are the norm.

All normal ammunition can be fired in a vacuum, or underwater, as the rounds are

COMMAND REVIEW • АРХИВЪ НА РЕЦЕП

Firearm Action

The game term Action refers to when a character does something in the Round. The firearm term "action" refers to the mechanism of how a gun readies a bullet.

- iii. With a *single-action* (such as a shotgun or rocket-launcher), after firing one shot, the user must slide a bolt, pump a lever, or otherwise do something to ready the next shot.
- iiii. With a *semi-automatic action*, every time the user pulls the trigger, another shot is readied, so bullets are expended as fast as someone pulls the trigger, which could be two or three every second. Semi-auto allows a shooter to quickly correct for a miss, but firing too many shots this way (with recoil, shell ejections, and the motion of repeated trigger pulls) will reduce accuracy.
- v. With a *fully-automatic action*, the gun fires bullets as long as the trigger is held down, allowing the user to expend bullets very quickly (10 bullets a second or more) and to properly suppress an area.

All fully-automatic guns in this game are also *selective-fire* – the user can choose among single, semi-auto, and full-auto fire.

propelled by means of a chemical charge that contains sufficient oxygen within itself to ignite and explode. An unsupported person firing a gun in zero-g will find themselves moving in a direction opposite the one they were firing in. The movement imparted will be very slight in most circumstances. For example, an 80 kg character who fired a two-gram bullet at 400 meters per second would find himself traveling backwards at a rate of one centimeter per second, or 0.036 kph. Even firing under full automatic for several seconds would not send the character spinning away into space. A gun fired underwater works normally, but accuracy is very poor.

Weapons of the EDF

EDF military weapon design philosophy proceeds from the assumption that their forces will be engaged with armored, military opponents. As such, they are loaded with rounds specifically designed to penetrate normal infantry armor. All EDF weapons use standard 8 mm ammunition, and may also fire non-saboted 8 mm civilian rounds. The only differences lie in the length of pistol and rifle ammunition, 24 mm and 56 mm respectively. Civilian models of most weapons are available – with the exception of assault and support weapons – but these may have limited capabilities depending on local laws. A digital camera that broadcasts an image of the target to the local police station whenever a shot is fired is a common addition to civilian weapons, as are mechanical restrictions on fully automatic fire.

LAKW 1-56 rifle

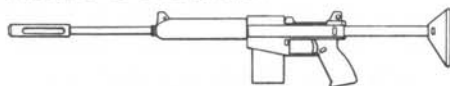

The standard combat weapon of EDF surface operations, the LAKW-156 8 mm automatic rifle is efficient and easy to use. Administrative Operations personnel attached to surface units are also issued these weapons, though they are usually kept in storage. Known to most troopers simply as the LAK (and informally as "the lackey"), the LAKW is an excellent all-round weapon, suitable for a range of operations. Standard

surface operation models include a laser spot, and may also come with digital sights that feature night-vision and zoom capabilities. Homeguard units often have stripped down versions, with just a laser-spot. The metal stock may be slid into the body of the weapon – this is commonly done when fighting in close quarters. The military version of the LAKW is capable of single-shot, burst, or fully automatic fire. EDF battlefield philosophy discourages the use of auto-fire. It has a magazine capacity of 24 rounds. It weighs 3.5 kg, unloaded.

LAKW 1-30 carbine/assault weapon



The LAKW 1-30 is a stripped down version of the LAKW 1-56, with a shorter muzzle. It is used for close range fighting. Among EDF forces it is most commonly seen in the assault weapon variant, with a grenade launcher slung under the barrel. In this configuration the LAKW 1-30 also serves as a powerful support weapon. Digital sights work with the launcher to determine range and targeting, automatically informing the user of the best angle for firing. The grenades may also be set to explode at certain ranges before impact – allowing a soldier to rain shrapnel on the heads of enemy troops by exploding a grenade above their heads. The carbine magazine contains 24 rounds, while the grenade launcher holds a single 32 mm grenade. With the launcher it weighs 3.5 kg, unloaded. Without, it weighs 3 kg.

GLKW 32 under-rifle grenade launcher



Not an independent weapon of its own, the GLKW is designed to be mounted under the muzzle of any of the LAKW rifles. It is essentially a barrel designed to accommodate a single 32 mm grenade. Internal electronics can adjust the standard EDF variable grenade, allowing the firer to control at which range the grenade explodes. The GLKW must be used on a rifle

with digital targeting sights to make use of this capability. The GLKW weighs 0.5 kg.

PAKW 4-12 semiautomatic pistol



Issued to everyone of rank O6 or above, regardless of service, the PAKW is nearly as common as the LAKW. A durable and simple weapon, it is also commonly found in civilian use, for personal use or civic security. The PAKW is used solely for close-range fighting, and is particularly useful for indoor engagements or fighting in close quarters, as aboard a ship. The military version of the PAKW usually features a laser-spot. Its magazine holds 16 rounds. It weighs 0.75 kg, unloaded.

MPKW 2-18 machine pistol



The MPKW is the standard weapon of Aerodyne crews and Aerospace security teams, and also sees use with surface operations specialists and armor crews. It combines high rate of fire with a compact size essential for shipboard actions and storage in a cramped cockpit. The MPKW includes a folding wire stock and laser spot, and may be fitted with digital sights in special situations. Its range is limited, but its magazine capacity and capability for automatic fire make it an excellent tool for clearing rooms. It may be fired in single shot or burst modes as well. The magazine holds 24 rounds. It weighs 1.5 kg.

CKW 8x56 precision rifle

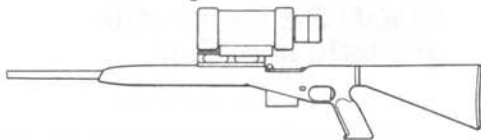

A military version of an early civilian weapon, the CKW is extremely accurate out to several hundred meters. They use standard 8 mm rifle rounds, and have powerful optical telescope sights that feature digital targeting assistance. The precision rifle is not same as a sniper rifle, as it is less powerful and has a shorter range. Precision

rifles are used to kill individual enemy personnel from a distance during an advance. The CKW may only fire single shots. Its magazine holds 24 rounds. Unloaded, it weighs 5 kg.

MAKW 3-60 light machine gun



A rugged and relatively light-weight weapon, the MAKW is the standard support weapon found in most light infantry squads. If belt-fed, it is capable for firing continuously. However, it is more commonly fed with 100 round magazines. The MAKW fires standard 8 mm rifle rounds. It comes with a folding bipod for stable fire, and some squads may also use a tripod. The MAKW may be fired without a support, but at greatly reduced accuracy. It weighs 8 kg when unloaded.

LRCKW 10x56 sniper rifle



This bulky and powerful tripod weapon is capable of puncturing vehicle armor at ranges of near 1 kilometer. Due to the ranges involved, optical sights are required, but these have extensive digital targeting assistance enhancements. The LRCKW fires 12 mm sabot rounds from an 8 round magazine, and must be mounted on a tripod to be fired properly. Ideally, it is placed in a very high vantage point, such as an apartment building. LRCKWs are too bulky to be assigned to squads in normal operations, and are controlled as company level resources. It weighs more than 15 kg.

GAKW 32 grenade launcher

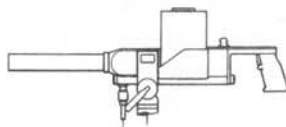

An imposing looking piece of armament, the GAKW fires 32 mm grenades up to 400

meters. It is normally used for indirect fire over the heads of the enemy, though it can also be used to disable armor and APCs. It includes digital sights that can be used to pre-set detonation times and ranges. The magazine contains four grenades. Unloaded, it weighs 6 kg.

PRLW portable rocket launcher



The PRLW portable rocket launcher is the most devastating conventional weapon available to a squad level unit. When uplinked to Command and Control through a field computer (see Infantry Gear) they are capable of striking targets up to 4 km away. While normally operated by two people, the PRLW may be fired by a single soldier if necessary. It is capable of firing anti-armor or fragmentation anti-personnel missiles. Fragmentation missiles are typically used against large concentrations of enemy troops and thin-skinned vehicles. While it is capable of severely disabling armored vehicles, the PRLW is less useful against flying targets. Aerodyne gunships can usually out-maneuver or outrun the missiles, and larger vessels are unlikely to suffer serious damage. However, the PRLW can be extremely effective when used against an aerodyne as it is landing. The launcher weighs 12 kg, and each rocket weighs 3 kg.

SBKW 10 Shotgun



Shotguns were invented fairly early on in history, and continue to see use as a civilian self-defense weapon and as a specialized firearm by security and military forces. The shot-gun is a smooth-bore rifle that is most commonly loaded with shells containing "shot," tiny metal pellets. When the gun is fired these pellets spread over an arc, potentially striking a number of targets. They have a relatively short range.

While shotguns are largely ineffective against armored targets, they are useful for untrained shooters, allowing them to at least graze a target without precise aiming. They are also useful for security teams driven to use force against a large group of rioters. Military personnel find shotguns handy in cramped conditions, such as indoor fighting; shotguns can be issued for infiltration of urban settings.

HAKW 1-100 Heavy Machine Gun

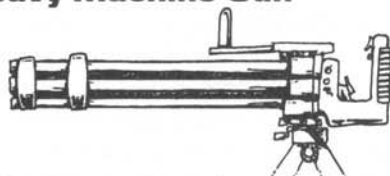

The largest of the infantry machine guns, the Heavy Assault Kinetic Weapon is a tripod-mounted heavy machine gun that fires 12mm-caliber ammunition. Commonly mounted on vehicles and in defensible installations, the HAKW is a belt-fed weapon. As a field piece, the HAKW is moderately impractical; 2,000 rounds of ammunition (enough for about 20 seconds of sustained fire) weighs 10 kilograms -- more than one infantryman could carry. Sometimes, tracer ammunition (bullets that lead a bright smoke trail) are employed, for increased visibility for the shooter and to increase the deterrence factor of the beaten zone (for it shows the opposition very clearly where the bullets are going).



VAKW-20 Vehicular Machine Gun

A rotary Gatling-gun construction, the Vehicular Assault Kinetic Weapon is much too large to be used in the field, weighing 100 kilograms without tripod or other mounting. Its rate of fire is in excess of 6,000 rounds per minute, making it excellent for beating zones. Its 20mm-caliber bullets are optimized for penetrating vehicles; their effect on infantry is devastating. A standard aerodyne gunship has two VAKW-20s mounted front, with eight HAKW-100s mounted underneath, all synchronized by the fire-control computer. As a vehicular weapon, VAKW-20s employ a sophisticated combination of radar, laser, and sonar guidance systems, linked to the vehicle's computer

Variable Grenades



EDF variable grenades may be thrown or fired from 32 mm grenade launchers. When used with a launcher, they may be manually set to explode after a given period, and to

either serve as armor-piercing or fragmentation grenades. The armor-piercing setting is only useful when the grenade is fired from a launcher, as it will only explode when it strikes the target. This setting is useful against lightly-armored vehicles, and can also cause severe damage to structures. The fragmentation setting explodes after a set period (or at a preset range if used with a digital targeting sight), and spreads shrapnel over a large area. The casing of the grenade is made of sturdy plastic infused with razor sharp metal flechettes. These provide the shrapnel. When they are set for armor piercing, three guidance fins pop out of rear of the casing. Each grenade weighs 0.5 kg.

Specialized Grenades



The EDF produces a number of highly specialized grenades for specific purposes. There are five basic types, incendiary, smoke, flare, irritant and stun. All of these grenades may be thrown or launched. They weigh 0.5 kg.

Incendiary grenades are packed with napalm, a highly flammable and sticky chemical

that spreads over a large area when the grenade explodes. These devices can cause horrific (and often nonfatal) wounds, and are rarely issued to EDF troops. Smoke grenades are used to conceal troop movements from the enemy, and provide thick, billowing clouds of smoke for several minutes. They have no other use, though they may be combined with irritant chemicals to create opaque clouds of tear gas. Flare grenades use burning magnesium to illuminate a large area, and may also temporarily blind enemy combatants, especially if used at close range. Flare grenades may also serve as a signal to passing aircraft.

Irritant grenades emit a cloud of noxious chemicals, such as tear gas, potent enough to force most unprotected people to flee the area. Typically, they cause shortness of breath and extreme eye irritation. These effects are temporary, but highly unpleasant. Depending on the chemical used, they may linger for several hours. Stun grenades emit a powerful burst of sound and light meant to shock and disorientate the target, and can be devastatingly effective if used indoors.

Weapons of the ILR

Cost, reliability, and fully-automatic fire capability are the greatest deciding factors when it comes to the design of weapons in the Independent Lapine Republic. ILR conscripts are typically not as well-trained as their EDF counterparts. Reliable weapons do not require skilled maintenance, and very high rates of fire compensate for mediocre marksmanship. The average ILR infantry squad is equipped with stripped down automatic carbines, submachine guns, or

COMMAND REVIEW • АРКАНАД РЕГЕРУ

Equipment of ILR Troops

Republican troops on the ground often lack access to specialized equipment. There are two reasons for this. First, the overriding desire to achieve the most "bang for buck" means that advanced or expensively manufactured equipment is spread as thinly as possible. Secondly, the average ILR recruit has rather weak technical skills, and cannot be trusted to make use of some equipment. As an example, hand computers are assigned only to officers.

machine pistols, all using saboted 6x40 mm rounds. While this ammunition load is not always effective against EDF troops in battle armor, it is brutally efficient when it comes to killing lightly-armed Homeguard troops and civilians. The high rate of fire also makes these weapons effective tools for denying passage through a given area to enemy troops – ILR squads are trained to simply hose the enemy with projectiles until they can close with them.

AW 191 carbine

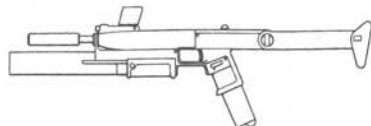

This is the standard weapon used by ILR heavy infantry squads and boarding teams. The AW 191 is an extremely rugged weapon, and capable of very high rates of fire. It has a laser spot and an optical "snap shot" sight. It has a folding metal stock. The AW 191 is the weapon that most ConFed citizens envision when they think of the ILR. The magazine has a capacity of 48 rounds.

ML 199 submachine gun



While the AW 191 is representative of the ILR in the minds of many, the ML 199 is actually the weapon most commonly found in the hands of Republican troops. This is an odd-looking weapon, scarcely larger than a machine pistol when the stock is folded. The ML 199 has a laser spot and short sight, and has a magazine capacity of 32 rounds.

MP 197 special weapon



The MP 197 is assigned to officers and armor crews in the ILR. It is even more compact than the ML 199, and when the stock is retracted or removed it would be indistinguishable from a machine pistol, where it not for the extra-long magazine protruding from the grip. The MP 197 is a devastating weapon in close quarters

combat. It has a laser spot and short sight. The magazine contains 32 rounds.

MS 195 shotgun



The preferred weapon for pacification forces on the ILR homeworlds, the MS 195 does not often see field use -- the ILR prefer to use machine-guns, rifles, and armor to prevent hostile troops from entering territory in the first place. However, police forces and hold-outs during EDF mop-up operations will often encounter desperate soldiers holed up in buildings, with these shotguns.

Clothing and Armor

Clothing presents a special problem for the EDF, given the varied body-types of the species in the service. Entire committees of administrative and logistics staff work to solve the matter, spending months designing a better sock, or a VHALO boot that will fit a penguin. Avians are a particular problem, with the exception of penguins, who may dress in tailored version of normal garb with extremely short trousers. The avian body form is simply unsuited to military garb and armor, and most birds go unclothed. While this undress causes no concerns when it comes to modesty or comfort, an eagle (for example) who ventures onto a battlefield in the altogether is going to be at a significant disadvantage when facing his well armored enemies. Solutions do exist, but they are far from perfect, and as a result very few birds end up in combat roles.

Most military garments make use of ballistic cloth. This is a light-weight, durable fabric made from multiple layers of synthetic fiber that are, weight for weight, many times stronger than steel. When a bullet or fragment of shrapnel hits the ballistic cloth, it cannot penetrate, and the force of the impact is spread over the surface of the fabric. Handguns are incapable of penetrating standard EDF ballistic cloth, though rifle rounds may do so. It is possible to severely injure or kill someone

who is wearing ballistic cloth armor, even if firing a weapon that cannot penetrate the material, as the force of impact is in no way reduced. It is simply spread over a larger area.

Battle Armor: Surface and Aircrew



Worn over the standard combat fatigues (see below), EDF infantry battle armor provides ample protection, and can even deflect direct rifle hits. A shell of ballistic cloth contains several monomolecular plates that protect the torso and limbs. To preserve flexibility, the joints are protected with an additional layer of ballistic cloth instead of metal plate, making them somewhat vulnerable. A ballistic cloth collar may be closed around the throat and chin, though this is normally only done when a soldier is bracing for an explosion. Aircrew battle armor is similar to infantry armor, but is

much less bulky in order to deal with cramped cockpits. Consequently, it offers less protection from direct fire. This armor is worn by aerodyne pilots and crew while they are in the atmosphere, and expect surface fire.

Both versions of the battle armor are worn in two pieces – trousers and jacket – and may be worn underneath foul weather garb. It contains biometric sensors that monitor the life-signs of the soldier wearing them. These are constantly relayed to *Command and Control* (C&C), and also serve to act as a locator beacon that displays the soldier's location. The avian version of this armor is comprised of a rugged bib that protects the soldier's torso, lined with monomolecular plates. The wings are covered with a thick cape of ballistic fabric. All versions of the battle armor include durable gloves.

Standard Battle Helmet and Field Communicator



Lightweight and durable, the standard EDF battle helmet is designed to protect against impacts and shrapnel, as well as keep an infantryman in constant contact with the chain of command. The rigid monomolecular shell can deflect direct hits from smaller caliber sidearms, and internal padding diffuses the shock of impacts. The internal padding is shaped to reflect the diverse ear types of EDF soldiery. Rabbits and similarly large-eared animals keep their

ears under the helmet, which may become uncomfortable after long wear.

The helmet is open-faced, with a padded chinstrap. Transparent ballistic visors can be affixed to the front of the helmet for face and eye protection, but these are distributed only for specific short-term operations (such as raids), and soldiers on long-term duty in the field rarely use them. Helmet electronics are powered by a small battery, which typically has a field-life of 96 hours. Soldiers carry several of these batteries.

The helmet is a miracle of compact electronics. It incorporates a computer controlled radio headset and throat microphone that allows a soldier to stay in contact with C&C, and with members of his own squad. Squad leaders are able to carry on private conversations with individual members of their unit, and can enforce radio silence. The helmet understands basic verbal commands for directing communications – a squad leader who requests a private channel to his superior is connected without pressing a single button. C&C passively records every conversation for later reference, but does not actively monitor radio chatter.

Embedded sensors in the helmet monitor brainwave activity, and upload this information to C&C. An alarm is triggered if brainwave activity ceases or drops below a certain level. Medical officers and psychologists can actually interpret this data to determine the basic emotional state of an individual.

Advanced Battle Helmet and Field Communicator

Worn by combat officers, armor crews, and pilots, the advanced battle helmet is actually comprised of two separate layers. The first is a padded skull-cap that contains communications gear and biometrics. This skull-cap is covered with ballistic cloth, and provides enough protection against impacts that many armor crew rely on it alone. In the field the padded cap is worn under a monomolecular shell similar to the standard battle helmet. The advanced helmet contains more extensive electronics, and a longer range integral radio. It may also be fitted with an armored face plate that

automatically seals to the helmet, making it a suitable component for a spacesuit. If this is done, a miniature oxygen tank and rebreather provides life-support for up to two hours. VHALO personnel invariably wear this face plate during drops.

Concealed Armor

Dignitaries, secret police, criminals, and other folks of means who are expecting violence may employ varieties of concealed armor. Protective vests can be worn under bulky clothing, but sometimes such clothing is inappropriate. Clothing can be crafted from monomolecular fibers woven over protective plates, appearing almost indistinguishable from regular clothes, but providing protection that approaches full battle dress.

Footwear

The design and issue of practical footwear provides a particular challenge for the EDF, given the wide differences in foot and leg physiology amongst the various races of the Confederation. The sentient races have hooves, trotters, and paws of every description. The talons of birds present a particular problem. Though they are able to go "bare-foot" in almost all situations, they obviously require foot protection in combat conditions, extreme environments, and in a vacuum.

Another complicating factor is the difference between digitigrade and plantigrade legs. Digitigrade legs most closely resemble those of real world dogs and cats, and feature what appears to be a "backward knee." In reality, this is an extended foot and ankle structure, and the toes are used as the foot. Digitigrade legs appear in a small, but significant, portion of the population, most commonly among foxes. Plantigrade legs are humanoid. To address this problem, the EDF is forced to produce a large range of fairly generic shoes and boots suitable for both leg types. Digitigrade footwear is simply more flexible than plantigrade footwear, almost resembling a snug sack that is placed over the leg. It has a smaller sole to reflect the smaller walking surface.

All EDF personnel are provided with a pair of combat boots and uniform shoes, with the exception of birds, who receive

general purpose "gloves" they may choose to wear over their talons. Aerospace crews wear a combat boot variant that connects to their spacesuit. Non-avian officers with higher than O6 rank also receive parade boots (plantigrade only) to wear with their dress uniforms. Normal combat boots are made from durable, waterproof synthetics, with a rubber sole. They are laced up the front. Aerospace boots are laceless, and must be pulled on. They may be sealed to any standard spacesuit or vacuum-suit liner. VHALO troops wear specialized combat boots that contain a complicated internal metal framework that provides ankle support during drops. Combat boots are worn by all personnel when they are dressed in their utility fatigues or battle armor.

Uniform shoes and dress boots are made from a glossy synthetic coating over a organically grown suede-like material, similar to patent leather. They are worn more for their appearance than durability. Uniform shoes are worn with the standard general duty uniform, and are laced. Dress boots rise to the knee, and are lace-less. They are meant for wear with the formal dress uniform, but are sometimes worn with the general duty uniform by officers in specific units, as part of an obscure military tradition that likely originated in a local shortage of uniform shoes.

Socks are worn under all footwear, to provide additional insulation and protection from chafing. Socks of different weights and warmth are worn in each season - this is affectionately known as the CSS, or Combat Sock System.

Foul Weather Garb

In cold weather infantrymen will don insulated jackets and trousers over their fatigues and battle armor. These waterproof garments are bulky, especially when worn over battle armor, but are loose and light enough that they do not impede mobility. The padding provides a small degree of protection against minor impacts, such as punches and kicks. Foul weather garb is invariably olive green, no matter the service. The avian version of this clothing resembles an insulated cape, with leggings. In extremely wet or rainy conditions infantrymen

will be issued a rain poncho made of coated cloth that goes over all other clothing. It is open at the sides to allow access to firearms and gear. Avians may wear this poncho with only minor modifications.

Headgear (non-combat)

EDF units normally disdain non-functional headgear, limiting themselves to woolen toques or watch-caps in cold weather, and peaked caps (similar to a baseball hat) in sunny weather. Homeguard units have a wide variety of headgear, much of it simply decorative. These hats serve to distinguish units and identify their planet of origin.

Spacesuit: EDF Utility

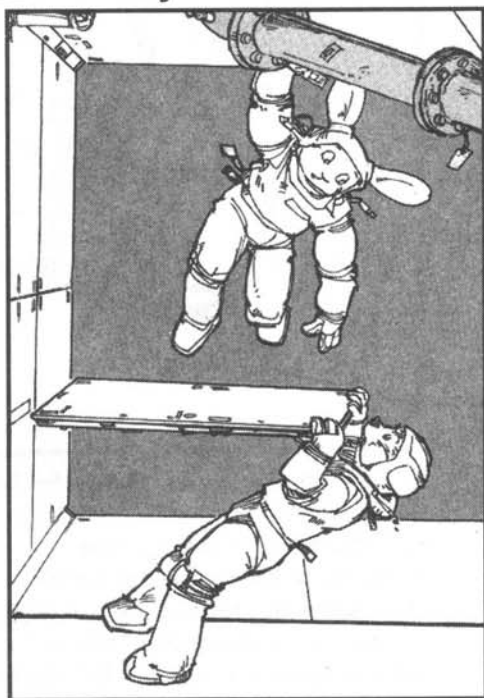

The standard EDF spacesuit is little different from the civilian model. It is made from two semi-rigid layers of synthetic cloth, in between which are suit electronics, a layer of sealing gel, and a Mylar sheath that blocks a portion of incoming cosmic radiation. The gel also acts as temperature regulator, and is capable of rapidly cooling or heating. The outer layer is a light ballistic cloth that resists tearing and micro-meteor impacts. The outer layer is not flexible, requiring the joints to be made of a complicated "accordion" of ballistic fabric that

allows the wearer to bend his arms and legs normally. Gloves and boots are separate from the basic suit, and must be worn for it to be effective. Normal Aerospace combat boots can be used with the suit, but these do not offer the same protection.

If the suit is slashed, the gel forms a barrier that serves as a temporary patch. Larger tears can be repaired with adhesive repair patches that are stored in a pocket. The most obvious difference between the EDF suits and civilian models are the protective monomolecular plates sewn into the torso section. These provide substantial protection against firearms and accidents.

The suit is a one piece garment (aside from the helmet, gloves, and boots) that is put on like a coverall. It must be worn over a liner (see below) for maximum effectiveness, though in a pinch it may be worn alone. Biometric and environment sensors are located throughout the suit, and transmit data to a tiny computer in the helmet. A computer jack and status monitor is affixed to the left breast, and it may be used to patch into shipboard computers. Spacesuits have a variety of Velcro patches, clips and pockets for storing tools, as well as a detachable electric lamp used to provide light during repair jobs. EDF suits have electromagnetic pads on the soles and palms. These pads can be activated at will, and allow the wearer to adhere to any metallic surface. A flexible coil of tether line is normally secured to the ship as an additional precaution.

The suit is light enough and flexible enough to be worn on the surface, and may be used to explore airless bodies, or planets with poisonous atmospheres. It is water-tight, but the military version is not buoyant, making it a poor choice for underwater exploration. It offers limited protection against high pressure conditions, and specialized hard-shell suits are required for exploring planets with very high atmospheric pressure. Utility suits are not suitable for protection from large amounts of hard radiation, though they do provide enough protection for normal wear in space. The suit has a small backpack with an oxygen supply and advanced rebreathing system that provides about 12 hours of life support.

This backpack may be replaced or supplemented by a much smaller unit that attaches to the back of the helmet. This smaller unit is only useful for two hours.

Spacesuits cannot recycle bodily waste. Urine is usually collected by a super absorbent gel pad (essentially a diaper) that can trap several times its own weight in liquid. This is usually sufficient for the normal duration of the suit's life support. Some suits intended for only extravehicular use have the option to store urine in a bladder that may be discharged into space. While no provisions are made for the collection of solid waste, the suit is designed so that a bowel movement will cause no serious problems, though the personal comfort and pride of the wearer will certainly be damaged.

The suit helmet consists of a durable shell that covers the head and a separate face plate. The face plate is designed to suit a range of muzzle sizes and types. It is made from monomolecular metal, with a transparent polycarbonate visor. If the user wishes, a second photosensitive visor can be lowered over the main visor. This automatically darkens when exposed to very bright light or flashes. Wearers normally lower the photosensitive visor while moving from place to place outside the ship, and raise it when doing repairs or other tasks that require full use of their vision. Some faceplates are simply transparent plastic half-spheres that affix to the helmet – these are worn when full visibility is required. The helmet incorporates much of the suit electronics, and includes a radio, additional biometric sensors, and a miniature video projector that can display visuals on the inside of the faceplate. Vomiting inside a suit helmet is a potentially serious matter, especially for zero-g novices. EDF suit helmets are equipped with filters that prevent vomit from entering the rebreather system, and all internal helmet electronics are waterproof.

Utility suits are issued to normal EDF crew and are donned whenever the vessel enters a hostile system. Passengers, such as infantry in transport, are given generic emergency suits. Some crewmen may wear armored spacesuits instead, especially on

smaller ships. Civilian ships are not required to provide utility suits to passengers, but they must have an adequate supply of emergency suits or rescue balls (see below) for everyone aboard. Avian spacesuits are available, though they greatly reduce manual dexterity because the delicate, feathered fingers must be enclosed in fairly crude mittens.

Spacesuit: Armored

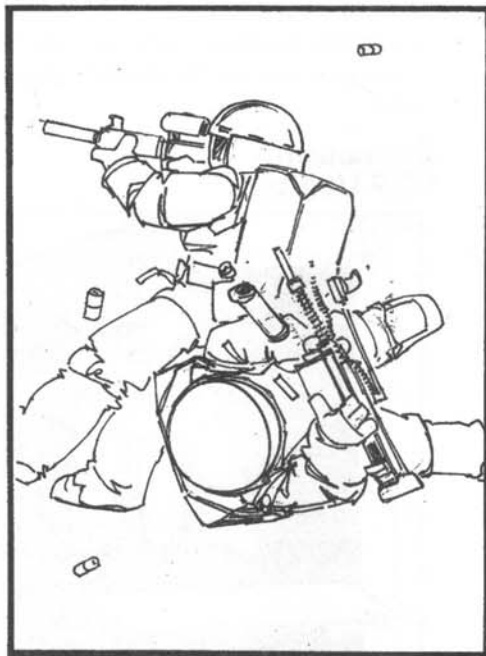

Armored spacesuits are worn by freefall infantry and aerospace crew in extraordinary situations. It is simply a more extensively armored version of the EDF utility suit, with additional plates in the legs and arms, and a more durable helmet. The suit is designed to fit onto the EVA rig (see below) and has an elaborate system of backpack clamps to accommodate the rig. It also has clips and ammo pockets, similar to those on surface body armor, for securing arms and ammo. It is otherwise identical to the utility suit.

Armored spacesuits are very bulky – anyone wearing one moves much slower.

Spacesuit: Emergency

Emergency spacesuits are issued to passengers on civilian liners and infantry in transit aboard a capital ship. They are

necessarily very generic, and a given suit can be adjusted to fit every body type, though some of the more unusual avian types will require some effort. Essentially, the emergency suit is an air-tight bladder in roughly humanoid shape, topped with a metal collar that holds the helmet. A small canister on the chest contains basic life-support equipment, and a pouch around the waist contains an emergency repair patch. Unlike rigid utility suits, which are able to maintain a constant volume of air and pressure, emergency suits inflate like large balloons, lending the wearer a somewhat comical appearance.

Emergency suits have a durable outer layer of thin ballistic cloth that serves to block micro-meteor impacts and resist tears. An inner layer of Mylar and fabric insulates the suit somewhat and deflects a portion of incoming radiation. The limbs and torso of the suit are covered horizontally and vertically with belts and straps that may be used to crudely tailor it. For example, the arms can be shortened by folding the sleeves onto themselves and securing them with straps. Emergency suits are not suitable for extended wear outside of a spaceship, and are intended for protection in the event of a hull breach.

The "fish-bowl" helmet is divided into two pieces, front and back. These are locked together with metal clasps, and the whole assembly snaps on to the metal collar. The helmet is made of a durable transparent polymer. The canister on the chest contains a basic rebreather and small oxygen supply, enough for eight hours under normal conditions. The canister has a small heater and air cooler unit that regulates temperature, but if the wearer undertakes any vigorous action his body heat will rapidly make the suit extremely uncomfortable and cause condensation to form on the interior of the helmet. The suit and helmet can be folded down and stowed in a very small compartment. Ideally, they should be worn with a vacuum-suit liner.

Uniforms

When not in combat or engaged in potentially messy duties, cadets and officers alike are expected to don their general duty

uniform. The general duty uniform is made of light-weight material, and is intended for indoor wear or temperate weather. A short-sleeved tunic is often worn aboard ship. Aerospace personnel wear blue uniforms, while Surface Operations wear green. Administrative staff and specialists wear the color appropriate to the service to which they are attached, with the exception of certain departments. Doctors, especially in space, wear white versions of the uniform when not in field. Most avians do not wear general duty uniforms, with the exception of a collar featuring rank and service insignia.

The normal general duty uniform consists of high collared tunic, belt, and trousers. The jacket is fastened up the left hand-side of the torso with clasps that are concealed when the jacket is closed. Service insignia is placed on the collar, while rank insignia is placed on the left breast. The uniform is belted around the middle, with a shoulder strap for additional support if a pistol is worn. Only commanding officers are normally issued pistols. A long overcoat is available for cold weather conditions, though most prefer to wear the more durable coat that is issued with foul weather garb. The general duty uniform is worn on formal occasions by cadets, while officers have a dedicated dress uniform.

The EDF dress uniform may vary in slight particulars between units, with one unit having a different cap, or color patches. Essentially, the dress uniform is a more elaborate version of the general duty uniform, with knee high jackboots. A full-length cape is worn over the shoulders. The dress uniform is worn at diplomatic functions, social affairs, and important events, such as treaty signings and medal award ceremonies.

Utility Fatigues

A set of durable one-piece coveralls made of lightweight acrylic fabric for most personnel, and a bib covered in pockets for avian troops. Normal infantry wear olive green, though black fatigues may be issued to commandos for night-time raids. Aerospace technical personnel wear orange fatigues while aboard ship, while normal

starship crews wear blue. The overalls have several pockets and Velcro patches for easy equipment storage. They're treated with an oil and water repellent, and are ideal for warm-to-cool temperate environments. They are designed to be worn comfortably over spacesuit liners, and under battle armor, spacesuits, or foul weather garb.

Spacesuit Liner

This is a skin-tight body sheath that covers the torso, arms, and legs, rather like a pair of long underwear. Aerospace crew wear liners under their outer clothing at all times. When worn under a normal or emergency spacesuit the liner provides additional support to the internal organs and guards against chafing. The liner may also serve as a very short-term spacesuit in and of itself. The collars, sleeves, and pant cuffs of the liner can be secured to a normal spacesuit helmet, gloves, and boots respectively and thus serve as a crude spacesuit. They may also be used with normal Aerospace combat boots, and experienced Aerospace personnel will keep their gloves and helmet within easy reach. In the event of a hull breach, these can be

donned much faster than a full spacesuit. A vacuum-suit liner used in this way provides adequate life-support for up to two hours, using the miniature life-support pack on the helmet. After 30 minutes, however, the wearer will experience severe discomfort as the liner is unable to provide adequate support for internal organs on its own.

Other Gear

Military planners in the EDF believe that it is essential for their troops to be prepared for anything. As such, they are sent into the field with an enormous supply of resources. Most of these are kept in the stores of the central Administrative Group for the unit, and are distributed as needed. Larger units, such as carrier groups, actually have an extensive manufacturing capability, and can create new equipment when the demand arises. However, every individual crewman or soldier is assigned a broad selection of tools and gear designed to support them in their day to day tasks. The list below is a representative sample of the typical items a player can expect his character to have at hand at short notice, within reason. A



shipboard technician is not likely to have an entrenching tool in his personal kit, and a light infantry lieutenant won't be able to obtain an EVA Rig from her platoon quartermaster.

When sent into the field, Surface Operations troops are equipped with either a 24 hour kit, or a 72 hour kit. These kits contain everything the soldier is likely to need to survive in the field during that period.

24-Hour Kit

The bulk of the 24-hour kit is contained within a small backpack with a rigid frame. The pack is one size fits all and is held with padded shoulder straps, a chest strap, and a detachable waist belt. It is made of light ballistic cloth, affording an additional layer of protection to the back, and weighs about 1.5 kg when empty. The main compartment has a volume of 20 liters, and two side pouches hold 5 liters each. A rifleman's 24-hour kit includes the following items, some of which are stored in the pack, and some of which are clipped to the front of the armor:

- Aid kit (personal for riflemen, trauma for medics)
- Battery pack (25 batteries)
- Blanket
- Canteen (2)
- Cord
- Entrenching tool
- Flare (2)
- Flashlight
- Gas mask
- Grenade, variable (2)
- Hand Computer
- Hygiene kit
- 8 mm rifle or machine pistol magazine (8)
- 8 mm pistol magazine (4)

COMMAND REVIEW · ΔΡΟΜΟΙ ΔΕΦΕΡ

Gear of the ILR

ILR equivalents to all the EDF equipment listed above exist, but they tend to be made as cheaply as possible. This does not necessarily mean that ILR equipment is unreliable, but it does mean that ILR forces do not always have the same level of flexibility as their EDF counterparts. Even a piece of ILR equipment as basic as a canteen will tend to be somewhat basic. The ILR strives for durability over flexibility.

(Officers only)

- Ration bars (3 meals)
- Utility tool

The total weight of the 24-hour kit ranges between 12 and 16 kg for most personnel.

72-Hour Kit

The 72 hour kit is issued when troops can expect to be in combat without support for an extended period. The majority of the items are contained within a large rucksack that covers the entire back. The rucksack is made from ballistic cloth, and armor plates may be placed in the external pockets for added protection. Internal support is provided by two aluminum stays which are bent to the shape of each individual's back. It has a capacity of approximately 80 L. The rucksack can be divided into two compartments by a draw cord closure in the center, or used as a single large bag. Access is through the top. A strap on the hip belt is attached to load transfer rods that run up the sides of the rucksack. This allows weight to be transferred between the shoulders and the hips. It also has a chest strap. The 72-hour kit includes the following:

- Aid kit (2 personal kits for riflemen, 1 trauma kit for medics)
- Battery pack (25 batteries)
- Blanket
- Canteen (2)
- Cord
- Entrenching tool
- Flare (2)
- Flashlight
- Gas mask
- Grenade, variable (6)
- Hygiene kit
- Infantry Field Computer
- 8 mm rifle or machine pistol magazine (16)
- 8 mm pistol magazine (6) (Officers only)
- Ration bars (12 meals)
- Utility tool
- Tent (Personal)

The 72 hour kit weighs about 19 kg.

Aid Kit: Personal and Trauma

The personal first aid kit is a small zippered pouch containing pressure bandages, pain-killers, tweezers, scissors, and antibiotic spray. All personnel are issued a kit. Surface Operations troops carry theirs into the field, while Aerospace crews typically store them in their personal lockers. The pain-killers are mildly narcotic, and it is possible to form a psychological addiction to them. However, psychological screening keeps addictive personalities out of regular service, and regular equipment checks quickly turn up missing painkillers. The personal kit weighs 0.25 kg.

The trauma aid kits issued to medics are much more extensive. In addition to a wide selection of bandages they include: burn dressings, blood clotting spray to quickly seal injuries, wound probe, large syringes for wound irrigation, 2 meters of plastic tubing, antibiotic spray and pills, various forceps, scalpel, sutures, needles, tweezers, penlight, cold packs, painkillers, sedatives, pep pills, and eight life-sign monitors that can be placed on the chest or forehead of the wounded. These monitors constantly transmit data to the medic's hand computer. The medic kit weighs about 3 kilos, and is contained in a 15 cm x 10 cm case.

Battery Pack

Standard EDF batteries are used to power everything from field computers to digital sights to helmet radios. They can provide a continuous charge until almost entirely depleted, something that may take several hundred hours in the case of low-power devices. Physically, they are tiny flattened cylinders, about 2 cm thick and 1 cm wide. They may be fully recharged by plugging them into a charger unit connected to a central power supply for an hour. Surface operations personnel in the field are issued a package of 25 batteries, and rarely have the opportunity to use more than one or two of them. The battery pack weighs 100 grams.

Blanket

The Surface Operations field blanket is 2 m x 1 m rectangle of thinly quilted water-proof material, containing several tiny heating elements that run the length of the fabric. When these are switched on, the

blanket provides adequate sleeping protection for temperatures as low as -14 C. The blanket uses standard batteries and can operate for more than 100 hours on a single cell. When the heating elements are off, the blanket alone is suitable for temperatures as low as 10 C. It can be folded into a 30 cm x 20 cm x 10 cm bundle. The blanket weighs 0.5 kg.

Canteen

More than a simple container for water, EDF canteens also feature micropore filters under the cap that can remove most chemical or biological contaminants from water. To use the filter, the top piece of the cap is removed during filling, which exposes the filter. The canteen is held underwater, and water pressure pushes the liquid through the filter. Contrary to barracks rumor, they cannot be used to make urine into potable water. Unpopular Homeguard recruits are often told otherwise. Canteens are normally only issued to surface troops, and are carried in ballistic cloth case. They are canisters, similar in size and shape to a thermos. A full canteen contains 1.5 liters of water, and weighs 2 kg in total. An empty canteen weighs 0.5 kg.

Cord

A 15 meter length of thin nylon rope, typically yellow. It can support about 150 kg of weight, but is easily cut. It weighs about 0.25 kg. It can be used to tie up prisoners, or as a garrote.

Entrenching Tool

Ubiquitous among Surface Operations troops, but very rarely used. The entrenching tool is essentially a small metal shovel that folds into a very compact package, about 15 cm x 12 cm. It is next to useless as a serious tool, but is better than nothing. Though its stated purpose is to dig shallow trenches during extended firefights, it most often sees use in the construction of impromptu latrines. When unfolded, the shovel is about 40 cm long. It is heavy enough to be used as a light club. It weighs 2 kg.

EVA Rig

Intended for extended jaunts away from a spaceship, the EVA (Extravehicular Activity) Rig is a bulky backpack that plugs

over the life-support unit on a utility or armored spacesuit. A series of miniature rockets propel the operator at great speed towards his target. The operator approaches the target in an upright position in order to ensure maximum visibility. The Rig is designed to automatically correct for dangerous trajectories, and will brake to avoid impacts. It can propel the wearer at a relative velocity of 250 kph in zero-g, and can operate at full thrust for 10 minutes. It is useless in any kind of gravity field, though it might contribute to some impressively high jumps in very low gravity. The rig weighs about 30 kg.

EVA Unit

The EVA (Extravehicular Activity) Unit is a handheld device that resembles a pistol grip attached to a small oxygen canister. A small nozzle protrudes from the end of the canister. The unit is used to assist in moving around outside a spaceship. Essentially, the operator points the nozzle in the direction opposite the one they wish to move, and pulls the trigger. A jet of highly-pressurized oxygen is released, pushing them backwards. The operator should be tethered to the ship, as the unit has a limited number of charges. When full, it has enough for 30 one-second bursts. The canister actually does contain oxygen, and may serve as a supplement to the suit's normal supply by plugging it into the helmet life-support unit. The EVA Unit cannot propel the operator at speeds great enough to cause serious injury – a full strength blast would propel the operator at about 5 kph. It weighs 2 kg, and may be used as a very crude club.

Flashlight

The standard-issue EDF flashlight is a durable, handheld unit with a bright light-emitting diode. They differ very little from civilian models, and are capable of operating for several hundred hours on a single standard battery. Flashlights used by the military and civil police units are 35 cm long and artificially weighted so they can double as a nightstick. Flashlights assigned to normal EDF personnel are much smaller and lighter. The smaller models weigh 0.25 kg, while the nightstick variety are 2 kg.

Gas Mask

The gas mask locks in place over the front of the standard battle helmet. A pair of elastic straps allow it to be worn without a helmet. It is a generic garment designed to fit over any muzzle or beak, and such protrudes outwards noticeably. It is made of light, high-impact plastic, and does not provide any protection from gun fire. A visor and a single filter tube are set into the mask. If worn alone, it provides full protection against inhaled irritants like smoke. If used with gloves, boots, helmet, and full-length clothing, the mask provides adequate protection against most chemical agents in the short term. It weighs 1 kg.

Hand Computers



Everyone in the EDF has access to a personal hand computer that keeps them connected to the Net and military infrastructure. While these computers vary from service to service, they all are built around a standard form. The hand computer is made from sturdy titanium, measuring 10 x 12 cm, and is less than a centimeter thick. Inside are a powerful processor, digital camera, environmental sensors, and an effectively unlimited amount of memory. Users input information on the 8 cm x 10 cm touch-sensitive screen, or by using a tiny keyboard which slides out of the bottom of the unit. They may also be operated with verbal commands if the unit is connected to the Net. It weighs about 0.5 kg.

Sliding open a cover on the top right-hand of the back of the hand computer reveals a miniature camera lens, allowing the unit to be used as a digital video camera. The lens-cover swivels outward and snaps down into place, acting as a conven-

ient handle for steadier filming. The camera is capable of filming in infrared and low-light conditions. The computer also has miniature microphone and speaker, and may be used as a communication device or sound recorder when necessary.

The standard hand computer has two major variations, the Aerospace Field Computer (AFC) and the Infantry Field Computer (IFC), known familiarly as the "Af-cee" and "If-cee" respectively. The AFC has specialized connectors and software that allow it to be used as replacement for any crew station, and may even override commands given from the physical station, provided the user has the authority to do so. For example, if the bridge has been taken over by raiders, the ships engineer can plug his AFC into any data-port and issue commands to the helm. A simplified graphical representation of the crew station appears on the screen. The AFC camera may also be used to record a graphical representation of electromagnetic fields and local radiation levels, which is very useful for detecting reactor leaks.

The IFC is a flexible and highly portable tool that keeps individual infantrymen informed about changing battlefield conditions. It is designed to work with the EDF battle helmet, but may also function independently. The IFC is wirelessly connected to C&C through the radio in the battle helmet, and can also link into any standard communication device. The IFC can also be operated with verbal commands, and if linked to a battle helmet the operator can whisper those commands almost inaudibly. Under normal conditions, a soldier keeps the IFC unit secured in a padded ballistic-cloth pocket on the right leg of his battle armor. Only the commanding officer of a given unit is likely to have the device out at any time, to prevent battlefield distractions.

Before any military operation, every IFC assigned to a soldier participating in the action is preloaded with extensive maps, combat objectives, and other essential information. These maps are interactive and capable of displaying current battlefield conditions. For example, if a column of enemy armor is advancing along a road, the map will display its progress in near real-time. Any soldier can indicate enemy posi-

tions on the touch screen, and upload that data to C&C. However, in normal operations, only the officer in charge of a given unit is authorized to send these updates, and submitting false data is a serious crime. Each upload instantly updates the overall battle map at C&C, and this information is then downloaded to every IFC unit in the field. In this way, every soldier has quick access to maps that reflect a constant stream of new battlefield intelligence. C&C may periodically request live video feeds from the battlefield, and this can be easily provided with the camera. Footage from the camera is automatically uploaded to C&C, whether it has been requested or not.

The IFC is shielded against electromagnetic radiation (such as that caused by a nuclear explosion) though radio jamming devices can cut it off from outside communications. A miniature spool of fiber-optic wire can be drawn from the left-hand side of the IFC and plugged into the helmet to ensure secure communication between the IFC and the electronics in the battle helmet. Built-in environment sensors inform the operator over the battle helmet headset when local radiation levels are elevated. While the IFC itself cannot detect the presence of chemical weapons or similar toxins, it does automatically monitor any detectors a soldier may be carrying. If a soldier is captured or killed, or fears capture is inevitable, the computer's memory can be instantly purged with a signal from C&C. The computer's own operating system is intelligent enough to conduct this purge by itself if it feels the situation is dire enough, based on data it is receiving from the biometrics in the combat armor.

Hygiene Kit

This is a small flexible case of toiletries and soap that allows troops in the field to stay clean. It contains a toothbrush, 50 ml tube of toothpaste, fur comb, antibiotic wipes, plastic mirror, and a 150 ml tube of soap. All hygiene kits are issued three packaged condoms. These are assigned to male and female personnel alike, according to species. Though few will admit it, they are most often used to waterproof rifle barrels.

The hygiene kit weighs .25 kg.

Magazine

The standard EDF rifle magazine contains 24 8x56 rounds, and weighs 0.4 kg. An EDF pistol magazine contains 16 8x24 rounds, and weighs 150 grams. The machine pistol variety holds 24 8x24 rounds, and weighs 0.25 kg.

Rations

EDF field/emergency rations are simply preserved bars of nutritious organic material. A single bar fills all the basic vitamin and caloric requirements for a meal, though they are not particularly palatable. These rations are the only source of sustenance that surface troops receive while in combat, and each person carries a three-day supply. A huge store is kept on most capital ships as a supplement to ordinary nourishment in the event the organic food tanks fail. A single meal consists of a single 100 gram bar.

Rescue Ball

Used when emergency suits are unavailable, or when the crew needs to abandon a rapidly disintegrating ship, rescue balls represent an absolute last resort for protection against the void. They resemble enormous transparent beach balls, about two meters in diameter, and are designed to hold a single person. They are pulled over the head while uninflated, and the circular "door" is zippered shut behind the occupant. A small oxygen cylinder inflates the ball and provides sufficient breathable air for two hours. Rescue balls provide no protection against radiation, and contain no emergency equipment or maneuvering jets. The occupant simply bobs about forlornly in the hope of rescue. The rescue ball weighs 10 kg.

Suit Patches

These are 10cm x 10cm squares of flexible material with an adhesive backing. They come standard with all EDF spacesuits, and can be used to temporarily patch large holes or tears. They are not as strong as the original material, and should be replaced at the earliest opportunity.

Tent, 1-man

The personal tent is an extremely compact structure. It consists of a 2 meter long tube of waterproof, windproof fabric, and a collapsible square wire frame. The frame is placed in the open end of the tube, creating a small support doorway. The user simply climbs into the tube in order to sleep. Personnel are expected to sleep with their heads at the doorway to assist in quick exits. When used with the standard blanket, the personal tent is quite snug and resistant to all but the most extreme weather. It weighs 2 kg and may be folded down into a 20 cm x 15 cm x 5cm bundle.

Utility Tool

This pocket-sized, multipurpose tool has found its way into every branch of the EDF. It is made entirely from metal, and folds into a relatively small rectangle, about 10 cm x 4 cm in size. The edge of the tool has measurement markers that allow it to serve as a short ruler. The tool incorporates a full set of screwdrivers, wire-cutters, small pliers, a 5 cm knife blade, a serrated 8 cm saw-blade, and a 20 cm long wire saw. The knife and saw blades can be used as weapons in a particularly desperate situation. The wire saw can be used as a particularly brutal garrote. It weighs 0.5 kg.



HOSTING A GAME

To play *Albedo: Platinum Catalyst*, one person must serve as Game Host. The Host establishes a scenario and referees the

COMMAND REVIEW • APKAKAKA DECEUP

Multi-service Operations

EDF officers are often called upon to handle every kind of crisis or confrontation. This elasticity is particularly obvious in situations where several branches of service work together to achieve a specific goal. Officers from each branch are given positions that confers overall authority over aspects of the current mission.

- ii. The *Commanding Officer (CO)* is in charge of the given operation. The CO is usually the most senior officer in the group, providing overall direction for the extent of the mission.
- iii. The *Executive Officer (XO)* is responsible for implementing the strategy defined by the CO, determining the specific tactics that are required to achieve the strategic goal, and has the discretion to assign orders to teams.
- iv. A *Field Commander (FC)* is the chief officer "on the ground," closest to the situation in a short-term crisis. On long-term missions, such as a group assigned to run a garrison, the FC is often simply the officer in direct charge of the security personnel or ground troops. The FC has a significant degree of latitude in the execution of orders, and is authorized to respond to rapidly changing situations according to his or her best judgment.

Following each operation, all officers meet for a debriefing, in which the performance of the lower ranked personnel is reviewed, as well as a review of the mission goals. As Game Host, you should use this structure to give the players clear roles on what they should be doing on the mission. The roles of CO, XO, and FC will depend on the mission, and the different levels of responsibility will provide the Players with new role-playing opportunities.

Players' actions in it. The Host arbitrates the rules and describes the results of everything the Players do. The Host also plays the roles of all Characters not run by the Players themselves.

The ultimate aim of *Albedo* is for all participants to have fun. It is a game, after all. After a long week of school or work, it's fun to sit down and unwind by shooting rabbits. *Albedo* offers a variety of war exercises, such as escape, extraction, invasion, infiltration, sabotage, and assassination.

Albedo has no pre-determined conclusion, no magic number of points to accumulate, and no victory conditions other than those which the Players and the Host set for themselves. This is what RPGs are all about. Different Players will have different goals for their Characters, and meeting those goals is a form of winning. But everyone wins as long as the game is fun, so encourage fun whenever you can.

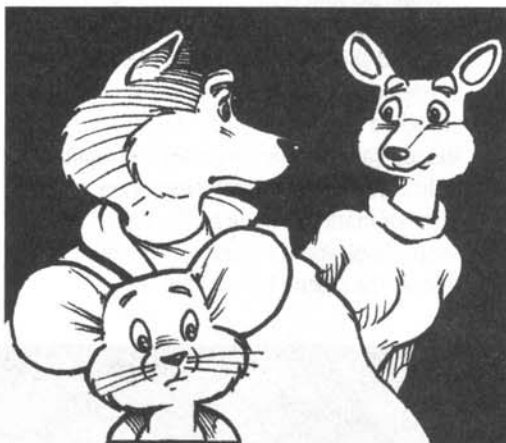

Narrative Elements

Role-playing is often compared to storytelling. But what makes a good story? Beyond the simple fun of the game, as Game Host you should keep in mind what makes for good narrative.

Developing a good game scenario is very similar to writing fiction. In some

ways it's much easier. For one thing, the Host doesn't have to worry about who the main characters are or whose point of view to present: The Players are the main characters, and the story is always told from their point of view.

The key element that is the same between games and fiction is the element of conflict. All good stories have conflict, because conflict brings change, and without change there is no story. A conflict can change one person, or it can change the entire world.

What is conflict? Conflict is an attempt to overcome one or more obstacles, antagonists, or disasters. Every important scene in a game session should include conflict. Going through a conflict can be outlined as a four stage encounter:

- **Meeting:** The Players meet the opposing force.
- **Struggle:** The Players attempt to overcome their opposition.
- **Resolution:** Win, lose, or draw, the conflict is resolved.
- **Change:** As a result of the encounter, something changes.

In a long-running campaign, the change brought about by each encounter can contribute to the next encounter. Each conflict builds on the previous one. The nature of those conflicts will help determine the overall theme of the game.



Theme

Behind every story is at least one message the story wants to tell. The personality and interests of the Host often determine the primary *theme* of the overall game.

Existentialism

The core theme of *Albedo* is *existentialism*—the idea that things happen because people make them happen. There are no gods who made the universe and who dictate the way things should be. The rules don't define good or evil. Even the SPI is just an arbitrary number determined by Confederation society. The best stories in *Albedo* are ones where the characters examine themselves and their own motivations. If things happen around them because of the choices they make, then what do those choices tell them about themselves?

As Game Host, you should invoke this theme often by presenting the characters with moral dilemmas. Do they call in an air strike on a target that has civilians? Can they carry out an assassination without having exhausted every other opportunity? When evacuating personnel, who gets shipped out first? The Player Characters will be officers with responsibility over other people's lives—remind them of the weight of that responsibility often.

Romanticism

A Romanticized setting is generous to the characters because the universe is benevolent. Things happen because of individuals, who are themselves larger than life. Lucky things happen to characters almost without effort. Characters can dodge automatic fire, and have peerless skills. They are set apart from society, because of how great they are. They do the impossible on a regular basis, and mundane individuals cannot compete. This theme functions in opposition to Naturalism, below.

A Game Host can invoke Romantic themes by personifying issues rather than leaving them abstract. An adventure about the dangers of runaway industrialism would feature an amoral company president for the PCs to meet and dislike. A hostage negotiation can be made more dramatic by having one of the hostages be

a subordinate or peer of one of the Main Characters. Whenever a situation comes up in the game, think of a way to make it relate directly to the Players.

Naturalism

Naturalist themes can be unforgiving to the characters, and present the universe as uncaring or even hostile to them. There is no meaning, only a lot of events that happen. Individuals are left to make their own meaning in the face of this. Bad things happen without reason. Characters can plan for things, but in many cases things just don't go their way. The future is uncertain, and something greater than the heroes often threatens to destroy them, with their best hopes lying in simple survival. Characters are isolated from society by their inability to affect change. They may bond with one another in their struggle to survive, but alienation is a recurring theme. This theme opposes Romanticism, above.

As Game Host, use Naturalism sparingly. Being powerless can be emotionally draining for the Players. On the other hand, fear and risk build tension. Naturalism gets its name from the natural world, so this theme works best in adventures pitting the Player-Characters against the environment, such as being stuck on a planet months with dwindling ammunition, or trapped on a decompressing space station.

Naturalism works best when used on Supporting Characters – having one experience a tragic, random demise can remind the Players of the fatalities of war.

Realism

Between these two extremes, Realism gives the characters a fair shake. The universe is neutral. Things happen because people make them happen, although every now and then a random turn comes up. Individuals can change their circumstances, but it usually takes a lot of effort. Good and bad things happen, but rarely unpredictably. Characters can have lucky breaks, but those are few and far between. Characters pushing their luck in dangerous situations sometimes suffer for it – but not always. Characters are encouraged to work together, to watch each other's back.

The Players should feel that their Characters are in a universe where many consequences to actions are pretty obvious, where random things rarely happen but can still be spectacular, and where working together in a society is the best way to accomplish goals. Keep things personable and fun, but don't be too generous or the Players will lose their motivation and their sense of wonder. Throw a curve every now and then, but don't crush your Players and deny control to their Characters, or they will become frustrated and lose interest in the game.



Social Elements

What makes tabletop Role-playing games different from other kinds of games? Tabletop Role-playing games are always social; at heart it's a group of people sitting around a table. Many computer Role-playing games can be played entirely alone, which begs the question, "to whom are you playing your role?" Tabletop Role-playing games may be played with unlimited durations and goals, while computer Role-playing games are pretty much over when a player has accomplished all of the goals set by the game. Tabletop games are also more flexible in their rules and in their settings. *Albedo* has many optional rules which the Host may include or disregard, and the Host determines the scope of the setting, whether it be a single military campaign on a single world, or a series of campaigns across the whole of space.

All these elements make tabletop Role-playing games far more social than their computerized counterparts. Hosts can alter the game to suit their own interests and that

of their Players. Everyone is involved in making the game work for themselves and for others. The Host's part in this lies in communication with and knowledge of the Players. Most communication is taken from verbal and visual cues. As Game Host, try to change the tone of your voice, or use gestures. Don't be afraid to use inside jokes with the Players, but don't let the game stray too far.

Know Your Players

Though there will only be one type of Host per game (you), there are liable to be several types of Players. The Host should know the Players well enough to craft stories that will be of interest to their Characters. What follows is a list of Player stereotypes.

The Author

This type of Player takes the narrative element of the story very seriously. An Author will often keep notes, and have lengthy character histories. This person has a serious interest in playing and is highly involved with the game. Such Players can be highly rewarding, but can also be very demanding of the Host. If Authors feel the Host doesn't take the game seriously, their own interest will decline.

The Stickler

Players who are familiar with the source material and the setting of the *Albedo* series often know more about this twenty-year-old setting than the Host. They are useful resources due to their profound knowledge of the original material. Sticklers can be blind to errors and contradictions in the source material, and often says something cannot happen in the game because it wouldn't happen in the series.

The Butcher

Players who design their characters around the idea of being the biggest, baddest killing machines possible will find they can do little outside of a combat situation. Such individuals may literally sleep through the stretches of the game between battles and thus may not be appropriate for most games of *Albedo*, unless they enjoy repeating the character creation process.

The Maniac

Some individuals, addictively attracted to Role-playing games, will have unholy compulsions to play. Maniacs take genuine interest in the game and are liable to want to play as long as possible, as often as possible. It might be necessary to talk to these Players out-of-game and talk them down.

The Professional

Those who want to be the best at everything. These Players are likely to have a healthy interest in character growth, but they can be annoying to other Players because of their lack of humility. Their interest in the game fades whenever their Characters are out of the spotlight or are in situations where their best capabilities don't come into play.

The Formalist

Some Players end up learning the rule book from cover to cover and can quote it from memory. These Players make excellent rules resources. They often go to the effort to fully comprehend the rules out of a genuine desire to do well in the game. From time to time they can bog down the game in a rules dispute. Some Formalists succumb to the Dark Side and become "Rules Lawyers", who quote only rules which help them and not the ones which may hinder them.

The Absentee

Some groups will include individuals who can only show up on occasion. These Absentees can present problems, for the Host must figure out what to do with their characters when absent. Not everyone gets taken out of action and called back to HQ every other week, after all. It is highly recommended that Game Hosts not depend on Absentees to trigger important plot points.

Rules Versus Play

Albedo is deliberately written to be simple. The numbers stay low, and Confidence or Panic are one's major modifiers. You as Host are the final authority on what happens and what does not happen. Remember that the Players are the stars. Find out what they like to do and make certain they get to do it a lot. Balance their interests with your own. If a rule bothers you, feel free to consider changing it, but remember that all changes will have repercussions. For example, if you give

everyone the "Semi-Automatic Expert" Gift for free, expect to see all Players hitting their targets more often. If you make up an "instant kill" rule, expect to see more Characters dying — including Player Characters. Some Players will argue for changes in the rules, but be wary of those who hope to get something "free" because they argued for a rule change in their favor rather than getting what they want the hard way, as advocated by these rules.

Controlling the Environment

The Game Host should be in control of the environment in which all participants meet for the game. Ideally the game should be played in a comfortable space where everyone can be together, with distractions minimized. If there is a television or radio nearby, it should be off; television and radio, by their very natures, clamor for attention. Computers not being used for the game should be idle; one who begins playing with a computer is soon lost to the game. Music can be used for ambient sound, but it should be music without lyrics; instrumental and electronic soundtracks from motion pictures and TV series are often good for setting the mood.

Away-from-Table Time

Some groups like lots of away-from-table communication. A Player might want to post a web-log of their adventures. Some Players will want to email you questions about their characters and about what to do at the next game session.

Like art, the reward you get out of a role-playing campaign is often directly proportional to what you put into it. If you find playing the game is more of a chore, then consider what you can do to kindle interest. Maybe someone else should be Game Host for a while. Maybe you need to examine the theme and take a new direction. Maybe you need to spend time away from the table talking with a problem Player to find out how you both can work towards a better game for all involved.

Gaming Elements

The last word in role-playing game is "game." Unlike fiction, role-playing games have rules that allow the Players and the

Game Host to have a common understanding of how the story is to play out. While the rules can answer questions like how far someone can jump, how much weight they can carry, or how many

Judgment Calls

For example, a character may be walking in the dark, when someone sneaks behind them and tries to stab them at Close Range. By some weird turn of the dice, the attacker misses. If the target fails a die-roll to observe the attack, should they still suffer Awe for something they didn't even know happened?

A rigid reading of the rules says the target should, but in this case, as Game Host, you should probably invoke your interpretation to say that no, a target can't suffer Awe from an attack that they didn't even know about.

As you play the *Albedo* game, you'll find lots of special circumstances crop up that the rules don't handle, at first reading. Writing these rules to handle every special case would be impossible.

Remember that the rules exist to be *fair and consistent*. Interpreting them in new and creative ways is one thing that separates table-top gaming from other kinds of gaming.



APPENDIX 1: VARIANT RULES

לְיָצֵר חֲסִידִים ■■■ רִגְלֵי אֶלֶף נֹסִים

The rules presented in the Basic Rules of Engagement and Spot Rules chapters are the "default settings." As designers, we feel they best express the themes and play-style that are what *Albedo* is all about.

Your campaign may differ. We encourage folks to come up with new rules.

Remember that if you change a rule, you're affecting other rules that depend on that one. What sounds like one little thing may have big changes down the road.

Players are always eager to suggest new changes. Be wary of what they ask for, though. *Albedo* deliberately restricts what Player-Characters can and cannot do. Many Players will be motivated to ask for a rules-change in their favor, particularly ones that make what's normally the province of a Gift to be "free."

Variant Rule: **Civilian Characters**

It may become necessary for the Game Host to write up civilian Main Characters. Alternatively, one or more Players may have civilians as their Main Characters. They could be embedded journalists, freelance contractors, or refugees from disaster.

Civilian Characters follow a similar process for creation, with a few changes. Civilians lack the intensive training of most army troopers.

- . Choose a Species. Apply Species Skill Marks. Choose one Species Gift.



- . Choose a Homeworld. Apply Homeworld Skill Marks. Choose one Homeworld Gift.
- . Choose a Personality, and increase Attributes appropriately.
- . Choose any three Group Gifts.
- . Choose any one Basic Gift.
- . Choose any one Gift, of any kind. (You can only choose an Advanced Gift if you meet the Requirements.)
- . Add 12 Marks to any Skills, putting no more than 3 Marks into any one Skill.

Variant Rule: **Stunts**

With this rule in play, Player-Characters can regularly go above and beyond what they're normally capable of.

A character can spend *one Attribute Points* and attempt almost any Gift, whether they have it or not, as a *Stunt*. This is in addition to however many points the Gift usually costs (which will often raise the cost to 2, or more).

Also, any time a character needs to do something above and beyond normal means, the character can spend *two Attribute Points* in whatever is most relevant (Body, Clout, or Drive) to attempt it.

This Variant greatly rewards characters who have lots of Attribute points. It also prevents Players from grousing too much that they "don't have the right Gift" to do something.

However, this Variant will require a lot more judgment-calls from the Game Host.

Variant Rule: **Random Generation**

With this rule in play, characters do not start with fixed values in their Body, Clout, and Drive.

- . For each Attribute, roll 1d6 and *add* the result.
- . Then, for each Attribute, roll 1d6 and *subtract* the result.

For greater randomness, the Game Host may use a d8, d10, or even a d12.

This Variant allows for greater variation of characters. However, this Variant also works like a lottery, rewarding characters more for randomness than for conscious, narrative decisions about their characters. Some Players will want to re-roll, or discard characters with low rolls and try again.

**Variant Rule:
Hit Location**

To lend your game a stronger visual element, you can use this rule of *Hit Location*.

Whenever you make an attack roll, include an extra twenty-sided die – the *Hit Location Die*. Consult the table below to see where your attack strikes the target.

d20 Location	Melee vs. vs.	
	Melee	Longarm Pistol
1 Far Foot		(Cover) (Cover)
2 Near Foot		(Cover) (Cover)
3 Far Leg	(Cover)	(Cover) (Cover)
4 Far Leg		(Cover) (Cover)
5 Far Arm	(Cover)	(Cover)
6 Far Arm		(Cover)
7 Stomach	(Cover)	(Cover) (Cover)
8 Stomach		(Cover) (Cover)
9 Far Hand		(Cover)
10 Near Leg		(Cover) (Cover)
11 Near Leg		(Cover) (Cover)
12 Chest		(Cover) (Cover)
13 Chest	(Cover)	(Cover) (Cover)
14 Shoulders		
15 Near Arm		(Cover)
16 Near Arm		
17 Near Hand		
18 Neck		
19 Head	(Cover)	(Cover)
20 Head		

"d20" refers to the roll of the twenty-sided die. "No Cover" shows the location of where the target would be hit, if they were out in the open. "Melee vs. Melee" refers to a target using their melee weapon as a parrying object, denying another Melee attacker access, and thus is only for hand-to-hand combat. "vs. Longarm" and "vs. Pistol" refer to the maximum cover advantage a target can have after shooting with the appropriate firearm.

"Near" almost always refers to the target's good hand – the one they use for

shooting, holding their weapon, etc. – but circumstances may vary. When in doubt, roll any die: even is the right, odd is the left.

Using Hit Location to Simulate Cover

In some cases, Hit Location replaces the Cover Dice. Instead of using the Cover Dice, the Game Host can rule which locations are Covered, and any result on the Hit Location table that would strike that body part, strikes the Cover. In other cases, such as 100% cover, or with fences and shrubs, or with a target that claims cover when passing through an open space, this technique won't work as well.

Hand-to-Hand Combat

Some people feel that hand-to-hand attacks are more likely to hit the upper body. In that case, with hand-to-hand attacks, roll two d20s and use the higher-rolling one as the location.

Modifying Damage Based on Hit Location

In the default system, the damage from the attack is abstract: the more damage inflicted, the more likely it was that the attack hit a target's vulnerable spots. With a Hit Location system, places like the Head and Stomach are thought to be more likely to inflict injury.

To simulate this, as another Variant Rule, any hit to the Head or Stomach rolls an extra d20 for damage.

Called Shot

Sometimes, an attacker will want to put a shot in the target exactly where they want it. This is known as a *Called Shot*. In game terms, an attacker may declare any *Critical Hit* they score to be a Called Shot, striking the target in the Hit Location of their choice. (When combined with "Modifying Damage", above, the shooter can choose to hit in the Head or Stomach, rolling +1d20 dice and thus being functionally identical to the original Critical Hit rules.)

Commentary

This Variant Rule adds detail, which can add to the role-playing experience. However, Hit Locations also increase the complexity of the game.

Hit Locations are also inappropriate for some kinds of damage, such as G-forces or concussion grenades. Also, these rules fail to compensate for the complexity of many injuries, such as spalling bullets

**Variant Rule:
Open-Ended Damage**

In the standard rules, damage for weapons is very predictable – the maximum any weapon can incur is the Base, plus one Penetration for each d20.

With this Variant Rule, for any d20 that shows a 20, roll another d20. If this extra d20 shows 20, roll yet another die.

This Variant Rule allows for some attacks to cause a fantastic amount of damage. It greatly rewards attacks like Explosions or Shotguns that already roll multiple d20s.

**Variant Rule:
New Species**

The Interstellar Confederation recognizes over 160 distinct Species. Only a handful are presented in these rules. Your Players might want to make New Species, or you as Game Host might want to add variety to the game.

As a general rule, Attributes should stay within the range of 5 to 13, with the average around 8. The total sum of Body, Clout, Drive, and Skill Marks should be 28. Species Gift choices should be either Basic Gifts or Dubious Gifts.

**Variant Rule:
Recoil**

While the source material makes reference that smaller races, such as the Rabbits of the ILR, prefer smaller caliber weapons, there isn't any actual rule that imposes penalties for using such.

With this Variant Rule, a Species suffers minor inconveniences if they attempt to use a weapon whose caliber (6mm, 8mm or 10mm) is larger than the character's Body Rating. If the character's Body is too small, the character spends +1 Drive (or Morale) when claiming Semi-Automatic Expertise, Following-Fire, or Suppression-Fire with the weapon, in any capacity.



While this rule adds a dimension of realism to the game, it also adds more complexity.

**Variant Rule:
Tracking Ammunition**

In the standard rules, ammunition for weapons isn't precisely tracked. For the most part, tracking each individual bullet isn't realistic – shooters are trained to discharge bullets in groups; in the heat of battle, most folks don't have a precise accounting of exactly how much ammo their gun contains (nor do they have long periods to think about it between their turns in the action sequence, like in a pen-and-paper RPG); and the large number of supporting characters can make tracking every spent bullet for every Supporting Character quite tedious.

However, it can add some dimension to game-play if troops have to count every last bullet. Under this Variant Rule, each bullet spent is tracked as follows:

<i>Circumstance</i>	<i>Bullets Spent</i>
Attack at Range	1
Suppress	20
Claiming Following Fire	+2 each time
Claiming the benefit of Semi-Automatic Expert	+2 each time
Botched Attack Roll	5

APPENDIX 2: SAMPLE CHARACTERS

ΛΥΧΕΝΔΥΧ III: ΖΑΝΥΟΙ ΗΛΟΛΗΖΕΝΖ

Sample Supporting Characters

These characters could be with nearly any faction (EDF, ILR, etc.). Naturally, Skills will vary based on Species, and not all abilities are listed here. The Game Host should feel free to improvise more involved characters at need.

Bomb Squad Expert

Skills: Demolitions +2, Information Analysis +2, Listen +2, Pistols +1, Run +2, Sneak +2, Spot +2, Weapons of Mass Destruction +2

Gift: Coolness Under Fire

Attack: Pistol +1 (d4 or 2)

Weapon: PAKW 4-12 (Damage 8+7; C5, S10, M40, L230, X1400)

Deflection: 11

Thresholds: 21/31/41/61

Capitalist

Skills: Bureaucracy +4, Gossip +2, Plan +2, Question +2, Research Analysis +2

Gift: Economics Influence

Attack: Pistol +1 (d4 or 2)

Weapon: PAKW 4-12 (Damage 8+7; C5, S10, M40, L230, X1400)

Deflection: 11

Thresholds: 14/24/34/54

Civilian

Skills: Listen +1, Sneak +1, Spot +1

Attack: Melee (1)

Weapon: Improvised 1-handed (Damage 2+7; C1)

Deflection: 3

Thresholds: 14/24/34/54

Civilian Engineer

Skills: Build +2, Design +2, Information Analysis +2, Listen +2, Repair +2, Run +2, Sneak +2, Spot +2

Attack: Melee (1)

Weapon: Improvised 1-handed (Damage 2+7; C1)

Deflection: 3

Thresholds: 14/24/34/54

Doctor (Military)

Skills: Medical Sciences +4, Question +2

Gift: Doctor

Attack: Pistol +1 (d4 or 2)

Weapon: PAKW 4-12 (Damage 8+7; C5, S10, M40, L230, X1400)

Deflection: 11

Thresholds: 14/24/34/54

Factotum (Military)

Skills: Bureaucracy+4, Question +2

Gift: Factotum

Attack: Pistol +1 (d4 or 2)

Weapon: PAKW 4-12 (Damage 8+7; C5, S10, M40, L230, X1400)

Deflection: 11

Thresholds: 14/24/34/54

Homeguard Trooper

Skills: Listen +2, Longarms +4, Run +2, Sneak +2, Spot +2

Attack: Longarm 4 Marks (d10)

Weapon: LAKW 1-30 (Damage 10+9; C5, S15, M50, L330, X2300)

Deflection: 11

Thresholds: 21/31/41/61

Light Infantry

Skills: Listen +2, Longarms +4, Run +2, Sneak +2, Spot +2

Attack: Longarm +4 (d10 or 5)

Weapon: LAKW 1-56 (Damage 10+10;
S15, M60, L470, X3700)
Deflection: 11
Thresholds: 21/31/41/61

Heavy Infantry

Skills: Listen +2, Heavy Weapons +4,
Longarms +2, Run +2, Sneak +2, Spot +2
Attack: Heavy Weapons +4 (d10 or 5)
Weapon: GAKW 32 (Damage 0+10 Explo-
sion 2m; S5, M20, L80, X400)
Deflection: 11
Thresholds: 21/31/41/61

Military Engineer

S Skills: Build +2, Design +2, Information
Analysis +2, Listen +2, Pistols +2, Repair
+2, Run +2, Sneak +2, Spot +2
Attack: Pistol +2 (d6 or 3)
Weapon: PAKW 4-12 (Damage 8+7;
C5, S10, M40, L230, X1400)
Deflection: 11
Thresholds: 21/31/41/61

Factotum (Military)

Skills: Bureaucracy+4, Question +2
Gift: Factotum
Attack: Pistol +1 (d4 or 2)
Weapon: PAKW 4-12 (Damage 8+7;
C5, S10, M40, L230, X1400)
Deflection: 11
Thresholds: 14/24/34/54

Spacer

Skills: Freefall +4, Spacesuit +4
Attack: Melee (1)
Weapon: Improvised 1-handed (Dam-
age 2+7; C1)

Deflection: 3
Thresholds: 14/24/34/54

Psychiatrist (Military)

Skills: Bureaucracy+1, Medical Sciences +1,
Question +4
Gift: Psychiatrist
Attack: Pistol +1 (d4 or 2)
Weapon: PAKW 4-12 (Damage 8+7;
C5, S10, M40, L230, X1400)
Deflection: 11
Thresholds: 14/24/34/54

Terrorist

Skills: Disguise +2, Listen +2, Heavy Weap-
ons +4, Run +2, Sneak +2, Spot +2
Gift: Cold-Hearted
Attack: Heavy Weapons 2 Marks (d10 or 5)
Weapon: GAKW 32 (Damage 0+10 Explo-
sion 2m; S5, M20, L80, X400)
Deflection: 3
Thresholds: 16/26/36/56

Sample Main Characters

What follows on the next page are sam-
ple main characters:

- Erma Felna, aerodyne pilot and hero-
ine of the *Albedo* series, shown here as
she might have appeared in *Albedo #1*.
- Toki, a friend of Erma's from her
academy days, an accomplished Ad-
ministrator.
- Dea-Huthok, a ConFed Secretary and
frequent aide to Erma and Toki.

... as well as five other samples unique to
this game.

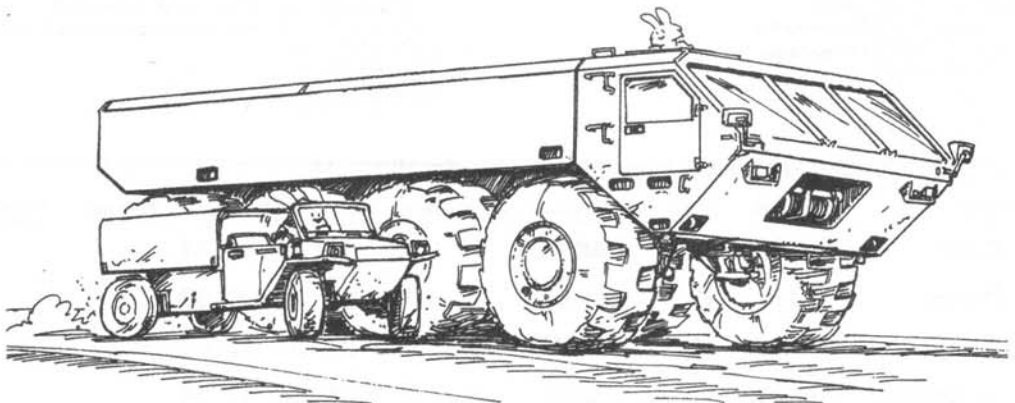

ALBEDO

PLATINUM CATALYST

MAIN CHARACTER

Name **Auitzotl the 3rd**

Species **Wolf (Canid)** Gender **Male**

Homeworld **Ktan-Tako (Rural)**

Personality Extroverted Sensitive Emotional Perceptive
 Introverted Intuitive Thoughtful Judgmental

Branch **Surface Ops.** Rank **Lieutenant (O7)**

Service **HI** S.P.I. **30**

Gifts **Athletics +2**
Coolness Under Fire
Firearms +1;
Following-Fire Expert
Healthy; Tough

Body 9
 Recovery: ___/___

- Brawl
- Climb
- Freefall
- G-Force
- Hike
- Jump
- Melee
- Run
- Sneak
- Spacesuit
- Swim
- Throw

Clout 10
 Recovery: ___/___

- Bribe
- Disguise
- Gossip
- Impress
- Innuendo
- Lead
- Persuade
- Question

Albedo ©1984, 2004 S.A. Gallecci, Platinum Catalyst ©2004 Sanguine Productions; All rights reserved. Permission to reproduce this character sheet for personal use only.

Height **148 cm**
 Weight **43 kg**
 Pelt **brown**
 Eyes **brown**
 Build **regular**



Deflection **11** Recovery **18**
 Thresholds Improvement Low
 Med
 Low
 Med
 Wounded | **28** | ~ 2 × Body + Armor
 Crippled | **38** | ~ 2 × Body + Armor + 10
 Incapacitated | **48** | ~ 2 × Body + Armor + 20
 Devastated | **68** | ~ 2 × Body + Armor + 40
 Low
 High

Drive 10
 Recovery: ___/___

- Build
- Bureaucracy
- Computer Sciences
- Demolitions
- Design
- Forge
- Heavy Weapons
- Hyperspace Sciences
- Information Analysis
- Listen
- Longarms
- Medical Sciences
- Navigate
- Physical Sciences
- Planetary Sciences
- Pistols
- Plan
- Repair
- Research Analysis
- Scrounge
- Search
- Sensor Operations
- Sixth Sense
- Smell
- Spot
- Vehicle Operations
- Vehicular Weapons
- Weapons of Mass Destruction

SUPPORTING CHARACTERS

Name	Species	Service	Weapon	Attack	Def.	Thresholds	Status	Recovery
1 Oshi	Canid	HI	LAKW	3	11	21 31 41 61		
2 Deras	Ursid	HI	LAKW	3	11	29 39 49 59		
3 Zyshiri	Procyon.	HI	LAKW	3	11	21 31 41 60		
4 Ty Darner	Canid	ENGS	LAKW	2	11	21 31 41 61		

ALBEDO

PLATINUM CATALYST

'MAIN CHARACTER'

NAME: BAYLOO

Name Bayloo

Species Crow (Avian) Gender Female

Homeworld Deep XIII (Corporate)

Personality Extroverted Sensitive Emotional Perceptive
 Introverted Intuitive Thoughtful Judgmental

Branch Surface Ops. Rank Lieutenant (07)

Service RR S.P.I. 31

Gifts Athletics +1
 Astronautics +1
 Energetic
 Firearms +1; Small
 Tough; Rapid Descent Expert

Albedo ©1984, 2004 S.A. Gallecci; Platinum Catalyst ©2004 Sanguine Productions. All rights reserved. Permission to reproduce this character sheet for personal use only.

Height 88 cm

Weight 13 kg

Pelt jet

Eyes blue

Build light



Deflection 11 Recovery 7

Thresholds Improvement

Wounded | **16** | -2×Body+Armor Low
 Crippled | **26** | -2×Body+Armor+10 Med
 Incapacitated | **36** | -2×Body+Armor+20 Low
 Devastated | **56** | -2×Body+Armor+40 High

Body 3
 Recovery: ____ / ____

- Brawl
- Climb
- Freefall
- G-Force
- Hike
- Jump
- Melee
- Run
- Sneak
- Spacesuit
- Swim
- Throw
- _____
- _____
- _____

Drive 13
 Recovery: ____ / ____

- Build
- Bureaucracy
- Computer Sciences
- Demolitions
- Design
- Forge
- Heavy Weapons
- Hyperspace Sciences
- Information Analysis
- Listen
- Longarms
- Medical Sciences
- Navigate
- Physical Sciences
- Planetary Sciences
- Pistols
- Plan
- Repair
- Research Analysis
- Scrounge
- Search
- Sensor Operations
- Sixth Sense
- Smell
- Spot
- Vehicle Operations
- Vehicular Weapons
- Weapons of Mass Destruction
- _____
- _____
- _____

Clout 9
 Recovery: ____ / ____

- Bribe
- Disguise
- Gossip
- Impress
- Innuendo
- Lead
- Persuade
- Question
- _____
- _____
- _____

SUPPORTING CHARACTERS

Name	Species	Service	Weapon	Attack	Def.	Thresholds	Status	Recovery
1 Murphee	Avian	RR	LAKW	3	11	[15 25 35 55]	[]	[]
2 Koniph	Avian	RR	LAKW	3	11	[15 25 35 55]	[]	[]
3 Erhart	Avian	RR	LAKW	3	11	[15 25 35 55]	[]	[]
4 Sonnel	Avian	ENGS	LAKW	3	11	[15 25 35 55]	[]	[]

ALBEDO

PLATINUM CATALYST

'MAIN CHARACTER'

Name **Dea-Htuhok**

Species **Fox** Gender **Female**

Homeworld **Dornthant II (Urban)**

Personality Extroverted Sensitive Emotional Perceptive
 Introverted Intuitive Thoughtful Judgmental

Branch **Specialist** Rank **Warrant Officer (S3)**

Service **EM** S.P.I. **28**

Gifts **Charismatic**

Cosmopolitan; Gadfly

Socialization +2

Subterfuge +1

Suspiciousness

Body 7

Recovery: ____ / ____

- Brawl
- Climb
- Freefall
- G-Force
- Hike
- Jump
- Melee
- Run
- Sneak
- Spacesuit
- Swim
- Throw
- _____
- _____
- _____

Clout 12

Recovery: ____ / ____

- Bribe
- Disguise
- Gossip
- Impress
- Innuendo
- Lead
- Persuade
- Question
- _____
- _____
- _____

Albedo ©1984, 2004 S.A. Gallecci; Platinum Catalyst ©2004 Sanguine Productions. All rights reserved. Permission to reproduce this character sheet for personal use only.

Height **155 cm**

Weight **42 kg**

Pelt **russet**

Eyes **green**

Build **slender**



Deflection **3** Recovery **16**

Thresholds Improvement Low

Wounded [**14**] = 2×Body+Armor Med

Crippled [**24**] = 2×Body+Armor+10 Low

Incapacitated [**34**] = 2×Body+Armor+20 Med

Devastated [**54**] = 2×Body+Armor+40 Low

Drive 9

Recovery: ____ / ____

- Build
- Bureaucracy
- Computer Sciences
- Demolitions
- Design
- Forge
- Heavy Weapons
- Hyperspace Sciences
- Information Analysis
- Listen
- Longarms
- Medical Sciences
- Navigate
- Physical Sciences
- Planetary Sciences
- Pistols
- Plan
- Repair
- Research Analysis
- Scrounge
- Search
- Sensor Operations
- Sixth Sense
- Smell
- Spot
- Vehicle Operations
- Vehicular Weapons
- Weapons of Mass Destruction
- _____
- _____
- _____

SUPPORTING CHARACTERS

Name	Species	Service	Weapon	Attack	Def.	Thresholds	Status	Recovery
1 Kodea	Vulpid	EM	PAKW	3	3	[14 24 34 54]		
2 Elshi En	Macropod	EM	PAKW	3	3	[16 26 36 56]		
3 Sadasho	Mustel.	EM	PAKW	3	3	[14 24 34 54]		
4 Toshi	Vulpid	SS	PAKW	3	3	[14 24 34 54]		

ALBEDO

PLATINUM CATALYST

MAIN CHARACTER

Name **Emphiro**

Species **Bear** Gender **Male**

Homeworld **Tygath III (Research)**

Personality Extroverted Sensitive Emotional Perceptive
 Introverted Intuitive Thoughtful Judgmental

Branch **Surface Ops.** Rank **Lieutenant (O6)**

Service **LI** S.P.I. **28**

Gifts **Coolness Under Fire**

Cold-Hearted

Martial Arts

Athletics +1; Firearms +2

Semi-Automatic Expert

Albedo ©1984, 2004 S.A.Gellecci; Platinum Catalyst ©2004 Sanguine Productions; All rights reserved. Permission to reproduce this character sheet for personal use only.

Height **233 cm**

Weight **145 kg**

Pelt **black**

Eyes **brown**

Build **stocky**



Deflection **11** Recovery **21**

Thresholds Improvement Low

Wounded [**29**] = 2 × Body + Armor Med

Crippled [**39**] = 2 × Body + Armor + 10 Low

Incapacitated [**49**] = 2 × Body + Armor + 20 Med

Devastated [**69**] = 2 × Body + Armor + 40 Low

High

Body **12**

12

Recovery: ____ / ____

Drive **9**

9

Recovery: ____ / ____

- Build
- Bureaucracy
- Computer Sciences
- Demolitions
- Design
- Forge
- Heavy Weapons
- Hyperspace Sciences
- Information Analysis
- Listen
- Longarms
- Medical Sciences
- Navigate
- Physical Sciences
- Planetary Sciences
- Pistols
- Plan
- Repair
- Research Analysis
- Scrounge
- Search
- Sensor Operations
- Sixth Sense
- Smell
- Spot
- Vehicle Operations
- Vehicular Weapons
- Weapons of Mass Destruction
- _____
- _____
- _____

Brawl

Climb

Freefall

G-Force

Hike

Jump

Melee

Run

Sneak

Spacesuit

Swim

Throw

Clout **9**

9

Recovery: ____ / ____

Bribe

Disguise

Gossip

Impress

Innuendo

Lead

Persuade

Question

SUPPORTING CHARACTERS

Name	Species	Service	Weapon	Attack	Def.	Thresholds	Status	Recovery
1 Aftal	Ursid	LI	LAKW	3	11	29 39 49 69		
2 Benbar	Ursid	LI	LAKW	3	11	29 39 49 69		
3 Dar Sai	Avian	LI	LAKW	3	11	15 25 35 45		
4 Aellias	Vulpid	ENGS	LAKW	2	11	29 39 49 69		

ALBEDO

PLATINUM CATALYST

'MAIN CHARACTER

NAME: ERMA FELNA

Name **Erma Felna**

Species **Cat, Small** Gender **Female**

Homeworld **Dornthant II (Urban)**

Personality Extroverted Sensitive Emotional Perceptive
 Introverted Intuitive Thoughtful Judgmental

Branch **Aerospace** Rank **Lieutenant (O6)**

Service **DYNE** S.P.I. **21**

Gifts **Astronautics +2**

Coolness Under Fire

Energetic; Firearms +1

Impulsive; Overconfident

Velocity Expert

Body 10 Recovery: ____/____

- Brawl
- Climb
- Freefall
- G-Force
- Hike
- Jump
- Melee
- Run
- Sneak
- Spacesuit
- Swim
- Throw

Clout 7 Recovery: ____/____

- Bribe
- Disguise
- Gossip
- Impress
- Innuendo
- Lead
- Persuade
- Question

SUPPORTING CHARACTERS

Name	Species	Service	Weapon	Attack	Def.	Thresholds	Status	Recovery
1 Galdos	S.Cat	DYNE	PAKW	3	11	21 31 41 61		
2 Charda	S.Cat	DYNE	PAKW	3	11	21 31 41 61		
3 Piar Ann	Canid	DYNE	PAKW	3	11	21 31 41 61		
4 Kathok	S.Cat	ENGA	PAKW	2	11	21 31 41 61		

Albedo ©1984, 2004 S.A.Gallecci; Platinum Catalyst ©2004 Sanguine Productions; All rights reserved. Permission to reproduce this character sheet for personal use only.

Height: **140 cm**

Weight: **36 kg**

Pelt: **lt. brown**

Eyes: **hazel**

Build: **regular**



Deflection: **11** Recovery: **18**

Thresholds: **Wounded [25]** = 2 × Body + Armor

Crippled [35] = 2 × Body + Armor + 10

Incapacitated [45] = 2 × Body + Armor + 20

Devastated [65] = 2 × Body + Armor + 40

- Low
- Med
- Low
- Med
- Low
- High

Drive 13 Recovery: ____/____

- Build
- Bureaucracy
- Computer Sciences
- Demolitions
- Design
- Forge
- Heavy Weapons
- Hyperspace Sciences
- Information Analysis
- Listen
- Longarms
- Medical Sciences
- Navigate
- Physical Sciences
- Planetary Sciences
- Pistols
- Plan
- Repair
- Research Analysis
- Scrounge
- Search
- Sensor Operations
- Sixth Sense
- Smell
- Spot
- Vehicle Operations
- Vehicular Weapons
- Weapons of Mass Destruction

ALBEDO

PLATINUM CATALYST

'MAIN CHARACTER'

Name **Lafigalti**

Species **Rhino (Ungulate)** Gender **Male**

Homeworld **Feloth I (Resource)**

Personality Extroverted Sensitive Emotional Perceptive
 Introverted Intuitive Thoughtful Judgmental

Branch **Surface Ops.** Rank **Lieutenant (07)**

Service **MSH** S.P.I. **31**

Gifts **Athletics +1; Congenial;**
Doctor; Firearms +1;
Healthy
Knack: Medical Sciences

Albedo ©1984, 2004 S.A.Gallecci; Platinum Catalyst ©2004 Sanguine Productions; All rights reserved. Permission to reproduce this character sheet for personal use only.

Height **231 cm**

Weight **121 kg**

Pelt **gray**

Eyes **brown**

Build **stocky**

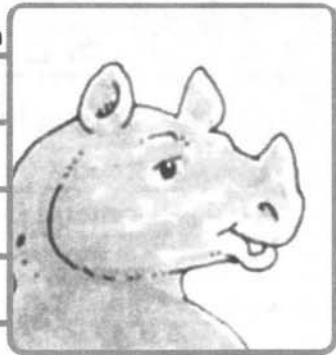

Deflection **11** Recovery **21**

Thresholds Improvement Low
 Med
 Low
 Med
 Low
 High

Wounded [**29**] = 2 × Body + Armor
 Crippled [**39**] = 2 × Body + Armor + 10
 Incapacitated [**49**] = 2 × Body + Armor + 20
 Devastated [**69**] = 2 × Body + Armor + 40

Body **12**
 Recovery: ___ / ___

- Brawl
- Climb
- Freefall
- G-Force
- Hike
- Jump
- Melee
- Run
- Sneak
- Spacesuit
- Swim
- Throw
- _____
- _____
- _____

Drive **9**
 Recovery: ___ / ___

- Build
- Bureaucracy
- Computer Sciences
- Demolitions
- Design
- Forge
- Heavy Weapons
- Hyperspace Sciences
- Information Analysis
- Listen
- Longarms
- Medical Sciences
- Navigate
- Physical Sciences
- Planetary Sciences
- Pistols
- Plan
- Repair
- Research Analysis
- Scrounge
- Search
- Sensor Operations
- Sixth Sense
- Smell
- Spot
- Vehicle Operations
- Vehicular Weapons
- Weapons of Mass Destruction
- _____
- _____
- _____

Clout **11**
 Recovery: ___ / ___

- Bribe
- Disguise
- Gossip
- Impress
- Innuendo
- Lead
- Persuade
- Question
- _____
- _____
- _____

SUPPORTING CHARACTERS

Name	Species	Service	Weapon	Attack	Def.	Thresholds	Status	Recovery
1 Pyna Jr.	Canid	MSH	PAKW	3	11	21 31 41 61		
2 Lyter	Canid	MSH	PAKW	3	11	21 31 41 61		
3 Ko Daro	Canid	MSH	PAKW	3	11	21 31 41 61		
4 Dea-Deshi	Canid	MSH	PAKW	3	11	21 31 41 61		

ALBEDO

PLATINUM CATALYST

MAIN CHARACTER

Name **Theodolu**

Species **Raccoon** Gender **Male**

Homeworld **Irimanti IX (Space Station)**

Personality Extroverted Sensitive Emotional Perceptive
 Intuitive Thoughtful Judgmental

Branch **Admin.** Rank **Lieutenant (O7)**

Service **SS** S.P.I. **30**

Gifts **Administration +1**

Cosmopolitan

Doctor; Natural Leader

Socialization +2

Suspiciousness

Body

6

Recovery: ____/____

- Brawl
- Climb
- Freefall
- G-Force
- Hike
- Jump
- Melee
- Run
- Sneak
- Spacesuit
- Swim
- Throw
- _____
- _____
- _____

Clout

8

Recovery: ____/____

- Bribe
- Disguise
- Gossip
- Impress
- Innuendo
- Lead
- Persuade
- Question
- _____
- _____
- _____

Albedo ©1984, 2004 G.A.Callocci; Platinum Catalyst ©2004 Gouguine Productions. All rights reserved. Permission to reproduce this character sheet for personal use only.

Height **128 cm**

Weight **32 kg**

Pelt **silver**

Eyes **gold**

Build **regular**



Deflection **11** Recovery **16**

Thresholds Improvement Low
 Med
 Low
 Med
 Low
 High

Wounded [**12**] = 2 × Body + Armor
 Crippled [**22**] = 2 × Body + Armor + 10
 Incapacitated [**32**] = 2 × Body + Armor + 20
 Devastated [**52**] = 2 × Body + Armor + 40

Drive

10

Recovery: ____/____

- Build
- Bureaucracy
- Computer Sciences
- Demolitions
- Design
- Forge
- Heavy Weapons
- Hyperspace Sciences
- Information Analysis
- Listen
- Longarms
- Medical Sciences
- Navigate
- Physical Sciences
- Planetary Sciences
- Pistols
- Plan
- Repair
- Research Analysis
- Scrounge
- Search
- Sensor Operations
- Sixth Sense
- Smell
- Spot
- Vehicle Operations
- Vehicular Weapons
- Weapons of Mass Destruction
- _____
- _____
- _____

SUPPORTING CHARACTERS

Name	Species	Service	Weapon	Attack	Def.	Thresholds	Status	Recovery
1 Myras	Raccoon	SS	PAKW	3	11	[12 22 32 52]	[/ /]	[/ /]
2 Ky Shoko	Raccoon	SS	PAKW	3	11	[12 22 32 52]	[/ /]	[/ /]
3 Darhaa	Lapine	SS	PAKW	3	11	[14 24 34 54]	[/ /]	[/ /]
4 Serrak	Raccoon	EM	PAKW	3	11	[12 22 32 52]	[/ /]	[/ /]

ALBEDO

PLATINUM CATALYST

'MAIN CHARACTER

Name **Toki**

Species **Mouse** Gender **Female**

Homeworld **Danet III (Research)**

Personality Extroverted Sensitive Emotional Perceptive
 Introverted Intuitive Thoughtful Judgmental

Branch **Admin.** Rank **Lieutenant (O7)**

Service **QM** S.P.I. **30**

Gifts **Administration +2**

Congenial; Coolness Under Fire

Grace Under Pressure

Logistics Expert

Socialization +1

Body

5

Recovery: ____/____

- Brawl
- Climb
- Freefall
- G-Force
- Hike
- Jump
- Melee
- Run
- Sneak
- Spacesuit
- Swim
- Throw
- _____
- _____
- _____

Clout

11

Recovery: ____/____

- Bribe
- Disguise
- Gossip
- Impress
- Innuendo
- Lead
- Persuade
- Question
- _____
- _____
- _____

Height **116 cm**

Weight **24 kg**

Pelt **silver grey**

Eyes **green**

Build **petite**



Deflection **3**

Recovery **11**

Thresholds

Improvement

Wounded | **10** | -2 x Body + Armor

Crippled | **20** | -2 x Body + Armor + 10

Incapacitated | **30** | -2 x Body + Armor + 20

Devastated | **50** | -2 x Body + Armor + 40

Low
 Med
 Low
 Med
 Low
 High

Drive

8

Recovery: ____/____

- Build
- Bureaucracy
- Computer Sciences
- Demolitions
- Design
- Forge
- Heavy Weapons
- Hyperspace Sciences
- Information Analysis
- Listen
- Longarms
- Medical Sciences
- Navigate
- Physical Sciences
- Planetary Sciences
- Pistols
- Plan
- Repair
- Research Analysis
- Scrounge
- Search
- Sensor Operations
- Sixth Sense
- Smell
- Spot
- Vehicle Operations
- Vehicular Weapons
- Weapons of Mass Destruction
- _____
- _____
- _____

SUPPORTING CHARACTERS

Name	Species	Service	Weapon	Attack	Def.	Thresholds	Status	Recovery
1 Zhoteth	Mouse	QM	PAKW	2	3	10 20 30 50		
2 Chana	Rat	QM	PAKW	2	3	14 24 34 54		
3 Lui Sa	Mouse	QM	PAKW	2	3	10 20 30 50		
4 Myka	Mouse	L	PAKW	2	3	10 20 30 50		

INDEX

INDEX

- 24-Hour Kit, 149
 72-Hour Kit, 149
 Action, 108
 Action Orientation, 85
 ACV, 39
 Administration, 65, 86
 Administration + 1, 96
 Advanced, 103
 Advanced Gifts, 96
 Aeostah, 21
 Aerodyne, 87
 Aerodyne Vehicle Operations, 64
 Aerodynes, 38, 39
 Aerospace, 87
 Aerospace Operations, 61
 AFTERMATH, 132
 Agriculture, 40
 Ahan-Tako, 24
 Ahnomia, 25
 Aid Kit, 150
 Aim, 110
 Air Support, 125
 Ambidextrous, 94
 Ammunition tracking (Variant Rule), 161
 Anarchism, 50
 Aristocracy, 51
 Aristocratic Influence, 94
 Armies, 58
 Armor, 59, 122
 Armored Vehicle Expert, 94
 Arras Charka, 20
 Art, 52
 Artillery Support, 125
 Astronautics, 34
 Astronautics + 1, 96
 Astronomy, 34
 Athletics + 1, 96
 Atmosphere, 124
 Attack at Range, 110
 Attack Hand-to-Hand, 112
 Attack Results, 110
 ATTRIBUTES, 72
 Autonomous Combat Vehicles, 39
 AW 191, 123, 141
 Awe, 118
 Baliannian, 30
 Basic Gifts, 94
 Battalion Admin Group, 66
 Battery Pack, 150
 Battle Armor, 142
 Battle Helmet, 143
 Bears, 80
 Belligerent, 99
 Biology, 32
 Birds, 74
 Blanket, 150
 Bleeding, 118
 Board Attendees, 56
 Board Members, 56
 Body, 72
 Bonuses, 104
 Boosting Morale (Rally), 113
 Botch, 104
 Botching, 104
 BRANCHES OF SERVICE, 86
 Brawl, 89
 Breezing, 103
 Bribe, 89
 Brigade, 66
 Build, 89
 Bureaucracy, 89
 Cadet, 57
 Canines, 75
 Canteen, 150
 Capital Ship, 63
 Capital Squadron, 64
 Capitalism, 48
 Carrier Group, 64
 Carrying Capacity, 73
 Castes, 46
 Cat, 76
 Centrists, 14
 Chalendar, 22
 Change, 155
 Character Improvement, 135
 Charge Action, 113
 Charismatic, 94
 Chief of Aerospace Operations, 56
 Chief of Surface Operations, 56
 Chishatta, 31
 Civilian Characters (Variant Rule), 159
 CKW 8x56, 138
 CKW Precision, 123
 Classes, 46
 Climb, 89
 Close, 109
 Close-Range Attacks, 120
 Clout, 73
 Cold-Hearted, 99
 Colonization, 20
 COMBAT, 107
 Combat Staff, 122
 COMMAND, 106
 Commander, 57
 Communism, 48
 Company Admin Group, 66
 Computer Sciences, 89
 Concealed Armor, 144
 Concealment, 109
 condoms, 152
 Confederacy, 50
 Conformist, 99
 Congenial, 94
 Conservatism, 51
 Coolness Under Fire, 94
 Cord, 150
 Core Worlds, 20
 Corporate Homeworld, 82
 Cosmopolitan, 94
 Counter-Attacks, 120
 Cover, 108
 Penetrating, 127
 Crippled, 117
 Critical Hit, 110
 Culture, 52
 CYCLOPEDIA, 4
 Daily Life, 55
 Damage, 116
 Damage Thresholds, 69
 Danet, 23
 Debriefing, 134
 Deceive, 90
 Democracy, 52
 Demolitions, 89
 Denotah, 25
 Derzon, 26
 Design, 89
 Devastated, 118
 Dice, 102
 Dictatorship, 52
 Die Rolls, 103
 Difficulty, 103
 Dilbion, 27
 Disarming, 130
 Distance, 124
 Doctor, 94
 Domestic Life, 54
 Dornthant, 23
 Drive, 73
 Dubious Gifts, 99
 DYNE, 64, 87
 Echak, 27
 Echidnas, 78
 Economic Influence, 94
 Economics, 48
 EDF, 56
 Ekosiak, 28
 EM, 67, 87
 Emissary, 67, 87
 Emotional, 85
 Emplaced Snipers, 125
 Enchawah Group, 19
 Enchek, 30
 Endly, 31
 Energetic, 94
 ENGA, 64, 87
 Engineering, 60, 64, 87, 88
 Engineering + 1, 96
 ENGS, 60, 88
 Ensign, 57
 Entrenching Tool, 150
 EQUIPMENT, 136
 EVA Rig, 150
 EVA Unit, 151
 Existentialism, 155
 EXP, 67, 87
 Experience (Character Improvement), 135
 Experience Awareness, 85
 Exploration, 67, 87
 Extraterrestrial Defense Force, 17, 56
 Extravehicular Activity Rig, 150
 Extravehicular Activity Unit, 151
 eXtreme, 109
 Extroverted, 85
 Factotum, 94
 Failure, 104
 Falling, 126
 Fantastic Leader, 96
 Fascism, 51
 Fast (Gift), 94
 Felines, 75
 FI, 64, 87
 Fire (Combustion), 128
 Firearms, 123
 Firearms + 1, 96

- Fist, 122
 Flashlight, 151
 Flight (Aerospace unit), 62
 Following Fire, 111
 Expert Gift, 95
 Master Gift, 97
 Following Fire Expert, 95
 Following-Fire Master, 97
 Food, 40
 Footwear, 144
 Forge, 90
 Foul Weather Garb, 144
 Foxes, 81
 Franchise, 51
 Freefall, 127
 Skill, 90
 Freefall Infantry, 64, 87
 FTL, 65
 Fun, 54
 Gadfly, 99
 GAKW 32, 123, 138
 Game Host, 101
 Games, 54
 Gaming Elements, 158
 Gas Mask, 151
 GAZETEER, 20
 Gear, 148
 Gender, 69
 General Secretary, 56
 General Treasurer, 56
 G-Force
 Skill, 90
 GIFTS, 94
 GLKW 32, 123, 137
 Gossip, 90
 Grace Under Pressure, 95
 Grappling, 129
 Gravity, 126
 Grenade, 123
 grenade launcher, 138
 Grenades, 140
 Grit, 95
 Group, 62
 Group Gifts, 96
 Guns, 123
 Hand Computers, 151
 Hand Weapons, 122
 Healthy, 95
 Heavy Infantry, 60, 88
 Heavy Weapons
 Skill, 90
 Helpless Target, 120
 HI, 60, 88
 Hiahhohch, 31
 Hike, 90
 Hit Location
 (Variant Rule), 160
 Homeguards, 17
 HOMEWORLDS, 82
 Horizon, 125
 Horses (Ungulates), 80
 Host, 101
 HOSTING A GAME, 154
 Hygiene Kit, 152
 Hyperspace Expert, 97
 Hyperspace Sciences
 Skill, 90
 Impress Skill, 90
 Impressive Leader, 95
 Impulsive, 99
 Incapacitated, 118
 Indefatigable, 95
 Independent Lapine Republic, 17
 Industry & Procurement, 86
 Industry and Procurement, 67
 Infrared, 131
 Initiative, 108
 Injury, 73
 Innuendo, 91
 Instructor, 95
 INT, 65, 87
 Intelligence Analysis
 Skill, 91
 Intermediate, 103
 Interplanetary, 65, 87
 Interstellar and Jump-Space Navigation, 65
 Interstellar Travel, 36
 INTRODUCTION, 3
 Introverted, 85
 Intuitive, 85
 Inventions Expert, 97
 IP, 67, 86
 Joint Chiefs of Staff, 56
 Judgmental, 85
 Jump
 Skill, 91
 Kangaroos (Macropods), 77
 Kawateena, 28
 Kitsune, 81
 Knack, 97
 Knife, 122
 Konattahtzah, 32
 L, 67, 86
 Labor, 105
 LAKW 1-30, 123, 137
 LAKW 1-56, 123, 137
 Lapines, 76
 Large, 99
 Lead Skill, 91
 LI, 60, 88
 Liaison, 67, 86
 Liberalism, 51
 Lift, 73
 Light Infantry, 60, 88
 Listen, 91
 Logistics Expert, 97
 Long, 109
 Longarms
 Skill, 91
 Lower Class, 47
 Low-light enhancement, 131
 Loyalty, 106
 LRCKW, 123
 LRCKW 10x56, 138
 Macropods, 77
 Magazine, 153
 MAKING CHARACTERS, 68
 MAKW 2-18, 123
 MAKW 3-60, 123, 138
 Marriage, 54
 Marsupials, 76, 77
 Martial Arts, 97
 MECH, 60, 88
 Mechanized, 60, 88
 Medical Help, 112
 Medical Sciences, 91
 Medicine, 40
 Medium, 109
 Meeting, 155
 Melee
 Skill, 91
 Melee Expert, 97
 Meritocracy, 52
 Mice, 79
 Middle Class, 47
 Misjumps, 38
 ML 199, 123, 141
 Mobile Surgical Hospital, 61, 88
 Monotremes, 77
 MP 197, 123, 141
 MPKW 2-18, 138
 MS 195, 123, 142
 MSH, 61, 88
 Music, 53
 Mustelids, 78
 Name, 69
 Narrative Elements, 154
 Nationalism, 51
 Natural Leader, 95
 Naturalism, 156
 Navigate, 91
 Net, 41, 43
 Net Influence, 98
 Neutrality, 106
 New Species (Variant Rule), 161
 Nigh-Impossible, 103
 Observation + 1, 96
 Old, 100
 Oligarchy, 52
 Open-Ended Damage (Variant Rule), 161
 Opposed Rolls, 103
 Otters, 78
 Overconfident, 100
 Oversight, 73
 Overwhelming Success, 104
 PAKW 4-12, 123, 138
 Panic, 119
 Patrol, 63
 Penalties, 104
 Penetration, 116
 Perceptive, 85
 PERSONALITY, 85
 Persuade, 91
 Physical Sciences, 92
 Pistols
 Skill, 92
 Plan
 Skill, 92
 Planetary Sciences, 92
 Platoon Admin Group, 66
 Platypus, 78
 Player-Characters, 101
 Players, 101
 Plutocracy, 52
 Points, 72
 Politics, 49, 50
 portable
 rocket launcher, 139
 PRLW, 123, 139
 Procyonines, 79
 Professional Help, 133
 Promotions, 135
 Property Damage, 127
 Provocation, 120
 Psychologist, 95
 Pushing, 102
 QM, 67, 86
 Quartermasters, 67, 86
 Question Skill, 92
 Quick Loading, 95
 R&D, 67, 88
 Rabbit, 76
 Raccoons, 79
 Rally, 112

- Random Generation (Variant Rule), 159
- Range, 109
- Ranks, 57
- Rating, 72
- Rations, 153
- Rats, 79
- Readiness, 107
- Realism, 156
- Recoil (Variant Rule), 161
- Recovery, 132
- Remote viewing, 131
- Removing Panic (Rally), 113
- Repair
 - Skill, 92
- Rescue Ball, 153
- Research Analysis, 92
- Research and Design, 67, 88
- Research Colony, 82
- Resolution, 155
- Resource Colony, 83
- Rest, 132
- Results of Rolls, 104
- Retinue, 106
- Retries, 104
- Righteous, 100
- Risking, 102
- Robotics Expert, 98
- Robots, 45, 46
- Rodents, 79
- Rolling, 102
- Romanticism, 155
- Rote, 102
- Round, 108
- Routine, 103
- RULES, 101
- Run
 - Action, 113
 - Skill, 92
- Rural Homeworld, 83
- SAMPLE CHARACTERS, 162
- SBKW 10, 123, 139
- Science, 33
- Sciences + 1, 96
- Scrounge, 92
- Search, 93
- Semi-Automatic
 - Expert Gift, 95
 - Master Gift, 98
- Semi-Automatic Expert, 95
- Semi-Automatic Master, 98
- Sensitive, 85
- Sensor Expert, 95
- Sensor Operations, 93
- Short, 109
- Shotguns, 122
- Sixth Sense, 93
- Size of Target, 128
- SKILLS, 89
- Skunks, 78
- Small, 100
- Smell, 93
- Sneak, 93
 - Action, 113
- Sniper Expert, 95
- Sniper Master, 98
- Social Awareness, 85
- Social Elements, 156
- Social Groups, 54
- Social Orientation, 85
- Social Political Intelligence, 69
- Socialism, 49
- Socialization + 1, 96
- Society, 46
- Space Station Homeworld, 83
- Spacer Influence, 95
- Spacesuit, 145, 146
 - Skill, 93
- Spacesuit Liner, 148
- Special Services, 67, 86
- Specialists, 87
- Specialized Grenades, 140
- SPECIES, 74
 - Best Choice for Player-Characters, 79
 - New (Variant Rule), 161
- SPI, 69, 135
- Spot, 93
- SPOT RULES, 124
- Squadron, 62
- Squads, 59
- Squirrels, 79
- SS, 67, 86
- Starships, 39
- Statues, 109
- Strong, 98
- Struggle, 155
- Stunts (Variant Rule), 159
- Subterfuge + 1, 96
- Success, 104
- Suffocation, 124
- Suit Patches, 153
- Summary, 103
- Supporting Characters, 70
- Suppression
 - Action, 114
 - Expert Gift, 96
- Suppression Expert, 96
- Surface Operations, 58, 88
- Surprised Targets, 120
- Suspiciousness, 96
- Swim, 93
- Table of Ranks, 57
- Target, 103
- Taskforce, 64
- Technology, 33
- Temperature, 128
- Ten Steps to Character Creation, 71
- Tent, 1-man, 153
- Terrain, 129
- Theme, 155
- Thoughtful, 85
- Thresholds, 117
- Throw
 - Action, 115
 - Skill, 93
- Tie, 104
- Totalitarianism, 51
- Tough, 96
- Trauma, 73
- Trivial, 103
- Trust, 106
- Tun Och Enchek, 29
- Unarmed Combat, 129
- Ungulates, 80
- Uniforms, 147
- Upper Class, 47
- Urban Homeworld, 84
- Ursines, 80
- Utility Fatigues, 147
- Utility Tool, 153
- UV sensors, 131
- Vacuum, 124
- Variable Grenade, 123
- Variable Grenades, 140
- VARIANT RULES, 159
- Vehicle Operations, 93
- Vehicles, 38
- Vehicles + 1, 96
- Vehicular Weapons
 - Skill, 93
- Velocity, 130
- Velocity Expert, 96
- Very Fast, 99
- Very Large Command Carriers, 39
- Very Strong, 99
- Very Tough, 99
- VHALO, 88
 - Expert Gift, 95
- Vice Admiral, 57
- Visibility, 130
- Vixens, 81
- VLCC, 39
- Vulpines, 81
- Waiting, 115
- Warrant Officer, 67
- Watch
 - Action, 115
 - with Following-Fire Weapons, 115
- Water, 129
- Weapons of Mass Destruction, 125
 - Skill, 93
- Weasels, 78
- Weather, 131
- Wing (Aerospace unit), 62
- WMD
 - Skill, 93
- WMDs, 125
- Wounded, 117
- Young, 100

THE COMIC THAT STARTED IT ALL RETURNS!

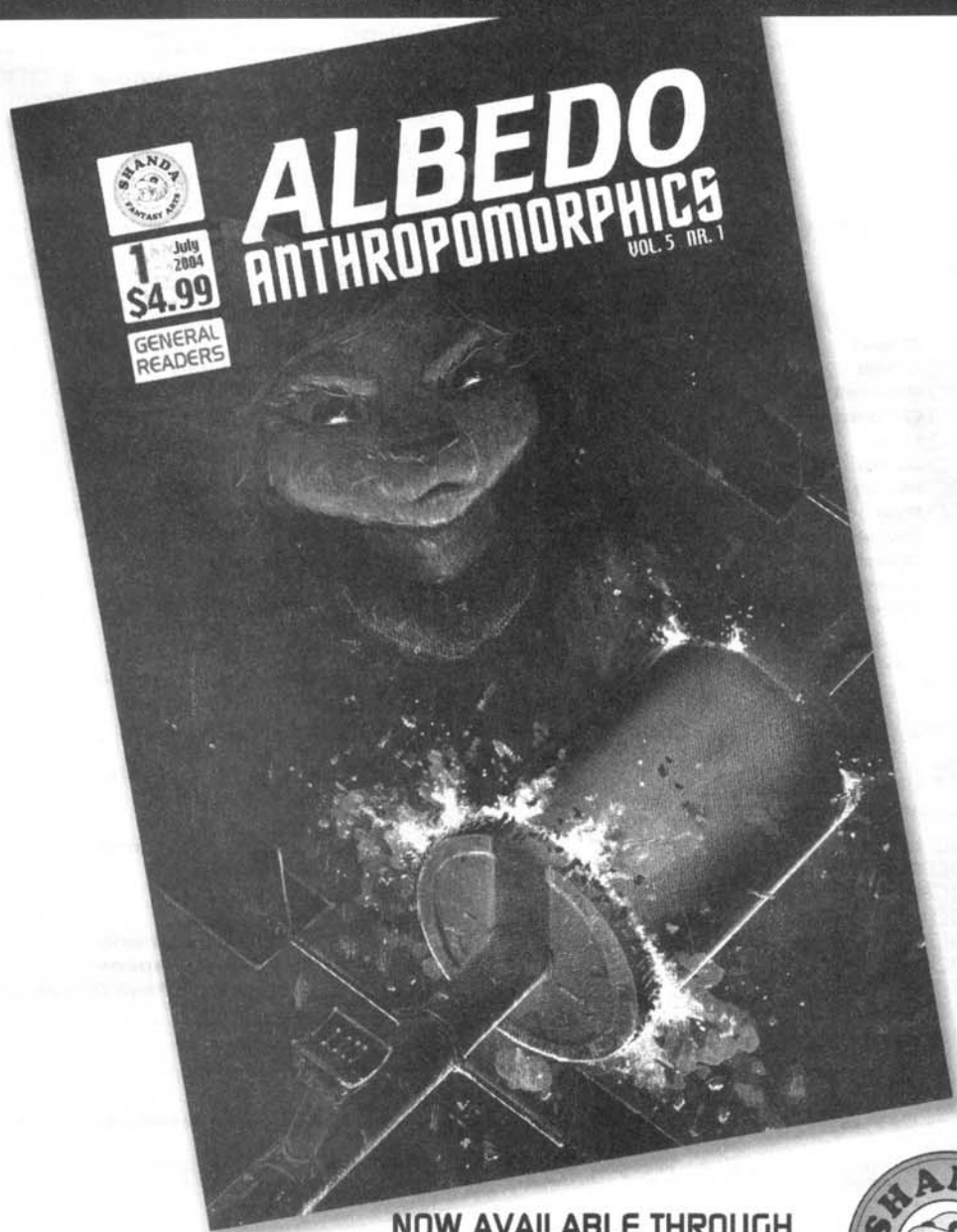

NOW AVAILABLE THROUGH
SHANDA FANTASY ARTS AT:
WWW.SHANDAFANTASYARTS.NET



