

CHESSEX

T&I 8851

# THE DRIFT



by  
**Paul  
Kidd**

an adventure for

## ALBEDO

THE ROLE-PLAYING GAME  
Second Edition

# THE DRIFT

an adventure for

## ALBEDO

THE ROLE-PLAYING GAME

Second Edition

**Paul Kidd**

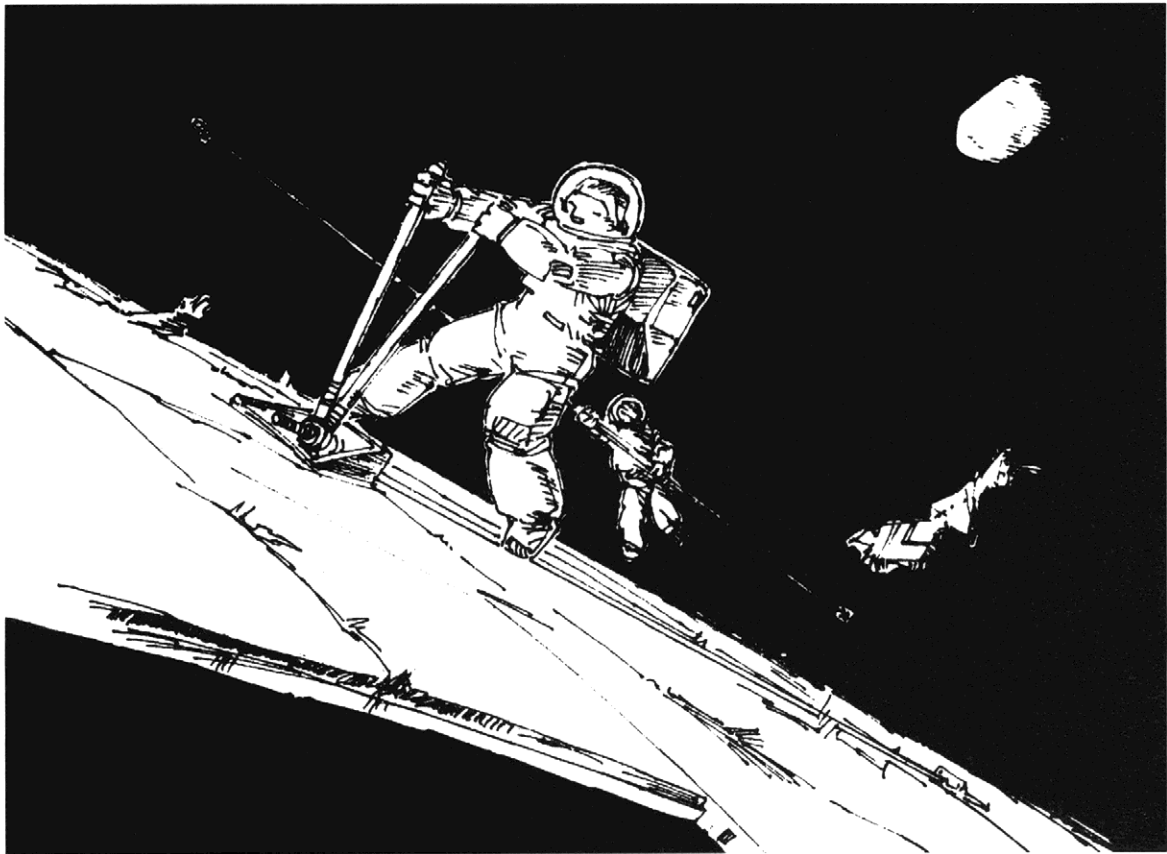

## Running This Scenario

This scenario has been designed to introduce players and umpires to the *Albedo* role-playing game's concept of interpersonal relations. *The Drift* uses the non-player characters of the DH-160's crew to provide the major element of the scenario environment. Players must learn to deal with the umpire-run personalities if they are planning on getting anywhere with the adventure. Likewise, umpires must gain the knack of endowing NPCs with personalities if the adventure is to be run properly.

Running NPCs is relatively easy when using the *Albedo* game system properly. Each character's Disposition gives the umpire basic cues to presenting the character's personality, and this scenario supplements this rather scant information by giving a descriptive paragraph below the character's statistics. Likewise, changes in character Ties and Antipathies are easily done. Umpires should make rolls whenever they feel that a change might possibly occur. Trust your own judgment!

This scenario was originally designed as a competition adventure for a game convention. As such, it was intended to be run in three 3-hour sessions. Umpires should feel worried if they manage to conclude the adventure in less than an evening's play, since the adventure will have gone by too quickly for anyone to have gotten very much out of it. It is not an adventure to be rushed, since atmosphere and a thickening plot provide much of the enjoyment for umpire and players alike. I suggest that the scenario not be played all in one sitting – give players time to go away and mull over their strategies away from the pressures of the gaming table.

Have fun, Paul Kidd *Melbourne, Australia*

### Editorial Note:

This is potentially a very interesting and rewarding module. However, it absolutely requires that the umpire read through the entire module before attempting to run it. Not doing so will probably mean a less than rewarding experience for umpire and players alike. Umpire: Carefully open center staple. Remove pages 21-46, which are the character sheets and deck plans. Close staples again. You might find it useful to keep these player items beside you as you read the Umpire's Notes which begin on page 47. The page which gives the small descriptions of the NPCs is meant to be cut up and put on the table for player reference. You may wish to photocopy the whole 'Going In' section as well as the Mission Briefing and description of the Hlian system which follow this page and the Drift Map on page 17.

### Credits:

**Adventure design:** Paul Kidd

**Development:** Steven A. Gallacci, Janice Sellers, Hilary Ayer

**Artwork:** Steven A. Gallacci

**Graphic Design and Layout:** Janice Sellers, Hilary Ayer

**Editors:** Janice Sellers, Hilary Ayer



**Play-testing:** Malcolm Dunn, Steve Kerry, Doug Palmer, Tim Danks, Damien Morton, Ross Taylor, David Potter, and Rory Deutsch. Thanks to all the 60 or so players who played the scenario in the ALBEDO tournament at Melbourne's GAMES '88 convention. The editors wish to thank players at GenCon© '94 and Pacificon '94. Thanks also go to Richard Falkner and Kevin Dillon, playtesters who volunteered extra time to finding glitches.

**Acknowledgments:** Special thanks to Brett Nielson for coming up with the idea for the character cards. Thanks also to Damien Morton for his technical advice on drives and computers. My gratitude (as always) to Steve Gallacci for putting up with my ravings and somehow finding the time for all this stuff!

© 1994 Chessex, Inc. All artwork © 1994 S.A. Gallacci. All rights reserved. *Albedo* is a trademark of Thoughts and Images. This product is protected by the copyright laws of the United States of America. Any reproduction or unauthorized use of the material or artwork contained herein is prohibited without the express permission of Chessex Inc.

*Albedo* and its related materials are works of fiction. Any resemblance to actual events or persons, living or dead, is purely coincidental. This product is based on the comic book *Albedo*, *Anthropomorphics* and the stories 'Erma Felna, E.D.F.' and 'Birthright' © Steven A. Gallacci

### Mission History

This adventure follows the activities of the crew of a badly mauled EDF long endurance destroyer, the DH-160 (fondly known to the crew as "the ship").

The DH-160 was dispatched to the Hlian system as part of an effort to locate three missing civilian freighters, *Toko*, *Aiko* and *Quitzi*, which are now about nine weeks overdue on their regular rim run. Upon entering the Hlian system, the DH-160 decelerated towards the system's L5 point to examine it more closely. The ship then detected an unknown vessel of about twenty kilotons displacement lying at rest near the L5 point. This vessel accelerated toward the DH-160 and deployed attack ACV's. In the ensuing encounter, the unknown vessel was completely destroyed, but at the cost of massive damage to the EDF vessel. The vessel's fusion reactors suffered massive damage as a result of the shock, and ceased to function.

The ship suffered a penetration into the bridge which killed the entire bridge crew at a stroke. The ship is without its command figures and department heads, leaving it in the hands of its least experienced crew.

The DH-160's crew must now consider the drift of debris at the system's L5 point (an operation requiring about 500 hours). The system briefing indicated that this debris contains wreckage from a battle which occurred about twenty years ago. It is hoped that the drift will contain spare parts and reaction mass which will allow the crew to repair their vessel..

### The Hlian System (CA 17109)

**Stellar type:** M6 dwarf

**Planetary bodies:** Super-Jovian

**Jump threshold radius:** 41 AU

**Population:** 0

**Brief:**

The Hlian system lies on the far outskirts of the rim, well away from normal shipping routes. It is well placed for jumps into several nearby rim systems, but the lack of usable planets has discouraged any efforts at colonization.



### History:

The Hlian system was discovered in year 170 (about twenty-nine years ago) by a privately sponsored deep exploration team, who named the system after a deceased comrade (Alisa Hlian, Y 148-170). The group performed a cursory survey before leaving the system for more promising climes. The system was not visited for another nine years.

In year 179 an ILR logistics task force entered the system, located ice bearing comets, and shunted these into the system's L5 point for use as starship fuel. The system was well located for an outflanking move on the ConFed forward bases on Tlakatan and Do-Marki. The subsequent ILR probe into the Do-Marki system was beaten off, and their fleet backtracked to Hlian. In the ensuing battle, the ILR refueling base and the mauled remnants of the ILR fleet were wiped out at heavy cost to the EDF task force. The battle of Hlian was notable for the violent, costly encounters around the system's L5 point, and for the dramatic rescue of the damaged EDF light cruiser CL-330 eight days after the battle's end.

In view of the system's strategic location, the EDF high command initiated a move to set up their own refueling point in the system, and to this end the wreckage of the battle was collected and deposited in the system's L5 point to remove any hazard to shipping. In subsequent months, however, the emphasis of the war shifted well away from the "Tlakatanii reach", and the fuel dump was never constructed. To this day, Hlian remains uninhabited.

### Miscellaneous data:

Hlian's M6 dwarf sun is dim, red, and gives very little illumination (about 10% of that given by a normal yellow star). The super-Jovian (Hlian 1) masses some 130 standard units, and is 4 AU's removed from the system's stellar body. Hlian 1 is ringed with a broad protoplanetary disc (a rough ring of gas, particles and other matter).

The concentrated clot of wreckage in the system's L5 point contains wreckage of all shapes and descriptions. It is registered as a navigation hazard, and as a war grave.

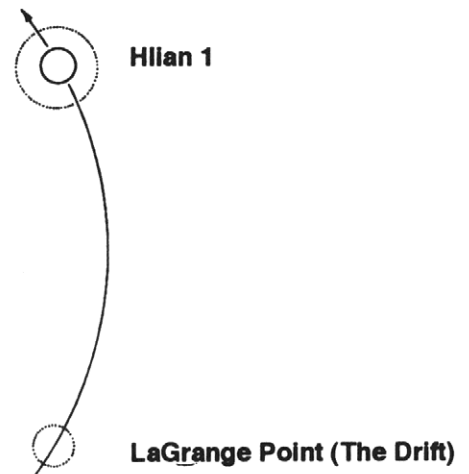

# Contact

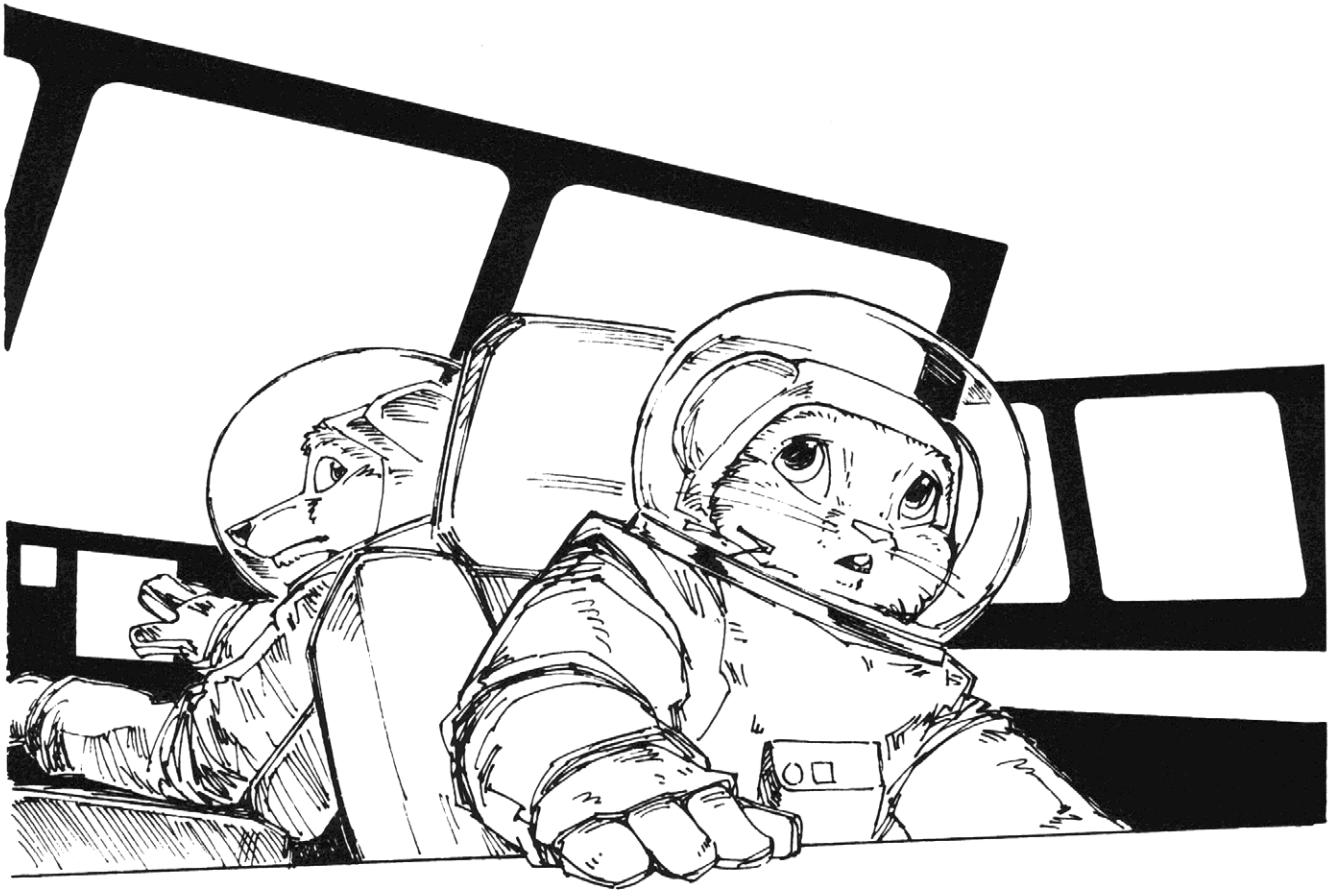

Down in the auxiliary control center, the tension is high. Clumsy inside their armored vacc suits, the crew are strapped to their couches. There is little for the back-up crew to do except wait and hope, desperately trying to stave off the fear. Their eyes follow the readouts on their monitor screens, their hands ready at their controls, but they will only be needed if the computer and the primary bridge crew are no longer able to work the ship.

“Contact, thirty seconds. Heads up, people.” The captain’s voice is clear and strong in their earphones. Looking ridiculously small in her battle suit, Sharna Aoki turns her helmet to lock eyes with her friend Torscha. The little mouse’s eyes are bright with fear. The fox grins back at her with his usual suave bravado, and the mouse relaxes slightly. Torscha is closely following the progress of the approaching enemy ordnance, his own attack plans already loaded onto his terminals in case they should be needed.

Twelve seconds. The crew stiffens, cringing inside their suits, but there is nowhere to hide.

The DH-160’s point defense suddenly opens fire, the hyperkinetic shells screaming out to intercept the enemy

ACV’s. The cloud of incoming missiles disintegrates under a rain of fire, blown to fragments in an instant.

WHAM!

A shock ripples through the ship, slamming the back-up crew against their straps. Their world begins to tumble, and air screams out of a breach in the hull. A shocking spray of red paints one wall of the room, and gobbets of blood dance in the thinning air. Numb with shock, Sharna stares at her control read outs – she has the con!

WHAM!

A second blow, more powerful than the first, and the ship begins to spin dizzily. Torscha yells a warning, and Sharna’s hands dance over her controls. Ignoring hazard warnings, she vents sideways thrust and stabilizes the ship. Torscha’s hands pound down onto his terminal, and the DH-160’s ordnance shifts into a new configuration. The point defense cannons hammer . . .

Nothing. The enemy vessel is a cloud of vapor; the enemy ACV’s are destroyed. The engines no longer respond to Sharna’s prompting, but the maneuver gas jets slowly ease off the spin.

## Immediate Post Contact Situation

For play starting immediately after the clash, the crew of the DH-160 will start by surveying the damage and rescuing casualties while attempting to secure and salvage surviving resources. Even with the shock of killed crewmates, intensive training should be able to get them through the initial hours of the grim work. This initial effort is a 'given'. For play, the referee need only present the assets and damage information. The damaged deck plans reflect conditions after an initial go-through that has patched and repressurized superficially damaged compartments and cleared debris from necessary accessways.

But after the initial effort, character dynamics come into play as the full extent of their situation sinks in. The ship is devastated and more than half the crew are dead. Of the survivors, Roilant Everrard is unconscious with a head wound, Tatzel Hulden is traumatized with shock, two members of the ship's company have had to be put into cold sleep, and Erwin Chehok is dazed. Other survivors are fully fit. Even the ship's computer will seem half-dead as it will default out of many of its roles. What is left of the crew will need to realign themselves to both a stark change of mission and a new and untried leader in Sharna Aoki. Note to Umpires: although the AI is damaged, Sharna's training will lead her to consult it frequently (remind the player to do so if necessary). Guidance may be necessary to bring out her leadership ability. The AI would be able and expected to provide such guidance.

Sharna will need to assert her practical authority more than any official interpretation of the regulations. So, she will have to demonstrate a quick grasp of the situation and confident decision making while dealing with both her own and the crew's collective trauma. The immediate external tactical situation appears to be safe after the engagement with the hostile ship, but with all the long range sensors gone there is no way to know what is happening throughout the system. Sharna may assume the possibility of follow-up hostiles, but can do little about that. Her major task will be to have the crew hold together and survive until a rescue mission can recover them.

An important detail: when the DH-160 entered Hlian space, it left a message ACV out at the edge of the system to monitor any action. That ACV has witnessed the combat and damage to the DH-160. As long range communications are now impossible, it will return to the nearest inhabited system to report on the incident. Even in the best of times, any rescue would likely take 40 or more days, but due to the larger situations in regional space, rescue may take 60 to 80 days. The crew, and unbeknown to them, the pirates, know that

rescue is but a matter of time. The question of how long they'll have to wait and who else may reach them first will weigh heavily on them.

The first thing that needs to be done is to assess the full situation and the available resources. The information given with the damaged ship plans reflects a superficial inspection. Assets and repair lists will have more specifics. Note which items require commitments of PC time to obtain information. Prioritizing tasks will be important, as there are only so many crewmembers that can be brought to bear on anything while still keeping operational watches going. EVAs (Extra Vehicular Activities, ie, working in vacc suits) are especially exhausting. Only 8 hours in 24 may be spent in EVA work with any hope of effective crew performance. Crews will also have to take radiation into consideration, spreading out exposure among the crew as much as possible to avoid any one person from accumulating a serious dose in those situations where irradiation is unavoidable.

The next thing to do must be to deal with the ship's trajectory through the Hlian system. The ship was headed for the Lagrange point known as the Drift and had largely decelerated. However, unless further deceleration and maneuvering is done, the ship will pass by the Drift and go into an independent orbit of Hlian with an unacceptably close aphelion. While there is a good chance that a follow-up mission would arrive and find them long before they got too close to the star, it would be prudent to avoid that possibility. There is one further possibility: they are nearly a year away from Hlian and the on-board solar collectors and photovoltaics could help generate enough power to electrolyze water into fuel to correct the ship's course into a better orbit.

Going to the Drift offers the possibility of finding useful resources to make repairs or extend their supplies. The crew could also carry out a bit more of their mission by examining the contents of the Drift for evidence of the mystery disappearances that brought them there. On a more visceral level, this is an attractive alternative because it gives the sense of things to hide behind if another hostile comes. On a practical level, this is meaningless, as a ship could easily find them and destroy or attempt to capture them. But it does provide some comfort over being out in the open (and since there is one surviving point defense weapon, they could set themselves among debris to have that weapon cover the only practical approach).

The one surviving ACV in ACV Bay 1 (previously in 6 o'clock airlock, now outside) can provide enough velocity to settle the ship into The Drift, with several refuelings from the undamaged cells of the otherwise wrecked ACVs in the bays

and dribs and drabs of fuel left in the ship. The actual maneuver is done by having the ACV pushing the DH-160 very much like a tug boat, finding the right position on the hull to thrust against, and repositioning itself for course correction. The operation will take many hours and consume just about all the fuel on board short of that kept in reserve for the electric fuel cells.

A more desperate option would be for the crew to disconnect as much of the severely damaged hull as possible before attempting to do any power maneuvers. With less dead weight to decelerate, there would be more fuel for power, allowing them to remove the ACV's reactor and installing it in into a reconstructed MHD generator to produce enough power for water recycling and even electrolysis, making more fuel to keep the reactor going all that much longer. Reconfiguring the ACV's reactor for this purpose might be a good move if no other reactor is salvagable and they hope to find fuel in the Drift. However, detaching the hull elements would be difficult and dangerous. The wrecked decks do provide some structural support, and if it takes more time than expected, they could pass the Drift and make any rendezvous even more fuel-intensive.

If that option is pursued, there is a 1 in 6 chance of complete success. If not (rolling again), then they would have a 2 in 6 chances of making the Drift but taking longer and losing any fuel advantage. Failing that, they would then have 3 in 6 chances of losing so much time that they can only put the ship into a large orbit around the Drift, but unable to get to the main mass of it, leaving them unable to get at any resources that the Drift might offer. There is also the possibility of more hostiles in the area, and being close by could make them easier targets, but they are equally vulnerable anywhere in the system. However, they have the option of not attempting the maneuver (don't roll) and saving the fuel for power generation as in the free fall into system option mentioned earlier. If they try and fail this roll, it would suggest that something bad had happened and they must now cope with the consequences.

*Consequence 1:* a 1 in 6 chance of an accident (examples: unexpected blow out of pressurized system or compartment, using a warhead to speed up the process of detachment that goes wrong, or murder) that loses critical members of the crew necessary to do the job or continue the mission within the time/distance window (note: the referee can build up to these consequences rather than announcing them immediately after the roll). The survivors' discipline and morale could collapse and have a situation very much like the default consequence (see below). The ship can just barely survive, but it will be very dependent on the remaining crew re-establishing some order.

*Consequence 2:* a 2 in 6 chance of a fuel accident that precludes the maneuver, but leaves enough for a comfortable free fall. The ACV reactor may be salvagable. It can be

fitted to an MHD generator as mentioned (elsewhere). As this becomes very much a sit and wait situation, not too uncomfortable, but boring, interpersonal dynamics can take the forefront.

*Consequence 3:* a 1 in 6 chance of a major explosion in the lower ACV deck that would lose both all the remaining fuel and breach deck 15, losing most of the water, good and bad. They will be stuck with the free fall profile with only the emergency reserves of the fuel cells and accumulators. Solar collectors and photovoltaics can produce power and electrolyze water for hydrogen and oxygen, but there is not enough water left to make enough hydrogen to run a reactor for power for any practical length of time, and definitely not enough to make any kind of course correction. As with consequence 2, the situation would be more or less a boring wait, with little to do to get on each other's nerves. However, without the cushion of extra water, there is not enough for biological processing for waste reduction, and more important, oxygen generation. So any new oxygen would have to be made by electrolysis, which will eat into water stores. Waste water can still be distilled, but the waste would not be usable in any way. (Dry waste is preferable to wet waste or waste in a water solution, as bacteria won't get to it and compete for oxygen, and algae oxygen processes need hundreds of liters per crewmember that now can't be spared) Anxiety about water and oxygen, as well as the overall condition could become a point of contention between rival crewmembers.

*Consequence 4:* a 1 in 6 chance, means losing the ACV through control failure (runaway), explosion due to unnoticed damage, or simple reactor failure. There would be enough fuel left on board to run a reactor if one could be rebuilt (see Assets). The personnel situation could go much like consequence 2 or 3. If the hapless player still has not yet 'won' a consequence, then it is assumed that things just haven't worked. The entire effort has been plagued with failures and set-backs and it is clear that they cannot get the ACV to work correctly as a tug. The module separation effort grinds down in frustrating failure. After several hundred hours of work, it is clear that all their efforts have been for naught. This will include the computer, which would otherwise provide a stabilizing effect and prevent, or at least discourage the following behavior. Rioltant Everrard will have recovered by the end of the initial effort and will attempt to use this opportunity to claim command, blaming it all on Sharna Aoki. Considering the crew's demoralized condition it won't be difficult. In this state of despair, everyone's thoughts turn to simply staying fed and warm. They could care less about making any organized efforts.

Individuals with high *Drive* and *Stability* may still be able to do positive and constructive tasks around the ship, defying Everrard's command with a fatalistic resignation of their possible collective demise ("What, you want to *shoot* me? With space pirates likely to blast us to aerosol, *you* are going

to shoot *me* for taking out the *garbage?*") Given time, the crew might recover itself to take care of survival tasks, regardless of any command structure. But in a crisis where single command authority is needed, they may look to anyone with a strong leadership image, regardless of official rank. Sharna has merely to do her duty. Recognizing the need for crew cohesiveness is more important than official authority. Everrard may desperately grab for authority if he already doesn't have it. If there isn't a strong consensus to support him because of current or previous impressions he has left with the crew, he will be rejected. In fact, under this special situation, if the perception of immanent destruction is strong enough, anyone getting too loud and obnoxious might get shot, though not necessarily killed, just to keep him or her quiet and out of the way. And under these circumstances, no one would think too much of it. However, this kind of behavior would only come up after a complete breakdown of the normal order of things and the creation of a new, more desperate order. This last is very much a worst case and should be considered only if the players have attempted the most risky course and have failed miserably.

Getting back to the main track, the umpire has about three weeks worth of game time in which to establish some relationships between the crew of the DH-160. Living conditions are terrible, and the crew is numb with shock, so tensions should run high. Roilant Everrard will be confined to sickbay, but will seem bitter about Sharna's turn of 'luck' in winning her command over his unconscious body. This should be the start of a 'beautiful friendship'.

The umpire should be able to create an atmosphere of hopelessness and hostility by the time the DH-160 reaches the edge of the Drift and Roilant Everrard takes up his duties once again.

## Battle Damage

The DH-160's existence is hanging on by the merest thread. Battle damage caused by fragments from enemy ACVs has vaporized a major portion of the ship's rear hull, smashing the propulsion and power reactors. Severe structural damage to the hull would limit acceleration to agonizingly slow rates even if the ship still had power. Major penetrations of the bridge compartments and auxiliary vehicle bays caused severe casualties among the crew.

The ship still has power for essential systems for the next fourteen days, provided by stored power from its fuel cells. Power usage must be kept to a minimum until the fusion reactors can be repaired and brought back on line. The ship lacks most of its sensors (blasted off during the encounter with the unidentified ship). The computer system is severely damaged.

The DH-160 originally had four auxiliary vehicles – a light cargo aerodyne and three small, unstreamlined ship's

boats designed as vacuum utility vehicles. All of these vehicles have been destroyed beyond all hope of repair or salvage.

After the battle, emergency hull repairs can be undertaken by the ship's engineering robots, allowing the central portions of the ship to be repressurized. The ship's single remaining piece of ordnance, a recon ACV (enhanced sensor package, no warhead), can be used to shift the ship across to the L5 point, its engine being fixed into a makeshift mount in the ship's stern. The crew will spend most of the next 500 hours living in cramped, makeshift quarters (over half the trip will probably be spent with the whole crew living in the common room and galley). Some tempers will flare, and the general atmosphere will be tense and strained.

To summarize: The ship has no auxiliary vehicles and no functioning beam weapons. Large portions of the hull are depressurized and unusable, and most functioning equipment is the result of several days improvised jury-rigging by the engineering crew. The ship is becalmed in the junkyard drift without fuel, and with no real idea of the area of space immediately surrounding it. The ship is **devastated**. Umpires are advised to constantly emphasize the ship's broken, damaged state.

Remember that the ship is in zero-G. This entire adventure takes place in a weightless environment.

### Assets on Board Ship

Resources available include the following:

- 1 AI computer (heavily damaged) linked to a defunct internal monitoring system.
- 1 functioning hyperkinetic point defense cannon
- 1 ACV (fuel depleted) containing a simple AI computer, sensors and a fully functional fusion motor. There are sub-assemblies in the ship's ordnance stores that can equip this missile with a warhead or a message torpedo. Unfortunately, there are no systems that could provide such a message torpedo with a jump drive!

A functioning and well supplied medical center containing six life support pods. These can be fitted for hyperbaric oxygenation and/or chill support, which maintains a near hibernation condition to give medical efforts more time to work on trauma, as well as intensive life support. ("Freezer" technology doesn't work in this situation) The computer can coach even an untrained individual to do some specific tasks with the help of manipulators which can be fitted to the pod. Two of the pods are inoperative, another two pods are occupied by severely injured crew members, and one of the surgeries have been depressurized.

There is only one functioning airlock on the ship, the one through the medical unit (deck 7). It can recover most of the air in the lock, but doing so costs power. Other sections of the ship can be used as impromptu airlocks, simply by opening



and closing various doors, if there is power available, or with the emergency pry bar if not. This method wastes a lot of air.

A functioning workshop (deck 9) containing the means of modifying or producing a variety of simple tools or special purpose items (given the correct expertise and/or computer assistance). The workshop has a limited stockpile of raw materials and modular parts for robots and gizmos, but bits and pieces scavenged from other sections can be used as well. While things as sophisticated as a gun can be tooled up, without the computer's CAD/CAM assistance, only the simplest single shot or zip gun would be possible in any practical amount of time. With CAD/CAM assistance, an automatic pistol or some mechanism of equivalent complexity and precision can be made in a few hours, though for reliable function, a fair amount of hand fitting and adjustment would also be needed. As most electrical hardware uses high-density integrated circuits, only modular sub-assemblies can be practically assembled or repaired.

Interchangeable modular parts allowing the crew to construct three robots (normally configured as engineering robots or robot probes). The ship also has two specialized robot "nurses" in the medical bay, which could be cannibalized for processors and parts at need.

Functional accumulators and fuel cells. Though there is not much fuel beyond what is necessary for basic survival power generation. The fuel cells generate water and heat as waste, which is salvaged by the water and power systems as a matter of course. There are also several portable photovoltaic kits, needing bright light or sunlight to generate electricity. (attempting to "salvage" electricity by having photovoltaics cells working on interior lighting would be largely a waste of time due to the inefficiencies of both the cells and the storage)

Sterling thermal/electric generator kits are also available that use waste heat from various processes or from a solar collector. Others can be salvaged from the reactor deck or other areas where waste heat can be scavenged.

1 hostile environment suit suitable for solid-framed characters.

1 arms locker containing two 8mm assault rifles with thermal imaging sights, along with eight magazines of 24 rounds each, and 236 rounds of 8mm pistol ammunition. The rifles may be modified into SMG, carbine or LMG configuration if desired.

Several thousand meters of fiber-optic communications cable (suitable for jacking into vacc suits, robots, etc.).

1 functioning hyperkinetic point defense cannon. (deck 17, 7 o'clock position) Between the rounds in it's magazine and additional rounds scrounged from the other units, and available fuel, 200 rounds of armor-piercing fragmentation can be ready and loaded. There are about 40 rounds extra for which there is insufficient fuel to propel. These rounds can be used as explosive devices with the appropriate modifications to the fusing mechanism. They can be remotely detonated by

wire or radio command, simple pull detonated, or timed set or timed pull-fused (up to 1 minute). The warhead can burst any normal bulkhead when placed along side and the fragments can penetrate even thick ship's hulls at any range, but due to dispersal of the fragments, is ineffective in inflicting specific damage beyond 50 meters. Similarly, as an antipersonnel weapon, the effects drop off with distance; at under 10 meters, it is absolutely lethal, even if the individual is wearing armor. But at any distance beyond that, its effects should be treated as random gunshot wounds, the number falling away with distance. (2 to 12 @ 10-20m., 1-6 @ 20-50m.)

Limited drinking water (1 ton or 1000 liters). Daily use converts about 20 liters of this "clean" water into "dirty" water every day, even with the most severe restrictions on bathing and washing.

While there is plenty of water on board, much of it is in dispersed storage in the individual compartment emergency tanks. Because of plumbing damage, most of it cannot be retrieved except by tapping each tank directly. Again, because of plumbing damage, any waste water above deck 15 cannot get directly to the recycling or distilling plant on deck 15. While various still kits are available, they are power intensive, unless a fusion reactor is on-line or a solar still can be set up. Alternately, there is sufficient hose and miscellaneous pipe on board to jury-rig a line to deck 15, but there is always a risk of blowout and losing it. There are also enough miscellaneous containers to "bucket brigade" water to deck 15, but that would require a series of airlock cycles that will eat up air.

Survival food capable of supporting the crew for a couple of years. This food is utterly, hideously boring! Miscellaneous attributes such as pressurized living quarters, functioning life support, and sundry semi-liquid garbage (which the life support system cannot currently recycle – a still is clearly going to be an early priority!). The ship has 'fancy food' enough for 2 gourmet meals apiece for 10 people.

There is tanked air and oxygen for at least 60 days. More oxygen can be got by drawing away from the fuel cells, but that would mean no power and no heat. There is enough power in the accumulators to keep a few lights on and a fraction of the ship's computer up, but no more. Obviously, salvaging more oxygen would be a good thing. So would getting more power, preferably getting a reactor on line to electrolyze oxygen and hydrogen out of the available water supplies.

One intact ACV, which is out of fuel by the time the characters get to The Drift if they decelerate in the safe way, or with fuel to spare if they have gotten rid of the remains of decks 1 through 4 and other debris. The ACV could then be used as a transporting device to forage for fuel or other resources, or the reactor can be dismantled and fitted to a salvaged MHD generator assembly to generate power to make more fuel and generally to improve the conditions on board ship.

If they choose not to decelerate into the Drift, they could attempt to recover or repair a reactor, or to dismount the reactor from the ACV to fit it to a salvaged MHD generator assembly. This would give them enough fuel to run ship's systems and to make more fuel for operations, and, if necessary, to change their orbital trajectory for a better orbit around Hlian. That would likely not be necessary if they have any hope of being rescued in the next six months or so.

There are also three damaged ACVs in the ACV bays. The reactors are destroyed, but there is some salvageable processing hardware in them, as well as two salvageable short range imaging sensors and the magnetic nozzle assemblies.

### Personal Equipment

Each character has a normal EDF shipboard kit, which includes fatigues, casual duty and service uniforms, a vacc suit liner, a helmet liner, a set of flak armor, a vacc suit and a vacc suit helmet. Other equipment includes a torso supporter, an 8mm (or appropriate to Strength for smaller characters) pistol and one full magazine (never worn under normal circumstances), and selected miscellaneous personal effects (up to 20kg in mass). All crew would have civilian attire (including formal party wear)

### Robots

The ship currently has processor cores for three robots. While capable of acting autonomously, robots will generally remain linked to the ship's processor net, becoming an extension of the ship's AI. Their skill level at various tasks is about 10 (when given the correct tools and data packages) but they receive a DRM of -1 or -2 when linked to the ship's computer. The robots used on the DH-160 are of modular construction. Specialized sub-assemblies may be linked to the processor core to produce robots capable of handling just about any task. Data packets and sub-assemblies currently on board will allow the crew to create engineering robots (specialized welding and manipulatory appendages) and probe robots (enhanced sensors and long range maneuver jets). Other configurations could be constructed at need (umpire's discretion).

One object that umpires and players might want to keep in mind is a robotic 'mini probe', a custom job made in the ship's workshop which will make exploring derelict ships safer and easier. A mini probe consists of an assorted bundle of jets, cameras and limbs attached to a small body (say about half a meter in length). Designed to look around corners and boldly go into areas where no character has ever been before, it is the technological equivalent of the good old fashioned 'ten foot pole'. It must be linked to a larger processor (such as the one in a robot) in order to function, and may be linked with the ship's AI. All robots which are linked to the ship's processor net will be via fiber-optic cable link. The ship has large stores of this cable.

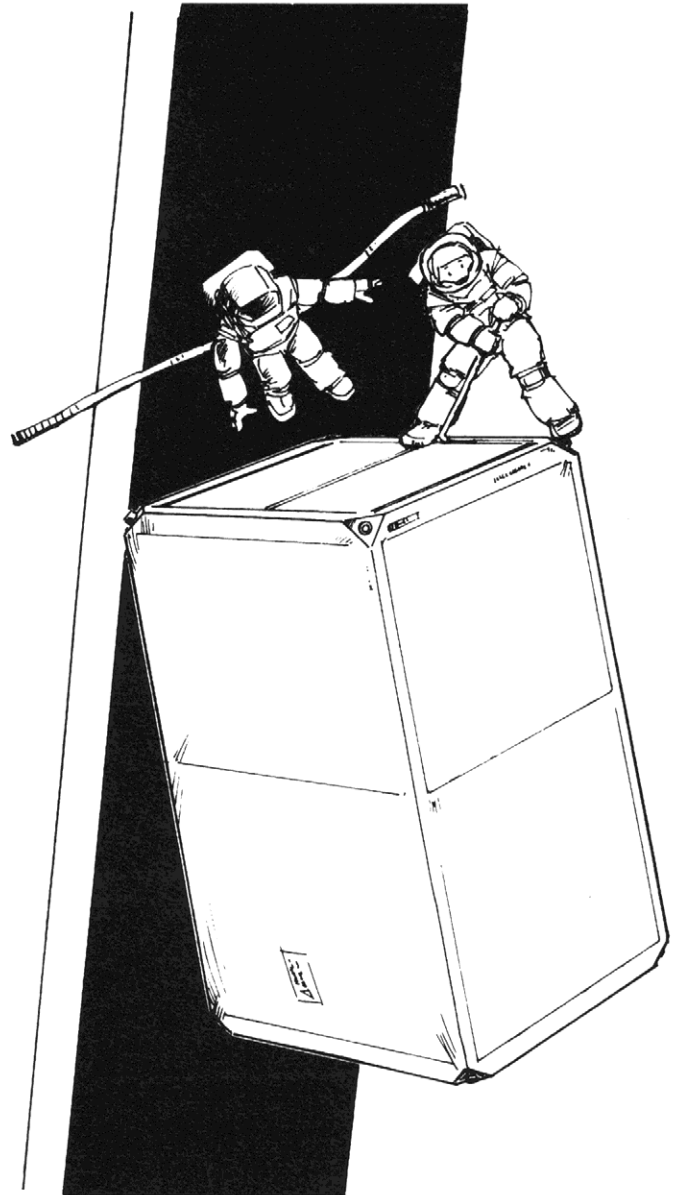

## Problems in the Crew

The interactions of the crew are a major part of this scenario's environment. A number of incidents could be staged which will bring the interpersonal relationships aboard ship into play. Use these sorts of events at need to add to your adventure's atmosphere and difficulty. These incidents, and others invented at umpire's discretion, will happen concurrently with the situations described in *Immediate Post Contact*, *Exploring the Drift*, and *The Takeover Bid*.

### Incident 1

The gourmet rations for the crew are plundered! In an off-duty period, one of the PCs passes the food stores and hears a noise. Upon investigating, he discovers that the gourmet food stores have been robbed of some choice items.

The theft causes a bitter flare of tempers among the crew. Obvious finger-pointing will be directed at Deika Tovan, a fatter character than most of the rest of the crew. He in return will claim that the PCs have been hoarding food – they were

probably caught in the act and are now trying to shift the blame!

Closer investigation can reveal the culprit. The items that have been stolen are all highly spiced vegetables from the planet Zho-Chaka – Sharna's homeworld, and a place familiar to Deika and to Aelis Eocha. This is a chance for new Antipathies to flare, and for Roilant to badmouth Sharna if she mishandles the investigation.

Who stole the food? Umpire's decision.

### Incident 2

Two NPC's – possibly Mank and Erwin, or Deika and Erwin – suddenly let their tempers snap. They begin to fight, and a PC must intervene.

Intervention might be dangerous, especially for a small character like Sharna. If a PC does wade into the fray, other NPC's may decide to take the chance to attack. The battling characters intend real bodily harm, so just letting them sort it out will result in one or possibly two hospital cases, reducing repair crews.

The best solution is to find a creative way to break up the fight. If the fight takes place in a living area, then dirty water might be used to sluice the combatants. Possibly, the depressurization alarm could be sounded, sending both fighters into a panic trying to get into vacc suits.

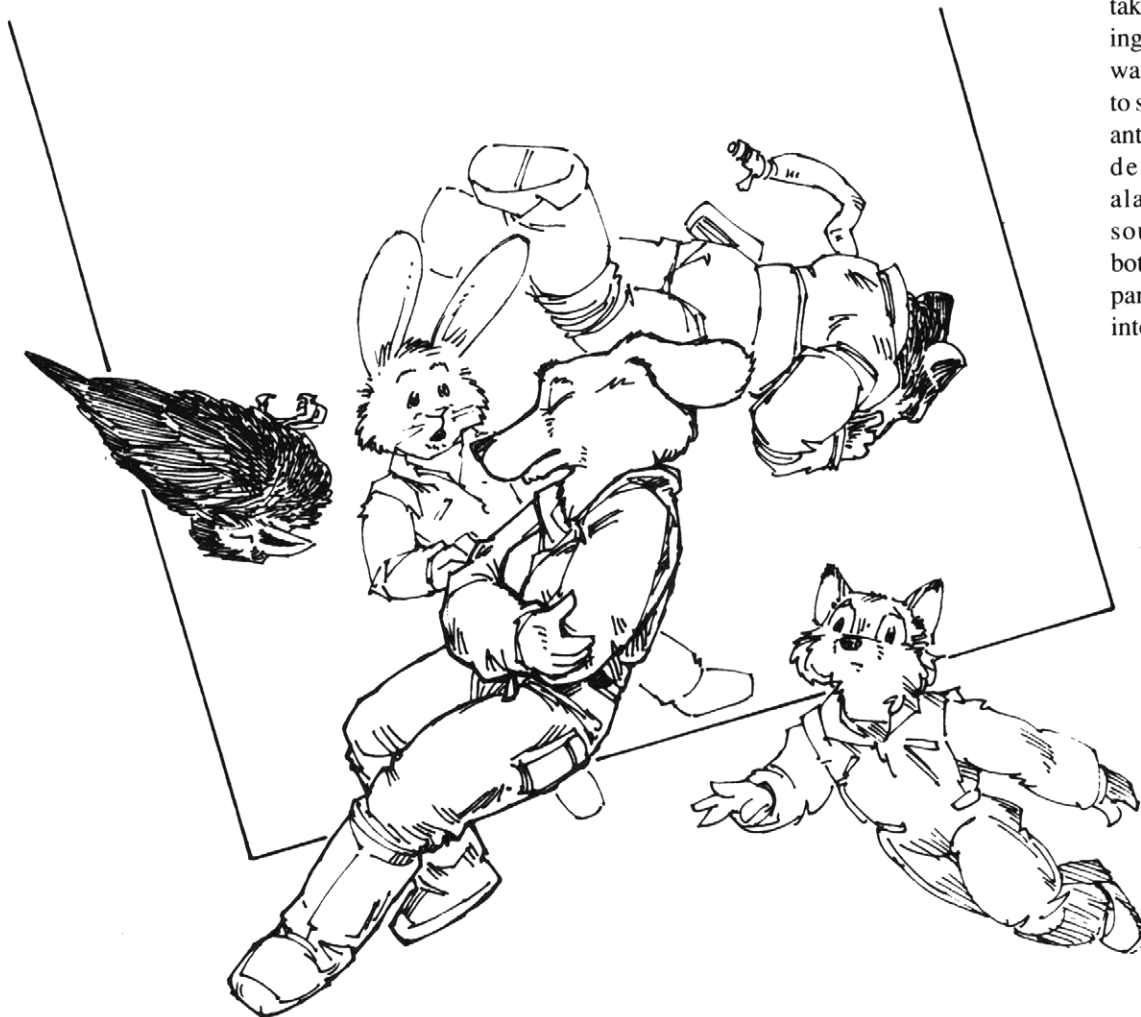

**Incident 3**

Aelis Eocha suffers a tension-induced hormone imbalance (she goes into heat). Utterly absorbed in her work, she does not realize her hormonal state, and is only dimly aware of a growing restlessness and “dissatisfaction” which makes her unproductive and argumentative – a true chore to work with.

Aelis begins to send out pheromonal scents attractive to any canine character, although in the general stink of the overloaded environmental systems, no one will realize that these ‘scent cues’ are in the air. Aelis will also unconsciously become more coy and more feminine, and will adopt attractive poses to catch the eye of potential suitors. Torscha Derling and Braddock Haina will find themselves drawn to Aelis, and will find each other’s presence near her to be a ‘challenge’; in cramped crew quarters this could lead to quite a brawl.

If Julius Clari can be made aware of the problem, he will treat Aelis’ imbalance. If Aelis and Torscha mate before the problem is treated, it will remove any chance for a romance between Torscha and Tatzel. If a romance has already begun between Torscha and Tatzel, and Torscha mates with Aelis, Tatzel will be heartbroken.

**Incident 4**

Deika begins to spread the rumor that Mank may actually be an ILR spy. Obviously the DH-160 was attacked by ILR rabbits. How did they know the ship was on its way? What could be easier than sowing operatives on local EDF ships? Why else would everything be going wrong all the time?

Deika will try to engender antipathy against Mank, leading to a nasty confrontation and attempted bashing. This could lead to Mank being hospitalized.

**Incident 5**

The assault rifles are missing. Someone has breached the ship’s arms locker and has stolen the only combat rifles on board. Ship’s security was disabled in order for the incident to occur.

The umpire has a number of options: A well-meaning character like Tatzel may have hidden the weapons to prevent Sharna or Roilant from murdering each other. Roilant may have become EXTREMELY paranoid and is disarming his opponents. Or perhaps the ship’s manifests are wrong, and the weapons were never there after all?

**Incident 7**

To conserve power, everyone is living on a single living deck. Everyone will have to double up with another character, sharing a room stuffed with emergency supplies and equipment salvaged from other decks.

PCs are each be given a roommate. Each roommate must make a Stability roll; a failed roll indicates that the antics of one’s roommate are extremely irritating. He sheds fur; he snores; in the case of mice or rabbits, he gets up in the morning and files his incisors down (with a noise that can go right through bulkheads!). Remaining for a week with an irritating roommate will be cause for a mutual Antipathy roll.

**Incident 7**

With the breakdown in proper environmental controls, a nasty mildew begins to spread itself throughout the ship.

Pick one or two areas of the ship which are consistently warm and damp (such as living quarters or a rec area) and have these as the first areas of infection. The virulent mold begins to coat surfaces with an unsightly, smelly slime.

Depressurizing the areas infected by the mold will kill it off for a day or two, but the spores seem to survive the rigors of vacuum quite well. The only way to kill the wretched stuff is either to burn it out with caustic liquids or heat (difficult if your underwear is affected), or to lower temperatures in the ship to about 5 to 10 degrees, halting the mold’s breeding cycle.

**Incident 8**

No baths or showers and a closely packed furry and feathery crew in zero gee puts a lot of dander and such in the air, causing respiratory problems. And itchy skin elevates the general sense of tension and irritation.

Formal grooming sessions may have to be arranged. Nudity and overall contact doesn’t necessarily mean anything sexual. (The equivalent would be massage necessary to soothe muscles which are doing heavier work than usual.) But as everybody has to groom everybody, according to who’s available and off-shift, ties and antipathies could get a workout.

It’s also possible that a random allergy might crop up to complicate someone’s life.

**Incident 9**

In the few peaceful moments when the characters are actually getting some shut-eye, a ship’s depressurization alarm goes off accidentally. One or more PC’s and one or more NPC’s are caught without vacc suits and catapult out of bed. Will gentlemen let the ladies through the door first, or is it every critter for himself?

The tensions on board ship must be relieved, otherwise real trouble will be forthcoming. A game, a dinner, or a major success should be staged in an attempt to allow a release of tension. While this will not affect major Antipathies, it may give the opportunity to smooth over minor rifts in the crew.



The ship has now arrived at the Drift. As there is effectively no more fuel for ship's maneuvering, even with the load lightening option (any remaining fuel is only enough to run the ACV or ship's power), it is now adrift in or near a broad cloud of debris. The crew can now attempt further repairs to the ship and search for resources from the Drift.

### General atmosphere

The drift is *spooky*. The torn and twisted remains of ships are a constant reminder of death. The absolute silence and complete devastation can eventually get to anyone after long exposure. Characters with sensitive personalities will rapidly become depressed or nervous after a few hours of investigating the sad, jagged wreckage under the baleful light of the red dwarf sun.

The Drift is formed from dozens of concentrated clumps of debris, the clumps being formed by mutual attraction or deliberate placement. The concentrations of debris that make up The Drift are quite closely packed. The elements within them are within visual distance of each other, and sometimes fragments are separated by only a few eights of meters. Debris clumps are usually separated by many kilometers of relatively open space. Searching the drift by means of the gas

## Section 1: Exploring The Drift

jets on EVA packs is quite out of the question. Each hex of the Drift Map is about 500 kilometers in width.

### Getting to The Drift

Although the ship's auxiliary vehicles have been totally wrecked, the crew will have to find some way of travelling out into The Drift to search for water and spares. If there is fuel left, the ACV can be used as a tug/transport for searching and retrieving materials. The efficiency of the reactor is such that only a few hundred kilos of hydrogen can fuel it to go back and forth to just about anywhere in the area, even while hauling multi-ton items. Thrust, especially with personnel hanging on, would be in short, sharp bursts, as the more normal operating mode would require continuous twenty-gee burns. Control of the ACV is possible via normal voice command, as it has a fair AI processor. Prudent speed for the ACV while in the Drift, partly for safety and partly for fuel economy, shouldn't be more than a few hundred kilometers an hour, though with secure quantities of fuel, continuous acceleration/deceleration at a moderate gee load is possible, allowing up to 10,000 kilometers of range in an hour's running time.

But if all the fuel was used up in the trip in, other sources will have to be found or made. Actual stores of hydrogen would be unlikely, but not impossible. Collecting water and building a large solar collector to drive a thermal electric generator or concentration photovoltaic unit which in turn can electrolyze water into hydrogen and water would be the obvious option. It will take about 1.5 to 3 mandays EVA to set up the collectors and related hardware, [roll] 1.5 to 7.5 mandays [ half that EVA] to set up the hydrogen condensers from available hardware. With immediate materials on hand,

as much as 10 kilos of hydrogen a day can be made, as well as 80 kilos of oxygen. Though it would take ten days to get enough for an initial fire-up on a fusion reactor, that time could be spent dismounting the ACV's reactor or getting another one ready for power generation. Once the reactor is on line, it can generate more than enough power to process all the water to fuel the crew might want to spare.

NOTE: This set-up can be also done while en route but will require additional EVAs to insure proper alignment, and would not be recommended if the ship was intending to maneuver. As it would require so much effort, and would have to be partly torn down during any course correction, it would not be unreasonable to wait until the ship was settled before attempting it. This does not mean that smaller emergency power solar collectors could be erected at any time.

The major sensor groups were lost in the engagement, leaving only short range optical and EM hardware. With these, the crew can at least do a visual examination of the various clumps. A limited spectrographic analysis can be done with the optics as is. The unaltered optics can find water ice and differentiate a few things (and is an infrared detector). With the right reworking of robot optics, a more complete spectrograph can be cobbled up in (roll) 3 to 18 hours, and can get a more detailed analysis of more materials.

The ship's sensors are too damaged to make out much detail of clumps outside the ship's own hex (most of the external aerals are missing). It will be able to differentiate high albedo/low mass clumps from high albedo/high mass clumps, allowing the crew a fair guess at which clumps consist mostly of water ice. Umpires might want to pre-generate the random hexes within The Drift, and mark out those clumps which might be water on the player's map.

## Moving the ship

The ship's waste water and garbage may be used as fuel for the ACV (or the ship's reactors, once they are repaired), allowing the ship to give itself 2 hexes per day worth of velocity for 32 tons of fuel. This effectively means that for 32 tons of fuel the ship can move at a velocity of 1 hex per day and stop itself once it reaches its destination. Thus the ship may move across to ice asteroids as soon as they are discovered, allowing the vessel to refuel.

Once the ship has its exhaust outlets repaired, its fuel efficiency will climb.

## Damage control

A meeting of the ship's department heads will allow an accurate evaluation of the types of repair which the ship can undergo, and the time and materials involved. Another option might be for Sharna to simply require reports from the various departments. Either way, this will probably establish the basis for inter-crew relationships for the rest of this section

## Repair tasks

Several repair tasks can be defined, each of which will require man days of work and raw materials to complete (1 manday represents one person working at the project for most of his waking hours). A robot provides one and a half times the labor of a man. Many engineering projects will require at least two individuals to work on them.

Every task is divided into critical periods. At the end of each critical period, the persons detailed to the task must make skill rolls vs the task's difficulty. Failed rolls will cause one wasted man day of effort. Rolls which fail by more than 2 points are catastrophic failures, and will cause the whole critical period to be wasted for all workers involved. The computer may assist the crew in performing tasks by "talking them through". In order for this to have any effect, the umpire must make a successful roll of the computer's effective skill vs 10. If this roll succeeds, then the task's difficulty level is dropped by one step (e.g. a difficult task becomes an average task).

The possible repair tasks are as follows:

### *Repair Computer Systems*

Mandays required: 4+

Critical period: 2 man days

Task difficulty: Difficult

Equipment required: Electronics tools

Description: The ship once boasted an extensive computer network which performed a variety of vital tasks aboard ship. The extent of hardware damage aboard ship has downgraded the computer's ability to perform more than one operation at once. While capable of running all the routine operations, special operations will cause problems.

The number of special operations being undertaken simultaneously will govern the computer net's skill ability score in each operation.

Number of ops	Skill level
1	10
2	8
3	6
4	4
5+	2

Every time a manday is put into computer repair and a skill roll is made vs computer systems engineering, the computers skill levels are raised by 1 (to a maximum of ten). Thus if 4 successful rolls are made, the computer will be at skill level 10 when doing 1, 2 or 3 actions, and at level 8 when doing four actions.

Umpires should feel free to use the computer as a means of talking players through problems that they cannot figure out for themselves, helping them with the basic skills of defining problem elements.

### Repair Hull

Mandays required: 12

Critical period: 6 man days

Task difficulty: Average

Equipment required: Heavy tools, spare hull plates, structural members

Description: With its hull in its present condition, the DH-160 is incapable of anything but the most gentle acceleration. In addition, access through the ship is difficult due to depressurized sections and decks that are still open to vacuum.

While this task will secure and stabilize damaged hull sections, there is also the option of swapping out whole deck sections as well. Or the crew may elect to simply remove the more severely damaged decks to reduce mass in anticipation of future maneuvering ease. In either case, it will take 2 to 12 mandays (roll) to do the initial disconnects, depending on damage and practical expertise. Installing a new section will take 5 mandays plus a couple of mandays for testing and troubleshooting the connections, etc.

This task must be directed by a character with structural engineering skill. The project might cause dissent amongst the pessimistic members of the crew. Why prepare the ship for acceleration when it doesn't have any engines?

### Repair Drives

Man days required: 12

Critical period: 2 man days

Task difficulty: Difficult

Equipment required: Engine outlets, Fusion reactors, jump webbing.

Description: The DH-160 has suffered a hit from a fragment of ACV which largely destroyed the stern. There is no longer a stern fuel tank. High velocity debris has torn through most of the lower engineering decks, riddling the intricate plumbing networks for the power and propulsion reactors, as well as smashing up most of the individual reactors' beam generators and /or high pressure hydrogen injector pumps. Fundamental structural elements have been damaged or swept away, and all the MHD generators and magnetic nozzles have been knocked out of alignment or damaged beyond easy recovery.

To restore some sort of power generation to the ship, beyond the emergency accumulators and fuel cells, the reactor from the ACV will have to be dismantled and fitted to a salvaged MHD to supply the vessel's power (this takes 1.5 + 2-12 (roll) mandays to get a MHD generator operational).

There is radioactivity in this region of the ship, and continuous monitoring is necessary. The reactor's final focus will be hottest. There a robot will be needed to do any tasks that need more than a few minutes' exposure. Similarly, the reactor thrust plenum is hot enough to limit live exposure to only a few minutes. Other hardware, like the inner liners of the MHDs and magnetic nozzles, will also be warm, but the risk would be in hours rather than in minutes. It is vital that

anyone working below deck 15 has a total dosage monitor to prevent cumulative exposure danger. Robots will have to do much of the work in these areas. Any relatively simple live work should be shared out to keep any one person from excessive exposure.

The reactor area will need to be surveyed for extent of damage in general, and each reactor assembly will need to be examined individually. The initial survey will take 2 to 12 hours (roll), and the inspection of each reactor could take 20 to 120 minutes (roll). Two reactors will eventually be found to be intact, but will need to be dismantled and fitted to undamaged or repaired MHD or propulsion assemblies. There will also be 3 to 18 (roll) repairable MHDs at 2 to 12 mandays each, half of which must be done by robots which do not need to take the same precautions against radiation ('robot radiation work'). Only 2 to 12 (roll) mandays magnetic nozzles are repairable, and half of those will need important structural work. Figure 2-12 (roll) mandays per nozzle for basic refit or half that time for robot radiation work, while it will take 3 to 18 manhours (roll) for structural work.

The ship may then generate power, removing the necessity for using stored power. The ship is now capable of moving at *very* slow speeds, as long as a character with fusion engineering skill is constantly on watch while the vehicle is under thrust.

Rendering the ship capable of proper maneuver requires either fussily repositioning the ACV to act as a tug, having three or more propulsion reactors running.

### NASTY SURPRISE!

Once the ship has decent levels of power restored, the ship's jump engineers will begin to go over the DH-160's jump web - the complex lacing of jump generators that line the vessel's hull. After a day of furious work, the engineers will dejectedly report that the jump web is irreparably damaged.

This puts a halt to any plans about jumping the DH-160 out of system. The only option is to outfit the remaining ACV with elements of the DH-160's jump web and a message packet, and send a mayday out to the nearby Tlakatan system to ask for a rescue mission. This is a difficult task requiring successful rolls from a jump engineer, a mechanical engineer and a fusion engineer. A navigator will then have to prepare the necessary computer programs for the message torpedo. This task will take at least one day. The ACV will require about 20 tons of hydrogen fuel for its journey.

## Within the drift

As parties enter the drift in search of usable scraps, they will shift from clump to clump. The map of the drift zone shows a number of identifiable clumps (shown up by the ship's mass detectors) which are numbered for ease of identification. Some clumps are specifically listed below as

detailed locations. Other clumps are rolled randomly on the encounter chart at the end of this section.

One hex on the general map of the drift is about 500 kilometers across. The DH-160's radar and telescopes can pick out all of the clumps on the map as major sources of reflection, but cannot tell the composition of the clumps (the ship can tell whether clumps within 4 hexes of the ship are ice or not by their low density as compared to their high light refraction).

### The Clumps:

Clumps not described should be generated at random.

#### 1 - Search time = 1 hour

Grim reminders of a past battle will be found by one of the searchers: 5 torn, dismembered bodies of rabbits drift amongst the debris, the remains of a burial in space. Miscellaneous fittings and smaller sub assemblies can be cannibalized here.

#### 3 - Search time = 1 to 3 hours:

The booby trapped hull of a heavily damaged ILR frigate. Although the hull contains working fusion reactors, jump web, some salvageable electronics and many tons of usable hull segments, getting to it will be a problem. The hull has been thoroughly booby trapped by its old crew. Previous EDF salvage engineers decided that the risk of clearing the ship was not balanced by the value of the salvage in it. The ship was shunted into the drift, and warning signs were placed on all airlocks and access ports.

If the crew of the DH-160 wishes to explore inside the hull, then create a ship using the same module maps as the DH-160. Explosive charges, 6mm SMG's and electrical discharges will be hooked up all over the ship in a number of cunning and lethal booby traps. Umpires will have to use their discretion and imagination in the layout of these traps. A particularly subtle booby trap would be a computer "virus" programmed into some choice, juicy bits of electronics that the exploring crew can't help but take home. Tracking down the virus once it is loose will require the partitioning and "quarantining" of all electronics on board as the computer engineer tracks down the little blighter, which is meanwhile trying to replicate itself throughout the ship's computer network and cause as much trouble as possible. Fun, eh?

Once the crew have encountered this ship, they may want to be more careful with future search missions. If so, then double the standard search time for checking out ship's hulls.

### Random Clump generation

When an exploration team enters a clump that is not described in the text above, the clump's contents are determined randomly on the charts below:

Roll 1D10 and consult the following chart:

#### 1 Ice - Search Time: 10 minutes.

The clump contains several lumps of water ice (1D10 x 100

#### 8 - Search time =

#### 10 minutes + 10 minutes per entry attempt.

The front end of some sort of frigate tumbles lazily end over end in the middle of an agitated cloud of jagged debris. Maneuvering into the frigate hull section will require a roll on the character's zero-Gee movement skill, with a failed result indicating a possible suit tear (attack the character with the equivalent of a knife). Characters who manage to enter the hull will find a scene of absolute horror. The remains of 2 or 3 persons are sprayed about the walls. The vessel's interior is a shambles of flattened equipment spattered with organic fragments. This hull contains 2 usable hull struts.

#### 12 - Search Time = 15 minutes

The virtually intact hull of an ILR supply vessel. This ship was of modular construction, and seems to be missing its cargo pods. The ship is of a similar radius to the DH-160.

The ship has been scavenged almost bare. It lacks electronics, engines, detectors - any usable hardware. What it does have to offer are enough intact hull segments to replace the compromised sections of the DH-160's hull. The fuel tanks contain 1000 tons of liquid hydrogen. Most importantly, although the ships reactors are missing, the actual hull modules that housed them are intact. Since these are of the same standard size as those used on the DH-160, the crew can replace their own damaged stern modules with the ones from this ship. This will give the DH-160 a structurally sound engineering section, needing only the reactors and associated nozzles or MHDs to fit it out. Swapping the entire engineering section would take 2 to 8 mandays, due to damage complicating the job. Then another 4 to 12 mandays will be needed to test and troubleshoot the joined section. It will also require the use of the ACV as a tug to maneuver the several-thousand-ton sections into place.

#### 15 - Search Time + 1/2 to 1 1/2 days

A stationary cluster of 4 damaged ACVs of Republican manufacture. All are heavily damaged, but three of these little beauties still have intact reactors.

Of the 3 drones that still have drives, 2 are somewhat "hot" (irradiated), and can cause sickness in any person in close contact with them for a few hours. The third drone has been sheared in two, and lacks a bow section, but is otherwise in excellent condition.

The drives on these ACVs could be a gift from Khai to the crew of the DH-160. Two hours work is required to separate an ACV's reactor packet from the remnants of its hull, and care should be taken in transporting each reactor module back to the ship. These reactors are interchangeable with some juryrigging of power or propulsion fittings.

#### 20 - Time to search = 20 minutes.

The heavily damaged hull of a 20,000 ton freighter. The front fuel tank and most of the forward superstructure has been sheared off by an ACV strike. Characters who come



close enough will see the name "Quitzi" emblazoned on the scarred hull. The inside of this ship is a shambles. Immediately apparent is a vacc suited body just inside the airlock which has been riddled by bullets at close range. Five other bodies may be found inside in a similar condition.

This ship has been stripped of its engines and valuable parts, but still retains its jump web, hull plates, engine outlets and other useful gear.

After a day of working in this area, the pirates at location 23 will probably notice the activity in the region and will investigate - see skirmish section.

### 23 - A comet husk- see

*The Pirate Base.*

**26 - A fragment of starship hull bearing the letters " \_ \_ K O" (part of the hull of the AIKO, blown up by the pirates some weeks ago).**

## Random Clump generation

When an exploration team enters a clump that is not described in the text above, the clump's contents are determined randomly on the charts below:

Roll 1D10 and consult the following chart:

### 1 **Ice - Search Time: 10 minutes.**

The clump contains several lumps of water ice (1D10 x 100 tons). There is nothing else of value here.

### 2,3 **Debris - Search Time: 30 min to 3 hr**

The clump is a dense cloud of torn hull plates and fragments of starship. While this area might contain something of value, it can be dangerous to search.

### 4 **Vapor cloud - Search Time: 30 min to 3 hr**

This area consists of a dense core of debris surrounded by a thick cloud of vapor or ice crystals. There may be items of value inside, but the severe restriction of vision might make it dangerous to search the area.

### 5 **Particle cloud - Search Time: 30 minutes.**

A zone of metallic dust. If the party decides to enter and search, they will pick up a high static charge, which may suddenly ground out with interesting results when they get back on board ship (e.g. it might flash weld their boots to the floor). The particle cloud might contain interesting items, and can be well worth searching.

### 6 **Comet husk - Search Time: 10 minutes.**

A lump of silica sheathed in ice. This huge object might yield about 500 tons of water ice. If the umpire wants a bit of fun, it might pay to remember that very cold water ice is capable of absorbing large amounts of CO<sub>2</sub>. This creates a great big block of frozen soda water . . .

### 7,8 **Nickel/Iron asteroids - Search Time: 20 minutes.**

The original occupants of the L5 point.

### 9 **Fused lump - Search Time: 10 minutes.**

An interesting abstract lump which was probably once a starship. There is nothing else of interest in this area.

### 10 **Radioactive debris - Search Time: 30 min to 3 hr**

Much like the debris clump listed above, except the individual elements are highly radioactive. The clump might well contain items of interest.

## STEP 2:

If the party decides to search a clump which is listed as possibly containing items of interest, then roll a random event on the following chart (roll 1d10):

### 1-2: **Nothing**

### 3: **Enemies**

This clump has an active mechanical weapon lurking within. This might be an ACV with enough fuel and power to try to slowly home in on a target and explode, or a ship with a functional point defense cannon which opens fire on objects attempting to close with it. It might even be an empty hull which holds a damaged, armed robot which will attempt to kill intruders. However, if IFF (identification, friend or foe transponders) are activated by the PC's, there is a 50/50 chance that the weapon will be friendly.

### 4: **Puncture**

A random character tears his suit. Roll 1d6: 1-2 is a minor breach; 3-4 is a puncture; 5 is a tear; 6 is a major breach. Coolness under Fire check vs 10 is required for the character to instantly patch the tear; otherwise, a turn will go past before he may act.

### 5: **Radio noise.**

All suit radios register a brief burst of static, followed by a collection of beeps and buzzing sounds.

### 6-7: **Item**

Roll 1d6 to see what the characters have found:

- 1 Ship's Sensor Array
- 2 Corrosive liquid
- 3 ACV fragments
- 4 Minor tools or personal effects
- 5 Transponder
- 6 Gas cylinders

### 8: **Space burial**

The party suddenly encounters several horribly mutilated bodies of ILR spacers (play this up for shock effect). The bodies might well be clutching useful or interesting items in their frozen hands.

### 9: **Radioactive junk**

The party finds a potentially useful piece of equipment. Unfortunately, the item is highly radioactive.

### 10: **Heebie-jeebies**

One random character suddenly succumbs to nerves. Roll Coolness under Fire vs 10.

If the test is passed, the character freezes for a few minutes, or until someone physically snaps him out of his reverie. If the test is failed, the character will become nervous, and will

overreact to stress situations for the next few days. He will also become particularly susceptible to Evertard. If the test was drastically failed (i.e., by more than 2 points), then the character will suddenly start to act in an irrational manner (umpires – indulge yourselves!).

### Searching Derelict Ships

Although the derelict starships found in the drift are some twenty years old, they follow the same basic construction patterns as the DH-160's generation of ships. The umpire may thus use the internal maps of the DH series vessels from the technical handbook to represent the internal areas of derelict vessels. Umpires should feel free to change around the internal arrangements or add internal damage.

If umpires wish to liven up the exploration of derelict space craft, the following list of problems might come in handy:

#### Volatile items

The remains of workshops, weapon bays or cargo holds might contain dangerous volatile substances (damaged canisters of gas, industrial explosives, etc.). Fooling around with unknown objects can be dangerous for the incautious.

#### Booby traps

A booby trapped ILR vessel will have explosives wired to doors, guns laid to fire down access shafts, etc. More ingenious booby traps could include hidden structural age to important pieces of equipment, computer viruses, etc.

#### BLOCKED ACCESS

Battle damage can block access through corridors and hatchways. Debris and water ice can all form obstacles that must be cleared away before exploring characters can continue. Remember that with no power, all closed doors and hatches will have to be cranked open by hand.

## Map of The Drift

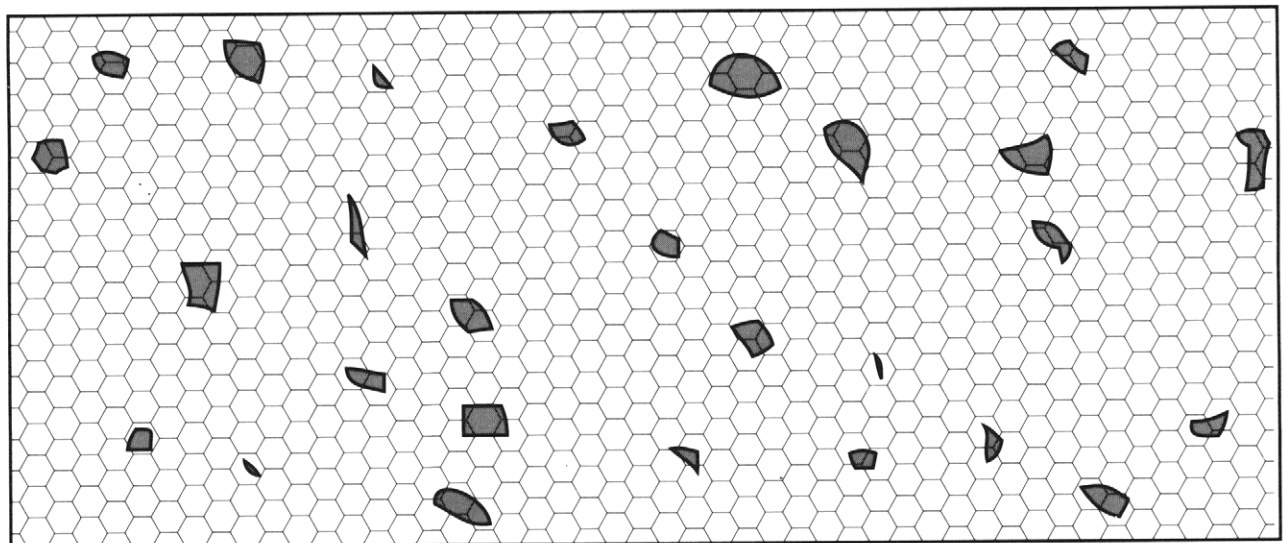

One hex = 500 km. Objects are not to scale, but should be considered as occupying the hex at their seeming center. Umpire should assign numbers, either rolling at random or choosing objects to represent chosen table entries. The DH-160 enters from upper left corner.

#### SEALED CONTAINERS:

Sealed containers can be good, harmless traps for unwary characters. Many containers are sealed for a reason. Imagine opening a container of cherry fondant or maple syrup while in a vacuum – yeuchh!

## Meeting the Pirates

The players will have an encounter with a hostile scavenging party (the marooned pirates from clump 23) after the crew of the DH-160 has been actively searching The Drift for six days. Feel free to stage this combat however you like, matching the EDF characters with enough pirates to provide challenge, but not enough to be lethal.

If fighting in a debris clump, use a standard blank star map, but add in a selection of minor obstacles (clouds of jagged debris which will attack characters with 0 to 3 slashing weapons [-2 damage] when moved through), major obstacles (hull plates and rocks that may be used as stable platforms or cover) and clouds of gas/ice crystals (which partially obscure vision). Combats aboard derelict ships should use the module maps from the technical handbook.

The scavenging party will be attacked by one to five pirates, all equipped with vacc suits, armored helmets, flak armor and 8mm pistols firing dart ammunition. They have entered this area by means of a zero-G utility vehicle (a small six-seater with a limited cargo capacity). The vehicle is parked some distance away from the area of conflict, as is the ACV/shuttle from the DH-160.

The pirates have been searching The Drift for spare parts and were not expecting trouble. They have noticed the EDF party's radio chatter and come to investigate. If for some reason the PCs have maintained radio silence, this is a surprise encounter for both sides.

All pirates have gun skills and Zero-G Maneuver skills.  
Choose the attacking pirates from the following:



**Pirate #1**  
 Critter type: Rat (Small frame)  
 Disposition: Cautious  
Characteristics  
 Str: 5  
 Sta: 12      Sta/2: 6  
 MDex: 12  
 Coord: 13      Actions/turn: 5  
 Reas: 10  
 Intu: 10      Init. dice: 1d6  
 Drv: 10  
 Stab: 9

A sneaky character who will take a minimum of risks.



**Pirate #2**  
 Critter type: Dog (Average frame)  
 Disposition: Reckless  
Characteristics  
 Str: 11  
 Sta: 14      Sta/2: 7  
 MDex: 10  
 Coord: 9      Actions/turn: 4  
 Reas: 12  
 Intu: 9      Init. dice: 1d6  
 Drv: 13  
 Stab: 8

A low stability, high drive type, much taken with sudden attacks and dangerous moves.



**Pirate #3**  
 Critter type: Rabbit (Light frame)  
 Disposition: Deceitful  
Characteristics  
 Str: 8  
 Sta: 9      Sta/2: 5  
 MDex: 12  
 Coord: 11      Actions/turn: 4  
 Reas: 9  
 Intu: 12      Init. dice: 1d6+1  
 Drv: 11  
 Stab: 10

This character will use ruses and cunning tactics rather than a straightforward approach. If captured, he will try to mislead his captors into thinking that he and his group are marooned merchants from the Quitzl.



**Pirate #4**  
 Critter type: Tiger (Solid frame)  
 Disposition: Straightforward  
Characteristics  
 Str: 13  
 Sta: 10      Sta/2: 5  
 MDex: 10  
 Coord: 9      Actions/turn: 4  
 Reas: 8  
 Intu: 10      Init. dice: 1d6  
 Drv: 9  
 Stab: 12

A strong, stolid character with a decided vicious streak



**Pirate #5**

Critter type: Dog (Average frame)  
 Disposition: Cruel  
Characteristics  
 Str: 9  
 Sta: 12                      Sta/2: 6  
 MDex: 9  
 Coord: 11                    Actions/turn: 4  
 Reas: 10  
 Intu: 8                        Init. dice: 1d6+1  
 Drv: 13  
 Stab: 14

A brutal monomaniac who tends to pursue a single foe to the detriment of any coordinated attacks made by his group. He will singlemindedly attack his chosen mark, delighting in inflicting a nasty death on a helpless individual. He will never surrender, preferring to play dead and have one last try at killing his opponents.

**Notes on the Combat:**

This enemy party should give the players few problems. If Torscha is present in the scavenging party, then this is a good chance for him to use his Small Unit Tactics skill. If he uses it successfully, then he will gain a chance for Self Image improvement. If things go badly for the EDF party, then they should retreat back to their vehicle and leave. A poor showing in this combat will affect the self image of the party leader, and will fuel Roilant Everrard's support among the crew (unless he was leading the scavenging party, which seems unlikely). If pirate survivors make it back to the pirate base, then the pirates will become aware of unwanted company in the drift (the DH-160 is in for trouble!).

Prisoners brought back from the encounter will be very useful. If the players can figure out a way of extracting the requisite information, a prisoner will be a valuable aid in tracking down the pirate base. Beating up prisoners is against regulations, and is definite grounds for arrest.

**Aftermath:**

The EDF crew may try several different ways of tracking down the pirates' base. The electronic wiz kids on board can shift off other projects and try to repair the ship's EM detectors, which would pick up the presence of operating fusion power plants, radios or fusion drives within the drift. Repairing the detectors is difficulty level 20, costing 2 mandays per attempt at repair.

Adventure Continued on page 56

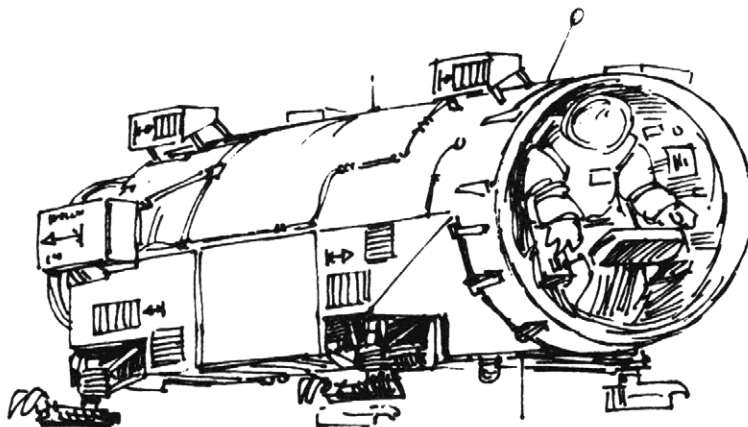

**Pirates' Vehicle**



**Roland Everard**



Critter type: Horse  
Rank: 0  
Spec. Level: 3 (Starship pilot)

**Mankheeharhallian (Mank)**



Critter type: Rabbit  
Rank: 0  
Spec. Level: 4 (Jump drive engineer)

**Tatzel Huden**



Critter type: Cat  
Rank: 0  
Spec. Level: 3 (Starship navigator)

**Erwin Chehok**



Critter type: Raven  
Rank: 0  
Spec. Level: 2 (Starship engineer)

**Julius Clari**



Critter type: Bear  
Rank: 0  
Spec. Level: 4 (Starship medic)

**Deika Tovan**



Critter type: Pig  
Rank: 0  
Spec. Level: 3 (Starship computer tech)

**Aelis Eocha**



Critter type: Dog  
Rank: 0  
Spec. Level: 2 (Starship systems tech)

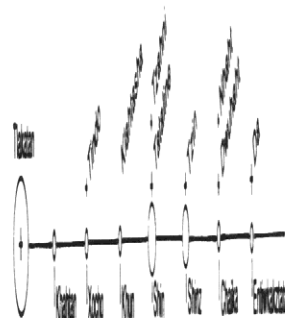

A neat, self-possessed character who seems unusually zealous in the pursuit of his duties. He has a strange love/hate relationship with Aelis Eocha (both parties rain insults and sarcasm on each other, argue loudly and frequently, and spend an awful lot of their spare time together).

Always a self possessed and confident character, Roilant radiates a sort of dapper charisma, but has a sarcastic wit (usually at the PCs' expense!). Roilant was wounded in the head during the battle with the unknown "bogey", and has been recuperating ever since.

Everrard was highly put out that Sharna has assumed the position of Mission Commander in his absence, and he clearly feels that he has an equal claim to the position.

A talkative character who has managed to corner you several times for a very one sided chat. Apart from this, Erwin seems to keep very much to himself. He is devastated by the loss of the ship's chief engineer, who was his only real friend, and has become more withdrawn than usual.

One of the most open, friendly characters that you have ever met, Tatzel has shown herself to be level headed and calm under stress. Tatzel is Sharna's best female friend aboard, and spends a lot of her off time with the PC's. Intelligent, cheerful and active, Tatzel has a habit of seeing the good in everyone.

Torscha will also attest that Tatzel is extremely attractive.

Another newcomer to the crew, Deika avoids the company of the other new crew-members. Deika is short tempered and self important, so the player characters don't really miss his company.

As the vessel's chief medic, Julius has always tried to maintain equal relations with the entire crew. He has always been a jovial, plain speaking character with a high regard for his fellow crew. He often acts as a listener when people have gripes or personal problems.

Julius has been very withdrawn and preoccupied ever since the battle, and has ceased to take much notice of the people around him – perhaps he is grief stricken at the loss of the ship's captain, with whom he had served for many years. Whatever the reason, he is currently not very approachable.

Remember that the computer is an intelligent character whose task is to serve and assist the living crew. Use the computer as a source of advice and assistance (even with personal problems). The ship's robots are also an important part of the maintenance crew – don't forget them!

Aelis is happy-go-lucky but very moody. She is also has a very annoying habit of assuming that her companions always know precisely what she wants from them without the bother of an explanation. She is so honestly friendly, however, that few people can hold grudges against her for long. She has unshakable concentration when working on a problem.

# ALBEDO

## Character Sheet

Player

Name	<u>Sharna Aoki</u>
Sex	<u>Female</u>
Critter Type	<u>Rodent (Mouse)</u>
Frame Size	<u>Small</u>
Disposition	
Core, Inclination	<u>Responsible, Polite</u>
Position	<u>Starship Pilot Officer</u>
	<u>Specialist 3</u>

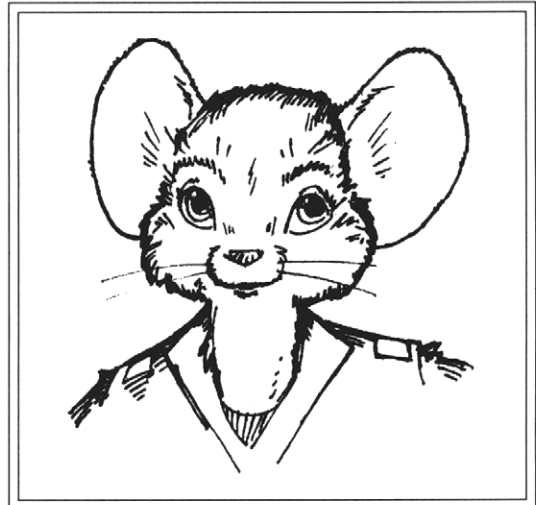

<b>STRENGTH</b>	<input type="text" value="5"/>	x 1/3 = Recoil Number	<input type="text" value="1"/>	<input type="text"/>	modified
<b>STAMINA</b>	<input type="text" value="11"/>	x 3 = Maximum Fatigue Points	<input type="text" value="33"/>		
<b>MANUAL DEXTERITY</b>	<input type="text" value="12"/>	Current Fatigue Points	<input type="text"/>		
<b>COORDINATION</b>	<input type="text" value="13"/>	x 1/3 = Actions per Turn	<input type="text" value="5"/>	<input type="text"/>	modified
<b>REASON</b>	<input type="text" value="13"/>	(REAS+INTU+DRV)/10 = SPI	<input type="text" value="3.5"/>		
<b>INTUITION</b>	<input type="text" value="10"/>	Initiative Dice	<input type="text" value="1d6"/>		
<b>DRIVE</b>	<input type="text" value="12"/>	x 1/2, x 1-1/2 = range of Self Image	<input type="text" value="6"/>	<input type="text" value="18"/>	low high
<b>STABILITY</b>	<input type="text" value="13"/>	Current Self Image	<input type="text"/>		

**WOUNDS\***

	<input type="text"/>	on
--	----------------------	----

\*All modifiers are cumulative.

Encumbrance level*	<input type="text"/>	<input type="text"/>	on Coordination
Burden level*	<input type="text"/>	<input type="text"/>	on Coordination and MDex
Fatigue level*	<input type="text"/>	<input type="text"/>	on all characteristics

**FATIGUE TRACK**

Keep position with a paper clip. Block out all boxes higher than Maximum Fatigue Value. Divide Fatigue into six equal portions for Fatigue Levels 0 to 5. Cross off boxes for non-recoverable Fatigue.

50
49
48
47
46
45
44
43
42
41
40
39
38
37
36
35
34
33
32
31
30
29
28
27
26
25
24
23
22
21
20
19
18
17
16
15
14
13
12
11
10
9
8
7
6
5
4
3
2
1
DEAD



## CHARACTER BACKGROUND

Sharna is a well spoken, attractive female mouse. A relative newcomer to the DH-160, she has begun to establish a foothold as one of the most competent, easygoing characters aboard ship. She has a definite grouchy streak, but keeps it well controlled with a sense of humor. Sharna will probably apply for command training if she survives this current mission.

Sharna is ambitious. She has had to fight against a fair amount of male chauvinism in her career so far, and so has learned to take her chances as they appear and to hold onto them *tenaciously*.

## SKILLS AND AREAS OF EXPERTISE

Assess Personality	Research
Computer Operations	Sneak
Coolness under Fire	Starship Navigation
Current Affairs	Starship Pilot
Detect Hidden	Starship Weapons
Detect Lie	Zero-G Maneuver
Drive Ground Car	
Electronics	
Handguns	
Hide in Cover	
Higher Mathematics	
Leadership	
Longarms	
Mingle	
Physics	

## TIES

Strength of Tie

Torscha Derling	8
Braddock Haina	5
Tatzel Hulden	5
Confed Charter	4
Mission Commander position	6

## ANTIPATHIES

Strength of Antipathy

Roilant Everard	2
-----------------	---

## POSSESSIONS

## NOTES

Sharna is currently acting in the temporary role of Mission Commander. While Roilant Everard (also a Pilot Spec. 3) has an equal claim, his injuries in the battle kept him unconscious for a few days, during which Sharna was forced to assume control of the ship. Despite the tragic way in which she gained her command, Sharna enjoys the role of Mission Commander and is aware that good performance during the current crisis will help to establish her reputation.

Sharna's Self Image is now heavily tied with the role of Mission Commander. She is proud of the position, and feels that she is the only person aboard who can do the job. She is avid to retain the position, and will go to great lengths to do so.

# ALBEDO

## Character Sheet

Player

Name	<u>Torscha Derling</u>
Sex	<u>Male</u>
Critter Type	<u>Canine (Fox)</u>
Frame Size	<u>Light</u>
Disposition	<u>Talkative, Devious</u>
Core, Inclination	
Position	<u>Starship Weapons Officer</u> <u>Specialist 3</u>

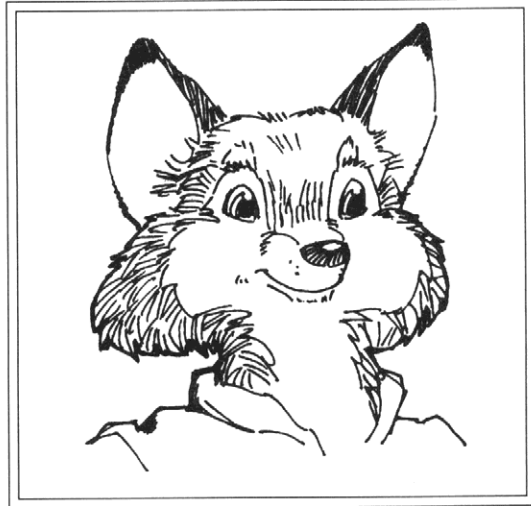

50
49
48
47
46
45
44
43
42
41
40
39
38
37
36
35
34
33
32
31
30
29
28
27
26
25
24
23
22
21
20
19
18
17
16
15
14
13
12
11
10
9
8
7
6
5
4
3
2
1
DEAD

<b>STRENGTH</b>	8	x 1/3 = Recoil Number	2		modified
<b>STAMINA</b>	8	x 3 = Maximum Fatigue Points	24		
<b>MANUAL DEXTERITY</b>	12	Current Fatigue Points			
<b>COORDINATION</b>	12	x 1/3 = Actions per Turn	4		modified
<b>REASON</b>	11	(REAS+INTU+DRV)/10 = SPI	3.9		
<b>INTUITION</b>	14	Initiative Dice	3d3		
<b>DRIVE</b>	14	x 1/2, x 1-1/2 = range of Self Image	7	21	low high
<b>STABILITY</b>	7	Current Self Image			

**FATIGUE TRACK**  
 Keep position with a paper clip. Block out all boxes higher than Maximum Fatigue Value.  
 Divide Fatigue into six equal portions for Fatigue Levels 0 to 5.  
 Cross off boxes for non-recoverable Fatigue.

<b>WOUNDS*</b>		
		on

\*All modifiers are cumulative.

Encumbrance level*			on Coordination
Burden level*			on Coordination and MDex
Fatigue level*			on all characteristics

## CHARACTER BACKGROUND

Torscha is a cunning male fox. An ardent student of military history (what there is of it), he has managed to conquer his mathematical dyslexia enough to master the skills of starship combat. Although he has little affinity for machinery, he has a natural talent for starship weapons deployment, which almost certainly saved the DH-160 during the recent encounter. Torscha admires cunning and artistry, but abhors outright brutality.

Torscha feels that he is emotive, moody and proud, facets of his personality which he tries hard to control in the best traditions of the EDF. He is actually far too hard on himself, and keeps track of his own failings long after others have forgotten.

## TIES

Strength of Tie

Sharna Aoki	5
Julius Clari	2
Braddock Haina	5
Tatzel Hulden	10
Duty	7

## POSSESSIONS

---



---



---



---



---



---



---



---



---



---



---



---



---



---



---



---

## SKILLS AND AREAS OF EXPERTISE

Assess Personality	Research
Computer Operations	Small Grnd Unit Tac
Coolness under Fire	Sneak
Current Affairs	Socio-history
Detect Hidden	Starship Weapons
Detect Lie	Swimming
Electronics	Zero-G Maneuver
Handguns	
Hide in Cover	
Leadership	
Longarms	
Melee (Armed)	
Melee (Unarmed)	
Naval Deployment	
Political Science	

## ANTIPATHIES

Strength of Antipathy

Deika Tovan	1

## NOTES

Torscha is a character with considerable charisma, since his ready enthusiasm is quite infectious. He would like to hold a position of authority, but no one yet knows whether he is really suited for command.

Torscha is thoroughly infatuated with Tatzel Hulden, a preoccupation which he has so far kept to himself. He fears making a fool of himself. He is, however, keen to win the respect and admiration of Tatzel.

---



---



---



---



---



---



---



---



---



---

# ALBEDO

## Character Sheet

Player

Name	Braddock Haina
Sex	Male
Critter Type	Canine (Wolf)
Frame Size	Solid
Disposition	Core, Inclination Laconic, Reserved
Position	Starship Engineer Specialist 3



50
49
48
47
46
45
44
43
42
41
40
39
38
37
36
35
34
33
32
31
30
29
28
27
26
25
24
23
22
21
20
19
18
17
16
15
14
13
12
11
10
9
8
7
6
5
4
3
2
1
DEAD

<b>STRENGTH</b>	13	x 1/3 = Recoil Number	4	modified
<b>STAMINA</b>	12	x 3 = Maximum Fatigue Points	36	
<b>MANUAL DEXTERITY</b>	10	Current Fatigue Points		
<b>COORDINATION</b>	9	x 1/3 = Actions per Turn	3	modified
<b>REASON</b>	10	(REAS+INTU+DRV)/10 = SPI	3.0	
<b>INTUITION</b>	10	Initiative Dice	1d6	
<b>DRIVE</b>	10	x 1/2, x 1-1/2 = range of Self Image	5	15
<b>STABILITY</b>	9	Current Self Image		low      high

**FATIGUE TRACK**  
 Keep position with a paper clip. Block out all boxes higher than Maximum Fatigue Value.  
 Divide Fatigue into six equal portions for Fatigue Levels 0 to 5.  
 Cross off boxes for non-recoverable Fatigue.

<b>WOUNDS*</b>				on
Encumbrance level*				on Coordination
Burden level*				on Coordination and MDex
Fatigue level*				on all characteristics

\*All modifiers are cumulative.

## CHARACTER BACKGROUND

A bit of an enigma, Braddock seems to be a typical, clichéd starship engineer—devoted to his ship, short on conversation, and serenely preoccupied with the world of machines and starship drives. Those who truly know him will soon realize that he has a great deal more to his character. He is very well read, and excels in conceiving and producing gadgets of all kinds. Beneath his reserved exterior lies a cunning (and often bizarre) sense of humor and a lively imagination. If a practical joke is played anywhere on board, it is a safe bet that Braddock was probably behind it. He has an aversion to violence, and prefers to solve problems through wry cunning.

Braddock tends to shelter himself from other people, and has few social skills. He dislikes the public display of strong passions of any kind, be it pride, live, hate, or anger.

## TIES

	Strength of Tie
Sharna Aoki	3
Torscha Derling	3
Aelis Eocha	5
DH-160	8

## POSSESSIONS

---

---

---

---

---

---

---

---

---

---

---

---

---

---

---

---

---

---

---

---

---

---

---

---

---

---

## SKILLS AND AREAS OF EXPERTISE

Computer Operations	Zero-G Maneuver
Coolness under Fire	
Detect Hidden	
Detect Lie	
Electronics	
Fusion Engines	
Handguns	
Hide in Cover	
Jump Engines	
Leadership	
Longarms	
Mechanical Repair	
Physics	
Sneak	
Spin Yarn	

## ANTIPATHIES

	Strength of Antipathy	
Roilant EVERRARD		2

## NOTES

Braddock has had vague yearnings towards Aelis Eocha, but hardly admits this even to himself, preferring to pretend to himself that he is his own, self-contained universe. This leaves him capable of dealing with tension, loss and grief better than just about any other person on board, but at too great a cost. Braddock is in danger of becoming a totally insular personality.

Braddock has developed a passing friendship with Sharna and Torscha. His calm, calculating wit tends to balance Torscha's devious, energetic personality and Sharna's quick temper. He has never really shared any deep personal thoughts with his two companions; he keeps such things very much to himself.

---

---

---

---

# ALBEDO

Name	<b>Roilant Everrard</b>
Critter Type	Male
Frame Size	Ungulate (Horse) Solid
Disposition	
Core, Inclination	Cautious, Conceited
Position	Starship Pilot Specialist 3



50
49
48
47
46
45
44
43
42
41
40
39
38
37
36
35
34
33
32
31
30
29
28
27
26
25
24
23
22
21
20
19
18
17
16
15
14
13
12
11
10
9
8
7
6
5
4
3
2
1
DEAD

<b>STRENGTH</b>	13	4		Recoil Number Modified
<b>STAMINA</b>	7	21		Max Fatigue Pts
<b>MANUAL DEX</b>	7			Current Fat. Pts
<b>COORDINATION</b>	8	3		Actions / Turn Modified
<b>REASON</b>	10	3.5		SPI
<b>INTUITION</b>	10	1d6		Initiative Dice
<b>DRIVE</b>	15	8	23	
<b>STABILITY</b>	7			Range of Self Image (low to high) Current Self Image

**SKILLS**

- Coolness under Fire
- Detect Hidden
- Detect Lie
- Handguns
- Hide in Cover
- Leadership
- Longarms
- Public Speaking
- Sneak
- Spin Yarn
- Starship Navigation
- Starship Pilot
- Zero-G Maneuver

**TIES**

**ANTIPATHIES**

- Sharna Aoki 4
- Torscha Derling 3

A stubborn, overbearing character who is convinced of his own infallibility, Everrard often dominates weaker personalities through his air of competence and self assurance. He is currently preoccupied with the notion that he, not Sharna, should be in command of the ship. He wrongly believes that Sharna snatched her opportunity for command unfairly, and even suspects that he was secretly kept sedated long enough for Sharna to consolidate her position. He is developing all the classic signs of stress-induced paranoia. If the ship's computer were still running, it would certainly have noted his strange behavior by now.

Everrard begins the adventure suffering from a head wound. He is up and about, but he still gets weak after physical activity, which will last for the next three days. He receives an additional +1 DRM to Strength and Coord when he receives a Fatigue DRM.

Everrard currently believes that the ship which attacked the DH-160 was an isolated ILR commerce raider, and that this system is now safe.

Everrard will develop further antipathy toward Sharna whenever her leadership proves succesful, and whenever his pet theories are proven wrong (he can glibly explain away his failings with an increasingly paranoid rhetoric). When his Antipathy for any person reaches 15, he will begin to actively work against that person with all the means at his command. He will gladly plot the death of another crew member, but would prefer to use others as his tools, since he must justify his actions upon return from this mission.

<b>WOUNDS*</b>			on
Encumbrance level*			on Coordination
Burden level*			on Coordination and MDex
Fatigue level*			on all characteristics

\*All modifiers are cumulative.

# ALBEDO

Name	<b>Tatzel Hulden</b>
Sex	Female
Critter Type	Feline (Cat)
Frame Size	Light
Disposition	
Core, Inclination	Friendly, Responsible
Position	Starship Navigator Specialist 3



	Recoil Number Modified		
<b>STRENGTH</b>	6	2	
<b>STAMINA</b>	14	42	Max Fatigue Pts
<b>MANUAL DEX</b>	11		Current Fat. Pts
<b>COORDINATION</b>	13	5	
		Actions / Turn Modified	
<b>REASON</b>	12	3.0	SPI
<b>INTUITION</b>	9	1d6	Initiative Dice
<b>DRIVE</b>	9	5	14
	Range of Self Image (low to high)		
<b>STABILITY</b>	11		Current Self Image

- SKILLS:**
- Coolness under Fire
  - Detect Hidden
  - Detect Lie
  - Handguns
  - Hide in Cover
  - Jump Navigation
  - Leadership
  - Longarms
  - Repartee
  - Sneak
  - Starship Navigation
  - Starship Weapons
  - Zero-G Maneuver

TIES	ANTIPATHIES
Sharna Aoki	4
Torscha Derling	3
Braddock Haina	3
Duty	6

50
49
48
47
46
45
44
43
42
41
40
39
38
37
36
35
34
33
32
31
30
29
28
27
26
25
24
23
22
21
20
19
18
17
16
15
14
13
12
11
10
9
8
7
6
5
4
3
2
1
DEAD

Trim, taut, and terrific, Tatzel projects an image of good natured intelligence. She is also perhaps a touch too innocent, since she has trouble thinking ill of anyone. She will not easily come to terms with duplicity in a comrade. If she is forced to perform violence against someone that she knows, her Self Image will suffer.

Tatzel is Sharna's best female friend aboard the ship.

While Tatzel finds Torscha witty and amusing, she does not yet suspect his feelings toward her. She would need a far greater level of Tie with him than she currently has in order to reciprocate, but she will avoid hurting him if he suddenly presses the issue. She would find this sort of incident very distressing, and would lose 1d3 points of Self Image. Crying is very difficult to conceal in zero-G, so if she is seriously upset, her friends will soon know.

<b>WOUNDS*</b>			on
Encumbrance level*			on Coordination
Burden level*			on Coordination and MDex
Fatigue level*			on all characteristics

\*All modifiers are cumulative.

# ALBEDO

Name	<b>Julius Clari</b>
Sex	Male
Critter Type	Ursine (Bear)
Frame Size	Huge
Disposition	
Core, Inclination	Straightforward, Laconic
Position	Starship Medic
	Specialist 4



<b>STRENGTH</b>	13	4		Recoll Number Modified
<b>STAMINA</b>	11	33		Max Fatigue Pts
<b>MANUAL DEX</b>	10			Current Fat. Pts
<b>COORDINATION</b>	8	3		
<b>REASON</b>	11	3.0		Actions / Turn Modified SPI
<b>INTUITION</b>	10	1d6		Initiative Dice
<b>DRIVE</b>	9	5	14	
<b>STABILITY</b>	14			Range of Self Image (low to high) Current Self Image

**SKILLS**

- Coolness under Fire
- Detect Hidden
- Detect Lie
- First Aid
- Handguns
- Hide in Cover
- Leadership
- Longarms
- Medical
- Sneak
- Surgery
- Starship Weapons
- Zero-G Maneuver

**TIES**

- Sharna Aoki 2
- Roilant Everrard 2
- Duty 4

**ANTIPATHIES**

Julius is caught between two camps, and often finds himself cast as the listening post for Sharna's and Everrard's gripes. He is far too preoccupied to pay attention to the mental state of the crew, since he is deeply affected by grief over the death of the ship's captain and chief navigator, with whom he had served for many years.

If asked to prepare a report on stress among the ship's crew, Julius will depend on the AI too much, not grasping its limited ability. He will produce an evaluation which shows no real grasp of the crew's current mood. This negligence may well cost him dearly should he survive the current mission.

Julius will find it difficult to choose sides if matters should come to a head, but he will choose. Since he has paid little attention to the state of the crew's interpersonal relations, he will be easily influenced by the first person to corner him during a real crisis.

<b>WOUNDS*</b>			on
Encumbrance level*			on Coordination
Burden level*			on Coordination and MDex
Fatigue level*			on all characteristics

\*All modifiers are cumulative.

50
49
48
47
46
45
44
43
42
41
40
39
38
37
36
35
34
33
32
31
30
29
28
27
26
25
24
23
22
21
20
19
18
17
16
15
14
13
12
11
10
9
8
7
6
5
4
3
2
1
DEAD



# ALBEDO

Name **Erwin Chehok**  
 Sex **Male**  
 Critter Type **Avian (Raven)**  
 Frame Size **Light**  
 Disposition  
 Core, Inclination **Responsible, Talkative**  
 Position **Starship Engineer**  
**Specialist s**

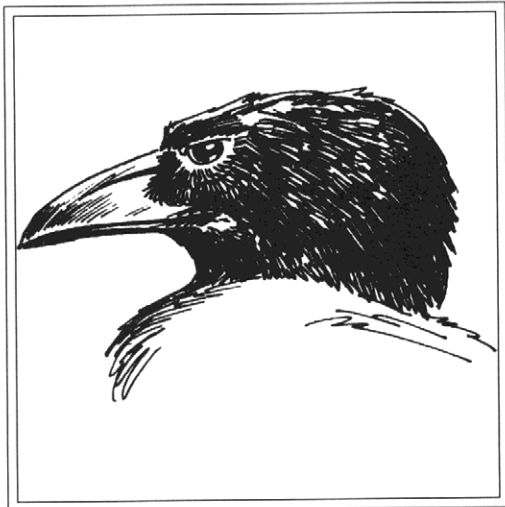

50
49
48
47
46
45
44
43
42
41
40
39
38
37
36
35
34
33
32
31
30
29
28
27
26
25
24
23
22
21
20
19
18
17
16
15
14
13
12
11
10
9
8
7
6
5
4
3
2
1
DEAD

	Recoil Number Modified		
<b>STRENGTH</b>	6	2	
<b>STAMINA</b>	8	24	Max Fatigue Pts
<b>MANUAL DEX</b>	12		Current Fat. Pts
<b>COORDINATION</b>	12	4	
		Actions / Turn Modified	
<b>REASON</b>	11	3.1	SPI
<b>INTUITION</b>	18	1d6-1	Initiative Dice
<b>DRIVE</b>	12	6	18
		Range of Self Image (low to high)	
<b>STABILITY</b>	14		Current Self Image

- SKILLS**
- Coolness under Fire
  - Detect Hidden
  - Detect Lie
  - Electronics
  - Handguns
  - Hide in Cover
  - Longarms
  - Mechanical Repair
  - Sneak
  - Structural Engineering
  - Zero-G Maneuver

**TIES**                      **ANTIPATHIES**

Duty                      4                      Separatism                      4

A completely self-reliant character, Erwin greatly values his own opinions. This has not won him many friends among the crew.

Always tending to verbosity, Erwin will often corner other crew members for a rather one-sided chat.

Erwin's only friend aboard the ship, the chief engineer, was killed in the battle with the pirates. Since that time Erwin has been seeking some means of affixing blame for his friend's death. This attitude might leave him vulnerable to manipulation by Roilant Everrard.

<b>WOUNDS*</b>			on
Encumbrance level*			on Coordination
Burden level*			on Coordination and MDex
Fatigue level*			on all characteristics

\*All modifiers are cumulative.

# ALBEDO

Name	<b>Mankheeharhallian (Mank)</b>
Sex	Male
Critter Type	Rodent (Rabbit)
Frame Size	Light
Disposition	
Core, Inclination	Generous, Exacting
Position	Jump Drive Engineer Specialist 4

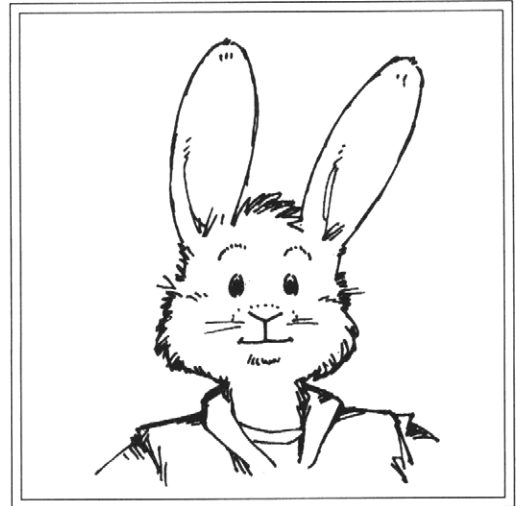

<b>STRENGTH</b>	8	3		Recoil Number Modified
<b>STAMINA</b>	13	39		Max Fatigue Pts
<b>MANUAL DEX</b>	10			Current Fat. Pts
<b>COORDINATION</b>	11	4		
<b>REASON</b>	12	3.3		Actions / Turn Modified SPI
<b>INTUITION</b>	13	1d6+1		Initiative Dice
<b>DRIVE</b>	8	4	12	
<b>STABILITY</b>	13			Range of Self Image (low to high) Current Self Image

**SKILLS**

- Boxing
- Coolness under Fire
- Detect Hidden
- Detect Lie
- Electronics
- Electrical Engineering
- Handguns
- Hide in Cover
- Leadership
- Longarms
- Public Speaking
- Sneak
- Starship Weapons
- Zero-G Maneuver

**TIES**

Aelis Eocha 2  
Duty 2

**ANTIPATHIES**

ILR 6

A neat, precise individual who loves his work. He has a rather peculiar love-hate relationship with Aelis Eocha, with whom he usually works. While being extremely fond of her, her vagueness periodically drives him crazy.

Being the only rabbit on board, Mank is constantly aware that some people might think poorly of him purely because of his race (i.e., if anyone was going to be a spy for the ILR, it would be a rabbit, right?). He overcompensates for this by carrying out his duties with an admirable zeal.

Mank begins the adventure with his self-esteem at 5, due to his fear.

<b>WOUNDS*</b>			on
Encumbrance level*			on Coordination
Burden level*			on Coordination and MDex
Fatigue level*			on all characteristics

\*All modifiers are cumulative.

50
49
48
47
46
45
44
43
42
41
40
39
38
37
36
35
34
33
32
31
30
29
28
27
26
25
24
23
22
21
20
19
18
17
16
15
14
13
12
11
10
9
8
7
6
5
4
3
2
1
DEAD

# ALBEDO

Name	<b>Aelis Eocha</b>
Sex	Female
Critter Type	Canine (Dog))
Frame Size	Average
Disposition	
Core, Inclination	Friendly, Vague
Position	Starship Systems Technican Specialist 2



<b>STRENGTH</b>	Recoil Number Modified		
	10	3	
<b>STAMINA</b>			
	10	30	Max Fatigue Pts
<b>MANUAL DEX</b>			
	11		Current Fat. Pts
<b>COORDINATION</b>			
	9	3	
<b>REASON</b>	Actions / Turn Modified		
	14	3.3	SPI
<b>INTUITION</b>			
	5	1d6-1	Initiative Dice
<b>DRIVE</b>			
	14	7	32
<b>STABILITY</b>	Range of Self Image (low to high)		
	6		
			Current Self Image

**SKILLS**

- Coolness under Fire
- Detect Hidden
- Detect Lie
- Electronics
- Handguns
- Hide in Cover
- Longarms
- Mechanical Repair
- Sneak
- Structural Engineering
- Zero-G Maneuver

**TIES**

- Sharna Aoki 4
- Roilant Everrard 2
- Braddock Haina 3
- Mank 4
- Duty 4
- ConFed Charter 4

**ANTIPATHIES**

- 50
- 49
- 48
- 47
- 46
- 45
- 44
- 43
- 42
- 41
- 40
- 39
- 38
- 37
- 36
- 35
- 34
- 33
- 32
- 31
- 30
- 29
- 28
- 27
- 26
- 25
- 24
- 23
- 22
- 21
- 20
- 19
- 18
- 17
- 16
- 15
- 14
- 13
- 12
- 11
- 10
- 9
- 8
- 7
- 6
- 5
- 4
- 3
- 2
- 1
- DEAD

Happy-go-lucky but very moody. Some people have problems working with Aelis since her preoccupied air can drive them to distraction. She is so honestly friendly, however, that few people can hold grudges against her for long.

Aelis can hate very deeply. Should harm come to a friend, Aelis will reveal a vicious, vindictive streak. She will pursue revenge with a cruel imagination and absolute singlemindedness.

<b>WOUNDS*</b>			on
Encumbrance level*			on Coordination
Burden level*			on Coordination and MDex
Fatigue level*			on all characteristics

\*All modifiers are cumulative.

# ALBEDO

Name **Deika Tovan**  
 Sex **Male**  
 Critter Type **Ungulate (Pig)**  
 Frame Size **Average**  
 Disposition  
   Core, Inclination **Reckless, Devious**  
 Position **Starship Computer Technician**  
                                   **Specialist 3**

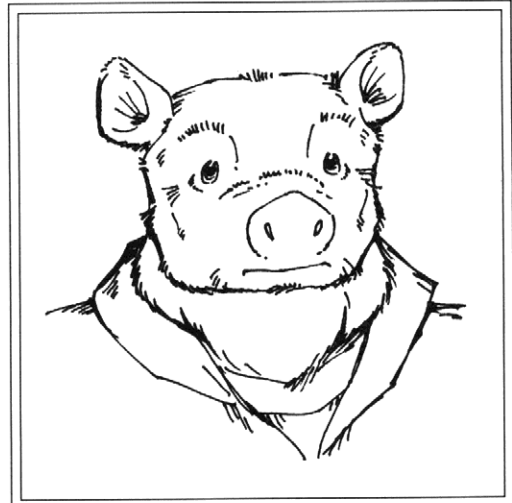

	Recoil Number Modified	
<b>STRENGTH</b>	11	2
<b>STAMINA</b>	13	39 Max Fatigue Pts
<b>MANUAL DEX</b>	12	Current Fat. Pts
<b>COORDINATION</b>	9	3
	Actions / Turn Modified	
<b>REASON</b>	14	3.0 SPI
<b>INTUITION</b>	9	1d6 Initiative Dice
<b>DRIVE</b>	7	4
	Range of Self Image (low to high)	
<b>STABILITY</b>	10	11
	Current Self Image	

**SKILLS**

- Computer Engineering
- Computer Operations
- Coolness Under Fire
- Detect Hidden
- Detect Lie
- Electronics
- Handguns
- Hide in Cover
- Leadership
- Longarms
- Sneak
- Zero-G Maneuver

**TIES**

Roilant Everrard 6  
 Duty 3

**ANTIPATHIES**

Sharna Aoki 4

A newcomer to the crew whose haughty attitudes try to cover for a sycophantic personality. Deika is short tempered and violent.

Deika will attach himself to Everrard like a limpet the first time that Everrard seems to score a point over Sharna Aoki. He will most likely become Everrard's tool for any arranged "accidents", but will usually think that he is performing such on his own initiative.

<b>WOUNDS*</b>			on
Encumbrance level*			on Coordination
Burden level*			on Coordination and MDex
Fatigue level*			on all characteristics

\*All modifiers are cumulative.

50
49
48
47
46
45
44
43
42
41
40
39
38
37
36
35
34
33
32
31
30
29
28
27
26
25
24
23
22
21
20
19
18
17
16
15
14
13
12
11
10
9
8
7
6
5
4
3
2
1
DEAD

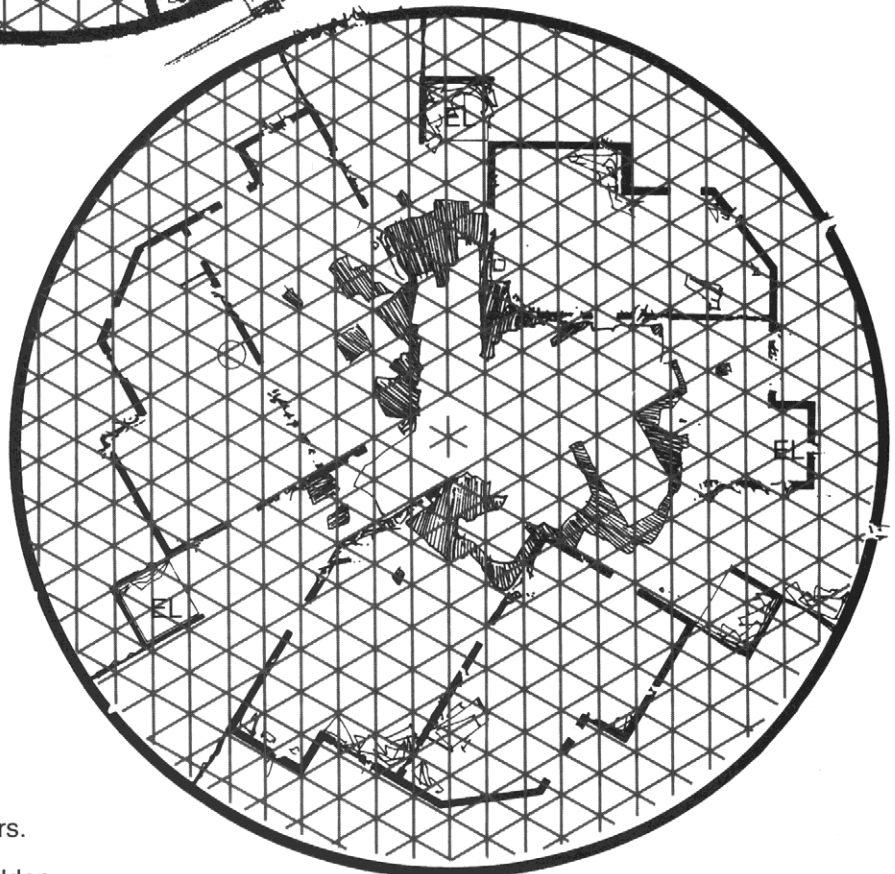
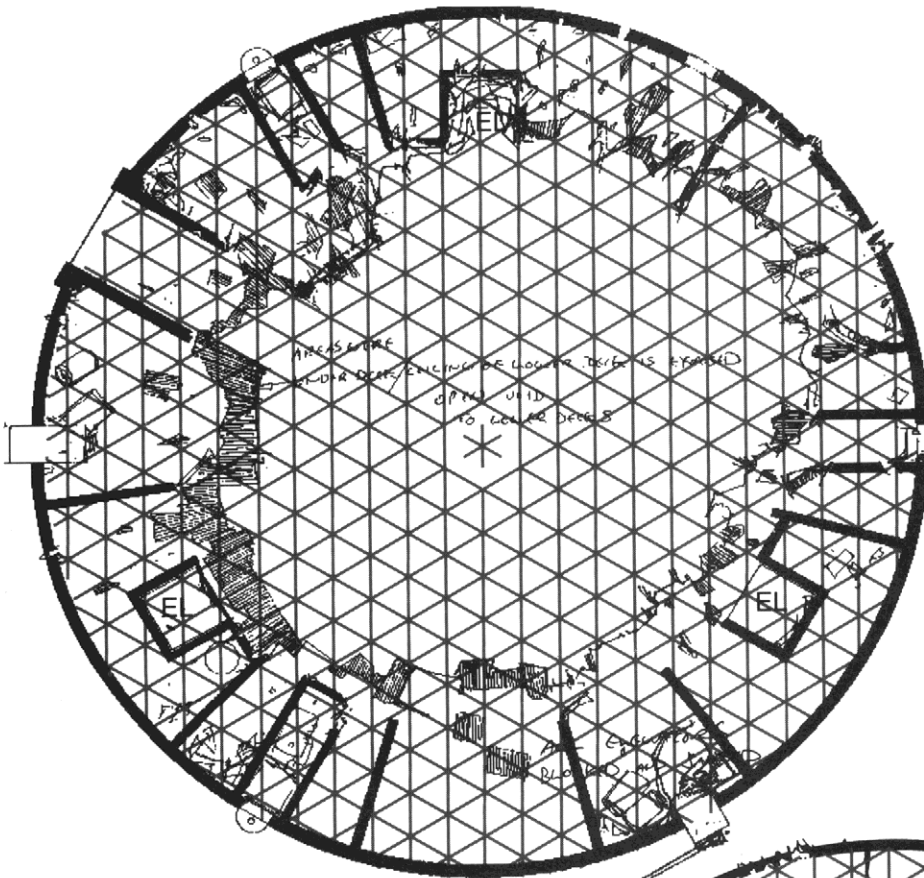

Decks 1 and 2. Storage and Forward Crew Compartment. The middle areas of the decks are entirely gone, burst through by the impact that entirely exploded away the forward fuel tankage. The remaining decks and bulkheads are a torn ruin with virtually no utility at all. Any remaining hardware is crushed by blast or riddled by high velocity fragments. Only the smallest of fittings have any chance of salvage.

Scale: 1 triangle -side = 2 meters.

Handwritten notes by Tetzal Hulden

Deck 3. Main Bridge Deck. There is a breach in the middle of the deck and most of the central area bulkheads are blown. The command centers are completely destroyed with no salvageable elements. There are crew remains mixed with the crushed debris. The 2 o'clock airlock is jammed and would take a major effort to repair (10+ mandays) There might be a few salvageable bits of hardware and fixtures, and maybe a bit of water, but the effort is only marginally worth it.

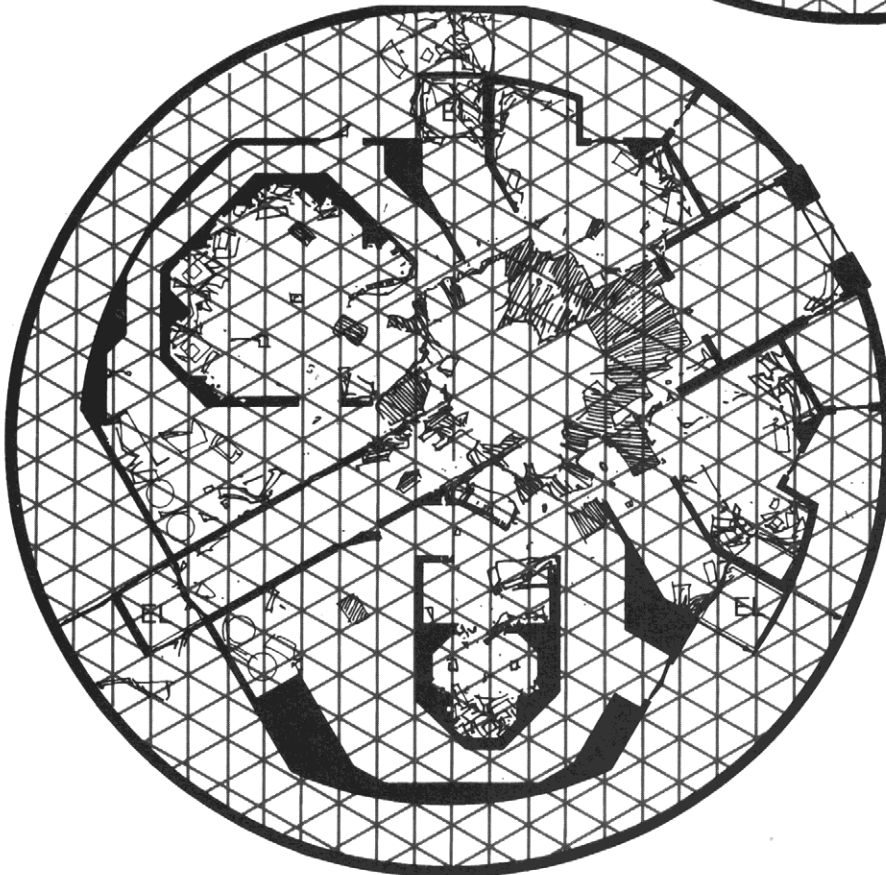
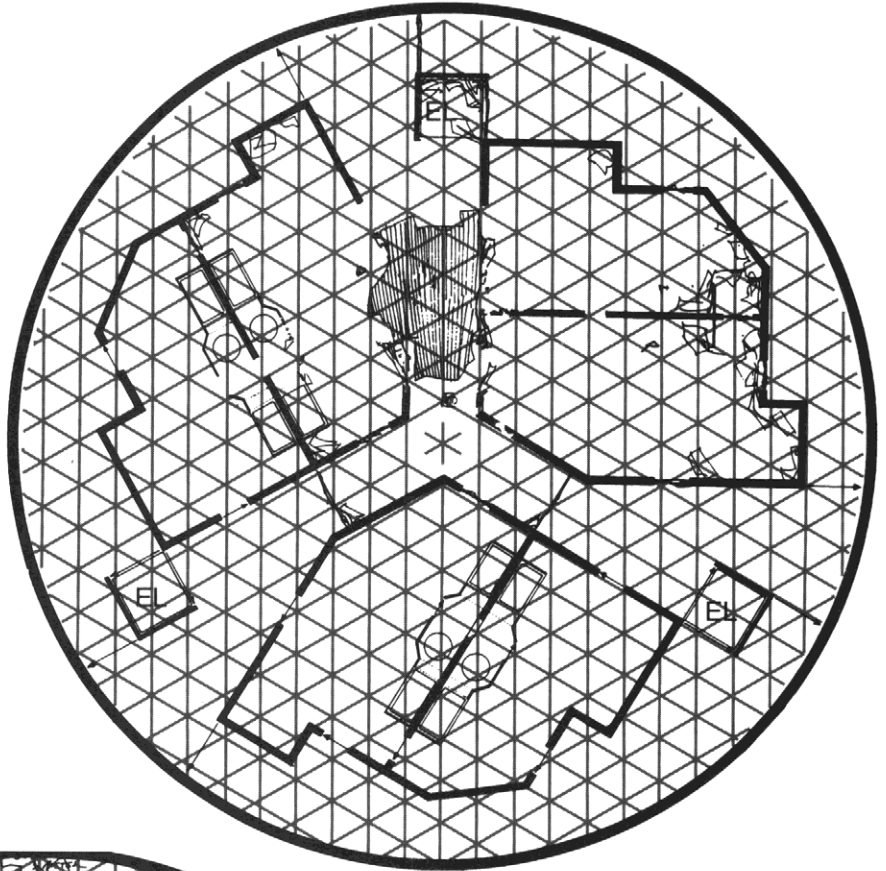

Deck 4. Crew Compartment. Major damage to several compartments, effectively gutting them. Other compartments have substantial damage but major systems are either intact or salvageable. Two compartments can be secured and be made habitable.

Deck 5. Recreation and Mess Deck. A through penetration has depressurized the main recreational area and there has been superficial blast damage, but the rest of the space is otherwise operational. (This deck layout is common for just about any ship)

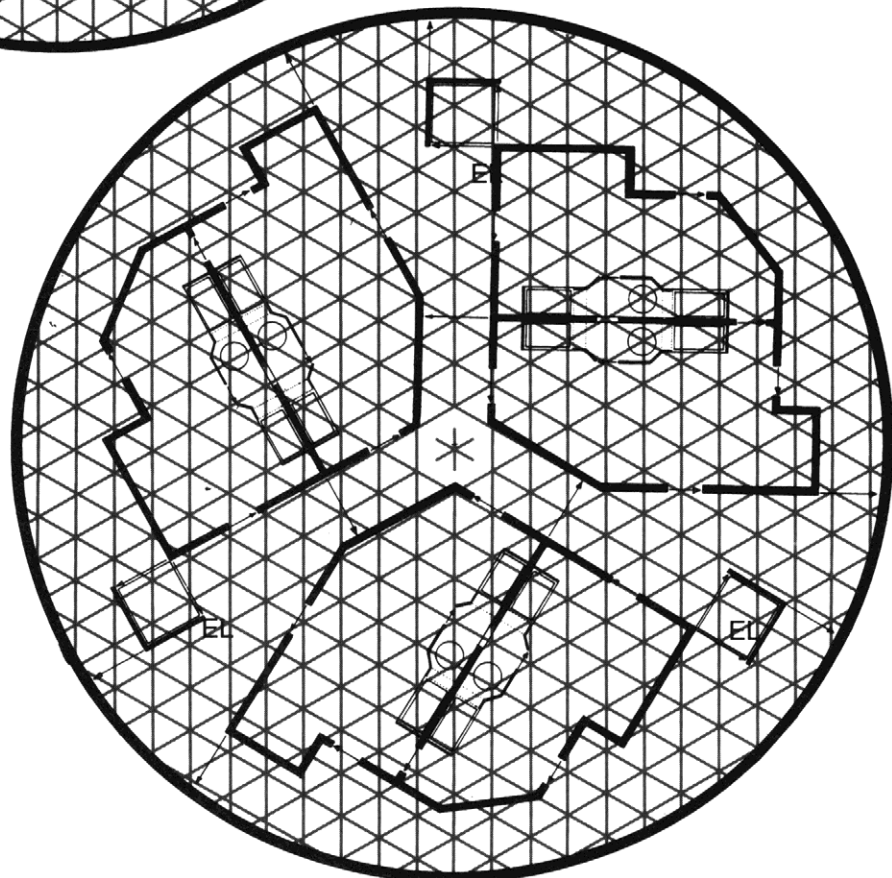
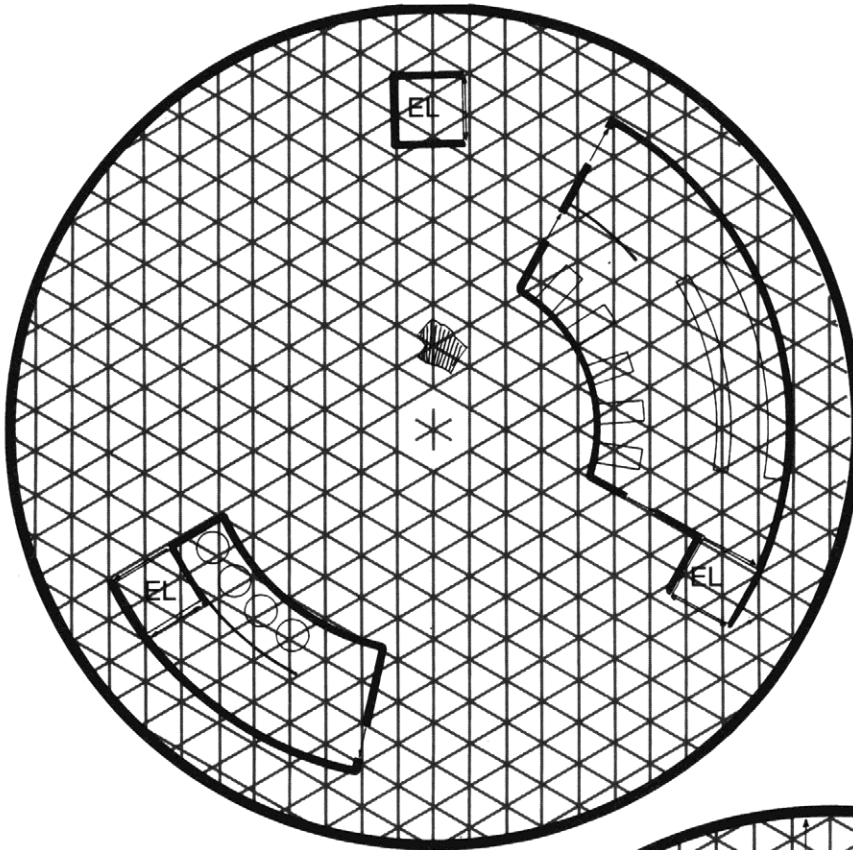

Deck 6. Crew Compartment. Through penetrations have depressurized some compartments and caused moderate damage. (This deck layout is one of several common for ships of this size and can be used for other ships in the game, see *Going In* for more general details)

Scale: 1 triangle side = 2 meters.

Deck 7. Medical Deck. There has been limited penetrations and only superficial damage in those effected areas not actually struck by flying debris. (See Assets. This deck is distinctive for the DH160, as most commercial ships only have a fairly limited sick bay, but can be used for other ships in the game)

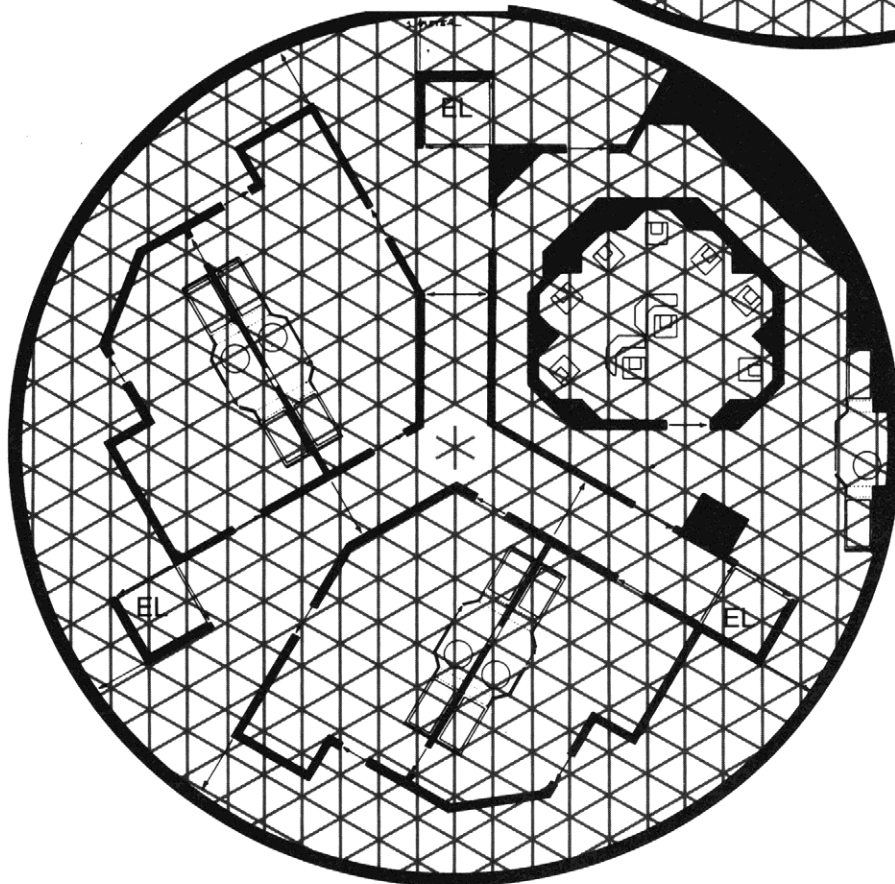
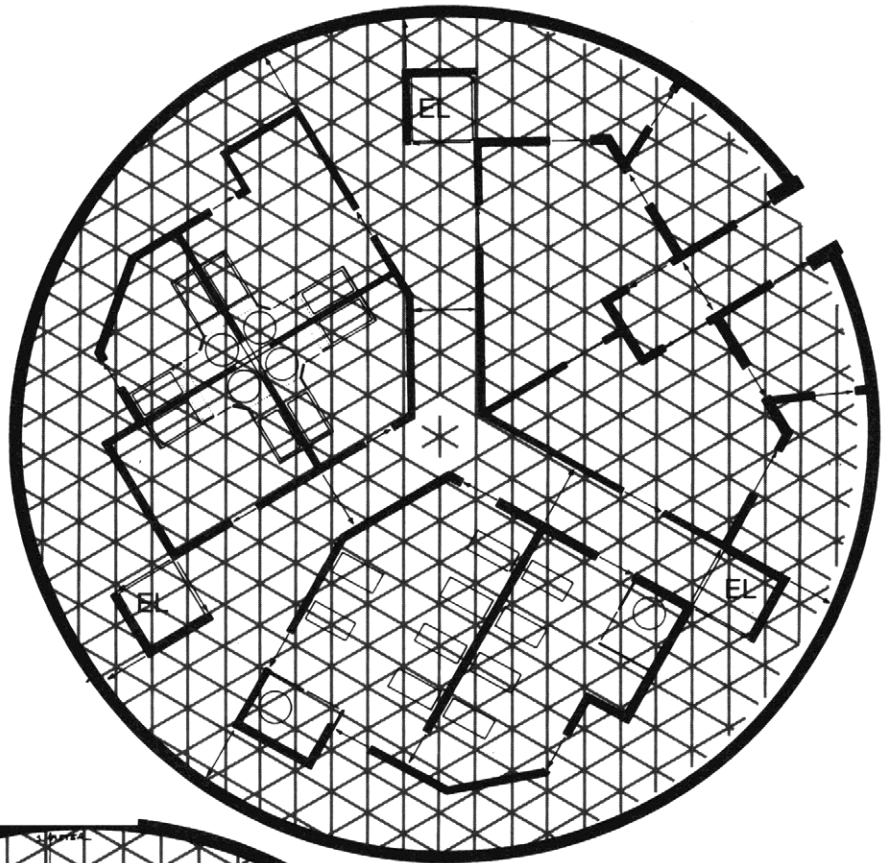

Deck 8. Auxiliary Control. There have been only superficial penetrations and limited damage here. (Details of the auxiliary control compartment can vary widely from ship to ship, but are similar enough to be used for other ships in the game)



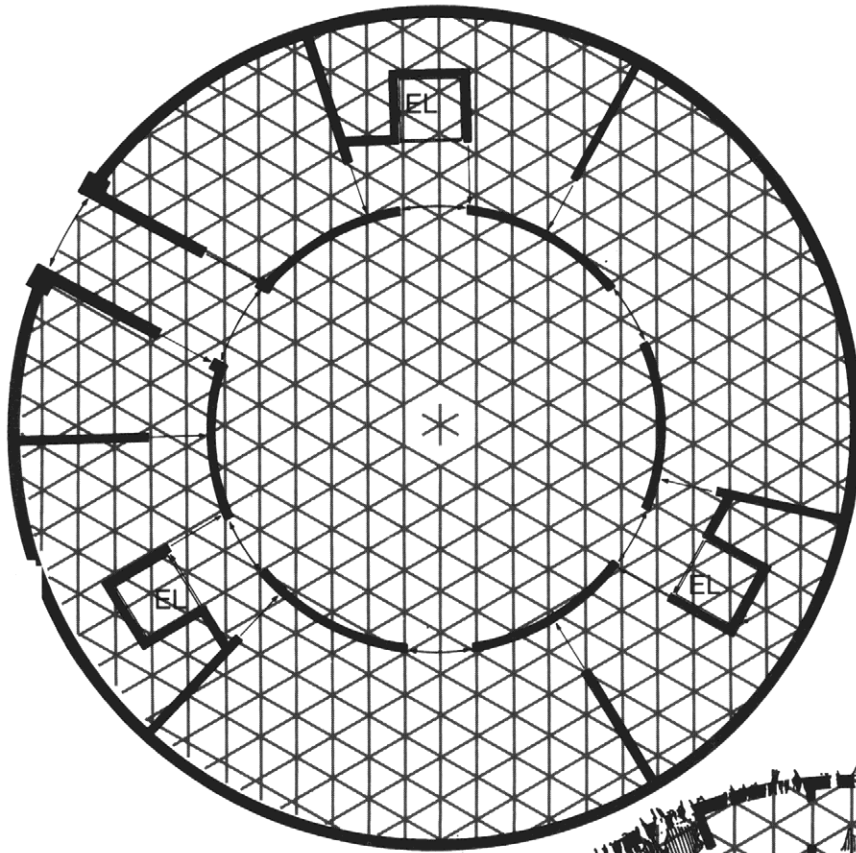

Deck 9. Stores. The ship's stores and miscellaneous work area is entirely intact. Bulk stored rations and other crew consumables, along with hardware for equipment maintenance are available. There are machine shop tools and a CAD/CAM work station with raw materials on hand, as well as spare common fixtures and fittings and spare modules and sub-assemblies for equipment that cannot be easily repaired in the field. Excess baggage for the crew is also stored here. (This is a universal deck plan for this size ship and is the basis for several types of utility decks)

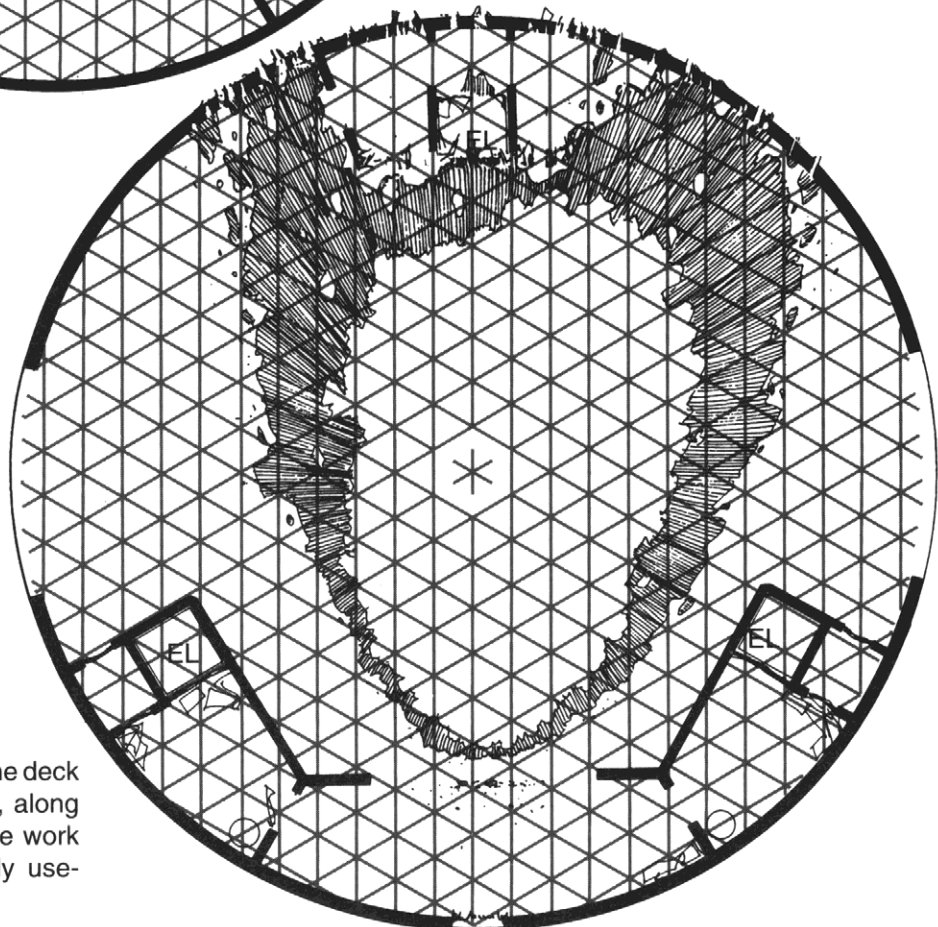

Deck 10. Hanger. Most of the deck has been entirely blasted away, along with the main hanger doors. The work areas are gutted and effectively useless.

Scale: 1 triangle side = 2 meters.

Deck 11 and 12. AVC Bay 1. Blast debris have swept across the bay, riddling the 10 to 2 o'clock sections of both levels. Equipment there is now useless. However, the rest of the bay is largely intact, with the exception of two ACVs which have been damaged. One is completely wrecked and lies on its side on deck 12. The other has had its reactor and fore end controls and sensors clipped off, though it is otherwise intact. However, it is jammed at the entry to the 6 o'clock airlock, which is otherwise operational. Some machine tools and ACV related hardware are stored here and have mostly survived.

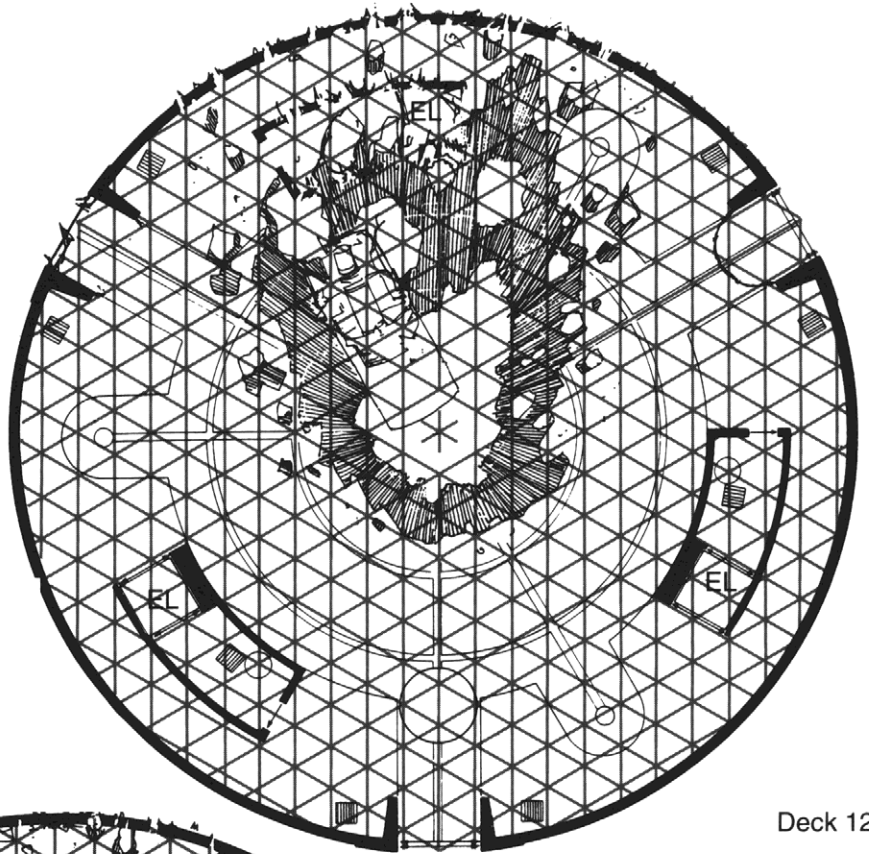

Deck 12.

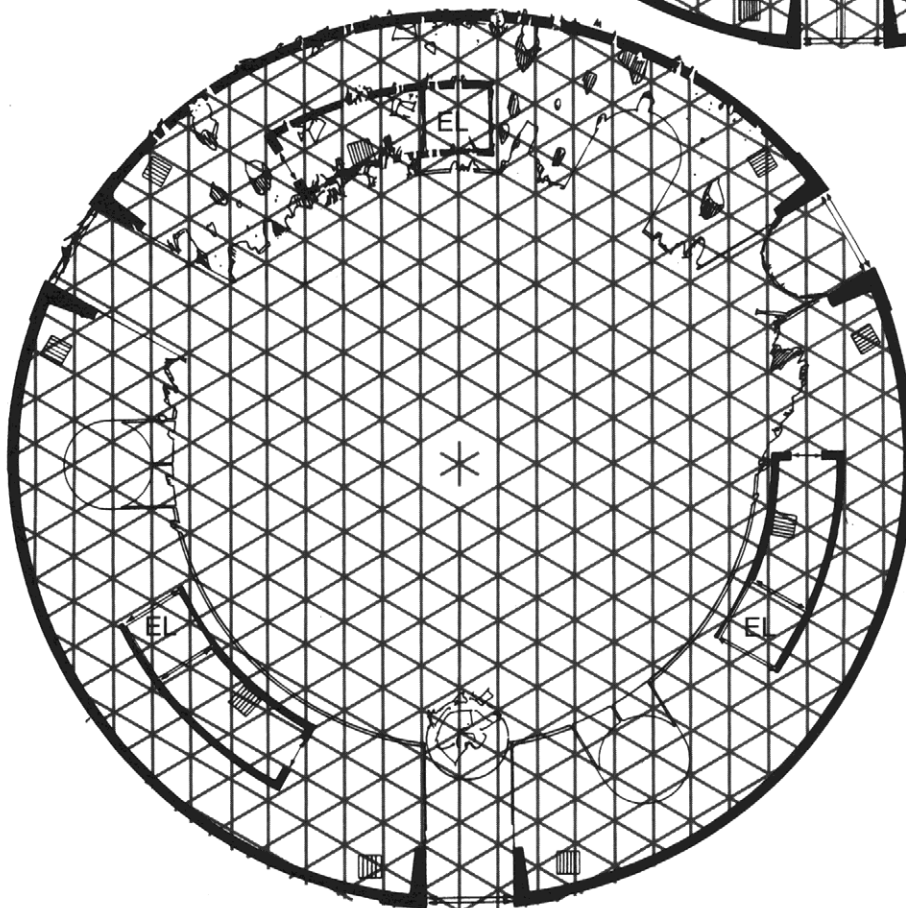

Deck 11.

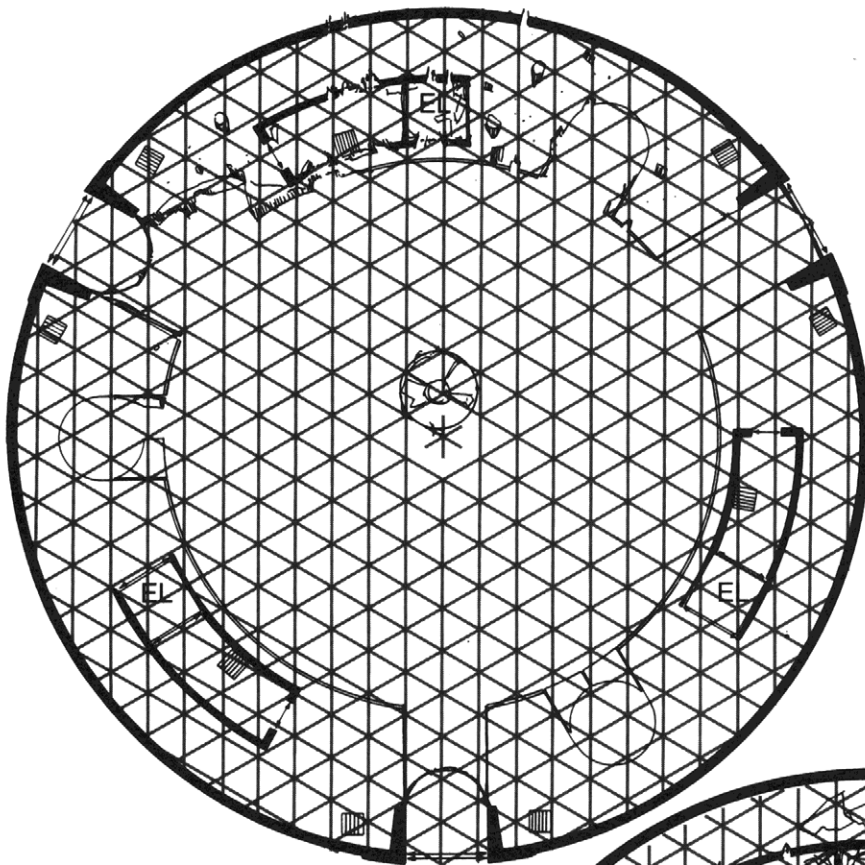

Deck 13

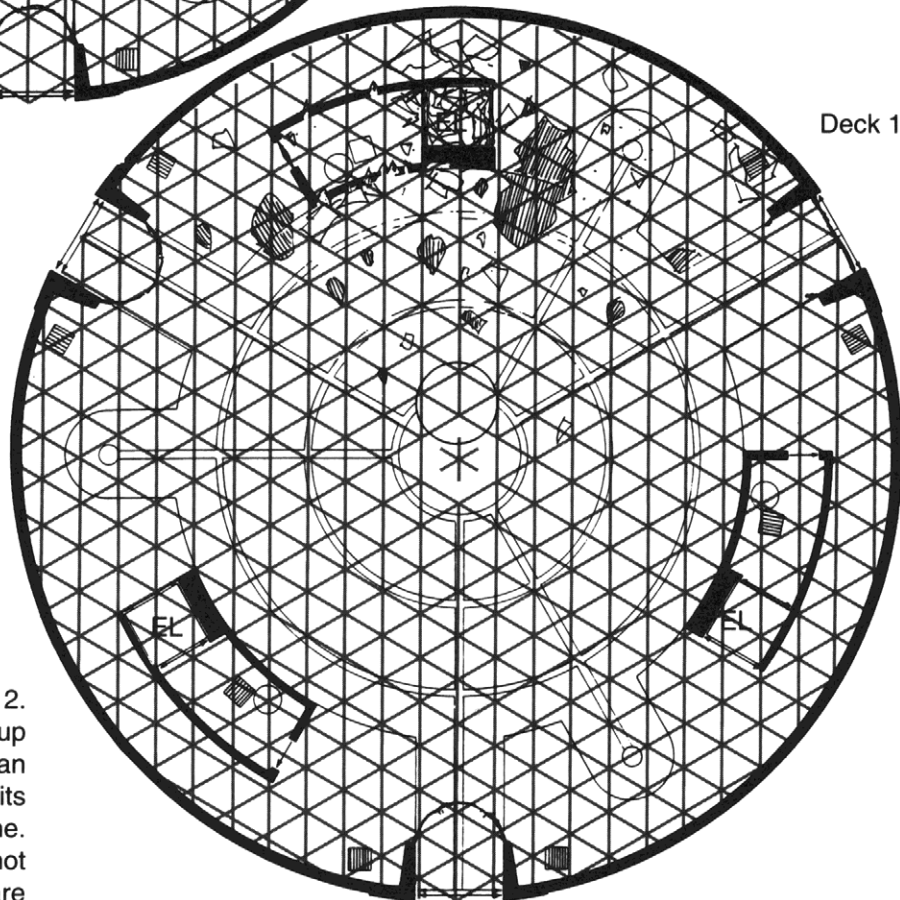

Deck 14

Deck 13 and 14. AVC Bay 2. High velocity debris has chopped-up portions of the decks, including an ACV that is now largely useless, its reactor and fore end controls gone. Those areas of the compartment not in the direct path of the debris are pretty much intact, including tools and hardware.

Deck 15. Water Recycling and Waste processing. While one compartment has been depressurized, the recycling and processing systems are otherwise intact and need only power and reconnecting (see assets/immediate repair list) with the rest of the ship to operate.

Scale: 1 triangle side = 2 meters.

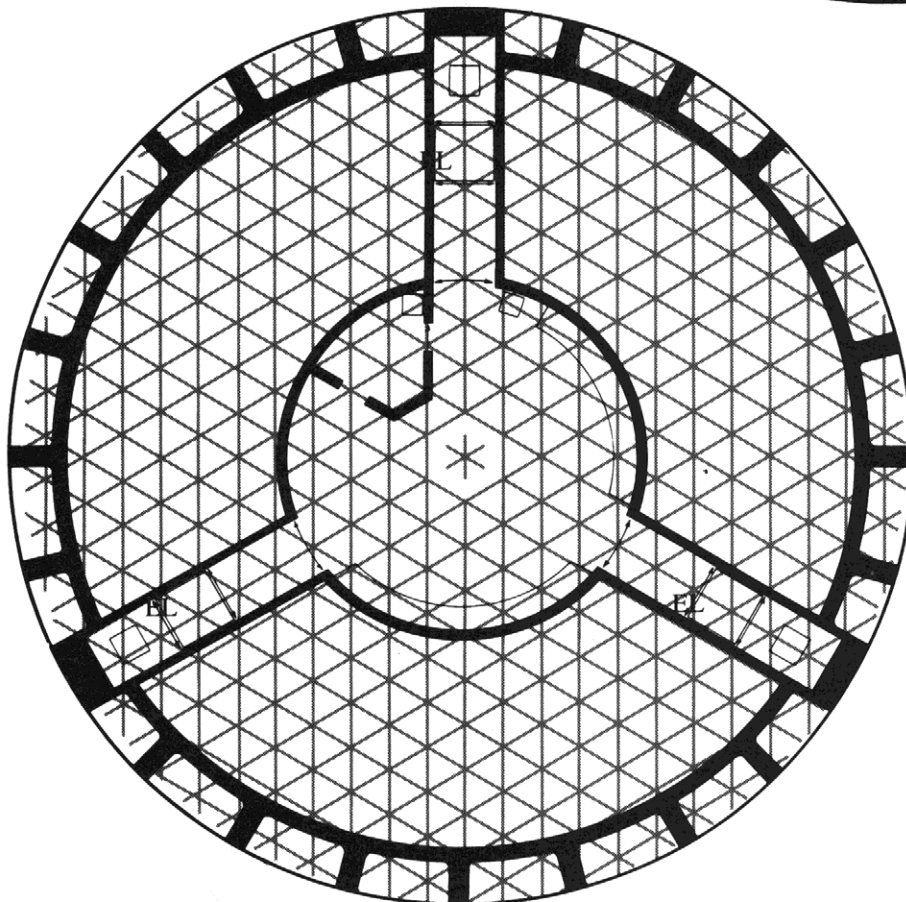
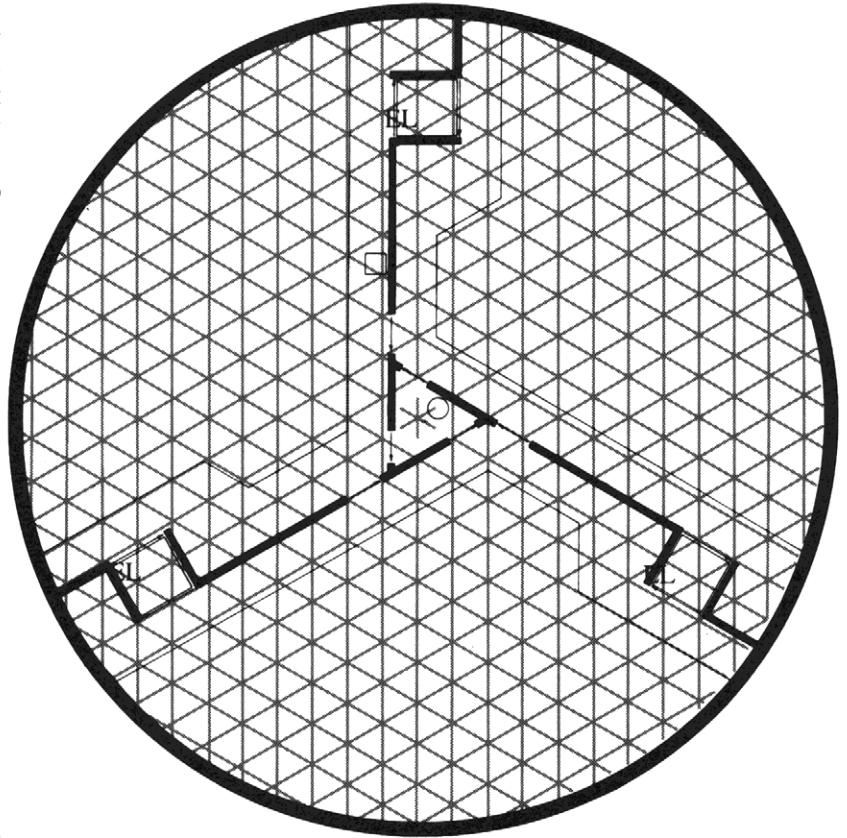

Deck 16 and 17. Accessways to Weapons and miscellaneous Engineering Space. Through penetrations and blast effects have badly damaged most of the compartments and drained the large water tanks which also occupied these decks. Heavy bulk hardware and raw materials, as well as a CAD/CAM work station are mixed in with the mess, much of it made useless or in need of major repair. The 7 o'clock position gun mount is still operational (see Assets)(This is Deck 16: Deck 17 next page).

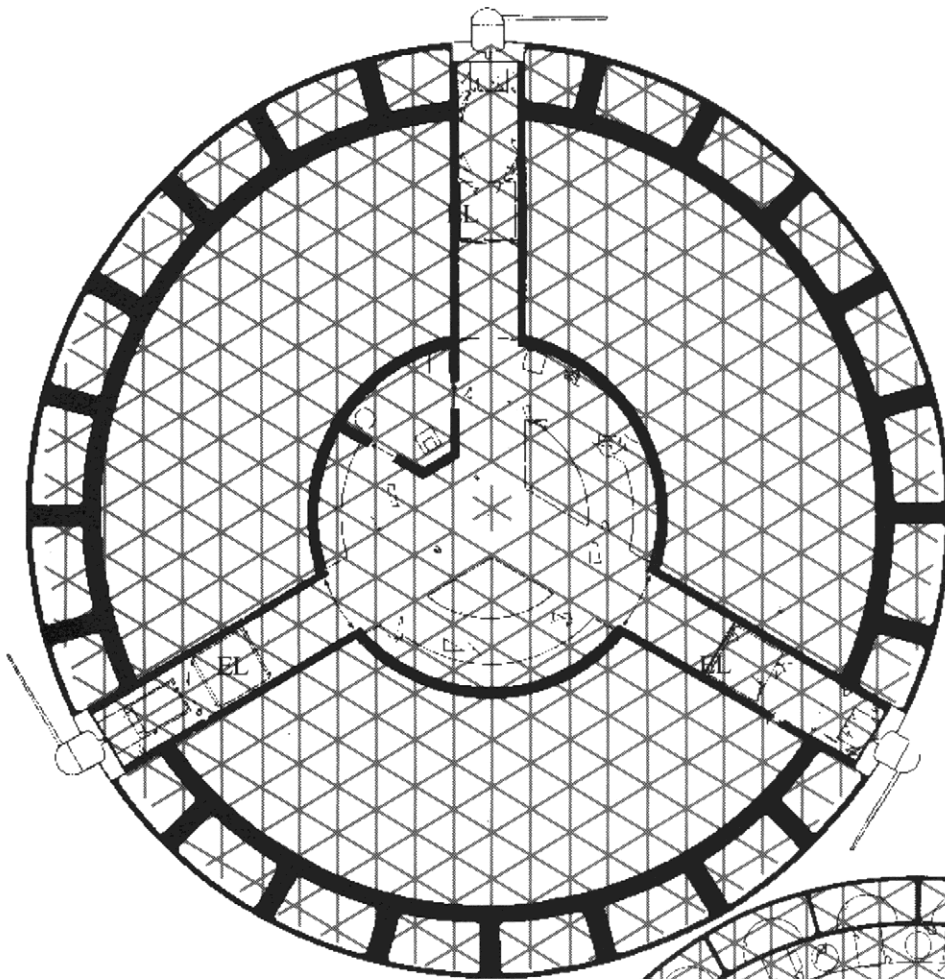

Deck 16 and 17. Accessways to Weapons and miscellaneous Engineering Space. Through penetrations and blast effects have badly damaged most of the compartments and drained the large water tanks which also occupied these decks. Heavy bulk hardware and raw materials, as well as a CAD/CAM work station are mixed in with the mess, much of it made useless or in need of major repair. The 7 o'clock position gun mount is still operational (see Assets) (This is Deck 17)

Scale Deck 17: 1 triangle side = 2.2 meters.

Deck 18. Reactor Deck and Engineering Space. An impact in the stern blew away the aft fuel tank and sent high velocity debris forward, tearing through the engineering decks and chopping through the intricate plumbing networks for the power and propulsion reactors. The blast also smashed most of the reactor's beam generators and/or high pressure injector pumps. Fundamental structural elements have been damaged or swept away and all the MHD generators and magnetic nozzles have been knocked out of alignment or damaged beyond easy recovery.

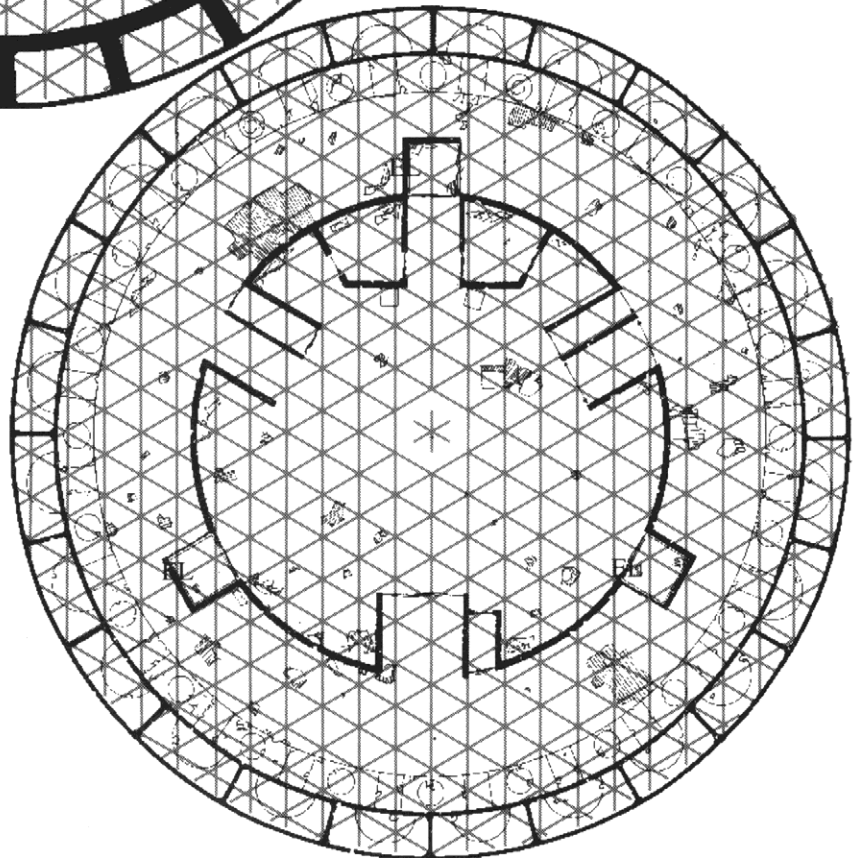

Scale: 1 triangle side = 2.5 meters.  
This is a larger deck than the others.

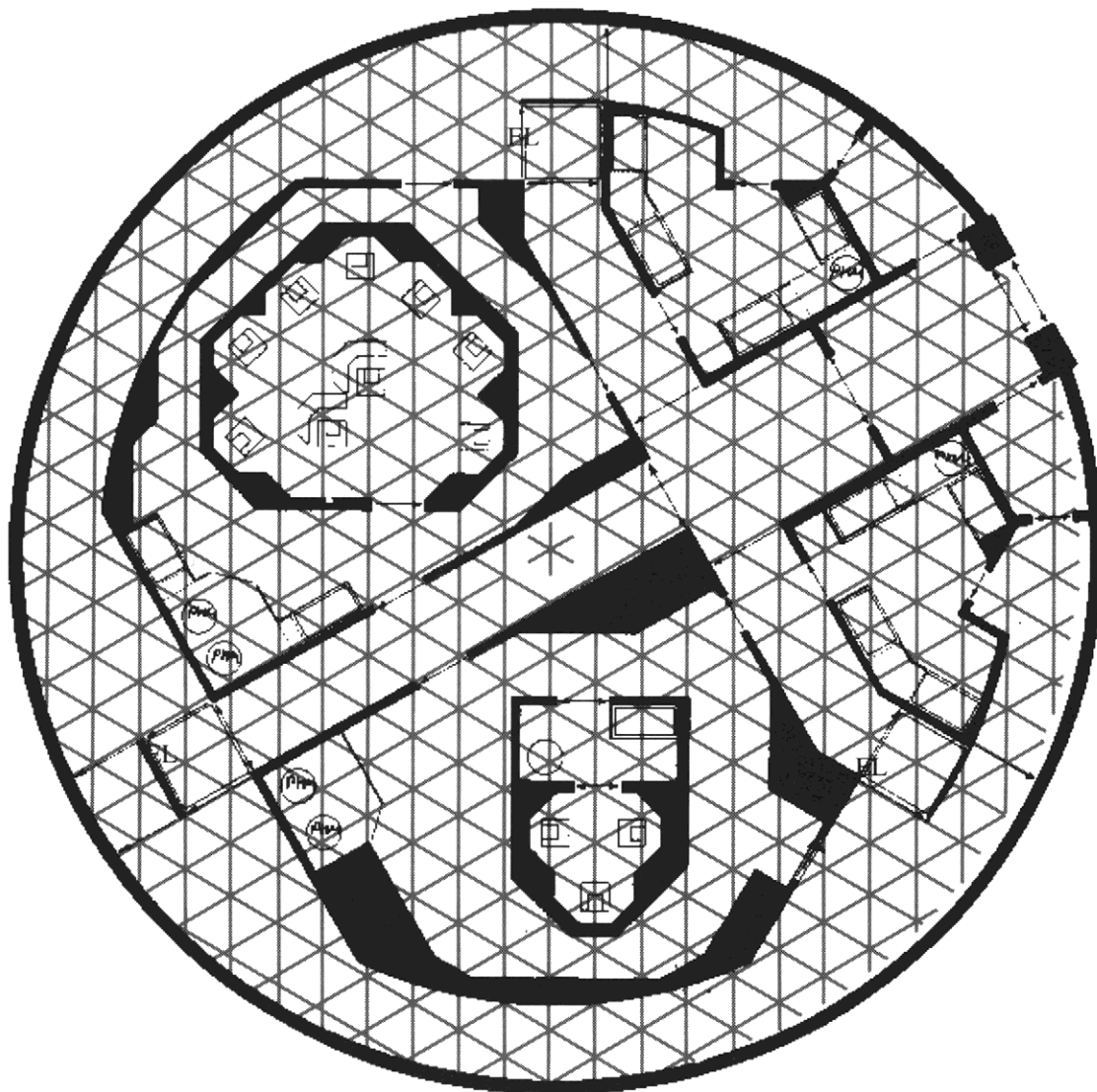

Undamaged DH-160 Command Deck 3. While work station arrangements vary from ship to ship, the over all layout is common to all. This deck can be used for any ship of the same size class.

Scale: 1 triangle side = 2 meters.

# Damaged DH-160

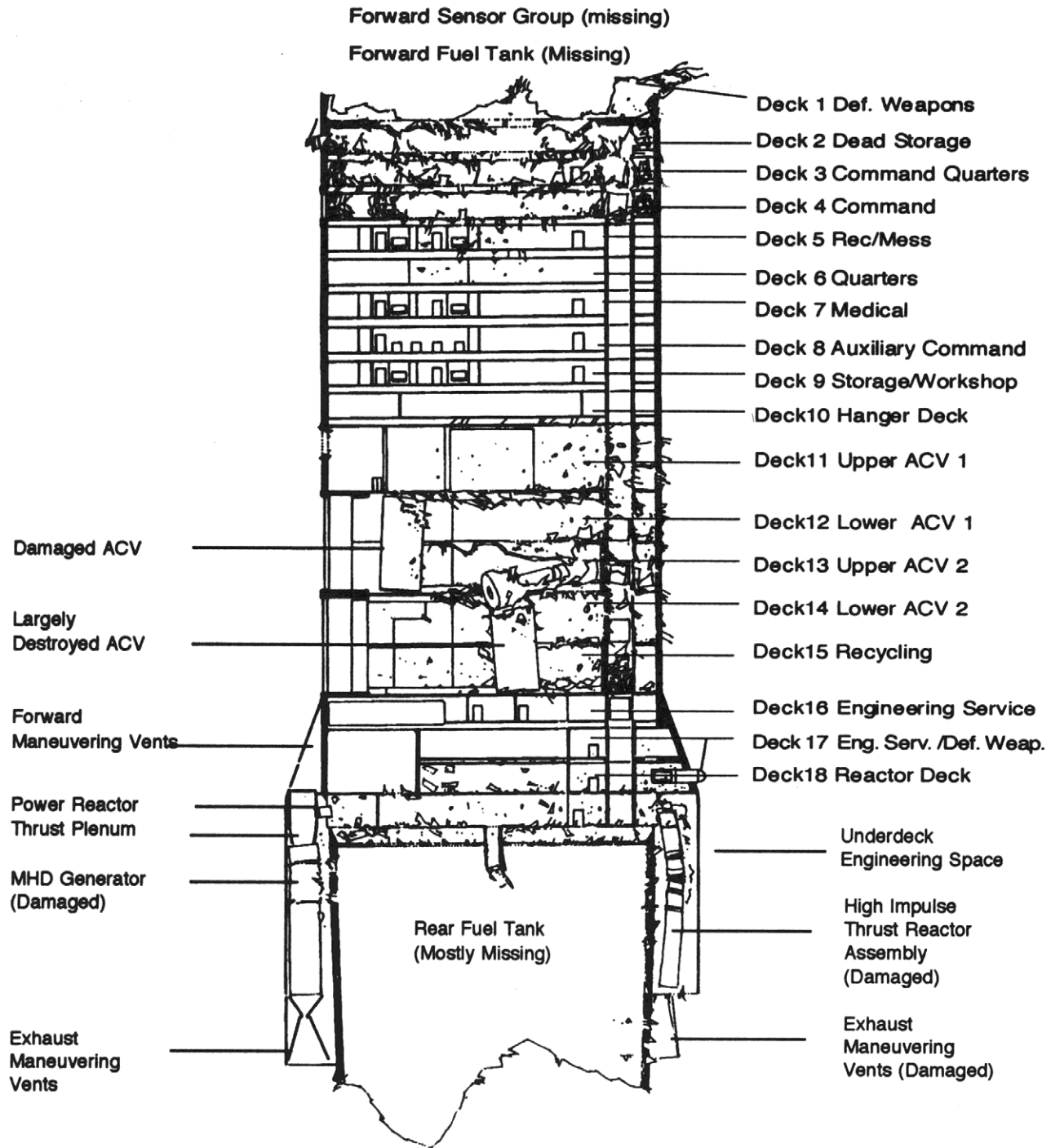

# DH-160: ConFed Destroyer

Mass: 34,000 tons  
 Structure DRM: +1  
 Maneuver DRM: +1  
 Beam DRM: +1  
 Ordnance: 15

Length: 200 meters  
 Diameter: 40 meters (50 meters at stern)  
 Decks: 18 decks plus hangar bay

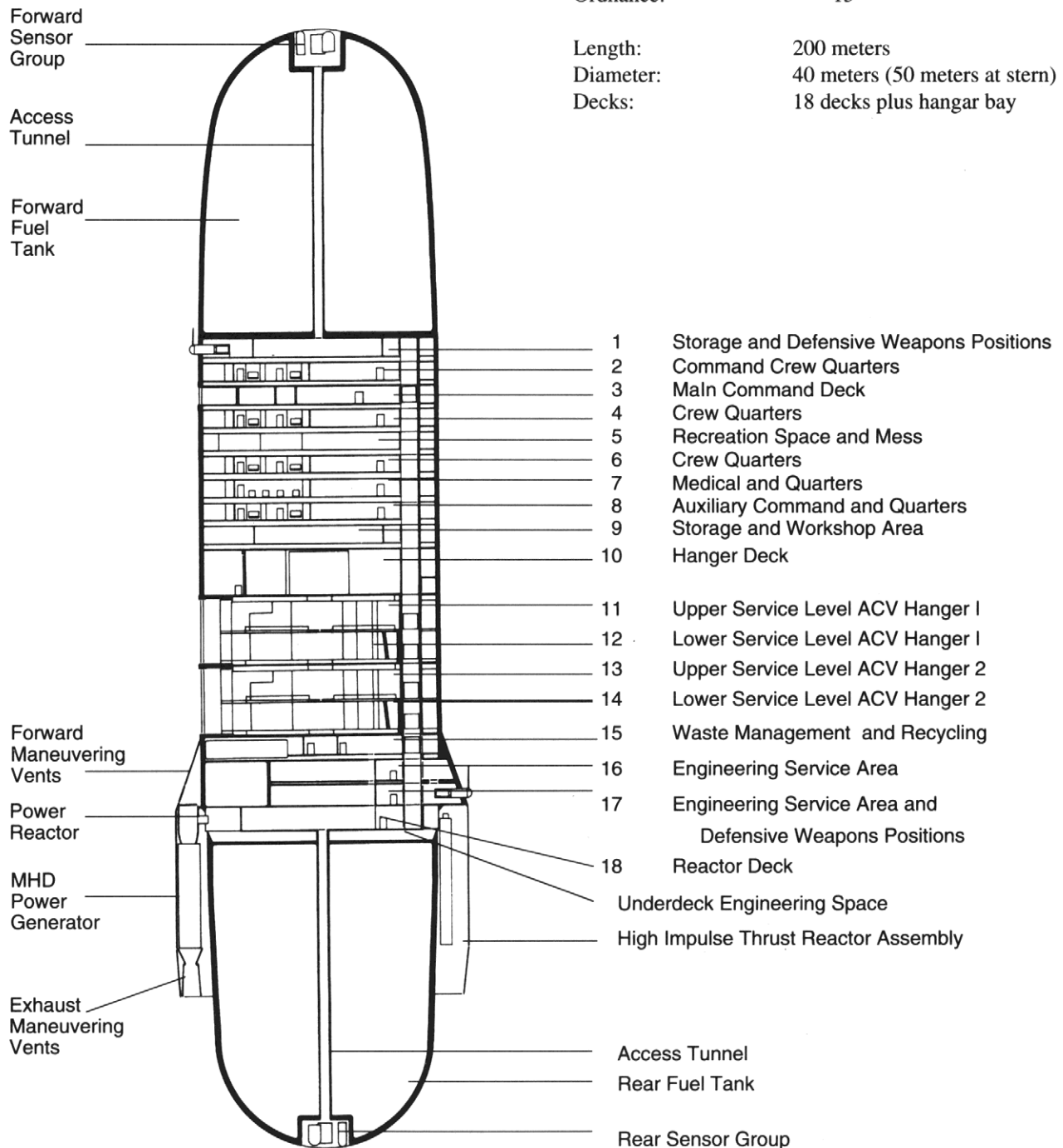

Forward Sensor Group  
 Access Tunnel  
 Forward Fuel Tank

Forward Maneuvering Vents  
 Power Reactor  
 MHD Power Generator  
 Exhaust Maneuvering Vents

1 Storage and Defensive Weapons Positions  
 2 Command Crew Quarters  
 3 Main Command Deck  
 4 Crew Quarters  
 5 Recreation Space and Mess  
 6 Crew Quarters  
 7 Medical and Quarters  
 8 Auxiliary Command and Quarters  
 9 Storage and Workshop Area  
 10 Hangar Deck  
 11 Upper Service Level ACV Hanger 1  
 12 Lower Service Level ACV Hanger 1  
 13 Upper Service Level ACV Hanger 2  
 14 Lower Service Level ACV Hanger 2  
 15 Waste Management and Recycling  
 16 Engineering Service Area  
 17 Engineering Service Area and Defensive Weapons Positions  
 18 Reactor Deck  
 Underdeck Engineering Space  
 High Impulse Thrust Reactor Assembly  
 Access Tunnel  
 Rear Fuel Tank  
 Rear Sensor Group



# GOING IN

The ship and its crew are a largely integrated unit going into the situation, and though there will be interesting divergencies as the action plays out, there is a fundamental body of knowledge that the characters will be aware of, over and above their specific stats. This should also help gamers who may not be familiar with the details of military crew conduct or features of the ship and related technologies.

## The Ship

The DH family of ships are adaptable, mobile vessels which lend themselves to a variety of tasks. They are commonly used for independent patrols, scouting, escort, and interception duties. The DH-160 is currently fitted as an up-armed patrol craft with two sections of ACVs fitted. As its mission is not intended to last very long, it does not have extra crew or accommodations for extended operations.

Like all *Albedo* starships, the DH series destroyers are blunt-ended tubes with bulk fuel tankage fore and aft. Variable geometry exhaust venturi ring the ship's stern, and a number of retractable aerials and sensor turrets stud the hull. The ship moves itself by heating hydrogen (via the ship's multiple fusion reactors) and venting this out through the exhaust outlets as reaction mass. When building up power for a jump, this exhaust is fed past huge superconductive coils (the ship's MHD coils), which adds to the ship's power generation capabilities. When the ship jumps, this power is released into the ship's jump field generators, a fine web of devices which line the outer hull. *Albedo* ships are not capable of using plain water as reaction mass – water must first be separated into hydrogen and oxygen, and then the hydrogen is fed into the fuel tanks. The use of water as reaction mass will be the next stage of technological development.

Starships have numerous back-up systems. Computers and life support are distributed throughout the ship, meaning that the loss of any one segment will simply shift a slightly higher burden onto the whole network. There are no central vital systems that can be crippled at a single blow. Likewise, power is provided by a number of fusion reactors in the stern. Fuel cells store power for emergency use.

Each deck is a circular module equipped with a central access shaft and three elevators. The accommodation and command modules are laid out on a three corridor floor plan (larger ships might have four, six or eight corridors).

The ship has a hangar containing one aerodyne and two small auxiliary vehicles.

Each deck is a largely self-contained unit, with decentralized life support packages installed under the floor of most compartments. These systems can be accessed through re-

Each deck is a largely self-contained unit, with decentralized life support packages installed under the floor of most compartments. These systems can be accessed through removable panels, and in a pinch, sub-floor/ceiling panels can also be removed for emergency deck to deck access. The life support hardware includes temperature and humidity controls as well as carbon dioxide and volatile gas scrubbers. Oxygen is piped in from a network that services the whole ship and keeps topped-off emergency tanks that can provide up to a week's worth of air in each compartment.

## STRUCTURE

Starships in *Albedo* are tubular affairs consisting of a stack of circular decks sandwiched between two blocks of fuel tanks. Avionics and sensory equipment are placed at the fore, and a ring of reactors with their attendant exhaust venting are placed near the ship's rear. Ships are of a modular design to simplify construction, modification and repair. The internal crew and hardware occupy portions of the ship are constructed from stacked independent modules, which form a core inside the ship's outer hull. Each module has its own life support, computer systems and emergency power, and is designed to fill a specific function. The central core of a DH class vessel consists of up to twenty decks. These decks are modular, and can be swapped and changed about according to the ship's mission. At the beginning of its current flight, the DH-160 was configured to hold a crew of twenty-four in fair comfort, and to have both a hangar deck and an auxiliary control center. The hangar deck on the DH-160 holds an aerodyne designed for use as a shuttle vehicle, and two smaller vehicles designed for use only in a vacuum environment.

The outer hull of a ship is clad in thick layers of thermal insulation and armor. Items such as sensors and beam weapons have only their aerials or projectors poking out from the hull, with the machinery being mounted deep inside the hull. Many of these external extensions will be capable of folding back or retracting into the hull to lessen the chance of suffering damage in battle or collisions.

Ships of the DH class' size spin to provide 'gravity' for the crew. The decks are thus oriented with the 'down' direction towards the engines. The ships are laid out for easy access in zero-G.

Power, mainly electricity, is generated by fusion reactors driving MHD generator coils. Sterling generators and other heat/electricity systems are primarily driven by waste heat, but can also use solar collector heat. Small portable solar generators, both photovoltaic and heat/electric, are also available. Oxygen/hydrogen fuel cells are also dispersed throughout the ship for emergency power and the waste water is usable.

Thrust is produced by fusion reactors, identical and interchangeable with the power reactors, but fitted to high efficiency magnetic nozzles for propulsion. The exhaust is of such high velocity that it has the hazards of a plasma torch at several kilometers, being able to blast/melt through sheet metals or vacc suits in an instant. All these reactors are built up out of interchangeable modules that can be repaired or replaced with only a few tools and basic instructions, though some of the hardware inside these modules is very complex and would be all but impossible to service in the field.

Similarly, the MHD generators, magnetic thrust nozzles, and associated hardware are also designed for simple in-the-

field repair or replacement. In any case, such work, though not outside the ability of a rated crewmember, will still be a major task. These parts are still very busy, some with dozens or even hundreds of fasteners and connections. Others are quite large; a whole magnetic nozzle assembly is about 10 meters long and weighs several tons. Normal deck to deck access is via the three elevator shafts and on several of the engineering decks, ladderways as well. While pressurized elevator cars are available, they are normally held in reserve and most routine movement is done by using ladder rungs on the inside of the shaft. Pressure doors between decks are left half closed to serve as landings for such climbing. An emergency hatch is also available in the center of each deck if no other way is available. In all cases, doors, hatches or removable panels will not open if there is a noticeable pressure differential between the two sides. Most doors and hatches are powered and computer controlled (indicated as arrowed lines on the deck plans), but sprung or otherwise balanced so that they can be easily opened manually if no power is available. While doors can be locked, a specialized

pry bar can destructively force the lock, though not without alerting the security system. The same pry bar can force open a door with a pressure differential. While these tools are available on every deck for emergency purposes, access can be limited if there are security or safety concerns.

Normal crew accommodations would include individual bunk space which can double as a short term emergency shelter. Inside the bunk space/shelter are a computer terminal and access to the compartment's air and water stores. Through a removable panel, the occupant can gain access to emergency rations and a emergency vacc ball, as well as a respirator and first aid kit. Further digging will allow the occupant to get to the Personal Hygiene Module and connection with the adjacent bunk space, as these combinations usually pair two bunks with a PHM. The PHM has provision for zero gee showering and toilet, even in emergency conditions, but if the ship-wide wastesystem is inop-

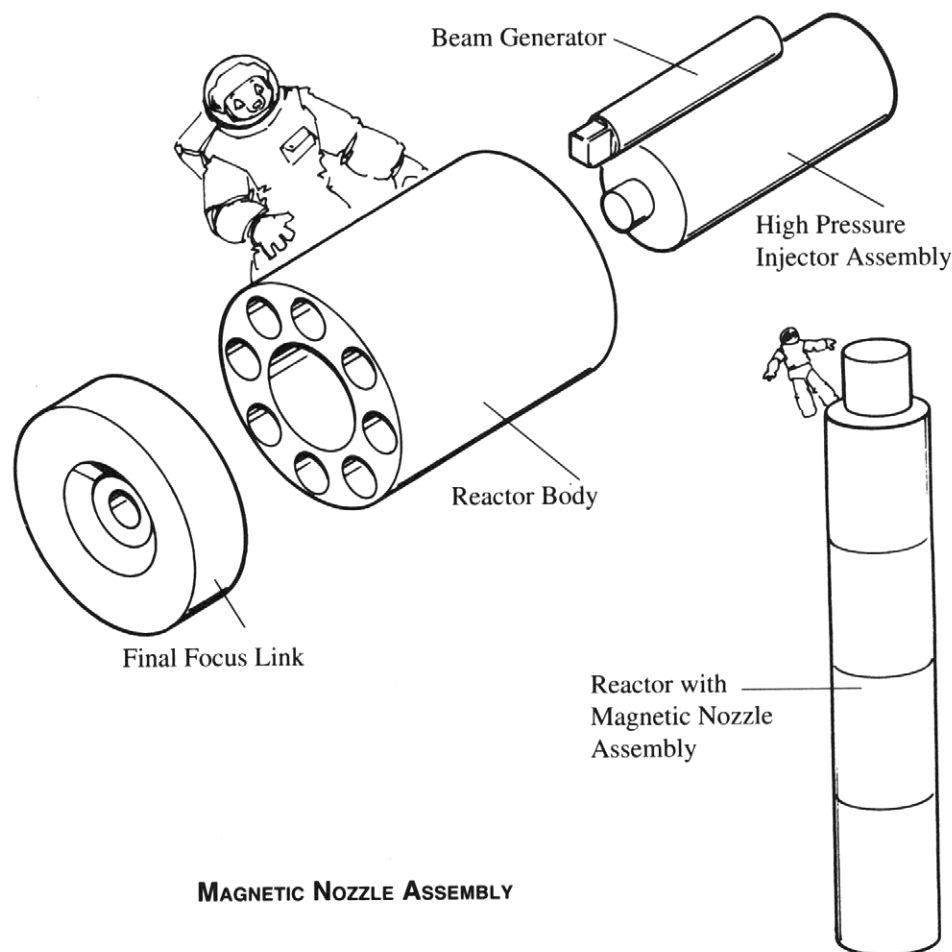

**MAGNETIC NOZZLE ASSEMBLY**

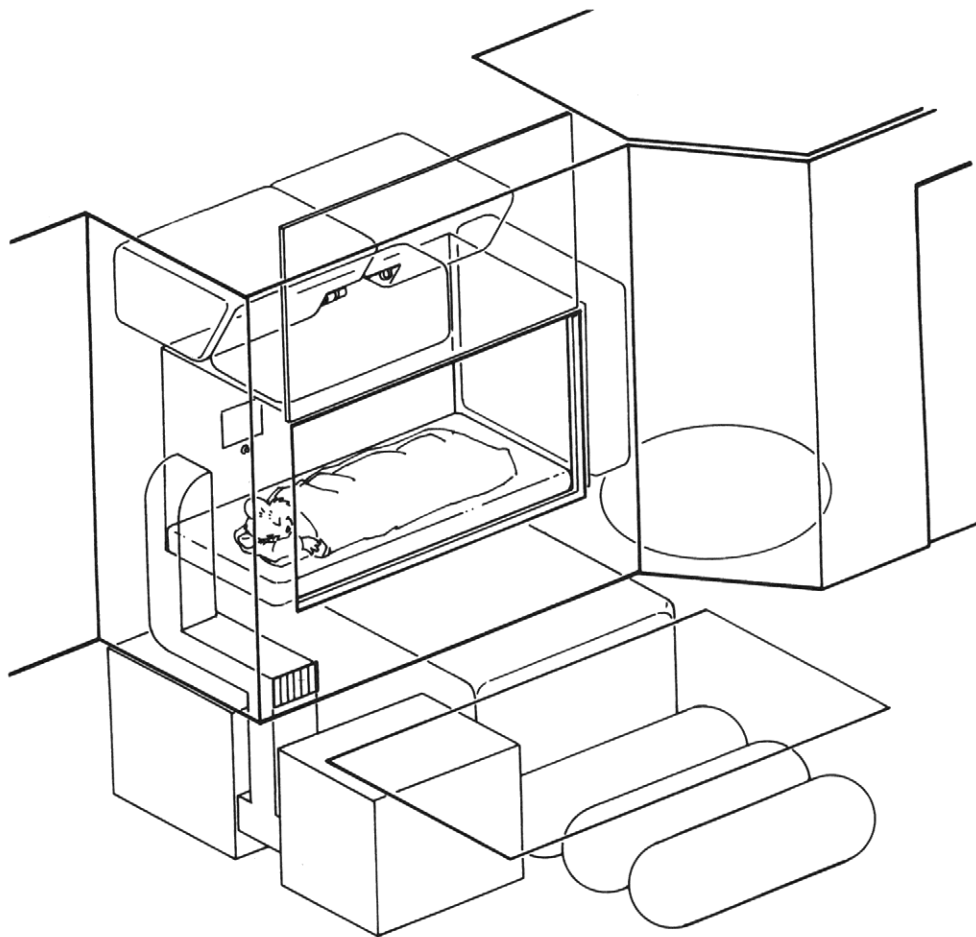

Inside the bunk space/shelter are a computer terminal and access to the compartment's air and water stores. Through a removable panel, the occupant can gain access to an emergency shower and toilet, but if the ship-wide waste system is inoperative, the limited storage of each compartment's holding tank could make for a noisome condition in time.

The sub-compartment that contains the PHM also has a small sink and space for appropriate personal items.

Crews quarters have odds and ends of furniture like work desks, chairs, sofas or futons, all locked down or 'velcro'ed to the floor. Closet space and cubbyholes can contain clothes and personal items. The ship's storage areas could have larger personal items if weight allowances or future posting options make it necessary or convenient to carry additional personal items.

#### AN IMPORTANT NOTE

Throughout all inhabited areas in zero-gee, all fans and ventilation grills have banners or flags to show that air is being circulated, for if the air is allowed to be still, dangerous accumulations of carbon dioxide or other gases are possible. Remember, in zero-gee there is no convection currents of "rising" air, so unless there is something to keep air stirred up, it becomes motionless and nothing will settle out or dilute (there is slow mixing of gases by diffusion, but it is practically negligible). CO<sub>2</sub>/hazardous gas detectors are installed everywhere, and portable, battery-powered fans are available, just to be sure.

Water, for live use, heat exchanging, and waste, is also netted throughout the ship. Emergency supplies of up to 500 liters can be found in each compartment and temporary liquid waste storage of up to 1000 liters is also available. The main recycling plant can take care of most organic material or simply distill water for reuse. In an emergency, there is hardware for alternate power applications for distillation and the crew would be familiar with its use. There is also hardware for electrolytic separation of oxygen and hydrogen, but this is a power-intensive process and is only efficient with surplus power from a reactor or solar collector.

erative, the limited storage of each compartment's holding tank could make for a noisome condition in time.

The sub-compartment that contains the PHM also has a small sink and space for appropriate personal items

Normal deck to deck access is via the three elevator shafts and on several of the engineering decks, ladderways as well. Routine movement is done by using ladder rungs on the inside of the shaft. Pressure doors between decks are left half closed to serve as landings for such climbing. An emergency hatch is also available in the center of each deck if no other way is available. In all cases, doors, hatches or removable panels will not open if there is a noticeable pressure differential between the two sides. Most doors and hatches are powered and computer controlled (indicated as arrowed lines on the deck plans), but sprung or otherwise balanced so that they can be easily opened manually if no power is available. While doors can be locked, a specialized pry bar can destructively force the lock, though not without alerting the security system. The same pry bar can force open a door with a pressure differential.

Normal crew accommodations include individual bunk space which can double as a short term emergency shelter.

## ARMAMENT

The main armament of DH class warships consists of a number of Autonomous Combat Vehicles (ACVs), huge 'smart' missiles capable of coordinating attack and defense plans with each other and the mother ship. These weapons come in a number of different configurations, with varying sensor packages and warheads. The velocities at which ACVs encounter their targets generally make warheads superfluous. Many ACVs surround themselves with a cloud of heavy fragments just before impact to increase their chances of scoring a hit.

Each ship is also armed with beam weapons made along one of several patterns (lasers or particle beams), each consisting of a generator mounted inside the hull, and a projector/focusing device set into a hemispherical turret immediately above. Beam weapons are of limited use in encounters at high relative velocities, since a considerable amount of time is needed for a beam to work its way through the target's layers of fuel and armor. The bulk fuel tankage fore and aft of most vessels acts as very efficient shielding against beams.

The ship's weapon systems are supplemented by a defensive armament consisting of autocannon and hyperkinetics designed to attack and break up incoming ACV's. Such systems are only useful while the ship is capable of dodging the debris thus caused – being hit by fragments of an ACV is almost as destructive as being hit by the intact projectile.

## AUXILIARY VEHICLES

Most vessels will carry one or more auxiliary vehicles. These might be zero-G utility vehicles of one kind or another, or aerodynes designed to act as an interface between the ship and planetary surfaces. Once again, the presence or non-presence of vehicles will depend upon the ship's mission. The DH-160 carries one aerodyne in a hangar deck. The hangar deck holds all the necessary tools and equipment to fuel, service and repair the aerodyne under normal conditions.

## SHIPBOARD LIFE

In an organization which lacks rigid military formalities and ferocious 'sea laws', reliance upon individual responsibility and intelligence is high. Interstellar travel is a time consuming business. Most trips will involve at least a couple of weeks acceleration out to the edge of the star system's gravity well, followed by an equivalent period of deceleration at the other end. For periods of a month or more, the starship becomes the crew's whole world. The ship's environment must thus be capable of catering to the crew's physical and psychological needs for extended periods of time.

Ship's gravity conditions vary between normal thrust and zero-G ('zee gee'). Under normal thrust, the crew will

experience G forces at levels which allow normal movement (normal acceleration will be about .5 of a G). In zero-G, the ship's environment becomes more "three dimensional." Most trips will involve periods of zero gravity, since ships often coast for a proportion of their journey. Extended periods of zero-G are avoided because of the problems involved in maintaining the physical condition of passengers and crew. Even the best of P.T. programs will leave personnel weak and exhausted upon the return of gravity.

## GENERAL ENVIRONMENT

Starships in *Albedo* are largely devoid of blinking lights, loose wiring and pipes. This type of hardware is all concealed behind wall panels. A starship's interior thus has a clean, orderly, comfortable appearance. Computer terminals are always readily at hand, giving the crew constant access to information. The physical environment of a starship is aimed at ease of crew orientation and minimization of stress. Plants (usually sealed inside environmental bubbles), furniture and equipment are placed so as to create an illusion of space wherever possible. Different levels of the ship are color coded for ease of crew orientation.

A starship crew becomes a small community, and social interaction within the crew helps keep crew members stable (crew sizes are often dictated by social needs, and can vary from culture to culture). Sexual liaisons between crew members are not discouraged as long as they do not interfere with duty. The ship's computer monitors the crew, and works hand in hand with the ship's medical personnel to ease social tensions and maintain crew cohesion.

## DRESS AND EQUIPMENT

In emergencies, all crew don vacc suits and helmets. Vacc suits (sans helmets) are worn during alerts.

On-duty crew will wear service overalls. Some might wear helmet liners (if earphones were necessary for the crewman's job, or if the crewman had long hair in a zero-G environment). Vacc suit liners are optional. When gravity is present, crewmen might wear normal EDF service uniforms.

When relaxing, civilian clothing is the norm. In zero-G, long hair will be firmly tied back, or braided. In zero-G, skirts and loose flowing clothing obviously are given up in favor of shirts and trousers.

All crew carry pocket terminals. While all military crew are issued pistols, these will almost never be worn, never even be available while aboard ship, except in emergency conditions.

## BATTLE DRILL

Before hostile contact, all crew don armored vacc suits and helmets, and hook into the ship's air supply via umbilical hoses. All crew strap down at their battle stations, and robots

stand by near vital systems ready to make emergency repairs. Once final tactics are planned, there is little for the live crew to do except hang on and hope! If the computers downgrade, the crew will rapidly act to take over ship's functions, relieving the burden on the remaining electronics.

The ship is not depressurized before battle, since this procedure is time consuming and inconvenient. All doors, hatches and bulkheads are sealed, so that hull ruptures will depressurize the minimum possible area of the ship. and the other.

#### ABOUT CREW STRUCTURE

The typical DH class vessel might have a crew of about twenty-four. This will include a captain; pilots; fusion, jump and computer engineers; navigators; weapons officers and medics. EDF ships will often carry a Mission Commander, who is responsible for carrying out mission objectives. While the Ship's Captain has jurisdiction over the vessel itself, the Mission Commander may override him. While Ship's Captains remain with specific vessels on long term bases, Mission Commanders are shifted from vessel to vessel according to mission needs.

All actions taken by a Mission Commander must be in accord with EDF doctrine, unless the Commander can prove that unorthodox procedures were absolutely necessary for the survival of mission personnel or the completion of the mission (if the mission goals are important enough to justify the means). This sort of evaluation requires a fine sense of judgment, and this is why EDF training stresses initiative and responsibility. All questionable actions taken by the Mission Commander will be subject to review by a board of inquiry.

Mission Commanders may not summarily execute crew, even if they are proven saboteurs.

Below: Destroyed Bridge of the DH-160  
showing effects of an ACV hit and explosive decompression.

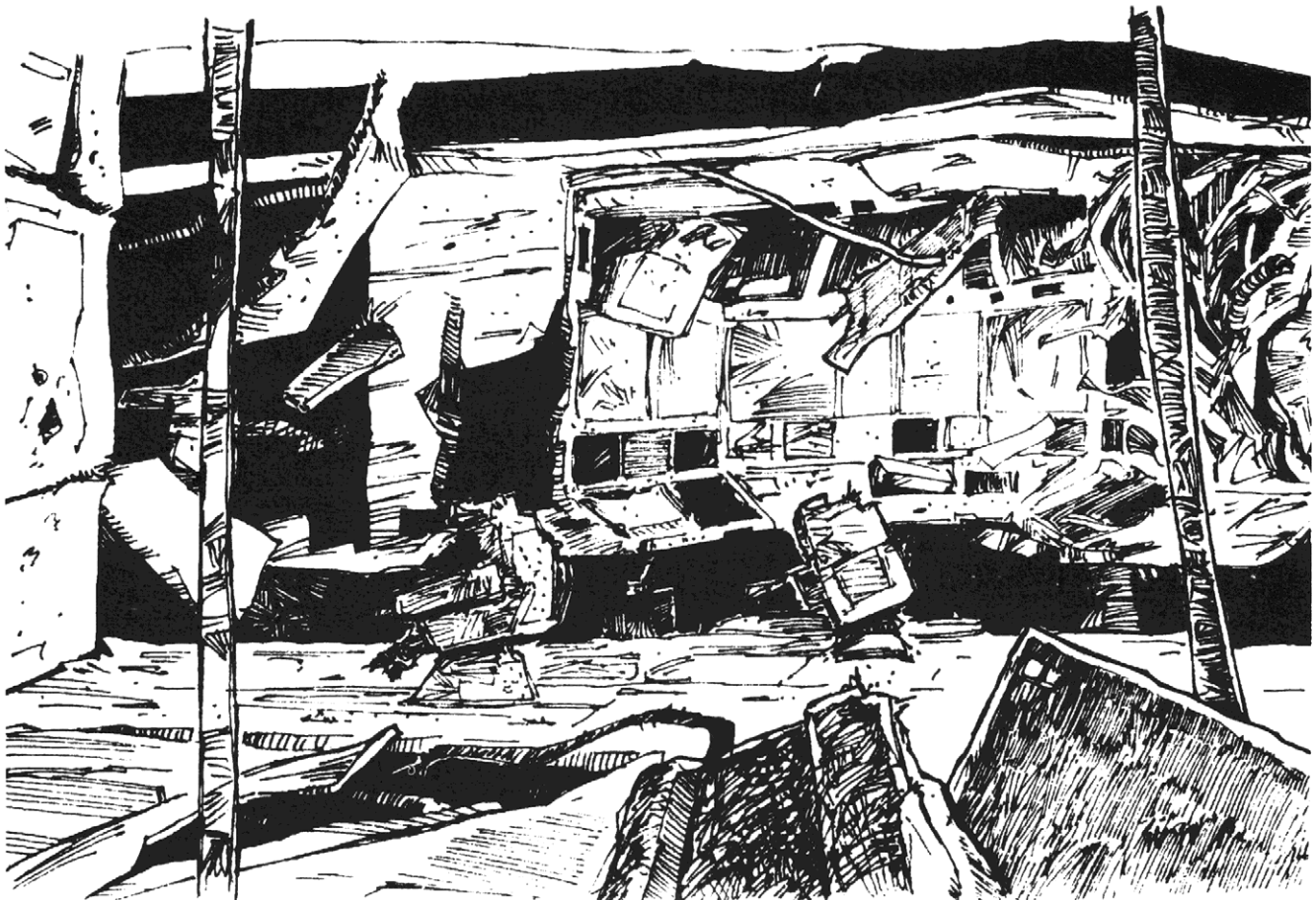

# Umpire's Notes

The scenario begins with the ship becalmed at the edge of the Hlian system's L5 point, a dense cloud of debris littered with the remnants of an old battle. Crew specialist Sharna Aoki has assumed command of the mission, a move which is resented by some of the crew.

The crew of the DH-160 repair their ship while they wait for help from the ConFed base in the nearby Tlakatan system. The player characters must define the tasks needed to send accomplish repairs, and divide up the crew labor to complete the various repair tasks involved. Exploring local space and scavenging in The Drift for spare parts will be a necessary but dangerous operation.

This otherwise simple situation is complicated by two things. First, the L5 point is being used as a staging base by a team of terrorist bandits ('pirates'), who are diverting civilian freighters into the deserted Hlian system and attacking them. Although the pirate's battle craft was destroyed in the encounter with the DH-160, the staging base crew will search for the EDF vessel once they are aware of its presence and attack it if they can. In the immediate necessities of survival, the PCs are in danger of forgetting that the ship which attacked them may have been part of a larger force. They could pay dearly for such preoccupation.

The second complication is the DH-160's crew. The crew is shocked and disoriented by the losses among its essential personnel. Building crew tensions lead to a takeover bid by Roilant Everrard, who 'removes' Sharna Aoki through foul play and takes over the position of Mission Commander. The player characters must oppose and remove Everrard, reinstate Sharna, and destroy the pirate base before it is possible to escape the Hlian system.

The umpire has about two weeks worth of game time in which to establish some relationships between the crew of the DH-160. Living conditions are terrible, and the crew is numb with shock, so tensions should run high. Roilant Everrard will be confined to sickbay, but will seem bitter about Sharna's turn of 'luck' in winning her command over his unconscious body. This should be the start of a 'beautiful friendship' . . .

The umpire should be able to create an atmosphere of hopelessness and hostility by the time the DH-160 reaches the edge of the Drift and Roilant Everrard takes up his duties again.

The adventure will proceed in three general sections: **Exploring The Drift**, **The Takeover Bid** and **The Pirates**, each of which is detailed as a separate chapter. These segments are *not* quite sequential. The takeover bid may occur at any point during the game, whenever the umpire deems appropriate.

## THE PIRATES

The 'bad guys' of this scenario are an independent group of bandits who are preying on merchant shipping. For want of a better phrase, we shall call them pirates. The pirates had two ships: a battle worthy ship of about destroyer size (which was destroyed by the DH-160), and a nondescript merchantman. The merchantman is currently outsystem selling the booty taken from the merchant ships *Toko* and *Aiko*.

The L5 point in the Hlian system conceals a hidden refueling/maintenance base. This base was set up by the pirates, who are using the flare-up between the ConFed and the ILR to conceal their activities. By infiltrating merchant ship crews with gang members, the pirates have managed to divert three merchant ships into the Hlian system using a number of pretexts (Hlian is an acceptable though unused alternate route to Do-Marki), where they have subsequently been ambushed, boarded, and their crews massacred. Cargoes are taken by the pirates' merchant ship to be sold at various nearby outworld ports.

Currently present in the system are ten pirates, who have been left to complete the stripping of the *Quitzi*. They are aware of the death of their destroyer, but lack the detection equipment to know the whereabouts of the EDF ship. Radio silence has so far been kept, and the pirates are awaiting the return of their merchantman, which will be able to confirm the destruction of the DH-160. Until that time, they will lie quietly, unless they actually encounter the EDF crew out in The Drift (see Section 2, **Exploring The Drift**).

The pirates at the refueling base have workshops and tools, vacc suits and personal pistols. They also have a five kiloton demolitions nuke, which is to be used for the disposal of the hull of the *Quitzi* once it has been stripped.

## RUNNING THE NPC CREW

Read notes sections of the NPC character sheets very carefully.

This is a crew in shock. Of the ship's original complement of twenty-four, only twelve now survive. Two of the survivors (Junior Pilot Officer Topa and Engineer's Assistant Mavik) are "frozen" in cold sleep in the ship's medical center. The dead crew members include the ship's captain, mission commander, first officer, chief pilot officer (second officer), chief navigator (third officer), chief medical officer, and chief engineering officer.

An EDF starship crew is a well balanced, highly motivated community. The EDF emphasis on steadiness and rational behavior creates very steady, reliable crews. Computer monitoring and competent stress management by the medical personnel act to identify and counteract morale problems before they become too serious. Unfortunately, the crew of the DH-160 has lost too many vital personnel in too short a time. In a single blow the ship has lost all of its authority figures. The computer has suffered damage to many of its systems, and now lacks confidence in its ability to accurately assess and intervene in psychological matters. Minor tensions are now beginning to create serious rifts in the crew.

Despite petty bickerings and differences of opinion brought about by stress, the rest of the crew (except perhaps Deika Tovan) are all good, reliable EDF members. They can normally be relied upon to behave responsibly. Growing antipathies will surface as surliness and fraying tempers, and not outright attacks or insubordination.

The command structure of the vessel has thus effectively been broken. Junior Pilot Assistant Aoki has assumed command, but her authority is rather shaky. Both Aoki and Everrard had equivalent claims to the post of mission commander. Since Everrard suffered disabling wounds during the battle, Aoki swiftly took charge, a fact that is now strongly resented by Everrard and his cronies.

A major portion of this adventure concerns the relationships between the ship's crew members. Everrard will attempt to rally support among the engineering and services crew in order to usurp command. Keep careful track of the developing friendships and enmities between characters. When major crises erupt, Ties and Antipathies will become very important. The crewmen of the DH-160 are highly intelligent and well motivated. Most are also stunned from the recent disaster, and bad tempered after a couple of weeks spent living the same room with one another.

Most of the crew want to know precisely what Sharna's plans are, and what their roles will be. A certain amount of jostling for precedence between the various specialty fields is inevitable. Since this is no longer strictly a piloting situation, Sharna's command could be challenged by other departments, but inertia will prevent this at early stages of the game.

The solution might be for Sharna to retain the position of Mission Commander (responsible for the mission's goals) and to give another character the position of Ship's Captain, (responsible for the safety of the ship)

### JULIUS CLARI

A real 'swing vote', Julius could wind up supporting either faction. He is so used to depending on the AI in his work that it will not occur to him to question the crew evaluations it gives. He will believe Roilant's excuses to stay off hard work details. He knows that he himself is not too stable; he will make allowances for his judgement being affected by grief. If one of the player characters takes the trouble to explain to him just how deeply the AI has been affected, citing it's inability to run many of its accustomed subroutines, it's newly flat, mechanical voice, etc., Julius will prove quite able in crew assessment. Such a conversation would strengthen his tie to that PC's faction.

Tatzel, Mank and Aelis may all become player characters if necessary. If they are, umpire should use the following guidelines to keep game balance.

### TATZEL HOLDEN - BRADDOCK HAINA RELATIONSHIP

Wooing the fair Tatzel is no easy matter. If she ends up with a tie ability score of 10 or more with Torscha, then a relationship is possible. In order for Tatzel to recognize and declare affection for Torscha, she would have to be approached properly and under the right circumstances (umpire's discretion).

### MANK'S INFERIORITY COMPLEX

If Mank becomes a PC, be certain the player understands what the ILR is and why Mank has a basis for his worries. If he is an NPC, the shock of the fight triggers his fear that this is an ILR. attack and he will somehow be at fault. Mank begins the scenario with an his self image at its lowest. Whichever leadership faction takes the time to make him feel 'more himself' will gain his loyal support.

### AEELIS EOCHA

If Aelis is a player character, ignore Incident Four in *Problems with the Crew*.

## ROILANT EVERRARD'S TACTICS

Roilant should not be an immediately obvious 'bad-guy'. The threat that he represents should only gradually dawn on the players, or should be dramatically discovered.

On the other hand, players should also be made to dislike Roilant if the maximum enjoyment is to be reaped from finally defeating him. Umpires must take their clues from their players as to how to best present Roilant. For instance, Roilant can be presented as being sexist to annoy players who are running Sharna Aoki as a character.

Roilant's trauma-induced psychosis will make him actively seek to undermine Sharna's authority. He will fix upon Sharna as an object of hate, and sees her as an obstacle to his own career. Roilant will make an appearance of being a very trustworthy character who will easily woo the support of his fellow crew.

Roilant Everrard will initially beg out of any assignments due to his head wounds. He will take the opportunity to spend the first few days of the adventure in chatting up any characters who seem to be approachable. Roll Roilant's public speaking skill vs. the stability of his target. If the roll is successful, then the target characters will roll for tie experience with Everrard. If the scavenging teams start to become successful, then Everrard will insist on leading one. If he is successful in bringing back some plunder from The Drift,

his self image will climb by 2 points and his attempts at 'chatting up' other crew members will be at a -1 DRM for the next day or two. Roilant will try to cast himself as a main organizer of the repair project. If Sharna goes off into the Drift, he will attempt to reshuffle work schedules to suit himself, winning support amongst the disgruntled workers by organizing extra rest periods.

Roilant Everrard spends most of his spare time winning over the engineering crew. If trustworthy characters (player characters or firm friends of Sharna) are put in charge of the repairs, they will be able to thwart his main design. Roilant will "earbash" one random character per day in an attempt to give the character an antipathy towards Sharna Aoki (roll spin yarn vs the target character's reason to force the character to roll for negative experience with Sharna). If a friend of

Sharna's is present and watching out for this kind of thing, they can intervene (this must be done tactfully if more tensions are not to flare).

Player characters will realize that something funny is going on if they can make a roll of intuition vs 10 when speaking to any characters that Roilant's rhetoric has effected. Good tactics to try on Roilant would be to isolate him on some project or other set a trustworthy character to follow him about and take the wind out of his persuasion attempts, while setting aside a part of Sharna's day to winning over the crew herself. If the crew feels well directed, there will never really be any serious cause for complaint against Sharna, and all will be well. If Sharna moves from task to task, working beside the repair crews and lending a helping hand, it will certainly help her gain the crew's respect. If Sharna sits on the bridge issuing orders and doing no visible work, that would cause resentment amongst the crew. If she consults the AI, it could appropriately suggest the better course.





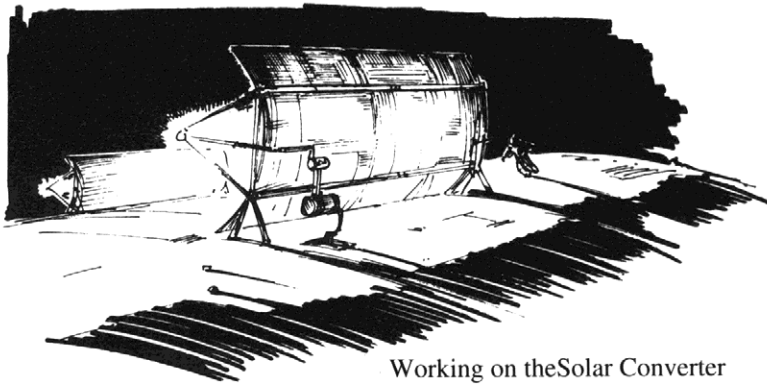

Working on the Solar Converter

The inter-personal relations aboard ship are a major part of this adventure, and requires a great deal of careful judgment on behalf of the umpire. Players who ignore the potential trouble brewing amongst the volatile crew will pay for their mistake in section 2 of the adventure.

## RUNNING THE COMPUTER

The DH-160's most important crew member is its AI computer. The computer is an independent intelligence in its own right, and is an aspect of the Net as described in the umpire's background information of the *Albedo* rulebook. The ship's AI net on ConFed vessels will be a part of the greater Net. These scattered fragments of the Net will be updated on current plans and thoughts of its brethren every time the ship docks, receive information transmissions or accept data downloads from other AI's.

Characters who are in contact with the Net may continue constant relations with the Net while travelling aboard a starship

Crewing a ship is a partnership between computers and personnel. The ship's computer net is normally capable of running the ship with no need for a live crew. Live crew act as creative tactics planners and emergency back-up for computer systems. The computer net monitors the welfare of the live crew (physical and mental – psychological balance must be carefully maintained in the fragile enclosed environment of a starship), and can act as a counsellor for all manner of personal problems. Mini sensors throughout the vessel monitor the day-to-day actions and interactions of the crew. All data entries into the ship's net will be assessed and evaluated. The ship's sensors are subtle and sensitive; they can detect the hormonal and physical changes brought on by stress or pregnancy, or alert medical personnel when a crew member is suffering from a temperature.

Processor nets require authorization from command-level crewmen to take autonomous actions (actions not directed by live crew), but show a high level of initiative within their operating limitations. The computer is accessible from and has access to all areas of the ship.. Radio and fiber-optic

communications also allow work parties direct access to the computer. For its part, the computer can look into any area of the ship via its internal sensors.

The computer handles a huge number of routine tasks on board ship. All calculations, structures and equipment are constantly monitored by the intelligent, self-aware computer. The computer works hand in hand with the organic crew as part of a complementary team.

At the time the scenario begins, the computer has shut down all monitoring functions except vital emergency monitoring. Although it will be aware of leaks and gunshots, it is not keeping close watch on the psychological state of the crew. This task has been relegated to the ship's medic, who is failing his duty due to personal shock and grief.

The computer of the DH-160 is severely damaged. Its behavioral models have been compromised, and it has withdrawn them from use since it feels that its findings would not be acceptably accurate. The computer can still help the players with the problems of leadership and crew control if consulted, or if it sees things going seriously awry.

The ship's AI computer net has also been severely damaged. Massive loss of ship's electronics has downgraded the net's ability to do more than one thing at once. The computer is still capable of carrying on conversations, course calculations, communications and environmental monitoring. Likewise, it can easily control a robot, or talk characters through difficult tasks, but only if it is not heavily occupied with other tasks.

Where the computer suffers most is in the area of personnel assessment. Internal monitoring of security is difficult to maintain – the computer will report intrusion, sabotage and accidents, but has trouble evaluating crew mood. The computer can conduct lengthy interviews with individuals to assess mood and efficiency, but it may not be particularly efficient. (Treat it as having a psychological evaluation skill of 10. If the computer fails to make an assessment, it will simply state that its behavioral analysis models are compromised, and that further assessment of the personality in question will be of dubious value.) If asked to go to full psychological monitoring on all of the crew, the computer will tie up so much of its processing power that all other tasks will become slower and less efficient. Under properly monitored conditions, Everard's aberrant behavior would have been noted and acted upon long before it could endanger the cohesion of the crew.

Even with these limitations, the AI is an intelligent, resourceful character. It will aid the best interests of the organic crew in any way that it can. The AI requires authorization for autonomous action, but once correct authorization is given it may act without further guidance.

# The Takeover Bid



# Section 2:

Continued from page 19

Sometime during the game before the finding of the pirate base, Roilant Everrard and his closest cronies will attempt to take over command of the ship. Their plan is first to 'neutralize' Sharna Aoki, and then to press Everrard's claim to the role of Mission Commander. Other key posts will be given to Everrard's associates.

## EVERRARD

The blow to Everrard's head has brought out his psychopathic/sociopathic tendencies. The lack of routine and proper computer monitoring, combined with the negligence of the ship's medic, has let this condition gain a firm hold, and the crew has not paid the right kind of attention, allowing the problem to develop further. Remember that Everrard is not 'evil', and that killing him is a bad solution, since it would cost the EDF a potentially valuable officer.

Everrard has an outward appearance of self confidence, charisma and authority (much of which has been brought out by his psychosis). He is not well balanced psychologically, and by this stage of the game his passions tend to get away from him. In his dealings with the crew once he has taken command he will seem arrogant and obsessive. He will take *direct, violent* action if he is defied or if a plan does not work out the way that he had planned. Roll Everrard's Antipathy strength with the object of his hate vs his Reason. If the Antipathy overcomes his Reason, he will directly intervene and damn the consequences. Sabotage, murder, false reports and rattle rousing are all possibilities that he might try. Referees should use their discretion and have Everrard act in any way which adds to the interest and excitement of the adventure's story line.

## PHASE 1 REMOVING SHARNA

Everrard will make an attempt on Sharna's life through sabotage. The deed will be cleverly done, making full use of the lowered security monitoring and slackened safety discipline of the crew to make the attempted murder seem like a plausible accident.

The type of sabotage will depend on Sharna's current activities. If she is in the habit of going outside the ship into vacuum conditions, the air supply of her vacc suit might be tampered with (e.g., her environmental monitors might be disabled, and then her life support pack could be swapped for a depleted one, or her EVA jets could malfunction and slam her against the ship's hull). If she works mostly indoors, any number of "accidents" could be arranged (the ship is still very heavily damaged, and can be dangerous to the incautious). Umpires will have to use their imagination to come up with

a plausible, effective sabotage method.

The umpire will have to 'cheat' on this encounter to determine the correct result for game story line purposes. The attack on Sharna must fail to kill her. It will leave her seriously injured and unconscious, and she will be taken into sick bay. The crew must have reason to believe that Sharna will be comatose for a long while to come, and that they will have to continue without her for a while.

## PHASE 2 TAKING COMMAND

A meeting of all ship's personnel will be called, and Everrard will now announce his assumption of the role of Mission Commander. With Sharna incapacitated, his claim is justified, and the motion will be passed without much argument.

Everrard will then rearrange work schedules to confirm his new control. All repair work grinds to a halt as crew are put to work creating portable EM detectors, which Everrard plans to use in an all-out attempt to find the pirates' base of operations. He firmly believes that the pirates have an operating ship hidden somewhere in the drift. He plans to return home using the captured pirate ship, making further repairs on the DH-160 unnecessary.

Careful scrutiny of Everrard during this period would give players clues as to his aberrant behavior. He will always be armed; he will have the arms locker sealed, allowing no other characters to have access to weapons. If Mank has been accused of being a spy, then he will ensure that Mank is persecuted unfairly. If Sharna's friends seem to suspect him of foul play, he will keep them constantly watched, and will look for the chance to have them die heroically.

## PHASE 3 SHARNA'S RECOVERY

Sharna will surprise everyone with a rapid recovery. Roll once per day, checking her Stamina vs 15. If this roll is made, Sharna will snap out of a coma into semiconsciousness. A day later, Sharna will awaken, but will remain weak for another 24 hours (the equivalent of serious wounds to the head and chest).

While in a semiconscious state, Sharna is vulnerable and in serious danger. Unless closely guarded, she will be killed by Everrard or one of his faction. This phase is tricky for the umpire. If the doctor both is friendly and has been approached with suspicions regarding Everrard, he might well conceal Sharna's recovery from all but a chosen few, giving the players an increased number of options for action.



## PHASE 4

### THE STRUGGLE FOR COMMAND

If Sharna suddenly reappears and attempts to take control of the ship once again, Everrard will declare her irrational and have her confined.

The best ploy for uncovering Everrard is to make him betray himself. The computer could be temporarily dedicated to performing an in-depth analysis on Everrard, revealing his mental instability. Another ploy would be to play Everrard off against someone that he hates, and have the crew see that Everrard is dangerously irrational. Everrard will collapse into absolute paranoid delusion if the tide turns against him, and will attempt to kill his opponents by any means possible. He would be assisted by anyone who has performed sabotage or murder attempts on his behalf. Other crew who are tied to Everrard must check their Tie strength vs their Reason. If their Tie fails to overcome their Reason, then they will back Sharna, and not Everrard.

A dramatically staged entrance for Sharna, coupled with damning evidence against Everrard, should prove the most effective means of reestablishing Sharna's control over the ship. If well played, this sort of set-up can be most enjoyable for both the umpire and the players.

Wresting control of the ship from Everrard is an opportunity for careful thinking, good problem solving and nerve wracking man hunts along the ship's badly lit, ruined corridors. Use it well.

# SECTION 3:

## The Pirate Base

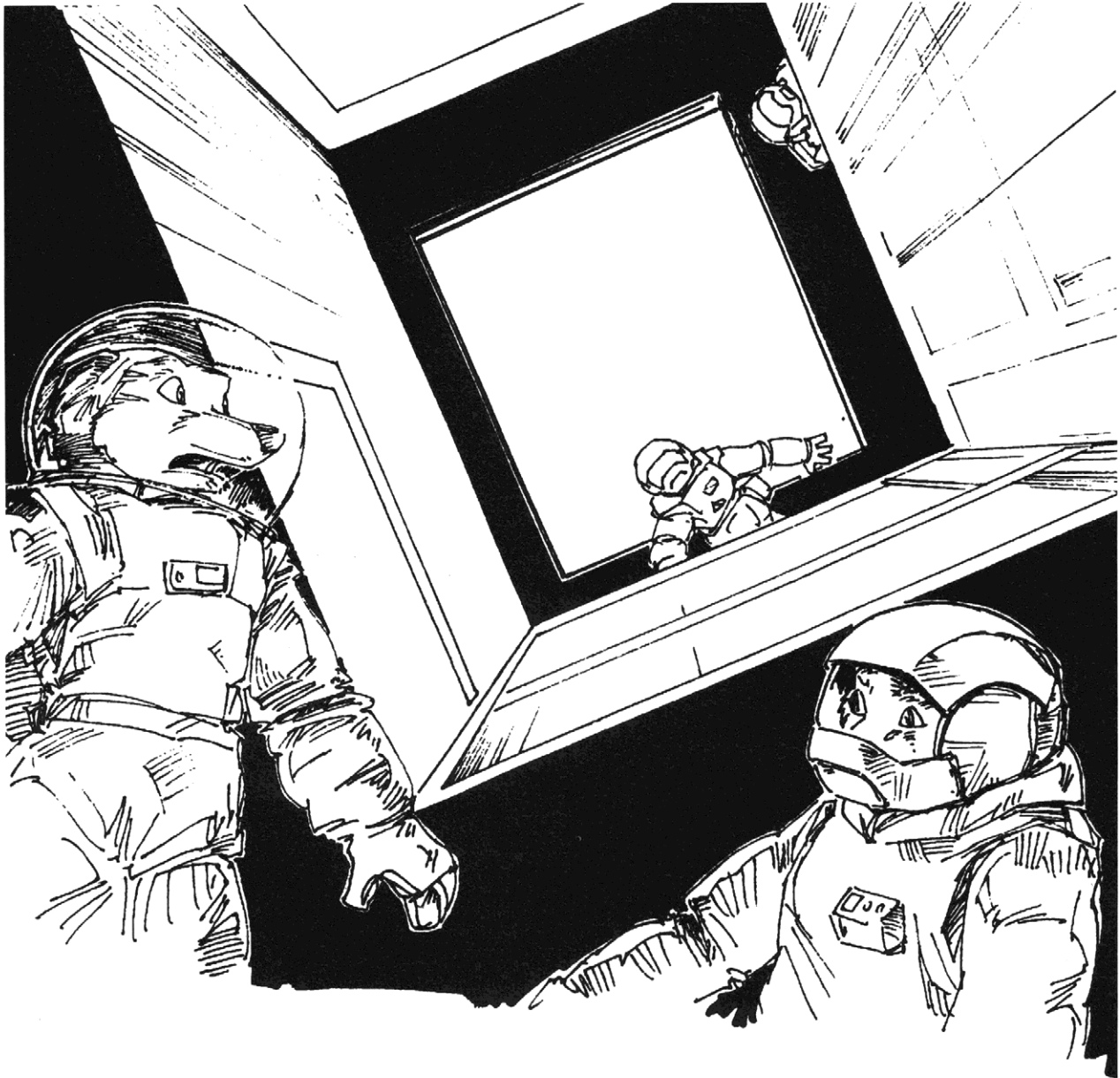

Clump 23 is the pirate base. This consists of an icy comet husk (used for refueling the pirates' ships) and an old ILR destroyer hull refitted for supporting twenty individuals. The base holds five individuals plus any survivors from the first skirmish. At rest beside the base is the hull of the freighter *Toko*, which the pirates are refitting with salvaged engines in an attempt to escape The Drift (reactors, computer and armament were taken off for sale outsystem by the pirates' other ship).

If the first skirmish was won by the pirates (or if pirate survivors from the combat reach their home base), then the pirates will actively seek out the EDF ship with search parties of three members. There is a 1 in 6 chance per day that the DH-160 will be found. If the EDF ship *is* found, then an assault party will return bearing the pirates' demolitions nuke .

**THE PIRATES**

**Pirate #6**

Critter type: Mouse (Small frame)



Disposition: Callous  
Characteristics  
 Str: 5  
 Sta: 12      Sta/2: 6  
 MDex: 12  
 Coord: 12      Actions/turn: 4  
 Reas: 10  
 Intu: 14      Init. dice: 3d3  
 Drv: 15  
 Stab: 10

This character might booby trap himself or hide out inside the base after his comrades have surrendered, etc.

**Pirate #7**

Critter type: Sea gull (Light frame)



Disposition: Cruel  
Characteristics  
 Str: 8  
 Sta: 12      Sta/2: 6  
 MDex: 12  
 Coord: 11      Actions/turn: 4  
 Reas: 12  
 Intu: 10      Init. dice: 1d6  
 Drv: 10  
 Stab: 10

This character will always attack helpless opponents in preference to more active enemies.

**Pirate #8**

Critter type: Cougar (Average frame)



Disposition: Reckless  
Characteristics  
 Str: 10  
 Sta: 10      Sta/2: 5  
 MDex: 10  
 Coord: 9      Actions/turn: 4  
 Reas: 12  
 Intu: 13      Init. dice: 1d6+1  
 Drv: 13  
 Stab: 6

Might make a stupid escape attempt.

**Pirate #9**

Critter type: Wolf (Solid frame)



Disposition: Straightforward  
Characteristics  
 Str: 12  
 Sta: 10      Sta/2: 5  
 MDex: 9  
 Coord: 9      Actions/turn: 4  
 Reas: 10  
 Intu: 10      Init. dice: 1d6

This character is an adventurer who let his love of action lead him into a life of crime. He could be won over by the right persuasion.

### POSSIBLE TACTICS

Several ploys might be tried by the players, such as threatening the pirate base with the DH-160's point defense cannon, or threatening to ram an ACV through the pirate base. If an idea sounds good, let the players try it! There should be a number of ways the scenario can end without the crew having to storm the base in a blaze of gunfire. The pirates will surrender if they seem to have no other option.

The detector modules outside the pirate base can be used as access to the base's computer network. A talented hacker will be able to use the base's system as a weapon against the pirates: sealing doors between the pirates and their hostages, or using the internal sensors to help pinpoint the pirates' location.

If the players decide to attack, a careful survey of the pirates' detectors will show that there are blind spots in their radar patterns. By drifting slowly and making the best possible use of natural cover, it might be possible to make it to the surface of the pirates' asteroid. After that, it's up to the players.

If the DH-160 hovers nearby, the pirates might try lobbing their demolitions nuke towards it, probably deploying the nuke inside one of their shuttles. They will also use the surviving passengers from the *Aiko* as a bargaining counter, threatening to kill them if they are not allowed to go free.

Note: Once again this party should provide a challenging but winnable combat. The EDF has the advantage in that they should have prepared for the encounter and should have a trick or two up their sleeves.

### INSIDE THE PIRATE BASE

The pirate base contains a selection of valuable spare parts, and a large store of foodstuffs. If the base is captured intact, then the players will also find records of the pirates' activities and details on their victims, method of operation and personnel. The pirates will attempt to destroy this evidence if capture seems imminent (e.g., performing manual data dumping, or even by setting their demo nuke before abandoning the station).

All pirates have grenade, pistol and Zero-G Maneuver skills. They have carbines if on duty.

The pirate base contains several gigatons of fuel, tons of hull plate, and food, as well as the engines and MHD coils stripped from the freighter *Quitzi*. The base contains records of the pirates' activities, as well as their off world contacts.

#### AREA 1: HANGAR

This is the storage area for the pirates' zero-G shuttles. There are tanks of liquid hydrogen here, as well as heavy hull plate sections. Robotic arms are used to manipulate large, heavy elements of cargo. If accessed via the base's computer network, they might make a potent weapon.

#### Pirate #10

Critter type:

Cow (Solid frame)



Disposition:

Deceitful

#### Characteristics

Str: 12

Sta: 12

MDex: 9

Coord: 10

Reas: 10

Intu: 8

Drv: 13

Stab: 13

Sta/2: 6

Actions/turn: 4

Init. dice: 1d6-1

The group's spokesman, this female character might peddle a story about her actually being a captive of the nasty pirates, etc., thus gaining the opportunity to work harm upon her would-be rescuers.

The engineering workshop can provide enough segments to make one robot, which can be used as a nasty weapon against the pirates if the PCs have the programming and electronics expertise to take control of the device.

**AREA 2: CONTROL ROOM**

At least one pirate will be here, carefully monitoring the base's defenses. His systems include video surveillance in all rooms and halls, as well as alarms, noting any changes in internal pressure or the loud noise of gunfire. From this position, one can lock any door in the complex, and can depressurize areas at will

**AREA 3: HABITAT AREAS**

Empty dormitories, empty rec rooms, a medical station, and an empty kitchen. This is the most probable battleground in the station, with both teams of combatants fighting a running gun battle through the rooms and corridors.

The medical station is home to a nurse robot, which can be reprogrammed into a frightful weapon. The medical unit and kitchen are just rooms with ex-shipboard hardware stuffed in rather unceremoniously. The rec room has a pair of large screen vids and some zero-gee exercise equipment. All the open surfaces will have gymnastic mats attached to them.

**AREA 4: LIVING QUARTERS**

All off-duty pirates will be in these rooms.

Living Quarters have floor to ceiling bunk frames and zero-gee sleeping bags 'velcro'ed into them, along with duffle bags and misc. small bags or containers for personal items. Several portable PHMs will be set up at one end and the environmental control modules would be at the other. As per the rest of the base, all the fixtures and plumbing would be out in the open. There is no fixed computer terminal or communications station. The dormitories would be similarly fitted, but having no signs of current use.

**AREA 5: HOSTAGES**

The storage areas are just open rooms with an open pattern of floor to ceiling struts to attach hardware to.

This storage area is being used to hold seven passengers taken from the *Aiko* – all spouses, children or relatives of rich, influential citizens, from whom the pirates hope to extort a ransom. One pirate will always be on guard outside this area. In case of EDF attack, he will burst into the room and begin gunning down the hostages, perhaps keeping a single one alive as a final bargaining chip for his own life.

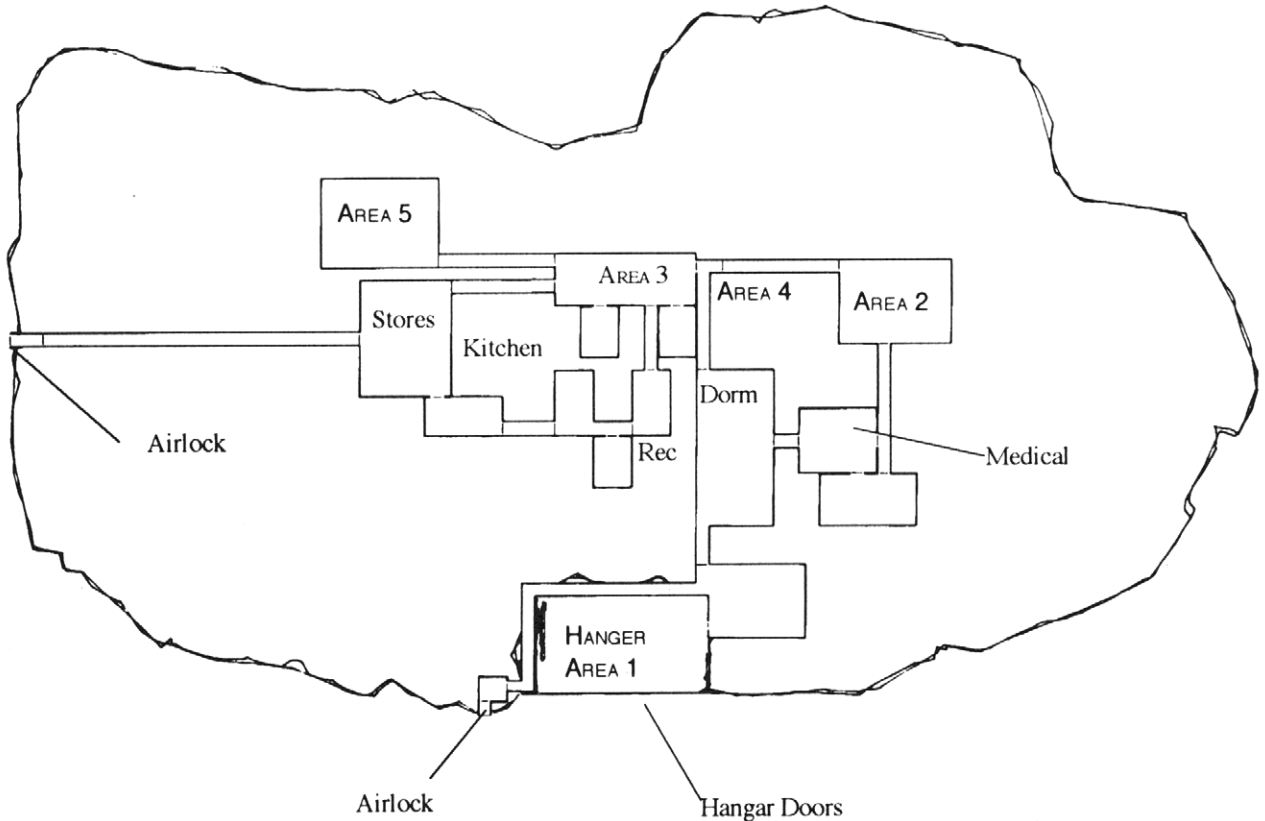

**PIRATE BASE**  
Inside Hollow Comet



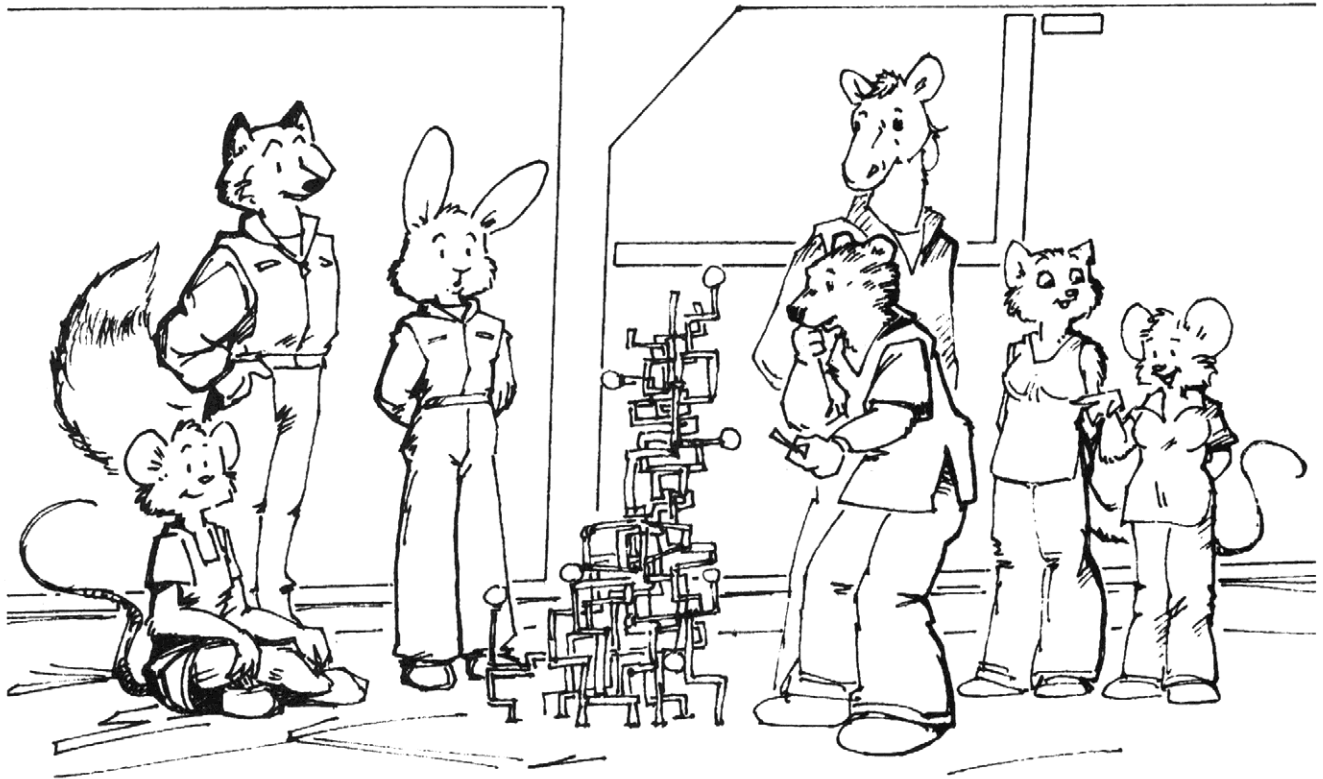

## Epilogue

This is the adventure's denouement. The crew will have to wait a month or two for a rescue mission from Tlakatan. The waiting could get awfully boring, but there is time for the umpire to pursue to a conclusion any interesting interpersonal affairs between the crew.

The perfect game will end with the ship being rescued, and Sharna still in control as Mission Commander. There will be one or more pirates held as prisoners on board, and the crew will have recovered some sort of hard evidence as to their activities. Torscha will have won the heart (or at least the respect) of the fair Tatzel, Braddock Haina will have come out of his shell and will have gained new friendships, and there will be no dead EDF crew members who weren't dead when the scenario started (that includes Roilant Everrard!).

Needless to say, very few scenarios will have the perfect ending, although the perfect ending is not too hard to achieve.

The most important things which measure the success of the players will be an evaluation of how their performance on the mission will affect their future lives. The ship's computer will render a report on all of the ship's crew once the scenario is over. Characters who have behaved irresponsibly, or who have performed actions which are in any way questionable, will be dragged before a board of inquiry and required to defend themselves. The EDF will censure an officer for being too close to a problem to view it objectively, so be warned! The best way for the P's to neutralize Roilant Everrard is therefore to have him brought before a military court for a real offense (e.g., mistreating a prisoner, mutiny or attempted murder), rather than shooting him dead during play. Crew deaths will all be investigated.

If any of the player characters have performed their duties well and are seen to have proven their abilities, then they will be commended and rewarded. If they prove to be particularly talented, the Net might even decide to take a special interest in them from now on . . .

# THE DRIFT

an adventure for

## ALBEDO

THE ROLE-PLAYING GAME  
Second Edition

Many years ago, a bitter battle was fought. Now the debris from that battle, broken ships and bits of wreckage, floats in space, abandoned and alone. The player characters are wrecked near The Drift. They must improvise repairs to their wrecked ship from other ruined ships as their air and food grow dangerously low. Hungry, with interpersonal problems complicating their efforts, and air leaking out of their ship, will they succeed in time to survive? Is The Drift even more dangerous than it seems?

This scenario is designed for a referee and three players, with an option for adding one to three players if necessary.



Price: \$12.00  
Stock Number: T&I 8851  
ISBN: 1-883240-13-1



2990 San Pablo Avenue  
Berkeley, CA 94702