

THE ONE PAGE DUNGEON CODEx

2009



Edited by Philippe-Antoine "Chatty DM" Ménard and Michael "Chgowiz" Shorten

Introductions

Philippe-Antoine Ménard, Michael Shorten

I'm a firm believer in Terry Pratchett's take on inspiration. In one of his early novel he explains that ideas travel through the Cosmos as tiny particles of creative energies. Getting an idea involves being at the right place, at the right time where an idea particle hits a tiny place of your brain... which then explodes with a new idea.

Wait, that's not how it works for you? It sure does feel like it to me.

During the winter of 2009 , shortly after I discovered the One Page Dungeon template, I thought to myself "Now wouldn't it be nice to get more people to know about the One Page Dungeon Template". I had successfully used it in my new Primal/Within campaign and I really wanted to show people how cool the template could be.

The idea of making a contest on my blog naturally followed. However, while the template was distributed under the creative commons licence, I wanted to ask the creator of the template permission to go ahead with the contest.

As I wrote that first email to Chgowiz, who had probably never heard of me up to that point, I decided to not only ask permission, but to bring him in so we could co-host the contest. From my cursory review of his blog, it was obvious that he was as much Old School as I was a New and I wanted the contest to appeal to the whole spectrum of D&D fans. Chgowiz was understandably wary of my proposal but he agreed to mull it over.

Our early discussions led to what I think was the best decision we made about the whole contest and was likely pivotal in its success: we decided to ask participants to make thier entry system - neutral. No monster stats, just descriptions and names.

The idea snowballed from there, we got more than 10 sponsors, awesome prizes and 112 entries in the contest. It was hard work, much more than I had envisioned but the results are staggering. I wish to thank Chgowiz and our 4 judges: Sham, Amityville Mike, Dave the Game and Alex and my friend Graham for sharing the work, providing technical support and wading through all those entries.

This PDF is the culmination of my little idea , I want it to be a gift back to the community that has shown tremendous interest and support of the whole project. I don't know if I'm ready to do it again next year, but I'm proud beyond belief of what the project achieved.

I wish you hours of fun with theses dungeons!

Philippe

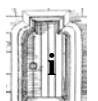

Every so often, serendipity and obsession get together and create the right environment for something wonderful to happen. I think that if Dave Arneson and Gary Gygax hadn't had a little bit of obsession and serendipity in how they came together to create Dungeons & Dragons(tm), we probably wouldn't be having the same kind of conversation. They did, so here we are. That's what happened to create the One Page Template, as well as pull this contest together.

Telling a computer geek "I wish someone would create XYZ" is like laying out the Ultimate Challenge. Ask those guys that made the Apollo spacecraft computers, or the guys who programmed those breadboard microcomputers. I have the same "attribute" - someone says "It can't be done..." or "Wouldn't it be neat if..." and I start to create ideas in my head.

When Dave and I collaborated on the One Page template, we were just thinking how neat it would be for us to share megadungeons and our odd bits of obsession with a "niche within the niche" - the old school movement. We really didn't give much thought if this would be applicable anywhere else. Little did we know...

When Philippe/Chatty approached me in March with his enthusiasm about the One Page template and his idea for a contest, I was really surprised and worried. I knew of Chatty and his love and support of the newer versions of D&D, and I had the irrational fear that our old-school tool was about to be co-opted. Silly, I know... right? Well, I hemmed and hawed and with advice from my wonderfully supportive wife, I decided to enter into the contest venture with Chatty.

I really wanted something that would bring together gamers, not separate them. I wanted the contest results to reflect the purity of the dungeon - that place that the game of D&D started from - so Chatty and I agreed that we would run a system-neutral, all-ideas-welcome inclusive contest.

The results were far beyond my wildest expectations. I thought we'd get forty entries - fifty would be fantastic. We ended up with one hundred and twelve! We had dungeons of multiple entry points, dungeons inside of living things, dungeons in jungles, dungeons in the air, infinity level dungeons - you name it. We saw the most amazing nuggets of imagination, fantasy, mystery and above all, a sharing of a person's love for this game.

I've said it many times and I'll say it again - I am humbled and honored to have been able to read each and every dungeon submitted. Each one told me that the simple "playing field" that we all enjoy shares timeless and edition-neutral commonalities. I think that's an amazing thing to see, over 35 years of history and play reflected in these entries.

I hope you enjoy what you find in these winning entries. Each one represents a neat and amazing idea on a theme, or across a broad spectrum of fantasy gaming. Most of all, I hope you have the same fun in playing in these dungeons as we did putting this little contest together. Have fun!

Michael

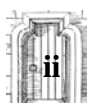

The Contest Judges

We were thrilled to have a wide variety of gamers and bloggers agree to judge and help us with the contest. We'd like to acknowledge all those involved in the organization of running of the contest:



Chatty DM AKA Philippe-Antoine Ménard is one of the crazy minds behind the One Page Dungeon Contest. He also is the person behind [Musings of the Chatty DM](#), a D&D-Centric RPG blog that captures that familiar feeling of hanging out at your favorite gaming shop. It is the perfect place to discuss with friendly geeks who share your passion for RPGs.



Chgowiz AKA Michael Shorten is another crazy, obsessive geek behind the One Page Dungeon Contest. He writes the blog [Old Guy RPG Blog](#) where he shares the fun and joy of the original editions of D&D, one game at a time. He's been published in [Fight On!](#) and [Knockspell](#), is part of [Three-Headed Monster Games](#) and writes for Examiner.com as the [Chicago Dungeons & Dragons RPG columnist](#).



Kensanata AKA Alex Schröder is the grumpy old-school gamer wanna-be with a German accent living in the land of the Swiss Gnomes. The [RPG category of his blog](#) is where he puts his rambling thoughts on adventure design, D&D rules, RPG publishing, international shipping rates, and neo-classical gaming. He has been published in [Fight On!](#) and runs the very simple but serviceable [Campaign Wiki](#).



Sham AKA David Bowman is a 30 year veteran of D&D. Three decades of campaign building, rules tinkering and home brewing have brought Dave back to the source of all this madness, 1974's original D&D. A contributor to [Open Game Table](#), [Fight On!](#), [Knockspell](#) and the recently announced [Three-Headed Monster Games](#), the author can often be found rambling about various game topics online at [Sham's Grog 'n Blog](#).



Amityville Mike AKA Michael Curtis is neither crazy, obsessive, nor grumpy, but he was picked to help judge the One Page Dungeon Contest nonetheless. Crawling through dungeons since Holmes Basic, Michael currently spreads his philosophy of “Stop worrying and love the Dungeon” on his blog, [The Society of Torch, Pole and Rope](#). He has written articles for [Fight On!](#) and [Knockspell](#) magazines, and is the author of Goodman Games' forthcoming [The Dungeon Alphabet](#).

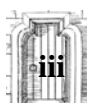



Dave The Game AKA Dave Chalker is the editor-in-chief and co-founder of Critical-hits.com, executive director and co-founder of RPGBloggers.com, and his Gygax Number is 1.



Graham Poole is the warped mind behind CriticalAnkleBites.com, and the technical mind behind about half of the RPG Blogosphere. As one of the founding members of the [RPG Bloggers Network](http://RPGBloggersNetwork.com), he keeps it afloat through constant infusions of code and metahuman-level force of will. He has been published by nobody, and writes purely for himself on his own sporadic schedule. (He doesn't mind if people like to read it, though.)

Contents

The Origin of the One Page Dungeon Template	1
Building the Font of Sorrows with the One Page Dungeon Template	3
Creating a map for the One Page Template with GIMP	6
"How to use the One Page Template" Contest posts	7
The One-Page Manifesto	10
The 3 Winning "Best Of" Dungeons	11
The Runner Ups	15
Honorable Mentions.....	22
Our final thoughts	35
Our Sponsors.....	37

Cover Art by Mark Allen - Marjasall Productions <http://portfolio.marjasall.com> – Mark is the first place (Color) winner of the 2009 Erol Otus Art Challenge by Fight On! magazine and Otherworld Miniatures. Mark is also known for his work with Troll Lord Games LLC. Cover art is used with permission, all rights reserved by artist. The cover depicts a scene from the “Best Overall One Page Dungeon” winner.

All dungeon contest entries and the One Page Dungeon Template are released under the [Creative Commons Share-alike license \(v. 2.5 - US 2008\)](#).

All other content is copyright 2009 by the authors of article or text: Philippe-Antoine Ménard, Michael Shorten, Santiago Luis Oría, and David Bowman. All rights reserved by authors.

Page footer graphic courtesy of [Karen's Whimsy](#), public domain image.

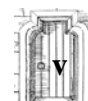

The Origin of the One Page Dungeon Template

by Michael Shorten

In December of 2008, Dave of Sham's Grog 'n Blog had started a personal project called "The Dismal Depth". A discussion on the OD&D Boards (a forum dedicated to the original 1974 edition of Dungeons & Dragons) [about megadungeons](#) had prompted Dave to reconsider how he went about creating his dungeons. [2] (The post has been slightly edited for brevity) – Chgowiz

The notion of a no-frills megadungeon was the kindling for this project, but what truly pushed it over the edge into actual design process was a comment by one of my favorite odd74 posters, Dwayanu in [this thread](#). For ease of clicking and scrolling, here's the blurb:

I'm trying out an approach of mapping by sectors of 30 x 30 squares. That leaves room on the same page for a succinct "key."

Now, in hindsight I don't think Dwayanu meant for his design process to result in anything more than a handy key on the map, but his words helped me form the approach for The Dismal Depths, a megadungeon with dungeon level maps, tables and room descriptions entirely on a single page.

It sounded like a brilliant idea. We've all seen plenty of similar maps online or in print, but I hope to offer a megadungeon that requires no more than a few handwritten notes on the part of the referee to dive in and enjoy a full-blown dungeon crawl campaign.

The Dismal Depths will hopefully embody the [Empty Room Principle](#); giving referees

more than ample creative opportunity, either beforehand, during a session, or afterwards when restocking or altering the dungeon.

I designed Level 1A, The Tunnels of the Mole-Men. A 30 square x 30 square map which encompasses the north-west corner of Level 1:



This was then scanned and cropped after filling the map in greater detail.

The rest of my time has been spent working with scanning, Photo-shop, and Word. I cropped, pasted, and played with all the various Word settings to produce this first draft version of Level 1A:

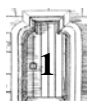
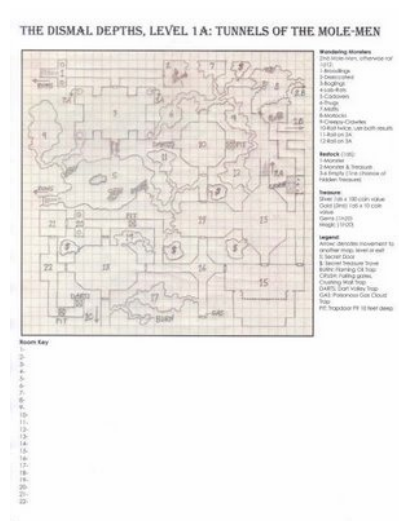

While I haven't typed in the Room Key just yet, the end result will be something limited to what I can type on a single line, maybe like so:

3-The Laughing Idol. Four shafts with ladders leading down. Mole-Men (7), Silver (300), Gold (50).

With just simple text, a referee could invent details on the fly, and still have the basic text for future use in order to jog his memory on how he handled the room in the past.

But then, in a comment, Dave confesses:

I'm realizing that if given time, I could write pages of text on nearly every aspect of my campaigns, but these words are simply messages to myself. I enjoy writing my thoughts and ideas, but perhaps the focus should be on the actual play and less on the frills. Thus I've been pursuing the notion of an economy of words for dungeons, encounters and monsters. This is a major departure for me.

After fooling with this for the past few days, I'm afraid I cannot quite get everything to my liking. I might scrap the single page idea, which I do believe has great merit but requires better computer art skills than I command (and perhaps better equipment and more time), and revert to a single map but maintain the bare-bones room descriptions. I'd simply merge the proposed four quadrants per level onto a single map. This would require multiple pages of text to describe the greater number of rooms, but I could actually get back to drawing maps and stop scanning, copying, pasting, cropping, coloring and making templates.

Maybe this is simply a neat idea, but not so easy to implement and master.

And then Dave asked the all-important question:

... My troubles with the entire scanning, cropping, lay-out have forced me to scrap the initial plans, BUT I am moving full steam ahead with the project without the one page approach.

I'll update the project once I have the first map done, but the gist of DD will now be detailed, involved maps with bare-bones room descriptions and monsters.

In essence the same approach, but no longer limited by the quadrant, one-page template.

I hope someone with more computer skills can take up the torch.

This is where Michael (Chgowiz) came into the picture in a comment a few hours later...

... I've created an OpenOffice Document with a 30x30grid (6 lines per inch) and the same "layout" you had. I've not tested it with an example, but here's how it would work... you could sketch something out to get the basic rooms, write it up in OO, then print, draw the actual map and you've got it done. If you wanted it to really be one stop shop, you could scan the map and using OO Draw, copy/paste it back into the ODT (document) I suppose.

From his blog, [Chgowiz posted on the following day](#) (12/31):

... one of my "McFly" weaknesses is someone saying "Gee, I wish a geek would do this...". ... it's how I was tempted (obsessed) to solve Sham's problem.

The hardest part actually was getting the 6 line/in, 30x30 grid from the Incompetech PDF (I used the [Cornell template](#), based on

[Norman Harman's suggestion](#)) into the OpenOffice document ... After that, it was pretty easy to use frames (text boxes) and line everything up.

The [One Page Dungeon Level Templates](#) can be downloaded here. This zip includes both Word and OpenOffice documents and templates.

Some back and forth ensued, with versions of the one page template were traded back and forth between the old-timers for both dungeon and wilderness adventures. A couple of bloggers even started their own long term megadungeon projects based on the One Page Template - most notably the "Stonehell" megadungeon by Amityville Mike of the blog [The Society of the Torch, Pole and Rope](#). The template remained with the old school niche, but little did we know what we'd just created. 4 months later, ChattyDM discovered the One Page Dungeon Template and brought it from the old school blogosphere to a wider audience.

Building the Font of Sorrows with the One Page Dungeon Template

By Philippe-Antoine Ménard

This is the blog post I wrote when I discovered the One Page Dungeon. It shows how I designed the first dungeon of my Primal/Within Campaign where an underground City grows within a sentient Dungeon. -ChattyDM

Recently, I was trawling the Web for ideas and tools to create dungeon maps to actually have places for my players to adventure in.

I wasn't looking for software mapping tools, because the barriers to entry are too high for me. Furthermore, all the options of such software tend to distract me from actually designing. What's worse, when the software does not do exactly what I want, I obsess about it for hours and stay stuck .

No, really, nothing beats a sheet of paper and a sharpened pencil...

That is, until I found out about the work that [Chgowiz](#), [Sham](#) and [Amityville Mike](#) did to develop a dungeon design tool.

The One-Page Dungeon Template

It started in a [discussion](#) back in 2007 about making Megadungeons. The idea of drawing part of a Megadungeon's level on a 30X30 map, making it fit on one page and leaving room for some brief notes for Wandering monsters and room key was discussed. From there, Chgowiz, Sham and Mike developed tweaked and used a [One Page Dungeon Template](#) (as well as a larger scale [30X30' map](#)) to create all kinds of cool old-school dungeons.

I've really got to thank these guys for making the idea into a tangible tool. While initially developed to answer their needs of creating dungeons for older editions of D&D and its myriad of retro-clones, I've found these tools to be very helpful for my current 4e needs as well.

The templates can be used many different ways. If your are the type to follow the classic "Fill the Map" method, you can print out the empty template and start drawing your dungeon. Once this is done, you can fill in wandering monsters, legends and the room key.

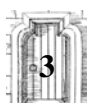

For DMs who like to improvise adventures, doing just this is often enough to create a full gaming session.

Alternatively, if you want to follow the 'Fill the Map' method but want a larger map to draw in, you can use this [large scale 30X30 map](#) created by Sham. Once done, you scan the sheet at 600 dpi, cut it in your favorite software (I'm fond of [The Gimp](#)), import it in the template and fill the rest in your favorite word processor.

If you're more of the "Map the Fill" type (i.e. you design your encounters then make a map to fit them in), you can open an empty template on your word processor and fill in all the text boxes. Once done, you print out and draw your dungeon or import it image file from your favorite imaging software.

Using the Template for D&D 4e

Anyway, when I looked at the template, I realized that a 30 X 30 grid was the perfect size to create a 10-15 room dungeon at a scale of 10' per square. This is exactly what I'm looking for in my next campaign. With such a scale, you can get 4e friendly scaled rooms without any problem.

In fact, you can use the same grid at different scales to represent a regional map (1/4 mile per square), a Dungeon level (10'-20' per square) and a tactical battlemat (5' per square).

Being of the 'Fill the Map' school of dungeon design, I modified the template to suit my needs and used it as a planning tool.

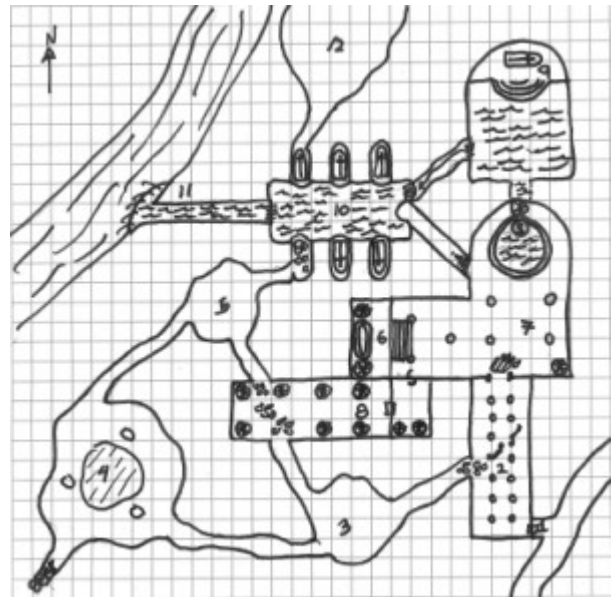

I then printed out the template and started drawing a dungeon. I didn't have any specific idea when I started out. I wanted some sort of abandoned temple complex. Having it dedicated to an aspect of Elemental Chaos establishes the influence of the dungeon's imprisoned Primordial and goes in the direction of the campaign's background.

I started by drawing an entrance leading to a pillared hall (I like pillars, they provide cover and can often be toppled on the head of PCs/monsters). From the hall I drew a huge temple room, complete with a raised basin/altar and a large circular pool. (The post's image is the dungeon I'm describing here)

That made me think that a cult devoted to Primal Water elements would have a lot of water running around. That's how I made a hidden room filled with water accessible from the Pool only. In that room I put a lone sarcophagus and let the concept simmer at the back of my mind.

Water Elemental Vampire! Sea-Mist Wraith, Mummified Shauagin Lich Priest... possibilities endless!

Having a temple and one sarcophagus, I thought about adding the obligatory crypt.

That's when the main trick of the dungeon came to me. Abandoned evil water cult temple, water everywhere, crypts...

How about I made the guardians of the temple be the spirit of enslaved undead humanoids, all ex-enemies of the Cult, forced to serve for eternity?

In my mind's eye, I could see a room filled with glass coffins in which marine ghouls were forever trying to claw through the transparent walls while their spirits were forced to guard/patrol other areas of the temple as spectral guardians.

Ding! I had a winner!

I added another crypt and some guardians and I had my dungeon.

At that point, I was thinking how to work in wandering monsters into the place. I abandoned random encounters when I switched from AD&D 1e to GURPS in the late 80's. Re-implementing this aspect of Old-School gaming in my adventures wasn't going to be easy. For it to work for me, I needed a rationale to explain monsters walking around an abandoned temple. I had the temple's guardians, but I wanted something more... random yet believable within the design space defined by my players' suspension of disbelief.

That's when I thought about adding burrowed tunnels around and through the temple structure. Thus, with a dungeon that's been breached by a burrower that made its

lair nearby, I could picture monsters walking around and interrupting PCs during a rest period.

I added more tunnels and caves, including the obligatory collapsed passageway for DMs wanting to expand the dungeon further. I also had the tunnels breach certain areas of the temple.

At that point, I thought about the possible effects that a large burrower could have on the dungeon, so I knocked down pillars, busted door open and even destroyed one of the ghouls' glass sarcophagus.

As I was doing this, the story of the dungeon was taking shape and I hadn't even written one room description yet.

The last element that clicked the whole thing was to determine what kind of burrowing creature could have set a lair here. Considering that my players would likely be level 6-7 when they'd be playing it, I searched the online D&D Compendium for all burrowers between level 7-9.

I got the Bulette...

Joy!

Since the Bulette is a level 9 elite Skirmisher it's a perfect model to create an unofficial "level Boss" monster by upgrading it to a Solo monster with a few more HP and new powers (the real boss would, of course, be the one in the hidden Water crypt room).

So I pictured a dungeonbred Bulette, large sized, covered with silvery runes, that escaped from some Mad Wizard's laboratory that settled in this dungeon.

The concept and maps of the Font of Sorrows was done.

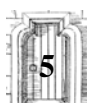

I then described , very briefly, what each room would contain so that when I actually prepped for that game, I'd have all critical elements to build from.

Of course the dungeon is not playable as is. Unless you're a great improv DM (which I'm not), more prep needs to be done. I'll need to stat out all monsters, flesh out interactive terrain elements (falling pillars, acid pools, etc), place treasure Parcel and work out to present each elements like the various implied rituals.

Finally, I need to place the exploration of this dungeon in the context of a plot that involves factions of the city, the dungeon or both to get my storytelling players to enjoy it more.

Heck, I'm thinking of adapting the one page template to allow one sheet 4e encounter...

I'll let you know how that works out!

Creating a map for the One Page Template with GIMP

By Michael Shorten

One of the most widely asked questions I've gotten is how to create the actual map in the template. While some people choose to draw their maps the old fashioned way, on graph paper, and then scan it, I have been using drawing programs to create my maps. It's not as hard as you might think, and the programs one can use are cheap. (as in free)

I've been drawing my maps using [GIMP](#) (a freely available, open source image editing tool similar to Photoshop) and my trusty old school serial Wacom tablet. I started doing this last year. A lot of this is thanks to the [ZombieNirvana set of RPG mapping videos](#)

and the fine [RPG mappers at Cartographer's Guild Forum](#). I did want to share the things I've been doing in GIMP and the resources I've used to create my dungeon maps in GIMP.

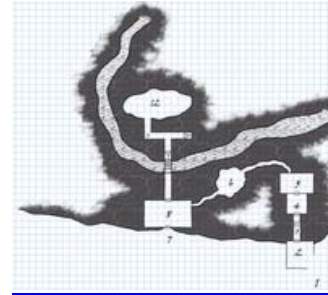

I was inspired by these three forum threads and highly recommend them as starting points:

- [How to create simple dungeon plans](#) (this thread has specific GIMP instructions, see [post #12](#))
- [RobA's Using GIMP to create artistic regional maps](#)
- [Creating an old school map in GIMP](#)

These, as well as the aforementioned ZombieNirvana videos have really helped me to learn a lot about mapping and using a program like GIMP. Although the ZN techniques are done in Photoshop, you can easily translate to GIMP. There are posts on Cartographer's Forum where people offer advice on how to do that.

To use the [One Page Dungeon Key](#) with GIMP, I do the following:

1. Draw my map in GIMP, using this [template of the 30x30 squares grid map](#). This GIMP native file (XCF) is set to 5"x5", 300dpi, the grid is roughly 6 squares/inch (about the same as what we use on regular graph paper).

2. "Compress" the map by setting the colors to indexed. Menus: Image > Mode > Indexed - select/leave it on the "Generate Optimum Palette" option. This reduces the number of colors your image will "save", making your file smaller.

3. Export it as a PNG. Import the PNG into the One Page Key template in Open Office (or Word) and move it to fit the space for the grid. (You will need to remove the existing blank grid if it's still there.)

4. Format the picture so that it "floats" over the text. This allows you to precisely place it into the area that you want it to go.

That's it!

"How to use the One Page Template" Contest posts

By Michael Shorten & Philippe-Antoine Ménard

In case some of you are still wondering "Just how can I use this one page template?", Chatty and Chgowiz did a bit of "He Said/He Said" on the fourth week of the contest. We hoped that we could give the contestants some advice that might help them to get the creative juices flowing. We also hope to help readers use the one page template going into the future for their own campaigns.

Chgowiz's Post:

1. How can I use the template to Brainstorm adventure ideas?

One of the most daunting places for many DMs to start is with "where do I send my players today and how do I tie it all

together?" Whether you're doing a sandbox or plot-based adventure, you want the various pieces to fit. Sometimes, trying to come up with the complete megadungeon or entire city full of places to go seems overwhelming.

When I'm designing a dungeon, I tend to doodle the general outline with maybe some big areas sketched in. I'll then jot down various brief keywords or notes about what I want to go where. Once I've done that, I'll go in and detail out those areas, then move on to fill the rest of the dungeon. Since I subscribe to the [original edition theme of "empty rooms outnumber filled rooms"](#), I may have quite a few rooms that I'll either leave for "in game inspiration" or I'll fill at design time with the results of random fill. Doing this in brief allows me to move quickly through the dungeon, getting a feel for the overall theme quickly.

From that, I've often gained inspiration for the entire area around the dungeon, or hooks that will bring adventurers into the dungeon. An example is the current dungeon that my players in my Dark Ages campaign are going through. They heard of the dungeon via rumors in the city. As they began delving the caves, they found a factional fight between cavemen and kobolds. The cavemen were actually the result of my above approach - they were a random monster that suddenly clicked in my head - there's a fight going on down here. Using a minimalistic, "fill it in" approach led me to that point.

2. How do I approach dungeon building that includes a sense of setting when being brief?

I answered that in part above - usually the dungeon or level will have a "theme" that plays out as the party moves through it. The

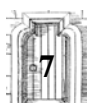

one page encourages me to With the one page template, I tend to leave in keywords for each room, that help me to decide on the spot how to describe this, but also gives me the room to modify it or wing it on the spot.

An example is from my [Kobold Caves of Terror from Winterwar 2009](#):

8. Ivy choked room. Movement slowed to half. 4 Assassin vines bearing melon like fruit (AC15 HD 4d6, slam +2 (1d6+2))

The phrase "Ivy choked room" gives me a sense of what's happening, without going into details - I can change it to suit my needs. Maybe the ivy is just choking a certain portion, maybe the whole thing.

I also let the monsters and the hooks set the theme. With the one page, I can adapt the dungeon to fit my needs for the campaign without having to undo a lot of things.

3. How do I make the one page fit my own system of choice?

That's pretty easy for me, as I use systems that have very simple stat blocks to begin with. Using the above example, I have enough in a few characters to run those 4 vines effectively.

One other "cheat" is that I might have the common monsters of the level statted on the wandering monster table, and leave the statblocks off of the key, except for the monsters who are unique to the key. You can see that in [Kobold Caves pdf](#).

The other nice thing is that my dungeons, as simple one pagers, are system-neutral for the most part. Just about any system could support the assassin vines described above - and allow the DM to adapt/change to his/her liking.

4. How do I think the one page can be used by other DMs?

It sets the tone to "just the facts, Sir/Ma'am!" I think one page dungeons/adventures encourage a DM to pick up the dungeon and use it with a lot of ease in their campaign. There's not alot of room for fluff for the DM to have to read through and it's enough of a skeleton that the DM can add to it very easily to reflect their unique setting. To me, having the basics and allowing me the room to expand and change a dungeon makes it more valuable.

- Michael

Chatty's Post:

How can I use the template to Brainstorm adventure ideas?

What's great about a one page template is that you can print out a bunch of them and have at them with nothing but a pencil. Depending on your personal adventure design style, you may start with drawing a map and then as you draw/cross-out/erase/redraw you might see an adventure seed unfold.

As ideas come to you, you can jot them down directly in the large white spaces (The Title bar, the right box or the bottom half 'dungeon key') sitting around the map.

Don't feel constrained by the page, you don't have to finish one, you can scrap it and start again, or you can return to an unfinished one to steal an idea, a structure or complete it.

Once you've got your dungeon's idea firmly in mind, you can re-do it with your favorite document creation tools (Word, Gimp, Photoshop, etc).

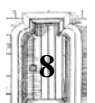

Alternatively, you can start by jotting down plot ideas and room contents on the template and draw a dungeon to fit your ideas. This backwards approach is also a great brainstorming strategy as the constraints you give yourself by pre-designing the adventure's content can help you draw a map more easily.

At least, that's how my creative process works for me.

How do I approach dungeon building that includes a sense of setting when being brief?

A common thing among GameMasters is that they get lost in the details of their adventure. They start to design an adventure and get caught up in writing pages and pages of maybes/options/background material. All this, while possibly useful in the coming game, can end up eating a lot of your most productive time where your mind is set to prepping your game.

Using a one-page document to fit your adventure forces you to focus on what the PCs are going to have to do in the adventure, and spend less time on "getting it perfect". If you see it to the end, you'll at least have a good idea of what's going to happen and how.

Once you are done doing that, you will likely have a To-DO list of things to finish your prep, keeping you organized and focused. For example, when I designed the [Font of Sorrows](#), I drew the map and filled the template in less than 2 hours (counting me inking over my pencil-drawn map and cutting and pasting the document). After that, I knew that I had to get monster stats, place treasures and work out the terrain features and of each encounter.

This was as clear a roadmap to finish the adventure as I was likely to get.

How do I make the one-page template fit my own system of choice?

I think that the one-page template is perfect for D&D 4e if you use it at two different levels of your prepping.

First off, the template is perfect to act as a summary of your site-base adventure. Exactly like the maps and short keys you find in current D&D published adventure, a completed template can represent each locale or dungeon level in your adventure. In that, the template is used exactly like for other role playing game.

But here's where the template really shines. You can modify it a bit to use one sheet (possibly two) for each encounter! The map is there to draw a larger scale depiction of the encounter's battlemat and you can use all the remaining white space to include monster stat cards, tactics and terrain features.

Even if you keep monster stats in a different place, you can detail individual NPC reactions and describe traps and other hazards in detail.

How do I think the one page can be used by other DMs?

The template is simple enough to cater to the styles of all types of DM.

Freeform DMs that prefer Sandbox campaigns can create many one-pagers to drop on players at a moment's notice and improv anything that isn't already written. In fact that's probably what many old-school users of the template do.

DMs who prefer more structured game notes can use the template like I've been describing above. First they can use it as a brainstorming tool. Then, they can use it again as a more refined adventure summary to place at the start of their gaming notes.

Also, note that the one-page limit only applies to the contest we're having now. DMs are free to explode the template to take as many pages as they need too.

- Philippe

The One-Page Manifesto

by Santiago Luis Oría

[Originally posted](#) at the OD&D Boards.

One of the greatest joys for someone who writes and creates gaming content is to see that content taken to places the author(s) never imagined. With the one page template, that has certainly happened. – Michael

I'm getting very excited about all this one-page philosophy. I love how, by self constraint, you get much more energy to produce your own stuff. You focus on what's important and relevant to the game, you leave the rest to healthy, good improvisation. You don't over prepare, you can adapt to your campaign needs and the decisions of the player's easier. Everything also becomes much more manageable at the table.

The One-Page Manifesto goes:

Have a 1 page wilderness map: like Melan's Fomalhaut maps or [Chgowiz's One Page Wilderness Template](#)

Have 1 page of hex descriptions: like early JG products.

Have a 1 page of random encounter charts: like the ones of the AD&D DMG - you could have 1 for hot climates, 1 for temperate and 1 for cold, finally 1 for sea adventuring and 1 for cities. But you are using 1 at a time.

Have many 1 page cities: like [Enharza](#).

Have many 1 page adventure sites: ruins, dungeons, caves, crashed spaceships, you name it - like what we have already seen.

Have a 1 page player's handout of your campaign.

Have a 1 page "stock monsters" compendium of stats: like the JG ready ref sheets.

Have 1 page of weird tables.

Of each of anything... have 1 page.

The 3 Winning “Best Of” Dungeons

These top 3 dungeons represent a lot of hard work, imagination and a very interesting situation from a judging perspective - these 3 were the easiest to agree up on as nearly all of us had them at the top of our lists. These entries each earned a bundle of valuable prizes from our sponsors. So, here are the Best of the Best entries:

Best Overall One Page Dungeon: *Secrets of the Old City* by Simon Bull

Best New School Dungeon: *Cry of the Gravegod* by Heron Prior

Best Old School Dungeon: *Valley of the Necromancer Kings* by Andrew Gale

Secrets of the Old City - A One Page Dungeon Level by Waysoftheearth

Background

Almost every inhabitant of The City has heard that it was built upon the ruins of an older place – indeed, evidence of the Old City is everywhere. And rumors of its hidden treasures persist, even now.

The histories recount that the Old City was buried by cataclysmic ashes long before The Kingdom grew up to resume the industry of these parts.

However, few among the wisest scholars know that the Old City was itself founded upon an even deeper ruin – a far more ancient and treacherous place. None now recall who the *Ancients* were, or what disaster befell them...

The Old City

The Old City now lies buried some 30' below The City, above. Its dilapidated streets now serve as a drainage system. The stink of rubbish and sewerage is pervasive throughout the dank tunnels, as are rats and centipedes.

Most of the Old City buildings are at least partially collapsed, and filled with rubble. Some few may yet be entered – as may scores of unexplored crawlways.

The two principal causeways have been shored-up by dubious stone work, and are dimly lit through the overhead sluice grates and by torches maintained by the City Guard. The remainder of the Old City is of far older stone work, and is unlit.

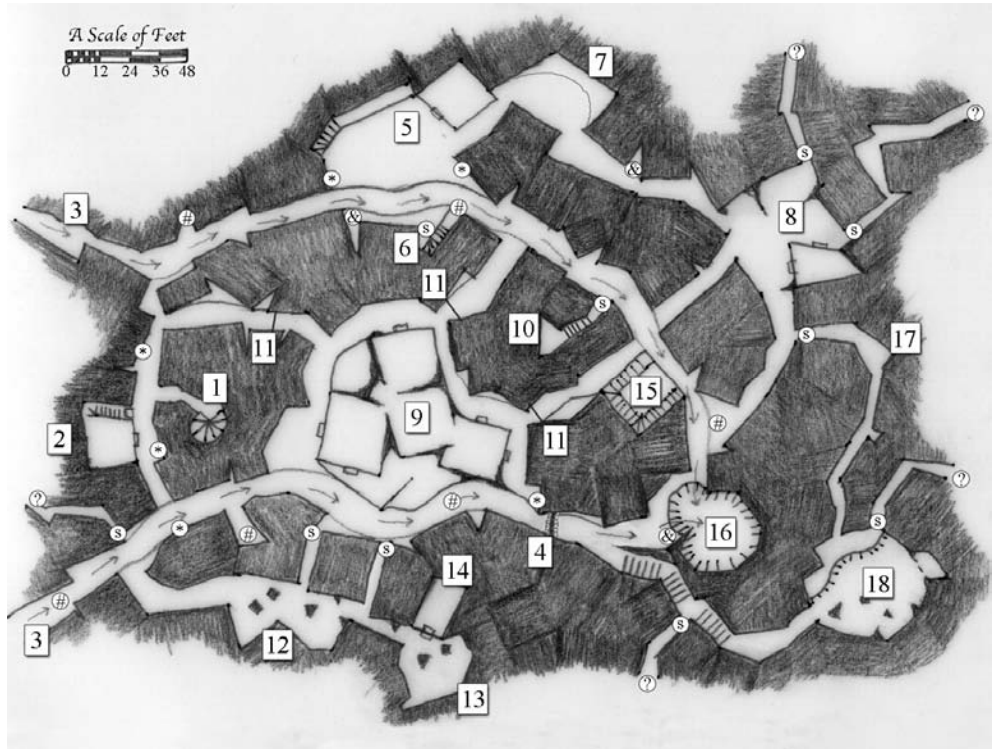

Map Legend

(*) **Torch.** 1-2 lit, 3-4 guttering, 5-6 spent.

(S) **Secret Entrance.** Hidden in the broken stonework.

(?) **Unexplored Crawlway.** An opportunity for the referee to extend the Old City.

(#) **Sluice Grate.** Drainage from The City's streets 20' to 30' overhead. A narrow grate that admits sewerage, storm water, and a dim shaft of daylight (or moonlight).

(&) **Yellow Mold.** This hazardous growth is almost indistinguishable from other filth in the dark sewers.

Keyed Areas

[1] **Entrance.** Spiral stair descends from the surface to a locked door. A sign on the door says "Keep Out".

[2] **Guard House.** 3 bored **City Guards** are here, shuffling work rosters, cleaning gear, drinking coffee, and playing cards. They will object to PCs trespassing in the sewers, and may even try to arrest them.

[3] **Causeways.** A foul 9" deep slick of city waste crawls toward area 16. Luckily, a 2' wide ledge is raised 3" above the filth along either side. Unluckily, it is slippery and broken in many places. Fallen stones make tiny, unsteady islands amid the horrid flow.

[4] **Submerged Pit Trap.** The ledges are badly broken hereabouts, and a number of slippery "stepping stones" may tempt explorers. Hidden by the filthy runoff is a 10' deep, 6' wide fissure. Anyone slipping into it will vanish into the foul muck and risk drowning.

[5] **Works Depot.** A large area mostly cleared of rubble. Tools and equipment suitable for maintaining the sewers is stored in a locked, dilapidated building.

[6] **Thieves' Entry.** An unsteady stair hidden within a ruined building leads right up to a loose sluice grate. Shifting the grate aside a slim PC may access the sewer.

[7] **Toad's Grotto.** A **Giant Toad** lurks beneath the filthy mire, likely attacking by surprise, and possibly swallowing whole. It submerges itself for protection. The grotto contains evidence of a recently eaten Goblin.

[8] **Goblin Foothold.** A band of 12 **Goblins** have recently arrived in the sewers, but have already sent word to summon their cousins. They know of the toad and of the thieves. Their treasure is limited to the result of today's minor mischiefs in The City, above.

[9] **Thieves' Den.** A gang of 7 **Thieves** hide out in this ruinous knot of free-standing Old City buildings. They may feign cooperation, but betray and rob the PCs given half a chance. They have amassed a modest hoard which is hidden in 2 separate stashes; a small locked chest of coins lies beneath a loose floor-board, and a sack of silver wear is hidden up a chimney chute. They know of and avoid the Ogre.

[10] **Renegade's Stash.** A double-crossing thief stole the gang's prize loot and smuggled it here. His **Rot Grub** infected corpse still clings to a small lockbox that contains a small coin purse and an enchanted lantern.

[11] **Trip Wire Traps.** Set by the thieves to warn them of visitors. Causes stones to topple off a wall with a clamour, possibly causing injury.

[12] **Spiders' Ante.** A web-strewn cave littered with skeletal remains. 4 **Large Spiders** are hidden in dark recesses, watching over 23 un-hatched giant spider eggs. One of the dried corpses wears a silver ring, but an alluring gleam is visible ahead (see area 13).

[13] **Spider's Lair.** Another web strewn feeding ground where a **Giant Black Widow** awaits. She will likely surprise from above and behind, possibly dragging her luckless victim into an dark tunnel to be devoured. The gleam visible from area 12 is from a brass helm. Former victims' goods make up the loot, but access to area 14 is the main prize.

[14] **Old Gem Cutter's Workshop.** Forced entry into this Old City building may reveal a small trove of Old City vintage coin, uncut stones, as well as gem stones.

[15] **Old Watch Tower.** The only access is via an open window space some 14' above (reachable by an Ogre). The tower contains a dark stair up to a condemned ruin in The City's poor quarter, where children sometimes play. Optionally, also leads down to dungeon level 2.

[16] **Drop Hole.** The causeway filth drops some 30' into a wretched cesspit (welcome to dungeon level 2).

[17] **Fugitive's Hideout.** A terrified **Girl** has escaped the Ogre's cook-pot (area 18) and hides in this tiny cave. A single shaft of light falls from an awkward crack between street cobblestones, 30' above. Her poor parents will pay a modest reward for her rescue.

[18] **Ogre's Lair.** A narrow ledge 20' above overlooks a grisly cave occupied by an **Ogre** and his pet **Worg**. A giant cook-pot in the middle of the cave is surrounded by children's shoes (former victims). 2 terrified **Boys** are penned in at the rear. The Ogre wears a stout ring mail shirt and carries a great flail, the Worg wears a collar that protects it from magic. If pressed, the Ogre throws black toadstools into his fire, creating a *stinking cloud* that he and the Worg are immune to, or upends his boiling cauldron. The Ogre's loot is children's dolls and toys, and the gear and coin of slain guards. The boys' poor parents will pay a pittance for their rescue.

Random Encounters

2d6	Encounter
2	1 Girl (escaped from the Ogre).
3	d3+1 Boys (1-2 fleeing for their lives, 3-4 lost and afraid, 5 looking to become brave adventurers, 6 looking to join the thieves).
4	d4+2 Thieves (1-2 heading to a job, 3-4 setting a tripwire trap, 5-6 returning from a job with loot).
5	d4+2 City Guards (1-4 on patrol, 5 returning with wounded, 6 making dirty deal with local thieves).
6	1d6 Giant Centipedes
7	Rat Swarm of 4d6 x10 Rats.
8	1d6 Giant Slugs
9	d4+2 Goblins (1-3 scouting, 4 setting a trap, 5 disarming a trap, 6 hiding loot).
10	1 City Surveyor (apparently surveying state of The City's foundations, but...)
11	1 Ogre (1-3 scouting, 4-5 heading out child-snatching, 6 returning with a child).
12	1 Wight (tormented spirit of an <i>Ancient</i> that has found its way up from deeper levels).

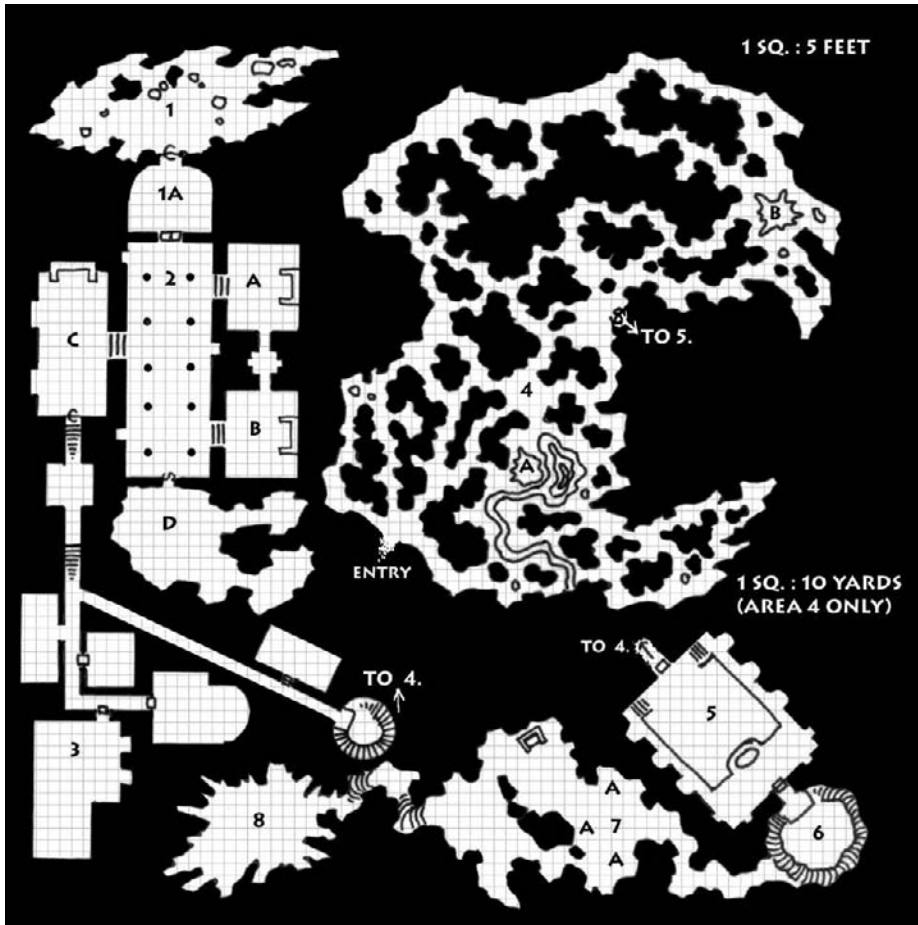
**Vekkoru, God of the Ghostly Pathways**

Vekkoru was a legendary hero of a people now lost from memory. When at last he was slain, his Gods were heartbroken. Rather than allowing him to pass into the Heavens, they bestowed upon him a place in death - to guide and protect the spirits of the dead on their long journey to the afterlife. His tomb became a shrine, and his killer - the Night Hag, Greva - was sentenced to guard over his remains for all time.

Now, his people have vanished, and their Gods have faded. Only Vekkoru remains. As the pantheon died, so did the pathways to its afterlife. The spirits of the last of Vekkoru's people gathered around his barrow, but he could deliver them no longer. He remained trapped in this plane, tied to his tomb by the same magic which had bound his killer.

The hill above his shrine became a haunted place, its rocky crags thick with the ghosts of the fallen. To free Vekkoru and the tortured souls who surround him, his guardian must be destroyed and the ritual of binding undone.

Random Encounters

- Ghostly Procession (a line of wailing figures, groping and stumbling along as if in darkness)
- Phantom (touch causes glimpse of spirit's final moments of life. 50% chance of uncontrollable panic)
- Spectre (a visitor to the shrine, attracted by the spiritual upheaval)
- Wraith (same as Spectre)

General Note: Undead native to the Shrine cannot be turned

1. Vestibule. A steep-walled sinkhole, 20–30' deep, open to the sky and full of leaves and tumbled stones. (A) Small stone door, concealed by ivy and wedged ajar. Within are 2 charred skeletons. Carved in the floor before doorway to 2. is a bas-relief of a bear, wreathed in flame. Inscription above doorway, in forgotten tongue. (if deciphered: "Who shall lead us on the final path?") Speaking Vekkoru's name allows passage. Otherwise, touching door summons a Huge, bear-shaped Fire Elemental.

2. The Dead Shrines. Lit by eternal torches. Signs of combat in main hall...many green stone shards and splintered bone. Shrines A & B are darkened, no longer holy. (A) shrine of Zan, Lord of the Skies. Statue has gold inlay, some missing. (B) Minah, Goddess of the Hearth. Statue has jade details. (C) Vekkoru's Shrine. Statue has pearl eyes. West wall is lined with hundreds of eternal candles in many colors. A carving on the South wall shows a line of wretched souls moving through a burning wilderness. Above, the three gods of the shrines look down. Below each god is a small alcove. Placing candles of the correct color in each alcove (A – gold, B – green, C- white) opens a secret door to area 3. Placing the wrong candles or damaging the statues triggers a trap - a horde of Petrified Skeletons begins to stream from hidden room (D.). (99 skeletons total. Covered in greenish mineral deposits. Treat as sturdier, double-strength Skeletons with stone clubs) The skeletons pursue only as far as the Vestibule.

3. Deserted Chambers. Abandoned rooms once used by caretaker priests. One holds 3 Phase Spiders and a desiccated corpse. A milky blue *Etherweb Stone* is hidden in the dust. Functions as a minor Ioun Stone, but cursed. Creates disturbances in the Ether. 20% chance per day of attracting 1-3 Phase Spiders at a random hour, day or night.(!)

4. The Graven wood. Lit by magic starlight. Elaborate stonework, carved to resemble a forest in exquisite detail. An illusion of a real forest shifts in and out of vision. This is the dream-realm of Daughter of the Leaves, a sylvan spirit allied with Vekkoru. Her domain has been invaded by a Spirit Naga - a servant of Greva's mother. The power of its will corrupts the dream realm, and DotL cannot drive it out. ...When the party enters, ghostly forest animals attempt to lead them to DotL at her Stone Oak (A.). She begs them to kill her enemy, but cannot answer questions about rest of shrine. If Naga is destroyed, she rewards with healing, several useful scrolls, and by revealing the door to the Hall of Brides. If attacked, she disappears.

...The northern half of the wood is corrupted, its stone crumbling and dripping with slime. Wandering are 3-6 corrupted ghostly wolves. (Incorporeal Dire wolves) The Naga is at (B), coiled high in the branches. Below it sit two Yeth Hound servants and the withered corpse of a charmed warrior who starved to death. The Naga wears a valuable collar of gold and jade, and a rune-etched false tooth functions as a brooch of shielding. Warrior's corpse has adventuring gear and a magic shield.

5. Hall of the Brides. Lit by eternal candles. Alcoves hold sarcophagi, depicting Vekkoru's earthly brides. Damaging a sarcophagus causes the bride within to emerge as a Wight. A faceless, 7' "fertility figure" statue blocks the door to 6. If examined, her surface is crudely chiseled, but lips are smooth and polished. A watery basin at her feet holds semi-precious stones, small bits of jewelry, and odd coins. Stealing from basin animates statue as Clay Golem. Returning stolen items halts attack. Retreating to Graven Wood resets the golem. ...Placing a gift of 100+ gold value in the basin causes the statue to kneel and hold open its arms. Kissing the statue on the lips causes her to step aside and allow passage.

6. The Well of Sorrows. Ringed by a descending stair. A stench rises from below. In the center, hundreds of moaning spirits swirl like a spiraling pillar, giving off a faint blue glow. Anyone touching the beam will be rended as if by a Blade Barrier. Each minute, 25% chance a spirit splits off from the spiral to approach the party. (treat as Phantom or Shadow, as desired)

7. Greva's Prison. The night hag, Greva, (Night Hag, mid-level Cleric/Sorceress) riding an Abyssal goat (treat as Nightmare) and carrying a magic, acid-tipped spear. She is aware of any intruders and will be waiting. Eager for knowledge, she pretends to parley, but will kill all regardless. If killed, she dissolves in a mist. (A) Three former victims, impaled on stone spikes, can animate at Greva's command. [Treat as Mummies] In North corner is a plain stone chair where Greva spends eternity. Tucked below is a box made from a mummified head, (holds gems) and a valuable magic tome. Greva has etched elaborate images on the walls with her spear. These are crude but truly disturbing artworks. Examining for too long may bring nightmares in days to come, and a chance of attracting the attention of one of Greva's sisters.

8. Tomb of the Gravegod. Room is interior of massive red crystal geode, formed from Vekkoru's heart's blood. Floor of crushed shells. Sound of a slow heartbeat reverberates. In center, a large, pulsing heart made of ghostly fire hovers above a single candle. Items of gold and silver are heaped below. An impenetrable wall of spirits swirls around all of it. ...Greva's skeleton lies on a raised slab near entrance, staked through chest with a crystal spear. A rune-covered jar holds her withered organs, and allows Greva to resurrect after seven days. The Spear binds her to the shrine. Destroying both spear and jar causes spirits to draw back. Snuffing the candle releases Vekkoru's spirit with a grateful, echoing sigh. At this point, the entire shrine begins to creak and collapse. The party has 30 minutes to get out – be sure escape feels urgent! If they are quick, they can grab whatever portable valuables the referee deems appropriate, as well as a magic bow, mace and talisman used by Vekkoru in life.

VALLEY OF THE NECROMANCER KINGS

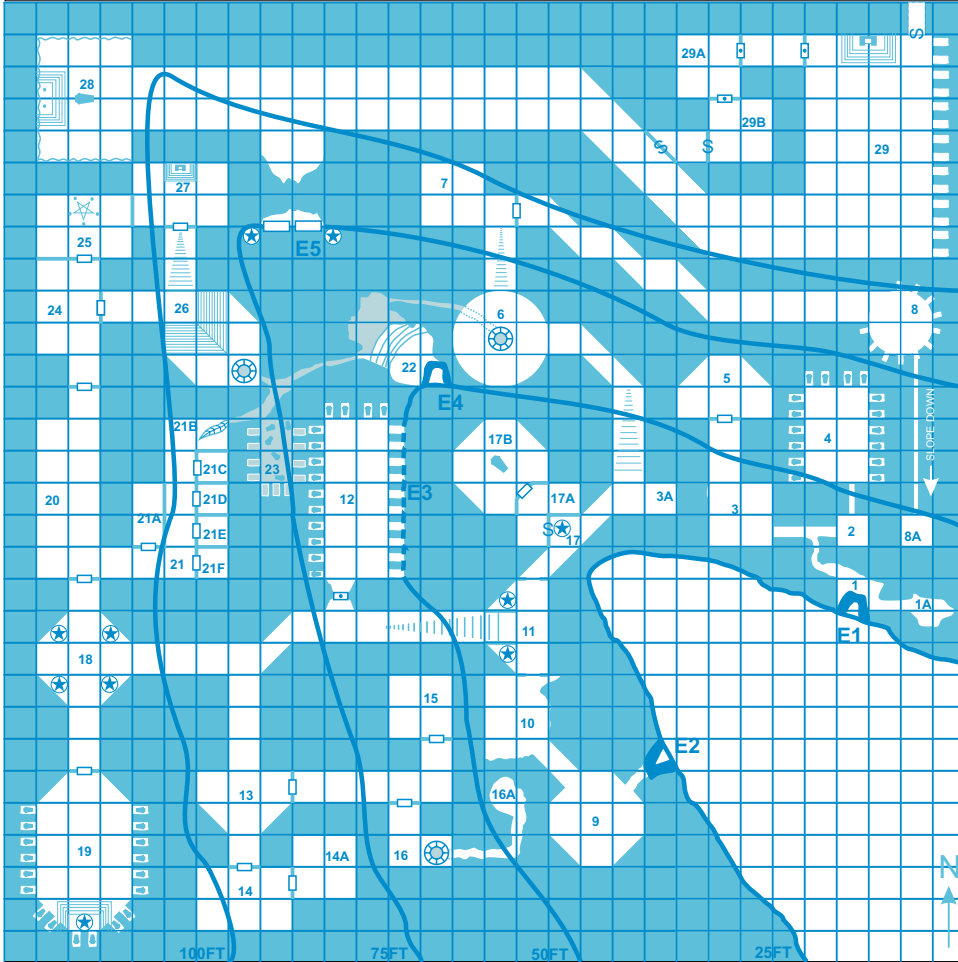

BACKGROUND:

Seeking to evade capture for his atrocities, **Ungoth**, the last Necromancer King fled his besieged city of **Tyrsis** to a desert valley. There, he completed rites to attain immortality; a state the Necromancer King has enjoyed for a millennium. Recently, a coven of cultists led by a triumvirate of evil necromancers (**Manse**, **Darghul** and **Balagos**) have discovered this secret valley. They have moved to the catacombs within and every night, practice rites to renew the reign of the Necromancer Kings. The Triumvirate sees their cultist minions as mere fodder to be exploited as they see fit.

ENTRANCES:

E1: The worker's tombs, now dormitories for the cultists.
E2: A new tunnel that leads an empty mausoleum and the main catacomb complex.
E3: Elements have exposed the tomb wall at area 12. Ghouls inside now use the short tunnels to gain access into the valley and beyond.
E4: Limestone cave leads to area 22. Formerly a **Troll's** lair.
E5: The Black Gate. Weathered statues are indiscernible. Stone doors are barred and *arcane locked* (or equivalent). The tunnel beyond has collapsed. The walls of Areas **28**, **29** and the passage between have been enchanted to forbid teleportation spells at or below 5th level (with the exception of the **Crypt Thing** at area 27), as well as all transformation spells. Because of the cave-in however, a *transmute rock to mud* has a 50% chance of working in the entryway. **Doors in 29 (including the secret doors) are arcane locked (or equivalent) and bear a Symbol of Insanity and an Alarm spell.**

WANDERING ENCOUNTERS (d20):

(Encounter chance is a base 11%, checked hourly or as required)

01-04: 1d3 **Ghouls**
 05-08: 1d4 **Cultists**
 09-12: **Cleric Overseer** and 1d3 **Zombies** or **Skeletons**
 13-16: 1d4 **Cultists** and 1d2 **Hyanas**
 17-19: 1d3 **Lacedons**
 20: **Troll** from area 21A hunting for food.

LEGEND: □=10ft

1. SMALL CAVE: Low-ceiling and sandy floor. Many tracks. Faint sound of excavation comes from the west. Foul dog-smell drifts from east.
1A. HYENA LAIR: Unlit cavern, overwhelming stench of dogs. **6 trained Hyenas.** In the many gnawed bones littering the ground is 2d20sp.
2. ANTECHAMBER: Featureless. Excessive noise alerts occupants of areas 3 and 4.
3. UNFINISHED CHAMBER: **5 Zombies (Cleric Overseer** in north passage) toil at the west wall of this rough chamber, tunnelling through the bedrock to the passage leading to 3A. The **Zombies** are equipped with various picks and shovels. The **Cleric Overseer** has standard equipment and 13gp.
3A. DEAD END: **6 Skeletons** toil tirelessly against east end of passageway.
4. CULTIST DORMITORY: Formerly a worker's tomb. Alcoves contain open sarcophagi that cultists now use as rest areas. **14 Cultists.** Each has a black cult robe, dagger, and 1d4x5gp.
5. STORAGE: Formerly a canopic jar storage. A number of barrels contain iron rations and a 6 locked trunks contain cult robes, weapon racks contain swords and maces.
6. WELL: Stone well leads to area 22. Off-used as the cultist water supply. Water brackish and cloudy. Loud noises will attract 1-2 **Lacedons** from area 23. At the bottom of the well submerged in silt is a locked coffer that contains a *Scroll of Transmute Rock to Mud*, a *Potion of Flying*, and a ruby worth 50gp; being the items of a treasure hunter who sought to bypass the cave-in at **E5** but was killed by **Lacedons** years ago.
7. PLUNDER STORAGE: Items plundered from caravan raids: Tack and harness, tents, camping gear, several crates of adventuring gear and other odds and ends may all be found here.
8. ADEPT'S CHAMBER: This small tomb now serves as a dormitory for four **Dark Adepts** who have risen from being mere cultists. **Dark Adept #1 (+1 Mace)**, **Dark Adept #2 (+1 Dagger)**, and **Dark Adept #3 (+1 Shortsword)**. The fourth has become a **Wight** that now is down in 8A. So far, the **Wight** has not attacked its former companions. Each of the **Dark Adepts** wears cult robes, standard equipment plus 1d4x10gp each.
8A. WIGHT LAIR: Tunnel slopes down to this chamber. **Wight.** Standard treasure and +2 *Scimitar*.
9. EMPTY MAUSOLEUM: Sand from the valley has blown in here from the NE. Faded frescoes depict the golden age of the Necromancer Kings.
10. COLLAPSED ROOM: East section of this chamber is filled with scree that tapers to the roof.
11. CATACOMBS OF THE NECROMANCER CULT: These stone steps lead up into the deeper reaches of the valley. Two ancient statues of Necromancer Kings guard the stairs. There is a double chance of wandering monster in this area during the day, triple chance at night.
12. GHOUL WARREN: This large tomb is now home to **12 Ghouls** and **2 Ghosts.** The eastern alcoves open onto the valley wall at **E3.** The main door in south wall is made of stone and is locked. **Balagos** in area 14A has the key. A large mountain of bones dominates the floor of this chamber, an extensive search reveals +1 *Elven Chain*, +1 *Shield*, +2 *Longsword* and 29gp.
13. ANTECHAMBER/TRAINING AREA: Training area for **Sarixx** from area 15. Swords and daggers of every type rest on wall-mounts along the SE and SW walls.
14. THE NECROMANCER'S STUDY: This room is always guarded by **5 skeletons** (falchions, shields, plate armor). A large stone slab dominates the centre of the room upon which are various books, implements and devices relating to the black arts. A bookshelf occupies the south wall and contains similar information on necromancy and mummification rites (worth 500gp).
14A. BALAGOS' CHAMBER: Furnished room with a bed, a small table and chair as well as a locked chest in NW corner. **Balagos the Necromancer** (*ring of wizardry, wand of magic missiles, wand of lightning*) and **Kerxit**, his **Quasit familiar** are located here when not in areas 14 or 19. The chest contains **Balagos'** spellbook, **Darghul's** spellbook (see area 17B), extra material components, and spare clothing. **Balagos** owns the key to the chest and the key to area 12. If **Kerxit** is slain, **Balagos** advances from the 'middle aged' to the 'old' age category and loses 2 levels.
15. ASSASSIN OF THE NECROMANCER CULT: Sparsely furnished with a straw mattress, a chest, and a table and chair. Trapped chest contains 5 vials of spider poison, a *potion of poison* as well as a number of courtesan's gowns. Private chamber of **Sarixx the Assassin** (+1 *leather armor, cloak and boots of elvenkind, dagger of venom, +2 shortsword, Figurine of Wondrous Power - Golden Lions*).

16/16A. DRY WELL & SPIDER LAIR: A dry well leading down to area 16A. **3 Giant Spiders** were brought in by **Sarixx** who farms their poison. Two live in area 16A and the third on the ceiling above the well in area 16. It will drop onto anyone that descends inside the well. Standard Treasure at 16A.
17. STATUE: Secret door hidden behind statue. Activated by pressing the statue's left eye.
17A. CANOPIC STORAGE: Fresh organs occupy canopic jars within a marble basin.
17B. DARGHUL'S CHAMBER: **Darghul**, second of the Triumvirate lays here in a desperate bid to overcome a magical wasting disease and become immortal. Instead of creating **Darghul** as a mummy, **Balagos** turned **Darghul** into a **Son of Kyuss.** **6 zombie cultists** also guard this chamber.
18. ANCIENT GALLERY: Four stone statues of the Necromancer Kings stand here. The statues are in fact 4 inert **Stone Guardians** and if anyone not wearing cultist robes enters, they attack.
19. THE NECROMANCER CULT: **14 cultists** reside here having recently marvelled at **Darghul's** transformation. At night, **Balagos** conducts necromantic rites in this chamber with the **Dark Adepts** from area 8. A silver ring on the statue's finger is a *Ring of Invisibility.* The **Spectre of Ungoth's** last vizier lives within the statue, attacking anyone who tries to steal the ring.
20. TRIUMVIRATE CHAMBER: Meeting chamber for the Triumvirate. Long oaken table with only three chairs. **10 skeletons** (falchions, shield and plate armor) stand to attention along the west wall. This area is off-limits to cultists. Various plans for expansion and conquest are strewn on the table.
21A to F. PRISON: Holding area for prisoners of interest and captured PCs. **21A: Troll Gaoler** lairs here, having moved from the cave at area 22. Scattered in this filthy chamber is the gaoler's keys and the possessions of any prisoners. The **Troll** disposes bones and waste in the fissure at 21B. **Mercia the Cleric** from **New Tyrsis** is imprisoned at 21C. 21D-21F Are empty.
22. LIMESTONE CAVE: This cave situated 50 feet above the valley floor. Excessive noise will attract 1d4 **Lacedons** from area 23. Natural stone steps lead down to a murky pool.
23. SUBMERGED TOMB: A minor cave-in has caused this tomb to flood with water. The dead resting within are unquiet and have arisen as **12 Lacedons.** Standard treasure for each.
24. THE NEW NECROMANCER KING: A stone slab dominates the centre of the room and bookshelves containing necromantic lore occupy the north and west wall (as area 14). A finished, but inanimate **Flesh Golem** lays on the slab. **Manse the Deathpriest** (*Rod of Thunder & Lightning* (or equivalent), *Flesh Golem Manual* (or equivalent), +2 *Shield*, +3 *Chain*) carries the blood of demons in his veins, sits at a desk in the NW. If necessary, **Manse** strikes his *rod* on the floor, alerting the **Lacedons** from area 23, the **Skeletons** from area 20 and then tries to activate the **Flesh Golem.**
25. MANSE'S CHAMBER: Largely unadorned except for a pentagram ringed with candles on the floor. Owing to his heritage, this is where **Manse** meditates instead of sleeping. **Mercia's Staff of Healing** stands in the SW corner. A *glyph of warding* guards a chest containing priest robes, a *Periapt of Foul Rotting* (which formerly belonged to **Darghul**) and 1000gp.
26. WELL: If alerted by **Manse**, the **Lacedons** arrive from here. **Water Weird.** No treasure.
27. SENESCHAL OF THE TRUE KING: A **Crypt Thing** sits on a throne atop a dais as the final guardian to **Ungoth's** sanctum. The **Crypt Thing** uses his ability to *teleport* those worthy enough to area 28 after inscribing **Ungoth's Mark** on their forehead. So far, the **Crypt Thing** has not allowed **Manse** or any of the others to pass. The **Crypt Thing** is immune to *turning.* No treasure.
28. CHAPEL OF SHADOW: Richly appointed chamber with black velvet curtains along N, W and S walls. The stone sarcophagus is where **Ungoth** reclines during rest and *Astral Projection.* Hidden in the curtain folds are **16 Shadows** that attack any group not bearing **Ungoth's Mark.** **Candelabra and object d'art** are worth 9000gp. Behind the west curtain above the dais is a *Mirror of Mental Prowess.*
29. THRONE OF THE TRUE KING: Ungoth the Deathless (*Robes of the Black Archmagi, Staff of Power, Mirror of Life Trapping*) resides on his throne. In the east alcoves stand **13 Skeleton Warriors** (+1 *plate, +1kopesh*) and **Sothgar the Death Knight** (+3 *Plate, +5 Defender*). A secret tunnel leads deeper into the valley. Anyone not bearing **Ungoth's Mark** are attacked immediately.
29A. UNGOTH'S TREASURY: 50,000gp in coins & jewels, and the following magical items: a *Holy Avenger*, 2 *weapons*, 1 *rod*, 1 *armor*, 1 *ring*, 1 *staff*, 6 *potions*, 3 *scrolls* and 5 *wondrous items.*
29B. READING ROOM: Bookstands contain: **Ungoth's** spellbook and a *Book of Infinite Spells.* **Alarmed** stone chest contains the 13 *Circlets* belonging to the skeleton warriors in area 29.

The Runner Ups

These dungeons were the top of the Judges Picks, after we had picked the top 3 winners. Each of these represents an outstanding dungeon, certain to appeal to most everyone. These entries earned a prize each. The category that they won in is as the Judge picked it:

Best Hack-n-Slash: *The Gray Goblin Warrens* - Christopher Brackett

Best Non-Fantasy Entry: *The Horror of Leatherbury House* - Michael Wolf

Best Pub: *Arendt's Old Peculiar*- Antti Hulkkonen

Best Replayable Entry: *The Infinite Tower* - James E. Raggi IV

Best Retro Use of 30x30 Space: *Megadungeon of the Mad Archmage Gary Stu* - Adam Thornton

Best Silly Dungeon: *Maze of NAMCAP* - Patrick Riley

THE GRAY GOBLIN WARRENS

Created by C. Brackett

10 FEET

-  COVERED PIT
-  SPIKES FROM WALLS
-  DEADFALL
-  GREASED STAIRS
-  HOLE -1D6+2
-  ARROW SLITS
-  FIRE PIT
-  STAIRS
Go down in direction of arrow
-  GATE (all locked)
-  HOLE

70' to river (submerged)

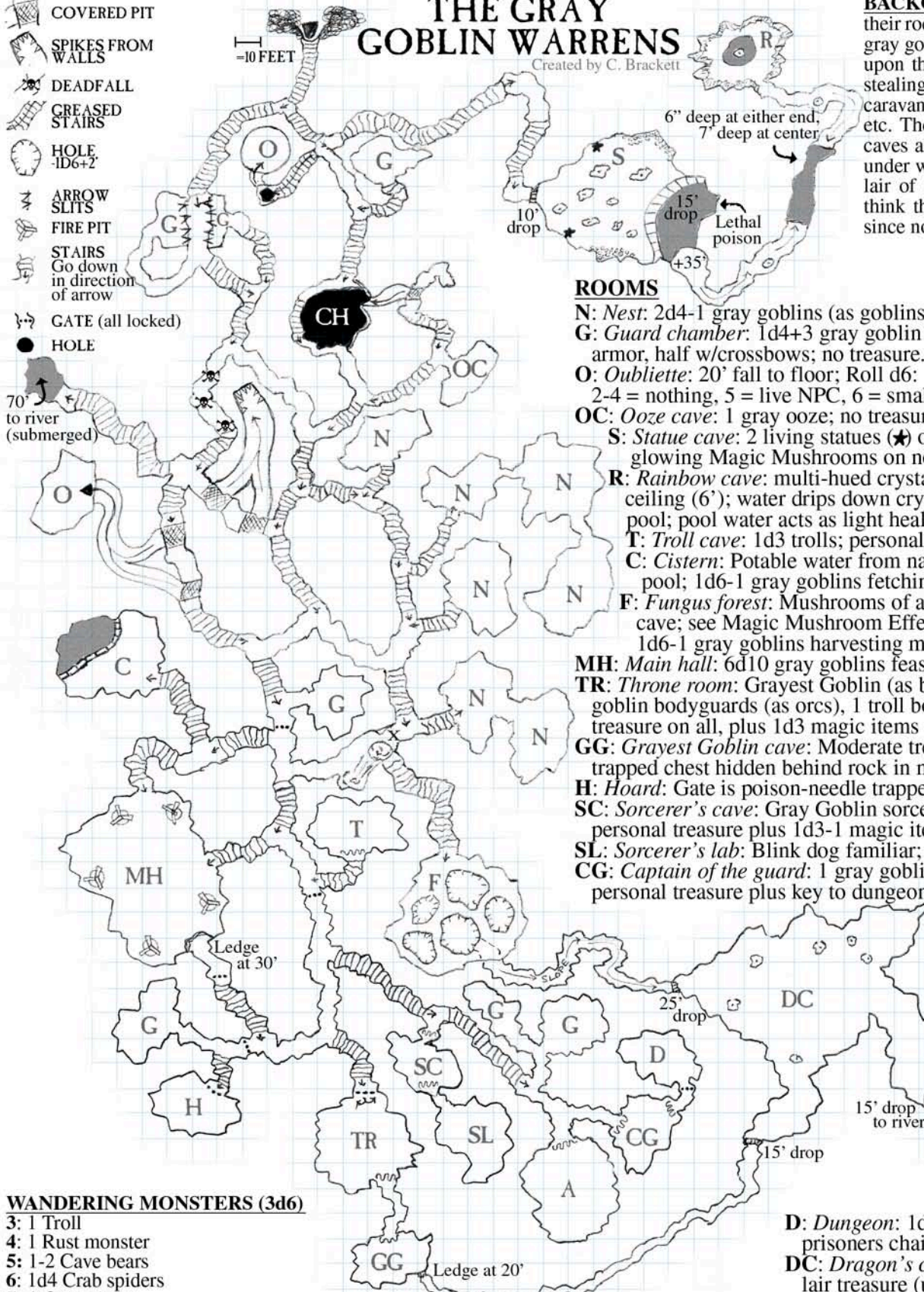

BACKGROUND: Recognizable by their rock-gray, wart-covered skin, the gray goblins have long been a scourge upon the local area: raiding villages, stealing livestock, attacking merchant caravans, kidnapping young maidens, etc. The goblins lair in a network of caves and tunnels beneath Hags' Tor, under which is also rumored to be the lair of a red dragon (although many think this nothing more than legend, since nobody's seen it in 100 years).

ROOMS

- N:** Nest: 2d4-1 gray goblins (as goblins); personal treasure only.
- G:** Guard chamber: 1d4+3 gray goblin guards (as orcs) in light armor, half w/crossbows; no treasure.
- O:** Oubliette: 20' fall to floor; Roll d6: 1 = wandering monster, 2-4 = nothing, 5 = live NPC, 6 = small treasure.
- OC:** Ooze cave: 1 gray ooze; no treasure.
- S:** Statue cave: 2 living statues (★) of Goblin-mother goddess, glowing Magic Mushrooms on north & south walls.
- R:** Rainbow cave: multi-hued crystals line the walls & low ceiling (6'); water drips down crystal formation in center of pool; pool water acts as light healing if ingested.
- T:** Troll cave: 1d3 trolls; personal treasure.
- C:** Cistern: Potable water from natural spring collects in pool; 1d6-1 gray goblins fetching water; personal treasure.
- F:** Fungus forest: Mushrooms of all sizes (up to 8' tall) fill cave; see Magic Mushroom Effects table if any are eaten; 1d6-1 gray goblins harvesting mushrooms; pers. treasure.
- MH:** Main hall: 6d10 gray goblins feasting; pers. treasure.
- TR:** Throne room: Grayest Goblin (as bugbear), 1d4+1 gray goblin bodyguards (as orcs), 1 troll bodyguard; personal treasure on all, plus 1d3 magic items on Grayest Goblin.
- GG:** Grayest Goblin cave: Moderate treasure in poison-needle trapped chest hidden behind rock in northeast alcove.
- H:** Hoard: Gate is poison-needle trapped; lair treasure.
- SC:** Sorcerer's cave: Gray Goblin sorcerer (4th level); personal treasure plus 1d3-1 magic items.
- SL:** Sorcerer's lab: Blink dog familiar; moderate treasure.
- CG:** Captain of the guard: 1 gray goblin captain (as hobgoblin); personal treasure plus key to dungeon (see Room D).

A: Armory: Poor quality weapons of all basic varieties.

CH: Chasm: Shaft drops 127' to underground lake below; rises 216' to top of Hags' Tor.

X: Boulder trap: Giant boulder rolls from wall to 'x' when triggered; PC's at 'x' save or die; attracts monsters: immediately make 1d3 rolls on Wandering Monster table.

D: Dungeon: 1d4-1 live & 1d4 dead prisoners chained to wall. No treasure.

DC: Dragon's cave: Mature red dragon; lair treasure (under the dragon).

WANDERING MONSTERS (3d6)

- 3: 1 Troll
- 4: 1 Rust monster
- 5: 1-2 Cave bears
- 6: 1d4 Crab spiders
- 7: 1 Ochre jelly
- 8: 3d6 Giant rats
- 9: 1d4+2 Gray goblin guards (as Room G)
- 10: 1d4 Gray goblin guards (as Room G)
- 11: 1d4+1 Gray goblins (as Room N)
- 12: 1d4+3 Gray goblins (as Room N)
- 13: 2d4 Giant centipedes
- 14: 1d8 Stirges
- 15: 1d8 Shriekers
- 16: 1d4 Carrion crawlers
- 17: 1 Gelatinous cube
- 18: Strange Discovery (roll on next table)

STRANGE DISCOVERIES (3d6)

- 3: Green slime on the ceiling above!
- 4-5: A 3'-diameter hole; where does it lead?
- 6-7: A small treasure, dropped & forgotten.
- 8-9: A mundane item, dropped & forgotten.
- 10-11: Nothing - must have been the wind.
- 12-13: An escaped prisoner (live NPC).
- 14-15: A friendly rat (it becomes your pet).
- 16-17: A key (will open the next locked gate).
- 18: Funny looking mushrooms. (Roll on next table if ingested.)

MAGIC MUSHROOM EFFECTS (d12)

- 1: "Gack!" (You're dead.)
- 2-3: "Urk!" (You suffer a light wound and spend the next 1d6 turns vomiting.)
- 4-5: "Ungh!" (Nausea; -2 "to hit"/1d6 turns.)
- 6-7: "Whoa! Look at my hand!" (You're unable to do anything useful for 1d4 turns.)
- 8-9: "Tastes like chicken." (No effect.)
- 10-11: "Yummy." (+2 "to hit"/1d6 turns.)
- 12: "Mmmm... Mushrooms..." (All wounds healed, but save or fall asleep/1d6 hours.)

The Horror of Leatherbury House

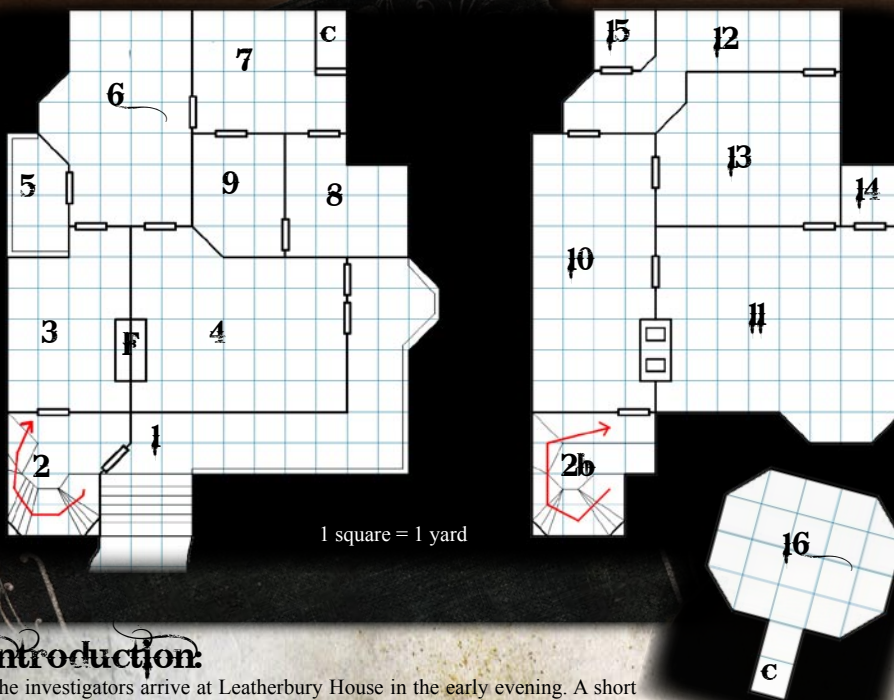

Background:

It's the year 1889. A group of investigators has been contacted by Lady Catherine Westmoreland. She is the heir to Leatherbury House, a mansion in the country, that has been abandoned by her family for over 50 years now, and the locals believe that the house is haunted. Lady Catherine wants the investigators to look into this.

Lord Winston Leatherbury had made quite a fortune in his early years and after the death of his wife his interest turned to the occult. His only son Robert was a good-for-nothing that spent his father's money on women and gambling. One evening Robert lost a lot of money in a game and so he asked his father for money. Lord Winston was outraged and told him that he won't be paying for any of his escapades again. The discussion got heated and then Robert struck his father down with a poker. He panicked, dragged the lifeless body down to the cellar and bricked him up behind a wall, not realizing he was still alive. When Lord Winston awoke he screamed for help but nobody could hear him. With his last breath he uttered a terrible curse. Shortly after that several servants died in accidents in the house and finally Robert fell ill and died shortly thereafter. A few weeks the dead servants and Lord Winston's son rose again from their graves, bound by the curse to defend Lord Winston's fortune even in death...

Introduction:

The investigators arrive at Leatherbury House in the early evening. A short gravel walk leads to the front porch. The house is in a bad state of disrepair and the front porch is partly overgrown with ivy. A large dead willow tree, stands right next to the house.

Room Key:

- 1. Front porch:** The front porch of the mansion is partly overgrown with ivy. Both entrances to the house are locked. The windows have been boarded up. No sounds can be heard from within the house.
- 2. Staircase:** The staircase leads up to the second floor. The door to the living room is closed but unlocked. The floor is thickly covered in dust and there are a lot of cobwebs in the corners of the room and the staircase. When the players first enter this room, footsteps can be heard that seem to come down the stairs but nothing can be seen. There's a chance of $15+$ on a $d20$ that one of the steps of the staircase breaks when a player step on it. This is automatic when two players step on the same step at the same time.
- 3. Living room:** The living room contains several comfort chairs that are covered with white linen sheets. The large open fireplace on the right wall obviously hasn't been lit for ages. On a small coffee table in the corner of the room lies a leather-bound book. When someone opens it, the pages turn to dust. When a player examines the fireplace closer, it suddenly starts burning with an explosive flame possible hurting the player that examined it. The poker is missing from the fireplace. Two crossed longswords are hanging above the fireplace.
- 4. Foyer:** This large room contains a couple of comfort chairs covered with white-sheets, a large grandfather clock and the fireplace on the left wall. On a roll of $15+$ on a $d20$ scratching sounds from above can be heard. When the players stay in the room to examine it more closely, a swarm of bats comes flying down the chimney and out of the fireplace, attacking the players. Strangely the bat corpses disappear after a few minutes leaving no traces.
- 5. Porch:** The porch on the left side of the house is in slightly better condition than the one in the front.
- 6. Dining hall:** The dining hall is dominated by a large dining table surrounded by six heavy chairs. On the far side of the room there is a large cupboard. The furniture is covered by large greyish-white linen sheets. Everything is covered by a thick layer of dust. Four zombies are standing in the middle of the hall, clothed in servants' livery. They don't move or attack as long as the players keep a distance of at least one yard. The cupboard contains various dishware and silver cutlery.
- 7. Kitchen:** In the kitchen two undead dogs guard the door attacking anyone who enters. The cupboards contain normal kitchen utensils and spoiled food. The steel door to the cellar is locked and can only be opened with the key that hangs on a chain around Robert's neck. Even brute force won't open that door.
- 8. Storeroom:** This storeroom contains two empty barrels and several cup-

boards with spoiled food. Aside from that the room contains two female zombies that attack the players as soon as they enter the room.

9. Bathroom: This bathroom contains a bathing tub, a toilet and a bathroom sink. The first time anyone opens the water-tap blood gushes out.

10. Hallway: The hallway on the upper floor is empty aside from three paintings on the right. The paintings are portraits of Lord Winston Leatherbury, his beloved wife Elenore and their son Robert when he was approximately six year old. When the players pass these portraits the faces start slowly to change into terrible grimaces. When examined closer, the paintings start floating from the wall, arms with clawed hands emerge from the picture frames and start attacking.

11. Master bedroom: This was obviously the bedroom of Lord Winston and his wife. A large bed stands in the middle of the room. Although the room hasn't been used for many years it still is in a surprisingly good condition. On a roll of $10+$ on a $d20$ the silvery laughter of a woman can be heard. On the nightstand lies a small bronze key. The armoires contain old and half-rotten clothes.

12. Robert's bedroom: The walls are covered in dried blood and all the furniture has been smashed. When the players enter the room, the shadows seem to grow even darker. Then suddenly an elite zombie (Robert warped by his father's curse) and two zombies attack the players out of the shadows. Robert carries a iron key on a chain around his neck. His father's musket pistol causes double damage against him but not the other zombies. In the remains of the furniture Robert's diary can be discovered that reveals what he has done!

13. Study: The walls of the study are covered by bookshelves that contain hundreds of books. Lord Winston was a learned man and had books about several fields of study from the natural sciences to the occult. In the middle of the room stands a large desk. The desk is locked but can be opened with the key found in the bedroom (see room 11). The desk contains various papers, a golden pocket-watch, a silver locket containing a portrait of Elenore Leatherbury and a musket pistol and some blackpowder and $2d6$ balls.

14, 15. Bathrooms: The bathrooms in the upper floor are dusty and filled with cobwebs but otherwise unremarkable.

16. Cellar: The cellar contains several shelves along the walls filled with the remains of rotten food. A wine rack stands before the back wall of the room. A closer examination shows that the wine rack contains $d20$ bottles of expensive wine and that the wall behind it has a different texture than the rest of the walls. When the players move the rack from the wall, a wraith (Lord Winston) appears from behind the wall and attacks them. The locket of his wife (see room 13) can keep him at bay and he disappears as soon as the sun is up again. When he is defeated he reappears on the next night. He can only be laid to rest by burying his remains that can be found behind the wall.

Arendt's Old Peculiar



– Because you really can't survive on water and rations alone –
 (Dedicated to all those players who'd rather squirrel away their hard-earned gold in hollow tree stumps than treat their characters to something nice every now and then... and a bunch of others, I guess.)

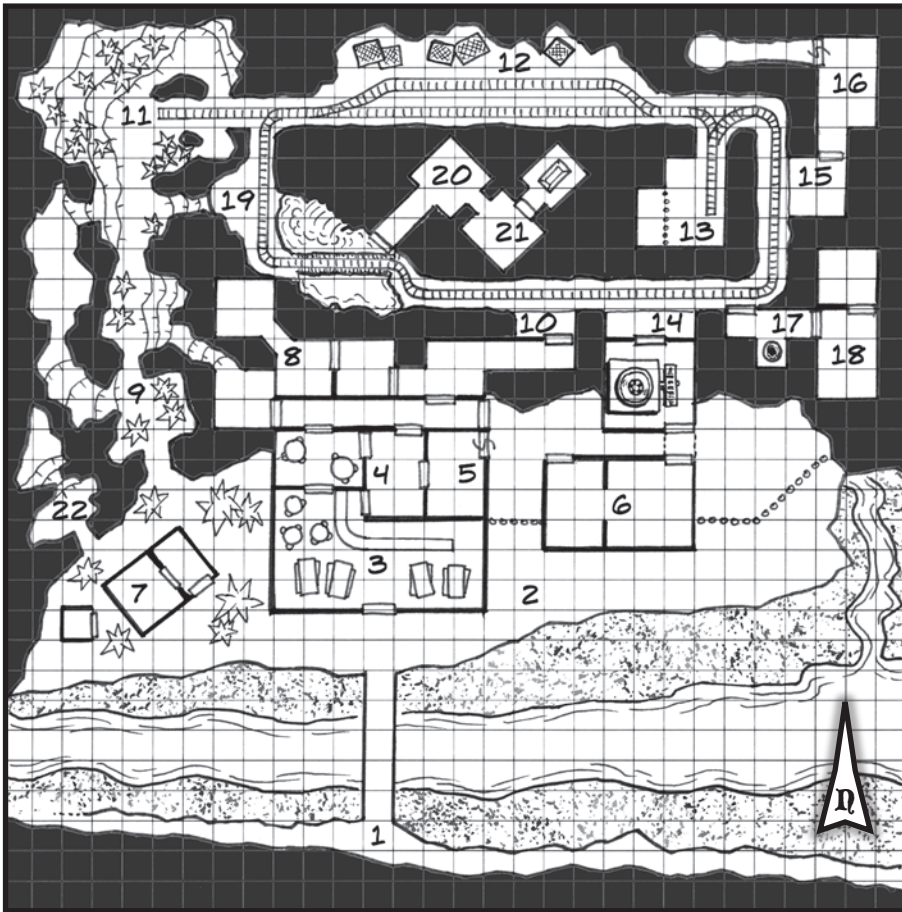

For many, Venerable Arendt was a saint. He led a simple life in a cave in Blackwater Gorge, a deep, narrow fissure in the hills, yet many people made the arduous journey to visit him. His underground garden was a wonder, his magnificent railway a mechanical marvel unheard of outside the grandest dwarven mines. What made him legendary, however, was the sublime, invigorating drink he brewed from the aromatic *kurá* beans in his garden. Arendt's hot *kurá* was bliss in a cup, a delicacy without peer. But alas, Venerable Arendt is no more.

Decades after his passing, a band of goblins took over Arendt's caves. Led by Boss Hog, a smart (for a goblin) and industrious individual, the band discovered some of Arendt's secrets and opened an establishment for selling *kurá* – at exorbitant prices. While their version is a mere shadow of what Arendt brewed, many patrons have become thralls to the addictive drink... and

Boss Hog Gob's Hot Slop Shop
 (as it is now called) has become a lucrative (if seedy) business.

Random patrons:	Misc. encounters:	Brew of the day:
1 2d4 kobolds	1 Assorted vermin	1 <i>Abdo's Black Bile</i> :
2 2d4 goblins	2 Boss Hog + 1d6	Belch acid for
3 1d6 orcs	goblin workers	about an hour.
4 1d4 ogres	3 1d4 escaped	2 <i>Lord Hastings'</i>
5 1d3 trolls	giant rats	<i>House Blend</i> :
6 An NPC party	4 An NPC party on	2 x speed, 10 min.
(Note: The patrons	a spying mission	3 <i>Egnoran's Bliss</i> :
tolerate each other	5 A runaway cart	Become lethargic
– anything for <i>kurá</i> !)	6 1d6 giant bats	for 1-2 hours.

Note on style: While not dead serious, "Arendt's Old Peculiar" is by no means a comedy dungeon. Attempting to loot or trash the place should lead to disaster for the PCs. The patrons and employees may tolerate a well-behaved PC party, but troublemakers will be dealt with... brutally.

Note on treasure: There's very little gold and just a few magic items in the dungeon, but clever PCs could make a killing with *kurá* – it is a valuable commodity if they manage to cart it to civilization.

- 1 Blackwater Gorge: A narrow ledge descends from the surface. Halfway to the bottom, a bridge spans the chasm. Most of the time, 2d6 patrons loiter on the bridge in a semi-orderly queue, waiting to be admitted in to the *kurá* shop (#3).
- 2 The Yard: A covered ledge cut into the cliff face. The larger buildings reach the ceiling, some 30' above. The W end is overgrown with *kurá* plants. In the E end is a storage area, separated by a 10' tall wooden fence.
- 3 The Common Room: A smoky, dimly lit hall strewn with crude tables, stools and benches. Gorra the troll bouncer guards the front door and maintains order, while 3 goblins serve bowls of *kurá* to the patrons. The place is usually packed. The small private room at the back is reserved for important (or potentially dangerous) guests.
- 4 The Kitchen: A crude fireplace with several pots of boiling water; copper kettles for brewing drinks; open kegs of the latest batch from the warehouse; piles of mismatched earthenware bowls for serving hot *kurá*.
- 5 The Office: Boss Hog the goblin proprietor keeps his ledgers here (the entries are gibberish – he can't write). A stone block on the E wall can be pushed aside, opening a crawlway out. A bag of coins is hidden under a loose flagstone in the NW corner.
- 6 The Warehouse: Sacks of beans and kegs of ground *kurá*. The NE door opens under the arch of a gateway connecting the house to the one on the north.
- 7 The Huts: The stench of unwashed goblin workers hangs heavy in these ramshackle sleeping huts. Straw, trash, and animal hides cover the floors.
- 8 Side Chambers: These small rooms, carved by idle hands suffering from a severe caffeine rush, serve no practical purpose. They are full of trash and vermin. Lazy goblins hide here when they're in the mood for shirking their duties.
- 9 The Caverns: Natural caves with an uneven, rocky floor. Some *kurá* plants try to thrive in the dim light trickling in from both north and south.
- 10 The Platform: A small, raised alcove opens into the main railway tunnel. Boss Hog leaves for his frequent inspection tours from here.
- 11 The Plantation Cave: A large cave lit by a single, huge, glowing mushroom in the centre. The best *kurá* plants grow here. A gargantuan toad – too large and lazy to leave – eats the *kurá* berries, then regurgitates the beans and spews them out. A troop of goblins scurry about, picking the beans from the pools of bile (and sometimes end up on the toad's menu, to the amusement of their co-workers).
- 12 The Roastery: Rahra the troll roasts the beans (carted from #11) on mesh grilles set over jets of hot, volcanic gas on the floor. He is always sweaty and irate.
- 13 The Workshop: The Glorious Order of Engineers (really just a group of self-

- important goblins) work and live here. They run and maintain the carts and care for the giant rats used for pulling them. The rats are kept in a pen at the back.
- 14 The Grindery: A platform strewn with empty sacks leads to a room housing a giant *kurá* grinder. It is powered by a treadmill run by a hamster – grown to enormous size by a Girdle of Gigantism it wears as a collar. The 20' animal is quite timid, but if let loose, its panicked scurrying can be quite devastating. Garn the troll, who operates the machine, feeds the hamster *kurá* beans to keep it energetic.
- 15 The Junkyard: This disused platform serves as a scrapyard for the engineers (#13). Someone has recently cleared a hidden path to the N door.
- 16 The Secret Room: An unknown party has managed to ferry some sacks of beans to this room. They smuggle them out through a vertical shaft accessible via a secret tunnel at the back of the room. (Note: The PCs could also enter through here.)
- 17 The Well: A circular shaft leads to the underground stream (from #19).
- 18 The Alchemy Shop: Sly Eyes, Boss Hog's brother, studies alchemy here. He tries to recreate Arendt's *Perfect Cuppa* with his foul chemicals. Boss Hog showers him with gold from the bar, but it keeps turning into lead (or so he claims – he actually smuggles it out through the well in #17).
- 19 The Waterfall Cave: Cold, clear water rushes out of fissures in the ceiling to form a deep pool. The railway crosses the pool on a creaking, dilapidated bridge. The nearby "S" bend on the tracks, together with the engineers' penchant for speeding, results in spectacular crashes here every now and then. Near the water on the NE wall, shadowed by the bridge and obscured by spray and moss, is the door to Arendt's crypt, which the goblins haven't found yet. There's also a small opening on the W wall, some 10' above the cave floor.
- 20 The Antechamber: The first chamber of Arendt's crypt houses his collection of fine china. Several valuable *kurá* services are displayed on niches cut to the walls.
- 21 The Crypt: Venerable Arendt left his diary here for the edification of those who came after him. The book of recipes and instructions lies on an ornate bookstand. Behind a stone door to the NE lies his stone coffin – on top of which is a simple copper *kurá* pot, *The Blessed Pot of Brewing*. (It is the secret of Arendt's *Perfect Cuppa*: It produces a smooth, inimitable flavour – with no annoying magical properties.)
- 22 The Hermit's Cave: Ancient Melith, Arendt's last apprentice, lives here. He is reduced to begging and appears to be quite mad. While old and somewhat disoriented, Melith could act as a guide – but he claims he really needs his morning *kurá* first... Spare some gold for a cuppa, kind sirs?

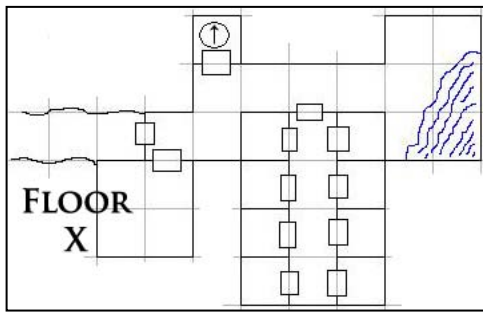
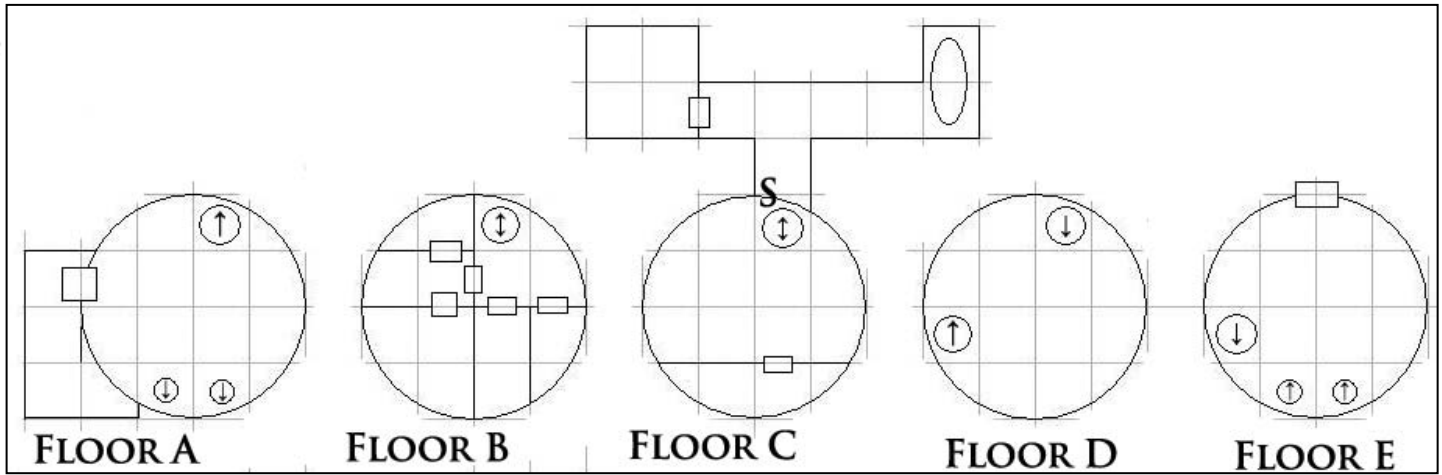

The Infinite Tower

By James Edwardaggi IV
www.lotfp.com/RPG/

The Infinite Tower runs up the side of a cliff, its base sunken into a lake. Stairs lead from the lake to a landing with a door. At the top of the cliff is another door.

The tower looks immense from outside, clinging to the cliff face for many hundreds of feet. But inside, it has an infinite number of levels. Each level is composed of a series of floors, labeled above Floor A – X.

Each level has 3d20 occupants. These occupants are listed on the Level Occupants chart below. Each level has a total of 1d4gp x 100 x tower level. (count negative numbers as positive for this purpose), except for the goblin level which has 2d% gold and the kobold level which has d% gold. The treasure will not all be plain gold pieces, but a combination of various coin types, gems, jewels, etc.

One square equals five feet on the maps.

Floor A

This room is used as a guard room. Each level's occupants want to prevent the lower level from rising up, so they keep a garrison here of about 25% of their warriors.

The West door leads to the stairs that go to the lake. It is an Outside Door. The northern trapdoor leads up to Floor B of the same level. The left southern trapdoor leads to Floor E of the next lowest level, and the right southern trapdoor leads to Floor X of the same level.

Floor B

This floor houses the important residents of the level, who get their own rooms. The chief lives in the southeast room. The trapdoor goes down to Floor A and up to Floor C, all of the same level.

Floor C

This is a common room where level residents socialize and eat. The room to the south is a storage room.

No level residents are aware of the secret door. The left-hand room contains cells with long-dead prisoners in them. The right hallway has a large sarcophagus at the end of it. Inside is an undead creature, as described on the Crypt Occupants chart below. There will be treasure worth d6 x 1000 x tower level (treat negative numbers as positive) in non-empty sarcophagi.

Floor D

This is the sleeping chamber for the common folk of the level. The western trapdoor goes up to Floor E of the same level, the north trapdoor down to Floor C of the same level.

Floor E

This is another guard room as this is a point where levels meet.

The north door is an Outside Door that goes to the top of the cliff. The westernmost trapdoor goes down to Floor D of the same level.

The leftmost southern trapdoor goes up to Floor A of the next level higher, and the rightmost trapdoor goes up to the roof.

Floor X

This is a common basement. The northern trapdoor goes up to Floor A of the same level.

The water in the eastmost room is the outside lake leaking in. One can swim under the edge of the tower to the outside (treat this as an Outside Door, so anyone swimming in comes in at Floor X of Level 1).

The southern set of rooms are where the women and children of the level's tribes live.

The western passage with curved walls is a time trap. Anyone walking down this hall is lost for d6 x d10 years before coming back to this same place on the same level. There is a 50% chance they come back this many years after they left, and 50% chance they come back this many years before they left. Every tribe is used to strangers coming to them this way and have a guard posted here.

The square southwest room is a storage facility with miscellaneous junk. The contents completely change every d3 days.

Outside Doors (the door on Floor A, the southern right trapdoor on Floor E, and the north door on Floor E) lead to the outside, on every level. However, you can only enter Level 1 through any of the entrances. For example, if you are on Floor E of the 8th level, and you go out the North door, turn around, and walk back in, you will be on Floor E of level 1. It doesn't matter if someone holds a rope or another character's hand. You can exit from any level, but all external entrances lead to Level 1. Another example: The southern right trapdoor of Floor E goes up to the roof. Every level has this trapdoor to the roof. There is only one roof, and every level's trapdoor leads to this one roof, but if you climb down the trapdoor from the roof, you are on Floor E of Level 1. Note that opening an outside door makes you visible to every level, and all sounds outside these doors are audible on every level.

Using a dimension door, passwall, or similar magic on an Outside Door from the outside before going through will

transport the enterer to a random level: Level of the spell cast + d8.

Because of this, residents of each level are both free to leave, and also trapped because leaving often means they can only rejoin their tribe if they fight their way through many levels... Note that the ceiling height of various levels will match the residents, so the kobold level might have a 4.5' ceiling while the hill giant level has 15' ceilings.

The gnolls realize they are on level one, but the residents of every level higher than that will exaggerate their level to seem more powerful and important, and the residents of levels -1 to -3 will pretend they are level 1. If parleying or making alliances (many creatures, if obviously overmatched by the PCs, would rather get help to gain a level in the tower rather than fight... and they will use that "we want to gain a level" term) this can be used to confuse the PCs even more about where in the tower they might be.

Level Occupants

10	11 th Level Evil MUs
9	10 th Level Evil Clerics
8	9 th Level Evil Elfs
7	Hill Giants
6	Ogre Magi
5	Trolls
4	5 th Level Evil Dwarfs
3	Ogres
2	Bugbears
1	Gnolls
-1	Orcs
-2	Goblins
-3	Kobolds
-4	Empty
-5	Empty
-6	Spider-Men, 2HD with 6 arms and save-or-die poison bites
-7	Snake Men, 3HD with acid spittle
-8	Sulphur Men, 4HD, can cast 4d6 damage in combat per round, immune to fire
-9	Men of Living Crystal, 5HD, are only hit on a natural 20, do 2d6 damage in combat
-10	Soul Suckers, 6HD, energy drain gaze, but are not undead.

... and so forth and so on. The creatures get nastier the further up you go, and the further down you go.

Crypt Occupants

10	Vampire (d10+7 Lvl MU)
9	Vampire (d10+7 Lvl Ftr)
8	Ghost
7	Spectre
6	Wraith
5	Wight
4	Ghast
3	Ghoul
2	Zombie
1	Skeleton
-1	Empty (25% chance Skeleton)
-2	Empty (25% chance Zombie)
-3	Empty (25% chance Ghoul)
-4	Lich (17+d4 Lvl MU)
-5	Empty (25% chance Wight)
-6	Lich (17+d6 Lvl MU)
-7	Empty (25% chance Wraith)
-8	Lich (17+d8 Lvl MU)
-9	Empty (25% chance Spectre)
-10	Lich (17+d10 Lvl MU)

... and so forth and so on.

Megadungeon of the Mad Archmage Gary-Stu – Level 5 - Crypt

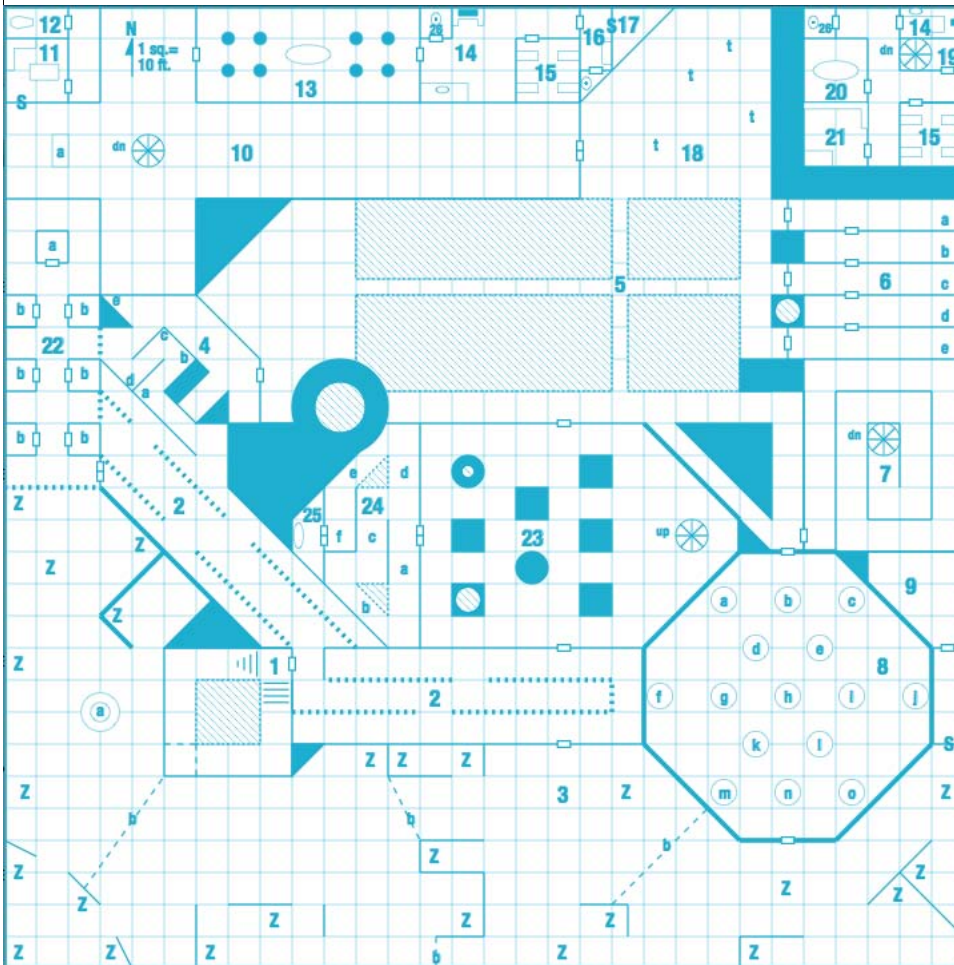

Wandering Monsters

- Check every 20 minutes, 1 in 8 chance; then d12:
- 1-4: wraith of character previously slain in dungeon. Causes level drain. Silver or magic weapon to hit.
 - 5: 1d3 ghouls. Cause paralysis.
 - 6-7: 1d8 skeleton warriors armed with scimitars
 - 8-9: 1d6 zombies with clubs and claws
 - 10: 1 wight. Causes level drain. Silver or magic weapon to hit.
 - 11: Abbot Yorick (see below)
 - 12: Carlotta (see below)

Legend

- S – Secret Door
- crosshatching – Pit in floor
- dark – solid rock
- dark with light center (5,6,23) – shaft to other level (no entrance this level)

Subtable A: Q—n Room

- a: cool water
- b: illusory bottom, 20' drop to next level
- c: murky water hides angry viper
- d: treasure pool with gold and silver
- e: firewater: belch flame or hold it in and explode
- f: green slime
- g: dimensional portal
- h: acid pool with gold-plated key at bottom (no matching door)
- i: boiling water
- j: lair of water weird
- k: fake dry pool: appears dry, holds tepid water
- l: healing pool, one drink per character per day
- m: living, pulsing entrails. Edible (ew!)
- n: cold lager
- o: blink juice: next five hits received may cause short-range teleport instead of damage

Room Key

1. **Grand Stairway:** up and down to other levels. Ceilings on level are generally 10' high; levels are 20' apart (for pits, stairway, *fireball* calculations, etc.).
2. **Halls of Bone:** each room has 10 skeleton warriors armed with crossbows behind the iron lattices indicated by dots.
3. **Zombocalypse:** 25 zombies ("Z"). Appear to be corpses until one of the dotted lines "b" is crossed, then all animate at once. Ruined fountain at "a" with a little silver coinage, some copper coins, rusted *magical dagger*.
4. **Hall of Shadows:** check at each of a-e. Torchlight or less: 4 in 6, lantern 3/6, *Magical Light* 2/6, of a shadow appearing and attacking. Drains strength.
5. **Catwalk:** Dark Knight (strong skeletal warrior, turn as ghoul) guards bridges, attacks with greatsword. If struck, target may fall in pit to next level (20' fall). Ceiling is 16' high.
6. **Barrows:** Wights drain levels. A: Wightsnake (4 platinum albums, constrict), B: Wighty Ford (4 world series rings, ranged attack—baseball), C: Barry Wight (5 gold albums, 5 platinum albums, can *charm*), D: Great Wight ("Are you ready to rock, Rhode Island?" then self-immolates with *fireball*, half-melted gold album), E: Wight Zombie (2 platinum albums, dreadlocks, scary eyes). No entry to shaft in column from this level.
7. **Winding Corridor:** nothing special, but roll dice at each corner, purse your lips, and shake your head sadly.
8. **Q—n Room:** 15 pools. See subtable A or use Room 31 from B1 if you have it. Domed ceiling is 10' at walls, 16' in center.
9. **Secret Armory:** *magical sword*, silver-plated war hammer, *magical bracers*
10. **Unholy Church:** altar at "a", 2 gargoyles attack with horns and claws. Altar furnishings and 3 fairly valuable gems. Spiral staircase down. 16' ceiling.
11. **Parlor:** Comfy couches, bookshelves (books mostly lurid vampire romances). 25% chance Carlotta is here, reading.
12. **Vampire's Lair:** home of Carlotta the Vampire (75% chance at home). Her bite drains levels. Magic/silver weapons to hit. Can take gaseous or bat form, cannot cross running water, only stays dead with stake through heart, etc. Coffin contains delicately scented scarlet silk pillow, dirt from homeland (local, so stealing it just pisses her off), jade erotic clockwork appurtenance worth a lot to a discerning buyer. Room contains stylish and expensive garments, potion of *Giant Strength*, *Ruby of True Vision*, a bit of platinum and gold coinage, and valuable gold jewelry.
13. **Cloister:** 25% chance of encountering Abbot Yorick here.
14. **Kitchen:** Kobold chef de cuisine and 3 halfling line cooks armed with knives. Various foodstuffs.
15. **Kitchen Staff Dormitory:** 3 bottles of cheap wine, a few copper and silver coins, girlie magazines.
16. **Abbot's Cell:** 50% chance of encountering Yorick here. Abbot Yorick, midlevel Evil Priest. Wears *magical plate mail* and *magical shield*, attacks with *magical mace* or any appropriate priestly spell. Carries some silver coins and an unholy symbol.
17. **Treasury:** 25% chance Abbot Yorick is here. Lots of gold and platinum coins, 6 valuable gems, *Flying Carpet*, *magical dagger "Goblin-bane"*
18. **Lawn.** Stone tree trunks at "t" ascend to ceiling. Central one has Assassin Vine, which grabs and constricts. 16' ceiling.
19. **Stairs:** 19-21 are a separate lair not reachable from this level except via teleportation, magical wall-tunneling, or similar. 12' ceilings.
20. **Dining Room:** 30% chance Edgar is here. Table settings are valuable, but bulky and fragile.
21. **Study/Bedroom:** 70% chance Edgar is here. Edgar, Ogre Mage: attacks with large scimitar, can *fly*, turn *invisible*, *create darkness*, *sleep*, *charm*, *icy blast*. Carries a little platinum, some gold, and a *portable hole*.
22. **Churchyard:** Each crypt "b" holds a ghoul: claws paralyze, stench nauseates for 1-3 minutes. Crypt "a" holds a ghastr (like ghoul but stronger).
23. **Egyptian Temple:** 2 cobras: bite paralyzes immediately/die in 1-3 minutes, spit poison.
24. **Temple Maze:** traps at a) swinging bladed pendulum, b) giant grinding rollers under illusory floor, c) north and south walls slam together, d) *sleep* gas released, e) corridor pivots longitudinally around centerline dumping party 20' into level below, f) floor-and-ceiling spear trap.
25. **Mummy's Crypt:** Mummy. Vulnerable to fire. Touch causes horrible rotting disease. Gold sarcophagus, scepter, crown.
26. **Toilet:** actual flushing toilet. With 10' ceilings and 20' between levels, there's plenty of room for pipes and air ducts in inter-level spaces.

MAZE OF NAMCAP

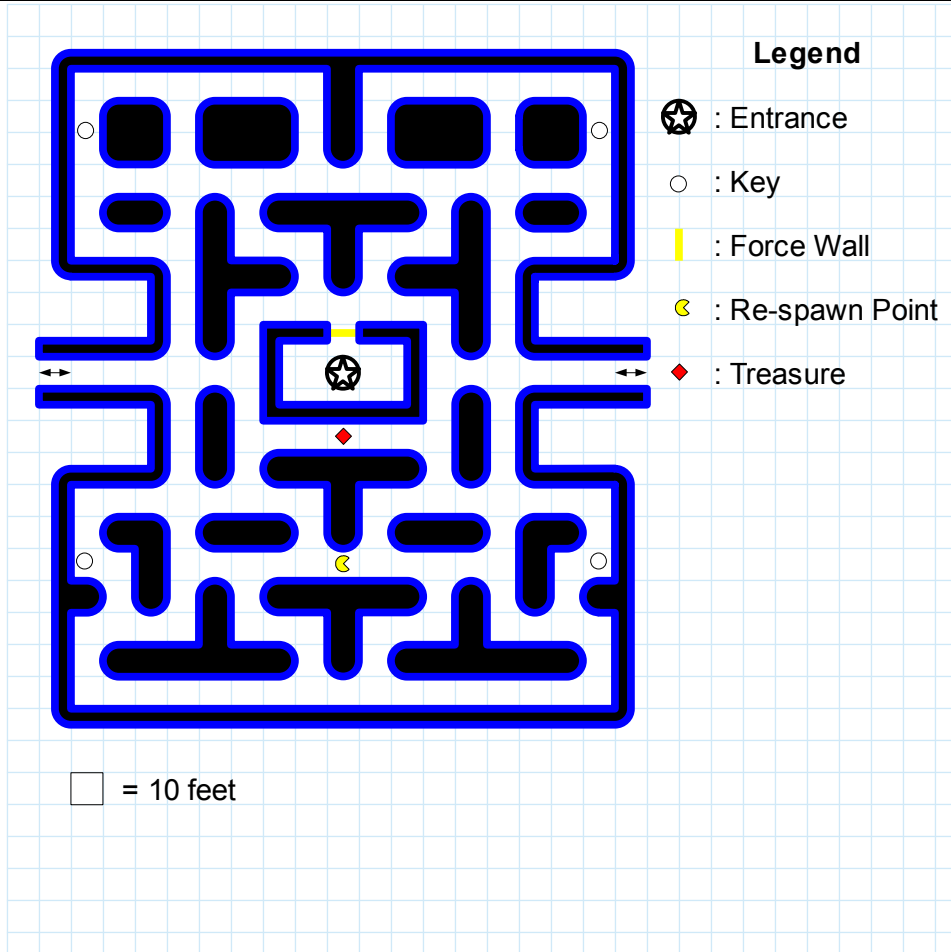

Background: In a long forgotten age (the '80's), in a dark, twisted areade dimension, a legend was conceived. It sucked the souls (and pocket change) of countless adolescents (and adults who should have known better). As its renown and reach grew, it spawned many children, inspired countless knock-offs, and even had its own pop song. And yet now, it is all but forgotten, a footnote of history known only to the geekiest wisest sages.

Incorporating the dungeon into your campaign: This one-level dungeon can be included as yet another level in a massive dungeon complex, a floor in a mad wizard's tower, or simply a nostalgic diversion from their epic, plane-spanning quest. To escape this awful place, the PCs must collect the four keys and return them to the entrance room.

How the PCs arrive to this dungeon is up to you but a portal malfunction is common. If incorporated into a larger dungeon, the PCs can arrive by stairs, ladder, or flume ride (not shown). No matter how they get here, they begin at the entrance, as shown on the map.

The Maze: The floor, walls, and ceiling are perfectly smooth. All the corridors are exactly 10 feet wide and 10 feet tall. The corridors leading off to the left and right connect, creating no escape except to find the keys and return to the starting room. Though the maze is fairly simple, the PCs may have trouble navigating all the twists and turns to find the keys. Just figuring out where they are and what they have to do is much of the challenge. Going old school and making them do their own mapping helps. The PCs can make efficient work of the maze if they split up, but it would leave each one vulnerable to the guardian of the maze.

The Guardian: Several options are provided for the guardian of the dungeon. Feel free to use the one that is most appropriate to the power level of the party. Or not. Whatever, man. The guardian has precise knowledge of where the PCs are at any time and can adjust its movement accordingly. To increase the tension and suspense, you can have the PCs hear the guardian moving closer with an ominous, never-ceasing waka-waka-waka sound.

The guardian has infinite quarters lives. Each time the guardian is killed (and when the PCs first arrive), it reappears in the re-spawn point noted on the map. For added excitement, increase its movement speed by a 5 feet per round (or more) each time it re-spawns. You may also want to cycle through the list of guardians, to keep the PCs on their collective toes.

- 1) **Gelatinous Cube:** If you want to describe it not so much as a 10' translucent cube as a yellow sphere with a gaping maw, I'm not going to stop you.
- 2) **Eye Stalker:** It could start off as simply a large floating sphere with a mouth and a single, hideous eye, but with each re-spawn, it grows another eye and gains another funky power.
- 3) **Air Shark:** Frickin' lasers optional. You may also change the theme music to "duh-dah, duh-dah..."
- 4) **Purple Worm:** At 5' in diameter and 80' long, it cannot actually turn around in the maze and must instead make long, looping turns. The PCs can attack it from behind or the side, but they're in serious trouble if it can line them up with its mouth.
- 5) **Minotaur:** Sometimes the classics are best.
- 6) **Flaming Sphere:** Not a monster that can actually be killed—just a runaway spell.

The Entrance Room: An arcane pattern is carved into the floor, just as it shows on the map. Four empty slots for keys are clearly visible within the design. While in this room, the PCs are safe and invisible to the guardian. A force wall, through which only they can pass, protects them from the guardian. If all the PCs are in this room, the guardian will move randomly through the maze (roll a die at each intersection to determine its direction).

The Keys: The PCs must collect four keys, which are positioned at the edges of the maze, as shown on the map. You can describe these as being shaped like actual keys or glowing orbs of energy. Once put into their proper positions in the entrance room, the PCs are transported to where they were going before being sidetracked to this silly place. If the guardian runs into and consumed a key, a cruel GM would have the PCs turn blue and lose all of their defenses for six turns.

The Treasure: Periodically, a treasure or reward of some sort will appear where indicated on the map. Typically, the treasure is a fruit (cherry, banana, etc.) that acts as healing potion. Other times, it might be something inedible, like a bell. To increase the treasure available in this dungeon, you can place a coin every five feet in the center of the corridors (on the floor is logical, but hovering 5 feet in the air would be cool too). Of course, these will probably be scooped up the guardian as it moves around the maze, so the PCs will have to kill it to get the full reward. The coins do not re-spawn.

Afterwards: Having escaped the dungeon, you can send the PCs on to their next destination, whether that be the next leg of their quest, the stairs to the next level of the dungeon, the portal they were trying to reach in the first place, or a weird aerial plane where they are attacked by knights armed with lances and mounted on vicious flying ostriches.

Honorable Mentions

These dungeons did not receive a prize, but they are extremely worthy of note and made it into the final Judges Picks before we had to whittle the list down to the last winners. The category that the dungeon was given was the decision of the judge who selected the honorable mention entry.

Best Aquatic Entry: *The Barnacle Caves* - Sam Kisko

Best Classic: *Ruffthroat's Rathskeller* - Lee Barber

Best Dungeon Circa 1974: *The Crumbling Dungeon* - Lord Kilgore

Best Dungeon Crawl: *Shrine of the Savage Jungle* - John Laviolette

Most Elegant: *Clockwork Crypt* - Gary S. Watkins

Funniest: *The Vareh'gra Depths* - Gary McCammon

Best Geometry: *Halls of the Mad Mage* - Justin Alexander

Best Homage: *The Omenous Portent of the Highlands Meteor* - Tim Hensley

Best Introductory One-Shot: *The Tomb of Durhan Oakenshield* - Dyson Logos

Best Non-Dungeon: *The Great Cloud Caper* - Jonathan Lee

Best Unconventional: *Traps-R-Us* - Chris Torrence

Best Use of Tables: *Mountain Lair of the Misanthropic Magus* - Sean Wills

The Barnacle Cave

Adventure for Levels 2-3
1 Square = 10 Feet



Wandering Monsters d6

- 1 – A fetid **Hippo** that is insane with pain.
- 2 – 6 **Kobolds** poke a large rat with a stick.
- 3 – A **Walking Bush** shuffles about.
- 4 – A talking **Hedge Lizard** gives the PCs non-sense advice if they give it food.
- 5 – An **Orchid** plant that always points north.
- 6 – A fire-breathing **Were-Boar** is heard long before it is seen.

Hook

The PCs are asked to aid in delivering a lockbox to the Ulerishian Temple, which is 30 miles outside of town. The path can occasionally be treacherous with highwaymen and forest drakes. Two Acolyte maids, Avraren and Bingood, travel with PCs along with their holy familiar, the Hooduk, to deliver the box. The Hooduk is diminutive, has no hair, no eyes and has vestigial wings on its back that look vaguely like chicken wings with no feathers. It follows the Acolytes orders unquestioningly.

One morning during the journey, the PC awake to find the lockbox has been looted and Bingood and the Hooduk are missing. Tracks can be followed to a nearby cave.

Barnacle Caves Key

- 1 – Steam billows forth from the cave entrance. Bleached bones and dragging tracks are easily spotted on the ground.
- 2 – A **Cave Fisher** nests above the cave entrance hidden by the rising steam. It attacks only if loud noises are made.
- 3 – A white 'river' of crystalline rocks lines the floors in this large cavern. Large toadstools cover erratic areas and the floor emanates heat. Six **Steam Turtles** are here, milling about peacefully and are only hostile if attacked.
- 4 – The phosphorescent toadstools here can be as large as tall as 10'. A large waterfall cascades from the southern wall and a whirlpool violently drain the water coming from the waterfall. The toadstool have a number of large barnacles attached to them, 10 **Barnacle-Encrusted Kobolds**. The barnacle Kobolds attempt to push interlopers into the whirlpool. When 5 or more are slain they will make a shrill droning noise that will summon the **Steam Turtles** from area 3, which will aid them.
- 5 –The cavern is very warm and smells sweet, like heated fruit or honey. Here dwells **Derkomai**, a wingless and blind Black Dragon that 'breathes' the 12 **Stirges** trapped in its huge maw at interlopers. The **Hooduk** is here also, prostrating itself and offering a holy amulet, which the Derkomai seems to be wholly unaware of. While the Derkomai attacks relentlessly, the Hooduk merely watches. The Hooduk will offer the amulet to the victor and will gladly follow the PCs or Acolyte. A pile of coins and objects are scattered about the Derkomai lair. 575g, 732s, 822c as well as a *Magical Hammer*.
- 6 – A large central plateau rises 12 feet above the ground with blankets of steam radiating downward. The chamber is very large with many rock piles, toadstools, piles of sand, and farms of fossilized coral. 12 **Barnacle-Encrusted Kobolds** and a **Huge Crab** inhabit the upper plateau. The barnacle Kobolds have a stash of polished coral (value 350g).
- 7 –A muddy geyser is here that erupts every 4 minutes. The Barnacle Kobolds make offerings here, 7 pearls, one of which is Black (total gp value 1200). The pearls are jammed in the muddy walls and will take 2 minutes to work out for each one. Geyser spray will cause 3d6 damage to any foolish enough to be hit.
- 8 – This cave is the home of the **Molluetuesk**, a Mimic, which appears as a tranquil pool of water with small fish swimming inside. The pool is faintly radiant and is lined with stalactites and stalagmites. In the refuse under the Molluetuesk a *Magic Shield* sits along with the bones of its previous owner.
- 9 – This sloping cave holds dozens of mineral pools and toadstools. The Acolyte **Bingood** lays hidden in the north section as 6 **Barnacle-Encrusted Kobolds** are hunting for her methodically. If found Bingood will gladly join the party and will insist on finding the Hooduk and the amulet (see area 5). Three of the pools radiate mild magic. The other pools are normal.
 - Yellow pool** – Spindly crystals grow in the yellowish water. Any metal coated in its waters no longer rust or dull.
 - Muddy pool** - An albino frog lives in this pool, it is the size of a dog. It will obey simple orders if spoken too.
 - Blue Pool** – This blue water drips upwards in slow motion. Fey creatures are attracted this unearthly water.

RUFFTHROATS Kathskeller

Created by Lee Barber

HISTORY: Ruffthroat Keep is no longer the hideout of infamous cultists, after being raided by frightening Thouls. However, even these new marauders don't realize what awaits in the catacombs below the aged tower...

WANDERING MONSTERS:

- 1) Thoul Scout
- 2) Grave Harpy Chick
- 3) Mrs. Lovestrong, wife of Halfling Thief
- 4) Slithering Tracker
- 5) Swarm of Roaches
- 6) Gas Spores
- 7) Hobgoblin Envoy
- 8) Insane Cannibal
- 9) Tancred the Lost Druid
- 10) Earth Elemental

RANDOM RUMORS:

- 1) A giant bird is killing farm animals around town.
- 2) A man escaped a Thoul attack by leaving them his cart of potatoes.
- 3) There is no reward for finding Tancred this time.
- 4) Foppish tunic sales have plummeted now that the Ruffthroats are dead.

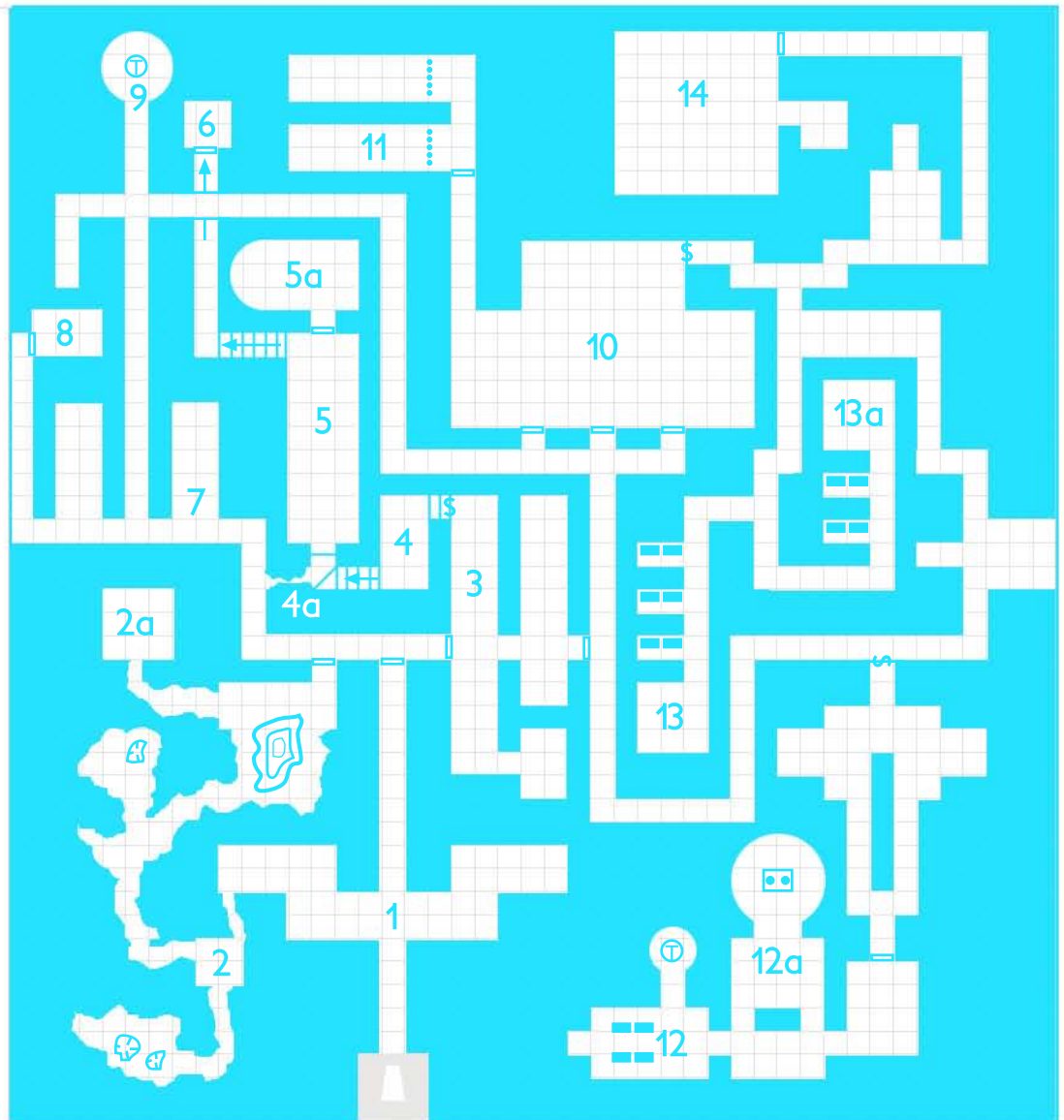

1) **Wormy Casks** - A pair of raven winged Grave Harpies are breaking open old barrels looking for worms. Claw wounds inflict disease called Prickly Wryneck.

2) **Grave Harpy Dens** - Poisoned to ambush intruders are five Grave Harpies. If searched, the pool hides a silver holy symbol.

2a) **Hatchling Nest** - nine chicks are fighting over a severed horse head, still covered by a champron. The barding has an inset emerald.

3) **Amber Scarab Patrol** - Four large crystalline beetles, animated by magic, patrol these galleries. The secret door is warded by a Rune of Slowing. In the south chamber, a message reading "Beware the Bones" has been carved into the wall.

4) **Deadite Claw Trap** - Center of dark room has pressure plates, triggering any releases 24 chained claws which drop from ceiling niches. The undead arms are reeled up and the trap reset after 2 hours.

4a) **Crushed Halfling Thief** - slain from falling rocks, protruding from the waist into the stairwell. Holds a key and wears one platinum earring.

5) **Rolling Ribcage Trap** - Seven bovine ribcages roll about the floor, seemingly guided to collide with PCs. Anyone struck may be knocked down; prone victims are then pummeled by the ribcages till they die of dehydration, or the ribs are smashed to dust.

5a) **Room of Noxious Odor** - The smell permeates clothing after a few minutes, preventing any attempt to sleep or study spells.

6) **Chest of Lead Skulls** - Beyond a locked door (opened by Halfling key) is a chest with a dozen skulls. From a skull on the bottom emanates an orange glow. Every round the skulls increase 25 lbs in weight, until they become immovable. If the glowing one is opened, a peach-sized orange gem will be found.

7) **Thoul Brigands** - a screeching female voice coming from here is a Grave Harpy being plucked by five hungry Thouls. The west alcove holds a giant cauldron and a cache of studded clubs.

8) **Thoul Warlock** - The brigand spellcaster is celebrating here, as he is the new leader. The former captain had met his doom in Area 14.

9) **Teleporter of the Serpent Eye** - Within a circle on the floor is a tiled image of a snake head in profile. The eye socket is a hole, into which the orange gem from 6 can be placed. This action teleports PCs to Area 12.

10) **Gloomwing Moth Vault** - Gliding overhead are the moths, which attack any warm-blooded creature. Corpses are dragged through the dislodged secret door by the monster in Area 14.

11) **Cursed Prison Cells** - The rusty iron grilles here can be smashed, allowing entry. There is a 50% chance that an ichor-dripping Spectre will float through the dividing wall, surprising the party. It will not attack PCs that make the Ruffthroat Secret Sign.

12) **Ancient Barrow** - Another teleporter is here, which activates if the orange gem is placed betwixt the snake jaws (sending to Area 6). The four coffins here contain a cache of electrum goblets and jeweled pins.

12a) **Altar of the Feast** - This cobwebbed altar depicts a great snake eating a struggling antelope. Touching the sculpture compels one to devour all available foodstuffs. When sated, the afflicted has any recent wound or disease healed.

13) **Burial Chambers** - Six charred Zombies stand vigilant in this room, armed with thin daggers in each hand and wearing reptilian bronze helmets. The lids to their coffins appear to open mechanically.

13a) **Cannon Post** - Four rotting Zombie females are in position here, hoisting a fire-belching mortar on their shoulders. The flames are magical, and create no smoke. Each corpse wears a gold circlet.

14) **The Serpent God** - Freed by the unsuspecting Thoul Captain, a large Boalisk is shedding its skin here. The discarded hide is covering the petrified humanoid (crouched near a floor lever) and a magic bow. If the snake fails its gaze, it will retreat to the secret door in Area 10. The treasure vault to the east contains 3 silver planks inscribed with random spells, a vase of jade chunks, giant owl talons, and Kyvl's Staff of Decaying Dust.

The Crumbling Dungeon

by Lord Kilgore

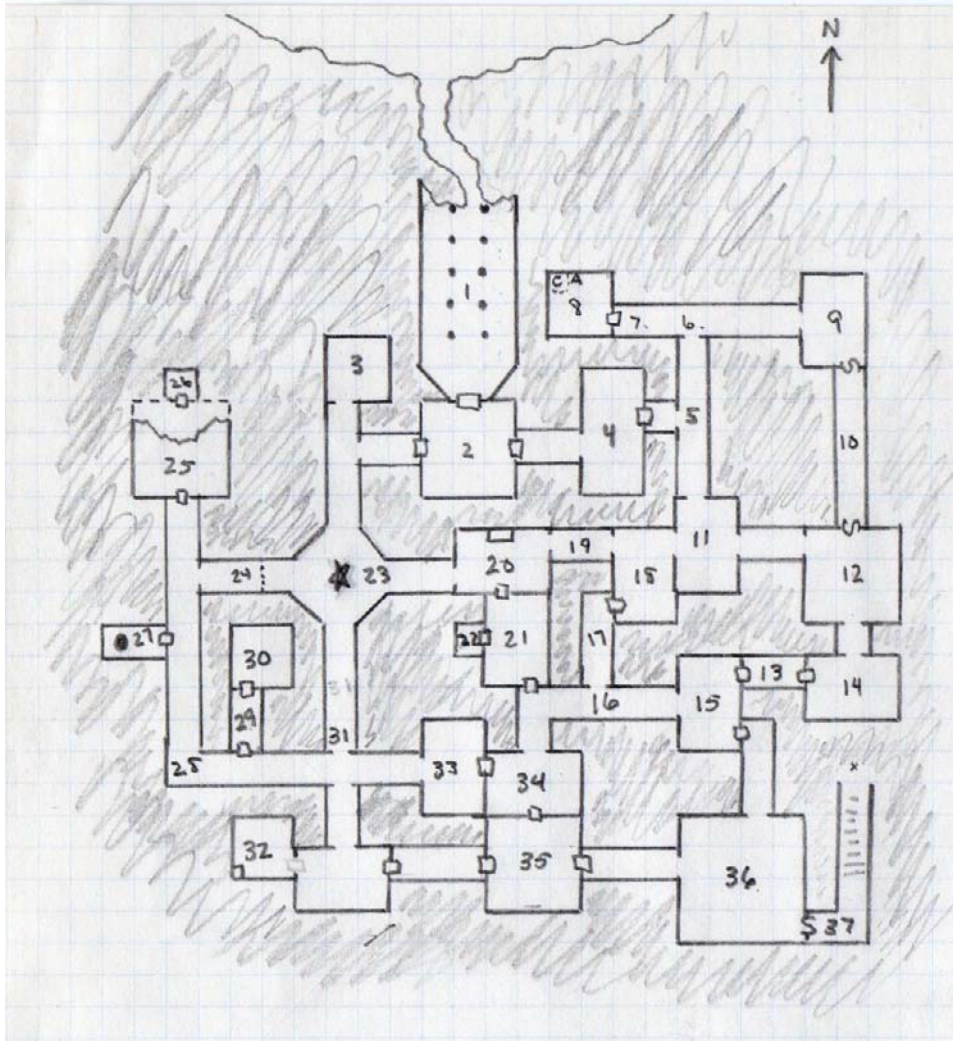

These ruins can be reached via a narrow tunnel in the side of a crevasse in a region known for earthquakes and landslides. The chambers and corridors are often littered with broken stone, the walls are often cracked or uneven, and the doors are often jammed by the geological forces in the area. What power fuels these forces, no one can say.

Random Encounters (1 in 6 chance every half hour)

1	Tremor – see sub-table
2	1 Large Scorpion
3	1-4 Giant Rats
4	1-3 Giant Centipedes
5	2-5 Kobolds
6	1-4 Skeletons

Tremor Sub-Table

1	Save vs. paralyzation or take 2-5 damage from falling rock
2	Floor cracks open, Dex check or fall in to 10' pit
3	Entrance tunnel collapses – 1d6 days to clear
4	Crack reveals ancient tomb – 1-6 Skeletons rise and attack
5	Water floods area
6	Total collapse – Dex check to escape in random direction

Encounter Key

- 3 Large Spiders in webs between columns– Kobold skeleton (dead) hangs in webs
- Potion of Healing* buried in pile of rubble
- 6 Giant Rats gnawing on skeleton of Kobold
- 4 Kobold guards with spears and daggers, will fall back and try to draw invaders into pit (#5)
- 10' trapdoor pit – Kobolds will know to avoid it
- Defensive barrier of stones piled in doorway manned by 4 Kobolds with spears
- Giant Badger (Kobold leader's guard dog) chained to wall
- Kobold leader with 3 Kobold bodyguards, each has spear and short sword
 - Hidden under loose stone in floor: Iron box with three 50gp gems, 100 gp, 250 sp
- 2 Large Bats and 150 normal bats – 2 vials of holy water buried in guano
- Dead human in chainmail with shield, longsword, dagger, and 50gp
- Leaves on floor - fissure in ceiling leads to surface, humans can not fit through
- 4 barrels: 3 of wine (100gp value), 1 containing Large Scorpion
- 2' deep water on floor contains swarm of leeches (1-2 damage per round spent in water after 1st)
- 2' deep water on floor, +1 *dagger* lies near center of chamber
- 2' deep water on floor
- Rubble strewn on floor of corridor – half movement rate, Dex check to avoid fall if running
- Corridor filled with thick webs
- Moss-covered fresco, must clear to see horned giant opening door for travelers
- 5' wide crevasse spans corridor – 50' deep
- Huge fireplace, chimney leads to surface but is inhabited by 200 normal bats
- Rubble-strewn chamber, west door is locked and trapped (dart fired from above)
- Bag on floor contains 100gp, scroll of *Cure Light Wounds*, and scepter for statue in #23
- Statue of ancient queen, her crown broken and right hand empty. If scepter from #22 is placed in hand, secret door in #36 opens
- Portcullis jammed in lowered position
- Partially-collapsed chamber – six skeletons (normal) partly buried. 2 hours to dig out north door. 5% chance each turn that further collapse undoes all digging.
- +1 *Spear*, 6 +1 *Arrows*, and a scroll of 3 random 1st-level magic spells
- 6' diameter well, 200' down to underground lake – walls of well contain entrances to levels 2, 4, and 5
- 2' water pooled in corner
- Rubble piled high in corridor, must crawl over one at a time
- Crypt – 20 skeletons, 1 rises every other round, cannot be turned in chamber. Each crypt contains 2-24gp
- 6 Shriekers clustered in doorway
- Lit fireplace in southwest corner contains Hell Hound. Key to west door in #21 lies on mantle
- Illusion of five-headed Hydra guarding door
- 6 giant rats lurking in cracks near ceiling waiting to drop on prey
- 3 large clay jars: one contains 20 doses of water that heals 1-4 hp (once per person per day), one contains 20 doses of sleeping potion (save vs. magic or sleep for 2-12 turns), one contains water and a sealed scroll tube with a treasure map
- 2 Giant Lizards nest in a huge pile of bones and stones which contains 5 gems (100gp each), 250gp, potion of speed, ring of 5 keys for level 2, and a necklace (250gp). Horned giant carved on wall near southeast corner. Secret door cannot be opened except by giving the scepter in #22 to the statue in #23.
- Stairs lead down to level 2 and further adventure.

Shrine of the Savage Jungle – Level 1 by John Lavolette (talysman@gmail.com)

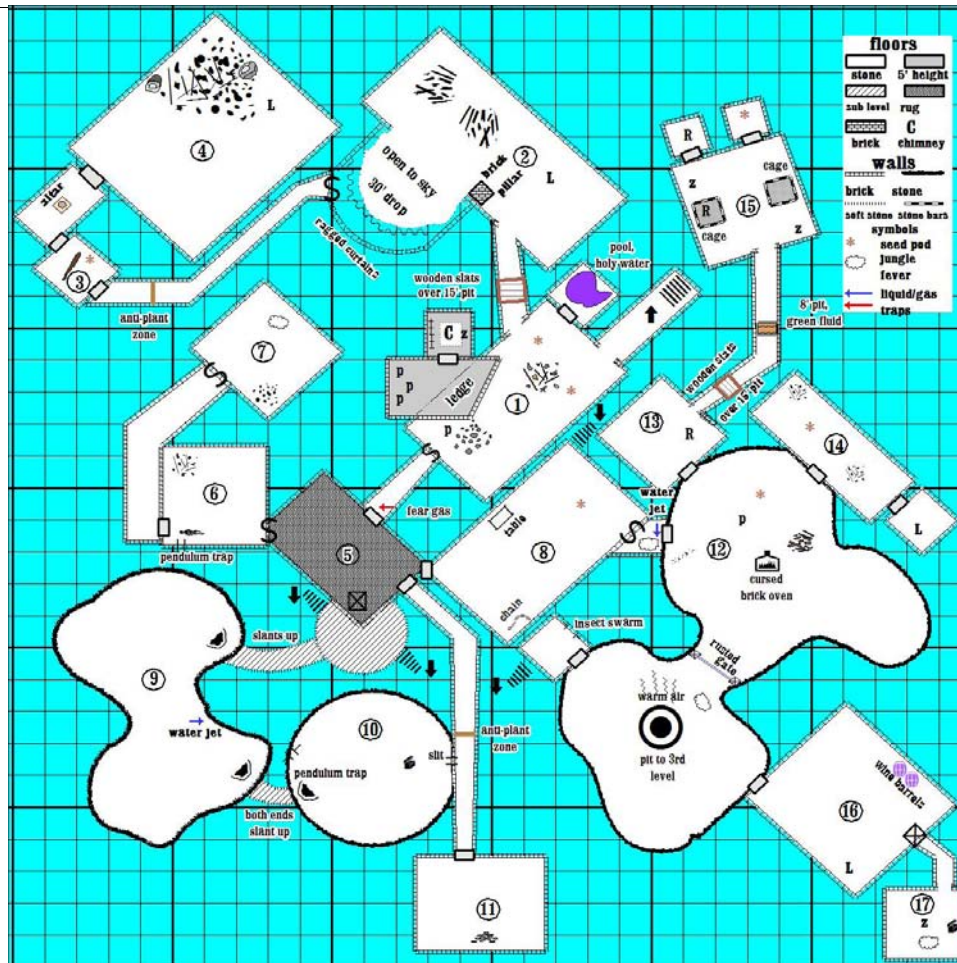

Defiled temple turned into shrine of Miazeim, the Lord of the Fiery Green.

Surface level: jungle ruins, large open pit (30-foot drop to chapel area 2) and intact 15-foot chimney (climbable, 45-foot drop to area 1C.)

Needs 2nd level w/ old priests' quarters in NE corner and 3rd level, any design.

Wandering Monsters (1d6) and Map Key

- 2-5 Pteroblins (winged 1' high goblins armed with darts, blow out candles & torches and deflect arrows with gusts of wind from wings.) Also marked "p" on map. Worship Miazeim & vine seed pods.
- 6-20 Giant Rat-sized red snapping lizards. Marked "L" on map.
- Vine infection seed pod (1' diameter, floats slowly, contact with flesh or burst after hit: victims become vine zombies in a matter of hours.) Asterisk on map.
- Vine zombie goblin, seed pod bursts from chest when slain. Marked "z" on map.
- Jungle rot (slow crawling fungus, destroys cloth and leather, eats flesh.) Marked "R" on map.
- Jungle fever (mobile, ravenous green mist of insect-level intelligence.) Cloud symbol on map.

In areas 3, 4, and 12, results 3-5 are treated as 1-6 ordinary goblins. They fear seed pods, vine zombies, jungle rot, and jungle fever.

Scale: 1 square = 10 Feet

Multi-location or Tunnel Traps/Features

Pit covered by wooden slats: 15' deep, crossable, but slats might break for heavily encumbered characters.

Anti-plant zone: section of red stone burns vine-infected, seed pods, other plant life.

Pit of green fluid: may be mistaken for acid, but does less damage. Odor causes slowed movement for an hour.

Water jet: blast of scalding water triggered by pressure plate. Resettable.

Fear gas: released by wire attached to top of door. Resettable.

Pendulum trap: tripwire releases wooden beam + stone weight from slot in wall, smashing as a war hammer. Resettable by goblins, not pteroblins.

Room Key

- Entry Chamber:** locked room next to stairs: pool of glowing holy water (no affect on vine zombies.) 2 Seed pods. Pteroblin carries 1 dart, small golden bottle (20 gp) of "unholy sap" with golden vine inlay. Shaded area: ledge 5' from floor, rooms with 4' ceiling; 3 pteroblins, rack of 30 extra darts, bag of 150 copper coins, vine zombie backup in nearby room. Small blade stuck into inconspicuous slot in south wall unlocks secret door.
- Chapel:** pack of red snapping lizards. Short, locked brick pillar contains 10 gold coins. Secret door behind rotted curtains opened by lifting stone slab (weight: 2 grown men.) Must be propped open or held to pass through.
- Vestment Room:** Seed pod, massive stone mattock, peg on wall w/ vestments of high priest of (human) God of the Gentle Dark. Brass sacral crown worth 10 gold, much more to someone who recognizes historical value. Room beyond contains stone altar with ashes from burnt sacrifices in central depression.
- High Priest's Chamber:** Large pack of snapping lizards. 3 silver bars under huge pile of rubble (300 coins worth.)
- Priests' Antechamber:** Secret door opens when pushed. Rotted carpet covers door in floor down to subchamber w/ two staircases to 2nd level (NW and South areas.)
- Skeleton w/ crushed skull marks location of pendulum trap. Secret door at end of passage opened by dagger in slot as for area 1.
- Cloud of jungle fever guards bag of 280 copper coins beneath rubble.
- Preparation Chamber:** Seed pod, large table, locked door down to 2nd level (NE, old priests' quarters.) Pulling chain in south opens secret door, revealing jungle fever.
- Hidden Double Cavern:** Entered by slanting passage from sublevel. One silver bar near water jet trap. Another hole in ground leads to another subtunnel to area 10.
- Hidden Cavern:** Pendulum trap triggered as characters exit crawlhole. Small chest near eyeslit in wall contains leather bindings and a copper branding tool with vine pattern.
- Treasure Chamber:** Extra difficult lock on door. Contains a sack of 200 copper coins. Signs that several chests used to be in room.
- Double Cavern:** East door protected by water jet trap. Cavern split by gate (rusty shut.) Jungle fever in south can pass through bars. Pterolin and seed pod can't. Burning wood in cursed oven creates a jungle fever cloud. Door to down staircase releases insect swarm onto landing.
- Guard Room:** Jungle rot covers 4 silver bars.
- Storage:** Broken glass and pottery, rusted pots, and wood. Seed pod. Lizards behind door crawl on small box of rare incense worth 20 gold coins.
- Jail:** Two goblin-made cages with stone bars, vine zombies near each. Jungle rot in one cage can crawl through bars. Locked rooms contain more jungle rot and a seed pod.
- Cellar:** Pack of lizards, 2 kegs strong wine (60 gp each, 1 glass = confusion, 2 = sleep.) Covered pit drops victim 10 feet, then floods with water.
- Annex:** Vine zombie and jungle fever, locked chest contains bronze flask of aromatic oil (10 gold coins.)

The Clockwork Crypt – Level 1

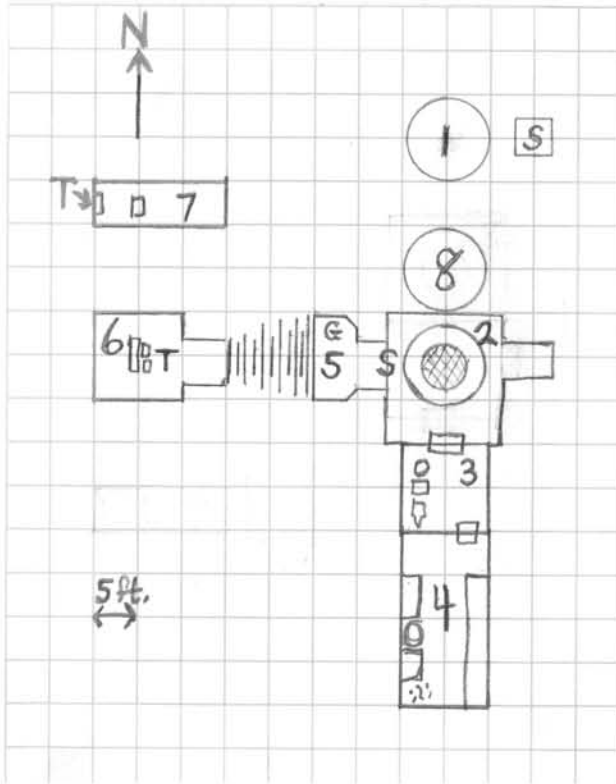

Lighting: Magically lit glyphs illuminate each room (equivalent to moonlight).

Background: The clockwork crypt is the final resting place of Findle Cynwyk Etchwhistle, an eccentric gnomish tinker and musician. The complex lays concealed beneath a wondrous, musical water fountain in the pastoral city of Wellspring. This morning, the fountain didn't seem to be functioning properly. Several pipes alternately became clogged, then spewed slightly acidic blasts of water, injuring several onlookers. The fountain was shut down and a low level group of adventurers was called in to investigate the disturbance and clean out the waterworks.

Unknown to the community, Findle's crypt, containing his secrets and treasures is hidden within, awaiting those clever enough to solve the tinker's tricks and traps.

(The fountain is fed from a springhouse located several hundred feet away and slightly uphill. Channels carry water to the fountain and beyond to two watering troughs a hundred yards to the south of the fountain. The water continues, flowing over a large (10' x 30'), inclined slate slab set in another trough where city folk can wash their laundry. The water is then used to irrigate parks and gardens in other parts of the city. Only the fountain and its substructure are used in this adventure.)

Legend

S – Secret Door G – Clockwork Gnome
T – Trap

Room Key

- Fountain:** A gleaming cascade of slotted pipes in copper, bronze, and brass, surrounded by a low wall of flagstones. One flagstone, hinged, opens to reveal a series of valves that varies the water patterns and songs produced by the fountain. Rotating one of the fountain's pipes (currently out of alignment and slightly off-key) causes a 5' x 5' paving stone on the east side of the fountain to slide aside, uncovering a spiral staircase going down 15 feet.
- Collection Pool:** The circular staircase ends in a room beneath a web of pipes and valves that forms the fountain's substructure. A 5-foot wide pool occupies the center of the room and collects any water dripping down from the plumbing above. The walls of the pool gently slope up to a 3-foot wide walkway. A closed door is located on the left (south) side of the room. (A secret door resides in the west wall.) **Monsters:** Two ooze mephits were trapped in the pool when the fountain shut down. They are not happy about it and attack immediately.
- Workshop:** This 10' x 10' room contains various tools for cutting, bending, and threading pipe. A small anvil sits on the right side of the room with a small stone trough and an empty wooden bucket next to it. A door occupies the left side of the opposite wall. **Treasure:** magical anvil – any metal placed on the anvil can be heated on command (as the spell), yet the anvil remains cool to the touch. The command word, "ignus," is inscribed on the bottom of the anvil. **Trap:** Moving the anvil uncovers a magical glyph on the floor (explodes for moderate frost damage in a 5' radius).
- Supply room:** The door from the workshop opens onto a long supply closet 10' x 20'. The room contains several shelves, racks, and crates filled with various gears, belts, chains, pipes, pulleys, work clothes, and a few tools. A small pile of broken and discarded equipment has been swept into the far right corner. **Monster:** A guttersnipe hides amongst the cast offs and will attack the last character leaving the supply room. If it gains control of the character, it will try to escape to the city above as quickly as possible.
- The secret gnome:** Opening the secret door activates a magical voice which says, "Enter Findle's clockwork crypt and learn the tinker's secrets, if you're worthy and if you dare, lest the crypt become your own!" The secret door in Room 2 opens onto a 5' x 10' corridor that ends at a slightly expanded landing. At the end of the corridor, a stone stairway slopes downward. Above the stairwell, etched into the wall are the words, "Watch your step." A bronze sculpture of a gnome (G) stands on the right side of the corridor, just prior to the stairway. His small, outstretched short sword points the way down the stairs. **Trick:** Carved on the vertical surfaces of each step are the words, "This Side Up ↑," but the words and arrow are upside down. Anyone will notice the inscriptions if they turn around and look at the stairs from somewhere on or past the staircase. The sculpture is actually a clockwork winch system. Anyone examining the gnome can activate the mechanism with a successful disable device skill check, causing the gnome to raise its sword arm. As it does so, the stairway pivots 90 degrees upward, becoming a stairway up instead of down. Anyone on the stairs will be thrown back for minor damage. In the upright position, the stairway ends at the "Watch your step" wall. The wall is an illusion. The winch is also activated by a pressure plate (T) in Room 6.
- False crypt:** The stairway ends at a short hallway that extends 5' to a doorway, which opens onto a 10' x 10' room. At the center of the room is a marble casket capped with a gnome carved in bas-relief. The casket rests on a pedestal of interlocking gears. Leaning against the base of the pedestal are a large brass bound tome with three ornate locks and a small chest of jewels and gold coins. **Trap:** Immediately in front of the pedestal is a pressure plate that causes a large slab of granite to slide into the doorframe, trapping all within. Anyone struck by the stone suffers 8d6 points of damage and is pinned beneath it. The staircase leading down to the crypt rotates 90 degrees upward, becoming a stairway up instead of down. The book only has writing on the first page, which reads, "Greedy fools. Welcome to your final resting place." The jewels and gold coins are cut glass and brass coins.
- True crypt:** Stepping through the illusory wall, the characters see a marble gnomish sarcophagus standing against the far wall in this 5' x 15' room. **Treasure:** 10' into the room, on a simple wooden table can be seen the following: a battered leather bound tome, a sheaf of scrolls, a small silver hammer, and a pouch with 15 assorted gems spilling out of it. The tome contains all of Findle's clockwork designs and copious notes granting a character a +10 skill bonus on creating or disabling clockworks. The scrolls are a collection of the gnome's musical compositions (of little value). The hammer has an enchanted +1 combat bonus. **Trap:** Anyone damaging or attempting to open the sarcophagus (T) will trigger a pit trap covering the entire floor that drops everyone into the false crypt for minor damage before closing back up, trapping the tomb robbers.
- Cistern:** A large cistern is set into the ground north of the fountain. Water released from the cistern provides the hydraulic pressure to power the various traps and other clockwork mechanisms in the complex.

The Vareh'gra Depths – Level 6

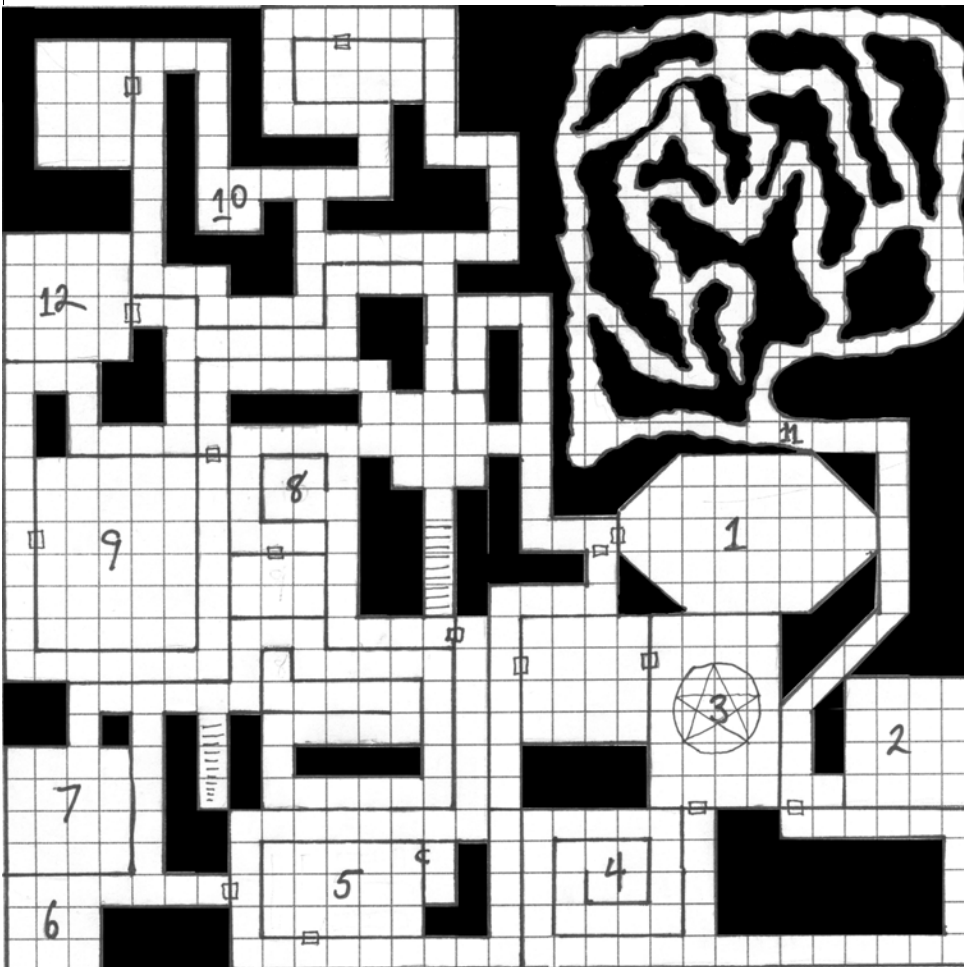

Wandering Monsters – (2d6)

- 2-5 Plaid slime
- 6 Orc with flamethrower
- 7-9 1d20 Gold Bugs (as in area 4)
- 10-11 Nurse (roll on Nurse Reaction Table)
- 12 Gelatinous Sphere

Legend

- C – Concealed Door
- - Door
- ||||| - Stairs

Nurse Reaction Table (d20)

- 1 - Drags random PC off to "see the doctor"; PC is never seen again
- 2-8 – Heals random PC of all damage
- 9-15 – Heals all PCs half-way
- 16-18 – Demands PCs pay "doctor's bill" of 1d100x6 gold
- 19-20 – Attacks

Fruit Consumption Table (d20)

- 1-2 - Consumer's skin turns bright green
- 3-4 - Consumer switches alignment
- 5-6 – Consumer adds 1d6 to random stat
- 7-9 – Consumer's voice is 1-3 louder 4-6 quieter for 2d10 turns
- 10-12 – Consumer's hair grows 6 feet longer
- 13-15 - Consumer falls asleep for 1d10 turns
- 16 – Save or turn to stone
- 17-19 – Consumer gains 1 additional language
- 20 – Save vs. poison or die

Room Key (Note: North is at top of page)

1. Sound Amplification room – Door slams and locks shut 2 turns after entering; thereafter all sounds made within are 100 times louder than normal
2. 2d6 DNA monsters – look like huge strands of DNA; 1d6 atoms in each monster are actually gems
3. Faded pentagram on floor; inside is a six-armed snake-woman demon holding 4 laser swords and a .50 caliber machine gun
4. Pile of 1d100 Gold Bugs (look just like gold coins, if bitten save vs. poison or bitten area turns into living gold for 1d6 days)
5. Magic Library – books contain all known spells, but if PCs touch any of them without a library card (which they of course don't have) the Medusa librarian turns the offender into stone and stores him in the concealed room with 2d4 other petrified "troublemakers"
6. Living head of Crool the Wizard, set on a steel platter and carried by a kobold slave – Crool is anti-social and will attack with spells if bothered
7. Zombie Jamboree – 2d10 zombies standing around, ghoul band plays music on rib-bone and skull instruments – will not attack if not attacked themselves (it's a party, after all!)
8. Artist's easel set up with half-finished painting and a fruit "still-life" on a nearby table – if fruit is eaten roll on Fruit Consumption Table for result
9. Flying man-sized strip of bacon armed with trident that shoots hot grease in combat with man-sized slice of burnt toast (w/ face & arms) – winner of the combat attacks the party
10. West-facing wall has mounted on it a Mirror of Gender Opposition – the first person into the chamber must save vs. spells or look into it; an exact duplicate of them, but the opposite sex, will appear and attack them
11. There is a dwarven rune meaning "TURN BACK – DANGER" carved into the floor at the entrance to this maze - the first Random Monster encounter rolled therein will be with Slivvy The Rat-Demon; the rat-demon is immune to spells and weapons, but takes damage from the PC's saliva (thus they have to spit on it to defeat it!) - maybe they should pay more attention to warnings hereafter...
12. Skeletal corpse of artist from Area 8, paintbrush still clutched in bony hand – if the brush is used anything non-living it paints will become real w/ 3 "charges" of paint left in the brush

THE HALLS OF THE MAD MAGE

(1 square = 10 feet)

The archmage Callisto once claimed to have “conquered the insight of the seventeen quasi-dimensions of the elder lords of Oud”. It was not long before he had become known as the Mad Mage. But perhaps there was some method in that madness: His long-abandoned sanctuary – inhabited now by his former slaves and arcane experiments – is a place where space is contorted impossibly upon itself.

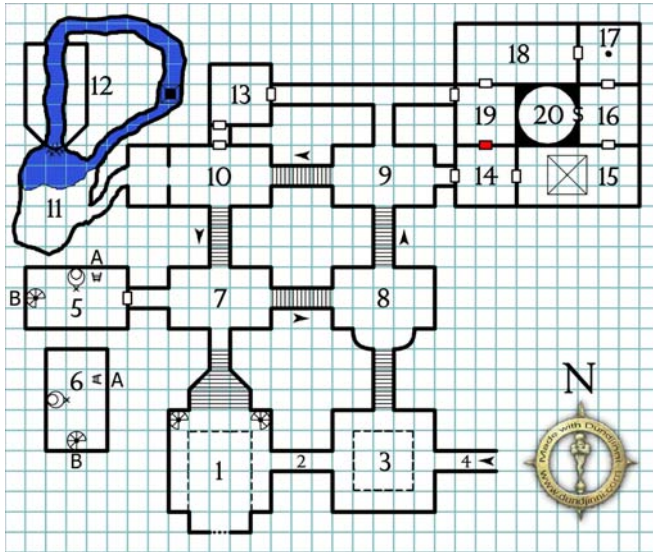

ESCHER EFFECTS

Teleportation spells and similar effects within the complex render random and unpredictable results (roll 1d20 on the area key to determine destination).

Everfalling River: The river leaving area 11 flows downhill to area 12, where it turns into a waterfall leading back to area 11. The river is waist-deep and can be easily waded in either direction, except for the 20' pit hidden underwater at the point indicated.

Endless Stairs: The stairs in areas 7-10 all rise in the direction indicated by the arrows. (You can climb counter-clockwise and end up where you started without ever descending again, or vice versa).

Twisted Observatories: The ladder marked A in area 5 leads up to the ladder marked A in area 6. Similarly, the stairs marked B in area 5 lead to the stairs marked B in area 6. This is impossible, but neither the ladder nor the stairs appear to care.

Mobius Chambers: The ceiling of each chamber in areas 14-19 is the corresponding chamber 14A-19A. Characters flying up to the corresponding chamber will find their gravity inverted if they touch the floor. Passing through the red door leads seamlessly to the inverted chamber on the opposite side. (A character completing two complete circuits through these chambers would end up back where they started).

AREA KEY

- 1. Entry:** A balcony studded with grotesque statuary surrounds three sides of an entry hall lined with gothic arches. 8 three-eyed, purple-skinned goblins lurk on the balcony, firing crossbows at those below.
- 2. Inverted Halls:** Two halls leave the entry, one from the balcony and one from the lower level. Both halls proceed in a straight line, but the hall from the balcony arrives in the lower level of the ballroom while the lower hall arrives upon the balcony of the ballroom.
- 3. Ballroom:** A floor of marble mosaic encircled by a balustraded balcony. Four automata dance amidst their 13 ruined brethren (who stand like broken marionettes). Each automata contains a small heart of mithril (worth 100 gp), but disturbing any of the automata triggers the wrath of the dancers (who attack as lesser golems).
- 4. Hall of the Ballroom:** This hall is arrow-straight, but both ends enter the ballroom from the east (one from the balcony and one from below).
- 5. Ethereal Observatory:** This telescope peers into the Ethereal Plane. Proper alignment of its chaotic lenses allows observation of the plane anywhere within 50 miles.
- 6. Observatory of the Unseen Sky:** This telescope can be trained anywhere in the sky. Looking through it reveals constellations alien to this world, even if the observations are made during the day or while the sky is overcast.
- 7. Callisto's Library:** Hundreds of books and scrolls can be found here, detailing impossible and improbable knowledge of all sorts. Many of the tomes are now infested with bookworms. Lairing here are six imps who once served as Callisto's librarians but have now reverted to savagery.
- 8. Tripod Salon:** All the furniture here has three legs and some of it is suited only for alien physiologies. There is a collection of fine wines behind a hidden panel.
- 9. Ethereal Fishery:** Dozens of stone fish hang motionless in mid-air. Those upon the Ethereal Plane find the chamber filled with water and there the fish swim freely. A large ethereal marauder lurks here, feeding periodically upon the fish.
- 10. The Slipstream:** A blue vortex of arcane energy is suspended in the center of this empty chamber. Anyone touching the vortex is immediately pulled onto the Ethereal Plane. There is a 10% chance that anyone merely passing through the chamber is similarly affected.
- 11. Pool of Black Crystal:** Clumps of strange black crystals protrude from the walls of this natural cavern. The cerulean pool, rimed with more of the black crystals and stygian in its depth, is home to the Tentacled Thing.
- 12. Waterfall Cavern:** Portraits and statues of multi-colored, living water fill this chamber. The roar of the waterfall provides pleasant white noise. Two of the “statues” are actually water elementals *geased* to protect the art.
- 13. Bedchamber:** Small globes glowing with magentic hues float through this richly-accoatered bedchamber. A poltergeist haunts the room, but anyone holding one of the globes is invisible to him. The globes burst like soap bubbles if removed from the room.
- 14. Circle of the Fiend:** 6 legless, well-cushioned chairs float around a magic circle. If any of the chairs are used, the illusion of a pit fiend appears in the circle. If attacked, the pit fiend vanishes forever. If addressed, the pit fiend will answer 1d6 questions as per a *commune* spell. If blood is shed in the circle, the pit fiend summons 1d6 lemures who serve their blood master for 1d20 days.
- 14A. Fairy Pond:** The lily pond here is home to a water fairy named Ussa. Ussa is pettily attractive, knows much of the complex, and is a consummate liar. She will particularly warn the PCs not to trust the “fiend below” (referring to the pit fiend illusion in area 14).
- 15. The Twice Pit:** The pit is 20' deep. Those who fall then suffer *reverse gravity* and fall up to the floor of the inverted chamber.
- 15A. Battle Chamber:** Animated toy soldiers endlessly play out the assault upon the Moathouse in miniature. If disturbed they band forces against the interlopers.
- 16. Crystal Lies:** A *crystal ball* sits on a pedestal of dreadwood. It shows only endless lies until the victim realizes it's lying. It then reverts to normal operation.
- 16A. Tomb of Many Callistos:** The 12 sarcophagi in this room each contain an identical corpse.
- 17. Eldritch Pole:** A pole of blackened adamantine thickly etched with arcane runes extends from area 17 to area 17A (it can be easily climbed). The flagstones in this chamber are rounded domes. Several stones, if pressed upon, glow with a magical light which will be mirrored by the identical stones in the inverted chamber.
- 17A. The Other End of the Pole:** Indistinguishable from area 17.
- 18. Hall of Mobius Portraits:** 13 portraits hang on the walls here. 11 depict the other mobius chambers and can be climbed through as if they were windows (return is not possible). The remaining 2 depict strange vistas, but are quite impassable.
- 18A. The Imperfect Mirror:** The floor of this chamber is mirrored glass, but does not reflect anyone walking upon it. At first glance, it appears to reflect area 18 perfectly, but anyone studying it carefully will realize that their own reflection is imperfect – its actions slightly (and disturbingly) different from their own.
- 19. Reagent Stores:** The low, tightly crammed shelves in this chamber contain a vast storehouse of common magical reagents. A thorough search turns up 6 pearls suitable for *identify* spells. A dusty skull sitting atop one shelf acts as a *stone of alarm*, screeching loudly if any of the room's contents are disturbed.
- 19A. Garden of Black Roses:** The room is filled with black-bloomed roses. They fill the room with mild, nausea-inducing fumes. The blooms themselves are a contact poison. A giant black snake (immune to the poison) lairs here.
- 20. Sphere of Twin Trees:** The interior of a huge sphere of smoky-grey glass (impossibly four times the size of the area shown on the map). Those inside can walk completely around the sphere in all directions. In the center of the chamber are two large, gnarled trees, growing in opposite directions with their roots tangled together around a silvered branch of Yggdrasil (which can be used as a staff with the function of a *rod of wonders*). The tree with leaves of pure white is home to the Pearlescent Dryad. The tree with leaves of midnight black is home to the Obsidian Dryad.

The Omenous Portent of the Highlands Meteor

Tim Hensley (geistweg@gmail.com)

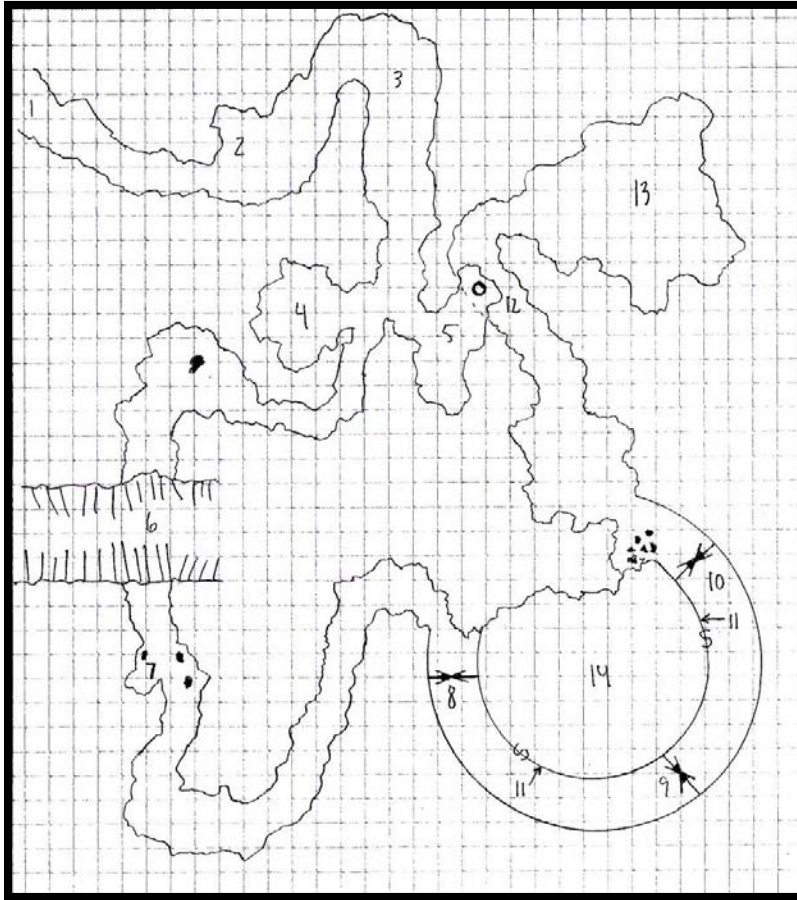

Background: During the long winter months, the Highlands witnessed the fiery crash of a silvery meteor into nearby Dover's Peak. Being superstition, they took it as an omen that the harvest would be particularly bad this year. As the growing season began, however, the ill fate appeared in the guise of farmers going missing. The PCs are hired to investigate the crash for signs of the missing people and a possible means to appease the heavens.

GM's Note: The meteor was actually a crashing flying saucer. The aliens onboard survived and have been using local humanoids to "farm" the surrounding land for "food." General guidelines for the aliens are listed below.

Encounter Key:

1 square = 10 feet

1. **Entrance:** A cave in Dover's Peak makes the most reasonable entrance. Like much of the complex, it's dark and smells slightly earthy.
2. **First sentry:** 2 Orcs stand guard in this natural alcove. Treasure: light coins.
3. **Stasis trap:** Walking around the corner triggers a stasis device (treat as *Hold Person* spell, save is treated as *Slow* spell), giving the orcs in #4 and #5 a chance to attack.
4. **Sleeping quarters:** This large cavern

serves as the sleeping quarters for 10 orcs. If the trap at #3 is triggered they will rush to attack. Treasure: light coins.

5. **Kitchen cavern:** The kitchen is a makeshift fire pit with various large metal pots. Stores of rancid meat and other such supplies are stacked on the south wall. A dry well in the northern section drops into area #12.

6. **Chasm:** The cavern opens into a 40' wide chasm that falls hundreds of feet. The southern corridor is nearly 25' lower than the northern.

7. **Ambush:** If the stasis trap is tripped an alien will wait in this alcove to ambush the players as they attempt to cross the chasm at #6.

8. **Iris valve:** If the players come from area #7 this will be opened; if they come from area #9 it will be closed. If it's closed, the doors will require a lot of damage to get through.

9. **Open valve:** This iris valve was stuck open during the crash.

10. **Closed valve:** The aliens keep this valve closed unless they're disposing of bodies in area #13. It will require a lot of damage to get through.

11. **Secret doors:** Nothing is visible of the door, but there are alien looking handprints on the wall next to each of these secret doors. Placing the hand of an alien on the print will trigger the door.

12. **Below the well:** The well in #5 drops 25' to this chamber. The chamber is empty but if the Mouther in area #13 hears/detects the PCs it will begin gibbering.

13. **Mouther lair:** The aliens have been disposing of the remnants of their victims in this giant chamber. Over the last month the remains have soaked up the ship's radiation enough to coalesce into a Gibbering Mouther; like all such creatures it will attempt to draw the party into the chamber in order to attack.

14. **Cockpit:** This large metal room contains several chairs and consoles shaped and fitted to the aliens. Three aliens will be found here, guarding the inside of their ship, where they'll fight to the death. Along the northwestern wall are six lidless coffins containing unconscious farmers, wrapped in a gauzy, web-like substance. Treasure: Various odd, but valuable, devices made of precious metals.

Aliens: Each alien should be drafted as a moderate opponent with slightly better than average defenses and weak natural attacks; however, they carry Death Ray guns (save reduces to damage instead).

The Tomb of Dûrahn Oakenshield

(bv Dvson Loos for level 3 characters)

The tomb of the dwarven warlord Dûrahn Oakenshield is said to still be home to his remains, including his skull which is needed by his clan brothers now to prove their provenance in order to reclaim their title.

Wandering Monsters

1 in 6 every turn of wandering monsters

1-3. 2 guards from 2b

4-5. 2 guards from 5

6. Leader from 7

If a wandering monster rolled is already slain, then no encounter occurs.

Map Legend

1 square = 10 feet

Doors

strong wood construction.
hinges are old and not oiled.

Lighting

natural light in 1
natural light from outdoors in 2
shadowy light from outdoors in 2a
very dim light from outdoors in 2b
no light in 3, 4 & 6
torches in 5 & 7

Structure

hewn stone with masonry overlay
floors are clean and smooth

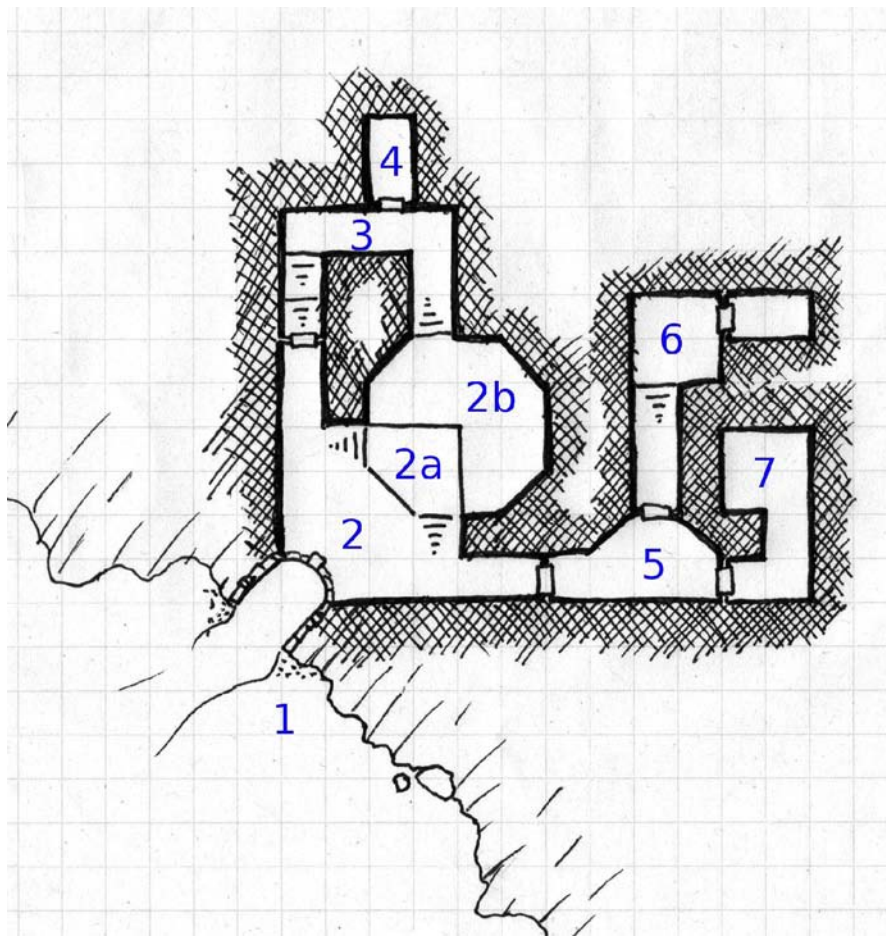

1. Tomb Entrance: The entrance to the tomb is a massive stone archway obviously carved by dwarven craftsmen in years past. The archway is built into the cliff face in the cemetery of the abandoned city – looking up from the entrance the ruins of the old city hall can be seen amongst the trees sixty feet up on the top of the cliff. There is a 15 foot wide passage leading ten feet into the tomb from here, to room 2. Trails in the graveyard indicate that people travel to or from this tomb with some regularity.

2. Antechamber: This multi-level room was the main room of the tomb, where offerings were made to the ancestral dwarves and their deities, as well as where mourners would gather before opening the doors to the individual tombs. The ceiling of this chamber is 35 feet above the floor and bears a mosaic of a dwarven noble with gold armour and a huge axe. Both 2a and 2b look down on room 2 – 2a is 8 feet above the floor level, and 2b is 24 feet above floor level. The floor is scattered with debris from outside – mostly leaves and some dirt, along with many dwarven skeletons in funeral wrappings (evicted from 2b). See rooms 2a and 2b for encounters.

2a. Raised Platform: This section of the antechamber is raised 8 feet above the floor below, and is accessed by one of two open stairs. There is a brazier in the northeast corner. 2 **human raiders** are on this platform on guard duty (one on watch, the other sitting in the corner). Unless the party is exceptionally sneaky, they will have seen their shadows obscure the sunlight when they entered if the party is entering by day.

2b. Observational Chamber & Tomb: This raised chamber has niches carved into the walls where dwarven remains were once kept. It is the primary camp of the raiders, with 4 **human raiders** up here right now – there is a small fire pit and a table and four tree-stump chairs in the rough middle of the room, along with 8 small cots spread along the floor against the walls.

3. Stairway Passage: This passage way has stairs leading up 16 feet to it from room 2 and stairs leading up another 8 feet to room 2b. It is empty and dark.

4. Isudan's Crypt: The door to this chamber is slightly ajar. Inside is a sarcophagus within which are the remains of a dwarf – Isudan son of Dûrahn.

5. Guard Room: This room was once a crypt like 2b, with niches in the walls. The door to the North is barred and locked, the door to the East is ajar. 2 **human raiders** are here, guarding the doors.

6. Dûrahn's Crypt: Since the defilement of the tomb by the raiders, Dûrahn has been forced back into unlife as a dwarven wight. Treat as a wight in all ways, but his heavy golden scale mail improves his armour class by 2. He waits behind the door to his crypt at the top of the stairs. His axe is forgotten in his sarcophagus, the haft rotted away, the enchantment long gone. The amulet he wears is worth 1,000 gp.

7. Gneissus' Crypt: Once the crypt of Dûrahn's wife, this tomb has been taken over by the leader of the raiders. He is a level 4 thief with +1 leather armor and a +1 sword. He has a potion of healing and a potion of gaseous form he will use to escape if needed. On the table are his books indicating that he sold the treasures of the tomb to merchants and fences in the nearby city. A coffer under his table contains 1,000 gold and 4,000 silver.

Human Raiders: level 2 thieves with leather armor, sword, 3 daggers and light crossbows (with 10 quarrels). Each has 2d20 gold pieces and 2d20 silver pieces.

THE GREAT CLOUD CAPER

or, Trouble in the Seven Skies, or Gnomes on a Plane

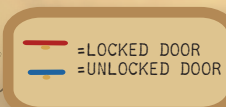
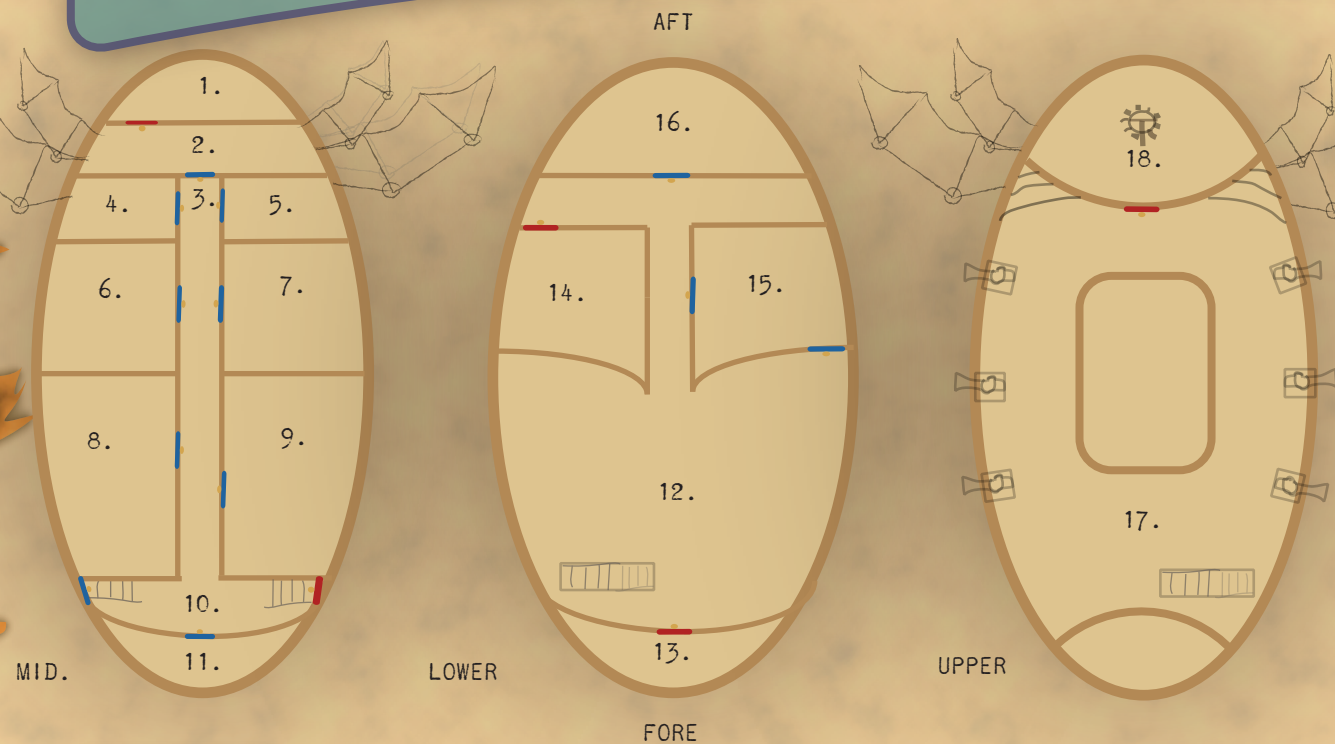

This dungeon takes the form of a great oak airship commandeered by pirates of a Gnome variety. Players begin as stowaways on the middle deck (furthest to the left) and must make their way to the top deck and slay the Captain and/or gain control of the ship. But to get to the top deck players must seek out the drunken first mate who holds the keys (alternatively players could start in the prison).

Treasure: detailed treasure should be used as a guide, DM can alter quantity/kind as necessary. The most valuable treasure noted is the telescope in the special cargo.

Enemies: Gnome Pirates- Individual pirates should prove reasonably strong but by themselves should prove little bother to the party. As a group (3-6) they should prove to be more of a challenge. Drunken First mate- if woken from his intoxicated slumber he should prove to be an *interesting* challenge (interpret as you will). Captain- Should be quite powerful, especially in a group; should attempt to flee to his cabin if bested. All should be equipped with short swords and light armour except first mate and captain who should be a bit better

1. STOREROOM (ENTRANCE)- Locked door that can be picked (easy) or bashed (easy) or players can make noise to attract attention of nearby guard. If sufficient noise is made then guard in room 2 may notice.
2. RIGGING ROOM- One Gnomish Pirate, if not dealt with in room 1.
3. CORRIDOR.
4. WORKSHOP- Full of Gnomey bits and bobs. If workbench is tampered with a shock trap is released.
5. MINI LABORATORY- Full of bubbling potions. A successful search roll reveals a potion of intelligence and a potion of strength.
6. ENGINE ROOM- Contains the ship engine, if damaged or destroyed may cause ship to crash. Contains tools. Very loud. If players spend more than 2 rounds they take sonic damage unless preventative measures are taken.
7. SLEEPING QUARTERS- Contains 2 Gnome Pirates (some may be sleeping to begin with). Several chests altogether containing gold and common clothes.
8. SLEEPING QUARTERS- Contains four Gnome Pirates, several chests containing more gold and common clothes.
9. DINING ROOM- Contains set common cutlery. Also a cabinet of expensive cutlery with a shock trapped handle.
10. STAIRS- there are two sets of stairs, one leading down, one leading up (upper stairs lead to locked door- very hard to pick-key gained from first mate in room 13).
11. GALLEY/KITCHEN- Contains a Gnome pirate chef. Also contains cheap utensils. A Gnomish cookbook. A locked chest contains several valuable wines (medium lock), chef holds key.
12. MAIN LOWER DECK- Contains six sleeping Gnome Pirates, will wake easily if disturbed.
13. SPECIAL CARGO HOLD- Entrance is locked (very hard), key obtained from First Mate in room 16.
14. MOSTLY EMPTY CRATES- Successful search roll reveals very expensive telescope.
15. PRISON- holds two prisoners- Jerome the Gnome (Chaotic good) and Cpt. Jones of the Gnomes (Lawful Evil). Each will attempt to persuade the party that they are good and that the other is evil and will backstab them if set free.
16. TEMPLE- Temple of a god of travel, engineering or something equally Gnomish. Contains Cleric Quentin who will not attack players unless provoked. May heal party if persuaded.
17. MAIN CARGO HOLD- contains First Mate passed out in, holding keys to special cargo and top deck door. Also contains crates containing normal weapons (short swords, short bows, daggers etc.).
18. TOP DECK- Contains four Gnome Pirates and Gnome Pirate Captain. When losing the battle the Captain will run to his cabin.
18. CAPTAIN'S QUARTERS- Locked (medium), keys held by pirate captain. Also a chest of 200 gold, various trinkets and gems.

LEVEL 7A (INTERLUDE) – TRAPS-R-US

1 Square = 5 feet

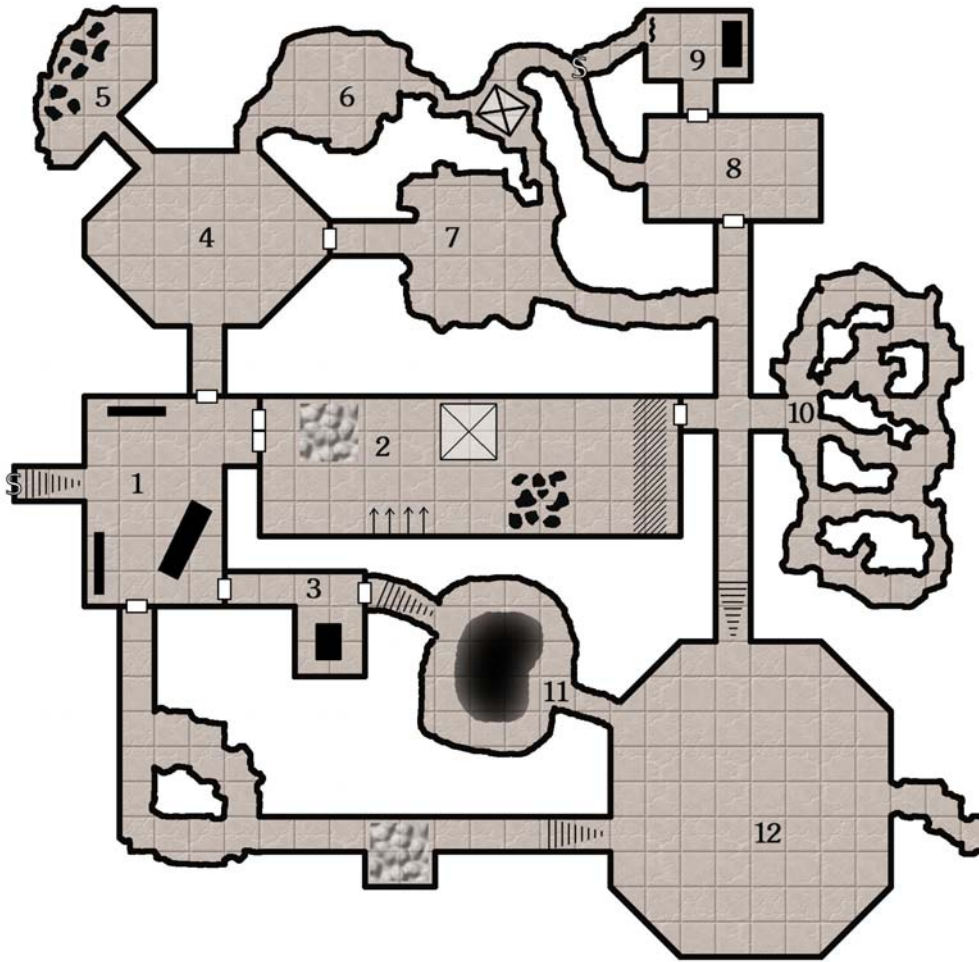

Background

Where do all those traps come from? How does your megadungeon get restocked with bats and skeletons? That's right, level 7A, located halfway between levels 7 and 8, just beyond the secret door!

The PC's can treat this as a standard hack-n-slash, or they can haggle with the kobolds for the latest tricks and traps, and maybe even pick up a pet giant spider or two.

The kobold entrepreneurs will follow the party incessantly, fawning, and asking if there is anything they are looking for in particular. All inhabitants are peaceful unless provoked.

Lighting: Torches everywhere except 5 and 10.

Random Encounters (1d20 every 10 minutes)

- 1–10: No encounter
- 11–12: Magic mouth, shouts random questions
- 13–17: 1d4 kobolds with giant spider
- 18–19: 2d6 tame giant rats
- 20: The giant worm from area 10

Traps (1d6)

- 1. Gas, blindness and weakness
- 2. 1d6 flaming arrows
- 3. 10' pit with spikes
- 4. Collapsing wall
- 5. Teleport to Reception Area, all clothes that the PCs are wearing are randomly interchanged
- 6. Broken trap, roll again for type

1. **Reception Area:** Two stone benches, large stone sarcophagus desk, 1d4+2 kobolds, giant spider on leash. Top of desk has assorted potions, vials of poison gas, all neatly labelled with prices. A hidden compartment within the desk contains 50 silver, 20 gold, and assorted gems.
2. **Trap Showroom:** From left-to-right, there is a blindness and weakness gas trap, a flaming arrows trap, a 10' pit with spikes, a collapsing wall trap, and a teleport trap (see Trap Table for details). All traps can be disabled via levers under the desk in area 1. Giant rats are used for demonstrations. The pit trap has a desiccated halfling thief, wearing a magic dagger with a jeweled pommel. Each trap is hand-built to custom order, with free delivery to all dungeon levels.
3. **Break Room:** 2d6 kobolds + 1 leader-type kobold, sitting at a scarred wooden table, minor treasure.
4. **Spider Farm:** Lease or buy spiders, 6 kobolds running 3 giant spiders through their paces. Two sickly giant spiders in cages, one has 4 glass eyes (really diamonds). A dense web near the ceiling has a dead kobold in it - "Poor Scabby never was a fast runner."
5. **Trash Dump:** (Pitch black) Huge mound of broken traps and shattered stalactites. A large gray ooze lives in the center. Every 5 minutes of exploring, roll on the trap table.
6. **Empty Room**
7. **Dungeon Accessories:** Hollow stalagmites, 12 large pots of dungeon dust, 2 sets of giant wooden feet, for use with the dust. Bats flutter about.
8. **Undead Dealer:** Sign on entrance - "Sale on skeletons! 10 silver each! Money back guarantee!". Inside: 12 corpses in various states of decay, 2d4 animated skeletons, mildly evil cleric named Raleth. Raleth has a magic rod and an obsidian unholy symbol.
9. **Raleth's Room:** A curtain conceals a secret passage. If Raleth is attacked, he will run around, re-enter area 8, and attempt to reanimate his skeletons.
10. **Lair of the Giant Worm:** (Pitch black) This huge worm can easily swallow an unlucky adventurer. Stomach acid causes ongoing damage. If found wandering, adventurers can use torches to herd the beast back into area 10.
11. **Pool of Reflection:** Kobolds shun this area ("bad bad monster") except when they need water. At the bottom of the pool is a very lifelike statue of a medusa.
12. **Dragon in a Bottle:** In the center of this tall cavern lies a huge old red dragon, Drangorg by name. Actually a young red dragon in disguise. A shelf on the back wall (15' above floor) holds 20 potions of growth, hidden behind these are 500 copper, 750 silver, and 200 gold, all very neatly stacked. This is Drangorg's share from the Rent-a-Dragon service.

The Power Behind the Throne

The stone sarcophagus desk contains a very cranky lich named Karerak. He is the original owner of this dungeon level, and was trapped within the sarcophagus by the kobolds. If all 5 levers within the desk are pulled simultaneously, then the lid will arise and Karerak will awaken. Inside are gems and jewelry worth 500 gold. In his hands, the lich holds a highly-reflective silver-plated shield with the hideous image of a medusa burned within it.

Mountain Lair of the Misanthropic Magus — To gain a huge reward, the characters must rescue the Merchant's daughter Fayona from some Bandits who dwell deep within a mountain, home to a reclusive Magus.

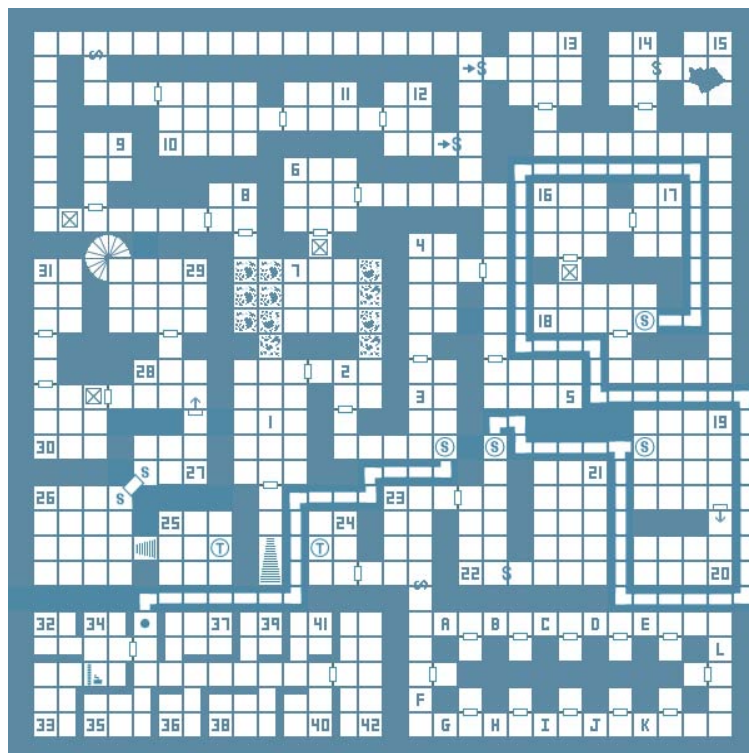

Map Key

S - Secret Door, an arrow beside it means the door is one-way only.

Circled S - Secret Trapdoor.

Circled T - Teleporter. Transports individual to another room.

Boxed X - 10ft deep covered pit with either (roll 1d6):

1 to 3 Tar at the bottom, a dropped torch will ignite it.

4 to 6 Rusted spikes down the sides and at the bottom.

Rumours (Roll 1d6 once per character at start.)

1 to 3 - Goblins have been spotted nearby by shepherds.

4 to 5 - Merchant's daughter is shy and scares easily.

6 - The Bandits work for a Magus who shuns mankind.

Wandering Monsters

The GM should check every third turn; 1 in 6 (roll 1d6)

chance. If encountered, roll 1d6 to indicate which monster.

Then determine if either side is surprised.

1 to 2 - 1d6 Goblins. 3 - 1d4 Giant Rats

4 - 1d4 Giant Ticks 5 - 1d6 Bandits

6 - Roll Twice.

Restocking Rooms if return to Lair (1d6).

1 - Monster. 2 - Monster & Treasure Chest.

3 to 6 - Empty (1 in 6 chance of hidden Treasure Chest).

Contents of Treasure Chests

2 in 6 chance of gas being released on opening, causing itching for 2d4 rounds, the opener cannot spellcast during this time due to inability to concentrate.

Silver 1d6 x 100. Gold (3 in 6) 1d6 x 10.

Gem (1 in 20). Magic Item (1 in 20).

Entering The Mountain Lair

Characters enter via a long steep flight of stone steps leading to Room 1. A sign above reads 'UNWELCOME'.

Lair Description

Rooms and tunnels are cold, unlit and musty. All doors are stuck shut and require force to open. Magus' chambers are warm and lit by oil lanterns. Whole lair is magically sound-proofed so noises are contained within each tunnel/room.

Room Key

written by Sean Wills

1 **Entrance Hall:** 1d3 Giant Spiders emerge from rubble at far end. Walls are painted with murals of pastoral scenes.

2, 5, 6, 8, 12, 14, 16, 32 **Empty**

3 **Chamber of Cacophony:** Loud discordant noise fills the room if both doors are closed, magic users and clerics cannot concentrate to cast spells within this room.

4 **Black Pool:** Sunken floor, 5ft deep pool of murky water.

7 **Cave In:** ceiling collapsed, blocking access on two sides

9 **100ft Ceiling:** no gravity, entrants float upwards 10ft/round

10 **The Drop:** Floor drops by 10ft/round for 4 rounds.

11 **Flypaper:** Entrants stick to floor. Must be burnt free.

13,19,22 **Bandit Guard Posts:** 1d4 Bandits in each.

15 **Deep Pit:** 1d6 Stirges will fly out to attack.

17 **Storeroom:** Crates, Yellow Mold, empty Treasure Chest

18 **Gallery:** Ceiling has a painting of a dragon hunt across it.

20 **Dark Room:** One-way door opens into this. No non-magical light can penetrate the dark. Otherwise empty.

21 **Bandit HQ:** Bandit Chief (who is actually Fayona) and 2d4 Bandits, Treasure Chest. Fayona will try to escape.

23 **Bat Room:** 1d8 Vampire Bats hanging from high ceiling.

24 **Teleporter Room:** Currently de-activated. Needs Star pendant inserted in depression and turned to activate teleporter to transport people to Room 25.

25 **Teleporter Room:** Straw and empty barrels in the bottom left corner. 1d3 venomous Snakes are nesting there.

26 **Guardroom:** A Stone Golem is pacing the room and attempting to whistle. Upon seeing the characters he smiles and says, in a deep booming voice, "He doesn't want to be disturbed, Get out or else" then adds "Please choose the latter option."

27 **Gas Room:** Anyone attempting to open the one-way door into 28 has a 2 in 6 chance of setting off this trap. The room will fill with sleeping gas that lasts 1d4 rounds.

28 **Parlour:** Exquisitely furnished, Magus' pet Wolf is in here.

29 **Storeroom:** sacks, staircase that leads out of mountain.

30 **Study:** The Magus is here, wizened and anti-social, he shakes his head and sighs, 'You wouldn't leave me alone, would you' then rolls up his sleeves, preparing to spellcast.

31 **Magus' Bedroom:** Treasure Chest under bed.

33 **Cell:** Bruised Halfling shepherd imprisoned here.

34 **Guardpost:** Rotund Goblin Jailer with club eating gruel.

Winch mechanism on wall operates portcullis to cell.

35 - 41 **Goblin Quarters:** mattress, pot, 1d3 Goblins in each

42 **Leader's Room:** Sarcastic Hobgoblin with Star pendant and 1d6 Bodyguard Goblins. Will fight rather than flee.

A - L **Catacombs:** No wandering monsters in this section.

All catacombs contain skeletons (each has 2 in 6 chance of coming to 'life' and attacking characters with swords. If A=1, B=2 etc, roll d12 for location of Treasure Chest.

Empty Room features (Roll 1d6 once per room)

1 to 4 - Water drips from ceiling at regular intervals.

5 - Low ceiling (4ft) 6 - Goblin graffiti on walls

Arms and Armour

When Goblins or Bandits are encountered, 2d6 should be rolled for each individual, one die for the weapon they carry, the other for the armour they wear. Bandit Chief, Hobgoblin and Bodyguard Goblins add 1 to each roll.

1 to 3 Spear No Armour

4 to 5 Light X-Bow Leather Armour

6 Sword and Shield Chainmail Shirt

Our final thoughts

I hope you've enjoyed this collection of the winning dungeons and some of our thoughts on the One Page Template. The idea is still alive and well, with people using the idea of brevity and simple thoughts to give Game Referees the ideas they need to easily plug into their games. We've seen a lot of different hobbyist contributions show up all over the web lately using that idea. The Society of the Torch, Pole and Rope blog has an ongoing megadungeon based on the One Page called "Stonehell" that has received a lot of favorable reviews. The blog Sham's Grog-n-Blog also has a One Page based megadungeon/game system called The Dismal Depths that is exciting to watch develop. Many ideas, like Santiago's One Page Manifesto, are giving people the incentive to put forth their ideas without having to write reams of content. I can only see that as a good thing.

Will we do this again? I don't know - best I can say is that "we'll see." Most of us have Gamer's Attention Deficit Disorder and we might be taken to the latest, newest thing. This collection, though, will be our way of marking a point in time when the various cantankerous camps of RPG and D&D came together to share in a simple love - the dungeon.

As a final thought - we are making the full collection of all 112 entries available from our blogs. While we've presented the winners here, we think that there are many good dungeons that you ought to take a look at. Go check out our blogs for the link to the archive.

Thank you for reading... and remember - Have Fun!
- *Michael*

Never in a hundred years would I have thought that our little idea of a one page dungeon contest would end with such a high PDF anthology of the best entries. As I reviewed all contest entries, I was amazed to see such skill and creativity at work..

I strongly believe that a community thrives or dies through the initiation and completion of collective projects. From edition wars to the explosion of online-based indie RPG micro-companies, from the rise of RPG bloggers to the creation of the Old School Renaissance movement our community is going through one of it's most turbulent periods ever. It is my fervent wish that other initiatives like the One Page Dungeon contest see the light of day. I'm an optimist at heart and I know that awesome things are awaiting us just around the corner.

I truly hope you've enjoyed these dungeons and I wish to thank you for having read this document. I wish you many hours of exciting dungeon crawling.
-*Philippe-Antoine*

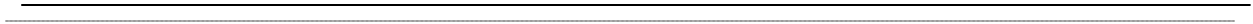

Our Sponsors

The prizes awarded to the "Best of" and "Runner-up" winners were generously donated by our sponsors. We are truly thankful for the enthusiasm and support that they gave us. They were key to getting this thing rolling and we hope you appreciate their support as much as well do. Please be sure to show them your support as well.

[Avatar Art](#)



**Brave Halflings
Publishing**
[Brave Halfling Publishing](#)

Fight on!

[Fight On Magazine](#)



[Goblinoid Games](#)



[Goodman Games](#)



[Malhavoc Press/DungeonADay](#)

[Mythmere Games](#)

[Necromancer Games](#)



[Neoncon](#)

[Obsidian Portal](#)

OPEN DESIGN

[Open Designs](#)



[Otherworld Miniatures](#)



[Smiteworks](#)



[Tabletop Adventure](#)

